

CIRCULATION LARGER THAN THAT OF ANY OTHER RADIO PUBLICATION

# RADIO NEWS

REG. U.S. PAT. OFF.

25 Cents

JULY

Over 200 Illustrations

Edited by H. GERNSBACK



**\$500.00  
RADIATION  
PREVENTER  
CONTEST**  
*See Page 33*

**RADIO  
RESCUES  
MINERS**

*See Page 14*

**THE RADIO BEGINNER**

*SEE PAGE  
34*

**THE 100% RADIO MAGAZINE**

EXPERIMENTER PUBLISHING COMPANY, NEW YORK, PUBLISHERS OF

**SCIENCE and INVENTION**

**PRACTICAL ELECTRICS**

**MOTOR CAMPER & TOURIST**



# Cunningham RADIO TUBES

*The Standard Tube of the World*

for

## RADIO RECEPTION

The Radio Tube, through radio telephony and public broadcasting, has been largely instrumental in establishing the new and increased interest to humanity attuned to Radio. This tremendous progress in Radio has brought about the development of radio receiving sets resulting in clearer reception of voice and music throughout the broadcast world.

Cunningham Radio Tubes are the product of years of research and experimental work by the engineers of that great scientific organization, the Research Laboratory of the General Electric Company.

There is a Cunningham Radio Tube designed to meet the requirements of your particular set — ask your dealer.



### PATENT NOTICE

Cunningham tubes are covered by patents dated 2-18-08, 2-18-12, 12-30-13, 10-23-17, 10-23-17, and others issued and pending. Licensed only for amateur, experimental and entertainment use in radio communication.

Any other use will be an infringement.

Cunningham 40-page Data Book fully explaining care and operation of Radio Tubes now available by sending 10c in stamps to San Francisco office.

*E. J. Cunningham Inc.*

Branch Office  
Chicago

HOME OFFICE:  
182 Second Street  
SAN FRANCISCO

Branch Office  
New York

### PRICES ON CUNNINGHAM RADIO TUBES

Now in Effect

C-301A—5 Volts 1-4 Ampere filament ..... \$5.00  
C-299—3 Volt .06 amp. Dry Battery Det. and Amp. .... \$5.00  
C-300—5 Volts Gas Content Detector..... \$5.00  
C-11—1.1 Volts .25 amp. Dry Battery Det. and Amp. Special Base. \$5.00  
C-12—Similar to C-11 with standard base.. \$5.00



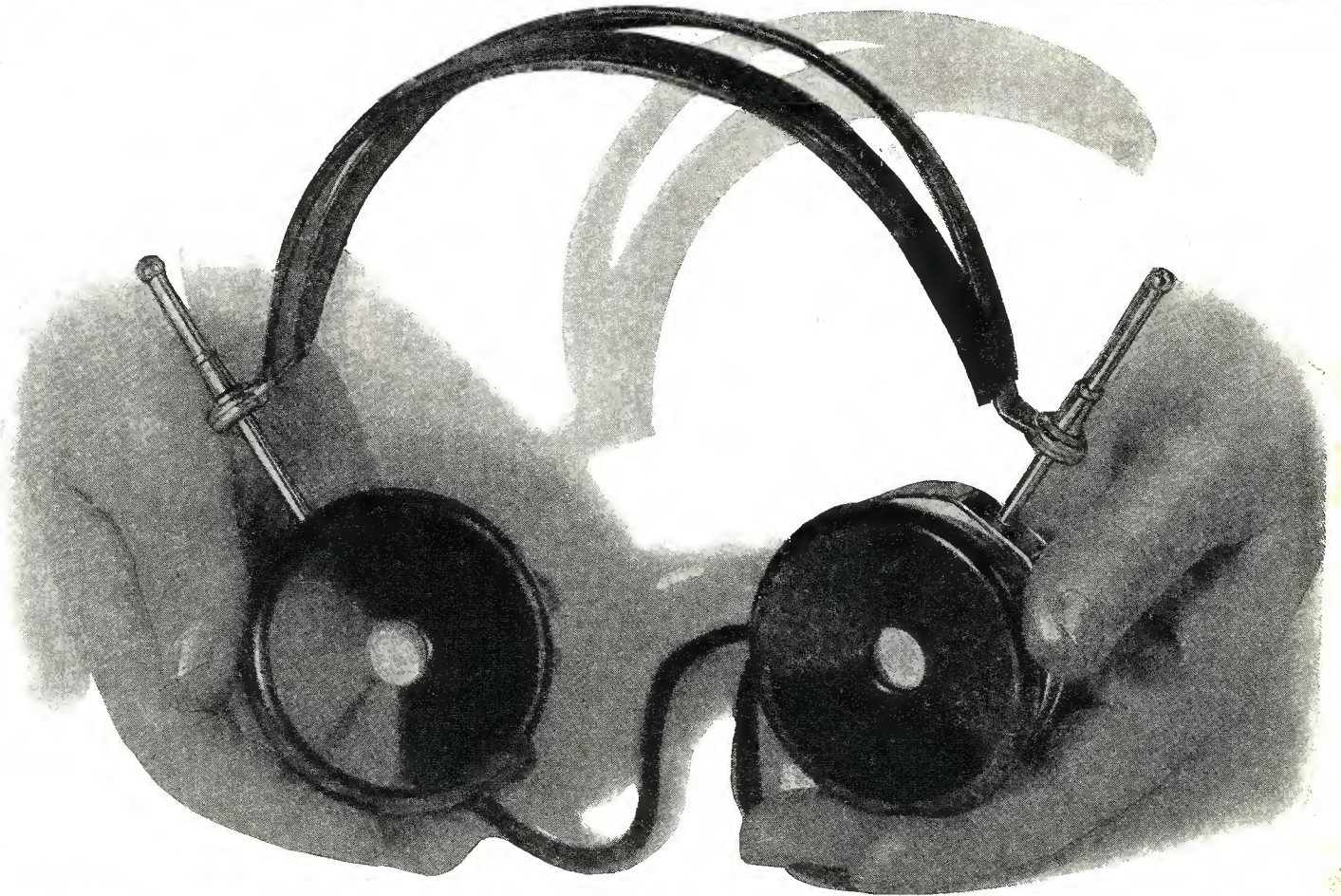

## The Phones with the New Idea

**N** & K Head Sets mark a new era in radio reproduction—an era of *clearness* and *naturalness*. Designed especially for the reception of *musical tones*, they record the entire range of the human voice and of musical instruments with extreme clearness and freedom from distortion. This is due to mechanical design different from that of any head set produced in America. And to an *extremely careful quality of workmanship* almost impossible to obtain in this country.

### Sold on a comparison basis

If, when you use N & K Phones on your own radio set, you do not find that they reproduce all the tones more clearly and naturally than any set you ever used before, and if they do not fit more comfortably, the store where you bought them will refund your money, promptly and cheerfully. We protect dealers and replace any returned phones.

N & K Head Set, Model D, 4000 ohms, has extra large diaphragms and ear caps, insuring better reproduction, better comfort and the exclusion of outside noises. Sanitary, leather-covered head bands. Six feet of stout cord. Retail price \$8.50. Write for "*The Phones the Fans Are Talking About*," interesting new descriptive folder.

**TH. GOLDSCHMIDT CORPORATION**  
Dept. R7, 15 William St., NEW YORK  
Exclusive Distributors for United States, Canada and Mexico



## Imported PHONES

DEALERS: N & K Phones provide the high spot in the radio stocks of dealers all over America. Backed by advertising and strong sales cooperation, they are proving attractive profit-makers. Packed in cartons of ten, with display material and literature.





# RADIO NEWS



Published by EXPERIMENTER PUBLISHING COMPANY, INC.,  
 Publishers of "Radio News," "Science and Invention," "Practical Electrics" and  
 "Motor Camper & Tourist."

Editorial and General Offices: 53 Park Pl., N. Y. C.  
 H. GERNSBACK, President. S. GERNSBACK, Treasurer. R. W. DEMOTT, Secretary.

MEMBER: AUDIT BUREAU OF CIRCULATIONS

## VOL. 6 CONTENTS FOR JULY NO. 1 1924

Page	Page
Editorial ..... By Hugo Gernsback 13	Station—4EO—4ZD ..... 45
Radio to the Rescue ..... By J. Farrell 14	Calls Heard ..... 46
Broadcasters, Broadcatchers and Broadcasters. By Armstrong Perry 16	How to Make and Use a Wavemeter By L. W. Hatry 47
Radio Experts of the Future..... 18	A Local V. T. Transmitter..By Howard S. Pyle 48
Radio Pictorial Section..... 19	A Reflex Receiver With Neutrodyne Control By A. D. Cowper 49
Radio News' Fifth Birthday ..... 23	Distortionless Broadcast Reception By H. J. Round 50
Vacation Radio Hints..... 24	Matching Intermediate Wave Transformers for Super-Heterodynes By Prof. Grover Ira Mitchell 51
The Importance of the Trivial By Sir Oliver Lodge 28	Mica Diaphragm Phones As Loud Speakers By Leslie R. Jones 52
Radio, A Leading Industry By Roger W. Babson 30	Standard Hook-Ups ..... 53
Lucy's Radio Present.....By Warren Ordway 32	An Efficient Untuned Primary Coupler By W. L. Pearce 55
The Radio Tax Was Defeated..... 33	American Broadcasting at 5,000 Miles By John English 55
\$500 Radiation Eliminator Prize Contest..... 33	Awards of the \$50 Radio Wrinkle Contest.... 56
The Beginners' Radio Set.....By A. P. Peck 34	Correspondence From Readers..... 58
Timely Suggestions.....By Howard S. Pyle 37	New Radio Patents.....By John B. Brady 59
The Trouble Corner.....By Adsum 38	Radio News Laboratories..... 60
The Loop Antenna.....By R. H. Langley 40	I-Want-To-Know ..... 62
De Forest Controls Regeneration Patents By W. B. Arvin 41	Complete List of Broadcast Stations Revised to May 1st..... 64
Ring Up Your Friend By Radio..By H. Diamond 42	
With the Amateurs..... 44	
Index to Advertisers..... 4	

RADIO NEWS is published on the 10th of each preceding month. There are 12 numbers per year. Subscription price is \$2.50 a year in U. S. and possessions. Canada and foreign countries, \$3.00 a year. U. S. Coin as well as U. S. Stamps accepted (no foreign coins or stamps). Single copies, 25 cents each. A sample copy will be sent gratis on request. Checks and money orders should be drawn to order of EXPERIMENTER PUBLISHING CO., INC.

All communications and contributions to this journal should be addressed to Editor, RADIO NEWS, 53 Park Place, New York, N. Y. Unaccepted contributions cannot be returned unless full postage has been included. All accepted contributions are paid for on publication. A special rate is paid for novel experiments; good photographs accompanying them are highly desirable.

RADIO NEWS. Monthly. Entered as second-class matter at the Post Office, at New York, N. Y., with additional entry at Long Island City, N. Y., under the act of March 3, 1879; formerly entered at Brooklyn, N. Y. Title registered U. S. Patent Office. Copyright, 1923, by E. P. Co., Inc., New York. The Experimenter Publishing Co., 53 Park Place, New York. The Contents of this magazine are copyrighted and must not be reproduced without giving full credit to the publication. Copyright in Germany. Publication and reproduction of articles in Germany is reserved for Radio, Berlin 42, Germany.

New York City  
 General Advertising Dept.  
 53 Park Place

Western Advertising Representatives  
 Finucan & McClure  
 720 Cass St., Chicago, Ill.

Pacific Coast Advertising Representatives  
 A. J. Norris Hill Co.  
 Hearst Bldg., San Francisco, Calif.

Kansas City Advertising Representatives  
 George F. Dillon  
 Republic Building, Kansas City, Mo.

RADIO NEWS is for sale at all newsstands in the United States and Canada, also at The International News Co., Ltd., Bream's Building, London, E. C. 4, England, and at Brentano's, 37 Avenue de l'Opera, Paris.

HOW TO SUBSCRIBE FOR RADIO NEWS. Send your name, address and remittance to Experimenter Publishing Co., 53 Park Place, New York. Mention the name of the magazine you are ordering. We also publish SCIENCE AND INVENTION, PRACTICAL ELECTRICS and MOTOR CAMPER & TOURIST. Write early.

RATES AND TERMS. The subscription rate for RADIO NEWS is \$2.50 per year. (12 numbers). When remitting do so by check, money order, or registered letter if cash is enclosed. Avoid sending cash through the mail if possible. Subscriptions for less than one year are not accepted. Subscription may be made in combination with SCIENCE AND INVENTION or PRACTICAL ELECTRICS. POSTAGE. We prepay postage in all parts of the United States, Mexico and island possessions. For foreign or Canadian subscriptions we require 50 cents in addition to the subscription price for additional postage charges.

CHANGE OF ADDRESS. Notify us as far in advance as possible. It requires several weeks to make an address change on our records. Always write clearly. ON EXPIRATION of your subscription we enclose a renewal blank in our last number to you; we stop our delivery to you on expiration.



# Index to Advertisers

Name	Page	Name	Page	Name	Page	Name	Page
<b>A</b>		<b>E</b>		<b>L</b>		<b>S</b>	
Ackerman Bros. Co., Inc. ....	139	Diamond Electric Specialties Corp. ....	120	Kennedy Co., The Colin B. ....	116	Radio Tube Corp. ....	93
Acme Apparatus Co. ....	12	Dictograph Products Corp. ....	96	Kilbourne & Clark Mfg. Co. ....	120	Radio Tube Exchange ....	100
Acme Engineering Co. ....	82-84	Dieterich, Albert E. ....	114	Kimley Electric Co. ....	122	Radio Tube Mfg. Co. ....	128
Adams-Morgan Co. ....	70	Dubilier Condenser & Radio Corp. ....	104	Klaus Radio & Electric Co. ....	110	Radio Units, Inc. ....	122
Adams Radio Mfg. Co., The. ....	127	Duck Co., The Wm. B. ....	113	<b>M</b>			
Alden Mfg. Co. ....	84-88	Durkee-Thomas Products Co. ....	129	Lacey & Lacey ....	104	Rahn, John F. ....	128
Allen, Inc., L. B. ....	70	<b>F</b>		Lambert, Leon ....	70	Randolph & Co. ....	119
Allen-Bradley Co. ....	144	E. I. Co. ....	130	Lancaster & Allwine ....	114	Rathbun Mfg. Co., Inc. ....	100
American Art Mache Co. ....	90-124	Eagle Radio Co. ....	126	Lee Electric & Mfg. Co. ....	104	Rauland Mfg. Co. ....	72
American Hard Rubber Co. ....	78	Eastern Coil Corp. ....	108	LeFax, Inc. ....	82	Readers' Service Bureau ....	5
American Radio Mfg. Co. ....	125	Eisemann Magneto Corp. ....	74	Leich Electric Co. ....	108	Red Seal Coal Co. ....	102
American Specialty Co., The. ....	120	Electrad, Inc. ....	126	Lincoln Mfg. Co. ....	86	Reliable Parts Mfg. Co. ....	128
American Standard Electric Co. ....	122	Electrical Research Laboratories	77	<b>N</b>			
American Transformer Co. ....	92	Electric Service Supplies Co. ....	102	Nassau Radio Co., Inc. ....	116	Rolls-Royce Tube Co. ....	143
Amplex Instrument Laboratories	134-141	Electric Specialty Co. ....	76	Main Electric Co. ....	141	Royal Mfg. Co. ....	98
Andrea, Inc., F. A. D. ....	103	Electrotype Blocking Co. ....	110	Marle Engineering Co. ....	76	Ryder, Frank A. ....	120
Arrow Battery Co. ....	116	Elgin Radio Supply Co. ....	137	Marshall Radio Products, Inc. ....	90	<b>R</b>	
Atwater-Kent Mfg. Co. ....	101	Erie Fixture Supply Co. ....	104	Martin-Copeland Co. ....	143	S & H Battery Supply Co. ....	123
Automatic Electrical Devices Co., The	122	Evans & Co., Victor J. ....	114	Marvel Radio Specialty Co. ....	26	Saturn Mfg. & Sales Co., Inc., The	116
<b>B</b>		Experimenters Information Service, Inc. ....	83	Michigan Radio Co. ....	135	Scientific Electric Works, The. ....	90
B-Metal Refining Co. ....	118	<b>G</b>		Midwest Radio Co. ....	127	Service Battery Co. ....	141
Bakelite Corp. ....	123	Fahnestock Electric Co. ....	137	Mitchell & Co., R. ....	139	Shamrock Mfg. Co. ....	99
Barawik Co., The ....	6-7-143	Fansteel Products Co., Inc. ....	137	Modern Electric Mfg. Co., The	110	Shepard-Potter Co., Inc. ....	107
Barkelew Electric Mfg. Co. ....	114	Federal Telephone & Telegraph Co. ....	111	Montrose Mfg. Co. ....	132	Shipman-Ward Mfg. Co. ....	94
Bel-Canto Mfg. Co. ....	68	Ferbend Electric Co. ....	80	Mozart-Grand Co., The ....	131	Sidbenel Radio Equipment Mfg. Co. ....	124
Bell Mfg. Co. ....	139	Ford Mica Co., Inc. ....	70	Multiple Electric Products Co. ....	70	Signal Electric Mfg. Co. ....	143
Benson Engineering Co. ....	98	Formica Insulation Co., The. ....	91	Mu-Rad Laboratories, Inc. ....	120	Silver-S. Battery Co. ....	122
Beta Battery Co., Inc. ....	116	French Battery & Carbon Co. ....	92	Murdock Co., Wm. J. ....	81	Specialty Service Co. ....	104
Blue Seal Mfg. Co. ....	108	Freshman Co., Inc., Chas., 124-127-134-143	143	Music Master Corp. ....	78	Sta-Rite Battery Co. ....	118
Dogue, B. N. ....	131	Friedlander-Kopple Radio Service	96	<b>O</b>			
Boice, W. & J. ....	141	Frost, Inc., Herbert H. ....	68	Omnigraph Mfg. Co., The. ....	118	Sterling Mfg. Co., The ....	124
Boonton Rubber Mfg. Co. ....	114	<b>H</b>		National Airphone Corp. ....	10	Stevens & Co. ....	126
Brach Mfg. Co., L. S. ....	100	H & H Radio Co. ....	108	National Carbon Co., Inc. ....	71	Stransky, John A. ....	139
Brady Co., A. C. ....	120	Halldorson Co. ....	78	National Radio Institute ....	11	Stromberg-Carlson Telephone Mfg. Co.	110
Brady, John B. ....	92	Hammer Radio Co., S. ....	126	Nestor Mfg. Co. ....	141	<b>T</b>	
Brandes, Inc., C. ....	65	Hammarlund Mfg. Co. ....	66	Newman-Stern Co., The ....	76	Telephone Maintenance Co. ....	66
Branston, Inc., Chas. A. ....	119	Harvard Radio Laboratories. ....	72	New York Institute of Photography	122	Terlee Electric & Mfg. Co. ....	134
Breakers, The ....	122	Hayden Radio & Research Co., A. C.	112	New York Radio Co. ....	134	Thompson Mfg. Co., R. E. ....	132
Bremer-Tully Mfg. Co. ....	112	Heath Radio & Electric Mfg. Co.	123	Norden, Hauck & Co. ....	66	Thor Radio Co. ....	104
Bristol Company, The. ....	117	Herbert, Inc., Harold ....	110	<b>P</b>			
Brown & Co., Thos. ....	125	Holtzer-Cabot Electric Co., The	78	Patent Electric Co. ....	92	Tresco Sales, Inc. ....	102
Brownlie, Roland ....	74	Hommel & Company, Ludwig. ....	102	Parker, C. L. ....	114	Triangle Rubber & Supply Co. ....	107
Dunnell & Co., J. H. ....	112	Howard, Mr. ....	114	Pathé Phonograph & Radio Corp.	121	Trimm Radio Mfg. Co. ....	112
<b>C</b>		Hudson-Ross ....	120-132	Pfanstiehl Radio Service Co. ....	78	Tripart Radio Mfg. Co. ....	112
Cannon & Miller Sales Corp. ....	104	<b>I</b>		Phenix Radio Corp. ....	85	Tuska Co., The C. D. ....	137
Carter Radio Co. ....	98	International Correspondence Schools	112	Pioneer Radio Corp. ....	116	<b>U</b>	
Charlotte Furniture Co. ....	128	<b>J</b>		Precision Coil Co. ....	116	U. S. Tool Co., Inc. ....	122
Chemical Institute of New York, Inc.	115	Jones, Howard B. ....	131	Precision Electric Co. ....	117	Uncle Sam Electric Co. ....	68
Chicago Salvage Stock Store. ....	111	<b>K</b>		Press Guild, Inc., The ....	102	United Electric Stores ....	88
Chicago Solder Company. ....	109	K Electric Co. ....	96	Primary Mfg. Corp. ....	88	United Mfg. & Distributing Co. ....	125
Clapp Eastham Co. ....	134	Kellogg Switchboard & Supply Co.	87	Pyramid Products Co. ....	129	Unity Mfg. Co. ....	98
Clapp Mfg. Co. ....	105	<b>L</b>		<b>V</b>			
Connecticut Telephone & Electric Co. ....	Inside Back Cover	<b>M</b>		Valley Electric Co. ....	108	Utility Supply Co. ....	128
Consolidated Instrument Co. of America	118	<b>N</b>		Van-Le Corp. ....	110	<b>W</b>	
Conrad Co., Inc., The. ....	97-106	<b>O</b>		Vesco Radio Co. ....	128	Walbert Mfg. Co., The ....	128
Continental Fibre Co., The. ....	108	<b>P</b>		<b>X</b>			
Continental Radio & Electric Corp.	86	<b>Q</b>		<b>Y</b>			
Cooper Corp., The ....	126	<b>R</b>		<b>Z</b>			
Cosmopolitan Plusiformer Corp.	90	<b>S</b>		<b>XYZ</b>			
Coto-Coil Co. ....	66	<b>T</b>		Y. M. C. A. Radio Institute. ....	112	Zenith Radio Corp. ....	67
Cox Co., A. J. ....	141	<b>U</b>		<b>XYZ</b>			
Coyne Trade & Engineering Schools	131	<b>V</b>		<b>XYZ</b>			
Cressman, Russell B. ....	129	<b>W</b>		<b>XYZ</b>			
Crosley Radio Corp., The. ....	79	<b>X</b>		<b>XYZ</b>			
Cunningham, Inc., E. T., Inside Front Cover	122	<b>Y</b>		<b>XYZ</b>			
<b>D</b>		<b>Z</b>		<b>XYZ</b>			
D. X. Instrument Co. ....	89	<b>XYZ</b>		<b>XYZ</b>			
Dey's Radio Service ....	100	<b>XYZ</b>		<b>XYZ</b>			





# GREBE

## INDIVIDUAL SHIELDS

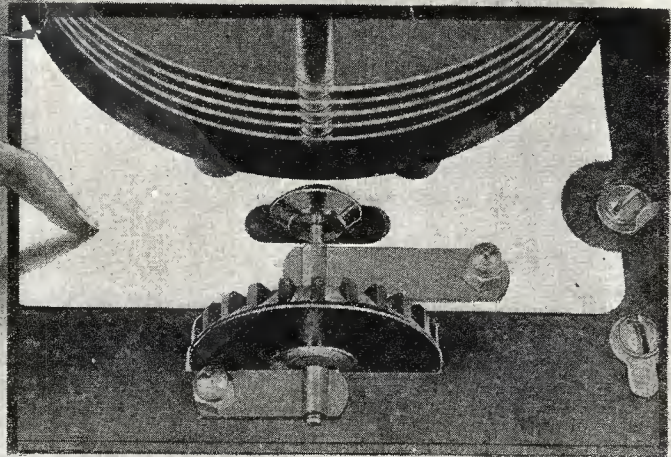

"The Sage attends to the inner and not to the outer."  
—Lao Tzu

The wise buyer of a radio receiver is not misled, he looks inside the cabinet.

*Doctor Mu*

CLOSE inspection of many receivers reveals but one large shield to prevent body-capacity effects. As a result of research, each tuning control on a GREBE Receiver has its own aluminum shield of special size and shape.

This is just one of many details of craftsmanship which make for the high efficiency of GREBE Receivers.

Ask your Dealer or write us.

A. H. GREBE & CO., Inc.  
Van Wyck Blvd. Richmond Hill, N. Y.  
Western Branch: 451 East 3rd Street, Los Angeles, Cal.

Grebe Regenerative Receivers are licensed under Armstrong U.S. Pat. No. 1,113,149.



# RADIO NEWS READERS' BUREAU

## Time and Postage Saver

**I**N every issue of RADIO NEWS you undoubtedly see numerous articles advertised about which you would like to have further information. To sit down and write an individual letter to each of these respective concerns, regarding the article on which you desire information, would be quite a task.

As a special service to our readers, we will write the letters for you, thus saving your time and money.

Just write the names of the products about which you want information, and to avoid error the addresses of the manufacturers, on the coupon below and mail it to us.

If the advertiser requires any money or stamps to be sent to pay the mailing charges on his catalogue or descriptive literature, please be sure to enclose the correct amount with the coupon.

We will transmit to the various advertisers your request for information on their products.

This service will appear regularly every month on this same page in RADIO NEWS.

If there is any Manufacturer not advertising in this month's issue of RADIO NEWS, from whom you would like to receive literature, write his name, address and the product in the special section of the coupon below.

TEAR ALONG THIS LINE

**READERS' SERVICE BUREAU,**

Experimenter Publishing Co., Inc., 53 Park Place, New York, N. Y.

Please advise the firms listed below that I would like to receive detailed information on their product as advertised in the \_\_\_\_\_ issue of RADIO NEWS.

NAME	ADDRESS	List here specific article on which you wish literature.	If Catalogue or complete list is wanted, check in this column

If you desire any special information from a manufacturer whose advertisement does not appear in this month's issue, use this space.

\_\_\_\_\_

\_\_\_\_\_

\_\_\_\_\_

Your own name here \_\_\_\_\_

Address \_\_\_\_\_

City \_\_\_\_\_

State \_\_\_\_\_



# BUILD YOUR SET BETTER-AT LOWER COST

**SUPERIOR 180° VARIOCOUPLER**  
Z521 Each.....\$1.10  
A wonderful value. Produces excellent results. Green silk windings on black fibre tubes. Rigid mounting support for table or panel mounting. Primary tapped for fine tuning. 1/4 inch shaft. Range 200 to 600 M.  
Z522 Variometer—same style. Each \$1.10

**SUPERIOR VARIOCOUPLER**  
Z523 Each.....\$3.35  
A handsome instrument of superior design and construction. Stator tube and rotor ball of moulded red brown bakelite. Large size green silk windings insure highest efficiency. Table or panel mounting. 1/4 inch shaft. Superior results in circuits for 180 to 650 meters. Tapped primary for finest tuning. Noiseless contacts.  
Z526 Special single circuit type.....\$3.75

**SUPER MOULDED VARIOMETER**  
Z412 Each.....\$2.48  
Polished black moulded rotor and stator forms. Maximum inductance with greatest efficiency and minimum distributed capacity. A high grade instrument that will get the best results.  
Wave length 180 to 600 meters.

**EXCEL MOULDED VARIOMETER**  
Z524 Each.....\$3.95  
A wonderful value at our price. Properly designed and constructed. Polished black bakelite rotor and stator forms. Large size green silk wire insures greatest efficiency. 1/4 inch shaft. Noiseless spilt connection. Table or panel mounting. Split stator winding with binding post connections.

**SUPERIOR VARIOMETER**  
Z525 Each.....\$3.69  
Forms moulded of red brown bakelite. A neat handsome instrument. Green silk windings calculated for highest efficiency. 1/4 inch shaft. Noiseless spilt connection. Table or panel mounting. Produces superior results in any type circuit 180 to 650 meters.

**SPIDER WEB COIL FOR REINARTZ CIRCUIT**  
Z296 Each.....\$1.30  
Lists for \$1.75. A very unusual bargain. Made of green silk covered wire. Spider web wound to produce greatest efficiency and lowest losses. 21 taps so arranged that crossing is avoided. Two fibre strips and wooden rod furnished permit various styles of mounting. With this coil a high grade set can be built at a low cost. Directions included.

**ULTRA AUDION COIL**  
Z297 Each......85c  
Spider web wound of green silk covered wire. Four taps. Produces wonderful results. Fibre strips and wooden rod for mounting and directions included.

**COCKADAY COILS**  
Z298 Per Set.....\$1.95  
Complete set coils for Cockaday circuit. Properly calculated and made to give best results on this new wonder circuit.

**NEUTRODYNE TRANSFORMERS**  
Z571 Each \$1.75. Per set of three. \$4.95  
An air core transformer for use in neutrodyne method of reception. Can also be used for tuned radio frequency or as a fixed coupler with condenser across secondary. Proper design for results and efficiency. Green silk windings on bakelite tubes with adjustable mounting brackets to fit most any condenser.

**NEUTRALIZING CONDENSERS**  
Z572 Per set of two......40c  
Simple, inexpensive, effective precision type. Micrometer adjustment is attainable.

**STANDARD NEUTRODYNE PARTS**  
Z851 Licensed Neutrodyne (combined transformer and condenser). Each.....\$4.78  
Z852 Licensed Neutrodyne Kit.....\$14.95  
Includes 3 WorkRite Neutrodyne, 2 WorkRite Neutrodons, panel layout, paper template and book of instructions.

**Z853 Licensed Neutrodon. Each......43c**  
A very accurate and easily adjusted condenser for neutralizing tube.

**SPIDER WEB COILS**  
Z299—25 turn 39c    Z292—50 turn 47c  
Z291—35 turn 42c    Z293—75 turn 54c  
Z294—100 turn. Each......68c  
A new popular type of inductance of highest efficiency. Lowest distributed capacity and lowest high frequency resistance. Firm green silk windings with fibre mounting strips.

**YOU SAVE MONEY WHEN YOU BUY FROM US**  
We Pay Transportation Charges in U. S. East of the Rockies  
THE PRICES QUOTED DELIVER THE GOODS TO YOUR DOOR  
FAST SERVICE—TRY US AND BE CONVINCED  
THIS GUARANTEE PROTECTS YOU—Examine the goods we ship you. They must suit you in every respect. If you are not satisfied with your purchase return the goods at once and we will refund the price you paid.

## OUR SPECIAL VARIOMETER AND VARIOCOUPLER

Build into your set reliable instruments. You can depend on this variometer and variocoupler to give you the best results in any circuit working from 180 to 650 meters. In design and construction they are the best. Only the highest grade materials are used. The prices quoted save you 30 to 40 per cent. Why pay more?

**Z418 Variocoupler. Each.....\$2.45**  
The most efficient type of coupler. Insures better tuning and louder signals. Primary and secondary wound on natural uncolored genuine bakelite tubes. Primary tapped for fine tuning. Can be panel or table mounted. 3-16 inch shaft.

**SOLID BARE COPPER WIRE**  
Solid bare copper wire for aerials, leads or wiring instruments.  
Solid Bare Copper Wire, size 14.  
Z240 100 ft. coil......48c  
Z242 500 ft. coil.....\$2.25

**STRANDED ANTENNA WIRE**  
Cabled of fine copper strands. Very flexible. High tensile strength. Best for aerials.  
Z248 100' coil 58c    Z249 500' coil \$2.75

**MAGNET WIRE**  
Insulated copper wire. Best quality even drawn wire, one piece to a spool. Prices quoted are for 8 oz. spools unless otherwise stated. Note our prices are prepaid.

Double Cotton Covered	Enamelled Insulation	Single Green Silk-Covered
Number Z990	Number Z992	Number Z991
Gauge Price	Gauge Price	Gauge Price
18 ..... \$2.80	35c 20 ..... \$0.75	20 ..... .90
20 ..... 48c	45c 22 ..... 1.05	22 ..... 1.15
22 ..... 60c	50c 24 ..... 1.25	24 ..... 1.35
24 ..... 75c	55c 26 ..... 1.45	26 ..... 1.55
26 ..... 90c	60c 30 (4 oz.) 1.90	30 ..... 2.00
28 ..... 95c	65c 32 (4 oz.) 1.30	32 ..... 1.40
30 ..... \$1.15	85c 36 (4 oz.) 1.30	

**ANTENNA INSULATORS**  
Z260 Size 1x3/4. Composition, metal eyelets. Two for 2263 Ribbed Porcelain insulator, 2 1/2 in. long. Ea. 6c  
Dozen .....55c  
Z265 Ribbed porcelain insulator 5 inches long. Each......15c

**LEAD-IN INSULATORS**  
Z270 For 4 inch walls or less......42c  
Z271 For 9 inch walls or less......69c  
The only practical lead-in insulator for aerial wires. Small, neat, effective, durable. Fits 5/8 inch hole. Securely locked by two adjustable nuts.

**OUTDOOR LIGHTNING ARRESTER**  
Z980 Price.....\$1.24  
Protect your instruments with lightning arrester. Weatherproof Bakelite case. Air gap type. Permanent. Durable. Underwriters approved.

**JEWELL LIGHTNING ARRESTER**  
Z981 Each......85c  
A dependable protector at ways on guard. Small and compact. Weatherproof porcelain case. Easily fastened and connected. Underwriters approved. Lists for \$1.10.

**PANEL MOUNTING VARIABLE CONDENSERS**  
These are especially high grade condensers and we guarantee them to be mechanically and electrically perfect. Fine polished end plates of heavy bakelite. Shaft 1/4 inch diameter. Sturdy heavy aluminum alloy plates perfectly spaced to insure smooth, even, reliable capacity. Our low prices save you money. These condensers are of the very best make and are not to be compared with many inferior, cheap condensers offered. We guarantee them to please you or your money back. The vernier style has one separately controlled plate which permits of the finest tuning. Quality considered, these values are unapproached by others.

**REGULAR STYLE**  
Z815—3 plate......58c  
Z816—5 plate......97c  
Z814—11 plate .0025 mfd.....\$1.13  
Z813—21 plate .0005 mfd.....1.27  
Z812—43 plate .001 mfd.....1.47

**TINNED COPPER "BUS BAR" WIRE**  
Size 14 tinned copper wire. For wiring sets. Best size for neat job and easy soldering.  
Z957 Round. Ten feet for.....12c  
Z958 Square. Ten feet for.....14c

**SPAGHETTI**  
For covering connecting wires in sets. For size 12 and 14 wires.  
Z955 Finest quality braided and saturated with best baked lustrous transparent insulating varnish, 3 feet for......19c  
Z956 Best quality braid and covered with black insulating compound. 3 feet for .9c

**PORCELAIN BASE SWITCHES**  
Fine white porcelain bases. Copper contacts and blades. Can be used as antenna switches.  
Z385 Single Pole Single Throw. Ea. 20c  
Z383 Single Pole Double Throw. Ea. 32c  
Z384 Double Pole Double Throw. Ea. 50c

**RADIO SOLDER SET**  
Z538 Complete.....83c  
Handy for soldering radio connections or for general small repair jobs. Consists of soldering copper with handle, sal ammoniac, soldering salts, solder and sand paper.

**RADIO SOLDERING IRON**  
Z540 \$1.35  
Soldered connections in radio sets produce better results. This guaranteed iron is exactly right for radio work. A neat solid connection quickly and easily made. Operates on any lighting current 100 to 120 volts. 6 ft. cord with attaching plug. Length 13 inches. Heats quickly, will not overheat.

Heavier irons for general repair work. Wonderful values at our prices.  
Z541 Medium size.....\$3.48  
Z542 Large size......425

**MIGNON VERNIER VARIABLE CONDENSERS**  
Z827 .0002 M.F. Each.....\$2.30  
Z828 .0005 M.F. Each......2.70  
Z829 .001 M.F. Each......2.95  
Highest grade instruments. Accurate rating. Extremely low dielectric losses. Independent friction vernier control insures perfect positive adjustment. 1/4 inch shaft. No dial included.

## DUR SPECIAL AUDID FREQUENCY AMPLIFYING TRANSFORMERS

Z550 Each.....\$2.25  
In quality of tone and volume of sound, the things a transformer is built for we guarantee it to equal or surpass any other transformer. Neat in appearance. Carefully made. Fully mounted with plainly marked binding post connections. Wonderful results on one, two or three steps without distortion or howling. A quality item in every respect.

**SHIELDED TRANSFORMER**  
Z551 3 1/2 to 1 Ratio \$2.48  
Z552 6 to 1 Ratio 2.68  
Note that our price is prepaid. The same high grade style of transformer as above enclosed in a metal case which completely shields it from any outside magnetic influences. Free from howling and local disturbances.

**OTHER STANDARD BRANDS AUDIO FREQUENCY TRANSFORMERS**  
Fresh, Clean Stock in Original Containers  
Z232 THORARSON Ratio 3 1/2 to 1 \$3.50  
Z233 THORARSON Ratio 6 to 1.....3.70  
Z553 Acme. Each......4.20  
Z554 Coto. Each......4.45  
Z555 Federal No. 226. Each......4.45  
Z712 Radio Corp. Each......5.70  
Z234 All American 10 to 1 Shielded 3.80  
Z239 All American 5 to 1 Shielded 3.60  
Z236 All American 3 to 1 Shielded 3.60  
Z231 All American Push Pull.....5.10

**TRICOIL RADIO FREQUENCY AMPLIFYING TRANSFORMER**  
Z560 for 201A or 301A.....\$1.58  
Z561 For 199 or 11 or 12 Tubes......1.58  
This transformer will produce wonderful results in any type of regular or reflex radio frequency circuit. Perfect for one, two or three stages. Compact, convenient form, easily mounted. Range 175 to 600 meters.

**OTHER STANDARD BRANDS RADIO FREQUENCY TRANSFORMERS**  
Z568 Our special—as good as any of them......3.48  
Z562 Dubilier. Each......3.48  
Z563 Acme. First stage. Each......4.45  
Z565 Acme. First stage. Each......4.45  
Z566 Acme. Second stage. Each......4.45  
Z567 Acme. Third stage. Each......4.45  
Z714 Radio Corp. Each......5.95  
Z395 All American. Each......3.95  
Z575 Erla. First stage. Each......3.45  
Z576 Erla. Second stage. Each......3.45  
Z577 Erla. Third stage. Each......3.45  
Z578 Erla. Reflex No. 1 or 2. Each 4.35

**FAHNESTOCK CONNECTORS**  
Z366 Single. Dozen......25c  
Z367 Double. Dozen......39c  
Handy and convenient for connecting wires or making connections on binding posts or other parts of instruments. Wires held firmly in spring grip but may be instantly removed.

**LIGHT SOCKET ANTENNA**  
Z251 Each......97c  
Screws into any light socket. Replaces the regular out door antenna. Very satisfactory for nearby stations and under favorable conditions will bring in distant stations. Easy to install. No danger. Gives clear reception with little static interference. Ideal for people in apartment buildings.

**TINOL**  
Z969 Per tube......19c  
A combined solder and flux in handy form. Put a little on the connection, heat with a match, torch or solder iron and you have a neat electrically and mechanically perfect joint.

**AUTOMATIC BLOW TORCH**  
Z543 Each.....\$1.19  
Burns denatured alcohol. Automatically generates pointed flame in a few seconds. Easy to solder joints in hard places. Lights with a match. Burns 20 minutes on one fill. 5 1/4 inches high, 7/8 inch diameter cylinder. Works fine with Tinol listed above.

**ANTENNA LEAD-IN**  
Z259 Each......25c  
Solves a hard problem. With it you can bring in the antenna wire without drilling a hole in an insulator. Place on window sill and window can be closed down tight and locked as before. Takes but a minute to install. Perfectly insulated. Can be bent into any shape. Made of copper strip properly insulated. Neat and durable.



# WITH BARAWIK QUALITY RADIO GOODS

### VACUUM TUBES

Standard Brands—Cunningham, Radiotron. Every one guaranteed new and perfect. We will ship brand in stock unless you specify otherwise.

Z105 Detector UV200 C500 Each ..... \$4.45  
 Z112 Amplifier, UV201A C301A, Each ..... 4.45  
 Z118 5-Watt Transmitter, 7.70  
 Z107 WD11 C11, Each ..... 4.45  
 Z101 WD12 C12, Each ..... 4.45  
 Z102 UV199 C299, Each ..... 4.45  
 Z104 UV199 Adapter fits 199 tube to standard socket ..... 39  
 Z108 WD11 Socket, Each ..... 39  
 Z109 WD11 Adapter, Each ..... 42

### BAKELITE TUBE SOCKET

Z140 Standard base... 39c  
 Z141 UV199 base... 39c

Moulded of genuine red brown bakelite. Binding post connections. For table or panel mounting. Neat and strong.



### 199 SOCKET

Z145 Each ..... 59c

Moulded of high insulating material. Sponge rubber base prevents ringing in tube. Plainly marked binding post connections. Neat and compact.



### STANDARD TUBE SOCKET

Z150 Each ..... 76c

Bakelite base. Polished nickel tube. Highest quality socket on the market. Best insulation. Positive contact. Marked terminals. For base or panel mounting.

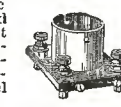

### FILAMENT CONTROL RHEOSTATS

Z132 6 ohm, Each ..... 38c  
 Z129 20 ohm, Each ..... 40c  
 Z131 30 ohm, Each ..... 44c  
 Z135 8 ohm, Vernier, .95c

Best grade. Will give real service. Durable and lasting. High heat resisting base, diam. 2 1/4" in. Tapered polished black knob 1 1/4" diam. Potentiometers. Match above rheostats. Same high grade construction.

Z151 200 ohm, Each ..... 50c  
 Z152 400 ohm, Each ..... 55c

### OTHER STANDARD BRAND RHEOSTATS AND POTENTIOMETERS

Z207 Filkostat, Each ..... \$1.90  
 Z208 Bradleystat, Each ..... 1.74  
 Z209 Bradleystat 200 ohm, Each ..... 1.99  
 Z210 Bradleystat 400 ohm, Each ..... 2.89  
 Z211 Howard 6 ohm Plain Rheo, Ea. .85  
 Z212 Howard 6 ohm Ver. Rheo, Ea. 1.25  
 Z213 Howard 25 ohm Plain Rheo, Ea. .85  
 Z214 Howard 25 ohm Ver. Rheo, Ea. 1.25  
 Z215 Howard 40 ohm Plain Rheo, Ea. .85  
 Z216 Howard 40 ohm Ver. Rheo, Ea. 1.25  
 Z217 Howard 200 ohm Potentiometers, Each ..... 1.25  
 Z218 Howard 400 ohm Potentiometers, Each ..... 1.69  
 Z219 Klossner 6 ohm Vernier, Each. 1.19  
 Z221 Klossner 30 ohm Vernier, Each. 1.45  
 Z222 Amperite rheo mounting, ..... 95c

### SUPERIOR RHEOSTATS

Z153 6 ohm, Each ..... 69c  
 Z154 20 ohm, Each ..... 76c  
 Z155 30 ohm, Each ..... 83c

The finest rheostat. Smooth, even action. Best design, best workmanship. Supplied with attractive dial and knob. Potentiometers to match above rheostats with dial and knob.

Z156 300 ohm ..... 92c

### UNIVERSAL CONTROL DIAL

Z918 For 5/16 inch shaft, ..... \$1.15  
 Z919 For 3/4 inch shaft, ..... 1.15

Replaces ordinary knob or dial. Gives perfect vernier control on condenser, variometer, varicoupler, flicker, etc. Positive easy action. Looks fine. Easily installed. Especially desirable in tuning neodyne sets.

### COMPOSITION DIALS

Z921 Diam. 2 in. for 3-16 in. shaft, Ea. 16c  
 Z922 Diam. 2 in. for 1/4 in. shaft, Ea. 16c  
 Z923 Diam. 3 in. for 3-16 in. shaft, Ea. 22c  
 Z924 Diam. 3 in. for 1/4 in. shaft, Ea. 22c  
 Z925 Diam. 3 1/2 in. for 3/4 in. shaft, Ea. 27c

Handsome dials moulded in one piece of polished black composition. 2 inch size has 270° scale marked 0 to 100 finely engraved in contrasting white enamel. 3 and 3 1/2 inch size have 180° scale marked 0 to 100.

### BAKELITE DIALS

Z931—2 in. Diam. for 3-16 in. shaft, Each. .35c  
 Z932—2 in. Diam. for 1/4 in. shaft, Each. .35c  
 Z933—3 in. Diam. for 3-16 in. shaft, Each. .39c  
 Z934—3 in. Diam. for 1/4 in. shaft, Each. .39c  
 Z935—4 in. Diam. for 1/2 in. shaft, Ea. 48c

Moulded in one piece of genuine bakelite in polished black finish. Finely engraved scale in contrasting white enamel. Sure grip knob that fits the fingers. Higher grade dials for good sets. Match perfectly.

### VERNIER DIAL ADJUSTER

Z941 Each ..... 19c

Easily installed at edge of dial, gives finest vernier adjustment of condenser or inductance. A great value. Polished black knob.



### WE PAY TRANSPORTATION CHARGES IN U. S. East of the Rockies

PRESERVE THESE PAGES—ORDER FROM THEM AND SAVE MONEY  
 FAST SERVICE—TRY US AND BE CONVINCED  
 THE PRICES QUOTED DELIVER THE GOODS TO YOUR DOOR

**OUR GUARANTEE PROTECTS YOU**—We handle only the best goods, carefully tested and checked by expert radio engineers. You are assured of getting guaranteed apparatus that will give superior results. And while our goods are best, our prices are lowest. Our goods equal or surpass the claims we make for them. We do not attempt to deceive or mislead. Our reputation for fair dealing is our most valued asset.

**HOW TO ORDER**—Write your Order plainly, state Article Number, Description and Price of items wanted. Send Postoffice or Express Money Order, Certified Check or Bank Draft for Total of Order. Prompt Shipment is assured when these directions are followed.

### CABINETS

Fine locking cabinets solidly built. Elegant hand rubbed dark mahogany finish. You will be proud of your set mounted in one of these cabinets. Hinged tops. Front rabbeted to take panels. Panels not included. Prices are transportation paid. Note that our prices are prepaid.

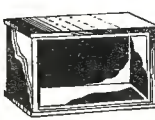

Panel Size	Inside Dimensions High   Wide   Deep	Art. No.	Price Each
6x 7"	5 1/2"   6 1/2"   7"	Z420	\$1.95
6x10 1/2"	5 1/2"   10"   7"	Z422	2.45
7x10"	6 1/2"   9 1/2"   7"	Z421	2.60
7x12"	6 1/2"   11 1/2"   7"	Z424	3.05
7x14"	6 1/2"   13 1/2"   7"	Z426	3.45
7x18"	6 1/2"   17 1/2"   7"	Z428	3.45
7x21"	6 1/2"   20 1/2"   7"	Z425	3.85
7x24"	6 1/2"   23 1/2"   7"	Z429	4.35
7x26"	6 1/2"   25 1/2"   7"	Z431	5.50
9x14"	8 1/2"   13 1/2"   10"	Z428	3.55
12x14"	11 1/2"   13 1/2"   10"	Z430	4.00
12x21"	11 1/2"   20 1/2"   10"	Z432	5.05

### CRYSTAL DETECTORS

The latest development in Crystal Detectors. Give better results and more reliable than old style. Used in Reflex circuits.

Z242 Gremol Detector, Each. .... \$1.48  
 Z243 B Metal Detector, Each. .... 1.39  
 Z244 B Metal Crystal, Each. .... .45  
 Z241 Gold Grain Detector, Each. .... .83  
 Z245 Yellow Tip Detector, Each. .... 1.79  
 Z246 Du-Tec, Crystal, Each. .... .27

### SUPERIOR VARIABLE GRID RESISTANCE

Z167 Each ..... 80c  
 Z168 With .00025 Condenser ..... 99c

Eliminates hissing, clarifies signals. Capacity smoothly varied from 0 to 6 megohms by half turn of knob. Easily mounted on any panel.

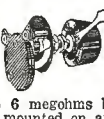

### RADIO "BAKELITE" PANELS

Notice our very low prices on this fine quality material. Others ask as much for hard rubber panels which are worth much less. We supply genuine Bakelite, Condensite Celcon or Formica, all of which are materials with practically identical mechanical, chemical and electrical properties. Machines well without chipping. Won't warp. Waterproof. Highest mechanical and dielectric strength. Attractive natural polished black finish which can be candied and oiled. Note that our prices are prepaid.

Panel Size Inches	1/4" thick		3/16" thick		1/2" thick	
	Art. No.	Price	Art. No.	Price	Art. No.	Price
6x 7"	Z450	\$ .55	Z460	\$ .89	Z470	\$ 1.15
6x10 1/2"	Z451	.86	Z461	1.10	Z471	1.73
7x14	Z458	1.38	Z468	1.73	Z478	2.76
7x18	Z453	1.78	Z463	2.27	Z473	3.56
7x21	Z457	2.05	Z467	2.65	Z477	5.10
7x24	Z459	2.42	Z469	2.97		
7x26			Z462	3.25		
9x14	Z454	1.85	Z464	2.35	Z474	3.56
12x14	Z455	2.42	Z465	2.97	Z475	4.78
12x21	Z456	3.62	Z466	4.25	Z476	7.13

### GRID LEAKS

Z177 Freshman back of panel style, ..... 59c  
 Z178 Freshman back of panel style with .00025 Condenser 79c  
 Z171 Freshman base mounting type with .00025 Condenser, 79c  
 Z172 Durham Variable Grid Leak with Mounting ..... 89c  
 Z173 C.R.L. Variable Grid Leak, ..... \$1.19  
 Z175 C.R.L. Variable Grid Leak with grid condenser, ..... \$1.48

### DUBILIER MICADON TYPE 601

Z502 .0001 ..... 28c  
 Z503 .00025 ..... 28c  
 Z504 .0005 ..... 28c  
 Z505 .001 ..... 32c  
 Z506 .002 ..... 32c

Z507 .0025 ..... 32c  
 Z508 .003 ..... 40c  
 Z509 .004 ..... 40c  
 Z510 .005 ..... 48c  
 Z511 .006 ..... 60c

### BARAWIK QUALITY HEADSETS

Z770 Per Set, 2000 ohms, ..... \$2.60

These headsets have proven on rigid tests to be one of the very best on the market. The tone quality is excellent with an unusual volume. Skilled workmen make them from only the best selected materials. The receiver cases are fine polished finish with polished black ear pieces. Fabric covered head band comfortably and quickly fitted to the head. Supplied with 5-foot cord. These sets were designed to sell for much higher prices than we ask, and at our price are a wonderful bargain. We guarantee that you will be pleased with them and agree that they are the best value by far yet offered. If they don't suit you we will cheerfully return your money.

Z754 Baldwin Type C with 2000 ohm \$3.30  
 universal jack plug \$10.45  
 Z766 Frost, 2000 ohm \$3.95  
 Z758 Western Elec., \$9.50  
 Z759 Federal ..... \$5.50  
 Z751 Murdock 56, 2000 ohm ..... \$3.25  
 Z752 Murdock 56, 3000 ohm ..... \$3.90

Z756 Red-Head, 3000 ohm ..... \$5.78  
 Z768 Brandes, 2000 ohm ..... \$5.25  
 Z769 Brandes, 3000 ohm ..... \$6.95

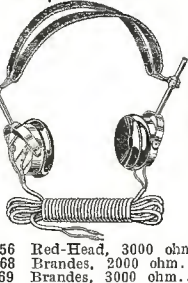

### SUPERIOR RADIO JACKS

Finest grade jacks. Improved design. Best materials. Phosphor bronze springs. Silver contact points. Nickel finish. Mount on panels 1/2 to 3/4 in.

Z390 Open circuit, Each ..... 36c  
 Z391 Closed circuit, Each ..... 45c  
 Z392 Two circuit, Each ..... 54c  
 Z393 Single circuit filament control, 52c  
 Z394 Two circuit filament control, ..... 68c

### STANDARD JACKS AND PLUG

Z387 Open circuit jack, Each ..... 27c  
 Z388 Two circuit jack, Each ..... 35c  
 Z396 Plug takes two sets of phones, 35c

Well made, durable, smooth working, nickel finished frame. Well insulated.

### SUPERIOR RADIO PLUGS

Z395 With Set  
 Screws for fastening cord, Each. .... 35c  
 Z397 Two-way — takes two pair any style cords. Lists for \$1.00, Each. 59c  
 Highest grade plugs. Fit any standard jacks. Polished round barrels.



### SWITCH CONTACT POINTS

Brass polished nickel finish. All have 1/4 in. long size 6-32 screws and two nuts. All prices the same.

Dozen 15c      Hundred \$1.00

Order by Article Number.

Z360 Head, 1/4" diam., 1/4" high.  
 Z362 Head, 3-16" diam., 1/4" high.  
 Z363 Head, 3-16" diam., 1-16" high

Solder Lugs to Fit Contact Points  
 Also for connecting wires to binding posts, etc.

Z365 Dozen 8c      Hundred 30c

### SWITCH LEVER STOP

Brass polished nickel finish.  
 Z366 Dozen 18c      Hundred \$1.05



### SWITCH LEVERS

Very neat polished black composition knob. Exposed metal parts polished nickel finish. Fitted with panel bushing and two set nuts. A high grade switch.

Z381 1 1/4" Radius, Each 14c



### INDUCTANCE SWITCH

Z285 Price including knob and dial, \$1.18  
 Mounts switch points and contact lever behind panel. Only one hole needed to mount. 15 switch points; any number of which may be used.

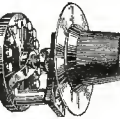

### BINDING POSTS

Brass, polished nickel finish. Washer and 6-32 in. screw extending 3/4 in.

Z370 Large size—barrel and knob 3/4" long, Dozen ..... 70c  
 Z372 Smaller size 2376-8 barrel and knob 9-16" long, Dozen, 70c  
 Z374 Large size with composition knob, Dozen ..... 45c  
 Z376 Large size with hole for phone tip or wire, Dozen ..... 80c  
 Z378 Small size with hole for phone tip or wire, Dozen ..... 35c

### SUPERIOR INDUCTANCE SWITCH

Z288 Each ..... 85c

Quickly and securely mounted by drilling one hole. Only knob and pointer show in front of panel. Connections can be soldered before fastening switch, making assembly much easier.



### STANDARD BRAND LOUD SPEAKERS AND UNITS

Z610 Murdock Loudspeaker ..... \$2.75  
 Z613 Barawik with Baldwin unit, ..... 9.75  
 Z615 Pathe Loudspeaker ..... 15.95  
 Z616 Atlas Loudspeaker ..... 22.50  
 Z612 Magnavox P3 Loudspeaker ..... 29.50  
 Z614 Magnavox M1 Loudspeaker ..... 29.50  
 Z617 Music Master Loudspeaker ..... 27.00  
 Z755 Genuine Baldwin type C unit, ..... 5.10  
 Z619 Murdock Special Unit ..... 2.60  
 Z618 Brandes Table Talker ..... 9.25  
 Z620 Baldwin Loud Speaker ..... 22.50  
 Z618 Atlas Unit, Each ..... 10.75  
 Z607 Western Electric Unit, Each. 10.75

### RADIO SWITCH

Z287 Each ..... 28c

Cuts current on and off instantly by a push or pull. Very neat. Well made. Durable. Saves tubes and batteries.

### BEZELS

Z399 Diameter 3/4 inch, Each ..... 15c  
 Z400 Diameter 1 1/4 inch, Each ..... 15c

Polished nickel finish. Finest quality. Fit any thickness panel. Greatly improve appearance of any set.

### PLATE CIRCUIT "B" BATTERIES

You can make real savings on these batteries. We guarantee them to equal any on the market regardless of price. Extra long life. Don't throw away your money on cheaper inferior useless batteries.

Z180 Signal Corps type, small size, 15 cells, 22 1/2 volts, Each. .... \$1.10  
 Z182 Large size, 5 taps, 16 1/2, 18, 19 1/2, 21 and 22 volts, Each. .... \$1.45  
 Z184 Variable Large Navy size, 6 1/2x4x3 inches, 5 taps, giving range from 16 1/2 to 22 1/2 volts in 1 1/2 volt steps, Each \$1.70  
 Z188 Combination Tapped 45 volts, 30 cell, 13x4x3 battery. Tapped to give 45, 22 1/2, 21, 19 1/2, 18 and 16 1/2 volts. Handles both detector and amplifier tubes, Ea. \$3.28

### "B" BATTERY METER

Z189 Each ..... 98c

Reads 0 to 50 volts. Accurately tells you the exact condition of your "B" Battery. Convenient watch size. Polished nickel case with wire lead.



### STORAGE "A" BATTERY

A high grade battery. Guaranteed for three years. Made of best new materials. Full capacity. The best battery buy on the market. Try one of these batteries on your set for 10 days. If at the end of that time you are not fully satisfied with the battery return it and we will refund the purchase price.

Z194 6 volt, 60 amp. size, Each. \$9.90  
 Z196 6 volt, 100 amp. size, Each. \$13.25



### HOMECHARGER BATTERY CHARGING RECTIFIER

Charge your battery at home overnight for a few cents. Simply connect to any 110 volt 60 cycle light socket, turn on current and rectifier does the rest automatically. Will work for years without attention. Simple connections. Give a tapering charge which batteries should have. You can make it pay a profit charging your friends' auto batteries. Long connecting cords with pair of battery clips.

Z201 For 6 volt battery ..... \$12.95  
 Z203 For 12 volt battery ..... 12.95



### HYDROMETER

Z190 Each ..... 48c

Accurately tells you the condition of your storage battery. Helps you keep your battery in better condition.

### BATTERY CLIPS

Z198 Two for ..... 28c

Clip onto storage battery terminal, lead coated. Make positive non-corrosive contact at all times.



### WIRE CONNECTING CLIPS

Z199 Per dozen ..... 30c

Small connecting clips for quickly fastening leads on to binding posts, etc. Handy and useful. Every radioist should have at least a dozen.



### RUBBER COMPOUND PANELS

Made of a special compound having a rubber base. Equal in appearance and in all essential points to any other class of panels. Fine smooth polished finish. Can be drilled or cut without chipping. Guaranteed not to warp and to be a perfect insulator for radio use. Smooth, clean edges. Thickness 3/16 inch. Size given is in inches.

Z481 7x10 ..... \$ .80      Z484 7x13 ..... \$1.38  
 Z482 7x12 ..... .90      Z485 7x21 ..... 1.65  
 Z483 7x14 ..... 1.08      Z486 7x24 ..... 1.95



Nationally Advertised.

**RICO**

The Mark of Guaranteed Products

**THE BEST BY TEST**

Sooner or later you will build your own and you will want the best. The "RICO" Kit is made of only the highest grade materials obtainable and manufactured under the supervision of Radio experts. It has been tested by 3 Radio Laboratories and passed by them. You therefore have the opinion of technical men to guide you in your selection. And the cost is not prohibitive — \$15.00 complete.

**Tuned Radio Frequency**

BUILD YOUR OWN WITH THIS SET.

Complete "RICO" Kit \$15.00

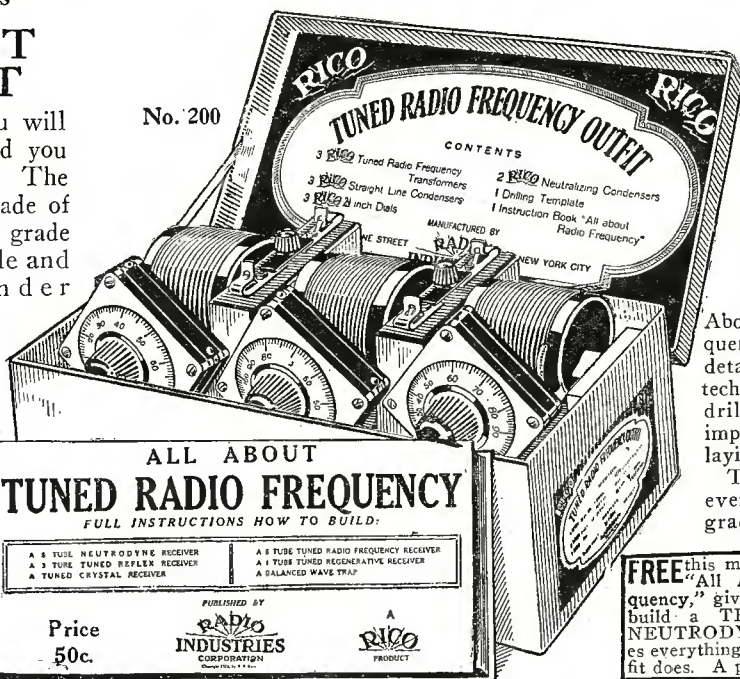

Contains 3 "RICO" Radio Frequency Transformers, coupled with the "RICO" Straight Line Condensers and Dials and two "RICO" new model Neutralizing Condensers. The booklet "All About Tuned Radio Frequency" is complete in all details, without the use of technical language. Two drilling templates make it impossible to go wrong in laying out the panels. This is the greatest value ever offered for a high grade product.

**FREE** this month. Eight page booklet, "All About Tuned Radio Frequency," giving full instructions how to build a **THREE TUBE REFLEX NEUTRODYNE** outfit that accomplishes everything a five tube neutrodyne outfit does. A postal-card will bring it.

**"RICO" STRAIGHT LINE CONDENSER**

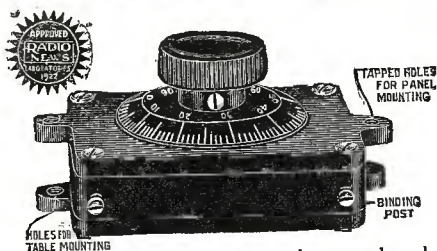

All Types \$1.75 Each

As the electric tramway has replaced the horse-drawn street cars, so will the RICO Straight Line Condenser replace the old mesh plate type. The Rico Straight Line is dustproof and constant. It occupies two-thirds less space and can be had in .001, .0005 or .00025 mfd. capacities. Made for both panel and table mounting. One complete revolution of the dial from minimum to maximum. The dial has 100 point marking over 360°. Solidly built and impossible to short.

No. 411—Straight Line Condenser .00025.....\$1.75  
 No. 423—Straight Line Condenser .0005.....1.75  
 No. 450—Straight Line Condenser .001.....1.75

**"RICO" NEUTRALIZING CONDENSER**



No. 205

Another "RICO" Product to help make a good circuit better. Made of unbreakable parts, Bakelite base, easy to adjust. Simply turn the knob. Extremely low capacity to give the best results. Tried, tested and approved by leading laboratories. This is the same neutralizing condenser contained in the famous RICO Tuned Radio Frequency Kit and is sold separately to meet the popular request of radio fans.

No. 205 Condenser each \$0.50

WHEN A BETTER PRODUCT IS MADE, RICO WILL MAKE IT

**COUPON** RN7

Radio Industries Corp.,  
 131 Duane St., New York, N. Y.

Gentlemen: As my dealer cannot supply my needs, kindly ship to me direct the following material, for which I will pay the postman on arrival.

.....  
 Name .....  
 Address .....  
 City .....  
 My dealer's name is.....

**RADIO INDUSTRIES CORPORATION**  
 131 Duane Street  
 New York

Cable Address: Ricotrade, New York

**DEALERS EVERYWHERE:**  
 Consistent advertising in all leading periodicals is creating a tremendous demand for "RICO" Products. Write to us for our complete catalog and proposition of live wire merchandise at money making prices. Be in line to supply your trade with "RICO," the 100% guaranteed merchandise.

RICO RICO RICO RICO RICO RICO RICO RICO RICO RICO



Nationally Advertised

**RICO**

The mark of Guaranteed Products

\$ **15.00**

No. 120  
Patented  
Dec. 25, 1923

# EVERY STATION Is Reproduced With Clarity Tone and Volume

THROUGH THE  
MARVELOUS

**GRAND OPERA**  
LOUD SPEAKER

No 120

THE MASTER  
OF THEM ALL

Proclaimed by users to be the wonder of the age. You get so much for so little when you consider the price of this marvelous loud speaker. Tunable and adjustable by means of the VOLUMETER (Pat. Dec. 25, 1923) and no metal can touch the diaphragm.

Like the waters of the brook flowing gracefully on to the river, so does the broadcasting come to you through the throat of the RICO GRAND OPERA.

No additional batteries are required. Operates best on two stages of amplification.

Insist on the GRAND OPERA. If your dealer cannot supply you, then order direct with coupon below.

24 IN. HIGH  
LARGE BELL  
BLACK FINISH



**RADIO  
INDUSTRIES**  
CORPORATION

131 Duane St. New York

Cable Address: Ricotrade, New York

SEND NO MONEY

Radio Industries Corp. R.N. 7  
131 Duane St., New York City

Gentlemen—Please send me by Parcel Post 1  
RICO GRAND OPERA LOUD SPEAKER No. 120,  
for which I will pay the postman the amount of  
\$15.00.

Name .....

Street .....

City ..... State .....

131 DUANE STREET, NEW YORK

WHEN A BETTER PRODUCT CAN BE MADE—RICO WILL MAKE IT!





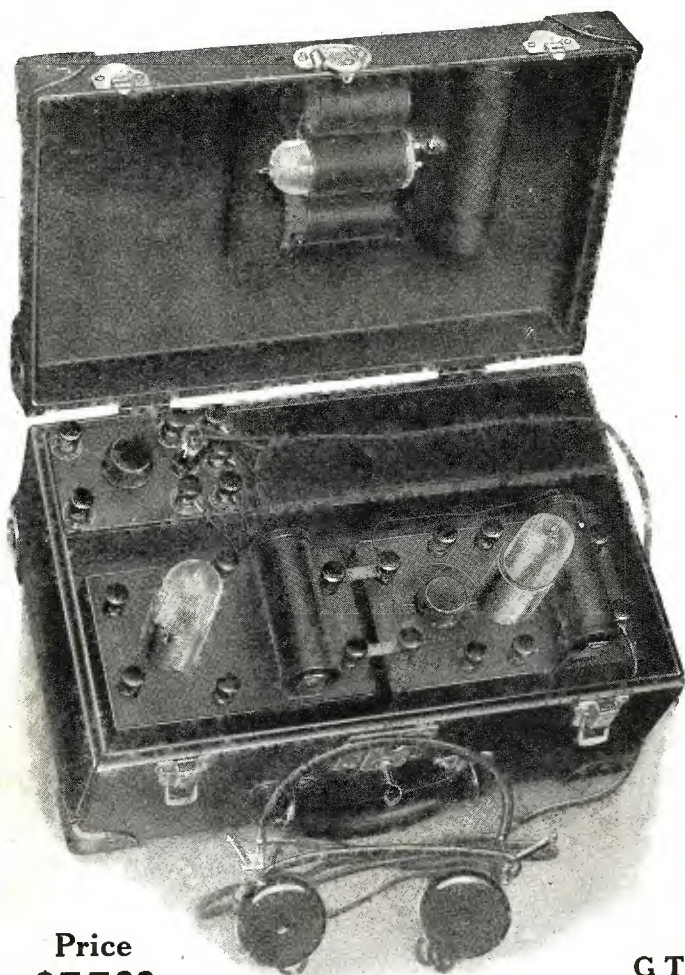

Price  
**\$55.00**

GT  
20



ANY months of patient experiments and research tests under all possible conditions by masters of radio engineering have at last produced the perfect portable radio receiver—just in time for the out-of-door season.

Now you can have the finest possible radio reception—clear and loud, free from distortion, wherever you may go, best in camp,—auto tours—at the seashore—in the mountains,—on the lakes,—at summer hotels—anywhere. Think of listening to this summer's political speeches while in camp or on your auto trip!

NATIONAL  
**AIRPHONE**  
CORPORATION

18 HUDSON ST.

NEW YORK

-----S-E-N-D N-O M-O-N-E-Y-----

National Airphone Corporation,  
18 Hudson Street,  
New York City.

R N 7

Gentlemen:

Please send prepaid one No. .... MONODYNE portable outfit, for which I will pay the postman, upon delivery, the advertised price.

Name .....

Address .....

City..... State.....

# Monodyne PORTABLE Outfits

## Technical Description Model GT-20

The illustration shows the two tube model GT-20 portable Monodyne set. This set with telephone receivers will easily receive all broadcast within a range of 1,000 miles or more. Will operate a loud speaker within a radius of 100 miles with moderate volume. Only one control knob used, under ordinary conditions. New volume control shown in upper left hand corner for very fine regulation when receiving long distance. *The outfit does not include phones, tubes or batteries.* The battery compartment is located underneath the instrument board. There is sufficient space to carry telephone receivers and aerial equipment. With the outfit is furnished FREE a complete aerial equipment. On the inside of the cover there is a neat leather holder in which three tubes can be carried. Size of case 7½"x9"x14¼", covered with Walrus Grain Fabrikoid. Weight complete with batteries, phones, tubes, aerial, etc., 15 lbs. Solid brass fittings, leather corners—A BEAUTY. Strongly reinforced and braced leather handle.

MONODYNE—the perfect portable radio set, entirely self contained. Concealed dry batteries, only one tuning control, *new volume control*, nothing to adjust, nothing to get out of order.

## MONODYNE Three Tube Portable Set Model GT-30

This set is full panel mounted, with automatic filament control jacks on each tube and has one vernier tuning dial and volume regulator. Marvelous for volume and loud speaker reception. Extremely sharp tuning, eliminating all interference. The ideal set for the vacationist, tourist or motorist.

Size 11½ x 14 x 6¾.

GT-30—three tube MONODYNE complete without batteries, tubes or loud speaker, but with complete aerial equipment—

**\$75.00**

Order from your dealer, or sent post-paid to any address in the United States. Dealers write or wire for exclusive Agency proposition.



# Earn \$5<sup>00</sup> to \$20<sup>00</sup>a Day in RADIO

You can! Hundreds of ambitious men are already earning thousands of dollars in this wonderful new industry—many working only in their spare time. Mail coupon below for Free Book which describes fully the amazing money making opportunities in Radio and tells how YOU can earn from \$5,000 to over \$10,000 a year!

The astounding growth of Radio has created thousands of big money opportunities. Millions of dollars were spent during the past year on Radio—and thousands of young men are needed right now to meet the ever increasing demand of work. Never before has there existed so many and such remarkable opportunities for making money in this wonderful new field.

Men are needed to build, sell and install radio sets—to design, test, repair—as radio engineers and executives—as operators at land stations and on ships traveling the world over—as operators at the hundreds of broadcasting stations. And these are just a few of the wonderful opportunities!

### Easy to Learn Radio At Home In Spare Time

No matter if you know *nothing* about Radio now, you can quickly become a radio expert, by our marvelous new method of practical instruction—instruction which includes all the material for building the latest up-to-date radio apparatus.

Scores of young men who have taken our course are already earning from \$75 to over \$200 a week. Merle Wetzell of Chicago Heights, Ill., advanced from lineman to Radio Engi-

neer, increasing his salary 100% *even while taking our course!* Emmett Welch, right after finishing his training, started earning \$300 a month and expenses. Another graduate is now an operator of a broadcasting station, PWX of Havana, Cuba, and earns \$250 a month.

Still another graduate only 16 years old, is averaging \$70 a week in a radio store.

### Wonderful Opportunities

Hardly a week goes by without our receiving urgent calls for our graduates.

“We need the services of a competent Radio Engineer.”

“We want men with executive ability in addition to radio knowledge to become our

local managers.”—“We require the services of several resident demonstrators”—these are just a few small indications of the great variety of opportunities open to our graduates.

Take advantage of our practical training and the unusual conditions in Radio to step into a big paying position in this wonderful new field. Radio offers you more money than you probably ever dreamed possible—fascinating easy work—a chance to travel and see the world if you care to or to take any one of the many radio positions all around you at home. And Radio offers you a glorious future!



### Send for FREE BOOK

Learn more about this tremendous new field and its remarkable opportunities. Learn how you can quickly become a radio expert and make big money in Radio. Find out what remarkable successes our graduates have had—even a few weeks after their training finished.

We have just prepared a new 32-page booklet which gives a thorough outline of the field of Radio—and describes our amazing practical training in detail. This Free Book, “Rich Rewards in Radio” will be sent to you without the slightest obligation. Mail coupon for it *now!*

**1000 Mile Radio Set**



**FREE**

In order to complete your practical instruction at home, learning by actual experience, this splendid regenerative receiving set is now included in addition to material for building the latest up-to-date receiving sets without the slightest additional cost.

Trusco Reg. Licensed Armstrong U. S. Patent No. 1,113,149

### National Radio Institute

Dept. 13GA  
Washington,  
D. C.

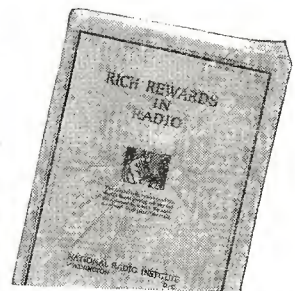

National Radio Institute,  
Dept. 13GA, Washington, D. C.

Please send me without the slightest obligation your Free Book, “Rich Rewards in Radio” and full details of your special Free Employment Service.

Please Write Plainly.

Name ..... Age.....

Address ..... Occupation.....

City ..... State.....

Radio Firms—Secure practical Radio Experts among our graduates. Write us today.



# Ask your neighbor —he knows

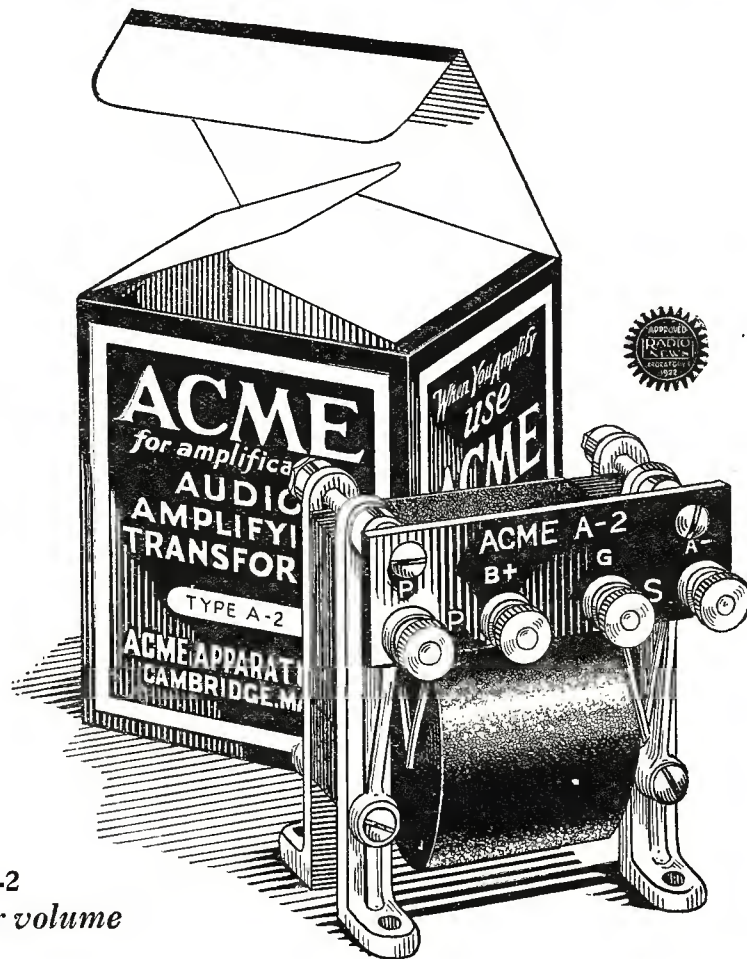

ACME A-2  
*for volume*

**A** CME Transformers are used by thousands of radio owners to get increased range and louder, clearer radio. Acme Transformers give maximum amplification without distortion. Each transformer is tested and carries a guarantee tag. The name "Acme" is guarantee of best results. Use Acme Transformers in the set you build. Look for them in the set you buy.

ACME APPARATUS COMPANY  
*Transformer and Radio Engineers and Manufacturers*  
Cambridge, Mass.

# ACME

*~ for amplification*



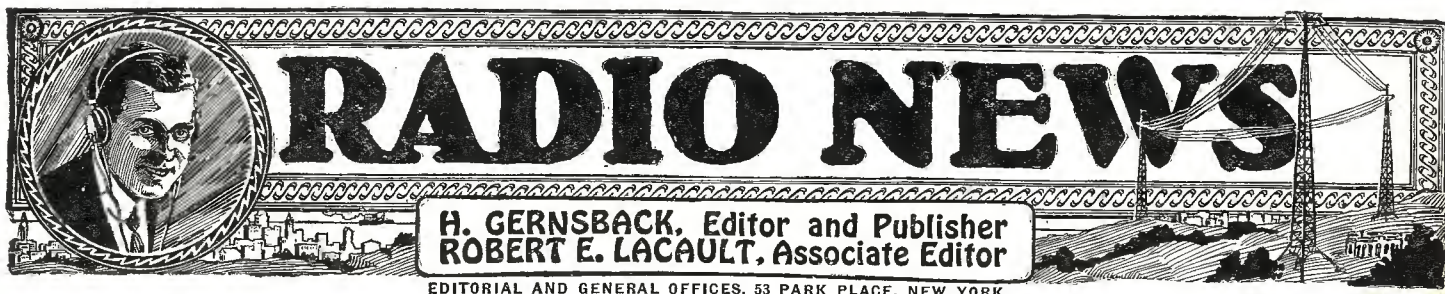

Vol. 6

JULY, 1924

No. 1

## Radio Patents

By HUGO GERNSBACK

**L**IKE most new industries, radio has its patent phase, but unlike other similar industries, it has not been built up upon a strictly patent foundation. Take, for instance, the moving picture industry, the phonograph industry, and the automobile industry; these have been built up on a patent foundation—broadly speaking. Curiously enough, the radio industry, based upon a revolutionary invention, so to speak, has no patent platform. When Marconi first brought out his wireless apparatus, he did indeed take out a number of patents, not only in his native country—Italy—but subsequently in Great Britain, later in America and still later in all civilized countries. It should be remembered that his patents could not be basic because the real discoverer of wireless, Henrich Hertz, a German professor did not take out patents on the original idea. If Marconi had made a basic invention, instead of its having been made by Hertz, he would have had the wireless industry in his control for at least 17 years. So the fact remains that his patents did him very little good. Everyone who so desired went into the wireless business, every company in the business had its own system and while there was some radio litigation, it was of no great importance. As far as apparatus was concerned, anyone and everyone could make and sell it, with but few exceptions. This was particularly true of receiving outfits.

This was the situation when broadcasting started. The situation, however, has not changed very greatly, although there are patents on broadcast transmitters. Those patents involved in the broadcasting transmitter practically all center around two pivotal points—the vacuum tube and certain radio circuits. On the other hand, it is possible to construct a broadcast station without infringing any patents.

On the receiving side we find a great many patents which do not seem to do their owners much good. The most famous patent, the Armstrong regenerative circuit—possibly the strongest of the lot—has just now been invalidated in favor of De Forest, who seemed to have conceived the idea before Armstrong. Even De Forest will not be able to enjoy the full fruits of his invention, due to the peculiar workings of the radio art.

In the instance of the Selden automobile patent, the inventor reaped worth-while benefits for the reason that it was practically impossible for a private individual to build a car for himself from parts he could buy in an automobile accessory store. Not so with radio. Despite Armstrong, or now De Forest, the average experimenter can walk into any store and buy the parts for a set which contains the patented regenerative circuit with no law to stop him. It is calculated that of the 3,500,000 outfits in America today, fully one-half are

such home made outfits. This is a peculiarity of radio, possibly not found in any other industry.

Not only do the dealers openly encourage the sale of such parts, but are openly selling all the parts sufficient to build a certain patented circuit with impunity. The reason is that as long as the outfit is not sold complete or wired up, it is impossible to prove in any court that such apparatus could not be used in a different circuit from the patented one. The dealer or manufacturer of these goods does, of course, not really infringe a patent any more than does a magazine when it publishes a patented circuit. Therefore, as far as patented circuits are concerned, they produce revenue only when a manufacturer sells a complete outfit, ready wired.

The only other patents of any real value to the owners are those of the vacuum tube. Here we have an instrument that cannot possibly be made at home. It requires expensive machinery, much capital and wide and long experience. Before the Fleming patent expired early this year the vacuum tube situation probably was the strongest in the radio industry.

The owners of the vacuum tube patents successfully enjoined infringers from making tubes and this is practically the only case where the owners of a basic radio patent reaped the full benefit of their patents.

With the expiration of the Fleming valve patent, the situation regarding the vacuum tube is no longer strong. Soon anyone with the necessary money will be in a position to make tubes.

It would seem, therefore, that only basic patents are of value in radio and from the very nature of the art there can be only a few such patents. Unless a radio invention is basic, there would appear to be little use for patenting the invention. The owner must be the judge.

On the other hand, what does not seem to be an important invention today may prove so tomorrow. The writer would strongly urge all those who do much experimenting to make careful notes of all their experiments. If you run across something that is new, you should put the data concerning it on paper and have it witnessed by a notary. This only costs a few cents and may prove of tremendous value later.

Then there are, of course, many mechanical patents of high value in the radio industry. There are excellent patents on such items as telephone plugs, head bands, loud speaker construction, detector detail, condenser construction, grid leaks, rheostats, etc.

Some of these have been extremely valuable for their owners. If properly drafted by a competent patent attorney, such patents will effectively protect their owners.

It may be interesting to know that fortunes have been made in articles of this kind which are simply improvements on existing devices and are not at all basic.



# Radio to the Rescue

By J. FARRELL

The recent succession of mine tragedies has made an indelible impression on the public and the U. S. Bureau of Mines has taken steps to prevent similar occurrences. Mr. Farrell gives an interesting description of the part radio will play in rescuing mine workers in the future.



A portable experimental loop transmitting and receiving station used in studying the absorption of signals in passing through beds of coal, effects of metallic conductors and mine water.

**“R**USH help! Trapped on thousand-foot level near shaft six!” The call for aid coming from a group of miners entombed in Mine 7 in the Pennsylvania coal fields was plainly heard at station WWY, the radio laboratory of the Bureau of Mines at Pittsburgh. A fleet of rescue cars was soon racing to the scene of the disaster, and the work of digging out the trapped miners was begun. As the rescue party cut through the wall of the cave-in, the miners inside directed their activities.

No, this is not wholly imaginative. It is a picture of the utilization of radio in mine rescue work, as made possible by recent experiments conducted by the United States Bureau of Mines. Radio, *per se*, has been found ineffectual in underground communication, but the practicability of a system of line-radio or wired-wireless has been demonstrated.

The Bureau of Mines line-radio system utilizes trolley wires, mine tracks, compressed air and water piping, cables and similar carriers for voice transmission.

In a series of tests a 10-watt telephone transmitting set was mounted on a mine locomotive and the outfit connected to the harp of the locomotive trolley pole. A portable receiving set, detector two-step audio-frequency, was used on the surface and connected to a 50-foot single wire antenna. The mine is a shaft about 400 feet deep. There was no difficulty in picking up the underground moving locomotive station as long as the receiving antenna was placed in the vicinity of any electrical conductor extending into the mine. The signals were picked up readily when the receiving antenna was near the surface trolley wires, power and lighting circuits, telephone lines, and hoisting cables, the relative magnitude of the signals from the different carriers being in the order named.

In a series of tests conducted to determine the transmission range underground, a portable 10-watt transmitter was mounted on a storage battery locomotive. A short three-wire antenna mounted on the top side of the locomotive was used for transmitting. It was found that the range was dependent

almost entirely upon the type of conductors present, their electrical constants, and other factors. The transmitting range of the set in the average coal mine was only a few hundred feet when no conductors were present, but several thousand feet when operating in the vicinity of metallic carriers.

#### LOOP TESTS

Similar effects were obtained in another series of tests when using a loop aerial for transmission and reception. In practically every case where the receiver was placed at a sufficient distance underground to be shielded, it was found that the loop antenna made for better reception when near metallic carriers. Moving the set to another location in the vicinity often resulted in the loop pointing in a different direction. A study of nearby conductors indicated that when using a capacity type antenna, such as a wire stretched along the mine entry, the loss of directional properties cannot as a rule be noticed.

The tests made by the Bureau indicated that the absorption of radio waves in pene-



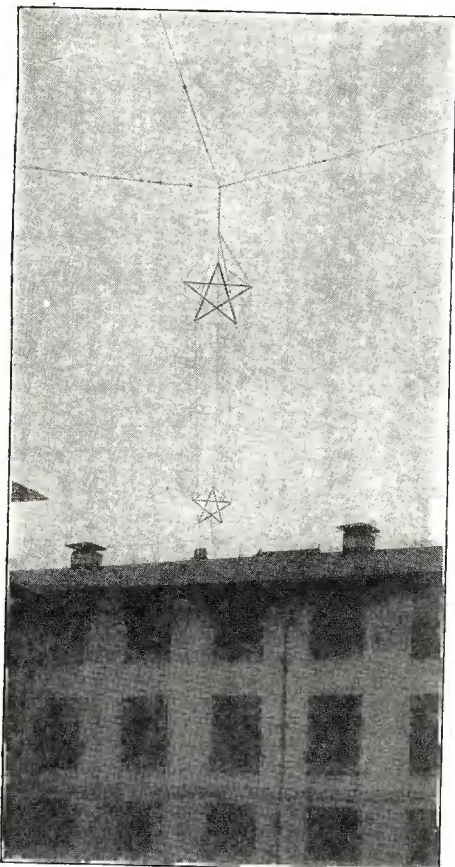

The antenna system used by the Underground Communication Laboratory of the Bureau of Mines at Pittsburgh, Pa.

trating the earth depends mainly upon the relative conductivity of the strata through which the waves are propagated. The conductivity of the earth depends largely upon the quantity of water present and its sheet distribution and to a somewhat less extent on the type of ore or mineral. Some strata such as coal, shale and some rock formations were found to be good insulators, and often to possess a good dielectric value when dry.

The metals recovered from ores may be excellent conductors, but their ores as they



An experimental loop receiver mounted on a storage battery locomotive. This and similar apparatus is being used to study the attenuation of waves in penetrating the earth.

exist in the earth are not necessarily good conductors the tests showed. This is due to the fact that the metallic particles, if existing as such, are separated by the matrix which, as a rule, is a non-conductor. In most ores the metals do not exist as such, but as chemical compounds.

Coal, while often containing as high as 95 per cent. carbon, is usually an excellent insulator. Practically none of the carbon in coal is existent in the free state but is present in the form of a complex bituminiferous material—a pitch-like material, which is an insulator. Practically all the eastern coals are of such close structure as to contain very little “free” water or moisture. The “combined” water does not affect the electrical conductivity. Many seams both horizontal and vertical between strata con-

tain sheet waters and seepages which prevent transmission of signals through them for any considerable distances.

#### SOME CONDUCTORS

Other minerals such as hematite and certain sulphide ores are conductors even when dry. In all cases, however, the conductivity of beds of ores and minerals is greatly increased by the presence of water. Mine waters containing relatively large quantities of dissolved salts are good electrolytes. There is a high attenuation of the waves in penetrating such waters and when horizontal uniform strata formation exists with numerous sheet waters only a short penetration of the radio waves may be expected. The thickness and number of such sheet water formations limit the penetrating power of the radio signals. Similar effects have been noted in numerous Government tests conducted in submarine signaling. It has been found that even the comparatively high-powered transmitting stations aboard battleships cannot be relied upon for continuous communication with submarines when the latter have submerged to a depth even approaching that of the average shallow coal mine.

The Bureau of Mines' tests in receiving from surface stations showed that the signal strength is not greatly affected at a short distance underground, but drops off very rapidly as soon as a depth below the surface is reached approximating that of seepages and the sheet water formations. This holds true when there are no metallic conductors present to act as carriers, but in mines having electric light and power circuits, such conductors carry the signals down from the surface, and often with inappreciable, or but slight diminution in intensity.

The extent to which such conductors act as carriers for the high frequency waves depends upon their electrical characteristics and the frequency of the wave. If the electrical circuits are such as to offer high reactances to the high frequency currents, there is a great loss in signal strength. However, the capacities existing between machine windings, parallel wiring, etc., are often of sufficient magnitude to offer a relatively low reactance by-pass or shunt for the high frequencies.

(Continued on page 124)

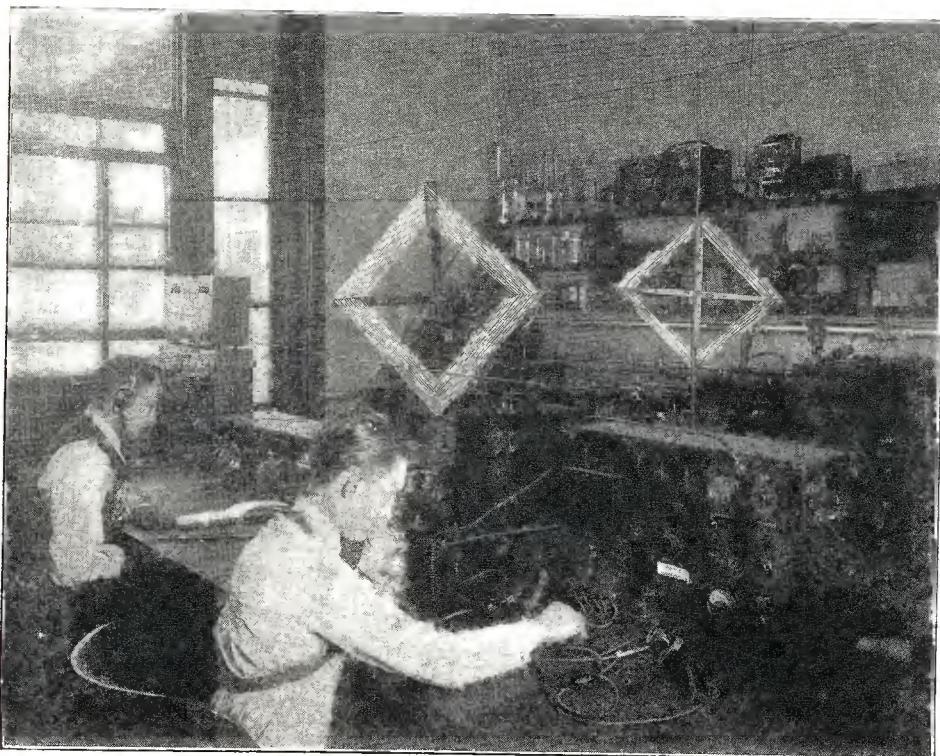

Various types of transmitting and receiving apparatus is used by this laboratory to keep in touch with portable field stations making tests in the coal mines in the vicinity of Pittsburgh.



# Broadcasters, Broadcatchers and Broadcasters

By ARMSTRONG PERRY

**T**HREE of the elements in the complex and difficult broadcasting situation are the broadcasters, the broadcatchers and the broadcasters.

By broadcasters is meant those persons who, having something to say, play or sing to the world, find the microphone a channel through which to reach it. By broadcatchers is meant the listeners-in who are supposed to be catching the speech or music of the broadcasters. By broadcasters is meant the persons and concerns who pay the bills at the transmitting end and who, presumably, hope and expect that their expenditures will be justified by either a direct or an indirect return in cash, or by some adequate result of another sort.

It has become a habit among radio writers and editors to state that the listeners-in, the broadcatchers, express so little appreciation of the programs put into the air from hundreds of stations, day after day, that the broadcasters are becoming discouraged. The broadcatchers have even been threatened with the collapse of broadcasting if they do not support it better with applause cards and letters. They have taken the threat with a grain of salt, in view of the battle that is being waged for supremacy in the ether. It became apparent, however, that an investigation was needed to clear the atmosphere and the editor of RADIO NEWS invited the writer of this article to find out from broadcasters, broadcatchers and broadcasters just what the situation is and how it can be improved, if it needs improving.

Accordingly, a letter was sent to each station from which programs for the general public are transmitted. An attempt was made to include in brief questions covering the whole situation. A great many managers of stations replied promptly, courteously and with letters that showed constructive thought on the problem. Others indicated by their silence that the listeners-in are not the only folks who are pessimistic.

## NOT DIFFICULT TO SECURE ARTISTS

One of the statements that has been made frequently is that the shortage of applause has made it difficult to secure artists for broadcasting. Like most things that "everybody is saying" this proved to be untrue. How such false impressions gain currency as truth must be accounted for by the human weakness for passing along gossip that sounds interesting. A tabulation of the replies from stations showed that the satisfied artists outnumbered the dissatisfied ones by more than three to one. It is true that they often express disappointment at the small number of listeners who mentioned them by name. Naturally, an artist who is told that a million or more persons in all parts of the country, and outside of the country, are listening to his or her performance, expects that at least one in a hundred will be courteous enough to send a post card of appreciation when requested to do so. The artists do not know how small a percentage of replies satisfies the concern that buys a page of advertising in a magazine. That advertisers have been known to buy page after page, at what seems to the uninitiated as enormous prices, in order to reach a single large customer is not generally known.

Artists who entertain us by radio should not all be classed as advertisers, but the fact that the advertising received keeps the professionals seeking for opportunities to appear on the programs of the leading stations shows that they appreciate the publicity. Those who participate only in order to give pleasure to

their hearers still have the assurance that they are heard and appreciated to a greater extent than the acknowledgements show. An artist who has achieved such outstanding fame that the whole world is willing to pay large prices to hear him may quite properly demand his own price for an appearance. Success is entitled to its compensation. But what really happens is summed up in the following paragraph from one of the best-known broadcast stations in the east:

## SELECTION THE DIFFICULTY

"As to securing artists, we do not have difficulty in filling the time which we have available. In fact, it is a process of selecting artists from those who are available. It is rarely necessary to induce artists to perform. Usually their first performance is animated by the publicity value which accrues to them, but later appearances are animated nearly as much by generosity as by selfish motives. There is a growing realization on the part of artists who appear at our station that they

**W**E requested Mr. Perry to make a country-wide investigation into the broadcast problem regarding the much discussed radio applause. Does the performing artist care for applause? Is it difficult or easy to get performers to broadcast nowadays? Do they threaten to quit entirely, because of lack of applause?

Mr. Perry has been in communication with every broadcast station throughout the country and the present article is the result of his investigations.

Every broadcast listener, every amateur, every manufacturer, every dealer, in short, the entire radio world is tremendously interested in the problem. We recommend the article strongly to you. —Editor

are performing a helpful service which is appreciated by many listeners, particularly to those to whom radio brings, perhaps, the only real happiness they have. We have had many instances in which artists have been able to increase their incomes through engagements secured as a result of inquiries obtained through broadcasting."

## ARTISTS ENJOY BROADCASTING

Another supervisor of programs says of the artists: "Most of them enjoy broadcasting—otherwise they wouldn't travel a distance of 12 miles from the city to assist with concerts.

It cannot be said that the securing of competent artists is the easiest thing about broadcasting. Like everything else, the harder the thing is to obtain, the more valuable it is. However, we have found quite a willing spirit among the artists of the city, and have procured the hearty co-operation of some of the city's best."

A Middle West station says: "When we put on a musical program we are flooded with telephone calls, some of which are from the surrounding towns. For about two days after the program, we receive postal cards and letters from a radius of 50 to 60 miles." From farther west came the reply: "The

majority of the artists enjoy the work and after having appeared at our station once, are only too glad to return. In nearly two years I have only had two cases in which artists would not come back a second time. We make it a point to send them either the originals of the letters sent in commenting on their programs, or copies. This is definite proof to them that their work is of value. Many of them have obtained engagements by virtue of their appearance at our station. That is our principal means of remunerating them for their services."

A New England pioneer in the broadcasting game reports: "The best applause is that which comes over the telephone during the course of the evening's entertainment. Whenever it is possible we let the artists receive the message. If, for instance, some one calls in, we answer the telephone and as soon as the criticism is found to be favorable, we request the caller to talk with the artist in person. It is the greatest applause I know of. . . . All of our artists are enthused about broadcasting. They are glad to come back whenever we invite them. In many cases they pass the good word along to friends who, in their turn, come to our studio to entertain."

A voice from the South remarks: "We find the interest in broadcasting increases every day. Our mail runs about 2,000 letters a week from listeners who express appreciation of our concerts, and it is rare (knock wood) that we receive a kick. Competent artists are coming more and more to realize the great assets of broadcasting. If they are amateurs they are pleased and encouraged by seeing a large number of letters which mention them favorably. If they are professionals they realize that there is no form of advertising that brings as quick results as broadcasting. For instance, the leader of a dance orchestra, after a second concert at our radio station, reported to me that he had had opportunities to accept 16 out of town engagements in places which, otherwise, would never have heard of him. A large broadcast station might be likened to a huge electric sign in the sky without advertising matter on it, and the performers who take part in the concerts are each night privileged to write their names upon this sign which millions of people see. Such a value for so small an effort brings many requests to our station."

## NEWSPAPER PUBLICITY ATTRACTS

From New Jersey comes this statement of the situation: "These artists are induced to perform particularly because of the newspaper publicity we are able to give them through the co-operation of local dailies and because of the advertising value of broadcasting to them. Their comments regarding broadcasting have always been favorable."

That the condition indicated by the above letters is not confined to any one section of the country is proven by the following from the Pacific Coast: "Thus far no difficulty has been experienced in getting the very best material for radio. Only two or three musicians in the city are personally against contributing their services. All musicians, except a few who broadcast for the pure fun or generosity of it, do so for the publicity, both by way of radio and in the newspaper columns. Especially is this the case with music teachers. Most musicians are extremely interested in broadcasting as manifested in their anxiety to know how numbers are received."





Coming back to up-state New York, we read: "So far, we have experienced no difficulty in procuring competent artists to broadcast from this station, and we believe they will be willing to offer their services in the future. The only reward they receive for their efforts is the applause contained in the mail we receive from those who listen in. The mail received by us is continually increasing, and so long as this condition prevails we are sure that the artists will feel that they have been amply paid for their services."

From the coal fields of Pennsylvania a director of broadcasting writes: "Day after day I have to turn down talent. Only once in a while do I use professional talent. Vaudeville artists are anxious to appear for the picture layout and boosting they get in our paper, but I do not use them unless we are in a hole at the last minute."

A New England cotton mill town sent this statement: "As we have a small station, our response, which practically comes from local listeners, has been very good."

Bilingual, Canada finds similar conditions to those on this side of the border. A newspaper station reports: "We do not find it difficult to get competent artists because of the publicity we give them in our paper. Our current radio program is now published by about 800 newspapers in Canada and the United States."

**CONSTANT PROCESSION OF APPLICANTS**

A banking institution in the Middle West that has taken up broadcasting has no more difficulty in securing talent than newspapers or other stations. The manager of the radio department says: "We do not find it at all hard to secure competent artists. The only difficulty is to select the wheat from the chaff, to pick the good ones out of the constant procession of applicants who come to our station. The more established artists—who would not of their own accord come to us—we are able to persuade to go on our programs by a little selling talk concerning the advertising value of radio broadcasting. By endeavoring to get the best available talent which is interested in creating a market for its own abilities—that is, singers who are open for public engagements, orchestras anxious for bookings, and teachers who are anxious for pupils, etc.—we have practically no 'turn-downs' on requests that we make to orchestras or soloists in our city. In short, by showing them that they are getting value received for their services in broadcasting we induce them to perform. Their comments upon broadcasting show that the actual experience has given them the radio fever. They are really more enthusiastic over the fact that they were heard in some small town in Arizona than they are in the verification of the advertising value of radio."

(Continued on page 127)

The advertising value of radio can be compared only to an immense electric sign atop giant towers, so situated as to be discernible for miles around. Artists in all walks of life are coming to the realization that radio is one of the greatest and most effective advertising mediums of the present time.



# Radio Experts of the Future

**H**UNDREDS of thousands of the youths of our country are now interested and at work on radio problems. We have, then, the future inventive genius of the world already preparing to add to its great contributions. Many of the present great inventions have been made by such young men lured on by the unique and romantic characteristics of their subject.

Boys of to-day are going to be the radio engineers and experts of the future. The Chicago Boys' Club knows that the little chaps have keen minds, and is doing all it can to encourage them in the study of radio. In the radio department of the Chicago Boys' Club, No. 2, located at 1725 Orchard St., there is a complete radio laboratory and workshop, where the little fellows are given an opportunity to build and test receiving sets and experiment with various parts. The photograph shows some of the boys at work in the laboratory.

Remarkable results have been obtained in this workshop. Quite a number of the boys

have developed unusual ability in their new craft. Be it a crystal set, four-circuit tuner or neutrodync, you will find anywhere from one to dozens of them being constructed in the radio department of the Club.

The Club has now fostered the radio department for two years and has not only turned out hundreds of radio fans, but the sets made would constitute a complete radio show if brought together.

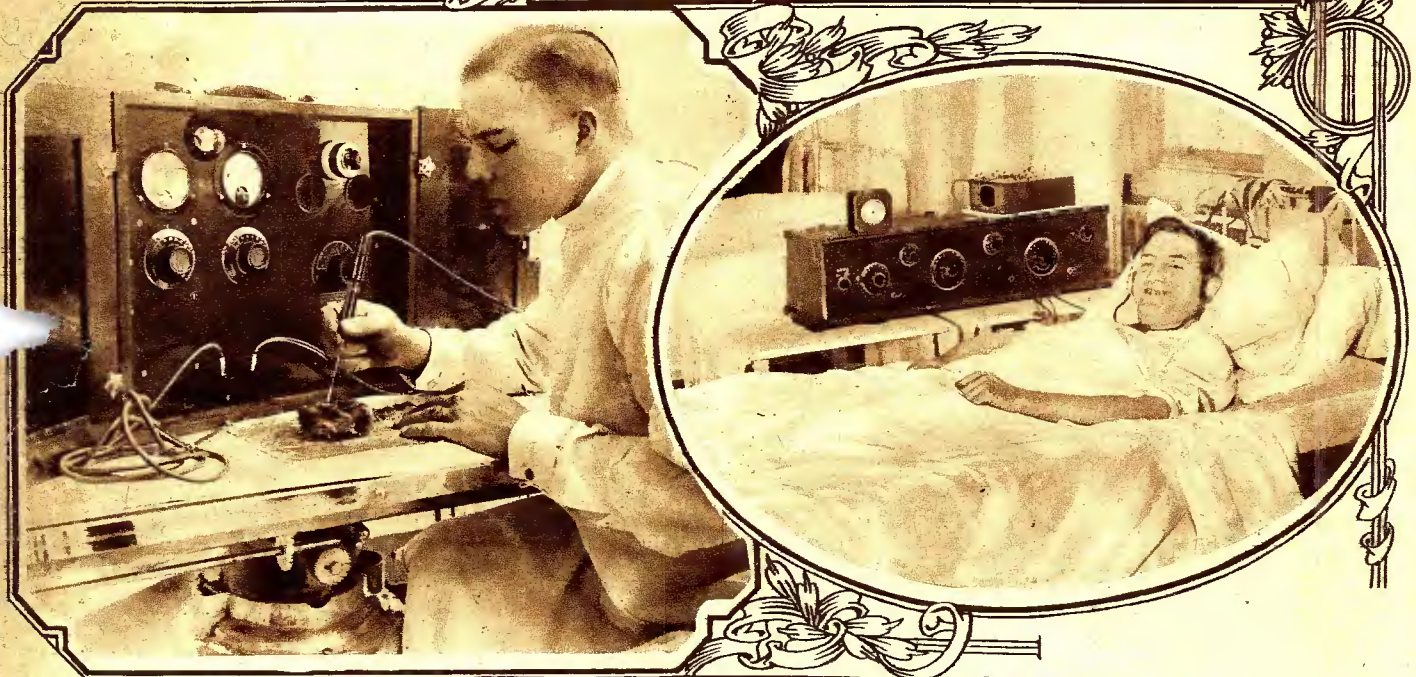

Above: Not really a knife, but more like a darning needle equipped with a rubber handle, is the new "Radio Knife," which is expected to create a revolution in the surgical treatment of certain diseases, notably cancer. The machine is called a Radio Therm and the manner in which it generates the high frequency current employed is similar to the system used in every broadcast transmitter. When one terminal is connected to the patient's body and the knife is applied, a circuit is formed and the knife literally burns the diseased tissue away in a line thinner than possible with a regular surgeon's knife. At the same time it prevents the flow of blood by searing the edges of the cut. The photo shows Dr. R. J. Carseth demonstrating the machine. © International.

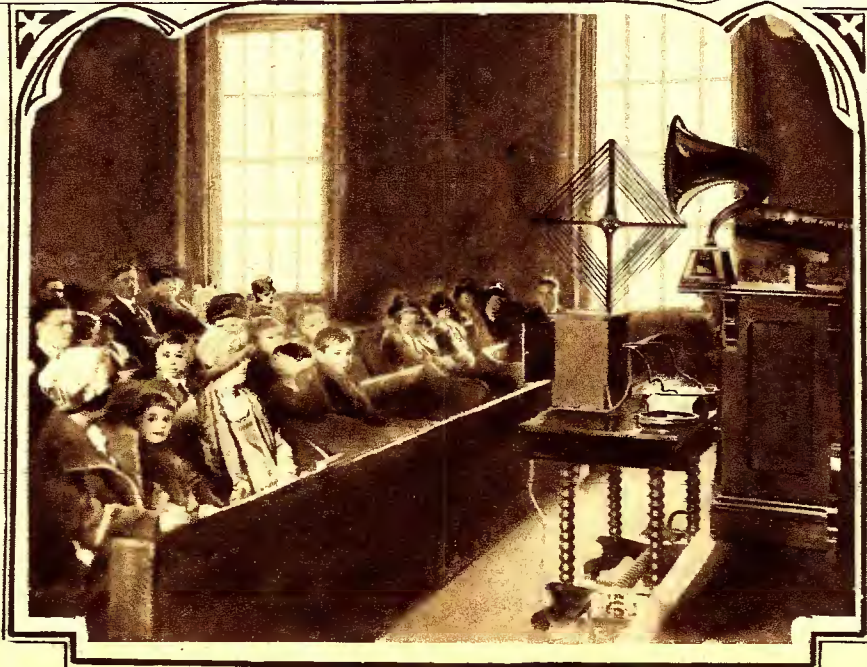

Above: Satisfied with his lot, but thinking now that there is a little more in life than the cruel war left him with, this bedridden soldier patient at the Walter Reed General Hospital in Washington, expresses his gratitude by a genuine smile to the man who made it possible, S. L. Rothafel. © Wide World Photos.

Left: When the Rev. H. J. Pulton, pastor of the Hampden (Mass.) Community Methodist Church went to Lynn, Mass., to attend a conference, folks at the Church resorted to radio for their Sunday service. A set was installed in the Church and they tuned in to the services of the South Church at Springfield, Mass. © Wide World Photos.



# Radio Pictorial



Left: Here is Paul Sollenburger, the man who attends to the transmission of the time signals from the U. S. Observatory at Washington, D. C. The signals are relayed from Washington by wire to the transmitting station, NAA at Arlington, Va., which works on a wave-length of 2,650 meters. This is a very powerful station and the time signals transmitted at noon and at 10 P.M. are heard by ships in both the Atlantic and Pacific oceans. No matter where you live, you have no doubt heard the time signals from NAA re-transmitted from some broadcast station. © Harris & Ewing

Below: Dr. Thomas broadcasting, from station KDKA at East Pittsburgh, the heart palpitations of the lovers' kiss. These palpitations, as recorded in the ultra-sensitive microphone, were plainly heard by crystal receiving set owners in England.

## THE ULTRA-AUDIBLE MICROPHONE

IT is rather hard to believe, after hearing the tick of a clock at a broadcast station in a receiving set, that a microphone more sensitive than the type now used by every broadcast station could be devised. Yet Dr. Phillips Thomas of the Westinghouse Electric and Manufacturing Co., is the inventor of an ultra-sensitive microphone, the development of which has opened up a new world of re-

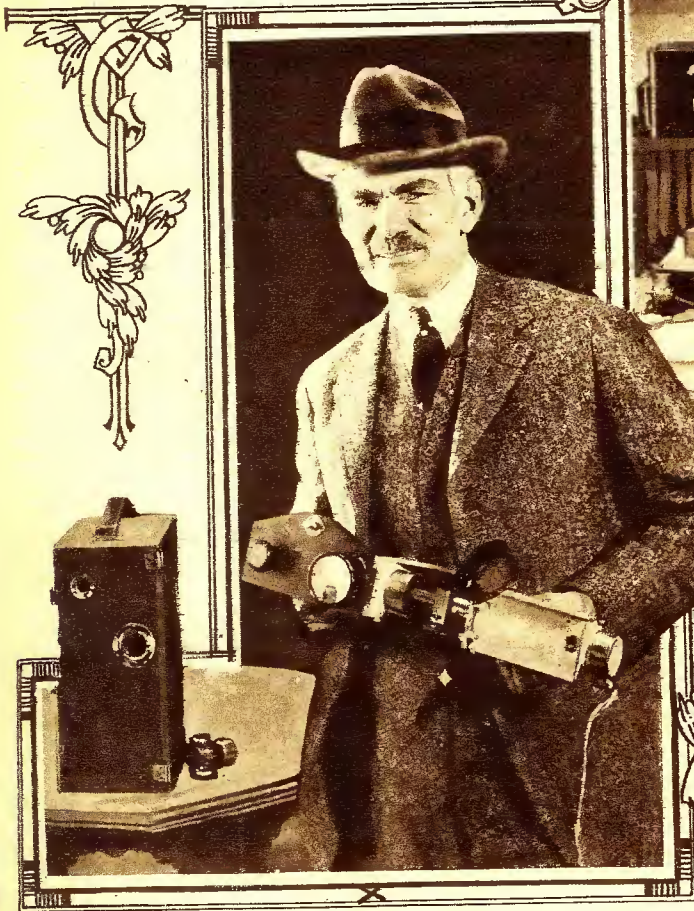
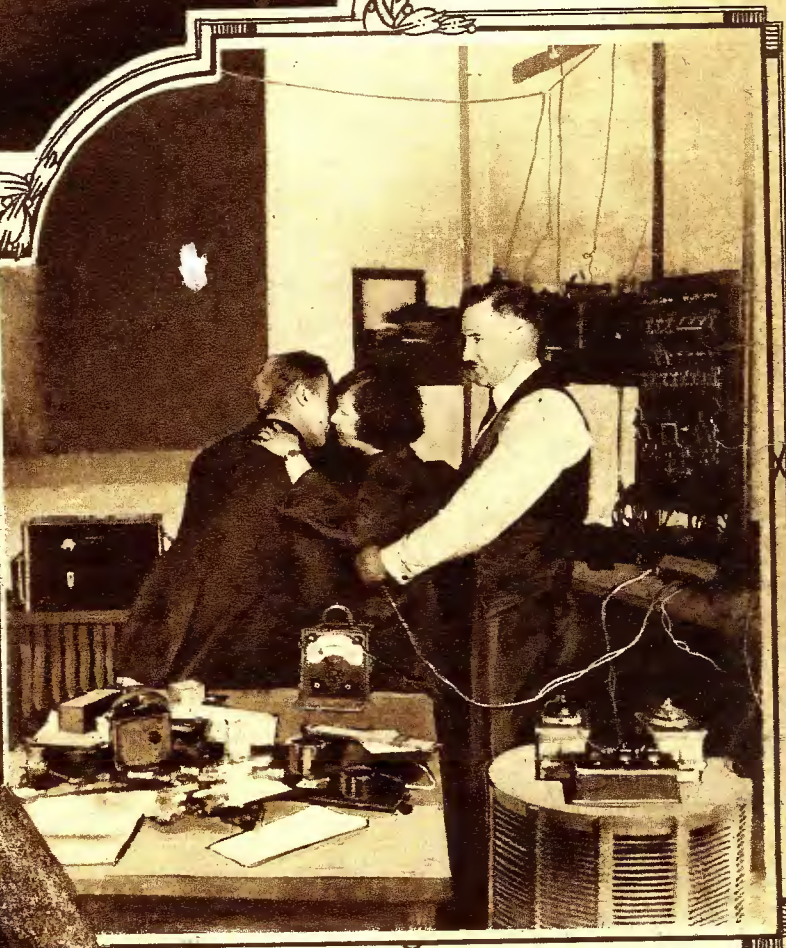

Left: Dr. Lee de Forest, inventor of the three element vacuum tube, shown with his latest invention, the Phonofilm — "talking motion pictures" which can be attached to any standard motion picture projector. This is the machine that puts the voice into the Movies.

search. With this microphone, in conjunction with some form of reproducer, it is possible to hear sounds inaudible to the natural ear. The noise a fly makes while walking, the thunder of a moth's wings while in flight, the language of the honey bee, all are revealed by the aid of the Thomas microphone.

Said Mr. Knat to Mrs. Knat: "Talk low, my dear, else the world hears what you have to say. The ultra-sensitive microphone is near-by and will broadcast your voice via radio to England, France and possibly to the North Pole. Be careful, my dear."

This new invention will also find a place in the doctor's laboratory and in this duty may take the place of the Stethoscope. It will transmit to the doctor's ear, noises that hitherto he has been unable to hear.





Above: The girl pupils of one of Chicago's public schools would not let the boys outdo them. Hence a contest was held for the making of radio sets, and prizes were offered. The girls have shown superior workmanship and attracted the attention of local experts. The above photo shows some of the prize winning sets and their owners. © P & A Photos

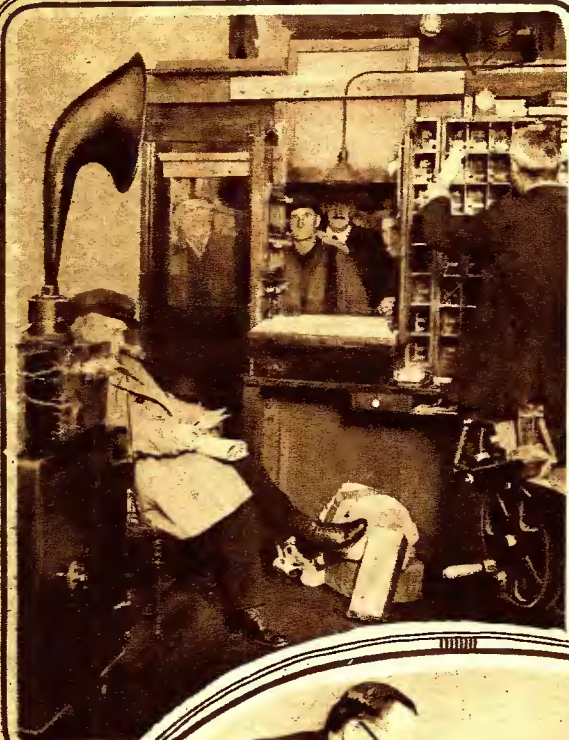

Left: William Swackhamer, the Postmaster at Whitehouse Station, New Jersey, sorts the mails to music broadcast by radio. As the melodies are amplified by a loud speaker, waiting for mail is not at all a tiresome task for the villagers. They congregate in the post office when the mail trains are due and listen to what is on the air. © Western Electric Co.

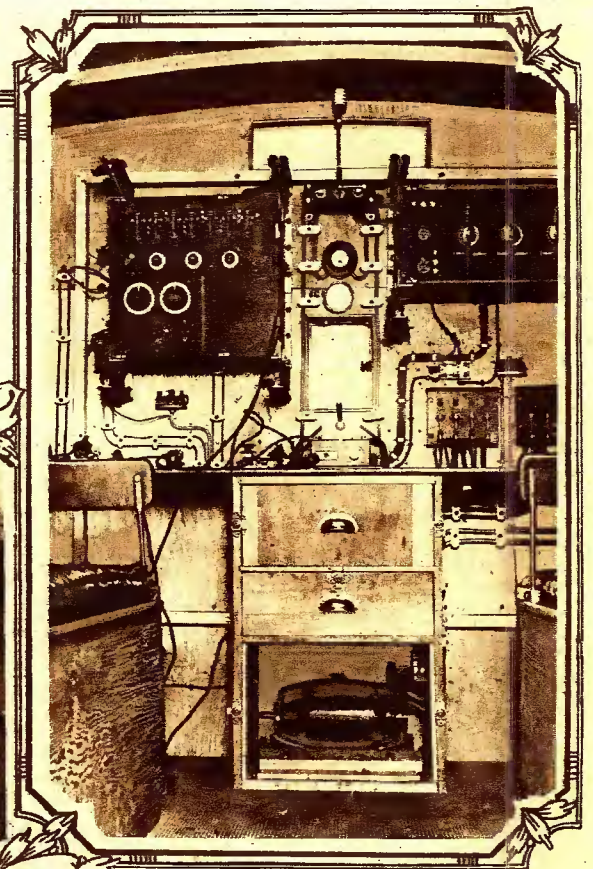

Above: Scotland Yard has just designed and has had built a completely equipped radio car from which communication can be established with Headquarters when it is traveling up to a speed of 40 miles an hour. The photo shows the interior of the car. © Wide World Photos

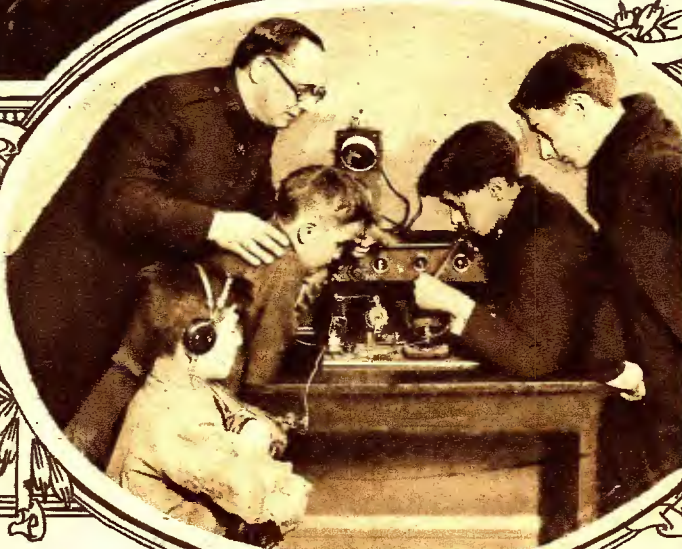

Radio works its charms over youngsters. Boys who were in danger of falling prey to bad associates were taken in hand by Capt. H. P. MacDonald of the Salvation Army, who organized a Boy's Club in New York City, and now he has them coming in for instructions in Radio, giving up all ideas of delinquency. ©Fotograms, N. Y.





Above and to the right is shown the orchestra of the Hotel Cecil in London, which has made numerous attempts to broadcast music by radio to the United States.

Above: A new combination of table lamp and loud speaker which was designed and displayed at a recent radio exhibition held at Leipzig, Germany.

Right: Dorothy, the three year old daughter of Mr. and Mrs. Babe Ruth, broadcasts her personal opinions of her celebrated Daddy.



Below: The Staccatone, a brand new musical instrument, the idea of which originated with Mr. H. Gernsback, Editor of RADIO NEWS. The one shown, which was recently used in the orchestra of the Rialto Theatre, New York City, was designed by Mr. Clyde J. Fitch.

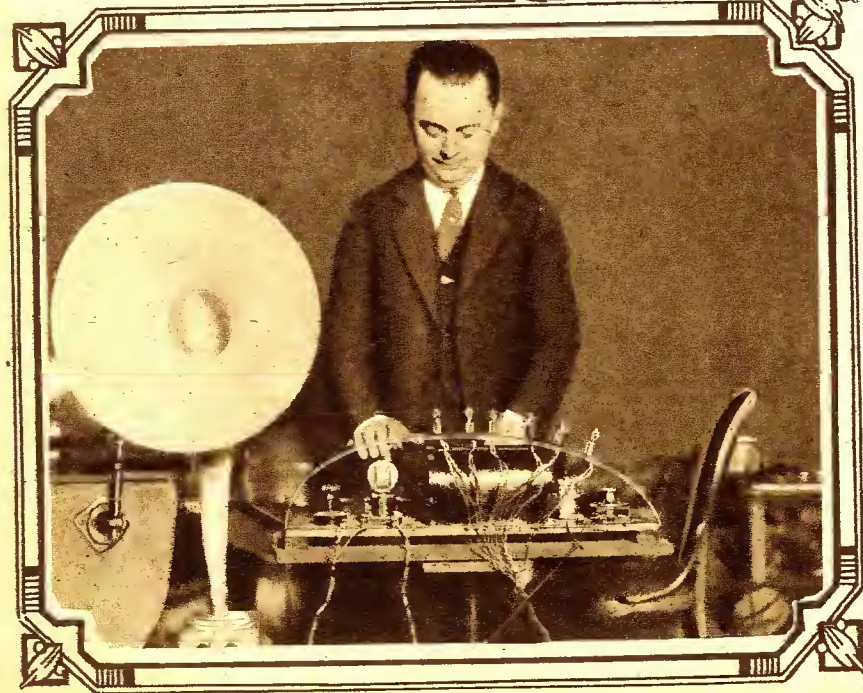

### The Staccatone

**H**AS it ever occurred to you that the squeals and whistling noises which you hear in your radio set while trying to tune in a distant station may be controlled so as to produce pure, musical tones; and that with a vacuum tube, a few coils and condensers a simple musical instrument is easily made, on which any song or tune may be played?

The characteristic squeal rising in pitch from zero to a note beyond the limit of audibility is familiar to all of us. This range of frequencies runs much higher than can be obtained from any known musical instrument. If properly controlled we have a musical instrument that surpasses in tonal range any other musical instrument, and the note is exceptionally pure, practically free from harmonics. Of course, with several vacuum tubes chords could be played. With the single vacuum tube musical chimes and tunes can be played that are very pleasing to the ear when played alone or in connection with an orchestra.

The squeals heard in radio sets are caused by the interference of two waves of different frequency setting up an audible beat-note, and squeals are difficult to

(Continued on page 101)



Right: Kaichiro Yonemura, superintendent of the Iwaki Radio Station at Tomioka, Japan, who has been awarded the Radio Corporation of America Medal for his prompt work in flashing the news of the Japanese earthquake to the world from the Iwaki station. He communicated directly with San Francisco, Calif., after all other forms of communication proved hopeless. The medal carries an honorarium of \$500 with it.  
© Keystone View Co.



Below: The radio has supplanted the one time popular phonograph on board water craft and is effectively employed for furnishing music for dancing. This group of charming maidens is enjoying some popular jazz between swims. © Atlantic Foto Service.



Above: Hudson Maxim, the well known inventor of the Maxim Silencer for firearms, before the microphone at station WRC, Washington, D. C., from where he addressed his radio audience on why they should vote for 2.75 per cent. beer and light wines.  
© Kadel & Herbert.

Left: The modern business man has come to realize that radio is a great help in increasing the efficiency of his office force. Music emanating from the radio set in the office helps to put all in a pleasant state of mind and makes the dreary life of the stenographer an enjoyment. This is the office of John V. L. Hogan, one of the country's most prominent radio engineers. He is seen giving dictation to his stenographer to the accompaniment of music from the set directly behind him. © Photonews, N. Y.



Right: The Police Department of Larchmont, N. Y., is getting after automobile thieves and other criminals, hot and heavy, and has installed a radio broadcast station and receiving set at headquarters. Every notification of a stolen car or robbery received at the station is given full publicity through this station. Full description of the suspected criminals, the license number of stolen cars, etc., is broadcast at certain predetermined hours during the day and evening. This system has proved very successful. The photo shows Officer Frank Hodson at his desk, on which rests the microphone connected directly to the transmitter on the top floor of the building. He can put his message on the air at a moment's notice.  
© Fotograms, N. Y.





# Radio News' Fifth Birthday

**W**ITH this issue RADIO NEWS celebrates its fifth birthday. In the past five years, radio has made tremendous strides. RADIO NEWS, although not the oldest radio periodical, today stands first of all the radio magazines of the entire world. Five years ago RADIO NEWS started with a circulation of 10,000. Of the last issue more than 355,000 copies were printed and distributed. In point of circulation, in point of advertising, in point of text, contents and illustrations, RADIO NEWS today excels any other radio publication.

Every promise that was made by the Editor to his readers, in the first issue of July, 1919, has been kept and fulfilled. During all of this time RADIO NEWS has been absolutely inde-

pendent, it has never been affiliated in any way with stifling commercial radio interests. It started out as a purely radio magazine—100 per cent radio—nothing else. This was the promise made July, 1919, and this promise has been kept.

On its fifth birthday, the Editor wishes to reiterate all of his promises made five years ago and also takes this occasion to thank the multitude of readers through whom it has been possible to build up this magazine. The Editor also wishes to thank all the authors who have, by their articles, made RADIO NEWS possible.

A few of the birthday congratulatory messages to the magazine are reproduced on this page. —THE EDITOR



Herbert Hoover

Editor, RADIO NEWS:

One of the marvelous developments in the wonderful march of radio has been the growth of the radio magazine. The fact that publications appealing only to the one particular line of endeavor can attain circulations running into the hundreds of thousands and far surpassing that of any other devoted to special fields is an obvious manifestation of the widespread interest in radio among the American people and to their desire for knowledge and improvement. Your magazine has been a potent force in the technical radio field and extremely important in welding together and wisely directing public opinion.

HERBERT HOOVER.



General G. O. Squier

Editor, RADIO NEWS:

I wish to congratulate RADIO NEWS sincerely on its fifth birthday. It has played a leading rôle in these years of phenomenal growth of the radio art.

MAJ. GEN. GEORGE O. SQUIER.

Editor, RADIO NEWS:

1,000 amplified high frequency congratulations to RADIO NEWS' jubilee which so ably broadcast to the whole world the thought of modern radio broadcast.

DR. EUGEN NESPER, Berlin.

Editor, RADIO NEWS:

I wish to extend to RADIO NEWS on its fifth birthday sincere congratulations on what it has achieved, and confident best wishes for its future usefulness. Its editors, with unusual insight, foresaw, even before the termination of the war, the



Dr. Le DeForest

dawn of popular radio interest. It was, therefore, foremost in the field of radio broadcast journals and has maintained the position which the enterprise of its founders so wisely built for it.

LEE DEFOREST.

Editor, RADIO NEWS:

Radio has made great strides in the last five years, but RADIO NEWS has made still greater strides and upon its fifth birthday you are to be congratulated not only upon its remarkable circulation, but upon the character of the technical articles which you publish. My best wishes for the continued success of RADIO NEWS.

LIEUT. COL. J. O. MAUBORGNE, Signal Corps, U. S. A.



Dr. L. W. Austin

Editor, RADIO NEWS:

Congratulations and best wishes to RADIO NEWS. L. W. AUSTIN.



Sir Oliver Lodge

Editor, RADIO NEWS:

Congratulations to RADIO NEWS and all readers thereby stimulated to keen interest in scientific progress and theory. May international friendship develop.

OLIVER LODGE.



General J. G. Harbord

New York, N. Y.

Editor, RADIO NEWS:

Without the proper dissemination of information, without the means for a general exchange of ideas, without the media which registers the economic pulsations, changes and developments of that vast group of people known as the general public, no industry can long endure.

The radio industry can well congratulate itself that in its infancy it has had the great helpful influence of an intelligent and progressive press.

On this occasion, the fifth birthday of RADIO NEWS, may I extend the sincerest congratulations and best wishes of the Radio Corporation of America? It is a great work that you are doing, and the radio industry anticipates a continuance of your splendid efforts.

J. G. HARBORD, President, Radio Corporation of America.

Editor, RADIO NEWS:

Heartly congratulations on fifth anniversary of Radio NEWS. You are grown up while others are but beginning school.

Dr. ROEMER, Berlin.



Dr. J. A. Fleming

Editor, RADIO NEWS:

Congratulations to RADIO NEWS on its fifth anniversary. Radio is changing conditions of human life.

J. A. FLEMING, University of London.

Editor, RADIO NEWS:

Heartiest congratulations on your fifth birthday from myself and the readers of my two magazines, Modern Wireless and Wireless Weekly.

JOHN SCOTT-TAGGART, London.

Editor, RADIO NEWS:

My congratulations on your fifth birthday. Many happy returns and may you long continue the good work which you have done in connection with



Professor R. A. Fessenden

the building up and the protection of the interests of the finest body of radio men in the world, our U. S. amateurs.

REGINALD A. FESSENDEN. (Continued on page 141)



# Vacation

Some very interesting tests were carried on recently by Boy Scout radio fans in Central Park, New York City, in an attempt to locate "dead areas" and experiment with portable radio receiving sets. The accompanying photographs, taken during their tests in the park, are quite instructive. The photo to the left illustrates a simple manner for erecting a temporary aerial. A stone or some form of weight is attached to the end of the wire to be used as the aerial and thrown over the branch of a tree. The higher the tree the better, of course, and for best results the aerial wire should have an insulation covering so that it does not come in direct contact with the tree. Lamp cord is the most suitable wire for this purpose and a section twenty to forty feet in length will suffice for all purposes

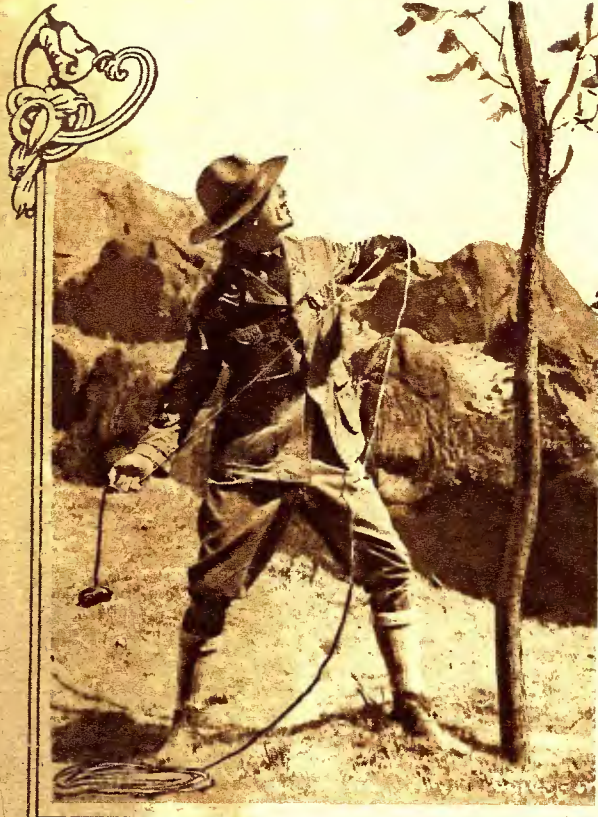

The photo above shows how a temporary ground connection can be made. In this case bare wire should be used. A stone is tied to the end in the same manner as mentioned before, and thrown in the water. The bare wire makes contact with the water and provides an excellent ground. This wire need not be very long. A section of bare or insulated wire twenty to thirty feet long stretched on the earth will also suffice as a "ground" and should preferably be stretched underneath the aerial wire. If only a short piece of wire is at hand, a small spike driven in the earth with the wire attached to the end of it, will suffice. The photo to the left shows a number of the Boy Scouts tuning in on a local broadcast station and taking notes on the signal audibility.

The photo to the right shows two views of the type of portable set used by the Boy Scouts. The "A" and "B" batteries, the phones and the aerial and ground wire are enclosed in the compartment made by the cover of the cabinet. This is a single tube set of the regenerative type. The control to the right is for tuning and the other control is for regeneration. The small switch in the upper center of the panel allows for a coarse adjustment of wave-length. The head-phones are plugged into the jack situated just above the tuning control. The two binding posts on the left of the panel are for the aerial and ground connections.

©Foto Topics, Inc.

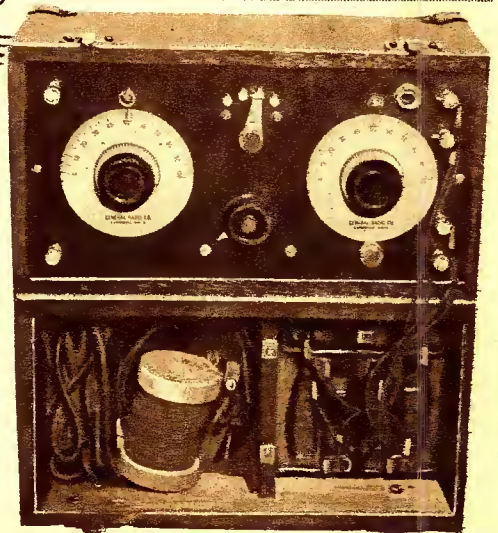



# Radio Hints

Below: Who wants to sit in the house listening to radio concerts when it is spring outside? This young boy hooks his set up in the big outdoors and enjoys the programs with plenty of fresh air and sunshine. His aerial runs from a nearby tree to the small branch stuck in the ground near his set. From the expression on his face one might judge that he is getting good results, even though he has only a crystal receiver.



Right: This novel two tube portable reflex set was built by Sidney Kasindorf, owner of station 2ATV. It is built into a small suitcase which holds all the necessary dry batteries, phones, etc. The most interesting feature of the outfit is the fishing line aerial and ground, both being wound on a regular fishing reel. This set employs UV-199 vacuum tubes which require very little filament current.

©Kadel & Herbert



Left: What could be more delightful than floating along in smooth waters with the strains of music from some broadcast station? This could well be called the "Radio Canoe" the way it is outfitted. A bit of paddling on the part of the man in the stern turns the canoe so that the loop aerial points in the direction of the desired broadcast station. Below: This light cruiser is completely equipped with radio apparatus and a broadcast receiver is put to use when the guests lose interest in the vast expanse of water and find life a bit boring.

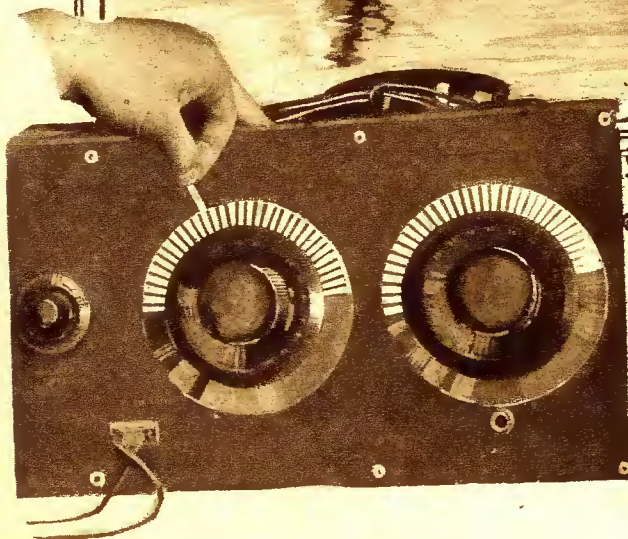

Something new in the way of kinks, the "Simplefinder." A station is tuned in on the receiver. Using the zero mark on the dial as a pointer, note is made as to what slot it lies over. A small slip of paper, with the call letters of the station tuned in printed on it, is inserted in the slot under the zero mark and is held in place by means of the spokes of the underneath cardboard. This procedure is carried out with all other stations that can be heard with the set.

© Photonews, N. Y.

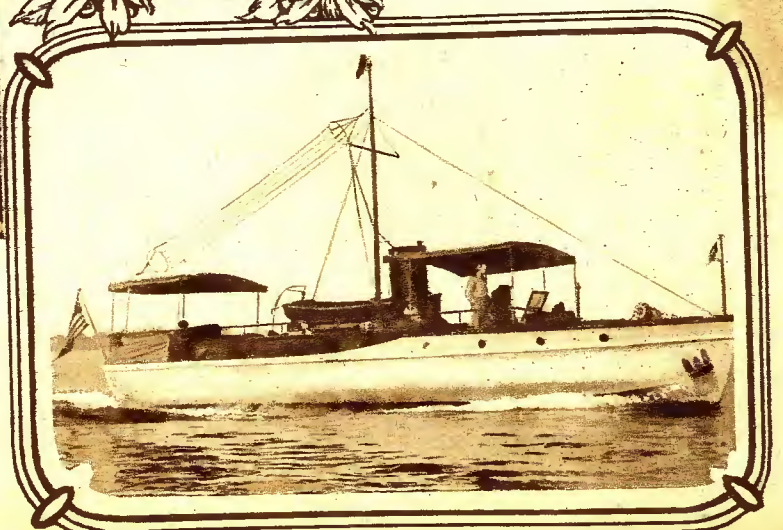



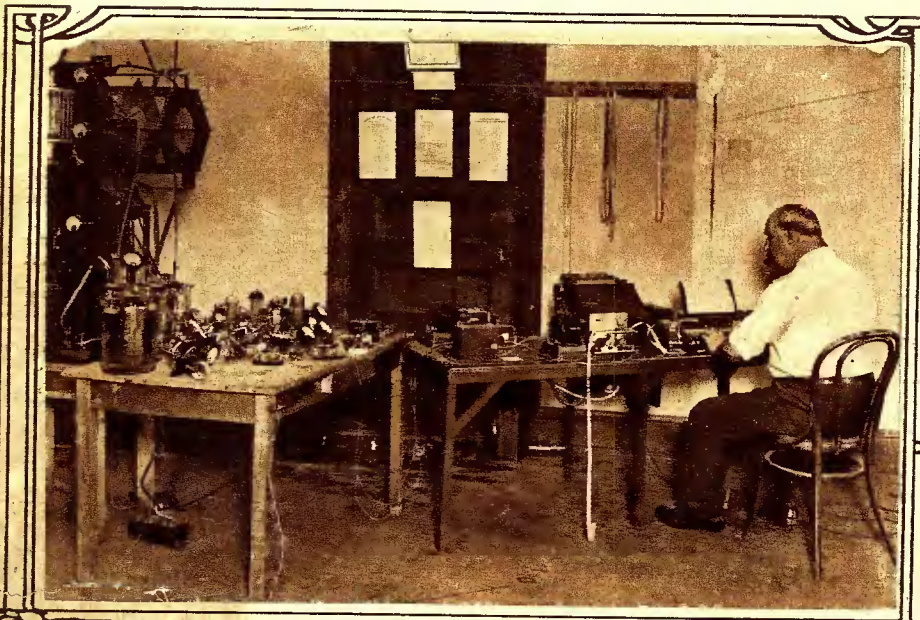

A group of engineers and newspapermen at the American Newspaper Publisher's Convention in New York City watched a typewriter being operated by a person who was sitting in the experimental laboratory of the International News Service, more than two miles away. The copy was clicked off at the rate of 65 words a minute with an accuracy of 99 1/4 per cent. The machine operates in conjunction with a short wave tuner ranging from 60 to 150 meters. The radio printer is connected to an "ejector," a device which makes possible reception in the most congested radio centers. The machine has been in experimental operation between New York and Tarrytown since 1921. It is used commercially between San Francisco and Los Angeles, a distance of 350 miles, by the Federal Telephone Company. The photo below shows L. R. J. George Usman and William A. Bruno who have both contributed responsible parts in the development of the machine and William Finch, the inventor, whose patents cover the system. This is the receiving apparatus. The photo to the left shows the operator at the sending end. © Kadel & Herbert.

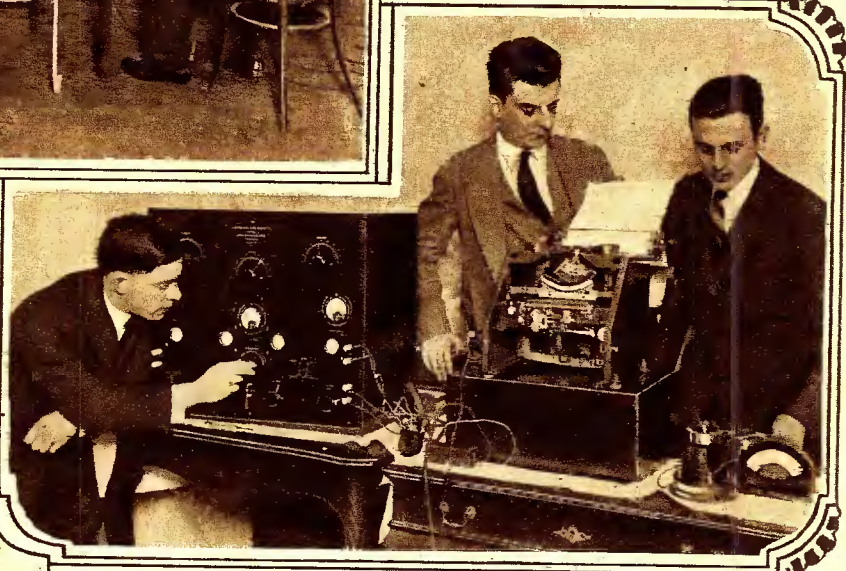

Left: Jockey Burns tunes in for Thurber just before the races at Belmont Park. The set employs two stages of radio frequency amplification, a detector and two stages of audio frequency amplification. © Foto Topics, Inc.



Right: The man who invented "applause cards" emerges from the shadows at last. Mr. Percy W. Andrews, Manager of the Radio Division of the Dictograph Products Corporation, and the man responsible for this revolutionary radio idea. It all came about on a railroad train as he was musing over a particularly good program he had heard the night before. As he remarked "There I sat thinking what a slacker I was not to have written in at least a post card of appreciation." Then like a flash the idea came. Applause cards!





Above: A new feature in radio sets is this one of Pelix, the Movie Cat. The tail forms the tuner and the solitary whisker on the face acts as the "cat whisker" for the crystal. © Keystone View Co. Right: A complete radio receiving set that fits the vest pocket. The crystal detector is mounted on the small panel containing the switch. Below: A miniature honeycomb coil tuner that operates just as well as a large one.

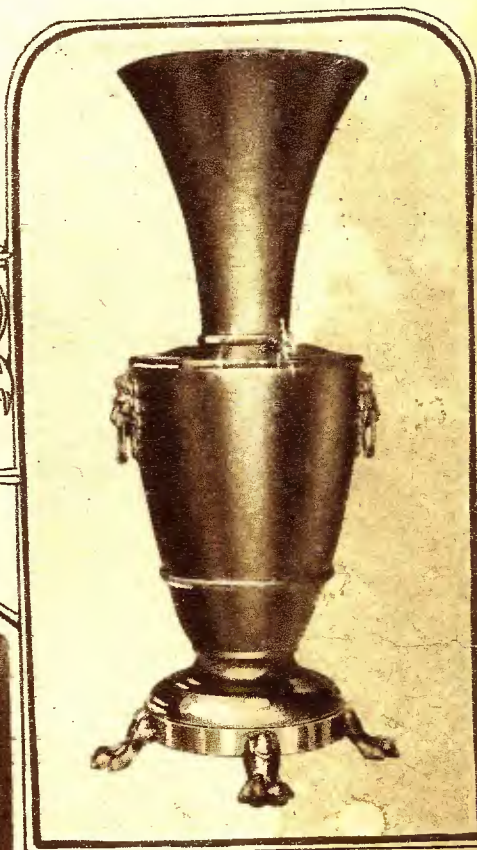

Resembling in outline a Greek vase, and standing over three feet high, this new loud speaker will add to the beauty of the most luxuriously furnished apartment.

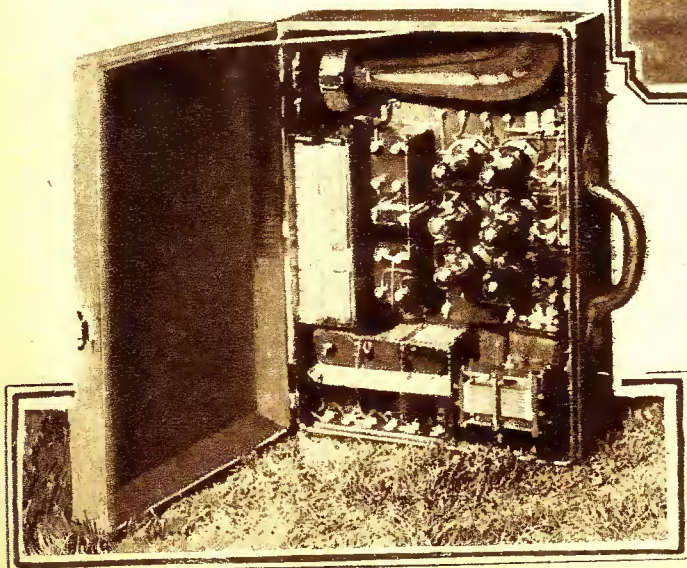
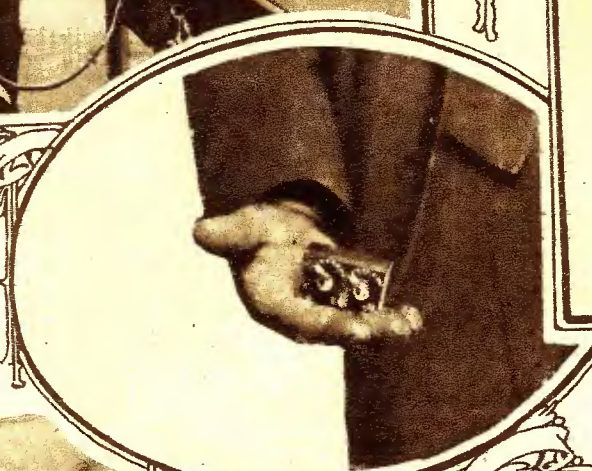

Above: This unique Super-Heterodyne was built by Henry Brinkman of Pelham, N. Y. The top shelf contains a two stage tuned radio frequency amplifier, the second shelf the detector, oscillator and intermediate radio frequency amplifiers, and the third shelf the second detector and three stages of audio frequency amplification, the third being push-pull. ©Kadel & Herbert. Left: John Shepherd, 3rd a prominent merchant of Boston owns this six tube portable radio set. It is composed of three stages of radio frequency amplification, a detector and two stages of audio frequency amplification. © International Newsreel.

**CARNEGIE INSTITUTE TO GIVE RADIO COURSE**

A six weeks' course in Radio Communication will be featured this year at the Summer School of the Carnegie Institute of Technology in Pittsburgh. According to an announcement, the course in Elementary Principles of Radio Communication will be given in the College of Industries from June 30 to August 8.

Although the course is arranged primarily for the benefit of teachers of industrial arts, the announcement emphasizes the fact that any one interested is eligible. The course will cover the high spots in radio communication, and no special restrictions have been placed on a prospective student's educational training.



# The Importance of The Trivial

By SIR OLIVER LODGE, D. Sc., LL.D., F.R.S.

This article contains a number of technical hints from Sir Oliver Lodge's radio writings. They are in his usual lucid, easily understandable style, interesting to all, including the beginner.

High frequency currents such as are employed in radio, travel on the outside of a conductor only. This is well illustrated in the two sketches below of the cross section of a solid wire and a piece of tubing. The shaded portion on the periphery represents the high frequency current flow. This is referred to as the "skin effect."

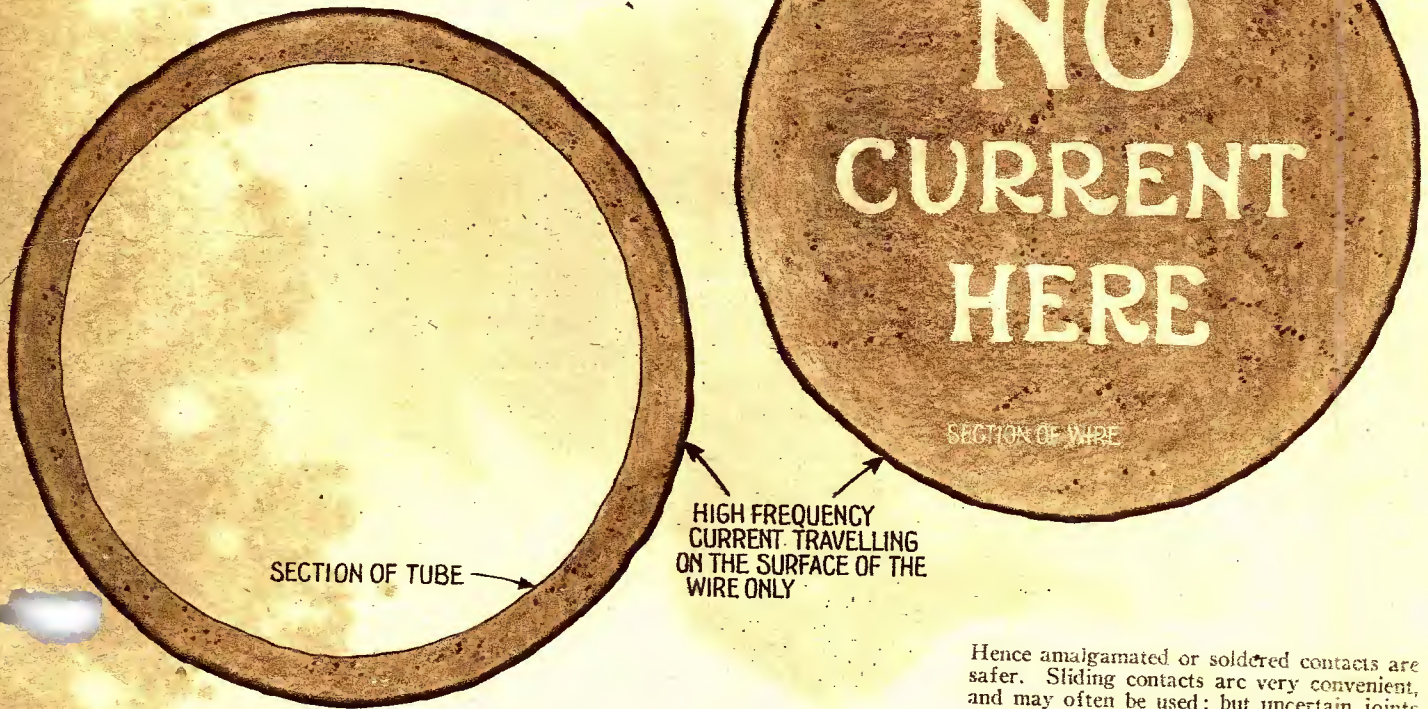

I AM not sure that amateurs fully realize the importance of perfect metallic connection in every part of a receiving set. When there is plenty of power, as when one is listening to a station in the neighborhood, any kind of contact suffices. But to get the benefit of refined and accurate tuning for the faint stations, we ought to realize that a tuned response begins with exceedingly small electromotive force. The whole point of tuning is that response begins with infinitesimal surgings, which, if of the right frequency will work up by resonance to a substantial magnitude, and that if the initial infinitesimal surgings cannot occur, there is nothing to work up, and there will be no response.

Whenever we are dealing with very small e. m. f.'s, as for instance in thermo-electric currents, perfect metallic connection is necessary. An e. m. f. of a volt or two is able to break down a thin insulating film, such as an imperceptible coat of oxide, and establish connection after the manner of a coherer, just as an e. m. f. of 100 volts can jump across a microscopic interval, while 3,000 volts can give a millimeter spark—that is, can jump across a coarse interval of anything short of a millimeter. But when we are dealing with a hundredth or a thousandth or even a millionth of a volt, no such facility exists. And yet the initial surgings from a very distant station must begin at *even less than a millionth of a volt*. The slightest imperfection of contact, therefore, is sufficient to check the initial response. The wonder is that a conductor responds at all to such an extremely minute force. The fact that it

does shows that some of its electrons must be free from the atoms and able to be directed by the slightest suggestion of a force, as they are no doubt in a vacuum bulb.

Not only in metals, but even in electrolytes, electrons seem free. Special tests have been made to see whether electrolytes accurately obey Ohm's Law; and they do. But they could not obey Ohm's Law if an infinitesimal e. m. f. did not produce a proportional infinitesimal current. The ratio of e. m. f. to current should be constant, and as far as experiment has gone, it is constant in metals and electrolytes, even for the smallest forces.

But directly we deal with insulators, that is not so. They do not attempt to obey Ohm's Law. They obstruct altogether until they break down. When broken down, they conduct freely. They are then said to be ionized; that is, their electrons are set free or liberated internally. But there is a critical force necessary to break them down. This applies not only to recognized insulators, but to any kind of a film; a film of oil or grease, for instance or a film of oxide. Such films cannot but exist on anything exposed to the air, where dust is prevalent. It must also exist on any surface touched by the hand, or breathed upon. It is impossible to avoid such films, and if scraped off, they will speedily renew themselves. Sliding contacts, therefore, must always be suspects.

The scraping action of the contact may usually be trusted to remove the film, and may leave the metals in complete contact, but if cohesion is interrupted by a shake, jar, or tremor, it may not so easily renew itself.

Hence amalgamated or soldered contacts are safer. Sliding contacts are very convenient, and may often be used; but uncertain joints are always liable to give trouble. Some of the stray noises and capriciousness, from which amateurs are said to suffer, can sometimes be traced to this source. It is really easier to avoid troubles of this kind than to detect them when they occur.

For purposes of sending, there is no such trouble—the e. m. f.'s are then big enough to break down obstacles—but for refined tuning every part of the aerial and every detail of the set should be thoroughly well joined up. And if sliding contacts are used, the binding or clamping should be firm enough to prevent accidental disarrangement. A gentle tap breaks contact in a coherer, as everyone who used to work with such things is well aware; and it takes an electric impulse of finite magnitude to restore connection. No such breaks should be allowed by anyone who desires perfect attunement.

## ADVANTAGES OF STRANDED WIRE

In a receiving set intended for the reception and accurate selection of distant stations, the importance of good joints should be supplemented by a recognition of the advantages of low resistance. Persistent oscillation is killed by resistance; if a conductor of infinitesimal resistance could be used, extraordinary results could be attained. Some day, perhaps, something will be done in that direction, by immersing the set in liquid hydrogen or even helium, for at those low temperatures the resistance of metals almost disappears. Conductors become perfect, and oscillations would work up to almost an infinite value, with small stimulus. Such an arrangement could surely never be more than a curiosity, and even as a curiosity it is hardly feasible at present, but I fully expect that someone will try it in the future.

Meanwhile, we have to do the best we can with ordinary high conductivity copper.





An enlarged cross section of two wires twisted together, but not soldered, would look somewhat like the above illustration. Dirt and oxide formation prevent good contact. The lower illustration shows the perfect contact gained by soldering the joint after the two wires are twisted together. The contact surface is large while in the other case there is only one actual point of connection between the two wires.

It must be realized, however, that when working with short waves and, therefore, very high frequency, the inner part of a wire of any ordinary thickness takes no part in the conduction. The oscillations have not time to soak or sink into the metal, and only the skin or surface contributes to the conduction. In steady or direct currents every part of the wire conducts equally. The wire acts as a tube does to water or air, except that in the hydraulic case, surface friction retards the flow a little, and leaves the interior of the tube the best and most

efficient part. In the electrical case, conditions are just reversed. The outside of the conductor is the best part; the inner portion is almost useless, except as contributing to mechanical strength. When a wire is very thin it may be thought of as all surface. It has no interior. Hence, thin wires are more efficient, weight for weight, than thick ones. The resistance of a thick wire is not so much less than that of a thin one, to high frequency currents. At the same time there must be a limit. If a wire is too thin, though it is effective as a

conductor, its resistance is unavoidably high, hence the current is somewhat throttled. To circumvent that, we use a stranded wire, and the strands *must not be* in metallic contact; otherwise, the interior is obliterated, since it cannot be got at, except through metal. Slight insulation suffices, a coat of varnish is enough; a very thin coating of silk is ample. The point is that the strands must all of them be bathed in ether, for it is through the ether that the waves can reach them. The propulsion of a current in a wire is effected later-

(Continued on page 132)



# Radio, A Leading Industry

By ROGER W. BABSON\*

Mr. Babson, whose reports guide bond and investment houses, here gives his opinion of the newest of the leading industries, radio. His opinion, from a purely business and industrial point of view, is indeed sanguine.

FIVE years ago business did not consider the radio industry of enough importance in the field to give it a separate classification. It was grouped as a subsidiary of electrical manufacturing and selling. Today it not only has a designation of its own, but is among the first thirty-five industries of the United States in point of value of product—the largest period growth of any industry. To those who still consider radio a fad, an examination of the accompanying article will result in a distinct shock. When it is learned that radio's position—as an industry—falls along with furniture, leather and chemicals, and ranks higher than railroad cars, it is high time

considering it a part and parcel of the lives of the inhabitants of the United States with as definite a place in their scheme of things as the very shoes they wear.

This year, according to conservative opinion, more than \$350,000,000 will be spent in the radio art. This figure includes only the general expenditures, not taking into account the expenditures in the production of communications, as it does not include the immense costs of investigations and experimental work being carried on continually by manufacturers, in an effort to constantly improve the art.

Truly radio is no fad. It is established and here to stay—

Those who think that radio is still a small minority of the public who are experimentally inclined, some figures dealing with the financial proportions of the industry at present may correct that impression. It has been my experience that very few people realize just how important, from a business standpoint, the radio industry has become. Just because an industry is comparatively new is not a reason for assuming that it is unimportant. The radio industry is new, but it has grown so rapidly in the last two or three years that it compares very favorably with many of the important long-established industries.

On the basis of figures for the year 1923 it is probable that the American people will spend approximately \$350,000,000 for radio equipment during the present year. A conservative estimate of the business in vacuum tubes alone is at \$50,000,000. At least five times as much, or \$250,000,000, will be spent for sets and parts. The sales of batteries, both dry cell and storage batteries, will very likely amount to over \$45,-

000,000. Miscellaneous equipment such as battery chargers, loud speakers and specialties may easily account for \$50,000,000 more.

### COMPARISONS

One of the best proofs that radio is one of the leading industries, and that it is well expended by the general public through the channels of the radio dealer with the sums spent in the same way for sporting goods and cameras. More than double the amount of money goes into the retailer's hands for radio than reaches him through pictographic supplies and sporting goods. No one will

cents is spent for radio. The value of radio business amounts to nearly three-fourths of the jewelry business as a whole, including clocks, watches and novelties.

I have given you these illustrations in order that I might emphasize the growing importance of radio from a business standpoint. It is not necessary for me to tell you of radio's importance from an educational and social standpoint. I see no reason why the radio industry should not continue to expand. There has been a decided improvement in the character of the broadcast programs, and we may doubtless look forward to still greater improvement in this direction.

### ORDER OF INDUSTRIES ACCORDING TO VALUE OF PRODUCTS 1921

No.	Industry	Value of Products
1	Slaughtering and Meat Packing	\$2,200,942,072
2	Petroleum refining	1,727,440,157
3	Automobile	1,671,386,976
4	Foundry and machine shop products	1,565,526,944
5	Iron and Steel works	1,481,659,352
6	Cotton goods	1,278,220,831
7	Car and repair shop	1,180,030,133
8	Flour-mill and grist-mill products	1,179,740,131
9	Printing and Publishing (papers and periodicals)	1,123,709,828
10	Bread and bakery products	1,089,971,652
11	Clothing—women's	1,022,742,796
12	Clothing—men's	934,776,275
13	Lumber and timber products	902,501,306
14	Boot and shoe	867,475,896
15	Electric machinery and supplies	833,985,443
16	Tobacco, cigars and cigarettes	806,748,865
17	Printing and publishing (book and job)	690,074,975
18	Paper and wood pulp	667,435,847
19	Knit goods	634,073,895
20	Silk goods	583,418,756
21	Furniture	539,687,194
22	Confectionery and ice cream	527,259,316
23	Worsted goods	524,638,921
24	Rubber tires	496,123,335
25	Butter	479,723,555
26	Sugar refining	466,602,352
27	Lumber and planing mill products	462,648,874
28	Iron and steel, blast furnaces	419,771,244
29	Gas, manufactured and illuminating	411,195,503
30	Motor vehicles, bodies and parts	408,016,532
31	Chemicals	390,768,434
32	Leather	383,365,046
33	Shipbuilding	356,214,854
34	Radio, estimated	350,000,000
35	Cars, steam railroad	325,680,157

### GROWTH

From a manufacturer's standpoint, the most feasible way of comparing different industries is on the basis of the manufacturer's value of products. Unfortunately the latest data available of this nature are published by the Department of Commerce for the year 1921. I refer to the Census of Manufactures for that year. Since then, no data have become available which give a satisfactory comparison on this basis.

With this article is a list of the leading industries based on their value of products for 1921. This list includes all industries whose value of products is \$300,000 or more.

Such detailed figures as were available for this industry in 1921 show that the production of radio apparatus and wireless telegraph supplies amounted to \$9,549,649. In 1919, the value of these goods amounted to \$8,074,636, but this amount included the value of motor generators, which was not included in the 1921 report. Furthermore, the number of radio lamps and tubes produced in 1921 was reported as 101,964 at a value of \$1,097,968. These statistics show clearly that the radio industry was not considered of enough importance in 1921 to be given a separate rating, and consequently cannot be compared directly to the other listed industries.

The best comparison available is given in a recent survey of this industry made by the Babson organization. The size of the business was compared with other lines on a retail basis. Although these data are all estimates, they give an interesting comparison and show clearly that the industry had had a remarkable growth during the past few years.

Let some say that radio cannot maintain its present pace, a saturation chart is given herewith. Note that there are more available families without radio by a large margin, than there are without phonographs, automobiles or electric service. It is not necessary to maintain that every family owning a phonograph will some day own a radio

deny that the latter two industries are well and firmly established. They are founded on a sales idea that is less stable than radio. Radio is universal in scope, its appeal is to all, whereas the other two industries mentioned are not. Is radio not much more well bottomed than either of them? It is interesting to see how the radio industry compares in dollars and cents with other large industries. Available figures on sporting goods, cameras, etc., show a value of about \$185,000,000 annually. Sales of radio equipment are running nearly twice as large as all kinds of sporting goods.

The value of the radio business is nearly twice as great as that of the carpet and rug business. For every dollar spent on furniture, 33 cents is spent on radio. For every dollar spent for boots and shoes, 25 cents is spent for radio. For every dollar spent for musical instruments of all kinds, including phonographs, pianos, organs, etc., 75

\*Famous Statistician and Business Analyst



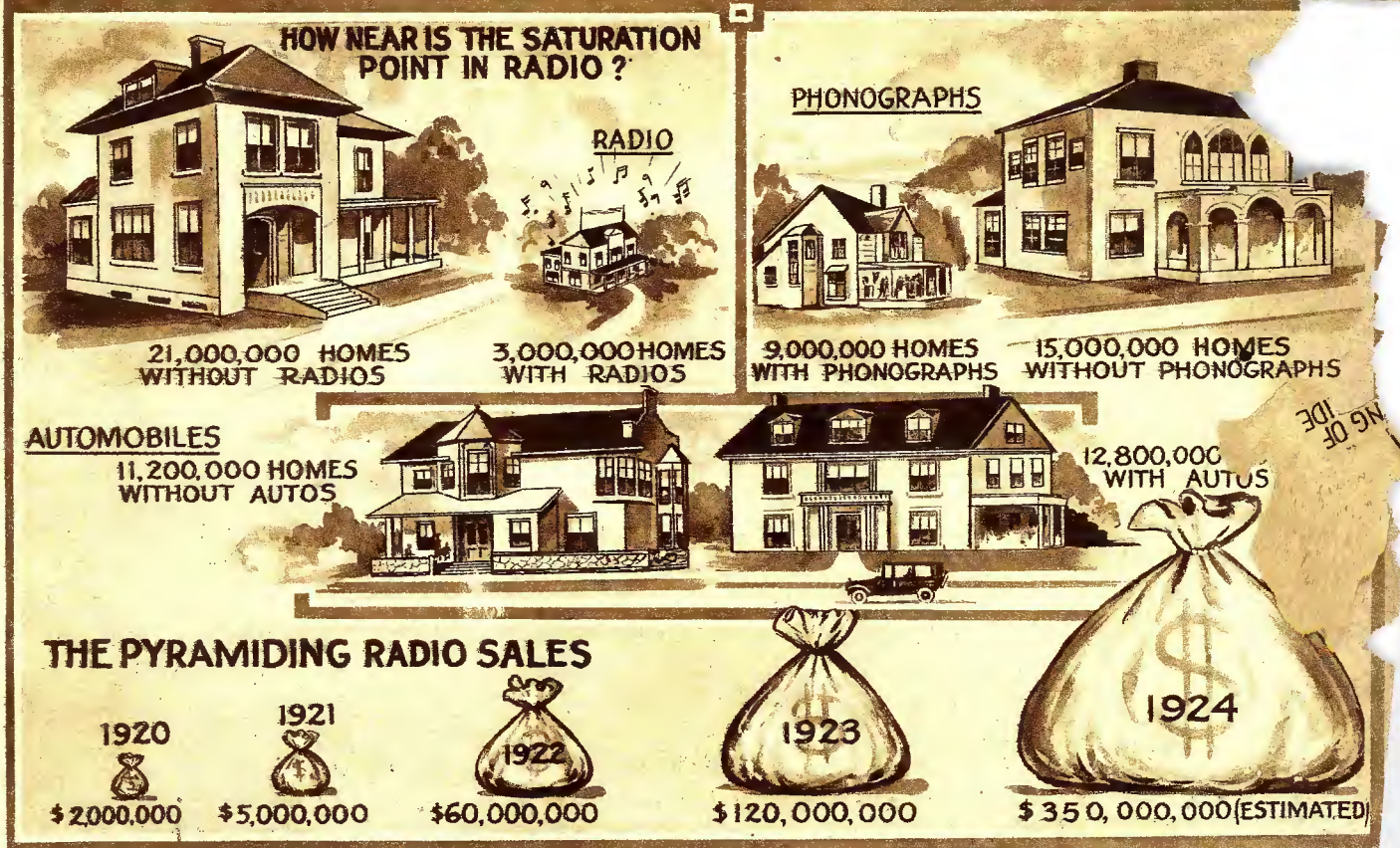
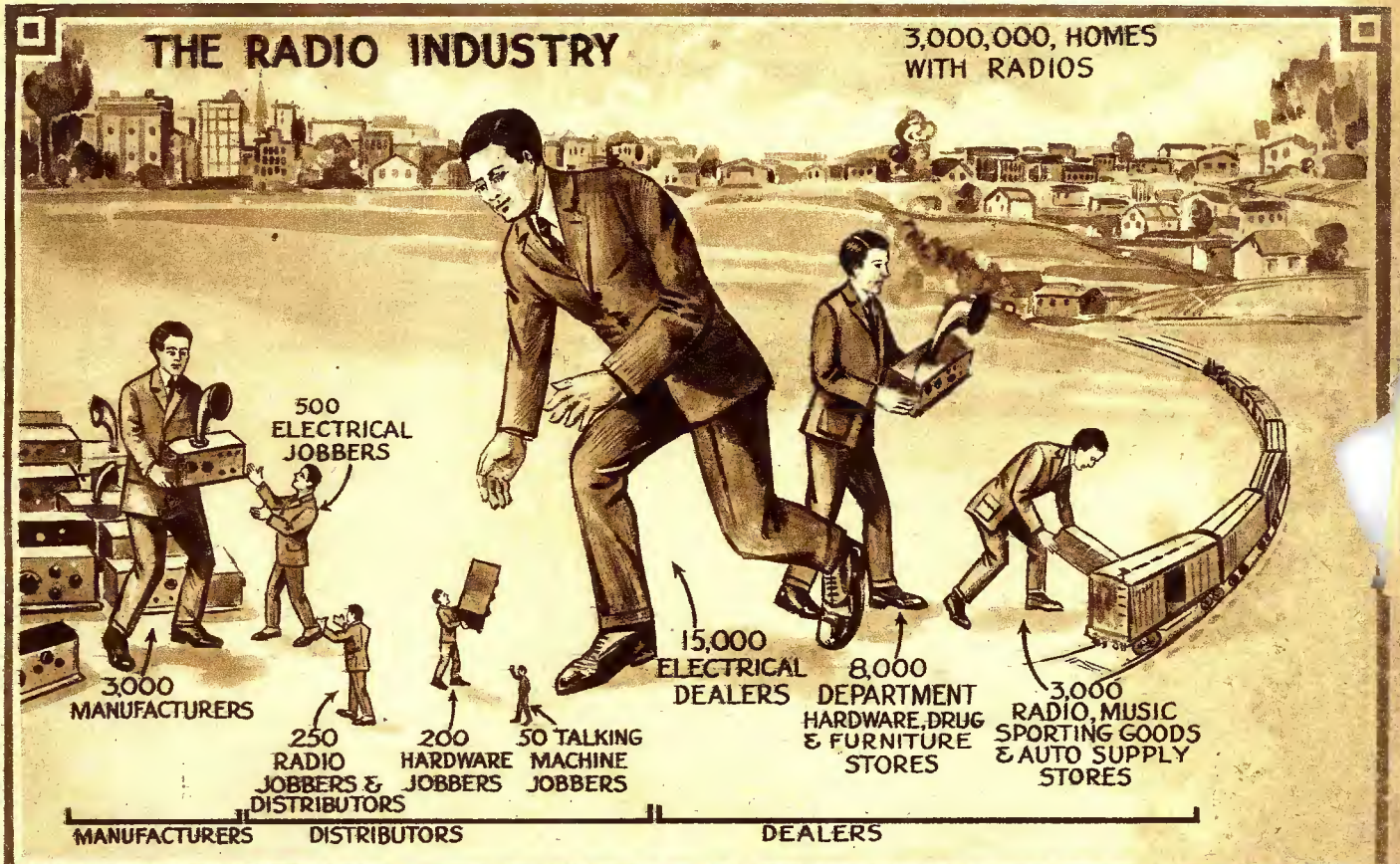

The above illustrations serve to form a conception of not only the comparison between the radio industry and other kindred services, and the rapid increase in radio sales for the past four years, but the most evident and magnificent future for the entire radio industry. There are years to come before radio sales will reach the saturation point.

set in order that sales may stay pretty much as they are for several years. The charts are clear and the reader may draw his own conclusions as to whether radio will suffer any great set-back for a number of years. Another chart shows graphically the growth of the sales for the last five years.

All in all, after a complete examination of the field and its possibilities, a report of other than a favorable nature is hardly possible. The figures given in this article are mere cold, hard, business facts. The reader must consider them and draw his own calculations. Those calculations, I think, must surely be favorable to the constant advance

of the radio industry. The future is indeed bright and even though the present rate increase is maintained for some years come there is little danger of the industry becoming top-heavy and suffering serious results. It is established in commerce and has a place in the American home. It grows, for its future is bright.



# Lucy's Radio Present

By WARREN ORDWAY

WHEN the radio craze struck the country it passed around Old Forge; that is, it passed everyone but Bill Shadwell. He caught the fever hard enough to make up for dozens of ordinary cases. His pockets were, most of the time, stuffed with hook-ups, blue-prints and magazines; and he wasted a precious lot of the time that he should have given to the business of the Old Forge National Bank, studying his diagrams, and drawing little wiring layouts on the bank's blotters and stationery.

He tried every month or two to get a raise from old Mr. Pulsifer, president of the bank, as he had been engaged to Lucy Hopkins for over a year, and he wanted enough salary to set up housekeeping. But Old Forge was a dead town, and Mr. Pulsifer was stony. Once, the town had hummed with activity. Its iron mines and blast furnaces had poured wealth into the pockets of its citizens, and into the coffers of the bank; but when the rich vein of ore in the Furnace Hills had petered out, the town collapsed with it. Geologists said that there must be other veins equally rich in the hills, but they had never been found.

Though Bill's prospects for a raise were slight enough, it did not help matters when Mr. Pulsifer caught him making his penciled hook-ups during business hours. Mr. Pulsifer thought radio was an invention of the devil, and he had only recently been reconciled to automobiles. So he had no great excitement when Bill came to his quiet walnut office and announced he had got a plan that will make us all want you to help me out with the money of it."

Mr. Pulsifer glimpsed the corner of a blue-print sticking out of Bill's side pocket, and asked, suspiciously, "Has it anything to do with this radio craze of yours?"

"Yes, sir; and I'll tell you, it's a sure thing—"

Mr. Pulsifer cut him off sharply. "No use, Shadwell. I'm simply not interested in any of your radio schemes. To my mind, the world would be much better off without

radio. When I was a boy, we used to put our minds on our business, but today, you young fellows seem to think of anything and everything but banking. Radio is turning you from a fairly promising banker into a poor amateur mechanic."

"But this scheme will bring the town back to life. It will make the old mines hum. Your bank will be bulging with money. What better plan for increasing your business do you want than that? If we can make Old Forge hum, surely the bank will profit."

Mr. Pulsifer remained stony throughout Bill's appeal. "No, I'm not interested in any absurd radio scheme to make the town prosperous."

Bill came up close to Mr. Pulsifer's black walnut desk, and appealed on a new tack. "Well, sir, if you won't help me out on this scheme, will you give me a raise, so I can buy the stuff myself? All I need is a hundred or so, for a portable set with three tubes—"

When he heard the word tubes, Mr. Pul-

sifer frowned, and broke in angrily, "Perhaps if you would drop all this foolishness about radio, I might consider the subject of more pay. But certainly, while your mind is taken up with radio tubes,"—he spat out the word contemptuously—"I can't do anything for you in the way of added compensation."

Mr. Pulsifer's mouth, compressed into a thin, hard line, should have told Bill that the interview was closed, but he kept on pleading. "If only you'll help me out, I know I can make a lot of money for you. All I want is enough to get married on, but you could make a fortune—"

Mr. Pulsifer significantly began fussing with some papers. "Mr. Shadwell, will you excuse me? Very busy morning."

(Continued on page 119)



Bill's actions on the hills were variously reported. Some said they saw him walking about the hilltops, holding over his head a square of wire, like an umbrella without any cloth cover; others saw him crouching near an outcrop of rock, with his headphones, apparently listening to a concert.



## A Revolutionary Radio Invention

**W**E are pleased to announce that in our next issue, RADIO NEWS will be the first to publish a revolutionary radio invention. RADIO NEWS has secured the exclusive American publication rights of the G. V. Downing and K. D. Rogers "Unidyne" principle. The "Unidyne" principle enables vacuum tubes to be operated without "B" batteries, or without high tension current supply of any kind.

This means that the "impossible" problem—detection and amplification of radio signals without "B" battery—has now been solved.

Once more the impossible has been made possible. This invention probably is the greatest radio advance since the De Forest regeneration principle.

Be sure to reserve your copy at your dealer's.

—EDITOR.

## The Radio Tax Was Defeated

**L**ATE on Friday, May 2, the Senate in a record vote refused to accept the finance committee amendments placing a tax of 10 per cent. on all radio sets, parts and accessories. There was considerable debate, a number of senators pointing out the bad features of such a tax.

The Radio Trade Association worked in close harmony with every organization in the trade and was at all times in possession of every available fact about the progress of the campaign. Only through the close co-operation of members out of town was the association able to secure such co-operation in the cities where other organizations ex-

isted, while the work of raising the protest in towns where no trade body was located was most ably handled by the members chosen for this work. It is remarkable that of 40 members called upon, all but three immediately offered their assistance and started to work.

Special credit is also due to the National Association of Broadcasters, who, through Paul B. Klugn, executive chairman, and E. T. McDonald, president, and other officials, conducted several polls of the Senate and otherwise kept the trade in touch with the situation in Washington. The importance of the work of this organization was not real-

ized by many because of the silence with which they worked, but those in a position to know realize how important their co-operation was. The American Radio Association, through Alfred M. Caddell, executive secretary was also of great assistance in the publicity work of the campaign.

The Associated Radio Manufacturers of Chicago, were in touch with this association practically from their organization and a great deal of good obtained by harmony of operation, there being no duplication of effort. The Musical Industries Chamber of Commerce was of special aid through their Washington News-Reporting Bureau.

## \$500 Radiation Eliminator Prize Contest

### Who Will Make a Radio Muffler?

**T**HE radio industry at the present time is confronted with one of the most serious problems that it has yet encountered. If you live in a city or other crowded section, it becomes almost impossible these days to enjoy a radio program. In the midst of a most beautiful violin solo, you will suddenly hear loud whistles, howls and shrieks, which are often strong enough to break up the entire concert. Thus, when we recently listened in to a speech by President Coolidge there were at least a dozen instances where whole words and even sentences were obliterated, due to this radiation interference.

As everyone knows, these whistles and howls are produced by nearby radio receiving sets. Ninety per cent. of the receiving sets used today are really miniature broadcast stations. When operated improperly they send out waves of their own. The minute the broadcast listener starts to twist the dials, he also sends out into the surrounding space waves which produce this interference. Experience has shown that attempts to educate the public as to the correct methods of operating these interference creating sets are futile. The public simply does not understand the interference and the only practical solution seems to be a *Radiation Eliminator*—a muffler, in other words.

There has been much talk to suppress all the receiving outfits that produce oscillations. If a law were passed today to this effect, fully 95 per cent. of the receiving outfits would have to be junked. At the present time, the condition has become so acute that sooner or later our legislators will enact a law to do away with radiation.

It is not impossible to produce a radiation eliminator that can be mounted into the receiving outfit at a small cost. There may be a new circuit, a new hook-up, a new instrument or some new stunt that will do away with the whistles and cat-calls.

RADIO NEWS aims to bring about this solution in a novel manner. In order to encourage experimenters, RADIO NEWS of-

fers \$500 in prizes for an efficient radiation eliminator. It should be designed along the following lines:

(a) The device should be as simple as possible and must be adaptable to any standard receiving set. The total cost of its construction must not be above \$3.00.

(b) It should be possible to manufacture the device, not only at a reasonable cost, but it must be possible to install the device without necessitating completely disassembling the receiving set to which it is to be attached.

First Prize . . .	\$250.00 in gold
Second Prize ..	100.00 " "
Third Prize ...	75.00 " "
Fourth Prize ..	50.00 " "
Fifth Prize ....	25.00 " "
<b>TOTAL . . . . \$500.00</b>	

(c) It should not be necessary to adjust the device when tuning in. In other words the new device should be fixed—not variable; or, if it must be variable, the adjustment must be so that once it is made for a particular aerial it *should not have to be touched again thereafter, when tuning.*

It should be thoroughly understood that this contest is conducted by RADIO NEWS merely for the purpose of encouraging research along the lines mentioned. **In no case will RADIO NEWS derive any financial benefit from the invention.** All patent rights, and any and all other rights revert to the inventor.

RADIO NEWS reserves for itself only the publishing rights, and nothing else. Moreover, in order to show its good faith, RADIO NEWS, at its own expense, will finance the cost of taking out the patent for the inventor, in the inventor's name, at no cost to the inventor himself; this, providing the article or device can be patented. RADIO NEWS, however, will only finance the patent of the first prize winner—not of the other prize winners. The financing of this patent

by RADIO NEWS will be in addition to the prize money paid to the successful inventor.

Regarding the patent phase of the other prize winners, special attention is called to the fact that by publishing the device in RADIO NEWS, the inventor has, practically two years during which he can apply for his patent. There is no better evidence than publication in a national journal. Had Dr. DeForest published his original sketches on regeneration in a magazine, he would have saved many years of litigation and a fortune in court costs.

### RULES OF THE CONTEST

1—A working model of the invention should be sent with the manuscript describing it. Transportation charges will be paid by RADIO NEWS both ways.

2—Schemes using so-called blocking tubes are excluded from this contest.

3—Contestants may enter more than one device in the contest. There is no limit as to number.

4—All manuscripts should be typewritten or written clearly in ink, and all diagrams should be clear enough to show the details of the invention. A photograph of the inventor is required as well.

5—All manuscripts not accepted will be returned to the owners at the end of the contest, but the publishers will pay full space rates for all manuscripts published in RADIO NEWS.

6—For the protection of the inventor, he should retain a carbon copy of the original manuscript. Both original and duplicate should be witnessed and signed with date, names, etc., before a notary public.

7—All prizes will be paid upon publication.

8—Should two contestants submit identical devices, thus tying the prize, the same prize will be awarded to both.

9—Excluded from this contest are: Manufacturers and the publishers' employees and members of their families.

10—This contest closes in New York on August 20, 1924.

Address all contributions to Editor, *Radiation Eliminator Contest*, c/o RADIO NEWS, 53 Park Place, New York City.





# The Radio Beginner

## The Beginners' Radio Set

By A. P. PECK

Having described aeriels and grounds in his last article, Mr. Peck proceeds with an explanation of the fundamentals of radio and furthermore, gives details for the construction of a complete receiving set of a simple form.

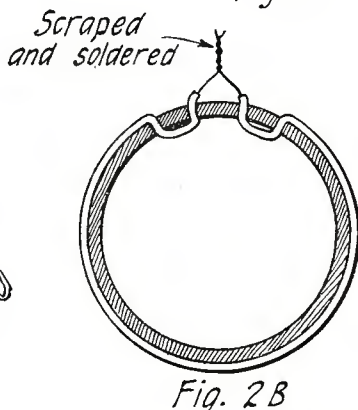
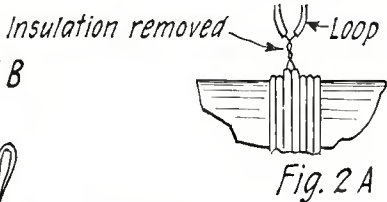
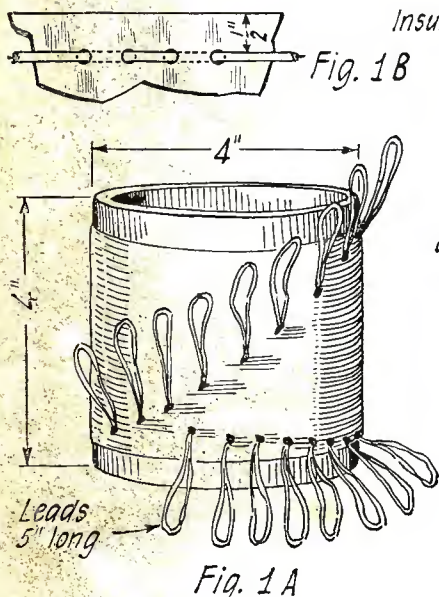

These sketches serve to illustrate means for providing taps on the coil employed in the receiving set described. Fig. 1B shows how the wire is secured at the beginning and at the end of the coil.

are said to be in tune. In a similar manner, waves of a certain length are sent out by the transmitting station. In order to receive them, the receiving station must be tuned to the same wave-length as the transmitter. This is sometimes done in a very similar manner to the tuning of violin strings. That is, the length of the wire in the circuit is lengthened or shortened as the case may be, until the entire circuit is in tune or, as is sometimes said, in resonance with the transmitting circuit. Then the current set up in the aerial circuit, as explained in the article on the antenna system, will pass through our coil and detector and we will hear audible sounds in the telephone receivers.

### CONSTRUCTING THE TUNING COIL

Let us now consider the tuning coil to be used with the radio set. The derivation of the name of this coil is obvious from the foregoing paragraphs. It is used for tuning purposes, and in reality gives us a longer aerial, as it adds to the length of the wire in the aerial circuit.

To construct this coil first a core will be necessary which may be a cardboard or bakelite tube, four inches in diameter by four inches long. You will not need quite as long a tube as this for the first set, but it is advisable to buy it this length as it can be used later on with a few changes in another set which will be described in a forthcoming issue. If you decide to buy a cardboard tube, which is much cheaper, first give it three or four coats of shellac, allowing each coat to dry thoroughly before applying the next. Some amateurs find it best, instead of using shellac, to coat the tube with a mixture made up as follows:

Break up an old phonograph record into small pieces. Place the pieces in a metal dish and with a hammer, pulverize them, so they will dissolve easily. Then place the fine powder in a glass jar and pour in enough alcohol to cover it. Put a cover on the jar and allow it to stand, shaking occasionally until the solid material is thoroughly dissolved. If the resulting mixture is too thin to use as a paint, allow the jar to remain open for some time until sufficient alcohol has evaporated to bring it to the correct consistency. If the resulting mixture is too thick, add alcohol until it is thin enough to use. Cardboard tubes, when painted with this mixture, are

**I**F you have not read the article on "The Antenna System," which appeared in the June issue of RADIO NEWS, it would be advisable to do so before you start this one. It is absolutely necessary that, in order to obtain maximum results, you erect the best type of aerial possible and observe certain precautions.

Prior to building a set, it is well to consider several things: First, your knowledge of radio; second, the amount of money you may spend on it; and third, the best type of set to build which will always be serviceable. Taking the first item into consideration, we will assume that the reader is absolutely new in the game and has never built a radio set before. In regard to the second condition, we will consider that the price is to be kept as low as possible for a good set. The third condition will be met by describing herewith a set, the parts of which can practically all be used later on when the receiving set is expanded. Thus the tuning device will be of such a nature that it can always be incorporated, with very few changes, into a larger and more efficient set.

### TUNING

Before going into the actual constructional work, let us consider what tuning means. We learned in the preceding article that there is a certain property of radio waves known as wave-length.

When we look at the waves in water, we note that there is a certain distance between the crests of the waves which will vary according to the height of the waves and according to the rapidity with which they go

over the surface. We find the same thing to be true in radio. There is a certain distance between the crests of succeeding radio waves and this distance is known as the wave-length. It is measured in meters, the European standard of linear measurement being equivalent to 39.7 inches. It is this property of the waves that enables us to separate one from the other. If this were not true, our concerts and entertainments would come in in an indistinguishable babble, as all stations which were transmitting would be heard at once. However, the character of radio waves eliminates this and we are able, almost always, to separate the waves of two stations so that we can listen to any desired one. To understand this, let us consider two violin strings. They are both of the same length and under exactly the same tension. When one of them is plucked, it sends out a certain musical sound. In reality this sound is a series of waves created in the atmosphere which strikes our ears and affect the ear-drums. Since the other string is of exactly the same tension and length, it will start to vibrate when the waves set out by the first string strike it. The two strings

Two excellent types of panel switches, either of which can be used in conjunction with the tuning coil. The taps on the coil connect directly to the switch contact points.

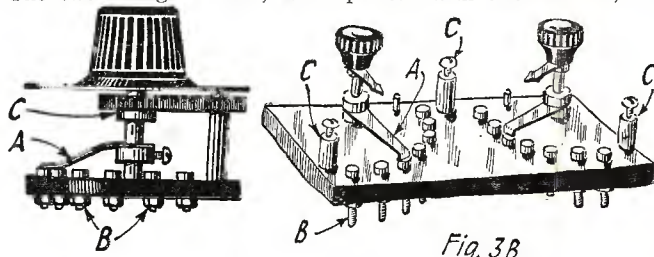

Fig. 3B



found to be very satisfactory for tuning coils. They present a neat appearance and the insulating quality of the tube is increased. If, however, you can afford it, purchase from your radio dealer a bakelite or micarta tube of the dimensions given in Fig. 1. Such a tube will be sturdier and will afford excellent insulation. Aside from this, it has an added advantage of not needing any finishing application, such as shellac or the mixture described. It is ready to use as purchased.

When you get the tube, purchase at the same time one-half pound of No. 22 D.C.C. wire. The term D.C.C. denotes "double cotton covered," or in other words, copper wire insulated with a double covering of cotton. Drill four small holes in one end of the tube,  $\frac{1}{2}$ -inch from the end and parallel with the edge. This is illustrated in Fig. 1B. Unless you already have tools, acquire a medium-sized hammer, a screw driver with a 3-inch blade, a square, a steel center punch, which is to be used for locating holes to be drilled, a cross-cut saw, several drills and a small hand drill, a hacksaw with extra blades, a pair of cutting pliers, and a medium-sized vise. When you buy these tools, buy the best for the price that you feel you can invest. Tools are always an asset in any kind of mechanical work and the best are none too good. In order to do a satisfactory job, you will need all the tools mentioned. As time goes on, you will acquire others which will make your work easier and which will enable you to finish a job with the utmost speed.

**TAPPING THE COIL**

We will consider that the four holes have been drilled as described and illustrated. Push about eight inches of wire into the first hole at the left, out of the second hole, back into the third one and out of the fourth one. You will find that this interlacing of wire will hold the end firmly in position so that it will not slip. Wind the wire around the tube nine times. Keep the wire as tight as possible and place the turns as close together as you can. The wire should be kept, at all times, free from kinks, as these spoil the appearance of the winding and sometimes cause the wire to break. When

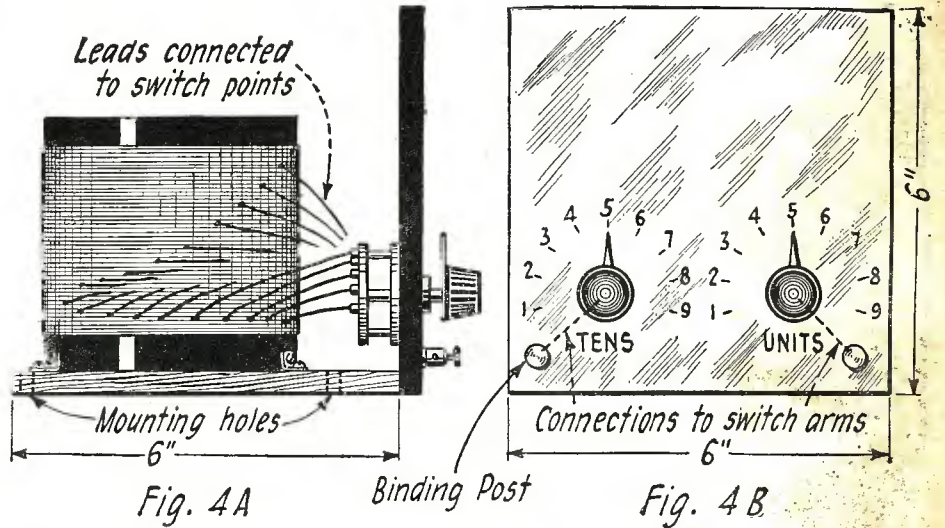

Fig. 4A shows how to mount the coil on the wooden base-board and how the taps run to the switch. Fig. 4B is a view of the front of the panel upon which the switch numbers are engraved.

you come to the ninth turn, take off a tap. Taps are provided on the coil so that various sections of the wire wound on the tube may be cut in or out of the circuit at will, in order that it may be tuned. There are two good methods of making taps and they are illustrated in Figs. 2A and 2B. The latter is the best method, but it is the most difficult and requires soldering. In regard to Fig. 2A, we see that when the place is reached where a tap is to be made, the wire is scraped at that point and at another point about 10 inches away. A loop is then formed so that the two scraped portions are next to each other, whereupon they are twisted together as shown. Twist tightly enough so that the joint will not become undone when you continue with the winding. It is well to solder the twisted portion of the wire, but if you are not proficient in this line, it need not be done until you have mastered the art of soldering, which will be described in another article. Now continue winding, tak-

ing off a tap every nine turns until there is a total of nine taps. Then take a tap every turn until nine more are made. The winding will be finished with the last tap. The end may be fastened in the same manner as the beginning.

In case you should desire to make your winding a little more elaborate and also tighter and more permanent, we will describe the type of tap illustrated in Fig. 2B. Four holes are drilled in a straight line as was done for the beginning and end of the winding. The wire is then cut, allowing about 3 inches more than is necessary to reach the first of the four holes. Push the wire into the first hole and pull it out of the second one. Then push the end of the wire which is still on the spool into the fourth hole and bring it out of the third one. Scrape the ends and twist together. Also solder if possible. At the same time twist, with these two wires, the end of a third piece of wire about five inches long. This is done in order to make connections as described below. This form of making a tap is much better in several ways than that illustrated in Fig. 2A.

This coil which we have just described is known by two different names. It is a tuning coil and at the same time it may be called a variable inductance. The term variable of course comes from the fact that the active amount of wire in the coil may be varied. The term inductance is applied to any coil of wire. The theory of inductance and its use in radio is rather complicated and will not be dealt with at the present time. However, a future article will deal with this term and its relation to radio circuits. It is sufficient to say here that the inductance used in this radio set enables you to tune your apparatus to a certain wave-length so as to receive from any particular station which happens to be operating on that wave-length.

**THE COIL MOUNTING**

The next step in the construction of the tuning coil is the mounting of it. For this purpose, a wooden base-board may be used; also, if desired, a wooden panel may be used. Greater efficiency, however, will be realized if the panel, instead of being of wood, is made of a sheet of bakelite, 6 inches square. Only well seasoned woods which are free from resinous substances and sap may be used. Wood is a fairly good insulator, but when it becomes damp, it allows the minute radio currents to leak off. This is highly undesirable and in order to offset this property, it is a good idea to treat the wood to prevent it from absorbing moisture. The easiest way is to give it two or three coats of orange or white shellac which may be bought at any paint or hardware store. Before putting on the first coat, the wood should be warmed slightly so that the shellac will

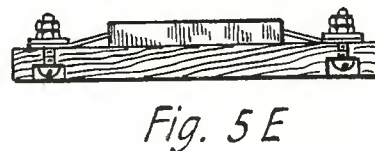
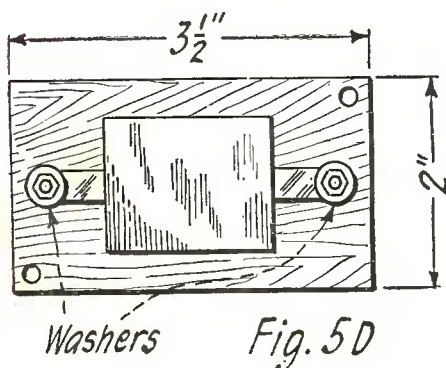
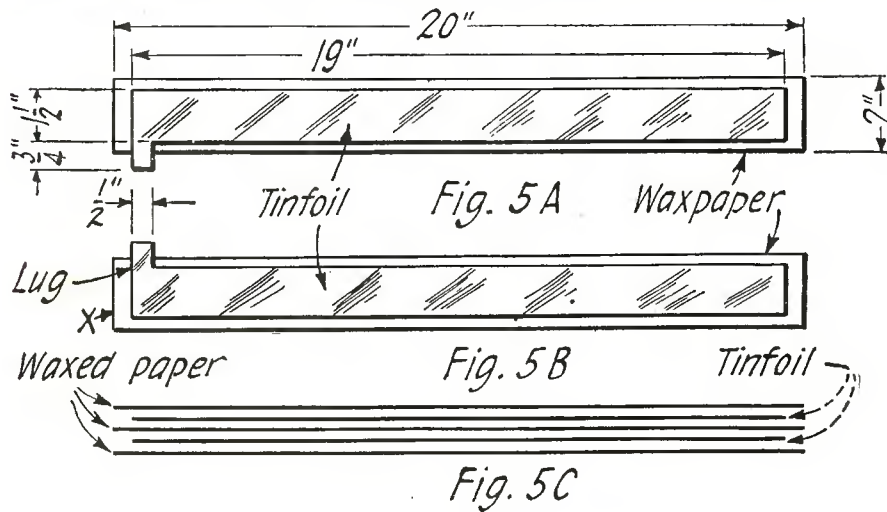

The progressive steps in the building of the fixed condenser are here shown, together with the correct dimensions. The completed condenser is mounted on an insulating base, as illustrated in Figs. 5D and 5E.



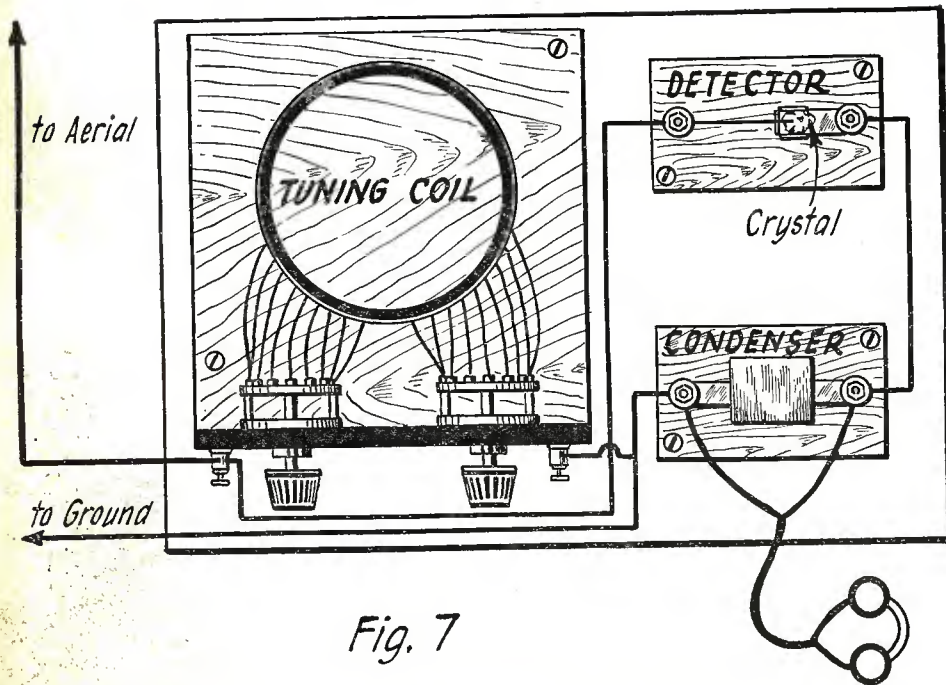

Fig. 7

Here is the complete wiring diagram for the receiving set consisting of the tuning coil, the crystal detector, the fixed condenser and the head-phones. The same layout of apparatus shown should be followed.

be thoroughly absorbed. For succeeding coats it is not necessary to do this. A second and more efficient manner of making a good insulator of a wooden part is to obtain a pan large enough to hold the largest piece which you are going to use; obtain sufficient paraffin wax so that when it is melted in the pan it will cover all of the wooden parts placed in the pan; melt the paraffin in the containing vessel and bring it almost to the boiling point; place the wood therein. It will be found necessary to hold the wooden parts down below the surface with a stick, as they will tend to float. Hold them there until all bubbling ceases. This will indicate that all the air which is between the fibres of the wood has been driven out and is now replaced with paraffin. The parts may then be removed and allowed to dry. The excess wax should be scraped from the surface with the edge of a straight knife. Parts treated in this manner will be found to possess excellent insulating qualities and will not allow a very great amount of leakage. For the set which is described here, waxed parts will be found quite efficient. If it is not possible to obtain a pan of sufficient size, the following procedure may be used, but not with as good results as the one described above. Melt the paraffin in any obtainable vessel and heat the wood to be treated. With a brush, apply the melted wax to all the surfaces of the wooden parts, at the same time keeping the wood warm by working near a stove. Make several applications and if possible, place the parts in a warm oven between the applications so that the wax will be thoroughly absorbed.

After cutting the two squares of wood for your tuning coil and waxing them, obtain two switches of the type illustrated in Fig. 3A, or one as shown in Fig. 3B, which are designed to be mounted in back of the panel. With the former it is only necessary to drill one hole for each, as the points or contacts, as indicated by B in Fig. 3A, are already placed and it is not necessary to drill a number of holes. Another good type of back panel mounted switch is illustrated in Fig. 3B. With this type it is necessary to drill five holes, two for the rods which control the switch levers A, and three for the mounting screws C. Whichever type of switch you get, mount it on the panel, as shown in Figs. 4A and 4B. While drilling the holes for the mounting of the switches, drill two for binding posts and two for mounting screws, as shown in Fig. 4B. Also, in the baseboard,

drill two holes for wood screws which are to fasten the base of the tuning coil to the large base illustrated in Fig. 7. The size of these holes will be determined by the sizes of the switches you get, as well as of the binding posts and the wood screws. It is a good idea to purchase a dozen each of two or three sizes of wood screws and machine screws, as well as washers and nuts to fit the machine screws.

THE SWITCHES

Install your switch units in about the relative position shown in Fig. 4B. The upper part of the front panel is left blank as it is to be used for something else when you are ready to expand your set.

If you have picked out the right kind of a switch set, you will find that it will not be necessary to solder the leads from the tuning coil to the switch point. Some of these sets are provided with small chucks on the switch points which grip wires in much the same manner as the chuck on the end of a hand drill grips the drill points. This does away with all soldering and makes a very neat job. These switches cost slightly more than the ordinary type, but they are worth the difference. In case you do not get one of this type and still do not want to solder, you will find that there are usually two nuts on each one of the switch points. Draw up the bottom one tightly so that the point is clamped firmly to its mounting, then scrape the insulation from the end of the lead of the tuning coil and place it between the bottom nut and the other one. Draw up the second nut so as to clamp the wire firmly.

When arranging the leads from the tuning coil to the switch sets, keep them in rotation. Keep them in order on the switches so that the top lead goes to the first point, the second lead to the second point and so on. Calibration of your set is possible if this system is followed. In order to facilitate matters, mark on the front of the panel graduations such as is illustrated in Fig. 4B, marking points with numbers so that indications of the positions of the switch arms in the rear of the panel may be obtained. The pointer should be set in the same relative position as the contact arm. Before connecting up the switches notice that a connection is to be made to each of the switch arms. Make this connection first, running a wire from one lever to one of the binding posts and from the other lever to the other binding post. The lever is indicated in Figs. 3A and 3B by the letter A. It is known variously as the switch

lever or switch arm. It serves to make connection between the binding post and any one of the taps on the coil which may be desired. After you have completed this assembly you will have a unit such as is illustrated in Figs. 4A and 4B and the tuning device for your first receiving set will be completed.

THE FIXED CONDENSER

In this article, we will not go into the theory of the actual operation of the various parts of your set, for to do so would take up too much space. The names of the instruments used will be given and their construction described. Then after you have built your set and are receiving messages, you will have more time to study the actual theory. This will be contained in succeeding articles.

The next instrument to be constructed is known as a fixed condenser. This particular type, for the use to which we will put it, is sometimes termed the phone condenser, as it is connected directly across the phones. These condensers can be purchased very cheaply in radio stores, but you will derive a certain satisfaction from making it yourself. Therefore the construction is given in Figs. 5A, 5B, 5C, 5D and 5E. In the first place, you will need three strips of paraffin paper or waxed paper 20 inches long by 2 inches wide. This paper must be perfectly free from imperfections and holes. You will also need two strips of tinfoil cut to the shape shown in Figs. 5A and 5B. The strips are 1 1/2 inches wide by 19 inches long and are provided at the end with a lug 3/4 inch long by 1/2 inch wide. These lugs are left so that connections can be made thereto. After you have the five parts cut to the correct size and shape, lay a strip of tinfoil on a strip of waxed paper, as shown in Fig. 5A. With a warm flat iron run over the surface of the tinfoil. Do the same with a strip of tinfoil and paraffin paper laid as shown in Fig. 5B. Then place the latter on the first strip of tinfoil and paraffin paper assembled, and place the third strip of paraffin paper over the entire unit. Press the whole together with a warm flat iron. Cut a piece of cardboard 3/4 inch wide by 2 inches long and roll up the condenser beginning at the end marked X in Fig. 5B. You will then have a unit such as that illustrated in Fig. 5D, without the base. One lug will extend on each side of the condenser.

Next, cut out a wood base for this condenser and wax it thoroughly, as described above. The size of this base is 3 1/2 inches by 2 inches. Next drill two holes in opposite corners for mounting screws and two more holes for the passage of machine screws for mounting the condenser. The assembly is shown in Figs. 5D and 5E. Either coun-

(Continued on page 132)

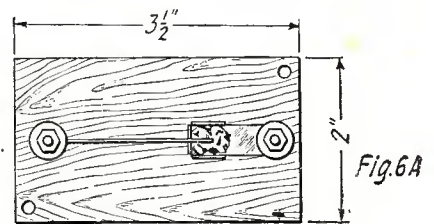

The constructional details of the crystal detector. This is a very simple type but is equally as sensitive as a more elaborate instrument.



# Timely Suggestions—

By HOWARD S. PYLE, A.M.I.R.E.



Those of you who are experiencing interference in one form or another will find this article by Mr. Pyle of material benefit. He has described the various forms of interference, how the source may be determined and means to provide for its elimination.

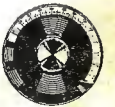

**R**ADIO broadcasting has just passed through its third successful year. From a little known mode of entertainment and news dissemination, it has grown to a place in the home that no other invention or discovery has yet equalled. And as yet, we have but scratched the surface. Progress in both the transmission of entertainment and its reception has been phenomenal, and where, but three years ago, we were dependent upon the crystal, the regenerative and the non-regenerative vacuum

as it exists today is that caused by other radio services, such as commercial ship to shore traffic, harmonic radiation from high power stations, oscillating receiving sets and the amateur transmitter. Among the foreign disturbances which are equally annoying if not more so, are X-ray machines, static, violet rays, power line induction and the like.

The interference caused by other radio services can be combatted in one of two ways. The receiver can be made more selective, or the constants of the antenna system so adjusted as to provide sharper tuning. The first method is, of course, particularly applicable to the single circuit type of receiver. It is an inherent characteristic of this circuit to be broadly tuned. In other words, not only the desired signals are picked up, but those of neighboring frequencies are unpleasantly audible at the same time. Let us consider a remedy. In Fig. 1 we have a typical single circuit receiver, variously called a "Copp" circuit, direct coupled and conductively coupled receiver. It is readily seen that any incoming energy affecting the antenna circuit, A, L, VC, and G, simultaneously affects the grid circuit, provided its frequency is somewhere near the range of the inductance L. No provision is made for adjusting the frequency of the grid circuit, therefore, it obtains "shock excitation" at any frequency affecting the antenna system. This makes for broad tuning and the consequent lack of selectivity.

it by an air gap of from one and a half to three inches. Experiments will determine the proper spacing, and it may then be permanently secured.

## ANTENNA CHANGES

A further considerable gain in selectivity may be made by reducing the length of the antenna system. Many use antennae more than 100 feet in length. This is poor practice for it tends to make interfering signals very difficult of elimination. True, shortening the antenna does diminish the signal strength, but is it not better to secure a slightly weaker signal, subject to but a fraction of the interference experienced on the longer antenna, than to get terrific volume, constantly interrupted by interference? Static, too, will be considerably diminished on the shorter antenna. Make the antenna 50 or 60 feet long and solder all joints carefully, leading the wire to the set in as direct a line as possible. Keep it well insulated where it comes in contact with any foreign material. Following these suggestions will considerably diminish interference from commercial ship and shore transmission.

The radiation of harmonics from nearby high power stations is a bit more difficult to eliminate. These should be brought to the attention of the station causing them and public opinion brought to bear so that they may be removed. A fair method of dealing with this interference at the receiver is the addition of a wave-trap.

While wave-traps are very desirable and do reduce interference to a considerable extent, they may not totally eliminate it, as we are often led to believe through advertisements. A wave-trap may be easily constructed at home, from a coil of wire and a variable condenser. The sizes of both the inductance and capacity must be determined from the frequency which is to be eliminated. Such traps may be connected in the circuit in two ways, both of which are shown in Fig. 3. Method B, while probably causing a greater reduction in signal strength than method A, is the more positive, but where the interference is not extreme, and the desired signal none too loud, method A is to be recommended.

The evil of radiating regenerative receivers is a particularly difficult one to combat. There is no practical method by which it may be absorbed or detuned at the receiver. Happily, this annoyance is gradually diminishing as the public begins to grasp the

(Continued on page 105)

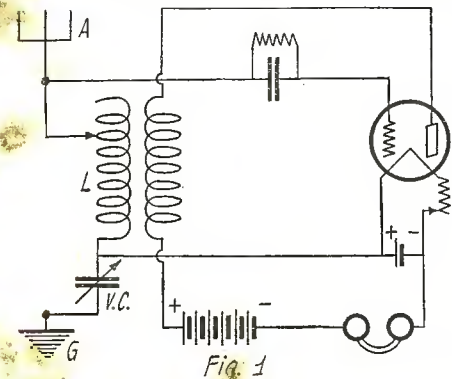

The above, a single circuit regenerative receiver, lacks selectivity in tuning, being coupled directly to the antenna system.

tube receivers, we now have our choice of a myriad of newer circuits; the super-heterodyne, the neutrodyne, the reflex and numerous others. Some are logical advancements; others should be looked on with misgiving, for as in any new industry, there are the good and the bad. Discrimination is difficult. Along with the newer developments, we have learned countless new "wrinkles" to improve our old stand-bys. For those whose success has not been all that might be desired, and for those to whom the first apparatus introduced for broadcast reception must still serve its purpose, this article is written.

From countless investigations conducted in connection with the transmission and reception of broadcast programs, the writer has gained considerable data. It has been definitely established that the greatest single detriment to the perfect reception of broadcast programs today is the interference problem. This is a broad subject, and under its head may be classed innumerable sources of such interference. Our problem, of course, is how to eliminate this annoyance.

## RADIO INTERFERENCES

The greatest single type of interference

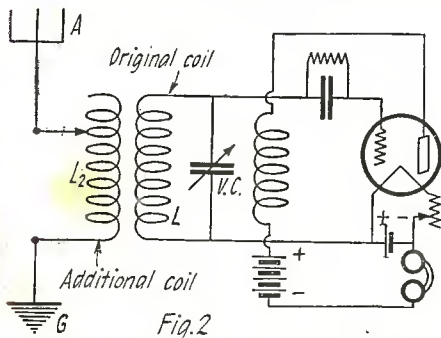

By the addition of one coil to the circuit of Fig. 1, as shown above, selectivity can be greatly increased.

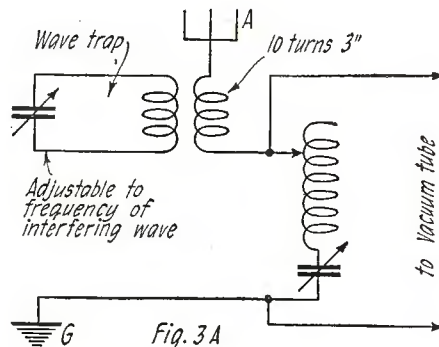

An inductively coupled wave-trap used in conjunction with a receiving circuit for the elimination of an undesirable signal.

By the simple process of adding an extra coil in the form of the inductance L<sub>2</sub> in Fig. 2, and changing the condenser connections, the single circuit receiver is improved 50 per cent. as to selectivity. In addition, to a considerable degree, the annoying radiation is reduced which manifests itself in neighboring receivers as a whistle. Surely it is worth the few extra pennies and 20 minutes' labor to add this extra coil to our single circuit sets! The tuning is not complicated by such a change—the condenser is used as before for tuning, but it now serves to tune the grid or secondary circuit, whereas in the original connection, it tuned the antenna circuit. It will be found that in the suggested new hook-up, the antenna tuning will not be critical, but can be adjusted very satisfactorily by means of taps taken at every 10 turns on the primary coil, L<sub>2</sub>. This coil should either be wound on the same tube as the original inductance, spacing it about an inch and a half from the original winding, or it may be on a separate tube, placed in inductive relation to the coil L, separated from

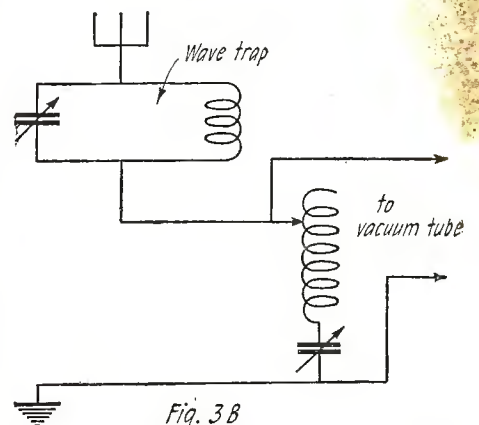

A series wave-trap, connected directly in the aerial circuit of the receiver.



# The Trouble Corner

By ADSUM

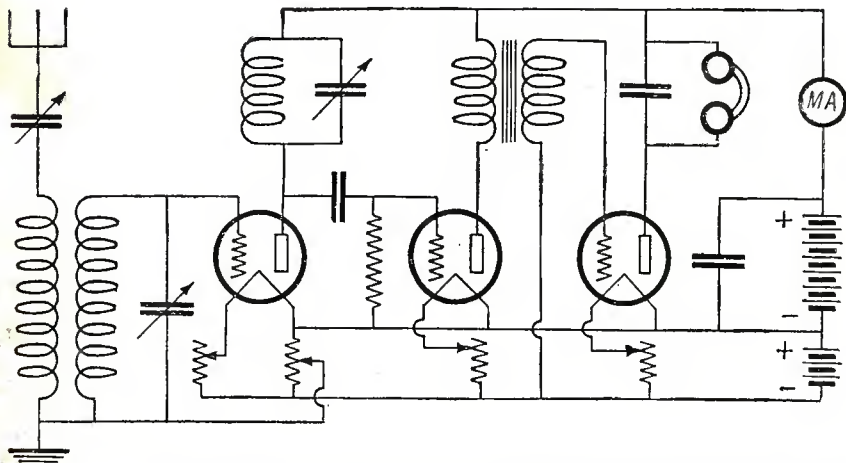

Fig. 1. How a milliammeter is connected in the circuit to register the amount of current flowing in the "B" battery circuit.

**W**HEN asked by a beginner what is the most useful instrument to buy, the writer always recommends the purchase of a milliammeter and strongly advises that it should be kept wired in series with the "B" battery when the set is working, in the way shown in Fig. 1. If this is done, one has one's finger, so to speak, always on the pulse of the set and one's search for faults when they occur is considerably narrowed down. Take for example the case of a set such as that shown in Fig. 1. The milliammeter reading when the set is working perfectly is taken and noted down for future reference. Let us suppose that it is two milliamperes. If at any time signals become weak the first thing to do is to glance at the pointer of the instrument. Should it still register two milliamperes we know: (a) that there is nothing wrong with the plate circuits; (b) that the tubes are above suspicion as regards at any rate three out of their four connections (filament and plate); (c) that we need not look to batteries or battery connections for the source of the trouble; (d) that there is no short circuit or broken circuit on the high tension side of the set. This narrows down the field of the search to quite small dimensions. The fault, if it is not in the phones, must lie either in the grid circuits, which include grid condenser, grid-leak and transformers, or in what we may call the tuning part of the set. So far as transformers are concerned we are limited to the secondaries, for their primaries are in the plate battery circuit. By the tuning part of the set is meant (1) the antenna; (2) the ground; (3) the antenna inductance, and antenna condenser; (4) the closed circuit inductance and closed circuit condenser. The grid circuits can be tested out very easily. Begin with the audio frequency tube. Increase the negative potential of the grid biasing battery and watch the milliammeter. If current passed decreases, this grid circuit is as it should be. If not there is a fault. Test the detector in the same way by removing the grid leak and connecting the grid battery in its place. The radio frequency tube may be tried simply by moving the slider of the potentiometer from end to end. If there is no fault the milliammeter will register an increase as it moves towards the positive end. Having thus tested all the rest of the set nothing remains but the antenna and ground and the fault will be found in one or other of these.

### USES OF THE MILLIAMMETER

Besides enabling you to trace faults, the milliammeter will tell you a whole host of

things about your set. You wonder perhaps whether oscillation is taking place; watch the pointer of the milliammeter as you tighten couplings or adjust the variable condens-

**I**T is intended under this heading to deal with various rather out of the way faults which occur in receiving sets. The writer has kept, for some time, a record of those which have happened to himself, and has also noted down such as have been experienced by his friends at various times. Some are fairly straightforward and might have been discovered almost at once if luck had been upon the searcher's side. Others, however, are of quite a different nature and unless one has some idea of what to suspect it will be—indeed it usually is—a long and difficult business to track them down to their sources. It is hoped that readers who are interested will give others the benefit of their experiences by sending in brief accounts of such difficulties, giving all the necessary details of the way in which the trouble first manifested itself and of the means whereby it had been eventually traced and cured.

er. As the oscillation point is approached the needle will begin to fall back a little, and when the set actually oscillates it will drop quite suddenly to something very much below the normal reading. Are you running

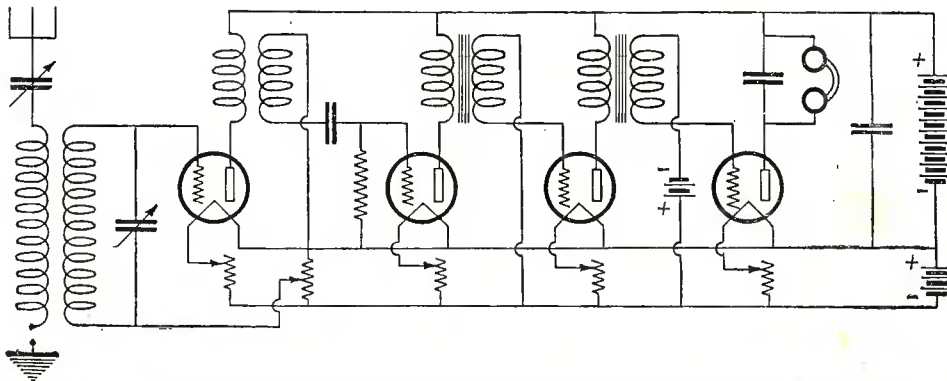

Fig. 3. A disconnected ground lead makes the set unstable in operation, though signals can be brought in by increasing the capacity of the series antenna condenser.

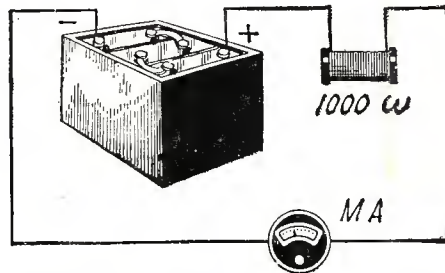

Fig. 2. How the storage battery is tested with the milliammeter and a 1,000 ohm resistance unit.

your filaments too bright? The milliammeter will tell you. If without any increase of plate voltage you find a slightly higher reading than normal shown, then you are obtaining a greater emission by overheating the filaments. In the same way, if the filament voltage remains unchanged the milliammeter will enable you to see whether you are using too high a voltage from the "E" battery. It will tell you better than any voltmeter the condition of either battery. For testing the "A" battery you require a 1,000-ohm resistance. Wire this in series with the "A" battery, as shown in Fig. 2, and take the reading when it is fully charged. If the resistance has its stated value, the reading will be 6 milliamperes; in fact, with a resistance of 1,000 ohms the milliammeter becomes a volt meter, each division representing one volt. If the value is slightly different, you can calculate it at once by

$$\text{Ohm's Law: } R = \frac{E}{I}, \text{ or resistance} = \frac{\text{volts}}{\text{amperes}}$$

Once the resistance is known exactly, the voltage can be measured at once by the formula  $1,000 \times \text{volts} = \text{amperes (milliamperes)} \times \text{resistance (ohms)}$ . For example if the reading is 9 milliamperes and the resistance 500 ohms then

$$\begin{aligned} 1,000 \times \text{volts} &= 9 \times 500 \\ 1,000 \times \text{volts} &= 4,500 \end{aligned}$$

$$\text{Therefore volts} = 4.5$$

To test the "B" battery it is best to use a resistance such as that employed in plate circuits with a value of about 50,000 ohms. Its true value may be found in the same way as before by actual test with the milliammeter and a new "B" battery. Future readings can be worked out in a moment by the formula. This method has the great advantage that it throws only a very small strain upon the high tension battery when the test is made, for the current passed even with a 100 volt battery will not exceed two milliamperes. Milliammeters are not expensive to buy and anyone who requires one will soon find that it is an extremely good bargain. The best type to purchase is one with a scale reading from 0 to 20 or 25



milliamperes. As the divisions are fairly large there will be no difficulty in obtaining quite an accurate reading.

**A CURIOUS CASE**

Here is a strange case, liable to happen to anyone, which occurred to the writer some time ago before a milliammeter was fitted to the set. On the previous evening reception had been very good indeed, but this time when the set was switched on signals had fallen off to but a fraction of their proper strength. The set was a four tube one with two radio frequency stages, tuned plate coupled, a detector and a stage of audio. Antenna and ground came through all tests with flying colors, there was nothing wrong with any of the coils or the condensers which tuned them, no loose connections or short circuits could be found in connection with any of the plates or grids. The head phones and transformers were tried and found perfectly in order. The batteries were up to their full voltage. All terminals were tested and found properly tightened up. The tubes fitted tightly into their sockets and no grid had sagged on to a plate.

When all tests had been made it seemed as if nothing else was left to be done and the matter might have remained a mystery had it not occurred to the victim to take a new tube (thoriated tubes were being used) and to try the result of using it to replace

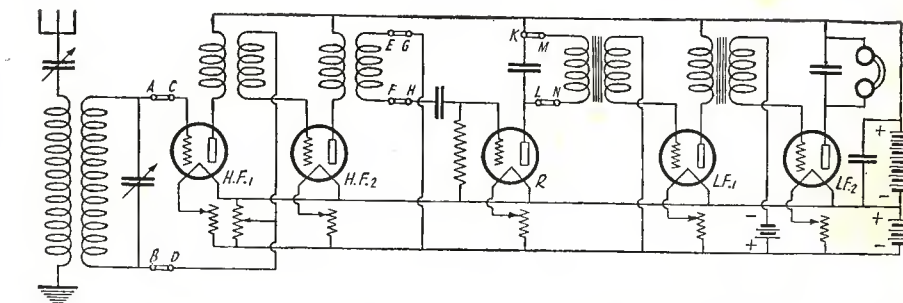

Fig. 4. A switching arrangement whereby the radio frequency or audio frequency tubes can be cut out at will.

each of the four in turn. Nothing happened when it was placed in the sockets of the radio frequency tubes or the detector, but when it was employed as an audio amplifier, signals suddenly resumed their wonted strength and clearness. The mystery was solved immediately. The audio frequency tube had suddenly fallen off in its emission either through ageing or because the filament had at some time during the previous reception been worked at rather too high a temperature. This is a fairly common fault with some tubes if one does not exercise extreme care when using them. It can be detected either in the way indicated or by employing the very useful milliammeter.

This particular defaulting tube was cured eventually by being run for a considerable time with the plate current switched off.

**A CURIOUS OCCURRENCE**

One night the set, when adjusted to the known setting of a local station, responded so weakly that signals were barely audible in the loud speaker though normally they could be heard all over the house. Though usually the particular set in use was so stable that it could not be made to oscillate upon broadcast wave-lengths it was now found to emit squeaks when either the tuning condensers or the coupling between pri-

(Continued on page 123)

## TROUBLE SHOOTING CHART

TROUBLE SHOOTING CHART			
Trouble in tuner or detector circuit	Weak Signals	Aerial ground circuit	Wrong values of condensers or inductances. Bad insulators. Something touching the aerial or lead-in. Ground disconnected or contacts oxidized. Bad contacts in condensers or switches.
		Secondary circuit	High resistance in the circuit due to bad contact in coils or condensers. Losses in condensers due to dust or particles of material between the plates or variable condensers. Broken connection between closed circuit and vacuum tube, or telephones, as the case may be. Batteries discharged. Wrong value of grid condenser or grid leak or defective vacuum tube.
		Telephone circuit	Insensitive or demagnetized telephone receivers. Disconnected or broken lead in telephone cord. Wrong value of by-pass condenser. "B" battery discharged. Wrong polarity or number of turns on tickler coil or variometer which may also be short-circuited.
	Intermittent Signals	Aerial ground circuit	Aerial swinging in the wind and touching tree or other object. Lead-in touching the house for same reason. Ground disconnected from ground plate or water pipe, touching it intermittently. Wire not making good contact with binding post.
		Secondary circuit	Bad contact in switch and switch points. Disconnected leads from coil to switch points. Variable condenser plates touching at one or more points when rotated. Broken pigtail connection. Too high a value of grid leak or condenser which tends to block the vacuum tube. Tube shaking in socket making bad contact with socket prongs. Bad contact in rheostat, discharged or defective filament battery. Too light a contact of cat whisker on crystal.
		Telephone circuit	Defective "B" battery. Bad contact or loose binding post. Diaphragm of telephone receiver bent, or not adjusted. Defective by-pass condenser.
	No Signals at all	Aerial ground circuit	Broken lead-in or ground connection. Aerial down or touching grounded object. Broken wire in coil or condenser contact due to corrosion. Defective lightning arrester.
		Secondary circuit	Broken wire or connection due to corrosion. Short-circuited condenser. Defective grid condenser or grid leak. Bad contact between grid prong of the tube and socket. Discharged "A" battery. Defective vacuum tube. Insensitive crystal.
		Telephone circuit	"B" battery connections reversed. Discharged or short circuited battery. Phones disconnected or short-circuited. Punctured by-pass condenser. Open circuit between the plate of the tube and the filament circuit.
Trouble in amplifiers	Radio Frequency Amplifiers	Continuous oscillations	Plate or "B" voltage too high. Potentiometer wire broken or disconnected on the positive side. Leads too long or crowded, causing feed-back. Apparatus too close to each other causing same effect.
		Weak or no signals	Batteries discharged. Defective tubes. Potentiometer wire broken or disconnected on negative side. Transformer winding open or short-circuited.
	Audio Frequency Amplifiers	Howling or whistling	Plate voltage too high. Secondary circuit open. Burned out or short-circuited transformer winding. Too high a ratio transformer. Transformers too close to each other or not at right angles. Wrong connections. Parallel connections causing feed-back.
		Weak or no signals	Batteries discharged. Defective tubes. Open or short-circuited windings. Wrong connections. Bad contact.



# The Loop Antenna

By R. H. LANGLEY\*

An exceptionally comprehensive and detailed dissertation on loop antennae is required if the beginner is to understand the technical side of their construction and mode of functioning. There are numerous pointers included in this article for the constructor.

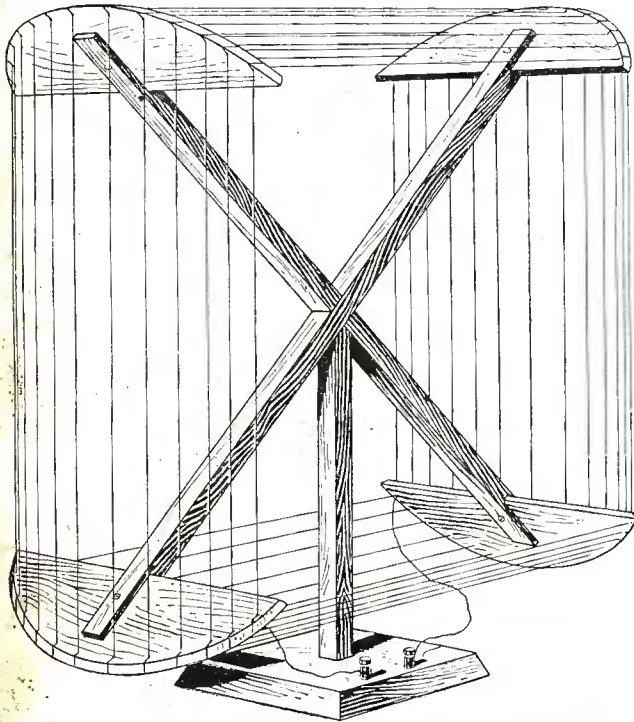

A loop aerial of good design. By stretching the wire on arc shaped ends greater spacing is possible for a given width.

THE loop antenna is a very interesting device. It is quite different in its method of operation from the outdoor antenna. The outdoor antenna is, in effect, nothing more nor less than a condenser. It is a very large condenser, to be sure, so far as its physical dimensions are concerned, but electrically it is a relatively small condenser. The loop, on the other hand, is an inductance. This fundamental difference between the two is the reason why it is necessary to use different methods of tuning in the two cases.

Let us examine this special form of inductance, which we call a loop, and see why it serves as a pick-up device for radio signals and how it should be made to be effective.

There is a very close parallel between the ordinary direct current generator or dynamo and the loop antenna exposed to passing radio waves. In the dynamo, a number of coils corresponding to the loop antenna are rotated in a powerful magnetic field. The purpose of rotating them is in order that they may move with respect to the field and thus have a voltage generated in them. The amount of this voltage depends, of course, upon the strength of the field and the speed at which the wires are swept through it.

In the radio case, the coil stands still but the field moves swiftly past the coil, thus accomplishing the same result. The speed at which the field moves cannot be varied and is always the speed of light—that is, 186,000 miles per second.

Let us see now what form of loop would have the greatest voltage generated in it by a passing radio wave. Let us think of this radio wave as very much like great smooth waves on the ocean, which also move forward with a very definite velocity. The turns of wire on the loop antenna are necessarily in series with each other; that is to say, they form a continuous winding. If

the maximum voltage is to be generated in any one turn of the loop, then the voltage generated in the two sides of this turn should be in an opposite direction, so that they may add and not oppose each other. If the voltage generated in both sides of the loop were in the upward direction at any one instant, then these two voltages would cancel each other, but if the voltage on one side of the turn was up, and on the other side of turn, down, then they would add, and if the loop were connected to a receiver, a current would flow around the turns of the loop. This is, of course, exactly what we wish to have happen.

In order to have the voltage generated on one side of the loop in the opposite direction to that generated on the other side, the loop would have to be one-half a wave-length long; that is to say, it would have to be long enough in the horizontal direction so that one side was in the crest of the wave when the other side was in the trough of the wave. Since the distance between the

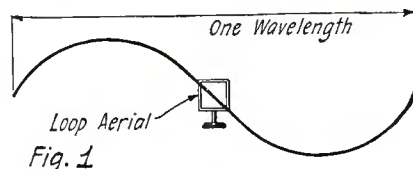

Showing how a difference of potential is induced in a loop aerial by the incoming wave.

crests of the wave is the wave-length itself, then the distance from the crest to the trough is one-half the wave-length.

The higher the sides of the loop arc—that is, the longer the vertical wires are—the greater will be the voltage generated.

But a loop one-half a wave-length long is quite out of the question. It would be as long as a steamship and almost as difficult to handle. The loops which we are using every day are of quite reasonable dimensions. They are only a few thousandths of a wave-length long. How do they function? In order to answer this question, let us ask ourselves how we would build a coil of wire in order that absolutely no voltage should be generated in it by the passing wave. The only way in which this could be accomplished would be to so build the coil that the same voltage would be generated in both sides of it, and the voltages generated in the two sides would be opposed to each other. This would give a complete cancellation and no voltage at all at the terminals of the loop or coil. It is obvious that the only way in which this could be done would be by so arranging the loop that it had no length at all. That is to say, arranging it so that the two sides were exactly in the same position in space. This would mean that the horizontal wires across the top and bottom of the

loop would cease to exist and the loop would become nothing but a wire laced up and down between pegs on the plain surface of a board.

If there is any distance at all between the two sides of the loop, then there will be some difference, not in the amount of voltage generated in the two sides but in the time at which this voltage is generated (Fig. 1), and there will consequently be some voltage at the terminals of the loop, since complete cancellation of voltages cannot occur.

If the loop is rotated so that its horizontal wires are at right angles to the direction in which the signal is coming, then the loop has no length so far as those signals are concerned. The passing wave strikes both sides of each turn in the loop at exactly the same instant and the voltages generated are, therefore, equal and opposed, and there is no terminal voltage (Fig. 2). This is the fact which gives the loop antenna its very useful directional property. It is to be noted, however, that if the loop is turned ever so slightly from this zero position the voltages no longer cancel and there is a voltage at the terminal. This means that the zero position of the loop is very sharp, but the maximum position is very broad.

In applying the loop antenna to an actual radio receiver, it is necessary that provision be made to tune it to resonance with the desired signal. This is accomplished by means of a variable air condenser, and since this condenser has a very definite maximum capacity, the amount of inductance which the loop can have is also limited. This maximum inductance with the maximum capacity of the variable condenser, must give resonance to the longest wave to be received. The specification for the best loop antenna, therefore, is that it shall have just as many turns as possible, each turn being just as long and just as high as possible, and still have no more than the required maximum inductance. The higher the loop is, the greater will be the voltage generated in each side of each turn, and the longer it is, the greater will be the difference in time at which these voltages are generated in the two sides of the loop, and consequently the greater will be the voltage at the terminals, but it must not have an inductance value greater than that required for tuning.

The inductance of a coil of wire increases very rapidly as the turns are wound closer together. The maximum inductance is obtained with the minimum number of turns

(Continued on page 70)

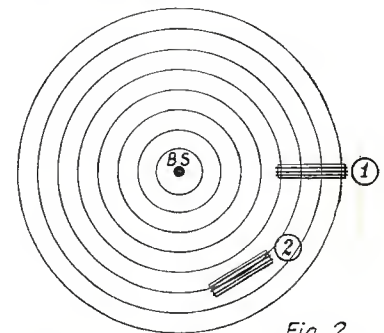

Fig. 2

The loop aerial 1 receives maximum energy from the Broadcast Station BS because the magnetic field passes through the plane of the loop while loop 2 receives no energy.

\* Radio Engineer, General Electric Co.



# DeForest Now Controls Regeneration Patents

By W. B. ARVIN



Never has the radio profession been fed such a sensational piece of news as the report covering Dr. DeForest's success in winning, after a seven-year fight, the patent rights to the oscillating circuit patents. Mr. Arvin gives an interesting and detailed account of the whole affair.



THE radio industry was fairly thrown into a state of frenzy early last month when Dr. Lee DeForest was given control of the oscillating vacuum tube patents by the Court of Appeals for the District of Columbia. The decision giving Dr. DeForest these rights culminated a seven-year legal battle and effects vitally practically every part of the radio industry of the United States.

According to the decision handed down, Dr. DeForest gets not only the control of the vacuum tube oscillators as used for transmitting, but also exclusive patent rights over the so called feed-back circuit, which will bring the tickler feed-back regenerative circuit and the Super-Heterodyne circuits under his control. As a matter of fact, attorneys are well agreed that in any case where a vacuum tube is used as a generator of alternating currents of any frequency, that use will be subject to the DeForest patents.

The effect of this decision is obvious, since, at the present time, all tube transmitting stations being manufactured and installed in the United States will come under the control of Dr. DeForest's patents. Those firms engaged in the manufacture of transmitting sets, regenerative and Super-Heterodyne receivers, will have to make their peace with Dr. DeForest and their further use of the oscillating audion in any form will depend entirely on the Doctor's good-will. Whether they will be granted licenses to continue their manufacture or not is a question that cannot be answered at present writing. It is positively certain that there will be no end of litigation brought with a view to straightening out this tangle, and it is a tangle, since all future vacuum tube transmitters—this includes all broadcast stations—must be made only with the sanction of Dr. DeForest.

### HISTORY OF LITIGATION

The history of the litigation which resulted in this decision is by no means uninteresting. The fight started in March, 1917, with the filing of an infringement suit in New York against Dr. DeForest by the Westinghouse company which, at that time, was in control of the Armstrong patents for generating continuous

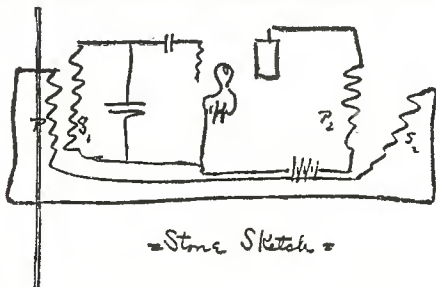

The oscillating circuit as drawn by Dr. Stone two years after Dr. DeForest revealed it.

waves by means of a vacuum tube—the patent which was given to Dr. DeForest by the decision. Shortly after this case was filed, a third claimant went before the patent office in Washington, claiming the discovery of the same idea. At that time there was still a fourth claimant contesting his own discovery. The result was that the Commissioner of Patents issued a Writ of Interference which directed all four of the claimants concerned to take their case to court and obtain a legal

The page from Dr. DeForest's note book shown here played a very important part in the litigation which has finally given him control of the oscillating audion and the regenerative circuit.

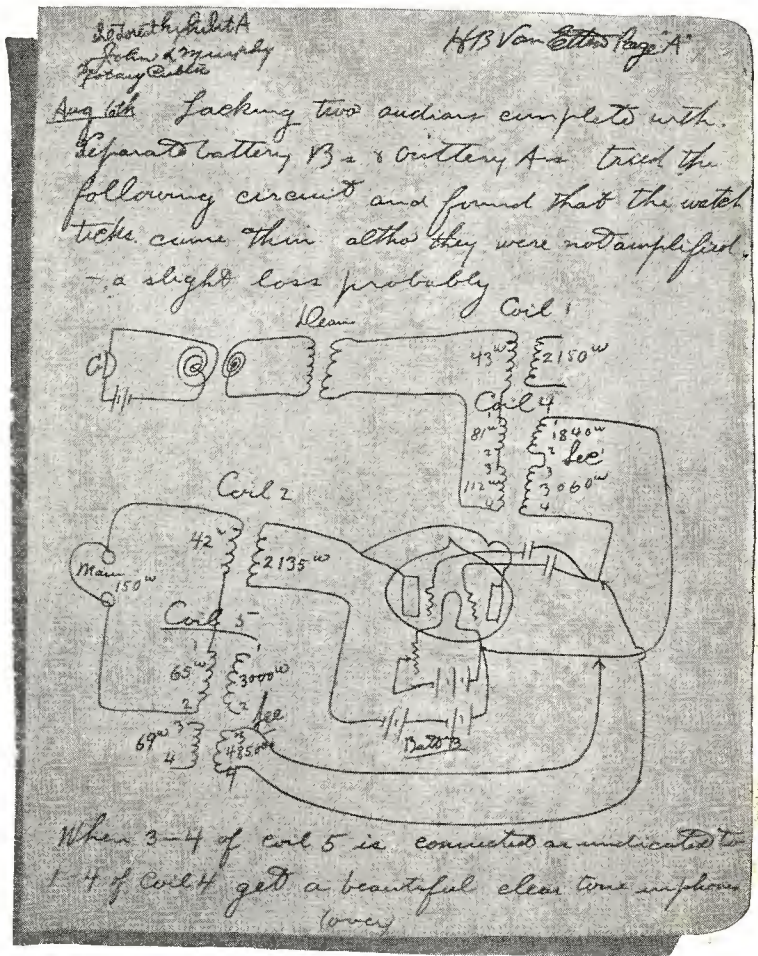

decision as to the rightful ownership of the feed-back oscillator idea. These four claimants were Dr. DeForest, Mr. Alexander Meissner, a German inventor, Dr. Irving Langmuir, of the General Electric Co., and Mr. Edwin H. Armstrong.

The first decision against Dr. DeForest was handed down by Judge Mayer of New York. The case was appealed and Dr. DeForest lost again. It was then taken before the three Patent Office tribunals, from where it was appealed to the Court of final authority which handed down last month's decision.

The question was never one of invention. From the first entry of the litigation it was admitted by all the attorneys concerned that Dr. DeForest had originally discovered the idea. The most important single piece of evidence in the case is the two-page excerpt from the note-book of Dr. DeForest's assistant, Mr. Van Etten, which shows the original circuit and gives the oscillation results obtained from the hook-up. The first of these pages is reproduced at Fig. 1.

The lower courts all maintain that the patent rights should go to Mr. Armstrong, because the lapse of time between Dr. DeForest's original conception of the idea, Aug. 6, 1912, and the time of his filing application for a patent covering it was sufficient proof to establish the fact that he had abandoned the idea. One of the greatest points in favor of Mr. Armstrong seemed to be that Dr. DeForest did not mention the use of the oscilla-

tory circuit for radio work at the time of discovery. Mr. Armstrong's application for patent contains specifically the radio application of the system.

The court who handed down the latest decision, however, took the position that since Dr. DeForest was investigating the use of the vacuum tube as a telephone amplifier and repeater in order to obtain funds to carry on his other research work at the time of his discovery, the lapse of time before the filing of the patent application did not actually constitute abandonment.

### DIFFICULTIES

It might be of interest here to relate a few of the Doctor's experiences and some of his difficulties encountered at this period of his experimental work. Other litigations caused the failure of his company and his own financial embarrassment just about the time of the invention in question. He was forced to give up his own laboratory and experiments in order to make a living. He took a post as engineer with the Federal Telephone Co. of California. During the time of his connection with this company, however, he carried on his own experiments with the vacuum tube as a telephone repeater and relay. On several occasions he made attempts to market this idea to some of the large companies, and in the face of several failures kept up his work, both along this line and in the investigation of the audion as an oscillator.

(Continued on page 129)



# Ring Up Your Friend By Radio

By H. DIAMOND\*

*A practical calling system for radio telephony has been developed by the engineers of the Western Electric Company. Mr. Diamond's description of this new system will prove of great interest.*

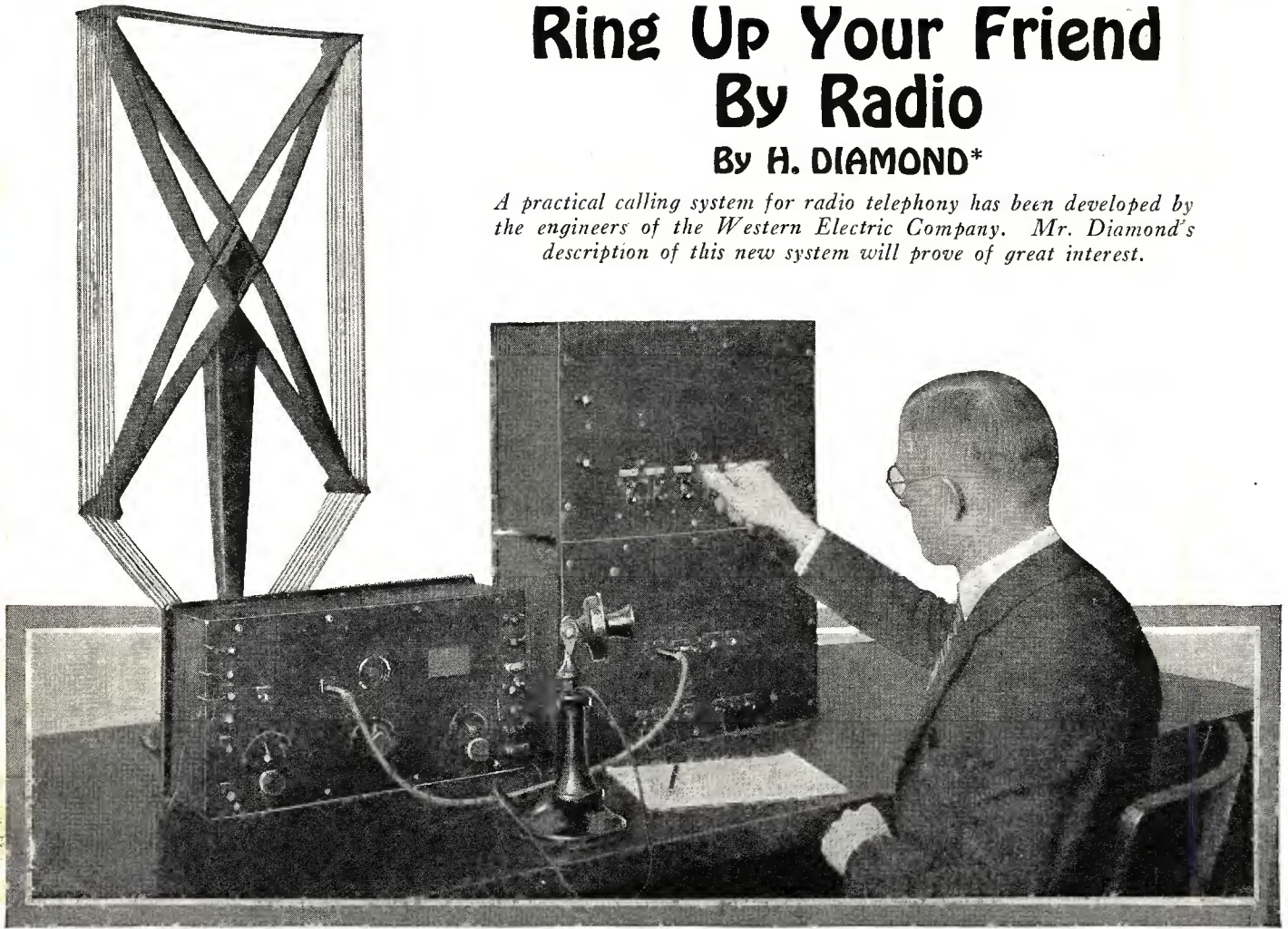

© Western Electric.

Sending a call over the radio. Milton L. Almquist shows how a central station can "ring" any or all of a group of receivers, all tuned to the same wave-length.

**T**HE rapid advance of radio has no doubt led to many conjectures as to the possible development of a radio telephone system offering the same convenience and efficiency as the wire telephone system of today. Obviously a vital factor to be considered is that of signaling. For radio telephony to be successful, a complex signaling system must be available, whereby any subscriber may signal any other subscriber without making it necessary that the called party listen in for the signal with a receiver. It will be interesting for radio fans to learn that an important step in this direction has already been made.

A signaling system has been designed, operating on a signal frequency of 135 cycles, by means of which as many as 78 stations may be signaled individually or simultaneously, with four supplementary stations possible for each main station. Furthermore, by a duplication of apparatus, this scheme need not be confined to one-way operation. It may be made intercommunicative so that any one station may signal any of the others on the same frequency, without calling in stations not desired.

The low signaling frequency permits the use of simple, reliable apparatus, applicable to ordinary radio transmitters and receivers, without requiring modification of the radio equipment, and not high in cost as compared with the remainder of the radio equipment. The low signaling frequency also introduces a high degree of freedom from interference, as brought out by tests made at the Bell System Research Laboratories during the development of this system. It was found

that with the interference caused by spark and I.C.W. telegraph, the received speech would become unintelligible when the energy level of the interference was only 20 to 30 per cent. of that required to cause the signaling to fail.

An additional advantage resulting from the use of a low signaling frequency is that the receiving apparatus may be made so sensitive that the energy output from the smallest vacuum tubes obtainable is more than sufficient to operate the relays successfully.

Although quite limited as compared with the extensive wire telephone systems of today, the selectivity, sensitivity, and degree of freedom from interference of this signaling system will undoubtedly cause its immediate application in marine radio telephony, where automatic signaling would greatly reduce the radio operator's duties.

Another application which readily suggests itself would be speech transmission over the ocean, in which case the length of cable and the impossibility of using Pupin coils and repeating amplifiers make wire telephony entirely out of the question. The same is true over a desert or any other undeveloped region, where it would be far more economical to use the radio telephone than the wire telephone.

It is seen that one system may well be used hand in hand with the other, as indeed is now the case in ship to shore communication, the transmission being accomplished by wire over land to a central radio station and from there by radio to the ship.

Automatic signaling, as described below, will show the way to many such applications.

## DETAILS

A simplified diagram for this scheme of signaling is shown in Fig. 1.

By pressing the ringing key the electromagnet, shown in series with the key and a battery through ground, is excited. Contact is thus made to the 135 cycle supply, the 135 cycle current being thus applied to the radio transmitter in the same manner as speech currents are applied. By magnetic coupling, an alternating e.m.f. of 135 cycle frequency is thereby impressed between the grid and filament of a modulator tube, the plate circuit of which is connected in parallel with the plate circuit of an oscillator, as shown, both circuits being supplied by a plate supply battery. In series with this battery is connected a choke coil of large inductance, which effectively opposes any change of current, and thus keeps the battery current constant even if the resistance of the external circuit is varied.

To fix ideas: At A, Fig. 2, is shown the direct current set up in the key circuit at the time the key is closed.

As explained, this results in the application of 135 cycle current, shown at B, Fig. 2, to the radio transmitter.

Now returning to Fig. 1, suppose that the oscillator generates a wave of, say 450 meters, which is radiated by an antenna inductively coupled to the plate or output circuit of the oscillator. The amplitude of

\* Department of Electrical Engineering, Lehigh University.



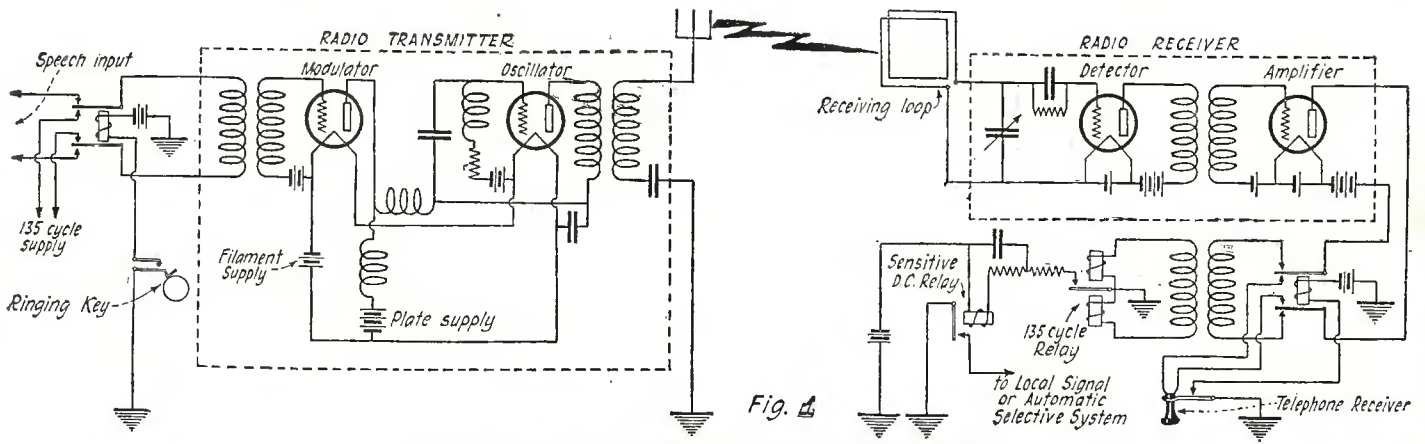

Fig. 1  
Simplified diagram of the basic system for 135 cycle signaling.

this wave is proportional to the amount of direct current supplied to the oscillator plate circuit by the plate supply battery. When a 135 cycle alternating e.m.f. is impressed between the grid and filament of the modulator, the current taken by the modulator plate circuit varies periodically. The oscillator plate current, being equal to the constant total current from the plate supply battery minus the modulator plate current, is correspondingly

the natural frequency of the vibrating reed is made equal to the frequency of the signaling current, the time taken by the condenser to discharge through the inductance of the electromagnet winding will be equal to the time between two successive closings of the circuit by the vibrating reed. The D.C. relay circuit will, therefore, remain closed as long as the reed is vibrating at the signaling frequency. F, Fig. 2, shows the pulsating

sensitivity of the system, a very nearly constant frequency is requisite. To this end, a 135-cycle interrupter has been developed which generates a sine wave of nearly unvarying frequency.

Each ringing key shown may be set to produce a series of impulses in the form of a code. For example, if a certain station, whose code signal is 8-5-4, is desired, the ringing key corresponding to this code is pressed and a series of impulses suitable for indicating this number is sent out. At the receiving end, after these impulses are detected and amplified, they are sent into the alternating current relay as described above. This relay controls a D.C. relay which in turn controls the local signaling circuit as explained. A selector mechanism is connected in this local signaling circuit and is set to operate a signal only upon the reception of the proper coded impulses.

When this signal rings, the called party presses the answering key and proceeds to tune in to the wave-length radiated by the transmitting station, assumed 450 meters above. In the case of one-way operation, the called party can listen to the calling party, but cannot reply. With two-way operation, as shown above, each party can signal the other party, and when the signal has been answered, each party can talk and listen at the same time as is done in ordinary wire telephony. It is evident that in a system of this kind some scheme must be applied whereby the current induced in the receiving loop by the local transmitting antenna is prevented from interfering with the signal e.m.f.'s from the distant transmitter. This is here accomplished by the balancing network shown.

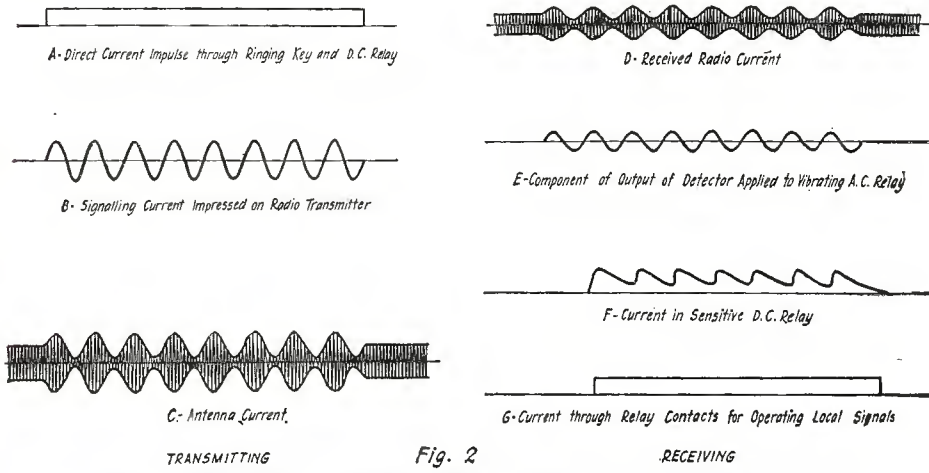

Fig. 2  
Form of transmitted and received signaling currents in operation of basic system.

varied. The current radiated by the antenna will obviously have the same variations. Variation or modulation, as it is usually termed, of the radiated wave (assumed 450 meters above) at the signaling frequency is thus effected. The radiated wave will now be of the form shown at C, Fig. 2.

At the receiving end, the current in the receiving loop is of the same form as the current sent out, but of smaller magnitude. See D, Fig. 2. This current is conducted into the grid circuit of a detector, the plate circuit of which gives as one of its components the 135-cycle current shown at E, Fig. 2, which is exactly similar to the original signaling current. The 135-cycle component is now amplified and by magnetic coupling sent into an alternating current relay, Fig. 3, which consists of a mechanically tuned reed set into vibration by the 135-cycle current.

VIBRATING REED RELAY

The vibrating reed intermittently closes a circuit consisting of two resistances, an electromagnet and a battery connected in series through a ground. A condenser is connected across the larger of the resistances in series with the electromagnet. It is obvious that when the vibrating reed closes the circuit, the electromagnet is excited and closes the local signaling system. The condenser is at the same time being charged. When the vibrating reed opens the circuit, the condenser discharges through the electromagnet. If

unidirectional current in the relay circuit. The current in the local signaling circuit which is operated by this relay is shown at G, Fig. 2. It is seen that this is identical with the current in the key circuit of the transmitting apparatus. Obviously, therefore, coded signals may well be utilized with this system.

The alternating current relay used is very sensitive, operating on as little power as 30 microwatts, corresponding to a current of .00025 ampere. It is also very selective, a 4-per cent. change in frequency necessitating a 100-per cent. change in current to give equally effective operation.

Since a slight change in the signaling frequency has such a great effect upon the

NUMBER OF STATIONS

As noted above, with a multiplication of apparatus, this system has a capacity for a large number of stations on one signaling frequency. It is, of course, understood that in order to prevent interference, each station has its own transmitting wave-length, differing from the transmitting wave-lengths of all the other stations of the system. The

(Continued on page 137)

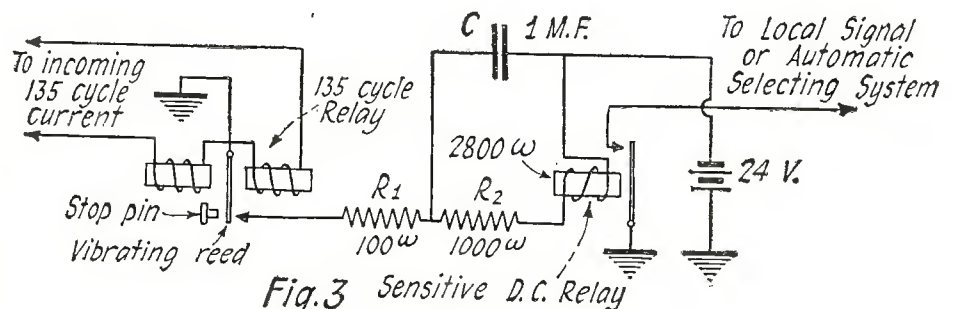
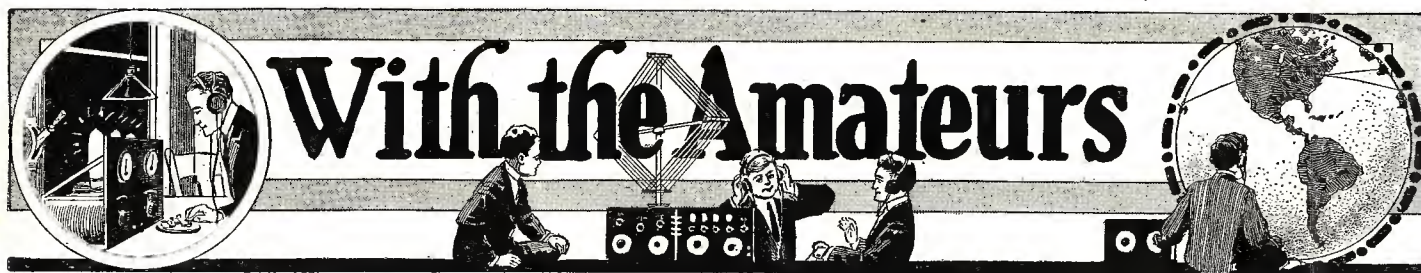

Fig. 3 Sensitive D.C. Relay  
The secondary circuit of the 135-cycle relay.





## The Transmitting Station of the Radio Society of Great Britain

By PHILIP R. COURSEY, B.Sc., F. Inst. P., A.M.I.E.E.



Fig. 1. A general view of the interior of British amateur radio transmitting station G-6XX. A. E. Treheam, the chief operator, is at the key. This station is located at Shepherd's Bush, London, and was erected in a room loaned by the Dubilier Condenser Co., Ltd. A special permit has been granted to use an input power of one kilowatt.

FOR the purpose of participating in this season's trans-Atlantic tests, a special station was erected and operated on behalf of the Radio Society of Great Britain under the call sign of G-6XX, the G prefix being added to designate British nationality in accordance with the scheme approved by the British Post Office. A special permit to use an input power of one kilowatt was granted for the purpose of the tests.

The station is situated at Shepherd's Bush, London, W., England, having been erected in a room loaned for the purpose in the works of the Dubilier Condenser Co., Ltd., which company also greatly assisted in fitting up the apparatus, etc. The aerial, of the inverted L type, is a six-wire cage on 7-foot spreaders, the flat top being about 75 feet long, and the down leads, a six-wire cage on loops of one foot diameter, about 40 feet long. One end of the aerial is supported by a 60-foot mast and the other by a brick chimney stack of about the same height. A six-wire counterpoise is slung beneath the aerial, extending from the window of the operating room to a point just beyond the further end of the aerial.

The vacuum tubes were supplied by the M. O. Valve Co., London, and were each capable of a plate energy dissipation of 450 watts. Two rectifying tubes were used for two-wave rectification at 6,500 volts, and two in parallel as oscillators.

The high-tension was obtained from a step-up transformer, fed at 600 cycles from a motor-generator, the signaling key being put in the primary circuit of this transformer. A general view of the interior of the station, showing the receiving position and controls, is reproduced in Fig. 1, and a view of the vacuum tube panel in Fig. 2. The four tubes in a row can be seen in the photograph, with the filament lighting transformers in the background, and the step-up transformers below the tubes.

### SERIES FEED

A "series feed" of the high tension between the filaments of the oscillator tubes and the oscillator circuit was used, as shown in Fig. 3, since this arrangement was found somewhat more effective than the conventional "shunt feed" of the tube plates through radio frequency chokes.

The filaments are lighted from the 220-volt 50-cycle mains through step-down transformers in the usual manner, a potentiometer resistance being connected across the filaments of the oscillator tubes to obtain the electrical center of the filaments for the connection of the grid leak and the high tension supply.

As may be seen from the diagram, a loose coupling to the aerial circuit was employed, the main oscillation circuit consisting of a condenser of .0005 mfd. capacity with a portion of the primary coil. The aerial coil was a flat winding of copper strip, as may be seen in Fig. 4.

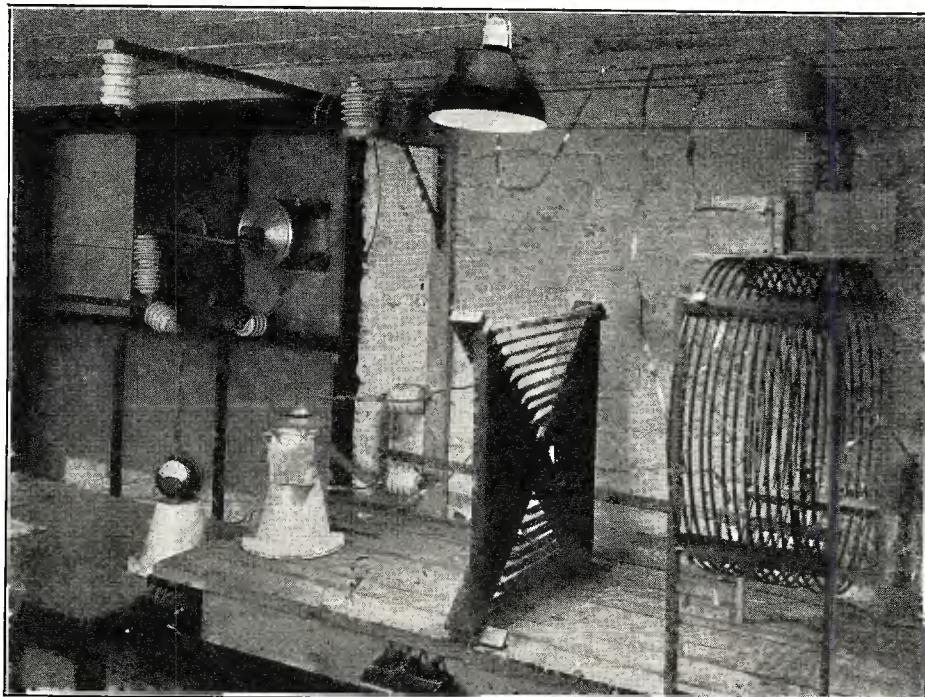

Fig. 4. A view of the apparatus composing the oscillating and antenna circuit. The antenna is coupled to the oscillating circuit by means of a spiral wound pancake coil. The series antenna condenser can be seen at the left of the second table perched atop a large porcelain insulator. The radiation ammeter is similarly mounted. Note the bulky aerial change-over switch.



The average aerial current is about 8 amperes at 193 to 200 meters. This current remains quite steady, even when the aerial swings in the wind, as the aerial circuit tuning is rather flat, while the wave-length is controlled almost entirely by the primary circuit, so that aerial changes make only small effects in the radiated wave-length.

The use of 600 cycles as the supply frequency for the rectifying tubes considerably simplifies the smoothing of the rectified current, so that by the use of a simple smoothing condenser the signal appears to be pure D.C.C.W. at any distance from the station.

The signals from this station have been reported by about 40 American and Canadian amateurs, as well as by the *Bowdoin* in the Arctic, and this in spite of the fact that the aerial is very much screened by surrounding buildings, an elevated railway track and other objects which must decrease the radiation of short wave-length signals.

**SHORT WAVES**

Experiments have also been made in the transmission of signals on about 120 meters from this station, using for this purpose special coils clipped on to the three feed leads between the tubes and the oscillation circuit. To facilitate such tests, these three leads—plate, grid and high tension positive—are carried along the test bench, overhead supported on porcelain insulators, as may be seen in the photographs, so that any convenient coil can be clipped on these leads in a few seconds.

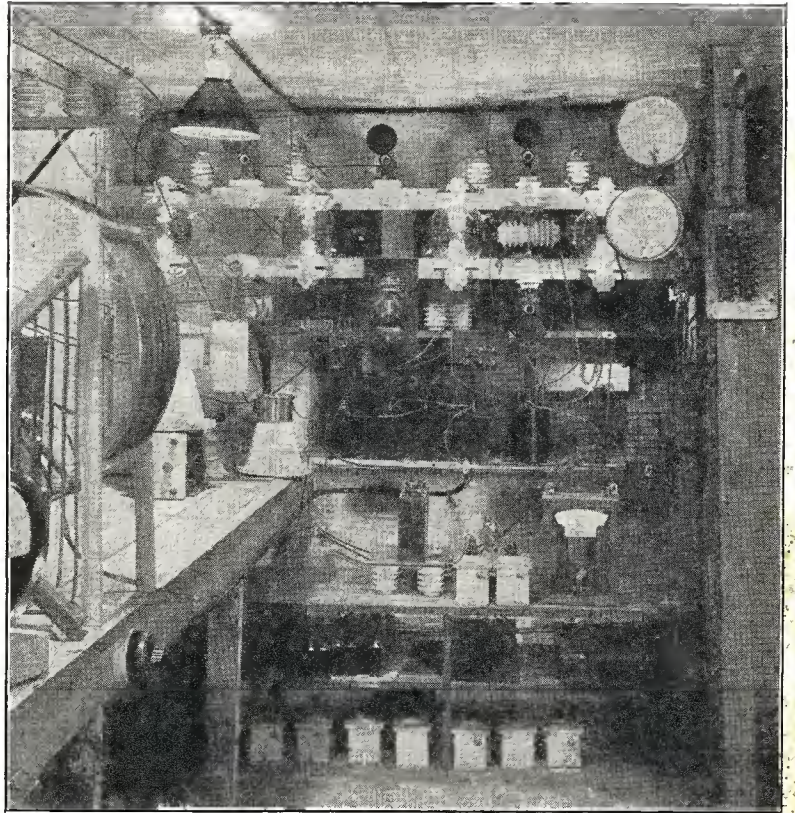

Fig. 2. A view of the vacuum tube panel. The four 450-watt transmitting tubes can be seen on the upper rack. The step-up transformers are located directly below the tube.

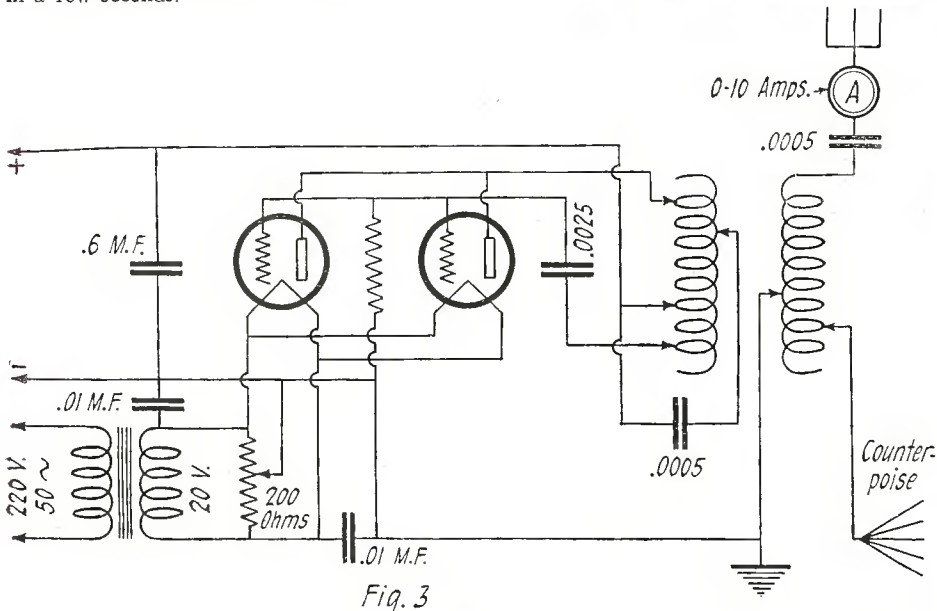

Fig. 3

A special aerial change-over switch is fitted which not only changes over the aerial from "send" to "receive," but also when in the latter position it interrupts either the primary oscillation circuit or the grid lead to the primary coil, as desired. The object of this is to prevent oscillations being set up by the tubes when listening for signals, as it has been found that these tubes oscillate quite strongly without any high tension sup-

Schematic diagram of the transmitting circuit employed at station G-6XX. The manner in which the antenna is coupled to the main circuit is rather unusual.

ply at all, provided the filaments are alight—the pulsating electron emission caused by the 50-cycle heating current of the filaments being sufficient to set the primary circuit oscillating to an extent sufficient to prevent reception on nearby wave-lengths. Interrupting the grid lead to the tubes when the aerial switch is in the "receive" position entirely prevents this trouble.

**Station—4EO—4ZD**

THE accompanying cut shows the general layout of station 4EO—4ZD, owned and operated by Paul G. Watson, at 830 East Park Avenue, Savannah, Ga. The transmitter is a 100-watt Reinartz-Hartley set, while the receiver is one of the writer's own design.

The transmitter is built with a Hartley oscillator circuit, and is coupled to the antenna and counterpoise through two variable condensers, in order to work the set below the fundamental frequency of the antenna. At present it is tuned to 215 meters. The idea of enclosing the set in a cabinet is a departure from conventional C.W. design, and requires careful balancing in order to prevent heat from being generated to any appreciable degree. Two UV-203 tubes are used as oscillators. The system of balancing the counterpoise and antenna with variable condensers allows a very quick change

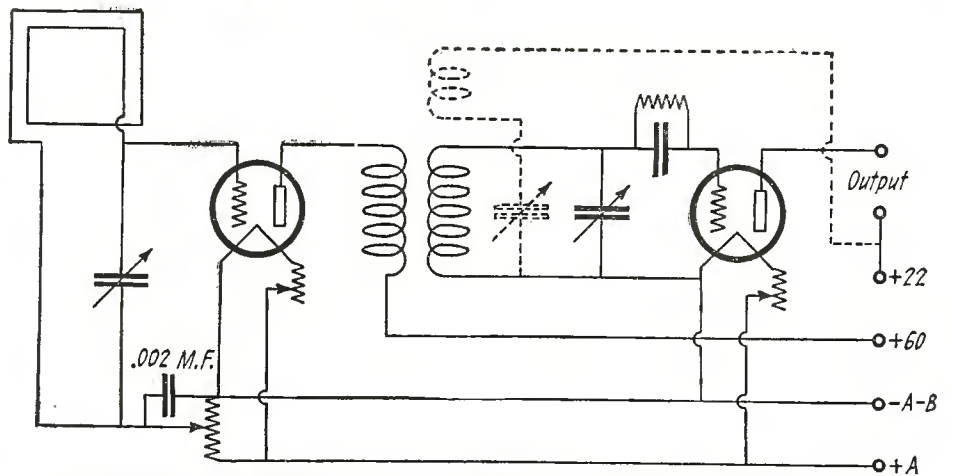

Circuit diagram of Mr. Watson's receiver. The stage of R. F. allows the effective use of a loop.



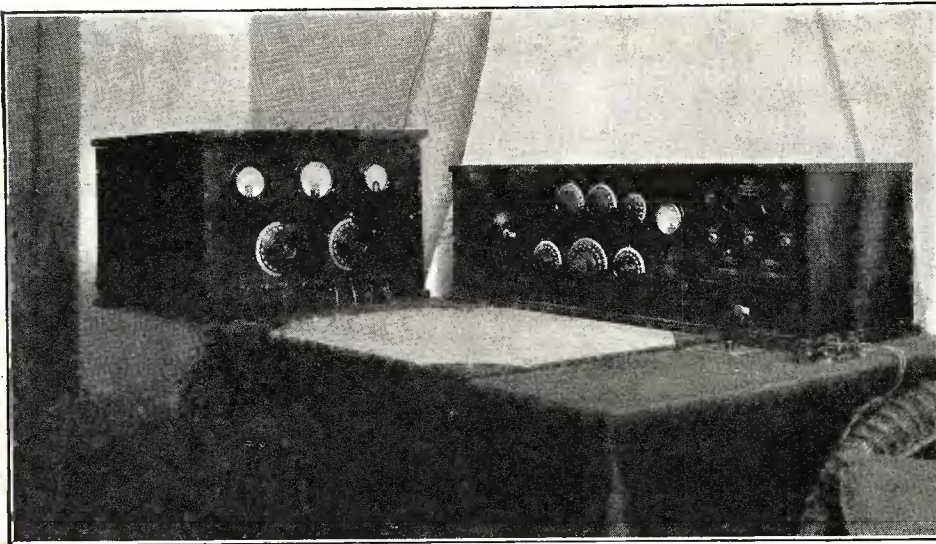

A photo of the transmitter and receiver at 4EO-4ZD. This is the neatest arrangement of apparatus we have seen in some time. Some amateurs would benefit greatly by a similar outlay. Note the audio frequency amplifier built into the receiver cabinet.

of transmitter wave-length, as they control this to a very large degree. The usual filament voltmeter, radiation meter and milliammeter can be seen on the panel. The parts are home-made.

The receiver circuit is shown in the accompanying diagram, and is worked from a two-foot 12-turn loop. The odd feature of this circuit is the fact that the radio frequency transformer is composed of two coils of the same size, coupled tightly. A tickler can be added to the secondary circuit, as shown by the dotted line, but is not essential to good operation. For BCL reception, two No.

50 coils are used, while two No. 25 coils suffice for amateurs, and are used in connection with a one-foot, 10-turn loop. Many amateurs in all parts of the country have been worked on this combination.

During the winter season, when static moderates, this set is connected to the antenna, but as the usual summer static has set in, it is impossible to do any receiving on the antenna. The loop eliminates nearly all the static and gives a very good volume of signals. Potentiometer control is used for regeneration and oscillation control of the loop circuit. The two-step amplifier works very well.

## Calls Heard

### 6ACW, MONETA, CAL.

1ASU, 1BIE, 1CMQ, 1XAH, 1XAO, 1OV, 1BGQ, 2BQ, 2AQB, 2GK, 2XAB, 2AZY, 3YO, 3BJ, 3MB, 3BQ, 3TJ, 3OI, 3ADA, 3AJD, 4EL, 4DY, 4LL, 4XC, 4XB, 4BQ, 4PB, 4MW, 4IQ, 4QW, 4HS, 4IU, 4ZA, 4BA, 4OA, 4FT, 4ER, 4GA, 5JH, 5EK, 5GM, 5NW, 5RV, 5SD, 5OD, 5BE, 5EH, 5NC, 5DC, 5EZ, 5QL, 5OV, 5QT, 5SG, 5RG, 5KC, 5TS, 5BO, 5AV, 5XD, 5NA, 5VM, 5OG, 5EP, 5LY, 5OY, 5NN, 5QX, 5ADO, 5ADW, 5AJJ, 5ZAV, 5ADB, 5AKN, 5AMU, 5AKF, 5AJT, 5ALR, 5XAT, 5XU, 5AHD, 5XAW, 5XAU, 5AIC, 5AGE, 5RH, 5CE, 5ZAT, 5ALJ, 5LR, 5VF, 5HE, 5XAB, 5GE, 5KK, 5HT, 5AJQ, 5AHR, 5LJ, 5RM, 5OT, 5WG, 5AIU, 5AMB, 5ZA, 6's too numerous, 7IO, 7OT, 7RD, 7WO, 7GC, 7AS, 7CO, 7EM, 7PX, 7DC, 7TD, 7OB, 7GW, 7WP, 7PJ, 7OD, 7ACM, 7AIM, 7FR, 7GU, 7ZL, 7AJD, 7TQ, 7AHV, 7FO, 7HW, 7FT, 7MP, 7BJ, others too numerous to list; 8ADG, 8BDA, 8BTV, 8BAU, 8DJP, 8CZC, 8ARD, 8JJ, 8AWG, 8DGO, 8UA, 8TS, 8CGU, 8APT, 8BZD, 8CUD, 8CKV, 8COM, 8FO, 8CZY, 8AMU, 8AQM, 8CXK, 8UE, 8BTO, 8RV, 8DLB, 8KG, 8DHS, 8ALM, 8AJH, 8ACY, 8ATC, 8BKN, 8XAN, 8XBH, 8CHY, 8CVX, 8CPK, 8UD, 8VQ, 8JY, 8ER, 8TV, 8WP, 8EG, 8XE, 8RC, 8RN, 8ZW, 8ND, 8AR, 8HN, 8RU, 8DAE, 8DHO, 8DGP, 8DDC, 8RC, 8SS, 8KO, 8HM, 8DN, 8GZ, 8VG, 8LZ, 8EM, 8EFP, 8EAK, 8EKY, 8EER, 8EJC, 8ELD, 8DWN, 8DYR, 8DCW, 8DKQ, 8DSW, 8DJZ, 8DRO, 8DOE, 8DPX, 8DTE, 8APE, 8AZG, 8AAW, 8ADZ, 8AIM, 8AFM, 8AKE, 8ARN, 8AOL, 8AEN, 8ARJ, 8AXX, 8ASW, 8ABC, 8AEK, 8AAG, 8AGE, 8AEM, 8AEY, 8AMB, 8AHZ, 8BLY, 8BAV, 8BRK, 8BAA, 8BZI, 8BCU, 8BTO, 8BHD, 8BEU, 8BDM, 8BBX, 8BRE, 8BUN, 8BTH, 8BSP, 8BSI, 8AQC, 8BOU, 8BDJ, 8BKF, 8CTG, 8CTU, 8CKP, 8CCZ, 8CYW, 8CFI, 8CLD, 8CGO, 8CYN, 8CDV, 8CWJ, 8CKZ, 8CZY, 8CHZ, 8CKA, 8CKJ, 8CLO, 8XAX, 8ZT, 8CUS, 8CAA, 8CPN, 8CJM, 8CJT, 8CHT, 8VW, 8YY, 8AP, 8MC, 8QR, 8RC, 8HN, 8BDZ, 8DXF, 8CVO, 8AFR, 8ACI, 8EDB, 8DUG, 8DBU, 8DFH, 8AWA, 8DID, 8BED, 8BJN, 8DXY, 8BOF, 8CVS, 8BKB, 8AEP, 8AMI, 8BEZ, 8DRN, 8DEC, 8DGV, 8CCV, 8CCM, 8CBI, 8DEI, 8DVE, 8AOU, 8CLY. Canada: 1BQ, C2BN, C3BP, C3NI, C3CO, C4CO, C5CO, C5EF, C5AF, C9BP, C4AW, C4BK, C4FZ.

Qsl to 6ACW, Moneta, California. WI Qsl om's.

### 2BIR, NUTLEY, N. J.

(1AAP), 1ACB, 1ACO, 1AER, 1AJX, 1AJT, 1AKZ, (1ALJ), 1ARE, 1ARF, (1ASU), 1AXZ,

(1AZR), 1BID, 1BIE, 1BNS, 1BOD, 1BOL, 1BVB, 1CIB, 1CPI, 1KL, 1KR, 1RR, 1YD, 2CPA, 2CWJ, (3ABF), 3ABW, 3ACY, 3ADB, 3ADE, (3AHP), 3AJD, 3APV, (3BCJ), 3BMS, 3BTA, 3BUY, 3BVZ, 3CDK, 3CDN, 3CJN, (3EK), 3HW, 3IW, 3MF, 3OT, 3TA, (3ZO), 3ZM, 4AF, 4AG, 4AZ, 4BG, 4CP, 4EQ, 4FT, 4IA, 4IT, (4JR), 4LL, (4RF), 4RH, 4SH, 4SU, 4XC, (4AIU), 5AMH, 5AMU, 5CS, 5EK, 5FV, 5LR, 5MO, 5OM, 5PM, (5OL), 5RG, 5SG, 5TT, 5UN, 5XA, 5YW, 5ZR, 7AJD, 8ABW, 8ACM, 8AIG, 8AKK, 8ALW, 8ALU, 8ANB, 8APN, 8ATC, 8BCH, 8BCK, 8BDU, 8BFE, 8BJV, 8BMG, 8BHN, 8BNJ, 8BPV, 8BXV, 8CBP, 8CEJ, 8CEO, 8CGJ, 8CMU, 8CNW, 8COM, 8CON, 8CRW, 8CWL, 8CWP, (8CYI), 8DAA, 8DBL, 8DBM, 8DDX, 8DGI, 8DGL, 8DGP, 8DOK, 8XBC, 8AQ, 8BK, 8ER, 8GX, (8IC), 8NB, 8OI, 8QB, 8RN, 8TT, 8UK, 8WO, 8WV, 8YN, 8ZZ, 9AAQ, 9AAU, 9ABE, 9AEF, 9AHJ, 9AIC, 9AMI, 9AMQ, 9AOM, 9ATO, 9AVB, 9AWG, 9AZJ, 9BAZ, 9BCC, 9BDB, 9BGC, 9BIW, 9BJK, 9BJL, (9BNA), 9BPY, 9BRK, (9BVZ), (9BWU), 9CAA, 9CCO, 9CII, 9CJC, 9CKO, (9CNB), 9CRM, 9CSN, 9CTG, 9CVO, 9CYP, 9CZQ, 9DAY, 9BDF, 9DDP, (9DHR), 9DMJ, (9DRO), 9DVW, 9DWW, 9DWX, 9DYY, 9EER, 9EFZ, 9EHQ, 9EIL, 9EJA, (9EKF), 9EKY, 9ELB, 9BK, 9CP, 9CT, (9ES), 9IL, 9LB, 9VM, 9WY, 9XM, If u hv hrd our 50 watter, pse qsl via crd.—Tks.

A filament voltmeter is included in the panel as a "safety first" measure, as the eye is very poor in judging the proper amount of current for any tube. Power amplification is used for bringing broadcast signals up to a great volume. The neighborhood has been entertained on numerous occasions with this set.

A 150-volt home-made "B" battery supplies the plate current for the receiver, while two D.C. generators supply the plate current to the transmitter. Twelve hundred and fifty volts are impressed on the plates of the transmitter, through the usual chokes and by-passes. Remote control is installed for controlling the motor generators and the filament transformer. When the receiver is used on the antenna, a break-in system is employed, and greatly expedites the handling of traffic.

As an "X" license is on the way, the antenna has been cut down to 55 feet long, and the counterpoise to match. The counterpoise has four wires 45 feet long and 25 feet from the antenna. No actual work on 105 meters has been done as yet, as at this writing the license has not been received. On test, the radiation meter shows about three amperes at this wave when the nodal points are properly adjusted. Every indication points to the fact that the usual fine DX will be had on 105 meters that is had on 215 meters, and even much better, as there is no question that signals go much further on that wave than on longer ones.

Practically all the larger broadcast stations have been heard, on the loop, while the list of DX amateur calls is much too long to give here. The California stations have been heard a number of times.

### 5QP, 410 REYNOLDS ST., GADSDEN, ALA.

3AMS, 3AUV, 3BUY, 3BVH, 3CJX, 3HS, etc., 3LV—\*\*\*—4AI, 4BK, 4CP, 4ER, 4EQ, 4EZ, 4JR, 4MY, 4NX, 4OA, 4PK, 4QF, 4SH, 4SU—\*\*\*—5AD, 5AGN, 5AIL, 5ALJ, (5BP), 5CN, (5GP), 5GL, 5KC, 5KQ, 5MI, 5OC, 5QH, 5RG, 5RV, (5VC), 5WS, 5ZAS—\*\*\*—8ACS, 8AIM, 8AJN, 8APT, 8ATC, 8AYT, 8BK, 8BFB, 8CGI, 8CEO, 8CKZ, 8CPK, 8CZZ, 8DEF, 8DHA, 8DKM, 8ER, 8OI, 8TJ, 8YN—\*\*\*—9AAU, 9AAC, 9AAI, 9AAQ, 9ACI, 9AGS, 9AJV, 9AOD, 9AOR, 9AUS (calling WNP), 9AVF, 9BAZ, 9BPV, 9BUB, 9BUZ, 9BRX, 9BSD, 9BSP, 9BSJ, 9BVZ, 9BYE, 9CFK, 9CLX, 9CMN, 9CJT, 9CZA, 9DHG, 9DUB, 9DRO, 9DVW, 9DXF, 9DXK, 9EAC, 9EDU, 9EFO, 9EFZ, 9EJX, 9EKF, 9EKY, 9MM, 9SS, (9TA), 9VK.

Spark: 4FG—ICW: 9DYN—Phone: 5LJ, 9DZO, 9ED—\*\*\*—Canadian: 3OH.

### 9CEN, SEIBERT, COLORADO

C.W.—5AAC, 5AMU, 5ALM, 5BX, 5EK, 5EN, 5LR, 5PH (5QL).  
Phone: 5ABK, (5ADO), 5AKF, 5AMW, 5LC, 5LJ, 5ML, (5OJ), (5OD).  
C.W.—6AOL, (6ADT), (6CNL), 6RN, 6PE.  
C.W.—7ADG, (7CO), (7HW).  
Phone: (7CO).  
C.W.—8DEK.  
Phone: 8BAT.  
C.W.—9AHJ, 9AMU, 9BA, (9BEU), 9BEY, (Continued on page 137)

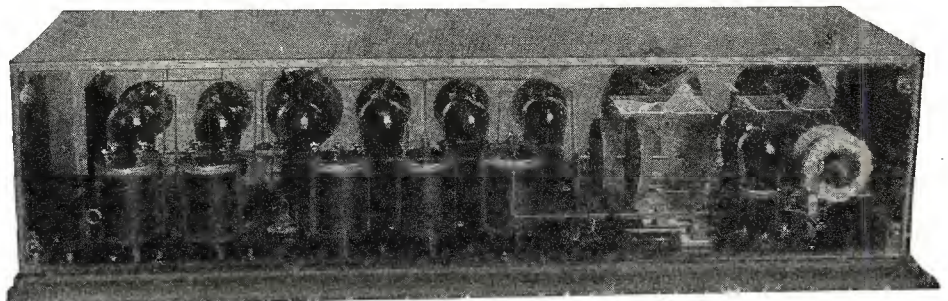

Super-Heterodynes built in glass cases seem to be the latest fad. This set was built up from marketed parts and employs the standard Super-Heterodyne circuit of a detector, an oscillator, three stages of intermediate frequency, a second detector and two stages of A. F. amplification.



# How to Make and Use a Wavemeter

By L. W. HATRY, 5 XU



*As Mr. Hatry puts it, there is a satisfaction and a feeling of security in knowing that your wave is where it should be. One has no fear then of the inspector. Possibly this reflection inspired Mr. Hatry to write this article.*



**T**AKE a deep breath and plunge again, for here's another article about wavemeters. Much has been said about them in the past and a lot more can still be said about them, but if somebody can only touch the spring that will make you realize the need of a wavemeter in your station, none of the advice will have been wasted. Indeed, I wonder at my boldness in telling you this, when so many men more able than myself have done so, and have been ignored. Yeah, and I despair at this waste of words, for you will most likely accuse me of "platitude." However, platitudes are quite often great hunks of the truth—which perhaps explains their standing.

First of all, let's get some doubts out of your mind. A wavemeter is not expensive, is not hard to build, is not difficult to calibrate, and you can do it all without outside assistance, barring the use of your set.

The materials necessary are merely a good .001 mfd. variable condenser and a coil. No crystals, buzzers, meters, phones or other paraphernalia need be attached or purchased. In fact, after you have tried such a meter it is doubtful if you would consider going back to the more familiar type.

Now then, to the part that is no doubt bothering you. With this simple wavemeter in hand and a signal coming in, the particular meterage of which you desire, the *modus operandi* is simple but effective. Place the coil of the wavemeter near to the secondary of your receiver, which should be made to oscillate, and vary the condenser slowly.\* At some point along the wave-meter dial reading, the receiver will go out of oscillation, and a little further on it will resume its oscillation. (You might practice finding this without any signal.) Having found the place on your wavemeter that stops oscillation, it is only necessary to gradually increase the distance between the meter and your receiver until the point that stops oscillation is right on the dot and tunes sharply on the meter, so sharply that a fractional variation on either side of the dead spot will let the receiver oscillate. Then you can read your wave direct from the meter scale, for the spot that stops the oscillation is directly in tune with your receiver, presuming, of course, that your meter is calibrated. This action of the meter should immediately suggest to

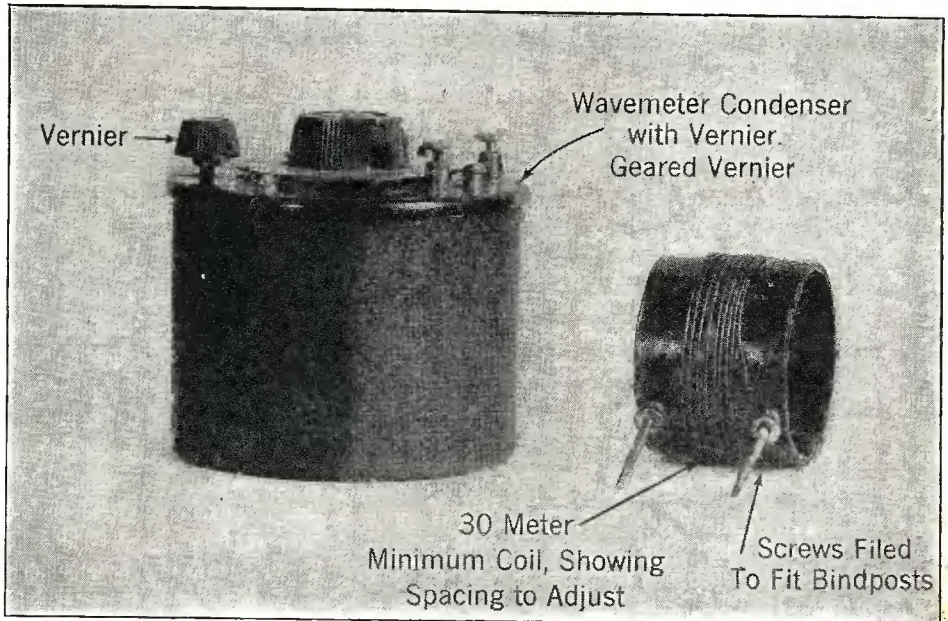

A photo of the variable condenser and one of the coils employed by Mr. Hatry for the wavemeter. The wire on the short wave coil is spaced considerably, as shown.

your mind an effective way of calibrating it. Usually the wavemeter coil will have a correct and incorrect polarity. It is not at



Fig. 1. The manner in which the coils and variable condenser are connected.

all difficult to determine, for one side will work and the other will not.

### WITH TRANSMITTER

The operation to determine your transmitting wave is much the same and acts exactly on the same principle. Place the wavemeter coil close to your aerial lead-in as it goes to your transmitter while the transmitter is in operation and you are watching the ammeter in the antenna. Then vary the variable

condenser so that you will not produce such a reduction that your transmitter will stop oscillating and thereby throw a healthy load directly on your tubes, that previously chased its way merrily up the antenna. This load can, and possibly will, make a good tube look bad and be bad. (It is necessary to vary the condenser very slowly to have time to notice when the reduction begins, without stopping oscillation.) By moving the meter away and adjusting as you go, you can get a distance where the antenna current only drops a tenth or some such fraction of an ampere, when the resonance point is passed. This, if your wavemeter is calibrated, is your wave-length.

If the wavemeter is not calibrated, it is only necessary for you to take some ham, whom you know is not the highest or lowest in wave-length among those you hear, and getting his reading on the wavemeter from your receiver, you can proceed to tune your transmitter as near to that wavemeter reading as possible. Your transmitter can help you solve the further calibration of the wavemeter by getting into communication with as many hams on different waves as possible and getting them to tell their waves as read by the inspector's meter, or by any meter, for that matter, provided it has been actually measured. With sufficient check on your meter readings, you will have one of the most important conveniences a station can own.

Furthermore, most of the more powerful amateur stations can tell you both your wave-length and their own at any time you happen to communicate with them, and it is easy for you to ask them if it is a measured reading and not a guess; they will gladly do this. Any time anyone cares to call me and can get my answer, I will gladly test with him on a series of different wave-lengths and give him their measured meterage with pleasure. I feel strongly enough on this wavemeter stuff to do my share. By the

(Continued on page 109)

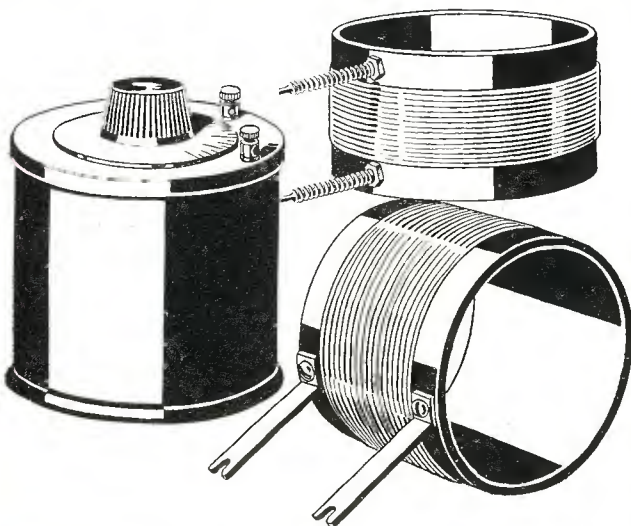

Fig. 2. Rigid metal strips or long machine screws can be employed for the coil terminals and for fastening the coil to the variable condenser binding posts.

condenser of your wavemeter slowly, watching for a reduction in the antenna current. Stop when a reduction is apparent and move slowly from your antenna lead

\*This wavemeter cannot be used with a non-oscillating set such as the Neutrodyne.



# A Local V. T. Transmitter

By HOWARD S. PYLE, A. M. I. R. E.



Mr. Pyle points out the importance of employing a low power transmitter for handling local traffic to minimize interference. He describes an easily constructed and inexpensive 5-watt transmitter and gives information on tuning and operating.

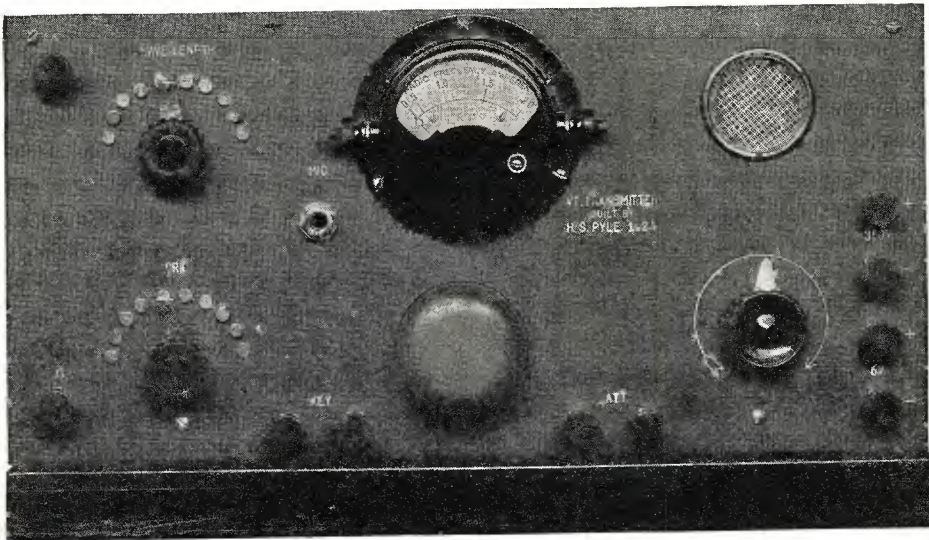

Front view of Mr. Pyle's 5-watt C.W. transmitter. The inductance is regulated by the two switches on the left of the panel. A buzzer for the modulation of the C.W. is mounted directly underneath the radiation ammeter. The vacuum tube filament control is seen at the lower right-hand portion of the panel.

IN the past year or more complaints against amateur stations which were alleged to be interfering with the reception of broadcast programs were many. In numerous instances they have not been justified, but nevertheless in several cases investigated in the larger cities, the amateur transmitter was guilty of causing a great deal of unnecessary unpleasantness to the broadcast listening public. In the great majority of cases such interference was traced directly to the use of more power than necessary to carry on the communication at hand. Particularly is this true of local communications—between points in the same city or within a radius of a few miles. The young fellow with the so-called "hundred-watt" transmitter—that is, employing two of the type of vacuum tube rated at 50 watts output in carrying on local communication—rarely ever makes any effort to decrease his power. His three or four or five amperes are pushed into the antenna circuit just as hard as if he were working a thousand miles. If he attempts to reduce his power, it is generally in the most logical form—the reduction of the plate or filament supply potential to the phiotrons. This, though, at best is unsatisfactory, for it is found that the present-day tubes will refuse to oscillate at plate potentials much less than the rated voltage. The same holds true with respect to the filament voltage. The reduction accomplished by such a method, therefore, is hardly satisfactory from the standpoint of the broadcast listener.

Then, too, regardless of the power used, where rectified alternating current supplies the plate potential, nearby receiving sets generally experience an annoying transformer hum. Efforts to eliminate this by the use of filter systems are but makeshifts and do not answer the purpose unless the filter circuit contains 50, 60 or even 100 henries of inductance in the form of iron core choke coils, and enormous amounts of capacity shunt to the supply source. Even then, without an efficient rectifier, such a filter system is far from efficient in itself. The same holds true for motor generator supplies, but to a lesser extent. Often a disagreeable

generator hum manifests itself in the receiving equipment located nearby. This, however, is much more easily filtered out than an A.C. ripple.

## A SOLUTION

What, then, shall the amateur who is conscientiously trying to co-operate with the broadcast listener do? There is but one answer. For his local and short range communication he had best provide himself with an additional transmitter of extremely low power, and use it in every instance where it will cover the required distance.

This is not an expensive proposition, for in almost every case there are enough parts in the "junk-box" of the average amateur to build a very complete low-powered transmitter. It is not necessary to use even a five-watt power tube, if one is not readily obtainable. An amplifier tube will answer very well. The plate potential may be supplied by four or five of the small "B" batteries, or from the motor generator unit driving the larger tubes used in the DX transmitter, running on reduced potential. The use of alternating current in any form is not recommended for the local transmitter.

Considering the matter further, what should a short range transmitter take into consideration? Should it be pure D.C.C.W., I.C.W. or voice modulated transmission? It has been found difficult to receive pure D.C.C.W. from local stations, and after numerous tests the writer decided in favor of buzzer modulated I.C.W. Many protests will doubtless be made at this, it being alleged that I.C.W. is a greater source of interference than higher powered C.W. Actual experiments have established the fact that this is not so. With key click transformer or generator hum and the general A.C. blanketing effect of higher powered transmitters, the low powered buzzer I.C.W. set will cast the former in the discard in the way of non-interfering characteristics. The writer debated long and earnestly over the subject of whether to include provision for voice transmission or eliminate it entirely. It was

(Continued on page 68)

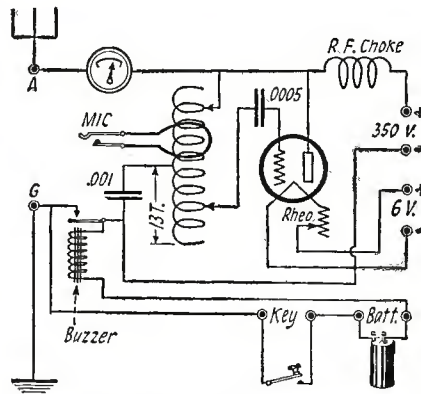

The circuit diagram of the transmitter described in this article. It will be recognized as the Colpitts circuit. Loop absorption modulation is employed for phone work.

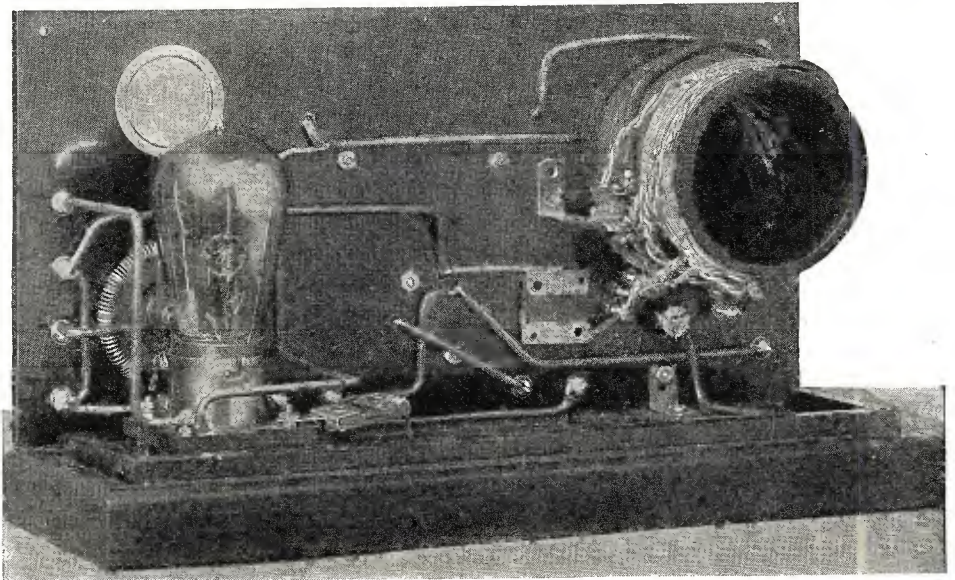

A rear view of the 5-watt transmitter showing the disposition of the parts and the manner in which the C.W. inductance is mounted. The jack for the microphone is mounted just to the left of the inductance.



# A Reflex Receiver With Neutrodyne Control

By A. D. COWPER



*In this instrument Mr. Cowper displays considerable ingenuity in adapting the Hazeltine Neutrodyne principle to an efficient reflex receiver. There is a marked simplicity in the design and construction of this set making it simple of construction.*

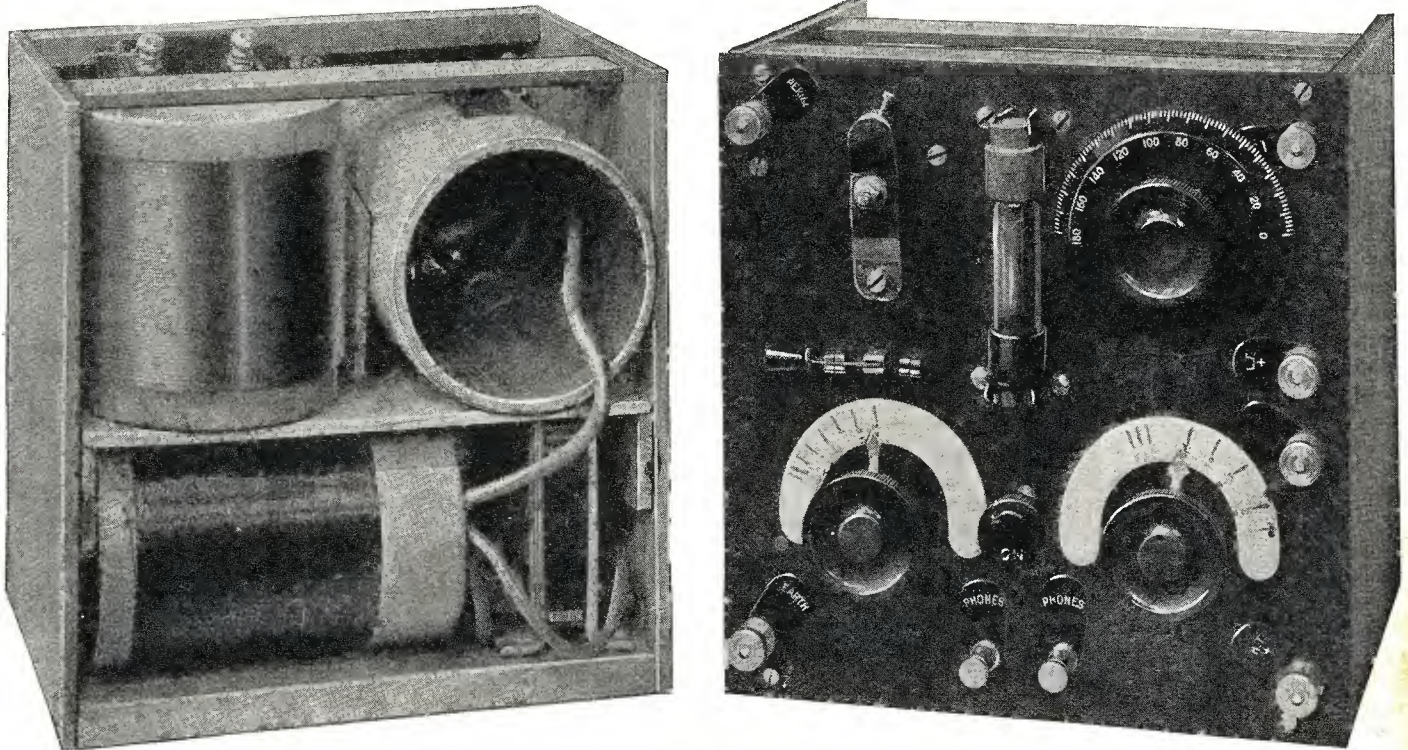

A front and rear view of the reflex set constructed by Mr. Cowper and described in this article. There are a number of new ideas incorporated in this set that make of it a receiver both sensitive and stable in operation.

**I**N order to obtain the maximum possible signal strength from a single tube crystal circuit it is desirable to utilize regeneration to a point which is just below actual oscillation, but which is narrowly adjusted to be as near this point as may be safe. This implies a positive and at the same time a smooth and easy control.

Undoubtedly the most efficient mode in which to link the tube, acting as the radio frequency amplifier, and the rectifying crystal, is by placing the latter instrument in shunt with a tuned plate circuit. The subsequent feed-back of rectified audio frequency energy is preferably carried out through a good step-up transformer arranged so as to apply the maximum possible signal voltage on the grid of the tube.

If a small series condenser be inserted in the aerial circuit (as should be done in little damped circuits so as to give a larger signal voltage across the inductance) or if loosely coupled circuits be used together with high plate voltage and a good tube, a critically tuned plate circuit generally means that self oscillation will take place. With the severe damping of the crystal circuit across the plate inductance, this may not be uncontrollable. For instance, in the familiar ST-100 circuit a resistance of some 100,000 ohms is introduced across the grid and filament, which in practice is found to be an adequate control of too exuberant oscillation, while at the same time allowing considerable increase of signal strength.

An exceedingly effective method of control is afforded by the Neutrodyne principle evolved by Professor Hazeltine. This can be used to stabilize a single tube circuit, or to give, at will, the finest possible control over the feed-back effect. In the receiver to be

described here, a fixed coupling is utilized between the plate coil and the Neutrodyne coil. For the sake of simplicity, the tiny coupling condenser, which transmits back to the grid of the tube the reversed stabilizing impulses, is made adjustable so that regen-

eration is controlled entirely by this neutralizing condenser.

Self-oscillation in a tuned plate circuit is generally ascribed to the back coupling effect of the small condenser constituted by the

(Continued on page 116)

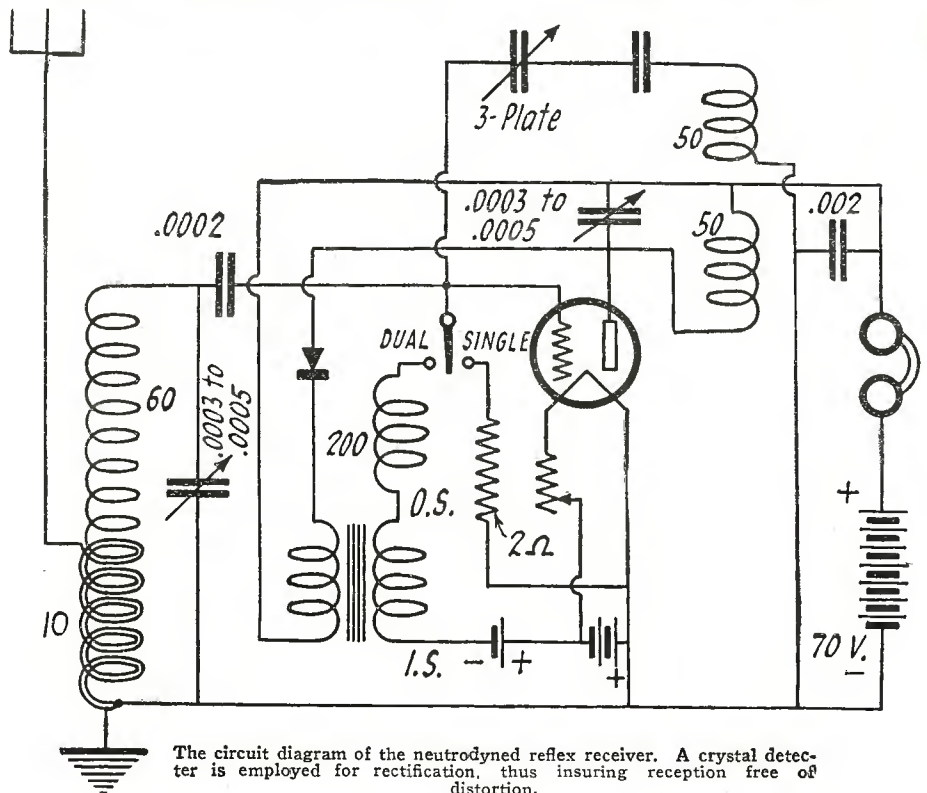

The circuit diagram of the neutrodyne reflex receiver. A crystal detector is employed for rectification, thus insuring reception free of distortion.



# Distortionless Broadcast Reception

By H. J. ROUND, M. C., M.I.E.E.



Captain H. J. Round, the author of this article, world famous for his radio inventions and discoveries, is the chief of the research department of the Marconi Company. He gives here some very valuable information on amplifiers and how to correct distortion.

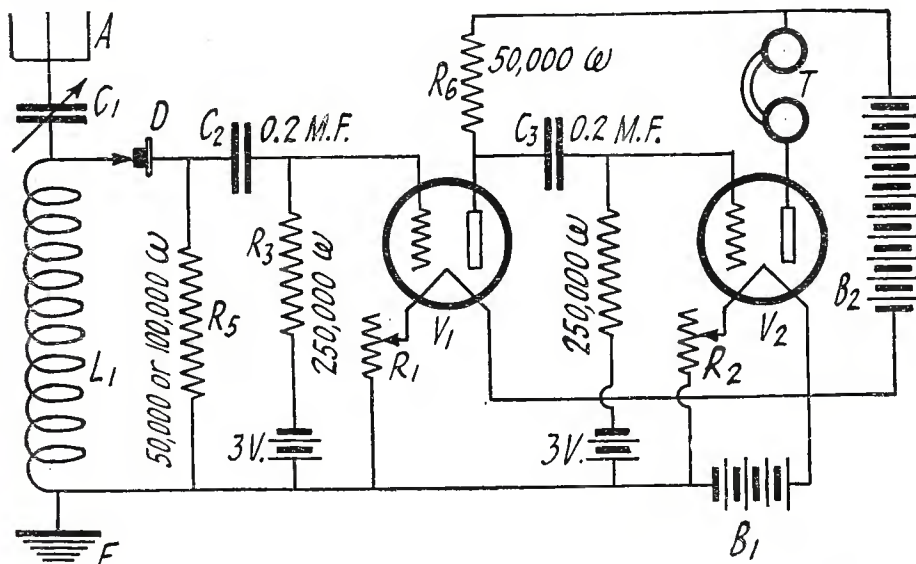

Fig. 1. An excellent distortionless receiving circuit employing a crystal detector for rectification and two vacuum tubes for resistance coupled audio frequency amplification.

PERHAPS you are satisfied with your broadcast reception, but even if you are, a few experiments in a novel direction may be of interest.

For these experiments the ideal radio receiver is that in which there is, with a fair element of certainty, no resonance. It is wiser, if the experimenter can afford the tubes and current, not to exaggerate the amplification to be obtained by each individual tube.

As I only intend these experiments to be done with head-phones, (the difficulties being much greater with a loud speaker) a three-tube set should be sufficient, or even two tubes with a crystal, and some work can actually be done with a crystal alone, or with one tube and a crystal. A great deal, of course, depends upon the proximity of the receiver to the broadcast station.

Figs. 1 and 2 represent two circuits which, if certain precautions are taken, will be distortionless up to the point where the head phones are connected.

In general, you can replace the 50,000-ohm resistances in the circuits by the secondaries of any commercial audio-frequency transformers without much risk of distortion, and in this way you will get more volume. Personally, I always use Lavite 50,000-ohm resistance whenever there is current to be carried, but the grid resistance can be of the usual type.

In the second circuit, particularly if you are near the transmitting station, I advise you to keep your first grid leak, R-4, down in value, otherwise you will get distortion. A number of grid leaks ranging from 50,000 ohms to two megohms are very useful adjuncts to the amateur laboratory.

If you have the use of a sensitive microammeter, an occasional measurement of their value is also useful. If you have such an instrument you can, of course, make them to any value at any time.

Do not force regeneration, as this is a well known way to distort. I like to have an easy adjustment of volume which is warranted not to alter quality, and Fig. 2 shows

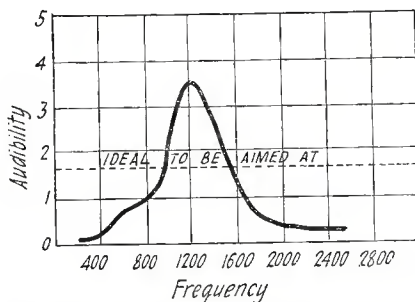

Fig. 3. How a good pair of head-phones deals with various audio frequency currents.

how the grid leak of 250,000 ohms was tapped to do this; but it can also be accomplished by either detuning or by varying the coupling.

Having assured ourselves that all the distortion is either in the transmitter or in the head-phones, let us attack the head-phone question. I have determined that on an average you will get equal voltage produced at the end of your receiver with equal audibility of sound produced at the transmitting end.

An example of this will make the point clear. Suppose a small drum giving a note of 300 vibrations per second and a Piccolo giving, say, 4,000 vibrations, are arranged some distance away from you so that each will be just audible, by arranging that the drummer plays weaker or stronger notes, as required. Then the transmitter will transmit such a modulation that the voltages across the grid of your last tube are equal. So you see that all you now require is a phone which delivers to your ear equal audibility for equal voltages applied to the grid of this last tube. Unfortunately, head-phones do not do this.

Fig. 3 shows approximately what a pair of well known (and considered good) head-phones do. The top notes come out fairly well, the middle ones much too strong, and the bottom ones, below 200 cycles per second, are hardly there at all. You have not noticed this directly because this resonant point is very flat as the scale covers such a big range of frequency, but you have, I expect, noticed it indirectly, and blamed it on the transmission. What you have noticed is:

1. Room echo effects, particularly from large halls.
2. Certain singers' notes being unpleasant and piercing.
3. Violins being rather flute-like.
4. And this is quite important—if you strengthen your signals more than a certain amount, they jar you, although that strength could not have been greater than that which you would have received directly if you had been listening in the studio.
5. Speeches when very weak, unintelligible.
6. The top notes of the piano are too wooden and the bottom notes are too weak.

(Continued on page 114)

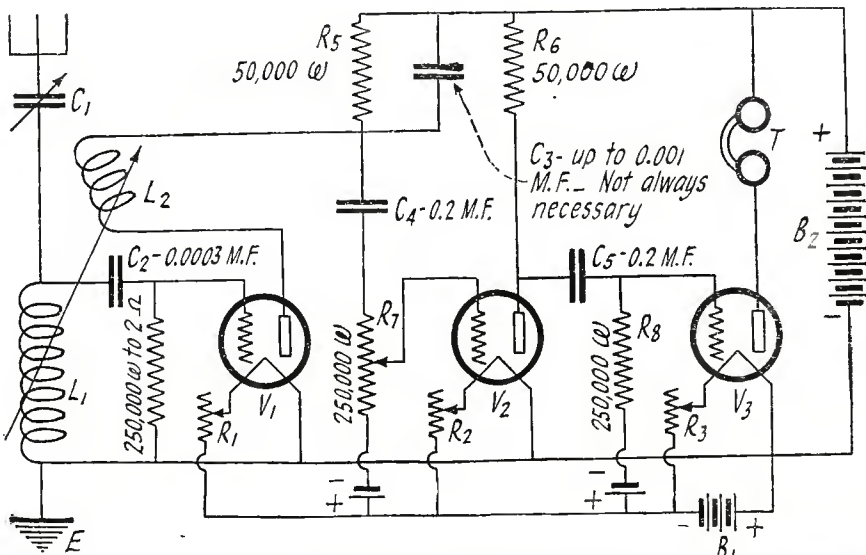

Fig. 2. This is practically the same circuit arrangement as Fig. 1, except that a vacuum tube is employed as a detector and regeneration is introduced.



# Matching Intermediate Wave Transformers for Super-Heterodynes

By PROFESSOR GROVER IRA MITCHELL\*

If maximum radio frequency amplification is to be obtained in a Super-Heterodyne receiver, it is necessary that each intermediate-wave transformer be tuned to the same frequency. Professor Mitchell has described in this article an excellent method of matching these transformers.

THE attention which the Super-Heterodyne circuit is receiving at this time has awakened a keen interest in the design of the intermediate-wave transformers used in its amplifying stages. These transformers are now made in two types, the first of which is able to respond to a wide range in frequencies, ranging from 5,000 to 25,000 meters; and the second, to respond to but a very narrow band of frequencies, usually in the neighborhood of 10,000 meters.

The amplifying curves of the two types are shown in Fig. 1. A comparison of the curves shows that the broadly tuned transformer has a relatively low amplification factor, while the sharply peaked transformer has a very high amplification factor for the frequency to which it is able to respond. It is at once realized that the maximum amplification of the heterodyned signal wave will be obtained only when the transformers in the intermediate stages are of the sharply peaked type with the peaks of all the transformers occurring at the same frequency. In order to be sure of this condition, the builder of a Super-Heterodyne receiver must make certain that the transformers he is using do peak at the same frequency. The exact frequency at which the peak occurs is of no particular importance, so long as it is in the neighborhood of 10,000 meters—a frequency which most authorities have accepted.

The sharply peaked transformers have an air core, since the presence of an iron core tends to broaden tuning. Several sets of specifications for building such air-core transformers have appeared in RADIO NEWS, and the radio experimenter will have no difficulty in building and winding his own. After such transformers have been constructed, it is necessary to match them so they will respond to the same wave-length if the maximum amplification is to be secured. The author has found that in winding these units, even when the same sized forms are used and the same number of turns employed in each transformer, unless the turns have been very carefully wound into flat layers with the same number of turns in each layer—a very painful and laborious job—the inductance of the windings will vary sufficiently between the different transformers to make their peaks occur at widely different frequencies.

### TEST METHOD

The author has used the method and apparatus, which will be described, to ascertain the point at which each of the several transformers peak and to select transformers for each set to be built which peak at the same point.

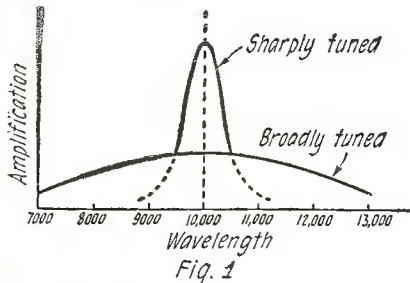

Amplification curves for a broadly tuned transformer and for a sharply tuned transformer. \*Iowa State College

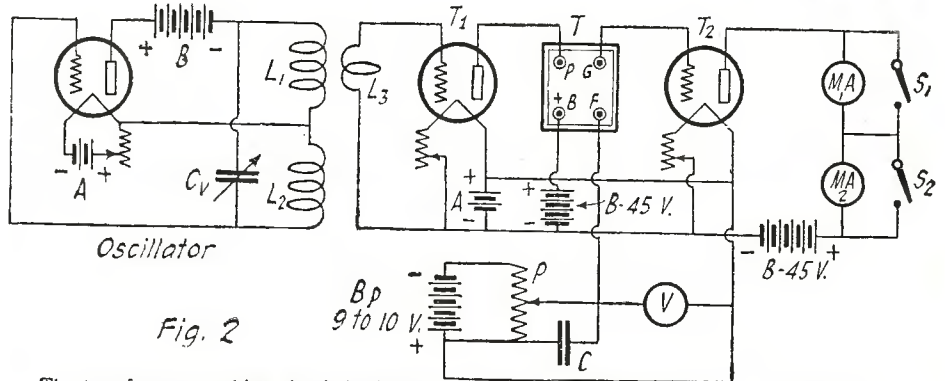

The transformer matching circuit is shown above. Coil  $L_3$  may be shunted by a sensitive ammeter in order to check the amplitude of the oscillator so that it may be kept the same throughout a test.

The first requirement is a vacuum-tube oscillation generator, the circuit for which is shown at the right of Fig. 2. This circuit must be capable of generating oscillations of a wave-length varying between 5,000 and 15,000 meters, or from 20,000 to 60,000 cycles per second. The author has found that if coils  $L_1$  and  $L_2$  are of 500 turns each, of the honeycomb type, the two coils being mounted side by side with their axes coinciding, taking care that their magnetic fields

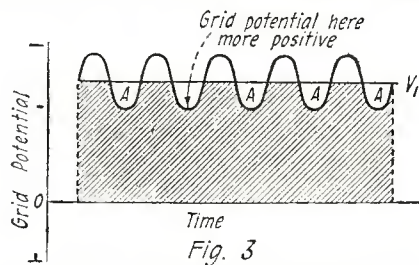

The effect of the oscillations produced by  $T_1$  on the grid potential of tube  $T_2$ .

are "boosting" and not opposing each other, and having the condenser  $C_v$  of the 43-plate type, the oscillating frequency of this circuit will be capable of variation within the mentioned limits.

The variable condenser  $C_v$  should have its settings carefully calibrated for the frequencies ranging from 8,000 to 12,000 meters, this being the range most apt to be used. The other frequencies between the lower and maximum limits may also be calibrated, but this is not so important. The calibration may be done by any one of the many methods described in past issues of RADIO NEWS, or the oscillator may be sent to the Bureau of Standards, or to the laboratories of many of our state colleges or universities, to be calibrated.

The remainder of the circuit of Fig. 2 is a straight amplifier circuit, modified to suit the requirements of this particular type of work. The coil  $L_3$  has but one turn. This coil is very loosely coupled to coils  $L_1$  and  $L_2$ , the coupling being variable to permit adjustment of the amount of energy it picks up.

The transformer to be tested is inserted in the circuit as shown at T, its +B terminal being connected to a 45-volt block of "B" battery and its F terminal is connected to the center terminal of a 400-ohm potentiometer P, placed across the  $B_p$  battery as shown.

This battery should consist of about six standard dry cells. This battery is connected to the positive terminal of the "A" battery supplying the filaments of the amplifying tubes. The voltmeter V is connected between the center terminal of the potentiometer and the positive "A" battery terminal, as shown. The fixed condenser C should be of about .0005 mfd. capacity and is inserted as shown to serve as a by-pass to the potentiometer winding for the radio frequency.

The plate circuit of the tube to the right of Fig. 2 contains two milliammeters,  $MA_1$  and  $MA_2$ , each of which can be short-circuited by a switch.  $MA_1$  should be capable of reading the maximum plate current, about 15 milliamperes, and  $MA_2$  should be a very low reading instrument capable of giving a large deflection for currents as low as 0.1 milliamperes.

The use of this apparatus for measuring the amplification of the transformers under test is as follows:

### METHOD OF MEASUREMENT

The oscillator is set for the frequency desired by means of the calibrated dial of  $C_v$ . Its filament switch should then be opened to render it inactive. The tubes  $T_1$  and  $T_2$  should then be lighted with the transformer T in place. The potentiometer arm should be placed over to the positive side as far as it will go. The switch  $S_1$ , which short-circuits the high-range milliammeter, should then be opened.  $MA_1$  will indicate several milliamperes of current flowing through the plate circuit of  $T_2$ . The movable contact of the potentiometer should then be moved toward its negative terminal, thus placing an increasing negative bias on the grid of  $T_2$ . The reading of  $MA_1$  will gradu-

(Continued on page 66)

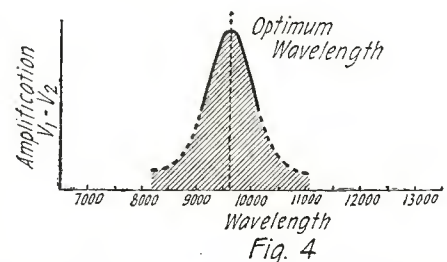

An amplification curve of a transformer which amplifies at maximum just below 10,000 meters.



# Mica Diaphragm Phones as Loud Speakers

By LESLIE R. JONES

Head-phones having mica diaphragms with an armature rod connecting to the center are admirable for use as loud speaker units. Mr. Jones elucidates several hazy points in connection with this type of loud speaker unit.

NOT every amateur or radio fan is in a position to expend money enough to purchase a loud speaker costing \$25 or \$50. Also, true is the fact that the market today is flooded with so many types of loud speakers, good and bad, that the average person is easily misled to the extent of spending his hard-earned money on an inferior article.

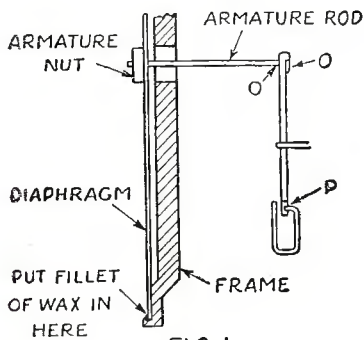

FIG. 1  
Showing the general arrangement of the unit. Note the point where the wax is placed.

Many of these so-called loud speakers are nothing more than poor horns, having cheap phones attached. These combinations can hardly be classed as loud speakers; the name "loud squawker" would be more appropriate.

With this in mind, I have prepared the following suggestions, which, if followed out carefully, will, without doubt, produce a very good loud speaking unit comparable with any.

The perfect loud speaker has yet to be developed. Many are good, but very few approach perfect reproduction. The big difficulty lies, however, not in producing an electrically perfect piece of apparatus, but in producing an acoustically correct unit. It is common knowledge that the science of acoustics has not developed to the extent that electrical science has. Therefore, only such companies that have conducted researches along the combined lines of the above can hope to develop an instrument approaching perfection.

Let us consider the requirements of a good loud speaking unit:

1. It must be designed to prevent electrical losses.
2. It must be adapted to strong or weak voice currents.
3. It must perform faithfully over a range of 60 to 3,000 cycles per second.
4. It must be rugged in construction.
5. The diaphragm should not be metallic.
6. It should operate with permanent magnets to avoid the use of a separately excited

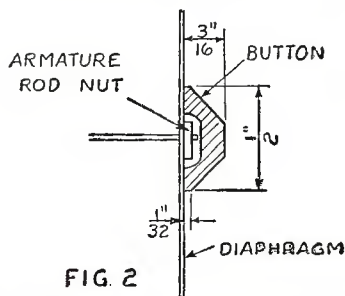

FIG. 2  
Showing the button in place and the clearance for the amateur rod nut.

field. (That is, not requiring the use of a storage battery to excite the field.)

One unit that meets most of these requirements is the Baldwin type C, since it is equipped with a non-metallic diaphragm. Certain alterations are necessary, however. Any phone with a good non-metallic diaphragm and the other qualifications may be used.

The electrical part of the Baldwin unit should not be changed. However, for best results the following changes should be made in the vibrating mechanism and diaphragm. It can plainly be seen from Fig. 1 that in the commercial unit the diaphragm is in contact with the metal frame supporting it. When used as a phone, this is permissible, but in use as a loud speaker unit this metallic contact allows the diaphragm to vibrate to and fro against the metal frame, introducing distortion and noise. This is especially

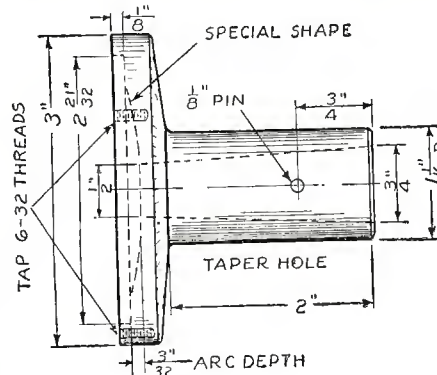

FIG. 3  
Details of an adapter for an Edison Phonograph. The dimensions given are the finish sizes.

true where heavy voice currents are present.

To overcome this defect the phone is held vertically, as in Fig. 1, and a fillet of beeswax is carefully melted into the corner by the aid of a small pointed rod or a clean soldering iron. This rod or iron should be just warm enough to cause the beeswax to run in under the diaphragm, as well as to make a fillet on the outside corner. After the beeswax has cooled, the diaphragm will be securely held in place in the retainer seat by a wax gasket. This simple operation will improve the tone quality wonderfully, and also permit the use of a greater amount of amplifier energy than is otherwise possible. Experiment has proven that ordinary waxes—paraffin, sealing wax, etc.—may not be used with success. Use a good grade beeswax, which can be procured at any good hardware store for a few cents.

Superfluous wax can be removed with a little gasoline or turpentine applied with a small cloth, care being taken not to scratch or damage the mica.

Another decided improvement is the button B. (See Fig. 2.) Its use prevents excessive vibration and the formation of harmonics, which occur when the diaphragm vibrates, not as a whole surface but at the center only. This reinforcement at the center of the diaphragm causes a greater area of the diaphragm to vibrate, thereby broadening and increasing the volume of the unit as a whole.

Dimensions for constructing the button are given in Fig. 2. It is applied at the center of the diaphragm concentrically with

the aid of a little beeswax and a warm iron. The warm iron in this case is held lightly on top of the button until heat enough is transmitted to warm the film of wax that has previously been applied to the center of the diaphragm. This button may be constructed of bone, ivory or celluloid and should be hollowed out enough at the under side center to clear the nut on the end of the armature rod R. Do not overload the button with wax. Too much wax at the center of the diaphragm will retard rather than improve the action.

One thing particularly noticeable in the design of loud speakers on the market today is the trend toward the use of horns of a type that was long ago discarded by prominent phonograph concerns. These horns in general would produce very poor music on a phonograph, and, as the experienced radio man knows, do produce poor music on a radio loud speaking unit.

If you have a good phonograph, take advantage of its acoustical value and use it. Adapt your unit to it; it will give better results than a horn, generally speaking.

The value of the unit will be depreciated considerably if it is not fitted to the sound chamber correctly. Hit-or-miss methods of coupling the two will not give maximum results.

Figs. 3 and 4 give the constructional details for making an adapter for the Edison and Victor phonographs. Adapters for other types will be simply adaptations of these two. The shape of the inside face of the adapter casting is very important, and if the shape is not followed closely the results will be impaired.

The adapter casting may be of aluminum, brass, hard rubber or steel, and should not cost more than a dollar or two. Any machine shop will make one very reasonably.

Referring again to Fig. 1, a drop of wax applied at point O and P will improve the action of the entire unit, particularly when the signals are of considerable volume, as these two joints are apt to rattle under such conditions. Great care must be exercised in applying this wax as the receiver is a very delicate mechanism and a slight bend in the armature rod or the connection will destroy the sensitiveness.

In closing, remember to reverse the phone tips to get the best polarity, if there is any choice, and also see that there is no dirt in the armature to hinder its action. If these suggestions are carried out carefully a loud speaker will result, which will be comparable with the best.

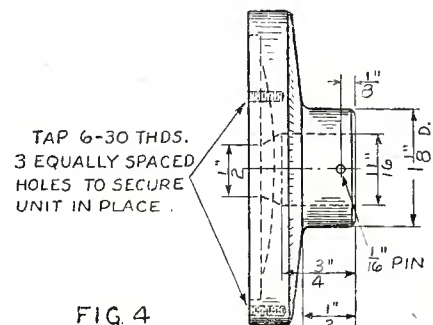

FIG. 4  
Details of an adapter for a Victor Phonograph. These are special dimensions. See Fig. 3 for other sizes.



# STANDARD HOOK-UPS

EVERY month we present here standard hook-ups which the Editors have tried out and which are known to give excellent results. This leaf has perforation marks on the left-hand margin and can be cut from the magazine and kept for further reference. These sheets can also be procured from us at the cost of 5c to pay for mailing charges.

RADIO NEWS has also prepared a handsome heavy cardboard binder into which these sheets may be fastened. This binder will be sent to any address, prepaid on receipt of 20c. In time there will be enough sheets to make a good-sized volume containing all important hook-ups. Every year an alphabetical index will be published enumerating and classifying the various hook-ups.

## Handy Reference Data for the Radio Experimenter

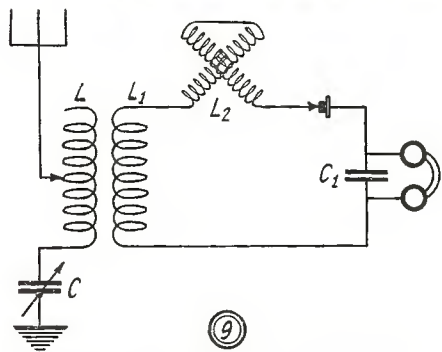

Double circuit receiver with variometer tuned secondary.

This circuit is similar to No. 8 which appeared in the June issue, but employs a variocoupler for tuning instead of a variometer. A variometer is also used in the grid circuit and such an arrangement will prove much more selective than No. 8. If interference is experienced, the secondary can be rotated so that it is at an angle to the primary and the set retuned. In this way it will not be difficult to tune out most interfering stations. The variable condenser shown as C may have a capacity of .0005 or .001 mfd. The variometer L2 is a standard instrument and should be of good construction for best results. It will be found that most of the tuning will be done with the variometer, and the primary after once being adjusted, will be varied very little except for large changes in wavelength.

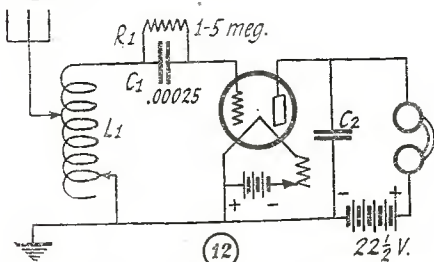

Single circuit receiver using three element tube.

Diagram No. 12 is the simplest of all circuits using a three-element tube and, as in the case of all preceding circuits, is non-regenerative. A fixed condenser of .00025 mfd. capacity is placed in the grid circuit between the grid of the tube and the tuner and is known as a grid condenser. A grid leak (R1) is shunted across the grid condenser and will usually be from one to five megohms in resistance. The usual bypass condenser C2, is .001 mfd. and is connected across the phones and the "B" battery. A "B" battery is always used in a circuit employing a three-element tube. The voltage of this battery will depend upon the type of tube used. If a soft tube, such as a UV-200 is employed, the "B" battery will vary between 16½ and 22½ volts. With such a tube, when the rheostat—which in this case will have a resistance of six ohms—is turned up to a certain point, a slight hiss will be heard in the phones. For best results the tube should always be operated just under this hiss.

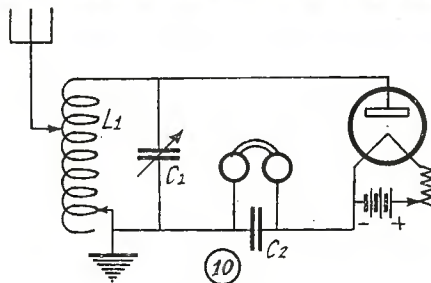

Single circuit receiver with two element tube.

Diagram No. 10 shows a single circuit receiver using a two electrode tube instead of a crystal. Although it is only a little more sensitive than a crystal receiver, it does not have to be adjusted and is always ready for operation. The inductance L1 may consist of the primary of a standard variocoupler or it may be made by winding 60 turns of No. 22 S.C.C. wire on a 3½-inch tube. The winding should be tapped about every six turns and two switch points are connected to each tap. This will give an inductance that can be varied over the same winding by two switches. A two-slide tuning coil may also be employed as the tuner, instead of the tapped inductance. The variable condenser C1 has a capacity of .0005 mfd. A condenser of this size usually consists of 23 plates. The by-pass condenser C2 is fixed and has a capacity of .001 mfd.

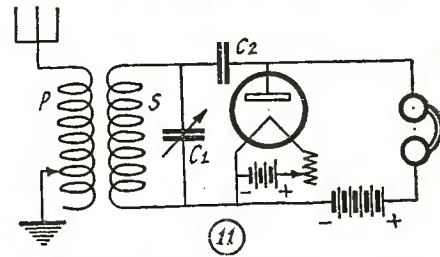

Two element tube receiver using "B" battery.

Diagram No. 11 also uses a two-element tube, but in this case a variocoupler is employed for the tuner. The primary of this variocoupler will consist of the same number of turns as the tuner in Circuit No. 10. Only one switch and one set of taps are used to vary the inductance. This primary may be tapped every six turns, which will give 10 switch points. The secondary of this coupler is made so that it will rotate inside of the primary and is wound with about 45 turns of No. 24 S.C.C. wire. The variable condenser C1 should be about .0005 mfd. and the fixed condenser, C2, is of the same capacity. A "B" battery of 22½ volts is used in this circuit and greater signal strength will be had with this arrangement than can be expected with circuit No. 10. If interference is experienced, the secondary may be turned so that it is at quite an angle to the primary and the set retuned until the station again comes in strong.

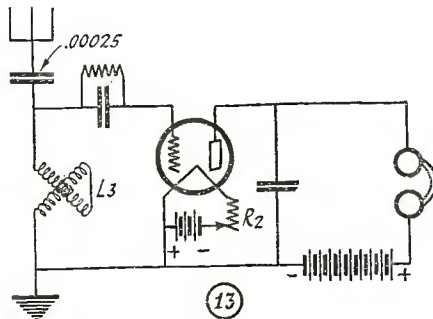

Simple receiver employing a variometer as tuner.

Diagram No. 13. This circuit is similar to No. 12, but employs a variometer L3, for tuning. The wave-length of the average variometer, when used in series with the antenna, is too high to respond to the lower broadcast wave-lengths and a fixed condenser of .00025 mfd. capacity should be placed in series with the antenna to reduce it. The grid condenser in this receiver is a .00025 mfd. one, which is standard for most circuits. The tuning is very simple, the variometer being varied until the station is picked up. The resistance of the rheostat R2 will depend upon the kind of tube used. The voltage of the "B" battery will also depend upon the tube, but it will usually be not higher than 45 volts. A circuit such as this, which does not use regeneration, will have a receiving range of about 100 or 200 miles.

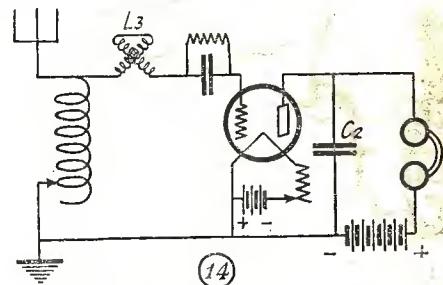

Single circuit receiver with variometer tuned grid circuit.

In diagram No. 14, a circuit is shown that will prove fairly selective. The antenna system is tuned by means of a tuning coil which may consist of 60 turns of No. 22 S.C.C. wire on a 3½-inch tube tapped every six turns. The secondary, or grid circuit, is tuned by a standard variometer L3. The switch on the antenna coil is varied until the desired signal is picked up and then the fine tuning is done by means of the variometer. If a UV-200 tube is employed as the detector, it would be best to use a "B" battery that is tapped from 16½ to 22½ volts, so that different voltages may be tried to determine which gives best results. Care should be taken that the positive of the "B" battery is always connected to the plate through the phones. The by-pass condenser C2 is not always necessary and the receiver should be tried both with and without it, to determine which gives better results. This condenser will be of about .001 mfd. and is not critical.



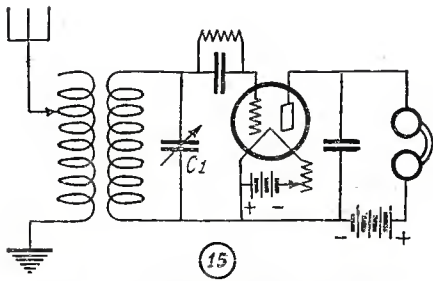

Double circuit receiver with secondary condenser for tuning.

Diagram No. 15. In this circuit a variocoupler is used in place of the tuning coil shown in Circuit No. 14. Also, the secondary circuit is tuned by means of a variable condenser of .0005 mfd. capacity, instead of the variometer. Much greater selectivity will be had in a two-circuit receiver of this kind, as it is possible to vary the coupling between the primary and the secondary coils of the variocoupler. When tuning, the primary switch lever is placed on the second or third tap and the variable condenser varied until a station is picked up. If no station is heard, the switch lever is changed to another tap and the condenser again varied. Sometimes certain taps on the primary will give better results than others for certain stations, but this can only be determined by experiment. As a rule, however, one certain tap on the primary of the variocoupler will bring in most stations in the broadcast wavelength range and it will not be necessary to change to another tap unless a great variation of wave-length is required. This circuit will give very good results, although as it is not regenerative, stations further than 100 or 200 miles distant will not be picked up except under exceptional conditions.

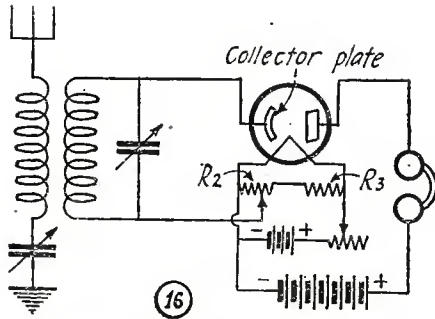

Receiver using the new Sodian tube.

In diagram No. 16 we have a circuit that will prove far more sensitive than any of the others thus far described. In this receiver the new Sodian tube is employed as the detector. A special form of loose coupler must be used with this tube, as very loose coupling is required for best operation. This tube does not have a grid, as is the case in a three-element tube, but instead it has a curved metal plate known as the collector. The circuit for this tube is similar to a standard vacuum tube circuit, but it requires a potentiometer of about 50 ohms (R2) in series with a fixed resistance of 150 ohms (R3) connected across the filament battery and rheostat as shown. The primary of the coupler may be tapped as usual, or it may consist of a fixed inductance with a variable condenser of .001 mfd. capacity in series. The secondary of the coupler is tuned by a variable condenser of .0005 mfd. capacity. This circuit is very sensitive, especially on weak signals, which makes it excellent for long distance reception. A receiver using this tube cannot oscillate, is non-regenerative, and will not interfere with other receiving sets.

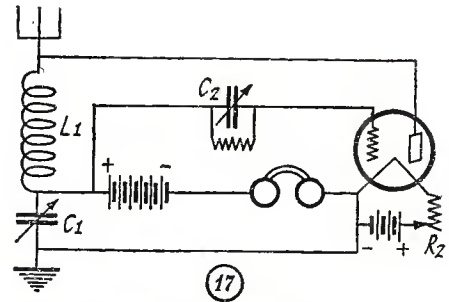

Ultra audion circuit with a single coil.

In Circuit No. 17 we have the simplest form of regenerative receiver using a standard three-element tube. This receiver is of the ultra-audion type, and regeneration is obtained and controlled by means of the rheostat R2 and the variable grid condenser C2. A fixed grid condenser of .00025 mfd. capacity may be used, but if a variable one of .0005 mfd. is employed, greater control over the regeneration may be had. The tuning coil in this circuit is a fixed inductance and may take the form of a honeycomb or spiderweb coil of 25 or 35 turns. This is shown as L1. The tuning is accomplished by means of a variable condenser C1, which is in series with the coil and ground and which has a capacity of .001 mfd. If desired, the inductance L1 may consist of a tapped coil such as the primary of a variocoupler. This type of coil is not absolutely necessary, but will prove of advantage where an antenna is too long or too short for a fixed inductance. A receiver of this type will prove fairly selective and should have a receiving range of at least 500 miles. As this is a regenerative receiver, it will cause great interference to other receiving sets if operated incorrectly.

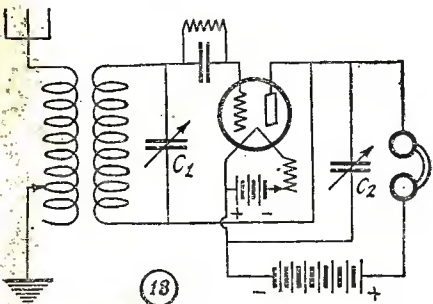

Ultra audion receiver with variocoupler for tuning.

Diagram No. 18 shows another form of ultra-audion receiver using a variocoupler in place of a single coil. Tuning is accomplished by means of the switch on the primary and the variable condenser C1 in shunt with the secondary. Regeneration in this case is controlled by means of the .0005 mfd. variable condenser shown as C2. It will be seen that the phones and "B" battery in this receiver are removed from the oscillatory circuit and the lower terminal of the secondary, instead of being connected to the "A" battery, is run directly to the plate of the tube. The grid condenser may be variable if desired, and will help to control regeneration, but this is not necessary for good operation. In tuning a receiver of this kind, the primary of the coupler is varied by means of the switch and the secondary circuit is tuned by means of the variable condenser C1. If the variable condenser C2 has all of its plates intermeshed, the tube will go into a state of oscillation which will distort signals and create interference in nearby receiving sets. The remedy for this is to furnish less capacity by moving the rotary plates of the condenser until the signals are clear and not distorted. If the signal is not very loud, more regeneration can be obtained by increasing the capacity of the condenser.

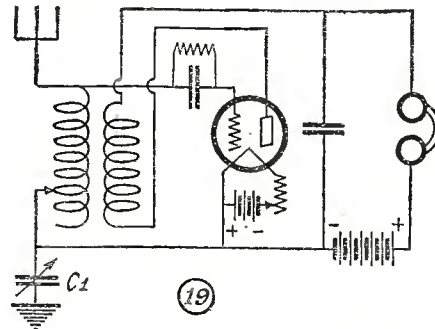

Single circuit regenerative receiver with tickler.

This circuit is of the single circuit type and tuning is accomplished by means of the switch on the primary and the variable condenser C1 of .001 mfd. capacity in the ground circuit. Any wave-length may be reached to the limit of the tuner by varying the switch and tuning between the taps with the variable condenser. The secondary of the coupler is connected in the plate circuit of the tube in series with the phones and "B" battery and regeneration is obtained by varying the coupling between the two coils. When assembling this circuit, and the primary and secondary coils are parallel with each other, the plate and grid leads should always be connected on opposite ends of their respective coils. When these two coils are parallel, greatest coupling is had and the tube will be in a constant state of oscillation. When a station is tuned in, the secondary should be placed at such an angle to the primary that the signal is loudest without being distorted, which will usually be just before the tube goes into oscillation. This oscillation point is indicated by a click in the phone and at this point a squeal will be heard and signals will become mushy and distorted. As stated before, never operate a regenerative set with the tube in an oscillating condition.

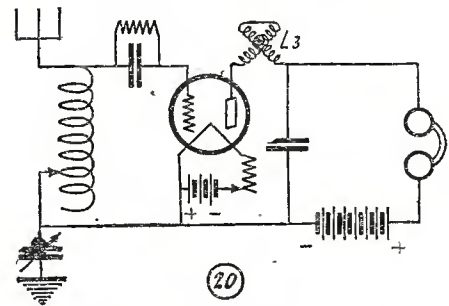

Regenerative circuit using tuned plate system.

In Circuit No. 20 we have another regenerative receiver which uses the same tuning system as Circuit 19, but in this case regeneration is obtained by means of a variometer L3, in the plate circuit instead of the tickler coil. This variometer tunes the plate circuit to the same wave-length as that of the grid circuit and when these two circuits are exactly in tune, or in resonance, the tube will go into oscillation. When a station is tuned in by means of the switch and series condenser, the variometer is varied and as it approaches the resonance point, regeneration will take place and the signals will increase greatly in strength. It will be found easier if the grid and plate circuits are both tuned at the same time, as in this way if any weak station is in the range of this receiver it will then be picked up. This receiver, or, in fact, any receiver shown in these pages with the exception of diagrams 10, 11 and 16, can be used with any of the three element tubes on the market. Great care should always be taken that the right voltage is used for the filament, as otherwise the tube might easily be burned out. This receiver is also of the single-circuit type and consequently will not give very sharp tuning, although it is capable of long distance reception if no interference is experienced.



# An Efficient Untuned Primary Coupler

By W. L. PEARCE

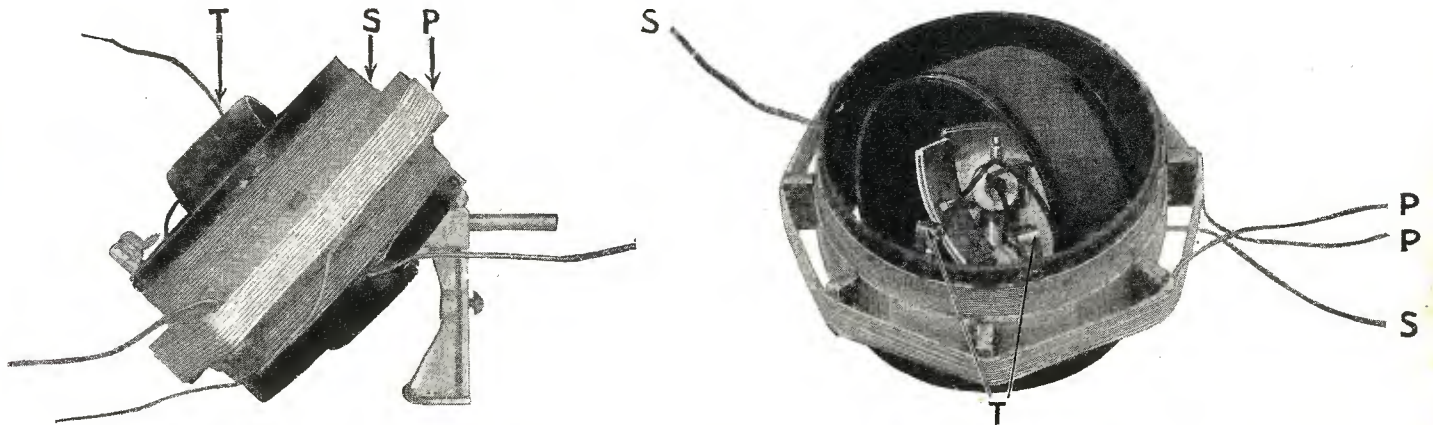

Two views of the untuned primary coupler showing all three windings. On the left, T is the tickler, S the secondary and P the primary. On the right P and S show the primary and secondary terminals respectively.

**T**HE ease of adjustment of a single circuit receiver and the selectivity of the two circuit tuner may be had by using an untuned primary coupler. A receiver using this coupler has only one control for tuning and one for regeneration. It is nearly a one control receiver, as the regeneration remains almost at maximum for all wave-lengths at a certain setting. If the tickler is set for maximum regeneration at the low wave-lengths, it need be varied only a few degrees for the higher waves.

The coupler is very easy to construct and may be made by anyone. A standard 180-degree variocoupler similar to the one in the photograph should be obtained. The primary winding should be removed from

the stator and a new winding consisting of 42 turns of No. 20 S.C.C. wire substituted. A little collodion may be applied to the outside turns to keep them in place. This winding will be used as the secondary of the coupler. A strip of flexible cardboard, three-quarters inch wide and just long enough for the ends to meet is wrapped around the new winding and secured in this position by a strip of adhesive tape. Eight small blocks of hard wood or some other good insulator, measuring  $\frac{3}{4} \times \frac{3}{8} \times \frac{1}{8}$  inch are procured and are secured at their edges, at equal distances, on the strip of cardboard. Collodion should be used for this purpose, as it dries in two minutes and will hold the blocks securely. The primary winding consists of 10 turns of No. 18 S.C.C. wire wound over the secondary winding on the edges of the wooden blocks. The beginning of this winding is secured by means of a piece of strong cloth tape about  $1\frac{1}{2}$  inches long and  $\frac{1}{4}$  inch wide. This is folded over the beginning of the wire and laid flat on one of the wooden blocks. As the primary is wound, each turn passes over the tape and holds it in place. Before the first turn is completed, a second piece of tape, folded in the same manner, is placed on the block directly in front of the other so that the looped end of the tape points in the opposite direction from that of the first. The first turn is then passed over this piece of tape and the rest of the winding is continued over both tapes. The last turn of the winding is passed through the loop of the second piece of tape and the other end is pulled until the wire is tight up against the rest of

the winding. This method of securing the ends is plainly shown in Fig. 1. A light coat of collodion may be applied to this winding to keep it in place.

This coupler makes a very efficient regenerative receiver and will tune to all broadcast wave-lengths when the secondary is shunted by a variable condenser of .0005 mfd. capacity. If amateur wave-lengths are to be received, the primary may consist of five turns and the secondary 20 turns.

The circuit diagram for this coupler is shown in Fig. 2. Usually, when a new circuit is wired, it is necessary to change the connections on the tickler coil to determine which gives best results. This is unnecessary if, when the tickler is parallel to the secondary, the plate lead is connected to the end of the tickler coil that is furthest away from the grid coil end connected to the grid. The windings must, of course, be wound in the same direction on all coils.

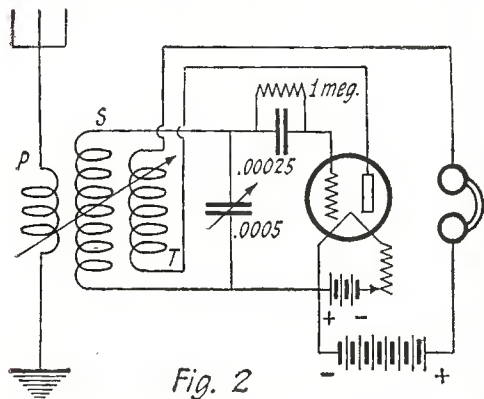

This circuit employing this coupler. Only one tuning control is required.

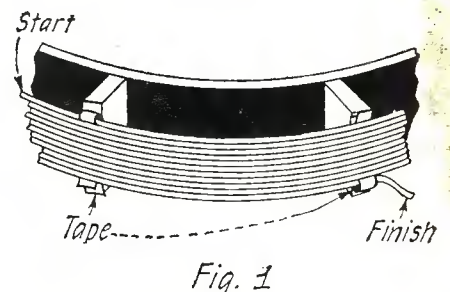

The beginning and end of the primary winding are held by pieces of strong cloth tape.

## American Broadcasting At 5,000 Miles

By JOHN ENGLISH

**D**URING last year some experiments were being carried on in South America by myself to determine the possibility of receiving radio signals from the United States. A location was selected on the Transandine railway at a small village called Puente Del Inca, 9,000 feet above sea level.

It was not desirable to employ a super-sensitive receiving set, but rather one of a common type, consequently an ordinary Armstrong regenerative set with a detector and two steps of audio frequency amplification was utilized. We were relying considerably on our advantageous location. On

one evening of the test during April, at approximately 2 a. m., weak music was picked up at a time when the local broadcast stations had ceased operations. There are so few broadcast stations in South America that the word "local" here means those of Chile, the Argentine and Uruguay. Hence local reception covers a radius of approximately a thousand miles. The set was being operated at the zero beat point and no difficulty was experienced in holding this adjustment which is usually very critical. At the termination of the musical concert being rendered an announcement was made in English. No further identification at that time

could be obtained. Later on, in September, the design of the receiver was changed to incorporate one stage of tuned radio frequency amplification, a detector and one stage of audio frequency amplification. The set was moved to Los Andes, a small town in Chile on the western slopes of the Andes mountains. The atmospheric conditions were very poor for radio reception, there being heavy static practically every evening.

Our first success was on the evening of October 30, at which time the complete program from station KDKA, East Pittsburgh, (Continued on page 113)



# Awards of the \$50 Radio Wrinkle Contest

## First Prize

### UV-199 CUSHION AND SOCKET ADAPTER

By W. T. R. PRICE

Most of us have found by experience, or otherwise, that soldered connections are more satisfactory than unsoldered connections. Yet we have no compunction as to pushing a dry-cell tube into an adapter, and then pushing the adapter into a standard tube socket, thus making eight connections which are not only unsoldered, but are not even as good as the average binding-post connection. In a three-tube set there would be 24 of these doubtful connections, 12 of which would be in the grid and plate circuits.

The home-made adapter described here, not only eliminates half of these poor connec-

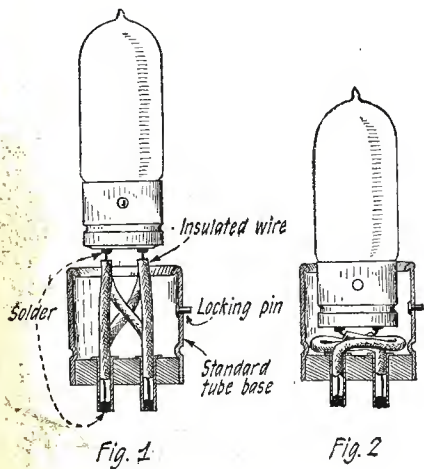

With a standard vacuum tube base and some flexible wire an excellent UV-199 tube socket can be made.

tions, but also provides a perfect cushion support for the tube. The adapter can be made in about 15 minutes, and at no cost whatever.

First procure a burned out or broken tube with standard base and break away the glass and the cement which holds it in place. Then heat the terminals sufficiently to melt the solder, and withdraw the element wires. To each terminal of the UV-199 or C-299, solder 2 inches of rubber insulated No. 18 strand wire, bared for 1/2 inch at the lower end. Introduce these bared ends to the hollow terminals of the standard base and solder in place, clipping off any excess wire which may protrude. (See Fig. 1.) The tube may now be pressed down within the standard base, which will double up the wire and form a spring, stiff enough to hold the tube in place, but much more resilient than a solid rubber base. (See Fig. 2.)

The terminals of the UV-199 and C-299 are not arranged as in the standard tube. Placing the locking pins relatively as shown, wires from terminals No. 1 and No. 2 should lead to the corresponding terminals of the standard base. Nos. 3 and 4, however, should be crossed.

## Second Prize

### AN EMERGENCY SOLDERING FLAME

By DR. WILLIAM H. McKIE

A tablet of Hexamethylenamine, or to use an easier name, Urotropin, will furnish an ideal soldering flame in an emergency.

A five-grain tablet when lighted with a match, will burn for two or three minutes

## Prize Winners

### FIRST PRIZE \$25

UV-199 Cushion and Socket Adapter

By W. T. R. Price,  
Scarborough, N. Y.

### SECOND PRIZE \$15

An Emergency Soldering Flame

By Dr. William H. McKie  
Wynne, Ark.

### THIRD PRIZE \$10

An Excellent Back Panel Switch

By Harold Hubbard,  
516 Leshar Place,  
Lansing, Mich.

with a steady, pointed, smokeless, sootless, odorless, blue flame of an intense degree of heat. The seven and ten grain tablets will burn proportionately longer.

Go to the drug store and get five cents worth of five-grain Urotropin tablets and put them in your tool kit. Then when you break a wire or want to make a new connection, and your soldering iron is loaned or is out of commission, or you do not want to start the blow torch, just take a tablet, lay it on a piece of metal or in a spoon, put your solder and flux on the piece to be soldered, light the tablet as you would a candle and hold it under the work. You will be surprised how quickly the solder will run and will be delighted at the clean, perfect joint.

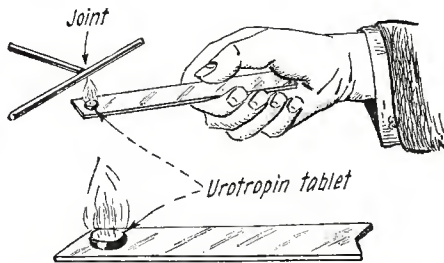

Urotropin tablets generate intense heat when lighted and prove handy as a soldering flame.

When soldering in this manner, care should be taken that too much flux is not used, as it might drop into and put out or dim the soldering flame.

## Third Prize

### AN EXCELLENT BACK PANEL SWITCH

By HAROLD HUBBARD

Do you need a good back panel switch? Here is one that can be made from an old rheostat and will prove as good as any on the market. The resistance wire should be removed and holes of the correct size drilled through the rheostat form at regular intervals for the switch points. These switch points should be of the kind that are almost flush with the surface. The usual rheostat shaft is not long enough so a bar of the same diameter and three inches long should be obtained. The regular rheostat contact lever is slipped on the shaft to about the center and fastened by means of the set screw. The shaft should now be

inserted so that the lever is on the same side as the switch points. A spring is placed on the end of the shaft protruding on the opposite side and compressed by the shaft collar, as shown in the sketch. This collar is secured by tightening the set screw in such a position that the spring exerts sufficient pressure to keep the lever snugly against the switch points. The

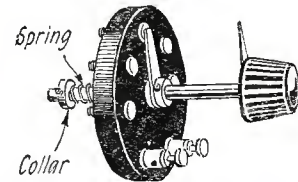

A clever design in back-of-panel switches. It is made from a discarded rheostat.

switch is secured to the panel by means of the two screws that were originally employed as the rheostat binding posts. A knob and pointer, or a dial may be used as desired. This switch, if carefully constructed, will be smooth running and will eliminate switch points on the panel.

## AUTOMATIC "B" BATTERY CUT-OFF

With vacuum tubes at \$5 each, it would seem worth while that the owner of a multi-tube set take precaution to see that the "B" battery voltage is not accidentally applied to the filament circuit. When the modern bare bus-bar wiring is used in a set it is highly important that the "B" battery be disconnected while changing tubes or making adjustments, for the slip of a screw-driver or pliers can cause a short circuit that may cost the owner several new tubes. No protective method was followed by the writer, until one day it was forgotten, with the result that two tubes went west. My set is now equipped with the automatic "B" battery cut-off, as illustrated. A few pieces of spring brass and a little time was all that was necessary, and I can now change tubes or make adjustments without fear of endangering the tubes, for the act of opening the cabinet lid automatically disconnects the "B" battery, while upon closing it the set is again ready for action. The diagram should be self-explanatory. Two small brass plates are screwed to the back of the cabinet. They are spaced about 1/4 inch apart, the one being connected to the "B" battery, while the other is wired to the "B" battery binding post of the set. A spring brass strip of the shape shown is fastened to the hinged lid in such a position that when the lid is closed it will close the

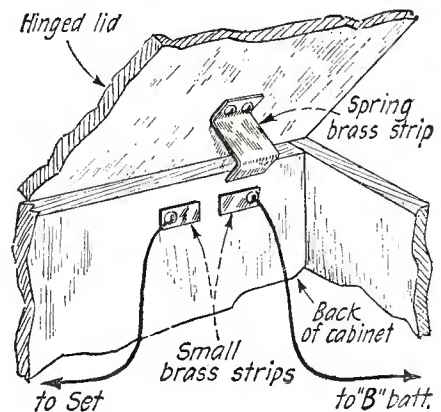

This "B" battery cut-off will protect your tubes while working with the wiring.



circuit between the two brass strips. All of the parts may be small and neat, and when mounted near the corner of the cabinet are not in the way. The owner of a set so equipped need no longer be in fear of burned out tubes.

Contributed by John J. Carl.

**ELIMINATING INDUCTION HUM**

If you are troubled by induction from a nearby high tension power line, this plan can be followed with gratifying re-

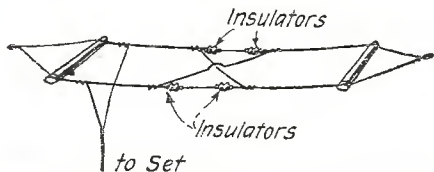

When the aerial is strung in this manner, electrical fields in opposite wires are neutralized.

sults. The plan is used to eliminate induction from power lines when they run parallel to telephone wires, and when used with an antenna proves of great advantage. A two-wire antenna must be used and is arranged as shown in the diagram. It will be seen that the two wires cross each other in the middle of the span and end on the side of the spreaders opposite to that which they started. The wires must not come in contact with each other where they cross. They are kept apart by a long insulator. This arrangement will prove particularly useful where the antenna can only be erected in a position which brings it parallel to a power line. It will be found that about 90 per cent of all induction hum will be eliminated with this antenna. The reason for this is that the two fields of the two wires are assisting each other at one end and are opposing at the other, thus neutralizing any induction hum that otherwise might be heard.

Contributed by Otto E. Steinberger.

**A MUSIC ROLL SWITCH KNOB**

Having required a switch knob in building a set, and unable to procure one without some delay, I looked around for a substitute and finally hit upon the following idea. I secured an old player piano roll and removed the composition end pieces, which have the same shape and appearance as a regular switch knob. The tubular end of this knob is too long, so about three-quarters of an inch must be cut off, as shown in the drawing. A hole is drilled through the center, through which a brass bolt is inserted and secured with a nut. The blade may be cut from spring sheet brass of the desired shape, and placed on the shaft, being held by a thick washer "A," which is threaded to fit the bolt. Various methods may be used

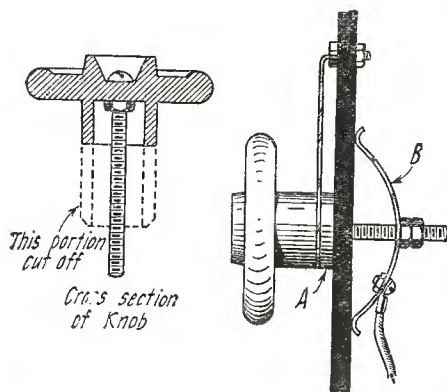

An excellent switch knob constructed from the knob of a music roll.

to fasten this switch knob to the panel but the plan shown in the drawing is recommended as giving exceptional results. A piece of spring brass is bent to the shape shown and slipped over the shaft through a hole drilled in it for this purpose. A nut is screwed down on the shaft until the right tension on the piece of spring brass is obtained. Another nut is also used as a lock nut so the original adjustment can be maintained. This switch knob looks very neat and will not detract from the appearance of any set.

Contributed by William G. Roth.

**AN IMPROVED "A" BATTERY SWITCH**

Having immediate need for an "A" battery switch, and not wanting to wait until I could get a switch from the wholesale house, I utilized a single circuit jack for this purpose. The accompanying drawing shows the method of use very clearly and little explanation is needed.

I used the rheostats in the negative lead in this case and carried the positive lead from the binding post of the "A" battery direct to the bottom lug of the jack, and the lead from the spring to the positive terminals of the sockets.

I had a short brass rod of the proper size to fit the hole for a standard plug, and I threaded this to fit a round button taken

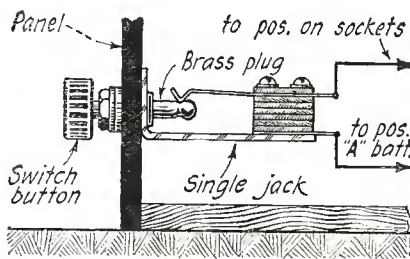

A simple "A" battery switch made from a single circuit jack, a switch knob and a brass plug.

from an old snap switch. While not as good as the manufactured switches on the market, it answered the purpose and the black switch button did not detract from the appearance of the set.

Contributed by G. E. Brumbaugh.

**AN INEXPENSIVE LOUD SPEAKER**

Any loud speaker consists of two fundamental units: First, a means of changing electrical energy into sound; and second, a means of amplifying the sound so produced. The first unit is, in most cases, an electromagnetic telephone or other device operating on similar principles such as an electrodynamic or moving coil instrument. The amplifying member is, almost universally, some form of horn.

In an instrument where low cost of construction is to be considered a phone should be used which is well adapted for the sound producing mechanism. It should be a modified electro-magnetic device that is capable of clear reproduction, and can handle all the energy from an ordinary receiving set without distortion.

The horn can easily be constructed at home. A square horn was selected in the present case because it was easily made and gave best results. No greater endorsement for the square horn is necessary, considering that some of the best phonographs on the market are using it. The pattern is shown in Fig. 1. It can be made of fibre or cardboard about 1/8 to 1/16 inch in thickness. The top, bottom and two sides are cut out as indicated and are fastened together on the outside with gummed art tape. This tape has great adhesive qualities and makes the

horn look attractive when finished. It can be secured 1/2 inch or more in width and comes in black and other colors. The cardboard can be bought in various shades and can be made to harmonize with the color scheme of the room.

The connection between the phone and horn must be air tight or the volume of the loud speaker will be greatly reduced. To

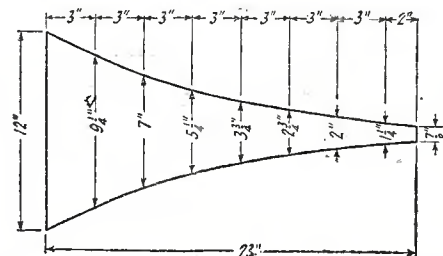

Measurements and details of the sides of the loud speaker horn.

secure this, a single phone-adaptor, of which there are many on the market, is used. The author used a rubber adaptor. These are equipped with a brass insert, which is fastened in the horn with a mixture of paraffin and sealing wax. Then the phone with the rubber part can be taken off if desired.

The tone chamber of this horn is about two feet long. This is about as small as can be used with safety. A horn of this size will respond to all tones and will provide ample volume, whereas a smaller one will not function on low notes and will give the music a sharp ring instead of the natural mellow sound.

With this loud speaker the author has brought in Los Angeles stations here in San Francisco (400 miles) with sufficient audi-

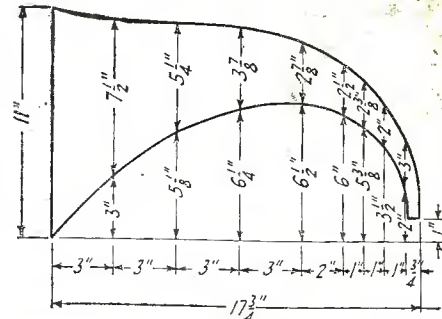

Measurements and details of the top and bottom of the loud speaker horn.

bility to be heard all over a five-room house on two stages of audio frequency amplification. The locals come in fine on only one stage.

Contributed by Harry Lubeke.

**A TUBE PROTECTOR**

Have you ever finished a new set, inserted the tubes, connected the "B" battery and immediately burned out the (Continued on page 72)

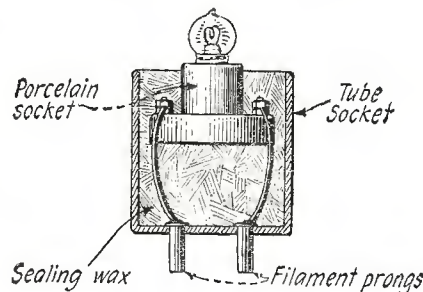

An instrument such as this to test the filament circuits of your tube sockets is well worth while. It may save you the price of a new tube.



# Correspondence from Readers

## THE NEED FOR APPLAUSE CARDS

Editor, RADIO NEWS:

In your issue for April, on page 1388, you made an appeal for the BCL to send more applause cards. I feel that you are right and that we should do this, and in fact I always keep a package of post cards on my table when receiving, and when anything especially good comes in I send one of them. But we BCL's are rather a lazy bunch and it is rather expensive and quite a bit of bother to have a form set up and printed just for our own personal use. If some magazine or printing company would get out a well designed applause card, both on government postal cards and also on post cards without stamps and sell them in packs of 100 at a reasonable cost, either by mail or through radio dealers, I feel that the listening public would send in many times the number of applauses that are now sent, and in that way the broadcast stations could get much clearer and better lines on the class of broadcasting that is most pleasing to the listeners.

H. W. WEBB,  
Columbus, Ohio.

## ANOTHER BROADCAST REVIEW

Editor, RADIO NEWS:

After reading Mr. Early's letter and your remarks concerning it, I cannot help but add a bit of contentment on my own account.

We live in a smallish town, only 87 miles from Chicago, but nevertheless it might as well be 1,000 so far as that goes. The kiddies listen to "Uncle Bob" from KYW, and when the radio weather is good, to "Dream Daddy" WDAR, in fact they both belong to the Jack and Jill club. Then we usually see what WOC has to offer, going from there to that incomparable voice of the "Atelanta Journal, Atelanta, Gawgia." Wouldn't miss that for anything. And who can pass up KDKA, or WBZ and that Trio? This season we have taken in President Coolidge's Washington's Birthday talk, grand opera, William Jennings Bryan, David Lloyd George (from three different stations in the United States), to say nothing of the banquets, shows, organ recitals and popular programs. We enjoyed immensely "Abie's Irish Rose" as broadcast by KYW recently. As soon as the roads are good we are going in to see the play. Also, we are regular Friday night visitors to the Hoot Owls at KGW; we took in the concert by the Fairbanks Trio assisted by KHJ's canaries. I heard Honolulu once this winter. The Skinner organ recitals are always good. The Fort Worth Star Telegram is another very good one to tune in. WOAI, the "Winter Playground," has had some interesting programs, as has WLAG. We usually poke around to see what WHAS has, and never fail to listen to PWX, and, by the way, that clock ticking between numbers is a fine thing, as with the neutrodyne using the long aerial I am never sure whether I have PWX or WHAS, as they are both on the same wavelength, but the clock tick sets us right always. The "Nighthawks" are always interesting, and the midnight revues of KYW are something worth staying up to hear. WTAS has some mighty entertaining programs and they may have a chair by our fireside any time, because on Sunday afternoons they are the only ones on the air who are not either preaching or putting on something that we do not care to listen to, that is, all the afternoon. We like a good sermon, and Rev. Shannon of the Central Church, Chicago, puts out some wonderful talks. The evening club from Orchestra Hall is also very interesting. Both of these features are put out through KYW.

Taking it all in all, we have listened to

about every 500-watt station in the United States this winter, and what we have heard and enjoyed coming out of that little box with a bunch of light bulbs in it money couldn't buy. There are programs that money would not admit one to, and it comes to the question of the day: Who shall pay, and how?

Personally, I believe that every owner of a receiving set would willingly contribute a given amount, if they knew the broadcasters were getting it.

The Federal Government has never acted as a collector for a private concern, but couldn't a workable plan be formed whereby the National Association of Broadcasters could be made an arm of the Federal or Government radio division and an appropriation made to that body, the same as to other Government agencies and departments? This

## Interesting Articles to Appear in July Issue of "Practical Electrics"

Electrocuting Whales  
By H. Gernsback, Member American Physical Society.

The Rain Maker  
By J. Kay London.

Comic Picture Projector  
By Harold Jackson

Ohm's Law  
By F. S. Yamanto.

Uses for Spark Plugs  
By Jacob E. Raible.

Electric Insects  
The Gate for Your Voice Highway  
By Paul B. Findley.

appropriation to come from revenue obtained by a tax on tubes, or entire sets. A man who has a five or eight tube set should pay more than the boy with a single dry cell tube that he has worked hard to procure. The man with a Packard pays considerable more license (in this state anyway) than the man with a Ford; he can afford to. We are all anxious to have the quality of the broadcasts kept up to the highest possible standard, and I'm sure that someone can think of a workable plan.

W. R. GEORGE,  
Dixon, Ill.

## AN SOS FROM WASHINGTON

Editor, RADIO NEWS:

Have just finished reading an article in the most valuable Radio magazine, RADIO NEWS, written by Mr. Glenn H. Putnam, of Rochester, and will say that "them's my sentiments."

I, numbered among the thousands of "radio infants," am at sea, adrift in an open boat, without compass or rudder and blowing a solid gale, when it comes to figuring the fine points and intricacies of a "wiring diagram," similar to a Sanskrit thesis written by a scofflaw Hindoo, in a Chinese graveyard, after running down a gray tombstone rabbit. I became a bug a little while back, and since then my one desire has been to build, without help of professionals, a three-tube set, but the "black magic" prohibits, and

ere long I will be in the long line of men, with little boxes under their arms, at Matewan or elsewhere, giving up the idea that I am Napoleon, and believing I am a Marconi or a De Forest.

Soon after my inoculation with the "radii-virus," and before I became violent, I made my first, single-tube outfit, from the directions and plans given in a small publication, and in place of the usual wiring diagram, pictures of the apparatus used were given, which, for a novice at the game, was a revelation; but, like others of the fraternity, I wanted the DX record of the world, and am still striving for that end, without success.

Of the many dealers in and about Washington, D. C. (averaging two or more to a business block) and from whom I have purchased many dollars' worth of supplies, none of them are able to give information relative to hook-ups and behavior of guaranteed materials, and when the brains of the firm was asked for, he was either "OUT" or getting over the effects of a "grid and plate pliodyne" debauch, somewhere south of the variometer regions, and west of the first step, (A. F. or R. F.), but, after many efforts, and many offers of far superior substitutions, I managed to get the articles desired, and until I stumble across, or catch unaware, some other misguided R. B. (radio bug) I will use either a purchased tube set, or a crystal outfit.

RADIO NEWS is offering a great fund of information each month to the fans, and it is well appreciated, and though not a subscriber, I get it each month, but must say if the different sets were augmented by picture diagrams, or even schematic drawings, it would not only be of greater value to me, but to thousands of others in the same boat, and I would be willing to pay double for the service, or as a suggestion, have copies of the different sets made in pictures and sold separately, direct from publishers.

The Radio Sea is a wide expanse of uncharted knowledge, and the Radio Editor is bothered enough as it is, but if space permits, give the fans a chance to express their views on this subject, and if it warrants, give 'em pictures, or something understandable.

A boy in High School, talking to me a few days ago, was wondering why radio diagrams were not lithographed, each line in a different color, that they might be traced without trouble; not a bad suggestion at that.

This letter is publishable, if you see fit, and I am for RADIO NEWS first, last and all the time, even if I cannot savvy the traffic lines in a modern radio circuit, and am bawled out by the traffic cop (juice) when I cut a corner too sharp or disregard the plus and minus signs.

M. A. P. ROUX,  
483 G Street, S. W.,  
Washington, D. C.

## INTERESTING NOTES ON STATIC

Editor, RADIO NEWS:

In your editorial of April, 1924, you say that we don't know the origin of static. I am a sea captain (not an expert or a scientist), a radio fan to the extent of having a De Forest D-10 Reflex set, which helps me to spend my evenings at sea pleasantly listening to KDKA and other stations.

Static in the Gulf of Mexico, which I happen to be crossing as I write this, and in the Caribbean Sea, is very bad, and I became interested as to its cause. At sea, where one is not shut in by houses and trees as on shore, it is easier to make careful observation of clouds and atmospheric conditions.

(Continued on page 74)





# New Radio Patents

By JOHN B. BRADY\*

## ARC OSCILLATOR

(Patent No. 1,478,638, H. G. Cordes. Filed May 10, 1917, issued Dec. 25, 1923.)

**ELECTRIC OSCILLATOR** of linear-sinusoidal characteristic in which oscillations are started by superposing a transient current upon a direct current and oscillations sustained by means of a sustained alternating current. The oscillator comprises a direct current capacitance charging circuit,

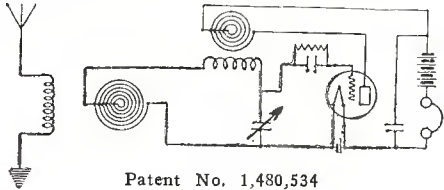

Patent No. 1,480,534

a direct current discharger circuit, a sinusoidal discharger therefor. An auxiliary oscillating current relay discharger actuating circuit is coupled to the said discharge circuit for actuating the relay discharger of the oscillator.

## AMPLIFICATION WITHOUT TUBES

(Patent No. 1,479,146, R. E. Marbury. Filed March 5, 1921, issued Jan. 1, 1924. Assigned to Westinghouse Elec. and Mfg. Co.)

**RADIO RECEIVING SYSTEM** wherein signals are amplified after rectification by means of a dynamo-electric machine, the incoming signals operating to produce a change in the magnetic flux of the machine for effecting the current output.

## TUBE CONSTRUCTION

(Patent No. 1,479,256, H. K. Sandell. Filed Aug. 28, 1919, issued Jan. 1, 1923.)

**SPACE CURRENT DEVICE** for electron tube wherein a block of insulating material is employed to support the electrodes with non-conductive spacing means supported by the electrodes independent of the block.

## CONDENSER

(Patent No. 1,479,315, G. W. Pickard. Filed Jan. 12, 1921, issued Jan. 1, 1924. Assigned to Wireless Specialty Apparatus Co., N. Y.)

**ELECTRICAL CONDENSER AND PROCESS FOR MAKING THE SAME**, in which the plates are formed by dielectric having thin film metal deposits on opposite sides thereof. The plates are stacked so that the metallic films make contact with each other, separated by the base dielectric material.

## RECEIVING CIRCUIT

(Patent No. 1,479,475, O. Minton. Filed Jan. 19, 1923, issued Jan. 1, 1924.)

**RADIO RECEIVING APPARATUS** in which the tuning system comprises two inductance coils connected in series and mounted for relative movement to vary the inductance linkage between them with a connection from a point of the circuit between the coils to the ground. The radio receiving apparatus, which may be a radio frequency amplifier, detector and audio frequency amplifier is directly connected across the terminals of the two inductance coils, which are shunted by a variable tuning condenser.

## LOOP RECEIVER

(Patent No. 1,479,638, V. K. Zworykin. Filed Aug. 28, 1922, issued Jan. 1, 1924.)

**MULTIPLE REGENERATIVE LOOP AN-**

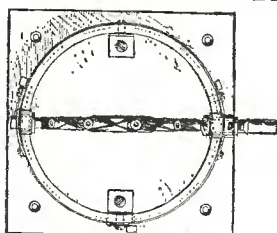

Patent No. 1,480,534

**TENNA AND CIRCUIT**, in which one of the loops in the system is connected with the grid circuit of a detector tube and two or more loops are directly connected in the plate circuit of the tube forming a regenerative system.

## TUBE CONSTRUCTION

(Patent No. 1,479,778, H. J. Van Der Bijl. Filed Sept. 30, 1918, issued Jan. 1, 1924. Assigned to Western Electric Company, Incorporated.)

**VACUUM TUBE DEVICE**, showing a construction wherein the plate electrode is formed in two parallel planes, the material of one plane being supported by metallic members which extend out from the other plane which in turn is substantially supported within the tube.

## TUBE CONSTRUCTION

(Patent No. 1,479,991, R. W. King. Filed Aug. 13, 1919, issued Jan. 8, 1924. Assigned to Western Electric Company, Incorporated.)

**ELECTRON DISCHARGE DEVICE**, in which the anodes are supported in the tube by forked metallic members mounted on the press. The tube structure also includes a block of insulating material supported by the anode which insulating material in turn includes supporting connections for the grid and cathode.

## TUBE CONSTRUCTION

(Patent No. 1,480,208, W. G. Houskeeper. Filed April 15, 1921, issued Jan. 8, 1924. Assigned to Western Electric Co., Incorporated.)

**VACUUM TUBE**, in which the filament electrode is supported by a spring suspension device anchored in an insulating member supported from the glass press of the tube.

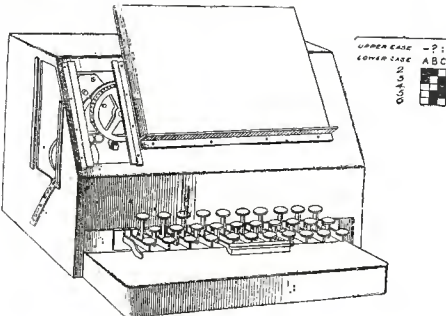

Patent No. 1,485,212

## RADIO AND LAND LINE COMMUNICATION SYSTEM

(Patent No. 1,480,216, J. Mills. Filed Oct. 11, 1916, issued Jan. 8, 1924. Assigned to Western Electric Company, Incorporated.)

**TRANSMISSION SYSTEM**, in which a plurality of terminal stations, comprising a radio telephone transmitting and receiving system and a line wire telephone system are employed. The object of the invention is to provide a circuit arrangement and system to prevent a circulation of power between the local transmitting and receiving system, or to insure that the signals received by a radio receiving system will be transmitted along the line wire in such manner as to not thereby effect the transmission of the same signal from the local radio transmitting station.

## SECRET RADIO TELEPHONE SYSTEM

(Patent No. 1,480,217, J. Mills. Filed Dec. 29, 1916, issued Jan. 8, 1924. Assigned to Western Electric Company, Incorporated.)

**METHOD AND MEANS FOR SIGNALING** wherein the intelligible interception of signals transmitted is prevented. This is accomplished by superimposing on the outgoing talk or signal currents a complex noise formed by currents of several frequencies lying in the most important part of the voice frequency range. To clarify the signal at the proper receiving station, the invention provides for the superposition upon the incoming talk and its combined noise of a complex noise similar to the noise originally superimposed, but exactly opposite in the phase of all its components. The noise is thus suppressed from the signal which may be received free from confusion.

## TUBE CONSTRUCTION

(Patent No. 1,480,219, A. McL. Nicholson. Filed June 25, 1917, issued Jan. 8, 1924. Assigned to Western Electric Company of N. Y.)

**VACUUM TUBE** in which the grid electrode

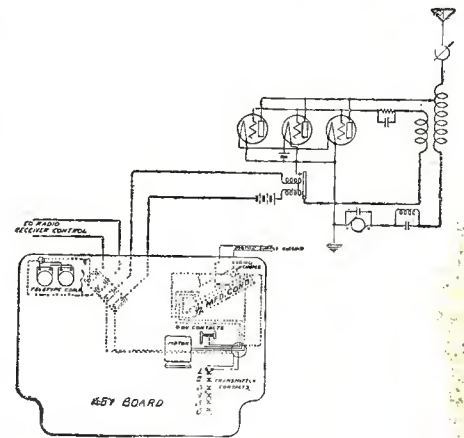

Patent No. 1,485,212

is supported by a spring tension member which compensates for the expansion of the grid under changes in temperature in the tube, whereby a uniform distance is maintained between the grid and the other electrodes at all times.

## IMPEDANCE DEVICE

(Patent No. 1,480,227, G. H. Stevenson. Filed May 16, 1921, issued Jan. 8, 1924. Assigned to Western Electric Company of N. Y.)

**IMPEDANCE ELEMENT**, for use in high frequency alternating current circuits. The construction of the element is such that the value of its impedance may be accurately adjusted. An electro-static shield is provided for the winding in the element.

## ARC OSCILLATOR

(Patent No. 1,480,388, A. L. Golden. Filed Sept. 16, 1919, issued Jan. 8, 1924. Assigned to National Radio Company of California.)

**OSCILLATOR** for arc circuits in which the arc is formed between a pair of tungsten metal electrodes submerged in distilled water.

## VARIOCOUPLER

(Patent No. 1,480,534, Alfred Crossley. Filed Aug. 16, 1922, issued Jan. 8, 1924. Assigned to Hartman Electrical Mfg. Company.)

**VARIOCOUPLER**, having extremely small electrostatic coupling between the windings. The variocoupler has a cylindrical stator and a flat rotor on which the secondary winding is arranged in such manner that the conductors are at all times approximately in a plane passing through a diametrical line through the cylindrical stator. Sufficient electromagnentic coupling may be introduced to neutralize the effects of capacity coupling to substantially zero coupling.

(Continued on page 102)

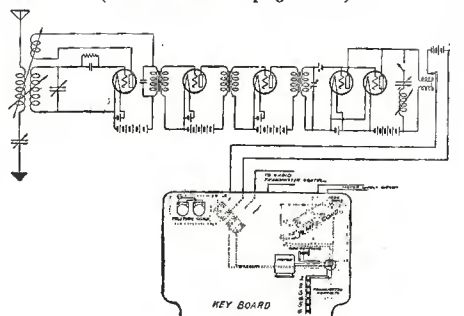

Patent No. 1,485,212

\*Patent Lawyer, Ouray Building, Washington, D.C.



# APPROVED RADIO NEWS LABORATORIES 1922

# RADIO NEWS LABORATORIES



**R**ADIO manufacturers are invited to send to RADIO NEWS LABORATORIES, samples of their products for test. It does not matter whether or not they advertise in RADIO NEWS, the RADIO NEWS LABORATORIES being an independent organization, with the improvement of radio apparatus as its aim. If, after being tested, the instruments submitted prove to be built according to modern radio engineering practice, they will each be awarded a certificate of merit, and a "write-up" such as those given below will appear in this department of RADIO NEWS. If the apparatus does not pass the Laboratories tests, it will be returned to the manufacturers with suggestions for improvements. No "write-ups" sent by manufacturers are published on these pages, and only apparatus which has been tested by the Laboratories and found to be of good mechanical and electrical construction is described. Inasmuch as the service of the RADIO NEWS LABORATORIES is free to all manufacturers whether they are advertisers or not, it is necessary that all goods to be tested be forwarded prepaid, otherwise they cannot be accepted by the Laboratories. Address all communications and all parcels to RADIO NEWS LABORATORIES, 53 Park Place, New York City.

## Apparatus Awarded Certificates

### ACE 45-VOLT "B" BATTERY

The Ace No. 1301 "B" battery, shown in the illustration, comprises 30 of the large type cells. This battery has five taps taken from 16½ to 22½ volts so as to give the voltage variation required by some detector tubes. The cells are securely sealed in place with paraffin wax so that should one cell

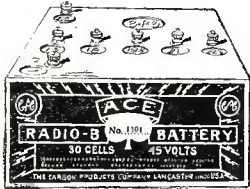

become damaged or leaky it will not short circuit any of the others. This battery is manufactured by the Carbon Products Co., Lancaster, Ohio.

Arrived in excellent packing. AWARDED THE RADIO NEWS LABORATORIES CERTIFICATE OF MERIT NO. 441.

### DE-TEC-TONE CRYSTAL DETECTOR

This crystal detector, as the illustration shows, is very compact and of neat appearance. It is designed for mounting on a base or front of a panel and the adjustment is obtained by means of the knob attached to the shaft on which the cat whisker

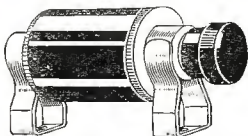

is mounted. The crystal is enclosed inside of the tube and is well protected. It is manufactured by the Pyramid Products Co., 117 No. Dearborn Street, Chicago, Ill.

Arrived in excellent packing. AWARDED THE RADIO NEWS LABORATORIES CERTIFICATE OF MERIT NO. 411.

### GILFILLAN SWITCH LEVER

This switch lever is of very rugged construction and of pleasing appearance. It has a double contact blade insuring positive contact with

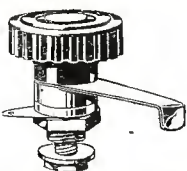

the switch points. It is manufactured by Gilfillan Bros., and is known as their type R-225 switch lever.

Arrived in excellent packing. AWARDED THE RADIO NEWS LABORATORIES CERTIFICATE OF MERIT NO. 393.

### RECEIVING SET

The American Radio & Research Corp., Medford Hillside, Mass., submitted one of its Model 2,500-3 Inductrol receiving sets. This is an ideal broadcast receiver as the set is complete in itself and is contained in a cabinet 12 by 17 by 14 inches, having separate compartments for the "A" and "B" batteries, as shown in the illustration. This receiver has a one-stage radio frequency amplifier, detector, and a two-stage audio frequency amplifier. The tuning units are the basket-wound variometers described elsewhere in these columns. By means of a two-point switch, the circuit

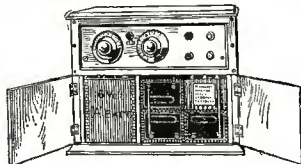

is changed from single to double, thus changing from single dial control to double dial control and facilitating the tuning. Excellent results were obtained from this receiver throughout the broadcast wavelength range.

Arrived in excellent packing. AWARDED THE RADIO NEWS LABORATORIES CERTIFICATE OF MERIT NO. 447.

### PERFECTION BATTERY HYDROMETER

The life and efficiency of a storage battery depends largely upon keeping it well charged and giving it proper care. In order to do this, an accurate battery hydrometer is required. With its use, the condition of the battery can be determined at any time. The hydrometer shown in

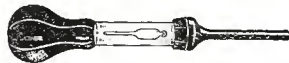

the illustration is of very good construction and is accurate in reading. It is manufactured by the Bemco Mfg. Co., 243 W. 55th Street, New York City.

Arrived in excellent packing. AWARDED THE RADIO NEWS LABORATORIES CERTIFICATE OF MERIT NO. 407.

### AMPLION LOUD SPEAKER

The illustration shows the Amplion loud speaker. Much care was taken in the construction and design of this instrument. The phone unit is fitted to the tone arm by means of a rubber gasket and the wooden bell-shaped horn is also fitted to the tone arm with a rubber gasket so that vibrations of the horn and tone arm will be muffled and will not interfere with the quality of the reproduced musical program. The phone unit is adjustable and employs a large diaphragm which makes the instrument more efficient on the lower notes of the scale than many other types of loud speakers. The

resistance of the unit is 1,731 ohms and the impedance at 1,000 cycles, 15,000 ohms. Submitted for test by the Signal Electric Manufacturing Co., 35 Warren Street, New York City.



Arrived in excellent packing. AWARDED THE RADIO NEWS LABORATORIES CERTIFICATE OF MERIT NO. 451.

### SEMI-PERMANENT CRYSTAL DETECTOR

The adjustment of this detector is obtained by simply turning the knob until the stations are heard at their maximum. The instrument is designed for back of panel mounting with the control knob in front. By turning the control knob the cat whisker contact is moved across the crystal by the action of the screw

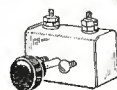

thread on the shaft and at the same time it is raised and lowered from the crystal surface four times in each revolution by means of a square cam on the shaft. Thus the knob only needs to be turned very little in order to obtain a sensitive adjustment. This detector is manufactured by the Harvey & Walter Mfg. Co., 32 Front Street, Cincinnati, Ohio.

Arrived in excellent packing. AWARDED THE RADIO NEWS LABORATORIES CERTIFICATE OF MERIT NO. 410.

### BALL BEARING SWITCH

The illustration shows a switch that is somewhat different in construction from the usual type of inductance tap switch. This switch, type S-3, is equipped with a ball bearing of very accurate mechanical construction that makes it exceptionally smooth running. Good electrical contact is also obtained. The switch arm radius is 1½ inches and

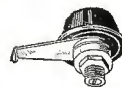

the diameter of the knob is 1¼ inches. It is manufactured by G. B. Fenstermaker, Lancaster, Pa.

Arrived in good packing. AWARDED THE RADIO NEWS LABORATORIES CERTIFICATE OF MERIT NO. 409.

### WORK RITE NEUTRODYNE KIT

The Work Rite De Luxe Model Neutrodyne Kit comprises three 15-plate variable condensers with special dials, three radio frequency transformers and two neutralizing condensers. The parts are of excellent construction and the tuned radio frequency transformers or neutrodyne transformers cover the entire broadcast wave-length range without regenerating or oscillating when the circuit is properly neutralized with the neutralizing condensers. This kit is manufactured by the Work Rite Manufacturing Co., Cleveland, Ohio. The illustration shows one of the transformers mounted on the condenser.

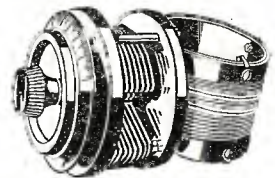

Arrived in excellent packing with instruction book, radio log, panel drilling template and angle for mounting the neutrodyne transformers.

AWARDED THE RADIO NEWS LABORATORIES CERTIFICATE OF MERIT NO. 438.

### RHEOSTAT

The Standard Radio Co. of Hoboken, N. J., submitted for tests one of its 6-ohm vacuum tube rheostats. This instrument is of very simple construction, is smooth running, and safely carries the current required of it without heating. This rheostat is shown in the accompanying illustration.

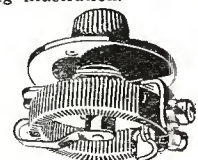

AWARDED THE RADIO NEWS LABORATORIES CERTIFICATE OF MERIT NO. 439.

### AMEREX UNIVERSAL TUNER

The Amerex Universal Tuner is a recent product of the American Standard Electric Company, 243 West 34th Street, New York City. This 3-circuit tuner comprises an aperiodic primary, secondary and tickler coils. The primary and secondary coils are wound on a 3¾ inch by 2¼ inch bakelite tube and the tickler coil is wound on the rotor. The primary winding is equipped with three terminals, one on each end and one in the center so that the instrument may be efficiently used with various sizes of aerials. The tickler coil is mounted at an angle, so as to give a 180-degree variation. The instrument



is arranged for both base and panel mounting.

Arrived in excellent packing, with hook-up.

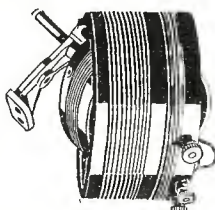

AWARDED THE RADIO NEWS LABORATORIES CERTIFICATE OF MERIT NO. 448.

**PICO HEAD PHONES**

The Pico Model 1924 head-set has a resistance of 2,057 ohms and an impedance at 1,000 cycles of 19,500 ohms. The phones are of unusual construction, having moulded shells in which are placed two small electro magnets, each having a round core 1/8 inch in diameter. These are mounted on the poles of the permanent magnet. This head-set is



very sensitive and reproduces speech and music with a minimum of distortion. It is manufactured by the Pico Head Phones, 1242 Holden Ave., Detroit, Mich.

Arrived in excellent packing.

AWARDED THE RADIO NEWS LABORATORIES CERTIFICATE OF MERIT NO. 443.

**VARIOMETER**

The No. 3650 variometers manufactured by the American Radio and Research Corp., Medford Hillside, Mass., are designed to cover the broadcast wave-length range. These variometers, as the illustration shows, are of the basket or spider-web wound type, thus reducing the distributed capacity of the winding to a minimum. Very little insulat-

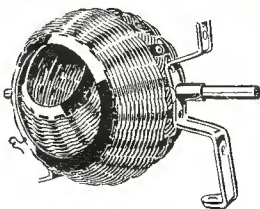

ing material is required to support the windings of this type of variometer. The instrument is light in weight and has low dielectric losses.

Arrived in excellent packing.

AWARDED THE RADIO NEWS LABORATORIES CERTIFICATE OF MERIT NO. 449

**MARLE AUDIO TRANSFORMER**

The Marle audio frequency amplifying transformer is of the standard shell design and has a very high voltage amplification factor throughout practically the entire audio range. The construction of the instrument is very simple. The

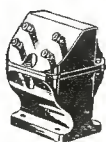

transformer unit is simply placed in two bakelite moulds on which are

placed the four terminals and also the mounting holes. These moulds are clamped together and hold the transformer in place. This transformer, Type A-19, is manufactured by the Marle Engineering Co., Orange, N. J.

Arrived in excellent packing.

AWARDED THE RADIO NEWS LABORATORIES CERTIFICATE OF MERIT NO. 442.

**CONNECTICUT HEAD-SET**

The Type J-125 sample head-set submitted by the Connecticut Telephone and Electric Co., Meriden, Conn., has a resistance of 1,886 ohms and an impedance at 1,000 cycles of 25,000 ohms. This head-



set is of the conventional two-pole construction and is very sensitive and reproduces with good quality.

Arrived in excellent packing.

AWARDED THE RADIO NEWS LABORATORIES CERTIFICATE OF MERIT NO. 444.

**ROYALTRON TYPE 201-A TUBE**

The Royaltron type 201-A vacuum tube is of the standard design and has a rated filament consumption of 1/4 ampere at 5 volts. The sample tube submitted by the Royal Manufacturing Co., 206 Broadway, New York City, gave very good results as detector, oscillator, and amplifier, and the characteristics were found very close to their rated values. This tube is guaranteed by the above company.



AWARDED THE RADIO NEWS LABORATORIES CERTIFICATE OF MERIT NO. 456.

**AJAX BINDING POST**

This binding post, as the illustration shows, is of the usual construction with an insulated cap, except that an additional washer is provided. This washer is bent in such a way that telephone cord tips or large wires may be securely clamped. It will also accommodate lugs and small wires. These posts are manufactured by the Ajax Elec-

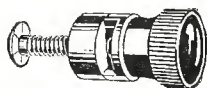

tric Specialty Co., 1011 Market Street, St. Louis, Missouri.

Arrived in excellent packing.

AWARDED THE RADIO NEWS LABORATORIES CERTIFICATE OF MERIT NO. 377.

**DETECTRON RADIO CRYSTAL**

The Detectron Sales Company, 907 Security Bldg., St. Louis, Missouri, submitted samples of its detectron radio crystals. These crystals were found to be very sensitive and are furnished mounted in metal to fit the standard 1/2-inch detector cup.

Arrived in excellent packing.

AWARDED THE RADIO NEWS LABORATORIES CERTIFICATE OF MERIT NO. 398.

**K-E LOUD SPEAKER**

The K-E Loud Speaker employs a gracefully shaped metal horn tightly fitted to an adjustable loud speaking unit. The instrument is very sensitive and reproduces musical programs and speech with excellent quality. The maximum efficiency of the instrument is in the



neighborhood of 630 cycles. It has a resistance of 1,057 ohms and an impedance at 1,000 cycles of 10,200 ohms. It is manufactured by the Kirkman Engineering Corp., 484 Broome Street, New York City.

Arrived in excellent packing.

AWARDED THE RADIO NEWS LABORATORIES CERTIFICATE OF MERIT NO. 452.

**BENJAMIN CUSHIONED SOCKET**

The Benjamin Cushioned Socket shown in the illustration is of very ingenious construction. The socket is made of two moulds held together by the same metal springs that form the contact springs. The base is fitted with mounting holes so that when the socket is mounted the tube is supported by the springs and thus vibration of the tube ele-

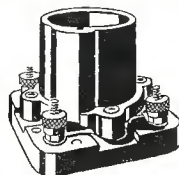

ments is reduced to a minimum. This socket is known as the anti-capacity type and is manufactured by the Benjamin Electric Mfg. Co., 847 West Jackson Blvd., Chicago Ill.

Arrived in excellent packing.

AWARDED THE RADIO NEWS LABORATORIES CERTIFICATE OF MERIT NO. 446.

**PRECISE TRANSFORMER**

Although the model 285-A audio transformer shown in the illustration is small in size, it was found to possess a very flat characteristic curve covering practically the entire audio frequency range encountered in broadcast reception. High voltage amplification is also obtained from this transformer. It is of the shielded type, as shown. Manufac-



tured by the Precise Manufacturing Co., Rochester, N. Y.

AWARDED THE RADIO NEWS LABORATORIES CERTIFICATE OF MERIT NO. 436.

**BRANSTON HEAD-SET**

The Branston standard 2,500-ohm head-set is of the usual two-pole construction with metal shells and insulated ear caps. This head-set is of excellent mechanical construction and was found to be very



sensitive to weak signals. The resistance of the sample head-set tested was 2,417 ohms and the im-

pedance at 1,000 cycles is 22,500 ohms. The maximum sensitivity is in the neighborhood of 1,750 cycles. It is manufactured by Chas. A. Branston, Inc., Buffalo, N. Y.

Arrived in excellent packing.  
AWARDED THE RADIO NEWS LABORATORIES CERTIFICATE OF MERIT NO. 455.

**REPEATER HEAD-SET**

The Repeater Head-Set shown in the illustration is of unusual construction. The shell is of steel permanently magnetized, in the center of which is placed an electromagnet having a round core. This magnet acts upon the diaphragm. The resistance of the sample head set submitted is 2,378 ohms and the impedance at 1,000 cycles is 23,000 ohms. This head-set is manufac-



tured by the Moss Chury Mfg. Co., Inc., 2011 Franklin St., Detroit, Mich. It is very sensitive and reproduces with good quality.

Arrived in excellent packing.  
AWARDED THE RADIO NEWS LABORATORIES CERTIFICATE OF MERIT NO. 445.

**BERWICK LOUD SPEAKER**

The Berwick adjustable loud speaker is a very attractive instrument and reproduces speech and music with little distortion. The phone unit is adjustable so that the instrument may be adopted for use under all conditions. It has a resistance of 1,416 ohms and an impedance at 1,000 cycles of 10,000 ohms. It has a fibre horn. It is manu-



factured by the Triangle Electro Trading Co., Inc., 632 Broadway, New York City.

Arrived in excellent packing.

AWARDED THE RADIO NEWS LABORATORIES CERTIFICATE OF MERIT NO. 450.

**HARMONIZED HEAD PHONES**

The Harmonized Radio Head Phones, manufactured by Hamburg Bros., 624 Grant St., Pittsburgh, Pa., are of the standard two-pole



construction with metal shells and insulated ear caps. The resistance of the head-set submitted is 2,391 ohms and the impedance at 1,000 cycles is 25,000 ohms. The head-set is very sensitive to weak signals and reproduces with little distortion.

Arrived in excellent packing.

AWARDED THE RADIO NEWS LABORATORIES CERTIFICATE OF MERIT NO. 454.





# I Want to Know

THIS Department is conducted for the benefit of our Radio Experimenters. We shall be glad to answer here questions for the benefit of all, but we can publish only such matter as is of sufficient interest to all.

1. This Department cannot answer more than three questions for each correspondent.
2. Only one side of the sheet should be written upon; all matter should be typewritten or else written in ink. No attention paid to penciled matter.
3. Sketches, diagrams, etc., must be on separate sheets. This Department does not answer questions by mail free of charge.
4. Our Editors will be glad to answer any letter, at the rate of 25c for each question. If, however, questions entail considerable research work, intricate calculations, patent research, etc., a special charge will be made. Before we answer such questions, correspondents will be informed as to the price charge.

You will do the Editor a personal favor if you will make your letter as brief as possible.

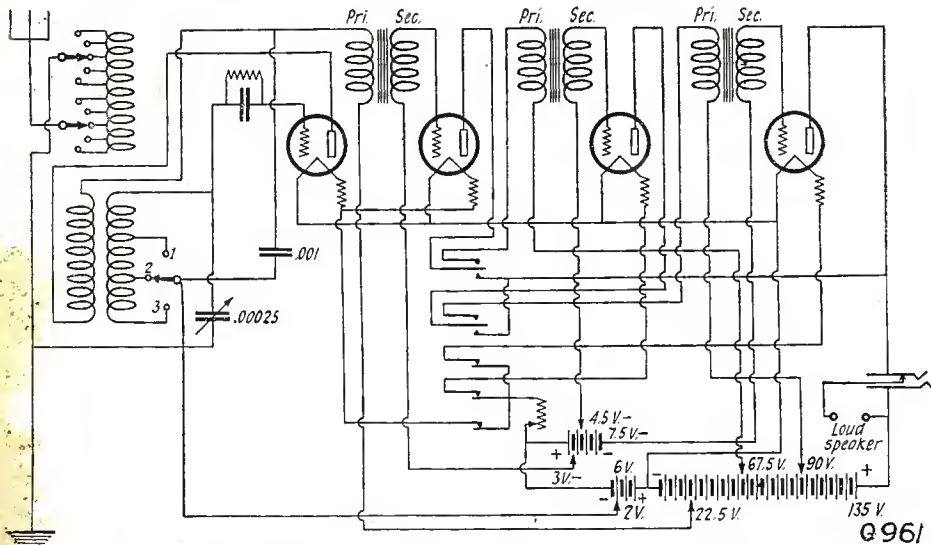

This is the Zenith 3-R circuit. A special switching system for selecting the amplifier stages is used which eliminates the usual jack-and-plug method.

### SUPER-PLIODYNE

(958) Mr. Rowland Cox, Fontana, Calif., wants to know:

- Q. 1. Please show the Super-Pliodyne circuit. A. 1. We are showing the circuit in these columns. Since this system tunes very broadly, it is much easier to extend this method of amplification to include many tubes, and control all the stages with one or two dials, than it would be with the usual neutrodyning system, which tunes very sharply at each stage.
- Q. 2. How are the transformers for this circuit made? A. 2. The secondaries of the transformers consist of 100 turns of No. 26 D.C.C. wire wound on a 2-inch tube. The primaries consist of 25 turns wound on a 1 1/4-inch tube. The primary winding has the space of three turns between each turn. The primary fits inside of the secondary. The primaries are wound in a reversed direction to that of the secondaries.
- Q. 3. What is the correct value for the neutralizing resistances? A. 3. All the values (R) are the same and must be determined by experiment, as the value is different for the different types of tubes. It will range

between 20,000 and 120,000 ohms. The condenser value (C) is not critical.

### BATTERY CHARGERS

- (959) Mr. Edward Westermire Eldon, Mo., asks:
- Q. 1. Is it possible to recharge a 6-volt 60-ampere-hour radio battery from a 24-volt automobile battery, and how? A. 1. It is possible to charge a radio battery from a 24-volt, D.C. source, by connecting the positive leads of both batteries together and the negative leads of both batteries together. A resistance must be inserted in series with either a positive or negative lead of the six-volt battery. The value of this resistance must be sufficient to permit not more than five amperes to pass through the circuit.
  - Q. 2. What would be the lowest specific gravity allowable for the radio battery? A. 2. The specific gravity should not drop lower than 1.200.
  - Q. 3. Could this radio battery be connected so as to charge from the automobile charger? A. 3. If the same charger is used, as is used with the 24-volt battery, this could not be done without special wiring.

### SECOND HARMONIC SUPER-HETERODYNE

(960) Mr. F. Bosch Ferran, Barcelona, Spain, writes:

- Q. 1. What is the general principle of the second harmonic heterodyne frequency used in the new Armstrong Super-Heterodyne? A. 1. Instead of using the major vibrations of the oscillator, the second harmonic is used to produce the beat note that is amplified by the intermediate frequency amplifiers.
- Q. 2. What is the advantage of this system? A. 2. By using this system it is possible to incorporate the oscillator and detector in one tube, thus eliminating the need for another tube.

### ZENITH RECEIVER

(961) Mr. Paul Bush, Edison, Ohio, requests:

- Q. 1. Please publish the hook-up of the Zenith 3-R receiver. A. 1. We are showing this circuit in these columns.

### BUZZER AS PLATE CURRENT SUPPLY

(962) Mr. Joseph Danley, Groveville, N. J., writes:

- Q. 1. What wave-length will be had when using a primary honeycomb of 1,500 turns and a secondary honeycomb coil of 1,250 turns? A. 1. A 23-plate condenser will be required to tune the secondary. This secondary will respond to signals between 7,000 and 14,000 meters. The primary may use the same size condenser connected in series with the aerial, but .001 mfd. would be better.
- Q. 2. Is there a way to prevent the oscillations of a single circuit receiving set from being transmitted? A. 2. A practical method is to employ radio frequency before the detector. A unit developed for this purpose was described in the June, 1924, issue of RADIO NEWS.
- Q. 3. Can a buzzer be used to supply the plate voltage for a 6-watt transmitter? A. 3. A buzzer of special design would be required in order to supply a sufficiently high voltage, and current for a 5-watt tube.

### "B" BATTERIES AND BALKITE CHARGER

(963) Mr. Lee R. Clemons, Caldwell, Idaho, wants to know:

- Q. 1. How can radio "B" batteries be charged with a Balkite charger? A. 1. The Balkite battery charger, while designed primarily for the purpose of charging 6-volt "A" filament batteries may be used if desired for charging radio "B" storage batteries. For charging one of these batteries with the Balkite charger the "plus" terminal of the battery is connected to the positive terminal of the charger. (The red tip is positive.) The other lead is connected to the connector strip in the middle of the battery, that is, between the 6th and the 7th cells. By turning on charging current, this section of the battery will charge at the proper rate.

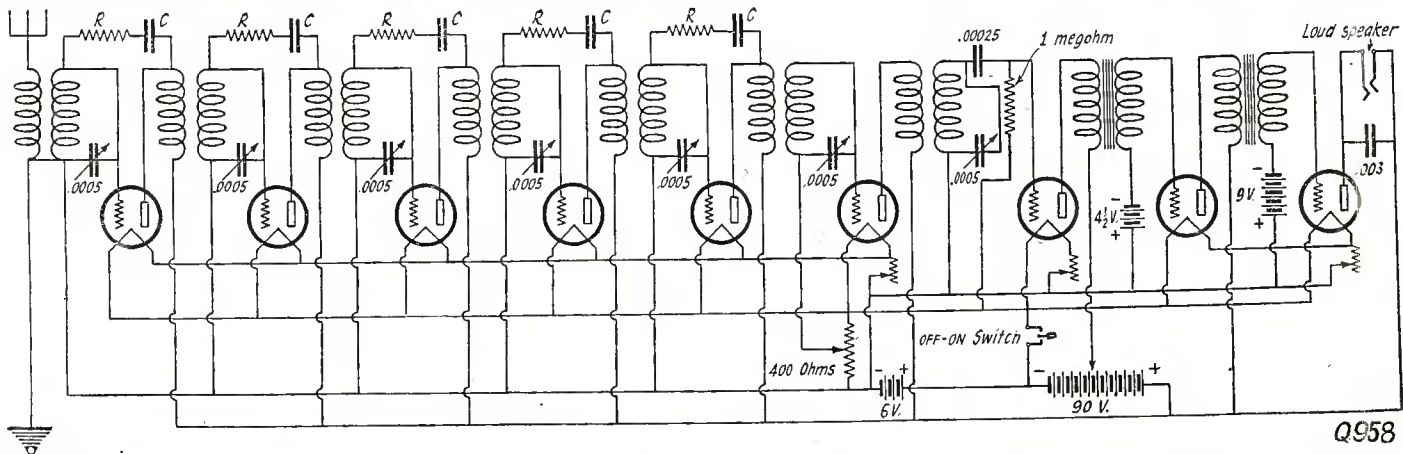

This Super-Pliodyne illustrates the Ferrand system for controlling the oscillations in radio frequency amplifiers, extended to include six stages of radio frequency amplification. Every stage must be carefully balanced. All the variable condensers are geared to one dial.



After charging the first section, the "plus" red clip is placed where the negative clip was, that is, at the midpoint of the battery, and the "minus" clip put on the negative terminal of the battery.  
 Q. 2. When using this charger, can the "B" batteries be charged in units of more than six cells?  
 A. 2. No.

**PATENT LICENSES**

(964) Mr. M. C. Spruce, Bangor, Maine, asks:  
 Q. 1. Who controls the Neutrodyne patents?  
 A. 2. The Independent Radio Mfgs., Inc., 165 Broadway, New York City.  
 Q. 2. Who controls the regenerative patents?  
 A. 2. The Western Electric Co., New York City.  
 Q. 3. Who controls the crystal detector patents?  
 A. 3. The Wireless Specialty Apparatus Co., Boston, Mass., control the original detector patents.

**LOOP LEADS**

(965) Mr. Philip Matthews, Tipton, Ind., writes:  
 Q. 1. Is it necessary to obtain permission to construct radio sets for sale?  
 A. 1. It would be necessary to make contracts with the companies holding the patents on the type of receiver you wish to make. See answers to question 964, above.  
 Q. 2. Should loop wires to a set run parallel and close?  
 A. 2. This will result in broad tuning and reduced volume. Use two separate leads and do not run them close together.

**AERIALS FOR SUMMER USE**

(966) Mr. A. Valverde, Havana, Cuba, requests:  
 Q. 1. Is the range of receiving sets less during the summer than during the winter?  
 A. 1. Yes.  
 Q. 2. Is the "static level" greater during the summer than during the winter?  
 A. 2. Yes.  
 Q. 3. What would be the best aerial system for summer use?  
 A. 3. A low aerial will pick up less static, in proportion to the signals, than a high aerial. A short aerial is better than a long one, for summer use. A loop aerial is best of all.

**M. P. M. REFLEX CIRCUIT**

(967) Mr. E. S. Brady, Frostburg, Md., writes:  
 Q. 1. Please show one stage of audio frequency amplification added to the M.P.M. reflex circuit.  
 A. 1. We are showing this circuit in these columns.  
 Q. 2. Is galena a good crystal to use in multi-tube reflex sets?  
 A. 2. Galena is usually a very sensitive detector mineral, but silicon is also quite sensitive and seems to work more efficiently where several tubes are used, in either standard or reflex circuits.

**RADIOLA SUPER-HETERODYNES**

(968) Mr. F. M. Smith, Dola, Ohio, asks:  
 Q. 1. Please publish full details for the construction of the Radiola Super-Heterodyne.  
 A. 1. The Radio Corporation of America does not make this information public.  
 Q. 2. Can UV-201A tubes be used with the Radiola Super-Heterodyne?  
 A. 2. These sets are designed to use UV-199 tubes only.  
 Q. 3. Will the Ultradyne operate a loud speaker from coast to coast?  
 A. 3. It has done so.

**SIMPLEST GRID LEAK**

(969) Mr. Jarvey Rohr, Vandalia, Mo., writes:  
 Q. 1. If the "A" battery is turned entirely off, and the "B" battery is left connected to the plates of the tubes, would there be any "B" battery consumption?  
 A. 1. There would be no consumption whatsoever.  
 Q. 2. Would there be any electrical discharge from the positive terminals of the "B" batteries, where graduated voltages are applied to the

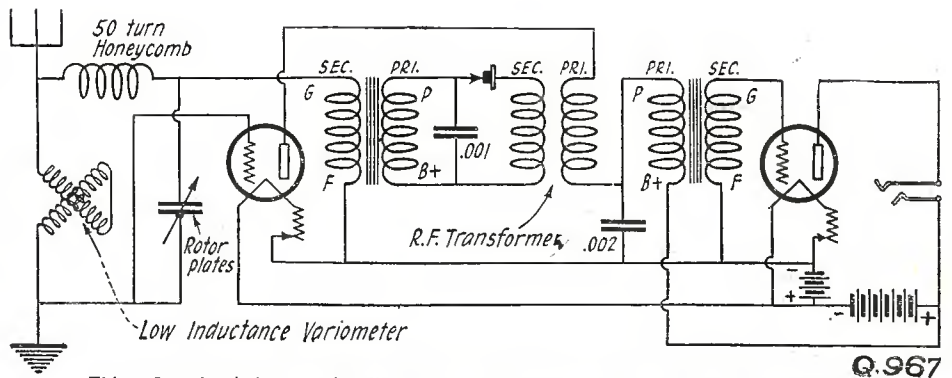

This reflex circuit is exceptionally free from distortion and is quite stable in operation.

various stages of amplification, if the negative lead is opened with a switch?  
 A. 2. No.  
 Q. 3. What is the simplest form of grid leak?  
 A. 3. Pencil marks between two machine screws, separated 1/2 inch, work quite well. The value of the leak depends upon the amount of graphite between the posts.

**IMPROVING A.F. AMPLIFICATION**

(970) Mr. Walter Crawford, Massillon, Ohio, requests:  
 Q. 1. Will radio frequency prevent radiation when placed before the detector of a regenerative set?  
 A. 1. It will greatly reduce, if not prevent, radiation.

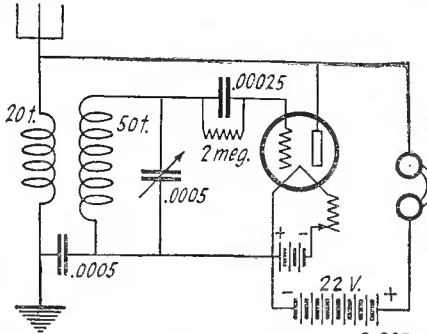

A one control receiver incorporating the advantages of regeneration. It has a fair degree of selectivity.

Q. 2. Why do not WD-12 tubes work better as amplifiers on 45 volts than 22 1/2 volts.  
 A. 2. Try using a "C" battery of 1 1/2 volts. The negative side of this "C" battery connects to the transformer post marked "A" minus (-) and the positive side of this battery will then connect to the minus post of the filament, or "A," battery.

**CODE SENDING REGULATION**

(971) Mr. W. T. Mitchell, Petersburg, Indiana, asks:  
 Q. 1. How can code broadcasting, before 8:00 p.m. and after 10:00 p.m. be prevented?  
 A. 1. Commercial transmitting on commercial wave-lengths may be done at any hour of the day or night. Amateur transmitting may be done, on the proper wave-length, by permission of the Government at any hour of the day or night, except

the period set aside and designated as the "quiet hours." The quiet hours are from 8:00 p.m. to 10:00 p.m.

**IN-DOOR AERIAL LIGHTNING PROTECTION**

(972) Mr. Raymond Kester, Chicago, Ill., requests:  
 Q. 1. What method is required for lightning protection, when an attic aerial is used?  
 A. 1. There is no danger from an in-door aerial and no protective measures need be taken.  
 Q. 2. The other night I heard a loud buzzing in the receivers when bringing the aerial and ground close together. A short spark would jump from one to the other. This only lasted for about half an hour. What was the cause of it?  
 A. 2. The occurrence you mention was due to the presence of atmospheric electricity. It is called "static." The same effects will be noticed whenever an electrical storm is within a few miles of the receiving set.

**32-VOLT "A" BATTERY**

(973) Mr. Walter S. Bell, Jr., Castleton, N. Y., writes:  
 Q. 1. Is there any way to use a 32-volt storage battery as a radio "A" battery?  
 A. 1. The most efficient way of doing this, without changing the connections on the battery, would be to connect the battery up in the regular way, but putting resistance in one lead. The value of this resistance would be about 128 ohms. When buying resistance wire it will be necessary to use a size sufficiently large to pass the amperage required by the tube; 1/4-ampere wire will be required if a UV-201A tube is used.  
 Q. 2. Would it be correct to use three cells at a time?  
 A. 2. This would be very injurious to the battery. One or two of the cells will probably never be charged to the full amount, if this system is used, and the battery will be useless in a short time.  
 Q. 3. Could the above mentioned battery be used as a "B" battery?  
 A. 3. It could be used very well. It would be advisable to connect a potentiometer across this battery. The resistance of this potentiometer should be 6,000 ohms. The potentiometer will be connected in the circuit between one battery terminal and the output, in the manner of a common rheostat. Voltage is thus regulated.

**POTENTIOMETERS**

(974) W. W. Lotspeich, Atlanta, Ga., asks:  
 Q. 1. Is it necessary to use a potentiometer in a tuned radio frequency set?  
 A. 1. The Superdyne, for one, uses negative feedback, eliminating the need for a potentiometer.

**ANTENNA WAVE-LENGTHS**

(975) Mr. Theo. W. Everhart, Strasburg, Ohio, writes:  
 Q. 1. What would be the procedure for tuning an amateur transmitting set to 400 meters?  
 A. 1. Two hundred meters is the limit for amateur wave-lengths. It is advisable to use a wave meter for properly adjusting the set. The transmitter may be put in operation and adjusted until the wave meter indicates that a wave-length not greater than 200 meters is being radiated.

**SHORT-WAVE TUNER**

(976) Mr. Raymond Letton, Mindenmines, Mo., wants to know:  
 Q. 1. Please show the circuit for an exceptionally short wave amateur receiving set having low losses, with one stage of audio frequency amplification.  
 A. 1. In these columns, we are showing the circuit. Coil No. 4 is used to cover the range of 110 to 220 meters. It consists of 30 turns on the same size tube as the coil No. 3.  
 Q. 2. Can this receiver be used for broadcast reception?  
 A. 2. For receiving broadcast signals it will be necessary to change the values so that coil No. 2 has 12 turns; coil No. 3, 20 turns; coil No. 5, 22 turns. The value of coil No. 4 may be determined by experiment. The variable condenser will have to be of .0005 mfd. capacity.  
 (Continued on page 125)

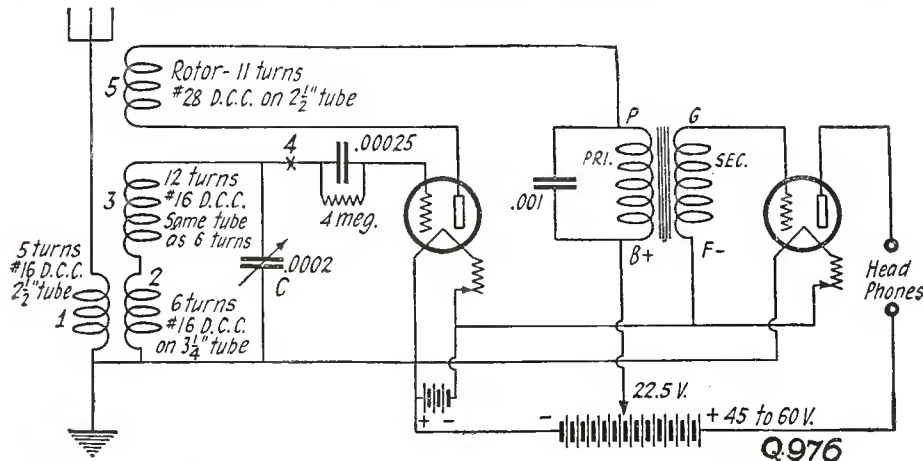

Low losses and a minimum wave-length of 65 meters are the features of this set. It is primarily designed for the reception of telegraphic code signals.



# Complete List of Broadcast Stations Revised to May 1st

Call	Owner	Location	Wave-length in Meters	Call	Owner	Location	Wave-length in Meters	Call	Owner	Location	Wave-length in Meters
KDKA	Westinghouse Electric & Mfg. Co.,	East Pittsburgh, Pa.	326	KFGC	Louisiana State University,	Baton Rouge, La.	254	KFKA	Colorado State Teachers College,	Greeley, Colo.	248
KDPM	Westinghouse Electric & Mfg. Co.,	Cleveland, Ohio	270	KFGD	Chickasha Radio & Electric Co.,	Chickasha, Okla.	248	KFKB	Brinkley-Jones Hospital Association,	Milford, Kan.	286
KDPT	Southern Electric Co.,	San Diego, Cal.	244	KFGH	Leland Stanford University,	Stanford University, Cal.	360	KFKQ	Conway Radio Laboratories,	Conway, Ark.	224
KDYL	Newhouse Hotel,	Salt Lake City, Utah	360	KFGL	Arlington Garage,	Arlington, Ore.	234	KFKV	F. F. Gray,	3200 Richardson St., Butte, Mont.	283
KDYM	Savoy Theater,	San Diego, Cal.	280	KFGO	Crary Hardware Co.,	Boone, Iowa	226	KFKX	Westinghouse Electric & Mfg. Co.,	Hastings, Neb.	341
KDYQ	Oregon Institute of Technology,	Portland, Ore.	360	KFGB	Heidbreder Radio Supply Co.,	Utica, Neb.	224	KFKZ	Nassour Bros. Radio Co.,	Colorado Springs, Colo.	234
KDYW	Smith Hughes & Co.,	Phoenix, Ariz.	360	KFGX	First Presbyterian Church,	Orange, Texas	250	KFLA	Abner R. Wilson,	1321 W. Platinum St., Butte, Mont.	283
KDYX	Star Bulletin,	Honolulu, Hawaii	360	KFGZ	Emmanuel Missionary College,	Berrien Springs, Mich.	268	KFLB	Signal Electric Manufacturing Co.,	Menominee, Mich.	248
KDZB	Frank E. Siefert,	Bakersfield, Cal.	240	KFHA	Western State College of Colorado,	Gunnison, Colo.	252	KFLD	Paul E. Greenlaw,	Franklinton, La.	234
KDZE	Rhodes Co.,	Seattle, Wash.	270	KFHB	Rialto Theater,	Hood River, Ore.	280	KFLE	National Education Service,	Denver, Colo.	268
KDZF	Automobile Club of Southern California,	Los Angeles, Cal.	278	KFHD	Utz Radio & Electric Co.,	St. Joseph, Mo.	226	KFLH	Erickson Radio Co.,	Salt Lake City, Utah	261
KDZI	Electric Supply Co.,	Wenatchee, Wash.	360	KHFH	Central Christian Church,	Shreveport, La.	266	KFLP	Everette M. Foster,	Cedar Rapids, Iowa	240
KDZQ	Nichols Academy of Dancing,	Denver, Colo.	360	KFHH	Ambrose A. McCue,	Neah Bay, Wash.	261	KFLO	Bizzell Radio Shop,	Little Rock, Ark.	261
KDZR	Bellingham Publishing Co.,	Bellingham, Wash.	261					KFLR	University of New Mexico,	Albuquerque, N. M.	254
KFAD	McArthur Bros. Mercantile Co.,	Phoenix, Ariz.	360					KFLU	Rio Grande Radio Supply House,	San Benito, Texas	236
KFAE	State College of Washington,	Pullman, Wash.	330					KFLV	A. T. Frykman,	1503 Fourth Ave., Rockford, Ill.	229
KFAF	Western Radio Corp.,	Denver, Colo.	360					KFLW	Missoula Electric Supply Co.,	Missoula, Mont.	234
KFAJ	University of Colorado,	Boulder, Colo.	360					KFLX	George R. Clough,	1214 Fortieth St., Galveston, Texas	240
KFAN	The Electric Shop,	Moscow, Idaho	360					KFLY	Fargo Radio Supply Co.,	Fargo, N. D.	231
KFAR	Studio Lighting Service Co.,	Hollywood, Cal.	280					KFLZ	Atlantic Automobile Co.,	Atlantic, Iowa	273
KFAU	Boise High School,	Boise, Idaho	270					KFMB	Christian Churches of Little Rock,	Little Rock, Ark.	254
KFAW	The Radio Den,	Santa Ana, Cal.	280					KFMQ	University of Arkansas,	Fayetteville, Ark.	263
KFAV	Virgin's Radio Service,	Medford, Ore.	283					KFMR	Morningside College,	Sioux City, Iowa	261
KFBB	F. A. Buttrey & Co.,	Havre, Mont.	360					KFMS	Freimuth Department Store,	Duluth, Minn.	275
KFBC	W. K. Azvill,	5038 Cliff Pl., San Diego, Cal.	278					KFMT	George W. Young,	2219 N. Bryant St., Minneapolis, Minn.	231
KFBE	Reuben H. Horn,	San Luis Obispo, Cal.	242					KFMU	Stevens Bros.,	San Marcos, Texas	240
KFER	First Presbyterian Church,	Tacoma, Wash.	360					KFMW	M. G. Sateren,	127 Blanche St., Houghton, Mich.	266
KFBK	Kimball-Upson Co.,	Sacramento, Cal.	283					KFMX	Carleton College,	Northfield, Minn.	283
KFBL	Leese Bros.,	Everett, Wash.	224					KFMY	Boy Scouts of America,	Long Beach, Cal.	229
KFBS	Trinidad Gas & Electric Supply Co. and The Chronicle News,	Trinidad, Colo.	360					KFMZ	Roswell Broadcasting Club,	Roswell, N. M.	250
KFBU	The Cathedral,	Laramie, Wyo.	283					KFNC	Alonzo Monk, Jr.,	First Methodist Church, Corsicana, Texas	234
KFCB	Nielsen Radio Supply Co.,	Phoenix, Ariz.	238					KFNF	Henry Field Seed Co.,	Shenandoah, Iowa	266
KFCF	Frank A. Moore,	707 Baker Bldg., Walla Walla, Wash.	360					KFNG	Wooten's Radio Shop,	Coldwater, Miss.	254
KFCH	Electric Service Station, Inc.,	Billings, Mont.	360					KFNH	State Teachers College,	Springfield, Mo.	236
KFCM	Richmond Radio Shop,	Richmond, Cal.	360					KFNJ	Warrensburg Electric Shop,	Warrensburg, Mo.	234
KFCP	Ralph W. Flygare,	2421 Jefferson Ave., Ogden, Utah	360					KFNL	Radio Broadcast Association,	Paso Robles, Cal.	240
KFCV	Fred Mahaffey, Jr.,	Houston, Texas	360					KFNV	L. A. Drake,	Santa Rosa, Cal.	234
KFCY	Western Union College,	Le Mars, Iowa	252					KFNX	Peabody Radio Service,	Peabody, Kan.	240
KFCZ	Omaha Central High School,	Omaha, Neb.	258					KFNY	Montana Phonograph Co.,	Helena, Mont.	261
KFDA	Adler's Music Store,	Baker, Ore.	360					KFNZ	Royal Radio Co.,	Burlingame, Cal.	231
KFDD	St. Michaels Cathedral,	Boise, Idaho	252					KFOA	Rhodes Co.,	Seattle, Wash.	455
KFDE	University of Arizona,	Tucson, Ariz.	268					KFOB	Glenwood Technical Association,	920 Fifth Ave. N., Minneapolis, Minn.	224
KFDJ	Oregon Agricultural College,	Corvallis, Ore.	360					KFOC	First Christian Church,	Whittier, Cal.	236
KFDO	H. Everett Cutting,	420 W. Koch St., Bozeman, Mont.	248					KFOD	The Radio Shop,	Wallace, Idaho	224
KFDR	Bullock's Hardware & Sporting Goods,	York, Neb.	360					KFOF	Rohrer Electric Co.,	Marshallfield, Ore.	240
KFDV	Gilbrech & Stinson,	Fayetteville, Ark.	360					KFOH	Radio Bungalow,	Portland, Ore.	283
KFDX	First Baptist Church,	Shreveport, La.	360					KFOJ	Moberly High School Radio Club,	Moberly, Mo.	246
KFDY	South Dakota State College,	Brookings, S. D.	360					KFOL	Leslie M. Schafbuch,	Marengo, Iowa	234
KFDZ	Harry O. Iverson,	2510 Thomas Ave. S., Minneapolis, Minn.	231					KFON	Ecbophone Radio Shop,	Long Beach, Cal.	234
KFEC	Meier & Frank Co.,	Portland, Ore.	248					KFOO	Latter Day Saints University,	Salt Lake City, Utah	261
KFEJ	Guy Greason,	1724 S. Jay St., Tacoma, Wash.	360					KFOP	Willson Construction Co.,	Dallas, Texas	268
KFEL	Winner Radio Corp.,	1435 Welton St., Denver, Colo.	360					KFOQ	Ora William Chancellor,	Galveston, Texas	240
KFEF	J. L. Scroggin,	Oak, Neb.	360					KFOR	David City Tire & Electric Co.,	David City, Neb.	226
KFER	Auto Electric Service Co.,	Fort Dodge, Iowa	231					KFOT	College Hill Radio Club,	Wichita, Kan.	231
KFEV	Felix Thompson Radio Shop,	Casper, Wyo.	263					KFOU	Hommel Mfg. Co.,	Richmond, Cal.	254
KFEK	Augsburg Seminary,	Minneapolis, Minn.	261					KFOV	Davis Electrical Corp.,	Sioux City, Iowa	234
KFEY	Bunker Hill & Sullivan Mining & Concentrating Co.,	Kellogg, Idaho	360					KFOX	Technical High School,	Omaha, Neb.	248
KFEZ	American Society of Mechanical Engineers,	St. Louis, Mo.	360					KFOY	Beacon Radio Service,	St. Paul, Minn.	226
KFFB	Jenkins Furniture Co.,	Boise, Idaho	240					KFOZ	Leon Hudson Real Estate Co.,	Fort Smith, Ark.	233
KFFE	Eastern Oregon Radio Co.,	Pendleton, Ore.	360					KFPB	Edwin J. Brown,	Seattle, Wash.	224
KFFO	E. H. Smith,	Hillsboro, Ore.	229					KFPD	Garretson & Dennis,	Los Angeles, Cal.	238
KFFP	First Baptist Church,	Moberly, Mo.	266					KFPH	Harold Chas. Mailander,	Salt Lake City, Utah	242
KFFQ	Marksheffel Motor Co.,	Colorado Springs, Colo.	360								
KFFR	Nevada State Journal,	Sparks, Nev.	226								
KFFV	Graceland College,	Lamoni, Iowa	360								
KFFX	McGraw Co.,	Omaha, Neb.	278								
KFFY	Pincus & Murphy,	Alexandria, La.	275								
KFFZ	Al. G. Barnes Amusement Co.,	Dallas, Texas (portable)	226								

## List of Radio Articles Appearing in the July, 1924 Issue of Science and Invention

- Novel Cockaday Set By M. A. Luyre
- A Combination Variometer and Variocoupler By Kenneth B. Murray
- Portable Radio Receiving Sets
- How to Build Radio Cabinets By William Butterfield
- An Efficient Loud Speaker Horn By Horace Porter
- Soldering in the Radio Laboratory By Edward F. Staver
- A Three Circuit Coupler By C. B. Kramer, Sr.
- Radio Questions and Answers
- News of the Broadcast Stations
- Photos and Description of Latest Radio Apparatus
- Radio Wrinkles
- Radio on Steamship Deutschland
- Numerous other Radio Instruments and Hook-ups Illustrated Especially for the Layman

KFHJ	Fallon & Co.,	Santa Barbara, Cal.	360
KFHR	Star Electric & Radio Co.,	Seattle, Wash.	283
KFHS	Clifford J. Dow,	Lihue, Hawaii	275
KFHX	Robert W. Nelson,	407 E. First St., Hutchinson, Kan.	229
KFI	Earle C. Anthony, Inc.,	Tenth and Hope Sts., Los Angeles, Cal.	469
KFID	Ross Arbuckle's Garage,	Iola, Kan.	246
KFIF	Benson Polytechnic Institute,	Portland, Ore.	360
KFIL	Windisch Electric Farm Equipment Co.,	Louisburg, Kan.	234
KFIO	North Central High School,	Spokane, Wash.	252
KFIQ	Yakima Valley Radio Broadcasting Association,	Yakima, Wash.	242
KFIU	Alaska Electric Light & Power Co.,	Juneau, Alaska	226
KFIX	Reorganized Church of Jesus Christ of Latter Day Saints,	Independence, Mo.	240
KFIZ	Daily Commonwealth and Oscar A. Huelsman,	Fondulac, Wis.	273
KFJB	Marshall Electric Co.,	Marshalltown, Iowa	248
KFJC	Seattle Post-Intelligencer,	Seattle, Wash.	270
KFJF	National Radio Manufacturing Co.,	Oklahoma City, Okla.	252
KFJI	Liberty Theater,	Astoria, Ore.	252
KFJK	Delano Radio & Electric Co.,	Bristow, Okla.	233
KFJL	Hardsag Manufacturing Co.,	Ottumwa, Iowa	242
KFJM	University of North Dakota,	Grand Forks, N. D.	280
KFJQ	Electric Construction Co.,	Valley Radio Division, Grand Forks, N. D.	280
KFJR	Ashley C. Dixon & Son,	Stevensville, Mont. (near)	258
KFJV	Thomas H. Warren,	Dexter, Iowa	224
KFJW	Le Grand Radio Co.,	Towanda, Kan.	226
KFJX	Iowa State Teachers College,	Cedar Falls, Iowa	229
KFJY	Tunwall Radio Co.,	Fort Dodge, Iowa	246
KFJZ	Texas National Guard,	112th Cavalry, Fort Worth, Texas	254

(Continued on page 88)



# Improved Radio Programs ~this summer!

*Millions of homes will be enlivened  
by stirring sports, important news  
and gay music — via Radio*

Plug in your headset or your *Table-Talker*. You're in the midst of a season of keenest enjoyment. More interesting programs than ever before—crammed with a diversity of vital events and artistic treats. And stronger sending and clearer reception to help you get the very *best* out of your set.

### *The Presidential Campaign*

is being waged right in your home. You can follow the important messages of all parties. You can be *part* of the stirring battle—not just an outsider wondering what is going on. You'll *know* the candidates—and their platforms. You will vote with keener interest—this year.

### *The Churches, Too,*

are promising to be generous in the broadcasting of their services. Off in the woods—down at the shore—or right in the city when you cannot attend you may have the word and the inspiration of your particular faith.

### *Tremendous Improvements*

in broadcasting and receiving assure you a full quota of pleasure. Stronger sending stations—the telephonic connection of distant stations—broadcasting over a waveband rather than a single wave length. Sets of greater selectivity, improved tubes and circuits and loud-speakers. Lowered prices. All these will contribute to making this a real radio season!

*All Brandes Products are sold under a money back guarantee by reliable dealers everywhere.*

*Table-Talker* \* \* \* \$10.00  
50c additional cost of the *Recliner*  
In Canada \* \* \* \$14.00

*Navy Type Headset* \$ 8.00  
In Canada \* \* \* 11.00

*Superior Headsets* \* \* \* \$6.00  
In Canada \* \* \* 7.00

*For sixteen years the Brandes name has consistently stood for service—for skill—and dependability.*

# Brandes

*The name to know in Radio*



"The only loud speaker that can hold my receiving set is the

# THOROPHONE

TRADE MARK REG. U.S. PAT. OFFICE

—says Wm. G. Smith



High Power Model S-5 \$45.00

**P**OWER that makes other loud speakers jump off the table merely makes the Thorophone produce greater volume. The Thorophone will take all you can give it and still reproduce voice and music so naturally that you'd think speaker or musician were right in the room.

Until you have heard the Thorophone you have not learned how wonderful radio is. Whatever your receiving set, the Thorophone will make it sound better. It reproduces perfectly. The controlled mica diaphragm; the scientifically designed Thorite horn; the additional power from the 6-volt storage battery—these things make the Thorophone the ultimate loud speaker.

For endless satisfaction, buy the Thorophone.

Write for booklet

**WINKLER-REICHMANN CO.**  
4801 S. Morgan St. Chicago, Ill.

## Matching Intermediate Wave Transformers for Super-Heterodynes

(Continued from page 51)

ally fall off as the potentiometer arm is moved, since a negative bias on the grid reduces the plate current of the vacuum tube. When the plate current is reduced to the safe limit of  $MA_2$ , the switch  $S_2$  should be opened to place this instrument in the circuit. Adjustment of the potentiometer should then be continued until the reading of  $MA_2$  is reduced practically to zero. The reading of the voltmeter  $V$  should then be noted, calling this reading  $V_1$ .

The adjustments already made should now be left as they are and the filament of the oscillator tube lighted to the point where oscillations begin. This will cause an oscillating potential to be impressed on the grid of tube  $T_1$ , and will cause an oscillation ripple to be impressed on the plate current to that tube. The transformer windings transfer this oscillation to tube  $T_2$ . This oscillating ripple in the grid circuit of tube  $T_2$  is superimposed on the steady grid potential maintained by the battery  $B_p$  and the potentiometer  $P$ , as indicated in Fig. 3. It is now seen that the potential of the grid tube  $T_2$  is not maintained at the point  $V_1$  required to block the action of the tube, but rises above this value part of the time as at A, Fig. 3. This causes some plate current to again flow through the millimeters and a further adjustment of the potentiometer will now be needed to again reduce the plate current of tube  $T_2$  to zero. The reading of the voltmeter  $V$  should now be noted, calling this reading  $V_2$ .

The quantity,  $V_1-V_2$ , is an indication of the amplification constant of the transformer under test at the frequency for which the oscillator was set. The amplification curve plotted from these determinations will have the general appearance of Fig. 4. By an inspection of this curve, the best frequency for use with this transformer will be learned. In Fig. 4, this optimum frequency is 9,600 meters, or 31,300 cycles per second.

The amplification curves for the other transformers to be used in the set should now be plotted in the same way. It will usually be found that, even with transformers made to the same specifications, the peaks will not occur at exactly the same frequency. The different transformers may often be made to peak at the same frequency by removing or adding turns to both the primary and secondary windings. This adjustment should be made by trial, adding or removing turns until the desired peak is obtained.

The results secured by this test are sufficiently close to secure a high efficiency in the selection of a set of matched transformers. The increased efficiency in reception will more than pay for the efforts required for testing and matching the transformers. Many manufacturers are now offering sets of matched transformers which have been matched by a method very similar to that described.

The test outlined may be improved by placing a buzzer in the grid circuit of the oscillator and using a headset in connection with an audibility meter to replace the milliammeters. The modulated continuous waves from the oscillator will cause the sound of the buzzer to be heard in the headset. The audibility meter should then be adjusted so that the sound is reduced to the proper standard. The data so obtained will permit the optimum frequency for the transformer under test to be more closely determined, thus improving the efficiency of the test.

## Super Heterodyne

We specialize in super heterodyne receivers and after making exhaustive tests find the circuits and parts designed by THE EXPERIMENTERS INFORMATION SERVICE to be the best known to the art today.

THEFORE WE OFFER

Complete model "C" super heterodyne parts including panel, cabinet and constructional drawings .....\$108.15

FEATURES VERY DESIRABLE BUT NOT ESSENTIAL

- Drilling and Engraving Panel..... \$10.40
- Special model "C" voltmeter, reading all tubes and "B" battery ..... 7.50
- Model "C" ammeter ..... 7.50
- Gear vernier attachment for heterodyne condenser ..... 2.75
- Resistors and Filament Switch..... 3.00
- Antenna Adapter "K" including Drilled and Engraved Panel Cabinet and Drawings ..... 29.00
- Model J 2-Stage Tuned Regenerative R. F. Amplifier for Model C or any other 8-Tube Super making a 10-Tube Set. Incl. Eng. Panel, Cab. and Drawings. 67.00

INDIVIDUAL PARTS

WE OFFER SEPARATE PARTS

- Oscillator Coupler ..... \$5.00
- R. F. Coupler (Filter), 10,000 M. .... 5.00
- E. I. S. Improved 10,000 M. Transformers ..... 7.50
- 21-K. W. E. Bypass Condensers..... 1.75
- Standard R. C. A. Loops, 30" sq. .... 22.00
- Western Electric 10-D Loud Speaker... 43.00
- Selected R. C. A. Tubes, 201A or 301A (only with Model C Parts)..... 4.25
- Wire, Tubing, Sockets, Jacks, Audio Transformers, etc., also.
- Model "C" Sets Rewired according to standard by experts ..... 60.00
- All Shipments F.O.B. Philadelphia or New York

### NORDEN, HAUCK & CO.

Engineers and Purchasing Agents

25 SOUTH ASHMEAD PLACE

GERMANTOWN

PHILADELPHIA, PA.

## TELMACO RADIO GUIDE 10

Describes the Best in Radio



### 20 Latest Circuits in Blue in New 64 Page Book

These include the Super-Heterodyne, Neutrodyne, Grimes Inverted, Colpitts, Flewelling, Reinartz, Push-Pull Amplifier, Diode Electrad, Super-Regenerative and many others.

#### Standard Guide for Thousands

The Telmaco catalog has become the standard guide for thousands of radio users in their selection of quality radio. Besides blue prints, it describes and illustrates the best products of America's leading radio manufacturers. Sent postpaid for 10c. Each circuit worth double. Send for your copy today.

**Dealers!** Dealers' Catalog and Price List FREE to all bonafide dealers making request on their business stationery.

Radio Division  
**TELEPHONE MAINTENANCE CO.**  
20 So. Wells St. Dept. B Chicago, Ill.



Quality Radio Exclusively Est. 1918

## Hammarlund Condensers

Grounded Rotor—Brass Plates

Increase Your Volume and Distance!

WRITE FOR FREE DESCRIPTIVE CIRCULAR AND PRICES

HAMMARLUND MFG. CO., 144 W. 18th St. N. Y. C.



"Built First to Last"

GUARANTEED RADIO PRODUCTS  
Coto-Coil Co.  
Providence, R. I.



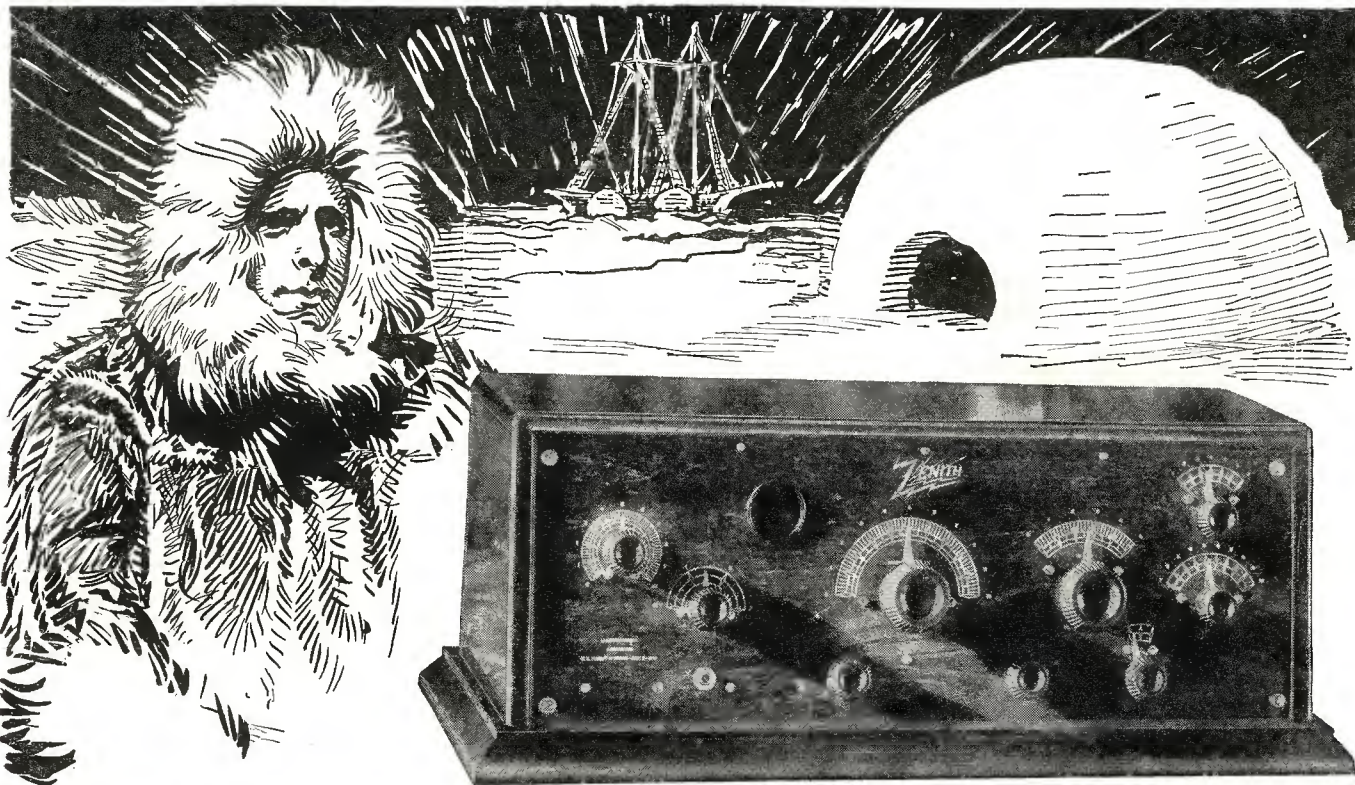

Licensed under Armstrong U. S. Patent No. 1,113,149.

# MacMillan Listens to Honolulu and New Zealand "Tunes In" California Using

From a little ice-bound schooner—eleven degrees from the North Pole—comes this message:

"Am very thankful that Arctic Exploring Ship Bowdoin is equipped with complete Zenith radio apparatus. Here at top of world, in darkness of great Arctic night, we have already listened to stations practically all over United States, from Europe, and even from far away Honolulu. Zenith has united the ends of the earth."

—"MacMillan"

Again, from far-off New Zealand comes a report of radio reception even more startling:

"It may interest you to know that the writer last evening landed KGO, Oakland, California, between 6:45 and 7:30 P. M. Heard his call four or five times distinctly, and jazz music. The music was not as clear as the voice, but one could pick up the tune all right. As San Francisco is 6,300 miles from New Plymouth, and only one tube was used, we think this is a very fair performance."

—(signed) H. Charles Collier.

The sets used by Captain MacMillan and Mr. Collier are earlier models—since improved by the addition of a **third stage of audio frequency**. These new models, described at the right, represent an achievement in radio construction not duplicated in any other set on the market. A demonstration will convince you.

Write today for full particulars and name of nearest dealer.

## Zenith Radio Corporation

McCORMICK BUILDING, CHICAGO



**Model 3R** The new Zenith 3R "Long-Distance" Receiver-Amplifier combines a specially designed distortionless three-stage amplifier with the new and different Zenith three-circuit regenerative tuner.

Fine vernier adjustments—in connection with the unique Zenith aperiodic or non-resonant "selector" primary circuit—make possible extreme selectivity.

The new Zenith 3R has broken all records, even those set by its famous predecessors of the Zenith line. Under favorable conditions, satisfactory reception over distances of 2,000 to 3,000 miles, and over, is often accomplished in full volume, using **any ordinary loud-speaker**. The Model 3R is compact, graceful in line, and built in a highly finished mahogany cabinet.... **\$160**

**Model 4R** The new Zenith 4R "Long-Distance" Receiver-Amplifier comprises a complete three-circuit regenerative receiver of the feed-back type. It employs the new Zenith regenerative circuit in combination with an **audion detector** and **three-stage** audio-frequency amplifier, all in one cabinet.

Because of the unique Zenith "selector," unusual selectivity is accomplished without complication of adjustment.

The Zenith 4R may be connected directly to any loud-speaker **without** the use of other amplification for full phonograph volume, and reception may be accomplished over distances of more than 2,000 miles..... **\$85**

ZENITH RADIO CORPORATION,  
Dept 1-P 328 South Michigan Avenue, Chicago, Illinois

Gentlemen:  
Please send me illustrated literature on Zenith Radio.

Name.....

Address.....





**FROST-RADIO**  
No. 620 BAKELITE Potentiometer  
Cut-Out Switch.....50c

We show here a few of the many items of **FROST-RADIO** accessories. All of these are of superb quality, finely finished and priced remarkably low.

# FROST RADIO

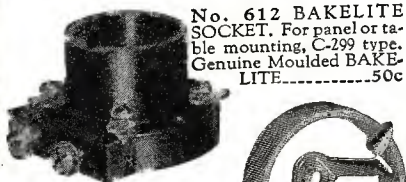

No. 612 BAKELITE SOCKET. For panel or table mounting, C-299 type. Genuine Moulded BAKELITE.....50c

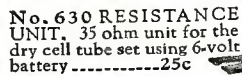

No. 630 RESISTANCE UNIT. 35 ohm unit for the dry cell tube set using 6-volt battery.....25c



No. 608 PUSH-PULL BATTERY SWITCH. Single hole mounting. BAKELITE panel. Wondervalue, 30c



No. 611 BAKELITE ADAPTER. Converts standard base to UV-199 or C-299 socket. Real BAKELITE, moulded.....50c



**FREE!**  
A post card from you will bring this 40-page catalog Address Dept. 10F183

**HERBERT H. FROST, Inc.**  
154 W. Lake Street, CHICAGO  
550 Gates Bldg., KANSAS CITY  
30 Church Street, NEW YORK

## A Local V.T. Transmitter

(Continued from page 48)

finally decided to incorporate a microphone circuit in the transmitter in view of the fact that, unfortunately, many amateurs prefer to communicate over short distances by voice. I say unfortunately because, in the opinion of the writer, if the amateur would discontinue, to a large extent, the practice of using telephony for his communication purposes, he would be much better off. It does not require any particular skill to talk over a radio telephone, but it does take application and perseverance to communicate by means of the telegraphic codes. However, it appears that the amateur must have provision for telephonic communication, therefore it has been incorporated in the small transmitter described herewith.

### THE CIRCUIT

Consideration of available circuits disclosed the fact that for ease of operation and adjustment, and general all-round satisfactory results, the Colpitts circuit was probably the most desirable. It was decided to modulate with the buzzer in the ground lead and use an absorption loop for voice modulation. Accordingly, it was found that the panel face should contain two inductance switches of 10 points each, a jack for the microphone, rheostat for the tube, the radiation ammeter and the buzzer, with the neces-

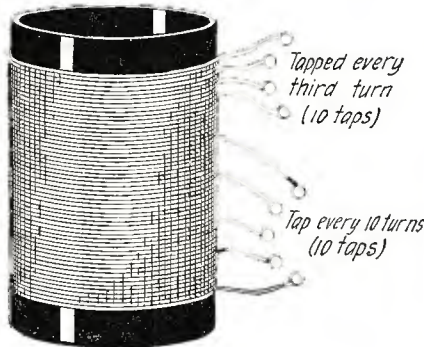

Details of the inductance for the low power C.W. transmitter.

sary binding posts. The layout of the panel face is clearly indicated in the accompanying photo. A panel of 6 x 12 inches was found ample.

The panel is attached to a rigid base board by means of two small brass angles. A cabinet may be easily constructed, as indicated, to fit snugly over the base. A radio frequency ammeter was used for the current indicating device, such meter being convenient. Obviously any make of equipment may be used throughout. Small mica receiving condensers were found entirely satisfactory for the grid and antenna circuits, and no difficulty was experienced from breakdowns, even at potentials of 300 volts. The inductance must be carefully constructed and well made, for it is here that much loss is liable to occur if careless construction is adopted. About 55 turns of No. 16 double cotton covered magnet wire is about right for transmission on the average amateur antenna on wave-lengths within the allotted band of from 176 to 200 meters. A three-inch form is used, preferably of formica, bakelite, radicon, micarta or a similar insulating substance. A neater job will result if the form is threaded to the wire, but this may be eliminated if care is used in winding. Taps to provide for adjustment of the radiated wave are taken every third turn from one end of the inductance, while the grid coil is adjustable in steps of one turn at a time from the opposite end. The coil may be secured in any favorable position on the rear

**\$25 for \$10**

DIRECT FROM MFG. TO YOU

**THE FAMOUS BEL CANTO**

LOUD SPEAKER Price **\$10** DELIVERED FREE TO YOUR DOOR

Adjustable Unit. Fiber Horn-22" High, 10" Bell



### GUARANTEE

Money back any time within ten days if dissatisfied. We further guarantee to the publication carrying this advertisement that each and every speaker will be sold on the above terms and the instrument will be exactly as offered in this issue.

- 7 POINTS OF BEL-CANTO SUPERIORITY**
1. Fiber Horn, Crystalline finish.
  2. Our own adjustable unit.
  3. Heavy metal base, eliminating top heaviness.
  4. All other metal parts heavy cast Aluminum highly polished.
  5. Height 22", Bell 10".
  6. Guaranteed one year against mechanical defects of any kind.
  7. No extra battery required, just plug in on the phone circuit.

CALL AT OUR FACTORY Send us your check, money order or pay the postman \$10.00. Prepaid to any part of the U. S. and Possessions.

**SENT FREE RADIO LOGGING CHART—GET ONE**

BEL-CANTO MFG. CO.

Bensel-Bonis Co., Inc. General Office and Factory, Dept. RN 417-419-421 E. 34th St., New York City Tel. Vanderbilt 8959

**8 1/2 HOURS ON THE AIR With Two Tubes**

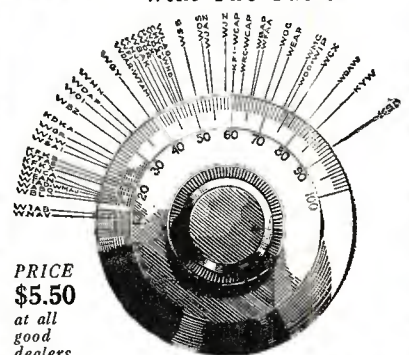

PRICE \$5.50 at all good dealers.

**UNCLE SAM MASTER TUNING COIL Does the Trick.**

This is a calibration of a set submitted to a committee of engineers in Philadelphia. Ask your dealer or send us a stamped envelope—self addressed—for wiring diagram and panel layout of this set.

**UNCLE SAM ELECTRIC CO., Plainfield, N. J.**



# Announcing:—

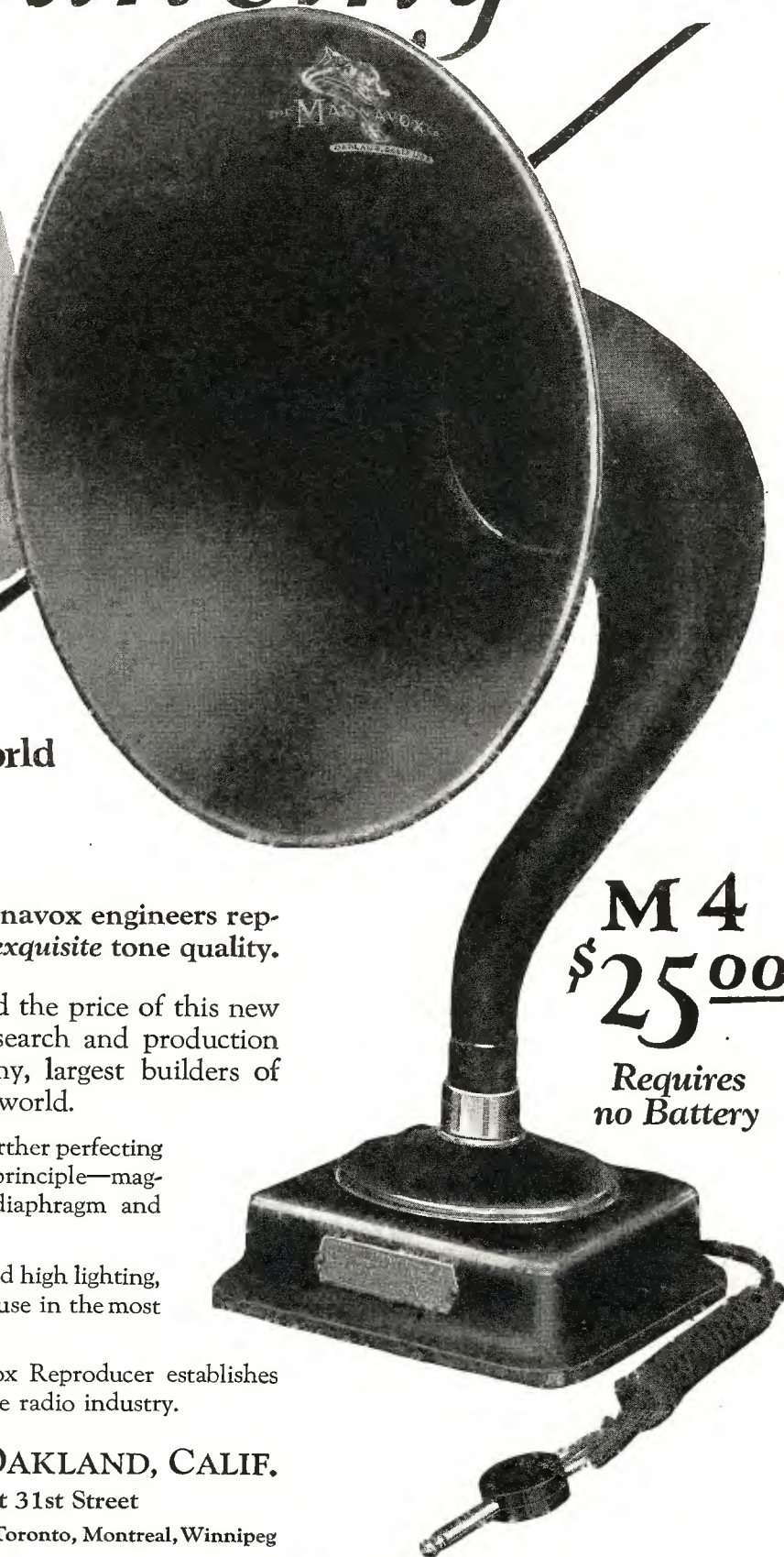

**A new Magnavox  
that will broadcast  
satisfaction to the radio world**  
*Here's big news  
"on the air"*

The supreme achievement of Magnavox engineers represented in a reproducer of truly *exquisite* tone quality.

**T**HE efficiency, the appearance and the price of this new instrument clearly reflect the research and production facilities of The Magnavox Company, largest builders of radio reproducing equipment in the world.

Its exquisite tone quality results from a further perfecting of the Magnavox semi-dynamic operating principle—magnetically balanced armature, improved diaphragm and extremely high resistance winding.

Beautifully finished in dark enamel with gold high lighting, the graceful appearance of M4 suggests its use in the most dignified surroundings.

The amazingly low price of this Magnavox Reproducer establishes an absolutely new standard of value in the radio industry.

**THE MAGNAVOX CO., OAKLAND, CALIF.**

New York Office: 350 West 31st Street

Canadian Distributors—Perkins Electric Limited, Toronto, Montreal, Winnipeg

**M 4**  
**\$25<sup>00</sup>**  
*Requires  
no Battery*

7R



# MAGNAVOX

*The Reproducer Supreme*







# Evenly

in every direction—to every corner of the room—Atlas reproduction sends a clear, rounded, faithful tone.

This is true—with Atlas—regardless of what set you use, regardless of what conditions may be, regardless of what type of program you are receiving. For since these things do vary, Atlas reproduction is provided with a simple adjustment to compensate for variation in receiving conditions.

On local or DX stations, on two tubes or eight, on voice or instrumental music, Atlas floods the room with the best that's in your set. Responsible dealers everywhere sell Atlas speakers for \$25.00.

Multiple Electric Products Co., Inc.  
36 Spring St., Newark, N. J., Dept. F.  
Boston, Philadelphia, Baltimore, Detroit,  
Pittsburgh, Chicago, St. Louis, Denver,  
550 Howard St., San Francisco.

# Atlas

TRADE MARK

## RADIO REPRODUCTION speaker

With the Atlas coupling, complete for \$13.50, any standard phonograph may be utilized to produce Atlas reproduction.

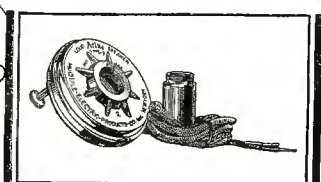

of the panel to provide short leads to the switch points. The writer mounted his inductance directly over the wave-length switch points; this results in very short leads for both controls.

It is often desirable, for various reasons, to light the filament of the vacuum tube with alternating current. In this event, the filament supply transformer may be mounted between the inductance and socket, there being ample room provided. Or this space may be used for suitable choke coils and filter condensers. The writer purposely left this space for the addition of another tube at a later date, should this be found desirable.

A good power rheostat of about two amperes carrying capacity should be provided as well as a standard socket of reliable make. A radio frequency choke coil should be inserted in the positive high voltage lead, and may consist of a 200-turn honeycomb coil or a hand-wound inductance of similar characteristics.

The assembly and wiring of such a transmitter is by no means difficult, being simpler in construction than the majority of broadcast receivers. The wiring should be of at least the same size wire as that used in the inductance, although No. 14 bus wire, covered with "spaghetti" tubing is preferable. All joints should be carefully soldered, and superfluous soldering acid or paste wiped away.

### TUNING

In connecting the transmitter for operation, the tube should be lighted with the high voltage leads disconnected to be sure there has been no error made in wiring. The high voltage may then be connected and the set tuned. This is accomplished by turning up the filament to the point of normal operation and setting the wave-length switch on some arbitrary point. The grid switch is then varied until the greatest radiation is shown. A reading is then taken with a reliable wavemeter and the wave-length switch adjusted to the proper tap. A readjustment of the grid switch will then be necessary for maximum radiation. The plate of the tube should at no time become brighter than a dull cherry red.

At 180 meters, using a standard five-watt tube and 300 volts of plate potential, the writer obtained seven-tenths of an ampere radiation and worked close to 200 miles with the buzzer system. The telephony connection gave an antenna current of 4 ampere and the voice was reported good at a distance of 18 miles. A radiation ammeter, with a scale reading 0 to 1, is ample, and a normal antenna current of from .4 to .8 ampere should be obtained. This will fall slightly when modulating, which is an indication of normal functioning.

The writer firmly believes that if more amateur stations would adopt a low power transmitter, such as the one described here, and use it for all communication where it would serve, his feud with the broadcast listening public would soon dwindle and more amicable relations would be established. Try it!

## The Loop Antenna

(Continued from page 40)

when they are wound just as closely to each other as possible. In order to get the maximum number of turns for a given inductance, which is what our loop requires, the turns should be wound just as far apart as possible. It is found that this spacing is best accomplished by winding the loop on a frame which has the form of a vertical cylinder. The wire goes up one side of the cylinder across the top and down the other side and across the bottom, and the turns are spaced around the circumference of the cylinder so that the complete winding covers an arc of about 120 degrees on each side of the cylinder.

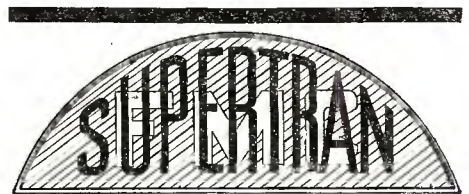

Registered U. S. Patent Office

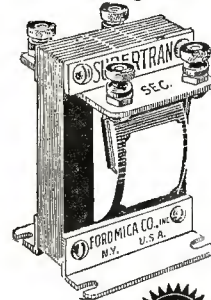

## CERTIFIED!

Supertran Audio Transformers have been certified by the largest testing laboratory in the United States. They are "certified" by scientific measurements to be unequalled for volume, quality, and electrical efficiency.

Price \$6.00



These transformers are specially designed for use in the Neurodyne and Reflex circuits.

Can be used with any amplifying tube on the market with excellent results.

Manufactured by

FORD MICA COMPANY, Inc.

33 East 8th Street

New York

Eastern Distributor

Wetmore-Savage Company, Boston

West and Southwestern Distributor

Beekly-Ralston Co., Chicago

## FOR SUMMER TUNING

Try the New



\$4.75  
Paid  
or at  
your  
dealer's.

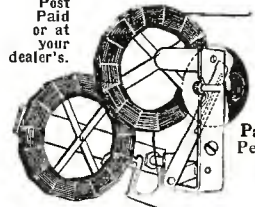

Patents  
Pending

Because its efficiency gives you greatest possible strength of signal. Therefore, as you lower the sensitivity of your set, static fades out before your signal does!  
"Pfanstiehl Book of Hook-Ups" free with order.

PFANSTIEHL RADIO SERVICE CO.  
Highland Park, Ill.

Write for complete illustrated FREE Catalog of

## PARAGON

Reg. U. S. Pat. Off.

RADIO PRODUCTS

ADAMS-MORGAN CO.

6 Alvin Place

Upper Montclair, N. J.

10 cents will bring one can of ALLEN SPECIAL RADIO SODERING PASTE if you mention this advertisement. A limited number of booklets on "How to Soder Radio Sets" will be given free to early replies.

L. B. ALLEN, Inc.  
4564 N. Lincoln St.  
CHICAGO, ILLINOIS

**YOU** to hear programs from stations 400 to 1000 Miles Away. I can show you how to get them on **YOUR CRYSTAL SET**. Changes often cost **Less Than One Dollar**. Send self-addressed envelope for picture of my set.

LEON LAMBERT

595 So. Volusia, Wichita, Kansas



**EVEREADY**  
Radio Batteries  
—they last longer

**FREE!**

*The Story of*  
**EVEREADY**  
DRY CELL  
**RADIO**  
"A" BATTERIES  
for  
DRY CELL  
VACUUM TUBES

How to  
get the most  
out of your  
"B"  
BATTERY

**EVEREADY**  
STORAGE  
"A"  
BATTERY

**EVEREADY**  
BROADCASTING  
HOUR GLASS  
*An Aid in Determining  
By Hours  
THE LOCATIONS  
CALL LETTERS  
& WAVE LENGTHS  
of Principal Stations*  
NATIONAL CARBON CO., INC.  
MAKERS OF EVEREADY BATTERIES  
NEW YORK SAN FRANCISCO

No. 771  
**EVEREADY**  
"C"  
RADIO BATTERY  
THREE  
CELLS  
THREE  
PURPOSES

Informative and money-saving booklets on radio batteries sent free on request. If you have any questions regarding radio batteries, write to G. C. Furness, Manager, Radio Division, National Carbon Company, Inc., 122 Thompson Avenue, Long Island City, N. Y.

## Every radio user should have these books

THEY contain battery facts that it is important for you to know. They are *not* catalogs, *not* advertising pamphlets, but each one tells the story of one kind of battery, what it is, what it does, how to connect it, how to get the most satisfaction and service out of it.

Do you know why a "B" Battery is necessary? Do you know how much "B" Battery current your tubes use? Do you know what a "C" Battery can do for you? All these things and many more are told in these informative booklets. Many of these facts you can secure elsewhere

only by digging through several different works on radio engineering. These booklets present battery facts, in plain language, with a few simple diagrams.

These pocket-size pamphlets cost you nothing. They are sent free on request, part of our service to the radio user. Whether you use Eveready Radio Batteries or not, these booklets will interest you, assist you, answer your questions.

To take the mystery out of radio batteries, read these four booklets. Write for them to-day. Remember, they are FREE.

### EVEREADY HOUR GLASS

When you wonder what that station is, turn to this list of Class B broadcasters and their schedules of transmission without waiting to hear the call letters. You can pick the station from its wave-length and the time at which you hear it. Sent FREE.

Eveready Radio Batteries are manufactured and guaranteed by

**NATIONAL CARBON COMPANY, INC., New York—San Francisco**

Headquarters for Radio Battery Information

Canadian National Carbon Co., Limited, Toronto, Ontario





# ALL-AMERICAN

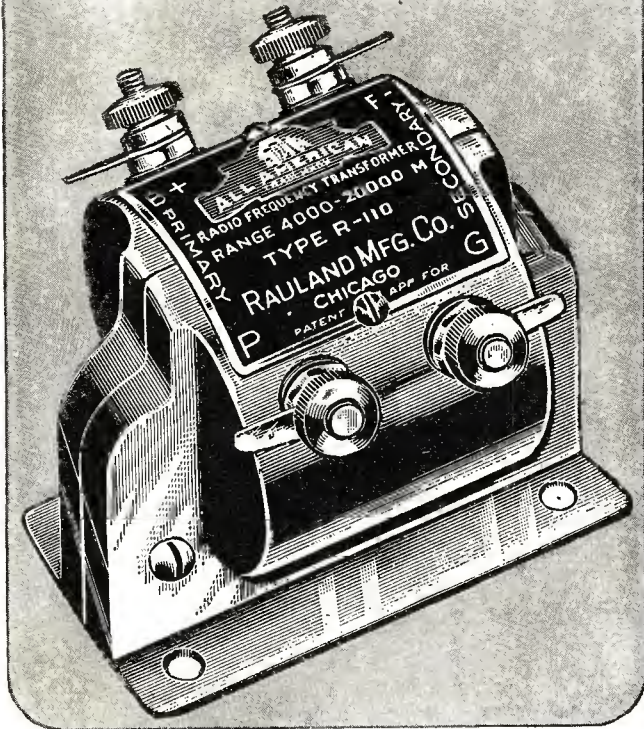

## for Super Heterodyne

Ultradyne and all straight radio frequency and reflex circuits. *Truly the Masterpiece of Amplification!* Could not be made better if it sold for ten times its price of six dollars. Built to uphold our good name, as nearly three-quarter million All-American Audio Frequency and Power Amplifying Transformers already are doing. Watch for the new All-American Low Wave Radio Frequency Transformer.

**RAULAND MFG. CO., 2646 Coyne St., Chicago**

*Pioneers in the Industry*

### LOST AND FOUND BY RADIO

Many persons annually drop from urban centers, and frantic and sorrowful relatives and friends in their desire to find them, have had to depend entirely on the police and the newspapers.

Now radio has been brought into use for their service by the Meier and Frank Co., a large department store of Portland, Oregon, which recently inaugurated a lost and found service to aid in locating lost articles and getting in touch with missing persons.

All that is necessary is to write KFEC, Meier and Frank Co., printing the names legibly and always being sure to give such essential information as will serve to identify the missing person or the article wanted. The service is free.

### A Tube Protector

(Continued from page 57)

tubes? If not, you always have this pleasure in store unless some precaution is taken to prevent such an occurrence. By using the device described here, you can always tell if the "B" battery circuit is mixed with the "A." An old burned out tube is obtained, and the glass and elements are removed and the base is thoroughly cleaned. The prongs of the tube are heated by a soldering iron or a blow-torch until the solder melts. Then the wires are withdrawn. A small porcelain socket designed for flashlight bulbs is obtained and wires are soldered to the contacts. These wires are run through the filament tube prongs and soldered so that the top of the flashlight socket is level with the top of the tube base. Melted sealing wax should be poured in the tube base until it is level with the top of the tube socket, and when it has hardened, the small socket will be firmly fixed. A flashlight bulb of the desired voltage to correspond with the voltage of the tube can be screwed in this test socket and the device inserted in the regular tube socket before the tube. If the "B" battery has been accidentally connected to the "A" battery leads, the flashlight bulb will go out, thereby serving as a danger signal. When one flashlight bulb is burned out, a new one can be screwed in, and the tester is ready for service again.

*Contributed by John J. Strayer.*

### RE-BROADCASTING RADIO RECORDED BROADCAST RECORDS

Station WGN has succeeded in broadcasting phonograph records of its opening program, which were recorded in New York, and they were sufficiently clear to make it possible to re-record the disks.

When WGN went on the air with its inaugural program Saturday night, March 29, Mr. Frank Hoyt, inventor of a new method of recording broadcast reception, tuned in at his laboratories in New York and recorded his reception of the program on aluminum disks. He succeeded in recording all of the program, which continued from 6 p. m. Saturday evening to 6 a. m. Sunday morning.

A part of these records were brought to Chicago by him and under his supervision were re-broadcast Thursday morning, April 10, as a part of the regular program for Dr. Donald B. McMillan, using, as always in the McMillan programs, the experimental call letters 9XN.

Arrangements were made for a recording of this broadcast of a previous recording, and both in Chicago and New York the broadcasts were received with sufficient clarity and volume to be recorded again, together with announcements about the experiment.

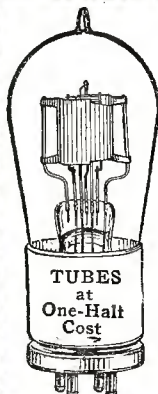

## Save 1/2 Cost of New Tube

GUARANTEED VACUUM TUBE REPAIRS AT POPULAR PRICES.

We try to maintain 24-hour service.  
All repairs guaranteed.  
Tubes satisfactory or money refunded.  
Special discounts to dealers.  
Send broken and burned out tubes parcel post.  
Repaired tubes returned parcel post, C. O. D.

**HARVARD RADIO LABORATORIES**

200 OLD COLONY AVE. SO. BOSTON, MASS.





These  
Broadcasting  
stations  
use

Willard B's:

- |      |      |
|------|------|
| CFDC | WJAR |
| KDYQ | WHAM |
| KFEC | KDYL |
| KFHJ | KZN  |
| KFIF | WOAI |
| KFNF | KSD  |
| KFOP | WDAE |
| KGK  | CFCA |
| WABO | WHAZ |
| WBBG | WJH  |
| WCAE | WCAP |
| WEAU | WMAH |
| WFAN | WFAV |
| WGAQ | KFBK |
| WHAD | WTAM |
| WHN  | WNAV |
| WKY  | KDZB |
| WNAP | KOP  |
| WOQ  | WSAB |
| WTAB | WDAR |
| WSB  | WJAM |
| WSY  | WCBF |
| WNAR | WPAD |
| WMAQ | KHJ  |
| WDAP | WHAH |
| WLW  | WRAY |
| WSAI | WJAZ |
| WHK  | KRE  |
| WJAX | WIP  |
| KFCK | WOO  |
| WDAO | WTAR |
| WFAA | WQAV |
| WOC  | WCAU |
| WWI  | WFI  |
| AA-3 | WCAO |
| KLZ  | KFJC |
| WGF  | CHBC |
| WCX  | WEAR |
| WWJ  | WIAJ |
| WBAP | WSAR |
| WEV  | WDAU |
| WCAK | CFCN |
| WDAL | CFAC |
| WOS  | CJCA |
| WDAF | CFCF |
| WHB  | KFIQ |
| KFI  | KFCF |
| WMC  | WKAA |
| WHA  | WJAG |
| WQAM | KDZE |
| WBAH | WIAO |
| WLAG | WTAY |
| WOR  | WGAZ |
| WCAG | WHO  |
| WCAL | WTAJ |
| WOAW | WNAC |
| WAAW | WCK  |
| WIAK | WABU |
| KGW  | WJAS |
| WTAG | WSAD |
| WEAN | WGV  |

# Better Results for Them Better Results for You ~

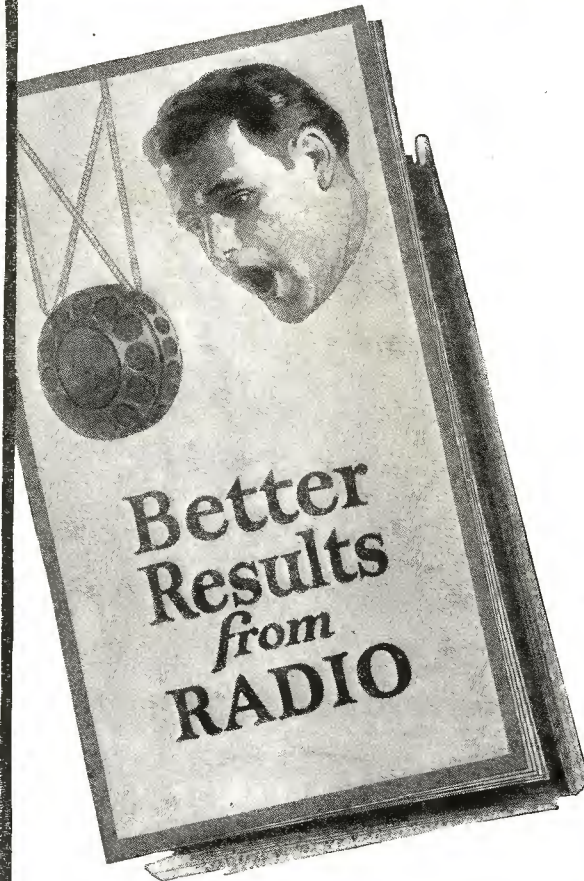

VOICE amplification requires batteries that give clear, quiet operation.

That is why 122 Broadcasting Stations use Willard B's in preference to other batteries. During the past thirty days 18 additional Broadcasting Stations have substituted Willard B Batteries for other equipment. The list grows daily.

Besides giving you better reception, Willard B's are the most economical batteries you can own. They can be recharged at any time and they last for several years.

THIS booklet tells how to get better reception. Ask your local Willard Service Station or Radio Dealer for copy, or write Willard Storage Battery Company, Cleveland, Ohio. (In Canada, Willard Storage Battery Company of Canada, Limited, Toronto, Ont.)



Willard Rechargeable B Batteries are made in 24 and 48 volt units, each type in two capacities, 2500 and 4500 m. a. h.

Glass jars and wide spaces between cells guard against electrical leakage.

# Willard Rechargeable Batteries for Radio



# New Series WORKRITE SUPER NEUTRODYNE SETS

## WATCH FOR ANNOUNCEMENT IN JULY



Just as the first Neutrodyne eclipsed all other circuits, so the New WorkRite Super Neutrodyne will eclipse all predecessors.

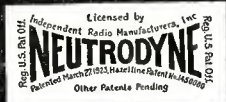

**DEALERS:** Be sure that your name is on our mailing list so that you will receive advance bulletin announcing the new Work-Rite Super Neutrodynes.

**The WorkRite Manufacturing Co.**  
1837 E. 30th Street, Cleveland, Ohio  
(Branch Office, 536 Lake Shore Drive, Chicago)

### Correspondence from Readers

(Continued from page 58)

I noticed, and I fancy that all others have found the same thing, that static usually starts shortly after sundown and continues until about 2 A.M.; it then ceases. I was on a voyage to Los Angeles from New York and on the Pacific Coast the sea was smooth and the horizon very clear of clouds. A cloud overhead was floating about 3,000 feet up. As the sun went below the western horizon, it threw a clear-cut shadow on this cloud, and as it did so, the cloud, which was now being chilled by the night air, began to shrink visibly—the static starting instantly, from a dead silence. I saw then what was taking place and why static starts up shortly after sundown. It was clear to me also why the sunset and sunrise lines affect receiving and sending. As soon as the shadow of the earth falls on the cloud overhead, it is chilled and starts at once to shrink. The electricity it contains has no alternative, but to get back to earth. This it does, causing tiny flashes of electricity—so tiny that the miniature waves caused by their passage are only audible in a radio set. It is evident that only those waves that touch the antenna are heard at all. This condition continues as long as the cloud continues to shrink, which is generally about 2 A.M. Then the sunrise line begins to warm up the eastern horizon and the clouds start silently to expand, and static ceases as the day begins.

Cold air currents will, of course, start cloud shrinkage in the daytime, but the principle is the same. Cloud shrinkage causes what we call static, and when I say cloud shrinkage, I include humidity shrinkage also.

I find that at sea static is apparently not directional—it shoots straight downward. On shore, however, there are places on the earth's surface more attractive than others. It is, therefore, natural that the tiny flashes of lightning called static by radio listeners are deflected diagonally towards this sensitive spot. In the winter, conditions are as poor for static as they are for lightning, which is all that static is anyhow. Cold air has pretty well squeezed out the electricity from the clouds—they have shrunk to a standstill.

The Gulf of Mexico has a bad name for static, but it is only owing to the fact that the sea is about 84 degrees F. and the humidity is enormous. Cold winds from the north, called Northers, chill and shrink this mass of vapor, precipitating its electrical contents to the sea below. The hotter a cloud is, the more it will shrink when chilled, and the more it shrinks, the less electricity it contains, and the precipitation to the earth is consequently greater, causing more of a rum-pus.

In very dry climates, like in California, there is very little static. I notice that during very heavy tropical rains, there are not as many static noises as one would expect. The electricity is coming down in the rain drops and does it silently.

HUGH L. MASON,  
Master S.S. James McGee, S. O. Co.

HAWAII—U. S. A.

Editor, RADIO NEWS:

I would appreciate it very much if you would broadcast through RADIO NEWS a word or two about Hawaii. There seems to be a general idea through the East that Hawaii is some kind of a foreign country.

Frequently people whom I know have sent to some of the Eastern cities for articles to be sent by parcel post C.O.D. as per the ads. in RADIO NEWS and electrical magazines, and invariably, after waiting a month or more, get a

## BROWNLIE CRYSTAL

Guaranteed the Best \$1.00

"REFLEX SPECIAL"  
QUICK CONTACT  
RECTIFIER

Withstands Heavy Plate Voltage  
The Acme Apparatus Co. says "prevent distortion and howling by using a BROWNLIE CRYSTAL in REFLEX SETS."

Order From Your Dealer or Direct

**ROLAND BROWNLIE & CO.**

22 Saunders Street Medford, Mass.

## EISEMANN RADIO EQUIPMENT

comprises

Headsets, Variometers, Variocouplers, Condensers, Potentiometers, Detector, Resistance-Adapter, Radio and Audio Amplifier Units, A.F. Amplifying Transformer, and ready drilled metal panels.

Also the new R.F.-2 Broadcast Receiver.

Write for Prices and Descriptive Literature



EISEMANN MAGNETO CORPORATION

165 Broadway, New York

Detroit Chicago San Francisco

Get a Handy Binder for your RADIO NEWS. Holds and preserves six issues, each of which can be inserted or removed at will. Price 65c. Experimenter Pub. Co., Inc., Book Dept., 53 Park Place, N. Y.



# "GOLDEN-LEUTZ" "SUPER-PLIODYNE 9"

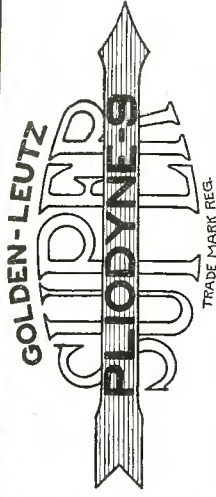

"The Perfect Broadcast Receiver"

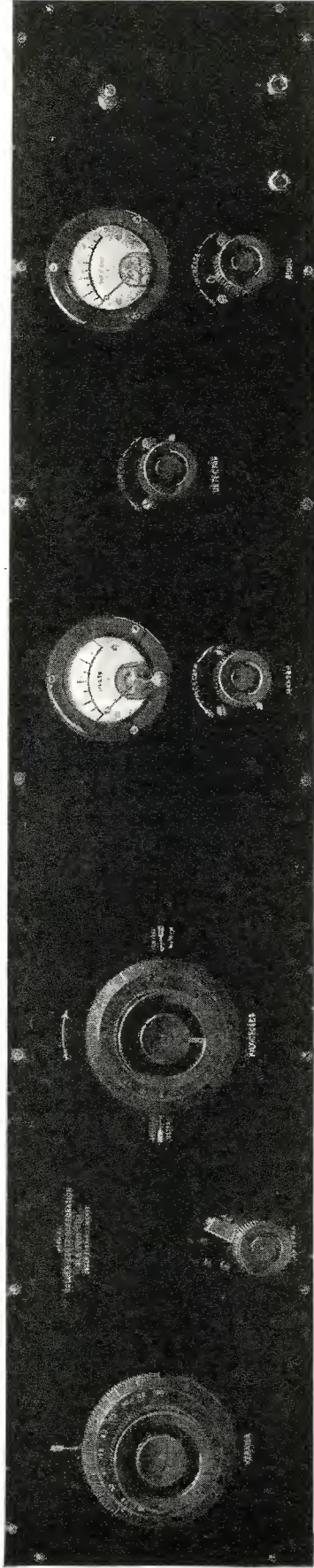

Size 40 x 8 x 8

Weight 65 Lbs.

MANUFACTURED UNDER FARRAND LICENSE

A New Broadcast Receiver having 6 Stages of Tuned Neutralized Radio Frequency Amplification, Detector and 2 Stages of Audio Frequency Amplification

*BUILT FOR PEOPLE WHO WANT THE BEST*

Complete Illustrated Catalog and Instruction Book mailed upon receipt of 25c

## GOLDEN-LEUTZ CORPORATION

476 BROADWAY

NEW YORK CITY



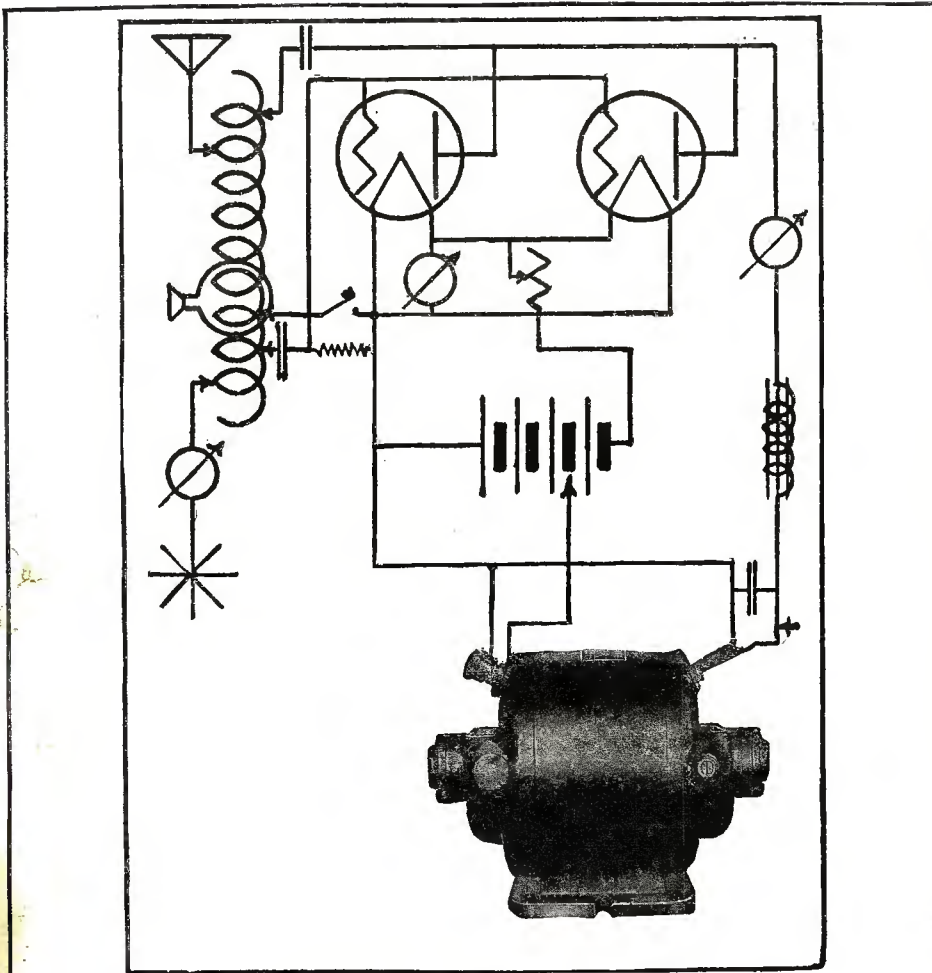

Item 45  
A FEW GOOD COMBINATIONS

Item	Description	Recommended for
2	350 V 40 Watt	2-5 watt with separate Fil. supply.
7	500 V 100 "	4-5 " with separate Fil. supply.
8	500 V 150 "	5-5 " 2 mod. 1 mast. osc.-2 osc. sep. Fil. supply.
13	1000 V 300 " dbl. comm.	2-50 " with separate Fil. supply.
15	1000 V 500 " " "	3-50 " or 2-50 watt and 4-5 watt as speech amplifier and mast. osc. Sep. Fil. supply.
16	1000 V 650 " " "	4-50 " with separate Fil. supply.
20	1500 V 600 " " "	2 to 3-50 " with separate Fil. supply.
24	2000 V 500 " " "	1-250 " with separate Fil. supply.
26	2000 V 1000 " " "	2-250 " with separate Fil. supply.
31	500 V 100 " 10 V 60 Watt	Same as item 7 but with Fil. supply.
35	1000 V 300 " 12 V 150 "	" " " 13 " " " "
41	2000 V 500 " 14 V 200 "	" " " 24 " " " "

Many other sets for various combinations of tubes. Special sets made to order.

TRADE "ESCO" MARK

MOTORS — DYNAMOTORS — GENERATORS — MOTOR-GENERATORS  
Used by more than 150 Universities, Colleges, Research Labs., etc. Many Federal, State, County and Municipal Depts.

Write for Bulletins 237B and 242A Listing over 200 Combinations

**ELECTRIC SPECIALTY CO., 211 South St., Stamford, Conn., U.S.A.**

Send us your problems—we'll help you solve them.

Pioneers in Developing and Perfecting High Voltage Wireless Apparatus

reply saying, "We do not send C.O.D. to foreign countries" or "We do no export business" or "No business done outside the U. S. A."

Kindly advise them that Hawaii is just as much a part of the U. S. A. as the Battery or Brooklyn Bridge, and they could see by the stamps and post marks on the letters that it came from a territory of the U. S. A.

Only a few months ago I sent to a well-known Brooklyn firm making a line of radio goods, asking for one of their catalogs. I received it O.K. in the course of time, and in about two weeks received another one, including numerous folders, all printed in Spanish. Evidently they are under the impression this is a Spanish country.

HOMER D. JAGGERS,  
Kahuku, Oahu, T. H.

**FROM A SLIGHTLY DIFFERENT ANGLE**

Editor, RADIO NEWS:

Having held out for a long, long time, an impulse finally forces me to gum up (with your kind permission) one of your columns, incidentally writing my first letter to any magazine.

My subject is the cry of the "Cost of Broadcasting," the last straw being a letter in the April issue where Mr. A. B. Curtiss says:

"We take too much for granted . . . . never stop to think . . . . cost real money," etc., etc., until I felt sick reading it. Have people ever stopped to think that all broadcasting is advertising—direct or indirect? That by broadcasting they *created the demand for radio receivers*, that the listener did not create a demand for *broadcasting*? That the Ham was very well satisfied to listen to sigs. and to send them out until radio corporations saw a big clean-up possible? Suppose we refuse to help support the broadcast stations; does any thinking person believe for one second that the big stations will be abandoned? I do not. Can we think that the people who are making millions of dollars worth of radio goods will let their market go, when by supporting their stations they keep up the market? I do not think so.

Therefore, in my opinion it is up to them to maintain these stations, good ones, too, and pay the artists out of their own profits, and keep still about it. They reap all of the material benefit, and the artists, of course, are entitled to payment for their services. The listener-in pays his share when he buys his set or the material for the construction of it, and, to my way of thinking as a mechanic, makes his contribution right there.

The above is without prejudice, and if I seem to be too forceful, hereby offer an apology in advance, as my intention is not to offend. I write, as someone has said, "from the heart."

H. MORTIMER,  
Outlook, Sask., Can.

**LOOK FOR THE SILVER LINING**  
Editor, RADIO NEWS:

I have been a regular reader of your most estimable publication for over a year. I was impelled to buy it for the first time purely by chance. Having been something of a newspaper man of past experience I picked up a copy on a newsstand, curious to note its make-up more than anything else. We old-timers have that failing, you know. I liked it so well that I bought it to take home to note the changes that had taken place since I had left the game. It satisfied me so well that I read it. I liked it so well I felt obligated to read at least the things the editor had to say. This matter had to do with the occasionally well written items the editor sees fit to send out to beginners in radio. In short, I swallowed the hook, line

**MARLE TRANSFORMERS**  
*The Heart of a Good Receiver*

Your dealer will tell you why Marle Transformers do not howl or distort. Uniform amplification up to as many as 3,500 cycles.

**Marle Engineering Co.**  
Orange New Jersey



**FREE**  
SEND FOR THIS  
**Catalog**  
AND  
**Save Money**  
ON  
Standard  
Quality Parts

**GREAT LAKES RADIO CO.**  
Marine Bldg. Dept. C  
136 W. Lake St. Chicago, Ill.

**RED-HEAD PHONES** Used and praised the world over  
3000 Ohm \$6.50 Complete with Cord and Headband.  
2000 Ohm \$5.00 At your dealer's, or sent direct.  
THE NEWMAN-STERN CO., Cleveland, Ohio

**AMPLION** The World's Standard Loud Speaker





# “Simply Divine” – Tamaki Miura



Unequaled ease and accuracy of tuning is gained through Erla Selectoformer. Distant stations are separated from local blasting at will. \$5



Erla Push-Pull transformers embody numerous scientific advantages over other types. For details, consult Erla Bulletin No. 22. Pair, \$10



Superior accuracy of Erla tested capacity condensers is invaluable for securing utmost efficiency from any receiving unit. 30c to 75c.

THE golden witchery of Tamaki Miura's internationally famous art finds ideal counterpart in the marvelous purity and tone quality of Erla Duo-Reflex reception.

“Never have I heard anything so beautiful,” concludes the eulogy of the Japanese nightingale upon the supreme flawlessness of Erla reproduction. “The tone is simply divine, so pure, so perfectly natural.”

Foremost musical authorities of all nations acclaim the exquisitely true, rich tone exclusive to Erla receivers as the ultimate in radio achievement.

Responsible for this unique excellence are Erla radio and audio transformers, synchronizing perfectly received and reflexed radio, as well as rectified radio and reflexed audio currents, in their simultaneous passage through amplifying tubes, with consequent unprecedented elimination of distortion.

You, too, can enjoy outstanding Erla superiority, at minimum effort and cost. Complete Erla parts, for sale by leading dealers, are assembled into the most modern and efficient of receivers in a few hours' time. Easily understood blueprints guide every step.

Ask your dealer; or write, giving your dealer's name. Electrical Research Laboratories, Dept. C, Chicago

# ERLA



Supreme sensitiveness and amplifying power of Erla reflex transformers is the secret of unmatched Erla range and volume. List, \$5



None but Erla transformers are encased in costly, one-piece, drawn steel housing, completely eliminating magnetic interaction. List, \$5



Indispensable to range and stability in reflex design, Erla fixed crystals create equal improvement in crystal circuits of all types. \$1 ea.





# BATTLE OF TRAFALGAR

ON October 21, 1805, Nelson's great naval victory of Trafalgar definitely ended Napoleon's scheme for the invasion of the British Isles. Although in a light breeze the English fleet maneuvered successfully in response to the signals from Nelson's flagship "Victory".

Modern fleets are not dependent upon the uncertainties and limited range of visual signals. Radio

which gives unlimited entertainment through broadcasting also is the modern agency which controls the movements of vessels in battle.

Holtzer-Cabot Radio apparatus has added greatly to the development of Radio. Holtzer-Cabot Headsets, Loud Speakers and Phonograph Attachments contain the perfection of design and care in manufacture to enable perfect reception of Radio.

- Holtzer-Cabot Loud Speaker ..... \$25.00
- Loud Speaker Phonograph Attachment ..... 10.00
- No. 2 Universal Headphones ..... 9.50
- No. 4 National Headphones ..... 6.00

Write for booklets explaining how the exclusive features of these instruments enable you to enjoy the wonders of Radio

THE HOLTZER-CABOT ELECTRIC CO.  
125 Amory Street, Boston, Mass.  
6161-63 South State Street, Chicago, Ill.  
Dept. D1

*Holtzer-Cabot*  
BUSINESS ESTABLISHED 1873

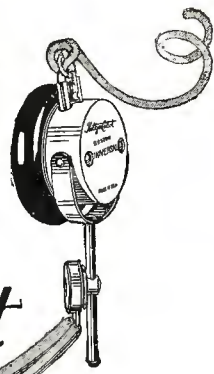

and sinker, and probably would have bitten off half the mythical pole as well, had it been possible.

Since then, it has been a crystal, single circuit (gol dern 'em), single-tube super, three circuit Armstrong, reflex, inverse duplex, two-tube super, various additions of radio frequency and what not. Now it's a Neutrodyne, and if the Lord is willing and lets me live long enough to raise the tariff for a Super-Het, I will have one this fall. For all of which you are responsible. It has cost much more than good reason would dictate, viewed from my financial platform, but, Sweet William, I have been happy; almost as happy and just as busy as a one-eyed kid at a three-ringed circus. You have made me spend a lot of money, but you have also given me many pleasant moments, not to mention those enjoyed by an 83-year-old grandma, who, convalescing from a broken hip, can listen in as often as she pleases and who goes to church regularly now without leaving the house. The other night she listened in to a three-hour concert from WTAM. It was composed almost entirely of old-time songs, songs she knew in early childhood. Right then and there every nickel I had spent previously paid super-dividends. She talked of that for three days. I don't know of anything anybody ever enjoyed quite as much as that experience. And our pleasure came through her enjoyment of the concert. So you see, in interesting me you have done a lot of good to this household. More power to your typewriter.

I read the article from the pen of the West Virginia contributor to your magazine, in the last copy. I echo every sentiment he propounds. We are all remiss in letting the stations know just how much good we get from what they send. On a money basis I could never have paid for one-tenth the good or pleasure I have had from every single station I have ever listened to. To me the end of a perfect day comes with the signing off to go to bed. I have no criticisms to offer. None but thanks for each and every one of them. If I feel that COW takes too long to make his announcements identifying his station, I have the privilege of either tuning in someone else or patiently waiting for him to tell me who he is, never forgetting that I am getting all of this for nothing. Some are not as good as others, of course, but my objections do not necessarily coincide. Perhaps I am not a judge of that form of entertainment. Who knows? The variety, however, is such, that everybody should be satisfied, or can be if they care to meet the question fairly. Whenever I read of someone, or hear someone razzing a station or performer, it strikes me that someone is looking a gift-horse in the mouth.

As for myself, I can say I have no kick coming. I have had lots of fun and real downright pleasure through my radio experience. I wouldn't take much money for my little range of equipment if no other could be had. My year's collection of RADIO NEWS numbers occupy the same monetary status. I have nothing material to offer the stations except when they need it, if that time comes, but my thanks for every angle of the broadcasting field are profound. And help yourself to a generous portion of the same.

The amateur is a pretty decent fellow, I find, after a year's association with him. My experience has been that more interference has been caused by commercial stations and whistling single circuit and double circuit stations than by the fellow who dents the atmosphere with a 10-ton crusher. I am surrounded by a herd of them, but only one has ever been guilty of busting the implied law. He plays some nasty tricks, such as holding down his key and fussing with his set in the neutral hours. A little conversation with the gentleman changed that, especially when notified that he wasn't a licensed sender. So beyond that I have found them a mighty fine set of fellows, who are ever

**HALLDORSON**  
**\$65 Radio Receivers**  
4-Tube Sets  
Designed and created with deliberate scientific foresight—not a "rush job" for immediate demand. Write today for facts on the most popular set for the home.  
Dealers and Jobbers: Write for Our Attractive Proposition  
**HALLDORSON COMPANY**  
1772 Wilson Ave. Chicago, Ill.

**Music Master**  
PROVEN RADIO PRODUCTS.  
MUSIC MASTER CORPORATION  
10th & Cherry Sts., Philadelphia

**RADION**  
The Supreme Insulation  
Panels, Dials, Sockets, Knobs, Insulators  
AMERICAN HARD RUBBER CO.  
11 Mercer St. New York

Operate your radio from your lamp socket with a  
**Gould Unipower Battery**  
For complete information address  
GOULD STORAGE BATTERY CO.,  
30 East 42nd Street New York





## Approved By Over 200 Experts New Crosley Engineering Achievement

A three tube set with five tube efficiency—the greatest selectivity with the minimum effort—positive calibration to any wave length between 200 and 600 meters. These are only a few of the many advantages offered in the remarkable new Crosley Trirdyn Radio Receiver.

It was only after a year of constant experimenting, that our engineering department perfected this exceptional receiver. Thorough tests proved to us that it would out-perform any receiver ever before produced. But we were not satisfied with our own opinion. So we shipped out 200 of these sets to experts in every part of the United States. Their criticisms are one and the same—"tried out your new Trirdyn Receiver Saturday night and logged 13 stations, among them Cuba, New York and Omaha, between 9 and 10 o'clock. The set was very selective. During the time this test was on local station KSD was operating and we went through them without any difficulty or interference whatever. The range of the local station was not more than three points variation in the dial setting."

"Tried one of these sets out and obtained wonderful results. Were able to log all stations which we heard very successfully. This set should go over big." "The set has wonderful volume and is selective"—etc.

This new Crosley triumph is called the Trirdyn because

of its original combination of the three "R's"—Radio frequency amplification, Regeneration and Reflex. The first tube incorporates non-oscillating, non-radiating tuned radio frequency amplification; the second tube, a regenerative detector is reflexed back on the first tube for one stage of audio frequency amplification. Then it has a third tube which acts as a straight audio frequency amplifier. It uses the ultra selective aperiodic antenna circuit and external selector coil, which adds to its wonderful selectivity.

The Crosley Trirdyn in range, volume and selectivity is the equal of any five tube receiver on the market. Greater volume will of course, be obtained through the use of storage battery tubes, but it will function well with any type and can be used with either indoor or outdoor antenna.

The opinions of many experts have convinced us that the Trirdyn is the best receiver ever offered the public regardless of price.

Practically every radio dealer can furnish you Crosley Radio Sets including not only the Trirdyn, but the Model 51, a two tube set for only \$18.50; the Model V, a single tube receiver at \$16.00; the Model VI at \$24.00; the Super VI at \$29.00; the Model X-J at \$55.00 and the Super X-J at \$65.00.

All Crosley regenerative sets are licensed under Armstrong U. S. Patent No. 1,113,149

**CROSLEY**  
Better-Cost Less  
Radio Products

Crosley Builds More Radio Receiving Sets than any other Manufacturer in the World.

SEE THIS NEW WONDER AT YOUR DEALERS

**THE CROSLEY RADIO CORPORATION**

POWEL CROSLEY, JR., *President*

*Formerly The Precision Equipment Company and Crosley Manufacturing Company*

722 ALFRED STREET

CINCINNATI, OHIO





# PROVED!

**DREADNAUGHT RADIO CORPORATION**  
NEWYORK, N.Y.  
MARCH 12, 1924.

**VILLAGE OF LE ROY**  
LE ROY, ILL.  
FEBRUARY 11, 1924.

**Parham Electric Co.,**  
Chicago, Ill.

**Parham Electric Co.,**  
Chicago, Ill.

**Parham Electric Co.,**  
Chicago, Ill.

Success is measured by results. Results are only as complete as signed testimony can make them. Read the evidence!

### Make Every Night Silent Night

The Ferbend Wave Trap is guaranteed to tune out any interfering station. It is not to be confused with imitations hastily assembled from ordinary parts. The price is \$3.50. Shipment is made parcel post C.O.D., plus a few cents postage. If you prefer, you can send cash in full with order and we will ship postage prepaid. Send us your order today.

**FERBEND ELECTRIC CO.**  
25 E. So. Water St., Chicago, Ill.

**FERBEND**  
TRADE MARK  
**WaveTrap**  
REG. U.S. PAT. OFF.



ready to help out when trouble knocks on the panel door. And they know a lot about your troubles when your set gets to fussing. One of them heard my regenerative set whistling louder than the ten o'clock local. His method of taking up the question with me and bringing about proper results has led me to believe that as an amateur operator that young man makes a first-class diplomat. He was 17 and I am old enough to be his grandad. Still, he showed me how to tune it right, and shades of Major Armstrong the little stunt he did with my one-tube set, and one stage of anemic amplification, was to tune in PWX and 6KW; Here Comes Brinkley, Montreal and divers other DX points. Since then I have had the same kind of luck, much to the comfort of my filament batteries and tubes. Yea verily, that kid was up to something I see where I am going to have some fun this fall with that kid and the prospective super I hope to build.

Altogether, I feel I owe the radio fraternity quite a bit. Much pleasure has been mine, also my family. We look for the evening concerts with the pleasure that comes to a kid who knows the next day will be Saturday and there will be no ashes to carry out. It is one round of pleasure, with just as much fun building the sets. Perhaps the A. T. & T. is assuming a monopolistic attitude. Also they furnish a fine variety of entertainment. We can't forget that. That capable gent by the name of Hoover will, no doubt, find some way to curb that tendency, but let us hope it won't interfere with the excellent programs their chain of stations broadcast. As for the Authors, Composers and What Not Association, there must be a hinge loose somewhere in their collective mental organism. Since radio hit my menage, I have bought more records and sheet music in one year than in any other five. If they won't believe me, I agree to play the finest collection of recent records and sheet music any one owns who is working on a budget as close to the handle as mine.

ARTHUR J. HINRICHS,  
Akron, Ohio.

### WHO CAN HELP?

Editor, RADIO NEWS:  
Although but 15 years of age, I have taken a very great interest in radio for some time. I began before the war—a bad time, to be sure. My interest was aroused by a ham who lived nearby. The purpose of this letter is to try and find an obliging amateur who will give me some inside dope on amateur life. I have every expectation of becoming a ham some day, but, living in a rural district as I do, and there being no OM's near me to my knowledge, I am unable to obtain the information I seek. When it comes to the code, I can send at fair speed, but cannot receive because every time I have attempted to get code practice from some station I have heard "DINNER." Grub is O.K. at the right time!

I have been reading, with interest, the "Correspondence From Readers" section of your magazine, and have found particular interest in the letters of Mr. Aldeman, and the answers—they took the bun.

MORTON BARTLETT,  
Norwell, Mass.

## 5 TUBE NEUTRODYNE

N. Eng 11  
ADDRESS ELECTRICIAN IN CHARGE  
U. S. NAVAL RADIO STATION  
AND REFER TO NO.  
NAVY DEPARTMENT  
NAVAL COMMUNICATION SERVICE  
U. S. NAVAL RADIO STATION  
Eagle Harbor, Michigan.  
April 7 1924.

Atlantic and Pacific Radio Co.  
223 West 34th Street  
New York, N.Y.

Dear Sirs,  
Please ship me by parcel post, collect, one complete set of parts for a five tube neutrodyne radio receiver. Duplicate parts of our order of fifteen March 1924. This order was shipped from your store on fifteen March. We prefer the same kind of parts as of your last shipment, that is, not the Freed eiseman parts or other expensive licensed equipment. The type you send us are proving very satisfactory. Please expedite this shipment.

Yours truly,  
H.L. McTighe,  
Radio, Eagle Harbor,  
Michigan.

Every part in the above kit as re-ordered by the U. S. NAVY DEPARTMENT is built in our own factory and is absolutely guaranteed. Every part needed to build a 5 TUBE NEUTRODYNE is included as follows:

- 3 Neutro-Coils, silk wire wound on all genuine Bakelite tubes; 3 Variable Condensers, high grade capacity .000375; 6 Mounting Brackets—Neutralizing Condensers (sets of parts with glass Dielectric), 5 Bakelite Sockets, One 20 ohm Rheostat, One 5 ohm Rheostat, Two shielded Audio Transformers, 3 Dials, 3 Mica Fixed Condensers (capacities .006, .001, .00025), 1 Tubular Grid Lock and Mounting, 9 Binding Posts, Lugs, 9 lengths Bus Bar, 2 lengths Spaghetti, 1 Panel (drilled and neatly engraved), Blue Print (large, with complete and simple diagrams), 1 Copper Sheet, 1 Print for placing parts.

**\$25.95**

ENCLOSE POSTAGE WITH ORDER

**The Greater Atlantic & Pacific Radio Corporation**  
223 West 34th Street, New York City

### FACTS ON SPARK INTERFERENCE

Editor, RADIO NEWS:  
I have been a constant reader of your magazine for several years, and so far have never taken up any appreciable space in your columns, so I would like to assert my opinion on one or two things through this medium.

I have read a great many articles in the radio magazines, and particularly in RADIO NEWS, written evidently by imaginative BCL's who thought they had a case against the commercial spark stations because they



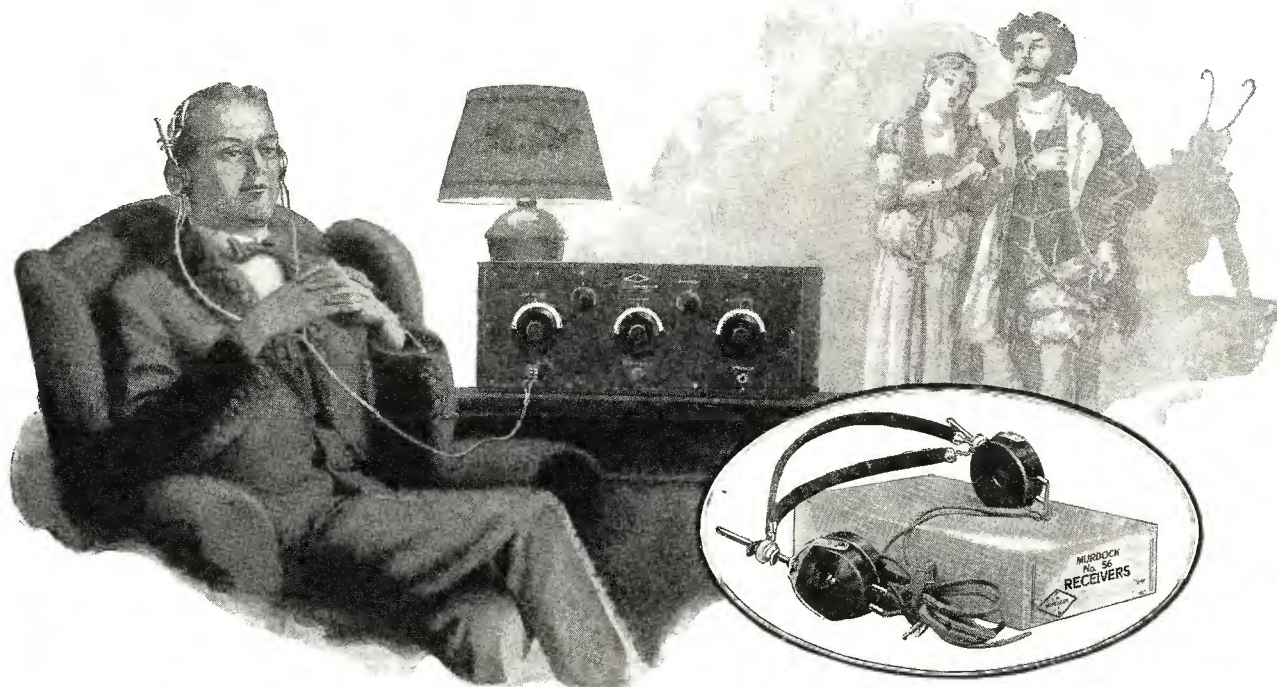

# Get a "close up" of the radio stage with Murdock Radio Phones

**H** EADPHONES are your ticket to the Theatre of the Air. If you make a poor selection, you'll find yourself in the rear row of the balcony, straining to catch the fun on the radio stage. Voices and music sound "over the hill and far away."

Plug in a pair of Murdock Radio Phones—and note the difference. It's just like being in fifth row center. High and low notes, loud and soft tones—come in round, mellow and true.

### High Efficiency

The fine acoustical qualities embodied in Murdock's permit the user to receive distant signals with great volume and clearness. Powerful magnets and sensitive diaphragms—correctly seated and clamped—are important factors in the success of Murdock Radio Phones.

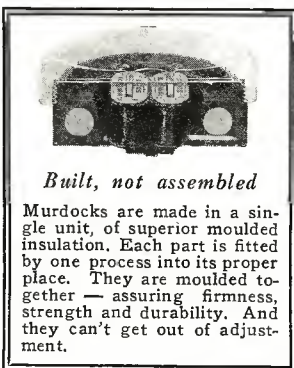

*Built, not assembled*

Murdocks are made in a single unit, of superior moulded insulation. Each part is fitted by one process into its proper place. They are moulded together—assuring firmness, strength and durability. And they can't get out of adjustment.

### Light and Comfortable

Murdocks are noted for their comfort. They are very light in weight. The new improved flat headband does not bind the head. Ear caps cover the ears and exclude outside noises. As a result of these features, you can wear Murdock's for hours without discomfort or fatigue.

When you compare the high efficiency of Murdock's, with their very moderate price, you'll be convinced that they are the best phone value on the market. Get a pair of Murdock's today and test them out. They are fully guaranteed.

### Murdock Neutrodyne

Licensed by Independent Radio Manufacturers, Inc., under Hazeltine patent. Assures the utmost in selectivity, distance, volume and clarity. See this beautiful set at your dealer's. (Illustrated above.)

WM. J. MURDOCK CO., 364 Washington Ave., Chelsea, Mass.  
Branch Offices: Chicago and San Francisco

# MURDOCK RADIO PHONES

Standard since 1904

MAIL COUPON FOR FREE BOOKLET

Wm. J. Murdock Co.  
364 Washington Avenue, Chelsea, Mass.

Gentlemen:—Please send me, without obligation, your free booklet "The Ears of Radio"—which explains in detail the importance of radio 'phones to efficient radio reception.

Name .....

Street .....

City..... State.....



## How You Can Know Latest Facts about **RADIO**

The one best way is with Lefax Perpetual Radio Handbook. Grows with every new discovery about Radio. Cannot become out-of-date. Gives all known facts and new ones as they are learned. The authors are Dr. J. H. Dellinger, Chief of the Radio Laboratory, U. S. Bureau of Standards, and L. E. Whittemore, Department of Commerce, Washington, D. C.

As a purchaser of the Lefax Radio Handbook you receive complete information on new Radio developments every month free for one year. This information comes to you on printed, punched, page form. You add the pages instantly, easily. Includes a complete list of broadcasting stations and full information about every one. No Radio Book is or can be like

### LEFAX PERPETUAL RADIO HANDBOOK

Pocket size, loose leaf, flexible Morocco grained fabrakoid binder, fine looking, long wearing. Type clear, sharp. Illustrations clean, fine, easy to understand. Index tabs of linen—tough, strong—plainly marked.

You get the complete Lefax Radio Handbook for \$5.00, and all new, useful, authentic information free every month. It comes to you automatically. Ask your Radio supply man, stationer or bookseller. If his stock is depleted we will send you a Handbook upon receipt of price or C. O. D., subject to return if you are not entirely satisfied.

**LEFAX, INCORPORATED, Publishers**  
147 South Ninth Street, Philadelphia, Pa.

## The ACME DUO POWER UNIT

is a high grade charger and battery combined in one cabinet, thereby eliminating the possibility of incorrectly connecting battery wires to charger; the usual mess of unsightly wires, cables, clips, etc., and the carrying to battery to charger or charger to battery for use.

Three  
Sizes  
80  
120  
160

Ampere Hour  
Capacity

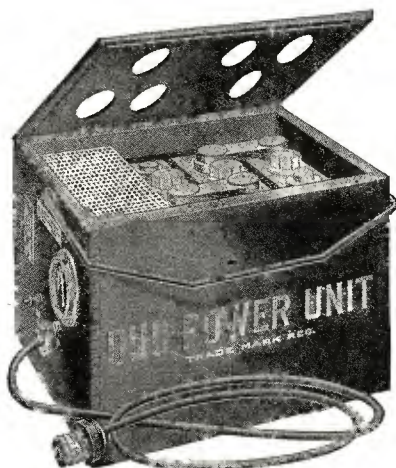

CHOICE  
ANY TYPE  
CHARGER

Bulb  
Vibrator

or ACME  
Super-Silent  
—which ever  
you prefer

PRICES—\$25.00 to \$40.00

Depending on type charger and capacity of battery

THIS DUO-POWER UNIT can be used while set is in operation; charger or battery can be used separately. All parts are easily accessible should adjustments or repairs ever become necessary. Will also charge your WET "B" BATTERIES.



Wire or write for full details on this and other ACME products—"For Better Results."



The ACME ENGINEERING CO., Inc.

Dept. D1

Louisville, Ky.

occasionally broke in on their evening's broadcast entertainment. From the attitude of a number of these writers, it is evident they are under the impression that shipboard and coastal stations have no business on the air and are installed expressly for the purpose of interfering with the broadcast programs.

If the broadcast public continues to take this hostile attitude toward the code stations, I have my doubts if anything ever will be done to clear up the interference question. If there were less barking on the part of the BCLs and a little more co-operation and patience, perhaps better results would be accomplished.

Radio apparatus is installed aboard ships to call assistance should any serious accident befall the vessel while at sea and to keep in touch with the offices of the owning companies in order to handle whatever business they may have pertaining to shipping, etc., with their vessels. In the case of passenger ships, the radio apparatus is for the convenience of the passengers as well, and many take advantage of it. Business men in particular who make frequent trips use this means of keeping in touch with their home offices.

It can be plainly seen that the work handled by the code stations is of much greater importance than the reception of broadcast programs. It is a case of business *versus* pleasure, and the old adage of "Business before pleasure" should be observed here as well as any other place. Should any of the kickers referred to above have occasion to make an ocean trip, and while at sea find it necessary to send a message to someone, and discovered that the vessel carried no wireless because it was declared a nuisance by the BCLs, he would naturally kick up some dust and condemn the company for rendering such poor service. Yet this same man makes a terrible sputter because others expect and make use of this service, which results in occasional interference with his evening's entertainment. This is pure selfishness, nothing else.

During the first year or so when broadcasting became so popular, there was much less interference caused by ships, due to the fact that the broadcast waves were considerably lower than they are at present. Later the Government boosted the broadcast waves up into the midst of the commercial waves, i. e., 450, 600 meters. Nothing but interference could result; not much, possibly, on the latter wave, but plenty on the other. I have heard music more than once come filtering through the mess of commercial code hash just a little below 600.

No doubt the broad tuning qualities or non-qualities of many BCL receivers are responsible for much of the interference. But the fact remains that the broadcasters want the commercial waves moved out of their way because they settled down in their midst. Wouldn't it be just as easy—in fact, easier—to move the broadcast waves, since there are a great many more commercial stations concerned than broadcast stations?

However, much could be done to improve the situation by the adoption of tube transmitters for all ships and coast stations. The advantages of the efficient little tube over the spark are well known by most everyone who has had any experience with them as generators of radio frequency oscillations. Much greater distances can be covered with less interference, due to the fact that a pure continuous wave has no decrement, and consequently tunes very sharply. More traffic could be handled on approximately the same wave-length with less jamming. In addition, the note emitted by a tube set is much easier to read through static and interference than that of the spark.

The truth of my statements are well borne out by the results the amateurs have accomplished since they gave up the spark. Hundreds of records have been set, only to be



# SUPER-HETERODYNE

## The World's Best Radio Receiver

BY PERFORMANCE

### ADVANTAGES NO OTHER RECEIVER CAN EQUAL

- 1. UNIFORM EFFICIENCY** over the entire wavelength range of 160 to 850 meters. This means that all stations, Radio-telephone Broadcasting, Amateur and Commercial within this wavelength range, will be received with maximum intensity. This very desirable feature is not obtainable by any other practical method using Radio Frequency amplification.
- 2. SELECTIVITY** by this system, greatly exceeds that obtained in all other methods of reception. Using the Model "C" with a loop in the Suburbs of New York, WOR 15 miles distance, operating on 405 meters, can be completely eliminated, and PWX 1300 miles distance operating on 400, can be received on a loud speaker. This holds true on an average cool night. There is no telegraphic interference from 200 meter amateur stations or 600 meter ship stations.
- 3. SIMPLICITY** to change from one station to another, there are only two dials to vary. The two dials can be calibrated for all the various stations, as there is only one best position for each station.
- 4. AMPLIFICATION** is much greater than obtainable in any other standard receiver. Total is as follows: 1st the Heterodyne Amplification in the 1st Detector; 2nd, the Regenerative Amplification in the 1st Detector; 3rd the 3 stages of Tuned Regenerative Radio Frequency Amplification; working at a low advantageous frequency; 4th, the second Detector action, and 5th, the two stages of low ratio distortionless audio frequency amplification.
- 5. RECEIVING RANGE** other factors correct, the receiving range is in proportion to the effective radio frequency amplification applied. As this receiver has much greater effective radio frequency amplification than all others, the range is proportionally greater.

Complete Constructional Blue Prints Consisting of Two Sheets 50x21" and Two Sheets 27x21", Our Numbers 30141-145. \$2.00 Postpaid.

**Experimenters Information Service** 476 Broadway :: :: *Designers of the Highest Class Radio Apparatus in the World* :: :: New York City



"THE ROLLS-ROYCE OF RECEPTION"

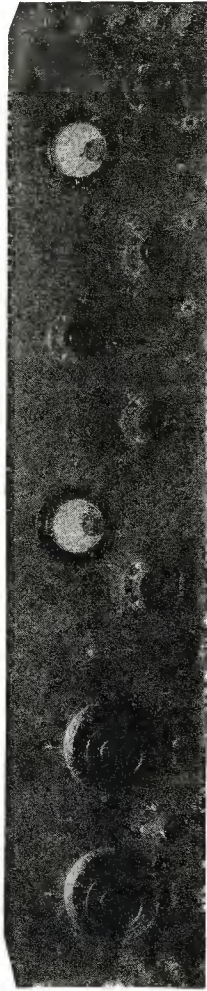

MODEL "C" SUPER-HETERODYNE

Wavelength Range 160 to 850 meters. Tubes, 2 Detectors, Oscillator, 3 Tuned Radio Freq. Amplifiers, 2 Audio Amplifiers.

The Super-Heterodyne is the most efficient method of short wave radio frequency amplification known. It is used extensively by the Commercial radio companies and various governments, when it is necessary to receive over extremely long distances, without interference from near-by stations. The remarkable results are due to the Super-Heterodyne action, which is briefly as follows: the incoming signal, which may be any wave from 160 to 850, is changed thru the use of a local oscillator, to a wavelength of 10,000 meters. At this wavelength an exact duplicate of the original signal is amplified at radio frequency with the very highest efficiency possible, rectified and amplified at audio frequency.

During this change a very high degree of selectivity is secured, due to the amplifier, which is designed to pass nothing but 10,000 meters. Accordingly while there may be ten or more signals in the loop, only one will be received at a time, the one that the oscillator heterodynes thru the amplifier.



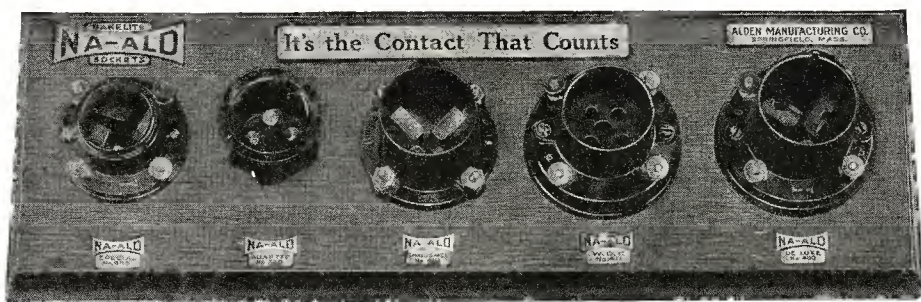

## Look for the socket board

UNIFORM CROSS SECTION OF THE NA-ALD DE LUXE SOCKET

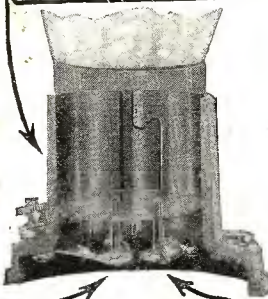

SPECIAL DIPPED BRIGHT PHOSPHOR BRONZE CLIPS, LAMINATED AND EXERTING DUAL-WIPE PRESSURE.

THIS ILLUSTRATION SHOWS HOW THE CONTACT STRIPS CAN BE MADE TO CLEAN TUBE TERMINALS AUTOMATICALLY BY ROTATING TUBE SEVERAL TIMES.

In leading radio stores you will find the Na-ald Socket Board, displaying the five standard Na-ald Sockets: For the 200 and 201 tubes, the De Luxe at 75c, and also the Small Space at 35c; for the UV 199, No. 499 at 50c and adapter at 75c; for W. D. 11, No. 411 at 75c.

Ask your dealer to show you the self-cleaning arrangement of contacts in Na-ald De Luxe, No. 400. These dual-pressure contact strips cut into the sides of tube terminals, keeping their surface clean and bright, and resulting in perfect contact.

These sockets have the highest dielectric properties, obtained by the thorough cure of the Bakelite used, and made possible by uniform cross-section.

There can be no noisy circuits due to poor contact with these sockets in use.

*New rotogravure booklet "What to Build" now packed with each Na-ald product. If your dealer's stock doesn't have this booklet send cover of Na-ald carton or 15c for it.*

Alden Mfg. Co. Dept. K Springfield, Mass.



broken again and again by their efficient little tube sets. Distances were covered that could not be touched had they used spark equipment instead. Would it have been possible for them to exchange messages with Europe had they used the latter? So it can be seen that by the adoption of this type of transmitter it would be of material benefit to the broadcast public, as well as the commercial companies.

No doubt it would be necessary to go to a great deal of expense in order to make all these changes. However, this item would not present such a huge expense as one would first believe, as much of the spark equipment in use today could still be used. All parts constituting the primary oscillating circuits could be removed, leaving the panels, mountings, tuning units, switches, circuit breakers and starters. The tubes and other parts associated with a tube set could then be substituted and fitted into the old mountings. The secondary side of the motor generator could be changed over into a generator to produce the necessary high voltage D.C. supply for the plates, leaving the motor as it is. Easier said than done probably, but still possible, although it might be an expensive operation.

Some will say that, due to the sharpness of the wave emitted by a tube set, it would present a danger rather than an improvement, as the possibilities of hearing a vessel in distress would be slight unless someone were especially tuning for him. This could be taken care of very easily by providing a chopper for the grid circuit, which would give the note a modulated effect and at the same time broaden the wave. The chopper could also be used in cases where difficulty was experienced in raising a certain station.

The use of tube transmitting equipment in every station, coastal and shipboard, as well as others, is bound to come sooner or later. Its greater efficiency over the spark is being realized more and more every day, and the doom of the crashing spark is not far off.

Before signing off, there is one more thing I wish to say, and that is to commend the article written by Mr. A. J. Charters, Radio KUVB, in the March issue of RADIO NEWS. Although I haven't experienced all the troubles he complains about, I do heartily agree with him regarding a commercial operators' organization. Why not? It would serve to band them together for legislative protection. Why shouldn't the commercial operators be united? It would be for their own protection and would serve, as Mr. Charters states, to help in retaining their old place on shipboard. I'm sure every op. would be willing to contribute a few cents each month for its support. Practically all other trades are organized, and have been for many years. Why not follow suit? Let's hear from others in this respect. How about you, Sparks?

R. C. WALKER,  
Radio KIBD ex 5ZAK.

### PLAIN TALK

Editor, RADIO NEWS:

I have been in the radio game since long before broadcasting began, and when it did begin, I was for it from the start. I am, principally, just a listening bug, but there is no one who is more interested in the future of the science and the success of radio business than myself.

When broadcasting began, I was a subscriber to several radio magazines, and usually bought several, each month, to which I did not subscribe. As the business began to boom, at first I was amused at the new concerns which were starting to get into it by making sets to supply the sudden demand; then I was amused at the claims they made for their sets. As the big boom got

# At Last!

a real  
**SILENT-super**

## BATTERY CHARGER

At a price every fan can afford  
Only

# \$10.50

AT YOUR DEALER'S  
or postpaid on receipt of price

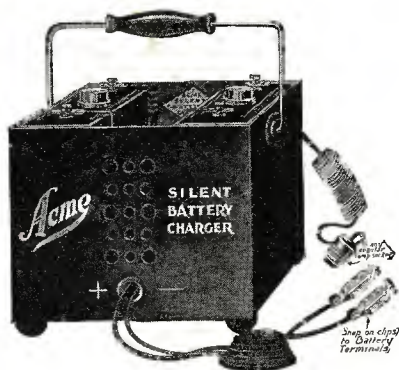

Charges BOTH  
"A" and "B"  
Storage Batteries

**FULLY  
GUARANTEED**

#### Dealers:

This charger is truly a sensation. Wire or write for our proposition and receive the benefits of the national advertising campaign now starting.

The Acme Battery Charger contains no bulbs, no glass, no contacts, no moving parts. It never needs adjustment, is fool proof, silent and practically indestructible. Charges both "A" and "B" Batteries properly without overheating or overcharging. Stops charging automatically when your battery reaches full strength. Simple and efficient—absolutely the last word in battery charging.

ACME ENGINEERING CO., Dept. 3, Louisville, Ky.



PENACOOK, N. H.  
63 Water Street

March 31, 1924.

Mr. R. E. Lacault.  
Dear Sir:  
The Ultradyne has brought in every-  
thing from the West Coast to the locals  
on a loop. It also does a mighty good  
job with no loop or aerial up to 1,000  
miles. I logged 156 stations in fifteen  
days. The tone quality is A-1 and  
there is no distortion.

Sincerely,  
J. C. BARBOUR.

# ULTRADYNE

*The Improved*

## SUPER-HETERODYNE

*"The Standard of Comparison"*

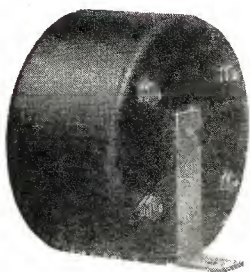
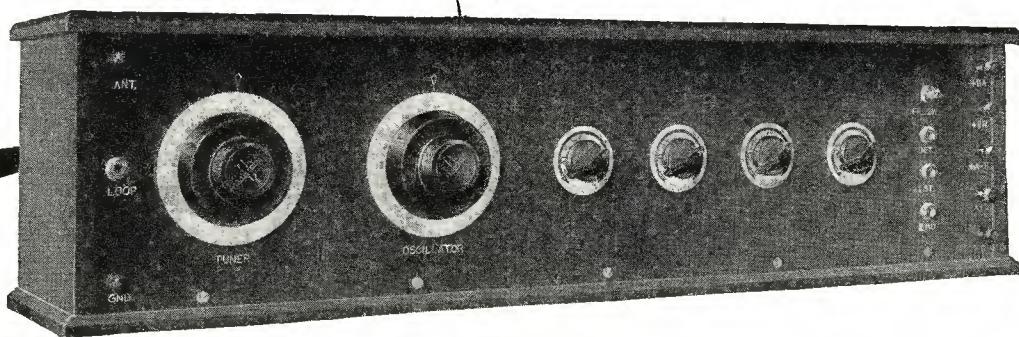

## Ultradyne Performance is the Envy of the Radio Industry

This envy is well justified, for the Ultradyne is fundamentally a decided advance in radio reception.

The Ultradyne employs the "Modulation System" of radio reception, an entirely new development by R. E. Lacault, A.M.I.R.E., formerly radio research engineer with the French Signal Corps Research Laboratories.

It is this exclusive feature that established the Ultradyne as the first receiver to officially report reception of the first concert program ever broadcast from London to America. The "Modulation System" increases the sensitiveness over that of any known receiver. Weakest signals are made to operate the loud speaker. Results exceed by far those secured by Reflex, Super-regenerative, Neutrodyne and the well known Super-Heterodyne.

In addition the Ultradyne incorporates every good feature of the famous Super-Heterodyne.

An Ultra receiver for those who want Ultra performance with greatest ease of operation.



**\$5.00**

Efficient operation of the Ultradyne Receiver depends principally upon the use of proper transformers. The Ultraformer, types A and B, are new improved long wave radio frequency transformers, especially designed by R. E. Lacault, A.M.I.R.E., radio engineer of this company and inventor of the Ultradyne.

The Ultraformer (Type B) may be successfully employed in any circuit where long wave radio frequency transformers are essential.

To protect the public, Mr. Lacault's personal monogram seal (R.E.L.) is placed on all genuine Ultraformers.

*Write for descriptive circular*

**50¢**

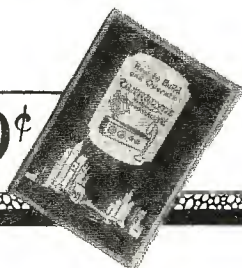

Send for 32-page illustrated book giving latest authentic instructions on drilling, wiring, assembling and tuning 6 and 8 tube Ultradyne receivers.

**PHENIX RADIO CORPORATION**  
3-7 BEEKMAN STREET  
NEW YORK





# CONTINENTAL

"New York's Leading Radio House"

## Standards of Quality

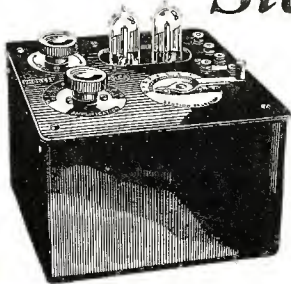

Radiola III

Receivers of real sales building merit are those which are nationally advertised and known to be "Standards of Quality." Your customers are buying "quality"—not quantity.

There is no better medium for an inexpensive portable radio receiver than the Crosley Model 51 or Radiola III. With either one of these two receivers the reception is exceptionally clear and loud enough to operate a loud speaker. They are selective and simple in operation.

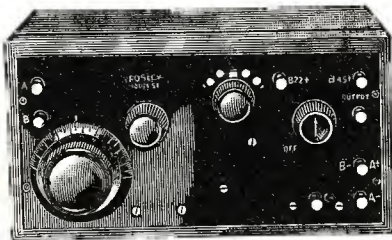

Crosley 51

Continental Radio and Electric Corporation offer you their—"Service for the Dealer" and Sales Building Helps. We can make immediate deliveries on these receivers. Send us your orders NOW!

2076-Q

CONTINENTAL RADIO and ELECTRIC CORPORATION  
FIFTEEN WARREN STREET, NEW YORK, U.S.A.

well under way, and radio began to be more and more popular, my amusement gradually turned to disgust, until now, it is well nigh exasperation, every time I look through the advertising section of any radio magazine or paper. Radio is new. There are millions who know nothing about it, and the advertisers are preying upon them. From reading the advertisements, one who is familiar with radio is immediately forced to the conclusion that the purpose of many of the advertisers is simply the sale of their apparatus, with not one thought about the satisfaction of the purchaser, and it is killing the business. As we look through the advertisements, we come on things like this: "Such and such a set gets 'em 3,000 miles on one tube." "No need to use tubes at all. Use our crystals." "The one tube set that works a loud speaker." "Our loud speaker received signals from China."

Naturally the man who knows nothing about radio, who is intending to buy a set, wants to buy the set that will accomplish the most for the least outlay of money, and looks through the ads. to find the one that seems to be that set. He picks out the 3,000 mile, one tube, loud speaker operating set, buys it, finds out that it will not do it, gets disgusted, and radio has another enemy.

A man cannot ride in the Rolls-Royce class for the price of a Ford. Everyone knows it, and the consequence is that the Ford Company does not advertise that their car is as good as the Rolls-Royce, because everyone would know that they were crazy; but in radio the poor gullible public does not know that the one tube set will not work like the super-heterodyne. It is very true that it is possible to get 3,000 miles with a one-tube set, but from the tone of the advertising, one would think it could be done all the time, at will, and perfectly, if only one will buy this particular set. Personally, I have often received from a distance of 3,000 miles with one tube, and that with very good volume and clarity, and I have heard stations as far as 500 or 600 miles on a crystal, but for some peculiar, silly reason, I use an eight-tube super-heterodyne, which runs my "A" battery down in no time, and uses up "B" batteries with almost unreasonable rapidity, but still I use it.

Every time an enthusiast buys a wildly advertised set, and it fails to live up to the claims made, radio has another enemy who might have been a friend. The man who pays out \$30 or \$40, on the strength of an advertisement that the set will bring cross-country results, sooner or later comes to the realization that he has thrown away his money, and will have to spend \$250 at least, to get the results which he expected in the first place, and is then and there disgusted and wants to see the entire broadcasting outfit in the hot place. One buyer of the wildcat advertisers probably spoils 10 sales for the good old companies who have been at it for years, and who are advertising the truth. If it is possible to do what some advertise with few tubes, why is the largest company of them all making a super-heterodyne? Surely, if there were anything to these marvelous one-tube sets, and so on, there would be no multi-tube sets made.

It is high time that the people who are really interested in radio get together and put an end to his wildcat business. The public can be instructed if time is given, but in the meanwhile radio is getting a black eye. My own personal idea is that the radio magazines could do nothing better for the general good of radio than to get together and decide that they will publish nothing which is not true. When a manufacturer wants to advertise his set, force him to advertise that his one-tube set is good for 1,000 or 1,500 miles with phones, that his crystal set is good for 25 miles with phones, that his loud speaker is a good one, but that it depends on the set to give it the signals which operate it, that his super-heterodyne is good for cross country on a loop, and then when

### "Kills Your Reflex Troubles" The "LINCOLN" Enclosed Fixed Adjustable Detector

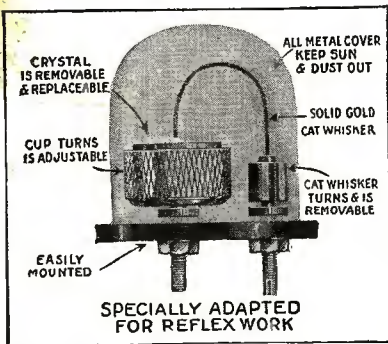

Radio fans throughout the country declare the Lincoln is the ideal detector. It has caused a tremendous sensation and thousands are already in use.

The solid gold cat's whisker—note the illustration—can be readily adjusted or removed. The crystal can be turned and

replaced easily. The nickel plated metal cover prevents breakage and keeps out both light and dust from hindering its remarkable efficiency.

Each Lincoln detector is absolutely guaranteed—any faulty part will be replaced within one year. If crystal defective, will be renewed within six months. Price of the "LINCOLN" detector only \$2.00. Ask for it at any dealer.

Jobbers, Dealers! Wire or write. Mention this ad. Address Dept. E-2.

Manufactured by

**THE LINCOLN MANUFACTURING CO.**  
115 East 11th Street Los Angeles, Calif.

**Thank Your Favorite Stations—Request Your Favorite Selection**

THANK YOU  
to the station that has given me so much pleasure in listening to its broadcasts.  
Name of station \_\_\_\_\_  
Date \_\_\_\_\_  
Name of my favorite selection \_\_\_\_\_  
Name of my favorite announcer \_\_\_\_\_

YOUR OWN Name and Address  
Printed FREE On Every Card

"Thank You" cards are all the rage. Stations appreciate them. A pleasure to use. Be in style. Low introductory price. 100—\$1.65; 200—\$2.60; 300—\$3.50 POSTPAID. Order today.

**MONEY REFUNDED if Not Satisfied**

Good quality cards—High grade printing. You will be DELIGHTED.  
Send order with check or money order today — NOW.  
**RADIO PRINTERS, Dept. 27** Mendota, Illinois

### O'NEIL AUDIPHONE

All music and speech re-vivified by "laminated voice-core." Complete with connecting cord ..... **\$30**

O'NEIL MFG. CO.  
719 Palisado Ave., West New York, N. J.



**KELLOGG RADIO**

P	C	OFFICIAL SCORE BOARD				
9	11	CHICAGO	0	0	0	2 1
17	8	ST. LOUIS	0	1	0	0
9	10	NEW YORK	0	0	0	0
11	11	BROOKLYN	0	2	1	1
11	9	CINCINNATI	0	0	0	0
8	16	PHILADELPHIA	1	0	0	1
8	10	BOSTON	0	4	0	0
9	12	PITTSBURG	0	0	0	0

# BASEBALL SCORES BY RADIO

*SAY THE RADIO BUGS*

**B**ASEBALL fans the country over will be counting on Radio this year more than ever before. Most Radio fans are baseball fans. Every one of them should see that his new set of Kellogg radio parts is ready in time for the baseball scores.

Get the Spring records and scores quickest by Radio—build your set of Kellogg radio parts for dependability and economy.

There is a certainty of satisfaction with Kellogg as shown by records of this equipment in use. Kellogg transformers rank among the best. To hear them in operation is to want them. Kellogg tube sockets give the utmost of service, while Kellogg switch arms and knobs are in a class by themselves for quick assembly, low resistance and satisfying operation.

Kellogg variable and fixed condensers, variometers and variocouplers are all designed and built to give the satisfaction which the word Kellogg expresses in the electrical apparatus field. Kellogg rheostats have but one movable part. They come in six and twenty-five ohm resistances, easily interchangeable. They are simple, yet vary in control on the half turn of the resistance element. Kellogg DX head sets are known wherever radio is in the air. They are built mechanically and electrically for long service, sensitiveness, extreme lightness in wearing, and handling does not affect their tuning. They have Kellogg solid bakelite shells and are furnished with the Kellogg famous receiver cords of which many hundreds or thousands are in use to day in the telephone field. Kellogg radio parts are especially suitable in portable sets because of their strength and high class manufacture. They will stand rough handling as will no other radio equipment and yet have the range and afford the selectivity, in the limits of the circuits, surpassed by none.

If you don't want to bother to pick out the parts for your favorite hookup buy one of our Radio Kits which include all the necessary and suitable parts including two stages of audio amplification; you can select the tuning units, as you desire.

This summer as never before radio will be heard in every summer resort and camp. See that your set is made of Kellogg radio parts.

Specify Kellogg Radio—

*Use—Is the Test*

## KELLOGG SWITCHBOARD & SUPPLY COMPANY

1066 West Adams St., CHICAGO, ILL.





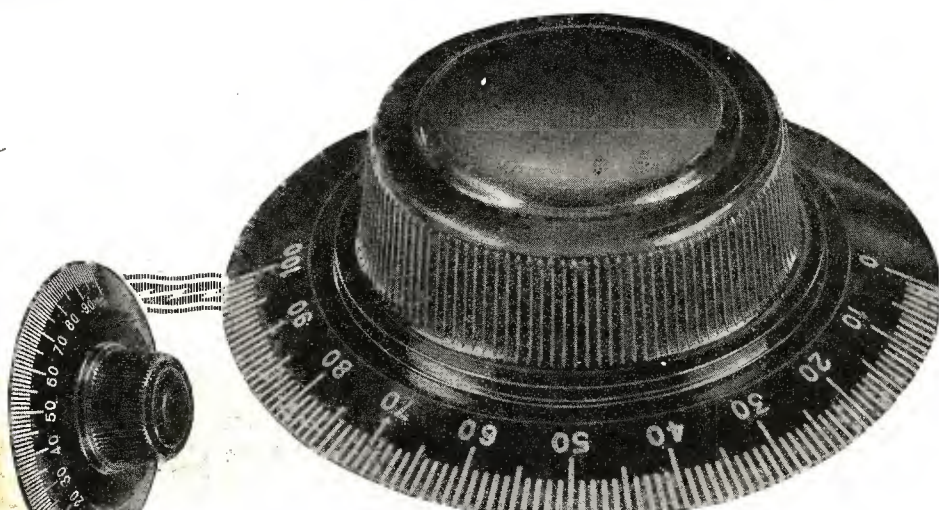

### The Super-De Luxe Dial

The Na-ald Super-De Luxe Dial is the crowning achievement of dial design and manufacture. It is a truly beautiful creation, which gives that final touch of dignity and attractiveness to the quality set.

All Na-ald dials express beauty. They have generous knobs which fit fingers perfectly and help to tune. Graduations, placed on the bevel of Na-ald Dials, are even, and marked with a permanent, brilliant white.

Na-ald dials are made of genuine Bakelite, with patented construction. They are trued with a diamond and provided with a generous-sized, positive-gripping set screw. No special screw driver is required for setting.

- Na-ald Super-De Luxe (with large knob).....\$1.00
- Na-ald 3 7/8" Dial ..... .75
- Na-ald 3" Dial ..... .35c. or 3 for 1.00
- Na-ald 2" Dial ..... .35c. or 3 for 1.00

The new rotogravure booklet, "What to Build" now packed with each Na-ald product. If your dealer's stock hasn't this, send cover of any Na-ald carton or 15c for it.

**ALDEN MANUFACTURING COMPANY**  
DEPARTMENT K, SPRINGFIELD, MASS.



an enthusiast buys, he will buy from true advertising, and will get what he thinks he is going to get and will remain our friend; no man will have the experience of buying a lot of junk and finding out for himself that a Ford is not a Rolls-Royce.

This applies to the makers of parts as well. We see the advertisements of wonderful condensers, wonderful phones, wonderful this and that, all for so much less than a man would pay for any other kind. I know of three instances where a wonderful stopping condenser was bought and put into the Ultradyne set which you published in your February issue, with the result that it punctured and six tubes went to the happy hunting grounds with it. If this has occurred three times to my own knowledge, how often has it happened in the United States? Do instances like this help the radio business? I will venture to say that at least half of those to whom such a thing has happened are through with radio. They sell what is left of the set for whatever they can get for it, and go back to the old phonograph, and one might as well talk radio to the lamp-post as to them, and they cannot be blamed. They paid their \$30 for tubes and more money for the highly advertised condenser, and it fell down on them, and they will not try it again.

It may be that the crystal set will pick up 1,000 miles, at times; it may be that one tube will pick up 3,000 miles and even twice that, at times; it may be that this or that piece of apparatus is excellent, as advertised. I, myself, have been able, from Arizona, to pick up Schenectady, New York, time after time, with one tube, using any one of two dozen hook-ups, and I have often gotten it remarkably well. I have built almost all the single-tube hook-ups that any claims are made for and found them all to be good, having been able to get distance with almost all of them, but I will say absolutely, that there is little choice between any of them; at least not enough to justify anyone in wild advertising. I have never failed with any of them, if I stayed with it long enough, to pick up some cross-country station, on one tube. I have made crystal sets, on which on very infrequent occasions, I have faintly heard stations almost 1,000 miles away. When I am experimenting I never use more than one good tube, but really and truly, when there is a particular program in the far East, which I am particularly anxious to hear well, after my years of experience with radio, and after reading all the advertising, for some peculiar reason, I hook my eight-tube Super-Heterodyne to my very good aerial, and tune in. When I want Rolls-Royce reception, I do not use my Ford.

A. M. RIORDAN,  
Flagstaff, Ariz.

## JUMBO "A" BATTERY

For WD12 or UV201A Tubes

Instantly Recharged Without Electrical Equipment

The single Jumbo for WD12 tubes, the double Jumbo for UV201A tubes will each operate 3 tubes 4 hours daily for 40 days—renewal cost 65c and 95c, respectively, including free home delivery service within Greater New York.

Outside of New York Jumbo Batteries can be recharged at the same rates by any Jumbo service dealer **WHILE YOU WAIT**—or in your own home without electrical equipment.

**30 DAY TRIAL**  
**AND 5 YEAR GUARANTEE**

Write or phone for our 30-day trial plan, which permits you at moderate cost to test Jumbo performance. Our guarantee, together with the unique method of recharging Jumbo Batteries, protects you against heavy depreciation and costly repairs common to other types of storage batteries.

Single Cell, \$5.25. Double Cell, \$10

Capacity: 100 amp. hours

**Primary Manufacturing Corp.**

442 West 42nd Street, New York  
TELEPHONE LONGACRE 1317-6765

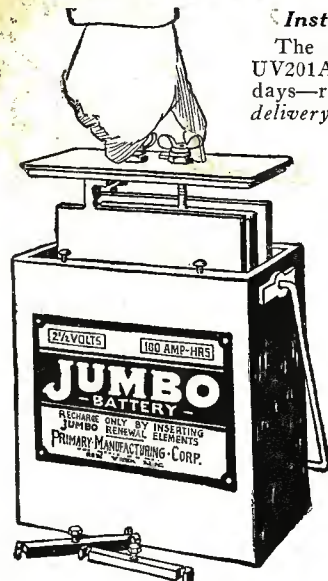

**UNITED ELECTRIC STORES CO.**  
East Pittsburgh, Pa. Next door to KD KA  
Same Day Shipments

Wholesale Radio Equipment

**Grewol Detector**  
The Reflex crystal detector, adjusted permanently at the factory.  
NEW LIST PRICE \$1.50  
Grewol Manufacturing Co.  
Newark, N. J.

Insure your copy reaching you each month. Subscribe to Radio News—\$2.50 a year. Experimenter Publishing Co., 53 Park Place, N. Y. C.

### Complete List of Broadcast Stations

(Continued from page 64)

Call	Owner	Location	Wave-length in Meters
KFPL	C. C. Baxter, Dublin, Texas.....		242
KFPM	The New Furniture Co., Greenville, Texas.....		242
KFPN	Missouri National Guard, Jefferson City, Mo. ....		242
KFPQ	G. & G. Radio & Electric Shop, Olympia, Wash. ....		236
KFPR	Clifford M. Esler, Denison, Texas... ..		231
KFPS	Los Angeles Co., Los Angeles, Cal..		231
KFPV	Carter A. Ross Motor Service Co., Casper, Wyo. ....		242
KFPW	Heintz & Kohlmoor, Inc., San Francisco, Cal. ....		236
KFPY	St. Johns M. E. Church, Carterville, Mo. ....		268
KFSG	Symons Investment Co., Spokane, Wash. ....		283
KGB	Echo Park Evangelistic Association, Los Angeles, Cal. ....		278
KGG	Tacoma Daily Ledger, Tacoma, Wash.		252
	Hallock & Watson Radio Service, 192 Park St., Portland, Ore.....		360



Supremacy Proven  
by Every Test

**Read FIL-KO-STAT  
Users Results**

"On my set, on which I use Fil-Ko-Stats, there is no state I have not heard. The farthest out of the U. S. A. is 5SC, Glasgow, Scotland." W. H. Sullivan, Macomb, Illinois.

"DX comes in fine. I got Belfast, Me., on my single circuit." J. D. Pattenger, Topeka, Kansas.

"It cuts out all noises experienced when a wire rheostat is used. On my Reinartz I have heard 180 stations during the past winter, KHJ, KFI, KFSG, KPO, KGO being over 2,000 miles from here. All these stations were heard on a horn." Eugene Markley, Crellin, Md.

"My greatest distance has been 2,800 miles, with satisfaction." G. E. Dill, Boston, Mass.

"I have tried nine different makes of rheostats, but up to date there is none I can compare with Fil-Ko-Stat." John C. Nisser, Haskell, N. J.



**Write For This Free Booklet**

It tells all about vacuum tubes and how to control them so as to get the most volume, DX and long life from all types.

**Write Today**  
Address

Dept. RN724

The filament kontrol of infinite adjustment

**FIL-KO-STAT**  
THE SCIENTIFICALLY CORRECT  
RADIO RHEOSTAT

**FIL-KO-STAT**  
Increases Reception in Any Set  
In Any Circuit with Any Tubes

The last control you touch to clear a distant station is your rheostat. WHY? Because the most important tuning unit in your set is—your tube.

**WHAT FIL-KO-STAT DOES**

- |  |   |
|--|---|
| 1 Brings in DX stations you never heard before.                    | 4 Permits maximum signal regeneration.                |
| 2 Makes tubes operate noiselessly.                                 | 5 Heats filaments suddenly, preventing crystallizing. |
| 3 Controls tubes at oscillating points.                            | 6 Lengthens life of tubes.                            |
| 7 Operates tubes at minimum voltage. Reduces drain on "A" battery. |   |

FIL-KO-STAT assures micrometer control of electronic flow—and all its benefits.

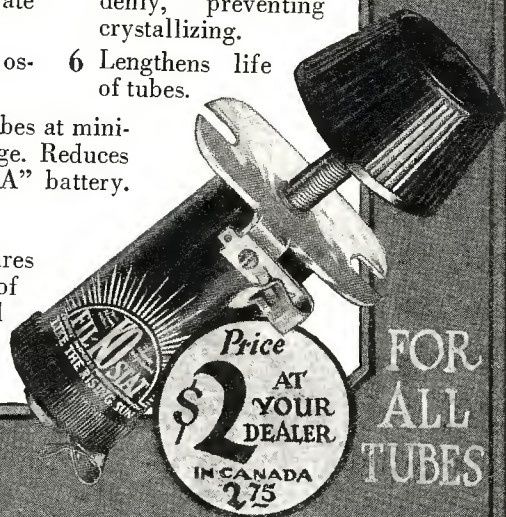

FOR ALL TUBES

MANUFACTURED AND GUARANTEED BY

**DX INSTRUMENT CO.**

HARRISBURG  
PENNSYLVANIA



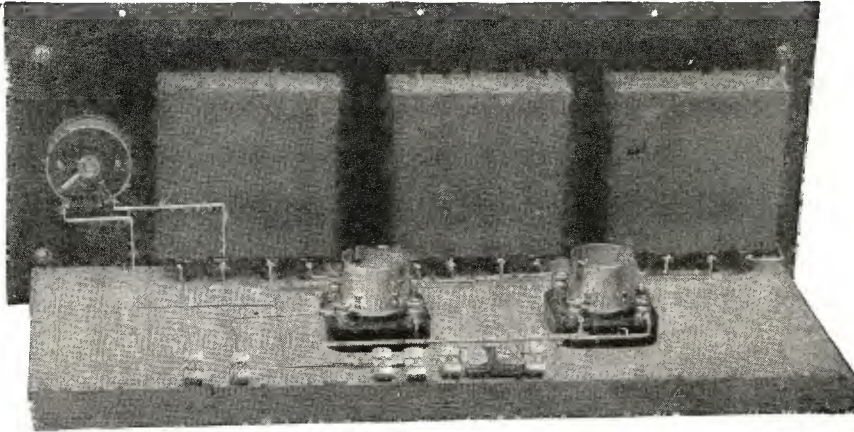

Build this yourself  
No neutralizing Condensers  
or other bothers.

Conversion set employing  
3 COSMOPOLITAN PHUSIFORMERS  
"The Missing Link in Radio"

## TWO STAGES OF TUNED RADIO FREQUENCY AMPLIFICATION Without Oscillation

Makes your regenerative set super-sensitive. Can be added to any standard receiving set. All tuning done with the three Phusiformers.



"The Year's Greatest Development."—N. Y. Evening Mail.

**COSMOPOLITAN PHUSIFORMER**  
"The First and Original"

A tuned Radio Frequency Transformer that cannot oscillate. Look for the Mahogany Block

**PRICE** with handsome 4" Bakelite dial **\$9.50**

**Cosmopolitan Phusiformer Corp.**  
15-17 WEST 18th ST., NEW YORK  
123 WEST MADISON ST., CHICAGO

Send 50c for Manual of Phusiformer Possibilities

**WEIGHS ONLY 8 OZ**

# The Scientific

**THE PHONE IT TOOK A SOLID YEAR TO DESIGN**

**SEND NO MONEY!**  
20,000 TURNS EQUIVALENT TO 3,000 OHMS

**\$2.95**

**POST-PAID**

**A \$200,000.00 COMPANY stands squarely back of the guarantee on every Scientific headset**

**Order TODAY by Postcard and Pay Postman on arrival**

**LOUD SPEAKER UNIT \$1.95**

**We Guarantee** The Scientific Headset to be the greatest value on the market. Try it for five days. If not satisfactory send it back and your money will be refunded immediately. Circular on request. Dealers wanted.

**THE SCIENTIFIC ELECTRIC WORKS**  
98 Brookline Ave. DEPT. H BOSTON, MASS.

Call	Owner	Location	Wave-length in Meters
KGN	Northwestern Radio Mfg. Co.,	1556 E. Taylor St., Portland, Ore.	360
KGO	General Electric Co.,	Oakland, Cal.	312
KGU	Marion A. Mulrony,	Waikiki Beach, Honolulu, Hawaii	360
KGW	Portland Morning Oregonian,	Portland, Ore.	492
KGY	St. Martins College,	Lacey, Wash.	258
KHJ	Times-Mirror Co.,	Los Angeles, Cal.	395
KHQ	Louis Wasmer,	2020 Thirteenth Ave., Seattle, Wash.	360
KJQ	C. O. Gould,	615 E. Main St., Stockton, Cal.	360
KJR	Northwest Radio Service Co.,	1328 Sixth Ave., Seattle, Wash.	283
KJS	Bible Institute of Los Angeles,	536 S. Hope St., Los Angeles, Cal.	360
KLS	Warner Bros. Radio Supplies Co.,	2201 Telegraph Ave., Oakland, Cal.	360
KLX	Tribune Publishing Co. (Oakland Tribune),	Oakland, Cal.	509
KLZ	Reynolds Radio Co.,	1534 Glenarm Pl., Denver, Colo.	360
KMJ	San Joaquin Light & Power Corp.,	Fresno, Cal.	273
KMO	Love Electric Co.,	818 N. L St., Tacoma, Wash.	360
KNT	Grays Harbor Radio Co.,	Aberdeen, Wash.	263
KNV	Radio Supply Co.,	815 S. Main St., Los Angeles, Cal.	256
KNX	Electric Lighting Supply Co.,	216 W. Third St., Los Angeles, Cal.	360
KOB	New Mexico College of Agriculture and Mechanic Arts, State College,	N. M.	360
KOP	Detroit Police Department,	Detroit, Mich.	286
KPO	Hale Bros.,	San Francisco, Cal.	423
KQP	Apple City Radio Club,	Hood River, Ore.	360
KQV	Doubleday-Hill Electric Co.,	719 Liberty Ave., Pittsburgh, Pa.	270
KQW	Charles D. Herold,	467 First St., San Jose, Cal.	360
KRE	Berkeley Daily Gazette,	Berkeley, Cal.	275
KSD	Post-Dispatch,	St. Louis, Mo.	546
KSS	Prest & Dean Radio Co. and Radio Research Society,	Long Beach, Cal.	360
KTW	First Presbyterian Church,	Seattle, Wash.	360
KUO	Examiner Printing Co.,	San Francisco, Cal.	360
KUS	City Dye Works & Laundry Co.,	Los Angeles, Cal.	360
KUY	Coast Radio Co.,	El Monte, Cal.	256
KWG	Portable Wireless Telephone Co.,	530 E. Market St., Stockton, Cal.	360
KWH	Los Angeles Examiner,	Los Angeles, Cal.	360
KYQ	The Electric Shop,	Honolulu, Hawaii	270
KYW	Westinghouse Electric & Mfg. Co.,	Chicago, Ill.	536
KZM	Preston D. Allen,	Thirteenth and Harrison Sts., Oakland, Cal.	360
KZN	Cope & Johnson Co.,	Salt Lake City, Utah	268
KZV	Wenatchee Battery & Motor Co.,	Wenatchee, Wash.	360
WAAB	Valdemar Jensen,	137 S. St. Patrick St., New Orleans, La.	263
WAAC	Tulane University,	New Orleans, La.	360
WAAD	Ohio Mechanics Institute,	Cincinnati, Ohio	360
WAAF	Chicago Daily Drivers Journal,	Chicago, Ill.	286
WAAM	I. R. Nelson Co.,	Bond St., Newark, N. J.	263
WAAN	University of Missouri,	Columbia, Mo.	254
WAAW	Omaha Grain Exchange,	Omaha, Neb.	360
WABA	Lake Forest College,	Lake Forest, Ill.	266
WABB	John B. Lawrence,	Harrisburg, Pa.	266
WABD	Parker High School,	Dayton, Ohio	283
WABE	Y. M. C. A.,	Washington, D. C.	283
WABG	Arnold Edwards Piano Co.,	Jacksonville, Fla.	275
KABH	Lake Shore Tire Co.,	Sandusky, Ohio	240
WABI	Bangor Railway & Electric Co.,	Bangor, Me.	240
WABL	Connecticut Agricultural College,	Storrs, Conn.	283
WABM	F. A. Doherty Automotive & Radio Equipment Co.,	Saginaw Mich.	254
WABN	Ott Radio, Inc.,	La Crosse, Wis.	244
WABO	Lake Avenue Baptist Church,	Rochester, N. Y.	252
WABP	Robert F. Weinig,	522 Wooster Ave., Dover, Ohio	266
WABQ	Haverford College Radio Club,	Haverford, Pa.	261
WABR	Scott High School,	Toledo, Ohio	270
WABS	Essex Mfg. Co.,	117 Mulberry St., Newark, N. J.	244
WABT	Holliday-Hall,	Washington, Pa.	252
WABU	Victor Talking Machine Co.,	Camden, N. J.	226
WABV	John H. De Witt,	1812 Fifteenth Ave. S., Nashville, Tenn.	263
WABW	College of Wooster,	Wooster, Ohio	234
WABX	Henry B. Joy,	Mount Clemens, Mich. (near)	270
WABY	John Magaldi, Jr.,	815 Kimball St., Philadelphia, Pa.	242
WABZ	Coliseum Place Baptist Church,	New Orleans, La.	263

### MAKE MONEY AS A RADIO DEMONSTRATOR

Big Opportunity now to everyone who knows how to set up and operate a radio set—also to take orders on a price and term basis more favorable than regular dealers can offer. Your chance to get into the Radio business. Own a set or not, as you choose. Give all or part time to this work.

**WRITE AT ONCE.** Give us this information: Age; Business; Do you own a Radio Set?; What kind?; How much time do you want to spend in this work?

**MARSHALL RADIO PRODUCTS, Inc.**  
Marshall Blvd. & 19th St., Dept. B-594 Chicago, Ill.



**Madera Clearspeakers**  
Built to Order  
For Set Manufacturers

We are prepared to make Madera die-cast wood Clear-speakers to order at very low prices in quantities for set manufacturers.

Either horn-type, or for interiors of cabinets—any size or shape.

In no other way can a set manufacturer protect the reputation of his instruments against the sinful shortcomings of "tin-lizzie" loud-speakers.

Send blue prints for estimates.

**AMERICAN ART MACHE CO.**  
343 W. Austin Ave. Chicago, Ill.



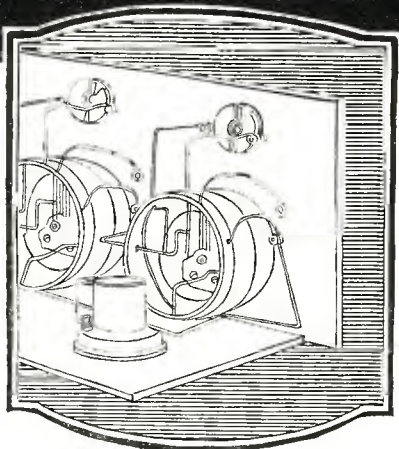

*The leading radio  
insulation—  
For good reasons:*

**F**ORMICA has earned a larger share of the business on radio insulation than any other maker by providing a uniformly better material, backed by uniformly better service.

Formica provides panels of superior finish, entirely free from pit marks. It has the finest, most realistic mahogany finish panel that is available today. It supplies high gloss tubes of handsome appearance in greater quantity than any other maker.

The careful control of processes in the Formica factory has maintained a uniform high quality. You know Formica will always be right. That is why 125 leading manufacturers of radio sets have standardized on Formica panels and tubes.

They find the mechanical qualities of Formica even more important than its high and uniform dielectric strength. Formica will not cold flow. It does not give under a tight binding post and cause it to loosen up. It does not sag from summer heat. It does not turn color from sunlight. It does not absorb water, or deteriorate with age.

The Formica plant has the largest capacity of any in its line. Its shipments are prompt, and its treatment of customers unusually satisfactory.

Insist on Formica and get the best.



**THE FORMICA INSULATION COMPANY**

4618 Spring Grove Avenue, Cincinnati, Ohio

*Sales Offices*

50 Church St., New York, N. Y.  
422 First Ave., Pittsburgh, Pa.  
1142 Granite Bldg., Rochester, N. Y.  
419 Ohio Bldg., Toledo, Ohio

1210 Arch St., Philadelphia, Pa.  
1026 Second Ave., S. Minneapolis, Minn.  
585 Mission St., San Francisco, California  
Whitney Central Bldg., New Orleans, La.

516 Caxton Bldg., Cleveland, Ohio  
9 S. Clinton St., Chicago, Ill.  
708 Title Bldg., Baltimore, Md.  
47 King St., Toronto, Ontario

**FORMICA**  
Made from Anhydrous Bakelite Resins  
**SHEETS TUBES RODS**



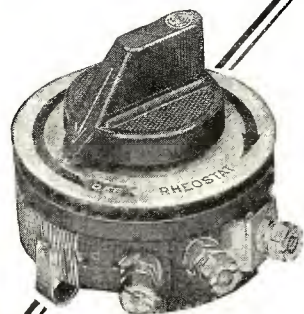

## Always a Contact —But It Turns so Easily!

If you didn't know that the Pacent Rheostat had a contact arm—you'd never guess it by its operation. From zero resistance to high, there isn't a place that sticks or binds.

Look at that dial! Beautifully finished in silver, it lends distinction to any radio set, whether factory made or home built.

*A quality product—for it's  
one of the well-known*

# Pacent RADIO ESSENTIALS

Rugged Construction. Only 2 Units.

In resistances of 6, 10, 20, 30 or 50 Ohms.....\$1.00

Power Rheostat, 2½ Ohms ..... 1.20

Potentiometer, 375 Ohms 1.25

Write for Complete Catalog N-7

PACENT ELECTRIC CO.  
22 Park Place New York City



## Improve your set with an AmerTran

—and enjoy radio  
this summer as  
never before.

THE AmerTran Type AF-6 (Turn ratio 5), has long been acknowledged the Standard of Excellence for audio amplification.

Type AF-7 (Turn ratio 3½), is now, after long study and experiment, offered in response to the demand for a companion transformer designed expressly for second or third stage amplification. In this use AF-7 decreases the tendency to overload the last amplifying tube on loud signals.

Henceforth, then, it is possible to obtain a low ratio AmerTran audio transformer, which insures perfect tone quality and full amplification of low notes when used in combination with an AmerTran AF-6 in the first stage.

American Transformer Company, 177 Emmet St., Newark, N. J.  
Designers and builders of radio transformers for over 23 years.



### Special Library of Information on RADIO PATENTS and TRADE MARKS

JOHN B. BRADY

Patent Lawyer

Ouray Building Washington, D. C.

Cable address:  
RADIOPAT

Telephone:  
Main 4806

**RAY-O-VAC**  
The most satisfactory  
batteries you can  
buy. There is a  
style for every  
radio use and need.

**RAY-O-VAC**  
Radio's Best Batteries

Call	Owner	Location	Wave-length in Meters
WBAA	Purdue University,	West Lafayette, Ind.	360
WBAD	Sterling Electric Co.,	31 S. Fifth St., Minneapolis, Minn.	360
WBAH	The Dayton Co.,	Seventh St. and Nicollet Ave., Minneapolis, Minn.	417
WBAN	Wireless Phone Corporation,	193 Ellison St., Paterson, N. J.	244
WBAO	James Millikin University,	Decatur, Ill.	360
WBAP	Wortham-Carter Publishing Co. (Star Telegram),	Fort Worth, Texas.	476
WBAV	Erner & Hopkins Co.,	146 N. Third St., Columbus, Ohio	390
WBAX	John H. Stenger, Jr.,	66 Gildersleeve St., Wilkes-Barre, Pa.	360
WBAY	Western Electric Co.,	463 West St., New York, N. Y.	492
WBBA	Newark Radio Laboratories,	Newark, Ohio	240
WBBD	Barbey Battery Service,	Fourth and Walnut Sts., Reading, Pa.	234
WBBE	Alfred R. Marcy,	113 W. Raynor Ave., Syracuse, N. Y.	246
WBBF	Georgia School of Technology,	Atlanta, Ga.	270
WBBG	Irving Vermilya,	24 Vermilya St., Mattapoisett, Mass.	240
WBBH	J. Irving Bell,	1511 Gordon St., Port Huron, Mich.	246
WBBI	Indianapolis Radio Club,	1721 N. Somerset St., Indianapolis, Ind.	234
WBBJ	Neel Electric Co.,	West Palm Beach, Fla.	258
WBBL	Grace Covenant Church,	Richmond, Va.	283
WBBM	Frank Atlass Produce Co.,	110 Park Pl., Lincoln, Ill.	226
WBBN	A. B. Blake,	225 N. Front St., Wilmington, N. C.	275
WBBO	Michigan Limestone & Chemical Co.,	Rogers, Mich.	250
WBBP	Petoskey High School,	Petoskey, Mich.	246
WBBQ	Frank Crook,	150 Exchange St., Pawtucket, R. I.	252
WBBR	Peoples Pulpit Associations,	Rossville, N. Y.	244
WBBS	First Baptist Church,	New Orleans, La.	250
WBBT	Lloyd Bros.,	3157 Frankford Ave., Philadelphia, Pa.	234
WBBU	Jenks Motor Sales Co.,	Monmouth, Ill.	224
WBBV	Johnstown Radio Co.,	324 Market St., Johnstown, Pa.	248
WBBW	Ruffner Junior High School,	Norfolk, Va.	222
WBBY	Washington Light Infantry,	Charleston, S. C.	268
WBBZ	Noble S. Watson,	Indianapolis, Ind.	227
WBL	T. & H. Radio Co.,	Anthony, Kan.	261
WBS	D. W. May, Inc.,	325 Central Ave., Newark, N. J.	360
WBT	Southern Radio Corporation,	1116 Realty Bldg., Charlotte, N. C.	360
WBZ	Westinghouse Electric & Mfg. Co.,	Springfield, Mass.	337
WCAD	St. Lawrence University,	Canton, N. Y.	280
WCAE	Kaufmann & Baer Co.,	Pittsburgh, Pa.	462
WCAG	Clyde R. Randall,	2813 Calhoun St., New Orleans, La.	268
WCAH	Entrekin Electric Co.,	321 W. Tenth St., Columbus, Ohio	286
WCAJ	Nebraska Wesleyan University,	University Place, Neb.	360
WCAK	Alfred P. Daniel,	2504 Bagby St., Houston, Texas	263
WCAL	St. Olaf College,	Northfield, Minn.	360
WCAM	Villanova College,	Villanova, Pa.	360
WCAO	Sanders & Stayman Co.,	Baltimore, Md.	360
WCAP	Chesapeake & Potomac Telephone Co.,	Washington, D. C.	469
WCAR	Southern Radio Corporation of Texas,	120 E. Travis St., San Antonio, Texas	360
WCAS	William Hood Dunwoody Industrial Institute,	Minneapolis, Minn.	280
WCAT	South Dakota State School of Mines,	Rapid City, S. D.	240
WCAU	Durham & Co.,	1936 Market St., Philadelphia, Pa.	286
WCAV	J. C. Dice Electric Co.,	113 W. Capitol Ave., Little Rock, Ark.	360
WCAX	University of Vermont,	Burlington, Vt.	360
WCAY	Kesselman O'Driscoll Co.,	517 Grand Ave., Milwaukee, Wis.	261
WCAZ	Carthage College,	Carthage, Ill.	246
WCBA	Charles W. Heimbach,	1015 Allen St., Allentown, Pa.	280
WCBC	University of Michigan,	Ann Arbor, Mich.	280
WCBD	Wilbur G. Voliva,	Zion, Ill.	345
WCBE	Uhalt Radio Co.,	4521 Chestnut St., New Orleans, La.	263
WCBF	Paul J. Miller,	Pittsburgh, Pa.	236
WCBG	Howard S. Williams,	Pascagoula, Miss. (portable)	236
WCBH	University of Mississippi,	Oxford, Miss. (near)	242
WCBJ	J. C. Maus, Jennings,	La.	244
WCBK	E. Richard Hall,	St. Petersburg, Fla.	266

Insure your copy reaching you each month. Subscribe to Radio News—  
\$2.50 a year. Experimenter Publishing Co., 53 Park Place, N. Y. C.



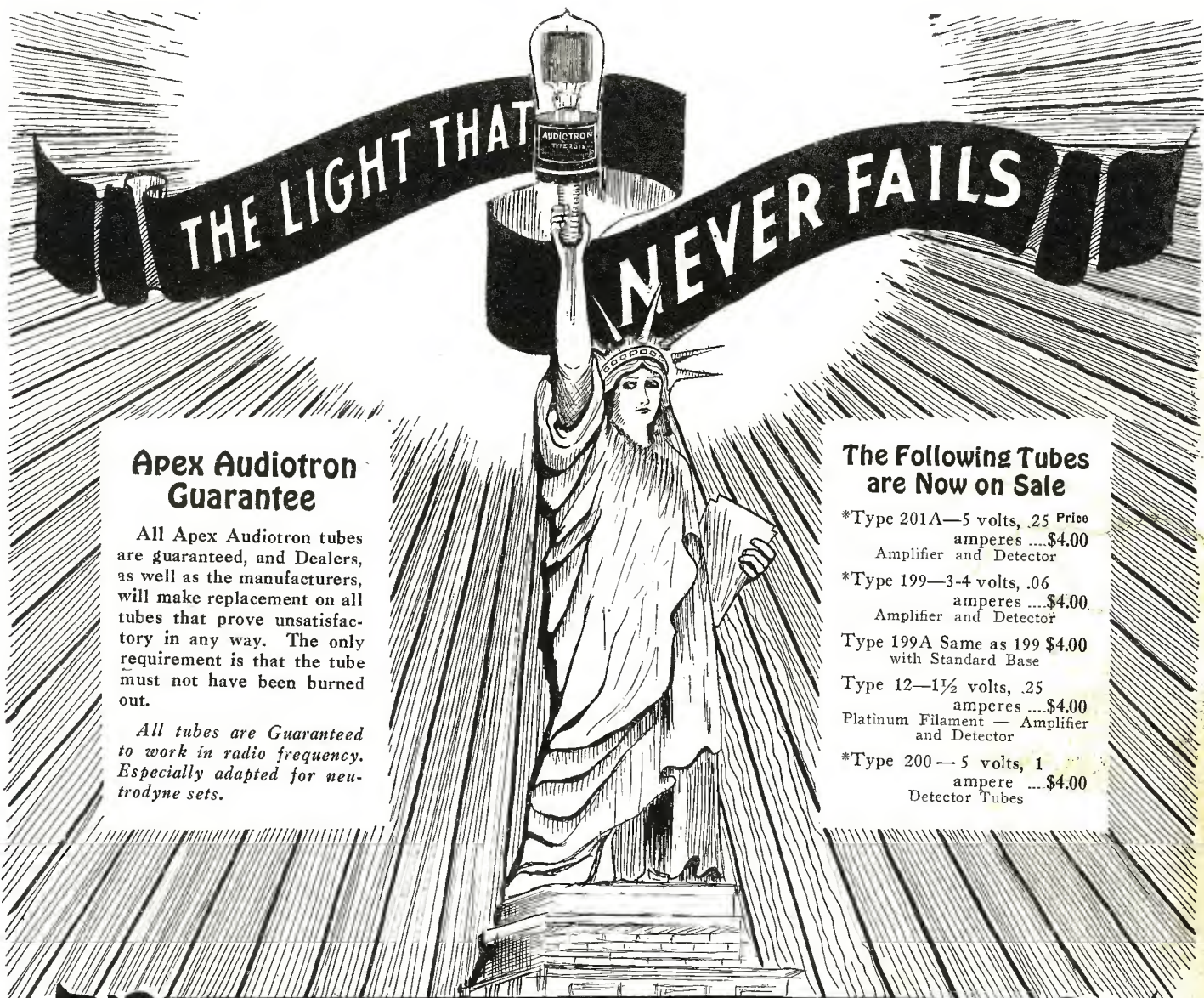

**Apex Audiotron  
Guarantee**

All Apex Audiotron tubes are guaranteed, and Dealers, as well as the manufacturers, will make replacement on all tubes that prove unsatisfactory in any way. The only requirement is that the tube must not have been burned out.

*All tubes are Guaranteed to work in radio frequency. Especially adapted for neu-trodyne sets.*

**The Following Tubes  
are Now on Sale**

- \*Type 201A—5 volts, .25 Price  
amperes ...\$4.00  
Amplifier and Detector
- \*Type 199—3-4 volts, .06  
amperes ...\$4.00  
Amplifier and Detector
- Type 199A Same as 199 \$4.00  
with Standard Base
- Type 12—1½ volts, .25  
amperes ...\$4.00  
Platinum Filament — Amplifier  
and Detector
- \*Type 200—5 volts, 1  
ampere ...\$4.00  
Detector Tubes

**SOUND PERFECTION**



*For Freedom of the Air, Use*

**APEX AUDIOTRON  
TUBES**

**“ATTENTION DEALERS” and “DISTRIBUTORS”**

*If your local dealer cannot supply you, order direct.*

**RADIO TUBE CORPORATION**  
671 Broad Street Newark, N. J.



## Better Distance—Longer Tube Life with this Filament Voltmeter

Put a Weston Filament Voltmeter on your panel for best DX results. Because exact conditions can be duplicated instantly, stations can be tuned in again and again quickly and easily. Also by operating tubes at correct filament voltage, the life of tubes is increased at least threefold. This Model 301 Filament Voltmeter costs little more than a tube. For quick tuning and good reception, it is an absolute necessity. Case diameter 3 1/4 inches. Every instrument guaranteed.



Filament Voltmeter



Weston Instant Change Plug

### Weston Instant Change Plug

Interchangeable in two seconds. Shove cables in to connect. Press triggers to pull cables out. No tools. The choice of A.R.R.L. men everywhere.

Booklet J contains full details, diagrams and connections for all Weston radio instruments. Sent free on request.

WESTON ELECTRICAL INSTRUMENT CO., 173 Weston Ave., Newark, N. J.  
Branches in All Principal Cities



Electrical Indicating Instrument Authorities Since 1888

STANDARD - The World Over

# Collapsible Loop Aerial

Folds Up As Easily As A Fan

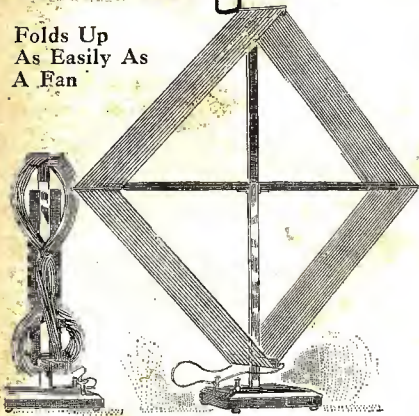

### Assures Clear, Uninterrupted Reception

The supreme aerial of them all. A highly selective, static-free aerial that collapses with the greatest ease. Elegantly made and a credit to the finest home. Is simple, allows no leakage, is not magnetic. No lightning risk and no interference from the landlord. When folded it fits into a suitcase.

### IDEAL FOR VACATION, CAMP OR HOME

Great for vacationists and tourists. No climbing trees or poles erecting aerial. Just set up anywhere and "listen in." Has a natural period of 145 meters. Will respond to waves up to 650 meters. On the end of each arm is a Bakelite insulator thru which the wire is always held at a tension, thereby making your set more selective and assures better reception. Wire is double insulated with green silk and consists of 10 separate strands. The frame is solid mahogany and the tubing is of brass, exquisitely nicked.

Order today. Remember, you risk nothing. We guarantee satisfaction. Get yours now. Price is **\$12.50** Postpaid

RADIO ASSOCIATION OF AMERICA  
4513 Ravenswood Ave. Dept. 157 Chicago

### DEALERS AND JOBBERS

We have an attractive proposition to dealers and jobbers who will order in quantities. Write today.

# AMPERITE

The "SELF-ADJUSTING" Rheostat

## For a 1 step Amplifier to the SUPERHETERODYNE

- simplifies wiring.
- eliminates hand rheostats.

the really perfect filament control.

—Manufacturers—  
**RADIALL COMPANY**

320 W. 42nd Street, New York



**\$1.10**  
FROM YOUR DEALER

WRITE FOR  
FREE HOOK-UPS

## \$3 Brings you a Genuine UNDERWOOD TYPEWRITER

**10 DAYS FREE TRIAL** Your \$3.00 unconditionally returned if at end of 10 days you are not satisfied with this late model UNDERWOOD typewriter rebuilt by the famous Shipman Ward process.

**GREAT PRICE SAVING** Direct to you from the largest typewriter factory in the world by our money saving methods.

**EASY MONTHLY PAYMENTS** So small that you will not notice it while you enjoy the use of this wonderful machine.

**FREE BOOK OF FACTS** Explaining Shipman Ward's wonderful system of rebuilding typewriters and also valuable information about the typewriter industry both instructive and entertaining.

Act Today!  
Mail  
Coupon



5  
Year  
Guarantee

Shipman Ward  
Mfg. Company  
B-195 Shipman Building  
Montrose & Ravenswood  
Aves., Chicago

Please send me a copy of your free book of facts, explaining bargain offer.

Name.....  
St. and No.....  
City..... State.....

Call	Owner	Location	Wave-length in Meters
WCBL	Northern Radio Mfg. Co.,	Houlton, Maine	280
WCBM	Charles Swarz,	Baltimore, Md.	229
WCBN	James P. Boland,	Fort Benjamin Harrison, Ind.	266
WCBO	The Radio Shop, Inc.,	Memphis, Tenn.	250
WCBQ	Robert G. Phillips,	Youngstown, Ohio	246
WCBR	Charles H. Meester,	Providence, R. I. (portable)	246
WCBT	Clark University,	Worcester, Mass.	238
WCBU	Arnold Wireless Supply Co.,	Arnold, Pa.	254
WCBV	Tullahoma Radio Club,	Tullahoma, Tenn.	252
WCK	Stix-Baer & Fuller Dry Goods Co.,	St. Louis, Mo.	360
WCM	University of Texas,	Austin, Texas.	360
WCX	Detroit Free Press,	Detroit, Mich.	517
WDAE	Tampa Daily Times,	Tampa, Fla.	360
WDAF	Kansas City Star,	Kansas City, Mo.	411
WDAG	J. Laurance Martin,	Amarillo, Texas	263
WDAH	Trinity Methodist Church (South),	El Paso, Texas	268
WDAK	The Courant,	Hartford, Conn.	261
WDAO	Automotive Electric Co.,	Ervasy and Corsicana Sts., Dallas, Texas.	360
WDAP	Board of Trade,	Chicago, Ill.	360
WDAR	Lit Brothers,	Philadelphia, Pa.	395
WDAS	Samuel A. Waite,	692a Main St., Worcester, Mass.	360
WDAU	Slocum & Kilburn,	23 N. Water St., New Bedford, Mass.	360
WDAY	Radio Equipment Corporation,	117 Broadway, Fargo, N. D.	244
WDBA	Fred Ray,	Columbus, Ga.	236
WDBB	A. H. White & Co., Inc.,	Taunton, Mass.	229
WDBC	Kirk, Johnson & Co.,	Lancaster, Pa.	258
WDM	Church of the Covenant,	Washington, D. C.	234
WDZ	James L. Bush,	Tuscola, Ill.	278
WEAA	Frank D. Fallain,	Police Bldg., Flint, Mich.	250
WEAF	American Telephone & Telegraph Co.,	24 Walker St., New York, N. Y.	492
WEAH	Wichita Board of Trade,	Wichita, Kan.	280
WEAI	Cornell University,	Ithaca, N. Y.	286
WEAJ	University of South Dakota,	Vermilion, S. D.	283
WEAM	Borough of North Plainfield,	North Plainfield, N. J.	252
WEAN	Shepard Co.,	Providence, R. I.	273
WEAO	Ohio State University,	Columbus, Ohio	360
WEAP	Mobile Radio Co.,	O'Gwinn Bldg., Mobile, Ala.	360
WEAR	Evening News Publishing Co.,	Baltimore, Md.	261
WEAU	Davidson Bros. Co.,	Sioux City, Iowa	360
WEAY	Iris Theater,	Houston, Texas	360
WEB	Benwood Co.,	1110 Olive St., St. Louis, Mo.	273
WEV	Hurlburt-Still Electrical Co.,	McKinley Ave. and San Jacinto St., Houston, Texas	360
WEW	St. Louis University,	St. Louis, Mo.	261
WFAA	Dallas News and Dallas Journal,	Dallas, Texas	476
WFAB	Carl F. Woese,	802 McBride St., Syracuse, N. Y.	234
WFAH	Electric Supply Co.,	637 Proctor St., Port Arthur, Texas	236
WFAJ	Hi-Grade Wireless Instrument Co.,	25 Hanover St., Asheville, N. C.	360
WFAM	Times Publishing Co.,	St. Cloud, Minn.	360
WFAN	Hutchinson Electric Service Co.,	Hutchinson, Minn.	360
WFAQ	Missouri Wesleyan College,	Cameron, Mo.	360
WFAT	New Columbus College,	Sioux Falls, S. D.	258
WFAV	University of Nebraska,	Lincoln, Neb.	275
WFI	Strawbridge & Clothier,	Philadelphia, Pa.	395
WGAL	Lancaster Electric Supply and Construction Co.,	23 E. Orange St., Lancaster, Pa.	248
WGAN	Cecil E. Lloyd,	216 W. Romana St., Pensacola, Fla.	360
WGAQ	Glenwood Radio Corporation,	900 Texas Ave., Shreveport, La.	252
WGAW	Ernest C. Albright,	1918 W. Chestnut St., Altoona, Pa.	261
WGAZ	South Bend Tribune,	South Bend, Ind.	360
WGI	American Radio and Research Corporation,	Medford Hills, Mass.	360
WGL	Thomas F. J. Howlett,	2303 N. Broad St., Philadelphia, Pa.	360
WGN	Chicago Tribune,	Chicago, Ill.	370
WGR	Federal Telephone & Telegraph Co.,	Buffalo, N. Y.	319
WGV	Interstate Electric Co.,	356 Barrone St., New Orleans, La.	242
WGY	General Electric Co.,	Schenectady, N. Y.	380
WHA	University of Wisconsin,	Madison, Wis.	360
WHAA	State University of Iowa,	Iowa City, Iowa	484



# "BUILD YOUR OWN" WITH "RASCO" PARTS!

## Buy from the Oldest and Original Exclusive Radio Parts House in the United States

We pay ALL transportation charges in U. S. ALL GOODS SENT PREPAID IN 24 HOURS

Order direct from this page.

### SPECIAL PRICES FOR THIS MONTH ONLY

Money refunded if goods do not satisfy

### COMPLETE SET SALE AT REDUCED PRICES

**Reinartz Receiver**  
Exactly as shown with mahogany cabinet, panel, all necessary instruments, binding posts and pattern for assembling. This set can be put together by anyone in a few hours.

L9988 Reinartz Receiver ..... \$13.50



**Autoplex Circuit**  
Will bring broadcast on loud speaker on single tube. Complete as pictured here. All parts, including mahogany cabinet, panel, instruments, binding posts, etc. Can be put together with a few hours time.

L9955 Autoplex outfit ..... \$15.00



**Two Stage Amplifier**  
Complete as pictured including mahogany cabinet, panel, all instruments, A1 audio transformers, binding posts, etc. Can be put together in a few hours' time.

L9966 Two stage amplifier ..... \$12.25

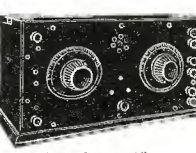

**Short Wave Regenerative Receiver**  
Complete as pictured with mahogany cabinet and all necessary instruments and parts. Can be put together in a few hours' time.

L9977 Short wave set.....\$11.50



**Rheostats and Potentiometers**  
Come with metal dials and composition knob. Excellent merchandise despite low price.

L4210 6 ohm Rheo. \$.27  
L4211 30 ohm Rheo. .30  
L4212 200 ohm Potentiometer ..... .45



**Moulded Dials**  
Only very best grades handled. Bushings absolutely true. Dials cannot wobble. Letters inlaid in fast white enamel. All dials for 1/4" shaft.

L3074 Dial 2" ..... \$.20  
L3075 Dial 3" ..... .25  
L3076 Dial 4" ..... .40



**Tapped "B" Batteries**  
We positively guarantee these batteries to be of long life. We carry only fresh stocks. All with taps.

L2250 Sm. 2 1/2" V. \$.85  
L2251 Medium Navy size, 2 1/2" volt 1.20  
L4500 Large size, 4 1/2" volt ..... 2.30



**Panel Mounting Condensers**  
Positively no better condenser on the market. Shafts 1/4". Save from 40 to 60% by assembling condenser yourself.

L1111 11 plate.....\$1.10  
L2121 21 plate..... 1.22  
L4343 43 plate..... 1.33



**"Rasco" Bezels**  
Finest Bezel on the market. Bezel comes entirely nickel plated. Can be used on 1/4" or 3/16" panel.

L1700 Rasco Bezel, 1" ..... \$.15  
L1701 Bezel, 1 1/2" diam. .... .20



**Rasco 180° Variocoupler**  
Silk wire wound on bakelite tubes. Six taps. Wave length, 150 to 600 meters. For panel mounting. 1/4" shaft. Your money refunded if it is not all we claim.

L3100 Variocoupler pre-paid ..... \$1.50



**Dilectryte Panels**  
Highest dielectric strength as per Bureau of Standards.

L7100 7x10x3-16" ..... \$.70  
L7120 7x12x3-16" ..... .85  
L7140 7x14x3-16" ..... .95  
L7180 7x18x3-16" ..... 1.25  
L7210 7x21x3-16" ..... 1.45  
L7240 7x24x3-16" ..... 1.65



**Silicon Steel**  
Used practically in all audio-frequency transformer forms. Better than iron. Extremely soft, 3/8" wide and .007" thick.

L4900 Silicon steel, per foot ..... \$.08  
10 feet lots ..... \$0.70



**Spider Web Forms**  
Fine forms to wind your spider webs. Made from hard, well seasoned fibre. 1-16" thick, center and side holes for wiring. Both 5" diameter.

L3200 Spider form... \$.25  
L3201 Spider form... .25

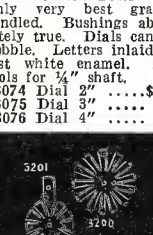

**Universal Bearing**  
To hold rotors. Length of bearing 2 3/4" shaft 1 1/4" thread 1 1/2" long thread sleeve 3/4" long, each ..... \$.25

L1550 Sockets. Four of these take one vacuum tube. Grasp tube firmly. Best by test. Set of 4 ..... \$2.25



**Brass Strip and Tubing**  
Brass strip 1/2" wide; 1-16" thick; 6" long. L1430 Per length... \$.10  
L1431 Brass tubing, dia. 1/4"; 6" long; length .15  
Threaded Brass Rods Sold in 6" lengths only. L6032 8-32" thread .06  
L6032 6-32" thread .06



**Alcohol Blow Torches**  
Best made. Give intense hot flame. Great for fine work.

L8981 5" Torch ..... \$.85  
L8982 3" Torch ..... .50  
L4104 Rosin Core Solder. A non-corrosive solder with flux inside. 18" length ..... \$.10



**Monodyne Socket**  
This socket takes up 25% less room than any other. No outside connections. Nickel plated shell. Has fiber bottom with sockets. Sockets hold socket to panel or board.

L6502 Socket ..... \$.25

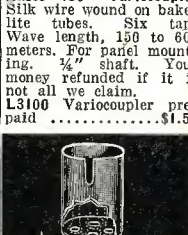

**"Rasco" Switch Points**  
Nickel and polished.

L301 1/4" x 1/4" - 6-32" doz. .... \$1.18  
L304 1/4" dia., 1/2" thick, 8-32" doz. .... .18  
L305 1/4" dia. 3-16" thick, 4-36" doz. .... .18  
L375 Switch cup 7/8" long, with nut, doz. .... .18

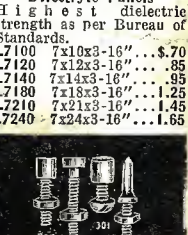

**Throw Switches**  
Mounted on composition block. Small enough for all radio purposes.

L4100 Single pole... \$.25  
L4101 Double Throw Single Pole ..... \$.35



**Bakelite 180° Coupler De Luxe Style**  
Tubes of natural color bakelite, wound with green silk. Cast aluminum bracket, 1/4" shaft. Primary 13 taps. 180 to 350 meters

L3150 Coupler ..... \$2.35



**"Rico" (Adjustable) Loud-Speaker Phone**  
Has rubber gasket underneath diaphragm, making phone fully adjustable. Gives amazing results as loud-talker on 1 and 2 stage of amplification.

L2525 Speaker with 5 ft. cord ..... \$2.65

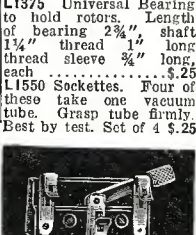

**Soft Rubber Ear Cap**  
At last! Ear Caps that will relieve headaches, earaches, and undue pressure on the ears. Fit all receivers.

L3500 Ear caps; pair ..... \$.50



**Series Parallel Switch**  
Quick change from one circuit to another. Black composition knob, nickel plated fittings. Blade radius 1 1/4".

L2950 Series parallel switch ..... \$2.25



**Melotone Loud Speaker**  
Best popular loud speaker. Fibre horn, heavy metal base, 5-ft. cord. Nickel goose neck. Greatest tuned (adjustable) talker. Horn length 1 1/2"; bell 6 1/2"; total height 9".

L255 Melotone Speaker ..... \$4.75



**Nickel Lugs**  
All lugs are nickelled.

L310 Brass Lugs for No. 8 screw, doz. .... \$1.10  
L311 Copper Lugs for Nos. 6 and 8 screws, dozen ..... \$1.10  
L309 Copper Lugs for Nos. 4, 6 and 8 screws, dozen ..... \$1.10

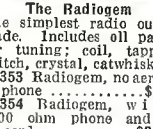

**Wood Cabinets**  
Highest grade mahogany cabinets made. Top is hinged. Made of 1/2" stock.

L710 Panel, 7x10" ..... \$2.60  
L712 Panel, 7x12" ..... 3.00  
L714 Panel, 7x14" ..... 3.35  
L718 Panel, 7x18" ..... 3.60  
L721 Panel, 7x21" ..... 3.90  
L724 Panel, 7x24" ..... 4.40

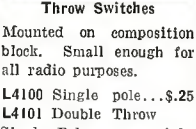

**Loop Aerial**  
Made entirely of well seasoned hard wood. Complete with all parts and base. Total height of loop 36". Can be put together by anyone in less than 5 minutes.

L2600 Two ft. loop aerial, complete ..... \$1.15



**Mica Diaphragms**  
Made of special India mica in two sizes. 2 1/2" diameter and 1-13/16" diameter. Cement iron washer in center for real up to 10/32".

L2550 Diaphragm, 2 1/2" ..... \$.20  
L2551 Diaphragm, 1-13/16" ..... .15



**Nickel Screws**  
Made of brass, nickel plated. Flat and round head style. Any thread up to 10/32".

Price, 1/4", 3/8", 1/2" long, dozen ..... \$1.15  
Price, sizes 3/4" and 1" long, dozen ..... \$3.30



**NEW! Push Pull Transformer**  
For many new circuits. See any radio magazine. Made of best materials. Coils impregnated. Silicon steel laminations. Save 50 per cent by assembling yourself. Simple instructions furnished.

L1159 Transformer. Ratio 6 1/2 to 1 ..... \$4.00

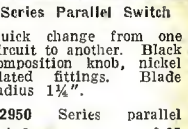

### NEW THINGS FROM CATALOG No. 11

**Dial Marker**  
The big little thing you have been waiting for. Just drill a hole in the panel and mount the marker above the dial. Very neat, nicely nickel plated and polished.

L7788 Dial Marker, each ..... \$.05



**Vacuum Tubes**  
Only best make tubes carried in stock. All tubes guaranteed to work or exchanged if filament lights.

L201A 5 v., 25 amp. \$3.75  
L199 3 v., .06 amp. 3.75  
L12 1 1/2 v., 25 amp. 3.75



**Three-Gang Socket**  
Aluminum shells, genuine heavy bakelite base, 3 brackets for mounting, 12 nickel binding posts. Length 7 1/4".

L5995 Three-gang socket ..... \$1.75

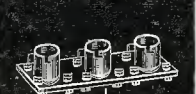

**Cockaday Coil**  
Guaranteed best make. Three windings of No. 18 D C C Magnet wire. Has brass brackets for panel or base mounting. Results guaranteed or money back.

L2750 Cockaday coil. \$1.85



**Neutralizing Condenser**  
Latest pattern. Genuine bakelite base. Fahnestock connectors, hard rubber composition knob, easiest to regulate. Size 3 5/8" long, 1" wide and 1" high.

L1202 Neutralizing condenser ..... \$.40



**Neutro-Transformer**  
Can be used for all neutrodyne circuits, also for all tuned radio frequency circuits. Made for usual broadcast waves. Secondary has one center tap. Two genuine bakelite tubes. Two nickel mounting brackets.

L6969 Neutro-transformer ..... \$1.70

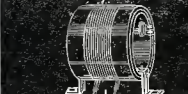

**Sponge-Rubber Cushions**  
Get rid of tube noises, due to vibration. Softest sponge rubber made. Also used under cabinets to absorb shock and vibration. Size 2 1/4"x3", 3/8" thick.

L8989 Sponge-rubber cushions, each ..... \$1.12



# RADIO SPECIALTY CO., 98 Park Place, New York City

Factories Brooklyn, N. Y.

Elkridge, Md.



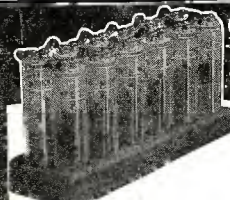

## The RāBAT Junior \$3.96

A Rechargeable Wet 'B' Battery. Capacity 800 Mil-Amps.  
12 CELLS 24 VOLTS

### Your Ultimate "B" Battery

Here are two acid type wet "B" radio batteries that are entirely free from internal current leakage. All elements visible through clear glass cells. RABATS have longer life with higher and more continuous voltage. Noiseless and compactly constructed—The Rabat Junior with a capacity of 800 mil-amps at \$3.96 and the Rabat Senior with a capacity of 2800 mil-amps at \$9.60 represent more actual battery value at a lower cost. More economical to buy—more economical to maintain. Easily recharged from ordinary house current. If your dealer cannot supply you send direct.

*Prices F. O. B. Cleveland, Ohio*

## The Radio Rabat Company

914 Bangor Building  
Cleveland, Ohio

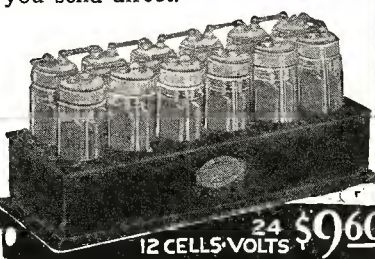

## The RāBAT Senior

A Rechargeable Wet 'B' Battery. Capacity 2800 Mil-Amps. 48 VOLTS \$17.88

**SPECIFICATIONS**

1. Operates without extra batteries.
2. Adjustable dial controls volume.
3. Handsomely compact in construction.
4. Finished in a rich ebony; set-off by a glistening silvered rim on the bell.
5. Fully guaranteed.

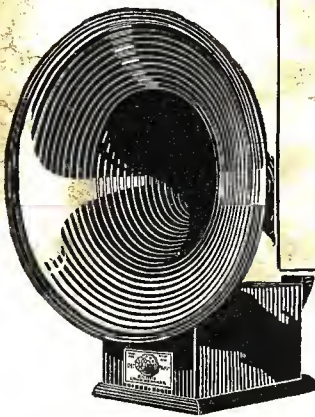

## Brooklyn Hears Great Britain on the DICTOGRAND!

DICTOGRAPH PRODUCTS CORPORATION 51 Hale Avenue, Brooklyn, N. Y.

Dear Sir: Kindly send me your large package of "Applause Cards" as advertised in the RADIO NEWS.

I have a Dictogrand loud speaker and received station 2LO and three other English stations all on the loud speaker on the last test. I have tried all makes and found yours to be the best.

Respectfully yours,  
C. J. LEAGUE.

Another record!  
First, San Francisco heard Japan and Newark on the Dictogrand.

Now Brooklyn hears Great Britain on the Dictogrand. Amazing? Not to owners of this incomparable instrument. For Dictogrand users in every state are familiar with the thrill of listening to far distant stations—night after night—right on the loud speaker.

And they have found that this marvelous mechanism, so magically sensitive to faint impulses from the other side of the world, is startlingly life-like on local stations!

Ask your radio shop to demonstrate the Dictogrand!  
(Get "Applause Cards" \* FREE at the same time.)

**Dictograph Products Corporation**  
220 WEST 42nd STREET NEW YORK CITY  
\*Copyrighted

\$ 24.50

SEND FOR YOUR FREE COPY

## TESTED HOOK-UPS

SUBMITTED BY USERS OF OUR



**WONDERFUL TRANSMITTER**

**BUTTON FOR LOUD SPEAKERS**

Price \$1.00  
POSTPAID  
with instructions

**AMPLIFICATION AND EXPERIMENTS**

**K. ELECTRIC CO.**  
15 PARK ROW NEW YORK

# 8 TUBE SUPER-HETERODYNE

We are distributors for the popular Radio Receptor Kit for the 8-Tube Radio Receptor Superheterodyne Circuit which is making the remarkable trans-oceanic records. The kit including special transformers, by-pass condensers, and coils, with a simple blue print chart for easy building \$55

Special beautifully engraved Bakelite panel for the Super-Het, with sockets, loop, variable and fixed condensers, rheostats, potentiometer, grid leaks, and all additional parts necessary for building the circuit \$55

Complete Radio Receptor Kit and Accessories .....\$110

**FRIEDLANDER-KOPPLE RADIO SERVICE**  
149 Church Street, New York  
Telephone: Barclay 4919

Call	Owner	Location	Wave-length in Meters
WHAB	Clark W. Thompson	Galveston, Texas	360
WHAD	Marquette University	Milwaukee, Wis.	280
WHAG	University of Cincinnati	Cincinnati, Ohio	222
WHAH	Hafer Supply Co.	112 W. Sixth St. Joplin, Mo.	283
WHAK	Roberts Hardware Co.	Clarksburg, W. Va.	258
WHAM	University of Rochester (Eastman School of Music)	Rochester, N. Y.	283
WHAP	Otta and Kubns	160 S. Water St. Decatur, Ill.	360
WHAR	Paramount Radio & Electric Co.	1215 Atlantic Ave., Atlantic City, N. J.	231
WHAS	Courier-Journal and Louisville Times	Louisville, Ky.	400
WHAU	Wilmington Electrical Specialty Co.	405 Delaware Ave., Wilmington, Del.	360
WHAZ	Rensselaer Polytechnic Institute	Troy, N. Y.	380
WHB	Sweeney School Co.	Sweeney Bldg., Kansas City, Mo.	411
WHK	Radiovox Co.	5005 Euclid Ave., Cleveland, Ohio	283
WHN	George Schubel	1540 Broadway, New York, N. Y.	360
WHO	Bankers Life Co.	Des Moines, Iowa	526
WIAB	Joslyn Automobile Co.	320 Church St., Rockford, Ill.	252
WIAC	Galveston Tribune	Galveston, Texas	360
WIAD	Howard R. Miller	6318 N. Park Ave., Philadelphia, Pa.	254
WIAP	Gustav A. DeCortin	139 N. Alexander St., New Orleans, La.	234
WIAI	Heer Stores Co.	Springfield, Mo.	252
WIAJ	Fox River Valley Radio Supply Co.	425 Sberry St., Neenah, Wis.	224
WIAK	Journal-Stockman Co.	Omaha, Neb.	278
WIAO	School of Engineering of Milwaukee	415 Marshall St., Milwaukee, Wis.	360
WIAQ	Chronicle Publishing Co.	413 S. Washington St., Marion, Ind.	226
WIAS	Home Electric Co.	315 N. Third St., Burlington, Iowa	283
WIAU	American Trust & Savings Bank	Le Mars, Iowa	360
WIAY	Woodward & Lothrop	Washington, D. C.	273
WIK	K. & L. Electric Co.	427 Olive St., McKeesport, Pa.	234
WIL	Continental Electrical Supply Co.	808 Ninth St., Washington, D. C.	360
WIP	Gimbel Bros.	Philadelphia, Pa.	509
WJAD	Jackson's Radio Engineering Laboratories	801 Austin St., Waco, Texas	360
WJAF	Muncie Press and Smith Electric Co.	Muncie, Ind.	360
WJAG	Norfolk Daily News	Norfolk, Neb.	283
WJAK	Clifford L. White	Greentown, Ind.	254
WJAM	D. M. Perham	332 Third Ave. W., Cedar Rapids, Iowa	268
WJAN	Peoria Star	Peoria, Ill.	280
WJAO	Capper Publications	Topeka, Kan.	360
WJAR	The Outlet Co.	Providence, R. I.	360
WJAS	Pittsburgh Radio Supply House	963 Liberty Ave., Pittsburgh, Pa.	250
WJAT	Kelley-Vawter Jewelry Co.	Marshall, Mo.	360
WJAX	Union Trust Co.	Cleveland, Ohio	390
WJD	Denison University	Granville, Ohio	229
WJX	Deforest Radio Telephone & Telegraph Co.	1391 Sedgwick Ave., New York, N. Y.	360
WJY	Radio Corporation of America	New York, N. Y.	405
WJZ	Radio Corporation of America	New York, N. Y.	455
WKAA	H. F. Paar	Cedar Rapids, Iowa	268
WKAD	Charles Loeff (Crescent Park)	East Providence, R. I.	240
WKAF	W. S. Radio Supply Co.	725 Tenth St., Wichita Falls, Texas	360
WKAN	United Battery Service Co.	Montgomery, Ala.	226
WKAP	Dutée W. Flint	Cranston, R. I.	360
WKAQ	Radio Corporation of Porto Rico	San Juan, P. R.	360
WKAR	Michigan Agricultural College	East Lansing, Mich.	280
WKAV	Laconia Radio Club	Laconia, N. H.	254
WKAY	Brenau College	Gainesville, Ga.	280
WKY	WKY Radio Shop	Oklahoma, Okla.	360
WLAG	Cutting & Washington Radio Corporation	18 W. Franklin St., Minneapolis, Minn.	417
WLAH	Samuel Woodworth	425 Brownell St., Syracuse, N. Y.	234
WLAI	Waco Electrical Supply Co.	616 Austin Ave., Waco, Texas	360
WLAK	Vermont Farm Machine Corporation	Bellows Falls, Vt.	360
WLAL	Naylor Electrical Co.	24 W. Second St., Tulsa, Okla.	360
WLAP	W. V. Jordan	Louisville, Ky.	360
WLAQ	Arthur E. Schilling	108 Elm St., Kalamazoo, Mich.	283
WLAV	Electric Shop	30 S. Palafox St., Pensacola, Fla.	254
WLAW	Police Department	City of New York, New York, N. Y.	360
WLAX	Putnam Electric Co.	(Greencastle Community Broadcast Station), Greencastle, Ind.	231



## Consrad Publications

### "The Experimenter's Library" Series

- Tips for the Radio Amateur Constructor.
- How to Make a Radio-Phone Receiving Set.
- Radio Questions Answered.
- Radio Frequency Amplification.
- Loud Talkers and How to Build Them.
- How to Tune Your Radio Set.
- One Hundred Radio Hook-ups.
- All About Radio Parts History and Operation of Vacuum Tubes.
- The Neutrodyne and All About It.
- How Radio is Received.
- How to Locate Trouble in Your Radio Set.

25c Each

### "The Radio Constructor" Series

- Radio Map of the U. S. on Cloth.
- How to Make the S. T. 100 Receiver.
- How to Make a Neutrodyne Receiver.
- How to Make a Reinartz Receiver.
- How to Make a Reflex Receiver.
- How to Make a Cockaday Receiver.
- How to Make a Short Wave Regenerative Receiver.
- How to Make a Radio-Phone Crystal Set.
- How to Make One or Two Stage Amplifiers.
- All About Aerials and Their Construction.
- 20 Radio Diagrams and Hook-ups.
- Radio Amateurs' Practical Design Data.
- How to Make the Ultradyne Receiver.
- How to Make a Five Tube Cockaday Receiver.
- How to Make a Portable Receiver.

50c Each

### Radio Books

- Radio News Amateur Handbook .....\$1.00
- Radio For All ..... 2.00
- The How and Why of Radio Apparatus ... .75
- Wireless Course in 20 Lessons ..... 2.00
- Experimental Electricity Course in 20 Lessons 1.25
- A Thousand and One Formulas ..... 1.50
- Radio Reading Course in 5 Volumes..... 1.25
- The Beginners Radio Guide .....ea. .10
- Building an Inexpensive Radio Crystal Set...ea. .10
- Radio Log Book ..... .50
- Radio March .. .35
- Radio Jazz.... .35
- Listen In... .35



## You Can Build this Portable Radio Set Quickly and Easily

The supreme gratification of work well done is the reward for the man who builds his own Radio Set. There is a definite, lasting thrill in the knowledge of the fact that the set you have built with your own hands, works sturdily and easily.

To those who want to be guided this summer in building a Portable Outfit, CONSRAD has prepared a new addition to its well known line of Radio Publications, THE PORTABLE RADIO SET PATTERN. It consists of diagrams with three full sized blueprints and complete instructions in simple everyday language so that you can follow them quickly and easily. In their complete form they show every step in the building of a complete, practical, PORTABLE Radio Outfit.

This set has been fully tested for results. It is designed by Radio Engineers who know what can be done in the way of Portable Outfits.

**Pattern No. 12—"How to Make a Portable Receiver"**

PRICE 50c PREPAID

At all reliable dealers or write direct

Address Department R.N.

**THE CONSRAD COMPANY, Inc.**  
233 FULTON STREET NEW YORK CITY

# Consrad

RADIO'S FOREMOST PUBLISHERS





# CARTER PORTABLE JACK

Just the thing to take along on your vacation. The Carter Portable Jack permits you to extend your head set, or loud speaker as far as you want from the receiving set.

Ideal for home use. You can keep your set in the house and place the loud speaker out in the garden or on the porch. Fits any standard plug. Any dealer can supply.

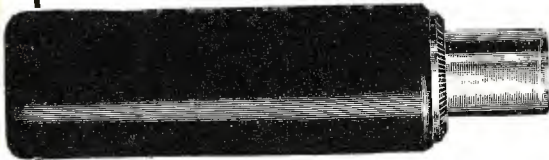

**\$1.50**

Write for illustrated catalog of other Carter original Radio Products



## Burnt-Out Tubes Replaced for \$2.50



Burnt-out, Defective or Broken Tubes of any brand or make whatsoever will be replaced by a brand new Royaltron Tube, at a cost of only \$2.50. Take this advertisement with your old tubes to any ROYALTRON dealer, or send them direct to us with \$2.50 plus 10c postage.

*It is with the Object of Advertising the MERITS of ROYALTRON Tubes, that we make the above unusual offer.*

Every ROYALTRON Tube is accompanied by a money back guarantee, or will be replaced by a new one if it lights but does not oscillate.

ROYALTRON TUBES are regularly priced at \$4.00 and are the equal of any \$5.00 tube on the market.

**"A ROYALTRON USER NEVER CHANGES."**

### ROYAL MANUFACTURING CO.

206 Broadway New York

Dealers and distributors, write or wire immediately for unusual proposition.

TYPES 199, WD12, 200, 201A

#### IT IS A PORTABLE

No aerial, ground or loop required for Local Stations.

You can take it with you when visiting. Use it in your Hotel room — On your vacation — Anywhere, Anytime.

**LONG RANGE**  
— coast to coast —

Reception Loud and Clear. Single Tube "SUPERFLEX" in Leatherette Case, Very Neat.

Order NOW—Will be sent C. O. D. parcel post anywhere on receipt of \$1.00 with order, to cover postage.

PRICE..... \$65.00 COMPLETE

Ready to operate. Dealers write

BENSON ENGINEERING COMPANY

2125 N. Halsted Street. Chicago, Illinois

#### "Stand by One Moment, Please!"

YOU lost that station because you didn't have enough room on your vernier attachment. You would have got it with a "UNITY" because the whole UNITY Rheostat is one continuous vernier

Efficient, compact, and guaranteed to give satisfaction. ALL RESISTANCES .....\$2.00



## UNITY

Vernier Rheostat

"Hear a Set that Uses One!"

UNITY MFG. CO., 224 N. Halsted St., CHICAGO  
NEW YORK OFFICE: 50 Church Street

Call	Owner	Location	Wave-length in Meters
WLB	University of Minnesota,	Minneapolis, Minn.	360
WLS	Sears, Roebuck & Co.,	Chicago, Ill.	345
WLW	Crosley Mfg. Co.,	Cincinnati, Ohio	309
WMAB	Radio Supply Co.,	707 N. Broadway, Oklahoma, Okla.	360
WMAC	Clive B. Meredith,	Fernwood St., Cazenovia, N. Y.	261
WMAF	Round Hills Radio Corporation,	Dartmouth, Mass.	360
WMAH	General Supply Co.,	144 N. Thirteenth St., Lincoln, Neb.	254
WMAJ	Drovers Telegram Co.,	Kansas City, Mo.	275
WMAK	Norton Laboratories,	Lockport, N. Y.	360
WMAL	Trenton Hardware Co.,	35 E. State St., Trenton, N. J.	256
WMAN	First Baptist Church,	Columbus, Ohio	286
WMAP	Utility Battery Service,	665 Northampton St., Easton, Pa.	246
WMAQ	Chicago Daily News,	Chicago, Ill.	448
WMAV	Alabama Polytechnic Institute,	Auburn, Ala.	250
WMAW	Wahpeton Electric Co.,	Wahpeton, N. D.	254
WMAZ	Kingshighway Presbyterian Church,	St. Louis, Mo.	280
WMAZ	Mercer University,	Macon, Ga.	268
WMC	Commercial Appeal,	Memphis, Tenn.	500
WMU	Doubleday-Hill Electric Co.,	Washington, D. C.	261
WNAC	Shepard Stores,	Boston, Mass.	278
WNAD	University of Oklahoma,	Norman, Okla.	360
WNAL	R. J. Rockwell,	5019 Capitol Ave., Omaha, Neb.	266
WNAN	Syracuse Radio Telephone Co.,	207 E. Jefferson St., Syracuse, N. Y.	286
WNAP	Wittenberg College,	Springfield, Ohio	275
WNAQ	Charleston Radio Electric Co.,	Charleston, S. C.	360
WNAR	C. C. Rhodes,	Butler, Mo.	231
WNAS	Texas Radio Corporation and Austin Statesman,	Austin, Texas	360
WNAT	Lennig Brothers Co.,	827 Spring Garden, Philadelphia, Pa.	360
WNAV	Peoples Telephone & Telegraph Co.,	Knoxville, Tenn.	236
WNAW	Henry Kunzman,	Box 167, Fort Monroe, Va.	360
WNAX	Dakota Radio Apparatus Co.,	Yankton S. D.	244
WNJ	Shotton Radio Mfg. Co.,	Albany, N. Y.	360
WOAC	Page Organ Co. (H. P. Maus),	404 N. Main St., Lima, Ohio	266
WOAD	Friday Battery & Electric Corporation,	Sigourney, Iowa	360
WOAE	Midland College,	Fremont, Neb.	360
WOAF	Tyler Commercial College,	Tyler, Texas	360
WOAG	Apollo Theatre,	Belvidere, Ill.	273
WOAH	Palmetto Radio Corporation,	267 King St., Charleston, S. C.	360
WOAI	Southern Equipment Co.,	San Antonio Texas	385
WOAN	James D. Vaughn,	Lawrenceburg, Tenn.	360
WOAO	Lyradion Mfg. Co.,	Mishawaka, Ind.	360
WOAP	Kalamazoo College,	Kalamazoo, Mich.	283
WOAR	Henry P. Lundsow,	1066 Sheridan Road, Kenosha, Wis.	229
WOAT	Boyd M. Hamp,	215 Market St., Wilmington, Del.	360
WOAV	Pennsylvania National Guard,	112th Infantry, Erie, Pa.	242
WOAW	Woodmen of the World,	Omaha, Neb.	526
WOAX	Franklyn J. Wolff,	600 Ingham Ave., Trenton, N. J.	240
WOC	Palmer School of Chiropractic,	Davenport, Iowa	484
WOI	Iowa State College,	Ames, Iowa	360
WOK	Pine Bluff Co.,	Pine Bluff, Ark.	360
WOO	John Wanamaker,	Philadelphia, Pa.	509
WOQ	Western Radio Co.,	Kansas City, Mo.	360
WOR	L. Bamberger & Co.,	Newark, N. J.	405
WOS	Missouri State Marketing Bureau,	Jefferson City, Mo.	441
WPAB	Pennsylvania State College,	State College, Pa.	283
WPAC	Donaldson Radio Co.,	210 Tiger Bldg., Okmulgee, Okla.	360
WPAJ	Doolittle Radio Corporation,	39 Center St., New Haven, Conn.	268
WPAK	North Dakota Agricultural College,	Agricultural College, N. D.	360
WPAL	Avery & Loeb Electric Co.,	114 N. Third St., Columbus, Ohio	286
WPAM	Auerbach & Guettel,	709 Kansas Ave., Topeka, Kan.	360
WPAP	Theodore D. Phillips,	222 Lexington Ave., Winchester, Ky.	360
WPAQ	General Sales & Engineering Co.,	Frostburg, Md.	360
WPAR	Ward Battery & Radio Co.,	Beloit, Kan.	236
WPAT	St. Patricks Cathedral,	El Paso, Texas	360
WPAU	Concordia College,	Moorhead, Minn.	360
WPAZ	John R. Koch,	Charleston, W. Va.	273
WQAA	Horace A. Beale, Jr.,	Parkeburg, Pa.	360
WQAC	E. B. Gish,	108 E. Eighth St., Amarillo, Texas	234
WQAD	Whitall Electric Co.,	59 W. Maine St., Waterbury, Conn.	242
WQAE	Moore Radio News Station,	Springfield, Vt.	275
WQAF	Sandusky Register,	Sandusky, Ohio	240

Insure your copy reaching you each month. Subscribe to Radio News—\$2.50 a year. Experimenter Publishing Co., 53 Park Place, N. Y. C.



Call	Owner	Location	Wave-length in Meters
WQAL	Coles County Telephone & Telegraph Co., Mattoon, Ill.		258
WQAM	Electrical Equipment Co., Miami, Fla.		283
WQAN	Scranton Times, Scranton, Pa.		280
WQAO	Calvary Baptist Church, New York, N. Y.		360
WQAO	West Texas Radio Co. (Abilene Daily Reporter), Abilene, Texas.		360
WQAS	Prince-Walter Co., 108 Merrimack St., Lowell, Mass.		266
WQAW	Catholic University, Washington, D. C.		236
WQAX	Radio Equipment Co., Peoria, Ill.		360
WRAA	Rice Institute, Houston, Texas.		360
WRAF	The Radio Club, Laporte, Ind.		224
WRAH	Stanley N. Read, 191 Alabama Ave., Providence, R. I.		231
WRAL	Northern States Power Co., St. Croix Falls, Wis.		248
WRAM	Lombard College, Galesburg, Ill.		244
WRAN	Black Hawk Electrical Co., Waterloo, Iowa		236
WRAO	St. Louis Radio Service Co., 5735 Bartmer Ave., St. Louis, Mo.		360
WRAV	Antioch College, Yellow Springs, Ohio		242
WRAW	Avenue Radio Shop, Reading, Pa.		238
WRAX	Flexon's Garage, Gloucester City, N. J.		268
WRAY	Radio Sales Corporation, 1110 Spruce St., Scranton, Pa.		280
WRAZ	Radio Shop of Newark, 89 Lehigh Ave., Newark, N. J.		233
WRC	Radio Corporation of America, Washington, D. C.		469
WRK	Doron Bros. Electrical Co., Hamilton, Ohio		360
WRL	Union College, Schenectady, N. Y.		360
WRM	University of Illinois, Urbana, Ill.		360
WRR	City of Dallas, Police and Fire Signal Department, Dallas, Texas.		360
WRW	Tarrytown Radio Research Laboratory, Tarrytown, N. Y.		273
WSAB	Southeast Missouri State Teachers College, Cape Girardeau, Mo.		360
WSAC	Clemson Agricultural College, Clemson College, S. C.		360
WSAD	J. A. Foster Co., 69 Dorrance St., Providence, R. I.		261
WSAG	Loren V. Davis and George Prestman, Sr., St. Petersburg, Fla.		244
WSAI	United States Playing Card Co., Cincinnati, Ohio		309
WSAJ	Grove City College, Grove City, Pa.		360
WSAN	Allentown Radio Club, Allentown, Pa.		229
WSAP	The Seventh Day Adventist Church, New York, N. Y.		263
WSAR	Doughty & Welch Electrical Co., Fall River, Mass.		254
WSAT	Donohoo-Ware Hardware Co., Plainview, Texas		268
WSAW	John J. Long, Jr., Canandaigua, N. Y.		275
WSAX	Chicago Radio Laboratory, Chicago, Ill.		268
WSAY	Port Chester Chamber of Commerce, Port Chester, N. Y.		233
WSAZ	Chase Electric Shop, Pomeroy, Ohio		258
WSB	Atlanta Journal, Atlanta, Ga.		429
WSL	J. & M. Electric Co., 26 Bank Pl., Utica, N. Y.		273
WSY	Alabama Power Co., Birmingham, Ala.		360
WTAB	Fall River Daily Herald Publishing Co., Fall River, Mass.		248
WTAC	Penn Traffic Co., Washington St., Johnstown, Pa.		360
WTAF	Louis J. Gallo, 2222 Lapeyrouse St., New Orleans, La.		268
WTAG	Kern Music Co., 84 Weybosset St., Providence, R. I.		258
WTAH	Carmen Ferro, Belvidere, Ill.		236
WTAJ	The Radio Shop, Portland, Me.		236
WTAL	Toledo Radio & Electric Co., Toledo, Ohio		252
WTAM	Willard Storage Battery Co., Cleveland, Ohio		390
WTAP	Cambridge Radio & Electric Co., Cambridge, Ill.		242
WTAQ	S. H. Van Gorden & Son, Osseo, Wis.		254
WTAR	Reliance Electric Co., Norfolk, Va.		280
WTAS	Charles E. Erbstein, R. F. D. No. 6, Box 75, Elgin, Ill. (near)		286
WTAT	Edison Electric Illuminating Co., 39 Boylston St., Boston, Mass. (portable)		244
WTAU	Ruegg Battery & Electric Co., Tecumseh, Neb.		360
WTAW	Agricultural and Mechanical College of Texas, College Station, Texas.		280
WTAX	Williams Hardware Co., Streator, Ill.		231
WTAY	Iodar-Oak Leaves Broadcasting Station, Oak Park, Ill.		283
WTAZ	Thomas J. McGuire, Lambertville, N. J.		283
WTG	Kansas State Agricultural College, Manhattan, Kan.		360
WVX	H. C. Spratley Radio Co., 357 Main St., Poughkeepsie, N. Y.		360
WWAB	Hoenig, Swern & Co., Trenton, N. J.		226
WWAC	Sanger Bros., Waco, Texas.		360
WWAD	Wright & Wright, Inc., 2215 N. Broad St., Philadelphia, Pa.		360
WWAE	Lawrence J. Crowley, Joliet, Ill.		227
WWAF	Galvin Radio Supply Co., 521 Market St., Camden, N. J.		236

# The Radio Marvel of 1924

## The Shamrock-Harkness two-tube reflex

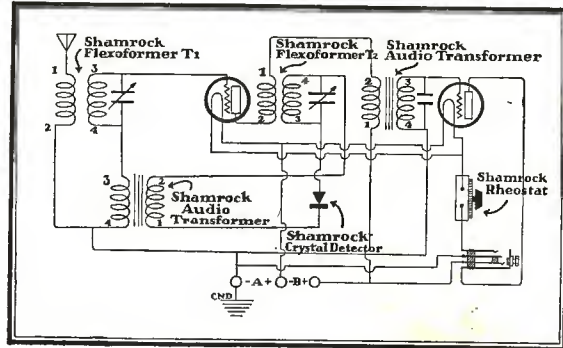

Licensed Manufacturers

### Shamrock-Harkness Kit includes:

- 1 Shamrock-Harkness Flexoformer T-1
- 1 Shamrock-Harkness Flexoformer T-2
- 1 Shamrock Rheostat
- 1 Shamrock Double Tube Socket
- 1 Shamrock Crystal Detector
- 1 Shamrock Single Circuit Filament Control
- 2 Shamrock Audio Frequency Transformers
- 4 Shamrock Binding Posts
- 2 Shamrock Dials
- 1 7x12 in. Complete Drilled Panel
- 1 5x6 in. Complete Drilled Rear Panel
- Screws for mounting all parts; bus bar wire for wiring
- Complete instructions, enabling you to complete the set in a half-day

Price  
**\$35**

THE Shamrock-Harkness Reflex is stamped the radio world. It's a whiz for performance. By an astonishing feat of engineering craft, this two-tube set has the pulling power of a standard four tube receiver. Operates a loud speaker with wonderful clarity and volume. Does not whistle, squeal—or radiate. It's remarkably selective and easy to operate—permitting you to log every station with the utmost accuracy. Many Shamrock fans report that they receive 1500 to 2000 miles consistently with this set.

Shamrock has spent months designing the various parts necessary to build the Harkness Reflex. All parts are included in the Shamrock kit. Buy only genuine parts—and avoid imitations. Only when you buy the genuine (guaranteed) Shamrock parts will you be sure of getting maximum results with this set.

Before building your set send for this booklet

The "Shamrock Radio Builder's Guide Book" contains diagrams and complete instructions for building the Shamrock-Harkness Reflex—and nine other receivers—at prices from \$15 to \$50. It makes set-building easy and accurate—shows you how to select the best set for your requirements—and how to construct it at the least cost. Send 10 cents for this booklet today. It will save you money.

SHAMROCK MANUFACTURING CO.  
Dept. 61, Market St. Newark, N. J.



# Shamrock

**FOR SELECTIVE TUNING**

SHAMROCK MANUFACTURING CO.,  
Dept. 61, Market St., Newark, N. J.

I enclose 10 cents (U. S. Stamps or coin) for copy of "Shamrock Radio Builder's Guide Book," containing log record. Also diagrams and complete instructions for building 10 sets—at prices ranging from \$15 to \$50.

Name .....

Address .....

Dealer's Name .....

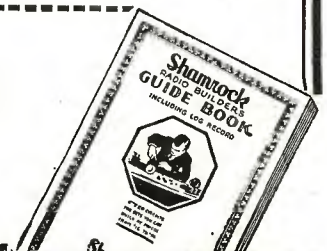



# RATHBUN

SINGLE-HOLE MOUNTING

## SUPERIOR CONDENSERS

**PRICES**

**Plain Types**

No. 3 Pl. Vernier	.000075	\$1.00
No. 5 Pl. Variable	.000125	3.00
No. 11 Pl. Variable	.00025	3.00
No. 23 Pl. Variable	.0005	3.50
No. 43 Pl. Variable	.001	4.50

**Combination Types**

No. 3-11 Pl. Vernier Variable	\$4.50
No. 3-23 Pl. Vernier Variable	5.00
No. 3-43 Pl. Vernier Variable	6.00

Combination Types Include Knob and Dial

Before you buy another condenser, compare other condensers with RATHBUN Condensers, point by point. *Single hole mounting, plates die-cast into milled tubes, absence of magnetic fields, longer brass bearings, split phosphor bronze contact spring*—these RATHBUN features guarantee you the **BEST Condenser value!**

The most accurate, continuously dependable condensers for the *Superheterodyne Four Circuit Tuner, Superdyne* and other exacting circuits. This wonderful accuracy also fits *Rathbun Condensers* excellently for use in wave traps as described in April "Radio in the Home."

Write for literature on the new *Rathbun Vernier Variable Combination Condensers* featured at the Chicago Radio Show.

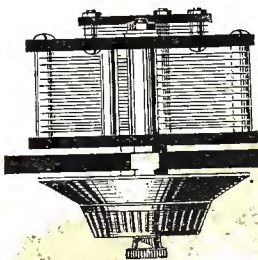

**RATHBUN MANUFACTURING CO., INC.**  
Jamestown, New York

# The BRACH

## vacuum radio ARRESTER

*Safety demands it*

made to protect—not to meet a price

Approved by the National Board of Fire Underwriters

At All Dealers

**L. S. BRACH MFG. COMPANY**  
NEWARK, NEW JERSEY



### Tubes Repaired

Only Middle West Tube Service Station  
8 Hour Service. No Extra Charge for Broken Glass.  
WD-11, WD-12, C-11, C-12 ..... \$3.00 Ea.  
UV-201, C-301 ..... 3.00 Ea.  
UV-201-A, C301-A, UV-199, C-299 ..... 3.00 Ea.  
UV-200, C-300 ..... 2.75 Ea.

We Buy Burnt Out Tubes  
All Tubes GUARANTEED and Returned P.P. C.O.D.

DEY'S RADIO SERVICE  
Dept. J, 5413 Race Avenue Chicago, Ill.

Genuine Gilfillan Radio Parts can  always be identified by this trade-mark —look for it

**GILFILLAN BROS. Inc.**  
Kansas City Mo. Los Angeles Cal. New York N. Y.

## RADIO TUBE EXCHANGE

We Repair All Standard Makes of Tubes Including

W.D.-11 or 12  
U.V.-199 or C.-299  
C.-11 or 12  
U.V.-201A or C-301-A \$2.50  
D.V.-1 or D.V.-2  
U.V.-200 or 201  
C.-300 or 301

All tubes guaranteed to do the work.

**RADIO TUBE EXCHANGE**  
200 BROADWAY NEW YORK CITY, N. Y.  
All Mail Orders Given Prompt Attention  
Orders Sent Parcel Post C. O. D.

You can be quickly cured, if you

# STAMMER

Send 10 cents for 288-page book on Stammering and Stuttering, "Its Cause and Cure." It tells how I cured myself after stammering 20 yrs. B. N. Bogue, 6950 Bogue Bldg., 1147 N. 11th St., Indianapolis.

Call	Owner	Location	Wave-length in Meters
WWAO	Michigan College of Mines,	Houghton, Mich.	244
WWI	Ford Motor Co.,	Dearborn, Mich.	273
WWJ	Detroit News,	Detroit, Mich.	517
WWL	Loyola University,	New Orleans, La.	280

### FRENCH BROADCAST STATIONS

Call	Location	Wave-length in Meters
YN	Lyon	740
FL	Paris (Eiffel Tower)	2600
8AJ	Paris	1780
ESP	Paris	450

### CUBAN BROADCAST STATIONS

PWX	Cuban Telephone Co.,	Havana	400
2DW	Pedro Zayas,	Havana	300
2AB	Alberto S. de Bustamante,	Havana	240
2OK	Mario Garcia Vélaz,	Havana	360
2BY	Frederick W. Borton,	Havana	260
2CX	Frederick W. Borton,	Havana	320
2EV	Westinghouse Elec. Co.,	Havana	220
2TW	Roberto E. Ramirez,	Havana	230
2HC	Heraldo de Cuba,	Havana	275
2LC	Luis Casas,	Havana	250
2KD	E. Sánchez de Fuentes,	Havana	350
2MN	Fausto Simón,	Havana	270
2MG	Manuel G. Salas,	Havana	280
2JO	Raúl Pérez Falcón,	Havana	150
2KP	Alvaro Daza,	Havana	200
2HS	Julio Power,	Havana	180
2OL	Oscar Collado,	Havana	290
2WW	Amadeo Sáenz,	Havana	210
5EV	Leopoldo V. Figueroa,	Colón	360
6KW	Frank H. Jones,	Tuinucú	340
6KJ	Frank H. Jones,	Tuinucú	275
6CX	Antonio T. Figueroa,	Cienfuegos	170
6DW	Eduardo Terry,	Cienfuegos	225
6BY	José Ganduxe,	Cienfuegos	300
6AZ	Valentín Ullivarri,	Cienfuegos	200
6EV	Josefa Alvarez,	Caibarién	225
7AZ	Pedro Nogueiras,	Camaguey	225
7BY	Salvador Rionda,	Camaguey	350
8AZ	Alfredo Brooks,	Santiago de Cuba	240
8BY	Alberto Ravelo,	Santiago de Cuba	250
8FU	Andrés Vinnét,	Santiago de Cuba	225
8DW	Pedro C. Anduz,	Santiago de Cuba	275
8EV	Eduardo Mateos,	Santiago de Cuba	180
8GT	Juan F. Chibas,	Santiago de Cuba	260

### BRITISH BROADCAST STATIONS

Call	Location	Wave-length in Meters
2LO	London	365
5TT	Birmingham	475
5WA	Cardiff	350
6BM	Bournemouth	385
2ZY	Manchester	375
5NO	Newcastle	400
5SC	Glasgow	420
2BD	Aberdeen	495
6SL	Sheffield (relay station)	303

All of the above named stations are operated by the British Broadcasting Co. The power normally used is 1½ kilowatts (input to main high-frequency generator), but 3 kilowatts are allowed, except in the case of the Sheffield station, which uses only 100 watts.

### CANADIAN BROADCAST STATIONS

Call	Owner	Location	Wave-length in Meters
CFAC	Calgary Herald,	Calgary, Alberta	430
CFCA	Star Publishing and Printing Co.,	18 King St. W., Toronto, Ontario	400
CFCF	Marconi Wireless Telegraph Co. of Canada,	Canada Cement Bldg., Montreal, Quebec	440
CFCH	Abitibi Power and Paper Co.,	Iroquois Falls, Ontario	400
CFCJ	La Cie de L'Evenement,	30 Fabrique St., Quebec, Quebec	410
CFCM	Radio Supply Co.,	10229 101st St., Edmonton, Alberta	410
CFCL	Centennial Methodist Church,	Victoria, British Columbia	400
CFCN	W. W. Grant Radio, Ltd.,	511 Lougheed Bldg., Calgary, Alberta	440
CFCO	Semmelhaack-Dickson, Ltd.,	Bellevue, Quebec	450
CFCQ	Radio Specialties, Ltd.,	791 Dunsmuir St., Vancouver, British Columbia	450
CFCR	Laurentide Air Service, Nickel Range Hotel,	Sudbury, Ontario	410
CFCW	The Radio Shop,	77 Dundas St., London, Ontario	420
CFDC	Sparks Co., Wallace and Fitzwilliam Sts.,	Nanaimo, British Columbia	430
CFQC	The Electric Shop, Ltd.,	144 Second Ave. N., Saskatoon, Saskatchewan	400
CFRC	Queens University,	Kingston, Ontario	450
CFUC	University of Montreal,	185 St. Denis St., Montreal, Quebec	400
CHAC	Radio Engineers,	Halifax, Nova Scotia	400
CHBC	Albertan Publishing Co.,	229 8th Ave. W., Calgary, Alberta	410
CHCD	Canadian Wireless and Electric Co.,	30 Fabrique St., Quebec, Quebec	410



Call	Owner	Location	Wave-length in Meters
CHCE	Western Canada Radio Supply, Ltd., 919 Fort St., Victoria, British Columbia		400
CHCL	Vancouver Merchants Exchange, Vancouver, British Columbia		440
CHYC	Northern Electric Co., 121 Shearer St., Montreal, Quebec		410
CJCA	Edmonton Journal, Journal Bldg., Edmonton, Alberta		450
CJGC	London Free Press Printing Co., 430 Richmond St., London, Ontario		430
CJCD	T. Eaton Co., James and Alberts Sts., Toronto, Ontario		410
CJCE	Sprott-Shaw Radio Co., 1604 Tower Bldg., Vancouver, British Columbia		420
CJCI	Maritime Radio Corp., 543 Albion St., St. John, New Brunswick		400
CJCN	Simons Agnew & Co., 19 Melinda St., Toronto, Ontario		410
CJCX	Percival Wesley Shackleton, Olds, Alberta		400
CJSC	Evening Telegram, Toronto, Ontario		430
CKAC	La Presse Publishing Co., St. James St. and St. Lawrence Blvd., Mon- treal, Quebec		430
CKCD	Vancouver Daily Province, Vancou- ver, British Columbia		410
CKCE	Canadian Independent Telephone Co., Wallace Ave. and Ward St., To- ronto, Ontario		450
CKCK	Leader Publishing Co., Regina, Sas- katchewan		420
CKOC	Wentworth Radio Supply Co., 31 John St. N., Hamilton, Ontario		410
CKY	Manitoba Telephone System, Sher- brooke St., Winnipeg, Manitoba		450

**MEXICAN BROADCAST STATIONS**

Call	Owner	Location
CYB	"El Buen Tono" Cigarette Manufac- turing Co., Mexico City	
CYL	"El Universal" (newspaper), Mexico City	

We shall be grateful if the owners of broadcast stations will inform us of any changes in location, wave-length or power. This will enable us to keep our broadcast station list up-to-date.

**The Staccatone**

(Continued from page 21)

control, as the slightest change in the capacity of the apparatus, such as is caused by moving the hand near the set, will change the pitch of the beat-note considerably. As such a system would be impractical for this purpose a vacuum tube is used connected so as to generate low or audible frequency notes which sound the same as the beat-notes heard in radio.

Such a circuit would require larger values of capacity and inductance than are used in the ordinary radio circuit, and for this purpose a number of large honeycomb coils are used with fixed and variable condensers of comparatively large capacities, so that the natural frequency of the oscillating circuit will be at a low audible note. By employing sufficient capacity and inductance in the circuit to give us the lowest note desired we can, with a number of switches corresponding to the keys on a piano, cut inductance or capacity, or both, in and out of the circuit and raise the pitch to any value we wish, each key or switch corresponding to a musical note.

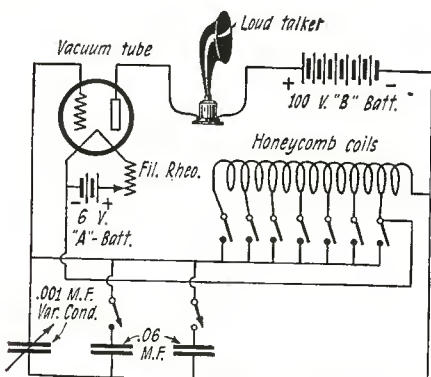

The circuit diagram of the Staccatone. This is a simple oscillating circuit employing large values of capacity and inductance.

# ATWATER KENT

Philadelphia

## Radio in the Home

IN MILLIONS of homes radio is now regarded as almost indispensable—it is daily gaining new enthusiasts. In every section of the country the name "ATWATER KENT" is accepted as the criterion of excellence.

Literature describing  
ATWATER KENT Receiving  
Sets and the ATWATER  
KENT Loud Speaker sent  
on request.

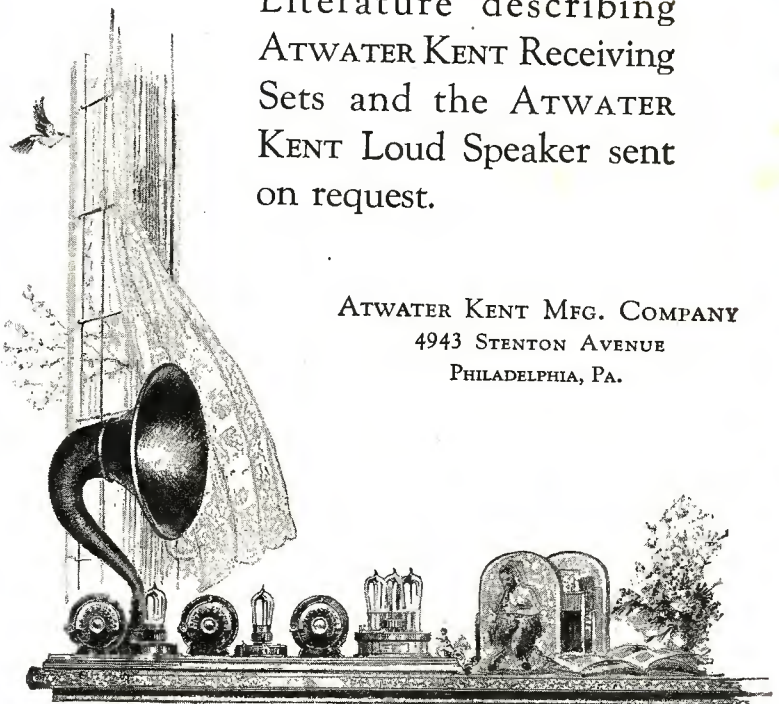

ATWATER KENT MFG. COMPANY  
4943 STENTON AVENUE  
PHILADELPHIA, PA.



# YOU CAN LEARN NEWSPAPER WORK

**Experienced Editor Will Teach You  
How to Become a  
Reporter**

**FACINATING WORK--GOOD PAY**

**Only a Few Months' Work Required  
To Qualify You for a  
Better Position**

Regular reporters earn from \$40 to \$125 a week. Good deskmen on a daily paper are paid from \$60 to \$100 a week. A "Star" Reporter can command his own salary. Hundreds of ambitious men and women enhance their income materially by corresponding for newspapers or writing for magazines in their spare time.

## We Will Teach You at Home

We can develop your talent for writing and lead you into this well paying profession. Our Practical Course in Journalism was personally prepared by Henry J. Brockmeyer, Assistant City Editor of the New York Evening Post. Mr. Brockmeyer has trained hundreds of men and women, many of whom have, under his guidance, developed into front rank reporters or feature writers.

Mr. Brockmeyer's course will teach you what it would take years of actual newspaper work to learn. It consists of six comprehensive lessons just brimful of everything a reporter must learn. The following are only a few of the subjects covered.

Starting in Journalism. What is a Newspaper? What is News? Start and Finish of a News Story. Technical Terms. The Type Point System. Styles of Type, Proof Reading. Capitalization and Punctuation. A Late Fire Bulletin. Court Stories. Libel Laws, Copyright. Hints to Reporters. Personal Conduct. Re-Writing and Condensing Stories. Paragraphs and Short Items. Good and Bad Styles. Broadening the Vocabulary. Aids to Good Style. Special Stories. Suggestions for Stories. Rhetoric. Preparing Your Story. Don'ts for Writers. Office Organization. Syndicated Matter. Business Office. Mechanical Department. Hints for Headline Writers. The Make-Up. The Country Correspondent, etc., etc.

## Use Coupon—Save 50%

Although the price for the entire course is \$10, entitling the student to full consulting services directed by Mr. Brockmeyer personally, we will accept enrollments, if the coupon below is used before August 20, at \$5—exactly half price.

## Five Days' Trial

Just pin a check, money order or five dollar bill to the coupon below and mail. Then take five days after the course arrives to decide whether you want to keep it. If not, return it at our expense and your money will be immediately refunded.

THE PRESS GUILD, Inc., 66-R West Broadway, N. Y.

THE PRESS GUILD, Inc. (Expires August 20, 1924)  
66-R West Broadway, New York City.

Enclosed find \$5 for which you are to ship me at once, prepaid, Henry J. Brockmeyer's complete course in Practical Journalism with the distinct understanding that if I return the course in five days my full \$5 will be refunded and no questions asked.

(Name) .....  
(Address) .....  
(City) ..... (State) .....

The tones are heard, of course, from a loud speaker connected in the plate circuit of the vacuum tube.

The complete circuit is shown in the accompanying diagram. Those familiar with radio hook-ups will recognize this at once as the Hartley circuit. The inductance consists of six 1,500-turn honeycomb coils, all connected in series and clamped together.

With a six-volt vacuum tube, such as the type UV-201, and a "B" battery voltage of 90 or more, the sound will be so loud as to be heard for several blocks. Of course, a good loud talker must be used. But for inside use in a small room, a dry cell tube may be used with a 45-volt "B" battery. In fact most of the instruments that are used in radio receiving sets may be employed in the Staccatone.

## New Radio Patents

(Continued from page 59)

### CONDENSER

(Patent No. 1,480,604, W. Dubilier. Filed Jan. 27, 1921, issued Jan. 15, 1924. Assigned to Dubilier Condenser and Radio Corporation.)  
**TERMINAL CONNECTION FOR CONDENSERS**, in which the conducting plates have terminals extending from the sides of the stack which are gripped together by a smooth, round metallic hook.

### ARC TRANSMITTER

(Patent No. 1,480,659, Q. A. Brackett. Filed Dec. 7, 1920, issued Jan. 15, 1924. Assigned to Westinghouse Electric and Mfg. Co.)  
**SIGNALING SYSTEM**, employing an arc which is controlled to produce signals with radiation of only a single wave. The arc is maintained in uninterrupted operation, while the energy is supplied either to an oscillatory circuit or to a non-oscillatory circuit in the process of producing signals.

### SELECTIVE RECEIVER

(Patent No. 1,480,891, H. I. Becker. Filed July 20, 1921, issued Jan. 15, 1924. Assigned to General Electric Company, Incorporated.)  
**HIGH FREQUENCY RECEIVING SYSTEM**, in which a link circuit is provided between a radio frequency amplifier and the detecting circuit for preventing disturbing currents from being transferred from the amplification circuit to the detector circuit.

### TUBE CONSTRUCTION

(Patent No. 1,481,422, Gilles Holst, E. Oosterhuis & J. Bruijnes. Filed June 1, 1922, issued Jan. 22, 1924. Assigned to Naamlooze Venootschap Philips' Gloeilampen-Fabriek van Eindhoven, Netherlands.)  
**ELECTRIC DISCHARGE TUBE**, in which the gas filling in the tube comprises neon to which 0.5 to 5 per cent argon is added. The inventors state that the ionization potential of argon is lower than the potential at which the first inelastic collision in the first mentioned gas occurs.

### INTERFERENCE ELIMINATOR

(Patent No. 1,481,945, J. Weinberger, filed Mar. 3, 1921, issued Jan. 29, 1924. Assigned to Radio Corporation of America.)  
**RADIO RECEIVING SYSTEM**, with a circuit arrangement between the antenna and the input of the receiver for eliminating interference. The system includes primary and secondary circuits with a pair of connections across the primary and secondary circuits, each connection comprising two parts including capacity and inductance in series, with one of the parts common to both connections and the other two parts arranged to couple the primary and secondary circuits. All of the factors in the circuits are adjustable to secure selectivity.

### DISTRESS SIGNAL ALARM

(Patent No. 1,482,122, W. N. Fanning, filed Mar. 30, 1922, issued Jan. 29, 1924.)  
**RADIO SYSTEM**, for operating a signal or alarm upon the receipt of a certain definite call by radio. The device is particularly described in connection with a receiver on shipboard to sound an alarm for operation upon receipt of a distress call.

### LOOP RECEIVER

(Patent No. 1,483,383, H. K. Sandell, filed Nov. 2, 1922, issued Feb. 12, 1924. Assigned to Mills Novelty Company of Chicago.)  
**RADIO RECEIVING SYSTEM** comprising a loop antenna having two parts, one of which is connected in the grid circuit of a detector tube and the other in the plate circuit forming a regenerative system. The loops are spaced apart in parallel planes on the antenna frame and a condenser provided in one corner of the antenna

## HOMMEL SERVICE MAKES MORE PROFITS

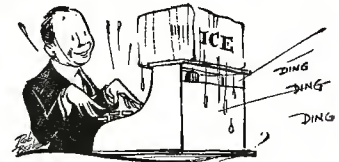

**T**HIS company wholesales exclusively—they never compete with their dealers by retailing;—their discounts are fair and liberal;—they represent only the leading manufacturers of radio equipment;—they carry complete stocks of radio supplies insuring prompt deliveries and a dependable source of supply for the dealers.

Dealers who align themselves with HOMMEL service enjoy a steady repeat business,—with satisfied customers—and that means more and better profits.

Let us send you complete facts—  
Encycl-pedia No. 246 S sent  
on request.

**LUDWIG HOMMEL & CO.**  
530-535 Fernando St., Pittsburgh, Pa.

# KEYSTONE RADIO LIGHTNING ARRESTERS

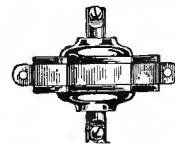

**NEW TYPE**

**\$1.50**

Do not delay installing a Keystone Arrester. Most practical type having heavy discharge capacity. Made of genuine Bakelite, absolutely weatherproof, no vacuum to lose, approved by Underwriters.

Mfr's. of over a million  
lightning arresters



**ELECTRIC SERVICE SUPPLIES CO.**  
17th & Cambria Streets, Phila.  
50 Church St., NEW YORK  
Monadnock Bldg., CHICAGO

## A RADIO SENSATION

Patent Applied For

A tuner that works without "B" batteries. Something new. Reliable, Portable, Fool-proof and a hook-up that will revolutionize the art. It positively does not re-radiate and works with loop or aerial. Works loud speaker with one tube on local signals.

Circulars two cents

**TRESCO SALES, INC.**

DAVENPORT

IOWA

**MAN WANTED** by largest concern of its kind. Part or full time. EXPERIENCE UNNECESSARY. **OUR MEN GETTING UP TO \$200.00 WEEKLY.** Lowest Prices.  
**RED SEAL COAL COMPANY**  
364 Coal Exchange Building, Chicago, Illinois



frame which forms a variable tuning connecting means between the loops.

**ANTENNA MAST**

(Patent No. 1,483,860, O. Von Bronk, filed Sept. 3, 1921, issued Feb. 12, 1924. Assigned to Gesellschaft fur Drahtlose Telegraphic m.b.h.)  
**ANTENNA ARRANGEMENT FOR RADIO TELEGRAPHY** in which the antenna is supported by a conducting mast and an electromotive force applied to the antenna mast substantially equal and opposite to the electromotive force normally induced in the mast by radiation from the antenna.

**LOOP AND ANTENNA RECEIVER**

(Patent No. 1,484,189, J. A. Proctor, filed July 6, 1920, issued Feb. 19, 1924. Assigned to Wireless Specialty Apparatus Company.)  
**RADIO RECEIVING APPARATUS**, utilizing a combined closed loop antenna and an open antenna. The open antenna comprises a conductor which is structurally separate from the turns of the loop antenna, but which is wound with the turns of the loop. The loop and antenna circuits are coupled with the receiving circuit.

**OSCILLATION GENERATOR**

(Patent No. 1,484,269, R. Mayer, filed June 21, 1923, issued Feb. 19, 1924.)  
**METHOD AND ARRANGEMENT FOR PRODUCING NON-DAMPED OSCILLATIONS**, in which a mechanical interrupter connected to a charging circuit is provided in circuit, with a separate circuit arranged to receive energy from the charging circuit and produce oscillations. The charging of the circuit proceeds until the electrical energy stored in said circuit is such that when oscillations begin the momentary value or strength of the oscillation current is substantially equal and opposite with respect to the value of the charging current and the circuit then oscillates under such conditions that the charging current will be substantially equal to the amplitude of the oscillation current still existing after one complete oscillation. The circuit can then be broken without sparking and after a brief period of interruption and recharging, more oscillations take place as before during a relatively longer period and this operation can be repeated as long as oscillations are needed.

**CALL SIGNAL DEVICE**

(Patent No. 1,484,405, A. Oswald, filed Jan. 12, 1920, issued Feb. 19, 1924. Assigned to Western Electric Company, Inc.)  
**SIGNALING SYSTEM**, having means for controlling a distant responsive device such as a call signal which will not respond to false signals or electrical disturbances. A slow acting indicator is provided for the receiver, which will only be actuated by the call signal. A source of opposing voltage is arranged at the receiver to cause the indicator to cease to respond upon cessation of the signaling waves.

**RECEIVER WITH RE-RADIATION PREVENTION CIRCUIT**

(Patent No. 1,484,411, H. S. Read, filed Sept. 14, 1920, issued Feb. 19, 1924. Assigned to Western Electric Co., Inc.)  
**RADIO RECEIVING SYSTEM**, having a circuit arrangement for preventing radiation of the locally generated wave energy from the receiving antenna. The circuit arrangement includes a radio frequency amplifier, a local oscillator and a detector and a circuit interconnecting the output of the amplifier and oscillator and the input of the detector which precludes radiation of energy from the local oscillator into the antenna.

**C. W. RECEIVER**

(No. 1,484,605, J. H. Hammond, Jr., filed Aug. 20, 1917, issued Feb. 19, 1924.)  
**RADIO DYNAMIC RECEIVING SYSTEM**, employing beat reception in which tuning is facilitated by an arrangement whereby two series of periodic impulses having different frequencies are impressed upon the oscillatory circuit. Periodic electrical beats are produced in the oscillatory circuit. The frequency of the beats may be maintained constant by varying the frequency of one of the series of impulses.

**ANTENNA TRANSFER SWITCH**

(No. 1,485,080, E. T. Jones, filed Dec. 27, 1921, issued Feb. 26, 1924.)  
**SWITCH**, particularly designed for transferring connection from the antenna ground system to the radio transmitter or the radio receiver. The switch has a shaft mounted on the extremity of an elongated support with switch blades carried by the shaft adapted to enter contacts on either side of the support when the switch shaft is rotated.

**ANTENNA SYSTEM FOR MULTIPLEX TRANSMISSION**

(No. 1,485,111, J. Bethenod, filed Aug. 2, 1921, issued Feb. 26, 1924.)  
**RADIO TRANSMISSION SYSTEM**, in which a plurality of high frequency generators are provided at the same station for simultaneous operation to obtain multiplex transmission. The antenna is divided into two separate sections adapted to radiate different wave-lengths. The generators



# FADA

**Announces a New Audio Frequency Transformer and New Variable Condensers**

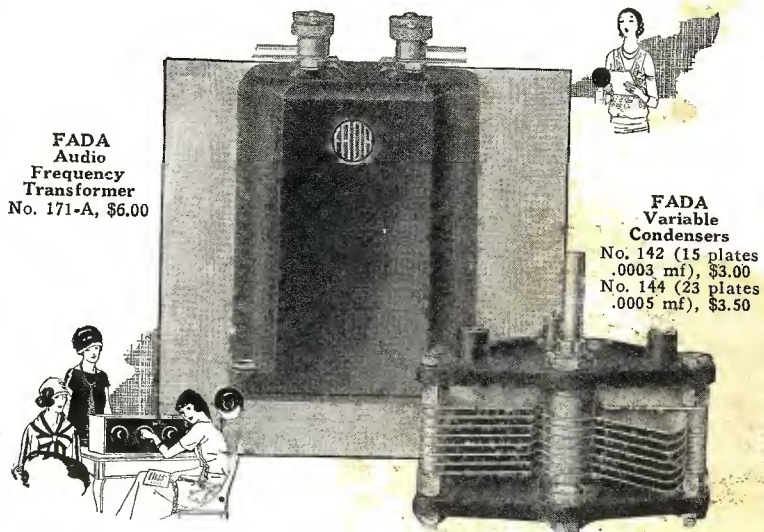

**FADA Audio Frequency Transformer**  
 No. 171-A, \$6.00

**FADA Variable Condensers**  
 No. 142 (15 plates .0003 mf), \$3.00  
 No. 144 (23 plates .0005 mf), \$3.50

**I**N KEEPING with its established policy of producing only the finest of radio apparatus, F. A. D. Andrea, Inc., announces a new Audio Frequency Transformer suitable for all circuits, and particularly adapted to the audio stages of Neutrodyne receivers.

A high average amplification over all audio frequencies is the outstanding accomplishment of this new FADA transformer. Encased in bakelite with nicked binding posts, it looks twice its worth. Try FADA Audio Transformers in your receiver and know what uniform and distortionless amplification really means.

**—and now, new variable condensers**

The name FADA on a condenser means just one thing—condenser satisfaction. The new FADA condenser is made in two capacities—15-plate, capacity .0003 micro-farads, and 23-plate, .0005 micro-farads; and each the exact capacity at which it is rated. Radio frequency losses are reduced to a minimum by special rotor wiping contact brushes. A true "low-loss" condenser with an efficiency exceeding that of condensers selling at much higher prices.

Dealers are now ready to supply FADA transformers and condensers.

**F. A. D. ANDREA, INC.**  
 1581 Jerome Avenue, New York





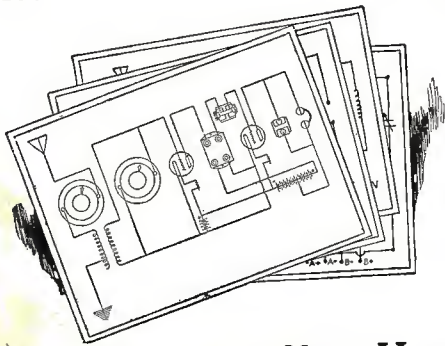

## Free Blueprints Show How to Increase Your Range

### Free Blueprints of Radio-Frequency Hook-ups

Ask your dealer for free blueprints of Duratran radio frequency hook-ups. If he has none, write to us for them and give us his name. They show how a Dubilier Duratran will convert your one-tube set into a sensitive radio-frequency receiver.

Don't throw your one-tube regenerative set away because you can't get the distant stations.

Simply add a stage of Duratran radio-frequency amplification. And you will save the ten or fifteen dollars you would spend in building a new radio-frequency set.

The Duratran will enable you to bring in the distant stations because it amplifies on all broadcasting wave-lengths twenty times. All the stations come in with equal clarity because of this unrivalled uniform amplification.

Your dealer sells Dubilier Duratrans. Price \$4.00.

**Dubilier Condenser & Radio Corporation**  
40-46 West Fourth Street  
NEW YORK

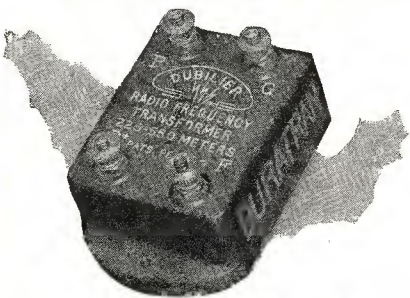

## Thor Reproducer



serves as a table lamp when set is not being used. NON directional perfect reproduction evenly diffused to all parts of the room. Far handsomer than ugly, unsightly horn. Price \$30.00. Order one today through your dealer or from

**THOR RADIO COMPANY**

1243 Sutter Street San Francisco

## PATENTS

As one of the oldest patent firms in America we give inventors at lowest consistent charge, a service noted for results, evidenced by many well known Patents of extraordinary value. *Book, Patent-Sense, Free.* Lacey & Lacey, 631 F St., Wash., D.C. Estab. 1869.

are connected to these sections of the antenna and a connection of substantially infinite impedance provided in each of the sections to the wave-lengths of the other section for limiting induction effects there between.

### CONNECTION BETWEEN OSCILLATOR AND LOAD CIRCUITS

(No. 1,485,156. H. D. Arnold, filed Aug. 28, 1917, issued Feb. 26, 1924. Assigned to the Western Electric Company.)

**SYSTEM OF DISTRIBUTION**, in which an oscillation generator delivers current at a constant frequency, regardless of the nature of the load by reason of the fact that the load is prevented from reacting on the generator. An asymmetrically conducting repeater is placed between the output circuit of the oscillator and the load circuit permitting the transferring of alternating current to the load circuit, but preventing reaction from the load circuit upon the generator.

### AUTOMATIC PRINTER RADIO SYSTEM

(No. 1,485,212. J. B. Brady, filed Dec. 28, 1921, issued Feb. 26, 1924. Assigned to Morkrum Company of Chicago.)

**RADIO TELEGRAPH SYSTEM**, wherein signals are automatically transmitted and received directly in print. The system contemplates the broadcasting of news by radio from a central transmitting station to newspaper offices where the news may be received on a machine which automatically prints the signals, eliminating the necessity of skilled operators at either end of the system.

### BROADCAST STATION

(No. 1,484,087. E. M. Ryan, filed Aug. 14, 1922, issued Feb. 19, 1924. Assigned to Western Electric Company, Incorporated.)

**RADIO BROADCASTING EQUIPMENT**, for controlling the radio transmitter. The patent describes circuit arrangements between a studio and a radio transmission room whereby a person in either room may broadcast. Signal indicators are provided in each room to automatically indicate that the circuits are in operating condition for broadcasting from that particular room.

### LIST OF RADIO TRADE MARKS PUBLISHED BY PATENT OFFICE PRIOR TO REGISTRATION

(The numbers given are serial numbers of pending applications)

- 149,747 "VACTUPHONE" for telephone for aiding hearing. Globe Phone Company, Reading, Mass. Claims use since April 12, 1921. Published December 25, 1923.
- 155,450 "UV" for vacuum tubes. Radio Corporation of America, New York City. Claims use since October 19, 1920. Published January 1, 1924.
- 157,776 "UC" for electrical condensers. Radio Corporation of America, New York City. Claims use since about August, 1921. Published January 1, 1924.
- 166,471 "Q-R" for complete radio sets and parts thereof. Robinson Specialty Co., Keyport, New Jersey. Claims use since on or about January, 1922. Published January 1, 1924.
- 170,674 "TEST-RITE" for condensers. Scholes Radio Manufacturing Corp., New York, N. Y. Claims use since August 14, 1922. Published January 1, 1924.
- 187,534 "MICROSTAT" for rheostats. Premier Electric Company, Chicago, Ill. Claims use since June, 1923. Published January 1, 1924.
- 187,856 "TELOS" for radio receiving sets. Danziger-Jones, Incorporated, New York, N. Y. Claims use since February 3, 1923. Published January 1, 1924.
- 164,007 "RACO" in ornamental design for antenna. E. Ross Antenna Company, Providence, R. I. Claims use since April 1, 1922. Published January 8, 1924.
- 170,764 "GEM" for radio apparatus. Gem Radio Company, Brooklyn, New York. Claims use since Sept. 27, 1922. Published January 8, 1924.
- 187,634 "B-METAL" for radio receiving apparatus. B-Metal Refining Company, Detroit, Michigan. Claims use since January 15, 1923. Published January 15, 1924.
- 181,105 "LISTENING IN—THE WORLD OVER" in ornamental design for radio headsets. N. Baldwin, Inc., Salt Lake City. Claims use since February 28, 1923. Published January 22, 1924.
- 173,684 "THE STENTOR—THE VOICE FROM THE SKIES" in ornamental design for loud speakers. Stentophone Company, Los Angeles, California. Claims use since Aug. 1, 1921. Published February 12, 1924.
- 175,822 "T T" for loud speakers. John S. Timmons, Philadelphia, Pennsylvania. Claims use since about July 31, 1922. Published February 12, 1924.
- 186,609 "PERFECTONE" in ornamental design for radio receiving apparatus. Perfectone Radio Corporation, New York, N. Y. Claims use since October 1, 1923. Published February 12, 1924.



## Camco Pure Tone Unit

for any Loud Speaker Horn or Phonograph, talks like a winner and folks boost it as a winner. If you have the opportunity to hear it in side-by-side comparison, you will select the Camco.

Price \$8.00.



**Camco Headsets**  
Cannon Ball, \$3.50;  
Grand, \$5. *At your dealers or write.*

**CANNON & MILLER SALES CORP.**  
47 W. HURON ST. BUFFALO, N. Y.



## Simplify Your Set!

Increase Your Range—  
Improve Your Control—  
Hook Up a

# LEMCO

EQUIPMENT

### TRIPLE DUTY TUNER

Insist on Lemco Products. If your dealer hasn't them we'll forward prepaid on receipt of purchase price.

No. 100. Broadcast Tuner list (less dials) . \$7.50  
With Bakelite dials (as illustrated) ... \$8.70  
No. 340. Crystal Set (as illustrated) ... \$7.50  
No. 250. Reflex Coils ..... \$3.00  
No. 275. Reflex Units (with 17-plate condensers) ... \$8.00

*Illustrated, descriptive circulars sent on request.*

**LEE ELECTRIC & MFG. CO.** *Dealers and Jobbers*  
220 Eighth St. - San Francisco, Cal. *Write for Attractive Proposition.*



## SURE-FIRE

# D-X

## CRYSTAL

### THE MARVEL OF ALL SYNTHETIC CRYSTALS

Extraordinarily supersensitive all over. Ideal on Reflex circuits. Tested, sealed, guaranteed. Indorsed by N. Y. Mail and Tribune.

50c. Mtd. at all dealers or sent postpaid.

Specialty Service Co., 9 Hanson Pl., Bklyn. N. Y.  
Radio, Ltd., Montreal, Can. Canadian Distributors.



## "Lighting Fixtures"

### READY TO HANG

(Direct from Manufacturer)  
Completely wired including glassware.  
Send for Catalogue No. 26.  
(Just off the Press)

Special Proposition to Dealers  
**ERIE FIXTURE SUPPLY CO.**  
STATION R ERIE, PA.



- 188,636 "MONODYNE" for radio receiving apparatus. National Airphone Corporation, New York, N. Y. Claims use since about May 15, 1923. Published February 19, 1924.
- 188,637 "GOLD GRAIN" for detectors and receiving sets. National Airphone Corporation, New York, N. Y. Claims use since Oct. 12, 1922. Published February 19, 1924.
- 189,237 "NU-TRON" in ornamental design for amplifiers and tubes. Fred W. Brown, Bethesda, Ohio. Claims use since Nov. 22, 1923. Published February 19, 1924.
- 189,884 "DICTO GRAND" for loud speakers. Dictograph Products Corporation, New York, N. Y. Claims use since March 6, 1923. Published February 19, 1924.
- 180,464 "ACME" for radio apparatus. Acme Apparatus Company, Cambridge, Massachusetts. Claims use since about March 1, 1919. Published February 26, 1924.
- 180,480 "THE LITTLE GIANT" for radio apparatus. Metropolitan Radio Corporation, Newark, New Jersey. Claims use since on or about August 1, 1922. Published February 26, 1924.



T. D. Wick of Ohio was making \$4.60 a day in an office. By taking orders for Comer Coats he made \$13.60 profit in two hours.

J. C. McCardell lives in a medium sized town in Pennsylvania. In two days' time he made a clean profit of \$58.20 just by taking orders for Comer Coats.

R. A. Prentiss was working in a factory at small pay. He has made as high as \$945 in a single month selling Comer Coats.

## Will You Give Me a Chance to Pay You \$100 a Week?

### Timely Suggestions

(Continued from page 37)

fundamentals of radio with a better understanding. The adoption of newer circuits is also doing much to discourage the use of radiating receivers. We had best "grin and bear it," for it is a foregone conclusion that this disturbance will die a natural death.

#### THE AMATEUR

We now have the amateur transmitter up for consideration. As a source of interference, the amateur with his transmitting equipment has been positively proven to be the *smallest* offender! This fact has been established by countless investigations. It is true that in various cases, the small boy with his spark coil, or even his vacuum tube transmitter has caused some interference, but it can almost be said that the amateur as a source of interference can be passed by.

There is, however, a general misunderstanding among the broadcast listening public relative to the amateur transmitter. He is licensed as required by law to use wavelengths between 150 and 220 meters, the particular band for any particular station being determined from the apparatus used and the possibility of it causing interference with broadcast reception. He is distinctly *forbidden* to transmit between the hours of 8 p. m. and 10:30 p. m. daily, local standard time, or during the broadcasting of local church services on Sunday mornings. Although he may be strictly observing these and other provisions of his license, his transmitter is capable of causing interference of a most obnoxious sort with the broadcast receivers within a few hundred feet of him, even though he may be operating entirely within his rights. This is due to what is known as "shock excitation," and is, as yet, non-preventable. The broadcast listener located within the shadow of an amateur transmitting station must, therefore, share the air until the progress and development of the art cares for the situation. As a general rule, if the amateur is approached in the proper spirit he will willingly relinquish some of his lawful operating time in an effort to co-operate with the nearby broadcast listeners.

#### FOREIGN INTERFERENCE

We have covered the chief sources of interference from other radio services. Let us now consider foreign disturbances. The broadcast listener living near a hospital or a doctor's office where an X-ray machine may be in operation, experiences an annoying source of interference, as yet not provided for in the Radio Communication Laws. However, disturbances of this nature, including the violet-ray, are entirely prevent-

(Continued on page 108)

I want to make an offer whereby you can earn from \$100 to \$1,000 a month, cash. You can be your own boss. You can work just as many hours a day as you please. You can start when you want to and quit when you want to. You don't need experience and you get your money in cash every day when you earn it.

#### These Are Facts

Does that sound too good to be true? If it does, then let me tell you what R. A. Prentiss of Massachusetts has accomplished. Prentiss was working in a factory. His hours were long, his pay was small. He accepted my offer. I gave him the same chance I am now offering you. At this new work he has made as much as \$945 in a single month. If that isn't enough, then let me tell you about J. C. McCardell of Pennsylvania. He didn't know anything about selling. In his first month's spare time he made \$308 profit. Since then he has made as high as \$58.20 profit in two days.

T. D. Wick is another man I want to tell you about. He was working in an office at a pay of \$4.60 a day. But with this wonderful new work he has made as much as \$13.60 net profit from two hours' work.

Yes, and right this very minute you are being offered the same proposition that has made these men so successful. Do you want it? Do you want to earn \$40.00 a day?

#### A Clean High-Grade Dignified Business

Have you ever heard of Comer Coats? They are advertised in the leading magazines. Think of a single coat that can be worn all year round. A good-looking, stylish coat that's good for summer or winter—that keeps out wind, rain or snow, a coat that everybody should have, made of fine materials for men, women and children, and sells for less than the price of an ordinary coat.

Now, Comer Coats are not sold in stores. All our orders come through our own representatives. Within the next few months we will pay representatives more than three hundred thousand dollars for sending us orders. And now I am offering you the chance to become our representative in your territory and get your share of that three hundred thousand dollars. All you do is to take orders. We do the rest. We deliver. We collect and you get your money the same day you take the order. You can see how simple it is. We furnish

you with a complete outfit and tell you how to get the business in your territory. We help you to get started. If you only send us four average orders a day, which you can get in an hour or so in the evening, you will make \$100 a week.

#### Maybe You Are Worth \$1,000 a Month

Well, here's your chance to find out, for this is the same proposition that enabled Fred Roberts of Ohio to make \$56.00 profit in a single day's work—the same proposition that gave William Bernsheim \$15.00 net profit from a single morning's work. It is the same proposition that enabled James A. Wilson to make \$654 in his spare time.

I need 500 men and women, and I need them right away. If you mail the coupon at the bottom of this ad I will show you the easiest, quickest, simplest plan for making money that you ever heard of. If you are interested in increasing your income from \$100 to \$1,000 a month and can devote all your time or only an hour or so a day to my proposition, write your name down below, cut out the coupon and mail it to me at once. You take no risk, and this may be the one outstanding opportunity of your life to earn more money than you ever thought possible.

#### Find Out Now!

Remember, it doesn't cost you a penny. You don't agree to anything, and you will have a chance without waiting—without delay and without investment—to go right out and make big money. Do it. Don't wait. Mail the coupon now.

C. E. Comer, The Comer Mfg. Co.  
Dept. BS-82 Dayton, Ohio

### Mail This Special Coupon Now

THE COMER MFG. CO.  
Dept. BS-82, Dayton, Ohio

Please send me, without expense or obligation, your special proposition, and tell me how I can get a Buick Touring Car free.

Name .....

Address .....

(Write Plainly)







**Radio March:**

Another Prize Winner of RADIO NEWS Broadcast contest. Here, music lovers, is a wonderful number! Is there anything so appealing as the stirring strains of a military march?

**Listen In:**

Featured in RADIO NEWS Broadcast contest, has caught the fancy of all America! Its rare swing hypnotizes—and its tuneful melody makes it simply irresistible.

**Radio Jazz:**

Irresistible foxtrot. One of the prize winners of RADIO NEWS Broadcast contest! Young feet dance—old feet tap time, to the fascinating melody of this real masterpiece of jazz.



# RADIO HITS!

In a recent nation-wide Musical Radio Contest three compositions were selected from the hundreds of Manuscripts submitted as prize winners. These numbers have now been published in the conventional form so that Radio Music Lovers and also Music Lovers everywhere can enjoy these distinctly new hits in Popular Music.

These prize Radio Hits will be a sensation in your dance folio. They offer you the opportunity of buying three fine melodies at the same time each better than the other. It were as if you had picked the choice numbers out of hundreds of songs at your dealer.

These Radio Song and Dance hits will be exclusively Radio—to and for the Radio Public. They will be Broadcast from your local Broadcasting station. Listen in for them. Your local Radio Dealer will have copies for you. Look them over the next time you visit him or write us direct for your copies.

*Published and Distributed by*

**The Consrad Company, Inc.**

233 Fulton Street,

New York City

**35c**  
THE COPY  
—  
AT ALL  
RELIABLE  
DEALERS

# Consrad

**RADIO'S FOREMOST PUBLISHERS**



# They're All Local Stations

Lucius Pendleton, Mystic, Conn., gets Walla Walla, Wash. J. W. Sutcliffe, Bristol, R. I., gets Los Angeles. F. A. Thompson, De Kalb, Mo., gets London, Eng. They ALL come in like local stations with a

## "SHEPCO" "ALL WAVE"

Trade Mark—Patents Granted and Pending

### Non Radiating DX Coupler



Exclusive bank wound tapped primary and tapped secondary.

Build an "All Wave" Coupler into your set and bring in distant stations with volume and selectivity you never thought possible. Doubles and triples the efficiency of your tubes. Honeycomb coil performance in one compact unit. Eliminates inductance losses.

1500 Miles Minimum Guaranteed

Guaranteed wave lengths: "All Wave" Jr.; 150 to 1,000 meters in single circuit, 150 to 700 meters in non-radiating triple circuit. "All Wave" Sr., 150 to 3,000 meters. Not handicapped by short aerials.

Build your set the "SHEPCO" way and we guarantee results.



Irving Herman, 134 Woodlawn Ave., Albany, N. Y., after testing "SHEPCO" "All Purpose" Set, says: "Better than my two tube set. Distant stations come in as good as Schenectady, only 16 miles away."

## "SHEPCO" "All Purpose"

Trade Mark—Patents Granted and Pending

### Receiving Set

Patented "SHEPCO" features make this complete one tube set a wonderfully selective distance getter. Equal to one step of audio frequency for volume. Contains only best units, including "SHEPCO" "All Wave" Jr. Coupler, mounted on genuine Bakelite panel in finely finished mahogany cabinet.

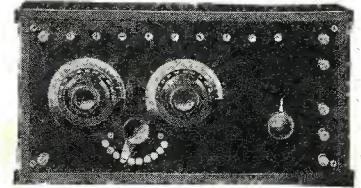

#### Interchangeable Circuits

Exclusive arrangement of terminals permits quick change of hook-ups without tools. Countless combinations possible. Ideal for novice or expert experimenter.

The parts bought separately would cost more than this assembled set. Without accessories.

**\$21**

Two Stage Audio Amplifier for use with "All Purpose" or any other set.

**\$21**

At all Dealers in Standard Radio Parts or Sent Prepaid on Receipt of Price

ABSOLUTE MONEY BACK GUARANTEE

SHEPARD-POTTER CO., Inc.

Plattsburgh, N. Y.

6 efficient hook-ups in every box or sent for 10 cents in stamps to cover mailing cost.

# CELESTO-PANELS

**H**ARD RUBBER is the most effective insulation for radio use—and CELESTO Panels are made of the finest grade of genuine hard rubber. When you build your radio set on CELESTO Panels you are therefore building on the bedrock of certainty.

Guard against losses by making CELESTO Panels your choice! CELESTO Panels are for sale by the better dealers everywhere. CELESTO Panels are packed in individual wrappers for your protection.



This trademark upon the wrapper identifies the genuine CELESTO Panel. Look for it!

CELESTO Panels are available in the following stock sizes:

7x9	7x30	6x24
7x10	7x40	6x26
7x12	6x9	6x28
7x14	6x10	6x30
7x18	6x12	6x40
7x21	6x14	8x12
7x24	6x18	8x40
7x26	6x21	9x28
7x28		

(Black and Mahogany Finish)

#### Some CELESTO Distributors

Bay State Panel Co.  
738 Broadway, New York  
Peerless Panel & Radio Co.  
38 Park Place, New York  
Viking Radio Co.  
16 Hudson St., New York  
Hub Cycle & Supply Co.  
19 Portland St., Boston  
New England Electric  
99 Bedford St., Boston  
Noble Radio Distrib. Co.  
9 S. Clinton St., Chicago  
Scott Bros., Ltd.  
332 St. Catherine St., Montreal  
Perkins Electric Co.  
247 Bleury St., Montreal

Northern Electrical Co.  
121 Shearer St., Montreal  
Vimy Supply Co.  
567 College St., Toronto  
Radio Engineers of Canada  
70 Granville St., Halifax  
Albert A. Bergman Co.  
12 N. Ninth St., Philadelphia  
Langsburch & Densten  
700 Bl. E. Balti. St., Baltimore  
Fulton Electric Co.  
65 Pryor St., Atlanta  
Sumter Radio Mfg. Co.  
Telephone St., Sumter, S. C.  
Perry-Mann Electric Co.  
Columbia, S. C.

Some Territories Are Still Open!

**TRIANGLE RUBBER & SUPPLY CO. 68-74 South St. Boston, Mass.**



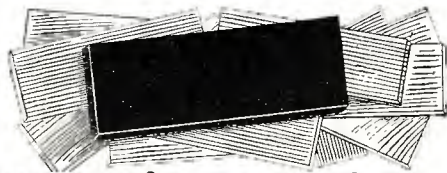

## The first choice of those who KNOW

When utter perfection in radio paneling is demanded uncompromisingly, Bakelite-Dilecto is chosen.

# bakelite-dilecto

(A Laminated Phenolic Condensation Material)

Finished a handsome, sleek, everlasting black. Almost unbelievably hard and tough for a material so readily machined. Will not warp, shrink, crack, swell, check, split or melt. Every fine radio set needs Bakelite-Dilecto panels to achieve highest results. Ask your dealer to get it cut and drilled to size for you.

## The Continental Fibre Co.

Factory: Newark, Delaware.

Service on Bakelite-Dilecto (also Continental-Bakelite, Conite, Contex and Vulcanized Fibre) from:

- NEW YORK, Woolworth Bldg.
- PITTSBURGH, 301 Fifth Ave.
- LOS ANGELES, 307 S. Hill St.
- CHICAGO, Wrigley Bldg.
- SAN FRANCISCO, 75 Fremont St.
- SEATTLE, 1041 Sixth Ave., So.

Offices and Agents Throughout the World

### We repair the following RADIO TUBES and Guarantee Them

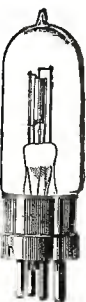

WD-11	.....\$2.50	UV-199	...\$2.50
WD-12	.....2.50	C-299	.....2.50
UV-200	.....2.50	UV-201A	.....2.50
UV-201	.....2.50	C-301A	.....2.50
C-300	.....2.50	Marconi	.....2.50
C-301	.....2.50	Moorhead	.....2.50
DV-6	.....2.50	6 v. Plain	.....2.50
DV-1	.....2.50	Detector	.. 2.50
DV-2	.....2.50	6 v. Plain	.....2.50
DV-6A	.....2.50	Amplifier	.. 2.50

Mail Orders solicited and promptly attended to. Dealers and Agents write for Special Discount.

H. & H. RADIO CO.

P. D. BOX 22-H  
Clinton Hill Sta., Newark, N. J.

## LEICH ELECTRIC CO.

Leich Headphones, Non Tune Rectifiers  
L'-Radio Jacks and Plugs  
Write for complete Radio Bulletin 101-C  
GENDA, ILLINDIS

(Continued from page 105)

able, and ordinarily the physician or the hospital authorities can be prevailed upon to take the necessary steps to eliminate it. Often certain parts of an X-ray machine are grounded. This results in the formation of an oscillating circuit when the machine is in operation. The ground should, therefore, be removed. Should the interference persist, the entire apparatus must be enclosed in a wire-screen cage, and the cage itself grounded. This is not an expensive procedure, but if the physician feels that the expense should not be his burden, small contributions from the suffering broadcast listeners would be accepted in good spirit.

Static, our next problem, we may as well pass over. No reliable method for practical home use has as yet been evolved for its elimination, and we can only await progress.

Let us consider next the inductive disturbances caused by leaky power lines. These manifest themselves in intermittent clicks, growls and buzzes, not unlike static, or sometimes in a low steady hum. The cause is generally a cracked insulator on a high power line, a wet tree branch touching a high potential wire, rain leaks across insulators or transformer cases. These all mean loss of money to the power company, and where such leaks are brought to their attention they will be only too glad to adjust them. Often such leaks can be located by comparing intensity of the disturbance at several receivers in the neighborhood. Look along your alley some dark, rainy night, particularly near pole transformers, and you may often see a little violet spark cavorting merrily across the wet insulation. In cold, snappy weather the leakage very often can be heard in the form of a crackling noise, audible for several feet from its source. The power company is the obvious remedy for these troubles.

### MINOR CAUSES

Minor causes of undesirable noise in the receiver are found in passing trolley cars—determined by gradually increasing intensity as the car approaches, reaching maximum when it is at the point nearest the antenna system and gradually decreasing as the car passes on.

Some great causes of noise in the receiver itself are run down and noisy "B" batteries, loose connections, particularly in the plate circuit of the tubes, and corroded contact pins on the base of vacuum tubes. The remedies in each case are obvious.

Small motors in the neighborhood may also cause an annoying hum; those on shoe repair machinery, meat-grinders and coffee-grinders, being common offenders. Fortunately, most of these are silent after the close of business at five or six o'clock.

A peculiarly persistent source of interference recently came to the writer's attention. It was finally found to be caused by mercury arc rectifiers in the garage of a large dairy company employing electric trucks. The operation of the charging rectifiers during the night in charging the truck batteries, produced a particularly disagreeable buzz.

We started out to discuss ways and means for improving our apparatus, and have wound up with a discussion of various sources of interference and their elimination. Perhaps it is as well, for running down interference is a sure method of improving reception. The summer season, when radio receivers are cast more or less in the discard, is a good time to put into practice all the little kinks and wrinkles picked up in the past winter.

Let us make our sets permanent. Dress them up. Put a neat cabinet around them; do a workmanlike job of the wiring and installation and go carefully over the whole set to see that there are no loose connections, or dirty contacts. Such time will be well repaid in the greater enjoyment derived from the receivers in the coming winter season.



# WORLD BATTERY

## Saves You 50%

Famous Guaranteed Quality and Service—  
Backed by Years of Successful Manufacture and  
Thousands of Satisfied Users.

**Prices That Save and Satisfy**

Auto Batteries	Radio Batteries
6-Volt 11 Plate, \$12.25	6-Volt 60 Amps. \$ 8.50
6-Volt 13 Plate, 14.25	6-Volt 80 Amps. 12.00
12-Volt 7 Plate, 17.00	6-Volt 100 Amps. 12.50
	6-Volt 120 Amps. 14.50
	6-Volt 140 Amps. 16.00

Special 2-Volt Storage Battery for W.D.11 and 12 tubes. Will run 200 hours on one charge. Rechargeable. \$5.00.  
Special 4-Volt Storage Battery for U.V.199 tubes. Same features as 2 Volt. \$8.00.  
Shipment express C.O.D. subject to examination. 5% Discount for cash in full with order.

**2-Yr. Guarantee Bond in Writing With Each World Storage Battery**  
proves satisfactory World performance. Just send your name and address and mention this advertisement and we will ship battery day order is received; and give you a 45-Volt "B" Battery and Hydrometer Free with each battery purchased. Write today.

**World Battery Company**  
Dept. 10, 1219 S. Wabash Ave.  
**CHICAGO, ILL.**

FREE

45 V. B. BATTERY  
and  
HYDROMETER

## EASTERN COUPLER

Price \$6.00  
An Unrivalled Value

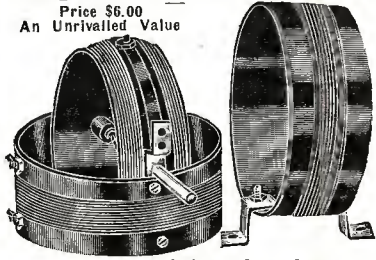

100% Efficient for the  
**SUPERDYNE CIRCUIT**

This circuit, which uses only four tubes, is the ONLY RIVAL of the SUPER-HETERODYNE and surpasses all other circuits for all around efficiency. Radio engineers all endorse the EASTERN COUPLER for maximum results with the Superdyne Circuit.

Wound with double silk wire on genuine bakelite tubing, with moulded rotor.  
This circuit is less expensive to construct than most 3 tube sets.  
Picture hook and material list FREE with each coupler. At your dealers or sent direct upon receipt of purchase price.

**EASTERN COIL CORP.**  
22 Warren St., Dept. RN, New York, N. Y.

ARE YOU A MEMBER  
**RADIO RAVENS?**



A Mutual Association for the Sole Benefit of Home Radioists.  
Membership—  
Saves you immense sums in the purchase of Equipment and Supplies  
Keeps you posted on every new feature of Radiology. Furnishes best experience and advice of thousands of Other Home Radioists.

**EVERY HOME RADIO FAN SHOULD BE A MEMBER**

Write for Circular B. No Cost or Obligation.

**RADIO RAVENS**  
1631 Howard Ave. Utica, N. Y.

### One Charger for All Batteries



Charges 2-volt peanut tube batteries, 6-volt A Batteries, 6- and 12-volt automobile batteries, and 1 to 4 B Batteries. It's the

**Valley Type ABC Battery Charger**  
**VALLEY ELECTRIC CO., St. Louis, Mo.**

**BRANCH MANAGERS WANTED FOR BLUE SEAL GUARANTEED RADIO**

If you have \$500 to \$1,000, and have a store or can get suitable space in a store, tell us about it and we will consider appointing you as our representative in your community.

**BLUE SEAL MANUFACTURING CO.**  
1406-8 South Michigan Ave., Chicago, Ill.



## How to Make and Use A Wave Meter

(Continued from page 47)

way, 5XV never goes above 200 meters as a transmitting wave.

The modus having been taken care of, next comes the construction of the meter. Obtain a good variable condenser, preferably one having a metal case with the rotary plates grounded to it. Also, it would be more than a good idea to have a vernier, as the fine adjustment is often wanted. Fig. 1 shows how to connect the coil and condenser, and is no doubt appalling in its simplicity. Fig. 2 suggests a possible method of mounting the coil on the condenser with rigid metal strips. The coil itself is of 19 turns of No. 20 D.C.C. wire and should be wound on a bakelite or other rigid type of form  $3\frac{1}{2}$  inches in diameter, and should be shellacked, varnished or bound into place to avoid losing the calibration once it is obtained. Nothing about a wave-meter should be variable but the rotary plates of the condenser, and they only in their fore-ordained manner. It is so easy to make a good job of this that there is no excuse in doing otherwise. But, above all, do it!

### OTHER COILS

Now you are wondering what you are going to do to increase the wave-length range of the thing, that you might check the higher waves as well. The process will amaze you in its simplicity—if you don't already know it.

Assuming, for convenience, that your wave meter has been calibrated for a wave range of 100 to 300 meters with whatever coil you happen to be using, the procedure to get the higher waves will be like this. Tune your receiver or transmitter, it doesn't matter which, to 200 meters, which, as you notice, is just double the minimum of your wave meter as it stands. This 200 meters will become the minimum of your new wave-meter calibration, which is to be exactly double that of the original coil; or, in the case of these illustrative figures, from 200 to 600 meters. (Please get it straight that these figures are just chosen at random to represent the scale your meter *might have*. It is necessary, though, to work out the system given here, to have a wave and its double: 150, 300; 125, 250; etc.) Now, having set your receiver or transmitter as exactly on that wave as possible, you should prepare the coil for the double range. The coil formerly mentioned was specified as having 19 turns, so this coil must cover just double the range of waves and will have 40 turns of No. 28 D.C.C. wire, or possibly smaller, on a form of similar dimensions. This should be wound carefully and tightly and given a *thin* coat of shellac. Make temporary connections of the wire terminals, for this coil is not yet finished. Attach the coil to your wave-meter and find out where, on the scale of the condenser, the 200-meter tuning point of the receiver, or transmitter, which you had set as per the foregoing, shows up. If it shows up exactly on the same reading that indicated the 100-meter point on the smaller coil, everything is O.K. If it falls below the scale reading that originally meant 100 meters, then things are also O.K., as that is what the coil is expected to do. Then, all that remains to do is to remove one turn at a time until the 200 points shows up *exactly* where 100 stood before, and the wave meter will be calibrated for just double scale reading. Further calibration will not be necessary for practical purposes, although it must be realized that this is not a laboratory precision method. The small coil, we'll say, originally read 150 meters at 50 on the condenser scale; the large coil will then, at 150, read 300 meters, and so on, covering the range of the meter, if care has been taken.

This method, of course, can be used to



# Soldering Hints

## for Summer Radio Fans

- ① Don't blame "static" entirely for poor summer results. Most similar sounds result from *loose connections*. During the summer *overhaul your set*. Inspect all contacts and make sure they are properly soldered—with *Kester*. One poor connection will jinx the whole set and kill all your and your friends' enjoyment.
- ② Those building portable vacation sets; use *Kester* while you're making it. And take a supply along; for even a successful journey is a hardship on a set. With *Kester* you have a solder ready and easy to use. It "requires only heat." Campfire will heat iron fine.
- ③ By all means heed these hints, for the value of good connections cannot be over-estimated. In most cases proper use of these hints will show surprising improvement in your D. X. reception.

"Requires Only Heat"



Underwriters' Laboratories Inspected

## Use KESTER Rosin-Core SOLDER for Radio Work

Kester Solder is ideal for Radio work. It's *safe, simple and economical*. It "requires only heat" because inside the hollow wire form of solder are tiny pockets full of scientifically prepared flux. This flows to the job bit by bit as the solder is used—saving the user's time and the material generally wasted by the old method.

For delicate Radio and electrical work Kester Rosin-Core Wire Solder is recommended. Standard diameter is about 3-32", and comes on 1, 5 and 10 lb. spools, 1 lb. coils in cartons, and 18" sticks in 5 lb. boxes.

For general soldering use Kester Acid-Core Wire Solder. Standard diameter is about 1/8". Packed on 1, 5 and 10 lb. spools and 1 lb. coils in cartons. Kester Solder is obtainable in standard size at most Radio, Electrical, Hardware and Auto Supply Shops.

Ask your dealer.

Manufactured by the

### CHICAGO SOLDER COMPANY

4245 Wrightwood Avenue, Chicago

Direct Factory Representatives

DAVIES-ELY CO., 149 Church St., New York City; 34 Portland St., Boston, Mass.

THE FAUCETTE-HUSTON CO., Chattanooga, Tenn.

LOUIS J. ZIESEL CO., 268 Market St., San Francisco, California





The voice from a thousand miles away!

There's an immense field of radio enjoyment in summer (the best political orators in America are on programs)—but you must have extremely sensitive reception apparatus to get good results.

## Stromberg-Carlson

HEAD SETS and LOUD SPEAKERS

have powerful magnets, the sensitivity of which gives them wide range, bringing in the fainter signals with volume and clearness.

They also have layer wound and layer insulated coils—an exclusive Stromberg-Carlson type of construction—which will stand up under the high plate voltages now used.

Ask your dealer

Stromberg-Carlson Tel. Mfg. Co.  
1060 University Ave.  
Rochester, N. Y.

Layer Wound and Layer Insulated

Powerful Magnets

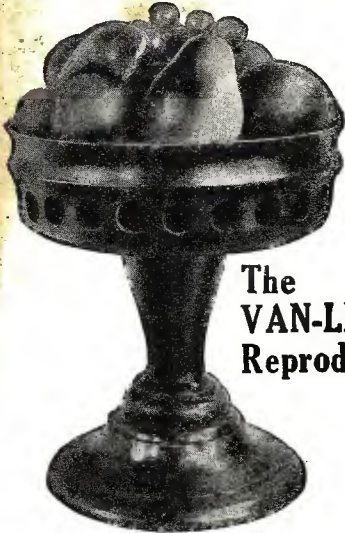
## The VAN-LE Reproducer

An entirely new and radical departure in the amplification of sound waves.

Throaty tones eliminated. Sound waves carry equally to any portion of the room.

Ask your dealer or write us.

Dealers write for our special proposition.

### VAN-LE CORPORATION

100 Sip Avenue, Jersey City, New Jersey

## RADIO EBCO CABINETS

"Ebcos Specials" and Standards. Solid Mahogany. Packed in Test Cartons. Prompt delivery. Write for prices.

### ELECTROTYPE BLOCKING CO.

410 West 27th St., New York City  
Phone Chickering 9843

make any number of coils, covering quite a range of waves, with passable accuracy and without any difficulty, once the thing is calibrated for one set of waves and one coil. One-half reading coils can be made as well as double reading ones, and so on *ad nauseam*. One hint, though, will not be amiss as to building the coils reading on half scale, if the original coil goes as low as 100 meters, for then your new minimum becomes 50. Unwind a turn at a time until the resonant point is achieved within about 10 meters, after which it becomes necessary to start spacing the turns on the coil to reduce the inductance. A single turn, on a small coil, throws too much meterage off at a time—makes too big a difference in scale reading due to the comparatively few meters the complete scale of the condenser covers, e.g., 50 to 100 meters on one coil makes one-half meter to the degree on a 100-degree scale, and as one degree off is a noticeable amount, it is obvious that it would take finer adjustment than a single turn to get exactly on the dot.

The importance of checking the calibrating wave several times during the operation is great because upon its accuracy depends the accuracy of the new range of waves.

Make the coil permanent by a finishing coat of the thin shellac and by soldering the coil terminals to the supports, attaching it to the wave-meter condenser, as in the illustration.

Using this method, I have built double and triple range coils that have checked within two to three meters of a Kolster decimeter, which is an accurate instrument, so that I feel really safe in recommending this method to you, only cautioning you to do it carefully.

One may also calibrate the larger coil by the method first described and using the carrier wave of some good broadcast station as the standard C.W. wave. Station WWV, at the Bureau of Standards, Washington, D. C., sends out some standard waves which are the most reliable to calibrate circuits and wave-meters.

### CALIBRATING RECEIVER

Having built the wave-meter and learned how to operate it, the next step should be to get some good use from it, such as calibrating your receiver, which will now be described. It saves hunting around for the wave-meter when you desire to know who is on what, and why.

It will be necessary, of course, to tabulate the settings of your receiver—all of them too—at the time of calibration and to keep various factors nearly constant, so that it will be possible to check waves at will and with accuracy.

Using a receiver of the same general construction as the one I gave data on in the March issue of RADIO NEWS, but in this case with a wave-length range of 73 to 320 meters and the one-step amplifier, that allows economical use of several headsets and to get away from possible variation being introduced into the detector circuit because of using several headsets or changing the number of them, the calibration curves shown herewith were made from these figures taken directly from the receiver by means of the wave-meter:

Scale	Meters	Scale	Meters	Scale	Meters	Scale	Meters	Scale	Meters
0-73	40-110	80-138	120-160	160-178					
10-80	50-118	90-143	130-164	170-182					
20-90	60-125	100-150	140-168	180-186					
30-101	70-132	110-155	150-174						

Antenna at tenth tap; load coil shorted out; "B" battery 9 volts on detector. Receiver tuned just past the oscillating point, controlled by the plate.

These, above, are the figures taken from curve No. 1 on the chart of Fig. 3.

The load coil referred to is the secondary load coil used in the circuit to get the second

# KLAUS

Complete Stock of

## Broadcast Receivers

Ready for shipment, KLAUS carries a complete stock of the latest and best broadcast receivers. All apparatus distributed by KLAUS is manufactured by the best manufacturers and bears the KLAUS GUARANTEE. Get our prices on amateur receiving and transmitting equipment.

## KLAUS RADIO BULLETIN for Dealers—Do You Get It?

Expert advice regarding radio problems, latest information about new equipment, and hints on radio merchandising which helps dealers make more money, is in every issue of the KLAUS RADIO BULLETIN. If you are not on our mailing list of dealers receiving the bulletin, send us your name and also receive our trade discount lists.

KLAUS RADIO & ELECTRIC CO.

Authorized Distributors

Dept. 200

EUREKA, ILL.

## Send for New MODERN Bulletin of Hook Ups

This new bulletin, issued by the manufacturers of MODERN "Push-Pull," "Reflex," and Standard Audio Transformers, is distinctly different.

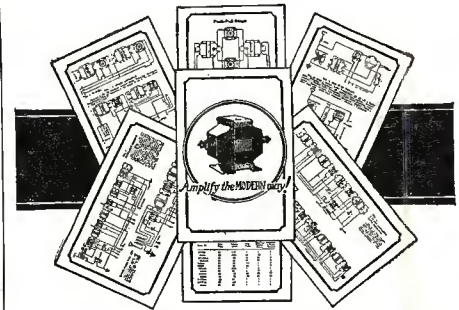

It so thoroughly, yet clearly, illustrates and describes the various hook-ups that any novice can easily build the set he desires without the assistance of some more experienced radio fan.

Your request giving your dealer's name brings this Bulletin by return mail. Send for your copy today.

The Modern Electric Mfg. Co.

Toledo, Ohio



## New York's Finest Radio Shop

Announce That Their LATEST CATALOGUE (which includes a complete log) is Now Ready For Distribution. To cover cost of mailing please send 10c. This will be credited to your first purchase of Radio supplies over \$1.00.

Harold Herbert, Inc.  
160 West 46th Street  
Just East of Broadway  
NEW YORK CITY

COCKADAY UNIT—Full Set A, B, C and D Coils

PRICE \$5.50

Three large blue prints, illustrated instructions and material lists for building the 1, 3 and 5 tube Cockaday sets

Price 50c (Free with order for unit)

General Radio Winding Co. 214 Fulton St., New York



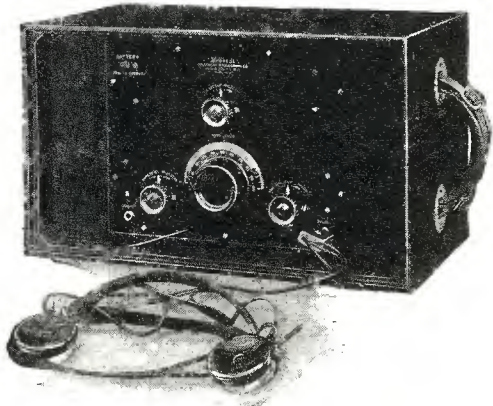

## Federal No. 102 Special Set Is CONVERTIBLE

"Convertible" is the only word that even nearly describes the Federal No. 102 Special Receiver. It is a complete "portable" set, with dry batteries, head phones, etc., ready for immediate camp or road use—PLUS the capacity for quick and easy changing to wet battery for city and country "home" use. True to Federal standards, the No. 102 Special incorporates exceptional tone beauty, selectivity and distance range. Federal flexibility pervades throughout—the No. 102 Special will operate perfectly on any tube interchangeably.

Ask any Federal Dealer for a demonstration of the Federal No. 102 Special Set.

FEDERAL TELEPHONE AND TELEGRAPH CO.  
Buffalo, N. Y.

Boston, New York, Philadelphia, Chicago, Pittsburgh,  
San Francisco, Bridgeburg, Canada, London, England

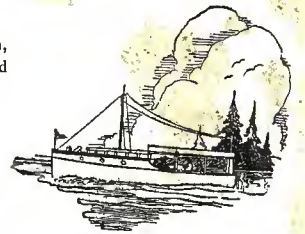

# Federal

Standard RADIO Products



**Western Electric VT-2 Tubes \$7.45**

Screws, Nuts and Miscellaneous for Set. Construction Book and Schematic Print.

3-Tube Set **\$28.60**

Complete Parts for 3 and 5 Tube

### NEUTRODYNE

With FREED-EISMAN or F.A.D.A. LICENSED PARTS. Parts for 5-Tube Set as follows:

- 7x28x3-16 drilled and engraved panel with baseboard.
- 2 Audio Frequency Trans.
- 3 Eria Bezels.
- 1 .001 Mica Condenser.
- 1 Mfd. By-Pass Cond.
- 3 Filament Control Jacks.
- 3 4-inch Dials.
- 1 Howard Vernier Rheostat.
- 1 Howard Plain Rheostat.
- 1 Strip of Bakelite.
- 8 Binding Posts.
- 1 Grid Leak and Mica Condenser.
- 2 Firth Sockets.
- 1 3-Gang Firth Socket with mountings and screws.
- 20 Feet Bus Bar Wire.

3-Tube Set **\$46.25**



MAIL ORDERS: Address, Dept. N-6, Chicago, Ill.

### SALVAGE MEANS Save, Service, Satisfaction,

When you buy radio apparatus from the Chicago Salvage Stock Store, the world's greatest radio store, you can be certain of these three things:

1. You have saved money through the hundreds of radio bargains made possible by our enormous buying power.
2. You have been served intelligently by men who are qualified radio experts.
3. You have bought quality apparatus because we handle nothing but brand-new merchandise GUARANTEED to give complete satisfaction.

Complete Parts for 1 and 3 Tube

### COCKADAY

Parts for 3-Tube Set as follows:

7x21x3-16 Drilled Panel and Baseboard	\$2.94
Cockaday Coil	1.95
2 Conso 26-Plate Ver. Cond. with Dials and Vern. Knobs	6.90
2 A. F. Transformers	8.00
1 Howard Ver. Rheostat	1.35
2 Howard 25-Ohm Rheos.	2.00
3 Firth Sockets	1.35
1 Switch Lever	.25
7 Points, 2 Steps and 8 Binding Posts	.55
1 Binding Post Strip	.05
1 Facet 2-Circuit Jacks	1.00
1 Facet 1-Circuit Jack	.35
3 Eria Bezels	.45
Grid Leak and Mica Cond.	.65
20 Feet Bus Bar Wire and Miscellaneous Screws, Nuts, etc.	.25
Schematic Blueprint	.50

1-Tube Set **\$11.95**

3-Tube Set **\$27.95**

**NEW CATALOG READY!**

Send 10 Cents for Copy Today



**10¢**

Hookups!

Complete Parts for a real 8 tube

- 8x40x1/4 Panel Engraved and Drilled.
- 43-Plate Webster Condenser,
- 23-Plate Webster Condenser,
- 8 Kellogg Sockets,
- 1 400-Ohm Frost Potentiometer.

Complete instructions for assembling and blueprints for wiring are included with each outfit. Instructions written so everyone can understand them.

### SUPERHETERODYNE

2 6-Ohm Rheostats,	2 1-Mf. Condensers,
5 .00025 Condensers,	1 Tuned R. F. Transformer,
1 .002 Condenser,	1 Oscillation Coupler,
1 .006 Condenser,	2 Jewell No. 54 Meters,
3 1-Meg. Leaks,	°10 D. C. Voltmeter,
2 4-inch Dials,	°10 D. C. Ammeter,
35 ft. Bus Bar Wire,	1 C Battery.
1 Single Jack,	
8x39 Base Board,	
7 Binding Posts,	
3 Radio Receptor 1716 Transformers,	
2 Radio Receptor Audio-Transformers,	

Our Price **\$9250**

Complete Parts for ALL Receivers

1-Tube Eria	20.90
2-Stage Amplifier	12.95
Honeycomb Receiver	17.95
Ultra Audion	8.95
Dverland Circuit	8.25
Haynes DX	10.95
Superdyne Receiver	15.85
Long-45 Circuit	16.25
Reinartz	11.45

Specially drilled panels are included with each of the sets illustrated and described here. We give this free service only on panels included with complete sets.



# The Greatest Book on RADIO ever written

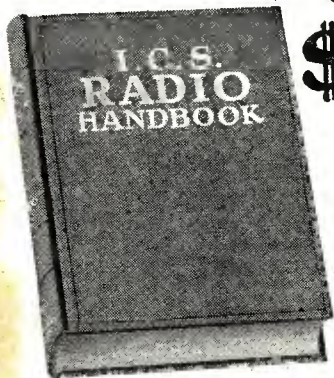

only **\$1**  
514 pages  
Pocket Size

40,000 ALREADY SOLD

Compiled by HARRY F. DART, E.E.  
Formerly with the Western Electric Co., and  
U. S. Army Instructor of Radio  
Technically edited by F. H. DOANE

New edition just off the press! The greatest book on radio ever written. Price only \$1. Filled with sound, practical, tested information for every radio fan, from beginner to hard-boiled owl. Written, compiled and edited by radio experts of national reputation.

Every page tells you something useful. And there are 514 pages! More than 150 illustrations and diagrams!

You may dip into this I. C. S. Radio Handbook at random, or hunt up special information you want, or read it right through. Different types of receiving and sending hook-ups are explained; interesting experiments; definitions; codes and symbols; technical data and thousands of suggestions for getting more pleasure out of radio. Will save you from wasting money on things that won't work. 40,000 already sold.

Send \$1 to-day and get this 514-page I. C. S. Radio Handbook before you spend another cent on parts. Money back if not satisfied.

INTERNATIONAL CORRESPONDENCE SCHOOLS  
Box 8280-C, Scranton, Penna.

I enclose One Dollar. Please send me—post-paid—the 514-page I. C. S. Radio Handbook. It is understood that if I am not entirely satisfied I may return this book within five days and you will refund my money.

Name.....

Address.....

## Travel As A Radio Operator

Scores of radio operators are now needed for the summer shipping trade. We prepare you in a short time for one of these positions. Radio Mechanics also needed. Inquire about these opportunities. Special course for amateurs.

Resident and Correspondence Courses.

**Y.M.C.A. RADIO INSTITUTE**  
158 East 86th St., New York

HEAD SETS LOUD TALKERS  
PHONO ATTACHMENTS

# TRIMM

RADIO MFG. CO., Dept. 66  
24-30 S. Clinton St. Chicago, Ill.

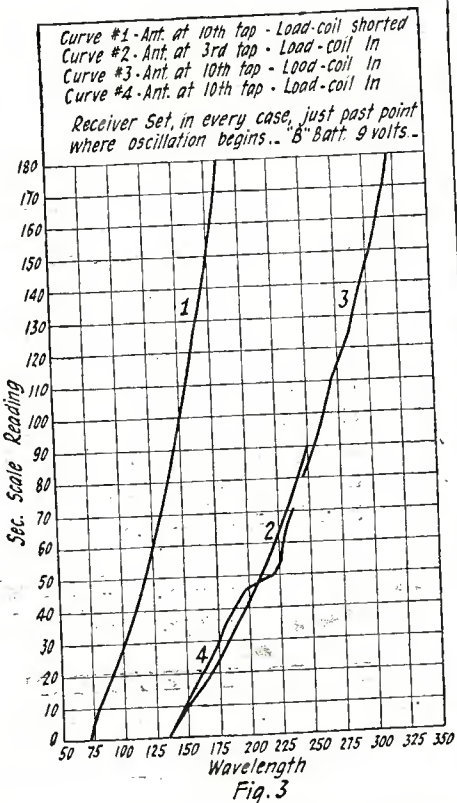

Wave-length curves plotted by Mr. Hatry for a receiver of the type described by him in the March issue of RADIO NEWS.

range of waves obtainable from curves 2 and 3. The antenna tap refers to the switch-point that the antenna tap switch happened to be resting on. (However, these taps were carefully chosen, as will be clear from what follows.) For curve 1, to get the lower range of waves, the load coil in the secondary circuit was shorted out. Curve 1 also holds accurate at 70 on the secondary scale and above, for the antenna switch at tap 1, but not below with that antenna setting, because of resonance effects with the small receiving antenna I use. The first antenna tap is important to me because that includes merely the single coupling turn for transferring the antenna energy and is the most selective position for tuning. With a large enough antenna, this single turn would be the most selective position for the whole range of amateur waves, barring resonance. A hard tube of some sort is the best type for the set, as it oscillates much the same over quite a variation of filament potential and thereby reduces the controls to one. The plate voltage is the same continuously for accurate calibration, and I consider myself lucky in getting a hard tube that works on nine volts.

### RESONANCE POINT

Curve 1 is explained sufficiently above and curves 2 and 3 are clear from the data on the curve sheet. Notice how smooth and straight they are in comparison to 4, which is really a continuation of 3 through the point of resonance that shows up at that big wave jump between scale readings of 45 to 50. Here the antenna circuit came in tune, which explains the necessity, for me, of curve 2. What it did to that perfectly harmless curve is bad enough, but it does even worse things to your selectivity, does this resonance point. Another fact is that it is almost impossible to get the same reading twice from this resonant antenna point, so that calibration is useless if such a condition occurs in a set like mine. With coupled sets, this is usually taken care of by loosening the antenna coupling coil for the necessary selectivity.

You can easily see that these curves give a knowledge of a receiver and the conditions under which it labors, that could be obtained

Complete Parts For The

## BREMER-TULLY "Nameless" R F Circuit

are now available in "Kit" Form

Kit No. 1—includes Vernier Condensers and Rheostats, 3-Circuit and Audio Transformers, Jacks, drilled and engraved panel, sub-base, etc. (everything for 5-tube set except Tubes, Cabinet and Phones)—all parts of every highest grade manufactured. Price \$63.50

Kit No. 2—essential B-T parts for 5-tube set.  
3—0005 Vernier Condensers  
3—3 Circuit Transformers  
2—3 Plate Condensers  
1—Set Diagrams, etc. Price \$26.50

Diagrams furnished with above show complete diagrams and instructions for building on the now famous "Step-by-Step" plan—circulars on request.

**Bremer-Tully Mfg. Co.**  
Canal and Harrison Sts. Chicago, Ill.

A Pleasant Surprise Awaits the User of the A. C. H. SHARP TUNER DIALS

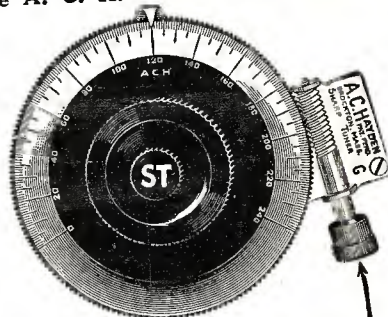

Why the A.C.H. is different  
3 in. DIAL (156-10-1)  
4 in. DIAL (215-10-1)

Will improve any receiving set, making difficult tuning easy  
Money Back Guarantee

Price 3" size...\$2.50 Price 4" size...\$5.00  
Regular fitting 5/16 shaft 1/4 and 3/16, 5c each extra  
Extra Advantage of the A.C.H.

1. Can be attached or removed from any instrument.
2. Rough tuning same as any dial.
3. Movement so fine that the eye cannot detect but the ear can.
4. Automatically locks instrument so no jar can disturb it.
5. Dial grounded reducing the body capacity to a minimum.
6. Special dial 2 graduations where ordinarily one.

MAIL ORDERS SENT PREPAID IN U. S. A.  
**A. C. HAYDEN RADIO & RESEARCH CO.**  
BROCKTON, MASS., U. S. A.

## GHEGAN RADIO RELAY

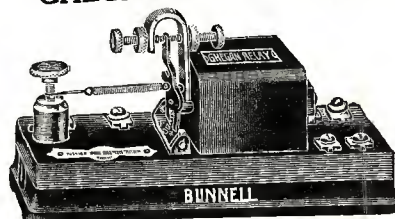

Taps permit tubes of various impedances to be used. With Bunnell Register this Relay will copy telegraphic signals at a speed of 60 to 90 words per minute. With Siphon Recorder speeds up to 200 words per minute have been obtained. Normal operating current is 1/2 to 2 Milli-Amperes. Send stamp for catalogue No. 43-B.

Ghegan Radio Relay .....\$40.00  
Special Price to Dealers  
J. H. BUNNELL & CO., 32 Park Pl., New York City



only indefinitely over quite a length of time and experience operating it. So I eliminate most of the time and save all that experience for a more useful purpose by gaining my knowledge from the curves which only required, with some others, a couple of hours of easy and pleasant work.

**SCHEDULE OF STATION WWV**

(Wave-lengths in meters in parentheses)

Eastern Standard Time	June 20	July 7
11:00 to 11:08 P. M.	550 (545)	1363 (220)
11:12 to 11:20 P. M.	650 (461)	1430 (210)
11:24 to 11:32 P. M.	750 (400)	1500 (200)
11:36 to 11:44 P. M.	833 (360)	1600 (187)
11:48 to 11:56 P. M.	940 (316)	1700 (176)
12:00 to 12:08 P. M.	1050 (285)	1800 (167)
12:12 to 12:20 A. M.	1150 (261)	1900 (158)
12:24 to 12:32 A. M.	1250 (240)	2000 (150)

**OTHER STANDARD WAVE STATIONS**

Station	Location	Wave-length in Meters
WWJ	Detroit, Mich.	517
WCAP	Washington, D. C.	469
WRC	Washington, D. C.	469
WSB	Atlanta, Ga.	429
WGY	Schenectady, N. Y.	380
KDKA	East Pittsburgh, Pa.	326

**American Broadcasting at 5000 Miles**

(Continued from page 55)

Pa., was received. The program lasted, in all, some four and one-half hours. This is believed to be the first successful reception of a United States broadcast station in Chile or the Argentine.

The first identified and proved reception up to the present time is, however, WEAJ. Their whole program was received on the evening of December 30. In this case items were quoted to New York by cable and cable confirmation was received, whereas KDKA was asked to confirm the program by letter and no reply has, as yet, been received.

Other stations identified but not confirmed are WGY and KHJ. All announcements from these two stations were quite intelligible. Others which are doubtful owing to difficulty in understanding the announcers are KPO, WNAQ, WJAZ, WOC and WBAP. There are at least a dozen other stations from which music was heard quite well but whose announcements were absolutely unintelligible.

This, of course, brings me to a most hearty support of the RADIO NEWS editorial of January, 1924, in which it was suggested that stations use an automatic transmitter to send their call letters slowly in code.

This is a magnificent idea, yet there is one further point about it that the editor did not mention, i.e., the advantage for the listeners who do not speak English. It is difficult enough to distinguish letters like "B," "D," "E," "G," "P," "T," "V" and "Z" even for an English speaking person. But what chance has the unfortunate listener unacquainted with the English language to determine a call such as WHAZ when it is spoken as "doubleyou aitch ay zee" and he knows them as "doblevay achi ah theta"? whereas the code is international.

It is interesting to note that the Argentine should have set the example to the world in this respect. There is already one station in Buenos Aires, operated by Senor Brusa, where the call letters TCR are sent automatically during the interval between one rendition and the next. This is accomplished by a tube oscillating at audio frequency which is connected into the microphone circuit.

This is the second time that Buenos Aires has led the radio world, having also been the first city to broadcast a complete season of opera from the theatre.

**USE "RAGECO" TOOLS TO BUILD BETTER RADIO SETS**

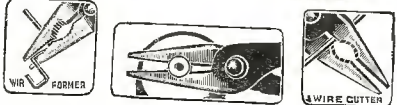

**AR202. Combination Plier, Wire Cutter, Wire Former and Wrench.** Drop forged, slender but exceptionally strong. 6 inches long.

Price .....75c

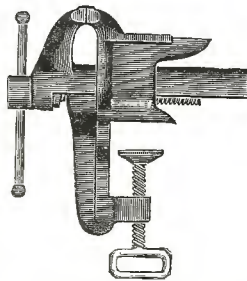

**AR700. Bench Vise.**

This vise can be clamped to any table. Can be used for filing, sawing, drilling, soldering etc. Very

strong jaws, 1½ inch face. Black japanned and finished.

Price .....60c

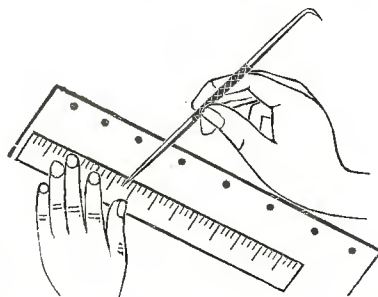

**AR600. Scribe and Marker.** Made of finest steel with hardened and tempered points, 8 inches long. Invaluable to the radio constructor to lay out and mark his panel. Marks on hard rubber, brass, steel, wood, etc.

Price .....25c

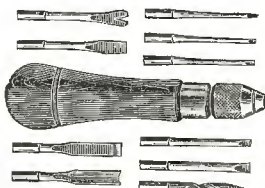

**AR400. Hollow Handle Tool Set.** Genuine Coco Bola handle, containing the following tools, four inches long, made of tempered steel:

Chisel, Reamer, Small Screw Driver, File, Brad Awl, Saw, Large Screw Driver, Scratch Awl, Gimlet, Gouge. Chuck is of the latest, most approved type, with hardened steel jaws.

Price per set .....\$2.25



**AR301. Three-in-One Nut Wrench.** Consists of handle with hollow stem 6 inches in length and three interchangeable sockets fitting popular sizes of nuts. The hexagon sockets grip the nut solidly.

Price per set .....65c

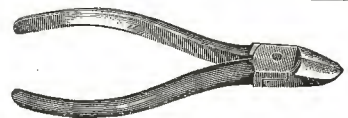

**AR201. Side Cutting Nipper, Lap Joint.** For cutting all kinds of wire. Jaws hardened and oil tempered. Natural steel finish with polished jaws. Length 6 inches.

Price .....75c

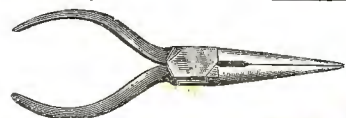

**AR200. Long Sharp Nose, Side Cutting Pliers.** Just the pliers for the radio constructor. Bends and cuts all kinds of soft wire. Nose 1½ inches long, black body, polished jaws. Length 5½ inches.

Price .....75c



**AR300. Set of Three Screw-Drivers.** Specially selected for the radio constructor. Black handles, popular fluted design. Round steel blades, with flat sides of point; nickel plated ferrule; lengths, 4¾, 5¾ and 7¾ inches.

Price per set .....60c



**Radiogem Complete Radio Receiving Outfit \$2.50**

This outfit is absolutely complete. Nothing more to buy—no batteries or tubes needed—no upkeep of any kind. The simplest radio outfit made—you build it yourself. So simple that anyone can construct it. Complete instruction book with every outfit.

Complete Radiogem Outfit .....\$2.50  
The Radiogem only ..... 1.00  
The Gemphone only ..... 1.00  
Aerial Outfit only ..... .50

Order by order numbers. Remit by check, money order, stamps or cash. All goods are shipped free of transportation charges to all parts of U. S. and possessions same day as order is received. If not satisfied, money will be refunded upon return of goods.

**The Radiogem Corp.**  
66-R-West B'way, N. Y. City

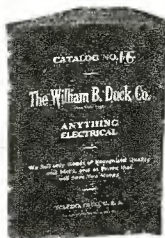

**DUCK'S 5 Tube Super Tuned Radio Receiver \$120.00.** Extreme simplicity of operation, wonderful selectivity, unmatched tone and maximum volume. The finest workmanship and highest quality instruments characterize this receiver. Backed by 16 years of continuous radio experience. Sold on money back guarantee.

4 Tube "Bear-Cat" Tuned Radio Receiver \$95.00. Same workmanship and quality of instruments as in our 5 tube set.

Jobbers and Dealers, write for literature and proposition. Literature mailed to anyone on request.

Our 256 page radio catalog No. 16 mailed for 25c in coin. Not sent otherwise.

**The William B. Duck Co., Dept. 3 711-12 Adams St., Toledo, Ohio**



## for Reflexing— BALLANTINE VARIOTRANSFORMER

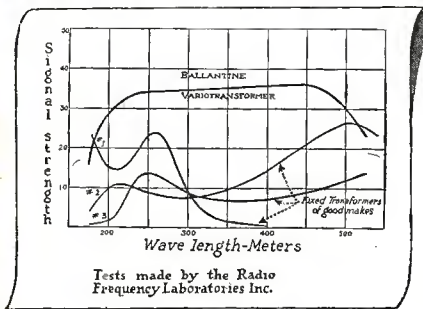

### Tuned Radio Frequency in Most Compact Form

That summer portable set you're planning—is it a reflex? Surely, it has some form of tuned r. f. for use on small antenna or loop. Well, here's a *tunable* transformer that requires scarcely one-fourth the usual space.

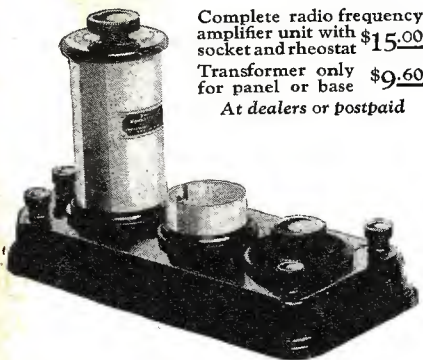

Complete radio frequency amplifier unit with socket and rheostat \$15.00  
Transformer only for panel or base \$9.60  
At dealers or postpaid

The superiority of the BALLANTINE variable over fixed transformers is shown by the curves. Consider this uniformly high amplification throughout the broadcast range—in connection with compact form. Then build with BALLANTINES.

Keep your set "on its toes" all summer with the BALLANTINE VARIOTRANSFORMER

**BOONTON RUBBER MFG. CO.**  
Pioneers in Bakelite Moulding  
624 Fanny Road, Boonton, N. J.

## RADIO FANS

Would you like to get a start as salesman or dealer in the radio field? We manufacture one of the best receiving sets and parts on the market. We want local representatives in your district. We show you how to get started in the radio business. If you are familiar with radio you can earn a big income immediately. This is open to part time men. Write to

**Mr. Howard, 1249 Wilson Ave.,  
Chicago, Ill.**

### 199 NECESSITIES

WIMCO 199 SOCKET .....\$ .75  
WIMCO 199 C SOCKET ..... 1.00  
WIMCO 199 ADAPTER ..... .75

Send for free literature  
Jobbers' inquiries solicited

**THE WIRELESS MFG. CO., Canton, O.**  
MANUFACTURERS—DISTRIBUTORS

Excuse this spasm of local pride from an English resident.

Returning to the receiving set employed in these essays, the primary and secondary of the radio frequency transformer are closely coupled, being wound together, half of each on the rotor and half of each on the stator of a variometer. Movement of the rotor, therefore, alters the inductance of the primary and the secondary thus accurately tuning the transformer. Furthermore, when one tunes the antenna circuit (by the ordinary variable condenser) and the transformer (by the rotor) to the same, or approximately the same, wave-length there is considerable regeneration created by inter-element tube capacity. From this it can be gathered that there are but two tuning elements, the condenser and the rotor of the variometer.

It is easy to tell when they are in tune by the fact that when the tube oscillates a carrier wave can readily be picked up. By proper adjustment zero beat point is reached and the speech frequency is passed minus the carrier wave. This set is just as easy to operate as the ordinary regenerative set with the same number of controls.

## Distortionless Broad- cast Reception

(Continued from page 50)

With our receiving set we can, with small additions, usually correct this at a loss of some volume which is not of great importance, because its necessity is imaginary more than real.

Try putting condensers across the resistances R-5 or R-6—anything you have for an experiment.

A .001 mfd. condenser will not have such action.

A .01 mfd. condenser will decidedly cut down the high tone.

A .1 mfd. condenser will muffle very greatly—giving orchestras a very decided distant sound.

Now try some inductance coils; and here is an inductance coil which will be generally useful. A standard transformer iron core is

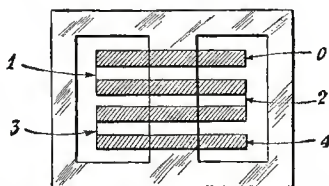

Fig. 4. How to use a standard transformer coil for the choke coil windings.

used, as shown in Fig. 4. Four sections, each of 600 turns of, say, No. 38 D.S.C. wire are wound and connected in series, arrangement being made for taps

Henries  
The total inductance is about ..... 10  
Half the number of turns will be .. 2.5  
Quarter the number of turns will be .6  
So that if you wind this with four sections and take off taps, you have a useful choke coil.

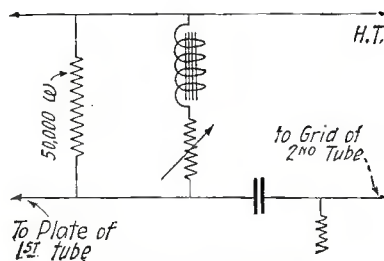

Fig. 5. How a choke coil and series resistance are connected in the circuit.

# PATENTS

**To the Man with an Idea**

I offer a comprehensive, experienced, efficient service for his prompt, legal protection and the development of his proposition. Send sketch, or model and description, for advice as to cost, search through prior United States patents, etc. Preliminary advice gladly furnished without charge. My experience and familiarity with various arts frequently enable me to accurately advise clients as to probable patentability before they go to any expense. Booklet of valuable information and form for properly disclosing your idea free on request. Write today.

**RICHARD B. OWEN**  
PATENT LAWYER  
2 Owen Building, Washington, D. C.  
2276A Woolworth Bldg., N. Y. City

**PATENTS** WRITE for our Three Guide Books and "RECORD OF INVENTION" before disclosing inventions. Send model or sketch and description of your invention for Examination and Instructions. Electrical cases a specialty. Highest references, reasonable terms, prompt attention.

No charge for the above information.

**VICTOR J. EVANS & CO.**  
919 NINTH ST., WASHINGTON, D. C.

## PATENTS

**DON'T LOSE YOUR RIGHTS**

Before disclosing your invention to anyone send for blank form "EVIDENCE OF CONCEPTION" to be signed and witnessed. Form and information concerning patents free. **LANCASTER & ALLWINE**, 270 Ouray Bldg., Washington, D. C. Originators of the form "Evidence of Conception"

## PATENTS

Trade-Marks, Copyrights and Patent Litigation

Write for advice and instructions how to proceed, costs, etc. Hand Book with illustrations of 100 Mechanical Movements sent free on request.

**ALBERT E. DIETERICH**  
Patent Lawyer and Solicitor  
Successor to Fred G. Dieterich & Co.  
690A Ouray Bldg., Washington, D. C.

## PATENTS

C. L. PARKER  
Formerly Member  
Examining Corps,  
U. S. Patent Office.  
PATENT - LAWYER  
McGill Bldg., Wash., D. C.

Patents, Trade Marks, Copyrights, Patent Litigation  
Handbook for Inventors, "Protecting, Exploiting and Selling Inventions," sent upon request.

## EARN MONEY AT HOME

YOU can make \$15 to \$60 weekly in your spare time writing show cards. No canvassing or soliciting. We instruct you by our new simple Directograph System, supply you with work and pay you cash each week. Write today for full particulars and free booklet.

**WEST-ANGUS SHOW CARD SERVICE LIMITED**  
Authorized Capital \$1,250,000.00  
154 Colborne Building, Toronto, Can.

## RADIO

FOUR-PHONE PLUG  
for  
STANDARD JACKS

CONNECTS IN SERIES ONE TO FOUR HEAD SETS

**The BARKLEW ELEC. MFG. CO.**  
MIDDLETOWN, OHIO. CAT. NO. 616 PRICE 1.50



If you put .6 henry across R-5 or R-6, the lower tones will be greatly reduced and speech becomes high pitched and super-intelligible (of course, weaker, due to the loss of amplification).

2.5 henries will be much less effective, but the four taps will enable you to vary the ratio of high and low notes considerably. Perhaps a simpler way to make this easily variable is to stick to a .6 henry and vary a series resistance in series with it. This is illustrated in Fig. 5.

The advantage of doing this operation on a tube plate resistance is that you can calculate exactly what you are doing.

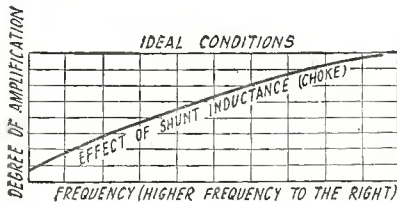
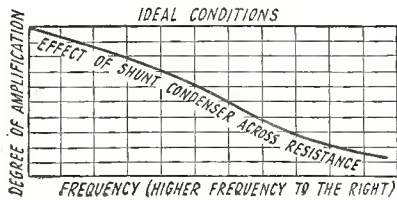

Figs. 6 and 7 herewith show the effects of a shunt condenser and a shunted resistance in the phone circuit.

In general, a condenser, shunted across the resistance does what is shown in Fig. 7 to our broadcast signals. It will be seen that the degree of amplification decreases on the higher notes.

Fig. 8 shows the effect of a shunt inductance, or the alternative arrangement of Fig. 6. The higher the note, the greater the amplification. In other words, the condenser weakens the higher notes, while the inductance accentuates them. The addition of resistance in series with the inductance holds down its action.

If we did the two operations together, then we would produce a curve, which would only exaggerate our head-phone curve, but if we put a condenser in series with the inductance and make the minimum impedance frequency the same point as the maximum response of the phone, we can see that a partial correction of our telephone curve is possible.

A good combination for most head-phones is shown in Fig. 9, and this combination is connected across one of the resistances in the resistance amplifier (e.g.,  $R_5$  in Fig. 2). You will quickly find approximately the best position for the condenser, which should be adjusted first with R at zero, as there is a peculiar place where speech changes over from muffle to nasal through an intermediate

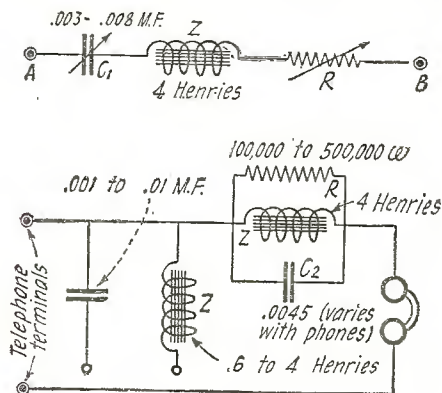
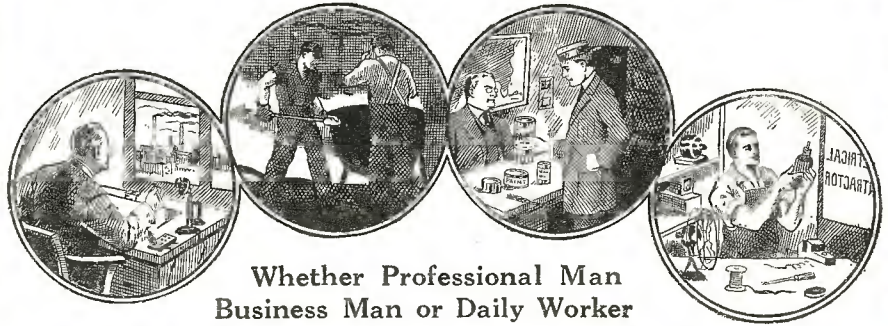

Fig. 8. Above: A good combination for most head-phones.  
Fig. 9. A good circuit applying the ideas covered in this article.

# No Matter What Your Vocation



Whether Professional Man  
Business Man or Daily Worker

## A Thorough Training In CHEMISTRY Will Help You To Get Ahead

**T**O be successful today is to know Chemistry! Every line of business, every branch of industry depends upon Chemistry in some form. You may not realize it, but your own proficiency in whatever work you are doing would be increased by a knowledge of Chemistry. In many lines such knowledge is absolutely essential. In others it is a guarantee of promotion and more money.

The keen competition that exists in every commercial activity today requires that a man know all there is to know about his vocation. If you have something to sell—no matter what—Chemistry enters into its makeup. The salesman who knows the chemical composition of his article can talk about it more intelligently than the one who lacks this information, and his sales are proportionately larger. In the building trades Chemistry is of prime importance. The mason, electrician or painter who knows something about Chemistry can do better work and command more money than the one who does not. Through Chemistry a shop-keeper learns how to attract the most trade, and even in clerical positions one can capitalize his chemical skill.

Chemistry should be as much a part of your mental equipment as the ability to calculate or to write correct English. The world is paying a thousandfold more for ideas than for actual labor. The big rewards go to the man who can show how to turn out a little better product at a little lower cost. And Chemistry will give you the ideas that will save money for yourself or your firm in the very fundamentals of your business. There is nothing remarkable about this; it is going on every day. If you have not heard of it before, it is because the general public has been slow to recognize the tremendous value of chemical training. People have been content to leave Chemistry in the hands of a few trained chemists who could not possibly develop the subject to anywhere near its greatest extent.

Now we are on the eve of a great awakening. Our heritage from the World War has been an intense development of the chemical industries in the United States and a tremendous interest in all the applications of Chemistry. People are taking up the subject merely for the good it will do them in their own line of business.

It is no longer necessary to enter college in order to learn this fascinating science. Our Home Study Course trains you just as thoroughly, and with the same assurance of success, as those who took the longer way. And our methods are so simple that we can teach you no matter how little previous education you may have had. Many of our graduates now hold responsible positions or have materially increased their incomes from private enterprises as a result of taking our course. Hundreds of letters from students testifying to the benefits they have derived from our training are here for your inspection.

Remember that you do not need to study Chemistry with the idea of actually practicing as a chemist, although a great many of our students are taking our course with this object in view. If you want to know more about what Chemistry will do for you, if you want to know what our home study course offers, sign and mail the coupon today for FREE BOOK, "Opportunities for Chemists."

**Chemical Institute  
of New York, Inc.**

HOME EXTENSION DIVISION 7  
66-R West Broadway, New York City

**DR. T. O'CONNOR SLOANE**  
Will Teach You Chemistry  
In Your Own Home

The Chemical Institute of New York, of which Dr. T. O'Connor Sloane is Educational Director, was founded to fill the need of ambitious, far-sighted men who realize and recognize the splendid future Chemistry offers them, but who cannot spare either the time or the money to attend college. Dr. Sloane, a foremost authority on Chemistry, will teach you and will give you any individual help you may require. He will personally go over your papers, correct them, point out your faults, teaching you in a practical and interesting way. No special education required other than the ability to read and write English. One student has characterized our lessons as "The course that takes the mystery out of Chemistry."

**Read What One of Our Recent  
Graduates Reports**

"I thought I would let you know of my success. I finished your course about two months ago and now have a fine position as chemist at the DuPont Dye Works. I am getting along fine with my work and like it very much. It was through your course alone that I have been so successful. It is wonderful and I hope you have great success with it."

(Name and Address on request).

**Easy Monthly Payments**

You do not have to have even the small price of the course to start. You can pay for it in small monthly payments—so small that you won't feel them. The cost is very moderate, and includes everything, even the Laboratory Equipment—there are no extras to buy with our course. Our plan of monthly payments places a chemical education within the reach of everyone.

**Laboratory Equipment Given  
To Every Student Without  
Additional Charge**

We give to every student without additional charge his chemical equipment, including forty-two pieces of laboratory apparatus and supplies and seventeen different chemicals and reagents. These comprise the apparatus and chemicals used for the experimental work of the course.

**Special 30-Day Offer**

For a short period we are making a special offer that will be worth your while to take advantage of. Write for particulars, using the coupon below or simply a postal card. This will not obligate you in the least. Do not wait until tomorrow. Send the coupon now while you think of it.

**Sign and Mail the Coupon for  
FREE BOOK**

CHEMICAL INSTITUTE OF NEW YORK, Inc.  
Home Extension Division 7,  
66-R West Broadway, New York City

Please send me at once without any obligation on my part, your Free Book "Opportunities for Chemists," and full particulars about the Laboratory Equipment furnished to every student. Also please tell me about your plan of payment and your special 30 day offer.

NAME .....

ADDRESS .....

CITY .....

STATE .....

R.N., 7-24



# KENNEDY PORTABLE Radio Receiver

MODEL III

*A handsome set for auto trips, camps, summer cottages or any room in any home at any time of year.*

A FIRST class regenerative receiving set that can be picked up and taken along anywhere. Completely self-contained—batteries and all. Operates on any aerial—or even with a wire fence for an antenna. Stations are always found at the same dial setting—wherever you are and regardless of the kind of aerial used.

—88—

Licensed under Armstrong Patent No. 1,113,149

Write for special circular.

THE COLIN B. KENNEDY CO.  
Saint Louis, Missouri

*The Royalty of Radio*

position which is the correct one. Without resistance, this may overdo the effect and give you 'speech which is full of "S" sounds, and low tones, but no middle ones. It all depends on your head-phones—how much resistance you must have to put in, to get it quite right. Voice and piano are the best to listen to, particularly if you know the man's voice.

After you have done all you can with the combination, you may still be a bit dissatisfied; then across  $R_6$ , if you are already using a combination across  $R_5$ , try the condenser "tone lowerer" or the inductance "tone raiser." You have available:

1. A tone-lowerer.
2. A tone-raiser.
3. A middle-weakener (the Fig. 9 combination without the resistance R).
4. And if you so desire, you can arrange two middle-weakeners for different maxima.

And now one more point. You probably know what blasting means—I will define it as when, either in the transmitter or the receiver, the tubes are carried beyond their straight line limits, i.e., the representative point travels around the bend in the characteristic turn. Harmonics are produced by these blasts.

Now on these receivers which I have shown, with "head-phone strength" of signals at the end, you are not likely to blast, so the blasts will be transmitter ones, because those produced by frequencies around 1,000 are much more noticeable on these corrected circuits than on any ordinary circuit. The reason is obvious—the 1,000 note is exaggerated in ordinary reception and any false harmonic passes unnoticed, but with the correct circuit the higher harmonic is given out in its right proportion. However, there is a counterbalancing advantage. Blasting by bass note is exaggerated by the ordinary head-phones, but minimized by the corrected circuit.

Those who do these experiments thoroughly will be very well satisfied, however critical they may be; voice, pianos and orchestras will be very much better than ever heard before.

Just one last word to those who have little time and patience. I will give a circuit, showing a crude way of doing the previous tests, though not so satisfying, but quite effective, if your receiver is fairly distortionless to start with.

The condenser  $C_1$  and the iron core inductance (choke) Z, may, if desired, be connected across the head-phone terminals of the set. The condenser  $C_2$  (.003 mfd. to .008 mfd.) depends on the phones, the choke Z (4 henries) and the resistances all enable different combinations of tone lowerers, tone-raisers, etc., to be obtained. All sorts of interesting experiments may be carried out by making different combinations of inductances, condensers, etc.

## A Reflex Receiver With Neutrodyne Control

(Continued from page 49)

plate and grid elements of the vacuum tube. Actually, more critical observation will show in many cases, that the real cause of self-oscillation is to be sought in casual magnetic and electrostatic couplings aside from the extremely small tube coupling. It is not generally realized that a tuned plate coil will, at times, produce violent oscillations when brought within a foot of the grid circuit in one position and will stop those oscillations immediately when the coupling is reversed. The casual couplings in a small compact receiver, such as the one to be described, is almost always sufficient to bring about self-oscillation, even when using tubes having a low inter-element capacity. It will be no-

## The Peak of Radio Perfection

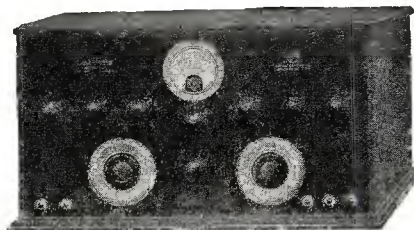

Type LR-170, 3 Stages Radio, Detector 3 Stage Audio Frequency Amplification

# Uni-Tune

TRADE MARK

## Receiver and the LOOP TUNER

TRADE MARK

Eliminates Aerial and Ground with Clearer Reception. EXTREME SELECTIVITY with easy manipulation. FLEXIBILITY—4 to 7 tubes may be used at will. RANGE—DX stations on the Loud Speaker. SPECIAL WESTON VOLT-METER—Showing A and B Battery voltages. Contains all batteries for dry cell operation. Write for Circular "R."

NASSAU RADIO CO., Inc.  
60 COURT ST., BROOKLYN, N. Y., U. S. A.

## RADIO "B" BATTERY

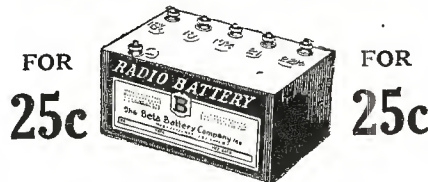

FOR 25c FOR 25c

Owing to great demand we have decided to extend this introductory offer for another month. Every Battery Guaranteed. The latest in "B" Batteries for VOLUME, DISTANCE and LASTING POWERS.

	One Battery	Two Batteries
22½ volt, large	\$2.50	\$2.75
22½ volt, medium	1.90	2.15
22½ volt, small	1.50	1.75
45 volt, large	5.00	5.25
45 volt, medium	3.80	4.05

Only Two to a Customer



Send Money Order to  
ETA BATTERY CO., Inc.  
15 Whitehall St., N. Y.  
Manufacturers of Radio "B" Batteries Only

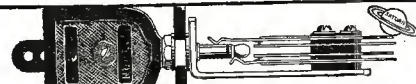

## The Saturn

Perfect Jack and Automatic Plug  
Write for Literature

Your order filled by mail promptly.  
Every article absolutely guaranteed.

The SATURN Mfg. & Sales Co., Inc.

48 Beekman St.  
New York, N. Y.

## Distance! The Only AUTHORIZED COCKADAY COIL

Gets distant stations easily and clearly. Made in strict accordance with specifications by L. M. Cockaday, inventor of the famous Cockaday Four Circuit Tuner. Greater volume, sharper tuning, maximum selectivity. Guaranteed. At your dealers—otherwise write us direct.

PRECISION COIL COMPANY  
209-D Center Street New York

## ARROW BATTERY SLASHES Prices TO CONSUMERS

Prices Smashed!  
Quality Not Sacrificed

Here is real battery quality, guaranteed to you, at prices that will astound the entire battery-buying public. Order direct from factory. Put the Dealer's Profit in your own pocket. You actually save much more than half, and so that you can be convinced of true quality and performance, we give a

Written Two-Year Guarantee

Here is your protection! Noneed to take a chance. Our battery is right—and the price is the lowest ever made. Convince yourself. Read the prices!

- Special 2-Volt Radio Storage Battery, \$3.75
- Special 4-Volt Radio Storage Battery, 6.00
- 6-Volt, 60 Amp. Radio Storage Battery, 7.00
- 6-Volt, 80 Amp. Radio Storage Battery, 8.00
- 6-Volt, 100 Amp. Radio Storage Battery, 9.50
- 6-Volt, 120 Amp. Radio Storage Battery, 11.50
- 6-Volt, 140 Amp. Radio Storage Battery, 13.00

We ask for no deposit. Simply send name and address and style wanted. Battery will be shipped the day we receive your order Express C. O. D., subject to your examination on arrival. Our guarantee accompanies each battery. We allow 6% discount for cash in full with order. You cannot lose! Act quick. Send your order today—NOW.



Arrow Battery Co.  
1421 South Wabash Ave.  
Dept. 6 Chicago, Ill.

PIONEER RADIO CORPORATION  
101 Pioneer Avenue, Galesburg, Ill.  
Variometers — Variocouplers



ticed that in this receiver considerable pains have been taken to minimize casual magnetic couplings by arranging all inductances mutually at right angles and in addition, a tube is employed, which has especially low interelement capacity, though not explicitly for this reason. Still, with a heavily damping crystal across the plate coil, the receiver will oscillate most violently when the plate circuit is tuned in unison with the grid circuit. The Neutrodyne coupling controls this in the smoothest possible manner when once properly adjusted with its small variable condenser. Material alteration in the arrangement of these inductances may possibly result in either accentuating the casual magnetic coupling to such an extent that it is no longer controllable by the Neutrodyne device, or perhaps by accidentally reversing the main magnetic coupling, and preventing the receiver from oscillating at all. Accordingly, the general arrangement of the plate and grid coils should not be departed from without careful preliminary trials to ascertain the effect.

Examination of the circuit diagram will show rather an unusual type of aerial coupling and a mode of introducing the audio frequency impulses onto the grid of the tube which has been described several times and is actually used in certain commercial reflex receivers. Apparently, it has not reached the popularity it deserves, possibly on account of the extra radio frequency choke it involves. This latter method shows a great immunity from howling and the effects of neighboring alternating current mains and so on. This also permits the use of a small condenser in the grid circuit to by-pass the radio frequency currents and stop the audio frequency impulses, giving most excellent signal strength with most any make of audio frequency transformer having the proper step-up ratio and adequate primary winding.

The aerial tuning is of an extremely selective type. Almost incredible selectivity results, together with a curious indifference as to aerial characteristics, so that both for wave-length and regeneration control, the effect of suddenly throwing on and off a good-sized outdoor aerial is hardly noticeable insofar as the wave-length adjustment is concerned. This makes possible the desirable feature of condenser scales graduated directly in wave-length (for stations), in place of meaningless or arbitrary degrees. In the outfit described here, both the grid and plate condenser scales are marked directly in stations. If searching is necessary, it is to be carried out with the single tube alone, the reflex action being eliminated temporarily by throwing over the switch shown so that the grid is connected by way of the customary grid-leak to the positive "A" battery instead of through the audio frequency transformer and the radio frequency choke. The margin between steady oscillation and howling is too small in a reflex receiver for comfortable searching when connected in the reflex condition.

Of other details, the placing of the phone condenser across the "B" battery as well, is merely a matter of convenience in actual wiring. It is well to have a 1-mfd. blocking condenser across the "B" battery, as this proves of considerable advantage when the "B" battery is run down.

**CONSTRUCTIONAL DETAILS**

As each constructor has his own ideas as to the style and size of the cabinet, in which he finally mounts his set, only the panel details are given here, together with a bare frame for use in the experimental stages, to hold the inductances and transformer in their respective positions. The panel has been kept as small as possible (eight inches square) with the result that the components appear to be somewhat crowded. Provided the matter of magnetic coupling, previously discussed, is borne in mind, when trying out other distributions of the parts,

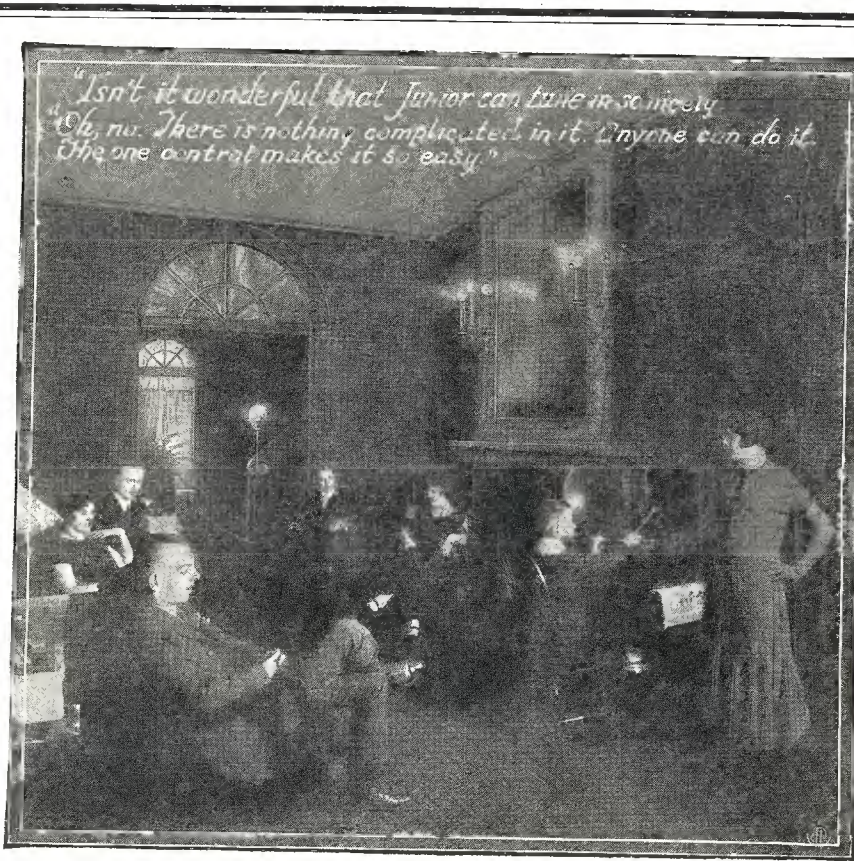

**Bristol Single Control Radio Receiver**

Complicated combinations are eliminated when tuning in with Bristol Single Control Radio Receiver—every station is on the one dial. It gives the joys of radio with technicalities left out.

The well known Grimes Inverse Duplex System (non reradiating) is utilized in this Receiving Set. Because of the reflex, only four tubes are required to give power equivalent to six. The price, without accessories, \$190.00.

**Audiophone Loud Speaker**

You forget the radio equipment when listening thru the Audiophone Loud Speaker. The tone is full, clear and pleasing. It gives a true reproduction of the original. Made in three models—Senior \$30.00, Junior \$22.50, and Baby \$12.50.

Ask for Bulletins Nos. 3014 and 3015-S

Made and Sold by  
**THE BRISTOL COMPANY**  
Waterbury, Conn.

**Stop Buying Dry Cells**

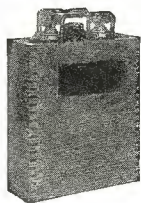

Rechargeable "A" Battery \$7.00 Postpaid

The PRECISION is a more economical A Battery. A single charge outlasts TEN dry cells and it is rechargeable. It has a handsome polished oak case. Gives constant voltage that insures maximum results. 60 ampere hours, 2 volts. Absolutely guaranteed. Shipped to you fully charged—dry.

**PRECISION ELECTRIC CO.**  
147 West 24th St. New York City

**DEALERS**

OUR LIBERAL DISCOUNTS

Will Save You MONEY

Standard Quality Parts. Send for this Free Catalog.

All Orders Shipped the Same Day.

**WESTERN RADIO MFG. CO.**  
Manufacturers and Distributors  
138 W. Lake Street, Chicago, Illinois

Get a Handy Binder for your RADIO NEWS. Holds and preserves six issues, each of which can be inserted or removed at will. Price 65c. Experimenter Pub. Co., Inc., Book Dept., 53 Park Place, N. Y.



# STA-RITE RADIO BATTERIES SAVE YOU 60%

And Guarantee You in Writing 2 Years of Better Battery Performance

STA-RITE RADIO BATTERIES are made especially for Radio and the big saving is made possible by coming direct to you instead of thru distributors dealers etc. Boxes are made of oak finished in mahogany and the plates very thick and will give a steady discharge over a long period. No premiums, just good honest battery value.

### TRY TO BEAT THESE PRICES

2 Volt for W. D. 11 and 12	\$4.00	6 Volt 60 Amphr.	\$ 7.50
4 Volt for U. V. 199 Tubes	7.00	6 Volt 80 "	8.50
RADIO B. STORAGE Glass Jars, Heavy Plates— Case of 12 Cells 24 V.	4.90	6 Volt 100 "	10.00
		6 Volt 120 "	12.10
		6 Volt 150 "	14.00
		6 Volt 200 "	17.00

Get Yours Today—NOW—Send No Money

The batteries are fully guaranteed in writing and shipped subject to examination on the day your order is received. You pay on delivery or deduct 5 per cent if full cash accompanies order. You may deduct 10 per cent if two or more are ordered at one time.

STA-RITE BATTERY CO.

Dept. 3

LOUISVILLE, KY.

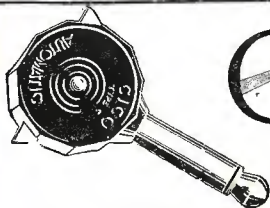
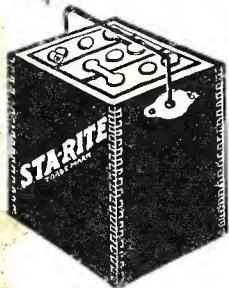

## CICO

### RADIO PRODUCTS



Cico Automatic Plugs—allow you to connect and disconnect cord tips automatically and instantly by a pressure of your fingers. Most ingenious single plug in use. Bakelite body. Fits all jacks. Takes all tips. 80c.

Cico Bakelite Jacks—moulded completely from bakelite. Neat binding posts for connections. No soldering necessary. Special phosphor bronze springs. Sterling silver contact points. Small and compact. Exceptional value.



Cico 2-Way Plugs—so constructed that loud speaker and headphones can be connected simultaneously or individually as you wish. Fit all standard jacks. Take all types of tips. Price only 60c.

Consolidated Instrument Co. of America, Inc.

41 East 42nd Street, New York

No. 30 Single circuit open	\$ .80
No. 31 Single circuit closed	.85
No. 32 Double circuit	.90
No. 33 "A" Battery Switch	.90

Every CICO PRODUCT is packed in a distinctive GREEN BOX and unqualifiedly guaranteed against all defects.

# LEARN THE CODE AT HOME

"Just Listen—The Omnigraph will do the teaching"

with the

## OMNIGRAPH

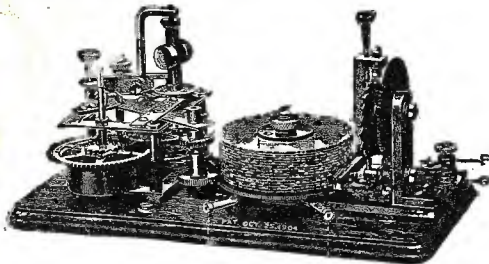

THE OMNIGRAPH Automatic Transmitter will teach you both the Wireless and Morse Codes—right in your own home—quickly, easily and inexpensively. Connected with Buzzer, Buzzer and Phone or to Sounder, it will send you unlimited messages, at any speed, from 5 to 50 words a minute.

THE OMNIGRAPH is not an experiment. For more than 15 years, it has been sold all over the world with a money back guarantee. The OMNIGRAPH is used by several Depts. of the U. S. Govt.

—in fact, the Dept. of Commerce uses the OMNIGRAPH to test all applicants applying for a Radio license. The OMNIGRAPH has been successfully adopted by the leading Universities, Colleges and Radio Schools.

Send for FREE Catalog describing three models.

DO IT TODAY.

The Omnigraph Mfg. Co., 20 Hudson St., New York City

If you own a Radio Phone set and don't know the code—you are missing most of the fun

and that grid connections are kept as short as possible, the whole may be rearranged at will for greater convenience.

The two tuning variable condensers have a capacity of .0003 or .0005 mfd. each. The neutrodyne condenser must be of a very low minimum capacity and should have a vernier adjustment. A small three-plate vernier will suit the purpose admirably. The principal difficulty in constructing the receiver is offered by the second small fixed condenser in the neutrodyne circuit. The minimum capacity of ordinary condensers is considerably too high for use in this position, and the capacity must be effectively diminished, at the same time retaining the variable feature. This is easily accomplished by introducing in series with the variable condenser a tiny fixed condenser. The value of this depends on the extent of casual coupling present, the particular tube used and so on; therefore, it cannot be stated dogmatically. In the author's receiver it had to be made of the order of .00005 mfd., and consisted of three pieces of tinfoil overlapping each other for about 3/4 square inch and separated by rather thick bits of mica. The whole was mounted in a commercial condenser shell; this is entirely a matter to be decided by careful experiment and adjustment. The goal at which to aim after completing the remainder of the receiver and finishing all wiring is to have violent oscillations manifest with the neutrodyne variable condenser at zero and cessation of oscillation before the complete capacity of the condenser is used, over the whole wave-length band. This may not be possible with a critically tuned plate circuit in the single tube circuit alone, but must be achieved when the set is working in the reflex condition. Too large a neutralizing condenser will bring in a fresh set of howls. Of course, all this adjustment is made without aerial connection. Lilliputian condensers of extremely low minimum capacity are on the market as a result of the growing popularity of the Neutrodyne. Such a type is suitable for use in the present set. In this case, a single small adjustable condenser was used, the total capacity required being only a few micro-microfarads.

The primary or aerial coil consists of 10 turns of double No. 20 D.C.C. wire (i.e., two wires laid side by side and connected in parallel) wound on an insulating tube 3 1/2 inches in diameter. This is to avoid using a few feet of a much larger gauge wire, which is difficult to work with. This forms the semi-aperiodic primary coil. It is then continued, auto transformer fashion for 60 turns more, single layer, and in the same direction, making, in all, 70 effective turns across the tuning condenser. The plate coil consists of 50 turns No. 22 D.C.C. wire, two-layer bank wound, on a tube of the same type as that used in the previous coil. A second coil, identical to the plate coil, is placed closely to, but not connected electrically with, the first. This serves as the Neutrodyne coil. These are connected as shown so that the inner end of each—the middle of the coil—is near "ground" electrically. As the two coils are wound in the same direction they will oppose each other's effect on the grid as desired.

The radio frequency choke may be any coil of fairly low distributive capacity, such as a No. 200 or 300 honeycomb or duo-lateral coil.

The tube actually employed was the low capacity Myers type. It has an extraordinarily generous filament emission for its filament current. This fits very compactly into its special clips on the front of the panel. As the tube is extremely robust it was not thought worth while to place it behind the panel. The circuit works successfully with any hard vacuum tube.

For the crystal detector, careful experiments showed that the extra sensitiveness of galena or other types do not justify their use in this circuit where stability must be the first consideration, so the simple and reli-

**VULCANIZED FIBRE**

Be sure and specify "WILMINGTON FIBRE"

Sheets, Rods, Tubes, Washers, Etc., Specialties

Wilmington Fibre Specialty Co. Wilmington, Del. Branch Offices "Everywhere"

**B-METAL**

For total purity use B-METAL Crystals. Ask your dealer to order them.

B-METAL REFINING CO. 4th fl. 525 Woodward Ave., Detroit, Mich.



able carborundum was used. It does not require any applied potential when used in this position. With a firm contact made with a springy piece of tinned iron (ordinary roofing tin) the fragment of carborundum being set in a cup with Wood's metal in the usual way, absolutely no attention or further adjustment is needed. Of course, any steady crystal detector is suitable for use in this position, but the carborundum is preferable.

In the experimental instrument shown, the panel is simply mounted in front of a frame eight inches square and nearly six inches deep, a narrow shelf on which the tuning inductances are supported. The audio frequency transformer, radio frequency choke and grid bias coil find accommodation below this shelf. The base board is of 1/2-inch soft wood 7 1/2 inches by nearly 6 inches. The two sides are of 1/4-inch hard wood, each of approximately the same size. The shelf is 3 1/2 inches wide and there are two strips of wood across the top to support the panel and to keep the arrangement secure. The tiny adjustable neutralizing condenser, in series with the vernier, is placed in an accessible position just inside the top.

Any sort of an aerial may be used, probably a loop also, though that has not as yet been tried. Of course, the higher the aerial the better, but the operation of this receiver is entirely independent of the type of aerial, within limits.

**ACTUAL PERFORMANCE**

The receiver illustrated gave, with the equipment described, and with a good outdoor aerial, the loudest signals that the writer has ever succeeded in getting with a single tube on any instrument.

The pleasant voice of one of the speakers at station 2LO London was clearly audible all over the house with the help of a good loud speaker. By placing the speaker at the open window, the signals were audible at the far end of a large garden. On a favorable night a great many stations came in at comfortable strength on the phones in turn, and with remarkable selectivity.

**Lucy's Radio Present**

(Continued from page 32)

Bill backed out of the office still trying to get a flicker of interest in Mr. Pulsifer's eyes.

That very afternoon, as Mr. Pulsifer was passing through the accounting room, he glanced across to where Bill worked, and saw him bending over a suspicious looking blueprint. He tiptoed to Bill's desk, and peered over his shoulder. There was the very same blueprint, covered with coils, angles and spirals, that Bill had carried in his pocket that morning. When at last Bill sensed the banker's presence, and turned around, startled, Mr. Pulsifer exclaimed, "So you're at your radio during business hours again, are you, Shadwell? If you continue to look into radio matters during business hours, the bank will have to find someone else to fill your place." Before Bill could reply, Mr. Pulsifer turned and stalked away.

For the next few weeks, Bill denied himself everything in order to save for the big radio set. He walked to and from the bank, instead of using his rattletrap fliwyer; he ate a couple of sandwiches carried from home, in place of the tasty lunch he usually enjoyed with the other fellows. Dollar by dollar, his account grew, until at last he could make out the money order that would bring him the carefully listed radio parts he needed.

After the apparatus arrived, he worked every evening, putting it together, until poor Lucy thought that he had forgotten her. When at last he called upon her, and told her about the set, Lucy protested, "But Bill, you ought not to spend your money that



Add Miles and Smiles with Branston Standard Radio Parts



**Branston Kit No. R-99 \$36.50**

**In the Summertime—You Need the Best Receiver You Can Build**

**Branston Honeycomb Coils**

and Geared Back and Front Panel Mountings. Best for Selective Tuning.



All Sizes:

Mounted or Unmounted. Note sturdy, substantial, permanent construction and beautiful finish. Genuine Bakelite used throughout. Licensed under De Forest patents.

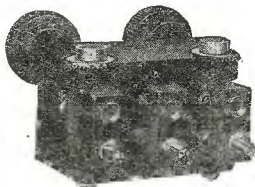

Send 2c Stamp for New Honeycomb Coil Hookups. Compiled by experts and includes five good Honeycomb Coil "Hook-ups" and complete catalog of famous Branston Radio Apparatus.

Build a Super Heterodyne Receiver that will bring in whatever you want in the Summertime, when adverse atmospheric conditions demand the best instrument you can get. (And remember, when next Winter's big radio programs come in, you will have the best possible receiver to get them.)

Branston Kit No. R-99 contains 1 Oscillator Coupler, complete with mounting brackets, bank wound inductance and adjustable coupling coil with locking device; 3 Intermediate Radio Frequency Transformers, very sharply tuned and completely shielded; 1 Special Transfer Coupler for first or last stage of Intermediate Frequency; and 1 Specially Designed Antenna Coupler so that either loop or antenna can be used. This apparatus has been specially designed for Super Heterodyne, Ultra-dyne and similar circuits. It has been rigorously tested and proved better than any heretofore obtainable.

**"Super Heterodyne Construction"**

Our Book (one dollar) explains operation of Super Heterodyne receivers, gives circuit diagram and full size panel layout. It contains complete directions for building a Super Heterodyne Receiver that will be extremely selective, free from interference and, in fact, better than any other radio receiving method. The amateur, with this book, can easily build a superior receiving instrument.

**CHAS. A. BRANSTON, Inc.**  
817 Main Street Buffalo, N. Y.

In Canada—Chas. A. Branston, Ltd., Toronto

Branch Office, London, Eng.

Manufacturers of Branston Violet Ray High Frequency Generators

**BRANSTON RADIO**

(Reg. U. S. Pat. Office)

**INVENTORS PROTECT YOUR IDEAS**

Send for our Guide Book, **HOW TO GET A PATENT**, and Evidence of Invention Blank, sent Free on request. Tells our terms, methods, etc. Send model or sketch and description of your invention and we will give our opinion as to its patentable nature.

**RANDOLPH & CO.**

Dept. 422, WASHINGTON, D. C.

Name .....

Street .....

City ..... State.....

Get a Handy Binder for your RADIO NEWS. Holds and preserves six issues, each of which can be inserted or removed at will. Price 65c. Experimenter Pub. Co., Inc., Book Dept., 53 Park Place, N. Y.



# Regal

**"Pays For Itself in Longer Service"**

**PERFECT CONTACT VERNIER RHEOSTAT**

For fine filament control of tubes and super-fine tuning, the Regal Vernier stands alone. Nothing just like it on the market. Complete with Knob. 6 Ohms .....\$1.25 30 Ohms ..... 1.25



**FIFTEEN TAPS—BUT ONLY ONE DRILL HOLE REQUIRED!**

A 15 Point Switch complete in one unit. No more messy soldering. No more drilling of holes. No more chipped panels. Complete with hard rubber Knob and Dial. Type No. 162.....\$1.50



**BROADCAST TESTED HIGH QUALITY AUDIO TRANSFORMER**

For clearness of tone, amplification of voice and music from nearby and distant stations, Regals are unequaled by any transformers on the market. 3 1/2 to 1 Ratio.....\$4.25 5 to 1 Ratio..... 4.50

At all good dealers—otherwise write direct for complete descriptive folder No. 24, sending dealer's name.

**AMERICAN SPECIALTY CO.**  
Bridgeport, Connecticut, U. S. A.

The New  
and Perfect  
Variable Grid Leak  
65¢



Can be installed in any set in a second! Does not change calibration with age or use! Officially adopted for Ultra-dyne, Polydyne, etc. circuits.

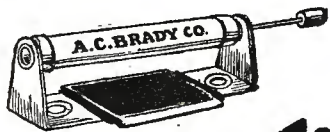

COMPLETE WITH MICA CONDENSER AND PERFECT LEAK MOUNTING \$1.00

A.C. BRADY CO.

Improved Radio Apparatus  
108-SEVENTH AVE. NEW YORK CITY

"VANGARD"

The Best Transformer Money Can Buy  
Correspondence Invited  
**Frank A. Ryder**  
19 South La Salle Street, Chicago

way. How can we ever get married, if we don't save?"

Bill usually caved in at once, before Lucy's shining black eyes, and her pouting lips, but this time he was firm. "Lucy, it may mean our fortune! I can't make enough to marry on, in that one-tube bank, if I work there a hundred years. I've got to take a chance, if I want to get anywhere. Aren't you willing to gamble with me?"

"It sounds so foolish, dear, to spend all your money for a radio set, when we might be paying something down on a little home of our own."

Bill kissed away Lucy's frowns, and tried to laugh away her fears. "You just wait, dear. I'll show you! You'll see that there's life in this old town, yet."

He finished the set on a Saturday night. The following morning, dressed in his oldest clothes, he started with it, up into the Furnace Hills.

In the square, Bill passed Mr. Pulsifer, who stared at the neat mahogany box, and asked what it was.

"My new radio," Bill replied. "Want to see it?"

"Heavens, no!" Mr. Pulsifer exclaimed. "What are you doing with it?"

"Just some experimenting, sir. This is the scheme I tried to interest you with. Here's the idea—" and Bill opened the cover of his mysterious box, disclosing an array of tubes and wire.

"No! Take it away, Shadwell!" Mr. Pulsifer exclaimed, pushing down the open cover. "That radio will be the ruin of you, now mark my words."

"Or the making of us all," Bill laughed. "If I ever catch you even thinking of radio in my bank—" Mr. Pulsifer sputtered; but Bill had turned, and was on his way.

Bill's actions on the hills were variously reported. Some said they saw him walking about the hilltops, holding over his head a square of wire, like an umbrella without any cloth cover; others saw him crouching near an outcrop of rock, with his head-phones at his ears, apparently listening to a concert. One fellow followed him, and asked him point blank what he was about; but Bill only offered him the phones, and asked if he wanted to hear Pittsburgh. Everyone agreed that something was the matter with Bill, and that radio was making him simply daft.

That evening, Bill took the flivver and drove over the long, rough road around one end of the Furnace Hills, to Lucy's home. Mr. Hopkins opened the door, nodding coldly to him, and eyeing suspiciously the mahogany radio box that Bill carried. Mr. Hopkins was a practical man; a farmer, who prided himself on his hard-headed common sense. What he called Bill's flightiness was particularly obnoxious to him, and his first question was about the stories that had come to him, of Bill's strange doings that morning, on Furnace Hills.

Bill explained that he was making some experiments with radio.

Mr. Hopkins flushed with anger, and burst out, "To think of buying an expensive radio set when you ought to be saving for your wedding! It's preposterous! I can't let Lucy marry an improvident, flighty fellow like you!"

Bill protested, "But Mr. Hopkins, this radio may make our fortunes! Let me tell you about it—"

"Foolishness! I don't want to hear about a toy for children. If you want to make money, you ought to spend your time on the bank's business and forget all this nonsense."

Bill finally got Lucy into the back parlor, where he set up the radio, and adjusted the head phones over her ears. "Now I'll tune in Pittsburgh," he told her, turning the two black dials to figures that were recorded in a little book, "How's that?"

Lucy shook her head. "I don't hear anything but a little buzzing."

Bill turned the dials, slightly. "That better?"

## Increase Your Range

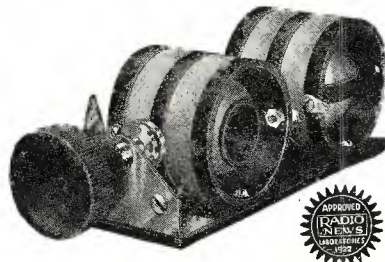

For long-distance work the K. & C. Frequency Transformer is a vital necessity. Its range covers entire band of present broadcasting wave lengths—150 to 550 meters. Not a small variometer, but an efficient circuit impedance. This transformer used in Haymond hook-up. Connections pig-tailed. Bakelite construction.

Single stage .....\$ 5.50  
Two stage (operated on one shaft).....\$10.00

**Kilbourne & Clark Mfg. Co.**  
SEATTLE

Branches: 591 Mission St., San Francisco; 205 Larrabee St., Portland, Ore.; 1103 West 10th St., Los Angeles. Steelman, Inc., 24 Murray St., New York Representative; O. P. Smith Co., 205 W. Harrison St., Chicago Representative.

K. & C. Parts Set The Standard

It's a



Radio Plate Battery

Try Them  
Once  
You'll Use Them  
Always!

DIAMOND "B"  
BATTERIES

At All Good Dealers

DIAMOND ELECTRIC  
SPECIALTIES CORP.

103 S. Orange Ave.  
Newark, N. J.

Dealers and Jobbers  
Write for Proposition

MU-RAD



RECEIVERS

THE ULTIMATE IN RADIO RECEPTION

5000  
RADIO DEALERS  
buy from

HUDSON-ROSS

123 W. Madison St. Chicago  
Send for dealers discount.



"I don't hear anything, yet."  
 "Let me try it." Bill put on the head phones, and jiggled the two dials, but finally had to confess failure. "That's queer," he said, with puckered brow, "I can get Pittsburgh easy, from my house. Let's see the paper, and find out what they're broadcasting now."

Bill's puzzled frown grew deeper, when he read that there was a concert of sacred music being broadcast at that very moment. "It's a perfect night, too; not a bit of static. Why, I had Pittsburgh as clear as a bell, at my house. But let's try something else."

Bill slowly turned the dials. "Well, I'll be—" he exclaimed. "What do you know, Lucy; Louisville is percolating as if it were in the next room! I never could get it at my house, though I've tried this combination a dozen times."

"Why is that?" Lucy asked.

"The greatest radio engineers in the country couldn't answer that one, Lucy. I suppose there are a couple of dead spots that intercept the radio waves—but here, dear, don't you want to listen?"

The next morning, as Mr. Pulsifer was making his rounds of the bank, he noticed Bill leaning over a big atlas of the country and a smaller county atlas. He tiptoed nearer, and saw Bill drawing lines on the pages of these books; apparently wantonly marking up the maps of Old Forge and the surrounding country. He marked an angle from the big map on a piece of paper, then transferred this angle to the local map. More of his flightiness! Finally Bill jumped up out of his chair, waving his arms, excitedly, and shouting, "Gee whiz! I believe I've got it!"

"Got what?" coldly asked Mr. Pulsifer, staring at Bill with fish-like eyes.

"See those lines, Mr. Pulsifer?" Bill asked, pointing where he had defaced the bank's atlas. "It's the radio! That's the—"

Mr. Pulsifer's cheeks flushed at the word "radio." "That's sufficient, Shadwell," he broke in, angrily. "I've had all I want of you and your radio. I've given you every opportunity to make good, and you've wasted every chance. I wash my hands of you. Go! Get your money at the cashier's desk, and never let me see you here again!"

Bill took Mr. Pulsifer's arm and pleaded, "But this is the opportunity I told you about! There's millions in it! If only you'll lend me a little money—"

The banker roughly shook himself free, and turned on his heel. "Shadwell, you're a fanatic!" he threw over his shoulder, as he strode away.

That evening, when Mr. Hopkins learned that Bill was fired, he was furious. "You're just a plain fool, Bill Shadwell," he raged. "I won't have my daughter tied to a ne'er-do-well! I never took any stock in you and your flighty schemes, but now, I forbid you to see Lucy again, till you can support her properly. Now get out of this house, and stay out, until you can prove you've made good."

Even Lucy seemed to lose a little of her faith in Bill. "How could you do such a thing, when we need the money so?" she reproached him. "How can we be married, if you have no work? You don't seem to think of me at all, but only of that old radio."

Bill tried to kiss away Lucy's tears, and whispered in her ear, "Cheer up, dear! You'll be surprised to see how quickly I'll be back for you, with your dad just eating out of my hand."

The next morning, Bill stopped in at Harlan's newsstand, and bought a pocket map of the county. Mr. Harlan winked to Sid, his clerk, when he saw the big hammer, and the short handled spade that Bill was carrying. And when Bill went whistling out of the shop, and walked towards Furnace Hills, Mr. Harlan burst out, "Another one of his flighty schemes!"

Bill returned staggering under the weight



# "MINUTE MAN" Radio Receiving Set Incorporating Pathe Type "P" Phusiformers

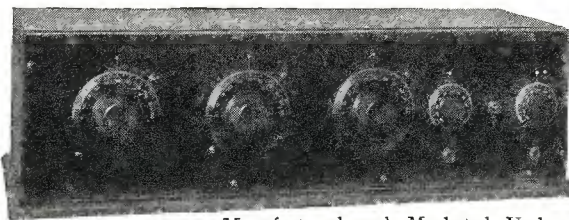

Manufactured and Marketed Under  
 Licensed Agreement, Patent Pending

**Price \$125.00**

(Tubes, Batteries extra)

**T**HE new five-tube "Minute Man" was specially constructed to meet the demand for a receiving set embodying these features:

### NO SQUEALS.

Tune in either with a loud speaker or head phones without any squeals or rasping. At any setting of the dials there is none of this unpleasantness so prominent in many other sets.

### PURE TONE.

The reproduction of broadcasting by the "Minute Man" is remarkable for its clarity and sweetness of tone, increasing your enjoyment a hundredfold.

### SIMPLICITY.

The "Minute Man" is simplicity itself to operate. The dials can be adjusted by a child—and the set is "Foolproof." The dial settings are constant. A station once located can always be brought in without preliminary searching.

Genuine mahogany cabinet and panels.  
 Gold engraved dials.

### FREE BOOKLET

Booklet, "How to Build a 5-Tube Receiver, Using Three Phusiformers," sent free on request. Address Dept. A21.

Dealers and Jobbers—Write Dept. A21 for catalogs and prices of Pathé Line.

**PATHE PHONOGRAPH AND RADIO CORP.**  
 20 GRAND AVENUE, BROOKLYN, N. Y.

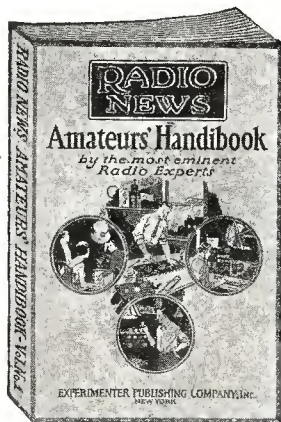

**Price \$1.00**

JUST THE BOOK YOU WANTED

## "Radio News"

*Amateur's Handbook*

Volume No. 1. (Second Edition)

Chock full of radio constructive and instructive articles from cover to cover. Written by foremost radio authorities, in plain everyday language which everyone can understand. Sections include articles on Receiving Sets and Sundry Apparatus, Transmitters and Accessories, Radio Theory, Vacuum Tube Data, and Practical Hints for the Amateur. A book which also serves as a ready reference and should find a place in the library of every amateur. It contains 224 pages and over 375 illustrations, diagrams, and photographs, bound in a multi-colored heavy board.

On sale at all leading radio stores. If your dealer cannot supply you, send a dollar bill and the book will be forwarded to you postpaid.

**EXPERIMENTER PUBLISHING, CO., Inc.**  
 53 Park Place, New York



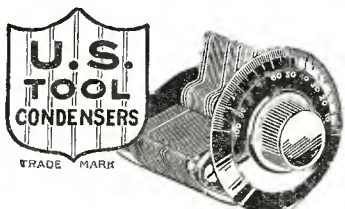

## It's Capacity That Counts!

Good condensers are designed according to microfarads, not number of plates alone. U. S. Tool Condensers are designed for correct capacity.

### 100% GUARANTEED End Plates of CELORON

FOR Superheterodyne  
Inverse Duplex  
Superdyne  
Four Circuit Tuner

USE Vernier Cap. .00057 Mfd.  
(24 Plate) or  
Plain Cap. .00055 Mfd.  
(23 Plate)

Condensers of recommended capacity for all known circuits are also carried in stock by leading radio retailers.

Write for booklet

**U. S. Tool Company, Inc.**  
118 Mechanic St., Newark, N. J.

## SAVES YOU 50%



Genuine **AHLBELL NEVERLEAK**  
Solid Rubber Case  
2-Year Unconditional Guarantee

### SILVER-S BATTERY

For AUTO and RADIO

Tremendous saving for you on this non-leakable, Guaranteed Superior Quality Storage Battery. One-piece indestructible case, can't leak, spill, or injure rugs or clothing. No more breakage of jars or acid eaten boxes. 2-year written unconditional guarantee covers leakage as well as performance and fully protects you. Silver-S quantity production and Big Buying Power makes possible this unheard-of value.

50%—SEE WHAT YOU SAVE—50%  
5 per cent Discount for cash in full with order.

AUTO PRICES		RADIO PRICES	
6-V, 11 Plate - \$13.00	6-V, 100 Amps. \$13.50	6-V, 13 Plate - 15.00	6-V, 120 Amps. 15.50
12-V, 7 Plate - 18.00	6-V, 140 Amps. 17.00		

Add 5 per cent Government tax Government tax exempt

Inspect this Wonder Battery. Read our 2-year Guarantee before you pay one cent. Satisfy yourself you are getting the best battery made—at 50 per cent saving. Shipment made by Express C. O. D. subject to examination. No delay. Send name and address and style wanted TODAY.

**SILVER-S BATTERY COMPANY**  
201 E. Ontario St., Dept. 50, Chicago, Ill.

SEND NO MONEY

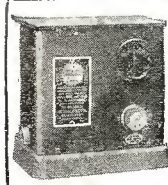

### Charge Your Battery For A Nickel

The Gold Seal Homcharger Charges Radio and Auto Batteries at home overnight for a nickel. Your dealer has it. Write for FREE booklet and list of broadcasting stations.

**The Automatic Electrical Devices Co.**  
118 W. 3rd St. Cincinnati, O.

of a big bag that contained some very heavy load. When he had carried this bag home, he went to Mr. Teagle's office, on the third floor of the brick block, over the bank. Mr. Teagle was lawyer, real estate agent, and notary public, all rolled into one, and transacted about all the legal business of Old Forge. After an hour or two, Bill left Mr. Teagle's office, whistling, with a very satisfied air, a big rubber band around a very legal-looking red paper document envelope.

That evening, Bill called at the Hopkins' house. When Mr. Hopkins met Bill at the door, his face turned purple with rage. "Are you here again, Bill Shadwell?" he stormed. "Didn't I tell you to get out and stay out, you worthless ne'er-do-well? Have I got to throw you out bodily?"

Bill spied Lucy timidly peering through a window. He waved to her, then told Mr. Hopkins, "I've come to claim Lucy!"

Mr. Hopkins braced his arms and legs across the narrow doorway: "You shan't enter this house!"

Bill reached into his pocket and pulled out the red envelope that he got from Mr. Teagle. He snapped off the rubber band, and drew out some imposing looking documents, which he handed to Mr. Hopkins. "Read those," he said.

As Mr. Hopkins read, his hands began to tremble. "You—you—" he began, shaking the papers in Bill's face. "Why, these are only options on some worthless land in the Furnace Hills. And you've come here to tell me about another one of your fool transactions?"

"Wait!" Bill interrupted, taking from his pocket a piece of dirty looking rock. "Look at that, Mr. Hopkins," he exulted, his voice trembling with excitement.

Mr. Hopkins turned the stone over in his hands. He stepped out into the light, and examined it closely. Then he whistled a slow "Wh-e-e-w! This looks like a bit of the old Furnace Hill vein! Where did you get it, Bill?" he added, with narrowing eyelids.

"It's a sample from that worthless land I hold an option on," Bill replied. "I control the vein that everyone has been looking for, since the old vein petered out."

As they entered the house, Mr. Hopkins eyed Bill respectfully. "Why, Bill Shadwell, you'll be rich!" he exclaimed, as the truth dawned on him.

Bill made a dash for Lucy. "There's enough in it to make us all rich! All I ask is that you take up that land covered by my options, and give it to Lucy for a wedding present," he said to her father.

"But how did you find the vein?" Mr. Hopkins asked.

"By radio. It's the new way of prospecting. When I found that I couldn't hear Pittsburgh from here, or Louisville from my home, I plotted the thing out on a map—that's what old Pulsifer fired me for. I found that both broadcast stations were apparently blocked by one dead spot; for the line from here to Pittsburgh crossed the line from my house to Louisville, somewhere in the Furnace Hills. The next day, I went to that spot, and found the rich iron vein that absorbed the radio waves, and made the dead spot. That concert here, saved me a good many weeks of wandering over the hills with my radio, and gave me the location at once."

"Great work! You can count on me to buy that land for Lucy's wedding pre—" Mr. Hopkins looked across to the divan where Bill and Lucy were sitting. As they had other interests greater than land or radio, he tiptoed softly out of the room.

## A Buffalo Radio Fan Gets London with the help of a KIC-O

Mr. E. C. Lewis on March 18th heard Mr. Marconi's voice on a Model 10 At-water Kent Machine. He said it would have been impossible without a KIC-O Battery. Improve your set with a KIC-O. Our guarantee protects you.

Your money back on any KIC-O Battery if not satisfied within 30 days' trial.	Price With Panels	
	Volts	Plain
22	\$5.50	11.75
32	7.25	14.00
48	9.50	17.00
68	12.50	22.50
100	17.50	28.50
145	23.50	

Write for full information on "A" and "B" Batteries

**Kimley Electric Company**  
2665 Main St. Buffalo, N. Y.

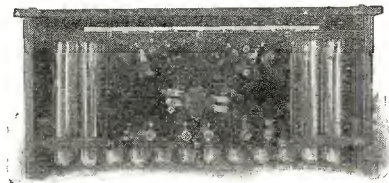

100 Volt Type

### Capacity 1,000

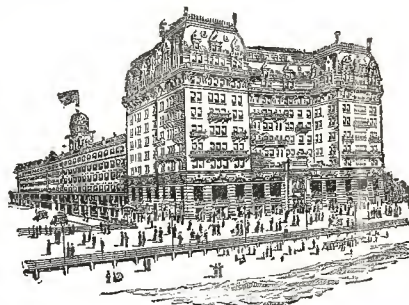

## The Breakers

Atlantic City, N. J.

ON THE OCEAN FRONT

Fireproof

American and European Plans

Orchestra Dancing  
Golf Privileges Cabinet Baths

Garage

JOEL HILLMAN, President

## HUNDREDS

won't part with their

### Amerex Universal Tuner

for twice what they paid for it. Write and find out why this 180°, 3 circuit tuner with free hook-ups is worth twice \$3.75.

Send name of dealer and \$3.75 for the Amerex Tuner. A written guarantee protects you.



American Standard  
Electric Co.

243 W. 34 St., New York



## BECOME A PROFESSIONAL PHOTOGRAPHER

EARNING \$35 TO \$125 A WEEK

Three to six months' course Motion Picture, Commercial, Portraiture. Practical instruction. Day or Evening Classes. Ask for Catalog No. 56.



**N. Y. INSTITUTE OF PHOTOGRAPHY**  
NEW YORK CHICAGO BROOKLYN  
141 W. 36th St. 630 S. Wabash Ave. 535 State St.



## The Trouble Corner

(Continued from page 39)

mary and secondary circuits were altered. A trial showed the signals could be brought in by leaving the secondary at its normal setting and increasing the capacity added to the primary to something considerably beyond the ordinary amount required. But when this was done the set was very unstable, oscillating on the slightest provocation.

The cause was not discovered for some minutes, but a little thought showed that something must have happened to either aerial or ground. A walk outside showed that the ground lead was no longer attached to the terminal of its insulated tube. A recently acquired puppy had found it a splendid thing to play with and his teeth marks on the insulation of the wire showed that he had pulled and pulled until it came adrift. A note was made for future reference: *If the set is unstable and if more capacity is required in the aerial tuning condenser, examine the ground lead.*

### TRANSFORMER TROUBLE

Here is another rather strange case. I received from a correspondent some time ago a long letter—it contained six pages—in which he told me that a perfectly untraceable fault had occurred in his 5-tube set (R. F. transformer coupled, a detector and two audio). Here is his account of the mishap. On the Thursday evening the set had been working perfectly. When switched on the next evening it refused to function. The greatest feats of tuning could extract nothing more from it than occasional faint signals from a high-powered spark station no great distance away. Eventually the set was taken to pieces, most of the connections being resoldered since a friend had suggested that the trouble might be due to the oxidation of the solder. The fault was at length traced to a burnt out primary winding in the first audio frequency transformer. This trouble again could have been diagnosed without much loss of time had a milliammeter been available. The reduced output reading would have shown that since all was well with the batteries something must be amiss with one of the plate circuits. Had the instrument been applied to each in turn it would have registered nothing or very nearly so when the audio frequency tube was reached. In this case one could first suspect the transformer and would test it for continuity with the help of the milliammeter thus coming to the solution of the problem.

### A USEFUL SYSTEM

I have always found it most useful with multi-tube sets to provide an easy means of cutting out either the radio frequency or audio frequency tubes or both at will. In this way one can make extremely rapid tests without the necessity of using any instruments. One of the simplest systems of doing this is as follows:—Place a group of four terminals upon the panel in the neighborhood of the first R.F. tubes. To two of them are connected (A, C, Fig. 4) the leads from the secondary coil of the tuner. The other two (B, D) are connected to the slider of the potentiometer and to the grid of the first tube. Normally these terminals are connected as shown in the Fig. (A-C, B-D) by swing hooks cut from sheet brass. A similar arrangement is made between the last R.F. tube and the detector, one pair of terminals (E, F) taking the leads from the transformer's primary while the others (G, H) are connected to those from the grid of the detector and "A" battery negative. These again are normally connected (E-G and F-H) by brass hooks. A third group of four terminals comes between the detector and the first audio frequency tube. Of these

# BAKELITE

TRADE MARK REG. U. S. PAT. OFF.

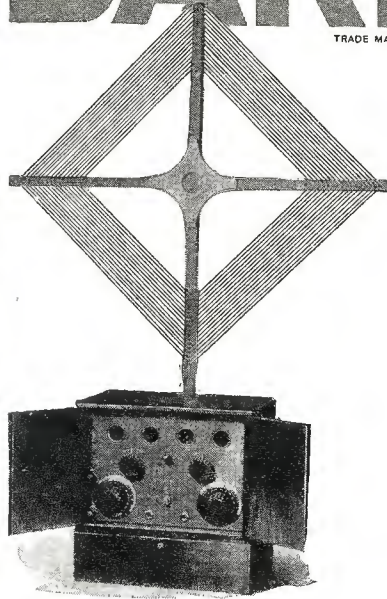

## DeForest and Bakelite

Bakelite is standard insulation on all DeForest Radiophones—from panels to transformer covers. The effective protection afforded by Bakelite is a strong factor in the success of these well known radio sets.

Good insulation must have, mechanical strength and rigidity, chemical inertness, heat and water as well as electrical resistance and, last but not least, durability. Bakelite possesses all these characteristics in a very high degree.

The fact that practically every radio manufacturer uses Bakelite is an excellent endorsement of its value for radio insulation.

Write for a copy of our Radio Booklet B.

### BAKELITE CORPORATION

247 Park Avenue, New York, N. Y.  
Chicago Office: 636 West 22d Street

### Send for our Radio Map

Enclose 10c and let us send you the Bakelite Radio Map. It lists the call letters, wave length and location of every broadcasting station in the world. Address Map Department.



## THE MATERIAL OF A THOUSAND USES

### HEATH RADIANT CONDENSERS

No warping or buckling of plates. Stamped to PERMANENT FLATNESS and tempered to STEEL HARDNESS—reasons enough for a guarantee of lasting accuracy.

#### Micrometer Geared Vernier

Reducing gear gives hair-line adjustment, so essential in the finely tuned circuits. Separate tension adjustment.

Jobbers and Dealers: Write for Proposition  
**HEATH RADIO & ELECTRIC MFG. COMPANY**  
206 FIRST ST. NEWARK, N. J.

Write for Literature!  
Canadian Distributor: Marconi Wireless  
Telegraph Co., Montreal, Canada

### GUARANTEED "B" BATTERIES

Large 45 volt.....	\$3.60
Large 22½ volt.....	1.80
Medium 45 volt.....	2.75
Medium 22½ volt.....	1.60
Small 22½ volt.....	1.00

All-Variable. Postage Free. Satisfaction Absolutely Guaranteed

**S & H BATTERY SUPPLY CO.**  
41 Nevins St., Brooklyn, N. Y.

Insure your copy reaching you each month. Subscribe to Radio News—\$2.50 a year. Experimenter Publishing Co., 53 Park Place, N. Y. C.



*Approved!*

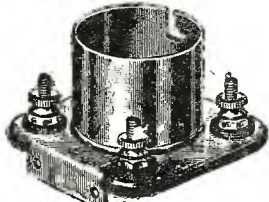

APPROVED  
**RADIO NEWS**  
LABORATORIES  
1922

50¢ AT YOUR DEALER  
**WALNART TUBE SOCKETS**

Adopted by leading radio set manufacturers. Dependable in all circuits.

Can be mounted on panel or base board (packed complete with mounting screws).

**Electrically Right**  
**Strongly Constructed**  
(Non-breakable)  
**Perfectly Insulated Thruout**  
**Fits Into Small Space**

Continental White Horn Fibre—the positive dielectric insulation is used in these sockets

Ask to see the Walnart Line of Quality-Radio Products  
Send for illustrated folder complete line  
**Jobbers—Dealers—Manufacturers**  
Write for Discounts

**WALNART ELECTRIC MFG. CO.**

Dept. 611, 1249 W. Van Buren St., Chicago

K and L are connected respectively to "B" battery and plate while M and N receive the leads from the transformer's primary. When the full set is in use they are connected as shown, K-M, L-N.

Should a breakdown occur it is best to see first of all whether the detector is functioning properly. To do this disconnect A from C, B from D, E from G, F from H, K from M, and L from N, to do which is a matter of a moment. Now place the telephone across K-L, connecting A-G, and B-H by means of wire leads. The set thus becomes temporarily a single-tube one. Should everything be satisfactory when it is worked, thus AC, BD, EG and FH are re-connected so as to test the R.F. side. This having been done one can rejoin KM and LN so as to see whether the fault if not so far discovered is in the audio amplifier. If preferred double pole single throw switches may, of course, be used instead of the four terminals, but I much prefer the latter since switches are apt to add to the capacity of the circuits and one cannot feel perfectly sure that their contacts are beyond reproach. The use of double pole double-throw switches to effect the changes in one simple movement is *not recommended*, since to employ them means using long leads, which is not good.

**Radio to the Rescue**

(Continued from page 15)

The higher the frequency used, the more efficient the radiation and the less loss in signal strength when carrying across gaps due to metallic breaks in the conductors. On the other hand, the attenuation of the high frequencies when traveling along metallic conductors or directly through the earth is very much greater than for the longer wavelengths. The optimum frequency to be used in each particular case depends upon the electrical constants of the underground metallic conductors, distances to be covered and type of communication desired.

**TEST PROCEDURE**

In practically all the numerous tests the general procedure has been to take a receiving set of varying degrees of sensitivity underground, and listen to broadcast music or speech from high-power broadcast stations. It is pointed out, however, that these tests should be interpreted with due reference to the conditions underlying them, such as general position of each test made in regard to surface and sheet waters, geological, mineralogical, and topographical conditions, and the presence of metallic conductors.

*The Complete Efficient and Economical Aerial*

**ANTENELLA**

No Aerial or Antenna Needed

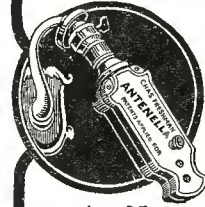

\$1.25

Why pay \$10.00 or more to have an aerial spoil the appearance of your home? *Antenella* eliminates all unsightly wiring, lightning arresters, etc., and precludes the possibility of dangerous grounding on a power line. It also stops "canary bird" re-radiation from nearby oscillating sets interfering.

**ANTENELLA**

is not only a real distance getter, but also overcomes troublesome static.

At your Dealer, otherwise send purchase price and you will be supplied postpaid.  
Ask for Circular A-15

**Chas. Freshman Co. Inc.**  
*Radio Condenser Products*  
106 Seventh Ave. New York

**Sterling**

No. 45 VOLTAMMETER

An All Around Good Pocket Meter

This meter does everything but "talk" and in its own language tells you all about the amperage of "A" Battery cells and the voltage of "B" Batteries both dry and storage. PRICE \$4.00

It is reliable, accurate and has the "right resistance" so as to protect your batteries from surplus drain under test.

**THE STERLING MFG. COMPANY**  
2850 Prospect Ave.  
CLEVELAND, OHIO

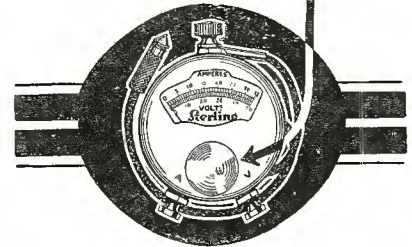

*Has the Bulge on them all*

**POWER from Electric Light Socket**

A PERMANENT POWER PLANT FOR YOUR RADIO  
OPERATES YOUR SET FROM YOUR LAMP SOCKET  
OR FROM YOUR LIGHTING PLANT

NO MORE BUYING OF BATTERIES

WRITE FOR DESCRIPTIVE LITERATURE

**SIDBENEL RADIO EQUIPMENT MANUFACTURING COMPANY**  
29 WEST MT. EDEN AVE., NEW YORK, N. Y.

**MADERA** Die-cast Wood

"Clearspeakers"

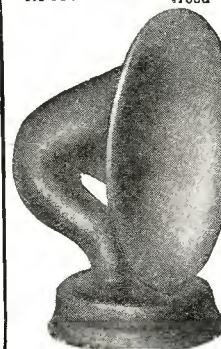

tend to neutralize, rather than amplify, summer static. The dense, homogeneous walls of these artificial wood horns have acoustic properties much like those of a rare old violin.

No. 804, here illustrated, 12 in. high with 10 in. bell, is especially suited to the rough treatment of summer camping—postpaid for. \$15.00

Larger sizes are proportionately inexpensive. Send for circulars. Mention dealers you wish to favor.

**American Art Mache Co.**  
343 W. Austin Ave.  
Chicago, Ill.

Insure your copy reaching you each month. Subscribe to Radio News—\$2.50 a year. Experimenter Publishing Co., 53 Park Place, N. Y. C.



Reception is usually from broadcast stations of a power very much greater than can possibly be considered practical for underground sending sets, yet even one way communication, from the high powered station on the surface to a receiving set in the mine, is of value if entombed miners are equipped with a dependable receiving set. They could be informed of the progress of the rescue parties and in some cases directed to different parts of the mine where rescue parties may reach them.

Transmission from within the mine to the outside is regarded as of greatest importance, and up to the present tests being made by the Bureau of Mines, no effective method of accomplishing this result had been found. If a reliable means of voice transmission can be placed at the disposal of entombed men, they can inform rescue parties of their exact location, the number of men entombed, their names and designation number, the number of men living, and the condition of air supply.

It would be admirable if adequate provision could be made for placing mine communication rescue sets underground and have such sets ready for use in cases of emergency. However, the capital invested in idle equipment while waiting for something to happen, offers a serious obstacle. A direct operating use for the apparatus must be found in the every-day operation of a mine. Because of the fact that radio can operate effectively and efficiently when the radiated energy can be guided by metallic conductors the use of a simple low-power portable line-radio set is possible.

It has been found that practically any conductor which is insulated sufficiently for the economic transmission of power or lighting current, will act efficiently as a carrier for the high frequency. The conductor acts in a double capacity—the high frequency current being superimposed upon the low frequency or direct current power without any interference to the power supply, and with only slight interference to the carrier current communication if proper coupling and filtering systems are used. No interference to telephone circuits is noted by superimposing the high frequency carrier on the telephone line. Short breaks in the carriers such as opening of switches are not directly noticeable in operation, and severe disasters which might cause one or more breaks will not completely destroy the conductors.

**I Want To Know**  
(Continued from page 63)

**MAGNAVOX AS MICROPHONE**

(977) Mr. Henry Smith, N. Plainfield, N. J., asks:

Q. 1. Would a properly insulated lightning protection system be of benefit in case the aerial was directly struck by lightning?

A. 1. The value of the lightning protection system is in keeping the air surrounding the aerial, from becoming too highly charged.

Q. 2. Could a Magnavox R-3 loud speaker be used as the microphone for a transmitting set?

A. 2. It would probably work quite well in such an arrangement. It would be advisable to remove horn, and arrange a small mouth piece instead.

**CORRECT TUBE BATTERY**

(978) Mr. Lloyd W. Cronse, Seward, N. Y., asks:

Q. 1. Do loud speakers having large horns require more energy in put than do those having small horns?

A. 1. No.

Q. 2. Are Leclanché wet batteries suitable for WD-11 tubes?

A. 2. These batteries are quite efficient. They may be used in place of the usual dry cell or storage battery.

Q. 3. Which would be more economical, a single dry cell or a 2-volt storage-battery unit, for lighting a WD-11 tube?

A. 3. If facilities for charging a storage battery are available, it will probably be better to use that type of battery. Otherwise it would be more economical to use a single dry cell.

**TUBE ADAPTERS**

(979) Mr. A. J. Thieler, Detroit, Mich., requests:

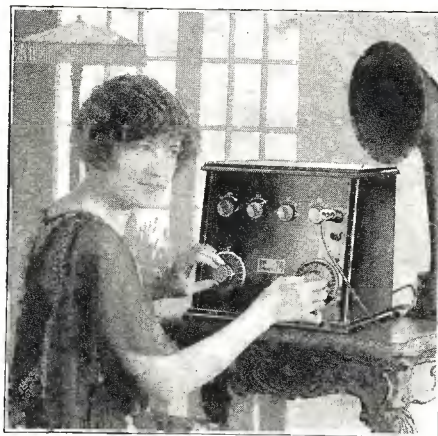

**Quiet Simplicity**

**I**F you are looking for a set that howls and screeches on the least provocation and that gets distant stations only occasionally, you will not be interested in the new UNIDYNE.

If, on the other hand, you are looking for the utmost in radio entertainment, you will want this new set. It is not a trick circuit and does not require an expert radio engineer to get results. It operates at all times with quiet simplicity. There are but two controls. Yet the new UNIDYNE is so selective that distant stations can be brought in by the novice while local stations are broadcasting. The new UNIDYNE is light and portable and makes an ideal summer set. Get a demonstration of this new four tube set from your dealer today. If he has not stocked the UNIDYNE we will see that you are taken care of if you will write us and mention your dealer's name.

**United Mfg. & Dist. Co.**  
9705 Cottage Grove Ave., Chicago, Illinois

**\$95<sup>00</sup>**

**UNIDYNE**

**CATALOG L-25-148  
PAGES  
FREE!**

**SUPER-HETERODYNE—  
NEUTRODYNE!**

New Complete Branston Kits Including Oscillator Coupler, Antennae Coupler, 3 Inter. R.F. Trans. and Special Transfer Coupler. Complete Kit Lists, \$56.50. Acme 30 Kilo Cycle R.F. Trans., \$5.00. All American 2,000 to 10,000 Meter Trans., \$5.00. Hileco Antennae Coupler, \$8.00—Oscillator Coupler, \$7.00. Gen. Fada Neut. Part. 5 tube, \$85.00; 4 tube, \$64.00; Kit, \$25.00.

**AMERICAN RADIO MFG. CO.**  
WHOLESALE DISTRIBUTORS

Dept. A G WEST 14TH ST. KANSAS CITY, MO.

**VACUUM TUBES  
REPAIRED**

WD-11, WD-12,  
UV-201A, UV-199 **\$2.50**  
and others for

Quick service. All tubes repaired by us guaranteed to work as good as new. Send your dead tubes. All you pay is \$2.50 plus postage to postman.

**THOMAS BROWN CO.**  
511-519 ORANGE ST. NEWARK, N. J.

Insure your copy reaching you each month. Subscribe to Radio News—  
\$2.50 a year. Experimenter Publishing Co., 53 Park Place, N. Y. C.



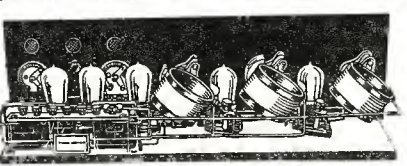

# FREE

**All About Neutrodyne!** The most elaborate descriptive literature ever published. Second huge printing ready June 1st. Why coast to coast, Hawaii, Cuba, reception is infallible. The secrets of 5-Tube achievements, selectivity, clarity. The wonders of new synchronized design. Amazing list of stations reached. Names and addresses of fans reporting from all parts of U. S. Miniature reproduction of master blueprint hook-up. Diagram of the ideal parts for perfect synchronization. List of 498 broadcasting stations with call letters and wavelengths. Key map of big stations. Every fundamental fact necessary to show you how to bring the great things of radio enjoyment within reach of a modest purse. We promise you the radio revelations of your life. Send now. It is FREE to every earnest fan. If you like, send 2 cent stamp to pay part of the cost. We will appreciate your courtesy. Address Dept. RN6.



**THE RADIO SHACK** 55 Vesey Street  
Largest Radio Dealers in America Dept. RN6, New York

## We Cut Rub-Mika Panels

to meet your requirements

Not necessary to order standard sizes. Cut to any sizes you desire. Rub-Mika is high grade panel material, low absorption, high tensile and dielectric strength. Let us quote you on your requirements. Fill in the coupon for samples and prices.

### The Cooper Corporation

Manufacturers  
Cincinnati, Ohio

The Cooper Corporation, Cincinnati, Ohio.

Please send me samples and prices on Rub-Mika Panels.

Name .....

Address .....

---

\$12.50 Como Push & Pull Transformers...	\$9.00 per Pr.
\$20.00 K1t Neutroformers & Neutralizing Conds.	\$ 9.35
\$ 6.00 Folding Loop, Silk covered wire.....	\$ 3.40
\$ 5.00 Globe High Ratio Transformers.....	\$ 2.50
\$ 5.00 Acme Audio & Radio Transformers.....	\$ 3.45
\$65.00 Crosley XJ-4 Tube Set.....	\$41.35
\$125.00 5-Tube Neutrodyne Set, guaranteed for one year against defective workmanship.....	\$55.00

Remittance must include postage. No C. O. D.

**MARVEL RADIO SPECIALTY CO.**  
132 Nassau St., New York City R.N.

Q. 1. What are the objections to using adapters with the various tubes?

A. 1. If the tubes are being used as radio frequency amplifiers, they will not function as well when adapters are used as when the correct sockets are used. This is due to the fact that the capacity between the elements of the tubes is increased. This causes a reduction in the amount of amplification. In addition to this fault, four more contacts are added to the set, at every tube, often causing tube noises.

#### LOUD SPEAKER EXTENSION CORD

(980) Mr. Clifford Froberg, Ridgeway, Pa., writes:

Q. 1. Would a wave-trap serve to tune out strong interfering stations?

A. 1. A properly designed two coil wave trap would probably greatly reduce, if not eliminate, the signals from interfering stations.

Q. 2. Can a 20-foot extension cord be used on a loud speaker without decreasing the volume?

A. 2. Using an extension cord will reduce the volume slightly, but results will be entirely satisfactory.

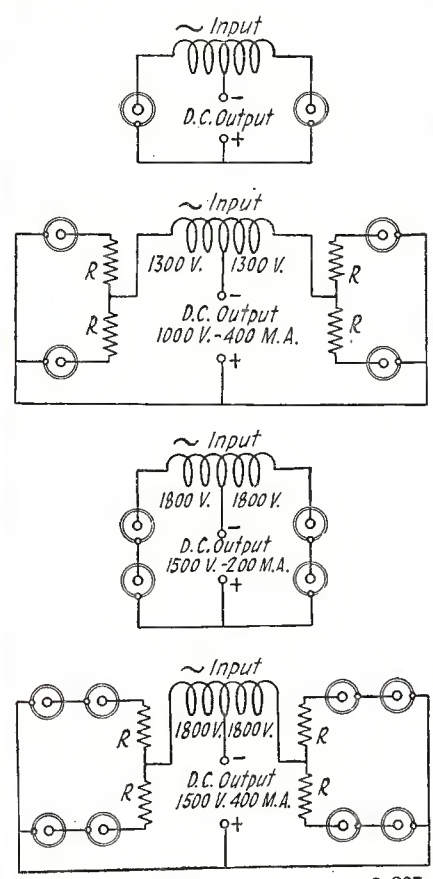

Q-983  
Showing the numerous ways in which the "S" tube rectifiers can be used.

#### BUS-WIRE CONDUCTIVITY

(981) Mr. Harry J. McBride, Detroit, Mich., asks:

Q. 1. Why is tinned bus wire used for connections if copper is a better conductor at high frequencies?

A. 1. Copper is not a good conductor if it becomes corroded, and tinning prevents corrosion. Theoretically, tinned bus wire has a higher H.F. resistance, but, practically, results are the same.

Q. 2. Why is gold plated wire not used more extensively, if gold is a better conductor than any other metal?

A. 2. The purest grades of copper have a greater conductivity than gold. Ordinarily, gold has a higher conductivity at low frequencies than the ordinary grades of copper, but copper takes the lead at high frequencies, as shown by recent tests by the U. S. Bureau of Standards. Gold plated bus wire has the advantage of not corroding.

#### ONE DIAL CIRCUIT

(982) Mr. Frank E. McKamy, Bushington, Iowa, writes:

Q. 1. Please give the circuit for a set using one dial tuning.

A. 1. We are showing the circuit you request in these columns. The primary and secondary must be wound in the same direction. One tube is used for both windings, with a separation of 1/4 inch between each.

#### "S" TUBES

(983) Mr. H. Selig, Pittsburgh, Pa., wants to know:

Q. 1. How is the "S" tube rectifier connected

## And Now for ROUND nuts- Spintite



Now you can tighten all the nuts on your set—Spintites for round nuts are ready. Go over your set with Spintites and make connections as solid as if soldered—then you will get greater distance and volume and cut out noises.

Set of 3 Spintites, for round nuts .....\$1.00  
Set of 3 Spintites, for hex. nuts 1.00  
Set of 9 Spintites, for all hex.nuts 3.50

If not at your dealer's, send us your order with his name. Write for Booklet of Special Radio Tools.

**STEVENS & CO., 375 Broadway, New York, N. Y.**  
Toolsmiths since 1899

### Stevens TRADE MARK Tools



## The Eagle

Balanced Neutrodyne  
"King Of The Air"

Write for Literature  
Dealers, Jobbers, Write

### EAGLE RADIO COMPANY

20 Boyden Place, Newark, N. J.

**S. HAMMER RADIO CO.**  
307 Atkins Avenue Brooklyn, N. Y.

\$150 FREE-EISEMANN NEUTRODYNE, Model N. R.-5, Wired in Freed-Eisemann's factory. None shipped C.O.D. Special.....	<b>\$121.00</b>
\$80.00 GENUINE FREE-EISEMANN. Model K.D.-50 parts for 5-tube neutrodyne set. Model K.D.-50	<b>\$61.00</b>
\$65.00 FAOA KNOCKDOWN PARTS. No. 167-A. Sealed in Fada's factory. N.&K. PHONES IMPORTED. 4000 ohms. Model D. List price, \$8.50. Our Price...	<b>\$49.00</b>
Orders over \$5.00 Shipped Prepaid. Money Orders or C.O.O. Write for Free List. Not Insured Unless Insurance Charges Included.	<b>\$5.95</b>

### Double Your Distance



The Variohm—the perfect variable grid leak enables you to get exactly the correct grid resistance for your tubes. Any resistance from 1/4 to 30 megohms, by turning knob. Once set stays permanently. Use with any fixed condenser. Price 75c.

Mounted \$1.00 at all good dealers.

**ELECTRAD, INC.**  
428 Broadway, Dept. H, New York





**Charlotte Cabinet No. R4**

Inside dimensions 32" x 12 1/2" x 10" high. Brown or Red Mahogany finish, rubbed. Lock on door. Weight 70 lbs. crated.

**\$25.00**

at your dealer's or direct from factory, F. O. B., cash with order

Other Cabinets up to \$18.00

There is a CHARLOTTE Cabinet for YOUR set

**CHARLOTTE FURNITURE COMPANY**  
CHARLOTTE, MICHIGAN

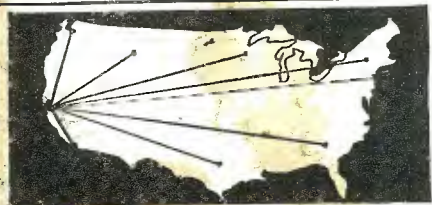

**ON ONE TUBE**

Broadcasting from Atlantic Coast, Canada, Mexico, Cuba and Hawaii heard in California by users of the CROSS COUNTRY CIRCUIT. Range due to simplicity. One tuning control. ANY NOVICE can build easily and cheaply. Dry cell tubes used. No soldering. Complete instructions, Blue print panel layout, Assembly Photo, etc., postpaid 25 cents. Stamps accepted.

**WHAT USERS SAY**

**EAST**—Am more than pleased with the parts ordered from you. The first night I hooked it up and received Omaha. Since then Minneapolis and Los Angeles. It works better without amplification than most sets with two stages. —Donals, S. C.

**WEST**—I am sending you a list of some of the stations heard on one tube: WSB, WGY, KDKA every night. PWX, WWJ, WTAM, WLW every night. CFAC, CHCB. Not long ago I purchased another set of parts from you and first night got WGR, Buffalo, and KDKA. —Ione, Calif.

**NORTH**—Received coils OK today. If I have same results with these that I had with last will be wanting more. I am 1,500 miles from nearest station and have picked 56 to date. Chicago, Havana, Mobile, New Orleans and TWO IN ENGLAND. —Lunenburg, Canada.

Send stamp for further information.

**Vesco Radio Co.** BOX RN-117 OAKLAND, CALIF.

**We Repair**

**RADIO TUBES**

A WRITTEN GUARANTEE WITH EACH TUBE

Dealers write for prices.

**RADIO TUBE MFG. CO.**  
154 Nassau St., New York  
MAIL ORDERS PROMPTLY FILLED. ALL MAKES.

**\$2.50**

job of introspection. The writer is the broadcast manager of an industrial concern that gives a high-class entertainment program once a week and, on Sundays, broadcasts services from the various churches of the city. He says: "We experience no trouble in obtaining letters from listeners in the United States, although we believe the applause card is hardly satisfactory to the artists. The card itself is printed with one object only, that of obtaining a verification from the broadcast station that so and so did get such and such a station on a certain date. Naturally the artists like to see mention made of themselves and their numbers, and while we pay some artists, many come voluntarily and we like to show that their efforts are appreciated. Listeners in Canada, for instance, are not good correspondents, although, as announcer, I personally make every effort to get them to write. We receive thousands of letters, 80 per cent. coming from the States and we believe that 50 per cent. of these are applause cards, which cards are more or less selfish in their make-up. They give no real appreciation, but ask for a reply which is, of course, a verification of their reception. The radio listener must always remember that artists are human and broadcast stations are to be considered artists too, and while appreciation from listeners costs much less than the broadcast, it means a great deal when it comes along in the mail bag."

**DO BROADCAST LISTENERS REALLY LISTEN?**

The director of broadcasting in a far western college expresses himself as follows: "I am glad" he said "to learn that you are writing an article that will wake up the broadcast listeners. The average listener will applaud until his hands are sore at a vaudeville show, but will never write a letter to the broadcast station. We have, so far, been able to get our lecturers and musicians to donate their services, but some of them frequently say that they believe they are wasting their time. Tell the listeners when they write to mention names of artists and lecturers and to indicate that they have really listened to the performance." [Ouch!] "Many of our people believe that entirely too large a percentage of the listeners are simply playing radio golf and getting no benefit from the programs."

In the southwest, a director finds: "There is a slightly increasing inclination of artists after they have appeared before the microphone a few times, to become less cheerful if asked to continue to render their services. We induce them to perform through the publicity which we are able to get for them in the newspapers with which we are co-operating. Except for the publicity which newspapers give them, they do not see much nourishment in broadcasting."

A New Jersey station, quoted above as saying that artists were satisfied to appear for the publicity value they saw in broadcasting adds: "It would not be hard to secure talent of a satisfactory calibre, if it were not so hard to secure written communications from the listeners-in. It has been the writer's experience that the public is quite liberal in sending cards to distant stations but absolutely forget the nearby stations, relying upon meeting them personally, or telephoning in during the course of a business conversation."

The situation in a section of the South where neither broadcast stations nor artists are too numerous is covered by the following Arkansas letter:

"We are very much in favor of your suggested article pointing out to the broadcast listeners their folly in not applauding the performers.

"In our experience, this is very trying. Our average range is 500 miles, having been reported in 41 states, Canada, Mexico, and Cuba, but alas and alack, the artists who perform once, say nevermore.



**FROM "FACTORY TO USER" PRICES**

High grade Radio Cabinets, sturdy built and fine looking. Built up from selected genuine black walnut or birch. Elegantly finished. The black walnut cabinets are finished in rich natural walnut. The birch cabinets are finished in Adam brown mahogany. All dull. Tops on all cabinets hinged. The black birch cabinets have continuous piano hinges. The cabinets are rabbeted to take the panel. Panels not included. Money back if not satisfied.

No.	For Panel	7" depth	Reg. hgs.	Birch, Adam Br. Mahog.	Gen. Blk. Walnut	Piano hgs.
67	6x7	7"	\$1.75	2.25	3.95	\$3.10
610 1/2	6x10 1/2	7"	2.75	4.85	4.85	
614	8x14	7"	3.25	5.70	5.70	
621	6x21	7"	2.40	4.20	4.20	
710	7x10	7"	2.80	4.90	4.90	
712	7x12	7"	3.00	5.25	5.25	
714	7x14	7"	3.25	5.70	5.70	
718	7x18	7"	3.60	6.30	6.30	
731	7x21	7"	4.10	7.20	7.20	
734	7x24	7"	4.75	8.30	8.30	
726	7x26	7"	5.00	8.75	8.75	
727	7x27	7"	5.25	9.20	9.20	
728	7x28	7"	3.35	5.80	5.80	
914	9x14	10"	3.85	6.75	6.75	
1214	12x14	10"	4.75	8.25	8.25	
1221	12x21	10"				

F. O. B. Milwaukee, Wis.

**UTILITY SUPPLY COMPANY**

435-439 27th Street Milwaukee, Wis.

**FREE**

NEW stations heard, records broken, greater accuracy in logging through UNIVERNIER control, have brought many requests for a new Radio Log. Hence the handy, pocket size UNIVERNIER Log. Tells how to compile a permanent log book. Gives valuable suggestions on DX tuning. A free copy awaits you at your dealer.

**WALBERT UNIVERNIER**  
Micro-selective tuning control

UNIVERNIER with the heavy knob and gold-plated dial \$1.50  
With black knob and silver dial \$1.25

If your dealer fails you send a two cent stamp for a copy to the

**WALBERT MFG. CO.**  
933 Wrightwood Ave. CHICAGO

**Get Them All**

**ANY PLACE ANY WAVE ANY TIME**

WITH THE **RELIABLE NEUTRALIZING CONDENSER**

Reach out into the most remote places, or isolate any nearby stations from several others, and hear what you want with this little condenser. Better neutralizing—longer range finest adjustment possible.

PRICE MOUNTED **\$1.00**

THE RELIABLE PARTS MFG. CO.  
2819 Prospect Ave., Cleveland, Ohio

KDKA KZM  
KZM WLW  
KZM WAK  
WOC WBY KLZ  
WOC WABU  
WCX WDAL  
WDAP WEAF  
KOXY WGAN  
WFAA WGI  
WAB WEAR  
WFC WTAX  
WOR WPG  
WONV WTAM  
WOAX  
KDYM  
KSS  
KGY  
KFLA



at various voltages, when used to supply current to transmitting sets.

A. 1. We are showing these circuits. By using a standard filter consisting of two choke coils and two condensers, practically pure D.C. will be had. The choke coils may be of one-half henry inductance. The condensers will have to be about 25 mfd. An electrolytic condenser will fill the requirements. When connected in parallel, "S" tubes require resistances "R" of about 1,000 ohms.

Q. 2. What is the life of the "S" tube?  
A. 2. Approximately 3,000 hours.

### Broadcasters, Broadcasters and Broadcasters

(Continued from page 17)

There is still another class of broadcast station that experiences no difficulty in securing artists—those operated by educational institutions. One in the Middle West says, "We have a Department of Music, which enrolls over 900 pupils. So you see, we, perhaps, have less difficulty than the average station in securing talent. All talent performing at this station is local."

A Pennsylvania college writes: "So far, we have not had any trouble in securing artists. We have some real talent around the college. The fellows get a kick when they receive cards from a distance. I only hope that it will not wear off."

Although the preponderance of evidence points to the error of the oft-repeated statement that broadcast artists are dissatisfied and threatening to quit, there is also evidence that the public is not supporting and encouraging them as they deserve. It appears sometimes in statements like this one from a New England department store station: "We firmly believe that the radio audience does not, in general, appreciate the fact that they are receiving what might be termed 'free entertainment.' We believe they should send more applause cards to the stations and artists from whom they secure this entertainment. The average person, the writer believes, leaves it to the other listener-in to send in the applause. Many radio fans believe if they write to a station once, that it is sufficient. From the station's point of view, it is desirable to have as many applause cards as possible on any one concert, as the artists who perform for that concert see only the cards that come in for that particular concert. Of course, they are more willing to come again if there is a good response. At times we have found it hard to secure competent artists, as some of them believe they should receive pay, and it has been our policy to depend on the advertising accruing to the artist from his appearance to remunerate him for his work. The average artist in the studio seems to like the idea of broadcasting as a novelty. If they receive a number of applause cards they are willing to come again."

A station in western New York reports: "While our station receives a goodly number of letters and cards in response to its broadcasting, we are still very anxious to receive more, as all such letters and cards are eventually turned over to the artists mentioned in them. This, as you know, forms their applause and is greatly appreciated by them."

#### ARTISTS DIGUSTED

Real trouble developed in the southern city from which this letter came. "It is difficult to secure competent artists for more than one or two performances. They are usually disgusted after their first appearance upon not receiving cards and letters to assure them that they 'get over.' There are apparently two schools of performers, one class desiring to broadcast, as they believe the publicity gained is helpful, and a second class who believe that it is injurious."

From the same city in Canada in which one station reports enthusiastically that there is no trouble in securing the best of talent, there comes a letter that should make the broadcasters—the listeners-in—do a little

# Reflex Problem SOLVED!

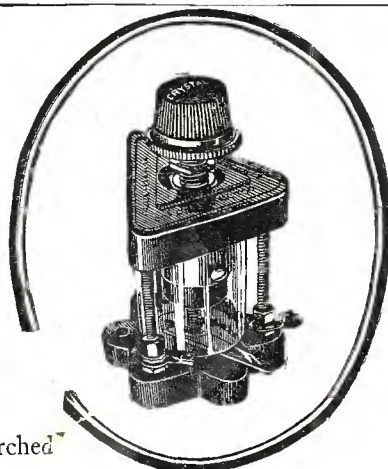

At last the experimenter who has searched for the ideal crystal can depend upon a perfect detector. The New Freshman Double-Adjustable Crystal Detector has met every requirement of the ideal unit. It affords uninterrupted, noiseless, distortionless reception, yielding extraordinary volume with entire absence of squeals and howls often induced by vacuum tube detectors.

### Note These Exclusive Features:

1. Turns the crystal without disturbing the contact pressure!
2. Non-metallic housing prevents short-circuiting noises during adjustment!
3. Mounts neatly on the panel with only small knob showing!
4. Contact cannot be jarred from sensitive spot!
5. Adjustable at panel, also at base, with tension adjustment additional!
6. Super-Crystal withstands high voltages!
7. Loop-end contact permits complete coverage of crystal with gliding movement!
8. Rigid construction!

Hundreds of enthusiastic users of the new Freshman Detector are proclaiming it by far the best detector ever offered. Manufacturers of Reflex receivers, tuned radio frequency, "Supers," and similar circuits are specifying Freshman's for their crystal detectors. More for your money than in any detector ever offered!

**FRESHMAN** \$1.50  
Double-Adjustable Crystal Detector  
For base or panel use, complete with super crystal  
Freshman Super Crystal With Non-Metallic Housing 50c

No more searching for the sensitive spot—merely turn the knob as you would a dial!

Free — Write for building plan of New York Times Reflex. Gives panel layout, list of parts required, etc. Operates loud speaker on two tubes. Ask for circular C-103.

**Chas. Freshman Co. Inc.**  
Radio Condenser Products

106 Seventh Avenue, New York City

#### What one Editor said of the Freshman Crystal

"The new Freshman 'double adjustable' crystal detector 'stayed put,' even when the set was deliberately shaken, stood up to 130 volts on the plate circuit without noise or distortion." wrote editor of *New York Evening World's Radio Magazine* in an article of March 19th, 1924. And in a previous issue he continued: "This detector meets every requirement of the reflex circuit."

"It is enclosed and provided with two adjustments, one varying the position of the crystal, and the other regulating the brush contact adjustment."

"The crystal is a pure natural ore and is embedded in an insulated housing, thus eliminating short circuits and consequent loud noises resulting from the cat whisker touching the metal housing."

"The Freshman detector can be panel mounted with only a small knob showing. All around it is the best crystal detector unit found for reflex work."

Other Freshman products include variable grid leaks fixed in place, condensers, variable condensers, A n - tenellas, resistances, by-pass condensers, etc. At your dealer's, or send purchase price and you will be supplied postpaid.



**MIRACO**  
GETS EM FROM COAST TO COAST

PRICE ONLY \$29.50

At rock-bottom prices you get the efficiency of sets costing three times as much. Users tell us that Miraco Radio frequency receivers pick up stations from coast to coast. Operate either on dry cells or storage battery. Solid mahogany cabinets—finest workmanship throughout. Order direct or send for bulletin.

Two tube outfit .....\$29.50  
Four tube outfit ..... 54.50

DEALERS, AGENTS—Write for proposition quickly—it's a winner.

**THE MIDWEST RADIO COMPANY**  
804 Main Street Cincinnati, Ohio

**GREATER EFFICIENCY**  
For Radio Followers Who Want the Best

The **Adams**  
*Perfected*  
**RADIO JACK**



Pure silver contacts—phosphor bronze springs—bakelite insulated. Its construction is scientifically correct—its new features make it a decided improvement over the ordinary jack. You'll say so, too!

Write for full information  
DEALERS: Get our attractive combination offer.

**THE ADAMS RADIO MFG., CO.**  
1042 West Van Buren Street Chicago

Insure your copy reaching you each month. Subscribe to Radio News—\$2.50 a year. Experimenter Publishing Co., 53 Park Place, N. Y. C.



"We wish to suggest in the beginning that reporting broadcast listeners cut out sending in a printed card, 'We wish to thank you for your excellent program of .....Sig,' and so on, that card doesn't mean much to a broadcast station. Let each person reporting give his opinion regarding the clearness, strength, and the numbers appreciated most.

"BCL's, if they are so termed, simply take good broadcasting as a matter of course, it was there when they bought their sets, it will probably stay there—so they think.

"Broadcast stations are invariably operated at a great expense. If it becomes necessary for them to pay for their talent in addition, many of the best ones will close. The artist doesn't enjoy broadcasting to an unresponsive audience. Reports of personal interest will help in the securing of programs from artists again.

"It only costs a cent or two to drop the station a letter, or better still a telegram. It is only through these expressions from the listeners that the stations can tell what they are doing.

"Primarily, stations are maintained for the good they can do. How then, we ask, are we to know what is wanted most unless the listeners write freely and often. Give us your suggestions and constructive criticisms often. Tell the artists that you appreciate their efforts, tell the broadcast station that is under a staggering operating cost that all is not wasted, but being received. Put the personal touch to it."

**CHICAGOANS GET RESULTS**

Chicago has probably established the world's championship for pulling in replies. It has not, however, relied so much upon the gratitude of the broadcasters as upon their cupidity. Early in the game the Chicago broadcasters learned the little trick of holding the attention of the public by prize schemes. Every listener-in knows before now that if he tunes in a Chicago station he is likely to hear of some prize offer and that if he does, he may be able to shoot in a reply by wire and secure some little gift such as a 7-tube receiver or a \$3,000 automobile. It is no reflection on Chicago's programs, which are excelled by none in the United States, to say that much radio applause secured by such methods is about as sincere as an oil stock promoter's flattery of a widow who has a legacy to invest. When, however, it is discovered—as it was discovered by the Chicago broadcasters—that so many members of the invisible audience have been taught appreciation of grand opera that 3,120 of them correctly identified the voice of a prima donna who sang incognito, announced as "Madame X," it is safe to assume that genuine appreciation is richly deserved and actually present.

**De Forest Given Control of Regenerative Patents**

(Continued from page 41)

A little over a year after the original conception, Dr. DeForest came to New York in an attempt to sell the telephone amplifier idea, and met Dr. John Stone, Consulting Engineer for the American Telephone and Telegraph Co. He showed Dr. Stone a sketch of the oscillator at the time. Subsequently this was to play a very important part in the patent litigation.

Another point stressed very strongly by Mr. Armstrong's attorney was that Dr. DeForest did not have a particularly clear idea of the use of the circuit. This notion possibly grew because no direct application of it was made until after the beginning of the legal squabble herein detailed. In the final court which handed down the decision, the fact that Dr. DeForest explained, in detail, his circuit to Dr. Stone upon the occasion of their visit in 1913, was taken to mean

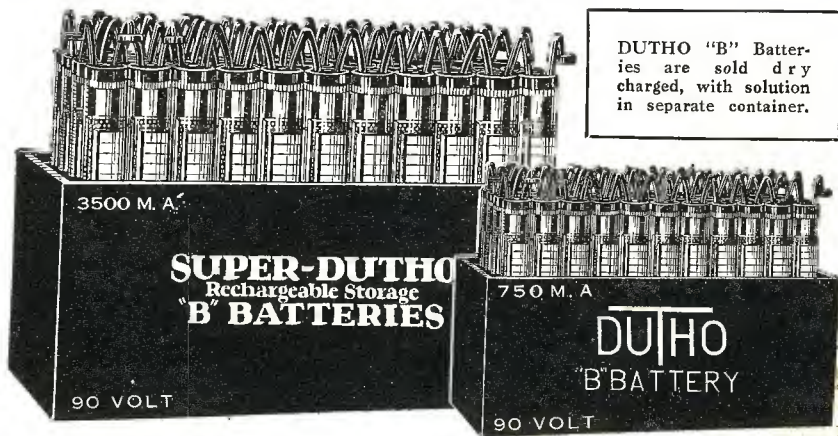

The NEW **SUPER-DUTHO** Rechargeable Storage **"B" BATTERIES**

have 3500 M. A. Hours capacity and are designed especially for larger sets which demand a steady plate current, for loud, clear, undistorted reception. Note the low prices.

You can still get the 750 M.A. Hour Dutho "B" Batteries for portable and all other sets

Here's what they cost you delivered

Super-Dutho 3500 m.a.hours  
24 v \$9  
45 v \$17  
90 v \$32

S Type Dutho 750 m.a.hours  
24 v \$5  
45 v \$9  
90 v \$17

**Important Technical Features**

The new exclusive Dutho-Seal eliminates leakage and electrical loss: prevents external discharge. Ample water space eliminates necessity of frequent filling. Arrangement of cells allows complete visibility. To separate plates Dutho employs rubber to insulate as well as separate: wood for its hygroscopic qualities. Any size Dutho "B" Battery can be charged at one time with the new Duthoid Rectifier, from any light socket for but a few cents. Special Hydrometer is furnished with every Super-Dutho "B" Battery. It accurately tells you when your battery needs charging—when charge is completed. There is no guesswork.

If your dealer can't supply you, we will send Dutho "B" Batteries, transportation charges prepaid anywhere in Canada and U. S. A., when money order or certified check accompanies the order.

"L" Type Battery 3500 M.A. Hours			"S" Type Battery 750 M.A. Hours				
Volts	Length	Width	Height	Volts	Length	Width	Height
24	6 3/4 in.	2 1/2 in.	8 1/4 in.	24	4 1/2 in.	2 in.	6 1/2 in.
45	11 1/4 in.	2 1/2 in.	8 1/4 in.	45	8 1/2 in.	2 in.	6 1/2 in.
90	11 1/4 in.	4 1/4 in.	8 1/4 in.	90	8 1/2 in.	3 1/4 in.	6 1/2 in.

**Duthoid Chemical Rectifier**  
\$1.80

charges up to 90 volts at one time  
keeps your battery in perfect condition for clear reception

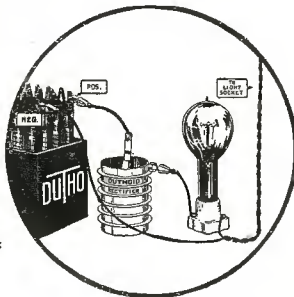

Send for our Booklet on Storage "B" Batteries

**DURKEE-THOMAS PRODUCTS COMPANY**

1228 FOLSOM STREET :: :: SAN FRANCISCO

702

DEALERS: Dutho "B" Batteries sell on sight. Write for our dealer proposition

**ZLO, LONDON**

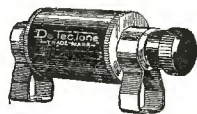

PYRAMID PRODUCTS CO., 117 N. Dearborn St., Chicago.

His goal—at last! Using a DE-TEC-TONE Crystal Detector in a 3-tube reflex receiver, ZLO, London, was heard in Hannibal, Mo., in latest tests verified by A.R.R.L. It is not uncommon to get stations 1000 miles away on simple crystal sets with DE-TEC-TONE. Dealers or direct, \$1.50 postpaid.



Wonderful, new device, guides your hand; corrects your writing in few days. Big improvement in three hours. No failures. Complete outline FREE. Write C. J. Ozment, Dept. 32 St. Louis, Mo.

**Stop Spoiling Your Rugs and Floors**

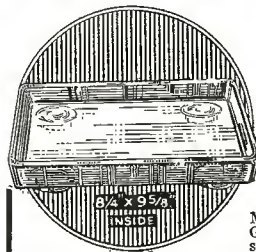

Use **TUFGLAS** Reg'd Battery Trays

Made of Acid Resisting Glass of great mechanical strength. Sent Parcel Post collect to any part of United States. Add \$75 to price if west of Mississippi.

PRICE \$1.50 EACH  
Dealers and Agents Wanted Dept. N

**RUSSELL B. CRESSMAN**  
General Sales Agent  
200 FIFTH AVENUE, NEW YORK

Insure your copy reaching you each month. Subscribe to Radio News—\$2.50 a year. Experimenter Publishing Co., 53 Park Place, N. Y. C.



# Two New Additions!

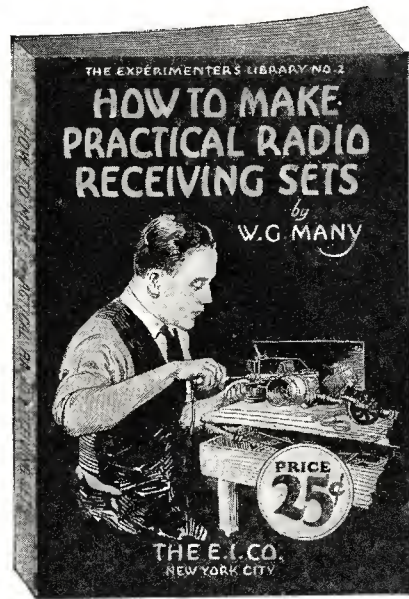
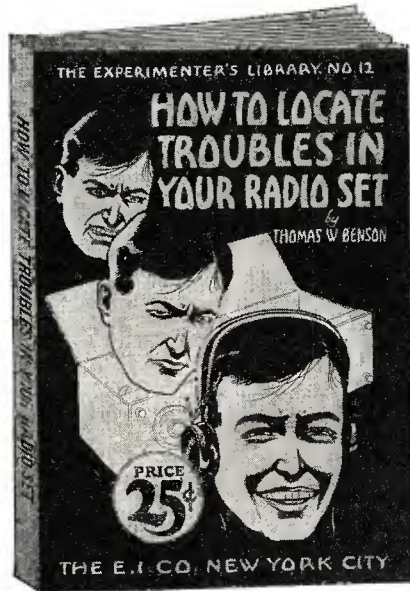
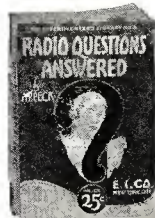
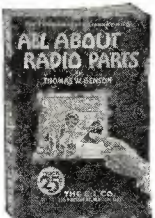
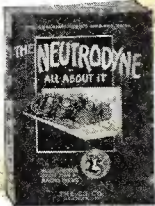
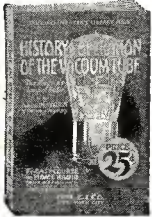
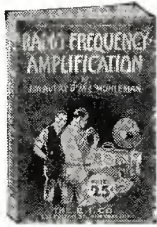

## How to Locate Troubles In Your Radio Set

By THOMAS W. BENSON

The simplified method of going after the trouble in your Radio Set. A handy book that takes every detail from the Aerial to the Ground and explains what might go wrong and how troubles can be remedied at home.

It is one of the best Radio Books for instant reference that is published today being written so that all the general troubles of the Radio Set can be quickly understood by the reader.

You can obtain a copy today at your local dealer or if he cannot supply you, write direct and we will send you a copy. Price 25c prepaid.

## How to Build Practical Radio Receiving Sets

By W. G. MANY

The Publishers of the Experimenter's Library, realizing an increasing demand, have published a complete book on some of the most effective standard circuits in use today.

The author has compiled in this book only those hookups that have been tested by time in the Radio Field, hookups that have and will always give complete satisfaction to the man who builds them correctly.

The book is made up in a standard, handy pocket size and is profusely illustrated with sketches and wiring diagrams that can be followed easily and quickly.

You can obtain your copy at any reliable radio dealer or write to us direct. Price 25c prepaid.

**AT ALL RELIABLE RADIO DEALERS**

### OTHER BOOKS IN THIS LIBRARY

Tips for the Radio Amateur Constructor  
Radio Questions Answered  
Radio Frequency Amplification  
How to Tune Your Radio Set

One Hundred Radio Hook-ups  
All About Radio Parts  
History and Operation of Vacuum Tubes  
The Neutrodyne

**The E. I. Company :: Consrad Co. Inc., Selling Agents**  
233 FULTON STREET, NEW YORK CITY



that Dr. DeForest had a pretty clear idea of his circuit's actions. The attorneys opposing Dr. DeForest also brought forward the fact that the Meissner circuit, which had become known in America about this time, failed to work under Dr. DeForest's hand. The only difference between the Meissner circuit and the original DeForest one, as shown to Mr. Stone, was that the Meissner circuit, including coils P1 and S2, Fig. 2, was shunted by a capacity. If the condenser giving this capacity is too large the circuit will not operate and the conjecture of attorneys in court—about the only way to settle the question, under the circumstances—was that Dr. DeForest had simply selected a condenser for this circuit, the capacity of which was too high. It must be remembered that at the stage of radio investigations discussed in this proceeding, none of the mathematics concerning the oscillating characteristics of a vacuum valve had been put on paper. Really, about the only thing known concerning the whole affair was that if the grid and plate circuits of a valve were allowed to interact upon each other, oscillation would result.

**THE FINAL DECISION**

Following the first court decision in which it was stated that Dr. DeForest produced the first vacuum valve oscillator, the claims of Dr. Langmuir were dropped; then, shortly Mr. Meissner's claims were also deleted from the cause on account of his filing date at the patent office. This narrowed the battle down to the claims of Mr. Armstrong and Dr. DeForest.

One of the chief troubles—at least it seems so to us—was the fact that Dr. DeForest's claims were so much more broad than the radio application that it was entirely possible for the issue to be mistaken all through the lower courts. It is hardly a fitting occupation to question the process of its honor, the judicial mind, but seemingly, it is a plausible explanation for the decision in Dr. DeForest's favor after seven years. The original idea, as conceived by Dr. DeForest, covers the use of a vacuum valve as a generator of alternating currents. May one be so bold as to suggest that possibly the legal lights were led into some entangling bypaths on account of the now extensive use of the vacuum valves as generators of high frequency alternating currents, as used, in radio?

A short history of how the oscillating property of vacuum valves came to be discovered may be of interest. Fig. 1 shows the laboratory sketch of the hook-up which produced the first oscillations. Mr. Van Etten, Dr. DeForest's assistant, working directly under the Doctor's supervision, set up the apparatus illustrated in the diagram. The experiment was primarily one looking toward the production of a telephone amplifier. The instruments used were for the most part pieces of telephone apparatus. The input circuit from the microphone was led to the grid side of the tube and the out-put with the receivers connected was taken from the plate. In the course of the experiments, the two leads running from the grid connection to one winding of the transformer connected in the out-put circuit were installed. Immediately the tube was lighted, instead of the amplification that was hoped for, a beautiful whistling tone in the receivers resulted. The notes state that the tone produced in the receivers was very similar to that produced when the ordinary telephone receiver is held close to its transmitter. This illustration, known to almost everybody, is a well known case of interacting circuits. This fact was stressed throughout the legal hearings as proof that Dr. DeForest and his assistants did actually know that the valve was oscillating at audio frequency.

Immediately they heard this whistling in the receiver, they proceeded to investigate the phenomenon, as is shown by the notes. Different "B" battery voltages were used and various incandescences were tried on the fil-

# Established!

## The MOZART Baby GRAND

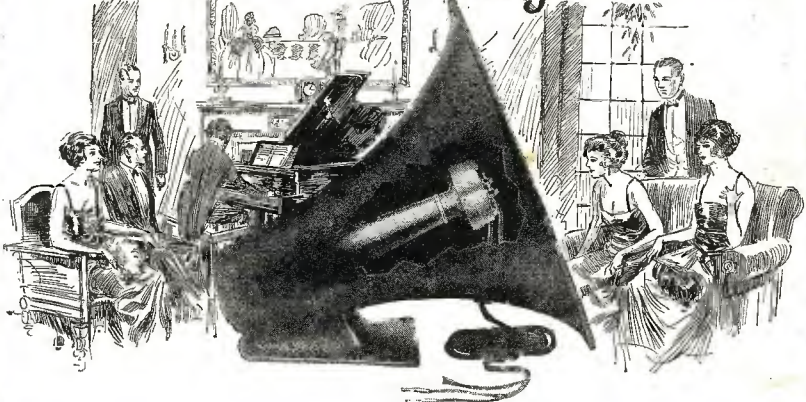

**N**O piece of radio apparatus was ever more firmly or more quickly established. From every point of the compass, entirely unsolicited appreciations, testifying to the merit of our product, continue to pour in.

From telegram (April 8th), and letters later:

"Reproducers and units received. Dealers and public enthused. You can expect big results from California. The real thing was greater than our anticipation."

"(Also) One party stated his wife was so pleased with your Reproducer that if he could not get another one, he would not take \$50.00 for it. It is a pleasure to sell merchandise that brings comments like these."  
(Signed) NELSON RUDE CO., 16 California St., San Francisco, Calif.

**PRICES . . . F. O. B. Factory**

Reproducer complete with (gold plated) unit and polarity-indicating cord .....	\$12.00
Unit only with polarity-indicating cord, gold plated .....	5.00
Unit only with polarity-indicating cord, nickel plated .....	4.00

Shipping weight of reproducer, 7 lbs. (aprox.).  
Dimensions—Diameter of bell, 12". Length and height over all, 12½".

**TERMS:** C. W. O. or C. O. D. when accompanied by small deposit. Orders shipped direct from the factory or through your Dealer.

### THE MOZART GRAND CO.

*Manufacturers of Fine Instruments*

**NEWARK, N. J. U. S. A.**

### Jones "COLOR CAP" Connectors

Follow the Colors—You Can't Go Wrong

Radio fans, this is just what you have long been looking for. An insulated plug connector protecting batteries as well as tubes.



Remove your old binding posts and put in color caps—7 colors 25c each.

Manufactured by  
**HOWARD B. JONES**  
612 S. CANAL STREET CHICAGO, ILL.

### Learn Electricity

By ACTUAL WORK in only **3** months in the Great Shops of Coyne

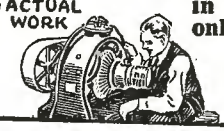

**Make \$3,000 to \$10,000 a Year!**

Not a correspondence school. We pay your railroad fare to Chicago—to the Great Shops of Coyne. You don't need education or experience. 3 months' work at Coyne on vast outfit of actual equipment makes you a Big pay Electrical Expert. Two extra courses FREE. Write NOW for FREE Book.

**COYNE**  
Electrical School  
1300-1310 W. Harrison St.  
Dept. 59-4B Chicago, Ill.

New catalog just off the press. Send for it NOW!

The oldest and largest electrical school in the world!

Insure your copy reaching you each month. Subscribe to Radio News—\$2.50 a year.  
Experimenter Publishing Co., 53 Park Place, N. Y. C.



# ADVERTISING TESTIMONY!

EXHIBIT B

NATIONAL RADIO INSTITUTE  
1345 PENNSYLVANIA AVENUE N.W. WASHINGTON, D. C.



OFFICE OF THE DIRECTOR

*Same old story!*

March 29, 1924.

Mr. Huston D. Crippen, Asst. Advertising Mgr.  
Radio News,  
53 Park Place,  
New York City.

Dear Mr. Crippen:

I am sure you will be glad to know that in checking up actual results received from our advertisements, we find Radio News is pulling larger returns than any other Radio publication.

There you have the real reason why we have not missed a single issue of your magazine for quite a number of years.

You can probably account for the extraordinary growth of your publication better than I can, but if I were asked my reason, I would say that it is due to the policy of the publishers to supply exactly the news that the B. C. L. and the Radio Amateur wants.

Cordially yours,

*E. H. Haas*  
Director.

ELD:P

## Another Example of What Radio News Means to Advertisers

[THIS IS EXHIBIT B OF A COMPLETE SERIES TO APPEAR EACH MONTH IN RADIO NEWS — WATCH FOR EXHIBIT C]

### THOMPSON

NEUTRODYNE and SPEAKER  
\$150 \$35

Representing 14 years' experience by an organization devoted to wireless and radio apparatus.  
R. E. THOMPSON MANUFACTURING CO.  
150 Nassau St., New York  
Factory: Jersey City, N. J.

### HUDSON-ROSS

Largest exclusive Radio  
Jobbers in middle West.  
Write for discounts.

123 W. Madison St. Chicago

### DUOSPIRAL HETRO-LOOP

Especially designed for Super-Hetrodyne Receivers. If your dealer hasn't it—write us.

RADIO UNITS, INC.  
1305 First Ave., Maywood, Ill.

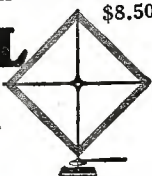

\$8.50



Ask Your Dealer For a  
MONTROSE VERNIER  
CONDENSER

The condenser with genuine bakelite end pieces. Has positive contact between the vernier plate and main shaft. Will get the results where others fail, guaranteed to give entire satisfaction.

MONTROSE MFG. CO.  
1333 Fulton St., Brooklyn, N. Y.  
Phone Decatur 7382

ament. The changes in the note made by these changes in the constants of the circuit were transcribed to the laboratory records.

The placement of the coils, and the two coils which are open, shown in the sketch, are simply the result of the fact that telephone apparatus was used in the experiment. Coils 4 and 5 were both standard telephone transformers. The Stone sketch shows that Dr. DeForest thoroughly understood just what was making the circuit oscillate.

The results of this decision are impossible to state at this writing. In view of the fact, however, that there are 17 companies manufacturing regenerative receivers under the erstwhile Armstrong patents and that there are some large firms engaged on a large scale in the manufacture of radio transmitters using vacuum tubes, it is almost obvious that on-lookers will be furnished with a grand show at someone's expense in the near future.

Mr. Samuel E. Darby, Jr., a member of the firm of Darby and Darby, Dr. DeForest's attorneys, states that it will probably be some time before the whole matter can be straightened out on account of the ramifications extending through half a dozen industries and twice as many companies. He says, however, that the question of patent ownership on the oscillating audion and the regeneration feed-back circuit is settled once and for all, and that further litigation on the subject is almost impossible. Mr. Darby has carried the legal battle from its inception to the present victory for Dr. DeForest.

## The Importance of the Trivial

(Continued from page 29)

ally, not by end-thrust. It is amazing to how small a depth really rapid oscillations sink into a wire. They sink further into copper than into iron, for an iron wire has to be magnetized by the interior currents, and this causes so much delay that high frequency currents keep wholly to a microscopic skin on the surface, and of course the resistance of this thin skin is very high, so that if ever a choke is required to kill oscillations by high resistance, an iron wire is suitable.

For receiving purposes we want the oscillations alive, and not killed. Hence a specially efficient aerial can be made of a great number of insulated stranded wires, even as thin as No. 40.

These remarks apply especially to the lead-in wires. The aerial itself acts partly as a capacity, and for capacity these considerations do not apply; they only apply to resistance for high frequency currents. Similarly, all high frequency transformers and the different leads employed should, if perfection is aimed at, be made of fine stranded wire.

## The Beginners' Radio Set

(Continued from page 36)

tersink the holes for the heads of the machine screws or else drill half way through the panel with a  $\frac{3}{8}$ -inch drill. After punching a hole in each one of the tinfoil lugs, place them on the base, pass the two machine screws through the holes provided and through the lugs. Place a washer on top of each lug and tighten a nut over each washer. A second nut is then placed on each machine screw for the purpose of making connections.

### THE CRYSTAL DETECTOR

In order to render audible the waves which are received by your aerial, it is necessary to have some sort of a rectifying device. As



with the condenser, the theory of the operation of this device will be explained later. It will only be necessary for you to know the construction of it at the present time in order to get your set working. The assembly of the detector is shown in Figs. 6A, 6B and 6C. First a base is necessary of the same size as the condenser base and drilled in the same manner. For this instrument it will also be necessary to secure a piece of fine wire. About No. 28 or No. 30 bare copper wire will be very satisfactory, and it need only be about 3 inches long. Also, from an old tin can, cut a piece of the shape shown in Fig. 6C. This is to hold the crystal and at the same time is connected to the binding post. The sides of this crystal holder are to be bent up so as to form a three-sided cup. It is then mounted with a machine screw, a washer and two nuts, as shown in Fig. 6B and on the opposite end of the base another machine screw, washer and two nuts are placed. One end of the cat whisker or fine bare wire is clamped between the bottom nut and the washer. This completes the assembly of the crystal detector with the exception of the crystal. The latter may be purchased at any radio supply store and practically any one of the good types will give results. Galena is among the best. Always buy a tested crystal guaranteed by the company who puts it out, as you will then be assured of results.

The next step is to assemble the entire set on a baseboard. Have the board large enough so that when you expand your set, you can place other instruments directly on this same base without having to buy a new one. In Fig. 7 we show the assembly on a base of just sufficient size to mount the apparatus. However, this form need not be adhered to and a base of any size may be used. This style of assembly is known as the "breadboard" type. The derivation of the term is obvious from the construction. The writer found that one of the best ways to get a good baseboard for experimental work was to purchase an ordinary drawing board such as is used by draftsmen. This is provided with cleats on the rear of it so that it cannot warp and its several advantages are obvious. These drawing boards can be obtained in various sizes to suit the purpose at hand. By using a lay-out of this type, instruments can always be changed around and other minor changes made in the set without the least difficulty. When a radio set has been assembled on a panel and placed in the cabinet, changes at once become quite difficult to make. For this reason and for the purpose of gaining a good knowledge of radio and at the same time having a usable set, the "breadboard" type is by far superior.

**WIRING THE SET**

When you purchase your other parts, get a half pound of bell wire or an annunciator wire. This is No. 18 wire covered with several layers of cotton insulation impregnated with wax. It gives excellent results for use in experimental hook-ups, as it is quite flexible and at the same time well insulated. The writer always uses this kind of wire for experimental purposes. After mounting your instruments on the baseboard, as illustrated in Fig. 7, run the connections as shown. Connect the aerial to one binding post of the tuning coil and the ground to the other. Also connect these posts to the condenser and detector respectively, connecting the condenser and detector together as shown. Next connect the terminals of the phones or receivers across the condenser, as shown, and your hook-up will be completed. The schematic lay-out of the circuit is given in Fig. 8.

In regard to the phones, we would advise that you buy a good pair in the first place, as they will give results for years and it will not be necessary to replace them. If possible, obtain a pair of the type utilizing mica diaphragms and operating on the

# Be A Master OF THE Air



## Pleasant Home Study

During the next few months you can, by devoting a few hours each week in pleasant home study, qualify yourself to get into the biggest paying field of all time. My practical, understandable course of instruction enables you to be a Master of the Air. Every problem in radio becomes an open book to you. *Be a Master of the Air and you will be a master of your future.*

## \$3,000 to \$10,000 a Year as Radio Expert

15,000 ships, hundreds and hundreds of Radio stations, with new ones springing up every day, are all keenly competing for the services of the radio-trained man. So enormous is the call for the radio expert that the man who knows his business in this field is in a position to command the size of his salary. On land or sea, in Government or private service, there are boundless fine paying opportunities for the man who understands radio problems and how to solve them.

# RADIO where Knowledge is Power — and Power is Cash

I show you how to construct, install, operate, repair and sell radio equipment. Instead of being a spectator in this big game with big stakes, you become an active player. I qualify you to handle every branch of radio. There is nothing theoretical or practical that is not presented to you in complete, concise form. You are standing face to face with the greatest money-making chance ever presented to you. Will you turn your back on it or will you decide now, once for all, that you will get your share of the millions being divided among radio-trained men? Right in your own neighborhood you can make easy profits. Neighbors and friends will gladly give orders for sets and pay for advice on radio problems.

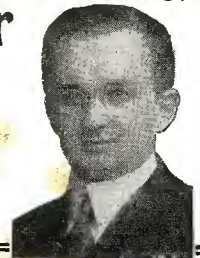

**A. G. MOHAUPT, B.A., M.S.**  
 Head of the Radio Association of America, Graduate Electrical Engineer, University of Wisconsin. Former Radio Instructor for U. S. Government. Author of "Practice and Theory of Modern Radio."  
 I give my personal attention to every student taking my course. Your individual problems and questions are answered by myself. I work with you at every stage of the course, guiding you, directing you to your goal to be a Radio Engineer in the big pay class. My course prepares you to successfully pass Gov't examination for Operator's License.

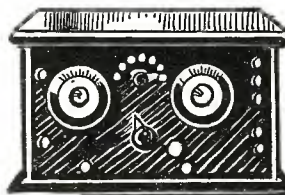

## FREE 1000 Mile Radio Outfit

This set, when completed, has a range of over a thousand miles. I give it free with my course. I give you practical training by having you work on this set. The knowledge you gain is not mere book knowledge, but is usable, practical experience. When you have finished my course, you can sell this set at a price that will more than pay the cost of the course.

## QUICK PRACTICAL TRAINING

Everything in my course is clearly and simply stated so that you can easily understand every point I bring out. No previous experience or education is required. I give you fundamental and practical training in every angle of radio. There is no time to lose. Now is the best time to pass the other fellow by. Mail coupon today and get full information on my course, also details of the thousand mile set that I give free.

**A. G. MOHAUPT, Radio Engineer**  
**RADIO ASSOCIATION OF AMERICA**  
 4513 Ravenswood Ave., Dept. 157, Chicago, Ill.

## MAIL COUPON

A. G. MOHAUPT, Radio Engineer,  
 Radio Association of America,  
 4513 Ravenswood Ave., Dept. 157, Chicago.  
 Please send me details of your Home Study Course—also your Free "Radio Facts" and information on how I can get a FREE 1,000 mile Radio Set.

Name .....

Address .....

City..... State.....

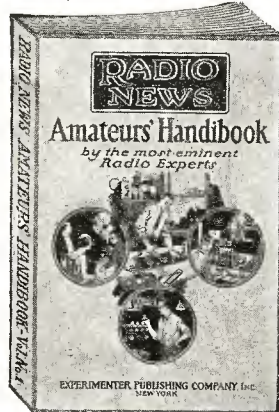

Price \$1.00

## JUST THE BOOK YOU WANTED

# "Radio News"

Amateur's Handibook

Volume No. 1. (Second Edition)

Chock full of radio constructive and instructive articles from cover to cover. Written by foremost radio authorities, in plain everyday language which everyone can understand. Sections include articles on Receiving Sets and Sundry Apparatus, Transmitters and Accessories, Radio Theory, Vacuum Tube Data, and Practical Hints for the Amateur. A book which also serves as a ready reference and should find a place in the library of every amateur. It contains 224 pages and over 375 illustrations, diagrams, and photographs, bound in a multi-colored heavy board.

On sale at all leading radio stores. If your dealer cannot supply you, send a dollar bill and the book will be forwarded to you postpaid.

**EXPERIMENTER PUBLISHING CO. Inc.**  
 53 Park Place, New York



# Silvertron Tubes

**\$3.75 Prepaid**



Type 201A operates as either Detector or Amplifier on 1/4 amp. filament consumption.

Type Detector 12 1/2 volt.

The Silver Tube with the Golden Voice

**A SUPER VACUUM TUBE for \$3.75**

GIVE WONDERFUL AND CLEAR RECEPTION

Operates as either detector or amplifier on 1 1/2 volts. When ordering specify if detector or amplifying tube is preferred. Fits standard socket. Filament consumption 1/5 of an ampere. Guaranteed to give entire satisfaction or money refunded. Sent parcel post prepaid carefully packed to any address on receipt of \$3.75.

DEALERS and JOBBERS

Sole Distributors for U.S.A. and Canada  
Write for Discounts and Circulars.

**New York Radio Company**

71 West Broadway  
New York City, N. Y.

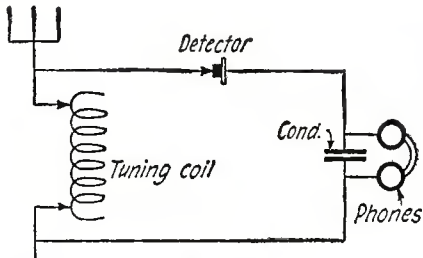

Fig. 8

The symbol circuit diagram of the receiving set.

principle which gives amplification in the phones themselves. Thus you will be equipped with an excellent pair of phones which can be used on any type of set and which, after you construct a two-stage amplifier, can be used as a loud speaker in connection with a horn or a phonograph. These phones do not cost so much more than the standard type that you cannot afford to buy them. It would be much better to spend a little less money on the rest of your apparatus, making most of it yourself, and so save money enough to buy this type of phones.

### OPERATING THE SET

After connecting up the apparatus as described in the above paragraph, place the phones on your head and the two switches at about a midpoint on their respective ranges. Then bend the cat whisker so that the point or free end of it just barely touches the surface of the crystal. Do this during a period when you know that some local broadcast station is in operation. Move the cat whisker over the surface, and if you do not hear any signals, vary the tens switch one or two points. Again move the cat whisker and keep up this procedure until you hear sounds. Once a signal is heard, further adjustment of the cat whisker for a sensitive spot on the crystal and also adjustment of the two switches on the tuning coil will bring the signal in to its maximum strength.

If you have followed the directions given above implicitly and constructed all the instruments in the correct manner, you will have in your possession a very well made receiving set which will enable you to receive from broadcast stations located 25 miles away, or less. Under extraordinary conditions, greater distances than this have been

# TERLEE

## "INS-UR-TUBES" Prevent Accidental Tube Burnouts

Here is a device that gives you complete protection—not half protection—against accidental tube burnouts. No device attached to the set as switch or binding post can insure against shorts within the set or misconnection of "A" and "B" battery terminals. Make no mistake about this. An "Ins-ur-tube" connected to each positive "B" battery terminal in use fully protects your tubes against all these slips. Protects both storage battery tubes and peanut tubes. Price \$1.00 each. Avoid substitutes.

### Improved VARIO COUPLERS

Special winding and improved insulating cut down that customary lost energy. "Terlee's" will give you range and selectivity even under the most trying summer atmospheric conditions. They're built for panel or table installation. Type "S" for crystal and audion circuits, \$6.00. Type "R" for regenerative and non-regenerative circuits using radio frequency amplification, \$7.50.

For best results, demand Terlee Products. If your dealer can't supply you, send your order direct to us.

**Terlee Electric & Mfg. Co.**  
Dept. A-7, 443 S. Dearborn Street  
Chicago, Ill.

"Makers of Radio's Best for Better Radio Results"

## LETTER Your Own Signs and EASY WAY Show Cards the Quick



You, too, can make striking, forceful signs and show cards with the aid of LETTER PATTERNS. Just lay the patterns down—trace around it—and you have a perfect letter in a jiffy. Prove it yourself and save money. Extra introductory offer. All capital letters 1 1/2 inch, all small letters 1 inch, also set of 10 number patterns 1 1/2 inch. All sets \$1.00 postpaid (regular value \$1.25). Samples of 10 different styles 10 cents. Free with order.

BOHN F. RAHN, N2433 N. Greenview Ave., Chicago, Ill.

# If You Build Your Own

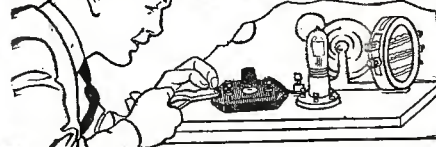

## SUPER-HETERODYNE

you will find that it is necessary to get the right Grid Leak Value  
YDU NEED TWO

## FRESHMAN

VARIABLE GRID LEAKS with .00025 Mfd. Condenser combined

**\$1.00**

FREE! Write for complete Super - Heterodyne wiring diagram showing all connections and parts required. Ask for Circular L-11.

Freshman variable grid leak is the most compact, most efficient, most adaptable to all grid circuits and, being entirely sealed, is unaffected by any climatic changes.

**Chas. Freshman Co. Inc.**  
Radio Condenser Products  
106 Seventh Ave., New York

**SAFE & SIMPLE**  
The Amplex Kit takes the "Guess" out of Radio. Each Kit has a Drilled Panel, Photograph Blue Print and complete instructions. No technical skill or knowledge required.

**BUILD YOUR SET THE AMPLEX KIT WAY**  
Amplex Instrument Laboratories  
57 Dey St., Dept. 7, New York City, N. Y.

**SAVE 1/3 rd**  
Our Amplex Kit costs you about 1/3 less than the price of all the parts bought separately. Every Kit is complete in every detail. No extras to buy.

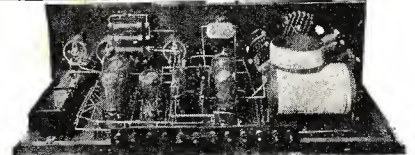

### Cockaday Improved 4-Circuit Kit

- K60 & 2L0 from New York, & WEAF from California on 5 Tube Cockaday Set built the "Amplex Kit Way"
- |                          |                            |
|--------------------------|----------------------------|
| 1 Panel 7"x24" Drilled   | 2 Switch Levers, etc.      |
| 1 4 Cir. Coil (bakelite) | 3 48,000 Ohm Lavites       |
| 2 Amplex 24 Pl.Vern.Con. | 1 Res. Mounting            |
| 5 Amplex Sockets         | 1 .0005 Mica Cond.         |
| 1 6 Ohm Amplex Rheo.     | 1 .00025 Mica Con.         |
| 3 20 Ohm Amplex Rheo.    | 2 P.P. Transf. (Corno) pr. |
| 2 Grid-Densers           | 1 Potentiometer            |
| 2 Grid Leaks, Var.       | 1 Baseboard                |
| 1 Amplex Imp. Jacks S.C. | 1 Set plans (blue print)   |
| 2 Amplex Imp. Jacks D.C. | 12 Binding Posts 5 amp.    |
| 2 Amplex Transformers    | Bus bar, Plans, etc.       |
- 5 Tube Cockaday Kit List \$71.25; KIT PRICE \$56.50



### COMPLETE PARTS FOR 5 TUBE NEUTRODYNE

- You Can Now Build This Popular Circuit "The AM- PLEX KIT WAY" and be Sure of Results
- |                                |                          |
|--------------------------------|--------------------------|
| 1 Panel 7"x24" Drilled         | 2 .006 Mica Condensers   |
| 3 Licensed Neutroformers       | 1 .00025 Mica Condensers |
| 2 Licensed Neutrodons          | 1 Leak                   |
| 3 Amplex Var. .0003 Condensers | 1 Amplex Imp. Jack S.C.  |
| 3 4" Dials                     | 1 Amplex Imp. Jack D.S.  |
| 2 Amplex Rheostats             | 1 Base Board 7x23        |
| 1 Battery Switch               | 7 Binding Posts          |
| 5 Amplex Sockets               | Bus Bar, Spaghetti, etc. |
- Plans (Blue Print)
- Parts for 5 Tube — List \$59.45; KIT PRICE \$39.75

**3 Tube Cockaday** Complete Guaranteed Amplex Parts \$24.75

**Superdyne** This 4 tube circuit is taking the country by storm. Employs 1 step tuned R. F., combined with regeneration. Includes everything from the bus bar to the drilled panel and an exceptionally efficient special Coil and Coupler. List, \$45.00—KIT PRICE .....\$38.75

**Important**  
Amplex Kits are NOT a combination of nondescript parts. Every part in every Amplex Kit has been especially selected, tested and guaranteed by our engineers as the most efficient for that particular circuit. Every Kit is Complete in Every Detail

"Amplex" Grid-Denser \$1.25 Each

**FREE** Send for Kit catalog showing how to build your set the "Amplex Kit Way."

# RADAK

RELIABLE RECEIVING SETS  
Licensed Under Armstrong Patent  
1,113,149

BUILT BY AMERICA'S OLDEST MANUFACTURER

**Clapp Eastham Co.**  
107 Main St. Cambridge, Mass.







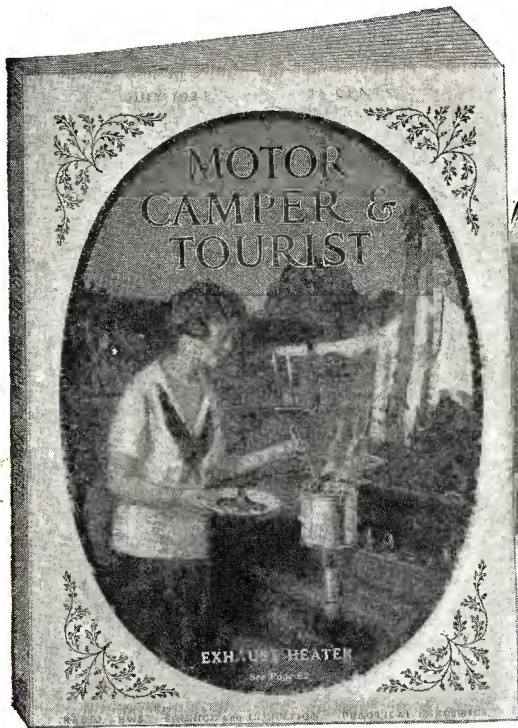

**SEND FOR  
FREE SAMPLE  
COPY**

Edited by H. Gernsback, Editor of **RADIO NEWS, SCIENCE AND INVENTION** and **PRACTICAL ELECTRICS**.

## The Signpost of the Open Road—

NOW is the time to prepare for your vacation trip in the car. Not one person in 50 knows how simply, how cheaply and how comfortably you can travel from coast to coast in your car or through the mountains of the east or west and live in the fresh, body-building out-of-doors every minute of the time.

**MOTOR CAMPER & TOURIST** tells you where to go, how much it will cost, when to travel and all those problems as to what to take, where to stop, etc.

The June issue is now on the newsstands. It contains 64 pages of information of value to anyone who owns a car. Printed in the finest modern process of Rotogravure. Buy your copy today or send in your subscription direct.

SUBSCRIPTIONS \$2.50 THE YEAR—FOREIGN 50c EXTRA  
ON ALL NEWSSTANDS 25c THE COPY

**GERMOTT PUBLISHING COMPANY, Inc.**  
53 Park Place New York City

Publishers of **RADIO NEWS, SCIENCE and INVENTION,**  
**PRACTICAL ELECTRICS** and **MOTOR CAMPER & TOURIST**

# MOTOR CAMPER & TOURIST

RN-7

Germott Pub. Co., Inc.,  
53 Park Place, N. Y. C.

Enclosed you will find .....  
dollars for my subscription to  
**MOTOR CAMPER & TOURIST**.

Name .....

Address .....

.....

.....



## Ring Up Your Friend by Radio

(Continued from page 43)

common signaling wave-length, however, welds them all into one unit. After a signal has been received, by tuning the receiving apparatus, which has a range wide enough to include all the transmitting wave-lengths, each individual station can establish speech communication with any of the other stations of the system.

That this system gives no privacy to the conversations is evident. Any station, or for that matter any receiving set within the transmitting range, can overhear what is going on. For some purposes, where all stations are more or less concerned in what is being done by others, this is a decided advantage. The system in its operating features is the radio replica of the train dispatcher's circuit where any station can be rung without disturbing others, and where any station can talk to any other as well as to the dispatcher.

Some idea of the apparatus requisite for this scheme of signaling may be had from the photographs shown. A uniform panel arrangement has been developed with the idea that the various units might be used interchangeably in meeting the requirements of different types of installations.

Thus, the particular apparatus shown is seen to take up very little more room than the ordinary radio receiving set. Of course, as the number of stations on one system is increased and if the system is intercommunicative so that each station may signal and speak with any other station of the system, the amount and size of apparatus required will become greater and greater.

## Calls Heard

(Continued from page 46)

(9BKF), 9BOJ, 9CBR, 9CKW, (9CLD), 9CWJ, 9ELB, 9EAE, (9CHT), (9DFH), (9CDE).

Others too numerous to mention.

Phone: 9AAO, (9AFM), (9AHJ), 9AIM, (9AJ), 9BEY, (9EBQ).

Anyone hearing my 10 watt C.W. or phone, please QSL card.

### SANC, ENID, OKLA.

All C.W.—(1AFE), 1APJ, 1ANA, (1ARE), 1ARP, (1AUR), 1AWW, 1BBO, (1BCR), 1BOO, 1BCG, 1BES, (1BKQ), (1BVR), 1BWJ, 1CKP, (1CIT), (1CPI), 1ER, (1FS), (1SN), (1TS), (1ZL), (2BLP), (2BRB), (2BSC), (2CDW), (2CNH), (2CPA), (2CXB), (2DX), (2KU), (3AAO), (3AB), (3ADB), (3APV), (3BDR), (3BWJ), (3CCF), (3CCU), (3CCX), (3CHH), (3CKJ), (3HS), (3QT), (3QV), (3LL), (3UD), (3VW), 4AF, 4AI, 4BQ, 4DB, 4DX, 4EB, 4ER, 4FT, 4FS, (4HS), 4JK, (4KU), (4MI), (4PK), (5's too numerous), (6AKZ), 6AOC, (6AUI), (6BKO), (6BKX), (6BLW), (6BMP), (6BQK), (6BQL), (6BSG), 6BUR, 6BUY, 6CGW, (6GI), (6ZBK), (7ABB), 7ACI, 7ADR, 7CO, 7FD, (7HG), 7OB, 7QD, 7SF, (7TO), 7WM, 7ZB, 7ZU, 7ZV, 7YL.

Canada C.W.—1AR, 1BQ, (UV QSA), 2BN, (2JE), 3AA, 3CO, (3DB), (3GG), (3IA), (3KO), (3ML), (3NI), (3XI), (3XN), (3ZT), (4AW), (4EA), 5GO, (5HE), 9BP, (9CF).

Mexico C.W.—AJ, (BX), CP, (NG), QRA?

### STW, HUGO, OKLA.

1AA, 1HA, 1EE, 1BIJ, 1QP, 1XAM, 1MO, 1AAO, 1BTA, 1CDM, 2OL, 2NV, 2HE, 2AZP, 31W, 3AB, 4CS, 4JK, 4AI, 5CG, (5LD), (5ACQ), (5ALK), (5GN), (5AL), 5AEU, 5AMW, 5TL, 5XAJ, 5TQ, 5ADV, 5OE, 5QY, 5HY, 5ALG, 5RV, 5AMG, 5JL, 5APX, 5AMU, 5EK, 5XA, 5AKC, 5RC, 5FC, 5FP, 5UK, 5VV, 5AJT, 5AJI, 5ALI, 5OH, 5SK, 5HE, 5AKH, 5JH, 5QKT, 5AIU, 5AIC, 5AAV, 5AFU, 5UA, 5QD, 5AAO, 5QQ, 5QW, 5ANA, (6LV), 6BSG, 6ABC, 6AAT, 6AWT, 7HW, 7LR, 8BNH, 8CPK, 9EBO, 9CCT, 9BRX, 9BWC, 9BSP, 9AHZ, 9CFK, 9BAZ, 9BSN, 9AVN, 9AHJ, 9CFI, 9CCS, 9BSC, 9AVN, 9AJD, 9DGX, 9CKJ, 9AHI, 9DBB, 9DII, 9CFY, 9CTG, 9ANO, 9EP, 9DWK, 9EIQ, 9CEA, 9BSI, 9DYY, 9BLW, 9BSI, 9SS, 9EAC, 9AAU.

Hawaiian—6TQ, 6CEU, WNP, F8AB, G2KF, G2CM.

New Zealand—4AA, JUPU?

If U want a crd pse QSL one and I'll do same. Has ani one hrd mi CW?

Tested and listed as standard by Underwriters' Laboratories



# The FANSTEEL Balkite battery charger

PATENTS APPLIED FOR

has no vibrators, bulbs or moving parts and is entirely noiseless

The Fansteel Balkite Battery Charger for Radio "A" Batteries [6 volt] is an entirely new type of rectifier, based on the use of Fansteel Balkite, a new and rare metal developed for this purpose. It is entirely noiseless. It cannot deteriorate through use or disuse. It has nothing to replace, adjust, or get out of order. It cannot discharge or short circuit the battery, and requires no attention other than an occasional filling with distilled water. It will not overcharge, and cannot fail to operate when connected to the battery and line current. It is unaffected by temperature or fluctuations in line current. It is simple, efficient, and indestructible except through abuse. The charger may be used while the radio set is in operation. Without added attachments it may also be used to charge "B" storage batteries.

## FANSTEEL BALKITE

is a new metal developed for this charger. It acts as a valve, allowing current to flow into the battery but not out of it. It is the most efficient charger valve made, is practically indestructible, and does away with noisy, delicate vibrators and fragile bulbs.

The Gould Storage Battery Company is also marketing, under the Fansteel Balkite Patents, a complete battery and recharging unit known as the Gould Unipower, into which this charger, under the name, "The Fansteel Balkite Rectifier," has been incorporated.

The Fansteel Balkite Battery Charger will charge the ordinary 6 volt radio "A" or automobile storage battery at 3 amperes, from 110-120 AC, 60 cycle current. It comes complete and ready for use. Get it from your dealer, or use the coupon below.

Price, \$19.50 <sup>\$20.00</sup> [West of the Rockies]

FANSTEEL PRODUCTS CO., Inc., Dept. 7-A, North Chicago, Ill.

FANSTEEL PRODUCTS CO., Inc., Dept. 7-A North Chicago, Illinois

Enclosed please find \$19.50 (\$20.00 west of the Rockies). Send me the Fansteel Balkite Battery Charger for Radio 6 volt "A" Batteries. If I am not entirely satisfied I will return it and you will refund my money.

Name .....  
Street .....  
City ..... State .....

## RADIODYNE NO LOOPS—NO AERIAL

Ready for operation by grounding to a water pipe or radiator, and throwing a few feet of wire on the floor. Uses any standard tubes—dry cell or storage battery. Extremely selective. Simple to operate—only two controls. Wavelength from 200 to 700 meters. Write for Folder describing this (antennaless) receiver.

WESTERN COIL & E. CO.

314 Fifth Street Racine, Wis.

## FAHNESTOCK CLIPS

"Popular Wherever Radio Is Used" 14 Sizes in Beautiful Display Case.

Dealers write for big money-making proposition.

FAHNESTOCK ELECTRIC CO. Long Island City, L. I.

## ELGIN SUPER-REINARTZ

The Set Which Copied

2LO LONDON, ENGLAND

ON ONE TUBE

Send Stamp for Descriptive Circular

ELGIN RADIO SUPPLY CO.

207 E. Chicago Street, Elgin, Ill.



## THRILLS!!

Tuska Receivers give never-ending thrills, from far and near. Famous for 13 years for volume, sensitivity and selectivity.

THE C. D. TUSKA CO. Hartford, Conn.

# TUSKA RADIO



# Science and Invention IN PICTURES

**THE RADIO AUTOMATON**  
A novel article on which ap-  
peared in a recent issue of  
SCIENCE and INVENTION.



### The Most Fascinating Magazine You Ever Read

**E**ACH month "Science and Invention" contains over 115 pages on the two most fascinating subjects in the world today. Everything in "Science and Invention" is explained by pictures with short captions so that anyone can readily understand the most intricate problems.

"Science and Invention" keeps you in touch with everything new and interesting through its correspondents located in every corner of the world.

There are also over twenty-five Radio Articles in every issue of "Science and Invention."

The latest issue can be obtained by mailing in your subscription today.

Subscription Price  
\$2.50 the Year

Foreign 50c Additional  
On All Newsstands  
At 25c the Copy

*Send for Free Sample Copy*

## Experimenter Publishing Co., Inc.

*Publishers of*

Radio News, Science and Invention, Practical Electrics and Motor Camper & Tourist  
53 Park Place, New York City, N. Y.





**SE-AR-DE**

QUALITY

**HERE IS A WINNER**

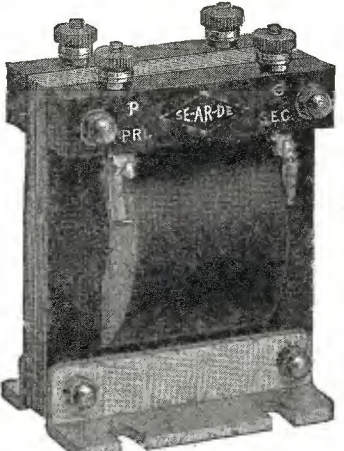

**SE-AR-DE**

Amplifying Transformer

Turn Ratio 4-1

20% louder signals with less distortion than any transformer on the market.

Large! But oh boy, you should send for copy of the amplification curve.

**PRICE \$5.00**

**R. MITCHELL CO.**

255 Atlantic Ave., Boston, Mass.

**FORD RUNS 57 MILES ON GALLON OF GASOLINE**

A new automatic and self-regulating device has been invented by John A. Stransky, 2559 Fourth St., Pukwana, South Dakota, with which automobiles have made from 40 to 57 miles on a gallon of gasoline. It removes all carbon and prevents spark plug trouble and overheating. It can be installed by anyone in five minutes. Mr. Stransky wants agents and is willing to send a sample at his own risk. Write him today.—Adv.

**BELL DIALS and SOCKETS**

Handsome molded Bakelite. The neatest and most efficient for your set. Bell Sockets give the unique double wipe contact, unlike any other. Write us for prices and details.

**BELL MANUFACTURING CO.**  
11 Elkins St. Boston 27, Mass.

A. HOWARTH, 7 ASHBRIDGE ROAD, NAPIER, N. Z. (One Tube)

6KA, 6CGW, 6CFZ, 6BBC, 6BAL, 6BYV, 6ACM, 6BBQ, 6CM, 6BPZ, 6VOD, 6AOS, 6OL, 6BVB, 2CXL, 8BDA, 8OIG, 9MC, 9BQP.

Would appreciate QSL's from any of the above mentioned stations.

7AJT, BASIN, WYOMING

C.W.—1BSZ, (?ICW), 2AFF, 3BZ, 3RG, (both QSA), 4JR, (VY QSA often), 6DAO, 5AGA, (5AIU), 5AJJ, 5AMU, 5AZU, (5EF), 5LR, 5RG, 5QD, 5QG, 5QL, 6ACV, (6ADT), 6AFA, 6AWQ, 6BBW, 6BLM, 6BRI, 6CMI, 6CMU, 6CKR, 6EI, 6FM, 6GR, 6OZ, 6QP, (6ZBU), 6ZH, 7ABY, 7ADS, 7AEL, (7AFK), 7AFO, 7AHS, 7AIQ, 7ALK, 7AKZ, 7AYD, 7CR, 7DI, 7FO, 7FS, 7GL, 7GV, (7GW), 7JU, 7KV, (7LH), 7NO, 7OM, 7OT, 7RY, 7RN, (7QC), (7QD), 7ZI, 8ATC, 8BBY, 8BCI, 8BFH, 8CKO, 8CLC, 8CMY, 8CNW, 8DAE, 8DED, 8DHO, 8DIO, 8GX, 8HN, 8HV, 8JY, 8KJ, 8WP, 9's too numerous.

Canada: 3RG, 4CO, 4EO, 4UV.  
ICW: 1UJ, 5CN, 5QD, (7EL), 8GA, 9AIM, 9CIP (?ICW), (9AEC).

Fone: 5AKE, 5QD, 6FM, 7CO, 7QC, 9AZG, 9CEI.

Dalite CW: 5AGN, (7CO), 9AGL, 9AMP, 9BHI, 9BOY, 9BVM, 9BXT, 9ACN, 9CYX, 9DEJ, 9DLF, 9DND, 9EAK, 9EGU, 9EKF, 9EKY, 9HK.

Wud App vy rpts on mi 10 watts. WI QSL abv if requested.

4SS, CHARLESTON, S. C.

1AJ, 1AVX 1BTW, 1CPN, 1CPO, 1GR, 1GM, 2BGI, 2BY, 2CJB, 2CPW, 3AFS, 3AJS, 3ALX, 3BBS, 3CF, 3CJN, 3MS, 3PH, 3ZO, 4's too numerous. 5AGJ, 5AIU, 5AKN, 5AMH, 5EK, 5GJ, 5HE, 5IH, 5LH, (QRA), 5MI, 5MW, 5NK, 5QW, 5QZ, 5RH, 5SP, 5UK, 5YR, 5YW, 5ZA, 5ZS, 6ACH, 6ACV, 6AHR, 6AMW, (QRA), 6APE, 6BBH, 6BCL, 6CMU, 6CNG, 6FR, (QRA), 6IS, 6OT, 6VT, 6XAD, 6ZH, 6WT, (QRA), 7CO, 7EL, 7HW, 7SC, 8ATY, 8AMR, 8ARD, 8ATC, 8BNH, 8BCI, 8BYI, 8CEJ, 8CKO, 8CNW, 8ESO, 8DAT, 8DPR, 8FU, 8JY, 8RY, 8ZC, 9AAU, 9ALE, 9AOK, 9ARM, 9ASN, 9AVB, 9AVN, 9BAK, 9BAX, 9BBF, 9BBR, 9BGH, 9BNH, 9BQF, 9BYE, 9CCJ, 9CCS, 9CCZ, 9CFI, 9CGY, 9CHN, 9CLK, 9CPK, 9DAZ, 9DCP, 9DEJ, 9DEN, 9DEU, 9DHR, 9DLL, 9DLV, 9DOF, 9DRS, 9DSV, 9DTE, 9DWK, 9DYH, 9EDB, 9EDO, 9EFZ, 9LY, 9MC.

Canadian: 1AR.  
Mexican: GW, (QRA).

L. F. STROBEL, 680 YALE ST., AKRON, O.

1AAC, 1AHL, 1AIY, 1AJC, 1AJU, 1ALR, 1ALW, 1ANR, 1APW, 1AR, 1ARE, 1ARP, 1ASF, 1ATJ, 1AVJ, 1AW, 1AYT, 1BCR, 1BH, 1BOA, 1BOD, 1BRL, 1CAZ, 1CCX, 1CDE, 1CI, 1CMP, 1CMX, 1DO, 1FD, 1FS, 1GL, 1IJ, 1IV, 1JT, 1JV, 1KC, 1KW, 1LC, 1LP, 1ML, 1MY, 1RS, 1SW, 1VC, 1WU, 1XAK, 1XI, 1XW, 1XZ, 1YW, 4AI, 4BA, 4BQ, 4DB, 4EQ, 4ER, 4FS, 4JR, 4LJ, 4LL, 4MY, 4NA, 4OA, 4OG, 4RR, 4SI, 4WC, 4XC, 4XE, 4XR, 4XW, 5AAZ, 5ABD, 5AC, 5AIC, 5AIR, 5AIU, 5AIY, 5AIB, 5AJT, 5AJT, 5ALV, 5AMF, 5AMG, 5AMI, 5AMU, 5AMZ, 5AP, 5EK, 5FC, 5FU, 5GJ, 5HT, 5KO, 5LR, 5MI, 5MO, 5MZ, 5NW, 5OT, 5OV, 5QF, 5QH, 5OL, 5OY, 5RG, 5RH, 5TS, 5TW, 5VC, 5VT, 5VV, 5XA, 5XAB, 5XAT, 5XD, 5YV, 5ZA, 5ZB, 5ZW, 6AAA, 6ADA, 6AER, 6AGE, 6AHP, 6AJH, 6AJP, 6AJS, 6AKW, 6BBC, 6BBW, 6BCL, 6BIC, 6BIJ, 6BM, 6BOU, 6BRF, 6BRI, 6BUU, 6CBW, 6CCY, 6CGW, 6CJV, 6CLB, 6CMR, 6CMU, 6CNG, 6EB, 6FO, 6FP, 6LV, 6NB, 6OJ, 6UX, 6ZH, 6ZT, 7ACZ, 7ADI, 7AJT, 7AKH, 7CO, 7FO, 7IJ, 7QC, 7OU, 7ST, 7ZU, 9AAL, 9AAU, 9ABC, 9ACI, 9ADR, 9AFZ, 9AGB, 9AGL, 9AGO, 9AHP, 9AIB, 9AIM, 9AKI, 9AMP, 9APE, 9APF, 9AOG, 9ARJ, 9ARP, 9ATO, 9ATU, 9AVB, 9AVG, 9AVN, 9AVO, 9AVS, 9AVT, 9AWY, 9AXX, 9AYJ, 9AYY, 9BAB, 9BAV, 9BAZ, 9BBC, 9BCX, 9BDO, 9BDZ, 9BGH, 9BHI, 9BHK, 9BHS, 9BHx, 9BHY, 9BIS, 9BIX, 9BLG, 9BLR, 9BMX, 9BOV, 9BOZ, 9BPC, 9BOY, 9BRK, 9BSI, 9BSS, 9BTE, 9BTO, 9BTT, 9BUN, 9BVV? (9BYE), 9BZE, 9CAA, 9CAU, 9CCM, 9CDI, 9CEH, 9CFI, 9CGK, 9CHI, 9CHT, 9CJC, 9CJY, 9CKM, 9CLD, 9CMK, 9CO, 9COG, 9COV, 9CPD, 9CPK, 9CPU, 9CPZ, 9CRD, 9CTG, 9CVO, 9CYG, 9CYN, 9CZM, 9DAI, 9DAO, 9DBA, 9DFH, 9DHW, 9DIP, 9DJA, 9DKY, 9DND, 9DNV, 9DOF, 9DOT, 9DPL, 9DPX, 9DQU, 9DR, 9DRO, 9DTE, 9DUJ, 9DWI, 9DWK, 9DWN, 9DXN, 9DXY, 9EAF, 9EAK, 9EAR, 9EBH, 9EBT, 9EER, 9EII, 9EKU, 9EKY, 9ELZ, 9FR, 9GS, 9HM, 9JG, 9LN, 9MI, 9RY, 9ST, 9XAX, 9XBD, 9XW, 9YAU, 9ZT.

Porto Rico: 4SK.

Canadian: 1DJ, 2AZ, 2CE, 2CG.  
Between 100 and 150 meters.

1AAC, 1AR, 1BCR, 1DQ, 1FD, 1IV, 1JV, 1SW, 1XAK, 1XW, 1XZ, 4OA, 4WC, 4XE, 4XR, 4XW, 5AIC?, 5LR, 5TW, 5XAB, 5XAT, 6BJJ, 7IJ, QRA?, 9XAX, 9XBD, 9XW.  
Canadian: 2AZ.



**Ackerman**  
RADIO LOUD SPEAKER  
Registered U. S. Patent Office

A Quality Speaker at a Moderate Price

**\$9.50**

MODEL 21

Special (non-vibrating) metal horn, 21 inches high, bell 11 inches in diameter, complete with special loud speaking unit and 5 foot cord. An ideal speaker for home use, reproducing voice and music in perfect mellow tone, with plenty of volume. No extra batteries required. Connects to receiving set in place of head-phones. Made in four finishes: Plain Black or Brown Satin; also Special Alligator grain in Black and Green or Black Crystalline.

**Ackerman**  
LOUD SPEAKER UNITS

For use with phonograph or horn. Complete, with 5 foot cord, ready for immediate use.



MODEL "A" (Non-Adjustable)

**\$4.00**



MODEL "B" (Adjustable)

**\$5.00**

At your dealer's or sent prepaid on receipt of price.

Jobbers and Dealers Wanted—Write for Discounts.

**ACKERMAN BROTHERS COMPANY, Inc.**  
DEPT. RN  
301 West 4th Street New York



# Practical Electrics

**Keeps You In Touch  
With the Progress  
of Electricity the  
World Over**

**SEND FOR  
FREE  
SAMPLE COPY**

Every important advance or change in the world of Electricity for the Electrical Experimenter and Electrician is published in PRACTICAL ELECTRICS and explained in language that everyone can understand. PRACTICAL ELECTRICS maintains departments, or special sections, devoted especially to the important phases of electrical development. These sections appear regularly every month. Some of these departments are: NEW THINGS ELECTRIC, MOTOR ELECTRICS, EXPERIMENTAL ELECTRICS, JUNIOR ELECTRICIAN, etc.

PRACTICAL ELECTRICS is edited by H. Gernsback, Editor of RADIO NEWS, SCIENCE AND INVENTION, and MOTOR CAMPER & TOURIST. It contains over 60 pages every issue and maintains prize contests that amount to over Five Hundred Dollars. Some of these contests are listed below.

*Send in your subscription today*

Subscription Price \$2.50 the Year.  
On All Newsstands at 25c the Copy.

**Germott Publishing Company,**  
INCORPORATED  
53 Park Place, New York City

**OVER \$500—IN PRIZES**

ODD ELECTRICAL EXPERIENCE CONTEST	CONTEST FOR ELECTRICAL EXPERIMENTERS	SHORT CIRCUITS	ELEC-TRICKS
	<p>ANGLE IRONS SPEED REGULATOR BRAKE DRUM THUMB SCREW TUBING - TOP VIEW CONNECTING ROD FLY-WHEEL SIDE VIEW END VIEW DETAIL OF SHAFT BEARING</p>		



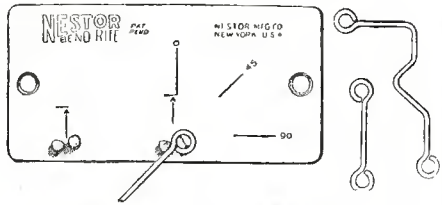

**Better Than Pliers**  
**EASIER TO USE—**  
**BETTER RESULTS**

**For Making Eyes, Loops, Bends and Offsets on Radio Bus Wire**

For Making Eyes.—Insert the Bus Bar between pin and lug as far as the line indicated by the arrow, then place bender over the pin with the lug catching the Bus Bar, and turn until coming to a stop—just as quick as it takes to tell it.

For Making Angles, Bends and Offsets.—Place the Bus Wire between pin and the lug and with bender turn as far as it is necessary for the particular angle or bend desired.

If your dealer has not been supplied send \$1 and we will forward a Nestor BEND-RITE by mail.

NESTOR MANUFACTURING CO.  
 40 West 13th Street, New York City, U. S. A

# NESTOR BEND-RITE

## AMPLEX GRID-DENSER

Improves ANY Circuit

Replaces FIXED CONDENSERS and gives

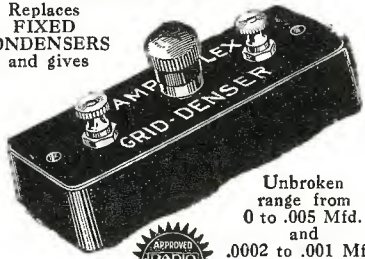

Unbroken range from 0 to .005 Mfd. and .0002 to .001 Mfd. \$1.25

ABSOLUTELY ESSENTIAL in

Cockaday, Super-Heterodyne, Ultra-dyne, Superdyne, Neutrodyne, Etc.

No two tubes or circuits are alike. Each requires a different EXACT capacity for maximum efficiency. A slight turn of the GRID-DENSER knob finds the CORRECT capacity for you.

Permits operating set at highest point of regeneration, controls oscillations, maintains perfect stability.

**SPECIFIED** by Haynes, Cockaday, Greif, M. B. Sleeper, Lescarboura, Foote, Pfeiffer, Tobias, in ALL circuits for **GREATER** Distance, Louder and Clearer Signals. **FREE** Booklet with hook-ups showing how to double the efficiency of your set.

At your Dealers, or send \$1.25 to **AMPLEX INSTRUMENT LABORATORIES** 57 Dey Street, Dept. 7A, New York City, N. Y.

## Big Money Building Cabinets

With a JUNIOR BENCH SAW

People will pay you liberally for handsome cabinets to cover their Radio and you can build them easily and quickly with a Junior Bench Saw. Does your ripping, mitering, rabbeting, tenoning, sanding, grinding and many other operations with ease and accuracy. Special blades cut bakelite. Saws 1 1/2" wood—driven by 1/4 or 1/3 h.p. motor attached to any light socket.

Sold on Absolute Money Back Guarantee Write for descriptive folder **W. & J. BOICE**, 1730 Norwood Ave., Dept. 807, Toledo, O.

- 7GR, VANCOUVER, WASHINGTON  
 1ASU, 1BCR, 1IV, 1KC, 2OD, 3BJ, 3RG, 4IO, 4XC, 4XE, 5AAQ, 5ABW, 5AHD, 5AIJ, (5AIC), 5AJT, (5AIB), 5AMP, 5AZ, 5BE, 5CV, 5DM, 5DJ, 5FG, 5GM, 5ID, 5LR, (5NN), 5OV, 5QD, 5QL, 5TS, 5VM, 5XR, 5XV, 8AIG, 8AH, 8ANM, (8ALF), 8APT, 8ATC, 8BGO, 8BKN, 8CKO, 8CHY, 8CTW, 8DAE, 8DDJ, 8DGO, 8PL, 8RJ, 8YCP, 9AAU, 9AEM, (9AEP), 9AFM, 9AKC, (9AGL), 9AQK, 9AOV, 9AMA, 9AMM, (9AMP), (9AMW), (9AND), 9BAB, 9BAV, 9BBV, 9BCX, 9BDJ, 9BFF, 9BPN, 9BRX, (9BZE), 9CCV, 9CCS, 9CDE, 9CDV, 9CFZ, 9CFK, 9CGA, 9CJM, 9CKM, 9CNB, 9CJY, 9CPD, 9CPZ, 9CXP, 9CYN, 9DBH, 9DPP, 9DEC, 9DHS, 9DCS, 9DOE, 9DYR, 9DHG, 9DR, 9DKA, (9YI), 9DGA, 9DKB, 9ELZ, (9EAK), (9HM), 9RC, 9RY, 9TM, (9XBE), 9YAU.

### NEW QRA'S

9CRS.—(Reassigned) Melvin Haas, Hubbard, Iowa. 10 watts C.W., I.C.W. and Fone. All QSL's answd.

9CSH.—(Reassigned) Harry Mauch, Jr., Hubbard, Iowa. 10 watts C.W., I.C.W. and Fone. All crds answd.

2AGM.—Charles C. Fingar, Jr., 335 Union St., Hudson, N. Y. All crds answd.

5LS.—J. C. Johnson, 522 Welch St., Denton, Texas. All crds answd.

5AOX.—Sam Zimmerman, Box 483, Port Lavaca, Texas.

2FO.—J. V. Settle, 32 Dodd St., East Orange, N. J. 20 watts C.W., I.C.W. and Fone.

4TX.—Donald Brown, 914 Abercorn St., Savannah, Ga. 10 watts C.W. Reports on sigs. appreciated. Will QSL.

3CCJ.—(Portable set call) Raymond J. Carr, 617 Union Ave., Petersburg, Va. Pse KSL.

3BMN.—Raymond J. Carr, 617 Union Ave., Petersburg, Va. 50 watts C. W. Pse QSL. All crds answd.

3BLI.—(Change of address) C. H. Hess, 5104 Rubicam St., Germantown, Philadelphia, Pa.

3SP.—Arthur B. Cochran, 317 Main St., Crisfield, Md.

1BX.—R. B. Hodskins, 24 Converse St., Longmeadow, Mass. All QSL's answd.

## Radio News' Fifth Birthday

(Continued from page 23)

Editor, RADIO NEWS:

I am glad that in my opinion RADIO NEWS merits a great deal of praise for the valuable service it has rendered to the radio art. It always utilizes every opportunity to assist in the progress and the development of the art in all its phases. I am sure the amateurs and engineers appreciate fully the value of your journal in bringing quickly to their attention, in an understandable form, every new development in radio.

LOUIS COHEN,  
 Office of Chief Signal Officer,  
 U. S. War Department.

Editor, RADIO NEWS:

RADIO NEWS is indeed to be congratulated on its fifth birthday. The circulation of over 350,000 is most astounding. Such popularity is without doubt an expression of approval on the part of radio folk from all parts of the globe.

The importance of RADIO NEWS, as a medium through which thousands are informed, is not to be neglected. The power of such a publication is almost unlimited. By including in each issue constructive and educational articles, RADIO NEWS is contributing in a large measure to the uplift of the vast throng of radio enthusiasts. By continuing to present radio subjects so that they can be understood by the non-technical man, the success of RADIO NEWS is certain to remain.

W. PALMER POWERS,  
 Stevens Institute of Technology.

# Get That Station Instantly



Just what every Radio Fan has been waiting for. No more struggling to get your favorite station. Contains a wealth of Radio information such as the World Clock, giving the time in all parts of the world; the location, the wave length and call signals of all American, Canadian, and Cuban Radio Stations; pictures, maps and logs for 135 different stations, etc.

## Don't Grope or Guess JUST DIAL

the Station You Want

Merely record your dial reading once. You can then instantly get any station you want at any time simply by referring to this Log Book.

The new Premier Radio Log is beautifully bound in genuine maroon Walrus grain Athol leather. The design is richly embossed. The biggest dollar's worth ever offered you. You'll wonder how you ever got along without it. Thousands have been sold thru recommendation of one Fan to another. Lose no time. Order today. Satisfaction guaranteed or money back.

**\$1.00**  
 Post Paid

**A. J. Cox & Co.** 521 W. Monroe St. Dept. A Chicago  
 Dealers and Jobbers Write for Prices.

## WHY PAY MORE?

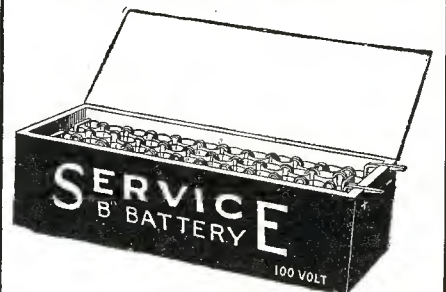

RECHARGEABLE	
50 Volts	\$5.50
75 Volts	\$7.75
100 Volts	\$10.00
125 Volts	\$12.50

Recharge from any 110 volt A.C. line with small home rectifier. Shipped fully charged and ready for use after adding acid. Will last for years with ordinary care.

### SERVICE "A" BATTERY

RADIO SERVICE BATTERY	6 Volt	\$14.00
	80-100 Amps	
RADIO SERVICE BATTERY	6 Volts	\$16.00
	100-120 Amps	

2 YEAR GUARANTEE  
 INDESTRUCTIBLE RUBBER CASE

**SERVICE BATTERY CO.**  
 704 East 102nd St., Cleveland, Ohio

## MAIN "B" STORAGE BATTERIES



Popular prices! Soon save their cost! Give better reception and are more satisfactory. Rechargeable at home from house current. Built in small and large sizes. Write. Wonderful opportunity for dealers.

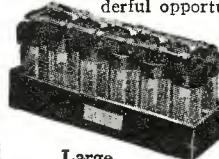

**MAIN ELECTRIC COMPANY**

Cleveland Ohio

Large



# OPPORTUNITY AD-LETS

Follow these advertisements every month. Reliable advertisers from all over the country offer their most attractive specials in these columns.

Classified advertising rate eighteen cents a word for each insertion. Ten per cent discount for 6 issues, 20 per cent discount for 12 issues. Name and address must be included at the above rate. Cash should accompany all classified advertisements unless placed by an accredited advertising agency. No advertisement for less than 10 words accepted.

Objectionable or misleading advertisements not accepted. Advertisements for the September issue must not reach us later than July 1st.

**CIRCULATION LARGER THAN THAT OF ANY OTHER RADIO PUBLICATION**

EXPERIMENTER PUBLISHING CO., INC., 53 Park Place, New York, N. Y.

## Agents Wanted

**Agents Wanted** in every city and town to sell standard radio apparatus. Attractive discounts given. If interested write us at once stating age and radio experience. Wilmington Electrical Specialty Co., Inc., 405 Delaware Ave., Wilmington, Delaware.

**General Agents—Service Men!** Genuine Gold Letters for store windows easily applied. 20 per cent cash commission on all orders from local agents appointed by you anywhere. 50 per cent discount on your own orders. Free samples. Metallic Letter Co., 422 N. Clark St., Chicago.

**Big Money and fast sales.** Every owner buys gold initials for his auto. You charge \$1.50; make \$1.35. Ten orders daily easy. Write for particulars and free samples. American Monogram Co., Dept. 193, East Orange, N. J.

**We want Salesmen and Agents,** either whole or side line, to sell our low priced radio books to the trade. Excellent proposition for live wires. The E. I. Company, Publishers, 253 Fulton St., New York City.

**Big Money and Fast Sales.** Every owner buys gold initials for his auto. You charge \$1.50, make \$1.44. 10 orders daily easy. Samples and information free. World Monogram Co., Dept. 27, Newark, N. J.

**Wanted—Representation** in each radio community to handle new type of rheostat among jobbers and dealers in your community. Much superior to any rheostat now on market. Big possibilities for right organization. State lines now handled. Box 165 Radio News.

**Agents make 40% commission** selling "My Radio-Log" as sideline. Every radio owner buys one. Send 25c for sample and particulars. Radio-Log Company, Department C, 3 West 29th Street, N. Y. C.

**Big Money** applying monograms on automobiles. Easy transfer process. Done while waiting. Cost 5c, get \$1.50. Sample Free. Raico 325-A Harrison Ave., Boston, Mass.

## Books

**Wright's Radio Log** and tuning record book, 64 pages; beautifully bound; convenient size. DeLuxe Edition 50c. H. G. Wright, 1521 Fisher Building, Chicago.

## Business Opportunities

**Make \$100 Weekly in Spare Time.** Sell what the public wants—long distance radio receiving sets. Two sales weekly pays \$100 profit. No big investment, no canvassing. Sharpe of Colorado made \$955 in one month. Representatives wanted at once. This plan is sweeping the country—write today before your county is gone. Ozarka, 813 Washington Blvd., Chicago.

**Start your own business,** remunerative, interesting, little capital. Learn privilege trading. Dept. X, Paul Kaye, 149 Broadway, N. Y.

## Chemistry

**Learn Chemistry at Home—Dr. T. O'Connor Sloane,** noted educator and scientific authority, will teach you. Our home study correspondence course fits you to take a position as chemist. See our ad on page 115 of this issue. Chemical Institute of New York, 66 West Broadway, New York City.

## Exchange

**For Sale** 200 Watts 1000 Volts D. C. Generator with 110 Volt A. C. Motor \$30.00 complete, other high voltage Generators in stock. Morton Electric Co., 4832 Rice St., Chicago, Ill.

**Trade Anything.** What have you? What do you want? Radio Dept., General Merchandise Brokerage, Box 641, Atlantic City, N. J.

## For Inventors

**Inventors' Educator:** 900 Mechanical Movements. 50 Perpetual Motions. How to procure and sell patents. Mechanical Movements greatly assist inventors, suggest new ideas. Explains how to select an attorney and avoid Patent Sharks. Price \$1.50. Postage Free. Albert E. Dieterich, 690 Ouray Building, Washington, D. C.

## For Sale

**4 Tube Superdyne** and **5 Tube Neutrodyne** for sale. Edw. Fischler, 138 Vine St., Plymouth, Penna.

## Health

**Free—Stop using tobacco.** We will give free information how to conquer habit easily and permanently. Results guaranteed. Anti-Tobacco League, Box M, Omaha, Neb.

## Help Wanted

**We Want Salesmen and Agents,** either whole or side line, to sell our low priced radio books to the trade. Excellent proposition for live wires. The E. I. Company, Publishers, 253 Fulton St., New York City.

## Help Wanted—(Continued)

**Earn \$25 Weekly,** spare time, writing for newspapers, magazines. Experience unnecessary; details free. Press Syndicate, 973, St. Louis, Mo.

**All Men, Women, Boys, Girls,** 17 to 65 willing to accept Government Positions \$117-\$250 traveling or stationary; Write Mr. Ozment, 251, St. Louis, Mo., immediately.

**Detectives Needed Everywhere.** Travel. Experience unnecessary. Write George Wagner, former Government Detective, 1968 Broadway, N. Y.

## Improved Made Toys

**Make Improved Metal Toys and Novelties** at home with our outfits and earn big money. No experience necessary. We purchase all your products made to our specifications and pay high prices all year round. Big demand. Write for free catalog and information. Improved B G Metal Casting Co., 342 East 145th Street, New York.

## Instruction

**Learn Chemistry at Home—Dr. T. O'Connor Sloane,** noted educator and scientific authority, will teach you. Our home study correspondence course fits you to take a position as chemist. See our ad on page 115 of this issue. Chemical Institute of New York, 66 West Broadway, New York City.

**Used Correspondence Courses** bought and sold. Bargain catalogue 1,000 courses free. Students' Exchange, Dept. 5, 47 West 42 St., New York.

## Miscellaneous

**Remanufacture Fords—Most profitable business** on earth—\$14,355.00 made on 300 complete jobs. \$850.00 completely equips shop with tools recommended by Ford Motor Company. Circular. K. R. Wilson, Buffalo.

**Silk Fish Lines.** 25c and up. Send stamp for samples. Silkline Co., Dept. O, Pekin, Ill.

**53 Great Money-making plans** free. R. Ross, Box 57-R, Medford, Mass.

## Motorcycles, Bicycles

**Don't Buy a Bicycle Motor Attachment** until you get our catalog and prices. Shaw Mfg. Co., Dept. 6, Galesburg, Kansas.

## News Correspondents

**Earn \$25 Weekly Spare Time** writing for newspapers, magazines. Experience unnecessary; details free. Press Syndicate, 972 St. Louis, Mo.

## Novelties

**Magie goods, cards, books, novelties, illusions.** Catalog free. J. Fenner, 2401 Jefferson, Louisville, Ky.

## Patent Attorneys

**Patents.** Send drawing or model for examination and report as to patentability. Advice and booklet free. Highest references. Best results. Promptness assured. Watson E. Coleman, Patent Lawyer, 614 G Street, Washington, D. C.

**Lacey Patent-Sense.** See page 104.

**Patents—Send for form "Evidence of Conception"** to be signed and witnessed. Form, fee schedule, information free. Lancaster and Allwine, 269 Ouray Bldg., Washington, D. C.

**Inventors—Should write for our Free Guide Books** and "Record of Invention Blank" before disclosing inventions. Send model or sketch of your invention for our Free Examination and Instructions. Radio, Electrical, Chemical, Mechanical and Trademark experts. Terms reasonable. Victor J. Evans & Co., 922 Ninth, Washington, D. C.

**Patents—My fees in installments.** Advice book free. Frank Fuller, Washington, D. C.

## Personal

**Lonely Hearts—Exchange letters** make interesting new friends in our jolly club. Eva Moore, Box 908, Jacksonville, Fla. Enclose stamp.

**Correspondence Club—Many wealthy members** everywhere. Fascinating particulars free. Smith, Box 1167Y, Denver, Colo.

**Lonesome—Join our club—make acquaintances** everywhere. Big illustrated book with descriptions and photos, sent in plain wrapper for ten cents. Bonafide Co., Dept. 53, Kansas City, Mo.

**Exchange chery letters** with new friends. Write Betty Lee, Inc., Box 320 City Hall Station, New York City. Stamp appreciated.

## Photo Finishing

**Films Developed 5c—Prints 3c each.** The new Davo finish. Davis Photo Shop, Dept. R, Cincinnati, Ohio.

## Printing

**Quality Printing—1,000 letterheads, envelopes, cards or statements, \$5.00.** Your name on 200 note sheets and 100 envelopes, \$1.00. Samples Free. Howlett's, Paris, Ill.

## Radio

**Boys! Don't Overlook This.** The "Rasco" Baby Detector. Greatest detector ever brought out with molded base. Fully adjustable. See former advertisements in this publication, or our catalog. Detector with Galena Crystal, complete 50c, the same detector with Radiocite Crystal, 75c pre-paid. Send for yours today. Radio Specialty Company, 96-98 Park Place, New York City.

**Attention!—50 Vacuum tube hook-ups.** The greatest collection of vacuum tube circuits ever brought under two covers at such insignificant cost. These diagrams will be found in the great "Rasco" catalog, which contains raw materials and parts in a greater profusion than any other catalog. 15c in stamps, or coin, will bring the catalog to you. Radio Specialty Co., 96-98 Park Place, New York City.

**Build Your Own.** The best hook-up I ever tried. Yours for a dollar. Any complaint your money back. E. F. Waits, Corinth, Miss.

**W. R. C. Radio Crystal Receiver.** Best value for the money. Money refunded if not satisfied. Postpaid, \$2.75. Wagner Radio Co., 2824 South Fourth, St. Louis, Mo.

**Panel Tool** for cutting deep or meter holes in radio panels. Cuts smooth hole one to five inches in diameter, with little effort. Only \$2.50 postpaid. Homer Malcomb, Whitewater, Wis.

**If your Neutrodyne won't "Neut!"** a.k.a., send 10c for details of Kladag Coast to Coast circuit, bill of materials, etc., to change over your Neut into a set that will bring them all in from Mexico City to Tunica, Cuba, on a loud speaker. Or send \$5.00 for all extra parts, blue print, etc., you need to do this. Stamps accepted. Radio list for stamps. Super Heterodyne specifications, 10c. Kladag Radio Laboratories, Kent, Ohio.

**Wholesale Prices on Standard Receivers,** 20% discount. Thomas Radio Co., Muncie, Indiana.

**Eliminate Body Capacity** with our anti-capacity insulated shaft extension bushings, 2 1/2 inches long, for 5/16 inch and 3/8 inch shafts. Excellent results when used on variometers, variocouplers and condensers. 25 cents each, postage paid. Jester-Cooper Company, P. O. Box 924, Houston, Texas.

**Radio Fans—Make your own transformers** by using Magto, the new powdered magnetic metal, for the core of your transformer. Five pounds for a dollar, postpaid. American Chemical Co., 62 First Street, East Youngstown, Ohio.

**Glass panels drilled.** Ten cents per hole. Box 123, Mandan, N. Dak.

**Tubes—type 201-A—\$3.50.** Guaranteed. Darveau and Son, 40 Michigan St., Mohawk, N. Y.

**Master Radio Code** in 15 minutes. Ten word speed 3 hours. Our students made these world records. Qualifying records 10c. Licensed Students free. Method \$2.00. Dodge Radio Shortkut, Dept. N, Mamaroneck, N. Y.

**Condensers.** 11-23-43 Plate Never been used. \$2.50—\$3.50—\$5.00 values. Made by prominent manufacturer and guaranteed perfect or money refunded. Will sell for \$1.25—\$1.75—\$2.50. Only five of each. A. L. Parke, 56 Montgomery St., Waterbury, Conn.

**Magnavox B3.** Latest nationally advertised reproducers; electrical modulator. List \$35. Introductory \$25. The factory sealed carton is your guarantee. Radio Central, Dept. R, Abilene, Kansas.

**The How and Why of Radio Apparatus,** by H. W. Secor, E. E. This newest book on radio matters fulfills a distinct gap in wireless literature in that, while the treatment is made as understandable and as free from mathematics as possible, it at the same time incorporates a wealth of technique and instruction for the Radio Amateur—the Radio Operator—the Installation and Designing Expert—as well as teachers and students of the subject in general. A very broad field has been covered by the author, at the same time giving a great deal of information not found in other text books. If you are engaged in any branch of the Radio or allied arts at all you will surely need this latest contribution to radio literature, which is destined to be found on every radio man's book shelf before long. A glance at the following list of chapters gives but a very scant idea of the extensive and useful radio knowledge provided in its text. The Induction Coil; The Alternating Current Transformer; Radio Transmitting Condensers; The Spark Gaps; Radio-Transmitting Inductances; Radio Receiving Tuners; Radio Amplifiers; Construction of a Direct Reading Wave-meter and Decimeter; Antenna Construction; The Calculation and Measurement of Inductances; Appendix containing very useful tables, covering all subjects treated in this very unusual book. This newest of Radio Works, cloth bound in Vellum de Luxe, Gold Stamped and Hand Sewed, has 160 pages. Size of book, 6x9 inches. The How and Why of Radio Apparatus. Postpaid, \$1.75. Experimenter Publishing Co., Book Dept., 53 Park Place, New York City.



## HIGH GRADE SUPER HETERODYNE PARTS AT UNEQUALLED PRICES!

We have all parts in stock for this latest and most efficient set. All parts are of the highest quality throughout and are fully guaranteed. Order by article number. We pay transportation to any point in the U. S. east of the Rocky Mountains.  
 Complete parts for Eight Tube Super Heterodyne Set including drilled panel and circuit diagram.  
 2868 ..... \$68.50  
 Super Heterodyne Kit containing 9 Intermediate Wave Length Transformers, Filter Coil, Oscillator Coil and 2 one M. F. Condensers.  
 2869 ..... \$29.85  
 Blue Print only with full size panel layout, circuit diagram and explanatory notes.  
 2829 ..... 21c

### Complete Sets of Parts for Popular Circuits

It pays to buy parts in complete sets. We supply high grade parts only and each part is guaranteed to be perfect. Drilled panel is included with each set of parts. This eliminates any possibility of spoiling the panel and insures a well balanced appearance and proper location of parts for easy wiring. The detailed instructions and diagrams supplied with each set make it easy for anyone without previous experience to build an outfit that will give most satisfactory results.

Five tube circuit using licensed Neutrodyne parts. Cabinet and wiring diagram included.  
 2858—Complete set parts ..... \$36.50

Five tube genuine Fada knocked down Neutrodyne set. Cabinet included.  
 2857—Complete set parts ..... \$65.60

Reinartz Circuit. No cabinets included.  
 2862—One tube ..... \$10.75  
 2863—Three tube ..... 17.95

Cockaday Circuit. No cabinets included.  
 2861—One tube ..... \$11.95  
 2871—Three tube ..... 18.55

Ultra Audion Circuit. No cabinets included.  
 2865—One tube ..... \$ 7.95  
 2866—Three tube ..... 15.95

See pages 6 and 7 for our liberal guarantee, how to order and prices on other merchandise.

## THE BARAWIK CO.

Chicago's Original Radio Supply House. Beware of Imitators.

102 South Canal Street, Chicago, Ill.

## FRESHMAN NOISELESS TESTED MICA CONDENSER

MFG. BY CHAS. FRESHMAN CO. INC. NEW YORK CITY

### ACCURATELY RATED CONDENSERS for CRITICAL CIRCUITS

Through the accuracy and dependability of Freshman Noiseless Tested Mica Condensers, hookups and circuits have been perfected which have completely revolutionized the art of radio reception.

The Freshman is so designed that constant equal pressure is exerted on the condenser plates over the entire area. They are the only condensers that have this construction and therefore the only ones that avoid noises, due to variable pressure on the plates.

All capacities from 35c up.

Your dealer has all sizes of Freshman Condensers in stock. Ask for prices.



"To Radio's The Long Distance Smile. —get Freshman's!"

## Chas. Freshman Co. Inc. Radio Condenser Products

106 Seventh Avenue, New York

SIGNAL ELECTRIC MFG. CO. Menominee, Mich.

Manufacturers of Radio Apparatus, Receiving and Sending. Dealers send for discounts and catalog.

### Radio—(Continued)

**Experimental Electricity Course in 20 Lessons.** By S. Gernsback and E. W. Secor, E.E. A course of the theory and practice of Electricity for the Experimenter. Every phase of experimental electricity is treated comprehensively in plain English. New experiments are described and explained and nearly every application of Electricity in modern life is given. 160 pages—100 illustrations. Flexible cloth cover, 75c. postpaid. Stiff cloth cover, \$1.25 postpaid. Experimenter Publishing Co., Book Dept., 53 Park Place, New York City.

**How to Make Radio Frequency Amplifiers.** This book is for the more advanced amateur, showing the construction of the Radio Frequency Amplifying Transformer and giving complete constructional data. It shows the application of Radio Frequency to amplifying units that the amateur may already possess and gives 15 hook-ups showing practically every use Radio Frequency Amplifying Transformers can be put to. 32 pages, 15 illustrations; bound in beautiful two-color cover. Prepaid 25c. The E. I. Company, 239 Fulton St., New York City.

#### Salesmen Wanted

A Salesman wanted in every town or city within 25 miles of a broadcasting station to sell Radiogem, the complete radio receiving set that retails for \$2.50. With Radiogem there is nothing else to buy—the outfit includes the Radiogem receiving apparatus, 1,000 ohm phone, and aerial outfit. The cheapest radio outfit on the market—yet as practical as the most expensive. Big money to the right men. Send \$2.00 for sample outfit. The Radiogem Corp., 66-R West Broadway, New York City.

**Sell Coal in Carload Lots.** Side or main line. Experience unnecessary. Earn week's pay in an hour. Liberal drawing account arrangement. Washington Coal Company, 847 Coal Exchange Building, Chicago.

#### Scenery to Rent

Settings for Opera, Plays, Minstrels, Plush Drops. Address Amelia Grain, Philadelphia.

#### Song Poems Wanted

Poems Wanted—Sell your song-verses for cash. Submit Mss. at once, or write New Era Music Co., 152 St. Louis, Mo.

#### Song Writers

Song Writers. Let me compose Real music to your poems. Have no "Shark" propositions to offer. My work is honest and reliable. Francis Conover (composer), Avon, N. J.

#### Stammering

St-Stu-t-t-tering and Stammering cured at home. Instructive booklet free. Walter McDonnell, 121 Potomac Bank Bldg., Washington, D. C.

#### Stamps and Coins

California gold. Quarter size 27c; half-dollar size 53c; Half-dime and Catalog 10c. Norman Schultz, Colorado Springs, Colo.

158 Genuine Foreign Stamps. Mexico War Issues. Venezuela, Salvador and India Service. Guatemala, China, etc., only 10c. Finest approval sheets 50 to 60%. Agents wanted. Big 72-p. Lists Free. We buy stamps. Estab. 20 years. Hussman Stamp Co., Dept. 148, St. Louis, Mo.

#### Telegraphy

Telegraphy—Both Morse and Wireless taught thoroughly and quickly. Tremendous demand. Big salaries. Wonderful opportunities. Expenses low; chance to earn part. School established fifty years. Catalog free. Dodge's Institute, Cour St., Valparaiso, Ind.

#### Wanted to Buy

Full Value Paid for Old Gold, Jewelry, Watches, Diamonds, crowns, bridges, dental gold, silver, platinum, gold or silver ore; magneto points, old false teeth. Packages returned if our offer is not satisfactory. United States Smelting Works (The Old Reliable) 120 So. State St., Dept. 16, Chicago, Ill.

## One Thousand Agents Wanted

We want one thousand agents to sell subscriptions to RADIO NEWS, SCIENCE AND INVENTION, PRACTICAL ELECTRICS and MOTOR CAMPER & TOURIST. We will pay a generous commission for this work and help you in every way. Our four publications are leaders in their fields, ready sellers and this is an offer well worth your while. A few spare hours a day will bring you a handsome return. Write regarding our proposition at once and be the first one to get started in your vicinity.

### EXPERIMENTER PUBLISHING CO.

HERBERT H. FOSTER, Circulation Manager  
 53 Park Place, New York

**Why shouldn't you be as particular about small parts as WE are?**

### YOU USE THEM.

YOU DEPEND on them to help your larger instruments.

YOU EXPECT small parts to preserve the energy that reaches your set.

So why shouldn't YOU be as particular about their quality as WE are?

WE think no accessory too unimportant to build as carefully as we make fine optical instruments. All the craftsmanship we have developed in 44 years of precision work, we put into every MAR-CO small radio part.

Then we put them into the unmistakable MAR-CO packages, so that if you are as particular as we are, you can easily get the "leak-proof" service we build into them.

Simply say "MAR-CO" . . . and insist on seeing the MAR-CO package . . . when you want plugs, jacks, switches, grid-leaks, vernier condensers and other small parts.

# MAR-CO RADIO PRODUCTS

## ROLLS ROYCE RADIO TUBES



Like their name, significant of quality. Durable and powerful. Bring in distance with a maximum of volume and clearness.

- Type 200—5 v., 1 amp. Detector Tube
- Type 201A—5 v., .25 amp. Amplifier and Detector
- Type 199—3.4 v., .06 amp. Amplifier and Detector
- Type 199—3.4 v., .06 amp. With Standard Base—Amplifier and Detector
- Type 12—1 1/2 v., .25 amp. Platinum Filament—Amplifier and Detector

"The Rolls Royce of Radio Tubes"

All Types **\$2.50** Every Tube Guaranteed

To work in Radio Frequency. Especially adapted for Neutrodyne, Reflex and Super Heterodyne. Shipped Parcel Post C.O.D. When Ordering mention type.  
 ROLLS ROYCE TUBE CO.  
 21 Norwood St. Newark, N. J.

Insure your copy reaching you each month. Subscribe to RADIO NEWS—\$2.50 a year. Experimenter Publishing Co., 53 Park Pl., N. Y. C.







# LOW LOSS



0.1  
ohm

AMATEUR  
150 RANGE 220

226

BROADCAST RANGE

546

## The Test That Tells the Truth

The test which established the resistance of the  
**CONNECTICUT**  
Triple Range Variable Condenser

as 0.1 ohm at a capacity of 330 micro-microfarads on a 215 meter wave length shows this to be one of the most efficient instruments of its kind yet developed.

This was a real test—and it tells a real story.

Had it been made in the usual way—by measuring the resistance of the condenser at a certain capacity at 1,000 cycles, audio frequency—it would not give you any more than a general idea of its efficiency—

But because the test was made at a wave length well within the range of amateur and broadcast work—

Because the resistance was measured at radio—not audio-frequency—and

Because the result obtained was secured under the same identical conditions you encounter in every day receiving—

It not only gives you an accurate indication of the losses in this instrument but it gives you a true idea of the extent to which it will increase the selectivity and the signal strength of your set.

### Triple Range—Three Condensers in One

This is the condenser which enables you—by a few simple changes in the wiring connections, to cover the full field of usefulness with a single instrument.

It is three condensers in one.

The chart tells the story—

The range indicated by Curve B—from .000075 to .000275 mfd.—approximately that of an eleven plate condenser, is secured by wiring into the circuit from posts G and B.

The range indicated by Curve A—from .0001 to .0006 mfd.—approximately that of a twenty-three plate condenser, is secured by wiring into the circuit from posts G and A.

The range indicated by Curve AB—from .00015 to .00085—approximately that of a forty-three plate condenser is secured by bussing A and B and wiring into the circuit from G and B.

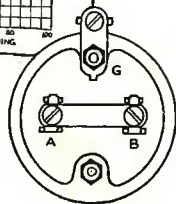
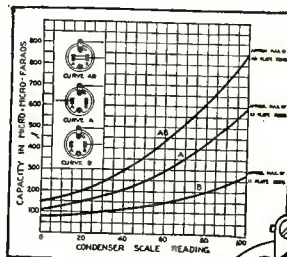

**FEATURES: Vernier Scale—Complete Shielding—Compact Size  
And all the convenience that goes with One-hole Mounting**

**PRICE \$4.50**

Complete with dial, index stud, spacing washers and buss bar.

Send for Bulletin A-104 describing this unique instrument, with information and diagrams illustrating its special applications.



**CONNECTICUT TELEPHONE & ELECTRIC**  
MERIDEN

**COMPANY**  
CONNECTICUT

RADIO DIVISION



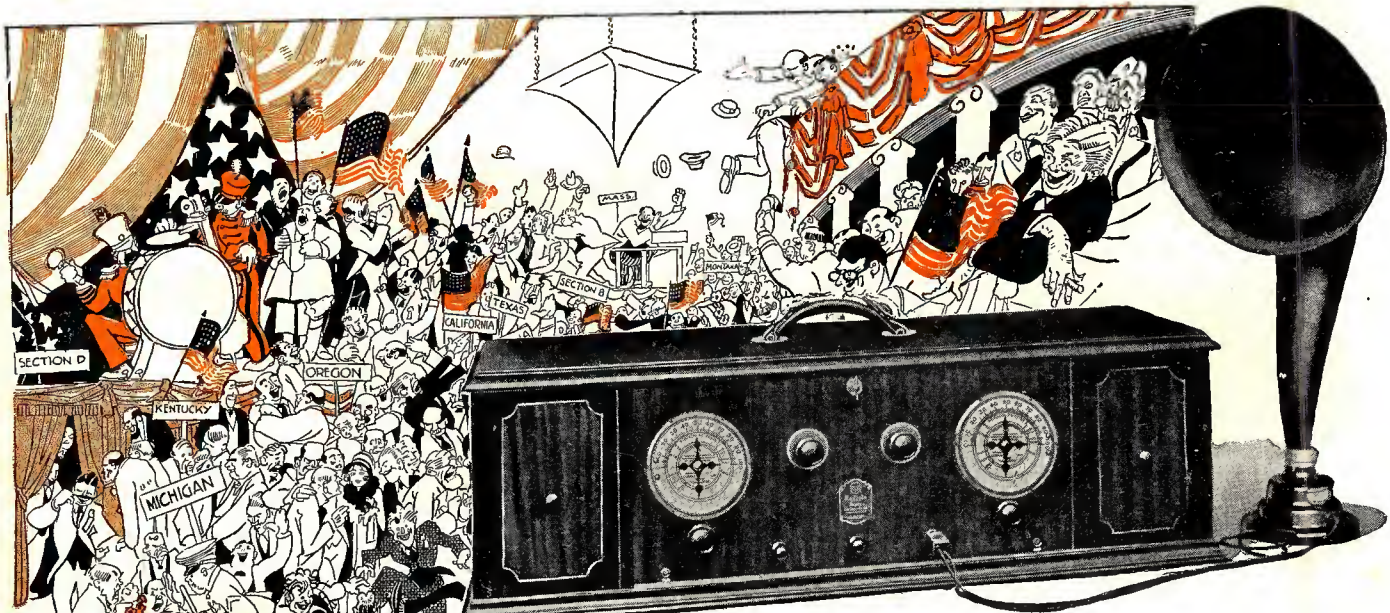

## Cheer with the Galleries When the Delegates March In!

No "influence" needed this year for a gallery seat at the big political conventions! Get it all with a Radiola Super-Heterodyne.

When the delegates march in—their banners streaming; when the bands play and the galleries cheer—be there with the "Super-Het." Hear the pros and cons as they fight their way to a "platform" for you. Hear the speeches for the "favorite sons." The sudden stillness when the voice of a great speaker rings out. The stamp and whistle and shrill of competitive cheering. Hear the actual nomination of a president.

It used to be all for the delegates' wives and the "big" folks of politics. Now it's for everybody. Listen in. Get it all! With the newest Radiola.

*"There's a Radiola for every purse"*

Radio Corporation of America

Sales Offices:

233 Broadway, New York

10 So. La Salle St., Chicago, Ill.

433 California St., San Francisco, Cal.



This symbol  
of quality  
is your  
protection

### Radiola Super-Heterodyne

is the great Radiola for the big events of summer broadcasting. Listen in, at your office to the conventions and the ball games. Take it everywhere.

It needs **NO ANTENNA**—no ground—no connections of any kind. Has a handle to lift it by. Tunes in with just two knobs that you turn to marked spots on the dials. Tunes out powerful near stations to get the far ones. A wonderful new achievement in the perfection of its tone—its sensitivity—and its supreme selectivity.

Complete with six Radiotrons UV-199 and Radiola Loudspeaker; everything \$286 except batteries . . .

External, rotating loop, easily assembled, larger than self contained loop in Radiola Super-Heterodyne, for extreme reception range. Loop A.G. 814 . . . \$12.00

Operates On  
Dry Batteries

Watch the radio columns  
of your newspaper for the  
big convention broadcast  
schedules.

There are many Radiolas at many prices.  
Send for free booklet that describes them all.

RADIO CORPORATION OF AMERICA  
Dept. (Address office nearest you.)  
Gentlemen: Please send me your free Radio  
Booklet.

Name \_\_\_\_\_

Address \_\_\_\_\_

# Radiola

REG. U.S. PAT. OFF.