

CONNECTICUT

RADIO

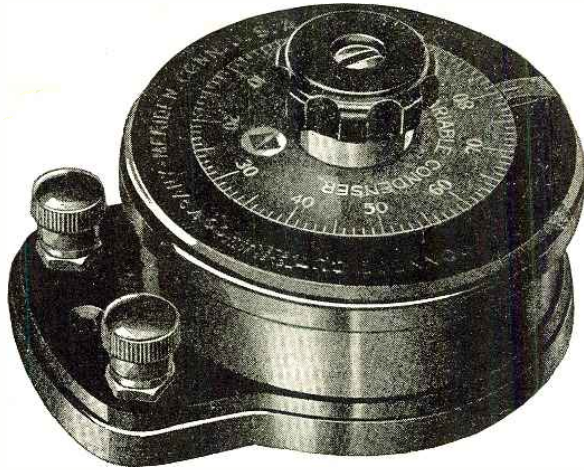

A New Variable Condenser —It Doesn't Get Out of Order

Your adjustments, once made with the new CONNECTICUT Variable Condenser, are secure—in any position. While delicate adjustments are easily obtained, the mechanism does not get out of order.

That's because of the simplicity of design—the kind of simplicity that comes from disregarding outworn tradition, and considering essentials only. And because that has been done, the CONNECTICUT Variable Condenser shows superiority not alone in design, but at every step in operation.

Our Booklet tells all about it and gives some interesting and important information about condensers in general. Send for your copy.

Mention your Dealer's name.

CONNECTICUT TELEPHONE & ELECTRIC COMPANY
Meriden Connecticut

RADIO AMATEUR NEWS

CONTENTS

VOL. 1

FOR JUNE

NO. 12

	PAGE		PAGE
Radio Kinetics.....By H. Gernsback	677	Awards of \$100 Radiophone Contest	
		Second Prize	690
French Application of the Momentous Vacuum Tube, Part II		Radio Wrinkles....By H. Winfield Secor	692
By Capitaine Metz	678	The Radio Constructor.....	694
Music by Radio Spark Tones		Easily Constructed Radio Mast	
By Rev. Georges Desilets	681	By Everett Leo Deeter	694
Enter—The Radio Controlled Bus		A Simple Magnetic Detector	
By Pierre H. Boucheron	682	By Forrest R. Kingman	694
Loose Coupled Receiver Tuning		A Compact Tube Control Panel	
By Dr. L. W. Austin	683	By J. Stanley Brown	695
Marconi's Yacht, "The Electra".....	683	Club Gossip	696
A New Inductance		Radio Digest	697
By Pierre H. Boucheron	684	With the Amateurs.....	698
British Radio Instruments.....	686	Junior Section	700
Development in Radio Receivers		Radio Dictionary	701
By R. H. G. Mathews	687	Junior Constructor	702
The Radiophone with the Atlantic Fleet..	688	I-Want-To-Know	703
A Radiophone Set that Really Works			
By E. W. Dannals	689		

RADIO AMATEUR NEWS is published on the 25th of each month at 233 Fulton Street, New York. There are 12 numbers per year. Subscription price is \$2.00 a year in U. S. and possessions. Canada and foreign countries, \$2.50 a year. U. S. coin as well as U. S. stamps accepted (no foreign coins or stamps). Single copies, 15 cents each. A sample copy will be sent gratis on request. Checks and money orders should be drawn to order of EXPERIMENTER PUBLISHING CO., INC. If you should change your address notify us promptly, in order that copies be not miscarried or lost. No copies sent after expiration.

All communications and contributions to this journal should be addressed to: Editor, RADIO AMATEUR NEWS, 233 Fulton Street, New York. Unaccepted contributions cannot be returned unless full postage has been

included. ALL accepted contributions are paid for on publication. A special rate is paid for novel experiments; good photographs accompanying them are highly desirable.

RADIO AMATEUR NEWS. Monthly. Entered as second-class matter June 6th, 1919, at the Post Office at New York, N. Y., under the act of March 3, 1897. Title registered U. S. Patent Office, Copyright, 1920, by E. P. Co., Inc., New York. The Experimenter Publishing Co., 233 Fulton Street, N. Y., N. Y. The contents of this magazine are copyrighted and must not be reproduced without giving full credit to the publication.

RADIO AMATEUR NEWS is for sale at all newsstands in the United States and Canada; also at Brentano's, 37 Avenue de l'Opera, Paris. For Great Britain: Geoffry Parker & Cress, 62 & 64, The Mall, Ealing, London.

Published by EXPERIMENTER PUBLISHING CO., INC. 233 Fulton Street, New York City
 H. GERNSBACK, President S. GERNSBACK, Treasurer R. W. DE MOTT, Secretary

DEALERS!!!

We shall be pleased to send our revised schedule of prices and discounts on request. Delivery on our standard equipment can be made immediately from stock, subject to prior sale.

WIRELESS SPECIALTY APPARATUS CO.

Engineers, Designers, Manufacturers

131 STATE ST., BOSTON, MASS.

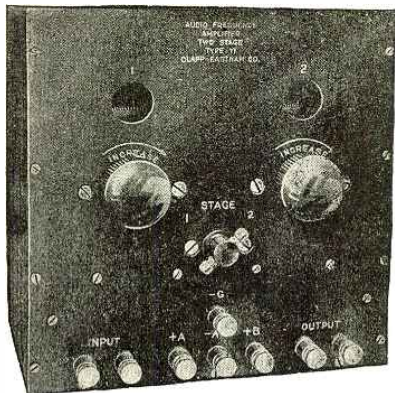

TWO STAGE AMPLIFIER

AMPLIFICATION Somewhat BEYOND THE USUAL

is

Secured with our type Q. O. coil, designed on a somewhat different principle. Its somewhat higher price is trifling, results considered.

- Two Stage Amplifier, complete.....\$50.00
- Type Q. O. Coil, mounted..... \$7.50
- Type Q. O. Coil, unmounted..... \$5.00

Immediate deliveries—From most good dealers. Bulletins F and Z sent for 4-cent stamps list our complete line of high grade, moderately priced, apparatus for the Radio Laboratory.

THE CAMBRIDGE RECTIFIER

illustrated here will charge your storage batteries at home from any alternating current lamp socket cheaply and simply. It is fully described in Bulletin R.

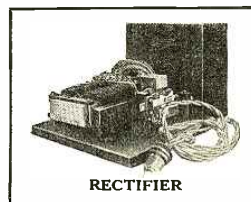

CLAPP-EASTHAM CO.

120 MAIN STREET

CAMBRIDGE, MASS.

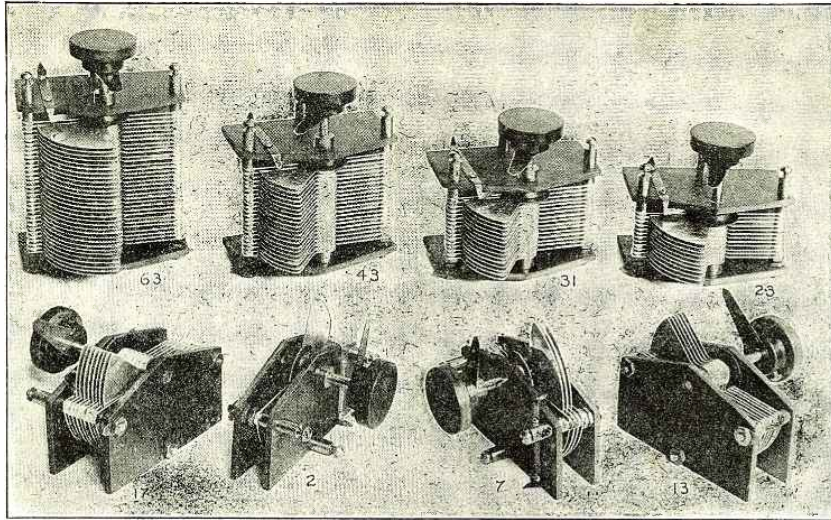

VARIABLE CONDENSERS SERIES "S"

For the Radio man who wants instruments that are right, in all respects, we can recommend this instrument. It is not built to sell in competition with some of the low priced instruments offered, but we are offering it at very reasonable prices, quality considered.

BAKELITE-DILECTO end plates support both the moving and stationary elements. Die stamped aluminum plates and spacers insure uniform and rigid construction. Copper Ribbon connection to Moving set of plates eliminating dirty, high resistance contacts. Steel shaft, accurately ground to size. Stop pin fitted to condenser. Moving plates will stay put in any position, although movement

is very smooth and easy. Bakelite-Dilecto end plates are now fitted to front and back end of all sizes listed, insuring perfect alignment.

Fitted with lathe turned knob, pointer and set screw, and mounting screws. Made for panel mounting especially. Specify the thickness of your panel and whether you want brass or nickle pointer and screws.

PRICES.

No. 2	2 plate Vernier	\$1.85
No. 7	7 plate, .0001 m.f. max. cap.	\$2.15
No. 13	13 " .0002 " " "	\$2.50
No. 17	17 " .0003 " " "	\$2.85
No. 23	23 " .0005 " " "	\$3.25
No. 31	31 " .0007 " " "	\$3.90
No. 43	43 " .001 " " "	\$4.75
No. 63	63 " .0015 " " "	\$6.75

SPECIAL.

We can now furnish our condensers fitted with a fine indicating dial instead of pointer. Dial is 3 1/8" in diameter, of heavy brass, black dial with white graduations and numbers.

If dial indicator is desired instead of pointer, add to above prices 75c.

Add to above prices postage on one pound to your postal zone.

Our new catalogue is now ready for mailing. Send 5c in stamps, and your copy will be mailed at once. It is full of just what you are looking for.

511 W. Washington
Street

The Wireless Shop
A. J. EDGCOMB

Los Angeles
Cal.



RADIO AMATEUR NEWS

H. GERNSBACK — EDITOR
PIERRE H. BOUCHERON — ASSOCIATE EDITOR



Vol. 1

JUNE, 1920

No. 12

Radio Kinetics

ONE of the least studied and least exploited branches of the radio art no doubt is the art of radio kinetics. Since the earliest days of radio, many investigators have busied themselves in building and constructing apparatuses to produce effects at a distance by means of radio.

Dr. Branley of Paris was perhaps the first one to work extensively in this branch of radio and as far back as 1906 this investigator fired guns, closed doors, started and stopt motors by means of distant radio control. This was in the age of the coherer, and probably due to its inherent shortcomings, the art of radio kinetics was not much advanced until very recently. The coherer is a very unsatisfactory scientific instrument insofar that even if constructed by precision mechanics, it has the great inherent fault of being susceptible to shocks as well as to most extraneous impulses.

Thus, for instance, a very sensitive coherer will usually operate on strays or static as well as inductive effects, and stray waves. In other words, this instrument, even the most balanced one, is not reliable. It will go off when least expected. A coherer heretofore was thought to be the prime necessity for radio kinetics, because it was practically the only instrument known that could close the contacts of a relay. Ordinary detectors, such as the crystal type and others, could not be used until about three or four years ago, at which time very sensitive galvanometer-relays were introduced which actually could be used to close a contact by means of a carborundum or silicon detector.

There was even constructed in France before the war a sort of string galvanometer which could close contacts, using an electrolytic or a galena detector. However, this instrument suffered also by reason of too great a sensitiveness. Of late great improvement has been made in radio kinetics, particularly in France, where this branch of the art has been investigated very thoroly by many workers. In perusing the illuminating article by Capitaine Metz in this issue, it will be seen that the French actually ring bells at a distance of 25 kilometers or more by using certain vacuum tubes for their purpose.

Of course, it had been known a long while that this could be done, but very few workers attempted it, as it seemed mostly to be a sealed book to them, and was considered as too ticklish a job as well as unprofitable. As Capitaine Metz points out, there is little doubt that the art of radio kinetics during the next decades will probably rank second next to radio-telephony. There are

numerous important things that can be accomplished by means of radio kinetics, particularly during times such as these where manual labor is at a premium. To mention but a few:

By means of radio kinetics, light houses far out at sea can be operated at will. Buoys can be lighted and extinguished. Freight steamers can be steered across lakes or even the ocean without having a crew, or even a single human being on board.

This already has been accomplished in an experimental way. The boat in this instance is protected from collisions by means of a fog horn which sounds every two minutes whether there is a fog or not. At night the lights are lighted automatically. The ship gives its position every fifteen minutes or every hour by radio automatically back to the control station on land. The ship is propelled by means of electricity, and the propellers can be started and stopt and the ship steered at will from the distant land station.

The same thing is true, and will be realized on land where freight trains can be sent without a crew for long distances over land. In this case, too, the train is propelled by electricity in the usual way. All other functions are fully automatic.

These things may seem like wild and extraordinary dreams today, but they are not wilder than wireless itself was thirty years ago, which could not even then be imagined. In this country, John Hays Hammond, Jr., is perhaps the greatest exponent of radio kinetics. Congress bought his invention for a radio-propelled airship which is propelled and steered entirely by radio. While the details of the invention had been kept secret on account of military reasons, there is little doubt that any first-class radio engineer could duplicate the experiments. As for safety and reliability of operation when employing the vacuum tube, there is today no question of a doubt. Interference does not bother greatly the engineer, who constructs an apparatus, operated exclusively by means of what is called time impulses. In other words, unless you have the correct key and send the radio impulses at the *correct* time intervals, no one can start or stop the instruments at random.

Wonderful things will be accomplished by means of radio kinetics, and it is to be greatly desired and hoped that our amateurs will take an active part in this, the most interesting ramification of the radio art.

H. GERNSBACK.

French Application of the Momentous Vacuum Tube

PART II

By CAPITAINE METZ

Translated from the French by Pierre H. Boucheron

RADIO TELEPHONY

UNDER this heading we shall discuss some of the difficulties encountered in radio telephony conversations as well as some timely remarks on this important subject.

We have previously seen that continuous wave vacuum tube sets can be readily employed in radio telephony as well, with very little difficulty and without extra appliances; as a matter of fact, they involve even less apparatus than other sets.

M. Goutton has devised two small vacuum tube sets especially designed for radio telephony. One is for the purpose of establishing conversations between airships in flight and the other is for radiophone work on land. These two interesting little sets have a maximum range of several kilometers.

However, the first set to be specially constructed for radiophone work is at the same time an undamped signal transmitter and is likewise a contemporary of the type C. A. units devised by Sub-Lieutenant Lévy. This set functions with six large tubes in parallel. The combined lamps absorb in the neighborhood of 1,000 watts; the plates require a potential of 1,000 volts and the filaments require 8 volts. One feature which makes this set rather original from a radiophone point of view is that the microphone does not function directly in the plate circuit as is the case in the two previously mentioned sets as well as many other vacuum tube sets. The microphone in this case is introduced in the circuit which is formed through the intermediary of several turns of the plate transformer, or through two or three independent turns bearing a mutual induction on the plate coil. In the set which we are describing, the microphone functions on the grid of the large tube thru the intermediary of a two-stage amplifier mounted exactly like that of the amplifier used in T. P. S. (ground telegraphy), but employing larger tubes. In this instance, however, the microphone circuit is closed to the primary of the transformer, the secondary of which is connected to the grid of the first lamp as in Fig. 7. The plate of this first lamp is connected to the

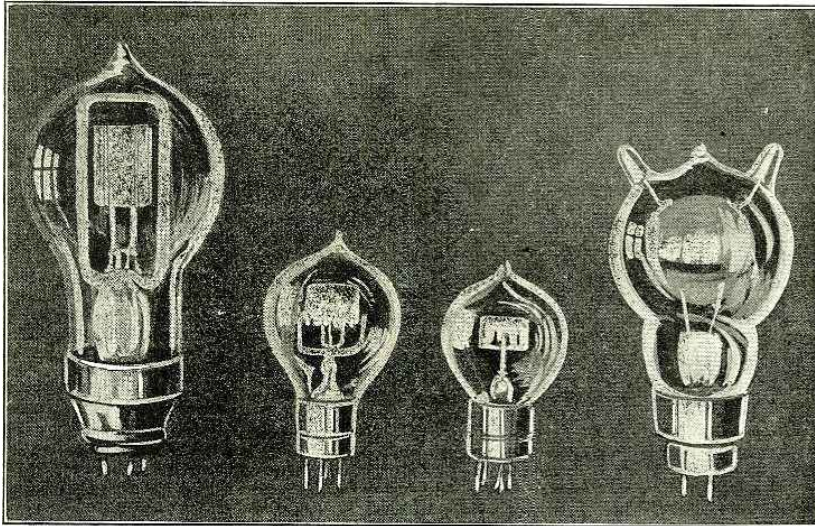

Fig. 14—Four Models of the Various Types of Vacuum Tubes Employed By the French Military Service.

grid of the second lamp by a second transformer. The third transformer still further connects the second plate to the grid of the six large bulbs. The microphone in this instance is of the regular type which necessitates a current of ten volts.

One of these units employing an umbrella antenna supported by a 27-meter mast has effectively covered a distance of 120 kilometers between the earth and airships, which as is known operate under difficult receiving conditions. In this connection no tests were made between two points on land to determine operating distance. It is certain, however, that several hundred kilometers can be easily covered. As for radio telegraphy, with the use of this set, 1,000 kilometers have been easily bridged. Radio telephone sets of high power have been mounted on automobile chassis as well as on desks or fixtures suitable for permanent stations such as that shown in Fig. 8. This is the most powerful of the vacuum tube sets employed by the French military service. With these and one thousand watts of input energy the same carrying distances are

is that there are no means of bell calling. The second, during transmission and speech; it is not possible to receive at the same time. In order to pass from transmission to reception it is necessary to switch over from the transmitting to the receiving bulbs. Thus it is impossible to reply immediately to the correspondent in the familiar manner used in the regular land line telephone. When an operator has finished speaking, it is necessary to wait patiently until he has declared the words "I will now switch over to reception. These two serious faults of radio telephony are about to disappear. This is due mainly to the work which has been accomplished in "telemechanics" of which we will speak in a future paragraph. In this instance, and by means of a Hertzian wave of long duration producing an emission similar to the Morse dash and with the aid of a special amplifier of very good frequency employed in reception, there has been effectively operated at the receiving sets a local relay which actuates a regular call bell. It has also been possible to insert in parallel, between the same antenna and the

ground, a transmitting as well as a receiving apparatus which have the power of *functioning simultaneously*. This is done by means of an instrument inserted in the receiving circuit which prevents the emitted current from passing thru or reaching the local receiving instruments. The telephone operator is therefore able to speak and transmit speech, and at the same time, by means of the head receivers, is able to receive distant stations; his speech

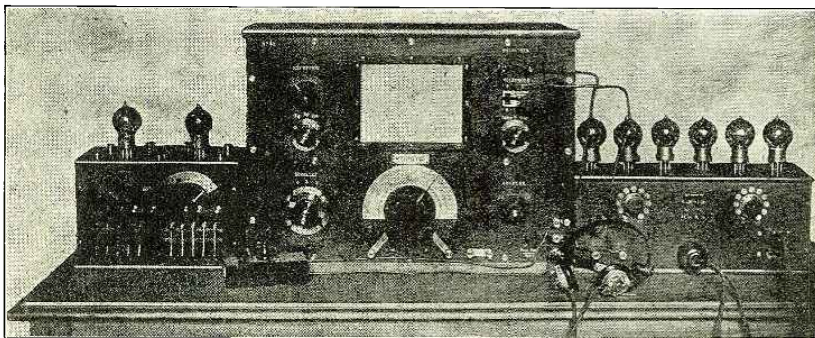

Fig. 12—To the Left is Shown the Multi-vibrator and Close to It the Tuning Fork Mentioned by the Author. To the Right is the Amplifier-Detector, While in the Center is Shown a Special Wavemeter.

can also be interrupted at any moment in the same manner as is done with a regular land line telephone set. An arrangement of this kind has been tried out with excellent results up to a distance of 20 kilometers. The bell rings at a distant point upon a simple make-and-break contact at the transmitting side. In this instance the transmitting set is of the C. A. type employing five vacuum tubes. The receiving set also employs several lamps and is of a type of which we will speak later. This set is at present in operation at the *Champ de Mars*. Incidentally the same unit was employed at the radio station of the *Champ de Mars* during the first historic attempt to bridge the Atlantic by means of the human voice. The transmitting set which employed a great number of lamps was installed at Arlington, near Washington, D. C. By means of the amplifier at *Champ de Mars*, the voice of the American telephone operator was very clearly heard several times in a most striking and effective manner. This occurred during October, 1915.

LOW FREQUENCY AMPLIFIERS.

These instruments, as is well known, amplify telephone currents of low frequency of which we have spoken in the previous installment. The most well-known and practical of the French amplifiers is the one known as the "3 ter," meaning three-stage amplifier, and which has rendered great service for the reception of T. P. S. (ground telegraphy); listening to enemy conversations, as well as the amplification of radio telegraphy signals. In this three-stage instrument, the first tube can also serve as a detector, and this compact unit is therefore used for reception on board airships. The amplification in this case begins at the binding post of the variable capacity, placed in the secondary receiving circuit and takes the normal place of detector.

HIGH FREQUENCY AMPLIFIERS.

This method consists of making the grid potential oscillate in the neighborhood of its normal value by connecting the grid to the binding post by a condenser, traversed by a current having the same frequency as that of the receiving antenna. Therefore the slightest variation of the plate potential caused by the antenna, produces correspondingly much greater variation in the plate current, and thus is realized the amplification of a current which maintains its original frequency. This current is detected after a number of amplifications which, when once detected will easily function a telephone receiver; in fact this resultant amplified low frequency current may still further be reinforced before it is actually made to operate the telephone receiver.

In accordance with the manner in which

the plate of each tube is connected to the grid of the following one is distinguished high frequency amplification making use of either transformers, resistances or resonances.

HIGH FREQUENCY AMPLIFIERS MAKING USE OF TRANSFORMERS.

These have largely been used in radio



Fig. 8—Desk Type Unit Containing the Necessary Apparatus for High Power Radio Telephony.

compass work. Their manner of construction and connection is similar to those of the "3 ter" type (3 stage), in other words the turns of their transformer primaries and secondaries are calculated so as to be suitable for high frequency or radio currents, that is to say, they have a small number of turns and the coil laminations are very small in diameter.

Fig. 9 shows two types of these amplifiers, one contains six tubes, in cascade where the first three amplify at high frequency, the fourth acts as a detector and the fifth and sixth amplify at low frequency. The second model which may be seen to the right of the photograph is equipped with but four tubes, but in this case the second and third accomplish two purposes, namely, they amplify at high frequency the current which is received by the first tube, then at the end we have the fourth lamp, which is a detector. These same two tubes also function as telephone current amplifiers; their grids and their plates being furnished with a second inductance which is designed to prevent the passage of low frequencies.

These two amplifier units are also exceptionally well adapted for loop reception; the first for the reception of wavelengths between 2,000 and 20,000 meters, and the second for the reception of small wavelengths up to 2,000 meters. These sets are essentially radio compass amplifiers.

RESISTANCE AMPLIFIERS.

The manner of connecting the plate grid circuits of consecutive tubes in this circuit is realized by means of a condenser which in turn is connected to the amplifying resistance having a value in the neighborhood of 70,000 ohms and placed in the plate circuit. The grid of each tube is connected to its respective filament thru a resistance of five megohms. The resistance and capacity system which connects the plate to the grids is more particularly adapted for each value of these resistances and capacities to certain definite wavelengths. That is the reason why each of these amplifiers from a wavelength viewpoint have a certain zone or range where amplification is much more effective. Fig. 10 shows three types of resistance amplifiers which have been constructed in great numbers. The first model which has four tubes is confined to regular antenna reception, the tubes amplify and detect at the same time, and the apparatus functions under best conditions with wavelengths above 800 meters.

A second model of resistance amplifiers is composed of eight tubes where the first six amplify and detect and at the same time receive currents at high frequency, while the last two lamps are for the purpose of amplifying the currents. It is with this amplifier that American stations were effectively intercepted merely by using a loop instead of an antenna. Finally the third model of resistance amplifier is similar to the preceding ones, but does not permit the reception of undamped waves without an auxiliary heterodyne. These resistances are metallic and much sturdier than those of the preceding types. This model also employs eight vacuum tubes.

RESONANCE AMPLIFICATION.

In this type of amplifier the connection of the plate of one lamp to the grid of the following tube is effected thru the intermediary of oscillating circuits, composed of an inductance and a variable capacity. The two applications of the principle of this type of amplifier is the box and the manner of connecting the tubes as well as the arrangement designed to eliminate parasitic noises, which will be mentioned later.

This receiving set consists of four lamps, the last three of which are mounted in a fashion analogous to the three stage low frequency amplifier; the first of these three lamps functioning as a detector and the last two as amplifiers. The very first lamp of the receiver is connected as a resonant amplifier. The antenna circuit is connected to the plate. By adjusting the antenna grid circuit as well as the secondary plate circuit an initial high frequency amplification is effected which precedes detection. The set permits the reception of undamped waves, the second tube being connected as a hetero-

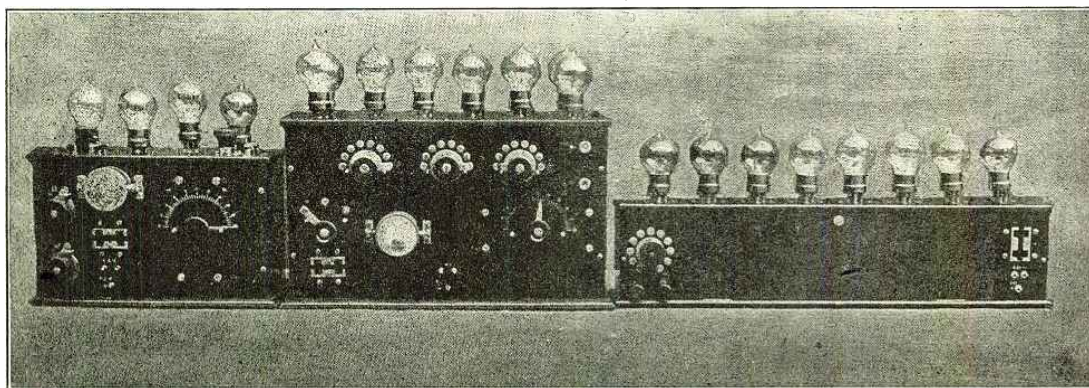

Fig. 10. High Frequency Resistance Amplifiers. Models Employing Four, Six and Eight Vacuum Tubes Specially Used for Long Distance Reception in Conjunction with Loop Antennae

odyne detector. It is with such an arrangement that radio telephony is also accomplished simultaneously. This set has served quite well as a listening-in unit on wavelengths ranging from 500 to 40,000 meters, particularly near general headquarters, thus permitting the surreptitious copying of many enemy radiograms; the eventual deciphering of which furnished the French army with valuable military information.

VERY LOW FREQUENCY AMPLIFICATION.

These amplifiers are constructed so as to furnish very low frequencies corresponding for example to those of Morse manipulation. These amplifiers were realized by a resistance arrangement where the plate grid capacities played an important part, or by an arrangement furnished with special amplifying transformers. These amplifiers have particularly served in the practise of so-called "telemechanics." Results of the greatest interest were obtained with these sets for instance, the manoeuvres of *airships were directed absolutely without the intervention or control of the pilot, by means of a control operated on terra firma thru the use of an undamp't wave transmitter.* It has also been possible to make a small vessel of the sub-chaser type perform the most complicated evolutions by guiding it with a radio station placed on a hydroplane and despite local transmissions of the Toulon stations which happened to

V. T. APPARATUS FOR RESEARCH AND MEASUREMENT PURPOSES.

Vacuum tubes are not only most suitable for the operation of transmitters and receivers as well as various amplifiers, but they permit as well, realization of certain laboratory apparatus and thus open an inexhaustive field for the most varied research work. We will confine ourselves in

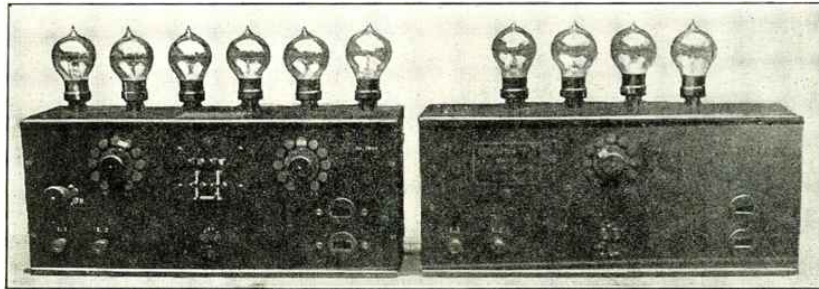

Fig. 9—High Frequency Transformer Amplifiers of the Four and Six Tube Types. These Sets are Particularly Adapted to Radio Compass Work.

this instance to but three examples which the French military service had occasion to study and employ most particularly and which are the multivibrator, which is for the purpose of precise measurement of wavelengths; the heterodyne which while acting as a generator of undamp't waves of a frequency immediately variable, lends itself admirably to all manner of measurements notably those of high frequency resistance and of which we will show the arrangement devised by Lieutenant Lévy for the prevention of parasite or howling noises, and finally the set suitable for very short wavelengths conceived by M. Goutton.

THE ABRAHAM MULTIVIBRATOR.

This is an apparatus containing two vacuum tubes which are mounted and connected in a symmetrical manner. The plate of each bulb is connected to the grid of the next by means of a variable capacity. Resistances are inserted between the filament and the plates as well as thru sources of current. See the schematic circuit of Fig. 11. It is shown by theory that the plate of each bulb detects into the grid of the next, and that the corresponding current fluctuations are sharply produced with a very constant frequency dependent upon the electrical constants of the parts. It is therefore possible to regulate this frequency by means of the variable capacities; thus it is seen that if the alternating current corresponds to the fundamental frequency of the apparatus the multivibrator will give numerous harmonics, that is to say currents, the frequency of which is in multiple reaching as far as 150 or more than the fundamental frequency. The regular multivibrator built by the French military service has a fundamental frequency in the neighborhood of 1,000. It gives harmonics reaching 150, that is to say, where the frequency is 150,000 per second and second-

ary corresponds with a wavelength of 2,000 meters. ($200 \times 150,000 = 30,000,000$ meters, which is the speed of radio waves as well as that of light.) In order to employ this multivibrator for measurement of wavelengths in such a manner that the results will be absolutely accurate, it is first necessary to regulate the fundamental frequency so that it is equal to that of a tuning fork of which we know the number of vibrations per second. We will take for example the tuning fork which gives the note *ut-5* (1,024 periods per second). To compare the frequency of the multivibrator to that of the tuning fork it is necessary to bring the multivibrator close to an amplifying detector which will be actuated by each change of the current direction of the multivibrator and which will give in the telephone receivers a sound, the note of which will be determined by the fundamental frequency of the multivibrator. If, while we are listening to this sound we vibrate the tuning fork and providing that the two frequencies under test are close to each other, we produce the phenomena of beats. At the moment where, by the manipulation of the variable condenser, we will have adjusted the multivibrator on the tuning fork, the resulting sound which is due to the phenomena of beats, disappears completely and we are sure at this moment that the fundamental frequency of the apparatus is the same as that of the tuning fork. This result once obtained, all that

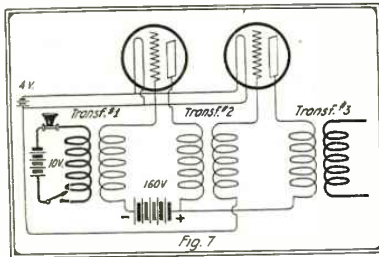

Schematic Wiring Diagram of High Power Radio Telephone Circuit.

be in the immediate neighborhood as well as the interference produced by many naval vessels. Finally more modest performances were accomplished which are nevertheless interesting. A call bell arrangement as an accessory to a radio telephone set was actually and effectively operated at a distance of 21 kilometers. These tests in telemechanics, which is a branch of radio strictly in its infancy, permits some of the most interesting applications of the vacuum tube. The tests, by the way, were carried out by Lieutenants Brillouin, Gueritot and Manescau of the French Army.

It was M. Abraham who paved the way toward telemechanics when he created his "T. B. F." amplifier which is the French abbreviation for *très basse fréquence*, meaning very low frequency.

Previous to the tests which have just been mentioned M. Abraham had succeeded in operating a Morse register instrument by means of radio telegraphy and with the aid of a very low frequency amplifier connected after the principle of resistance-amplification and furnishing at the output of the distant receiver from ten to fifteen milliamperes necessary to the functioning of the Morse register.

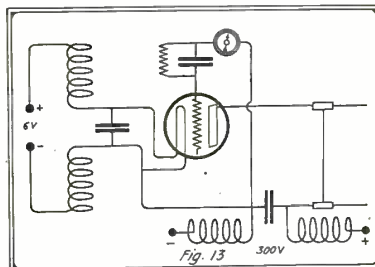

Circuit Diagram of the Very Short Wave Transmitter Which Permits the Study of the Characteristics of Hertzian Waves.

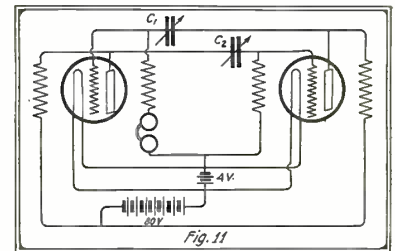

Schematic Diagram of the Abraham Multivibrator Which Permits High Precision Measurements of Wavelengths.

is necessary in order to measure or verify the scale of a wavemeter is to compare it to one of the harmonics of the multivibrator. To do this the multivibrator is set in operation and within a close distance is placed the wavemeter which is composed essentially of an oscillating circuit of which the inductance is fixed and the capacity variable. It is then necessary to listen-in on an adjacent amplifying detector as shown in Fig. 12. Each sine wave reversal of the multivibrator current produces an impulse in the oscillating circuit of the wavemeter which thus set in vibration gives a wave readily detected by the amplifying detector. If during this time we manipulate the varying capacity of the wavemeter at the moment where the wavelength of the oscillating circuit of the wavemeter is equal to that of one of the harmonics of the vibrator, there is a reinforcement of the detected sound of an extremely sharp nature. There is thus also a definite means, which did not exist before the introduction of the vibrator, of measuring to an absolute value any wavelength by bringing it to the frequency of the tuning fork.

(Continued on page 708)

Music By Radio Spark Tones

By The Reverend GEORGES DESILETS

THE invention is an apparatus for producing and transmitting musical sounds by radio as described in the present paper and illustrated in the accompanying drawing and photograph.

In this invention the ordinary sending and receiving apparatus is employed, except that in place of the ordinary sending key, a plurality of keys are employed, the operation of any one of which will cause a certain musical note to be transmitted, different notes being obtained according to which key is operated. The various musical notes are obtained through the medium of annular rows of rotating spark gaps, each row producing sparks of greater or less frequency than the adjacent rows. A most convenient way of obtaining this result is to provide the annular rows of spark gaps in the form of points or studs projecting radially from the surface of a conical or frusto-conical rotor, the points in one row being the same distance apart as the points in any other row. Thus, the points in the row of greatest diameter would be more in number and would travel at a greater speed than the points in the row of smallest diameter and produce

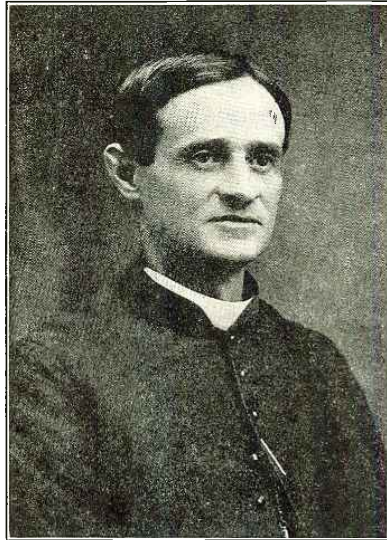

The Reverend Georges Desilets, Inventor of the Radio Organ.

which is pivoted intermediately to a fixed wooden bar. The underside of the outer end of each key carries a contact electrically connected by means such as the spring to one of the wires 34 of the line circuit and the other wire 35 of the line circuit being provided with a contact beneath each key adapted to cooperate with the contact to close the line circuit. Both ends of a key are insulated from each other by the joining arm made of suitable insulating material.

The outer end of each key is provided with a contact at its upper end which contact is also connected beneath the key to one of the high tension wires 39 by means of the spring. 41 are spring contacts insulated from each other, respectively extending from terminals 42 to which the wires 21 are connected. All the contacts are normally away from the contacts 41 and in pressing a key, the said contacts are adapted to be closed just a little before the contact at the other end of the key touches the other contact. Thus, the high tension contacts are closed before the low tension and opened after the opening of the low tension contacts, which prevents sparking at the high tension contacts.



Fig. 3—Front View of the Instrument Which is in Reality an Organ of the Regular Type.

length as to include more than one octave, but in order to keep down the size of the apparatus, it is preferred to provide the semitones and additional octaves in the manner hereinafter described.

The points belonging to each of the annular rows and the different rows before mentioned are electrically connected to each other and to the shaft 2. Further, the points of one row are the same distance apart as the points on the other rows and as an example, it may be mentioned for purposes of comparison that if the row 3 contains twenty-four points, the row 4 contains twenty-seven, the row 5 thirty, the row 6 thirty-two, the row 7 thirty-six, the row 8 forty, the row 9 forty-five and the row 10 forty-eight, according to the relation before mentioned.

The points before mentioned form poles and operate in conjunction with a plurality of fixed poles 11, 12, 13, 14, 15, 16, 17 and 18, one for each row of spark gaps and carried by a suitable insulator 19 provided with terminals 20 to which, and the fixed poles, are connected electric wires 21 leading from the key board 22.

The key board 22 comprises a set of keys 23, 24, 25, 26, 27, 28, 29 and 30, each of

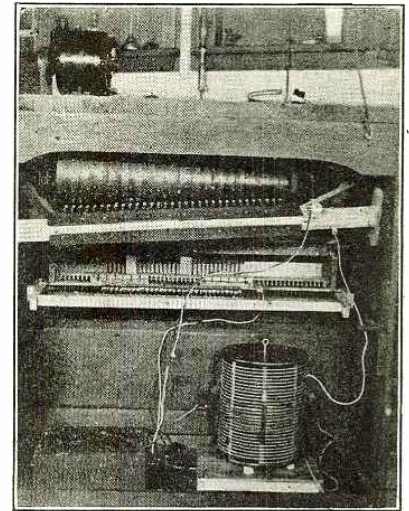

Fig. 4—Showing a Rear View of the Radio Organ Which Plainly Shows the Rotary Spark Gap and the Many Electrodes Corresponding to Musical Tones.

sparks with greater rapidity. In order to produce a regular scale of musical sounds the number of points on each row is determined by the following relation between the number of points in two adjacent rows well known in acoustics:—

$$1, \frac{9}{8}, \frac{5}{4}, \frac{4}{3}, \frac{3}{2}, \frac{5}{3}, \frac{15}{8}, 2.$$

The invention will be better understood with the aid of the accompanying drawing in which Figure 1 illustrates a diagrammatic view of the apparatus according to the invention.

Referring to the drawing, which of course does not show the receiving apparatus which is the same as any ordinary outfit, 1 indicates a rotor in frusto-conical shape supported on a shaft 2 rotated in any suitable manner for example, by an electric motor. The rotor is here shown as provided with eight annular rows of radially projecting points 3, 4, 5, 6, 7, 8, 9, and 10 corresponding in number to the natural notes in an octave, though it must be understood that the rotor could be of such

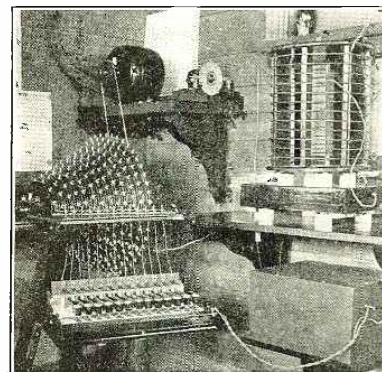

Fig. 2—First Model of the Original Radio Organ Constructed by the Inventor in 1916.

The wire 34 is connected with the primary coil of a transformer 43, while the wire 39, supported by an insulator is connected to the secondary coil of the transformer. The shaft 2 is also connected by a wire 44 to the ground wire 45 of the ordinary wireless outfit while the usual helix 46 (an oscillation transformer may also be used) and condenser 47 are employed, the former being connected with an antenna in the usual manner.

It will thus be seen that a series of sparks can be obtained at any one of the fixed poles 18 by reason of the closure of the high tension circuit consequent upon the pressure of the key corresponding to that particular fixed pole and, as hereinbefore explained, musical notes will be produced by the difference in the frequency of formation of the various series of sparks.

Obviously, in order to produce chords, it is only necessary to supply a current of

(Continued on page 710)

Enter—The Radio Controlled Bus

By P. Ex.

IF, in the near future, you happen to see a queer looking baby carriage, self propelled and with the weird power of being able to turn street corners, make a complete 360 degree turn; that is, retrack its direction, all this without any



Close-up View of the 49th Assistant Editor of "Radio Amateur News" Trying to Find Out How It Works. Note the Blank Expression.

visible control by Mr. Baby; or, on the other hand, if you happen to notice a strange cart dashing about city streets also without any apparent means of control yet having a very definite aim or destination, do not be alarmed, or do not think that the olden time genie has returned to these modern and prosaic days; it is simply this—the radio controlled bus has made its appearance.

Mr. Glavin, of Tuckahoe, N. Y., who is the inventor of the device, recently gave a demonstration which proved very interesting as well as convincing. The model which is rather a small one weighs 180 pounds and is somewhat the size of a small baby carriage; nevertheless, the inventor was able to control its starting and stopping as well as turning either to the right or to the left by simply pressing a distant radio telegraph key a certain number of times according to the action wanted.

Altho Mr. Glavin carefully guards the exact electrical and mechanical details making his invention possible, the device is probably not unlike Mr. Hammond's radio controlled torpedo which has been undergoing the process of development for several years. In demonstrating the performance of his invention, Mr. Glavin erects a small portable antenna about twenty-five feet long to which he connects a low-power radio transmitting set of the 50 watt Signal Corps type, controlled, of course, by a regular sending key. The arrangement at the controlling end, therefore, is the same as that of a regular radio transmitter. On the vehicle itself is erected a small antenna to which is connected the re-

ceiving system necessary for operation.

Briefly, the principle of the arrangement is that when the energy from the transmitter is received by the small antenna, it is made to actuate a very sensitive polarized relay thru the medium of a detecting device having the characteristic of a large potential rise and fall. This causes a sufficient energy variation to actuate the polarized relay.

The local circuit of the relay on the other hand is connected to a so-called contact drum which moves step by step by means of a ratchet device; the ratchet being actuated by a plunger electro-magnet which moves the drum one notch for each spark. The combined arrangement may be said to operate as follows: When one impulse of radiated energy, in other words, one complete make and break, is made to actuate the relay, the plunger magnet moves the drum to contact No. 1. The circuit of this first contact controls the starting of the motor driving the vehicle which is connected, of course, to a local source of storage battery power. The machine will then start and proceed at the rate of about three miles an hour. If another impulse of energy be transmitted, the drum moves the contact No. 2 at which the circuit returns to normal. The third spark moves the drum to a contact controlling the steering apparatus which in this case makes the car turn to the right. The fourth spark in a like manner brings the steering wheel to dead center again. The fifth spark turns it to the left. The sixth to center again. The seventh spark causes a small green electric lamp to light at the top of the mast (this lamp may be noted in the accompanying photographs). The flashing of this light is to warn the person controlling the device that the next and last contact which is No. 8 has almost been reached, and finally the eighth spark will stop the machine. By remembering previous signals or by "jamming" the drum in rapid succession any of the enumerated contacts may be reached, thus assuring desired control at any time.

These maneuvers and the electrical and mechanical apparatus necessary to perform them may sound simple enough to the electrical or radio man who will possibly exclaim, "Why, that is an old stunt; it has been done before even in the days of the coherer." However, it is another matter to get the system in complete synchronism and has taken the inventor nine long years of work and time to bring the device up to its present stage of development. He began his radio control experiments with the original Marconi coherer, but has since discarded it for another detecting device which he claims is neither crystal detector nor vacuum tube, but which is possess of

the fundamental requirements necessary to actuate a mechanical device by means of distant radio control. Moreover, Mr. Glavin freely admits there is much room for improvement and refinement; that is to say, making the invention absolutely fool-

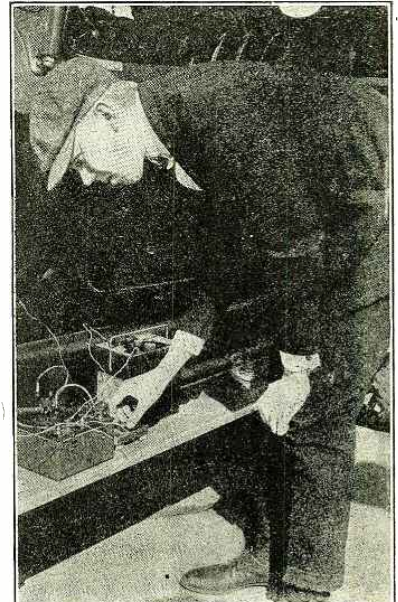

One of Mr. Glavin's Assistants in the Act of Controlling the Bus. The Transmitter Used is a Complete Boxed Unit of Small Power.

proof so that the receiving system will respond under all conditions.

As for the commercial possibilities of the radio controlled bus, this is a matter which the writer leaves to the imagination of the professional promoter. There is one thing certain, and it is that the controlling operator at the distant end must maintain a constant and careful *visual* watch of the car while it is under way in order to properly steer it from other vehicle traffic and thus avoid collisions. In view of this disadvantage, do not conjure one hundred-mile fetch-and-carry trips for the radio bus, for at the present stage of the game such voyages are not possible. It has, however, great possibilities along the lines mentioned at the beginning of this article, whereby all a fond mother of the future need do to air the baby will be to sit near a window and from this vantage point carefully guide baby's radio controlled carriage up and down the sidewalk at will. Or on the other hand, the bus may be sent around the corner to bring back some "wet goods."

A more serious use for the radio controlled bus would be one whereby it is placed upon tracks or hung upon a trolley and employed to deliver mail in rural districts thereby eliminating the rural postmaster. The starting and stopping as well as the systematic dropping of mail sacks could be accurately timed from a control center.

The possibilities of distant radio control has been the subject of close study and experimenting by the U. S. Navy for many years. A striking ex-

(Continued on page 714)

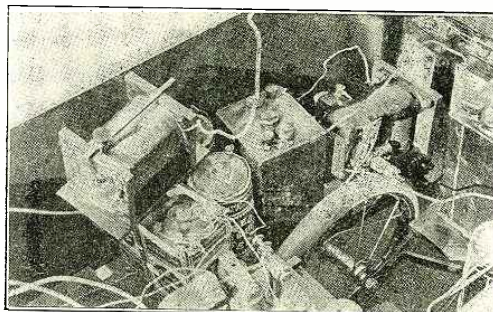

A Peep at the Apparatus Used. The Rubber Pulley on the Shaft of the Motor Propels the Driving Wheel.

Loose Coupled Receiver Tuning

By Dr. L. W. AUSTIN*

Editor's Note—Dr. Austin has written us that he considers the matter of receiver tuning of very great importance and to that end has specially written this article to RADIO AMATEUR NEWS in order to do his share in starting the present day amateur in the right way. Altho the practise of close coupled tuning is practically universal among both professional and amateur operators, it is inefficient and should be discontinued particularly in long distance reception.

IT is a curious fact that the proper method of tuning receiving sets so as to always get the best possible signal is known to very few, even among professional radio operators. The correct method, which I will call *loose coupled tuning*, is of special importance at short wavelengths, where the reactions between primary and secondary are strong. Loose coupled tuning has been recommended in several of my papers on

the measurement of the audibility of signals, but has apparently never been introduced into regular radio practise, possibly because it requires a few seconds more time than the close coupled method. The procedure is as follows: After the signal is picked up, the coupling is loosened to a point where the sound is just audible, or at any rate to a point where there is no reaction from the secondary on the setting of the primary; the primary and secondary are then tuned to give the best signal at this loose coupling; then, *without changing the setting of the primary*, the coupling is closed until the loudest signal is obtained, the secondary being retuned if necessary. The best coupling with this method of tuning will invariably be found to be much looser than it is with close coupled tuning, while the signal will often be many times louder. It will also be found that by using a loose coupling after tuning in this way interference is much more successfully eliminated than when the tuning is done at

close coupling and the coupling afterwards loosened as is often recommended.

The reason why it is impossible to get consistent results with close coupled tuning is evident when we remember that with close coupling the apparent tune of each circuit is changed by every change in the other, and that these influences also vary for every change of coupling, to say nothing of the fact that each of the circuits has also two free periods; so that there are an almost infinite number of combinations which will apparently give the correct tune, but with very small chance that the best combination will be found.

While close coupled tuning, since it is more rapid, may properly be used where frequent changes of wavelength are required and there are no particular difficulties in reception, every operator ought to be acquainted with the advantages of the loose coupled method, as there are many occasions on which it is the only method which makes reception possible.

*U. S. Naval Radio Research Laboratory, Bureau of Standards, Washington, D. C.

Marconi's Yacht the "Electra"

IT is perhaps not untimely that all radio men, and particularly the amateurs themselves, should be given a little information concerning the latest exploit of the father of radio, Signor G. Marconi. Here are three excellent views of the yacht in question, which has been termed "the sea laboratory." The "Electra" has recently left Southampton, England, upon a long cruise which has for its

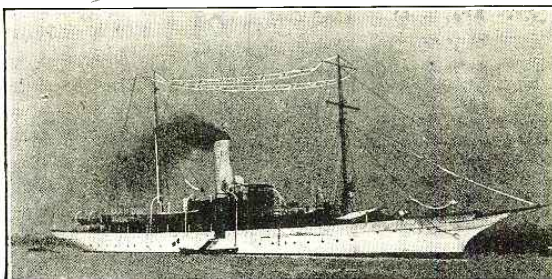

is that of the receiving room on board the "Electra" where is also located the apparatus for the new device.

Another important test to be made by Mr. Marconi on his extended voyage will be a series of experiments on Duplex radio telephony, having a range of 500 miles during daylight. The new device, it is understood, will permit the operator to speak thru the transmitter as well as listen

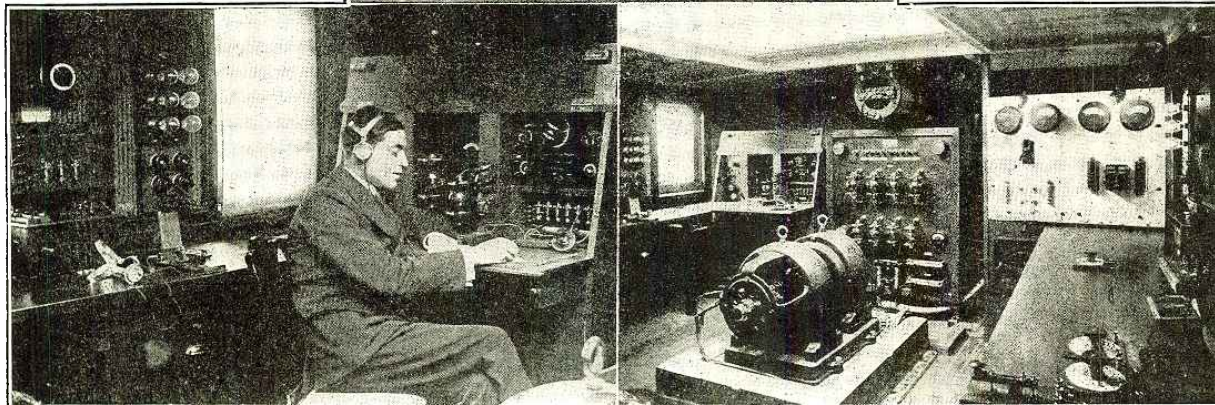

These Striking Photographs Show Three Views of the "Electra." The Upper Photograph is That of the Yacht Where May Be Seen the Unique Hoop Type Aerials. The Photograph to the Left Shows One of Mr. Marconi's Expert Operators Seated at the New Radiophone Instruments Having a Range of 500 Miles During Daylight. To the Right is Shown Another Section of the Operating Room. In the Immediate Center May Be Seen the Motor Generator Unit, Which is Mounted on Cork Padding in Order to Eliminate Vibration and Noise. In the Center Panel May Also Be Seen the Eight High-Power Transmitter Vacuum Tubes Employed in the Duplex Radiophone System.

main object scientific researches, which Mr. Marconi considers of a most important nature.

Mr. Marconi is accompanied by Lady Marconi, who was the famous Irish beauty, Beatrice O'Brien. The reason for Senator Marconi's voyage, which will be principally in the Mediterranean, is to make some necessary experiments on a new radio transmitter of tremendous power, which is at the same time able to radiate wavelengths of extreme shortness. Briefly the principle of the system is that the short waves can be reflected in beams similar to those

of light, which in turn can be conveyed from the transmitting station to a distant point by means of special arrangement at the receiving station. During thick or foggy weather a vessel equipped with an apparatus of this type will be in a position to receive a beam of light on its rotating mirror. The mirror will then automatically stop, thereby indicating the direction from which the signal of the other ship is emanating. In this manner the present great danger of collision at sea during thick weather will be considerably minimized. The photograph to the right

in the telephone receivers at the same time; that is to say, not having to resort to the present manner of switching over from transmitter to receiver and vice versa. The photograph to the left shows one of Marconi's expert operators seated at the new radio telephone instruments. Directly behind the operator may be seen an auxiliary set employed in the regular system of radio telegraphy.

Among the several unique investigations which will be conducted by the famous inventor is included a definite and final at-

(Continued on page 712)

A New Inductance

By PIERRE H. BOUCHERON

Some Interesting Facts Concerning the Birth of the Honeycomb Coil From Which Was Devised a Strikingly New Inductance Known as the Duo-Lateral Coil.*

EDITOR'S NOTE—
With this issue, we present to our readers some facts covered by a personal interview with Mr. Thomas P. Giblin, originator of the Universal coil, and who has lately invented a decided improvement upon the so-called honeycomb inductance.

ALL great and important inventions are not always the result of years of patient study and research work. In fact many inventions are actually stumbled upon or discovered by accident, and the well-known Universal or honeycomb inductance is an example.

Contrary to popular belief that the honeycomb wound coil is a new invention, it is approximately fifteen years since it was first conceived and samples actually made. As far as radio is concerned this is indeed startling, for certainly little was known at that time concerning multiple-layer inductances suitable for the high frequencies of radio.

The unique machine which winds this type of efficient inductance is manufactured by an eastern company, who are primarily makers of textile winding machines which include the winding of everything from fine silk thread to heavy rope as well as wire. Who would believe that this famous

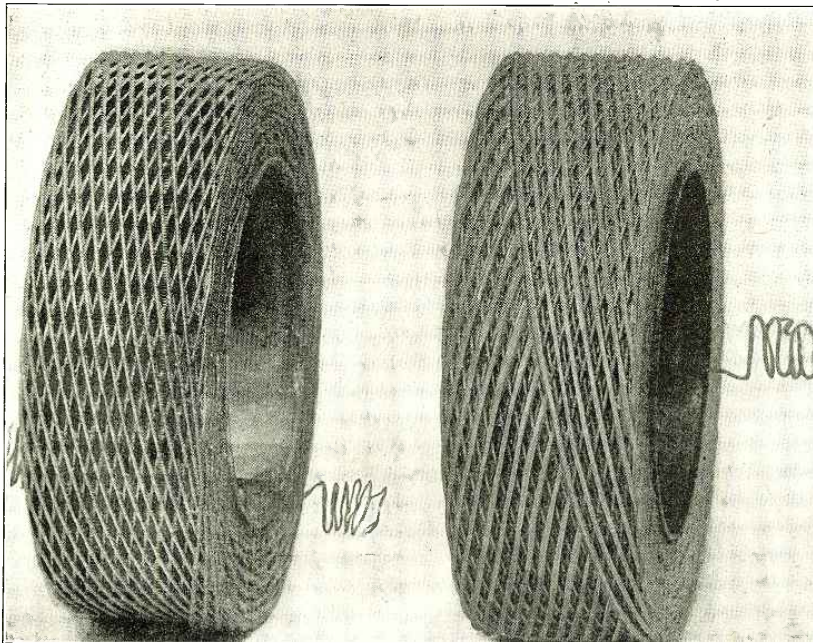

To the Left of This Photograph is Shown the Regular Honeycomb Coil, While to the Right is the Duo-lateral Coil. By Comparing Them Closely, the Different Manner of Winding May Be Seen. A Great Future is Predicted for This Type of Inductance.

inductance coil was in any way connected with the ordinary cotton yarn winding machine?

HISTORY OF THE H. C.

The machine which to-day winds the honeycomb coils was first devised about fifteen years ago, and its mechanism was such, of course, that it could wind wire as well as thread. Unfortunately this machine had at the time a rather limited demand, for it could be used only for the peculiar winding of wire similar to the cross wind yarn packages which is used in the textile trade to-day. Probably many of our young amateur friends have seen their mothers using yarn wound in this manner, and it is strange that the idea of winding inductances thusly did not become apparent to them at the time. As a matter of fact, however, as will shortly be seen, it was a former amateur who finally thought of the idea.

While the inventor was developing this textile machine he made various samples of this product, showing just what the machine could do in order to demonstrate its possibilities. At the time he wound open coils, which he termed basket winding, and which later was given the name of "honeycomb" or Universal coil. There was, of course, no startling demand for such a coil at the time; it was simply a novelty and was put aside by the company in a show case among other novel windings of various kinds.

HOW DISCOVERED.

It was shortly after the United States entered the War that the "bank" form of winding made its entry into commercial radio apparatus. As is well known, this winding was literally snapt up on account of its small distributed capacity within a minimum space area. Its great fault, however, was that inductances made after this

fashion had to be wound by hand, which proved very costly. The sudden overwhelming demand for efficient radio receiving apparatus of all types suitable for war work forced leading radio engineers to try to find a means of manufacturing banked windings in a much more rapid manner.

Accordingly a Signal Corps radio engineer stationed at a large eastern university for the purpose of research work connected with government radio apparatus, visited a textile winding company for the purpose of ascertaining whether a machine could not be devised and built for the express purpose of manufacturing bank windings in large quantities.

Mr. Thomas P. Giblin, an electrical engineer, and at that time a real and enthusiastic amateur, being connected with the Universal Winding Company, took up the matter of this proposed bank winding machine and after careful study and experimentation with mechanical experts decided that such a machine could not be developed in the limited time at the disposal of the Government; the primary consideration being to manufacture great numbers of receiving instruments as soon as possible in order that they be of use during the emergency.

The radio experts were distinctly disap-

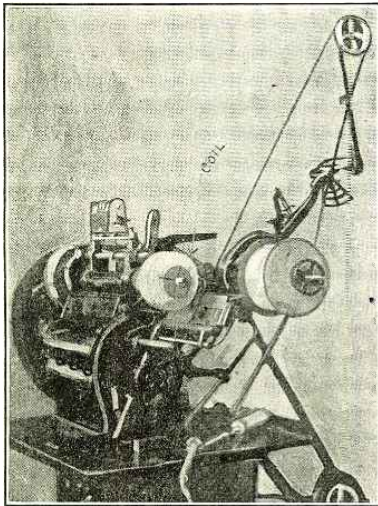

This is the Machine Which Winds the Duo-lateral and Other Types of Basket-Wind Coils. Coils Are Wound in from Five to Fifteen Minutes!

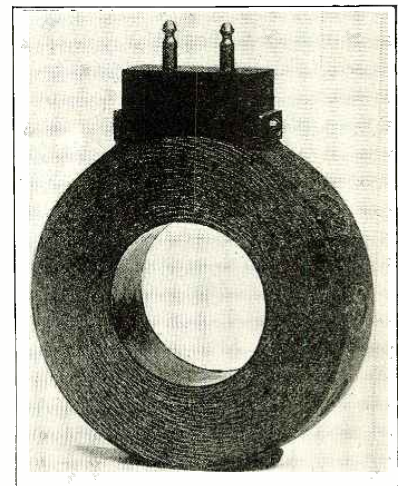

Showing the Completed Duo-lateral Coil on a Special Mounting Designed for Efficiency, and Which May Be Plugged In and Out of Its Receptacle.

*Photographs by courtesy of Electrical Products Mfg. Co., Providence, R. I., and Pacent Electric Co., N. Y.

pointed, and it was then that Mr. Giblin, anxious to put into practise an idea he had conceived for some time, gathered up the various samples of the basket wound coils made some fifteen years back, and a week later again showed them to the Government men, whereupon discussions as to its possibilities immediately arose. Mr. Giblin then promised to develop larger coils of the same basket winding suitable for radio test purposes. Just about this time, however, the pressure of war work became too severe and the proposition was laid aside and remained dormant until the end of the year of 1918.

Shortly after the Armistice was signed one of the large radio manufacturers became desirous of bringing out some startlingly new radio apparatus suitable for amateur work. Thereupon, one of their engineers was sent to the winding company for the purpose of testing various wire coils or inductances. Among these coils was again shown the now famous basket wound coil, and from an immediate test made upon it this gentleman quickly saw the possibility and advantage of using the coil for radio work. During his visit it was unfortunately impossible to make a coil large enough to be practical for radio inductance work. Mr. Giblin, however, was this time not to be sidetracked in his belief that this method of winding would prove effective for radio work, and, therefore, continued his experiments, so that about February, 1919, he developed the first practical honeycomb coil.

After a number of exhaustive tests at the Bureau of Standards, leading radio colleges, as well as large radio manufacturers, several designs were perfected, making this type of winding most suitable and effective for short and long wave reception. Several months after this the fame of the honeycomb coil had traveled far and wide, and today it is indeed a small hamlet that does not possess one or more amateur installations making use of the honeycomb inductance. As an example of the highly successful commercial value of the honeycomb coil, it has been estimated that from July, 1919, to April, 1920, something like 80,000 coils were distributed throughout the world. At present over 12,000 coils are being sold each month.

HISTORY OF DUO-LATERAL.

The inventor, however, was not fully satisfied with the characteristics of the coil, so that he has recently brought forth a new type of inductance called the *Duo-lateral inductance*, which by far exceeds other coils in efficiency. Altho this type appears somewhat similar to the honeycomb coil, it has decided electrical advantages, and these advantages are made possible thru its peculiar mechanical construction.

Recent experiments at the laboratories of reputable colleges, as well as at that of a nationally known electrical company, have proved that this coil, in comparison with other similar types, has 15% less distributed capacity, 12% more inductance as well as the 7 1/2% less high frequency resistance and natural period. Not only this, but it is much smaller in size for given inductances than any machine-wound coil on the market today. Radio men, and particularly amateurs, who are always looking for the last word in radio, may readily appreciate the meaning of these statements. Of course, these inductances can be wound to any size, and shaped in any desired inductance. This is on account of its mechanical construction, whereby greater inductance can be secured, and owing to its regulated construction it is a very strong compact unit. As an instance of its performance, a reception test was recently conducted with the Mexico City radio sta-



Photograph of Mr. Giblin's Original Amateur Station Located at Pawtucket, R. I., Where the First Honeycomb Coils Were Tested Under Actual Receiving Conditions, the Event Taking Place Several Years Ago. Note Several of These Coils on Top of Cabinet in Right Hand Side of Picture.

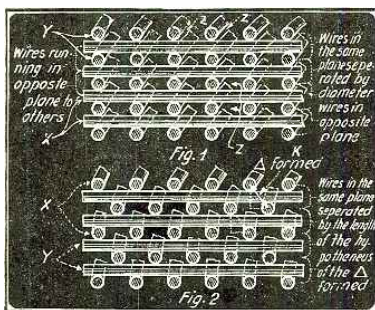

In This Diagram, Fig. 1, Shows the Cross-section of a Honeycomb Coil, While in Fig. 2 is Shown the Cross-Section of the Duo-lateral Coil. Note the Difference in Separation of Turns.

tion on a wave-length of 4,500 meters, which showed the signals to be 100% louder than other types of inductances!

In order that the reader understand just how the duo-lateral coil differs from the honeycomb, the following explanation is perhaps not untimely: In Fig. 1 we have an orthogonal* cross section of a regular honeycomb inductance. It will be readily seen that each layer of wire is in the same plane of the one beneath or above it. These

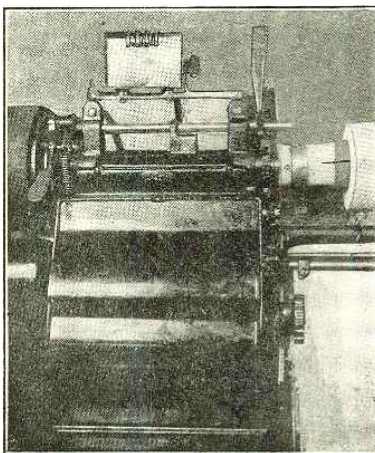

Another View of the Coil Winding Machine Described in This Article.

layers are separated solely by the diameter of the wires running in the opposite plane. In Fig. 2 is shown a cross-section of the duo-lateral coil. In this case, however, the wires of adjacent layers running in the same plane are separated by the length of the hypotenuse of the triangle thus formed, so that in reality the layers of wires are separated a comparatively much greater distance than the layers of honeycomb coils, and thus a decided advantage is gained by further reducing the effective distributed capacity.

Again in Fig. 1 and 2, the distributed capacity is reduced between X and Y layers because of the fact that the layers (X and Y) cross one another at angles. The distributed capacity is again reduced between layers in the same direction (such as all of X or all of Y) because they are separated by the diameter of the wire such as Z. In Fig. 2, the distributed capacity is still further reduced between layers in the same direction (such as all of X, or all of Y) because they are separated by more than the diameter of the wire since the illustration shows this distance to be equal to the hypotenuse of the right triangle K formed which is considerably greater than the distance Z in the honeycomb coil.

POSSIBILITIES.

The excellent photographs which accompany this article will show to the reader in a graphic and instructive manner just what these inductances look like; the machine that makes them, as well as a typical receiver fitted with the coils. Mr. Giblin, who in connection with Mr. McAvoy has organized a company devoted to the production of this unique inductance, is very enthusiastic concerning its future and possibilities.

The coil has attracted the attention of the "Big Three" (the three largest radio manufacturing companies.) The well-known Dr. J. H. Rogers is at present using them in connection with his underground circuit; not only that, but he is also making use of it in his experiments to determine whether or not Mars is signalling to the earth. In one experiment Dr. Rogers was using large inductance coils which, owing to the large surface they presented to surrounding influences, pick up all manner of disturbances, such as induction from trolleys, power lines, etc. By making use of this latest type inductance, these undesirable conditions were absolutely eliminated, on account of the very small surface which the coils present to local interference. Signals barely audible, and in some cases inaudible, are easily readable with the duo-lateral coil. Indeed, this is undoubtedly the greatest step forward in the radio art since the introduction of the vacuum tube.

This very latest development in the way of compact and highly efficient inductances is certainly considered a boon to the advancement of the radio art. It replaces the former large, awkward and certainly inefficient loading coils and tuning coils of the bygone days. In fact, by means of several of these Duo-Lateral Coils, together with one or two variable condensers and a vacuum tube unit, it becomes possible to receive a high range of signals and cover exceptional distances. In brief, such a combination represents the ultra-efficient in radio receiving with or without amplification.

* Meaning at right angles to the "lay" of one set of wires.

(Continued on page 720)

British Instruments

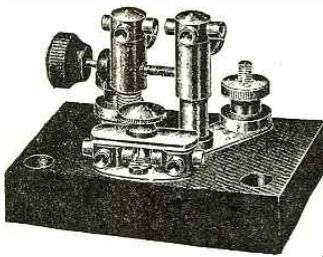

Fig. 3. A Mineral Detector Having Various Mineral Cups Mounted on Two Revolving Standards.

UNDAMPT WAVE RECEIVER.

Here are a few British radio instruments. Note the rather complicated aspect of the parts as compared to the simplicity of French apparatus. Fig. 1 shows a complete receiving set for undampt wave reception as well as telephony, and will intercept waves from 800 to 4,000 meters. As will be noted the set includes a vacuum tube of British make whereby the plate, grid and filament are in a horizontal position inside the tube as compared to the vertical construction of our American tubes.

CAPSTAN TYPE CRYSTAL DETECTOR.

It will be seen by consulting Fig. 2 that this detector contains five different crystal combinations any of which may be switched into circuit by means of a six-point rotary switch. It can also be used with crystals having wire contacts, as the cups are easily removed and any part of the crystal may be brought to the contact point.

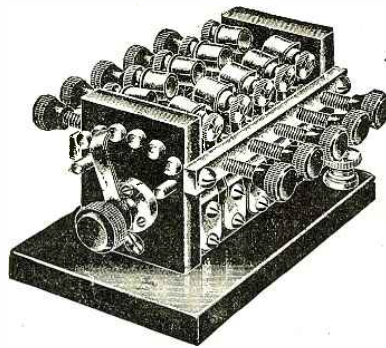

Fig. 2. What Do You Think of This Multiple Type Crystal Detector, Whereby, Five Different Crystal Combinations May Be Obtained by Means of the Six-point Switch Shown.

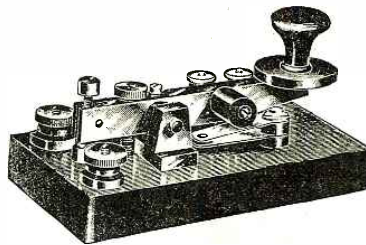

Fig. 4. This Key Brings Us Back to the Pioneer Marconi Days. British Keys Have Evidently Not Improved in Simplicity. Nice for the Chain Fob. What?

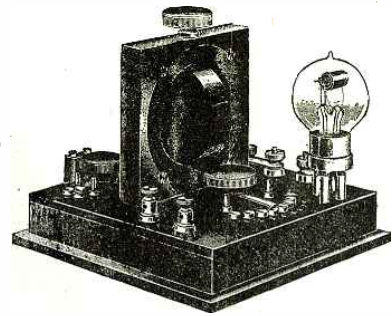

Fig. 1. Another Single Vacuum Tube Receiver Unit Making Use of a Variometer Arrangement.

ANOTHER MINERAL DETECTOR.

This is another type of mineral detector. The top section of the two standards is fitted with four cups each, which may be revolved in different directions for different crystal combinations. The adjusting knob regulates the pressure upon the crystal.

SENDING KEY.

This is one of the large commercial type sending keys suitable for stations having up to two kilowatt transmitters. The contacts in this case are composed of a platinum-silver alloy which lasts as long as pure platinum. Fig. 4 illustrates the key in which it may be noted that the side has a special contact which closes at each depression of the key and this affords excellent means of shorting the crystal detector of the receiver during transmission. Notice the ponderous knob of the key lever which is much unlike the light key knob of our American keys.

At Last, British Amateur Radio Licenses

The following is an extract from a speech delivered by Captain F. G. Loring, R.N., M.I.E.E., at the First Annual Conference of Affiliated Wireless Clubs, which was held at the Royal Society of Arts on February 27, 1920.

"It is proposed: (1) To issue receiving licenses freely to all approved persons, with exceptions as regards the use of valves in certain limited areas. (2) To issue 10-watt licenses wherever this can be done without interference with Government installations to approved applicants who can satisfy the Post Office that their qualifications, apparatus, knowledge of the subject and objects are sufficiently good to justify the grant. Licenses will not be granted for mere intercommunication purposes. (3) To issue licenses for the use of power exceeding 10 watts only in special cases. The requirements of paragraph 4 of the conditions of issue must be fully complied with, *i. e.*, that the applicant has in view some definite object of scientific research of general public utility. The issue of such licenses does not rest entirely with the Post Office but is subject to the scrutiny of the other Departments interested in wireless telegraphy. (4) To issue licenses for the use of an artificial aerial when desired. (5) To issue special permits for specific tests of apparatus on any power and wave length over and above the conditions

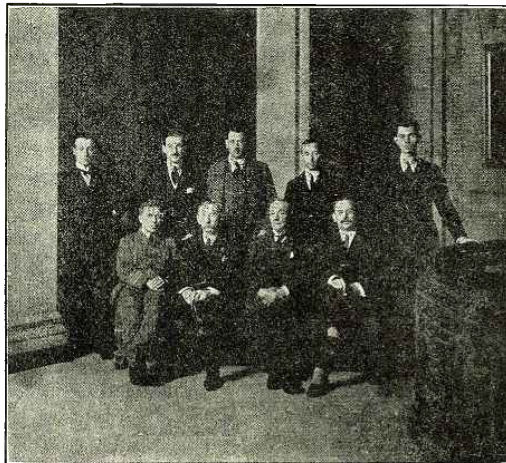

OFFICIALS AND COMMITTEE OF THE WIRELESS SOCIETY OF LONDON.

The Above Photograph Shows Some of the Most Prominent Radio Men of England. Reading from Left to Right, Standing, Are: L. F. Fogarty, A.M.I.E.E., Hon. Treasurer; R. H. Klein, L.S., Vice President; Leslie McMichael, Hon. Secretary; E. W. Kitchin, A.M.I.C.E., Committee; Maurice Child, Committee. Reading from Left to Right, Sitting, Are: Major J. Erskine Murray, D.S.C., F.R.S.E., etc., Vice President; Alan A. Campbell Swinton, F.R.S., M.I.E.E., etc., President; Admiral of the Fleet; Sir Henry B. Jackson, G.C.B., K.C.V.O., F.R.S., etc., Vice President; F. Hope-Jones, M.I.E.E., Chairman.

of the license. Application for such a permit will have to be made in writing at least a week before the test, and it is obvious, I think, that such permits will only be issued to persons who can satisfy the Post Office that they have occasion to try out in practise an arrangement which has been thoroughly prepared in the laboratory. (6) It is probable that all transmitting licenses will be restricted as regards both waves and hours of working. Those over 10 watts, at any rate, are almost certain to be so restricted." *Editor's Note.*—We certainly are delighted to note that Great Britain has at last begun to recognize the value as well as the rights of the British amateur. We congratulate them on this signal recognition. Now for some real experimenting by our cousins across the sea. Let us hear from you, boys.

A PROTEST.

Mr. Alan A. Campbell Swinton, F.R.S., President of the Wireless Society of London, protests against the manner in which the daily press deals with wireless telegraphy, and ridicules the fashion in which it proclaimed "mysterious messages from the unknown—from Mars." This, he states, is nonsense, since to transmit such messages it would need the stupendous force of 12,000,000,000,000 horse-power.

(*Fine. But what does the Hon. Mr. Campbell Swinton know about Martian Horses?—Editor.*)

Development in Radio Receivers

By R. H. G. MATHEWS *

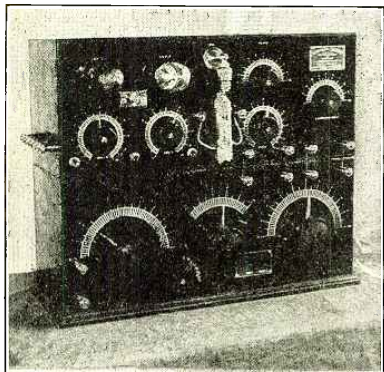

Fig. 1. This Paragon Type Short Wave Regenerative Receiver May Be Used in Connection With the Upper Unit Which Consists of a Detector and a One or Two Stage Amplifier.

THE past radio season has witnessed unusual development on the part of the radio manufacturers, this development having been largely influenced by the tremendous activity during the recent world war. The result of the influence of war-time designs upon standard amateur or experimental equipment has been very pronounced, and while very desirable in certain respects is equally undesirable in others. The mechanical construction of standard equipment has been vastly improved, and this is especially noticeable in the ruggedness of this construction. In the design of apparatus for war-time service two ideas were kept foremost, first the necessity for extremely compact construction, and secondly the necessity of having this apparatus so constructed as to be easily adjusted by the comparatively inexperienced operator. As will be quite evident, neither of these two things is necessary in amateur equipment, and the latter is therefore very undesirable. The amateur must get the absolute maximum of sensitiveness and delicate adjustment and thus, apparatus constructed for his use must be designed with efficiency foremost. Such apparatus would have been useless for government service because of the extreme delicacy required for its manipulation, and for this reason efficiency was not the prime object in the construction of Army and Navy instruments, and therefore apparatus on the amateur market which presumes to copy government designs is not suitable for the usual requirements of long-distance amateur work. This is especially applicable to receiving cabinets which cover extreme ranges, endeavoring to take in both amateur and undamp waves, and is also true of so-called short-wave regenerative sets employ-

ing capacity coupling or capacity feed-back. It has not been found possible to co-ordinate long and short wave receiving apparatus in such a way as to give the maximum of efficiency on the short waves and for this reason many of the more reliable manufacturers have made no attempt to produce a receiver with extreme ranges, confining their products to separate sets, each being suitable for the purpose for which it was designed.

It has been found that for short-wave regenerative work the absolute elimination of all capacity, both concentrated and distributed, is extremely desirable, and it has further been found that the use of properly designed continuously variable inductances, such as variometers, will give maximum results.

The Short-Wave Regenerative Receiver illustrated Figure 1 has been designed with these ideas in view. This instrument is unique among regenerative receivers since maximum amplification is secured without distortion of the natural tone of the incoming signal. It will be readily understood that this is of great value in copying thru interference, and especially valuable in "group-frequency" tuning. The users of this receiver have been securing heretofore unheard-of selectivity and amplification. Signals may be read from stations at extreme distances or thru heavy static and interference long after other receivers have failed, and weak signals may be amplified up to 100 times, using one audion only. Because of this fact extremely loose coupling may be employed, thus reducing interference from static and allowing the continuation of long-distance reception thruout the summer months. The set is especially adapted for use with the Rogers' Underground Antennae and, in fact, practically all of the development work on underground aerials carried on at the Great Lakes Naval Radio Laboratory was accomplished while using one of these instruments. The normal range is from 180 to 600 meters, but by the addition of external loaders this range may be raised as desired, altho, as before stated, it is not desirable to try to use the set for long-wave reception.

To operate with the receiver, its manufacturers have produced an audion control and amplifier cabinet known as the Amplifig, which, altho constructed in the form of a separate cabinet, may be used with it in such a way as to give essentially a unit set. The Amplifig is made in two types, one comprising a detector and one-step amplifier and the other employing an additional step of amplification. Phone plug and jacks are provided whereby detector or either step of amplification may be secured as desired and the leads are so brought out as to allow for the use of this instrument with an undamp wave receiver or in fact with any set of tuning devices, in addition to its use with the Paragon. A novel feature in the construction of the Amplifig is the special three-position battery switch. In the off position of this switch both filament and plate batteries are cut off. In the middle or transmitting position the plate battery is cut off, but the filament battery remains connected, while in the receiving position both batteries are, of course, connected. By the use of this switch the annoyance incidental to lighting the filaments of the tubes each time transmission is finished is eliminated, and at the same time, since the plate battery is disconnected, the receiver is cut out during transmission. It is not practical to throw the rheostats on any audion panel to zero each time the shift from receiving to transmitting is desired,

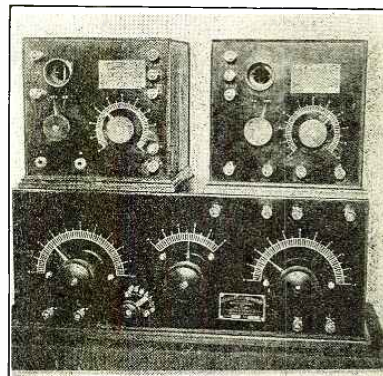

Fig. 2. In This Case the Same Receiver May Be Employed in Connection With Separate Detector and Amplifier Cabinets.

and for this reason a switch of the type just described is of great value, especially in relay work where a rapid "come-back" is an absolute necessity.

For those who do not wish to purchase a detector and amplifier cabinet in one unit for any reason, the makers have designed separate cabinets, similar in construction to the above receiver and its appliance, and which may be used either separately or in combination. These instruments are shown in Figure 2. As will be seen, the connections of these detector and amplifier cabinets are so brought out as to give maximum convenience, both in connection and operation. A special type of socket is used whereby a far better connection is secured with the standard bayonet base tube, than is ordinarily obtained by the use of the flat contact type of socket. These detector and amplifier cabinets are equipped with the necessary mica stopping condensers and accurately calibrated grid leaks.

As an adjunct to the instruments described in the foregoing, the same manufacturers have produced an undamp wave receiver, comprising a tuner with a maximum range of 20,000 meters in combination with a detector and the necessary controls therefor. This instrument is shown in Figure 3 and, in addition to being exceptionally efficient in operation, is made in an unusually compact form. The inductances used in this set are of the well-known universal wound type, which accounts partially for the efficiency of the instrument.

Another innovation is found in the Portable Receiver also produced by the same manufacturers. This Portable Receiver

(Continued on page 712)

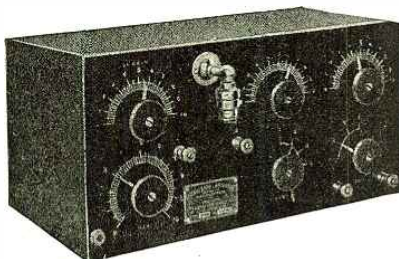

Fig. 3. Here We Have an Undamp Wave Receiver Having a Maximum Wavelength Range of 20,000 Meters.

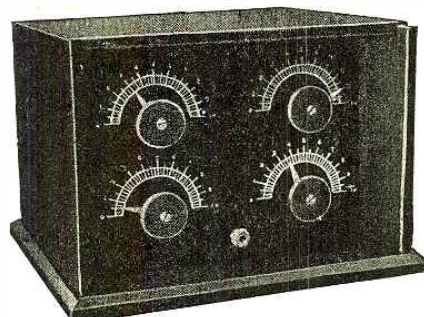

Fig. 4. This is a Portable Receiver Having a Range of 200 to 600 Meters and is Well Suited for Portable Work.

* Radio Engineer, Chicago Radio Laboratory.

The Radiophone with the Atlantic Fleet

Times Radiophone set carries Secretary Daniel's voice from ship to city

AN interesting example of the use of the radiophone was made recently when the first announcement of the arrival of the Atlantic Fleet off quarantine, N. Y. C., was made by the Secretary of the Navy, Josephus Daniels.

The Secretary spoke from the Flagship *Pennsylvania* by means of the radiophone to crowds who had collected in Times Square where a wire circuit carried the voice from the roof of the Times Building to a special sound amplifying arrangement below.

It is recalled that a similar demonstration was successfully conducted by the Navy on the Pacific Coast a few months ago, so that the above experiment is probably the first attempted on the Atlantic side from the deck of a battleship direct to city crowds. Considerable interference was at first encountered thru the activities of the various nearby radio stations, but at the repeated

request of the Brooklyn Navy Yard, asking that all stations "QRT" as well as a special request just prior to the time that Secretary Daniels began his speech from the deck of Admiral Wilson's Flagship, Mr. Daniels' words were fairly well reproduced at the

attached to the Magnavox amplifier, and this is the arrangement which was placed in the second-story building on the north side of Times Building in order to project Secretary Daniels' greetings from Admiral Wilson's flagship when approaching New York harbor.



Interior of the Radio Receiving Station in the Tower of the Times Building, New York City. Note the Sound Amplifying Instruments to the Left of the Picture Which Were Used to Receive Secretary Daniel's Voice from the U. S. S. *Pennsylvania* to the Heart of the City.

Times Receiving Station and no serious "QRM" was encountered thereafter. While the Atlantic Fleet was anchored in the North River, concerts by the Marine Band on board the U. S. S. *Pennsylvania* were reproduced in Times Square by the use of the Magnavox voice amplifier. Two concerts are generally held on board ship, one just before mess, and one just before sunset, which is the salute to the colors.

The accompanying photograph shows the interior of the radio receiving station in the tower of the Times Building, New York City. The sound amplifying horn which greatly resembles that of an old-fashioned phonograph is

X-Ray Photographs of Radio Apparatus

By PAUL C. ROULS

HERE are two striking examples of photographs taken by means of X-ray.

The photograph to the left is an X-ray radiograph of an original Audiotron Panel, which was manufactured by a San Francisco radio concern. Wiring and contacts are imbedded in the Bakelite panel which is 1/2 inch thick. Owing to the inability of the writer to trace the circuits in the ordinary way, he conceived the idea of this

X-ray negative which clearly shows the hook-up. Some readers may wonder why the supposedly clear glass of the vacuum tube should have reproduced so dark. This strange fact is probably due to the metallic deposit on the inside of the bulb produced by the ionic bombardment of the filament.

The photograph to the right is a negative of the Eaton Oscillator, manufactured by a Boston radio concern. In this in-

stance all metallic parts show up rather clearly so that one may know at a glance just what enters into the construction. Even the outline of the familiar circuit diagram which is marked on the Bakelite cover of the instrument was reproduced as well.

These photographs may prove suggestive to amateurs who wish to know just what "the works" look like in certain radio apparatus.

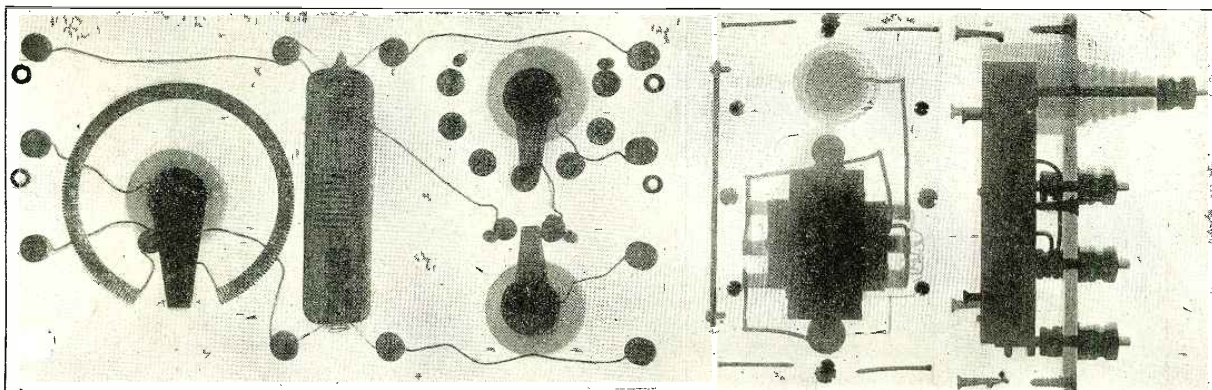

These Two Unusual Pictures Represent X-Ray Photographs of Radio Instruments. To the Left is an X-Ray of an Original Audiotron While to the Right is That of the Well Known Eaton Oscillator.

A Radiophone Set that Works

By E. W. DANNALS

Chief Electrician (Radio) U. S. N.

MUCH has been written about CW transmitters and wireless telephones in general, but there has been a lack of articles giving really constructive data. The purpose of this article will be to set forth constructional data which will enable the experimenter of average means to construct a wireless telephone that will work satisfactorily. The set about to be described has actually been constructed and most any amateur in the vicinity of New York can attest to the clearness of modulation and strength of signals. A brief summary of the working requirements will first be given:

First: Some source of high potential direct current 350 to 500 volts;

Second: A circuit that will oscillate satisfactorily on wavelengths from 200 to 450 meters;

Third: An antenna system with as large a capacity as the wavelength to be used will warrant;

Fourth, and last, but not least, an understanding of the principles involved.

It is not the purpose of this article to go deeply into the theory of bulb transmitters, but rather to explain how the set can actually be constructed and made to work.

The circuit used in this set is very similar to that used by the United States in the World War so successfully on board submarine chasers and small craft of our Navy, and also for communication between the ground and aeroplanes in flight and

vice versa, often mentioned before. Figures 1, 2, 3, and 4 are photographs of the set constructed by the author, and at the present writing the greatest distance

of Brooklyn, New York, N. Y.

Figure 5 gives an elementary diagram of the hook-up used. We make use of the well-known capacity feed-back to make this circuit oscillate to produce the high frequency carrier wave necessary for wireless telephone transmission. The capacity of C1 is preferably of .002 mfd. and is the feed-back condenser. The capacity of C2 need not be greater than .0005 mfd. the one in use here is .001 mfd. The inductance L1 is composed of fifty turns of No. 12 hard drawn bare copper wire wound on a bakelite tube which has previously had ten grooved turns to the inch cut in it. Taps are taken off every five turns. These taps are taken out to two 9-point switches on the panel. It will be noted that the contact points of both switches are common to both sets of taps.

(Continued on page 714)

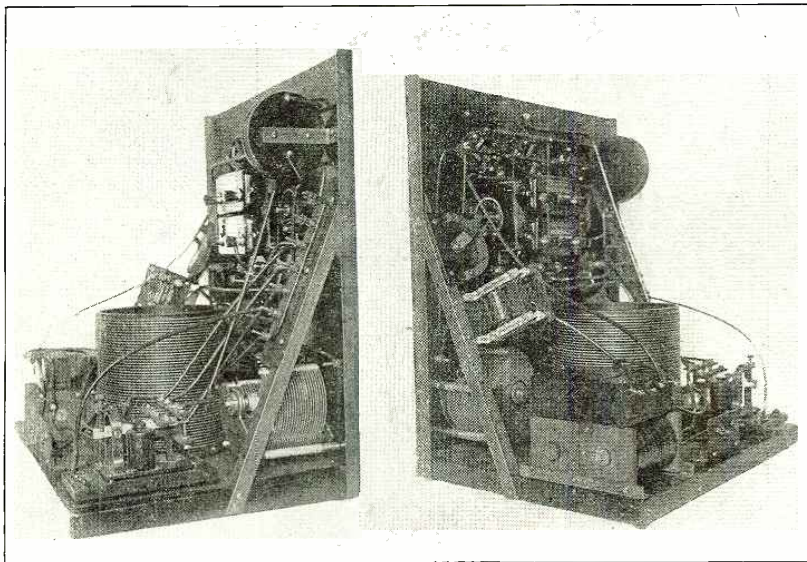

Fig. 1 and 2, Which Show Two Side Views of the Radiophone Set Which Certainly "Delivers the Goods," Its Record Up to Date Being 500 Miles. In the Left Hand Cut May Be Seen the Standard 20 Ohm Telegraph Sounder Arranged With a Contact Arm on Its Armature to Act as a Triple-pole Double-throw Switch, While at the Bottom of the Right Hand Cut May Be Seen the Two Low Frequency Choke Coils Comprising Part of the Filter System.

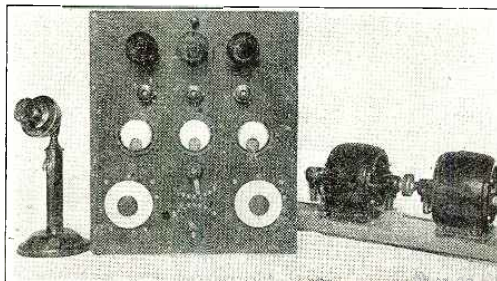
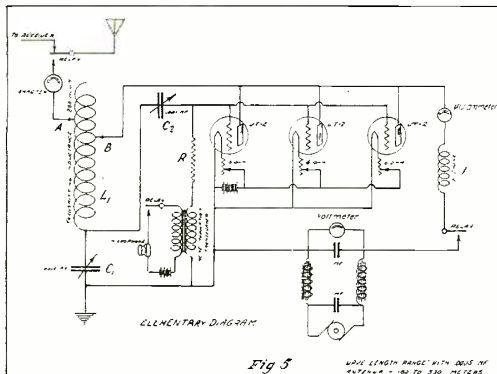

Fig. 3. Front View of the Transmitter Panel. The Microphone Used is of the Regular Desk Type, While the Motor Generator is One Manufactured By a Well-known New York Radio Company.

covered is about 500 miles. This is not to be considered the working distance of the set, but rather one of those freaks that crop up from time to time in this most wonderful and interesting art.

Mr. L. E. Furrow of Troy, Ohio, in a letter to the author, states:

"I have heard you several times but was unable to get your call until the night of December 8th. I cannot remember now just what time, but think it was in the earlier part of the evening. Had been trying very hard to get your call, but it seemed I could not get the right tune, so I made a small secondary loader and on December 8th was able to read you about one foot from the phones, using one audiotron bulb with regenerative hook-up of my own design and construction. You did not state which station you were operating,



Elementary Wiring Diagram of the Hook-up Employed By the Author and Designer of the Set.

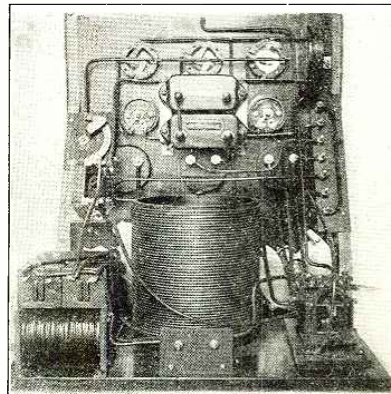
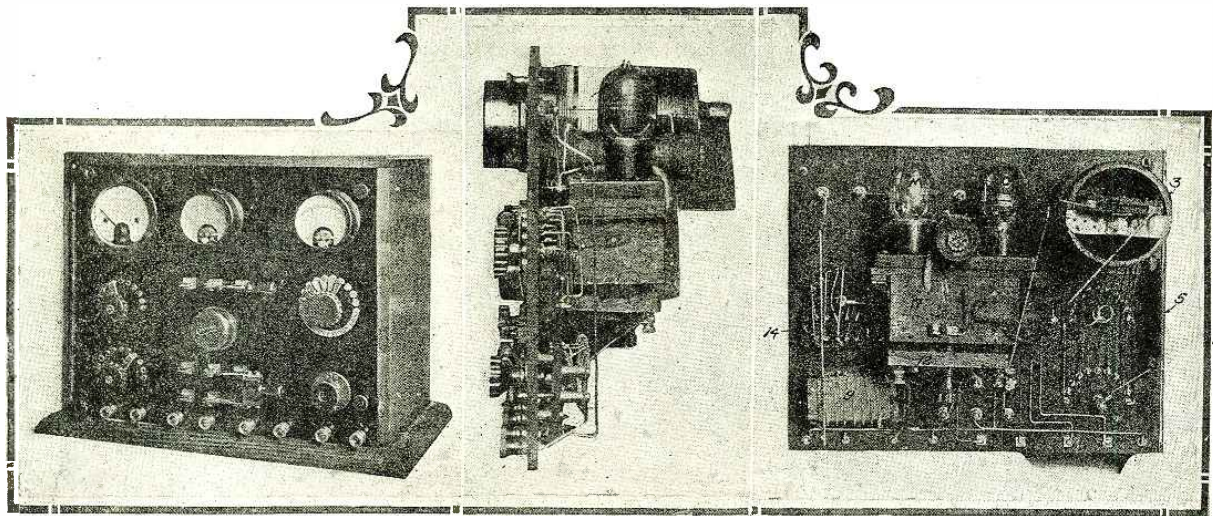

Fig. 4. Full Rear View of the Set. Note the Compact and Well Planned Construction.

AWARDS OF \$100 RADIOPHONE PRIZE CONTEST

SECOND PRIZE WINNER



Three Views of This Excellent Radiophone Set Which Won Second Prize. To the Left is Seen Panel Front, in the Center is a Side View, and to the Right is Shown the Back Part of Set With Designating Numerals.

A One Hundred Mile Radiophone and Telegraph Set

By Lieutenant W. L. WINNER

IN order for Radiophone Sets to become popular with 200 meter men it is necessary that they be not too complicated to construct; the cost must not be excessive; once adjusted they must give unflinching service, equal in dependence to the spark set, and last but not least, they must have a range greater than five or ten miles.

The phone set about to be described fulfills all of the above conditions, at least in a larger degree than any set I have yet seen described.

The circuit used is the well-known and excellent *Heising Circuit*, using one tube for oscillation and one for modulation.

The cost of this set will not exceed one hundred and fifty dollars, including the motor-generator unit. The set once adjusted will never fail to "deliver the goods," and as for range, 100 miles, under favorable conditions, can be obtained.

3XF in Washington has been worked in daylight from Baltimore with a radiation current of four-tenths of an ampere. Music is sent each night to all the amateurs in Baltimore and Washington, with signals and voice coming in clear and strong. 3XF reports that with one-step amplification and a loud speaker the voice was easily readable all over the room. 3XG, Johns Hopkins, reports music "clear and loud 100 feet from the phones." The S. S. City of St. Joseph, call KOSM, reported voice could be understood 60 miles down the bay and buzzer signals 100 miles, on ship set with no amplification. Revenue Cutter Bothwell, NEKD, with two steps of amplification, reported voice and buzzer good as far south as Newport News. Radiation on this test was 64 hundredths amperes. Mr. Ralph Norman, of Street, Md., reports voice and buzzer good on home-made set using galena. He is about 33 miles from Baltimore. The modulation was perfect during these tests as the ticking of the clock

shown standing on the wavemeter in the station picture could be heard when held before the transmitter.

DESCRIPTION OF THE SET.

The aerial switch is a four-pole double-throw switch. When thrown to the right, on the schematic diagram, the receiving set is put in the circuit. When thrown to the left the receiving set is disconnected and the transmitting side cut in. This switch closes the 110 A.C. current line and starts the motor-generator set. It also lights the filaments of the tubes as well as connects the phone set with the aerial and the ground as shown in Fig. 1.

1 is a hot wire ammeter reading to eight-tenths of an ampere and is of Westinghouse make.

2 is an eleven-point wavelength switch, reassembled DeForest type US-500.

3 is the inductance, consisting, in this case, of thirty-five turns of No. 12 D.C.C. wire spaced one-thirty-second of an inch between turns and wound on a bakelite tube 3 inches dia. Commencing 13 turns from the ground end, 11 taps are taken off, one every two turns and connected to the wavelength switch on thru to the plate coupling switch 4 as shown in the photograph of rear view of cabinet.

5 is a condenser of about .0008 mf capacity and is constructed of tinfoil between mica sheets. It is merely a protective condenser and may be dispensed with if desired. Its function is to keep the high voltage D.C. current out of the aerial circuit.

6 is the radio frequency choke coil, air core. A wooden spool is wound with No. 30 D.S.C. wire; length of winding one-half inch; inside dia. one-quarter inch, outside dia. one inch. Its function is to keep the high frequency oscillations generated by "O" out of "M."

7 is the audio frequency choke and is made by winding a soft iron core one-half inch in dia. with No. 32 D.S.C. wire. Length of winding four inches and dia. of same one and one-eighth inches. This coil keeps the current furnished by the generator constant and upon it depends the successful operation of the set.

PRIZE WINNERS

First Prize \$50.00 in Gold
MR. HERBERT W. HARMON*
Grove City College
Grove City, Pa.

Second Prize \$25.00 in Gold
LIEUT. W. L. WINNER
General Hospital No. 2
Ft. McHenry, Md.

Third Prize \$15.00 in Gold
MR. N. G. HERRESHOFF, JR.
149 High St.,
Bristol, R. I.

NOTICE

In the last issue we publish the names of four prize winners. Among these was Mr. Albert H. Rodde, 1516 Emmons Avenue, Sheephead Bay, N. Y., which appeared under third prize. Owing to a misunderstanding on the part of Mr. Rodde, there has since been found necessary to eliminate him as a prize winner. Mr. Rodde was under the impression that the radiophone set did not necessarily have to be built by the contestant, but since it is now learned that Mr. Rodde's set was designed and constructed by someone else, naturally this fact is not in accord with the rules of the contest.

The above, therefore, is a revised list of the prize winners which is reduced to the number of three as there were no additional entries, and we were unable to award a fourth prize. As will be noted Mr. N. G. Herreshoff, Jr., has been awarded the third prize instead of the fourth as mentioned in last issue. We hope this will be entirely satisfactory to the prize winners as well as to our readers.—THE EDITORS.

* See important notice concerning this set on page 721.

8 is the plate current milliammeter and has a range of from 0 to 200 milliamps, and is of Weston type.

9 is a filament rheostat for regulating the filament current. It should be capable of carrying a current of four amperes.

10 is the filament current ammeter and should read at least three amperes. Weston meter type 301 will be suitable.

11 is a S.P.D.T. switch whose function is to cut in or out the filament of "M." When sending signals by buzzer it is not necessary that the modulator bulb be lighted. So by throwing the switch to the left-hand position the modulator bulb is turned off and a small resistance X thrown in parallel to the "O" bulb. The resistance X has the same value as the filament of the "M" bulb. Therefore a readjustment of 9 is not necessary each time. This switch is not an absolute necessity but the use of it increases the life of "M" by not allowing it to burn when not in use.

12 is a grid leak of about 20,000 ohms. It is made adjustable and of the usual carbon potentiometer segment. It provides the grid of "O" with the proper negative potential for oscillation.

13 is the grid condenser and is of about .0005 m.f. capacity.

14 is the grid coupling condenser and is a DeForest type CS-3002 variable step condenser. Any variable condenser of sufficient capacity will do; it should have a maximum of at least .003 m.f.

15 is a D.P.D.T. switch for changing from buzzer to phone and back. This switch is not absolutely necessary, but owing to the fact that the buzzer vibrator points become corroded thereby putting high resistance in the aerial circuit, it was thought better to use the switch.

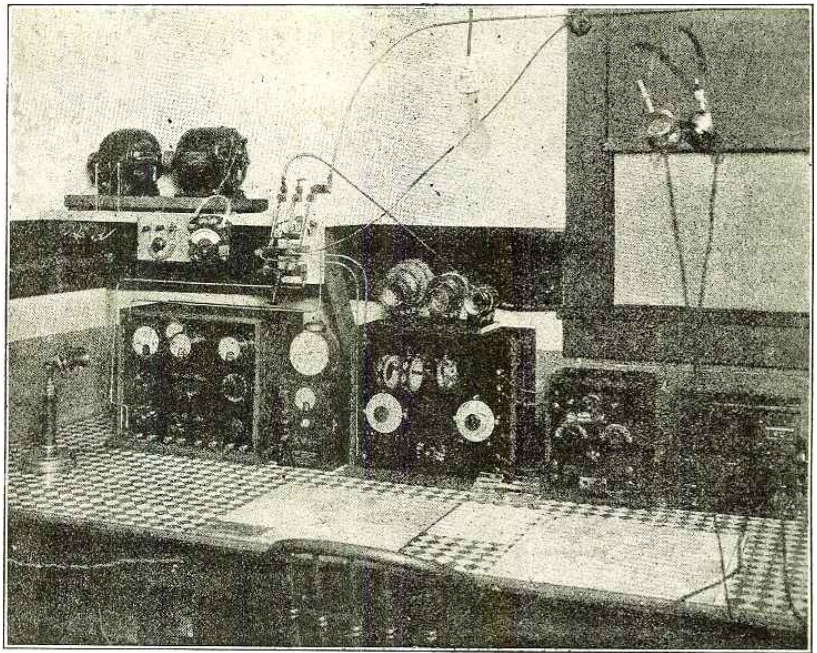

This is a Photograph of the Radiophone Station Constructed and Operated By Lieut. Winner, at General Hospital No. 2, Fort McHenry, Maryland.

16 is the Century high frequency buzzer the contacts of which are across the ground lead.

17 is the telephone transformer. In this connection it was found that a Ford spark coil gave far superior results when compared to the ordinary telephone transformer.

18 is a Western Electric transmitter type 323-w. It was mounted on an old stand as

shown. Of several makes tried this type was found to give the best results.

19 is a common type of telegraph key.

The motor generator set was purchased from the International Radio Telegraph Co. The field rheostat as will be noted is a carbon segment of 5,000 ohms in series with the shunt winding of the generator for regulating the voltage applied to the plates of the tubes.

It will also be noted that a negative potential of about 20 volts is applied to the grid of "M."

OPERATION.

To operate the set, 14 is given a fairly large value and the aerial switch is thrown to the left. Then vary in the order named: wavelength switch, grid coupling condenser, and plate coupling switch until the hot wire meter shows a reading. It will also be necessary to vary 12 to find the proper value. However, when once set it needs no further attention. Try various combinations of capacity, inductance and coupling until your aerial meter shows maximum reading, which for the Marconi VT-Class 2 tube will be about five-tenths ampere. Secure as great a radiation value for the selected wavelength with as small a plate current as possible. It is best to start with a plate voltage of about 300 volts and work up to what the tube will stand without "bluing." The fundamental of the aerial used with this set was 470, but it was found that the set worked best on 350 meters and this wavelength was kept. To telegraph, throw 11 to the left and work the key. A series of wave trains will be sent out, each train being composed of undamped oscillations. The frequency of the trains, however, will be the same as the frequency of the buzzer vibrator. A wonderfully clear tone is obtained, which may be changed by adjusting the buzzer vibrator.

To talk, throw 11 to the right thus lighting the tube "M" and throw 15 to the left. Speak evenly and in a clear tone of voice well up against the transmitter.

The wave sent out is exceedingly sharp and the receiving station operator will need to tune to within at least three meters of it, otherwise he will probably not get it.

(Continued on page 718)

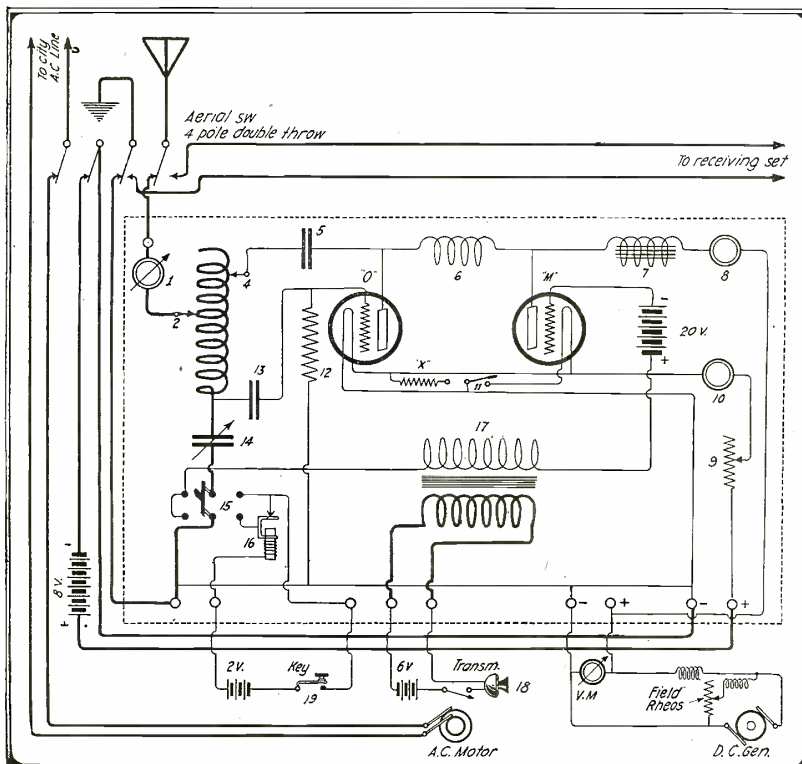

Fig. 1. Schematic Wiring Diagram of This Radiophone Transmitter. Designating Numerals are Explained By the Author in Text.

Radio Wrinkles

Some Practical Hints on Building Your Own Radio Apparatus

By H. WINFIELD SECOR

THE radio experimenter is often confronted with more or less baffling problems in the construction of his own apparatus, such as windings, condensers, choke coils, etc., and the writer thought that the following wrinkles of a practical nature may be found of value to those who "make their own."

Recently, a friend of the writer's wished to build a large wavemeter and while this required a variable condenser, having a capacity of .003 microfarad, the builder did not wish to go to the expense of purchasing a single condenser unit having this large capacity. It was suggested, in view of the fact that he possess three

variable condensers of different makes, each one of which had a capacity of .001, that he mount these on a common shaft so as to be controlled by a single unit, or else arrange these in a group, geared together, so that when one knob was turned all three condenser rotary units would rotate *proportionately and simultaneously*.

Fig. 1-A shows one method of doing this by means of either metal or fiber gears. With two condensers the joint capacity desired is twice the value of either one of the units utilized. The total capacity of several condensers connected in parallel is the sum of the combined capacities in microfarads. The joint capacity of several condensers of like values connected in series is obtained by dividing the capacity of one jar by the number of jars in the circuit. If the jars have unequal values, the formula of reciprocals is used. The following shows how each case may be determined:

For condensers in parallel
 $C = C_1 + C_2 + C_3 + C_4$, etc.

For condensers in series

$$C = \frac{1}{\frac{1}{C_1} + \frac{1}{C_2} + \frac{1}{C_3} + \frac{1}{C_4}}$$

At Fig. 1-B, two rotary variable condensers are shown connected together by means of a belt or chain, so that when one knob is turned both condenser rotary elements rotate proportionately and simultaneously. Before leaving this subject, it is also valuable to remember, that by filling in air condenser cases with castor oil, that the capacity of the condenser is increased approximately five times.

NOVELTIES IN LOOSE COUPLERS.

Several ideas which have been used in practise in building loose couplers are illustrated at Fig. 2. In constructing cabinet type receiving sets, which are now all the rage, it is, of course, desirable wherever possible to have the coupling or position of the secondary coil of the loose coupler variable, by means of a rotary control knob.

Fig. 2-A shows how this can be done by means of a strong cord passing around four small grooved pulleys, or even thru screw-eyes, which the writer has seen used in some amateur apparatus of this nature; the center of the cord making one turn around a large wooden disc secured firmly to the shaft of the rotary control knob. This knob is fitted with a pointer and a

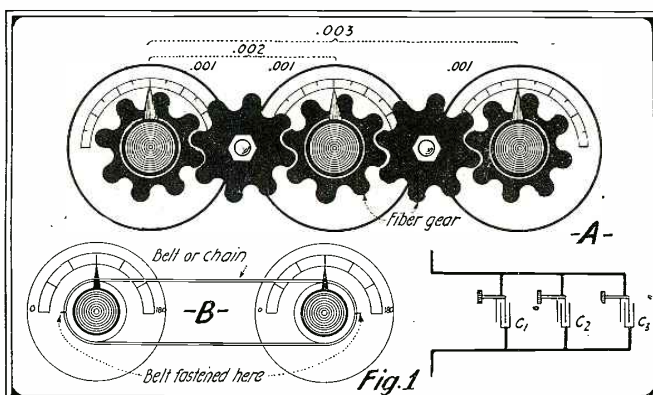

Illustrating Two Methods of Mechanically Connecting One or More Condensers So That They May Be Operated Simultaneously.

scale on the outside of the cabinet to indicate the position of the coil or the per cent. of coupling. The circumference of the wooden drum or block, which may be turned from a piece of $\frac{7}{8}$ " thick hardwood with a groove in it so that the cord will not jump off, should be figured out so as to be a little greater than the length over which the secondary is to move. Thus, if a secondary is to be moved 7" total, in order to clear the primary coil, then the circumference of the cord pulley should be somewhat greater, say 8". The diameter of the block on which the cord joins is readily found by dividing the length of action by 3.1416.

When the secondary is half way out of the primary, the center of the cord around the wooden pulley should then be suitably secured with a brad. At Fig. 2-B a vertical mounting of loose coupler is shown with cord control connected to a rotary knob mounted on the panel of the cabinet. Where the coupler is quite large, a balance weight should be inserted in the cord as shown, so that very little pressure is required to move the secondary up and down. The cord is secured to a grooved wooden pulley and nailed to the pulley when the secondary has been turned to the center of its movement, i. e., half way out of the primary.

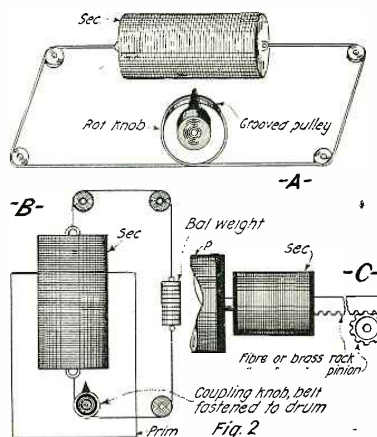

In This Case, We Have Three Methods of Varying the Secondaries of Loose Couplers. Surely You Will Find One of These Adaptable to Your Needs.

Another method which has been used for both vertical and horizontal loose couplers in order to have rotary knob control of the movement of the secondary is shown at Fig. 2-C. This scheme involves the use of a metal or fiber rack and pinion. A good plan would be to use a fiber or hard-rubber rack which could be filed out by hand, with a metal gage, to make an exact fit with a metal pinion of medium pitch. This pinion is secured to the shaft carrying the rotary coupling knob, which projects thru to the front of the panel. In any case, it is best and, in fact, imperative, that the secondary coil be accurately arranged on either two small round brass bars, or else on

brass, wood or fiber bar, on which to slide so that the secondary would not hit the end of the primary coil and damage the fine wire with which it is usually wound.

Fig. 3-A shows details of the secondary switch and how it may be arranged to have positive action from a centralized control knob mounted on the panel of the cabinet. Many designers of loose couplers, even those of larger sizes used in commercial receiving sets, including those designed by Marconi Co. engineers, have not gone to the trouble of developing any more or less complicated mechanical means for operating the secondary tap-switch, as here shown, but have simply fastened a multi-wire cable to one end of the secondary, and the other end of this cable to the switch panel. The wires making up the cable are usually small, stranded, rubber-covered wires and as many as 30 to 40 and more are sometimes made into a cable as shown in Fig. 3-B; also this giving very exact and perfect electrical connection between the secondary windings and the balance of the receiving circuit. Some builders prefer the switch control in the manner shown, or else switch control by some other scheme, while others would just as soon use the flexible cable.

The writer has recently constructed a long wave loose-coupler having a cable control such as shown at Fig. 2-A, and the secondary tap leads are brought over to the panel by means of a flexible wire cable comprising 40 wires, each wire consisting of 6 strands of No. 28 tinned copper wire, rubber covered. These were formed into a round cable about the size of your thumb, and tied with some soft cord (common store string) at intervals of about $1\frac{1}{2}$ ". The cable must be flexible enough so as to form a "U" and not pull too strong or awkwardly when the secondary is pulled out to its full limit.

As the average radio operator does not make such frequent changes of the secondary position all the way from minimum to maximum coupling, the cable idea works out better than it might be expected, as there is not so much "wear and tear" upon it, after all.

Another scheme of controlling the secondary movement suggested by Mr. H. Gernsback some years ago, is shown at Fig. 3-C, which comprises a jointed or rather extensible arm secured to the rotary control knob. A scheme used by the Clapp Eastham Company is also here shown at

Fig. 3-D and which may be of interest to experimenters, where a small movement of the winding is involved.

Data is given below on some windings for loose-couplers suitable for long wave work, as well as short waves. It should be remembered that for audion detectors much finer wires should be used on the secondary than where crystal detectors are employed.

Let us work out an example to see how the loose-coupler is related to the antenna. Let L = inductance required in primary of loose-coupler for any wavelength; λ = the wavelength required, and C = antenna capacity in micro-farads. For tables giving these values of L and C for various sizes of antennae, see C. Ballantine's article on "Design of Large Radio Receiving Transformers," in the Feb., 1917, *Electrical Experimenter*. A 4-wire antenna, with wires 3 ft. apart, has a capacity of .00086 m.f. for height of 50 ft. and length of 200 ft. For a similar antenna 100 ft. high and 100 long, the capacity is .00056 m.f. The inductance of the antennae is neglected for ordinary calculations.

Find the wavelength (maximum) for the .00086 m.f. aerial and the largest coupler primary (F) above, having an inductance of 121,801,000 centimeters.

$$\begin{aligned} \text{The wavelength } \lambda \text{ in meters} &= 59.6 \sqrt{L C}; \\ \text{Hence } \lambda &= 59.6 \sqrt{121,801,000 \times .00086} \\ &= 59.6 \sqrt{104,748.86} \\ &= 59.6 \times 320.3 \\ &= 19,089 \text{ meters wavelength.} \end{aligned}$$

The wavelength of the secondary circuit is computed from the value of the secondary inductance and the capacity of the variable condenser shunting it.

CHOKE COILS, ELECTROLYTIC INTERRUPTERS.

Radio experimenters who have transmitting sets often find it necessary to utilize a choke coil in series with their step-up transformers in order to more properly and efficiently control the output of the set as well as to tune the primary circuit of the step-up transformer, so that it will be in resonance with the secondary circuit.

There is one general rule in this case which it is well to keep in mind, and which will save the burning out of many fuses, besides providing an excuse for a lot of miscellaneous and fancy cussing. If a choke coil is necessary, then invariably the insulated magnet wire with which it should be wound is the same size of wire as that used on the primary of the induction coil or transformer with which it is to be connected in series.

Fig. 4 shows a radio transmitting circuit with an adjustable choke coil in the primary circuit and also high-tension choke coils at the secondary terminals of the transformer, these latter being supplied on all standard radio transmitting sets to prevent kick-backs from the high-tension oscillation condenser, surging back into the transformer secondary winding and causing burn-outs, besides aiding to keep the energy confined in the closed oscillatory circuit, comprising the spark gap, the high-tension condenser, and the primary winding of the oscillation transformer.

Many users of electrolytic interrupters experience considerable trouble owing to the fact that the primary winding of small induction coils do not possess sufficient self-inductance to cause the interrupter to function properly. Where small spark coils are used on 110 volt A.C. or D.C. circuits with an electrolytic interrupter, it is invariably found very beneficial to connect a suitable choke coil in series with the interrupter and the spark coil primary. Such a choke coil is made by winding 4 to 6 layers of No. 14 single or double cotton covered magnet wire on a fiber tube, having an inside diameter of about 7/8 inch. An annealed iron wire core is made up with a 1/8-inch brass or iron rod

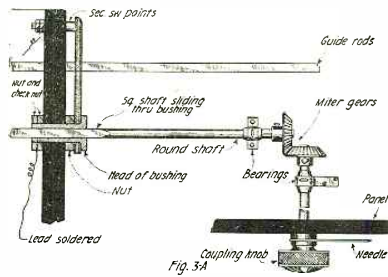

Showing the Details of the Secondary Switch and How It May Be Arranged to Have Positive Action from Centralized Control Knob Mounted on Panel.

in its center, and firmly bound so as to slide within the fiber tube. By bringing taps from the various layers out to a multi-point switch mounted on the base of the choke coil, a very wide range of self-inductance can be obtained. The farther the iron core is pushed within the coil and the more layers of wires in circuit at any instant, the higher the choking or self-inductance effect, and vice-versa.

Choke coils for use in the primary cir-

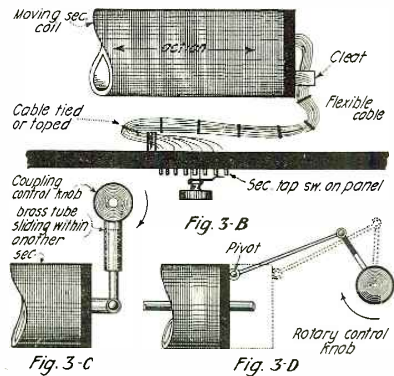

The Upper Sketch Shows Another Method of Tapping Secondary, While the Two Lower Designs Show Two Methods of Controlling the Secondary Coupling.

cuit of radio transformers such as 1/4 and 1/2 KW units, can be of the open core type just described, but usually are of the closed core type. A choke coil of the closed core type several of which are on the market, is shown at Fig. 4 also. In this case, the core may be composed of soft iron wire if the experimenter is ingenious enough to interweave and clamp the core so as to make a good job of it mechanically, but it is usual to make the core of sheet iron laminations and these are clamped together by any convenient means.

For a choke coil of this type, the winding is placed on one leg of the iron rectangle in the manner shown. For 1/4 KW units, this winding may comprise 6 layers of No. 14, with taps taken from various layers and brought to a multi-point switch,

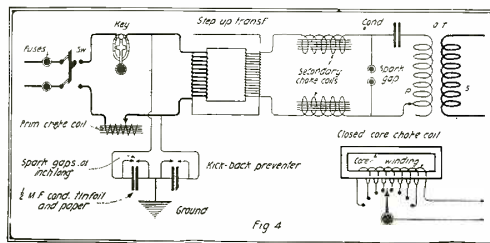

A Typical Radio Transmitting Circuit With an Adjustable Choke Coil in the Primary and High Tension Choke Coils in the Secondary. The Side Sketch is Also a View of a Choke Coil of the Closed Core Type.

so that any number of layers can be connected into or out of the circuit quickly. For a 1/2 KW transformer, the winding may comprise 6 layers of No. 12 insulated copper magnet wire. The sheet iron core may be made the same for both cases, and measures about 7 by 5 inches outside, by 1 inch in thickness. The legs of the core measure 1 inch across, thus giving one square inch of iron cross-section. The leg on which the winding is to be placed should be insulated with several layers of empire cloth or oiled linen. Roughly speaking, the choke coil for use with a transformer at least in small size units such as this, should be made the same size as the iron core and primary winding on the step-up transformer employed. Another rule is to allow 1000 circular mils of wire cross section per ampere of current.

The choke coils used on the secondary of small transformers are usually composed of a layer of fine magnet wire wound on a porcelain tube about 4 to 5 inches long. The turns may be spaced a short distance apart, and the porcelain tubes are procurable from any electric supply house or wiring contractor. Glass tubes are also used.

At this juncture, it would seem well to point out a very important fact which is frequently and in fact too commonly overlooked by the radio experimenter, and that is, wherever a potential of over 50 volts, or even 30 volts is employed for exciting a radio transmitter, etc., that wood should not be used for the base or mount of any of the live metal parts of the apparatus, no matter what its nature may be. Up to 500 volts, slate is used in all standard electrical apparatus, and of course marble makes a very fine job and will stand a potential of several thousand volts. As the panels, however, for radio experimental work are usually small, it is the best practice to use either hard rubber, or better still Bakelite-dilecto. Watching such points as these will prevent a leakage of current, disastrous breakdowns of insulation and burning out of apparatus as well as fires which may easily occur where wood is utilized for apparatus operating on 110 volt or higher potential circuits.

For direct current circuits, resistance coils or resistances with no iron cores are used within the coils. However, resistances should not be used for controlling the strength of current on alternating current circuits, as there is a large I²R loss in this case and the apparatus will not function properly. An iron core choke coil, preferably of the adjustable type should always be used for A.C. circuits. Alternating current arc lamps, motors and other apparatus are invariably fitted with iron core impedances or choke coils, and these have proven that the resistance coil is not satisfactory and at all desirable for the purpose, in this case. Resistance coils composed of iron, German silver or other well known grades of resistance metals, serve their purpose very admirably on D.C. circuits, where batteries are to be charged from 110 volts D.C. et cetera. The general rule for the required resistance to be placed in series in order to obtain the given drop in voltage for a certain current in amperes is as follows:

The resistance R in ohms of the coil to be placed in series with a lamp, battery, motor, etc., is equal to the drop in volts required, divided by the current desired. That is to say, that if the battery requires five amperes at a potential of 10 volts and the D.C. line potential is 100 volts, then the drop in volts occasioned by the resistance coil is 100 minus 10 or 90 volts, and R equals 90 divided by 5 or 18 ohms.

To determine the proper size of wire with which to wind this resistance coil and the length of wire, pro-

(Continued on page 716)

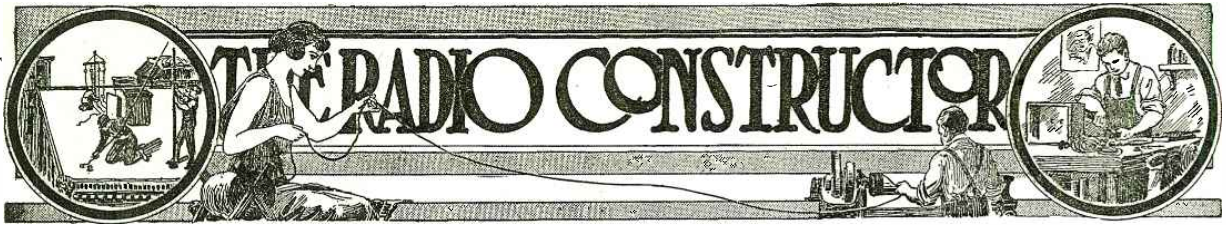

Easily Constructed Radio Mast

By EVERETT LEO DEETER

THE one thing that is most apt to discourage the amateur with a thin pocket-book (and others, too) is the question of obtaining, and in particular, the raising of a good tall radio mast.

Having had considerable trouble in attempting to raise a gas-pipe mast of considerable height and of apparently small size pipe, and after three failures ending in a broken pole or bent pipes, I employed the following method of construction and raising. It has proved itself a valuable method and works exceedingly well.

Using method shown in diagrams a pipe mast of apparently small size pipe and of a good length can be successfully raised, by the effort of one man, the pole being over 100 feet long.

In Fig. 1 the pipe should be jointed with knuckles and couplings, the pieces in descending sizes, according to the length of the pole. If not over

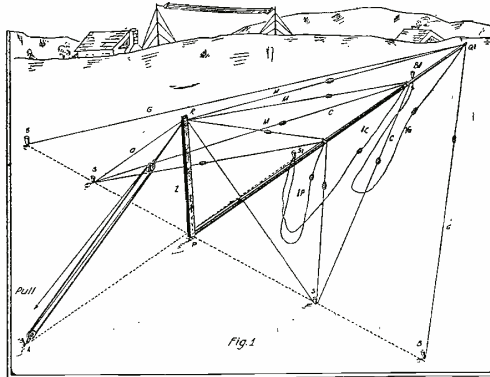

The Jointed-Pipe Mast Preparatory to Being Hoisted Into Upright Position by Means of Block and Tackle.

70 feet long, it may be made in three joints of pipe, the larger one being $1\frac{1}{4}$ inch, the second one 1 inch, and the top one of $\frac{3}{4}$ inch pipe, connecting a pulley at top as shown in Fig. 2-Q. If pole is to be over 70 feet in length, larger size pipe should be added to bottom joint. If under this length, the plank Z may be a solid 2 x 4, connected to pipe as shown in Fig. 2-D. It should be pointed as shown in diagram 2-R to keep it from slipping in raising, and if the pole is extra large and heavy a stake should be driven at that point. The length of Z should be about one-third that of the pole. On extra large poles two 2 x 4 should be bolted together and used.

All guy wires are staked out before raising, as shown in Fig. 1, the wires IP, IC, IG, and stake holes being estimated beforehand. The distance from P to SI should equal that from P to S; from P to BI

should equal P to B; and the wires should be the same length as the corresponding ones. Insert at least one insulator of the ball type at the center of each guy wire.

If plank Z is one-third the length of pole, then by using a three-to-one block and tackle the effort required to raise the mast will be the same as that required to raise one joint without it. When pole is raised, R should be securely staked down, after which the pole is ready for use. The pole will be found to raise stiffly and in a straight line, without the least bend of any kind if the wires supporting the pole when raising are sufficiently large. The pole would necessarily have to be of quite large size pipe to be raised otherwise.

If at any time the pole must be taken down to renew the rope on pulley, or any other reason, just hook on the block and tackle, let it down, easily raising it again after the work is done.

If you live in a section famous for its cyclones or storms and indications point to the approach of an ugly windstorm lower the mast and be on the safe side.

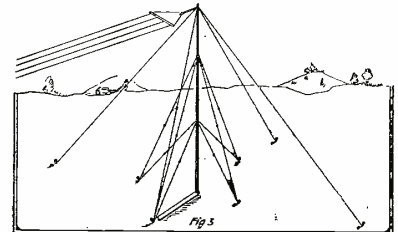

This is What the Mast Looks Like After Having Been Properly Raised.

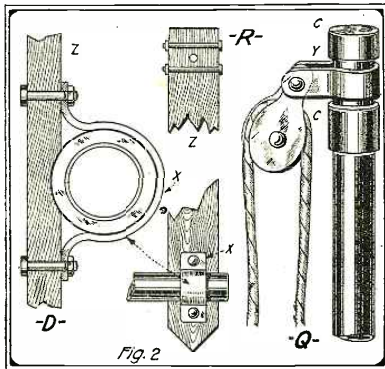

Construction Details, and Manner of Arranging Block to Mast.

A Simple Magnetic Detector

This type of detector works upon the microphone principle, but instead of using carbon I used a magnet and a plunger or armature, one end of each of which was rusted and so arranged that the rusted ends slightly touched each other. A 2,000 ohm

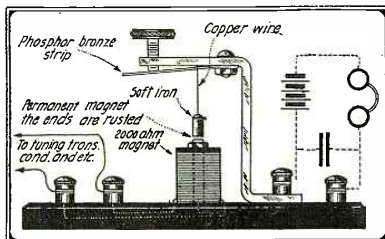

This is Rather a New Idea in the Magnetic Detector Line. As Will Be Seen It May Easily be Constructed.

winding was placed upon the core of the permanent magnet. No. 38 enamelled wire was used. The leads were connected as shown in the drawing. The armature was suspended by a small copper wire from a phosphor bronze strip as shown in the drawing. The distance between the rusted ends of the magnet and armature was adjusted by a thumb screw which varies the pressure on the phosphor bronze strip. The brass support from which the armature was suspended was fastened to the base by a binding post. The connections are as shown in the drawing. I hardly think it is necessary to explain how this detector works. However, I will attempt to give a brief explanation. As said before, the suspended armature is adjusted so that it slightly touches the permanent magnet. Now the magnetic waves or wave currents flowing thru the winding of the magnet produces variations in the flux strength tending to vary the resistance between the

two rusted points on the armature and magnet.

The armature and magnet are connected in series with a set of dry cells and a pair of telephones. When magnetic waves are sent thru the winding on the permanent magnet variations of current strength are sent thru the receivers, thus producing sound.

This detector acts as a relay and by using a number of these detectors signals can be brought in good and loud.

Contributed by

FORREST R. KINGMAN.

NOT YET, BUT SOON!

First "Bug": "I see we amateurs are seriously threatened to extinction by that new wireless system."

Second "Bug": "Why, how come?"

F. B.: "By the Ouija Board!"

(Copyrighted by P. Ex—all languages including the Scandinavian.)

A Compact Tube Control Panel

By J. STANLEY BROWN

ALTHOUGH V. T.'s. with standard bases are now very much in use there are still many amateurs who have and wish to experiment with the tubular type of bulb such as the Audiotron variety. Such tubes are excellent detectors and oscillators. They also make good amplifiers. They require rather critical adjustment of both filament and plate circuits. The grid voltage is some-

so arranged that single handed operation is extremely easy. In fact it would be difficult to control it with both hands. The filament and plate controls are mounted concentrically. Directly below them is a two point switch which cuts in either filament, and cuts out either one. Sufficient terminals are brought out to permit the use of any conceivable vacuum tube circuit. A

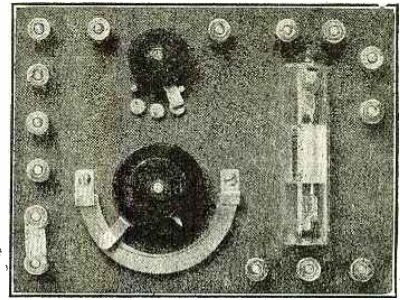

This is a Photograph of the Complete Instrument Actually Built by Mr. Brown. Neat Work.

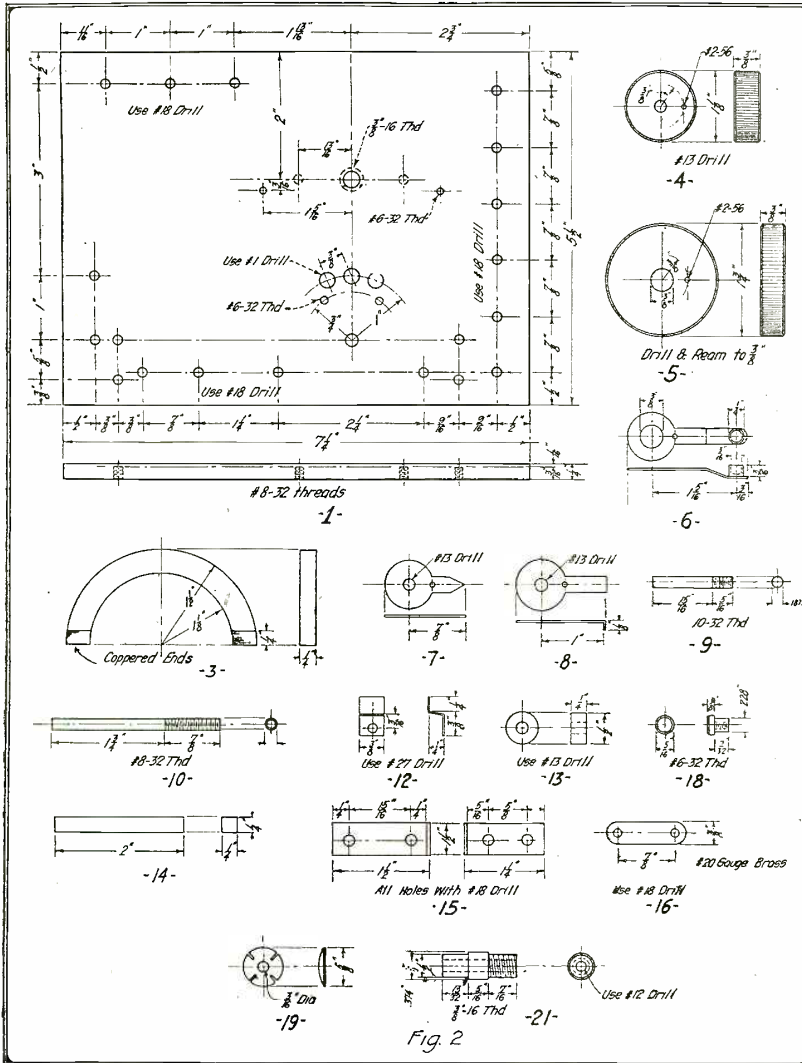

These Drawings Illustrate the General Assembly of All Necessary Parts. Each Numbered Item is Fully Described in the Text of this Article.

what self-regulating when one compares it to the exact values met with in the V.T.-1 and other standard types of vacuum tubes.

The majority of control panels made for use with the tubular bulb have been far too bulky, too spread-out and too difficult to use. With the preceding facts in mind, the writer proceeded to design the panel shown in the photograph and in the assembly drawing Fig. 1. It is only $5\frac{1}{2}$ " high by $7\frac{1}{4}$ " long and $2\frac{1}{4}$ " in overall thickness. It weighs less than 2 lbs. The controls are

grid condenser of .0005 mfd. capacity is mounted directly to the rear of the panel. The rheostat is of the standard 10 ohm porcelain base type and is simply reversed and screwed to the panel. The potentiometer is of the standard, semi-circular, graphite type and is of 6,000 ohms resistance.

CONSTRUCTION.

Make the panel with $\frac{1}{4}$ " black sheet "Formica" or "Bakelite". Give it a grain finish with fine sandpaper and oil. The in-

strument shown in the picture is not engraved, as it is only a hand made sample, but the regular instrument is, and if the constructor has access to an engraving machine his efforts will be more than rewarded by the additional beauty of the instrument. Lay out the holes as shown, on the front of the panel with a sharp lead pencil. It is necessary to drill "Formica" from the front, as it has a tendency to break out before the drill is quite thru. Details of the panel may be seen in 1 of Fig. 2. It is well to note that 4 holes are tap-in $\frac{3}{16}$ " deep from the rear for the purpose of holding the legs. These will not be necessary if the instrument is mounted in a cabinet.

The binding posts may be of any standard type if held by an 8-32 machine screw in the base. Connection clips are fastened under the heads of these screws.

The grid condenser is made with a mica dielectric to a capacity of .0005 mfd. Using mica .005" thick for the dielectric, an active area of about 1.6 sq. in. will be required.

The rheostat shaft is shown in detail in 10 of Fig. 2. It is made from $\frac{3}{16}$ " brass, as is the switch shaft, 9.

The potentiometer contact is detailed in 6 of Fig. 2. Note the little cup soldered on this arm. A piece of $\frac{3}{16}$ " graphite rod should be placed in it for a contact, as a metal contact fills in the depressions in the graphite sector with metal granules which decrease the resistance of the whole. Use No. 22 gage spring sheet brass for this and for the switch blade shown in 8, while 7 is a detail of the indicator for the rheostat. This may be dispensed with if the word "increase" is engraved on the knob, as shown in the assembly drawing, Fig. 1.

The bearing for the concentric controls is shown in 21 of Fig. 2. Turn it from $\frac{1}{2}$ "

(Continued on page 704)

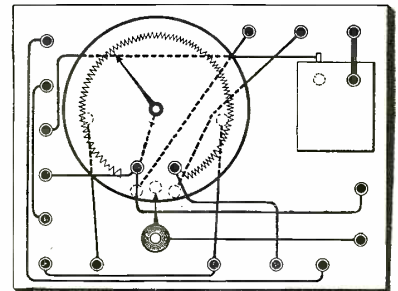

Fig. 3. Showing Wiring Diagram in the Back Part of the Panel. Make Connections Straight and Workmanlike.

CLUB GOSSIP

Newport News Radio Club.

The radio club of Newport News, Va., which the amateur wireless operators of the city formed the third of last February, is installing in its club rooms at 215 Fifteenth street one of the latest De Forest panel unit-receiving sets. When completed this set will be capable of receiving messages of the lowest amateur instruments of a wave length of 100 meters up to the 12,000 meter wave length of the Eiffel Tower at Paris and the high-powered station at Naucon, Germany, said Ralph Osborn, secretary of the club, recently. At present the club is equipt to receive amateur and commercial stations.

Besides this and the usual sending apparatus the club is planning to have a one K.W. sending transformer and an Amrad quencht spark gap. Two aerials, one for receiving and one for sending, are to be constructed as a part of their equipment. The receiving aerial is to be 300 feet long, one wire, and the sending aerial 35 feet long and 65 feet high, composed of six number seven, phosphor bronze wire.

The club was organized last February and has been growing in membership and importance in experimental wireless ever since. The president of the club is E. M. Peterson, a commercial operator, who is the official tester of the wireless telephone and telegraph sets in the plant of the Newport News Shipbuilding and Dry Dock Company. Nearly every member of the club have personal receiving sets, several being of the unit panel type. Several of the members have sending sets, one of them is a 1/2 kilowatt set, which is being used until the sending set has been installed in the club room.

The club meets every Monday and Thursday afternoon at 4:30 o'clock. Amateurs are invited to join the club, and visitors to attend the meetings of the club. Amateur operators and those interested in radio, who wish to become members, must have a general outline of the constitution and the by-laws, and pass an examination. A copy of this examination is given the applicant to study before he takes the examination.

The club aims to have a column of radio news in the daily papers once each week, to give the news that is going on in radio circles at home and abroad. In their column will be answered any questions relative to the work of the radio club as well as technical questions relative to the apparatus in use, and the tuning of instruments and the manufacture of tuning coils.

The Sequoia Radio Club.

A radio club has recently come into existence at Poughkeepsie, N. Y., formed by a number of amateurs who are anxious to learn more about the study of radio.

Meetings are now held at the different "stations" every Friday night, where assigned subjects are discussed and all problems confronting the members are explained.

The club makes use of every piece of available literature pertaining to the subject and operates a circulating library for the benefit of the members. At present the club has but one licensed member, tho it is expected that many others will be registered before long.

This club is known as the Sequoia Radio Club of Poughkeepsie. The president is Lealand B. Moss, secretary, P. Hankinson, and treasurer, J. DuBois. The dues, which go for literature, are fifty cents per month.

The Tesla Radio Club.

The Tesla Radio Club has been formed at Geneseo, N. Y., by sixteen amateur operators, young men of the town, who are taking the keenest interest in the advance of the science of wireless telegraphy. Charles Champ is president of the club, and Gilbert L. Courymay is secretary.

Most of the members have instruments capable of receiving messages, also there are none at present equipt for sending more than local messages. Time, weather and other reports are being received, and during the past few days the daily baseball reports of one of the prominent news agencies have been taken in out of the air. One or two members of the club have completed courses in the work of operating the Marconi apparatus and expect to take the government examinations for licenses as operators.

Hubert Holstein Post Radio Club.

The Veterans of Foreign Wars of Philadelphia, Pa., have honored the name of a young wireless operator, who was killed in the service, by naming post 483 the "Hubert Holstein Post." Hubert Holstein, whose parents reside at 131

Page street, enlisted in the navy and was assigned to the U. S. S. Tampa as wireless operator. His ship was engaged in the dangerous work of conveying troops from Gibraltar to Bristol Bay when it was blown up by a German submarine with the loss of many men.

Toledo Y. M. C. A. Boys' Radio Club.

The Y. M. C. A. Boys' Radio Club of the Toledo Y. M. C. A. has been organized for several months, and in that time, due to the efforts of our president, Darroll Drury, and our vice-president, Ernest Schultz, has grown to thirty-five members. Any member of the "Y" over twelve years of age is eligible. A junior club is maintained to prepare candidates to take up the work of the regular club.

We have our meetings at the "Y" every Thursday evening. Mr. Buckingham of Scott High gives us instructions in theory and then we have plenty

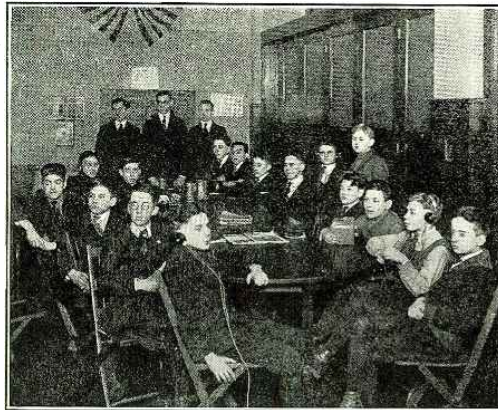

Photograph of the Toledo Y. M. C. A. Boys' Radio Club and Nineteen of its Members. Good Idea, Boys.

of code practice. At each meeting a member gives a talk on some current radio topic as discuss in the RADIO AMATEUR NEWS, and we have found that this helps to keep up interest in new radio development.

Nearly every member has a set of his own, and the club as a whole has an excellent receiving set with which some exceptional work has been done. We hope to have an efficient sending set in the near future.

Accompanying is a photograph which was recently taken which shows our club better than any written description can. Interested persons may communicate with William Steinhauer, Acting Secretary, Y. M. C. A. Boys' Radio Club, Toledo, Ohio.

The Terre Haute Radio Club.

The Terre Haute Radio Club recently held its second meeting at the Garfield High School since the reorganization of the club. Twenty-six young men were present and a very enthusiastic meeting was held. William Dean, who has been in radio work in the U. S. army in France, gave the boys a very interesting talk on his experiences with radio and its importance to the young men of today.

After the business meeting, problems in the construction of wireless instruments were explained, followed by an hour of code practice. The young men are becoming efficient in the code and before long an advanced class will be started. Boys from the Vocational School are planning to build a station at the school, and several of these boys were present at the meeting. There were also several boys present from Wiley High School and other schools of the city.

This organization is not a Garfield organization, but a club for any one interested in radio and all who are interested are urged to be present at future meetings which are to be held at the Garfield High School, Terre Haute, Ind.

Banquet of Youngstown, Ohio, Amateurs.

The Radio Amateurs of Eastern Ohio and Western Pennsylvania recently held a banquet and big get-together meeting in New Castle, Pa., in the banquet hall of the Y. M. C. A.

The banquet started promptly at 8:30 p. m., followed by an address by Father A. J. Manning, Radio "8DA," "Amateur Radio Communication,"

and "The Relay Work of the Amateurs." Prof. H. W. Harmon of Grove City College and Radio "8YV," spoke on "The Radio Phone and the Amateur." C. E. Urban, the well-known writer of Pittsburgh, addressed the gathering on "Unjust Legislation." R. L. Patch, Radio "8HA," acted as toastmaster.

G. A. Doeright, Jr., Radio "8IP," 145 Illinois avenue, was one of the members of the committee in charge of the banquet and get-together. The other members on the committee reside in various sections of Eastern Ohio and Western Pennsylvania. For several years Doeright has been interested in radio work. He has a well equipt wireless station where he receives and sends messages. He has supervised the installation of this district and is fast becoming an expert in radio work.

The Oxford Radio Club.

At a meeting of a few of the younger radio enthusiasts living near Oxford Park, Revere, the Oxford Radio Club was formed. All the younger Revere amateurs are invited to join. Don't be backward, boys.

Mr. L. Burns was elected secretary and Mr. D. Antonelli treasurer at this first meeting. Rules to govern the club were drawn up. It is intended to have illustrated lectures at some of the meetings. An entertainment in magic is planned for the benefit of the club.

Address all communications to L. Burns, 65 Revere Street, Revere 51, Mass.

Hampton Roads Radio Association.

Amateurs of Norfolk, Virginia, wish to announce the formation of the Hampton Roads Radio Association. The Association was started about three months ago and since then has been going strong. The meetings are held twice a month in the rooms of the Norfolk Radio School. An excellent commercial set has been installed at the school, and it affords splendid opportunities for illustrated talks and practical experiments.

A board of directors has been formed and is composed of the superintendents of three large wireless companies and others equally prominent in radio work. These men take great interest in the association and give very interesting talks at the meetings.

The Association is affiliated with the Relay League and is ready to take care of all traffic coming this way. At the present there are fifty members, but a much larger enrollment is to be expected. Our aims are to efficiently handle relay traffic and to help all amateurs in this vicinity. Those interested should communicate with Mr. R. L. Hopkins, 426 W. York St., Norfolk, Va.

A Canadian Radio Association.

The Hamilton Amateur Research Association was formed on January 22, 1920, and is now well organized for the study of the sciences and especially "wireless."

There are at present only two departments, namely, radio and chemistry, but it is hoped to include every branch of science when a larger membership is on the roll call.

The first aim of the radio department is to construct a complete receiving station and members are loaning various instruments to that end.

The research laboratory is situated in the center of the city at 9 James N. Hamilton, Ontario, Canada. Mr. Healey, the president, has been granted a Government license and allotted the call letters 3FN.

The association invites anyone in the Hamilton district (Canada) interested in science to become a member or correspond with the writer. Other clubs are also invited to correspond to the Hamilton Amateur Research Association, M. Barwick, Corresponding Secretary, 89 Britannia Ave., Hamilton, Ont., Canada.

The Geneva Radio Amateurs' Association.

The radio amateurs of Geneva, O., and vicinity have organized a radio club under the name of the Geneva Radio Amateurs Association, and have elected officers for the year as follows: Maurice E. Dietrich, President; George Hasenplug, Vice-president; and Harold E. Powell, Secretary and Treasurer.

The purpose of the club is to promote amateur radio work, scientifically study all branches of radio and electricity, and to furnish the community with all press news received.

(Continued on page 719)

RADIO DIGEST

WIRELESS EXPERIMENTS OF NOTE.

Several weeks ago experiments were conducted by the Radio Compass Research Laboratory at Philadelphia Navy Yard, endeavoring to ascertain the best type of compensator and the proper type of receiving and amplifying gear. Also whether the oscillating or non-oscillating detector shall be used. There will be a number of new pieces of apparatus used and it is expected that the results will have a tendency to standardize Radio Compass installations incorporating some of the latest refinements recently discovered in the art. It is expected that the Bureau of Steam Engineering will soon issue instructions regarding Radio Compass installations which will include the findings of these experiments.—*Abstracted from Scientific American.*

AMPLIFIERS.

BY MARIUS LATOUR.

In 1905 Mr. Latour proposed to use a three-electrode mercury-vapor tube for amplification of feeble currents, and a similar apparatus was later employed as a high-frequency generator for heterodyne reception. In an earlier article (*Electrician*, December 1, 1916) the author, in analyzing the behavior of three-electrode thermionic amplifiers, introduced the classical "tube constants," namely, the partial derivatives of the plate current with respect to plate voltage and grid voltage. In his present article a more complete theory is given, in accordance with a report prepared in 1916 for General Ferrié. The input impedance of the tube is taken into consideration, and regenerative amplifiers and self-oscillating circuits are dealt with.—*Bulletin de la Société Française d'Electriciens*, July, 1919, and *Revue Générale d'Electricité*, Nov. 22, 1919.

MULTIPLEX RADIO TELEPHONY.

Two radio telephone conversations thru a single antenna a distance of five miles was the accomplishment reported by F. M. Ryan, J. R. Tolmie and Roy O. Bach at the recent meeting of the Institute of Radio Engineers. The paper was read by Mr. Ryan, who is engaged in extensive radio research work. This authority states that as many as five telegraph messages were being sent or received simultaneously with a single antenna, and that as many telephone conversations could have been carried on had there been sufficient apparatus at hand. The method used was that of a number of radio frequencies with a series antenna circuit. The calculations of the circuit were also shown.—*Scientific American*, May, 1920.

THE HOW AND WHY OF RADIO APPARATUS.

BY HARRY WINFIELD SECOR.

This interesting volume consists of 160 pages illustrated with 159 illustrations covering the many phases encountered by radio experimenters and others in the most talked of and fascinating game of the century.

In general the book is designed to be considered as a treatise on the principles underlying the operation of radio transmitting and receiving apparatus. It also contains an appendix upon the calculation and measurement of inductance as well as other useful data. The book is published by the Experimenter Publishing Co., Inc., New York, N. Y.

Radio amateurs in general and particularly the beginner will find this book not only interesting in its manner of presentation, but of great value in learning the fundamentals of radio as well as the practical

operation of instruments beginning with the induction coil and gradually working up to the functioning of the more complicated and modern appliances.

DEPENDENCE OF AMPLIFICATION CONSTANT AND INTERNAL PLATE CIRCUIT RESISTANCE OF THREE-ELECTRODE VACUUM TUBE UPON STRUCTURAL DIMENSIONS.

BY JOHN M. MILLER.

The amplification constant of three-electrode vacuum tubes is mathematically derived in terms of readily measurable physical dimensions of the tube. Curves are plotted enabling the rapid predetermination of tube amplification constant on this basis. These curves are shown to give results agreeing with experiment for a number of types of tubes. The internal resistance of the tube is similarly deduced, and an agreement between theory and experiment is shown.—*Proceedings Institute of Radio Engineers*, February, 1920.

Radio Articles in June Issue Electrical Experimenter

*A War-Time Radio Detective,
2nd Installment—by Pierre H.
Boucheron.*

*600 Feet Radio Tower—Looking
Skyward.*

*New Wireless Portable Phone.
Radio Controls This Torpedo.
High Power Radio Arcs.*

*A Long Wave Vertical Coupler.
Building a Mica Diafram Micro-
phone.*

Making Test Buzzers Adjustable.

DIRECT WIRELESS SERVICE BETWEEN GREAT BRITAIN AND THE UNITED STATES.

The inauguration of this service marks a new departure, it being the first direct wireless link between this country and the United States.

The service will be conducted jointly by the English Marconi Company and the Radio Corporation of America. The wireless terminal stations are Carnarvon on this side and Belmar, New Jersey, on the American side. At present messages via this route can be accepted for New York, Greater New York and South America (at rates up to 4d. less per word than the existing cable charges), but it is anticipated extending the service for messages to all parts of the United States. The first messages sent over this route were exchanged between Mr. E. J. Nally, President of the Radio Corporation of America, and Mr. Godfrey C. Isaacs, Managing Director of the English Marconi Company, and between the latter gentleman and Mr. Davis, Vice-President of the General Electric Company, New York.—*The Wireless World*, April, 1920.

FRENCH EMPLOYMENT OF AUDIIONS OR THREE-ELECTRODE LAMPS DURING THE WAR.

BY GENERAL G. FERRIÉ.

A resumé of the progress made during the war in radio telegraphy and radio tele-

phony by the French Military authorities, with particular regard to the use of three electrode Vacuum Tubes. Such tubes were used from the very first months of the war, but their employment on a grand scale was not organized until 1915-1916. The author of the article is Director of the French Military Wireless Service.—(*Revue Générale de l'Electricité*; Paris, December 27th, 1919.

HARMONICS IN C.W. TRANSMISSION.

BY CAPT. L. A. I. BROADWOOD, A.M.I.E.E.

This paper summarized the results of some experiments carried out in France in December, 1916, on C.W. Transmitters. They were fundamentally concerned with measuring the efficiency of the transmitter, by determining the effective resistance of the aerial using a substitution dummy aerial circuit. The aerial capacity was measured by means of a charge-and-discharge commutator and the dummy aerial capacity given the value determined in this way. The effective resistance of the aerial was then determined at various wavelengths by adjusting the resistance of the dummy circuit until the same current was obtained as in the actual aerial. The curve of resistance was found to exhibit peaks at various wavelengths which were exact multiples of the fundamental wavelength of the aerial, and the efficiency curve likewise showed similar peaks.

The paper concluded with a graphical construction for obtaining the waveform of the plate current from the static characteristic of the oscillating tube. The wave was found to be flat-topped and unsymmetrical for the case considered in the paper. The harmonics in the plate current, which in the direct-coupled transmitter flow thru the aerial tuning inductance, excite the natural harmonics which are found in the aerial circuit itself by reason of its distributed capacity and inductance.

In the discussion a simple method was described for detecting the presence of an unsymmetrical wave in the transmitter, by coupling it to a tuned wavemeter circuit across which was shunted a crystal detector and galvanometer. By reversing the coupling a different deflection will be obtained on the galvanometer if the waveform is unsymmetrical.—*Paper read before the Wireless Society of London on March 26th, 1920.*

A NEW THREE-ELECTRODE VACUUM TUBE.

A novel type of three-electrode vacuum tube has been evolved by John Scott-Taggart. This tube differs from the usual pattern in that the grid takes the form of a metal plate close to the filament, while the anode, also in the form of a metal plate, is placed diametrically opposite and on the other side of the filament. The filament is arranged vertically, the tube support being a nickel-iron spring which keeps the filament taut. The anode is a small metal plate placed at a considerable distance from the filament. The control electrode which takes the place of a grid is in the form of a large metal plate situated within a few millimetres of the filament.

The tube operates efficiently as a detector, being specially suitable for strong signals, both half-oscillations producing decreases of anode current. The vacuum tube also operates excellently as an oscillator or self-heterodyne receiver with 100 volts on the anode and 6 volts across the filament.

No doubt the characteristics and general properties of the tube could be greatly improved by further research.—*Abstracted from Wireless Age for June, 1920.*

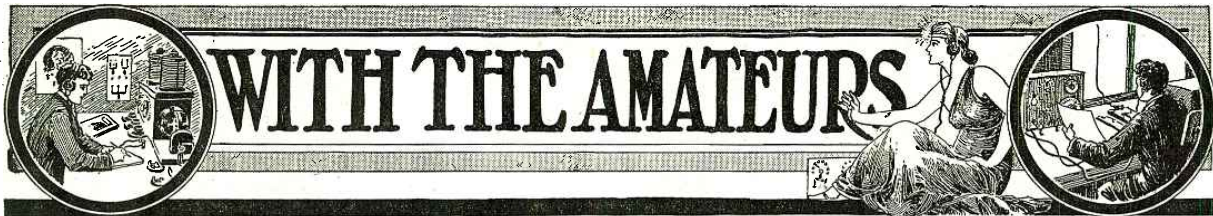

WITH THE AMATEURS

THIS department is open to all readers. It matters not whether subscribers or not. All photos are judged for best arrangement and efficiency of the apparatus, neatness of connections and general appearance. In order to increase the interest in this department, we make it a rule not to publish photographs of stations unaccompanied by a picture of the owner.

We prefer dark photos to light ones. The prize winning pictures must be on prints not smaller than 5 x 7". We cannot reproduce pictures smaller than 3 1/2 x 3 1/2". All pictures must bear name and address written in ink on the back. A letter of not less than 100 words giving full description of the station, aerial equipment, etc., must accompany the pictures.

PRIZES: One first monthly prize of \$5.00. All other pictures published will be paid for at the rate of \$2.00.

C. Valentine Celi Station

First Prize—Five Dollars

THE accompanying photographs show my transmitting and receiving outfit, which is highly efficient as well as portable. I hope the picture may furnish timely suggestions to "bugs" preparing to build a portable vacation set. The set folds into a square box one foot six inches by nine inches by one foot high and weighing about twenty-five pounds. The front, holding the key, spark coil and condenser, folds down, making a desk for copying, while the top opens and furnishes a bulletin board for weather forecasts, etc.

The set itself consists of a 3000 meter loose coupler, a pair of Murdock 2000 ohm phones, and a bakelite front cabinet, holding the bulb, B batteries, variable, and controls. The nine point switch on the left, every other one of which is a connection to the B batteries, on account of short circuiting them, varies the B voltage, while a Paragon rheostat adjusts the filament

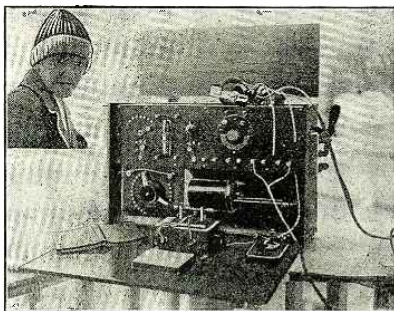

Vacation Time is Approaching, so Mr. Celi Wins First Prize for His Timely Description of the Portable Transmitting and Receiving Set Which He is Using.

current. The three point switch on the right puts the variable in or out of the antenna circuit, while the other changes from audion to ultra-audion circuits. I have found the change between audion and ultra-audion extremely valuable, as certain stations seem to come in better on one than the other. The four binding posts on the right are hooked up so that two pairs of phones may be employed.

The transmitter is operated by a small spark coil and condenser, giving a smooth high note with which I communicate several miles.

The antenna is composed of four copper wires, seventy feet long and fifty feet high.

With this set I copy NAR and ships off the Florida coast with ease. Time signals from NAA can be heard all over the room.

C. VALENTINE CELI.

4220 Vireo Ave., Bronx, N. Y. City.

Henry P. Asterberg Station

This is a photograph of my receiving set which consist of the following: Arnold loose coupler, Clapp Eastman 43 plate condenser in ground lead, El. Imp. Co. 43 plate condenser across secondary of loose coupler, Murdock 17 plate condenser across phones and small capacity fixt grid condenser. One pair each of Holtzer-Cabot,

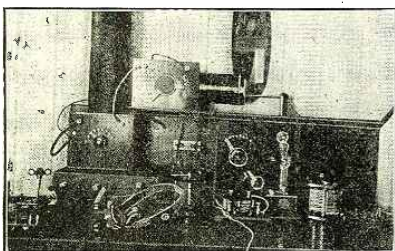

Mr. Asterberg Constructed This Set Four Years Ago for the Purpose of Listening-in to Radiophone Concerts.

Brandies and El. Imp. Co. phones. De Forrest type "T" tabular audion in home-made bakelite panel cabinet. In lower center of this panel is a grid leak, made by a semi-circle of drawing-ink, over which a switch blade is rotated by the knob. One home-made loading coil 4"x24" with 7 taps on bakelite panel. The antenna consists of 350

feet of 7 strand wire, strung up on the rafters in the attic.

The case under the loading coil contains a Mesco Radio Buzzer, dry cell batteries and tune regulating coil. This practise set is operated either by the omnigraph or the telegraph key.

This set was installed four years ago for the purpose of listening to the concerts given at that time by the De Forrest Co.; now it is used mostly for receiving Arlington time signals, but for these alone I think it is worth while having.

HENRY P. ASTERBERG,
Morsemere, N. J.

JACQUE DE LORME STATION

The outstanding feature about this set is that it is all home-made. The panel in the upper right-hand corner is of the ball and cup type. It tunes up to about six hundred and fifty meters. I have heard a vessel that was about a hundred miles from Sydney, Australia. I hear N U R, who is about four miles from me, twenty feet from the phones. N. A. J., another Nevel Station, I hear about fifteen feet from the phones. The set under it is a loose coupler regenerative, which tunes up to about fifteen hundred meters. I have heard N. A. J., N U R, W S O, Coast Stations and numerous other stations. The audion on the lower set is used to operate both sets. It is switched from one set to the other by means of a double pole, double

Jacque De Lorme Station

throw switch. My loose coupler and "loader" are connected together, but the "loader" can be cut out by means of a switch. I haven't an audion to work this set with, but I have a very good Marconi crystal detector, and a piece of Radiocite. I have a forty-three plate condenser between the secondaries. The loose coupler is two

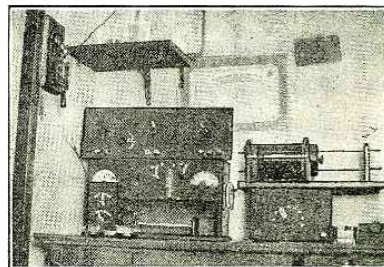

Practically All Parts of This Set Are Home-made, and Its Owner Obtains Very Good Receiving Results.

thousand meters and the "loader" is an E. I. Co. coil of three thousand meters. On the loose coupler and loader set I hear N. A. A. every night. I am also a member of the Radio League of America.

JACQUE DE LORME.

235 Menomonee St., Chicago, Ill.

Wesley Hope Tilley Station



Wesley Hope Tilley Caught in the Very Act of Pounding the Corona.

This special amateur station which has been allotted call "8ZU" is located on top of a high hill far above surrounding objects and is ideal for transmitting and receiving. One of the photographs shows the complete receiver and transmitter while the other shows myself seated at the receiver actually copying signals on a Corona typewriter.

The transmitter consists of a 1 K.W. Thordarson transformer, an oil condenser, an enclosed rotary which is quenched and noiseless, all connected by strips of copper ribbon and stranded cable.

The aerial is 100 feet long, 50 feet high, consisting of seven wires. The ground lead consists of thirty copper wires of different sizes up to No. 4.

The receiving set is composed of De Forest honeycombs of assorted lengths, Baldwin phones, audiotrons and General Electric V. T.'s as well as Murdock condensers. Amateur stations in Indiana and Illinois are frequently heard twenty-five feet from the phones.

Altho the radiation of this station is only 3 amperes, which is all that can be gotten on a sharp wave, stations within a radius of 100 miles report hearing me 50 feet from the phones at night time and from 5 to 10 feet in the day time.

WESLEY HOPE TILLEY.

Box 663, Austin, Texas.

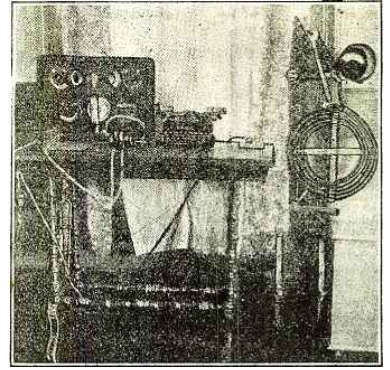

This Photograph Shows the Receiving Set as Well as the Compact Transmitter. The Owner Reports Transmission up to 100 Miles.

E. H. Walther Station

I became interested in wireless telegraphy in Great Britain in 1910, and did a great deal of experimental work from that date until War was declared in August, 1914, at which time my station, along with all the others in England, was taken away and put in bond. After coming to the United States, I came across RADIO AMATEUR NEWS, which re-awakened my interest in wireless, so that I started again to build a complete receiving set.

Starting from the front on the right of the photo, you will see small loose coupling inductance, the back of which is a 25-plate variable condenser, immersed in oil. I tried this condenser first with air, then transformer oil, with kerosene, and now use Vedol Motor Oil, which greatly increases the capacity and insures closer tuning. At the back of the condenser is a three-pole double-throw switch for changing from the

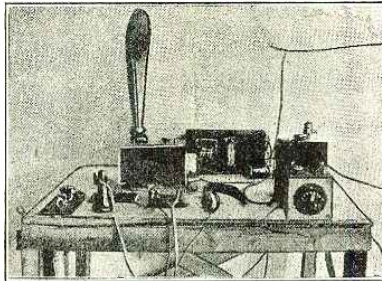

On the Right of the Audion Is the Rheostat, and On the Left is a Switch for Changing From Audion to Audion Amplifier and Crystal Detector, and in the Rear of the Table is the Loud Speaker.

small meter inductance before-mentioned to the large inductance on the left of the photo. In front of the large inductance you can see the crystal detector and the connection board for the phones, to the left of which is a three-pole double-throw switch for changing from crystal to audion detector, which is placed on the rear of the table. The only pieces of apparatus which I purchased whole were a 1,500 ohm E. I. Co. phone, a test buzzer and an audiotron bulb.

My one regret is that, as I am not yet an American citizen, I am unable to procure a permit to install a wireless telephonic transmitter, so must console myself by listening in to the lucky ones. I have found that in the States the amateur experimenter is able to do much more as much greater assistance is given him than is the case in other countries. E. H. WALTHER,

648 Wyoming Ave., Elizabeth, N. J.

Eugene R. Miller Station

Herewith is a picture of my radio outfit. I hardly flatter myself enough to think it would "cop" a prize, for I am young in the radio game. I took quite an interest in radio while serving in the 313th Field Signal Corps. When I returned from France I decided to make an outfit and this is the result, as far as I have gone, for I contemplate a first class outfit before long.

My chief idea in this set was compactness and I thought some other fellow who is crowded for room as I am, might profit by my idea. The pictures show open and closed views and you will note that the door when open serves as a desk, and when closed, as a protection to the instruments.

The entire set is a result of my own handiwork with the exception of V.T. tube and receivers. I use the regular V.T. hook-up. The panel is of bakelite and can be swung down until it rests on the desk giving access to all enclosed parts, without breaking a connection. My aerial is only two hundred feet long and forty feet high.

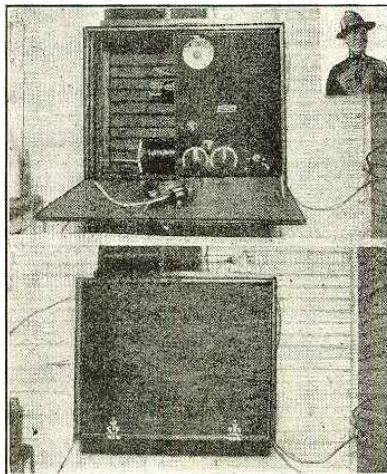

Here is Another Type of Receiving Set which Can Be Made Portable. The Desk Board is a Very Convenient Arrangement.

I use this set mostly for receiving time signals from Arlington but pick up many long distant stations including (X D A) Mexico City. EUGENE R. MILLER, Frankford, Md.

\$100 "PORTABLE RADIO" PRIZE CONTEST.

Have you seen this important announcement in the May issue of RADIO AMATEUR NEWS, which appeared on page 627?

The publishers offer prizes totalling \$100 in gold for the best article on the smallest, most practical and efficient portable radio telegraph or telephone receiving outfit. Don't miss this. For full details see the above mentioned page in the May number.



Junior Radio Course

How Radio Waves Travel

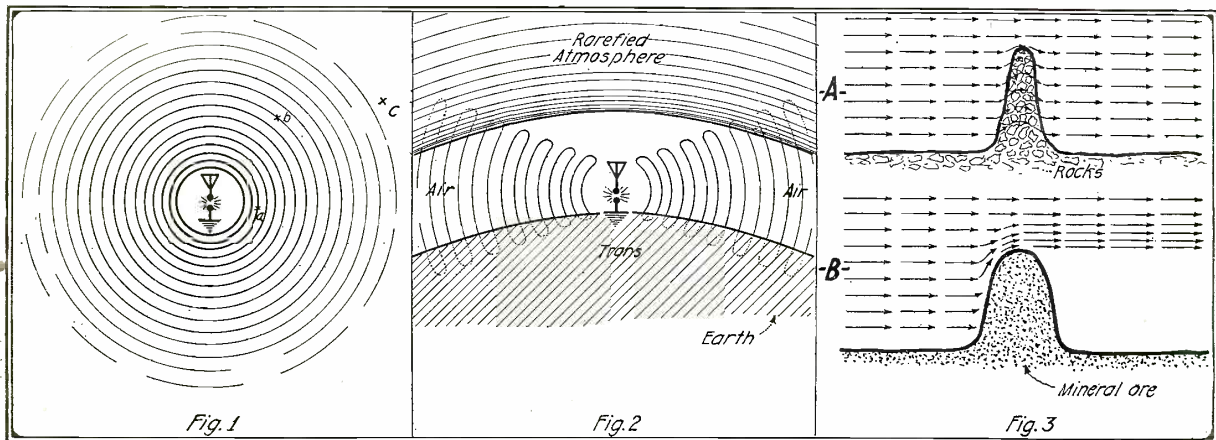

In These Sketches Fig. 1 Illustrates the Manner in Which Radio Waves Spread Out. Fig. 2 Shows a Cross Section of the Circle Shown in Fig. 1 Where the Transmitter Starts the Waves on Their Travel Thru the Space Immediately Surrounding the Earth. Fig. 3 Shows How the Waves Are Assumed to Be Affected in Their Travel Over Hilly or Mountainous Country.

In our last lesson we reached the point of our studies where the transmitter was made to send out waves thru space from the transmitter to the receiver end. You should, therefore, learn something about the manner in which these waves travel over the earth's surface from one point to another.

First, however, we shall refresh your memory with a few necessary facts. There are three general ways of signalling between two or more points which may be said to be:

1. By pushing or pulling a wire or a rod or anything else from one point to another, such as the method employed in the mechanical pull bell; railway signals; etc.

2. By rockets or projectiles or shells, such as those employed by ships at sea to signal to one another.

3. By wave motion such as is used in speech between persons where we send out sound waves and as in radio telegraphy and telephony, where we send out radio waves.

Since we are concerned with radio we shall not describe the first two but instead confine ourselves to the third method which is that of *wave motion*.

In the first lesson of this course (September, 1919, issue) radio waves, usually known as *Electromagnetic Waves*, were compared to water waves. That is, you were shown that radio waves were similar in shape to the small waves or ripples caused by throwing or dropping a stone in a pond of water. Not only that, but you were also shown that these radio waves travelled from the point of their origin to distant points within a complete circle; in other words, they travel in all directions. The *distance* they will travel, of course, depends upon the size of the transmitter or the power at which they are *pushed out* from their starting

point. See Fig. 1 for a clear understanding and reminder of just how radiation of radio waves takes place.

In this illustration, the heavy circles immediately surrounding the transmitter are quite strong in intensity and for that reason the receiving station at *a* will receive the waves quite loud. The circles near *b*, however, being farther away from the transmitter, are not as heavy or strong and therefore the receiver at *b* will receive the waves rather faintly. The circles in the neighborhood of *c*, having travelled a great distance, are almost or completely blotted out and for that reason the receiver at *c* will not respond to the waves at all. This explains the principle of radiation and the part that *power of radiated waves* plays in transmission.

SPEED OF WAVES.

Water waves, sound waves and radio waves travel at greatly different or varying rates of speed. For instance, water waves travel a few inches per second; sound waves travel 1,090 feet per second (or 330 meters); and radio waves travel at the same speed as that of light, which is 186,000 miles per second (or 300,000,000 meters). Memorize these simple figures or write them in your note book, as they are important and will prove useful later as a means of comparison with other speeds, or facts connected with radio.

The more the surface of a pool of water is displaced by dropping small or large stones into it, the greater is the amount of energy passed along from one wave to the next. The amount of energy transmitted by water waves depends upon the height of the ripples or crests. This is also true of all other kinds of waves and so the same principle applies to radio waves. In

radio, however, the height of the waves, that is to say, the displacement between the troughs (bottom) and the crest (top), is called the *amplitude* of the wave. Thus we say that the energy in wave motion depends upon the amplitude.

PROPAGATION.

The travelling of radio waves over the earth's surface is called *propagation*, which means to spread or extend into space. Fig. 2 shows a cross section of the circles shown at Fig. 1 where the transmitter starts the waves on their travel thru the space surrounding the earth. The space thru which the waves propagate reaches up from the surface of the earth to a certain distance above which contains rarefied gases strongly ionized by the sun's rays. For this reason radio waves are theoretically only able to propagate themselves in the air space shown. This air space forms an insulated medium surrounded on the lower side by the earth and on the upper side by the rarefied atmosphere, both of which are conductors and which would ordinarily have the effect of absorbing the waves and preventing them from reaching great distances.

Fig. 3 shows how the waves are assumed to be affected in their travel over the earth surface when their advance is met by hills or mountains of various sizes and substance. *A* is where the waves meet a narrow hill composed of rocks or other fairly good *insulating* substances. In this case the waves are not greatly affected but pass right on without being absorbed. *B* is where the waves are met by a wide hill or mountain composed mainly of mineral matter offering good conductivity and therefore part of the waves are deflected from their path and probably absorbed by the mineral with the

(Continued on page 706)

Dictionary of Technical Terms Used in Radio Telegraphy and Telephony*

Fahrenheit—Thermometer whose freezing point is at 32° and the boiling point at 212°.

Farad—Unit of Capacity. Conductor has capacity of one Farad when a charge of one Coulomb raises its potential by one Volt. This being too big for practical purposes, the Microfarad is usually employed. See Microfarad.

Faure Plates—Accumulator plates partly artificially formed by pasting lead grids with red lead (minimum). After a few charges and discharges the plates become completely formed into positive plate of lead peroxide, PbO₂, and negative plate of spongy lead, Pb.

Fc—Ferum. See Iron.

Feebly Damp—A train of oscillations having many complete oscillatory motions.

Field Magnets—Those electromagnets producing the magnetic field thru which the armature of a dynamo or motor rotates.

Field Regulator—A variable resistance regulating power supplies to Field Magnets.

Flame Arc—One produced between carbons impregnated with, or having a core of certain chemicals such as calcium fluoride, etc.

Flats—Dark marks which appear on commutator or slip rings of a dynamo alternator or motor. Easily removed with very fine emery and an oily rag.

Flat-Top Aerial—Aerial whose upper portion is parallel to earth. See T Aerial and Inverted L Aerial.

Flat Tuning—Exists where adjustment of tunes may be varied considerably without materially altering the strength of the signals heard in the phones.

Fleming Valve—See Valve.

Flex—A flexible wire formed by twisting together a number of very small wires.

Flux—The act of flowing—Motion of a fluid. Liquid state from action of heat. A compound used in soldering to cause two molten metals to flow together, i. e., to unite. See also Magnetic Flux.

Flux Density—Number of Lines of Force per sq. cm. x section, in a magnetic substance or field. Symbol B.

Foci (Plural of Focus)—Central points. Points of convergence.

Force—That which produces or tends to produce a change in a body's state of rest, or change its uniform motion in a straight line. See Various Units.

Forced Oscillations—Oscillations having different frequencies to Natural Frequency of a circuit in which they are set up.

Foucault Currents—See Eddy Currents.

F. P. S.—British system of units. Foot, Pound, Second.

Franklin Circuit—See Reaction Circuit.

Freak—A sudden peculiar change in the working range of radio station, without any alteration being made with regard to power or arrangement of instruments. Range may increase or decrease, or even both at once, i. e., signals become inaudible to a near station, while being strong at a much more distant one. Usually occur at night and early morning, mainly in fine weather and between 20° and 40° both sides of the equator, but occur with less frequency in all latitudes.

Free Magnetism—Magnetism not actually confined to the poles of a magnet.

Free Oscillations—Oscillations having the same frequency as the Natural Frequency of the circuit in which they are set up.

Frequency—Number of waves of complete

oscillations per second. Periodicity.

Frequencies, audio—Frequencies corresponding to normally audible vibrations below 10,000 cycles per second.

Frequencies, radio—Frequencies higher than those corresponding to the normally audible vibrations and usually above 10,000 cycles per second.

Fuller Cell—A Bichromate Cell in which the Zinc rod is placed in a porous pot containing dilute sulphuric acid with a little mercury at the bottom. The bichromate solution is in the outer pot. E. M. F. is about 1.9 Volts.

Fundamental—Serving for a foundation or basis. Primary. A primary principle. Groundwork of a system.

Fundamental Wavelength—Natural wavelength of an aerial or circuit.

Fuse—A short length of conducting material having a low melting point, usually lead wire, inserted in a circuit in such a manner that should the current rise above a safe amount the fuse melts thus break-in the circuit and preventing damage to instruments, etc.

Fusible Metal—See Wood's Metal.

New Radio Patents Page

The publishers again regret being obliged to omit the regular Radio Patents page this month. Up to time of going to press no patents were received from the Patent Office at Washington, information having reached us that none have been printed recently. We shall, however, endeavor to resume the page with the next issue.—The Publishers.

Galena—A natural crystal sulphide of lead. PbS. S.G.7.5. Also called Lead Glance. Has a blue-grey color similar to freshly cut lead. When heated in air becomes lead sulphate. PbSO₄. The cubical crystal is a non-potential rectifier. Is a thermo-electric detector. In use as such, it has an adjustable graphite point or fine metal wire resting on its surface.

Galvanic Cell—See Simple Cell. Named after Galvani, one of the discoverers, also called the Voltaic cell after Volta.

Galvanized—Coated with zinc to prevent rusting.

Galvanometer—An instrument used for detecting the presence of, and ascertaining the force and direction of current in a circuit. Consists of a small iron needle pivoted in the center of a hollow coil of wire, moving a pointer over a graduated scale. See Mirror Galvanometer, and Tangent Galvanometer.

Galvanoscope—Same as the Galvanometer but without the graduated scale.

Gap, Micrometer—Short gap designed to protect apparatus from excessive potentials.

Geissler Tube—A Vacuum Tube having its electrodes placed in bulbs at either end. See Vacuum Tube.

Generator—Any machine for producing electric energy.

German Silver—An alloy of brass and nickel of about 75% brass in the best qualities. Usually manufactured by mixing two molten alloys, one of copper and nickel and the other of zinc and nickel.

Glass—S. G. 2.89. S. I. C. from 6 to 9.

Melting point is 2007° Fahrenheit.

Glass-Plate Condenser—One formed of thin zinc sheets separated by glass plates, the whole being immersed in oil.

Glass Silencer—A glass tube having wooden ends with holes just large enough to admit the discharge rods of an induction coil, thus enclosing the spark gap.

Gold—Au. Aurum. A. W. 195.7. S. G. 19.26. Mit. Pt. 1913° F. S. R. Hard Drawn 2.197. E. Chem. Eq. 0.000,679.1.

Gramme Armature—See Ring Armature.

Graphic Tellurium—Sylvanite. A crystal rectifier. Tellurium in combination with gold or silver.

Gravity—Usually refers to weight, i. e., the attraction of the earth upon a body. See Specific Gravity.

Grid—The frame of wire gauze placed between and insulated from the plate and filament of a Vacuum Tube.

Grid Leak—A non-inductive resistance of denser or between the grid and filament of a three element vacuum tube and designed to permit excess grid charges to leak off to an external source.

Ground—Earth connection.

Ground Clamp—A metal device fastened to a gas or water pipe so as to secure an effective ground connection.

Ground Wires—Wires giving connection to earth.

Grove Cell—A double-fluid cell. Has a zinc rod in a porous pot of sulphuric acid, which is immersed in a jar containing platinum-foil in concentrated nitric acid, which latter is the depolarizer. Voltage 1.9. Has a very low internal resistance.

Growth on Plates—Spongy metallic lead forming on negative plate of an accumulator. Caused by small flakes of paste from positive plate falling on to the negative one where it discharges itself as well as the portion of plate on which it falls. During next charge this flake turns into spongy lead and grows rapidly with each successive charge and discharge. May finally cause short circuit of cell.

Guard Lamps—Straight filament lamps connected in shunt across armature and field leads of rotary converter to protect their respective windings from possible oscillatory surges from high frequency circuits during wireless transmission.

Guttapercha—Substance similar to rubber. Is a leathery, elastic, solid, but not flexible or resilient like rubber. It cannot be vulcanized. It is a very good insulator. S. I. C. about 2.5.

Guys—Ropes used for keeping the spreaders of a vessel's aerial in a horizontal position. Temporary Stays.

H.—Hydrogen.

Halhard—See Halyard.

Halyard—Rope used for hoisting aerial into position.

Hammer Break—Automatic Circuit Interrupter, operated by a magnet, usually the core of the induction coil, attracting the hammer-like head of a brass spring, thereby breaking the contact it normally makes with a brass pillar. Immediately circuit is broken current ceases to flow thru magnet windings, which becoming demagnetized allow spring to again close circuit, the whole process being rapidly and automatically repeated.

Harmonic Curve—See Sine Curve.

Harmonic Motion—Motion giving a Sine Curve.

Harmonics—Incidental waves, differing in length and frequency to the true and

(Continued on page 706)

* This Dictionary was started in our March issue.

Junior Constructor

AERIAL INSULATOR FROM CARTRIDGE FUSE

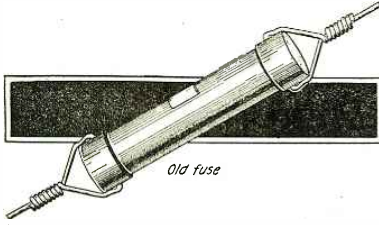

Here is a Way of Employing Old Cartridge Fuses for Aerial Insulators Suitable for Small Installations.

Here is an idea which I think will be of interest to the readers of R. A. N., namely, a Wireless Aerial Insulator constructed from a "blown" cartridge fuse. First melt the solder on the caps and remove the remaining pieces of fuse wire and the filling. Then drill two holes in the cap, as far from the ends as possible in order to include more of the fiber. After the connecting wires are inserted the cartridge may be filled with some insulating compound, such as sealing wax. Due to the insulation value of the fiber, I think that this will be one of the most efficient insulators that the amateur can construct from a liberal supply of "odds and ends."

Contributed by ESTELL M. WATSON.

BALANCED GALENA DETECTOR.

Upon testing many galena detectors and finding their faults I constructed a balanced detector which I have used very successfully. This type has the decided advantage of eliminating the poor pressure control usually found on detectors of other types (due to the unreliable pressure of "catwhisker" wires). It therefore has more accurate pressure control, more uniform in operation, more reliable and is easier to adjust.

The finished instrument is shown in Fig. 1. It will be noted that the cup is movable and the unique pressure control is fixed; this enabling one to obtain and maintain the desired pressure adjustment so essential to good results with galena detectors. The cup is adjustable by means of a ball and socket joint, a piece of spring brass being cut and drilled as illustrated. A brass ball about three-eighths of an inch in diameter is drilled and tapt, and attached to the mineral cup by means of a short screw. These may be spaced by a sleeve, altho this is not essential. The cup may be bought at any company handling radio goods. The base of the instru-

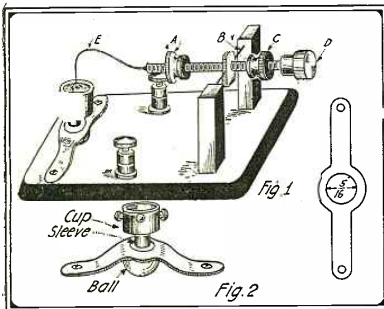

This Method of Detector Adjustment is Not a Bad Idea. Try It.

ment (formica, bakelite, or even composition) should be counter-sunk to receive lower part of the ball. See F, Fig. 2.

The balance arm is a ten twenty-four screw (two and one-half inches long) with its head severed off and in its place an ordinary electrose knob is screwed on. To the opposite end is soldered a gold or platinoid wire, which should be No. 18 or 20. Counter weights, A and C, enable any amount of pressure to be exerted upon the crystal. Knob D counter balances wire E. The trunion, B, is a small disk of brass with two very small screws projecting outward, exactly opposite each other. These have their heads cut off and are sharpened to a point.

The two uprights are then mounted on the base exactly the correct distance apart. These may be square or round rod about one and one-fourth inches long with a very small hole drilled one inch above the base. The points of the trunion rest in these holes and it should be so adjusted that the balance arm swings freely. Binding posts are then mounted and complete the instrument, unless the builder wishes to nickel-plate same for the sake of appearance.

It may be thought that a detector of this type would "jar out" easily, but I have found that this is not the case. Although the arm would ascend when detector is jarred, it would return to precisely the same spot as before, if the separation between the supports is not too great. Once the correct pressure for a certain crystal is found, all that is necessary to adjust the detector is to move the cup until a sensitive spot is located, this method being both rapid and permanent. The very satisfactory results obtainable with this device will more than compensate one for the little time required in its construction.

Contributed by

EDMUND S. SMITH, JR.

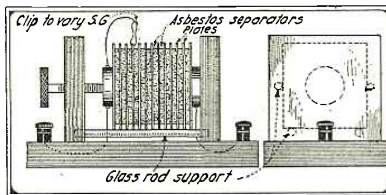

Here is a Little Quench Gap Which the Author Constructed and Found Quite Effective.

QUENCHED SPARK GAP.

First secure some aluminum and from it cut 18 pieces 2" x 2". It will pay you in the end to see that the pieces are perfectly flat. These pieces make up the plates for the gap. Now for the separators. Get some asbestos and from it cut 51 pieces 1 3/4" x 1 3/4". Three pieces of asbestos fit between 2 aluminum plates. Procure some wood and make base and 2 ends as per diagram. Now cut 4 glass rods 3 inches long and fit them into end pieces so they will support the plates and separators. Drill the holes half way through the wood. Through the knob put a screw that will screw in and out of the wood. Next secure 2 tops from two small tin boxes and scrape the paint off of them. Solder wires to them as in the diagram. Get a strip of brass about 2" x 1/4" and bend it like in diagram and solder a wire to it that leads from T1. When assembling be sure that the asbestos separators are 1/8 of an inch from the outside edges of the plates. The knob and screw are to tighten the plates when in position. The clip is to change the number of plates through which the spark jumps.—Contributed by W. E. WEAVER.

"B" BATTERY SWITCH.

This little scheme will help amateurs who

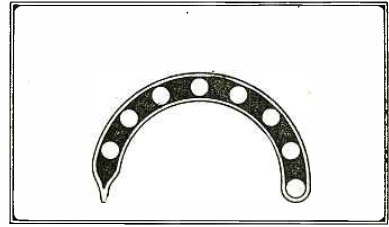

Method of Making "B" Battery Tap Switch Which Prevents Short Circuiting.

are constructing audion panels and do not wish to place dead taps on the B battery control to keep the cells from short-circuiting. The taps are first put in place on the panel, leaving room so that the switch blade will not touch any two at one time. Then a length of tin slightly wider than the taps are high is procured and bent around the taps, as in the illustration; then the insulating material from the top of a dry battery is poured into the spaces between the taps and you have a neat B battery control with no wastage of extra taps.

Contributed by JOHN BOWERS.

AUDIOTRON ADAPTER.

Take a burned-out Marconi VT tube or any other standard base tube, break the bulb and take the filament, grid, and plate out and finish breaking the glass down to, and at least and perhaps a little below the brass base. The four lead-in wires of the base may be taken out by putting a hot iron on the ends of the pins of the base and longer insulated wires substituted, thus preventing short circuits. Now the brass cup is filled one-third full with wax and, while soft, one end of the Audiotron bulb is inserted and held down. While being held fill the cup with melted wax. When cold, this makes a very desirable and convenient adapter for Audiotron purposes which may be used in the standard VT socket. The connections between the wires on the pins and the bulb can be made after the wax is cold. The wires from pins should be marked before wax is put in to be sure that they are correct. This may be done by putting the base into a standard socket and then marked. The wires outside of tube may be prest snugly against tube.

Contributed by ALFRED T. SIRRINE.

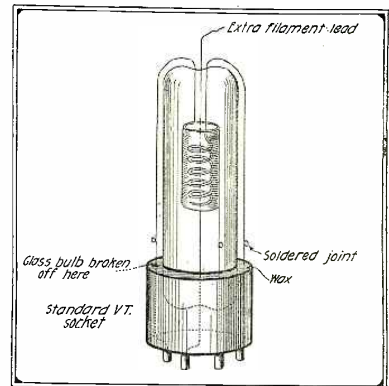

Now That Audiotrons are Scarce, Save Them from Injury by Mounting Them in This Adapter.



THIS Department is conducted for the benefit of our Radio Experimenter. We shall be glad to answer here questions for the benefit of all, but we can only publish such matter of sufficient interest to all.

1. This Department cannot answer more than three questions for each correspondent.
 2. Only one side of the sheet should be written upon; all matter should be typewritten or else written in ink. No attention paid to penciled matter.
 3. Sketches, diagrams, etc., must be on separate sheets. This Department does not answer questions by mail free of charge.
 4. Our Editors will be glad to answer any letter at the rate of 25c for each question. If, however, questions entail considerable research work, intricate calculations, patent research, etc., a special charge will be made. Before we answer such questions, correspondents will be informed as to the price charge.
- You will do the Editors a personal favor if you make your letter as brief as possible.

CONDENSER CAPACITY AND CONSTANTS.

(175) R. Elvert, Elmira, Ill., asks:

Q. 1. Can you give me the constants of the most widely used dielectrics?

A. 1.

Dielectric Constants	
Paraffined rice-paper.....	3.65
Bees' waxed rice-paper.....	2.53
Shellacked rice-paper.....	3.60 to 4.25
Mica sheet (pure).....	4.00 to 8.00
Flint glass (light).....	6.85
Common glass (radio frequency).....	3.25 to 4.21
Common glass (audio frequency).....	3.02 to 3.09
Castor oil.....	4.80
Transformer oil.....	2.50
Ebonite.....	2.05 to 3.15
Air (at ordinary pressure).....	1.00

Q. 2. How may the capacity of condensers be determined? If possible, give formula.

A. 2. A simple formula is herewith given:

$$C = \frac{KA}{4\pi D \times 9 \times 10^9}$$

where

- C = Capacity in microfarads.
- A = Area of one side of one conducting plate in square centimeters.
- K = Dielectric constant as shown on table above.
- D = Thickness of dielectric between plates in centimeters.

$$\pi = 3.1416$$

This formula can be reversed, so that should the capacity be known, the area of plates required can be determined when designing a condenser, thus:

$$C4\pi D \times 9 \times 10^9 = KA$$

These formulae are only roughly approximate, but should be of considerable assistance to the experimenter when building his own instruments. The same formulae can be used for condensers of more than two plates by taking the total area of the active surfaces of all plates attached to one terminal of the condenser. Thus it will be seen that the capacity of a condenser is proportional to the area of its plates, their distance apart and the value of the dielectric used.

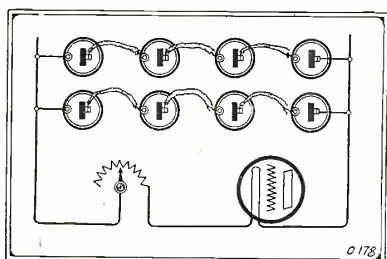

Manner of Connecting Dry Cells in Series-Parallel for Vacuum Tube Work Suitable for Temporary Work or When Storage Cells Are Not Available.

AN EARTH CONNECTION.

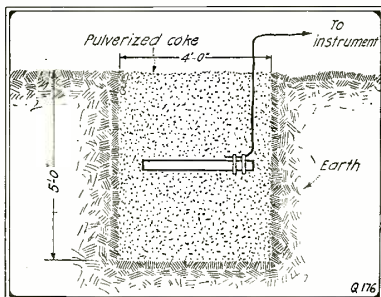

One Way of Securing a Ground When Water Pipe or Other Means Are not Available.

(176) J. Brown, Chicago, Ill., wishes:

Q. 1. Description of an efficient ground where gas or water mains are not to be had.

A. 1. Securing a proper ground is a very important subject. A heavy No. 12 or 14 wire should be securely bolted and soldered upon a metal plate having the general dimensions of 3 feet by 3 feet. This plate is then buried in moist soil. If no moist soil is obtainable it is good practise to surround the plate in pulverized coke to a depth of about five or six feet. See figure accompanying this question.

Q. 2. Is there a monthly publication issued by the Government which gives timely information on radio laws and other data necessary to commercial and amateur operators?

A. 2. Yes, such a publication appears regularly each month, entitled "Radio Service Bulletin." It is issued by the Bureau of Navigation, Department of Commerce, Washington, D. C., and may be secured by writing to the Superintendent of Documents, Washington, D. C. The charge is five cents per copy and twenty-five cents per year. This bulletin contains all important changes in radio regulations, applying to both commercial and amateur operators. Additions and changes of call letters are also given.

DRY BATTERIES FOR VACUUM TUBES.

(178) A. F. Kelly, San Francisco, Cal., asks:

Q. 1. What is the best way to get around using a six-volt storage battery to light the filament of an audion circuit? Are there any other types of batteries that can be used, and can ordinary dry cells be employed?

A. 1. You may use primary cells of the bichromate, Bunsen or Edison primary types. Dry batteries may also be used, but in the long run are really more expensive than buying a storage battery outright. If you must use dry cells they must be connected in series-parallel, as shown in the accompanying diagram.

Q. 2. Which is the best bulb to use, the Marconi VT or the audiotron?

A. 2. Both tubes have been found to give excellent results.

AMATEUR LICENSES.

(179) C. L. Swan, Decatur, Ill., asks:

Q. 1. How can I make a suitable secondary condenser for a 1/2 Kw. transformer?

A. 1. An effective transmitting condenser may be made by using tin-foil sheets on plate glass. A good quality of glass should be selected such as old photographic plates, which can be readily obtained. A square sheet of glass 9 by 9 and 1/8 inch in diameter may be covered on both sides by tin-foils to within one inch from edges, and will have a capacitance of about .0005. Sixteen plates of this type placed in parallel will give you sixteen times that capacity or .008 mfd. Forty such plates will do for a 1/2 Kw. set and if the transformer secondary exceeds 20,000 volts a series-parallel connection should be employed.

Q. 2. Is it necessary to have a Government license to send even when located several hundred miles from the nearest Government station?

A. 2. Yes, an amateur transmitter, no matter of what size, must be licensed by the Government. Write to your nearest Department of Commerce Radio Inspector.

TYPES OF AERIAL AMMETERS.

(180) J. Bennet, New York City, writes:

Q. 1. How many types of antenna ammeters are there at present in general use and what is their manner of operation?

A. 1. There are two general types in use. One employs wire or strips which expand when heated by the antenna current, thereby moving an indicating device or needle. The other type makes use of a thermo-couple arranged upon a wire heated by the high-frequency current.

SIZE OF AERIAL FOR AMATEUR TRANSMISSION.

(181) Herbert Bradley, South Haven, Mich., asks:

Q. 1. Please tell me what size my aerial (Continued on page 721)

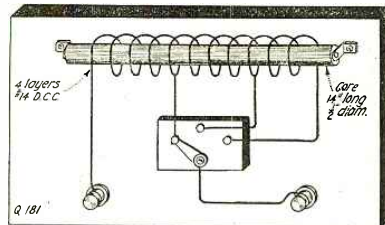

Schematic Diagram of Reactance Regulator Suitable for 1/4 k. w. Transmitter.

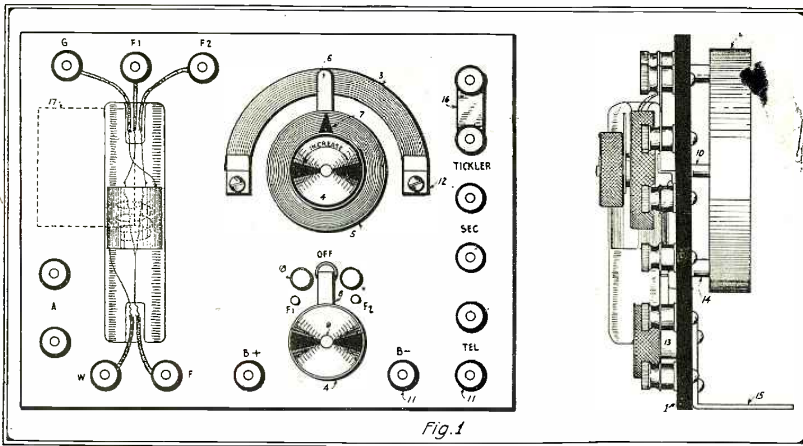

This Illustration Shows the Construction Details of the Panel in a Front as Well as Side View. Each Part is Numbered Corresponding to the Data Given by the Author in This Article.

Compact Tube Control Panel
(Continued from page 695).

brass rod. A No. 12 drill thru the center will give a good running fit to the 3/16" shaft of the rheostat. The two knobs are cut from 3/8" hard rubber sheet and knurled. The sizes are to be had from 4 & 5.

The small "on" and "off" switch is held clear of the panel by the spacer shown in 13. Contacts for the same are detailed in 18. Screw them to the panel with 3/16" x No. 8-32 R.H.I.M.S. with connection clips under their heads. The switch is held in place by a nut and a spring washer.

Designation 3 of Fig. 2 gives the general dimensions of a type of graphite potentiometer that may be purchased at any of the leading supply houses. Be sure that its resistance is 6,000 ohms or more. Clips for holding it are shown in 12.

Two posts at the upper right hand corner of the panel are provided for the connection of a tickler coil. When not in use they are shorted by the jumper, 16. This jumper could be improved if notched out at one side so as to permit it to swing free of one post without taking it off the panel.

Designation 15 is a two-view sketch to show the drilling of the legs or mounts. Make them of No. 14 gage spring brass sheet.

Screw the rheostat to the panel by means of 2 No. 8-32x1" F.H.I.M.S. It is held a slight distance from the panel by fiber blocks to permit the running of wires underneath it.

All wiring should be of No. 14 bare copper wire run in "Empire Cloth" tubing. Bend all corners square and use only resin-core solder for connections to the clips. Fig. 3 gives a detailed view of connections as seen when looking from the rear. The left hand end of the rheostat winding is the free end. The double circles shown at each end of the rheostat winding are to represent the heads of the machine screws on the terminal plates which serve to complete the circuit.

The various designation numerals in Fig. 1 correspond to those of Fig. 2. While building the set, the experimenter may thus refer to both figures and in this way better understand construction details as well as proper perspective of the numerous parts.

This panel is designed for connection to the left of the receiving cabinet as nearly all loose couplers have their primaries as well as all of their terminals to the left. If it is desirable the drilling of the panel may be completely reversed to permit connection to some of the more modern receiving sets.

If simplicity has a great deal to do with successful operation this little panel will surely improve the best of sets.

Some Timely Information

Station	Call letters	Wave lengths	When sent
Annapolis, Md.....	NSS	Meters *17,000	Daily at 11.55 a. m. to noon and 9.55 to 10 p. m., standard time, seventy-fifth meridian.
Balboa, Panama.....	NBA	* 7,000	Daily at 4.55 to 5 a. m. and 12.55 to 1 p. m., standard time, seventy-fifth meridian.
Cavite, P. I.....	NPO	{ 5,000 †952 † 1,500	Daily at 10.55 to 11 a. m. and 9.55 to 10 p. m., standard time, one hundred and twentieth meridian, east.
Colon, Panama.....	NAX	† 1,500	Daily at 4.55 to 5 a. m. and 12.55 to 1 p. m., standard time, seventy-fifth meridian.
Eureka, Calif.....	NPW	2,000	Daily at 11.55 a. m. to noon, standard time, one hundred and twentieth meridian, west.
Great Lakes, Ill.....	NAJ	1,512	Daily except Sundays and holidays at 10.55 to 11 a. m., standard time, nineteenth meridian.
Key West, Fla.....	NAR	1,500	Daily at 11.55 a. m. to noon, standard time, seventy-fifth meridian.
New Orleans, La.....	NAT	1,000	Daily at 11.55 a. m. to noon, standard time, seventy-fifth meridian.
North Head, Wash.....	NPE	2,800	Daily at 11.55 a. m. to noon, standard time, one hundred and twentieth meridian, west.
Pearl Harbor, Hawaii....	NPM	{ *11,200 †600	Daily at one hundred and eightieth meridian, mean noon.
Point Arguello, Calif.....	NPK	1,512	Daily except Sundays and holidays at 11.55 a. m. to noon, standard time, one hundred and twentieth meridian, west.
San Diego, Calif.....	NPL	{ *9,800 †2,400	Daily except Sundays and holidays at 11.55 a. m. to noon, standard time, one hundred and twentieth meridian, west.
San Francisco, Calif.....	NPH	{ *4,800 †2,400	Daily at 11.55 a. m. to noon, standard time, one hundred and twentieth meridian, west.
Washington, D. C.....	NAA	2,500	Daily at 11.55 a. m. to noon and 9.55 to 10 p. m., standard time, seventy-fifth meridian.

* Arc.

† Spark.

Time Signals By Radio

The Director of Naval Communications advises that time signals are being transmitted by the United States naval radio stations as shown on lower left hand of this page.

APPLICATIONS FOR RADIO CALL LETTERS.

Applications for radio call letters for ships should be filed with the collectors of customs at the various ports at the time application is made for the official number and signal letters and *not* before such time. When the official number has already been assigned, the application should give the number, and, in case a vessel has had a former name, the name should be given. All particulars regarding the hours of service, class of service, rates, etc., should be reported without delay in order that the information can be published in the RADIO SERVICE BULLETIN. When it is very inconvenient to apply to the collector of customs, application may be made to the radio inspector.

LAND-STATION LICENSES.

All commercial land stations, experimental and technical and training stations are required to obtain a license before operating, as required by section 1 of the act of August 13, 1912. The filing of the application or the assignment of radio call letters does not constitute authority for operating a station. Owners of stations who fail to comply with the above requirements may expect action to be taken in accordance with the above-cited act.

AMENDMENTS.

The Radio Laws and Regulations of the United States, edition August 15, 1919, are hereby amended as follows:

Page 58, paragraph 86, amended April 15, 1920, to read:

When applications and forms have been properly submitted, *ship and amateur* stations may be operated in accordance with the laws and regulations governing the class of station for which application for license has been made, until such time as the application can be acted upon unless the applicant is otherwise instructed and provided temporary official call letters are assigned.

Page 63, paragraph 119, amended May 1, 1920, to read:

If the applicant qualifies, the radio inspector or examining officer will forward the papers to the Commissioner of Navigation, with his recommendation. If approved, the license will be properly indorsed by the Secretary of Commerce and delivered to the license thru the recommending officer.

It will be noted that the following was eliminated from the above paragraph: "A blank commercial license, with."

USE OF 800 METER WAVE LENGTH.

The wave length of 800 meters, for radio compass work exclusively, must not be used for general public service messages. This is prohibited by the act of August 13, 1912, and the International Radiotelegraphic Convention.

EXAMINATIONS.

On and after this date radio inspectors will be governed by regulation 133 in the reexamination of applicants for radio operators' licenses, which requires applicants who fail to pass to wait three months before applying for another examination.

IT'S WIRELESS ALL RIGHT!

Dubb—"I received a wireless message yesterday."

Stubb—"How was that?"

Dubb—"They sent it through the mail."

C. A. MAIER, JR.

MURDOCK No. 55

IN APPEARANCE
THESE 'PHONES
SATISFY THE RE-
QUIREMENTS OF
THE MOST CRIT-
ICAL.

2000
OHM
COMPLETE
DOUBLE SET
\$4.50

IN DURABILITY,
THESE 'PHONES
WILL SERVE AS
LONG OR LONGER
THAN ANY.



IN OPERATION
THESE 'PHONES
SURPASS IN SENSI-
TIVENESS THE EX-
PECTATIONS OF
THE MOST OPTI-
MISTIC.

3000
OHM
COMPLETE
DOUBLE SET
\$5.50

IN RELIABILITY,
THESE 'PHONES
YIELD TO NONE,
THEIR CONSTRU-
CTION INSURING
"ALL-THE-TIME"
SERVICE.

RIGHT IN PRICE AND IN PERFORMANCE

The substantial success earned by these receivers can be attributed to the instant recognition and acknowledgment of their remarkable value, by thousands of users. If, by chance, you are not acquainted with their merits, or are dubious regarding the possibility of securing really good 'phones at such prices, we suggest a trial, with the customary assurance of "satisfaction or money back."

Our Bulletin No. 19B Illustrates and describes the Complete Line of Reasonably Priced MURDOCK APPARATUS. A Copy Will Be Sent at Your Request.

WM. J. MURDOCK CO.

50 CARTER ST.

CHELSEA (BOSTON 50) MASS.

509 MISSION STREET,

SAN FRANCISCO, CAL.

"Old Town Canoes"

You can lazy-paddle an "Old Town" all day long. "Old Towns" are light, buoyant Canoes that answer the slightest pressure of the blade.

They are strong, sturdy canoes built for years of service. The "Sponson Model" is safer than a row boat. Write for catalog. 3000 canoes in stock.

OLD TOWN CANOE CO.
936 Fourth St.
Old Town, Maine, U. S. A.

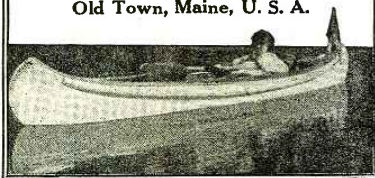

W. SIEGERT

Wood & Metal
Patterns & Models

1250 WEST 97th PLACE
CHICAGO ILLINOIS

TELEGRAPHY

Both wire and wireless, and Station Agency taught thoroughly and quickly. **BIG WAGES NOW PAID**, some of our recent graduates procuring \$138.00 per month to start. Great opportunities for advancement. Our school the oldest and largest—annual enrollment 600 students. Endorsed by railway, telegraph, wireless and government officials. Expenses low—chance to earn part. Catalog free. Write. **DODGE INSTITUTE**, 26th St. Valparaiso, Ind.

Tucker's Overall Waterproofing Insulator

Grade A replaces Shellac, Rubber and Tape on Tubes, Coils, Wires and Terminals. Used on Cotton Covered wire will carry high Voltage under water. Used on Terminals, prevents leaks, short circuits. Grade B. used in Cables and lead wires. Will stick to anything. Not affected by salt water, acid, oil. 90¢ pt., \$1.50 qt., \$5.00 gal. Tucker Waterproofing and Insulating Co., 664 Pleasant Street, Brockton, Mass.

POPULARITY FOLLOWS THE UKULELE

If you play quaint, dreamy Hawaiian music or latest songs on the Ukulele you will be wanted everywhere. We teach by mail 50 simple lessons, give you free a genuine Hawaiian Ukulele, music, everything no extra. Ask us to send the story of Hawaiian music. You will love it. No obligation—absolutely free.

The Hawaiian Institute of Music
1400 Broadway, Dept. 13F New York

PRaise RABBITS



Make \$60 a year profit from one pair. Thousands are doing it right now. It's easy, pleasant, profitable work and we help you get started.

Write today for circular.

ON SUPPLY HOUSE. Box 251. Hanover, Pa.
"Pigeons-Poultry-Pet Stock"

Junior Radio Course

(Continued from page 700)

result that less energy will reach the distant receiver owing to the fact that the waves have been *reduced in amplitude*.

In any case, whether the hill or mountain is composed of rocks or minerals, the waves suffer a certain amount of *bending* or *deflection* as in B and that is the reason why it is bad practise to erect a receiving or transmitting station near the base of hills or mountains.

QUESTIONS FOR THIS LESSON.

1. What is the speed of radio or electromagnetic waves?
2. What does the amplitude of radio waves depend upon?
3. What is Propagation?
4. How do hills or mountains affect the movement of radio waves?
5. Where is the best place to erect the antenna of a radio station?

NOBODY HOME



Courtesy of Albany, N. Y. Knick. Press.

Radio Dictionary

(Continued from page 701)

original wave of a transmitter. They are most noticeable in undamp't wave operation. In an earthed aerial the first harmonic is three times that of the natural frequency of, or one-third wavelength of aerial; second is five times the natural frequency or one-fifth wavelength; while the third is seven times and one-seventh, respectively.

Height of Aerial—Range of a station with constant power is dependent upon height of aerial so long as it does not alter the radiation, etc., i. e., increase of height increases range.

Helix—A hollow coil with only one "layer" of wire.

Henry—Unit of Inductance. Is that inductance in a circuit when amperage is changing at rate of one ampere per second and producing a difference of potential in that circuit of one volt.

Hertz, Heinrich—First scientist to prove the existence of and method of producing and measuring electric or other waves.

(Continued on page 723)

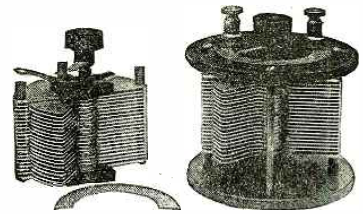

The "ILLINOIS" VARIABLE CONDENSER

Hard Rolled Aluminum Plates

Three Styles, No. 1. Panel, No. 2. Open Type as shown, No. 3. Fully Encased. Anti Proflator. Less than pre-war prices. Fully assembled and tested.

Style	No. 1	No. 2	No. 3
Plates	\$3.00	\$4.00	\$4.25
28 "	2.50	3.50	3.75
13 "	2.25	3.25	3.50

In Canada 25c additional

Sent Prepaid on Receipt of Price

Money back if not satisfied. Just return condenser within 10 days by insured P. P. These condensers are made by a watch mechanic schooled in accurate workmanship. Personally we will need no introduction to Amateurs who have "listened in" for "time" and "weather" from 9. ZS.

Postscript.

The above "Ad" certainly put "ILLINOIS" "on the map" in the Condenser Industry. Not only on the map, but scattered it all over the map, from Alaska to the Gulf, and from the Penobscot to the Golden Gate. The "money back" proposition seems to have been superfluous. Instead of having any instruments returned for credit, they ask for more. And, most satisfactory of all to us, our customers write to express their appreciation. All these, we take this occasion to thank heartily.

You will note a slight increase in our price list, on the "meunted" styles only. This will be effective from May first. The fact is we could not quite "get by" with our first prices.

The "Star Spring" feature of our design meets with great favor. We shall make this the subject of application for Patent, as we think it marks a step forward in the construction of Variables. It has two important functions. It keeps the plate accurately and permanently centered; without "endshake"; and provides sufficient friction to hold the "rotor" at any setting without liability of its dropping from its position by the unbalanced weight. It makes the Condenser, in this respect as reliable as the much more expensive "balanced" type.

Kindly note: We issue no Catalog, and make no "trade discounts." We set our prices at the lowest limit, and leave the "middle man" out for the sole benefit of the "consumer."

G. F. Johnson, 625 Black Ave., Springfield, Ill.

Brooklyn Radio Men

If you want good standard Wireless apparatus we cordially invite you to examine our complete line of all famous Manufacturers

RADISCO, GREBE,
MURDOCK, ETC.

Everything from Contact points to complete Stations sold at catalog prices.

Out Of Town Amateurs

Our delivery service is the most complete for reaching all points of the U. S. in the shortest possible time after receipt of your order. Our big stock of all standard radio parts, enables us to serve you promptly, give us a trial.

Agents for RADISCO Apparatu

KELLY & PHILLIPS

Brooklyn's Wireless Store
312 Flatbush Avenue,
Brooklyn, New York

ARE YOU SELF-CONSCIOUS?

Embarrassed in company, lacking in self-control? Let us tell you how you can overcome these troubles.

THE VERITAS SCIENCE INSTITUTE
1400 Broadway DESK 24 New York

RADIO APPARATUS

Distributors of Reliable Radio Apparatus for Experimenters in every branch of the Radio Field

“PITTSO” THE SIGN OF SERVICE AND IMMEDIATE DELIVERIES! ALL WE ASK IS A TRIAL!



REMEMBER WE CARRY AN IMMENSE STOCK AND CAN MAKE IMMEDIATE DELIVERY ON EVERY ITEM LISTED.

ANTENNA WIRE

- No. F-1 7 strand No. 22 tinned copper per foot.....\$0.01¼
- 500 ft. or over, per ft.....\$0.01
- No. F-2 No. 14 hard drawn copper, per lb.\$0.50
(80 ft. per lb.)
- No. F-3 7 strand No. 20 phosphor bronze, per ft.....\$0.02¼
- 500 ft. or over, per foot.....\$0.02
- F. D. PITTS CO., BOSTON, MASS.

GROUND EQUIPMENT

- No. G-1 100 Amp. 600 V. Ground switch.\$4.50
- No. G-2 Weather proof No. 4 Ground wire, per ft.....\$0.10
- No. G-3 Heavy porcelain knob, with screw for wire, complete, ea.....\$0.12
- F. D. PITTS CO., BOSTON, MASS.

GREBE BAKELITE DIALS

- No. PDA 0-100 4" dia. for variometers, couplers, etc.\$3.00
- No. PDB 0-50 4" dia.\$2.75
- No. PDC 0-100 3" dia.\$2.50
- No. PDD 0-50 3" dia.\$2.25
- F. D. PITTS CO., BOSTON, MASS.

RHEOSTATS

- No. R-1 Porcelain base.....\$1.10
- No. R-2 Remler back mounting.....\$1.75
- No. R-3 Paragon back mounting.....\$1.75
- No. R-4 General Radio back mounting.....\$2.50
- F. D. PITTS CO., BOSTON, MASS.

JACKS

- No. 1423-W Federal 2 circuit.....\$0.90
- No. 1422-W Federal closed circuit.....\$0.65
- No. 1421-W Federal open circuit.....\$0.55
- No. WE-1 Western Electric 2 circuit.....\$0.90
- No. WE-3 Western Electric open circuit.....\$0.55
- F. D. PITTS CO., BOSTON, MASS.

PLUGS

- No. 1428-W Federal Brass plug.....\$1.50
- No. 1428-W Federal silver plated.....\$1.75
- No. WE-4 Western Electric Brass.....\$0.95
- F. D. PITTS CO., BOSTON, MASS.

ANTI-CAPACITY SWITCHES

- No. 1424-W Federal DPDT 12 spring..\$2.50
- No. 1426-W Federal DPST 4 spring...\$2.25
- No. 1427-W Federal DPST 4 spring...\$2.35
- Note—1424-W and 1427-W are normally open, 1426-W normally closed.
- F. D. PITTS CO., BOSTON, MASS.

“B” BATTERIES

- No. P-1 Standard 22.5 volt small size..\$1.35
- No. P-2 Standard 22.5 volt large size..\$2.40
- No. 366 Everready 22.5 volt large size..\$3.25
- No. P-3 Everready flashlight, batteries 45 volts, set of 10.....\$3.50
- F. D. PITTS CO., BOSTON, MASS.

BUZZERS

- No. 178 General Radio.....\$1.95
- No. 77 Mesco H. H. frequency.....\$2.05
- No. 5 Century.....\$1.95
- No. 9010 Watch case brass.....\$0.75
- No. 9011 Watch case N. Plated.....\$0.75
- F. D. PITTS CO., BOSTON, MASS.

CRYSTALS

- No. B-1 Galena mounted in Wood's metal.....\$0.50
- No. B-2 Silicon mounted in Wood's metal.....\$0.50
- No. B-3 Galena unmounted.....\$0.22
- No. B-4 Silicon unmounted.....\$0.22
- No. B-5 Piece of Wood's metal, enough to mount crystal.....\$0.25
- Note—These crystals are exceptionally sensitive.
- F. D. PITTS CO., BOSTON, MASS.

DETECTOR SOCKETS

- No. GR-1 General Radio.....\$1.75
- No. MW-1 Marconi.....\$1.50
- No. R-300 De Forest.....\$1.50
- No. 550 Murdock.....\$1.00
- F. D. PITTS CO., BOSTON, MASS.

GRID LEAKS

- No. MW-2 ½, 1, 2, 3 or 5 megohms, ea.\$1.00

- No. G-100 De Forest variable type.....\$0.75
- No. ROCA Grebe grid cond. and 5 megohm leak.....\$1.60
- No. ROCB Grebe grid cond. and 3 megohm leak.....\$1.75
- F. D. PITTS CO., BOSTON, MASS.

AMMETERS

- No. H-1 Hoyt, jeweled bearing 0-3 amps. D. C. for Vacuum tubes, flush mounting.....\$7.50
- No. H-2 Hoyt, jeweled bearing D. C. 0-10 volts, flush mounting.....\$7.95
- No. W-1 Weston Model 301 0-3 Amps. D. C. for Vacuum tubes, flush mounting.....\$7.80
- No. W-2 Weston Model 301 0-50 volts. D. C. for Vacuum tubes, flush mounting.....\$7.80
- F. D. PITTS CO., BOSTON, MASS.

HONEY COMB COILS

- (Litz Wire.) (While they last.)
- LL-75.....\$1.66
- LL-100.....\$1.76
- LL-150.....\$2.11
- LL-200.....\$2.24
- LL-250.....\$2.47
- LL-300.....\$2.66
- LL-400.....\$3.10
- LL-600.....\$2.91
- LL-750.....\$3.11
- LL-1000.....\$3.57
- LL-1250.....\$3.99
- F. D. PITTS CO., BOSTON, MASS.

TELEPHONES

- No. 1 Type C. Baldwins, standard Navy type.....\$16.50
- No. 2 Type E. Baldwins, new type smaller.....\$18.50
- Brandes "Superior" 2000 ohms.....\$ 7.00
- Brandes "Trans-atlantic" 2800 ohms.....\$10.00
- Brandes "Navy Type" 3200 ohms.....\$14.00
- No. 32-W Century, standard Navy type 2200 ohms.....\$12.50
- No. 32-W Century, standard Navy type 3200 ohms.....\$14.00
- No. 55 Murdock 2000.....\$ 4.50
- No. 55 Murdock 3000 ohms.....\$ 5.50
- F. D. PITTS CO., BOSTON, MASS.

Important! Every article listed sent to any part of the United States postage prepaid or express prepaid. We want your business!

Series No. 3

(Keep this page and watch for next month's)

SEND 6 CENTS IN STAMPS FOR NEW CATALOG!

F. D. PITTS CO., Inc.

12 Park Square

Dept. C.

Boston, 11, Mass., U.S.A.

Why the
ROLLER-SMITH
T-A-W
Radio Ammeter?

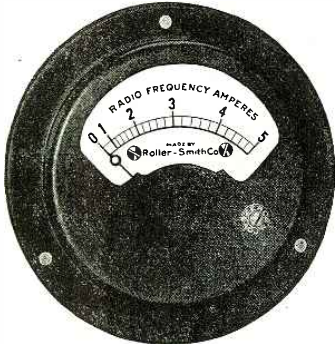

Type T-A-W, for flush mounting

Because it is
Simple,
Dependable, and
Universally useful
in your radio station for
measuring
radio frequency current,
audio frequency current
and
direct current.

Our V—T-A-W Catalogue
is yours for the asking.

ROLLER-SMITH COMPANY
Electrical Instruments Meters and Circuit Breakers

MAIN OFFICE:
15 Barclay St., New York

WORKS:
Bethlehem, Pennsylvania
CHICAGO, Monadnock Block
CLEVELAND, 6523 Euclid Ave.
DETROIT, Majestic Bldg.
Other Offices in Principal Cities

SKINDERVIKEN BUTTONS

\$1
Radio Apparatus
Bought, Sold, Built
C. McCONNELL
38 Warner Street
Springfield, Mass.

**French Applications of
the Vacuum Tube**

(Continued from page 680)

**HETERODYNYING AND THE SUPPRESSION OF
PARASITE NOISES.**

Heterodyning as we have seen produces in a very simple manner a means of local undamped wave oscillation, the wavelength of which may vary from 250 to 24,000 meters. It is with the aid of these waves that all manner of high frequency measurements may be made, the details of which is not within the province of this article. We will mention, however, a few words concerning an arrangement devised by Lieutenant Lévy, designed to eliminate parasite noises which have been termed "howling" in the United States, also those noises caused by atmospheric electricity or "static" which are absorbed by the receiving antenna or loop and which greatly interfere with reception at certain times and particularly in certain climates. Here is the principle of this ingenious arrangement which has already given very good results but which unfortunately is only applicable to undamped waves.

The wave to be received is impressed upon a primary heterodyne circuit which causes beats of a frequency in the neighborhood of 10,000 and which are consequently hardly audible. These beats are amplified and detected by an amplifier detector consisting of three vacuum tubes. After this the inaudible frequency currents which result from this detector-amplifier are impressed upon a second heterodyne circuit having for example a frequency equal to 9,300 and thus a second series of beats is produced of audible frequency, in other words, the frequency of the beats is equal to the difference between the frequency of the oncoming wave (in this case 10,000) and that of the local wave (9,300), the result of which is *once more amplified* and detected by an amplifier-detector having a resonance adjusted to the frequency of 10,000. In reality this resonant amplifier-detector and the generator of waves having a period of 9,300 constitute a single apparatus.

Parasite noises give rise to greatly damped oscillations. They do not act upon the second amplifier-detector, or at least if they do the action is very small and thus due to this detection of two stages the noises are considerably decreased.

It is with an arrangement of this type, employing the large antenna of the Eiffel Tower that the signals emanating from American radio stations were successfully intercepted which, with the ordinary receiving apparatus, were completely "blotted out" by parasite noises. If the arrangement of Lieutenant Lévy gives the future results which are expected of it, it will prove extremely interesting and useful particularly for stations located in tropical countries; in fact, in these localities atmospheric discharges are of such intensity at times that they often prevent all radio traffic during the night as well as during certain hours of the day. It is thus seen that if a satisfactory anti-howling arrangement is devised it will considerably reduce the number of radio stations; and by making reception less difficult it will also have a tendency to reduce excessive transmitting energy.

(Continued on page 710)

J. EDW. BROADBELT, Jr.

Maker of

**Precision Radio
Equipment**

553 East 38th Street · Baltimore, Md.

Standard and Special Apparatus
Instruments Built to Specifications

The Radio Engineering Company
MANUFACTURERS OF



"RADIO APPARATUS"

Beg to announce their reorganization and the opening of a show room and distribution center FOR THE SOUTH, of all standard radio apparatus.

The famous

"RECO" KEY

reduced for a short time to \$6.50. Six cents in stamps will bring our new and revised catalog now on the press.

Note New Address:

616 N. Calvert St., Baltimore, Md.

CALL 3 838

ANNOUNCING

**RADIO
SERVICE
TYPE S2
RECEPTACLE**

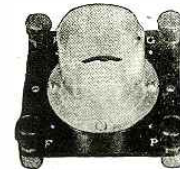

at the reduced price
of **\$1.50**
altho recognized as
the best socket obtainable. *Just ask your dealer.*

RADIO SERVICE & MFG. COMPANY
Lynbrook, L. I., New York

**WILCOX PANEL
SWITCHES**

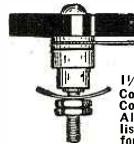

"The Best"

1/2 In. Radius Postpaid Price
Complete Switch, polished brass finish. 50c
Complete Switch, nickel plated finish. 60c
All kinds of Switches, Parts, etc., are listed in our loose-leaf Catalog "G." Sent for 5 cents in coin.

THE WILCOX LABORATORIES, Lansing, Mich.

Have you seen our 2500 meter

NAVY COUPLER at \$11.50

Send for circular.

PENN RADIO APPARATUS CO.
Greenville, Pa.

NEW ORLEANS

**WIRELESS SUPPLIES AND
MINERALS OF ALL DESCRIPTIONS**
L. A. ROSE
121 Camp Street
NEW ORLEANS, LA.
SEND 6 CENTS FOR CATALOG

WIRELESS AMATEUR

Send a 2c stamp for full description of the most efficient detector in the wireless field today.
Tested by Marconi Wireless Telegraph Co. and U. S. Government. Instantly adjustable at a constant pressure.

L. STEWART BARR, Inventor, Vice-President of The Service Radio School
THE BARR MERCURY-CUP DETECTOR Dept. B, The Wyoming, Washington, D. C.

30 DAY SPECIAL OFFER The WIRELESS EXPERIMENTERS MANUAL Price \$2.25 (E. E. Bucher's New Book) and one year's subscription to THE WIRELESS AGE \$2.00

Wireless Press
326R Broadway
New York City

Both for only \$3.75
Postage outside U. S. 50c extra.
Send for catalog.

Announcing New Prices

(EFFECTIVE JUNE 15, 1920)

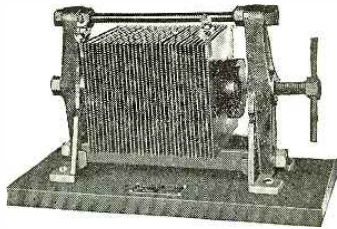

Type G-3

AMRAD QUENCHED GAPS

are now built for all classes of amateur stations. No matter what your conditions you can cover more miles per watt using the Amrad Quenched Gap, than with any other type.

Type G-1 20,000 volts up, 1 K.W. \$29.75

Type G-2 10,000 volts up, 1/2 K.W. \$18.75

Type G-3 5,000 volts up, 1/4 K.W. \$13.50

(Also for Induction Coils)

AMRAD RESISTANCES

Essential for obtaining highest efficiency and double frequency note with Amrad Quenched Gaps.

Type A-1 for 1 K.W. transformers, \$9.50

Type A-2 for 1/2 K.W. transformers, \$6.75

Type A-3 for 1/4 K.W. transformers, \$4.50

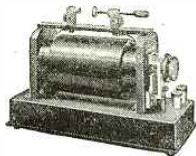

AMRAD INDUCTION COIL

Especially designed for radio work. In operation at 1AK, 1BM, 1GY, 4AI, 5ZC, 6BR, 6CS, 6HI, 8BQ, 8CB, 8HG, 9CA, and many other stations.

Type C6 volt primary \$35.75

Type C-1 32 volt primary \$38.50

Type D



Price \$7.50

AMRAD WAVEMETER

still leads all similar instruments in the important factors of low price, accuracy and ease of operation. Direct reading.

Type C



Price \$6.50

AMRAD DETECTOR STAND

provides a positive and yet sensitive finger tip adjustment. Compact, rugged, neat.

Single model, Type C-1 \$3.50

Type B



Price \$13.75

AMRAD LIGHTNING SWITCH

eliminates the usual weak point in antenna insulation. A standard 100 ampere switch mounted on 40,000 volt Electro-se insulators. Meets Fire Underwriters' specifications.

SPECIAL NOTICE: Until June 15, 1920 the above equipment may be obtained from your dealer at prices published last month.

AMERICAN RADIO AND RESEARCH CORPORATION

15 Park Row
New York

Address all Communications to New York

Factory and Laboratory
Medford Hillside, Mass.

AUDIOTRON ADAPTOR

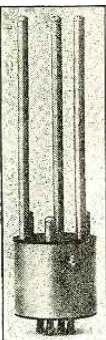

Consists of standard 4 prong base with brass supporting connectors. Permits mounting tube in vertical position so filament will not sag and touch grid.

\$1.75 POSTPAID
Beware cheap imitations.
NEW "VT" SOCKET

with positive lock contacts \$1. With brass bracket and oxidized screws for vertical back mounting, \$1.50.

Mica-Copper Foil .0005 MF. Grid Condenser (other capacities to order), 40c each.
Marconi Grid Leak (without base), 55c.

"Standard" Block "B" Batteries Small portable size, 3 1/4"x2 1/4"x 2", \$1.35. Long Life, Navy size, 6 1/4"x4"x3", \$2.40. Variable, Navy size with plugs, \$3.25. Include postage for 2 lbs., or Navy size, 6 lbs.

"Special" Audiotron 45 Volt Variable "B" Battery, \$3.60 P.P.



PARAGON RHEOSTAT

The 6 ohm, resistance permits fine filament control with 4 or 6 volts. Moulded in heat proof, composition and only 2 1/2" dia. See March R. A. N., page 467, for details.

\$1.75 POSTPAID
Can also be front mounted.

Western Electric P-11 Army-Navy Phones, \$12.00. Ground Wire, No. 4 triple insulated, 8c ft.; \$7.00 per 100 ft. Lightning Switches, 100 amp., 600 volt, \$4.00.

We carry a full stock of everything worth while in radio and neither "wildcat" nor "pad" our prices. Send your order to Boston for promptness.

RADIO EQUIPMENT CO.
630 Washington St., Boston-11, Mass.



LEARNERS KEY AND BUZZER SET \$1.50

Key made of solid brass, with screw adjustments.

Buzzer has pure silver contacts. Brass terminals.

Key unmounted, 75 cts. Buzzers, 35 cts. Send to

AJAX ELECTRIC CO.
Newberne St. Somerville, 44, Mass.

GET a good reasonable Grid or Stopping Condenser. Just the article you have been looking for. Each Condenser thoroughly tested by meter and guaranteed. All mounted with screws and nuts to assemble on panel. Patent applied for.

Price 35c each. Postage 4c. Excellent mounted galena crystal, formerly purchased for U. S. Army Corps. Triple tested, each crystal guaranteed for satisfaction and efficiency. 50c each. Postpaid. Don't lose this opportunity to obtain these crystals. Only a limited supply.

Switch Mounting includes 1 Moulded composition knob, polished nickel brush, etc., will fit any size panel. 50c.

Nickel Contact Studs, 3/16"x3/16" dia. per doz. 20c
Buzzers 75c
Push Buttons (for 3/8" hole) 25c
Code Chart (includes mailing) 7c
Stamps accepted. 5c Postage for above.

Send 2c for list of other apparatus. Dealers write for proposition on Condensers.



Esbro Radio Apparatus
P. O. Box 344, Brooklyn, N. Y.

Arnold Loose Couplers

Combination Loose Coupler Parts and accessories.
Send 3c stamp for literature, which is sure to interest you.

J. F. ARNOLD 2082 Lexington Av. N.Y.
Established 1910

STAMMER

Send 10 cents coin or stamps for 70-page book on Stammering and Stuttering, Its Cause and Cure. It tells how I cured myself after stammering for 20 years.
Benjamin N. Bogue, 859 Bogue Bldg., Indianapolis

APPARATUS FOR VERY SHORT WAVES

The schematic device of this arrangement which was designed by M. Goutton may be seen by studying Fig. 13.

This is somewhat of a special heterodyne circuit whereby the capacity is formed by the grid plate and the inductance formed by the connections between plate and grid.

The apparatus produces waves the length of which does not exceed four meters, and the performance of numerous and interesting laboratory experiments becomes at once possible. It will also be possible by means of this apparatus with the use of undamped waves to repeat the experiments performed by Hertz with damped waves and which permitted him to study the phenomena of optics; in other words, reflection, refraction, polarization, etc.

Thus we end our description of various sets and apparatus employing the momentous vacuum tube.

In our progress in radio telegraphy, we have made radio sets which starting with minute amounts of energy realized transmitting distances of several hundred kilometers as well as radio telephone sets of the most simple and practical types. As for amplifiers they have brought reception to limits almost inconceivable. They permit the passing of radiogoniometry from a purely theoretical stage to a most practical one. Thanks to these amplifiers, telemechanics will give us no doubt in a very short time results which at present it is almost impossible to suspect and which will probably revolutionize present ideas on the subject.

Apparatus for research work and measurements of the most perfect kind, telephone relays and repeaters which will permit the use of the most defective land lines, anti-howling arrangements which have been needed for so long.....all these and more will be given us by the use of the vacuum tube.

Radio telephony, radio goniometry, telemechanics, amelioration of land wire communication as well as wireless, are all made possible by the marvelous lamp. The most optimistic hopes are thus entertained for the practical adaptations of the tube. All this, therefore, permits us to make the statement that the vacuum tube is one of the most startling and marvelous discoveries of this century.

Music By Radio Spark Tones

(Continued from page 681)

sufficient intensity to permit of a plurality of different sets of sparks at the same time consequent upon the pressure of the corresponding number of keys. Further, regulation in the volume of sound for producing pianissimo, fortissimo and similar effects can be provided for by the inclusion of a rheostat in the primary circuit which may be regulated by the foot.

A photograph of the first model of the wireless organ is shown at Fig. 2. In this case, it will be seen that there are only thirteen keys, and the arrangement is rather an elementary one. In my improved model, however, the device is fitted with an oscillation transformer and employs the keyboard of an old organ. All parts are home-made, even the transformer which delivers 10,000 volts at an impress potential of 110 volts, 30 cycles A.C.

(Continued on page 712)

Radio Diagrams and Formulae in Loose Leaf Form

The publishers of the CONSOLIDATED RADIO CALL BOOK have completed the preparation of diagrams and instructions on—

- Measurement of Capacity of a Condenser. (Substitution Method.) Calibration of a Variable Condenser. Two Diagrams and Curve... No. 1
- Measurement of Inductance of a Coil or Circuit. Two Methods—Two Diagrams..... No. 2
- Measurement of Distributed Capacity of an Inductance. Diagram and Curve..... No. 3
- Measurement of Fundamental Wavelength of an Antenna. Three Methods. Three Diagrams..... No. 4
- Measurement of Wavelength of Distant Transmitting Station. Two Methods. Calibration of a Receiving Set. Two Diagrams..... No. 5
- Measurement of Effective Antenna Capacity. Two Methods. Two Diagrams..... No. 6
- Measurement of Inductance of Antenna and a Third Method of Measuring Effective Capacity of Antenna. One Diagram..... No. 7
- Measurement of Antenna Resistance. Substitution Method..... No. 8
- Schematic Wiring Diagram of Regenerative Audion Receiving Set Suitable for Receiving High Power Undamped Wave Stations. Connections shown are those used in most Navy and Commercial Receivers..... No. 50
- Table giving the value of LC (Product of Inductance and Capacity) for wavelengths from 300 to 20,000 meters. Inductance in Microhenrys..... No. 100
- Table same as above but with Inductance in centimeters..... No. 101
- Schematic Wiring Diagram of Signal Corps Type SCR-68 Radio Telephone Transmitting and Receiving Set..... No. 51
- Schematic Wiring Diagram of Type CW-936 (Navy Submarine Chaser) Radio Telephone and Telegraph Transmitter and Receiver..... No. 52
- Schematic Diagram of Type S.E. 1100 (Navy Flying Boat) Radio Telephone and Telegraph Transmitter..... No. 53

These diagrams and instructions are the most CLEAR, CONCISE, COMPREHENSIVE and CONVENIENT form of instruction that has ever been presented. They are printed on pages size 8 1/2 x 11.

Complete Set of 141 Sheets **75c** as described, sent postpaid

CONSOLIDATED RADIO CALL BOOK CO., Inc.
41 Park Row, New York, N. Y.

Recognized as the largest and best.



Send ten cents for descriptive catalogue to Dept. B, 900-902 Penna. Ave., N. W. Washington, D. C.

MERACO

Perfect "B" Batteries

Standard BA-2 TYPE, the same as used by U. S. Army & Navy Signal Corps.

Fully guaranteed on a money back basis. Order by Catalog Number.

Cat. No.	Volts.	Price.
BA-2-xpr-1K	22.5	\$1.20 postpaid
BA-2-xpr-2	22.5	\$2.20 postpaid
BA-2-xpr-3	45.	\$4.75 postpaid

Watch this Magazine for future advertisements.

Mercury Radio Appliance Co.
Dept. B-1, 672 Broadway, Brooklyn, N. Y.

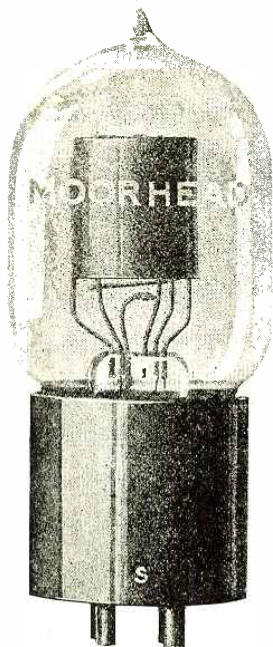

THE MOORHEAD ELECTRON RELAY

PRESENTING TWO
NEW TYPES OF
VACUUM TUBES FOR
EXPERIMENTERS



THE MOORHEAD PERFECT

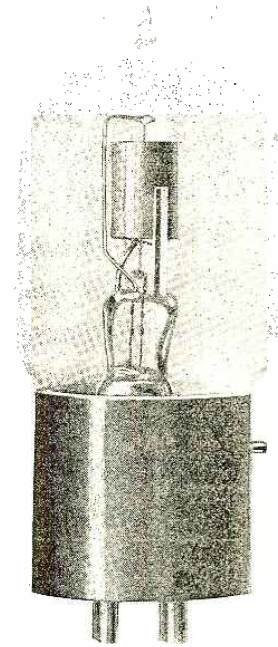

THE MOORHEAD VT AMPLIFIER-OSCILLATOR

VACUUM TUBE COMBINATION

—perfected to meet the increasing demand for tubes of superior efficiency, wherein all desirable characteristics are combined without subordinating any essential elements. A combination of two or more *VT* tubes as amplifiers with an *Electron Relay* as the initial detector or oscillator is *the ideal receiving combination* for long distance amateur or long wave reception. Both types of tubes are rugged in construction and unqualifiedly guaranteed.

THE MOORHEAD ELECTRON RELAY

The Electron Relay is the original tubular vacuum valve brought out by this company in 1915, now supplied with the standard four prong base for convenience. This tube has the familiar "his-sing" point and low B battery potential characteristic of the perfect vacuum detector. Of all vacuum tubes the Moorhead Electron Relay is the *most efficient spark receptor*.

Price — \$6 each. Immediate deliveries. Order from your dealer or remit direct to address below.

THE MOORHEAD VT AMPLIFIER-OSCILLATOR

The VT Amplifier-Oscillator is the Navy SE 1444 "hard" tube, and is designed and manufactured expressly for amplification and oscillation purposes. Particular attention is invited to the large amplification constant of this tube. Recent official Navy tests show conclusively that the Moorhead VT tube has a *higher amplification constant* than any other vacuum tube known to the radio art.

Price — \$7 each. Immediate deliveries. Order from your dealer or remit direct to address below.

Both tubes licensed under the DeForest Audion and Fleming Patents.

DEALERS—write for prices and particulars.

PACIFIC RADIO SUPPLIES CO.
DISTRIBUTORS FOR THE

AMATEURS—write for descriptive literature.

MOORHEAD LABORATORIES INC.

638 MISSION ST. :: :: SAN FRANCISCO :: :: CAL.

REFERENCE, THE AMERICAN NATIONAL BANK, SAN FRANCISCO.
Eastern Distributors—Atlantic Radio Supplies Company, 8 Kirk Place, Newark, N. J., Telephone, Market 1575

Standard "B" Batteries

Guaranteed for 2100 hours of shelf service
BUILT TO LAST LONGER

All STANDARD "B" Batteries are made of tested, high grade material. Each container is making it waterproof and weatherproof. STANDARD Batteries are one-quarter of an inch higher than any other make and consequently more powerful. Quantity production makes it possible to offer you a guaranteed, better battery for the same price charged for inferior ones.

The five ampere, 22½ volt size is illustrated herewith. Also made in ten and twelve ampere sizes. All sizes equipped with extra binding posts to allow variable voltage as desired.

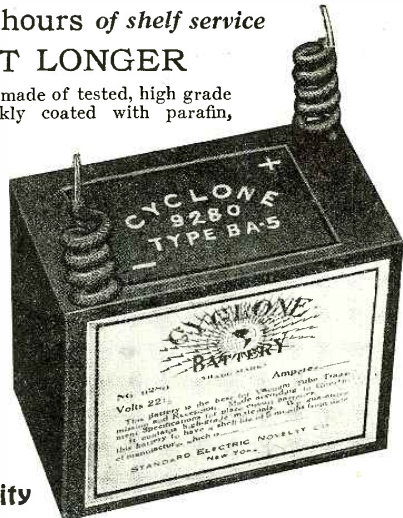

Standard Electric & Novelty Co., New York City

Insist on Standard "B" Batteries

SOLD BY:

J. H. Bunnell & Company,
 32 Park Place, N. Y. C.
 Manhattan Electric Supply Company,
 17 Park Place, N. Y. C.
 De Forest Radio Tel. & Tel. Company,
 1401 Sedgwick Ave., N. Y. C.
 F. Angelo, Barcelona, Spain

Continental Radio & Electric Corp.,
 6 Warren Street, N. Y. C.
 F. H. Thomson,
 Manila, Philippine Islands.
 F. D. Pitts Company,
 12 Park Square, Boston, Mass.
and all other leading dealers

SPECIAL—10,000 Navy Type Dials to be sold in 60 days

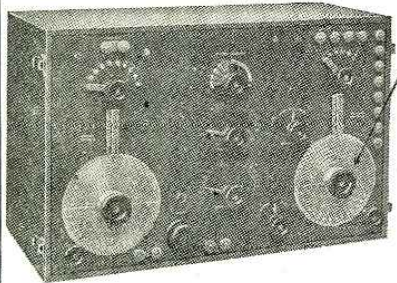

For Sale to Amateurs for first time
 We have been very fortunate in obtaining 10,000 Navy Type Dial Indicators for sale to amateurs. These dials are made of heavy white colluloid, highly polished, beautifully finished, and artistically engraved with two scales. One scale is divided into degrees; the other is calibrated for writing in station call letters at points at which station is received.

Put your set in the commercial class
 Not only do these dials add dignity and beauty to a set, but they are also a real utility and a necessity for reliable work. Use them wherever you would an old fashioned scale and pointer.

Buy today—Tomorrow may be too late!
 At the present rate of sale our stock will be exhausted within 60 days. So get the lead on the rest—lay in a supply now—while you can.

Price while they last 65c postpaid. Complete as described without knob (Stamps NOT accepted)

The C and S Radio Co. Omaha, Nebraska
 Department US6
 "Superlative Radio Engineering Productions"

AT LAST

Our wonderful catalogue is ready. A 100 pages of wonderful apparatus with prices up to date and 24 hour delivery on 90% of apparatus listed. 15c in stamps will bring this book to your door.

NOTICE TO AMATEURS:
 We carry in stock practically every known piece of radio apparatus on the market today that is worthy of consideration, and in most cases can make immediate shipment from our stock.

- Immediate deliveries on Brandes, Murdock, 55 and 30 Head Sets.
RADIO MEN
WIRELESS AMATEURS
- \$3.00 Graphite Potentiometers...\$2.85
 - 1.50 Detector and Crystal..... .95
 - 5.85 43 Plate Variables..... 4.85
 - No. 14 Copper Aerial Wire—
 per lb..... .75
 - 50s Moulded Ball Insulators..... .35
 - \$50 Navy Type Tuner and Condensers.....\$35.00
 - \$35 Coupler and Crystal Receiver.24.00

Catalogs positively will not be sent, unless 15 cents in stamps is remitted.
NATIONAL RADIO SUPPLY COMPANY
 808 9th Street, N. W. Dept. 140 Washington, D. C.

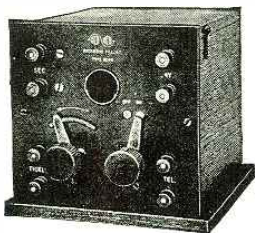

Agent, Grebe Mfg. Co., Distributor for the South

Fig. 3 shows a front view of the wireless organ. In the keyboard not seen in the illustration are the small knife switches which are actuated by the keys and which set the transformer in operation. In this most recent model also, the position of each

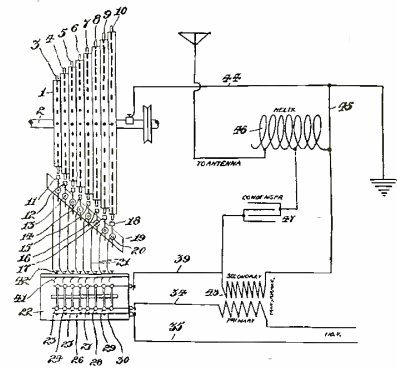

FIG. 1
 Schematic Wiring Diagram of the Radio Organ and Circuit.

point in the rotaries is determined by the rules of the *temperate scale* instead of the theoretical one previously mentioned. This method I have found quite successful. Fig. 4 shows a rear view of the organ, the cover of which has been opened for inspection.

Many amateurs as well as commercial operators have heard my music and they reported that they are well pleased with the tunes produced. My radio station was, of course, closed during the war. For that reason this later and practical model was devised four years after I had obtained my original patent.

Marconi's Yacht the "Electra"

(Continued from page 683)

tempt to try to determine the exact origin of the mysterious signals which have been received by radio stations in various parts of the world and which up the present time have baffled investigators as to a possible explanation. These mysterious signals as everyone knows have directed the attention of science owing to the fact that Mr. Marconi is said to have stated that the mysterious signals may possibly be caused by attempts of nearby planets to communicate with the earth. The upper photograph shows the picture of the "Electra" which as will be seen is a vessel of considerable dimensions. Note the unique basket type aerial wires which are used to a considerable extent by British and Italian radio vessels.

Development in Receivers

(Continued from page 687)

comprises a 200 to 600-meter tuner, supplied with regenerative features in combination with an audion detector and its necessary controls and a filament storage battery and high-voltage battery. The only external connections necessary are those to aerial, ground and phones, and it is believed that this instrument will be of exceptional value to campers and others who wish to keep in touch with the outside world in places where daily newspapers are unknown. As will be noticed, all these instruments are standard in appearance and design, thus allowing of the use of any desired combination. Panels are all of highly polished black Bakelite with all parts so sub-mounted that no supporting screws and other unnecessary pieces mar the appearance of the finished instruments. Scales are all engraved into the Bakelite panels and knobs are all of either hard rubber or Bakelite, the use of molded composition be-

LEARN WIRELESS AT HOME

The Demand for Wireless Operators Far Exceeds the Supply

The New York Wireless Institute will make you an operator—AT HOME—in your spare time—quickly, easily and thoroughly. No previous training or experience required. Our Home Study Course has been prepared by Radio Experts. Experts able to impart their practical and technical knowledge to YOU in an *easy to understand* way. The graded lessons mailed you will prove so fascinating that you will be eager for the next one. The instruments furnished *free*, will make it as easy to learn the Code as it was to learn to talk. *All you will have to do*, is to listen.

Big Salaries

Wireless operators receive excellent salaries ranging from \$125 to \$200 a month and it is only a stepping stone to better positions. There is practically no limit to your earning power. Men who but yesterday were Wireless Operators are now holding positions as Radio Engineers, Radio Inspectors, Radio Salesmen at salaries up to \$5000 a year.

Travel the World Over

A Wireless Operator can visit all parts of the world and receive fine pay and maintenance at the same time. Do you prefer a steady position without travel? There are many opportunities at the numerous land stations or with the Commercial Wireless or with the Steamship Companies.

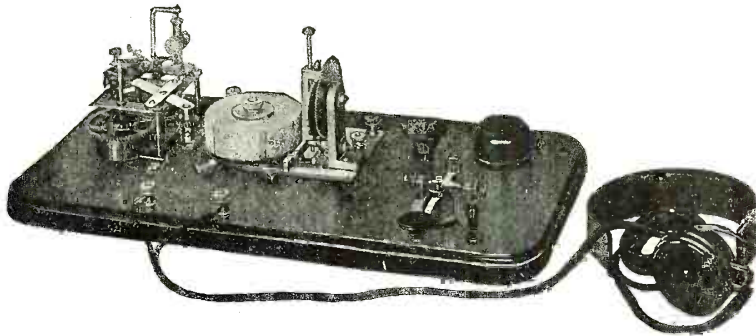

This wonderful Set for learning the Code furnished free with our Course

FREE Instruments and Text Books

We furnish free to all students, during the course, *the wonderful receiving and sending set exactly as produced in the illustration. This set is not loaned, but given to all students completing the Course.*

The Transmitter shown is the celebrated *Omnigraph* used by several Departments of the U. S. Government and by the leading Universities, Colleges, Technical and Telegraph Schools throughout the U. S. and Canada. Start the *Omnigraph*, place the phone to your ear and this remarkable invention will send you Wireless Messages, the same as though you were receiving them, through the air, from a Wireless Station hundreds of miles away. When you apply for your license, the U. S. Government will test you with the *Omnigraph*—the same model *Omnigraph* as we furnish to our students. Ask any U. S. Radio Inspector to verify this.

Easy Payments

A small payment down will enroll you. We will make the payments so easy that anyone ambitious to enter the fastest growing profession—Wireless—may do so.

Send for FREE Booklet

Without obligating you in any way, send for our booklet "How to Become an Expert Wireless Operator"—it is free. Mail the coupon below, or postal or letter—but do it today.

NEW YORK WIRELESS INSTITUTE

Dept. 22, 258 Broadway, New York City

New York Wireless Institute
Dept. 22, 258 B'way, N. Y. City

Send me free of charge, your booklet "How to Become an Expert Wireless Operator," containing full particulars of your Course, including your *Free Instrument offer*.

Name

Address

City or Town..... State.....

FREE Post-Graduate Course

A one month's Post-Graduate Course, if you so desire, at one of the largest Wireless Schools in N. Y. City. New York—the Wonder City—the largest port in the World and the Headquarters of every leading Wireless and Steamship Company.

Radio Apparatus

The Mutual Purchasers Association offers you membership on a dividend earning plan, whereby anyone buying thru the association automatically becomes entitled to a coupon check which is a dividend, and is acceptable as cash upon anything else you buy.

Our membership exceeds 1,900, and is growing daily. Members are earning dividends and getting other benefits of the association, such as hookup data and information on anything pertaining to radio.

We can furnish radio material and parts advertised in this magazine at manufacturers catalog prices.

Write Department R.A. for application blank and general information on how to earn these dividends. No application fee.

MUTUAL PURCHASERS ASSOCIATION

2 & 4 Stone St., New York

CANADIAN AMATEURS:

This is our popular \$7.50 Loose Coupler. Made of the best material, mahogany finish. Wave length approx. 1,200 meters. Postage extra.

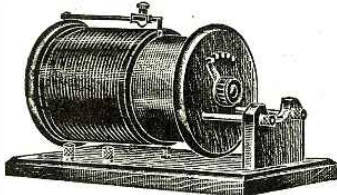

Send .50c for our code card and price list by buying from a Canadian Firm specializing in supplying Wireless Amateurs, you obtain the BEST SERVICE at the LOWEST COST.

LET US SERVE YOU THE VIMY SUPPLY CO.

585 College Street TORONTO, ONT.



Send stamped, self addressed envelope for bulletins detailing

Our \$1 Bakelite VT Socket with phosphor-bronze Fahnestock connectors and contactors. Brass bracket, etc., for vertical back mounting, for 25c extra.

Radio Phone Men! Get our Bulletin on accessories. We have Moorhead transmitting tubes—\$7.50—for experimenters. Takes 150-500 volts on plate. Standard 4-point base.

SOMERVILLE RADIO LABORATORY. AGENTS FOR MOORHEAD VT'S, ETC. 102 Heath St., Somerville, 45, Mass.

20,000 METER TUNER! \$15 Tuners, Cabinets, Condensers, Rheostats, Binding Posts, etc. All first-grade stock. Get all the data, boys, Free. Just write.

"ARK" RADIO SUPPLY 97 Hill Street, Shelton, Conn.

ing avoided thruout as inefficient. This apparatus should prove very popular with the amateurs who wish to cover really long distances and especially with those who wish to continue this work thruout the summer under the adverse conditions brought on by warm weather.

Enter—The Radio Controlled Bus

(Continued from page 682)

ample of this is shown by the recently disclosed statement issued by Washington whereby "Fighting Bob" Evans' old flagship, the U. S. S. Iowa, now condemned and out of commission, will shortly be equip with distant radio control apparatus and tests made where the ship will be sent out to sea to perform certain maneuvers controlled entirely by observing officers stationed at points on shore.

A Radiophone Set That Really Works

(Continued from page 689)

The switch point A and the condenser C1 determine the wave length, while the switch point B is varied to find the best point of coupling for the various wave lengths employed.

The adjustment of the condenser C2 is very critical, and upon it depends the clearness of modulation.

The inductance L2 is a high frequency choke coil and is to prevent the high frequency current, generated by the tubes from backing into the high voltage generator. It has been found that one hundred turns of No. 26 wire wound on a 3½ inch disc, or a 200 Honey Comb Coil, will answer the purpose quite satisfactorily.

The filter system consists of two low frequency choke coils composed of an iron core ½ inch in diameter by 3¼ inches long wound to a diameter of 2¼ inches. This will require about two pounds of No. 26 double cotton-covered wire. These are shunted by two one (1) mfd. condensers.

The transformer M is preferably the modulation transformer as supplied by the Acme Apparatus Company. Of the several types tried, the secondary impedance of this transformer was found to be of a correct value. The telephone transmitter is connected with the primary of this transformer and four dry cells. The resistance R is an ordinary graphite potentiometer of the semicircular type.

The plates, grids and filaments of the three tubes are connected in parallel. Where sufficient potential is available for the A battery, it is advisable to connect the three filaments in series using only one rheostat, thus requiring but one adjustment for the three tubes. However, if the filaments of the three tubes are connected in parallel, three rheostats will be required. This is an advantage in case one of the tubes should burn out while the set is in operation.

The relay used for changing the circuits from sending to receiving is made of a standard 20-ohm telegraph sounder remodeled so as to act as a triple pole double throw switch.

Figure 6 shows the manner in which this is accomplished and needs very little explanation. Three pieces of ¼ inch bakelite 3 inches long by ½ inch wide are clamped together and drilled and tapped to take a 6 x 32 thread. The top adjusting screw is then taken out and one of the bakelite strips inserted under the screw.

One of the strips is inserted under the adjusting screw on the sounder arm, while the third strip is secured in a recess filed in the support which carries the top ad-

MEMORIZE CONTINENTAL CODE ALMOST INSTANTLY

This method THE short cut to success

WHAT THEY SAY ABOUT IT Several members of our Club got hold of your clever little chart for memorizing Continental Code and it is so very helpful and so well liked that we have adopted it officially and shall use it in our classes. We need now forty copies which please send by mail.

R. M. Peterson, M.D., Secy. Radio Club, 425 East 145 St., New York City

Please send us twenty more copies of your Code Chart as before. Wishing you well for your splendid labors in behalf of the radio bug.

Yours, sincerely, R. M. Peterson, M.D., Secretary Radio Club, 425 East 145 St., New York City.

COMPLETE CHART and full instructions TWO DIMES

C. K. DODGE Box 100 Mamaroneck, N. Y.



INDICATING DIALS

Of polished hard rubber, accurately engraved, filled with brilliant white, furnished complete with knob, shaft, tension spring and nuts ready for panel mounting.

"The Best"

3" DIAM. { 180° scale 0-100 } \$1.50
 { 90° scale 0-50 } POSTPAID
2" DIAM. { 180° scale 0-100 } \$1.25
 { 90° scale 0-50 } POSTPAID

Five cents brings you our loose leaf catalog and puts your name on our mailing list. Write now.

THE WILCOX LABORATORIES LANSING DEPT. G MICHIGAN

FREE POKET HANDY BOOK CATALOGUE

Radio Handbook & Catalogue

Contains much valuable radio information, tables and data. Describes a remarkable line of wireless instruments including "Red Head" Phones, Arlington Tested Minerals, Del'orest, Murecock and Signal Apparatus. Write for this book today. The Newman-Stern Co. Dept. R. N. Cleveland, O.

Red Head Radio Phone

The accepted standard in wireless receivers. If they are not BETTER than anything you've ever seen return them for full cash refund. Our Radio Handy Book and Catalogue, free on request, describes them, and many other instruments. The Newman-Stern Co. Dept. R. N. Cleveland, O.

\$7.00

ARLINGTON TESTED CRYSTALS

Why buy minerals on a gamble? Be SURE when you put a crystal in your detector that it is EXQUISITELY SENSITIVE. Buy Arlington individually tested Minerals, Galena or Silicon, post paid on receipt of price. THE NEWMAN-STERN CO. Dept. R. N. Cleveland, O.

35c

SOMETHING NEW! DUO-LATERAL WOUND COILS

THE DUO-LATERAL COILS now being offered for the first time is not to be confused with any other type of machine wound inductances which have been on the market for some time.

The Duo-Lateral Coil made in various sizes for general and specific application has the following distinct advantages which make it superior to any other coil for amateur and commercial work alike.

1. Lower natural period.
2. Lower high frequency resistance.
3. Very low distributed capacity.
4. Lower direct current resistance.
5. Higher self-inductance.
6. Mechanically stronger.

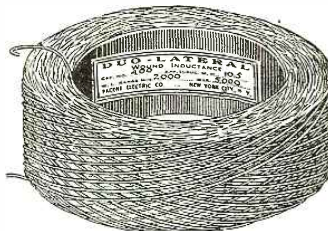

Bulletin P1R, containing valuable engineering data, constants and prices of numerous sizes of Duo-Lateral Coils covering practically every wavelength used, is yours for the asking.

MANUFACTURERS, DEALERS, JOBBERS and DISTRIBUTORS—write for our proposition.

SALES AGENTS for Electrical Products Mfg. Co., A. H. Grebe & Co., Dubilier Condenser Co., Richter and Byrne, Rawson Electrical Instrument Co., The Magnavox Company and others.

PACENT ELECTRIC COMPANY, Inc.

Builders and Specialists in Radio, Electrical and Laboratory Equipment.

150 NASSAU STREET

Telephone:
Beekman 5810

NEW YORK CITY

LICENSED BY DE FOREST AUDIOTRON

The Original Tubular Vacuum Amplifier

The AudioTron Vacuum Tube is now manufactured and sold as a genuine audion licensed under DeForest Patents Nos. 841387 and 879532 to be used only for amplification in radio communication and only for experimental and amateur purposes and only in audio frequency circuits.

The AudioTron has a double filament of special thorium tungsten and the operating life is over 2,000 hours. No special socket is required. The electrical and mechanical dimensions result in a heavy plate current and corresponding signal strength. Plate voltage under 40. Our guarantee insures satisfaction.

PRICE \$6.00 EACH

If your local dealer cannot supply you we will ship postpaid when cash accompanies order.

The AudioTron Exclusive Guaranty: Each and every AudioTron is guaranteed to arrive in good condition and to prove fully satisfactory. Replacement of unsatisfactory tubes will be made free of charge.

AudioTron Audio-Frequency Transformer \$7.00

Laminated closed core, two coil type.

DEALERS:—Write for our attractive trade Proposition.

AUDIOTRON SALES CO.

Lick Bldg.

SAN FRANCISCO, CALIF.



UTTMARK'S

NAUTICAL ACADEMY

RADIO SCHOOL

NEW YORK

BOSTON

THIS school offers a thorough course in all branches of Radio Telegraphy. Prepares you thoroughly for Government examinations, Merchant Marine, Commercial Land Radio, Radio for railroads, Radio for Aerial Mail Service, Etc. Elementary and Advanced Classes, day and evening sessions.

Nautical Academy established 1804; Radio School, 1920

CAPTAIN F. E. UTTMARK, PRINCIPAL

Write, call or phone for illustrated booklet.

8 STATE ST., NEW YORK, N. Y.

Facing Battery Park N. Y. Telephone, Bowling Green 8079

For Radio UTTMARK'S For Navigation

Hear 'em All Over The Room!

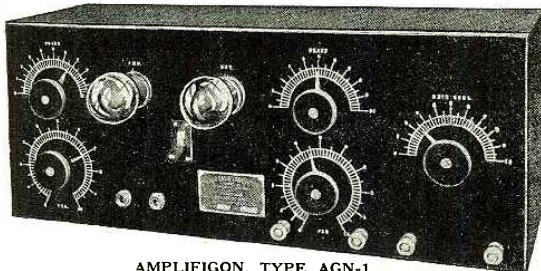

AMPLIFIGON, TYPE AGN-1

The Chicago Radio Laboratory Amplifigon, shown above, brings in ordinarily faint signals so loud that they can be heard "all over the room." Used at many prominent long distance stations. Made primarily for use with the Paragon regenerative receiver, but can be used equally well with ANY tuner or set of tuning devices.

Type AGN-1, as above, comprises detector and EFFICIENT one-step amplifier which actually AMPLIFIES, using our famous three-winding amplifier coil. Special circuit employed by which but one "A" and one "B" battery are used for all tubes, without impairing signal strength.

One step of amplification with our coils is equal to two with the ordinary type.

Type AGN-1, detector and one step amp. \$65.00

Type AGN-2, detector and two step amp. 95.00

We can also supply Vacuum Tubes.

Our audion apparatus licensed under DeForest patents Nos. 841,387 and 879,532.

Our new Bulletin J-20 out now. Send for it!

CHICAGO RADIO LABORATORY 1316 Carmen Avenue
Chicago, Ill., U. S. A.



Price \$15.00
Made in Canada

FOR CANADIAN AMATEURS

Complete
CRYSTAL RECEIVER
Range: 50 to 3000 Meters

This Crystal Receiver is specially designed for amateurs. It combines wide range of reception with simplicity of operation. Wave-length 50 to 3000 meters. We also supply a complete amateur Transmitting Set and carry a large stock of condensers, transformers, telephones, keys, detectors and all other articles of amateur equipment. Send five cents for latest catalogue.

SCIENTIFIC EXPERIMENTER, LIMITED

11 St. Sacrament St.

Montreal

Attention Beginners!

WILCOX WIRELESS PRACTICE SET



The first need of every amateur. Hightone buzzer and key for learning code. Also for test buzzer and four other purposes. With code and instructions. \$1.25 Postpaid.

THE WILCOX LABORATORIES, Lansing, Mich.



HERE IT IS

A sign for your den. Exceedingly attractive. Printed in bright red on white cardboard. No electrical bug should be without it. 7 1/4" x 11 1/4". 10c each in coin ONLY. Send stamp for postage. **LEONARD BECK, 1288 Carroll St., Brooklyn, N. Y.**

justing screw. Three contact strips are secured by means of 6x32 round-head brass machine screws to the bakelite strip which is carried on the movable arm. The first contact should be made double throw. This contact changes the antenna from transmitting to receiving. The second contact makes and breaks the high potential supplied to the plates, while the third contact makes and breaks the battery current in series with the telephone transmitter and the primary of the modulation transformer.

While it is advisable to incorporate this set in panel form, it is not at all necessary. The experimenter who attempts to construct this set will undoubtedly be guided by his pocket-book and the apparatus that he has available. It is surprising the results which can be attained with the junk that one ordinarily finds in the experimenter's laboratory. At this point it would be well to impress upon all those who contemplate constructing a set along these lines, the importance of the high voltage generator. There are a number of excellent machines now available in the market, and the type used will depend upon the voltage and character of the potential upon which it is to be used.

The question of tubes is by no means an unimportant one. *Practically any tube on the market today can be used as an oscillator.* However, if the experimenter is lucky enough to possess several Western Electric VT2 tubes, he need not worry about the results.

The radiation to be expected with a system of this type is approximately 1.2 amperes with VT2 (W. E. Co.) tubes.

In closing, a word about the adjustments of the various condensers and inductances for satisfactory operation may not be amiss. In adjusting to a given wave length, the wave length switch A is set at approximately the proper inductance value, and the feed-back condenser is then varied until the radiation shows a maximum value. The coupling switch B is now adjusted until the lowest reading of the space current milliammeter shows maximum radiation in the antenna ammeter. The condenser C2 is now adjusted to a point where the space current milliammeter fluctuates when speech is impressed on the telephone transmitter. A little experience will soon show the *proper adjustment* of this condenser. If too little capacity is used, the speech will "break"; while if the capacity is too great, only a small portion of the radiated energy will be modulated.

This set is no more complicated than the receiving sets now used by the amateur, and there is no reason why the experimenter who will devote a little time and patience to its construction cannot duplicate the results attained by the writer.

Radio Wrinkles

(Continued from page 693)

ceed as follows: Very valuable reference books giving data on many grades of resistance wires including German silver, are obtainable by writing to the Driver-Harris Company, Harrison, New Jersey, and also to the Electrical Alloy Company at Morristown, New Jersey. From the tables given in these books, also those to be found in the standard electrical engineering hand-books, the gage of wire necessary to carry a current of five amperes, with any desired degree rise of temperature above room temperature, as well as the resistance of the various wire per foot of length, is to be found without computation.

Quality—Efficiency—Economy

These are the three factors which combine to make all the equipment sold by us the best in the market today. A trial order will convince you. Our apparatus is service-tested. Look at the bargains below and then use your judgment.

O COPPER AERIAL WIRE 50c per 100 Feet

Another large shipment of this excellent solid copper wire has just been received by us. The gauge is No. 14 and the wire runs 80 feet to the pound. We also sell No. 12 gauge at 80c per 100 feet. This size approximates 50 feet to the pound.

A FEW MORE BARGAINS

- 500 cycle test buzzer—shipping weight, 1 lb. \$0.80
- 75 ohm watchcase receivers—shipping weight, 1 lb. 1.00
- Marconi VT Audion bulb—class 2—shipping weight 1 lb. 7.00
- Panel type rheostat—shipping weight 1 lb. 1.00
- 4 prong VT sockets, aluminum—shipping weight 1 lb. 1.50
- Telephone plug and jack—slightly used—shipping weight 4 ounces—complete 0.85

Cash in registered letter, check or money-order must accompany all orders. If shipment by parcel post is desired include postage, otherwise material will be shipped by express collect.

Our illustrated catalogue of 64 pages is now ready. 15c in stamps will secure a copy. This amount will be credited on your first order for \$1.50 or over.

Electrical Specialty Company
Dept. R—48-50 So. Front St., Columbus, Ohio

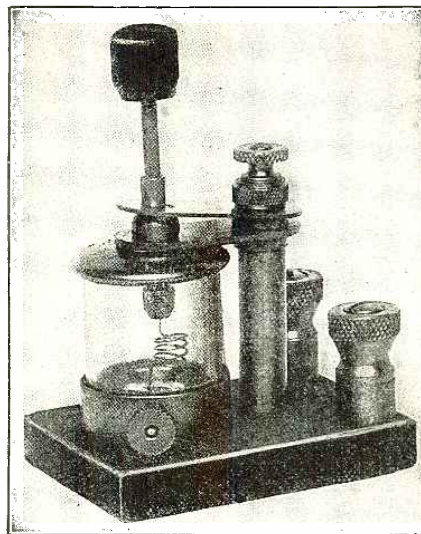

Weather Proof Crystal Detector

The type of the detector illustrated is being sold at prices ranging as high as \$4.50. Our price is \$2.80. This instrument is absolutely dust and moisture proof. The crystal, which is one of galena mounted in a block of Woods metal, is encased within a glass cylinder rendering it impervious to atmospheric conditions. Has ball and socket joint. Shipping weight 1 lb. Price \$2.80.

The ACME APPARATUS CO.

announces the birth of another

RADIO TRANSFORMER

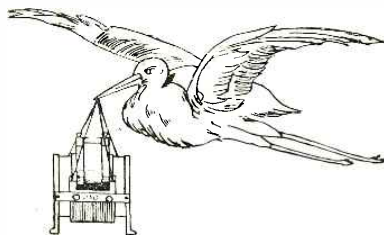

named **ACME 250** weight 13 pounds

250 watts, 250 miles—a mile per watt

ACME 250 has inherited the high efficiency, excellent operating characteristics, rugged construction and attractive appearance of its older brothers, and has come to

fulfill the demand for a transformer which, though it may not present as good a front, can make itself heard in any company.

The ACME cry is 800 cycles strong

PRICE, \$16.00 Dressed \$13.00 Undressed

110 volts 60 cycles ¼ K.W.

ACME APPARATUS COMPANY, 25 WINDSOR STREET, CAMBRIDGE 39, MASS.

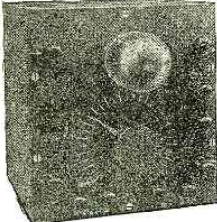

RADIO INTERNATIONAL

Vacuum Tube Detector OR Single Stage Amplifier

Single Tube Detector and Amplifier Units are among the most useful of the Interchangeable panel instruments in the International Experimental Apparatus Line.

Ready for Immediate Delivery

AUDION DETECTOR—RTD-102-A	\$15.00
SINGLE STAGE AMPLIFIER—RTA-104-A	26.00

F. O. B. NEW YORK CITY

Write to Dept. 22 for our new completely illustrated six page bulletin info.

INTERNATIONAL RADIO TELEGRAPH COMPANY
326 BROADWAY NEW YORK CITY

“YOU’D BE SURPRISED”

at the distance, strength of signal and freedom from Q. R. M. you get with Ace equipment. The type T. T. Tuner is *the kind* you want for that extreme long distance work thru the worst Q. R. M. Doc Ace has the right dope when he says, “You may pay more, but you can’t buy better.”



Type T. T. Regenerative Tuner, range 150 to 2,750 meters, F. O. B., Cincinnati—\$55.00

THE PRECISION EQUIPMENT CO.
2437 Gilbert Avenue Dept. A Cincinnati, Ohio

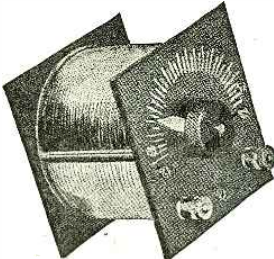

Variable Condensors of the Better Type

Note the square end piece on the cut of our condensers, facing the operator, also these condensers are enclosed in clear glass cases. Scales on these instruments are calibrated to 2½ degrees.

Prices:	R-35	21 plate	\$4.75
	R-34	43	“	5.50

ALL Instruments absolutely Guaranteed

THE TEWNO COMPANY
150 Chambers Street New York City

A 100 Mile Radiophone and Telegraph Set

(Continued from page 691)

Various tubes were tried among these being the Western Electric type VT-2, VT-1; General Electric VT-14, and Marconi VT-Class 2. All gave excellent results once the proper adjustments of individual tubes were found. Most of the work was done with the General Electric's VT-14. A filament current of 1.75 amperes was used. Plate current of “O” was 60 milliamps with plate voltage of 500 volts. Radiation current was 0.64 amperes. Greatest range recorded was about 180 miles.

A few suggestions will be given to help the prospective builder in his work. In my tests I used a *double slide tuning coil*, with all condensers variable, everything being spread out on the table where changes could be easily made. When I secured good radiation with a certain setting of all parts I noted the values in a note book. I noted the number of turns from the bottom end of the coil to the aerial slider; the number of turns from aerial slider to plate coupling slider; the value of 14, and so on. Then when I wound the inductance for the cabinet I made it the same size as the tuning coil and *soldered my leads* according to the data in my note book, when the set was in cabinet form I found that I had things about right. A wave meter was kept in inductive relation to a few turns in the ground lead at all times and when a maximum reading of the galvanometer needle was observed I knew that I had the best radiation on that wavelength. Of all wavelengths *there will be one at which the set will radiate best.* That in my case was 350 meters.

Be sure to solder all leads well. This is an important point. Also be sure that there is no leakage between circuits. The set is wired with bare copper wire No. 12.

The panel of my set is of hard rubber, as this was found to be much easier to work than other materials. It is 12 inches high by 14 inches long by five-sixteenths thick. It is hinged at the left end by a piano hinge which allows the front to be swung out for repairs and inspection of parts also to allow the insertion of tubes.

A filter is shown under the motor generator set but it was found that there was practically no commutator ripple without the filter, so it was not used.

All the instruments in the station were constructed by myself with the exception of the wave meter and the amplifier. I might state that NPU has been copied in daylight while working with NPM.

If there are any questions relating to this set that I can answer I should be very glad to do so.

For an excellent description of how this set operates the reader is referred to Lauer and Brown's Radio Engineering Principles, page 239.

“GROUNDS.”

Jones: Why is coffee like a wireless?
Bill: Why, Jones?
Jones: Because they both have “grounds.”
Contributed by LEON MILLER

PROBABLY FORGOT DETECTOR.

Anode: “My wireless set must be worth a lot.”
Cathode: “Why?”
Anode: “They say silence is golden.”
Contributed by SAM'L G. HOUGHTON.

Club Gossip

(Continued from page 696)

The club meetings are held every other Tuesday night, and as we have no regular meeting place, the meetings are held at the homes of the members, in rotation.

Suggestions from other clubs will be gladly accepted. Address all correspondence to Harold E. Powell, Secretary, 1128 W. Main St., Geneva, Ohio.

Monterey, California, Radio Association.

The first meeting of the Monterey Radio Association, composed of amateurs in the vicinity of Monterey, was held on March 15, 1920, at our rooms of the Presbyterian Church, Monterey, Calif.

The object of the association is the bringing together of amateurs in this vicinity who are interested in the advancement of radio telegraphy and desire to become more familiar with the art. At present we have twenty members, with prospects for more. Meetings are held every Monday evening at the above location, where subjects of interest to all are brought up. As yet we have not a costly array of apparatus, but for receiving we are using a single wire antenna with a crystal detector receptor and for transmitting we intend to operate one of the local amateur's transmitters by distant control from the association rooms.

The following officers were elected and are now holding office: H. A. Greene, Jr., President; H. Hand, Vice-President; S. J. Wood, Secretary-Treasurer. We would be glad to hear from other clubs and amateurs interested in any of the various phases of radio. Please address all communications to the Secretary, 512 Watson Street, Monterey, Calif.

LEARN WIRELESS TELEPHONY BY MAIL IN A SHORT TIME

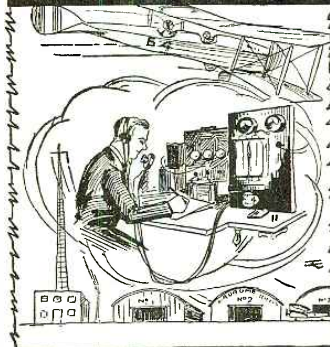

With our Home Study Course you can quickly, easily learn the greatest profession of all—WIRELESS—in all four branches—ELECTRICITY, RADIO TELEGRAPHY, BLUE PRINT READING, WIRELESS TELEPHONY. Our Course makes you master of these important subjects and enables you to quickly become an expert. Wireless Operators Earn \$200 Month and up. Never enough men to meet the demand. For a limited time we make a Special Introductory Offer of the FOUR COURSES IN ONE—\$200 worth for ONLY \$40—\$5 down and \$7 a month. EXTRA INCENTIVE to all students who enroll this month—AUDION BULB GIVEN! Other useful gifts named in literature. Take advantage of this offer before it is withdrawn. Send COUPON TODAY.

CHICAGO ELECTRICAL ENGINEERING CO.
1000 Diversey Parkway Desk J Chicago, Ill.

CHICAGO ELECTRICAL ENGINEERING CO.,
1000 Diversey Parkway, Desk J, Chicago, Ill.

Send particulars of Wireless Telephone Course, including Free Offer.
Name
Address



Hook er to yer bulb

Don't take our word, write the users. Read this unsolicited letter.

TO TRESKO, DAVENPORT, IOWA:
Just received your tuner and it is a wonder. Sigs sure pour in like a ton of bricks. Have had it for one day and here's my record so far. NSS—IDO—FL—POZ—OUI and XDA. Not so bad for a starter and no amplifier, but am using only a single wire aerial only 25 feet high. Had my doubts and thought the tuner was junk. Sure will boost this tuner. (Signed) ORSON FINCH, No. 1 Stuart St., Binghamton, N. Y.

TRESKO TRI-CITY RADIO ELECTRIC SUPPLY CO. DAVENPORT, IOWA.
Be a sport and send five cents in stamps for our catalog.

DOES YOUR STATION INCLUDE THESE INSTRUMENTS?

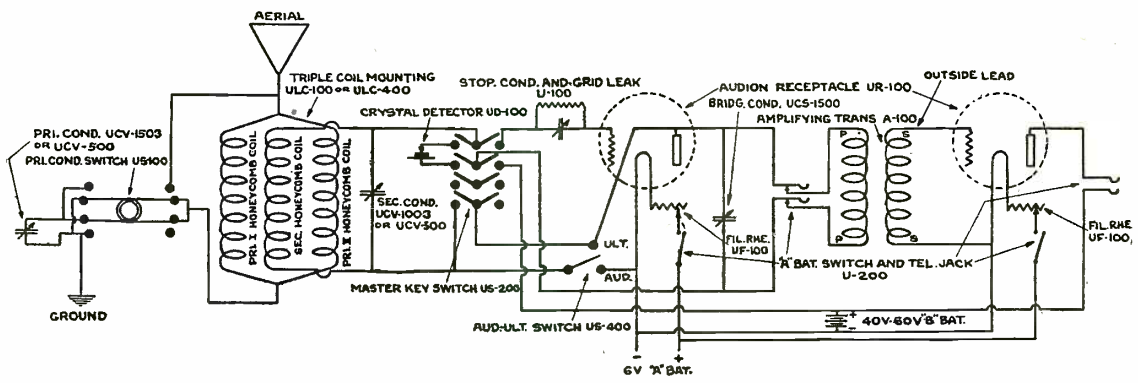

We Can Give You Immediate Deliveries on All the Units Described in the Above Diagram!

A COMPLETE STOCK OF DE FOREST UNIT PANELS, AT ALL TIMES

HAVE YOU SEEN OUR NEW SECTIONAL UNIT CABINETS OF TRANSMITTING AND RECEIVING INSTRUMENTS?

Send 4c. for Complete Catalog

Send 1c. for Unit Cabinet Circular

Western Representatives of Clapp-Eastham Perfection Radio Co. Amrad Products



Complete Stock of Wm. J. Murdock WIRELESS PRODUCTS

LEARN WIRING! EARN \$75. A WEEK

THIS YEAR'S EDITION WILL MAKE YOU AN EXPERT WIREMAN.

SEND FOR IT
TO-DAY

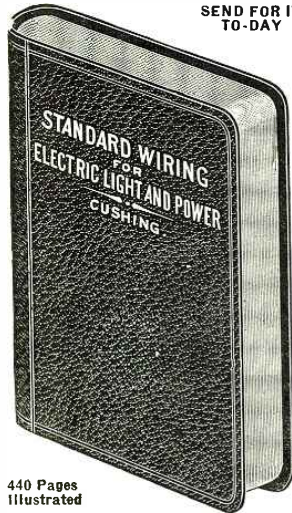

440 Pages
Illustrated

The National Authority for 26 Years
All the latest underwriters' rules. 52 of the latest and simplest tables which show, at a glance, just what size of wire is needed for any kind and size of lighting or motor installation, for any voltage, current and drop desired for any system. Direct Current, Alternating Current, single, two or three-phase. How to install and operate generators, motors and every kind of wiring device with diagrams of connections.

Leather Cover. Pocket Size. Gift Edges.
Sent Postpaid on Receipt of \$3.00.

H. C. CUSHING, JR.
14 W. 40th Street New York

HIGH SCHOOL STUDENTS and Others

Special Summer Courses in Wireless
during July and August

Day Course — Special Summer
Rate of \$10.00 per month.

Evening Course — Special Summer
Rate of \$5.00 per month.

Comprehensive Instruction in
"SPARK" or "ARC" and other
C-W transmitters.

Special Course in WIRELESS
TELEPHONY, including thorough
instruction in VACUUM
TUBES as Detectors, Amplifiers,
and Oscillators. Listen for our
Wireless Phone. The Radio
Compass also described.

Send in your enrollment early. All
Summer Courses begin June 28. Best
equipped Radio School in New England.

MASSACHUSETTS RADIO
& TELEGRAPH SCHOOL

18 Boylston St. (cor. Washington)
Boston, Mass.
Arthur Batcheller (Lt.) R. F. Trop. G. R. Entwistle
Tel. Beach 7168

PIGEONS PAY

They build their own nests and work for you 11 months in the year. A few good pair of pigeons now will bring you a good sized, profitable squab farm next season.

Write today for circular.

PIGEON SUPPLY HOUSE. P.O. Box 251. Hanover, Pa.

The Radio Science Club of Greenfield, Mass.

Announcing the formation of a wireless club known as "The Radio Science Club" (of Greenfield, Mass.). At the initial meeting the following officers were elected: President, Roland A. Stratton; Secretary, Stuart H. Nichols; Treasurer, Donald L. Perry. The membership was limited to fifteen, but there is still room for a few more amateurs so that any one living near Greenfield who is interested has a chance to join. We should also like to get into communication with any nearby amateurs or clubs. Kindly address any correspondence to Stuart H. Nichols, Secretary, 22 Union Street, Greenfield, Mass.

Washington Radio Club.

A number of technical and amateur radio men met at the National Radio School of this city on April 3 and formed the Washington Radio Club. The membership of the Suburban Radio Club joined in a body, thus giving the new organization a good membership at the start.

The Washington Radio Club is not connected with any commercial enterprise, but is organized as set forth in its constitution: "To advance the art of radio communication and to unite the amateur operators of Washington and vicinity, to the end that they may derive the benefit of each other's experience, reduce interference, aid one another in the erection of antennas, derive more pleasure from the use of their apparatus and stand together against unjust legislation.

While as indicated above, the club is primarily an amateur organization, it already numbers some prominent radio men among its membership, and hopes to become the general radio organization of the vicinity. The following officers were elected for 1920: President, J. V. Purcell; Vice-President, E. C. Reynolds; Chief Operator, Francis Baer; Secretary-Treasurer, Charles Seckinger; Assistant Secretary-Treasurer, Harold A. Snow.

The club will maintain headquarters at the National Radio School, 1345 Pennsylvania Ave., N. W. Washington, D. C., and the officers will be pleased to correspond with other clubs on any subject of common interest.

The Union College Radio Club of Schenectady.

The Union College Radio Club held a meeting recently and elected the following officers for the remainder of this college year and for next year: President, Frederick Gantner, '21; vice president, Ralph Bennett, '21; chief engineer, Wendell W. King, '21; secretary-treasurer, Jackson Bentley, '23; chief engineer, Francis J. Campbell, '22, and instructor, Professor Ernst Berg.

The College Radio Club was reorganized this year in the interest of those students who desired to receive practical radio work. Regular courses were offered for all those interested in radio telegraphy under the supervision of experienced members of the club. Practical talks have been given once a week by Professor Berg and several of the older members of the organization.

One of the most remarkable features of the work of the Radio Club has been the sending of messages for the students by radio free of charge. All of the results of the Union College basketball games were radioed thruout the country. A similar policy is to be adopted in regard to baseball and track this spring.

A New Inductance

(Continued from page 685)

SOME INTERESTING DATA FROM U. S. GOVERNMENT DEPARTMENT OF COMMERCE BUREAU OF STANDARDS.

Honey Comb Wind

Turns in coil 620
Inside Diameter 2"
Outside Diameter 4 1/8"
Axial Length 1"
Pure Inductance.....25.06 Milli-henries
Distributed capacity,
14.6 Micro Micro-farads

Duo-Lateral Wind

Turns in coil..... 665
Inside Diameter 2"
Outside Diameter 4 1/8"
Axial Length 1"
Pure Inductance.....30.00 Milli-henries
Distributed capacity,
13.5 Micro Micro-farads

Computing both coils for the same ratio of turns, the characteristics become:

For
Homes, Offices,
Factories, Farms

Complete Wall Set Magneto Telephone

Western Electric Type

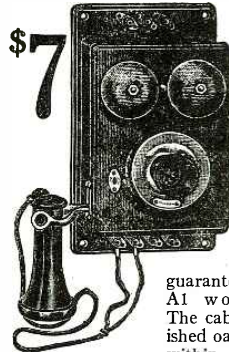

This is a complete commercial telephone station. They were bought from telephone exchanges who put in Central battery types. Slightly used but

guaranteed to be in A1 working order. The cabinet is of polished oak, piano finish, within which is contained the powerful magneto, the 300 Ohm polarized ringer, an induction coil.

The magneto is exceptionally efficient, being of the two bar type with brass gear transmission. The extra sensitive microphone, mouthpiece and two gongs are mounted on the front of the cabinet, giving the entire instrument that desirable appearance of compactness and efficiency. Guaranteed to work over 20 miles. The telephone receiver is a double poled one, and has a hard rubber case. Seven binding posts are provided for connections.

The instrument is one which we can offer with pride to our patrons at a ridiculously low price. It is unobtainable anywhere else at less than \$15.00 and is an instrument unequalled in value for the price we ask. Size over all 11x10x8 in.

Long Distance Telephone Set—
One station.....\$7.00
Shipping weight, 15 lbs.

Two stations
Shipping weight, 25 lbs.....\$13.00

Send 6c in stamps for our big 160 page
Wireless and Electrical Catalog No. 22.

The Electro Importing Co.
231 Fulton Street, New York

WHITE'S WORLD WIDE WIRELESS

is being organized with a capital of One Million dollars to manufacture and distribute modern Radio Equipment. Will specialize in the

"ETHERPHONE"

Special discounts on all apparatus to Amateurs.

Write for Catalog

White's World Wide Wireless
500 FIFTH AVENUE NEW YORK
Phone Vanderbilt 238

$$\frac{30.00 \times 620}{665} = 27.97 \text{ Milli-henries}$$

$$\frac{27.97}{25.06} = 1.12 \text{ or } 12\% \text{ more inductance}$$

$$\frac{13.5 \times 620}{665} = 12.59 \text{ Micro Micro-farads}$$

$$\frac{12.59}{14.6} = .86 \text{ or } 14\% \text{ less distributed capacity}$$

It will thus be noted that a considerably larger number of turns can be wound in the Duo-Lateral wind in the same space factor, than in the Honey Comb wind.

A PRACTICAL RADIOPHONE FOR THE AMATEUR.

Correction

Concerning the above article by Mr. Herbert W. Harmon which was awarded first prize and fully described in the May issue of RADIO AMATEUR NEWS, attention is invited to Fig. 1, on page 617. This diagram bears a circuit error which should be corrected.

The wire leading from the lower left-hand choke coil should be shown as making contact with the wire leading from the bottom connection of the lower left-hand pancake helix. Without this important connection there is an open circuit in the generator line. Radio men who desire to construct similar sets should particularly note this fact.

I Want to Know

Continued from page 703

should be in order to keep my transmitting set under 200 meters?

A. 1. In order to keep within 200 meters, the length of an amateur aerial must not greatly exceed 100 feet in length for the inverted L type and 135 feet for the T type, nor should the height of such antenna greatly exceed 35 feet above the ground.

Q. 2. How many miles will an amateur transmitter cover making use of the following apparatus: A one-inch spark coil, a glass plate condenser, oscillation transformer and open spark gap?

A. 2. You should be able to cover at least five miles and probably more under favorable conditions.

Q. 3. Please give me the dimensions for a choke coil suitable for a ¼ Kw. transformer.

A. 3. A reactance regulator or choke coil suitable for a ¼ Kw. transmitter can readily be constructed by winding four layers of No. 14 D. C. C. wire upon a straight iron core 1½ inches square and 14 inches in length. The coil may be tapt two or three places, or after each layer as shown on page 703 diagram.

PARTICULARS OF TRANSMISSION FROM EIFFEL TOWER AND LYONS RADIO STATIONS

In the March issue of RADIO AMATEUR NEWS on page 468 there appeared the above-mentioned article which gave credit to Mr. L. McMichael. We should have mentioned that this article was originally published in the Review Section of that excellent French publication, entitled "T. S. F.," on page 118, No. 9, of September 30, 1919.

THIS—
the second

Announcement

since our entrance into the Radio and Electrical field, is published to acquaint you with the fact that we have been taken at our word as an organization specializing in

"Personal Service to the Consumer"

Our efforts will always tend to serve each one of you individually and promptly, through our sales or mail order department, and to this end we have contracted with over ninety per cent of the leading manufacturers, which means that we will carry everything Radio, from Contact Points to Complete Stations.

Among the serviceable and high quality Radio and Commercial Apparatus which we offer you are to be found the foremost products of

- Radio Craft Corp.; A. H. Grebe; Clapp-Eastham; International-Radio Tel. Co.; De Forest; W. J. Murdock; J. H. Bunnell; Amer. Radio & Research Corp.; Manhattan Electrical Supply Co.; General Radio; Acme; Marconi; S. Cohen; Federal Tel. & Tel.; Electrosee; Brandes; Pacent Electric; Wireless Equipment; Wireless Improvement; Cole & Morgan, Books; Wireless Press, Books; Marko Storage Batteries and Endurance Storage Batteries; Standard V. T. Batteries; Adams-Morgan; Dublier Condensors; Firth; Omnigraph; Magnovox and others.

You have our most courteous invitation to spend a few moments in our spacious show rooms to look over our complete stock. We will gladly show you any instrument or part you may desire to examine. It will be a revelation to you—besides, it is part of our service.

OUR WORD OF HONOR TO YOU IS
OUR GUARANTEE. LET US PROVE IT

Write Dept. C-3 for literature and price lists

CONTINENTAL RADIO & ELECTRIC CORP.

J. DI BLASI, Secy.

J. STANTLEY, Treas.

6 Warren Street

New York

STORAGE BATTERIES FOR WIRELESS SERVICE

Batteries especially adapted for the amateur operator are described and illustrated in our new Bulletin, No. 175, copy of which will be furnished on request.

THE ELECTRIC STORAGE BATTERY CO.

The largest maker of storage batteries in the world
1888 PHILADELPHIA, PA. 1920

- New York
 - Atlanta
 - Boston
 - Pittsburgh
 - Chicago
 - Minneapolis
 - Washington
 - Denver
 - Kansas City
 - San Francisco
 - Detroit
 - Rochester
 - Cleveland
- Special Canadian Representative, Chas. E. Goad Engineering Co., Limited, Toronto and Montreal

Doron Bros. Elec. Co.
Hamilton, Ohio

We manufacture PARTS of all kinds for Radio and Electrical Apparatus
"DEPENDABLE"

Radio apparatus is better. We have a real factory
Send 10 cents for catalogue NO. 9 and June price list

NAME

ADDRESS

STATE

ELECTRO IMPORTING COMPANY,
231A Fulton St., New York City.

I enclose herewith 6 cents in stamps or coin for which please send me your latest Cyclopedia Catalog No. 22 containing 80 pages, 200 illustrations and diagrams, including Treatise on Wireless Telegraphy, and 20 coupons for your 160 page Free Wireless Course in 20 lessons.

R.A.N. 6-20

FILL IN THIS COUPON FOR YOUR COPY OF Our New 80 Page Cyclopedia No. 22 IT IS WAITING FOR YOU

Full size fac-simile of our catalog just as it looks when you get it
1-4 INCH THICK **WEIGHT ALMOST 1-2 POUND**
200 Illustrations

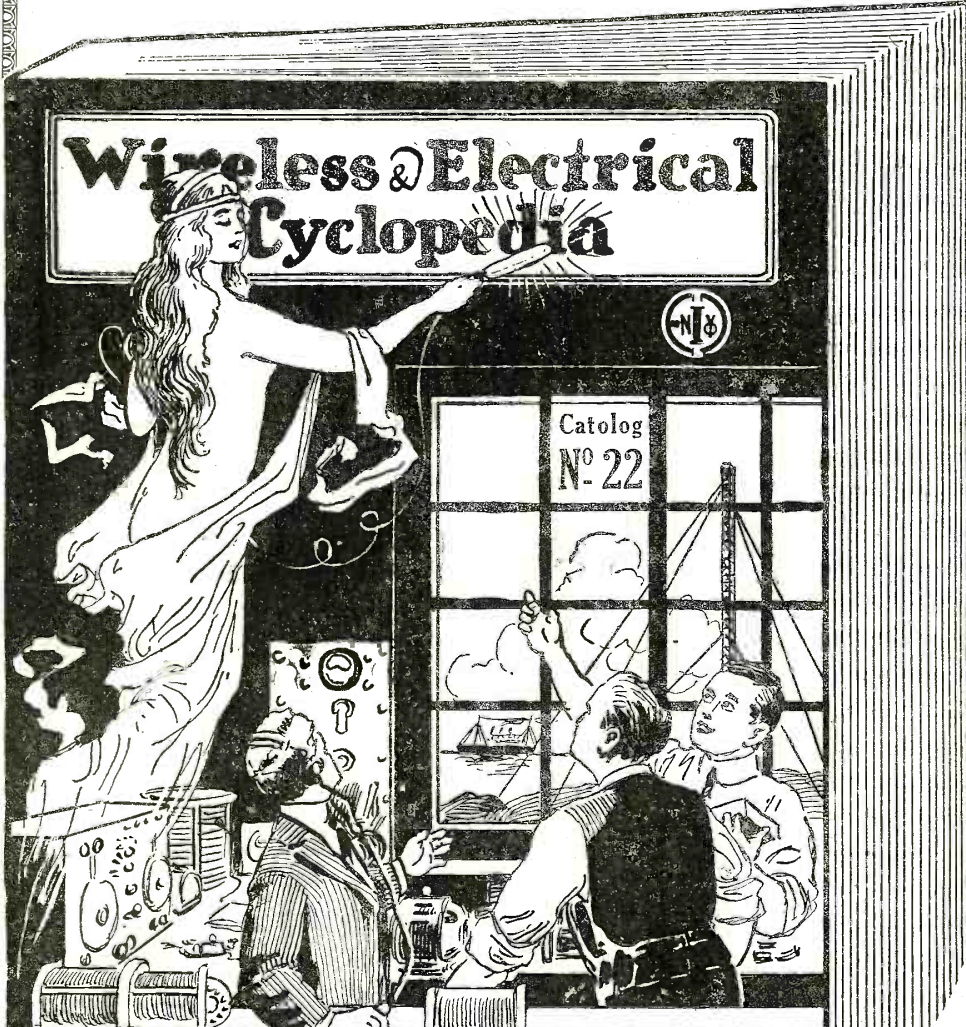

The Electro Importing Co.
231 FULTON STREET NEW YORK
"EVERYTHING FOR THE EXPERIMENTER"

A Few Interesting Things from Catalog No. 22

Treatise on Wireless Telegraphy by H. Gernsback, Editor Electrical Experimenter and Radio Amateur News—11 big pages, 3 illustrations.

The Wireless Law of 1912—all about it, what you can do and what you can't.

How to receive and send Radio messages.

How far you can send messages.

Table of wave lengths, of principal U. S. & foreign Radio high power stations.

How to receive time signals by Radio.

How to construct an amateur aerial.

How to use the test buzzer.

How to join the "Radio League of America" FREE, including application blank.

Experiments with a pony telephone receiver, with 6 illustrations.

Experiments with spark coils.

All about storage batteries; how to test them, recharging, etc.

Tesla experiments, 2 pages.

FREE with this wonderful cyclopedia—20 coupons for our 160 page Wireless Course in 20 lessons, 250 illustrations, 30 tables. Catalog explains how you can get this Course absolutely free.

"THE LIVEST CATALOG IN AMERICA"

IN this cyclopedia you will find all about radio. One of the greatest catalogs of its kind in print.

You will find in it dozens of wireless instruments of the famous E. I. Co. make. Remember always that this company was the FIRST to make and sell wireless instruments, the first wireless outfit having been placed upon the market by them in 1904. The E. I. Co. knows how, because it has the experience.

Others imitate but cannot equal E. I. Co. for quality and workmanship.

Other things you will find listed in this catalog: Electrolytic Interrupters, Bulldog Spark Coils, Chemical Outfits, Code Practice Sets, Primary Batteries, Storage Batteries, Hydrometers, Volt and Ammeters, Battery meters, Electrolytic Rectifiers, Rheostats, Tesla Coils, Microphones, Loud Talkers, Electro-magnets,

X-ray tubes, Telephones, Magnetos, Low Tension Transformers, Books, etc., etc. **IN A WORD THE MOST COMPLETE CATALOG IN PRINT**

ELECTRO IMPORTING CO.
231A FULTON STREET NEW YORK, N. Y.

"Everything for the Experimenter"

Radio Dictionary

(Continued from page 706)

Hertzian Oscillator—Consisted of two metal sheets of wings separated by a spark gap, used to produce oscillations which give rise to ether waves.

Hertzian Resonator—A wire ring broken by a small spark gap, used by Hertz to detect ether waves set up by his oscillator.

Hertzian Waves—Ether waves, named after the discoverer.

Hessite—Potential Rectifier. Occurs in nature as a telluride of silver, Ag₂Te.

Heterodyne Reception—See Beat Reception.

H. F. C.—High Frequency Current.

Hicks Hydrometer—A small glass tube containing three colored glass beads and fitted with a rubber teat at one end which is used for sucking up the liquid to be tested into the tube. When full and the yellow bead is floating nearest to center, the specific gravity of the liquid is 1.170. Should it be the blue one, S. G. is 1.185 or in the case of the purple bead S. G. is 1.200. It is used for testing the specific gravity of acid of accumulators.

High Frequency—Frequencies over a few thousands per second.

High-Frequency Resistance—Conductors offer more resistance to high-frequency currents than to low-frequency currents owing to the fact that since they, the H. F. C., use only the surface, a smaller amount of material is offered for the passage of the currents than in the case of L. F. C., which soak in and utilize the whole of the conductor. It is also called Skin Effect.

High-Frequency Sliding Inductance—Two brass rods bridged by a sliding brass clamp. Used for making final slight adjustment in closed oscillatory circuit.

Highly Damp Train—One having very few oscillations, owing to their rapid dying away.

High Resistance Telephones—Used, where a large number of turns are required round the magnets. The resistance is merely incidental and is not required. See Ampere-Turns.

Horizontal Aerials—Aerials having the larger portion of their length parallel to the earth's surface. See Flat Top "T" Aerial and Inverted "L" Aerial.

Horse-Power—American and British Unit of Power. Power required to perform 550 foot-pounds of work per second. Seven hundred and forty-six watts equal one horse-power.

Horse-Shoe Magnet—A magnetized steel bar bent into the shape of a horse-shoe whereby both its poles are brought near together.

Hot-Wire Ammeter—One measuring current amperes in a circuit by means of a wire which expands, i. e., lengthens in proportion to heat generated by passing current. The greater the amperage the greater the heat produced and consequently the greater the expansion of wire. Expansion of wire or amperage is indicated by a suitably connected pointer moving over a graduated scale.

Hunting—The getting out of "step" of synchronous generators or motors, due to momentary fluctuations of pressure which is produced by uneven running of machines. Also called Phase swinging.

Hugonium—An alloy used to mount radio crystals. Invented by H. Gernsback. Its melting point is slightly above boiling water. Composed of lead, tin, mercury and cadmium.

Hydrogen—H. Lightest known substance, Elem. Gas. A. W. 1. Val. 1. Chem. Eq. 1.

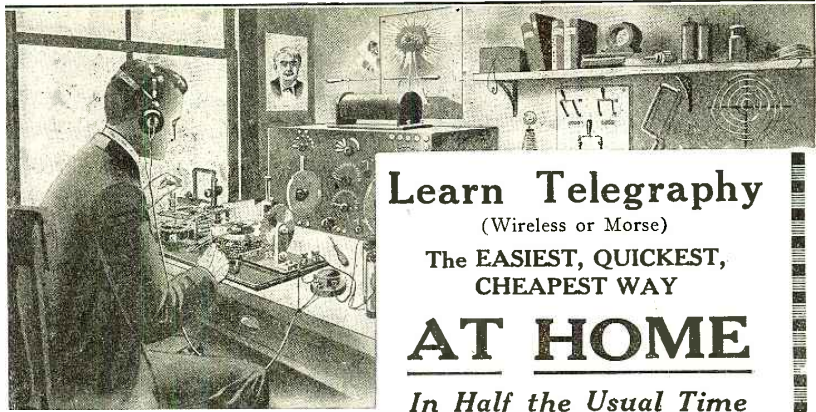

Learn Telegraphy

(Wireless or Morse)

The EASIEST, QUICKEST,
CHEAPEST WAY

AT HOME

In Half the Usual Time

WITH THE OMNIGRAPH

"Just Listen—The Omnigraph will do the teaching"

The Omnigraph is an *Automatic* Transmitter that teaches you both the Wireless and Morse Codes, at home, without any expense except the cost of the machine itself. Merely connect to battery and your Buzzer, or Buzzer and Head Phones, and the Omnigraph will send unlimited messages by the hour, at any speed you desire.

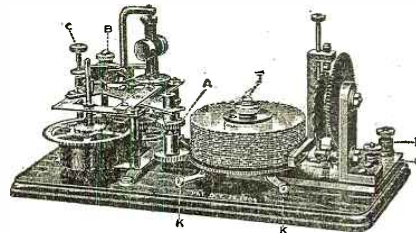

USED BY THE U. S.
GOVERNMENT

The Omnigraph is used by the Government in testing all applicants applying for a Radio License. It is also used extensively by the large Universities, Colleges and Telegraph Schools throughout the Country for teaching Wireless and Morse. Hundreds of the Army's skilled operators who served during the war learned with the Omnigraph.

Let The OMNIGRAPH Teach You Wireless

For a few dollars you can have a complete outfit that will make you an experienced operator in the shortest possible time. No hard, laborious work—just learn by listening. The Omnigraph is adjustable so you can start receiving messages slowly, gradually increasing the speed as you become proficient.

You'll be surprised how quickly you will attain speed. Even if you are already an operator the Omnigraph will help you. It will make you more proficient, more accurate and more confident. Thousands of Omnigraphs are in use to-day and thousands of operators owe their success to them.

Write for Free Catalog

Send for a catalog to-day, showing the 3 different models, \$12.00 to \$28.00. Every Omnigraph is sold with the absolute guarantee that you must be satisfied or your money back for the asking. Mail the coupon to-day—the catalog will come to you by return mail.

The Omnigraph Mfg. Co.,
39 F Cortlandt St.,
New York City.

The Omnigraph Mfg. Co.
39 F Cortlandt Street, New York City

Gentlemen:—
As per your ad in Radio Amateur News please mail me your free catalog of Omnigraphs.
Name
Address
City..... State.....

WIRELESS MANUAL-M12

Our 180 Page Combined Manual and Catalog Illustrates and Accurately Describes the Uses of Standard Radio Instruments.

We Make a Charge of 25c for it, Issuing a Coupon Receipt Redeemable on a Purchase of \$5.00 or More.

You cannot get satisfaction from wireless instruments unless they are absolutely perfect. The slightest imperfection in construction destroys their efficiency. We catalog and offer for sale wireless apparatus of the highest quality, guaranteed to be mechanically and electrically perfect.

Get a copy of our complete wireless catalog and order all of your radio material from one source of supply and save trouble. Ready about May 25. Send in your request now.

MANHATTAN ELECTRICAL SUPPLY CO., Inc.

New York—17 Park Place
Chicago—114 S. Wells St.

San Francisco—604 Mission St.
St. Louis—1106 Pine St.

MONEY for YOU Add to your Salary—Make extra Pin Money
Start a lucrative business of your own.
Spend an hour each day taking subscriptions for the "Radio Amateur News." We'll pay you well and you'll enjoy the work. Write for full particulars. Circulation Dept., RADIO AMATEUR NEWS, 236 Fulton St., N. Y. City.

The "A. R. CO." Variable Condenser

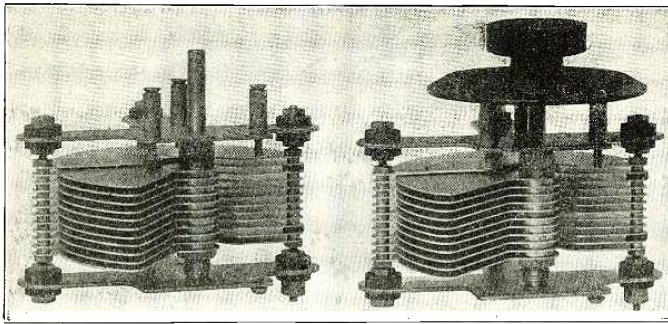

THE "A. R. CO." VARIABLE CONDENSER

Illustrated above, is made in two capacities—.0005 Mfd. and .001 Mfd. The rotary plates are rounded on one end, affording a straight-line capacity—a valuable feature in wave meter work. The condenser is furnished unmounted only but with the addition of Dial and Knob, if desired. Dial is of moulded composition, scale in white—0-100 reading. Bakelite Knob. We can guarantee this condenser in every way as to quality, reliability and satisfaction. The low price is decidedly an innovation.

Capacity	PRICES:	
.0005 Mfd.	Unmounted	With Dial and Knob
.001 Mfd.	\$5.00	\$6.00
	6.25	7.25

"BULLETIN 14"—describing and illustrating the best in RADIO EQUIPMENT will be mailed upon receipt of 10 cents in stamps—this amount may be deducted on your first order of \$1.00 or over.

ATLANTIC RADIO CO., Inc. :: 38 Broad St., BOSTON 9, MASS
NEW ENGLAND DISTRIBUTORS FOR "RADISCO" PRODUCTS

Build Your Own Wireless Receiving Set

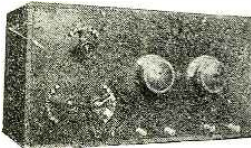

Think of the pleasure and practical experience you will gain in making your own set. You can save at least \$25.00 by buying the parts and assembling it yourself. This is not a toy, but a regular, large sized set (16"x8"x6") capable of receiving messages ranging in wave length from 170 to 2,500 meters. We will furnish you with large, full sized blue-print and full information concerning winding of coils, mounting of instruments on panel, "hook up"—in fact complete detailed instructions written in plain, easy to understand language.

Our Offer is This:

Send \$1.00 and we will send you the blue-print and instruction sheets—also prices of all parts. When you order at one time \$5.00 or more worth of parts, you may deduct this \$1.00 from the total. Since the blue-print and instructions alone are worth \$1.00, and since we can save you money on wireless material, you cannot possibly lose. So send \$1.00 today before this slips your mind and start making your set as soon as possible.

K. & G. WIRELESS SUPPLY CO.

Dept. 16B, 152 Chambers Street

New York City

REAL RADIO APPARATUS

Distributors—De Forest, Murdock, Grebe, Clapp Eastham Apparatus. Perfection Tuners and Condensers. Benwood Rotary Quenched, Honey Comb Coils, Better "B" Batteries.

Phila., "Radisco Agency"
The First Wireless School in America.
Established 1911.

Day and Evening Classes.
Correspondence Course.

PHILADELPHIA SCHOOL OF
WIRELESS TELEGRAPHY

Parkway Bldg., Broad and Cherry Streets

"P. W." Audion Panel. \$11.00
without Bulb.

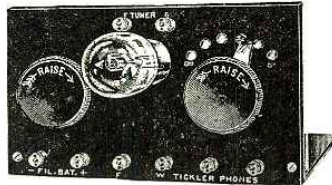

Best Polished XX Bakelite, lettered in white, a beauty. Use any American made bulb. Parts, ready to assemble, \$8.50.

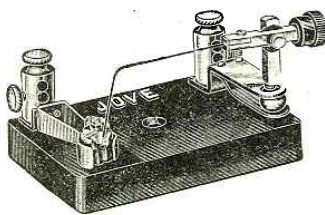

(GHEGAN PATENT)

Bunnell INSTRUMENTS Always Reliable
JOVE DETECTOR
Handiest, Handsomest, Best
Sample by Mail, \$2.00
Tested Galena Crystal, 25c

We are distributors of the Standard Electric Novelty Co.'s Type B "Cyclone" Audion Batteries. Also of De Forest and all the leading manufacturers of High Class Wireless Apparatus. Send stamp for new edition 42RN Catalog.

J. H. BUNNELL & CO., 32 Park Place, New York

Hydrometer—Instrument for measuring the Specific Gravity (density) of a liquid by flotation. See Hicks Hydrometer. Used for testing state of charge and discharge of storage cells.

Hygroscopic—Taking up moisture from the atmosphere.

Hyperbola Curve—A curve where one of the factors is inversely proportional to the other, e. g., one showing decrease of current with increase of resistance.

Hypothense—Side of a right-angled triangle which is opposite to the right angle.

Hypothesis—Supposition, assumed for the purpose of argument.

Hysteresis—Slowness or lagging behind when a change of condition is taking place. Preference to remain in one condition. Reluctance of changing.

Impedance—The resistance which a coil of wire offers to a current due to back T. M. F. apart from that offered by the Ohmage. It is due to *Reactance*.

Impedance Coil—A coil of wire wound over a soft iron core. See Inductance Coil.

Impulse Excitation—A method of producing free alternating currents in an excited circuit in which the duration of the exciting current is short compared with the duration of the excited current.

Increase Wavelength—Add inductance in series with the aerial though more than doubling causes appreciable loss of radiation.

Index—Figures to left of point in long number. The whole number of Log. Powers to which a given number is to be raised. Also called the Characteristic.

India Rubber—Or Caoutchous. S. I. C. 2.5, Vulcanized 2.8.

Indicated Horse Power—Total power a machine system exerts, including the necessary power to run the machine against its own friction. See Brake Horse-power.

Indirect Excited Aerial—Excitation of an aerial produced by Induction.

Induced Magnetism—The temporary magnetism produced in an unmagnetized piece of iron by close proximity to a magnet.

Inductance—Electrical Inertia, unit, Henry, which see.

Inductance Coil—A coil of wire so arranged as to have a large amount of Inductance. Also called Choking Coil, Impedance, Reactance, Retardation Coil.

Inductances in Parallel—Decrease total Inductance.

Inductances in Series—Increase total Inductance.

Inductance—The transfer of an electric or magnetic state from an electrified or magnetized body to a non-electrified or non-magnetized body by proximity without contact.

Induction Coil—Or Rhumkorf Coil. An instrument which increases the voltage of a D. C. current at the expense of a corresponding loss of amperage by induction. Comprises an iron core having a few windings of comparatively thick wire, over which is wound a secondary winding of much thinner wire and of many more turns. Usually an automatic make and break, of the hammer type, is in series with the source of supply to the primary winding. Two ends of secondary winding are attached to suitable dischargers. See also Tesla Coil. Compare Transformers.

Induction Motor—One having a rotating field called the rotor, while the stator, which is equivalent to an armature, is stationary. An alternating (usually Polyphase) current motor having a rotor of short circuited copper bars in which currents are induced by the stator or field magnets.

Inductive Capacity—Facility with which a dielectric permits static induction to act through it. See Specific Inductive Capacity (S. I. C.).

Inductive Close Coupling—One in which the inductances of the two circuits are very close to each other, but without actual metallic contact.

Inductive Coupling—Two oscillatory circuits coupled by bringing the inductance coil of one into the field of force produced by that of the other.

Inductive Loose Coupling—One in which the inductances are relatively far apart, without any actual metallic contact.

Inductive Shunt—See Static Leak.

Inertia—That property of matter which tends to preserve a state of rest or to resist a change of motion.

Infra Red Rays—See Light.

Inker—Or Inkwriter (Morse Recorder). A telegraph recorder by means of which an inked wheel attached to one end of a pivoted armature marks lines of varying lengths (dots and dashes) as it is periodically pressed against a moving paper tape during attraction of armature by magnets receiving line current.

Insulator—A material thru which electricity will not pass except possibly when under great pressure.

Integrating Wattmeter—An energy meter which shows total amount of energy in B. O. T. Units that has been used. Broadly speaking, is a type of small motor whose rotations are counted by means of a worm on the armature shaft engaging a set of cogs working a counter.

Intensifier Handle—Ebonite handle at right-hand end of multiple tuner which regulates the coupling of the intermediate circuit with the aerial and detector circuits.

Interference—In the case of wave motion, two sets of waves which proceed from one and the same source or from duplicate sources may arrive at a distant point in such a manner that the motions or changes which constitute these waves annul one another at that point. The waves are then said to interfere.

Interference Reception—See Beat Reception.

Intermittent Current—A current constantly interrupted.

Interrupter—An apparatus for breaking up a D. C. into a series of impulses, thus producing an intermittent current. Most commonly used in conjunction with an Induction Coil.

Interrupter, Electrolytic—A jar containing diluted sulphuric acid and metal elements whereby a current is interrupted so as to be suitable for small spark coil work.

Inverted "L" Aerial—One whose down-leads are tapt off from one end of its horizontal span. See Length of Aerials.

Ion—An atom of matter carrying an electron, or an atom deprived of electrons.



Hook'er to Yer Bulb.

The most wonderful Tuner in the world for only \$15. Last month this Tuner beat in a test one of the NAVY STANDARDS at Ketchikan, Alaska.

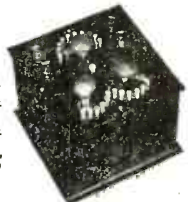

10 Captains of ocean going ships have had their wireless operators install one of our tuners in the captain's cabin so the exact time by wireless can be had without using either tube, bell, or hand. "GREAT" says one old sea dog. "WHAT IN SAM HILL, WILL YOU SMART ALECS GET UP NEXT?" European stations copied in day time and no fancy aerial is needed. A single wire about 40 long by 25 high will do the trick. London amateur W. K. Wade, Clifton, Bristol, promises report for the magazines to publish showing how the amateurs there read our sigs in England. Junk your funny wound coils and get a regular two pound tuner that you can use during the static season. 20000 meters maximum wave length. Hook up on bottom of tuner.

KNOCKED DOWN AND ASSEMBLED CONDENSERS.

Which kind do you want? Made for panel mounting and are complete with scale pointer and knob. Used all over the world now and still going strong. No. C.O.D. orders. Add parcel post. Buy from your dealers and send us his name if he cannot supply you.

Canadian amateurs buy from local dealers or write us for nearest dealer. Formula tops and bases. Movable plates are screwed on and not clamped.

11 plate knocked down	\$1.80
21 plate knocked down	2.25
41 plate knocked down	3.20
11 plate assembled	2.75
21 plate assembled	3.25
41 plate assembled	4.25

Sold by your dealer or
Tri-City Radio Electric Supply Co.

TRESCO—Davenport, Iowa

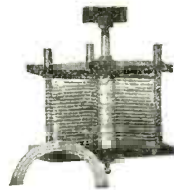

**EASTERN
RADIO
INSTITUTE
RADIO**

899 Boylston St.
Boston, - Mass.

TEL.
BANK BAY
5 9 6 4

LEARN WIRELESS

Splendid opportunities now in the Merchant Marine. Big salaries. \$100 to \$150 per month. food and quarters besides. REMEMBER: We are the OLDEST, LARGEST and BEST EQUIPPED school of its kind in New England, and have THOUSANDS of satisfied graduates to our credit. THIS SPEAKS FOR ITSELF. Day and Evening classes. Summer session. Start any Monday.

Our prospectus for the asking

MAKE YOUR OWN REGENERATIVE RECEIVER USE WILCOX VARIOMETER PARTS

SET NO. ONE contains carefully turned wooden parts as illustrated.

Price \$2.50 Postpaid



SET NO. TWO contains all parts for variometer including a 3" dial.

Price \$5.00 Postpaid

THE WILCOX LABORATORIES, - - LANSING, MICH.

THE NEW YORK ELECTRICAL SCHOOL

THE N. Y. ELECTRICAL SCHOOL is the pioneer and premier school of the "Learn by Doing" method. When you have completed this Course you shall be fully qualified to handle ALL branches of Electrical Industry. The equipment of this School is unequalled and up-to-the-minute. No preparation needed to become a "learner" in this school. You can start to learn on any day of any week throughout the whole year. Send for catalogue.

OPEN ALL SUMMER

NEW YORK ELECTRICAL SCHOOL
29-31 West 17th St. New York City

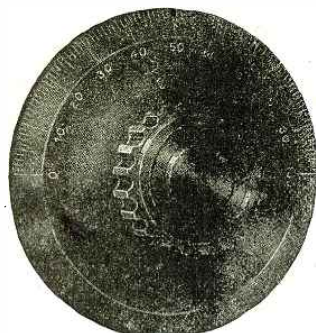

Indicating Dials

Make your radio apparatus up to date. Indicating dials now available at a reasonable price.

Made of fine black polished composition with radial lines and figures accurately engraved and filled with brilliant white. Diameter of dial is 3 inches and they are 3/16 inch thick. Have bevelled edge. We can furnish dial alone or with fine Bakelite Knob mounted. This knob has a set screw to clamp shaft of instrument to which dial is to be applied.

3 inch Dial only.....75 cents
Postpaid
3 inch Dial with Knob mounted..\$1.30
Postpaid

If your dealer cannot supply you send us his name with your order. Immediate deliveries.

OUR NEW CATALOG now ready for distribution, contains 24 pages of real, live, up to the minute illustrations, news and descriptions of all standard Radio parts, including the above Indicating Dial.

Sent anywhere upon receipt of 10c.

For sale at all Radisco Agencies and by

A. H. Corwin & Co.

4 West Park Street

Newark, N. J.

Summer Radio Course

Classes now in session. You may begin at once our complete course preparing you for commercial radio license. Rapid progress, individual attention, classes of limited size.

Ask for new descriptive booklet.

Y. M. C. A. RADIO SCHOOL

Marcy Ave., near Broadway
Brooklyn, N. Y.

Telephone, Williamsburg 3800

REMOVAL NOTICE

The undersigned desire to announce the removal of their offices from

19 PARK PLACE

to new and much larger quarters at

188-190 Greenwich Street, New York City

where they will be in a better position to accord their patrons more prompt and efficient service.

Send for catalogs as issued.

WIRELESS EQUIPMENT CO., Inc.
Manufacturers

COLE & MORGAN, Inc.

Publishers of the Arts and Sciences Series.

Monad-ion carries unit charge, dyad-ion, divalent, carries two units, while triad-ion carries three unit charges. Positive Ion is an Atom minus an Electron and a negative Ion is an Atom plus an Electron.

Ionization—The splitting up of molecules into Ions. Ionized air or gas becomes conductive. See Valve Detectors.

Iridium—Ir. Hard white, brittle metallic element. A. W. 191.5. S. G. 22.4.

Iron—Fe. Ferrum. A. W. 55.5, S. G. Cast 7.5. Wrought 7.74. Mlt. Pt. Cast 1960° F. Wrought 2912° F. S. R. Annealed 9,065. El. Chem. Eq. .000,290,2.

Iron Pyrites—See Iron Sulphide. FeS₂. Also known as "fool's gold" owing to its similar appearance to gold. Formerly used considerably as a detector.

Iron Sulphide—Occurs in several varieties, but only the bright crystalline one is sensitive as a rectifier. Is used with a phosphor bronze or gold point. See Pyrites.

Isodynamic Lines—Lines connecting all parts of the earth where the magnetic intensity is the same.

Isogonic Lines—Lines connecting all points of equal variation of Magnetic Meridian from the Geographic Meridian.

Isotherms—Lines on a meteorological chart joining all points having the same temperature.

Jamming—Expression denoting interference from another station. QRM.

Jigger—Term generally accepted to denote an Oscillation Transformer. Used for transforming trains of oscillations from one circuit to another. Dr. J. Erskine Murray refers to high-frequency oscillations as "Jigs."

Joule—Unit of Electrical Work. Work done by one Coulomb flowing under a pressure of one Volt. If one Coulomb per second, power is one Joule per second or one Watt. Commercial Unit same as above but with time unit of one hour called Watt-hour Joule, 100,000,000 Ergs.

Joule's Law—Heat produced in a circuit is directly proportional to square of the current to resistance and to time.

Kathode—See Electrolysis.

Kathode of Cell—Positive pole.

Kathode Rays—Electrons thrown off by the kathode of a vacuum tube, which produce a glow wherever they strike the walls forming the tube. They may be deflected by a magnet.

Key—The transmitting key is a switch by which the Primary Circuit may be readily and rapidly made and broken.

Keeper—The piece of iron used to close the magnetic circuit of a horse-shoe magnet to protect it from external disturbances. In case of straight bar magnets two are used, the magnets being laid side by side with unlike poles adjacent and the keepers placed across the ends.

Kilowatt—One thousand watts, K.W.

Kinetic—Producing Motion.

Kinetic Energy—Power in motion.

Knife Switch—One in which the movable arm wedges in between two parallel spring clips. May be either a single, double pole switch or double pole double throw switch.

MOONSHINERS HAVE RADIO

Revenue agents have discovered the reason for their inability to arrest the moonshiners in certain sections of West Virginia, Virginia and Kentucky. It has been found a wireless system is in operation through which the distilling plants are notified by a code of signals from the railroad station sent by confederates when danger threatens.

When the officers swoop down on a spot where a still is reported they find the outfit missing. At one place a diagram of a modern radio station was found. It is easily possible in the densely-wooded mountain sections to conceal radio stations and officers are now searching for them.

READ THE CLASSIFIED ADVERTISEMENTS ON PAGES 732-734, YOU'LL FIND MANY GOOD THINGS THERE.

Static Elimination

By John F. Bront

THE subject of the interference caused by static discharges has been a problem since the advent of radio communication. Different localities under observation have proved that the nature of the discharges are variable in frequency of occurrence, type of discharge, and intensity.

In the northern latitudes a certain amount of this interference is experienced to a certain extent, but southern latitudes are particularly affected with irregular occurrences of such force as to render communication impossible except over short distances and with the radiation of excessive amounts of energy. Of the atmospheric encountered in the northern zones, it is found that in fact the greater amount of the interference is due to discharges *traveling from the south.*

The Marconi Company, in their ventures in trans-oceanic continent-to-continent communication, were greatly hampered in their early attempts to maintain communication twenty-four hours per day. The balanced crystal receiver was employed with some success, but the ultimate results were far from being satisfactory. The stations near the American coast corresponding with European stations were able to maintain a dispatch of traffic only during the periods when weather conditions were such as to cause a minimum of atmospherics.

We discover in the use of amplifiers to step up radio signals, a corresponding increase in the strength of static discharges. It has been claimed that in the use of radio frequency amplifiers of certain construction the amplification of the atmospherics was *considerably less* than in other types, including audio-frequency amplifiers. The difference, however, is negligible as far as present developments show.

It has been advanced that the separation of the atmospherics from the signal wave is impossible after it enters the detecting and amplifying circuits. However, it is suggested that the greatest advance in the reduction and obliteration of atmospheric interference will be made in the primary circuits before it is impressed upon the secondaries or tertiary circuits.

The definite knowledge of the action of the discharges and their relative difference from the action of the propagated signal wave, will have to be fully understood, and research bent in that direction in order to secure any radical results possible at the present rate of progress. To date there has been no surprisingly efficient antidote brought forward for the elimination of the static interference.

It is noted, with a little satisfaction, in recent experiments with the underground and the underwater aerial, that a reduction in interference of this sort was experienced, and in some cases it was considerable. One experimenter of rather prominent accomplishment has made the statement that further development of these types of aerials will entirely eliminate atmospherics. But at the same time we cannot expect that at that stage the underground aerial will be of sufficient practicability to employ them in long-distance-long-wave communication.

However, it remains that atmospherics must be eliminated in an efficient manner and along that line lies a field for experiment and research.

The loop system somewhat similar to that of Weagant's and with which the writer experimented at the suggestion of a French engineer from a French University in 1918, during the war while in France, proved efficient up to a certain extent in "buckling" back the discharges upon themselves and thus reducing their strength.

In Weagant's experiments the use of a goniometer coupling of a straight wire

(Continued on page 729)

AMPLIFY YOUR RADIO SIGNALS

With the new DETECTAGRAPH-TRANSMITTER, the amateur can amplify radio signals to such an intensity that he can hear the signals about his station without the need of the telephone head set.

By the addition of a loud talking telephone he is able to hear the messages many feet away from the instrument.

The super-sensitive DETECTAGRAPH-TRANSMITTER herewith shown is two and three-eighths inches in diameter, five-eighths of an inch thick and weighs less than three ounces. It is the most sensitive sound detecting device ever brought before the public.

The manner in which

the amplifying process is attained is by attaching with tape the DETECTAGRAPH-TRANSMITTER to the regular wireless receiver.

Not only is this instrument applicable for amplifying radio signals, but it can be used with equal satisfaction for magnifying other sounds. Phonograph music can be transmitted from one place to another by means of this instrument, and those who are afflicted with deafness will find enormous benefit by using this transmitter. It is the greatest device for building

your own loud talking telephone, detectograph and other devices. Can be used for any purpose where a sensitive detecting instrument is required.



Our Super-Sensitive Detectograph Transmitter. Price, \$8.00 Complete



Our Special No. 25 Loud Talking Receiver. Price, \$4.50 Complete



Detectograph Rheostat, especially made for amplifying circuits. Price, \$2.00 Complete



Super-Sensitive No. 40 Receivers to be used in connection with Detectograph Transmitters. \$10.50



The Detectograph Junior Deaf-Phone \$18.00



Adjusted Model "B" Horn, with No. 20 High Grade Loud Talking Receiver, Cord Plugs and Disk Stand Base. Price, \$12.00 Complete

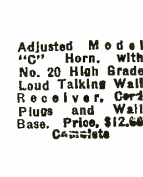

Adjusted Model "C" Horn, with No. 20 High Grade Loud Talking Wall Receiver, Cord Plugs and Wall Base. Price, \$12.50 Complete



Detectograph \$18.00 This detecting instrument of marvelous sensitivity can be used for detecting secret conversations. Outfit consists of Sensitive Transmitter, 25-ft. Black Cord, Receiver, Headband, Case and Battery.

Order direct from ad.
Or write for free descriptive circular.
G. BOISSONNAULT COMPANY
25 CHURCH STREET NEW YORK CITY
Makers of Super-Sensitive Microphone Devices

NEW MOTORS

FACTORY GUARANTEED - ALL SIZES - IN ORIGINAL BOXES

Your Opportunity To Buy New Guaranteed Electrical Apparatus of Standard Manufacture.

Single Phase Motors	Charging Generators	Polyphase Motors	Battery Charging Outfits
110-220 volts, A.C., 60 cycle 1800 R. P.M. with pulley	Suitable for all lighting, Battery Charging and Power Requirements.	2 and 3 phase, A.C., 280 v. 60c., 1750 R.P.M., complete with base and pulley.	To operate on A.C., 60 cycle, single phase. Voltage as specified.
1/4 H. P., 110 volts, induction, full load start - \$28.50	8 volts, 10 amp. - \$19.50	1/2 H. P. - \$46.50	110-220 v., A.C., 150 watts, 15 v., with switchboard - \$68.50
1/2 H. P., 110-220 volts, induction, full load start - \$38.50	15 volts, 10 amp. - \$24.50	1 H. P. - \$64.00	110-220 v., A.C., 150 watts, 20 v., with switchboard - \$68.50
1/2 H. P., 110-220 volts, repulsion, for compressor - \$52.50	40 volts, 6 amp. - \$31.50	2 H. P. - \$81.00	110-220 v., A.C., 175 watts, 24 volts, with switchboard - \$68.50
1 H. P., 110-220 volts, repulsion, with sliding base - \$76.50	110 volts, 6 amp. - \$46.50	3 H. P. - \$96.00	110-220 v., A.C., 250 watts, 50 volts, with switchboard - \$88.50
2 H. P., 110-220 volts, repulsion, sliding base - \$116.50	40 volts, 30 amp. - \$78.50	5 H. P. - \$112.00	220 volts, 2 phase, 500 watts, 24 v., without switchboard - \$75.00
3 H. P., 110-220 volts, repulsion, sliding base - \$142.50	110 volts, 18 amp. - \$106.50	1 H. P., high speed, 3600 R.P.M., 220 v 2 phase only - \$36.50	
5 H. P., 110-220 volts, repulsion, sliding base - \$184.50	110 volts, 30 amp. - \$146.50		
	Moving Picture Arc Generator 60 v., 35 a. - \$106.50		

WRITE FOR CATALOG. BARGAINS IN MOTORS AND GENERATORS

1/4 SPECIAL
110 volts
A.C., 60 c.
S. P., 1750 R.P.M.
Complete, cord, plug and pulley

\$22.75
Each

WASHING MACHINE MOTORS
Suitable for opening Small Compressor, Coffee Grinder, Bottle Washers, Etc.
Reg. Val. \$12.50

GUARANTEE

SHIPPING TERMS: 25% deposit required on all orders. Balance C. O. D. by Express. Slight draft with Bill of Lading attached by freight.

MANUFACTURERS' DISTRIBUTOR

CHAS. H. JOHNSTON, Box 16, West End, Pittsburgh, Pa.

A Little Thing That Does Big Things!

If you use mineral detectors try the SILVELL detector spring for clearer tone and greater volume to your signals. Once on that sensitive spot it stays put. A better piece of apparatus could not be added to your set for many times the dollar asked for six of these unusual springs. Send for yours now.

E. S. LINDMARK

215 AVENUE F, BROOKLYN, N. Y.

NEW AND POPULAR BOOKS

The How and Why of Radio Apparatus By H. W. SECOR, E. E.

This newest book on radio matters fulfills a distinct gap in wireless literature in that, while the treatment is made as understandable and as free from mathematics as possible, it at the same time, incorporates a wealth of technique and instruction for the Radio Amateur—the Radio Operator—the Installation and Designing Expert—as well as teachers and students of the subject in general.

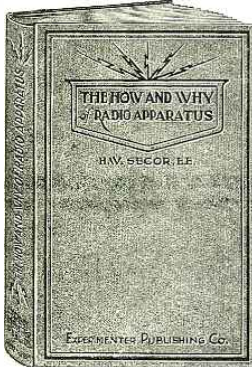

A very broad field has been covered by the author, at the same time giving a great deal of information not found in other text-books. If you are engaged in any branch of the Radio or allied arts at all, you will surely need this latest contribution to radio literature, which is destined to be found on every radio man's book shelf before long.

A glance at the following list of chapters gives but a very scant idea of the extensive and useful radio knowledge provided in its text:

The Induction Coil; The Alternating Current Transformer; Radio Transmitting Condensers; The Radio Receiving Tuner; Radio Receiving Condensers; Detectors; Telephone Receivers; Radio Amplifiers; Construction of a direct Reading Wavemeter and Decrometer; Antenna Construction; The Calculation and Measurement of Inductances; Appendix containing very useful tables, covering all subjects treated in this very unusual book.

Spark-Gaps; Radio-Transmitting Inductances; Radio Receiving Tuners; Radio Receiving Condensers; Detectors; Telephone Receivers; Radio Amplifiers; Construction of a direct Reading Wavemeter and Decrometer; Antenna Construction; The Calculation and Measurement of Inductances; Appendix containing very useful tables, covering all subjects treated in this very unusual book.

This newest of Radio Works, cloth bound in Velum de Luxe. Gold stamped and Hand Sewed has 160 pages. Size of Book 8 x 9 inches. The How and Why of Radio Apparatus, Postpaid.....\$1.75

A Thousand and One Formulas By S. GERNSBACK

A Laboratory Hand Book for the Experimenter and for Everybody who wants to "do things."

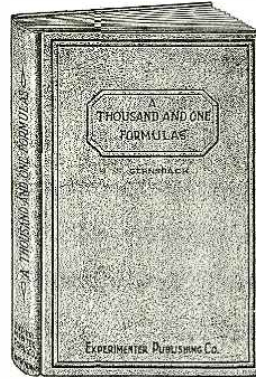

A Book, brimful with very important and priceless information, collected and selected for years.

The recipes and formulas are classified in such a manner as to be available at once, without long research. Invaluable for Students, Engineers, Physicians, Experimenters, etc.

Here are some of the chapter headings:

Cements and Glues; Compositions of All Kinds; Glass and Glassworking; Inks; Leather Polishes; Metal-raft; Perfumery, Soaps and Extracts; Photography; Blue Print and other Paper; Plating; Pyrotechny; Polishes and Stains; Varnishes and Paints; Various Cleaning Formulas; Wood-raft; Chemical Laboratory Hints and Experiments; Mechanical Laboratory Hints and Experiments; Electrical Laboratory Hints and Experiments.

Besides there are a score of tables and hundreds of Illustrations and Diagrams.

Book is cloth bound in Velum de Luxe. Gold stamped and hand sewed. It contains 160 pages. The paper has been especially selected to stand rough handling in laboratories. Size 8 x 9 inches. A thousand and one Formulas, as described, Postpaid.....\$1.75

Design and Construction of Audion Amplifying Transformers Radio and Audio Frequency Type

This latest and important book by Mr. Edward T. Jones, late Associate Editor of *Radio News*, will be of great interest to all radio amateurs thruout the land. The transformers shown in these books have never been described in print before, and have usually been considered a manufacturer's secret. Anyone who has several vacuum tubes cannot afford to do without this book because it will enable him to build the necessary amplifying transformers very readily. The designs are very simple and rugged, and anybody can make them without trouble.

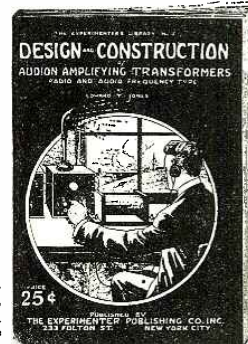

Mr. Jones, the author, is a practical man who is an experimenter himself and knows whereof he speaks. The book is printed on good paper and has an attractive cover in two colors. Paper bound. Size 5 in. x 7 in. Contains many illustrations, diagrams and working data necessary to build the transformers.

Price, Postpaid. 25c

Wireless Course in 20 Lessons

By S. Gernsback, A. Lescarboua and H. W. Secor, E.E.

A Course that tells you everything you want to know about "Wireless" starting off in lesson No. 1 by explaining the Principles of Electricity. By simple, easy stages, this wonderful Course takes you into "Wireless" by the use of such simple language so skillfully used that of necessity you must understand every word. There is a whole lesson devoted to the Theory and Mathematics of this epoch marking subject. The last lesson is devoted to a history of Wireless.

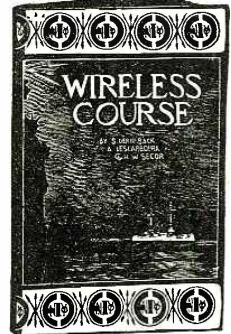

More than 50,000 of this course sold

(Eighth Edition)

Size of book is 7 x 10 1/4 in., 160 pages, 350 illustrations, 90 tables. Flexible cloth cover, per copy.....75c Stiff cloth cover, per copy... \$1.25 Postpaid

Experimental Electricity Course in 20 Lessons

By S. Gernsback and H. W. Secor, E.E.

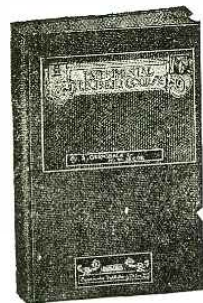

A Course on the theory and practice of Electricity for Experimenters. One of the most complete and comprehensive treatises of this special subject ever published. Written by the same authors, as the famous "Wireless Course."

Every phase of experimental electricity is treated comprehensively in plain English. New Experiments are described and explained and nearly every application of Electricity in modern life is given in simple language.

The Best Electrical Text Book on the Market
Size of Book is 6 x 9 in.

The book contains 128 pages and more than 400 illustrations. Flexible cloth cover, per copy.....75c Stiff cloth cover, per copy.....\$1.25 Postpaid

Two Remarkable Books

Book No. 1—How to make Wireless Sending Apparatus .25c Postpaid.
Book No. 1 contains 100 pages, size 7 x 5 in., and 88 illustrations.
Book No. 2 contains 100 pages, size 7 x 5 in., and 90 illustrations.



Written and published entirely for the wireless enthusiast who wants to make his own radio apparatus. Only strictly modern instruments are described and the illustrations and descriptions are so clear and simple that no trouble will be experienced in making the instruments.



THE EXPERIMENTER PUBLISHING CO.

Book Dept., 236-A Fulton Street

NEW YORK

aerial under the loops was said to be rather more fruitful of results.

The elimination of static is a wide field for experimenters and as important as the advancement of radio development in other directions.

In the application of the loop principle to the trans-oceanic stations, it would necessitate the erection of two loops for the reception of signals from each individual transmitter. In this matter the erection of only a nominal number of loops would be necessary, inasmuch as the corresponding stations are generally limited to one, two, or three, but in the coming scheme of greater radio construction, when the earth will be covered with a net-work of radio routes of intercommunication, more are obviously necessary.

In the stations of shorter wavelength and shorter distances of normal working ranges, the construction of a central revolving loop, which could be shunted into the plane of direction of the intended transmitting station and the fixed auxiliary loop for that station. The central loop could be swung in an arc of 180 degrees.

However, to date there have been no surprisingly efficient advances and we will have to wait for the future time when QRN can be stricken from the international radio signal code.

EDITOR'S NOTE: Some of you who are seeking fame and fortune, here is indeed a field for your endeavors. Many great discoveries and inventions are actually made by accident or while groping in the dark of scientific theories.

TRACING STATIC OR STRAYS

It is reported that all the amateur wireless telegraph operators of England are to be called on to help solve the mysteries of wireless wave antics and of strays—the electric forces often caught by wireless instruments, but which are recognized as stray electricity in the air.

It is now fairly well established, in connection with Eiffel Tower signals, that when it is raining at the sending end the receiving end is apt to be poor; but that if it is clear at the sending end and raining at the receiving end the signals come along normally. If it is cloudy at both ends the signals are better than ever. It has long been generally known that after sunset the strength of the wireless signals increases greatly; but the exact amount of this increase in thousands of cases is wanted for the study.

The subject of strays is a big one in itself; but if all the amateurs of the land were on the lookout for them, and sent in reports on all they noticed, it might be found that they travel on certain understood lines, like storms, or appear under certain conditions of weather.

NEWS SENT BY RADIO

Radio Club and Houston "Chronicle" Have Novel Service

Amateur wireless operators throughout the whole southwest recently sent congratulations to the Houston Radio Club and the Houston *Chronicle*, on the success of the first week's operation of the Houston *Chronicle's* radio news service.

Amateur operators in the Houston Radio Club are sending out each night within a territory having a radius of 500 miles, to all operators who "listen in," brief news items gathered by the *Chronicle*, including baseball scores and weather reports. The service is to be continued as a daily feature.

This particular newspaper is not the only one to inaugurate such or similar news service. Many publications in various parts of this country as well as in Europe have realized the value of radio as a news medium.

"SHRAMCO SPECIALTIES"

BRASS SWITCH POINTS

	Doz.	50	100
No. 626—1/4" x 3/8", with screw.....	.30	\$1.10	\$2.00
No. 627—1/4" x 1/4", head, 5/8" shank, with nut and washer.....	.36	1.25	2.25
No. 628—1/4" x 1/4", with screw.....	.30	1.00	1.75

KNOBS

	Each	Doz.
No. 601—1/2" dia., 8-32 bushing.....	\$.04	\$.45
No. 602—1" dia., 8-32 bushing.....	.08	.85
No. 606—1 1/4" dia., 13/16" high.....	.15	1.70
No. 800—Panel Binding Post, brass finish, black knob.....	.10	1.10
No. 751—Brass finish Panel Switch, single blade, 1 3/8" radius.....	.35	3.75
No. 850—3" Dial Indicator only.....	.70	each
No. 851—3" Dial Indicator with knob.....	1.25	"
No. 801—22.5 Volt "B" Battery, small.....	1.40	"
No. 802—22.5 Volt "B" Battery, large.....	2.40	"

Postage extra on above.

Send 5c in stamps for our Catalog J showing complete line

SHOTTON RADIO MFG. CO., P. O. Box 3, SCRANTON, PA.

**Perfect Tone—Increased Range
—Low Decrement**

You have heard the piercing tone of a synchronous spark. You know the superior characteristics of synchronous spark transmitters. Heretofore the bulk and expense of a motor generator and the practical necessity of D. C. supply have prevented the use of such transmitters by amateur stations. The

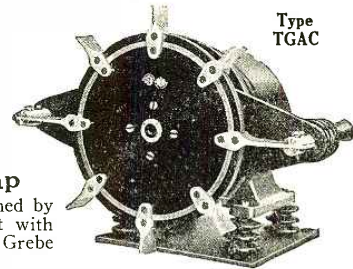

Type TGAC

Synchronous Rotary Gap

possesses all the advantages to be gained by the use of motor-generator equipment with none of the expense. You can use the Grebe Synchronous Gap on your A. C. line.

Ask your dealer to show you this gap.

A. H. GREBE & CO., Inc., 72 Van Wyck Blvd., Richmond Hill, N. Y.

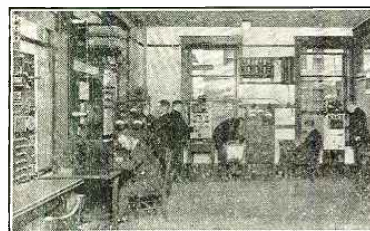

VIEW IN RADIO LABORATORY

**Become a
Operator
Commercial
on the
Pacific
Coast**

Positions constantly open on vessels plying to South America, the Orient, Alaska, Hawaii and Atlantic Coast. Salaries, \$125 and expenses. Best equipped Radio School on Pacific Coast. For further information address

**Y. M. C. A. School of Radio
Telegraphy
Seattle, Washington**



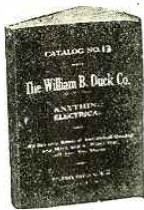

DUCK'S New Big 200-Page No. 14 Wireless Catalog and 100 Page Electrical Catalog

The wireless catalog mailed for 12c and the electrical catalog for 6c, either in stamps or coin, which amount you are privileged to deduct on your first order of \$1.00. Catalog positively not sent otherwise.

This edition of our wireless catalog is the most complete and elaborate we have ever put out. It embraces everything in wireless worth while.

As an encyclopedia of information it is invaluable. It is printed on excellent paper and with a beautiful cover. Your amateur friend will tell you that there never has been any wireless catalog to take the place of Duck's,

and above all that you can absolutely rely on the quality of every instrument listed in this catalog. In a word it is all worth while catalogs in one.

Audio Tron bulbs prepaid \$6.00

We discontinued selling Audio Tron bulbs and accessories for a short time but we have again resumed their sale and can guarantee immediate delivery.

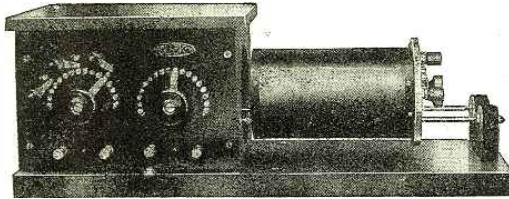

NEW MODEL 5BB. NAVY TYPE RECEIVING TRANSFORMER

A big improvement over our former model. Primary divided into four sections, with three dead end switches, greatly improving selectivity. Secondary divided into three sections, with two dead end switches, eliminating harmonics. The change in the construction of the guide rod support makes it possible to obtain a looser coupling. It is a wonderful improvement over our old model both in performance and appearance. Only \$27.50.

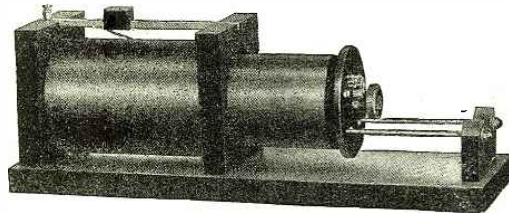

OUR IMPROVED ARLINGTON RECEIVING TRANSFORMER

The secondary on our new type Arlington is divided into three sections with two dead end switches, eliminating dead end effect and harmonics and giving greater selectivity. The end support is similar to that on our Navy type permitting a looser coupling. It is a beautifully finished instrument.

Price Only \$15.00

THE WILLIAM B. DUCK CO., 231-233 Superior St., Toledo, Ohio

12 Commandments for Amateurs

The Philadelphia Amateur Radio Association requests fellow amateurs to note these simple suggestions:

- 1—In making calls make only three CQ's, etc., then sign your call three times. Do not blast the air by needless calling.
- 2—Have your sets tested for two hundred meters or less; then you are safe.
- 3—Have the tuning made *sharp*. This applies to spark coils as well as to transformers. Do not use a spark coil on a large aerial.
- 4—Try not to QRM another station. Listen in, and if the air is fairly free, go ahead.
- 5—You can obtain assistance by applying to this Association direct or thru 3BB-3BF-3BT-3ZA-3BC-3PW, or others.
- 6—In testing do not "sit on the key." This does no good. It uses up power and disturbs your friends while they are listening in. Always sign your call after testing and use 111-1- as a finish signal.
- 7—Try to arrange with some friend as far away as possible to send your signals. The fellow around the corner does not help you very much, and, *above all, use a minimum of power in transmitting.* Do not use full power at all times. This is sensible and is the law.
- 8—We value our license. We believe you also value your license. Do not give cause for the Government to take it away from you for disobeying the law and the regulations. This Association stands for the Amateur only so long as he obeys the law.
- 9—In transmitting do not hesitate to repeat a word if your key sticks or you make a mistake. The best plan is to finish the word and then make two question marks or, best of all, about ten dots and a question mark, after which slowly repeat the word or words in error.
- 10—Always sign your call distinctly three times, or at least once distinctly.
- 11—Slouchy writing is always bad manners. Slouchy transmitting is worse. Remember there are many ears listening in. Do not use vulgar or other improper language. *Some day the signals you send will be reproduced on a phonograph record.*
- 12—If you wish to keep your license, *obey the law.* Do not throw a good thing away. The Department of Commerce is watching the Amateurs and is now sending out warnings. Did you receive one?

These are twelve Commandments. Improve your sets by tuning to two hundred meters, and not more. Do not give reason for Congress to annul your rights under the Law of 1912.—GORDON M. CHRISTINE, M.D., President, 3BF, 1611 Columbia Ave., Philadelphia, Pa.

AN OPPORTUNITY

Here's an Audion Control Panel for \$6.50

Made as well as the most expensive on the market. The panel is of bakelite dielecto, on which is mounted a Radio Service V T socket, a cage type rheostat and sufficient binding posts which enable you to use any type of circuit desired. The unit is mounted on a neat base and all parts easily accessible. Supplied for transmitting tubes if desired.



You can now buy the Radio Service aluminum socket as illustrated independent of the mounting. This is the same socket as supplied to the U. S. Navy. A flanged base with four holes enables you to mount it on your own made panels. The price is only 60c.



CAGE TYPE FILAMENT RHEOSTAT similar to Navy design, wound to allow sufficient heat radiating surface. All insulating parts of bakelite dielecto metal parts of brass or phosphor bronze; supplied with dial and index pointer engraved on knob. Price \$2.25.

Write for circular.

RADIO SERVICE & MFG. CO.
LYNBROOK, L. I. NEW YORK
Dealers: Write for our trade proposition.

American Electro Technical Appliance Company

Dept. E, 235 Fulton Street, New York City

Partial List of What We Distribute:

- | | |
|---|--|
| Loose Couplers, \$5.00, \$10.00, \$15.00, \$18.00. | White Metal Dials, 3", 50c. |
| Tuning Coils, 4,000 Meters, \$4.75; 1,250 Meters, \$3.50. | Binding Posts, 8c, 10c, 12c and 20c. |
| Crystal Detectors, \$1.75; DeForest Type, \$2.60. | Paragon Rheostats, \$1.75. |
| Murdock Variable Condensers, .001 MFD, \$4.75; .0005, \$3.75. | Parkin Rheostats, \$1.00. |
| DeForest Variable Condensers Always On Hand. | DeForest Rheostats, \$1.00. |
| Fixed Condensers, .002 MFD, 70c; .003, 90c. | All the Wireless Press Books. |
| Spark Gaps, 75c, 90c, \$2.00. | All the Cole and Morgan Books. |
| Oscillation Transformer (Murdock Type), \$5.00. | Hawkins Electrical Guides. |
| Decillation Transformer (Signal Type), \$16.00. | Marconi VT Bulbs, \$7.00; Socket for Same, \$1.50. |
| Lightning Switch, 600 V., 100 AMP., \$3.94. | Murdock VT Socket, \$1.00; DeForest Type, \$1.50. |
| Switch Points 3/16"x3/16", Threaded Shank with Nut, 3c Ea. | Western Electric Phones, \$12.00. |
| Switch Points, 3/16"x3/16" with Machine Screw, 20c Per Doz. | DeForest Coils, All Sizes. |
| Dials (Black), 3" and 3 1/2", 75c; with Knob, \$1.25. | Complete Stock of DeForest, Murdock and Grebe Manufacture. |
| | Oscillation Helix, Complete to Assemble, \$3.00. |
| | Loads of Other Apparatus On Hand. |

RADIO IN JAPAN

It has been reported that the estimates for radio expansion in the Japanese budget for the coming year do not cover the overhauling of the Funabashi station, which must soon be done, as the apparatus is of the old German one-mast type, but only provides for the replacement of the sending and receiving outfits. This is one of the three stations belonging to the Japanese Navy, the others being Hozan (Formosa) and the station at Sasebo, now in course of construction. It is anticipated that the navy will present a supplementary estimate to cover the construction and repair program considered necessary.

Do You Know that you can get large discounts on all instru- ments made by joining THE CO-OPERATIVE RADIO ASSOCIATION?

Every member gets the discount in the form of credit memos, which are sent to him together with the merchandise ordered. This amounts to a large saving which you should not overlook.

The nominal fee for becoming a privileged member is ten cents. Send your dime today and get the benefits of the large purchasing power of the association.

Write to
THE CO-OPERATIVE RADIO ASSOCIATION
849 Freeman St. New York City

BURGESS "B" BATTERIES

SEVERAL SIZES FOR SPECIAL WORK



SEND FOR CATALOGUE
BURGESS BATTERY COMPANY

HARRIS TRUST BLDG. - CHICAGO, ILL.

RADIOIST

Your Inquiries are Solicited



We can Supply the Apparatus You Need

We Carry a Complete Stock of Standard Equipment and Supplies

DOUBLEDAY-HILL ELECTRIC CO.

Radio Dept.—Desk B
715 12th St., N. W. Washington, D. C. 719-21 Liberty Ave. Pittsburgh, Pa.

OFFERS RADIO LEGISLATION REPORT.

House Committee on Merchant Marine and Fisheries Presents Findings.

To provide business and commercial agencies with radio facilities until private interests of the country can establish efficient means of communication, the House committee on merchant marine and fisheries submitted its report to the House recently on radio legislation.

A bill accompanying the report provides for the use of naval radio stations for business and commercial purposes. Special provision is made for the transmission of press messages offered by newspapers in the United States or by newspapers published by American citizens in a foreign country.

This provision was made necessary, the report points out, to afford a means of direct communication between the United States and China and other parts of the Orient, where the dissemination of "news" is subject to censorship and to coloring by other governments.

The report states that it is not the purpose to subject private companies to competition as to rates but to give competition as to service. As to press messages, however, the Secretary of the Navy is given authority to make rates as he sees fit.

In the United States naval radio stations are to be opened to general public business, the rates to be charged being subject to review of the Interstate Commerce Commission. The rates, it is provided shall not be less than those charged by private companies.

The report is opposed to government operations as a permanent policy and has fixed a two-year limitation to the rights, carried in the bill. As to the naval stations between countries or localities and between localities and ships, government operation would be maintained until private facilities are available to the public.

PERFECT A RADIO COMPASS.

Planes and Vessels Can Determine Position by Radio.

"Q. T. E.," the radio shorthand for "where am I?" is coming into use both on land and sea as the result of development of the radio or direction compass, considered by naval officers the Navy's most important wartime invention.

Secretary Daniels announced recently the first successful experiment enabling airplanes equipped with the radio compass to locate each other while far apart in the air. An airplane from Anacosti was able to locate and join the NC-3, en route from Philadelphia to Pensacola, without any previous rendezvous being arranged.

Previous steps had been the informing of airplanes and ships of their precise locations by reading made by land radio compass stations. Already the instrument is used generally to aid vessels approaching American ports.

When a ship radio operator sounds "Q-T-E" there are fifty government stations on the Atlantic, Gulf and Pacific coasts prepared to handle the query. The operators at stations within radius, usually three, listen and watch their radio compasses. The instruments indicate the direction from which the message comes. The stations compare readings and by a comparison of lines of direction are able to inform the ship of its precise location.

The information enables the ship to progress safely in for while near land, and to come close to shore under adverse conditions. In war, as is well known by most of our amateur friends, the radio compass was used successfully to locate German submarines, whose radio messages were intercepted.

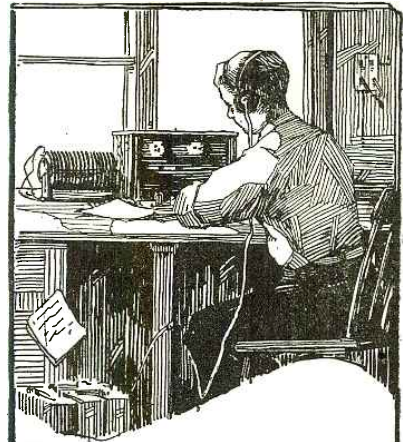

Stromberg-Carlson Radio Head Sets

**STRONG, DURABLE
CONSTRUCTION, YET
EXTREMELY SENSITIVE.**

This Stromberg-Carlson Radio Head Set is very simple and efficient. All operating parts are housed in dust-proof moisture-proof aluminum case. The diaphragm is mounted metal-to-metal in a way that the variation in temperatures cannot disturb the airgap adjustments. Non-conducting spool heads and slotted pole tips decrease the eddy current losses and make the set more efficient.

Each set wound to a resistance of 2,000 ohms with pure copper wire, furnished complete with 6-foot moisture-proof cord attached. All sets thoroughly tested in actual service before shipment. For \$12.00 we will ship sample set for trial in your own station. If not satisfied—return equipment and money will be refunded.

Bulletin 1606 will give full particulars. Write today.

**Stromberg-Carlson Telephone
Mfg. Company**
Rochester, N. Y.

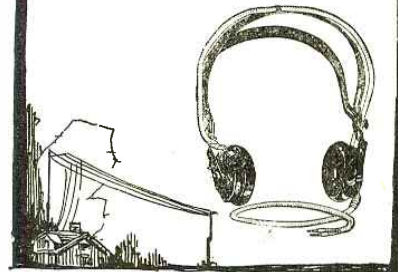

!!! YOU !!!

Can have the best apparatus, parts, raw materials and supplies, obtainable by buying on the

INSTALLMENT PLAN

without making a large outlay of cash at one time. If not already receiving it you should get the "RVA" BULLETIN each month. 10c, stamps or coin, brings it, with a Loose-Leaf binder, Bargain Supplement and extra bulletins. Write

J. Donald Vandercook & Company
First National Bank Building
ELMHURST ILLINOIS

OPPORTUNITY AD-LETS

Follow these advertisements every month. Reliable advertisers from all over the country offer you their most attractive specials in these columns.

Classified advertising rate three cents a word for each insertion. Ten per cent discount for 6 issues, 20 per cent discount for 12 issues. No advertisement for less than 30 accepted. Name and address must be included at the above rate. Cash should accompany all classified advertisements unless placed by an accredited advertising agency. Objectable or misleading advertisements not accepted. Advertisements for the August issue must reach us not later than July 10.

THE CIRCULATION OF RADIO AMATEUR NEWS IS OVER 35,000

EXPERIMENTER PUBLISHING CO., INC., 236 Fulton Street, New York, N. Y.

Agents Wanted.

Agents—Earn \$60 per week selling to merchants and professional people. Address Ideal Sales Co., P. O. Box 32 S. Cincinnati, O.

"No-Soot-En" cleans furnaces, stoves, pipes; "Sootless" guaranteed. Agents' outfit 35 cents. Charles Beavis House, Pineville, Kentucky.

Salesmen Wanted.

Salesmen, City or Traveling—Experience unnecessary. Send for list of lines and full particulars. Prepare in spare time to earn the big salaries, \$2,500 to \$10,000 a year. Employment services rendered members. National Salesmen's Training Association, Dept. 164 G, Chicago, Ill.

Help Wanted.

Railway Traffic Inspectors earn from \$10 to \$200 per month and expenses. Travel if desired. Unlimited advancement. No age limit. We train you. Positions furnished under guarantee. Write for Booklet CM 122 Standard Business Training Institute, Buffalo, N. Y.

Earn \$25 Weekly, spare time, writing for newspapers, magazines. Experience unnecessary; details free. Press Syndicate, 5665, St. Louis, Mo.

Dollars Saved. All kinds of used correspondence courses sold. (Courses bought.) Lee Mountain, Pisgah, Alabama.

Detectives make big money. Travel, be your own boss. Either sex. We instruct, small cost. Write Johnson's Detective School, 232 Sheldon Avenue, Grand Rapids, Michigan. Dept. A.

Be a Mirror Expert. \$3-\$10 a day; spare time home at first; no capital; we train, start you making and silvering mirrors, French method. Free prospectus. W. R. Derr, Pres., 579 Decatur Street, Brooklyn, N. Y.

Secret Service Operatives and Detectives are in demand. Earn big money. Travel everywhere. Fascinating work. Learn this profession by home study. Particulars free. American School of Criminology, Dept. R, Detroit, Mich.

Business Opportunities.

\$30 Per 100 Paid for Names. Particulars free. Victor-King Co., 36 Bromfield, Boston (5) Mass.

Substantial Manufacturing Corporation wants capable men to establish branch and manage salesmen. \$300 to \$1,500 necessary. Will allow expenses to Baltimore as explained. Address Treasurer, 416 N. Howard St., Baltimore, Md.

Stop Daily Grind. Start silvering mirrors, auto headlights, tableware, etc. Plans free. Clarence Sprinkle, Dept. 48, Marion, Indiana.

Patents For Sale. To sell, buy or obtain patents write Patent News, 309, Washington, D. C.

Get Into Photo Finishing Business. Quick profits. Make printing machine, simple construction, automatic light control, prints 2300 daily. Complete plans One Dollar. Practical Processes, Box 241, Decatur, Ill.

Turn Your Spare Time into money for that apparatus you want. Start a profitable, permanent home business. Steady weekly income. No investment but your brains and spare time. Positively no soliciting, agency proposition. Write today. Address: Opportunity, Box 175, Fredonia, N. Y.

American Made Toys.

We offer an opportunity to manufacturers with facilities for large production, also to home-workers on smaller scale, to manufacture Metal Toys and Novelties. Unlimited field and enormous business open for ambitious people. No experience required. No tools needed. Our castings turn out goods complete. Since the different Toy Expositions, manufacturers are covered with orders until December. You can enter this field now by manufacturing "American Made Toys." We furnish castings for Toy Soldiers, Army, Navy, Marine, Cannons, Machine Guns, Indians, Cowboys, Warships and other novelties. Castings complete outfit. \$10 up. We buy these goods direct from manufacturers. Yearly contract orders placed with reliable parties. We pay very high prices for clean painted goods. Samples furnished. "Bird-Whistles," great seller, just added to our stock list. Booklet, Information, Instruction free. If you mean work and business. No others invited to write. Toy Soldier Manufacturing Co., 32 Union Square, New York.

News Correspondents.

Earn \$25 Weekly, spare time, writing for newspapers, magazines. Experience unnecessary; details free. Press Syndicate, 566, St. Louis, Mo.

Books.

Books—How to talk and debate—How to entertain—Love, courtship, marriage—Social etiquette—How to woo—Don't marry—Art of Pleasing men—Ghost stories—Model letter writer—Children's recitations—Cook book—Macon Moore, a thrilling detective story. 35c each, three for \$1.00. Central Company, 601 Ninth Ave., New York.

Wanted—Back issues of Radio Amateur News and Electrical Experimenter. Boston Magazine Exchange, 109 Mountfort Street, Boston, Mass.

Concordia Magazine contains essays, short stories, travel stories, boy scout news, editorials, current events and poetry, formulas and plans. Two years' subscription, 20 cents. Concordia Magazine, 9 Water, York, Pa.

Blunders of a Bashful Man—some side-splitting book, 30c. Chas. Durso, Dept. 50, 25 Mulberry Street, New York City.

Pisgah, Alabama.

Radio Amateur News,
New York City.

Gentlemen: Kindly advise if you will accept my order. T. F. and how to me each month in advance. Am having splendid results in both the ELECTRICAL EXPERIMENTER (Science & Invention) and RADIO AMATEUR NEWS.

Very truly yours,
Lee Mountain.

Married and engaged people should read "Science of a New Age", nature explained. 400 pages, illustrated. \$2.00. Central Company, 601 Ninth Ave., New York.

How to Thought Read. Mind-reading at any distance. Both secret and public. Catalog free. The Midland Company, C 539 E. 149th St., New York.

How to Box 25c; Book of 125 Card Tricks 25c; Jokes on the Ford 10c; Star Amateur Electrician 10c; Hoyt's Poker Primer; or, how to play draw poker 10c. Henry Nelson, 1241 Madison St., Eau Claire, Wis.

The Scientific Boy, for boys interested in wireless, chemistry, and electricity. One year, 40c. Scientific Boy, Trout, Louisiana.

Star Amateur Electrician. Pocket size, 12c. Joel Tibberg, Proctor, Vermont.

Wireless Course in 20 Lessons. By S. Gernsback, A. Lescaurba and H. W. Secor, E. E. Tells you everything you want to know about "Wireless"—theory, practice and history. A clear, concise course on every phase of this subject. 160 pages—350 illustrations, 30 tables. Flexible cloth cover 75c postpaid. Stiff cloth cover \$1.25 postpaid. Experimenter Publishing Co., Book Dept., 233 Fulton Street, New York.

Experimental Electricity Course in 20 Lessons. By S. Gernsback and H. W. Secor, E. E. A course of the theory and practice of Electricity for the Experimenter. Every phase of experimental electricity is treated comprehensively in plain English. New experiments are described and explained and nearly every application of Electricity in modern life is given. 160 pages—400 illustrations. Flexible cloth cover, 75c postpaid. Stiff cloth cover, \$1.25 postpaid. Experimenter Publishing Co., Book Dept., 233 Fulton Street, New York.

Just Off the Press. Design and Construction of Audion Amplifying Transformers (Radio and Audio-Frequency Types). By Edward T. Jones, late Associate Editor Radio Amateur News. The transformers shown in this book have never been described in print before and have usually been considered a manufacturer's secret. The designs are very rugged and simple. A book that every radio "bug" should have. Written so you will understand every word. Price 25c postpaid. Experimenter Publishing Co., Book Dept., 231-A Fulton Street, New York City.

For Men.

Detectives Earn Big Money—Travel; great demand; experience unnecessary; we train you; write for free particulars. American Detective System, 1968 Broadway, N. Y.

Printing.

3,000 two color labels \$1.25. Irvin J. Wolf, Station E, Philadelphia.

Payne "Stick-Tight" Gummed Labels for every business and profession. Payne-Standard Co., P. O. Box 121, E. C. Passaic, N. J.

Radio League Members—50 name cards with emblem of League printed, 45 cents. 100 letter-heads and envelopes with emblem, \$1.75. Printing Arts Press, 483 East 24th St., Paterson, N. J.

Labels! Rubber Stamps! Pleasing samples free. Edward Harrison, "Printing", Baltimore.

Stammering.

St-Stu-t-t-ering and Stammering cured at home. Instructive booklet free. Walter McDonnell, 121 Potomac Bank Bldg., Washington, D. C.

Scenery For Hire.

Collapsible Scenery for all plays. Amelia Grain, Philadelphia, Pa.

Telegraphy.

Telegraphy (both Morse and Wireless) and railway accounting taught thoroughly and quickly. Big salaries now paid. Great opportunities. Oldest and Largest School. Est. 45 years. Catalog free. Dodges Institute, 25th Street, Valparaiso, Ind.

Tricks, Puzzles & Games.

Magic goblet produces before you very eyes ribbons, flags, flowers. Can perform many others. Inkwell size 25c and 50c., rabbit \$1 and \$3.00 postpaid; with directions. Rudolph Sinks, 3604 E. 48th St., S. E., Cleveland, Ohio.

Sensational Mysteries Spirit Cabinet Act, Hypnotism, Fire-eating, Magic Kettle Act, Handcuff Escapes, Beheaded Princess, Gambler's Secrets all revealed in Mystery Manual, a \$1.00 book for 25c coin. Prof. Leumas, 1306 Park Ave., New York.

Mystify Your Friends! Enter vaudeville; mind reading, spiritualism, gambler's secrets, sensational escapes, spirit cabinet act, fire eating, fortune telling, spirit paintings, card features, hypnotism, jail breaking, and scores of other carefully guarded secrets revealed in the "Mystery Book"; big, illustrated \$1.00 book, 25c. Hermosa Publishing Co., 1627 N. Harding, Chicago.

"Water-write" Pens write 600 words with one dip in water. Not trick. 10c. Lowell W. Hawkins, Piedmont, Mo.

For Advertisers.

Don't Experiment. White space is too costly. Let Jacobus write your advertising. Letters \$3.50. Jacobus Advertising Service, 1073 Sanford Ave., Irvington, N. J.

Health.

Pyorrhea (Rigg's Disease—Bleeding or Swollen Gums)—Hundreds have been helped by "Pyorem," a successful home treatment. Purifying, healing, preventative. Full month's treatment, consisting of a very beneficial massage paste and an antiseptic tooth-cleansing paste to be used in place of your ordinary dentifrice together with full directions for treatment, \$1 postpaid. Or write for free Booklet "R," Pyorem Mfg. Co., 439 Seventh Street, Brooklyn, New York.

Tobacco or Snuff Habit Cured or no pay; \$1 if cured. Remedy sent on trial. Superba Co., S.B. Baltimore, Md.

Miscellaneous.

Electrical Tattooing Machine, \$3, \$5, and \$7. Catalogue for stamps. J. H. Temke, 1019 Vine, Exp. Cincinnati, Ohio.

Oil Belt. Big production close by. Two hundred acres good land. Soft spring water. New buildings. Timber, sugar bush, live stock, tools, etc. Fifteen thousand dollars. Terms. C. E. MacDonald, Ceres, N. Y.

Tattoos Removed, simple process. Satisfaction guaranteed. Pharmaceuticals and instructions for \$1.00. No stamps. Alfred Hogue, 45 Gale Ave., Pittsfield, Mass.

Astrology—Stars tell life's story. Send birth date and dime for trial reading. Eddy, 4307 Jefferson, Kansas City, Missouri, Apartment 85.

\$10.00 brings you five guinea pigs (any sex) 7 months old. \$5.00 for five three months old (delivered). Raymond Fields, 939 West Craig Pl., San Antonio, Texas.

Novelties.

Magic water flowers 10c; fragrant Japanese incense, 15c and 25c package. Durso, Dept. 50, 25 Mulberry, N. Y. City.

Office Devices.

Multiphraphs, Addressographs, Duplicators, Sealers, Folders, Less than half price. Guaranteed one year. Pruitt Company, 112-C North La Salle, Chicago.

We Buy for Cash, Rebuild and Sell for about half new price. Multiphraphs, Addressing Machines, Duplicators, etc. Don't be misled by firms infringing on our name. We are the original Office Device Company, 154-C West Randolph, Chicago.

Wireless.

Special—You constructors, here is what you have been looking for—glass for building that transmitting condenser. This is the best grade of photographic glass—size 4 by 5 inches—and the price—five cents each or fifty cents a dozen, postpaid. Send in your orders early, as supply is limited. We also sell the best grades of radio apparatus—and our prices will surprise you. Radio Mail Order Supply Co., 533 West End Avenue, New York City.

Amateurs Attention—Loose Couplers from 800—15,000 meters \$4—\$20. Tubes wound to specifications. N. A. Radio Equip. Co., 510 Claremont Parkway, Bronx, N. Y.

Indicating Dials, brass, 2 1/2" in diameter; specially shaped with offset shoulder as stops; complete with genuine bakelite knurled knob 1 1/4" in diameter. Same as used on the Signal Corps 67 sets. Money refunded if not satisfied. Three for one dollar postpaid. Factory Distributing Co., 130 North Wells St., Chicago, Ill.

Hook Up Record sheets, loose leaf, 3" by 5" printed skeleton diagrams, 20 apparatus, instructive, makes valuable reference book, 5 kinds; assorted set 30, 25c, sample and circular 2c. E. R. Dike, 411 E. Lafayette St., Jackson, Tenn.

Loose Coupler for sale. Send stamp for particulars. Charles M. Butler, 70 Arlington St., Hyde Park, Mass.

Naa tested galena, 25c coin. Give time signal test. Miller Testing Station, 1814 York St., Des Moines, Iowa.

For Sale—1 Robbins & Myers 5 K.W. 600 cycle generator (no motor), 110 volts, 4 1/2 amperes. Separately excited type revolving field, stationary armature. Can be had at a very attractive figure. If interested, communicate for further details. Ralph Brooke Austrian, 694 Broadway, 12th floor, N. Y. C.

Hey bugs! get our price list. All best kinds of apparatus. Discount given. Write for list to Amateur Builders Supply Labs., 1315 East High St., Davenport, Iowa.

Sample Switch Point 5c. Points are 1/4" x 1/4" complete with screw and washers. U. S. Government type. Price per doz. \$33. 3c postage. Radio Testing Station, Sturges St., Binghamton, N. Y.

Just off the Press. Design and Construction of Audion Amplifying Transformers (Radio and Audio-Frequency Types). By Edward T. Jones, late Associate Editor Radio Amateur News. The transformers shown in this book have never been described in print before and have usually been considered a manufacturer's secret. The designs are very rugged and simple. A book that every radio "bug" should have. Written so you will understand every word. Price 25c postpaid. Experimenter Publishing Co., Book Dept., 231-A Fulton Street, New York City.

Wireless Course in 20 Lessons. By S. Gernsback, A. Lescarbours and H. W. Secor, E. E. Tells you everything you want to know about "Wireless"—theory, practise and history. A clear, concise course on every phase of this subject. 460 pages—350 illustrations, 29 tables. Flexible cloth cover, 75c postpaid. Stiff cloth cover, \$1.25 postpaid. Experimenter Publishing Co., Book Dept., 236 Fulton St., New York.

How to Make Wireless Receiving Apparatus. 100 pages—90 illustrations. Only strictly modern radio apparatus are described in this book and the illustrations and descriptions are so clear and simple that no trouble will be experienced in making the instruments. Paper covered, 25c postpaid. Experimenter Publishing Co., Book Dept., 236 Fulton St., New York City.

How to Make Wireless Sending Apparatus. 100 pages, 88 illustrations. Written and published entirely for the wireless enthusiast who wants to make his own radio apparatus. Contains more information on "how to make it" than any other book we know of. Paper bound, 25c postpaid. Experimenter Publishing Co., Book Dept., 236 Fulton St., New York City.

Wanted to Buy.

Send to Cleveland by mail or express any old or broken watches, false teeth, old or broken jewelry, brooches, bracelets, old gold, silver, platinum, diamonds, magnet points, platinum wire, contact points or crucibles, mercury, and anything valuable. We pay the highest prices in cash by return mail. Goods returned in ten days if you're not satisfied. The Ohio Smelting & Refining Company, 207 Lenox Bldg., Cleveland, Ohio.

Electrical Supplies and Appliances.

Water locating by Mansfield's water finder is interesting and profitable. Particulars from Edwin Mansfield & Co., 94 Victoria Road, New Brighton, England.

For Sale—No. 26 Cotton Covered Wire, \$75 per lb. Free samples. Ralph Winters, 404 Pearl Street, Camden, N. J.

Experimental Electricity Course in 20 Lessons. By S. Gernsback and H. W. Secor, E. E. A course of the theory and practise of electricity for the experimenter. Every phase of experimental electricity is treated comprehensively in plain English. New Experiments are described and explained and nearly every application of electricity in modern life is given. 160 pages—400 illustrations. Flexible cloth cover, 75c. postpaid. Stiff cloth cover, \$1.25 post paid. Experimenter Publishing Co., Book Dept., 233 Fulton Street, New York.

For Inventors.

Inventors—Models, dies, tools. 28 years' experience, work guaranteed, lowest price. Manufacturing of specialties our hobby. Peerless Die & Tool Co., 121 Opera Place, D. B., Cincinnati, Ohio.

Patent Attorneys.

Millions spent annually for ideas! Hundreds now wanted! Patent yours and profit! Write today for free booklet—tell how to protect yourself, how to invent, ideas wanted, how we help you sell, etc. 301 Patent Dept., American Industries, Inc., Washington, D. C.

Inventions patented for exploitation by W. Baff, Worcester, Mass., Patent Attorney and Expert Patent Salesman. Book: "Inventions; Their Development, Purchase and Sale" sent \$2 postpaid. 242 pages of brilliant information how to successfully finance inventions.

Patents For Sale.

Three Patents for Sale—One automatic gate; the others are lid lifters for respectacles in daily use for family. Sell outright. Ed. Snickers. Shelton, Wash.

Phonographs.

Build Phonographs—Universal Type Tone Arms, Motors, and all Hardware. Catalog for stamp and name of this publication. Sam R. Kremer, 118 Court Ave., Dayton, Ohio.

Rubber Stamps.

Rubber Stamps made to order. McCaddon Company, Zanesville, Ohio.

Stamps & Coins.

205 Different Stamps, 25 cents. Veaehe, Box 1362, Detroit, Mich.

Stamps, 50c. Catalog value, 15c. Particulars and Approvals. Stampcraft, Hanford, Cal.

300 Different Stamps, 50c. Fred Onken, 630 79th Street, Brooklyn, New York.

100 Different Stamps, 12c; 200, 27c. Michaels, 560 Prairie, Chicago.

Song Poems.

Have You Song Poems? I have best proposition. Ray Hibbeler, D 115, 4020 Dickens Ave., Chicago.

Song-Writers' Manual & Guide Sent Free. Contains valuable instructions and advice. Submit song poems for examination. We will furnish music, copyright and facilitate publication or sale. Knickerbocker Studios, 311 Gaiety Bldg., New York.

Exchange.

For Sale—Audio Tron Panel, Loose Coupler, 1/2 K.W. Oudin Coil, Receivers, etc. Address Douglas Mussinon, P. O. Box 32, S. Cincinnati, O.

One Pair Brandes "Superior" Phones, receiving cabinet, meters, motors, switches, spark-coil, 4-wire aerial, key, etc. Roger Whipple, 99 Central Street, Springfield, Mass.

For Sale, Western Electric VT 1, burned 3 hours, good as new. Prepaid \$6.00, Ralph Werner, 432 So. 15th St., Terre Haute, Indiana.

Exchange—Millivoltmeter, hawkins guides, D.C. motor, 1/2 H. P. Want V.T. panel and V.T. George Wolf, 5133 Main Ave., Norwood, Ohio.

200 to 17,000 meter undamp-damp receiving set for sale. Contains both short and long wave couplers. Cabinet style. Absolutely complete from antenna to ground, copies IDO. Van Slyck, Ironwood, Mich.

For Sale—1 pr. Murdock phones \$3.00, Naa, loose coupler, fixt and variable condensers, 1 inch coil, transmitting key and condenser, heavy gap, crystal detector, also change over switch. Everything in excellent condition. Write for details and price list. John J. Turner, 1147 Windrim Ave., Phila., Pa.

Wanted—Small experimental lathe. Stugman, 141 Cooke St., Brooklyn, N. Y.

Wanted—1 K.W. transmitting set complete or any separate parts for same. Harry Boyce, Mt. Vernon, Ind.

Cabinet Type 10,000 Meter Loose Coupler (like E. I. Co. Tuckerton Set), full bakelite panels and 4 pole double throw switch mounted on primary panel and connected to binding posts at bottom, for switching to short wave receiver. Gets N.A.O., N.S.S., X.D.A., N.D.D., N.P.G., and seeds of others. Would cost \$50. Sell for \$30. Carl Whittington, 629 West Main St., Benton, Ill.

Exchange—Continued.

For Sale—New radio set consisting of Grebe short wave regenerative set, also Grebe audion control unit type R.O.R.A. without tube. First \$30.00 money order gets it. J. Theband, Hotel Gotham, New York, N. Y.

For Sale—Generator 10 V, equip with flat and round pulleys and friction drive. Also speed governor \$25.00, large loose coupler \$6.00. Want wireless coil 2" or larger. Mr. Hayden Thompson, 149 Broad Street, Plainville, Ct.

Sell or Exchange—Motors: 1/6 H.P., A. C. and 1/6 1/2, 1/2 H.P. D.C., 1 H.P. steam engine, 1 H.P. gas engine. Phonograph and records. Want radio apparatus, lathe. Chas. Schmuck, 1384 West 95th St., Cleveland, Ohio.

Guaranteed Tested Galena. Price per box 25c. Radio Testing Station, Sturges St., Binghamton, N. Y.

For Sale—Complete radio station. Consists of Mignon Rv3 undamp wave receiving cabinet; 1/2 K.W. transmitting set, mounted; large "Trace" coupler; Holtzer-Cabot and Murdock 3,000 ohm phones; aerial, ground and cut-out switches; large assortment of miscellaneous junk, wire, etc. Sell as whole or in part. Get prices. F. H. Ransford, Dalton, Mass.

For Sale—One Western Electric type CW 834 DC resistance 4,400 ohms head telephones complete with cord \$6. One standard Navy type triple detector stand with galena, silicon and carborundum crystals \$5. Ten highly polished black 7-inch petticoat Electrocast wall insulators, type CH 528, 50c each. Three Signal Corps type V12 transmitting tubes, valued \$15, price \$7 each. All in perfect condition. Money refunded if not satisfactory. A. J. Phillips, P. O. Box 22, Boston 24, Mass.

Slaughter—"I" coil \$5.00. Never used Audiotron \$5.25. Rheostat \$7.50. Place, 350 Sprague, Fall River, Mass.

For Sale—General Radio 124A condenser \$7, Holtzer Cabot 2,000-ohm phones \$7. Murdock 55 phones \$3. E. D. Otts, 2355 Concourse, New York City.

One Minute Camera, great money-maker, \$15, or trade for good shotgun; describe fully. Durso, Dept. 50, 25 Mulberry, New York City.

Let's Swap! What'd ye got? What'd ye want? Three months dime. National Exchange Medium, Detroit.

Used Correspondence Courses, bought and sold. Stamp envelope. E. Moffett, Ruston, Louisiana.

Wanted—Navy type loose coupler, pair phones, variable condensers, etc., in good condition. Describe, giving best cash price. L. E. Morton, Anniston, Alabama.

For Sale—Complete receiving, sending wireless set. Send for list of instruments—too numerous for advertisement. \$16.50. Enclose stamp. Arnold Morgan, 106 Frederick St., Bluefield, W. Va.

For Sale—A-1 autographic Kodak with carrying case; loading coil; Murdock variable; detector; mineral; one inch coil; condenser, gap, key; shocking coil; E. I. code set. Others. Excellent condition. S. B. Logan, Box 71, Little Rock, Ark.

Sale or Exchange—C.H. Motor rheostat, 5 H.P., \$2; Disco electric starter for Fords \$25. Want wave meter, hot wire ammeter. Ralph Leffler, Tiffin, Ohio.

For Sale—Complete Thirty Dollar new wireless home practice outfit includes number two Junior, Omnigraph, transmitting. Key, telephone, and carrying case. Will sell for twenty dollars. A. Al. Keopfle, 601 21st St., N. W., Washington, D. C.

Want 1, 3/4 or 1/2 K.W. type R Thordanson or Acme Transformer, good condition. Answer if you have any of the above sizes. Will accept best offer. Allison Jago, Forest Hills, N. Y.

Typewriter, portable, nearly new, with carrying case, \$35.00; Duron 2,500 coupler, \$5.50; cycle car parts, \$10.00. Johnston, 9 Rutherford, Binghamton, New York.

Sell or Exchange—Radiographic, 1 1/2 H.P. motor, Oudin Coil, and many other attractive bargains. Send stamp for circular. Harry Hughes, Terrace Park, Ohio.

For Sale—Detector and single step amplifier panel, complete with four jacks, rheostats, three three-point switches, and two plugs. Bargain, \$14.75, less transformer. Copper strip, 26 B&S 1/4" wide, 3c per foot. Audion Panel, \$6.50, complete. Copper aerial wire, 15 B&S, 40c per hundred. Description on request. Hoke & Risher, Box 34, Carlisle, Indiana.

Wanted—15 dial Omnigraph, also Continental dials. State price. Write Hollander, 85 Lewis St., New York City.

Radio Spark and Arc Receiving outfit \$65.00, 2,000 ohm head set \$50.00. 2" Spark Coils \$9.00. Six sections Murdock Condensers \$15.00. D. C. Westinghouse Voltmeter \$2.00. No. 7 American Model Builder \$6.00. 7x7x7 Wall Tent \$7.00. Complete set Hawkins Electrical Guides \$7.00. Complete I. C. S. Electrical Engineers Reference Library \$20.00. Four Jar Rectifier \$4.00. Send stamp for list of other Wireless Apparatus. Hahn's Radio Station, Hamburg, Pa.

For Sale—Cabinet set as described by E. Dynner in the August R. A. N. First class material and workmanship. First \$25 takes it. Photo for stamp. Stuart A. Hendrick, Box 207, San Juan, Porto Rico.

(Continued on page 734)

AT LAST!! RIGHT PRICES!!

"B" Batteries IMMEDIATE SHIPMENT

22½ volts, Life 1500 Hours. Sizes: 2¾ x 3½ x 4½". Postpaid \$2.00
 45 volts, Life 1500 Hours. Sizes: 3½ x 4¾ x 5¾". Postpaid \$4.20

UNIVERSAL
 RADIO
 VARIOMETER

Price Lists on Request

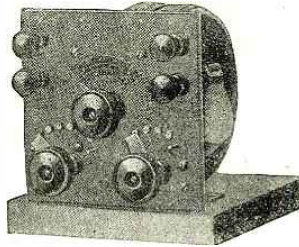

Type "S-1" 1000
 Meters — \$12.50

Type "S-2" 2500
 Meters — \$12.50

In ordering please
 specify winding. Size
 6 x 6 x 6 inches.

THE RADIO APPARATUS SERVICE

711-THIRTEENTH STREET, WASHINGTON, D.C.

"A SUPPLY COMPANY FOR THE RADIO AMATEUR"

Radio Call 3 E K

Phone Main 2833

ATTENTION AMATEURS

The only practical adapter

Price \$1.50

RADISCO AGENCY

We make up sets to specifications



Made by the
AMATEUR WIRELESS EQUIPMENT CO.
 1390 Prospect Ave., Bronx, N. Y.

SOLD BY THE
INTERNATIONAL ELECTRIC CO., 224 Fulton St., N. Y. C.

Catalogue sent on receipt of 10c, which
 may be deducted from first order.



Dealers write for proposition

Exchange—(Continued from page 733)

For Sale—One Wm. Duck No. 2 cabinet detector set, one Mignon RLC5 receiving set and pair three thousand ohm Murdock phones. Perfect condition. Will sell cheap, as I do not have time to work set now. Abdon Holt, Haskell, Texas.

Wanted—Martin Vibroplex sending key, any condition. Must be in plate state condition, price first letter. S. Goodwin, 52 Pond St., Lynn, Mass.

Here's your chance to get a brand new shop-model regenerative receiver. Cabinet type Bakelite front, size 17"x7"x6". Litz wound variometers. Fine variation of primary inductance. Simple, efficient and wonderful amplification on wavelengths from 150-600. Have two of these wonderful tuners specially constructed to specifications for wavelengths from 150-600 meters. Will sacrifice at \$3000, each prepaid and guaranteed from Robert J. Gallery, Bethesda, Md.

\$15 takes waterproof Automobile Tent, walled canvas, 2 compartments, 4 windows, 100% proof. Worth \$40. Will exchange for Omnigraph with Continental dial. L. R. Ferguson, Leroy, N. Y.

Daynor Control Cabinet \$10.00. Audiotron panel with bulb \$12.00, small Blitzen Rotary Coupler \$8.00. Martin Derrick, 58 North Sixth Street, Newark, New Jersey.

For Sale—Seven De Forest panels, ¼ K.W. Thordarson. Want Regenerative and ½ K.W. Thordarson. Address Edward Deutschman, E. Las Vegas, New Mexico.

Exchange—Shaw bicycle motor (little used) with magnetor and completely equip for two step Multi-Audi-Pone. Sell No. 5 Omnigraph with 30 dials \$500; small Weeden motor 50c; two Radiotone buzzers each 50c; De Forest condenser 50c; De Forest Master Anti-Capacity switch, never used, \$2.50; Experimental Electricity Course 50c. All prepaid. Want—Electrical Experimenters 1916, Jan., Feb., April, May. State price. Wilkes Dearing, Covington, Tenn. Route 2.

For Sale—One five-dial Omnigraph with five dials \$12.00. One single dial Omnigraph with 13 dials, \$10.00, new. Two Bakelite panels drilled for short wave regenerative set, 10x14½x¼" thick, \$4.00 each. Martyn Cooney, 475 30th St., San Francisco, Calif.

Will pay high price for electrical lab. Mr. F. Canepa, 128 E. First St., Jacksonville, Fla.

½ K.W. panel and 3,000 meter receiver panel. Lauren Burgess, Norwood, New Jersey.

Navy 3,000 meter loose coupler for sale \$12.00. Also pair Murdock 3,000 ohm phones, \$4.50, and a crystal detector \$1.00, or will sell all for \$16.50. Harry Bell, 228 Berkeley Ave., Bloomfield, N. J.

Four Bargains—Audiotron, \$3.00; Federal Amplifying Transformer, \$5.00; Clapp-Eastham Tuner, De Luxe style, \$10.00; Automatic Transmitter, \$10.00; all in A1 shape; also crystal detectors and other items. C. F. Allen, Box 1504, Providence, R. I.

Wanted to buy complete X-Ray outfit. Mr. F. Canepa, 128 E. First St., Jacksonville, Fla.

Arlington 3000 meter loose-coupler. Practically new, \$6.00 postpaid. Knapp 6-8 volt motor, wick feed, reversible switch mounted on base. Used, but is in good condition. Very thing for constructing rotary spark gap. \$3.00 postpaid. Ray Arledge, Ryan, Arkansas.

For Sale—¼ H.P. 60 cycle 110 volt A. C. motor. Write Edgar Rockwood, Two Rivers, Wisconsin.

Fine new Audion receiving cabinet, latest type, complete with vacuum tube, 75-volt storage battery and rectifier, \$50. Bargains in miscellaneous wireless apparatus. Information furnished gratis. P. A. Polson, 14629 Strathmore, Cleveland, Ohio.

For Sale—Complete wireless receiving set. First-class set for the beginner. Price \$20. For description address George Westcott, 31 Lyon St., Fall River, Mass.

¼ K.W. transformer set complete, including key, gap, condenser, \$15.00; 1¼" coil \$5.00. Or what have you? B. Pankhurst, 1431 Superior Road, Cleveland Heights, Ohio.

The Second Edition of the

Consolidated Radio Call Book

ALL AMATEUR CALLS ALSO LISTED

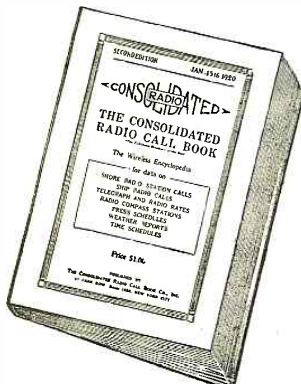

The only book in print officially listing all the radio calls as issued by the Bureau of Commerce. Every vessel and land station in the world is represented and listed alphabetically, according to names of vessels or land stations, and according to call letters; Revision of American coastal stations under U. S. Naval control, and their new calls.

SPECIAL
 Given Free With Each Copy
 A Wireless Map of the World in colors is given absolutely free with each copy. This map shows the locations of all the high powered RADIO stations in the world, including the time signal stations. In addition it tells at a glance how far away any of these stations are. Of greater interest are the time zones, which enable the amateur to compute instantly the correct time for the zone in which he is located from any time signal station.

PRICE \$1.00 PREPAID

CONSOLIDATED RADIO CALL BOOK CO., Inc., 41 Park Row, N. Y. City

SPECIAL TO YOU!

Read this Remarkable Offer!

Here Are 3 Books You Should Have

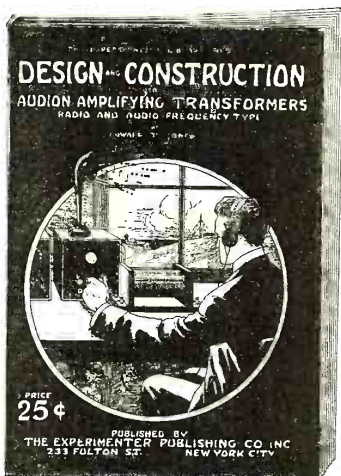

For a limited time we will send all three for only 50¢ when included with a one-year subscription to the RADIO AMATEUR NEWS. This offer is limited—it may be withdrawn at any time. Don't wait, get these books NOW and guarantee yourself twelve wonderful numbers of the RADIO AMATEUR NEWS.

Design and Construction of Audion Amplifying Transformers Radio and Audio Frequency Type

by E. T. Jones, late Associate Editor of RADIO AMATEUR NEWS, a wonderful book—the only one of its kind in print—

should be on the shelf within easy reach of every amateur. Every line of this book is written so that you can understand it. Every detail in the manufacture and construction of Audion Amplifying Transformers is described at great length. The book contains many illustrations and diagrams that make it a simple matter to build the Transformers described. Never before have these instruments been described in print. They have always been considered strictly a "trade secret."



How To Make Wireless Receiving Apparatus

A wonderful book for the man who would construct his own apparatus. Size 5¼ x 7½ inches. Containing 100 pages and 90 illustrations. Compiled of the writings of twenty-five Radio experts. Every amateur should have this book in his wireless room.

How To Make Wireless Sending Apparatus

In every detail equal to "How To Make Wireless Receiving Apparatus." Size 5¼ x 7½ inches. Containing 100 pages and 88 illustrations. Dealing at length on Quenched Spark Gaps, Rotary Gaps and Oscillation Transformers.

Any wireless amateur can easily construct a complete sending and receiving station, and will have his choice of many varieties after reading these wonderful books.

Remember, all three will be sent you postpaid just as soon as we receive your subscription and 50 cents toward the cost of the books.

EXPERIMENTER PUBLISHING CO., Inc.
236-A Fulton Street, New York City, N. Y.

R. A. N.
6-20

Experimenter Publishing Co.
236-A Fulton St.,
New York, N. Y.

Gentlemen:—You may send me the three books described in the "Radio Amateur News" and enter my name for a year's subscription, to the "Radio Amateur News" for which I enclose \$2.50.

Name

Address

City State

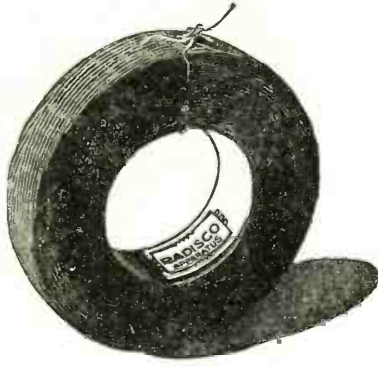

Two Famous RADISCO SPECIALTIES

RADISCO COILS

conceded by several well known Radio Men to be far superior to any similar type of inductances. Made in seventeen sizes, tapped and plain. Wave length range from 200 to 20,000 meters, priced from 70c to \$4.85. Plentiful supply in stock at all Radisco Agencies.

RADISCO BETTER "B" BATTERY

is made according to Government specifications in two (2) sizes— $3\frac{1}{4}'' \times 2 \times 2\frac{1}{2}''$ and $6\frac{1}{2}'' \times 4 \times 3''$. A first-class 15 cell, 5 group battery, VARIABLE VOLTAGE (Pat. applied for) is a special feature of this battery which enables you to provide critical voltage regulation for your vacuum tube by means of a switch connection with cells, taps of which have been taken off. Very economical and convenient. If one cell goes bad just test each group of 3 cells and short circuit the bad one. Price, small size, \$1.40. Large size, \$2.40, at any agency, or if ordered by mail include postage for 2 pounds on small size and 5 pounds on large size. Canadian prices somewhat higher.

RADISCO AGENTS carry only apparatus of proven merit. Look for the Radisco trade mark on all parts you buy and be sure of getting efficient apparatus.

Below are listed a few of the reliable firms who carry the RADISCO COILS, Better "B" Batteries and are our Agents for all other standard apparatus of merit.

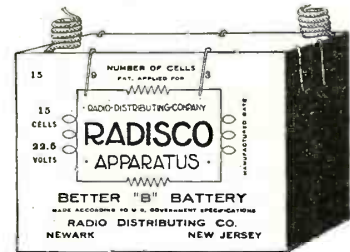

COMMUNICATE YOUR WANTS TO THEM

ALBANY, N. Y.

E. L. Long,
21 Magnolia Terrace

ATLANTIC CITY, N. J.

Independent Radio Supply Co.
118 So. New Jersey Ave.

BALTIMORE, MD.

Radio Engineering Co.,
614 North Calvert St.

BEINVILLE, QUEBEC, CAN.

Canadian Radio Mfg. Co.

BOSTON, MASS.

Atlantic Radio Co.,
88 Broad Street.

BROOKLYN, N. Y.

Kelly & Phillips Electric Co.,
312 Flatbush Ave.

BRONX, NEW YORK.

Amateur Wireless Equipment
Co.,
1390 Prospect Ave.

CHICAGO, ILL.

Chicago Radio Laboratories,
1316 Carmen Ave.

EUREKA, PEORIA, ILLINOIS

Klaus Radio Co.

HAMPTON, N. H.

DeLancey Felch & Co.

LOS ANGELES, CALIF.

The Wireless Shop,
511 W. Washington St.

McKEESPORT, PA.

K. & L. Electric Co.,
427 Olive Street.

NEW ORLEANS, LA.

L. A. Rose,
121 Camp Street.

NEWARK, N. J.

A. H. Corwin & Co.,
4 West Park Street.

NEWCASTLE, PA.

Pennsylvania Wireless Mfg.
Co., 507 Florence Ave.
"8HA"

PHILADELPHIA, PA.

Philadelphia School of Wire-
less Telegraphy,
Broad and Cherry Streets.

PROVIDENCE, R. I.

Rhode Island Elec. Equip. Co.,
45 Washington Street.

PITTSBURG, PA.

Radio Electric Co.,
4521 Forbes St.

SCRANTON, PA.

Shotton Radio Mfg. Co.,
P. O. Box 3
Branch 8, Kingsbury St.,
Jamestown, N. Y.

SPRINGFIELD, MASS.

Electric Service Co.,
585 Armory Street.

TORONTO, ONT., CAN.

The Vimy Supply Co.,
585 College Street.

WASHINGTON, D. C.

National Radio Supply Co.,
1405 U Street, N. W.

WICHITA, KAN.

The Cosradio Co.,
1725 Fairmount Ave.

If none of the above agencies are in your vicinity, communicate with

RADIO DISTRIBUTING COMPANY : : Newark, New Jersey