

CIRCULATION OF THIS ISSUE OVER 224,000 COPIES

RADIO NEWS

REG. U.S. PAT. OFF.

25 Cents

June

1923

Over 200 Illustrations

Edited by H. GERNSBACK

BROADCAST LISTENER'S NUMBER

See Page 2092



THE 100% WIRELESS MAGAZINE

CIRCULATION LARGER THAN ANY OTHER RADIO PUBLICATION



Cunningham

the standard tube for all makes of receiving sets

Mutual Conductance

The Correct Rating for Vacuum Tubes

Gas Engines are rated by their horsepower—Electric Generators are rated by their watt or kilowatt output—Mazda Lamps are rated by their candle-power. All of these factors actually express the efficiency of the article for the purpose intended.

In the past vacuum tubes have been known merely as Detectors and Amplifiers. These terms indicated only the use for which the tube was designed, but in no way expressed its efficiency for either of these purposes. Though little known to the general public, there is a factor—MUTUAL CONDUCTANCE—which adequately and accurately expresses the efficiency of vacuum tubes. The new Cunningham C-301-A has the *highest value of mutual conductance ever obtained in a receiving tube*, and it is this factor that is responsible for its superior operation as an Amplifier.

Write for Bulletin I-N explaining the uses and advantages of the term Mutual Conductance as the correct rating for Vacuum Tubes

Cunningham C-301 A Improved Amplifier Now \$6.50

Filament Current 1/2 Amp. Mutual Conductance—600 micromhos at 100 volts plate and 6 volts neg. grid potential

For the assistance of the public, in obtaining true musical quality and actual reproduction in broadcast reception, this company will, from time to time, issue Service Bulletins explaining in a clear and simple manner the most important technical features that must be observed in the selection and operation of radio apparatus.

Cunningham Service Bulletin No. 1 explains the use of the fact or mutual conductance as the standard rating for vacuum tubes. The information it contains should be thoroughly known to every owner of a radio set who is interested in obtaining maximum efficiency with a given number of vacuum tubes. This bulletin will be mailed to you, free of charge, upon request.



The trade mark GE is the guarantee of these quality tubes. Each tube is built to most rigid specifications.

Patent Notice: Cunningham tubes are covered by patents dated 11-7-05, 1-15-07, 2-18-08, and others issued and pending. Licensed for amateur, experimental and entertainment use in radio communication. Any other use will be an infringement.

E. J. Cunningham

Home Office:
248 First Street
San Francisco, Calif.

Eastern Representative:
154 West Lake Street
Chicago, Illinois

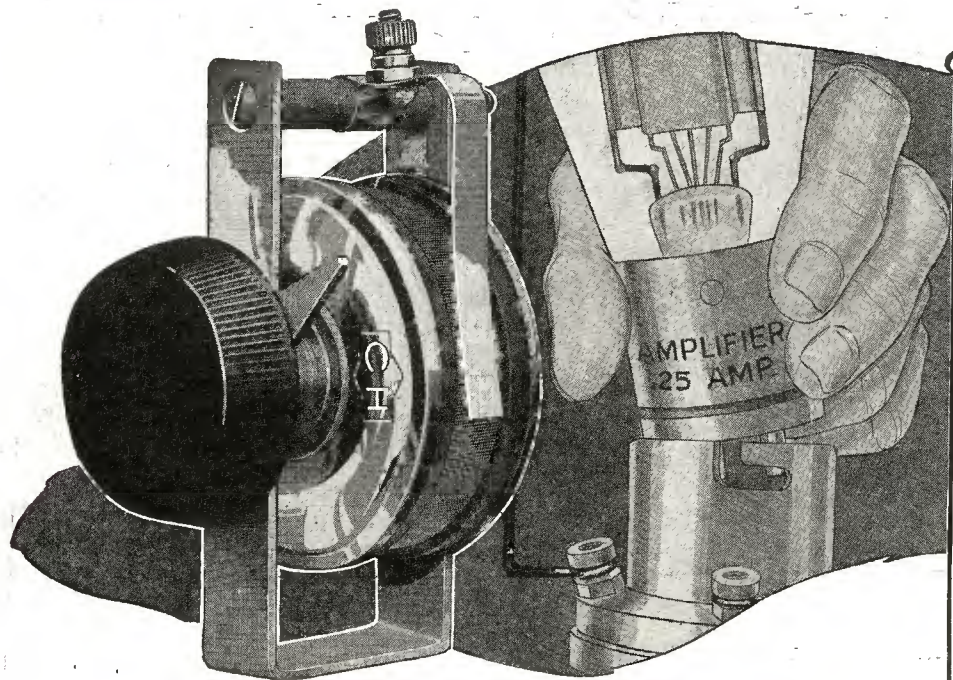

The Newest of the Famous Radio Rheostats by Rheostat Builders

For more than thirty years the name Cutler-Hammer has been recognized as that of the master builder of rheostatic control apparatus.

Engineers the world over have demanded the famous C-H trade-mark as ample assurance of dependable performance.

When radio swung into being, this quarter century of experience produced a rheostat of such mechanical precision and electrical perfection that more than one-quarter of a million were purchased as rapidly as they could be produced.

Now, with the introduction of the new and better amplifier tube, Cutler-Hammer offers a new rheostat with a thirty ohm resistance range to bring to your set the maximum efficiency possible. It replaces in your circuits the present 4 to 6 ohm rheostat, which resistance is too low for the new tube, and allows you the opportunity of *now* protecting your panel with "the mark of the master builder," if it were not possible to do so when purchasing your original equipment.

THE CUTLER-HAMMER MFG. CO.

Member Radio Section, Associated Manufacturers of Electrical Supplies
MILWAUKEE · WISCONSIN

One-Half Million C-H Radio Rheostats Now in Use



"Built by
Rheostat Builders"

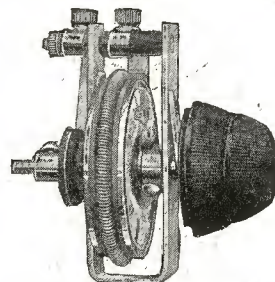

C-H Vernier Rheostat
Perfect detector tube control. Range 0 to 4 ohms. For one ampere detector tubes and WD11 (dry cell) tubes. Type 11601-H1 . . . \$1.50

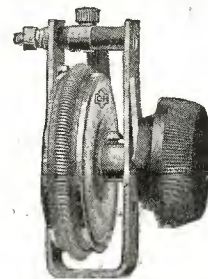

C-H Amplifier Rheostat
Accurate amplifier tube control. Range 0 to 4 ohms. For one ampere amplifier tubes and WD11 (dry cell) amplifier tubes. Type 11601-H2 . . . \$1.00

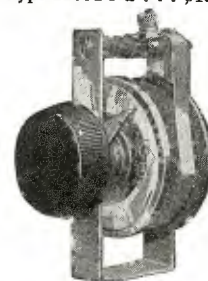

C-H Radio Rheostat
Perfect control for the new quarter ampere tubes (UV201A and C301A). Range 0 to 30 ohms. Type 11601-H9 . . . \$1.50

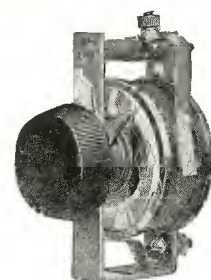

C-H Radio Potentiometer
For accurate control of the plate potential. Resistance 300 ohms. Provides increased range and signal strength. Resistor cannot become displaced under constant usage. Type 11602 \$1.50

CUTLER-HAMMER

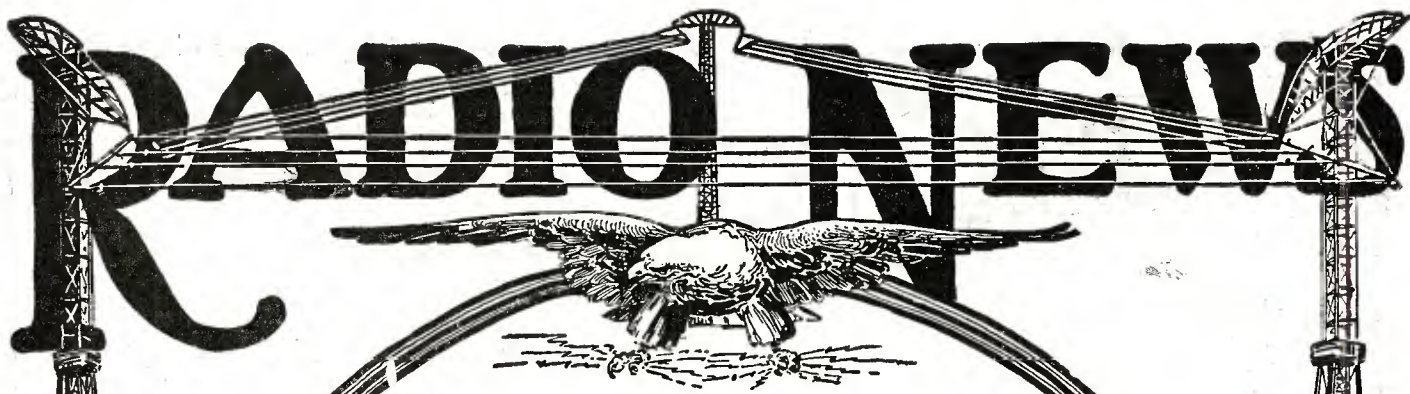

CONTENTS

VOL. 4

FOR JUNE

No. 12

| | Page | | Page |
|---|------|---|------|
| Editorial | 2073 | The Future of Radio | 2097 |
| Public Education by Radio.. | 2074 | Mr. Filbert Tunes In.... | 2099 |
| Trolley Cars Try Radiophones..... | 2075 | Newark Apartment Gives Complete Radio Service | 2100 |
| A Modern Liner Radio Outfit | | Notes on the WD-11 Tube | 2101 |
| By C. A. Reberger | 2076 | With the Amateurs | 2102 |
| Inauguration of the Cuban Academy | | C.W. and Phone Transmitter Contest Announcement | 2103 |
| By Ulpiano Muniz | 2077 | American Amateurs Heard in New Zealand.... | 2104 |
| Vast Range of Ether Vibrations | | Calls Heard | 2104 |
| By Sir Oliver Lodge | 2078 | Matching Impedances | |
| Recommendations of the National Radio Committee | 2079 | By Prof. W. Palmer Powers | 2105 |
| Awards of the Super-Regenerative Contest.... | 2080 | Construction of D-Shaped Variometers | |
| Try This New Duo-Vertical Winding | | By D. R. Clemons | 2106 |
| By Arthur S. Gordon | 2081 | A Spark Coil C. W. Set.... | 2108 |
| What Radio is Doing for the Blind | | A Three-Tube Reflex Receiver | 2109 |
| By John T. Timmons | 2082 | By J. R. Balsley | |
| The Vario-Aerial..... | 2083 | A Filter Circuit for High-Tension Supply | |
| Some New Dual Amplification Circuits | | By G. P. Kendall | 2109 |
| By John Scott-Taggart | 2084 | Awards of the \$50 Radio Wrinkle Contest.... | 2110 |
| Electrons, Electric Waves and Wireless Telephony—Part V. | 2086 | Radio News Laboratories | 2112 |
| By Dr. J. A. Fleming | | New Radio Patents | 2113 |
| Principles of the Antenna System | | Correspondence from Readers | 2114 |
| By Louis Frank | 2090 | Radio Humor | 2115 |
| Tuning Radio Receivers: An Explanation for the Novice | 2092 | With the Sea-Going Op.'s | 2116 |
| By Jesse Marsten | | Printing the Newspaper of the Sea | |
| Complete List of Broadcasting Stations in the United States | 2095 | By C. A. Reberger | 2116 |
| | | I-Want-To-Know | 2117 |
| | | Index to Advertisers | 2068 |

RADIO NEWS is published on the 25th of each month. There are 12 numbers per year. Subscription price is \$2.50 a year in U. S. and possessions. Canada and foreign countries, \$3.00 a year. U. S. coin as well as U. S. Stamps accepted (no foreign coins or stamps) Single copies, 25 cents each. A sample copy will be sent gratis on request. Checks and money orders should be drawn to order of EXPERIMENTER PUBLISHING CO., INC. If you should change your address notify us promptly, in order that copies be not miscarried or lost. No copies sent after expiration.

All communications and contributions to this journal should be addressed to Editor, RADIO NEWS, 842 Jamaica Avenue, Jamaica, New York; or 53 Park Place, New York, N. Y. Unaccepted contributions cannot be returned unless full postage has been included. All accepted contributions

are paid for on publication. A special rate is paid for novel experiments; good photographs accompanying them are highly desirable.

RADIO NEWS, Monthly. Entered as second-class matter at the Post Office at Jamaica, N. Y., under the act of March 3, 1897. Title registered U. S. Patent Office. Copyright, 1921, by E. P. Co., Inc., New York. The Experimenter Publishing Co., 53 Park Place, N. Y. The Contents of this magazine are copyrighted and must not be reproduced without giving full credit to the publication.

RADIO NEWS is for sale at all newsstands in the United States and Canada; also at The International News Co., Ltd., Bream's Building, London E. C. 4, England, and at Brentano's 37 Avenue de l'Opera, Paris.

General Advertising Dept., 53 Park Place, New York City. Western Advertising Representatives, Finucan & McClure, 720 Cass Street, Chicago, Ill. Kansas City Representative, Geo. F. Dillon, Republic Bldg., Kansas City, Mo. Pacific Coast Advertising Representatives, A. J. Norris Hill Co., Hearst Bldg., San Francisco, Cal.
 Published by EXPERIMENTER PUBLISHING CO., INC.,
 Publishers of "Radio News," "Science and Invention" and "Practical Electrics."
 Publication Office: Jamaica, N. Y. Editorial and General Offices: 53 Park Place, New York City
 H. GERNBACK, President S. GERNBACK, Treasurer R. W. DEMOTT, Secretary



“He who lightly promises,
is sure to keep but little
faith” - Lao Tzu

Wink knowingly
at him who would sell you
something “just as good” as a
Grebe Receiver

Doctor Mu.

A. H. GREBE & CO., Inc.
Richmond Hill, N. Y.

Western Branch
451 East 3rd Street, Los Angeles, Cal.

Write for
“Musings of
Dr. Mu.”

Licensed under Armstrong
U. S. Pat. No. 1113149

See The World and Earn Big Money!

Wireless operators visit the world's most interesting places—Paris, London, Venice, Shanghai, Sidney, Valparaiso—cities in every corner of the globe—in Europe, Asia, Australia, Africa and South America! Now YOU can know first hand the mysterious far-off lands you've dreamed of. You can enjoy the pleasure and education of travel—not as a hurried tourist, but as a ship's officer with plenty of spare time on board ship and freedom in port to explore each new land. And for this fascinating, easy work, you will receive splendid pay—in addition to your keep!

Get into the field of Radio now. From all over the world comes the call for men trained in Radio. Never has a field offered such glorious opportunities—both on land and on sea. And now in a few weeks you can easily fit yourself for one of these positions.

Easy Now To Qualify For Government Radio License At Home In Spare Time

The key to all the best paid positions in radio is the Government First Class Radio License. Every operator on a ship, in a commercial land station, or in a broadcasting station should have it. Every radio inspector, engineer, and installation expert should have it. This license is the Radio Expert's degree. It opens up to him all the wonderful opportunities in his profession.

You can easily qualify for this license—right in your home during spare time. You don't have to know a thing about electricity or radio to start. The National Radio Institute, America's first and largest Radio School, has perfected a home-study method of teaching radio which starts at the very simplest fundamentals of electricity and radio and takes you up to a point where you are qualified for the First Class Radio License.

The majority of all American wireless operators on land and sea are graduates of this home study course of the National Radio Institute!

An extraordinary feature of this home-study course is the use of four specially patented instruments, owned exclusively by this Institute. These instruments, included with the course, give practical training in radio operation, and enable the student to develop a high speed in transmitting and receiving code, required to obtain the first class license.

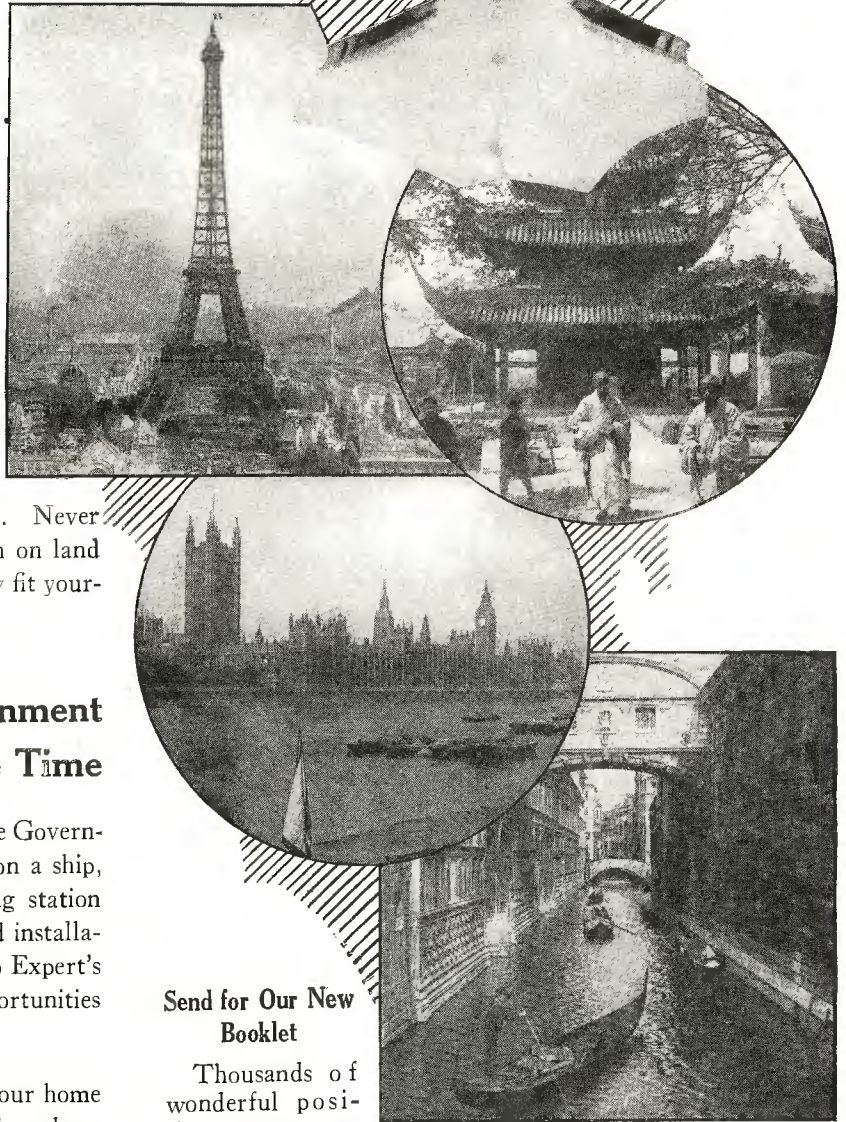

Send for Our New Booklet

Thousands of wonderful positions are open to licensed radio experts. Whether you want to travel or prefer an attractive land job, there is a wonderful opportunity for you in this fascinating, rapidly growing field. Send for our new booklet "How to Learn Radio At Home," which describes the remarkable openings in Radio and how you can qualify for them. Mail the coupon today.

NOTE—These opportunities are open only to those over 18 years of age. Boys under 18 write for special opportunities open to them—spare time opportunities for making big money in radio after school hours and during vacation.

NATIONAL RADIO INSTITUTE

Department 13FA

1345 Pennsylvania Avenue

Washington, D. C.

National Radio Institute,
Dept. 13FA, 1345 Pennsylvania Ave.,
Washington, D. C.

Without obligation please send me your booklet "How To Learn Radio At Home." I am
[] over 18 years old [] under 18 years old

Name
Street
City..... State.....

Every Radio "Bug" OK's the Kellogg Variometer

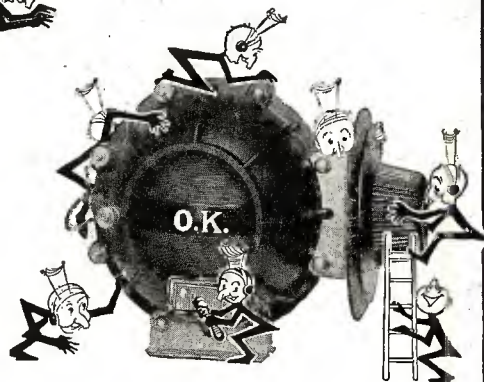

A product that stands up under the test of service of the widest range. The stator and rotor shells are of molded Bakelite, of extra strong rib design. A handsome brown in color.

The windings are of the highest grade insulated wire, terminating on binding posts securely molded in the Bakelite shell. The flexible wires used to bring the rotor leads to the outside of the variometer are of special construction with a heavy insulation.

Ample size bearings assure smooth, even movement with long life, a spring of proper tension takes up all play and prevents back lash. There are no sliding contacts, nothing to wear, nothing to "short," or produce noises.

High inductance and low distributed capacity.

Have your dealer show you other Kellogg radio parts — each in a class by itself.

Get the most out of radio. Build it with Kellogg time-tested equipment. Use the following KELLOGG radio equipment for better results:

Variometers, \$8.00; Variocouplers, \$9.00; Tuner Coils, \$3.00; Head Sets, \$10.00; Microphones, \$8.90; Tube Sockets, \$.75; Plugs, \$1.00; Four Conductor Jacks, \$1.10; Two Conductor Jacks, \$.75; Six Conductor Jacks, \$1.25; Four Inch Dials, \$1.25; Forty Three Plate Variable Condenser with Five Plate Vernier-Four Inch Dials and Knobs, \$8.75; Twenty Three Plate Variable Condensers with Five Plate Vernier-Four Inch Dial and Knob, \$7.75; Eleven Plate Variable Condensers with Five Plate Vernier-Four Inch Dial and Knob, \$6.75; Miniature Condensers, \$.75; Rheostats, \$2.00; Air Choke Coils, \$1.00; Iron Core Choke Coils, \$1.35.

Kellogg Radio Apparatus proves the least expensive in the long run. Why experiment. Buy the best.

All Kellogg Radio Parts are manufactured and guaranteed by

Kellogg Switchboard & Supply Company

CHICAGO, ILLINOIS

COLUMBUS, OHIO

KANSAS CITY, MO.

SAN FRANCISCO, CAL.

PORTLAND, ORE.

Kellogg Apparatus exclusively is used in building the Symphony Receiver





The City's Music In Vacation Times

Thousands of summer resorts are going to keep in touch with the world by radio. Thousands more will wish that they had thought of it.

The Jones *Symphony* Receiver, detector and three stage, is particularly fitted for this service.

Because: **FIRST**, it is positively in a class by itself in the durability of its construction and assembly.
SECOND, its simplicity of operation.
THIRD, its reliability.

We sell with the Jones *Symphony* Receiver, for this purpose, a stout traveling case. All you need to do is to disconnect your leads, put the *Symphony* in the case, turn the lock, put the case in your car with a couple of "B" batteries and you are all fixed. Use your automobile battery. If that isn't convenient, use "peanut tubes" with adapters. If you want the best, we suggest using regular tubes with a six volt battery. You can rent one at any town.

But in any case include a Jones Receiver in your summer outing plans. The *Symphony* will repay you many, many times over.

Summer radio has been handicapped by absurd stories of noises. The quality of our *Symphony* receiver, and more efficient broadcasting stations have eliminated many defects heretofore assumed to be caused by static. On most summer nights, especially in dry weather, the receiving is as good as at any other time in the year.

The use of the *Symphony* under many and varied conditions proves it to be one of the most efficient long distance receivers on the market. Every part of the *Symphony* is built and inspected by the Kellogg Switchboard & Supply Company, for twenty-five years manufacturers of highest grade telephone equipment.

Ask your dealer — If he has not a *Symphony* in stock, or complete information, wire us immediately. Get your order in at once to avoid delay.

JONES RADIO COMPANY
 LYTTON BUILDING, CHICAGO

The Symphony is manufactured under U. S. Patent No. 1113149, Armstrong Regenerative Circuit



RADIO NEWS

H. GERNSBACK—Editor and Publisher
ROBERT E. LACAULT—Associate Editor

EDITORIAL AND GENERAL OFFICES, 53 PARK PLACE, NEW YORK

Vol. 4

JUNE, 1923

No. 12

The Broadcast Listener

THIS editorial is written for the broadcast listener, also sometimes termed "Radiophone Fan," better known to radio amateurs as "Phone Hound."

The broadcast listener, as we all know, is in a distinct class by himself. He is not interested in the technicalities of either electricity or radio at all. He buys a radio set for one purpose only—to listen in. He receives a few directions either verbally or printed, when he buys his complete set at the store or from a mail order company, and as long as he is able to receive to his heart's content he is satisfied. He is exactly in the same large class with individuals who own phonographs, and who care not a hoot what is inside of the case or how the "blamed thing" works. He has not the slightest idea what the motor looks like—quite rightfully so, for he is not supposed to know. He is also like the automobile owner who knows how to drive his car, but who knows absolutely nothing about machinery, and does not want to know. He drives his car for pleasure or for business, but is not interested in automobile engineering, and does not care to be. This is exactly the position of the broadcast listener, and we may as well admit that he is in the overwhelming majority.

Indeed, radio engineers, as well as the entire technical radio fraternity today, bend every effort towards simplifying every radio set to such an extent that it will come into the class of the phonograph or the automobile; that is, that the owner does not need to know anything of radio whatsoever in order to operate his set.

Today there are such sets, and they are getting more common every day. If the owner of such a set feels that he wants to experiment with something different after he has become sufficiently interested in radio—well and good, but the greater majority will probably continue buying simpler and simpler sets, as new models come out.

This radio millennium, however, has not as yet been reached, and the broadcast listener, perforce, must learn some things today about radio if he wishes to get the maximum results from his set.

Let us first start with the crystal set owner: The broadcast listener probably knows that his receiving radius is rather small. It is given, as a rule, as 25 miles. However, there is no set rule about distances in radio, neither with a crystal set nor with a Vacuum Tube set. In some localities, as, for instance, large cities, mountainous regions, particularly where the mountains bear ores,—or if you are in the midst of great steel structures—a 25-mile receiving range is excessive. Oftener it is not even 10 miles, even if a powerful broadcasting station is near.

On the other hand, there are crystal sets in operation every day that receive from distances ranging up to 500 miles and more. Here the radio engineer frankly throws up the sponge, and admits that he doesn't know why such a condition should exist. He advances many theories why some crystal sets, particularly those located in the country, should make such records. So far we have not discovered the correct reason.

As to the operation of his set, the crystal set owner is not troubled very greatly, for the operation of such a set is simple. He turns one or more knobs, makes one or two detector adjustments, until the sounds come in strongest, and that is about all.

The crystal set owner is not bothered with batteries or tubes, as is the tube set owner, and his troubles are comparatively few. But once in a great while a crystal set goes dead. Nine times out of ten the trouble will not be in the "boughten" outfit—mostly it will be loose connections, either the ground clamp attached to the water pipe is loose or it does not make contact. Going over these connections should be the first thought. Scrape the metal perfectly clean and bright, and see that the ground clamp or wire is fastened with maximum pressure to the pipe. Next, the aerial and lead-in may have become disconnected. Sometimes the aerial is joined to the lead-in, and the connection may have become loose, particularly if it has not been soldered, which certainly should be done. If the set still does not work, the trouble may then be with the lightning arrester. This may be disconnected, or the connections looked over. If still results are not had, then the trouble is in the outfit.

First tighten up all the screws and see that all the connections are good. Many times the tightening and cleaning of a few connections will make the outfit work. The crystal, if a catwhisker is used, should be cleaned with Carbona on a piece of absorbent cotton.

If still no results are had, then the outfit must be returned to the maker.

Here is a new thought for crystal set owners. In recent experiments with crystal sets, the writer has very successfully used, instead of an aerial, a copper strip from $\frac{1}{4}$ " to $\frac{1}{2}$ " wide, and only .005" (five thousandths of an inch) thick. This copper strip can be secured from radio supply or specialty companies and is very cheap, costing only about one cent a foot. By using such strip, instead of wire, we catch, so to speak, more energy. *The bigger the surface that we expose to the waves, the more energy do we intercept.* Results with a copper strip antenna are really surprising.

The tube set owner has an entirely different problem. As to the distances over which he can receive, there are no fixed rules—just as with the crystal set. A single tube circuit, using no fancy hook-up, is good for anywhere from 50 to 100 miles. If the set is the so-called regenerative set, the distance is very much greater, running into hundreds and even thousands of miles. As a rule, the more tubes used, the greater the distance. This holds particularly true if the set is a radio frequency or Reflex Circuit set.

The Vacuum Tube set owner, with a few instructions, readily learns how to tune in, but again there are no set rules as to how this is done, either. It makes a difference for every outfit used. The broadcast listener is usually told, after the tubes have been lighted, to adjust either the condenser or variometer dials until the "whistle" is heard. That means that a particular station has been picked up. When the sounds are then heard weakly, other adjustments with other dials and knobs must be made, until the maximum sound is received. The directions naturally vary for every set. It is, however, not difficult to master the art of adjusting, particularly where local stations are concerned. Even the lady of the house, after a few instructions, has no trouble in tuning in for nearby stations. The trouble arises when you try to tune in for a distant station. There are very few sets on the market that can boast of tuning in to the so-called "DX" (distant) stations, while a local station is working on a similar wave-length. As a rule, the attempt proves hopeless for the local station. If it sends at 360 meters, it will positively drown out every "DX" 360-meter station. Even if a local station is sending on 360 meters and it is attempted to get a distant 400-meter station, the results are not always encouraging.

The Vacuum Tube owner, when his set gives him trouble, should pursue the same method in hunting for that trouble as explained under "crystal set operation." The tube set owner knows that when the light in the bulb fails, his storage battery (or dry cells, if he uses the new low-voltage tubes) is failing. If it is a storage battery, it must be recharged. If he uses dry cells, it is useless to do anything except throw them away and buy new ones. If a tube suddenly goes dead, a new one must be bought. Owners, however, have been fooled at times when a tube has gone dead, which was not dead at all. Often the socket connection goes bad, and for that reason before a tube is thrown away, it should be tested in another socket or another set, to make reasonably sure that it is really burnt out.

If the set emits weird and unaccustomed noises, there is either a loose connection somewhere that should be tightened, or the "B" batteries need renewing. "B" batteries, if they are of good make, last anywhere from 9 to 12 months, and should be renewed after such a period. It is much safer to do so, as many troubles arise from a "B" battery that is slowly but surely wearing out. The source of loud noises will often be found in the rheostat or potentiometer. The metal finger that rides over the wire convolutions may have become loosened, where it should be tight; this is a frequent trouble. If no reception is had at all, and the owner is not technically inclined, after he has looked the set over to the best of his ability, he had better call in a radio amateur or other expert, or otherwise return the outfit to the factory.

If the set is one in which dust can accumulate on the inside, a frequent source of diminished reception will be apparent. A thorough dusting of all the parts will often bring astonishing results, particularly if the dust is thick upon some of the condenser plates and other connections.

H. GERNSBACK.

Public Education by Radio

By S. R. WINTERS

THERE are 350,000 teachers in the United States who have had no professional training; there are 186,000 schools employing only one teacher; hundreds of thousands of children are

quartered in portable buildings, stores and lofts, and many more thousands are studying in halls, corridors, and attics; and more than 4,000,000 children, between five and eighteen years of age, in this country are not enrolled in school.

These and kindred impressive facts about our educational life have been repeated countless times before by word of mouth and through the medium of the printed page. However, they were never presented with more telling effect than when Commissioner John J. Tigert of the Bureau of Education, United States Department of Interior, recently, while seated in his home at Chevy Chase, District of Columbia, spoke into a telephone connected to the radio-telephone transmitting apparatus of the United States Navy Department, at Radio, Virginia. From this point his words were wafted through the air to an unnumbered invisible audience within a radius of hundreds of miles of our National Capital.

The favorable reaction to this service which has been entitled "Public Education by Radio" is partially responsible for this unqualified endorsement of the radio telephone as an educational factor by the Commissioner of Education when this writer was supplied with this statement: "I consider the inauguration of this service one of the most important pieces of work that the Bureau has ever started. In fact, the general public is one of the most fundamentally important audiences which we have to reach, since public education cannot progress any faster than the state of public opinion about education. This audience, however, has now grown too vast, the need for continuous education too great, and the necessity for sending out information quickly has become too pressing to be met any longer by the long-delayed, infrequent government bulletins." Ringing words are these, and coming as they do from the titular head of our national educational system, they constitute probably the strongest endorsement of radio as a medium of intelligence yet issued by any Federal Government official. Moreover, this official statement is the unbiased judgment of an educational authority whose bureau is purely concerned with the educational interests of 110,000,000 people.

The Commissioner of Education, whose vision dips into the future, is quick to appraise the advantages of radio telephony as a medium for disseminating educational truths. He at once realizes that unpleasant conditions—for instance, "The large majority

of school children in this country are housed at the present time in buildings of the type designed 75 years ago"—may be borne through the ether on electro-magnetic waves to effect. Father and son, with head tele-

is a glamour about it—this departure of broadcasting "Public Education by Radio."

Both in priority and significance, this is "the first instance in history that a national educational agency has broadcast messages on education by radio." Twice each week, on Monday and Thursday, for a period of fifteen minutes, from 6:45 to 7 o'clock in the evening, educational talks are broadcast from NAA, the transmitting station of the Navy Department, located at Radio, Virginia, the wave-length employed being 710 meters. If Commissioner Tigert is in the city, he usually delivers the lecture by use of a remote-control system interlinking his Chevy Chase residence with the powerful radio-telephone transmitter at Radio, Virginia. Absence from Washington or pressing duties that may engage the attention of the Commissioner of Education, then the duty of delivering educational hints devolves upon L. A. Kalbach, Chief Clerk of the Bureau of Education, who likewise maintains orderly telephonic communication from his home with the wireless broadcasting station, NAA.

Thirty-two broadcasts under the title "Public Education by Radio" had been issued before the end of March, 1923. In addition to the broadcasting of these educational talks, each consisting of about seven mimeographed pages, by the United States Navy Department through NAA, there are two private transmitting stations spreading the gospel of education. These are located on the Pacific Coast, namely, the Mercantile Trust Company of San Francisco, California, and the Tacoma Daily Ledger of Tacoma, Washington. Moreover, the Bureau of Education mails copies of these broadcasts regularly twice a week to 2,000 newspapers scattered throughout the length and breadth of the Nation. This service to the press was introduced on January 27, 1923. The co-operation of the newspapers in publishing these broadcasts is earnestly solicited by Uncle Sam's national educational agency. Thus, directly and indirectly, it is not an extravagant claim in assuming that millions of American citizens are benefitted by "Public Education by Radio."

"This audience of the general public which the Bureau of Education has to reach with educational information," to again quote the Commissioner of Education, "includes the entire voting population of the United States and particularly fathers and mothers. In 1920 there were 22,059,582 children in the public elementary and high schools of the United States. It is the parents of these children and the taxpayers in their communities that the Bureau of Education desires to reach, for no improvements in school build-

(Continued on page 2193)



John J. Tigert, Head of the Bureau of Education of the United States Department of the Interior, in the Act of Broadcasting "Public Education by Radio" from His Office, Through the Naval Station N.A.A., at Radio, Virginia.

A NEW situation in education has arisen and a new method of reaching it must be found. I believe that radio furnishes such a method. Radio is cheaper than printing; it reaches its audience quicker; it reaches the mass of people who will not read printed articles; it is more effective because it has the intimate contact of speaker and audience; and above all it can be continuous in service, which is vitally important for us since the only thing that educates the public is continuous education. Radio can be the means of such continuous education. I consider the inauguration of this service one of the most important pieces of work that the Bureau has ever started.—Commissioner John J. Tigert, of the Bureau of Education, United States Department of Interior.

phones clamped on their ears or mayhap by use of a loud speaking device, can "listen-in," without voicing denunciation, to the words of a constituted authority. "At present, 4,159,318 children, between 5 and 18 years of age, are not in school at all. Some schools are shortening their terms for lack of school funds, or shutting down entirely. Such a situation is a menace to the future of this country." These shortcomings—failure to enforce compulsory laws and to provide adequate school buildings—when disseminated in all directions by electric waves are even heard by over-burdened taxpayers without their voicing the usual complaints. There

Trolley Cars Try Radiophones

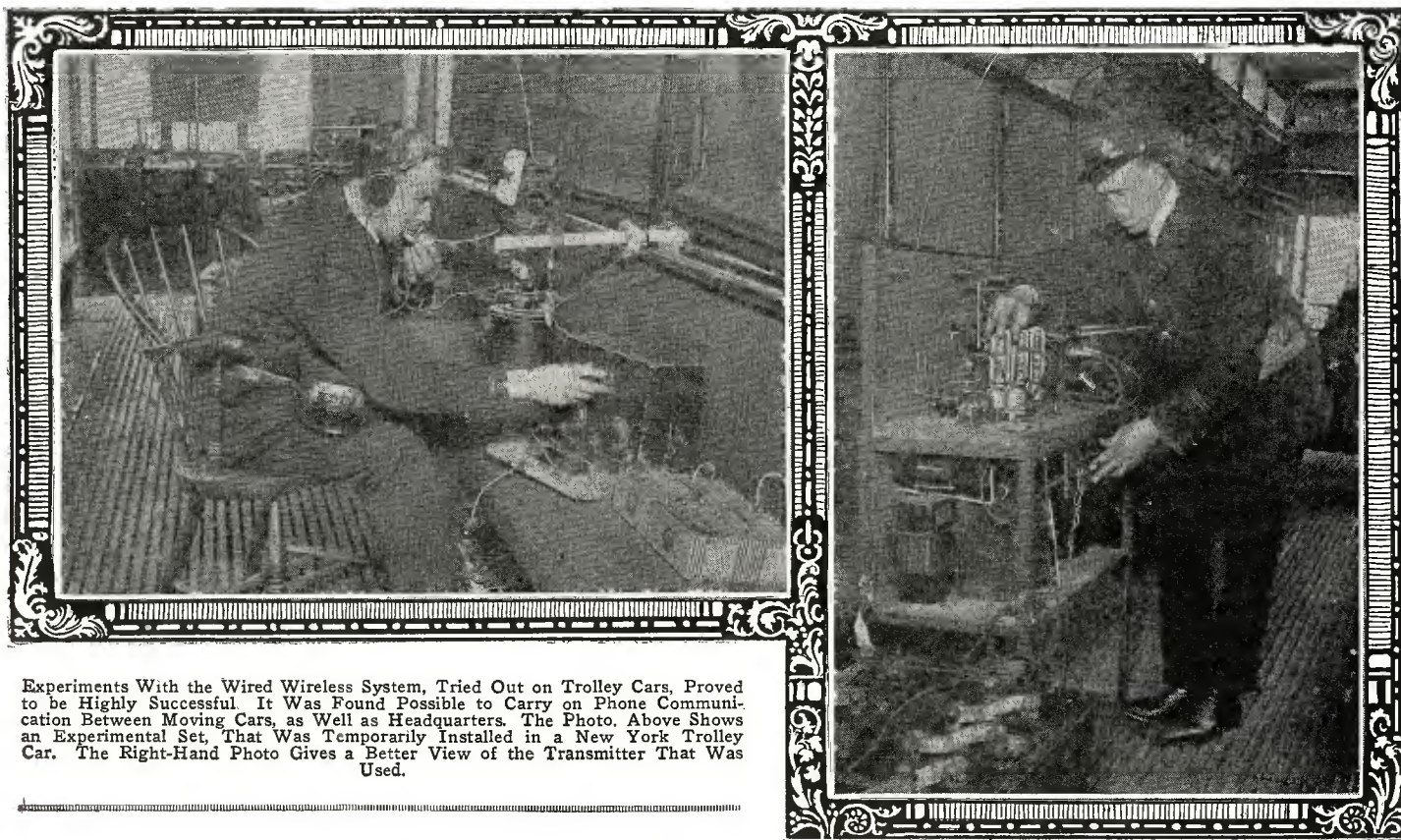

Experiments With the Wired Wireless System, Tried Out on Trolley Cars, Proved to be Highly Successful. It Was Found Possible to Carry on Phone Communication Between Moving Cars, as Well as Headquarters. The Photo. Above Shows an Experimental Set, That Was Temporarily Installed in a New York Trolley Car. The Right-Hand Photo Gives a Better View of the Transmitter That Was Used.

A CARRIER current telephone, operated by radio guided by trolley wires, was demonstrated recently on trolley lines of the New York Third Avenue Railway in the Bronx by engineers of the General Electric Company and the Third Avenue line. By the use of this current and the "wired wireless" telephone apparatus a conversation was carried on between a trolley car in motion along St. Ann's Avenue and a sub-station three miles distant. Walter J. Quinn, electrical engineer of the Third Avenue system, said:

"Operating delays usually occur through unforeseen causes, such as fires, accidents and traffic congestion. Even with the best telephone service time is lost in reaching emergency crews and other employees who are charged with the duty of maintaining schedules and clearing up trouble. Where such employees are beyond reach of immediate telephone facilities additional time is required to dispatch messengers for them. To improve this condition it seemed most logical to use the trolley wires and feeders of the system as a channel for the broadcasting of signals and messages, and with this in mind the General Electric Company and the Third Avenue Railway Company have been jointly experimenting for several months.

"The wires and feeders form a network covering the entire system which furnishes ready means of contact with all strategic points and also the means by which emergency motor vehicles may instantly make contact and be placed in communication with the central dispatching point. We have found that by a suitable modification of the conventional radio transmitting system the output of the transmitting station in the form of high frequency carrier currents is modulated by the voice through suitable amplifier and modulator tubes."

The General Electric Company said in a statement:

"This is the third practical use carrier current has been put to by the General Electric Company. It was first used to

operate a street lighting system from a remote power station, next for communication over high tension power lines which carry up to 120,000 volts and today for an inter-communication means between trolley cars and the sub-station or dispatcher's office. By installing the set on the repair or emergency wagon, a similar means of communication may be maintained which at the present time the Third Avenue Railway officials feel is

In the July Issue of Radio News You Should Read

Radio Control. By Capt. H. W. Webbe, A. I. E. E., Asst. Professor Communications, Military Dept., Ohio State University.

A New Type of Single-Tube Reflex. By Clyde J. Fitch.

Health by Radio. By S. R. Winters. **Construction of a 10-Watt C.W. and Radiophone Set.** By D. R. Clemmons. Radio Instructor, Dodge's Radio Institute.

Radio Control of Ships. Some heretofore unpublished data on the inventions of John Hays Hammond, Jr., and several other interesting articles for the amateurs and Broadcast listeners.

more essential than linking the trolley cars with the main office.

Several persons listened to the conversations which were carried on while the trolley car proceeded up and down St. Ann's Avenue at a slow speed and all agreed that the speech was as clear as that obtained over a land telephone."

WEATHER FORECASTS ARE BROADCAST BY RADIO-PHONE FROM NAA

Broadcasting by radiophone from the Arlington Naval Radio station (NAA) of

weather forecasts and warnings for each of the States comprised in the Washington forecast district was inaugurated February 15, 1923. Broadcasts are made three times daily, at 10:05 a. m., 3:45 p. m., and 10:05 p. m., respectively, on a wave-length of 710 meters. The State forecasts are for northern New England (Maine, New Hampshire, and Vermont), southern New England (Massachusetts, Rhode Island, and Connecticut), New York, Pennsylvania, New Jersey, Delaware, Maryland, District of Columbia, Virginia, North Carolina, South Carolina, Georgia, Florida, Alabama, Mississippi, Tennessee, Kentucky, West Virginia, and Ohio. A general forecast covering the entire district and such storm and flood warnings as are issued for any portion thereof are included.

On Saturdays there is included in the 3:45 p. m. broadcast the weather outlook for the ensuing week, Monday to Saturday, inclusive, for the North and Middle Atlantic States, the South Atlantic and east Gulf States, the Ohio Valley and Tennessee, and the region of Great Lakes. On Wednesdays, March 15 to November 30, inclusive, a summary giving the effect of the weather on crops during the preceding seven days ending at 8 a. m., Tuesday, will be given in the 10:05 a. m. broadcast.

A feature of this service, which provides for dissemination of the weather forecasts immediately after they are issued, is that the announcements are made directly from the Weather Bureau office in Washington which is connected by telephone with the radiophone transmitting apparatus located in the Naval Radio station (NAA) at Arlington, Va.

It will be appreciated if those listening in on these radiophone broadcasts of weather forecasts and information sent from NAA will write to the Chief of the Weather Bureau, Washington, D. C., by letter or postal card, advising as to clearness of the broadcasts and which schedule. (10:05 a. m.; 3:45 p. m.; or 10:05 p. m.) is most frequently
(Continued on page 2195)

A Modern Liner Radio Outfit

By C. A. REBERGER

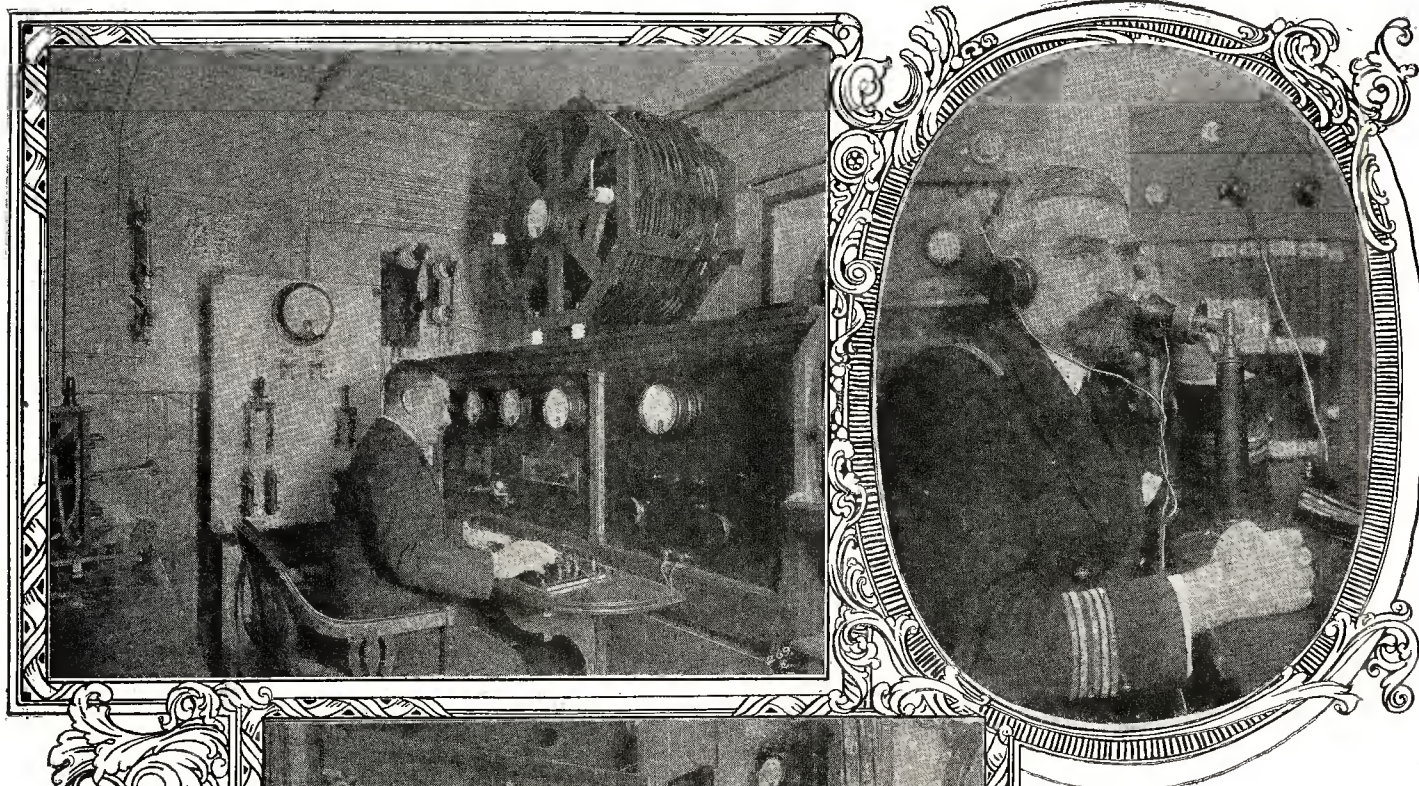

Upper Left: A View of the 5 K.W.-C.W. Transmitter of the S. S. Paris. Note the Large Oscillation Transformer Atop the Transmitting Cabinet. This Set is Capable of Covering Great Distance. Above: The Captain of the S. S. Paris, Communicating Direct With Land By Means of the Radio Telephone Transmitter Installed On His Ship. It Has An Approximate Range of 400 Miles.

radio cannot possibly be side-tracked as part of a vessel's equipment that are too numerous to mention here. A modern liner of today without wireless is well nigh like a city without telegraph or telephone lines, an aeroplane without wings or a ship minus a rudder.

One of the latest additions to the great vanguard of boats already engaged in the trans-Atlantic trade is the French line vessel *Paris*. The new boat is modern in every respect and every inch of her 800 feet is given over to some good purpose. Being an up-to-date ship, radio equipment could hardly have been omitted. Each voyage she carries hundreds of passengers across the rough Atlantic Ocean and each trip she sends and intercepts hundreds of important radiograms by means of her powerful radio. On such a liner, it is essential that there be the most modern radio apparatus—powerful, efficient and very reliable. It must be far better than the type of equipment found aboard the freight boat or the smaller passenger vessels, for much more is expected of it. The *Paris* has such equipment—the last word in high class commercial wireless apparatus of French manufacture.

The great ship carries two separate sending sets, one a spark outfit—the other a tube or C.W. transmitter. All new ocean steamers are carrying the new type tube set, for they have the reputation of causing much less interference to other ships, than the

(Continued on page 2132)

A View of the Receiving Apparatus Aboard the S. S. Paris. A Continual Watch Is Kept While At Sea.

IF we will but freshen our memories, we will recollect that not many years have elapsed since radio was in its infancy. Especially has ship wireless seen a wonderful change and those times people thought automatically of ocean liners when we spoke of radio. But the minds of the people, like the world, are changing every day. Wireless is one thing that has made extraordinary advancements and has tended to change millions. Broadcasting is now the vogue and untold thousands, both young and old, have suddenly become magnetized by its influence and enchantment. It is mainly for this reason that they are forgetting what part wireless plays on the sea and are unacquainted with the appearance of the wireless room aboard a present day trans-Atlantic liner, what it resembles and what it contains. Broadcasting is occupying nearly all their time, but hardly anyone would refrain from accepting an invitation to inspect the radio equipment

aboard a liner like the new *Paris*. It would be more than a treat to them.

The days when wireless was classed on board ships as only part of the emergency equipment, have vanished into the mist. Radio has more than once proven its great value and there are very few companies today that would think of sending their ships to sea minus radio apparatus. But there is a law that compels them to do this and in disregarding this law they would be liable to a fine of thousands of dollars. But even if there were no such law, ship owners would certainly be far-sighted enough to realize its usefulness. For one thing, it is an indispensable means of communicating with a ship far at sea, regardless of time and regardless of its location. It also safeguards the lives of those aboard and the great fear of disaster is partially blotted out, for with radio aboard, assistance can easily and quickly be had. But disregarding all this, there are other reasons why

Inauguration of Cuban Radio Academy

As Reported by ULPIANO MUNIZ

Cuban Correspondent of Radio News

SOMETIMES the result of the lightning flash of an idea which carries with it the conception of great ideals is a wonderful thing. On other occasions it is the result and accomplishment of long matured studies, of intelligent applications of the brain to actual problems. Doctor Cartaya, the clever Director of the Communications Department of Cuba, studied, applied his studies and developed, with a keen sense of worldly knowledge as well as farsighted comprehension of the great future this science will have, the Radio Telegraph and Telephone Academy of the Cuban Government.

It was opened, inaugurating the Radio Course, on February 24 of this year. With the cooperation of the Cuban Telephone Co.'s broadcasting station, PWX, and Romeu's orchestra, a select musical program enhanced the delightful hours passed in the distinguished company of those who were listening at the same time to the descriptions given by Mr. Enrique Lasanta, Chief Professor of the Academy, a man in the confidence of Doctor Cartaya, who chose him to carry on this important charge, on account of his personal merits and intelligence.

Marconi ship sets, wireless specialty receivers, short and long wave units, B. of S. audion control panels, radio and audio frequency amplifiers, U. S. N. field transmitters and receivers, a Westinghouse special 20-watt C.W. and telephone transmitter, De Forest honeycomb coil set, in fact, every modern piece of apparatus is available for the instruction of students. The work accomplished in distributing this course is simply wonderful, being the work of Dr. Cartaya with Messrs. Novo, Valladares, Mallo and Enrique Lasanta himself, who was the principal one of this consolidation of radio experts, being the appointed professor of the Academy. Mr. Novo and Mr. Valladares belong to the Technical Inspection Dept., and are both engineers. Mr. Mallo is the well known radio chief of Havana, also a radio engineer and writer of several radio books in Spanish for the amateurs.

The course is divided into three main

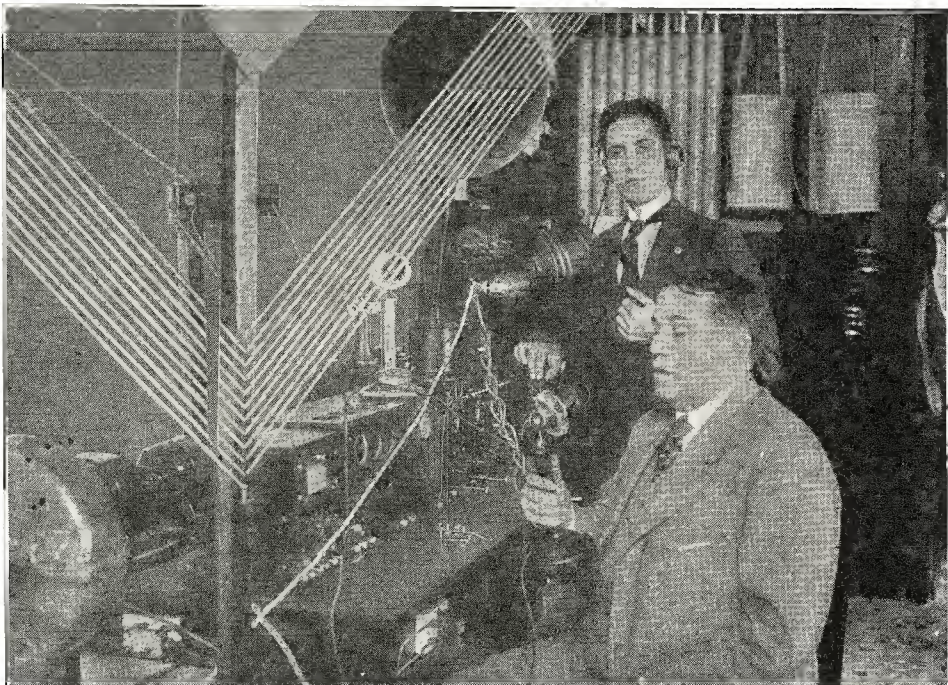

Dr. Cartaya, of the Radio Academy of the Cuban Government, Speaking to His Vast Radio Audience Through the Transmitter of the Academy, Relayed by the Cuban Telephone Co., Through Their Station PWX. We Have Here a Good View of a Part of the Academy's Apparatus Used for Instruction.

branches: 1st, code practice of actual radio-grams and press dispatches; 2nd, theory and application of theory to practice in the workshop; 3rd, actual practice on the apparatus, mounting and calculation of stations, etc., with a short post-graduate field course with the portable sets far away from the Academy and making the "acid test" for the star pupils.

Referring to the photographs, we see Doctor Cartaya speaking to his vast radio audience through the transmitter of the Academy, relayed by the Cuban Telephone Co., and Mr. Lasanta, his assistant and radio professor, standing by, watching the modulation of the set.

In the second one we may admire the good arrangement of apparatus and exactness of disposition. We look only at one-half of the equipment, as the most important field sets are behind the other door, out of sight.

It is our aim to congratulate the originators of the idea, as well as those persons who contributed with their valued assistance to make the Radio Academy a real fact, and Doctor Cartaya will be, no doubt, amply repaid for his efforts when he knows the benefits and big opportunities that he has afforded to young people to become proficient in the radio science and following a career that will bring many chances for advancement to those who take care of it NOW.

There is a project on foot to supply uniforms for the Academy's members. This is the idea of young Mr. Lasanta.

Meantime, let Dr. Cartaya and his staff receive our sincere congratulations, and hope to see the Academy's rooms crowded with eager young men in search of intellectual advancement.

RADIO REGULATION IN CUBA

PENDING the passage of a law to cover the use of radio telegraph in Cuba, a presidential decree has been issued defining the various classes of non-governmental radio stations and prescribing certain general rules for their operation, says Acting Commercial Attache P. L. Edwards in a report to the Department of Commerce. Up to the present time there has been no law or regulation covering the construction or operation of radio stations in Cuba.

Under the decree, non-governmental radio stations are divided into five classes, A, B, C, D, and E, to each of which is assigned a wave-length and a maximum power. No sets of any of these classes will be used for commercial purposes. Classification is as follows:

(Continued on page 2168)

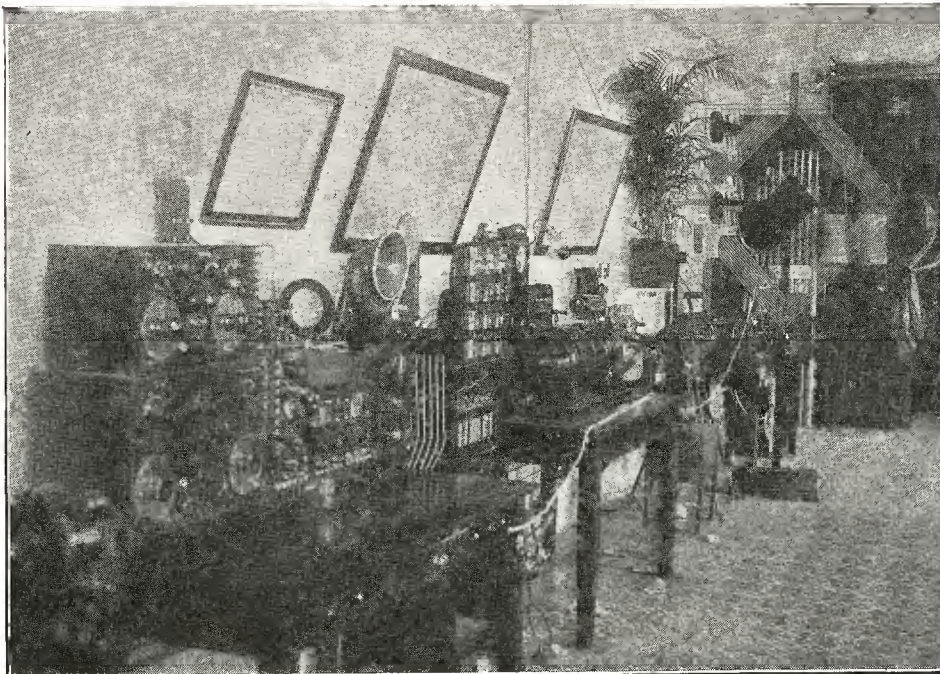

A Better View of a Part of the Academy's Apparatus. At the Extreme Left Are a Number of U. S. Navy Type Receivers and Amplifiers. The Academy Also Has Some Field Sets for Outdoor Instruction, Giving the Students the Chance for Practice Under Actual Conditions.

Vast Range Of Ether Vibrations

By SIR OLIVER LODGE, D.Sc., LL.D., F.R.S.

IT is of interest to call attention to the fact that what is called the spectrum—that is to say, the known range of vibrations in the ether—is now nearly complete. By different methods it is now possible to detect and obtain rates of vibration ranging from those of quite low frequency, expressed by such small figures as 1, or even a fraction, per second, up to those which are so immensely rapid as to be almost uncountable.

To deal with the slow ones first, the capacity of a farad joined to an inductance of a henry would have an oscillation period of six seconds, which is about the same as the oscillation period of a charge upon the sun. On the earth a charge would complete an oscillation in the seventeenth part of a second. A microfarad connected to a henry of inductance would oscillate a thousand times in six seconds, and so generate a feeble wave 1,800 kilometers long. To get anything like strong radiation we must quicken the rate of vibration, and shorten the wave; but a very practical wave, 1,800 meters long, with a frequency of vibration about 170,000 per second, can be got by coupling a millimicrofarad, or nine meters capacity, to a millihenry, or 10 kilometers inductance. It is still easier to get waves of great intensity only a few meters long. A wave of 300 meters has an oscillation frequency of a million per second; and with care and precaution these so-called wireless waves can be shortened in the laboratory down to something like a centimeter; which would correspond to thirty thousand million vibrations per second.

So already the electrical rates of vibration are getting considerable, but still nothing like those which we have learned to associate with ordinary light.

The range of luminous vibrations, that is, those which can affect the eye, and, therefore, are popularly called light, is, as is well known, limited to "an octave" ranging from about 400 to 800 millions of millions per second. But below the visible range we have the infra red, sometimes called "heat" waves, extending downwards without anything but an experimental limit, until they almost reach a range of extremely high electrical vibrations, such as those above mentioned, rising up to meet them. Electrical vibrations go on extending downwards, through the great range of wireless

waves, with frequencies of anything from a million to, say, ten thousand per second, to the slow oscillation of large capacities joined to great inductances, such as one might have in a transformer station, or with alternating dynamos, it being understood that the radiation from these slower things is insignificant, and that the radiating power increases (other things being equal) with the fourth power of the frequency of the

waves, with frequencies of anything from a million to, say, ten thousand per second, to the slow oscillation of large capacities joined to great inductances, such as one might have in a transformer station, or with alternating dynamos, it being understood that the radiation from these slower things is insignificant, and that the radiating power increases (other things being equal) with the fourth power of the frequency of the

waves, with frequencies of anything from a million to, say, ten thousand per second, to the slow oscillation of large capacities joined to great inductances, such as one might have in a transformer station, or with alternating dynamos, it being understood that the radiation from these slower things is insignificant, and that the radiating power increases (other things being equal) with the fourth power of the frequency of the

waves, with frequencies of anything from a million to, say, ten thousand per second, to the slow oscillation of large capacities joined to great inductances, such as one might have in a transformer station, or with alternating dynamos, it being understood that the radiation from these slower things is insignificant, and that the radiating power increases (other things being equal) with the fourth power of the frequency of the

waves, with frequencies of anything from a million to, say, ten thousand per second, to the slow oscillation of large capacities joined to great inductances, such as one might have in a transformer station, or with alternating dynamos, it being understood that the radiation from these slower things is insignificant, and that the radiating power increases (other things being equal) with the fourth power of the frequency of the

waves, with frequencies of anything from a million to, say, ten thousand per second, to the slow oscillation of large capacities joined to great inductances, such as one might have in a transformer station, or with alternating dynamos, it being understood that the radiation from these slower things is insignificant, and that the radiating power increases (other things being equal) with the fourth power of the frequency of the

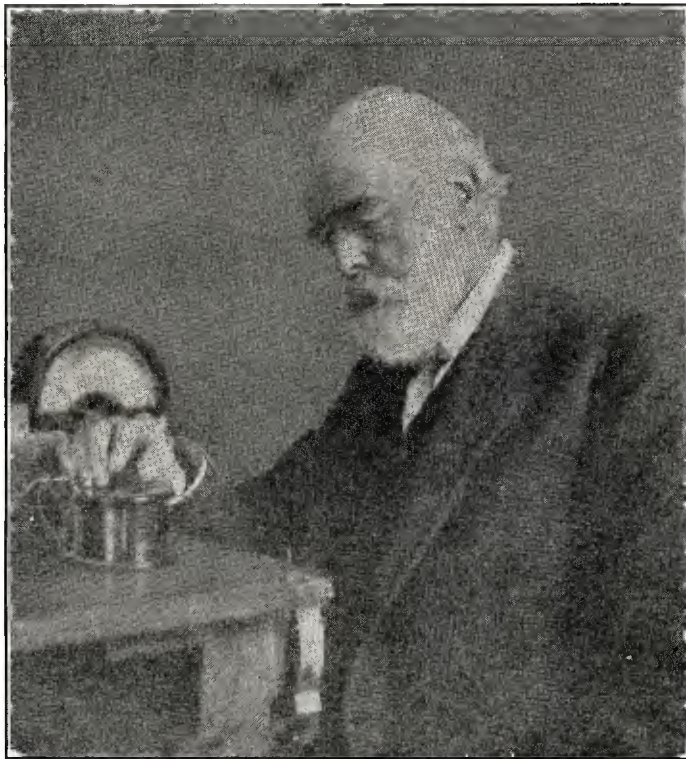

A Recent Photograph of Sir Oliver Lodge, the Eminent Scientist, Philosopher and Psychic Investigator. The Result of His Experiments with Ether Waves Appearing on These Pages Cover the Subject in an Admirable Manner.

vibration.

At the other end of the scale, above the visible range, we have ultra-violet radiation, extending into the photographic region without obvious limit. There has been a practical limit until lately, but now the range has been extended, by photo electric devices, until it overtakes and begins to overlap the soft x-rays. And these rise, through ordinary x-rays of excessively high frequency, up to the gamma rays emitted by radium, which at present constitute the highest terrestrially known rate of vibration, some hundreds of thousands of millions of millions per second.

It is possible that in the sun, or espe-

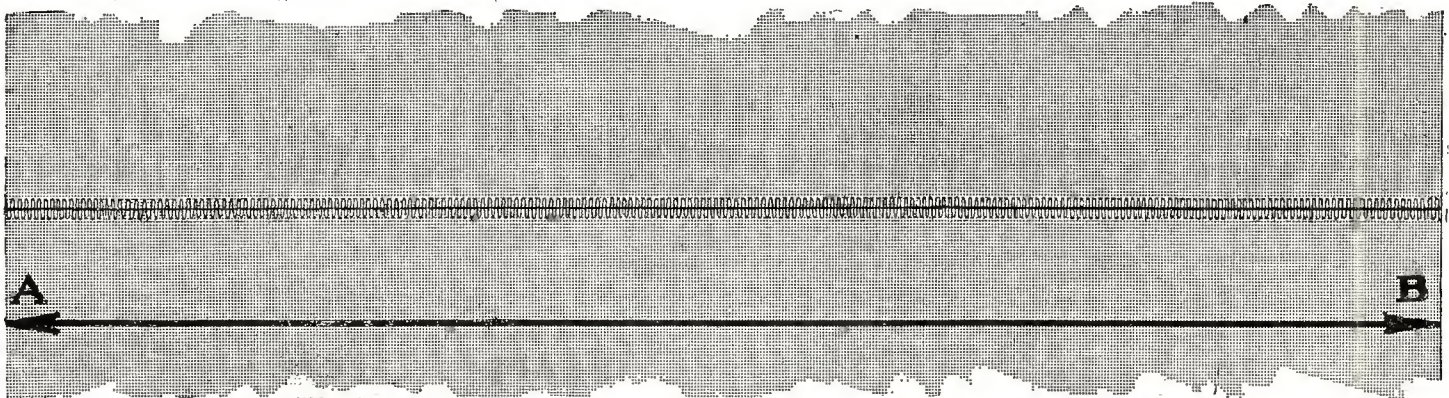

A Much Enlarged Illustration of the Minute-Waves of an Ultra-Violet Ray. The Distance from A to B Would Represent a Length no Greater Than the Thickness of a Page of This Magazine.

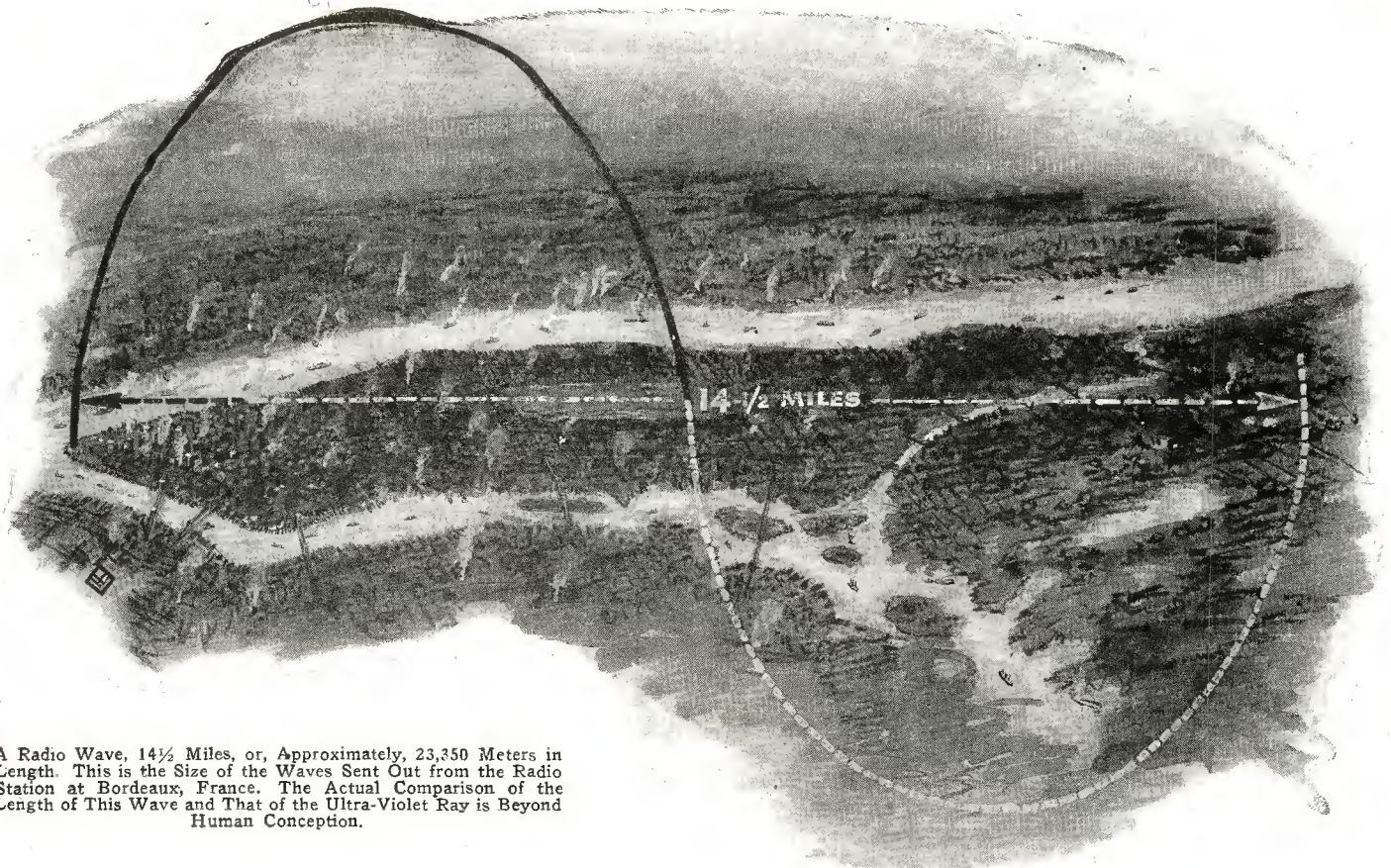

A Radio Wave, 14½ Miles, or, Approximately, 23,350 Meters in Length. This is the Size of the Waves Sent Out from the Radio Station at Bordeaux, France. The Actual Comparison of the Length of This Wave and That of the Ultra-Violet Ray is Beyond Human Conception.

outcome. The Ether has already brought us much information as to the chemical constitution and other details of what are called the Heavenly Bodies;—though it should always be remembered that the earth is one of them, though a small one, yet just as much a heavenly body as the others, difficult as it may be occasionally to believe it, or to reconcile that fact with some of the doings of humanity:—the Ether I say has already brought us so much information about the heavenly bodies that it may by the progress of Science bring us more; and so in due time we may receive

quite unexpected information about them. For Science is as yet in its infancy. Our methods of exploration are continually enlarging; and we have already found that we are not isolated and disconnected from the rest of the universe as we formerly believed, and as in olden times, for all practical purposes and by the methods of Science, we were. Though it should always be remembered and admitted that, by methods other than those of Science, men have always believed themselves to be in touch—at first awe-stricken but afterwards reverent and even affectionate touch—with a

higher order of existence. Things half known and but dimly glimpsed by the ancients may in process of time become known to us, through the accumulation and handling of laboriously acquired knowledge.

And just as the higher and lower regions of the spectrum have gradually united, so that some approach to continuity is established through the whole range, so it may be hoped, and even confidently expected, that in the long run the regions of knowledge and of faith will approach each other by gradual extension, and merge into a comprehensive unity.

Recommendations Of the National Radio Committee

THE second National Radio Conference announced that its recommendations to the Secretary of Commerce mark a new era for the radio public. It recommended that the interference experience by broadcasters and listeners be relieved by the opening up of a new wide band of waves by the Government and a new assignment of individual wave-lengths to broadcasting stations. This is made possible by the opening up of what was previously government reserved waves and the shifting of certain ship waves out of the broadcasting wave bands. The Department of Commerce, acting under its present authority, will be able to establish and enforce the new regulations, and thus bring order in the radio world.

Boiled down, the important recommendations of the conference are these:

Previously all broadcasting was concentrated on three wave lengths, 360, 400 and 485 meters. Now a new field extending from 222 meters to 545 meters can be created for the purpose. Within that field stations can be assigned individual wave lengths and divided into two classes. The higher power Class "A" stations corresponding to the present Class "B" stations can use wave-lengths

between 288 meters and 545 meters, while lower powered stations (new class "B" stations) can use the waves from 222 to 286.

This will enable the higher power stations distributed in 50 localities and comprehensively covering the United States, to be within the reach of every listener. Suitable wave-lengths are provided in the recommendations for the more than 500 existing lower power stations.

The report urges that the field of amateur activity be extended by allotting a band extending from 150 meters to 222 meters in place of the waves up to 200 meters now used. The band from 200 to 222 meters can be reserved for high grade continuous wave telegraph transmitting stations operating under special license. Technical and training school licenses can also occupy this band. The report confines spark amateur radio telegraph stations to the band 175 meters to 200 meters.

It also includes the provision that ships using 450 meter waves keep silent between 7 and 11 P. M. and, as soon as possible, readjust their equipment for transmission on wave-lengths above 600 meters.

Provision is made in the recommendations

for a new field of ship telephone service, enabling persons on shore to talk to those aboard ship. This can be carried out on waves far above broadcasting waves, so that no interference can result.

The reading of telegrams or letters by broadcasting stations should be permitted, says the report, so long as the signer is not addressed in person and so long as the text matter is of general interest.

Another recommendation is that simultaneous rebroadcasting be permitted as a service only on a broadcasting wave-length, and with the authorization of the original broadcaster and of the Department of Commerce.

The new regulations recommended are based on a plan submitted by the radio inspectors of the Department of Commerce, and include elements from other plans submitted by the Radio Section of the Associated Manufacturers of Electrical Supplies, The National Radio Chamber of Commerce, The Institute of Radio Engineers and the American Newspaper broadcasting stations and several other groups.

It is the unanimous opinion of the con-
(Continued on page 2169)

Awards of the Super-Regenerative Contest Third Prize Class I

A Portable Super-Regenerative Set

By E. W. CUTTING

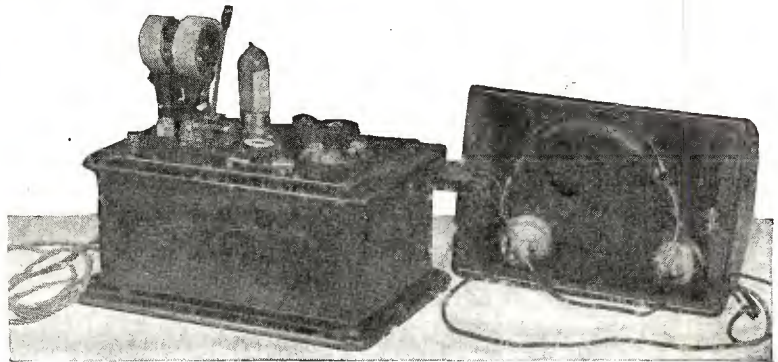
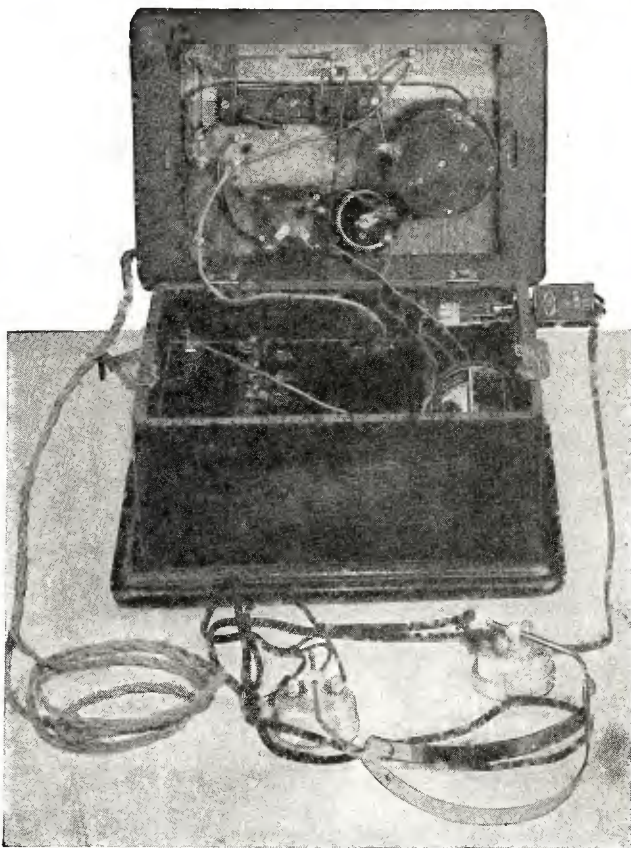

Two Views of Mr. Cutting's Super-Regenerative Receiver. A Peanut Tube and Honeycomb Coils Are Employed With This Set. Very Good Results Have Been Obtained With But a Few Feet of Lamp Cord as an Aerial. The Circuit Used is Shown on the Right. It is Known as the Flewelling Circuit and Employs the Principle of the Eaton Oscillator to Produce the "Super-Effect."

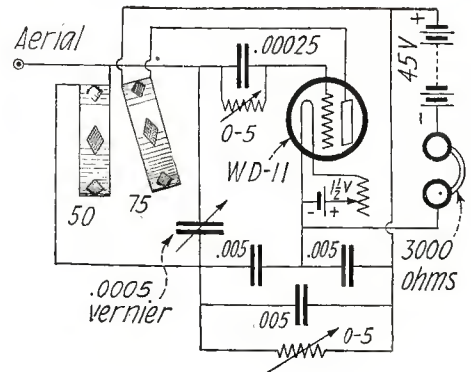

THIS super-regenerative set is of the bank condenser type, better known as the Flewelling circuit and consists of one 50-turn Remler coil, one 75-turn Remler coil, one 23-plate Murdock condenser (Vernier would be preferable), one Freshman variable grid leak and condenser, three .005 M.F. Dubilier condensers, one 101-Durham variable high resistance, one moulded socket, one "Kresge" rheostat, one W.D.-11 tube with adapter, one Red Seal dry cell, one

Eveready 45-volt "B" Battery, one Frost jack, one Deveau plug, one pair Penberthy phones, and about 6' of lamp cord for an aerial. The case is an old phonograph case with a curved lid which can be used as a loud speaker, as shown. The switch shown is to cut out the condenser bank, thus making the outfit work as an ordinary regenerative set.

The grid leak and the variable high resistance are very sensitive and somewhat

difficult to adjust, but when properly adjusted this set brings in WJZ, KDKA, WGY, KYW and others at least as loud as the ordinary one-tube set using aerial and ground. For daylight reception either a ground or an aerial may be used, but not both. At night neither seem to be needed. As can be seen from the photographs, everything needed is carried inside the case; phones, batteries, aerial, and all are out of sight. The total cost, including everything except the case is approximately \$40.

Fourth Prize Class I

The Armstrong Super-Regenerative Receiver

By W. HARPER, JR.

THIS remarkable principle of radio reception and amplification has probably created more discussion than any other since the advent of popular broadcasting; and it has been rather strange to me that a greater use has not been made of it among the amateurs, and that such a receiver has not as yet appeared on the market. After my own personal experience with all the other standard systems, I unhesitatingly say that, especially for city use, and also for the country, when one considers the Summer static difficulties, it is the real Rolls Royce of receivers.

Now it may be that on account of its radical departure, in principle, from the straight regenerative system that one attempting to wire up such a set for the first time may encounter a great many discouraging troubles until the new principle has really been mastered. At least, this was my own experience and it was only after

several months of very persistent effort that some of the mysteries dissolved into very simple facts. And even then, I confess, it was quite some time before I really began to appreciate this wonderful circuit and

could use it to somewhere near its full capacity.

In principle its range is unlimited as well as its amplification and it is solely temporarily restricted by the quality of tubes

A Rear View of Mr. Harper's Three-Tube Super-Regenerative Receiver. Note That the Large Honeycomb Coils Are Mounted at Right Angles to Each Other.

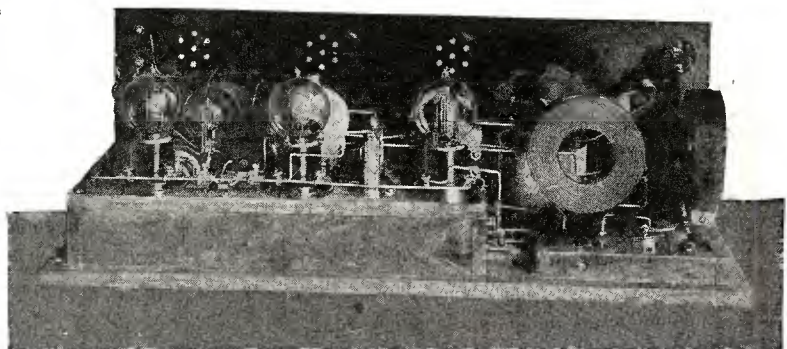

employed, the receiving phones and artificial local conditions, as all of these details will be subject to marked improvement in a short time.

It looks as though at last the human mind is at the threshold of touching upon the infinite.

To one who is contemplating experimenting with such a receiver I would say by all means do it, although so many have not been successful. Because, if the following instructions are carefully noted, it is really quite simple after all, as is the case with nearly every big thing worth while.

Contrary to the idea that it is critical and hard to tune I unhesitatingly state that the set here pictured and described is quicker and easier to operate than the most approved conventional phonograph and I don't mean just on local stations either, but from New York, tuning in KDKA and WGY.

It is the ideal receiver for the good little wife to use during some of those boresome lonely hours when friend husband is away at the office and she hasn't much patience to turn up a lot of rheostats and fish about with several dials.

In the case of a well designed "Super" all that is necessary is to push a button which lights the tubes, and if there is anything on at the station at which the one tuning condenser is set, you have it right away, full volume and quality with no critical rheostat adjustment or tickler setting to improve it or hold on to. And by tuning the one dial throughout its range, you will

Another View of Mr. Harper's Set. The Tubes From Left To Right Are, Detector and Regenerator, Oscillator, and Amplifier.

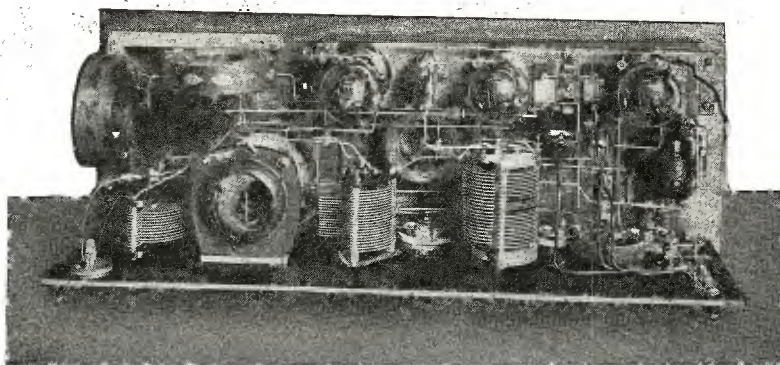

all that three V.T.-2 tubes can put into it. The amplification is faultless, so far as the work of the circuit goes.

A few moments ago, while writing this, I walked across the room and pressed the button without even looking at the receiver, and at the same moment I was searching my mind for a clear way to word the idea of its new simplicity, and until I returned to my desk I had not realized that I was listening to the overture at the Capitol theater and after a moment's thought decided it was too loud so the only adjustment made was to tone it down a little; quite a new complaint for a radio receiver.

There are some essentials to bear in mind regarding the assembling of the "Super." In the first place it should be placed in a cabinet not less than 24" by 8",

distributed capacity effect and there should be 58 turns of wire on its 2½" diameter rotor, with a respective number of turns on its stator.

Be sure that the tuning condenser is shunted between the loop and the primary coil. Use V.T.-2 tubes as I have found that very few of the U.V.201's are hard enough. However, I believe that the new 201-A should work nicely.

When you first try your "Super," set the variometer at full inductance and if there is no sound, reverse the leads to its terminal connections. Also turn the rheostat of the middle or oscillating tube on full and after the detector of the first tube is up, reduce the current on the oscillating tube until just above the point where it roars. (Quite the reverse of the case of the plain regenerative set).

The phone plug in the first jack which is using the first two tubes only will give all the sound a pair of head phones will stand; do not put them on the last tube if they are good phones. The first dial on the panel from the left controls the tuning by means of a .0005 mfd. condenser. The second controls the amount of regeneration, and on distant stations will cut out interference. The third is on a .001 mfd. variable condenser which controls the two grid oscillations and requires very little adjustment for local work; set it about half way in. The fourth is also a .001 mfd. variable condenser, and for all local work leave it at zero, but for distance and great volume turn in. This condenser controls the plate oscillations and upon it depends the absence of oscillating noises in the phone; the less condenser used the quieter it will be. It should also be noted that these last two variable condensers are merely the variable part of the whole condenser capacity used.

In constructing this set I would also advise that the various parts be placed exactly as shown and the wiring followed likewise.

The grid batteries are necessary and the one on the third tube should be at least 22 volts. These batteries are small and must be placed as near the tube as possible. Up to 300 volts may be used on the plate of last tube, if more grid battery is also used.

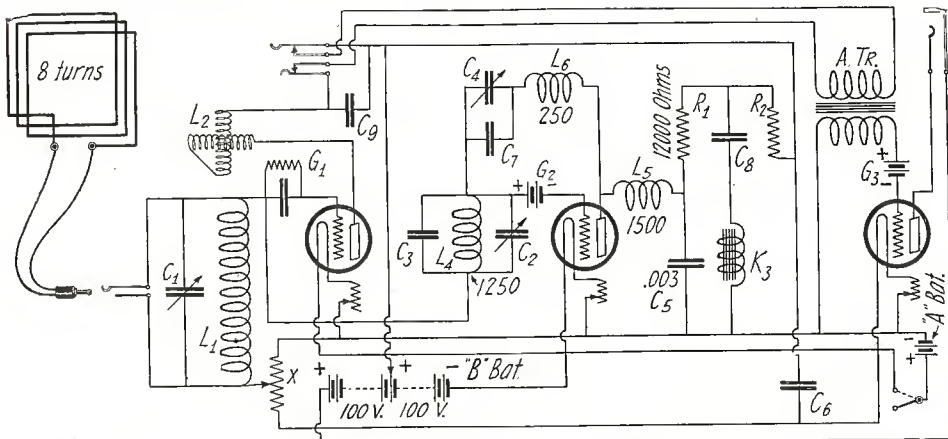

The Circuit Diagram of the Super-Regenerator Described. The Variometer L2 Is In Inductive Relation To Coil L1.

know whether anything else is doing between here and the Mississippi River. You see, there is the absence of the old idea of tuning the primary and then trying to coax in the signal with regeneration at each step in tuning.

As to volume and quality, the old style regenerative fan has a most pleasant surprise in store for him. There is not a loud speaker on the market that can take care of

inside measurements. The best of materials must be employed and the three variable condensers kept well separated. The inductance coils must be separated from the tubes as far as possible, and the tubes so placed that their respective plates shield each other.

It is also necessary that the primary winding is in the same direction as that on the stator of the variometer above it. This variometer should be of a type of least dis-

Try This New "Duo-Vertical" Winding

By ARTHUR S. GORDON

IN making a three-coil spider-web tuner, amateurs have often been dissuaded from completing the job because of the great size of form needed for the coil with the greatest number of turns. Take a tuner, for example, in which the primary has 35 turns, the secondary 50 and the tickler 80 turns. Using No. 22 S. C. C. copper wire, the radio amateur finds that he can get 25 turns to the inch, measuring at right angles to the direction of the winding; 80 turns mean a little over 3" of winding, which in turn require a form over 7½" in diameter.

This is too large to handle and to mount

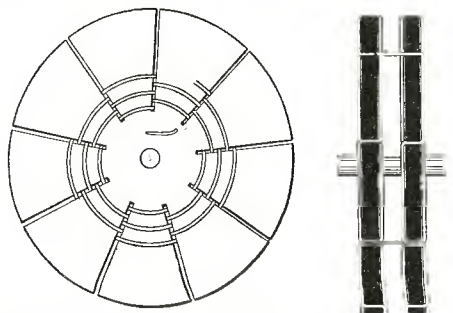

Method In Which the Duo-Vertical Coil Is Wound.

conveniently, and in searching for a better way to wind the tickler coil, a radio experimenter hit upon a novel plan, details of which are described and illustrated in this article.

Instead of providing one extra-large disc for the tickler winding, he made two small discs and put them side by side on a temporary shaft, as shown in the diagram. For uniformity's sake he made this double form the same size as the primary and secondary forms. Then he made what is described as a "duo-vertical" winding. That is to say, he wound identical coils side by

(Continued on page 2140)

Heard But Not Seen

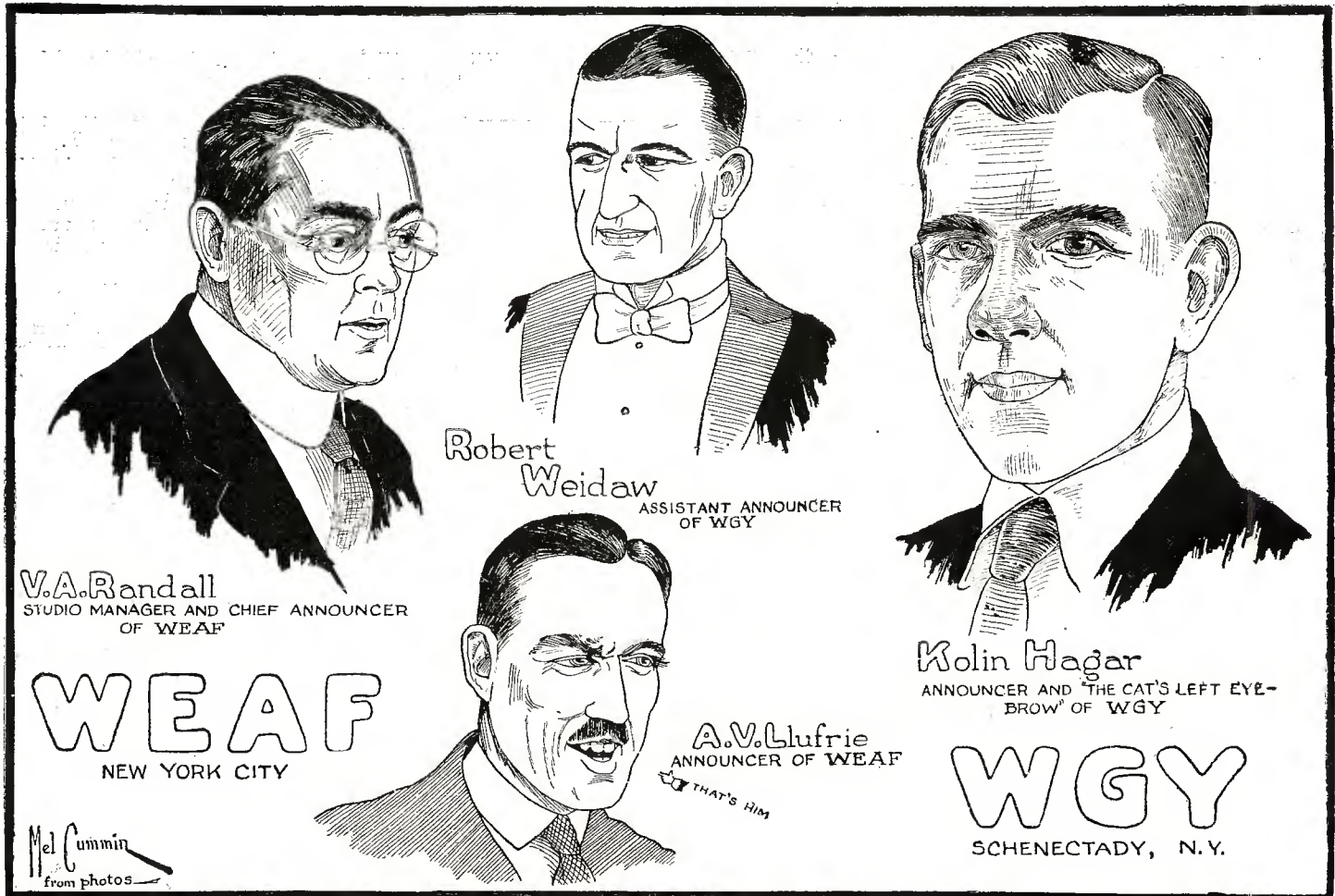

Here Are the Big Boys of Stations WEAF and WGY. Mr. Randall Gets Around His Tongue-Twisting Call In Fine Manner, By Repeating Slowly— This Is Station W-E-A-F. Mr. Lufrie Is Jus' As Good. Evidently, Mr. Weidaw Dresses For His Audience. We Can All Appreciate It From Now On. Kolin Hagar Has a Voice That Charmeth Women. Listen To Him, Girls!

What Radio Is Doing For The Blind

By JOHN T. TIMMONS

RADIO is making it possible for the afflicted to get much more out of life than it was possible to secure before the recent development of the marvels of radio service.

The blind are especially benefitted. In schools for the education of the blind, and in some of the working homes for the blind, radio sets are making it possible for many forms of entertainment that were until recently impossible, unless there was a large sum expended to secure musical and other talented entertainments.

Radio brings the very best of entertainers within hearing of the blind, and the reading of news items by the various broadcasting stations several times a day, and the weather reports, as well as the different timely talks and lectures on a wide range of topics, make something for the blind to look forward to each day, and since the afflicted cannot see to read the daily papers, and have little chance to keep posted on current events, they can listen in and get the latest news, and hear the different subjects of interest to everybody in the form of short talks and lectures.

Many of those who cannot see have put in radio sets, at their own homes, and they can soon learn to tune in and pick up the various points where there is good music and other forms of entertainment, and they find it much easier to be contented in their own home circle.

A fairly good receiving set will enable

them to listen in and pick up religious services at many different churches, and since the sense of hearing is so highly developed in the blind, it is possible to listen in and get the real benefit from any church service, both on Sunday, and often during the week.

The writer has been deprived of eyesight for

One Can Easily Imagine the Keen Enjoyment That the Blind Derive From Radio.

years, and has found radio very satisfactory. In spite of the fact that he cannot see the figures that tell of the wave-lengths, he can get different cities and separate them better when they are sending out on the same wave-length than many who have eyesight to aid them.

It is possible, by the peculiar rushing or hissing or
(Continued on page 2150)

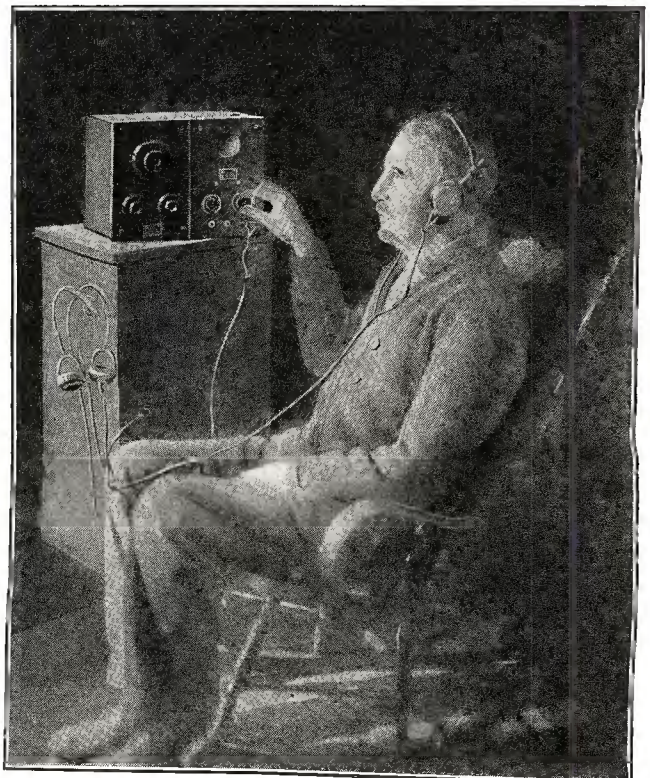

The Vario-Aerial

By D. E. GARNETT

A LOOP AERIAL AND VARIOMETER COMBINED, NO ORDINARY AERIAL, GROUND, TUNING-DEVICE, COIL OR CONDENSER BEING NECESSARY. USED IN LONDON. PARIS IS HEARD WITH IT.

MOST experimenters with multi-valve receivers have discovered that signals and short-range telephony can be picked up without using any aerial at all, the coil, if of suitable size, being capable of receiving signals direct.

The writer noticed some time ago that the same effect could be obtained with a variometer connected between the aerial and earth terminals of a receiving set; but, as in the case of a simple tuning coil without aerial, signals were very weak.

Further experiments suggested the idea of combining the variometer principle with a loop aerial, and resulted in the production of an instrument which, for want of a better name, has been called a vario-aerial.

Without making any extravagant claims for the efficiency of this device, it may be stated that it will work effectively wherever an ordinary loop aerial can be used. Further, it appears from comparative tests that a vario-aerial only 2 ft. in diameter will give results at least equal to those obtained with a simple loop aerial, no matter what the size or method of winding of the latter may be.

The chief interest of the vario-aerial lies, however, not so much in the question of efficiency as in the fact that no additional tuning device whatever is needed. It is placed directly between the aerial and earth terminals of the receiver without any coils or condensers, and, of course, there is no earth lead.

A few details of the performance of the vario-aerial, shown in the photograph, which is wound for broadcasting wave-lengths, may be of interest.

The receiver used consists, as can be seen, of five valves (2 R.F., 1 detector and 2 A.F.).

With two valves (detector and either one R.F. or one A.F. stage), a small loud speaker can be used.

With three valves the loud speaker is quite effective, one R.F. and one A.F. stage giving slightly better results than two A.F. stages.

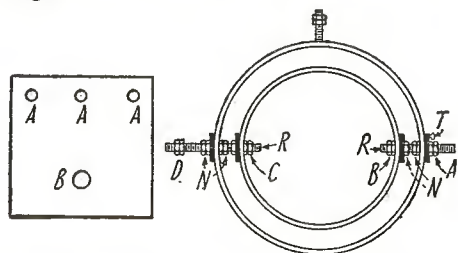

Fig. 1

Showing the Method of Constructing the Bearings and the Manner in Which They Are Mounted.

With four valves (1 R.F., 1 detector, 2 A.F.) speech and music can be heard all over the house and in the street below, the installation being on the second floor of the building.

The switching in of the second R.F. valve does not improve results; in fact, four valves work rather better than five.

No regeneration is used.

It may be noted that as the receiver in question consists of five valves, *not* in separate units, the results obtained with one, two, three, and four valves are probably not as good as they might be with a series of units, or a set designed for the particular number of valves used. A three-valve set

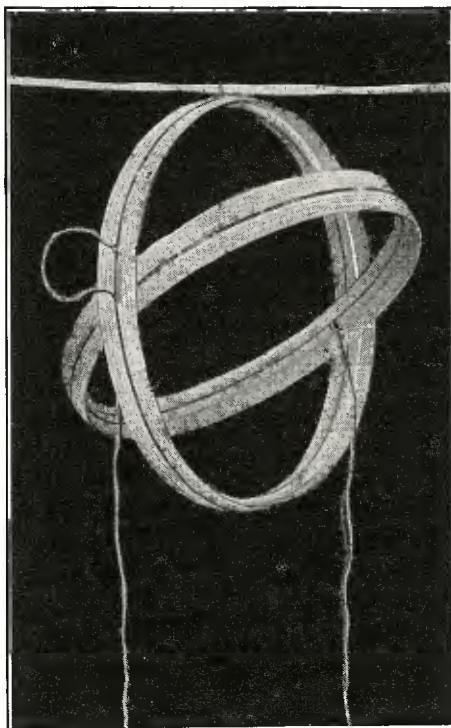

A Photograph of the Vario-Aerial. The Frames Are No More Than Children's Wooden Hoops, the Wire Being Wound Directly on Them.

should give excellent results with the vario-aerial

CONSTRUCTION

The construction of the instrument is simplicity itself. The materials used for the one shown in the photograph were as follows: Two children's wooden hoops, 2 ft. in diameter; 100 ft. (about) of No. 26 D.C.C. wire; four pieces of 1/4-in. ebonite 1 1/2 in. square; three pieces of threaded brass rod, 3 in. long; 18 nuts, and a few washers; one small terminal; one blind lath, 4 ft. by 1 in. by 1/4 in.

One of the hoops is unfastened at the joint and reduced in size by cutting away some of the wood and rejoining. When the smaller hoop is placed inside the larger there should be a space of about 1/2 in. all round between the two.

The four pieces of ebonite which act as bearings are drilled (A, B), as shown in Fig. 1, and screwed to the hoops at opposite points of their circumferences. In one piece an extra hole is drilled (shown dotted in the figure) to take the terminal. The object of these bearings is to insulate the spindles, which are utilized to make connection between the two coils. (The spindles might, of course, pass through the hoops themselves, but there would not then be room to wind the wire unless some sort of flat "tyre" were provided; as the insulation would not be good, direct connection between the coils would be preferable to the method now described.)

THE TWO HOOPS

Having screwed the bearings to the hoops, as shown in Fig. 2, the wire can be wound on. Taking the larger hoop first, fasten the end of the wire to the terminal T, and wind eight turns round the outside of the hoop, passing over the insulating bushes. The turns are not spaced. As soon as wound bind the hoop spirally with thread or silk (as shown in the photograph) to keep the

wire from slipping off. Fasten the end of the wire between the two nuts A (Fig. 2), leaving a few inches of slack to allow for the turning of the spindle.

Now for the second hoop. Fasten the end of the wire between the two nuts B and wind on eight and a half turns, finishing off between the two nuts C.

The third piece of brass rod and the two remaining nuts, are intended for hanging the vario-aerial from the blind lath, which can be laid across the picture moulding in the corner of the room. The brass rod may be merely bound with string to the outer hoop or passed through a small screw eye or brass lug. The end of the rod goes through a hole in the lath and is held by one or two nuts on top.

The vario-aerial is now complete. The aerial and earth terminals of the receiving set are connected by flexible wire to the terminal T and the nuts D respectively. Tuning is effected by rotating the inner hoop, either with the hand or by means of the ebonite rods.

A MODIFIED VARIO-AERIAL

Readers may think that as the vario-aerial was used in London to receive L O there is not much in the idea, since at such short range broadcasting can be picked up on almost any sort of aerial. In anticipation of such criticism, the writer decided to try for a long-distance station, and chose the Eiffel Tower as the most likely transmission.

The photograph herewith shows the vario-aerial wound for the experiment, which was quite successful. This instrument brings in the Eiffel Tower concerts clearly in the headphones with five valves, every word of the announcements being audible. The receiving set used is not particularly efficient, the valves being very old and the "B" battery down to 2 1/2 volts per unit. There is no doubt whatever that a good four-valve set (1 R.F.) would work well with this vario-aerial.

The method of construction differs from

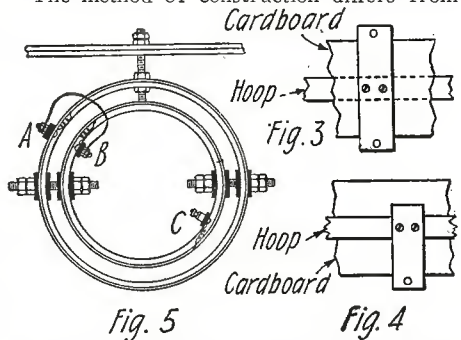

Constructional Drawing of the Completed Vario-Aerial. Note That Its Two Coils Are Connected in Series Like a Variometer.

that adopted for the broadcasting wave-length, but it is equally simple and calls for no greater skill in the making.

MATERIALS REQUIRED

- 2 Children's wooden hoops 2 ft. diameter.
- 1 Large sheet of stout cardboard.
- 1 lb. 26 S.W.G. D.C.C. wire.
- 1 Piece ebonite 3 in. x 1 in. x 1/4 in.
- 2 Pieces ebonite 2 in. x 1 in. x 1/4 in.
- 2 Pieces threaded brass rod 3 in. long.
- A length of threaded brass rod.
- 8 Nuts and washers.
- 14 Nuts and washers.

(Continued on page 2181)

Some New Dual Amplification Circuits

By JOHN SCOTT-TAGGART, F. Inst. P.

THE FOLLOWING ARTICLE DESCRIBES SOME RECENT EXPERIMENTS WITH CIRCUITS USING BOTH A CRYSTAL DETECTOR AND ONE OR MORE TUBES, THE OBJECT BEING TO FIND OUT WHICH CIRCUITS WILL GIVE THE BEST RESULTS WITH THE MINIMUM NUMBER OF TUBES.

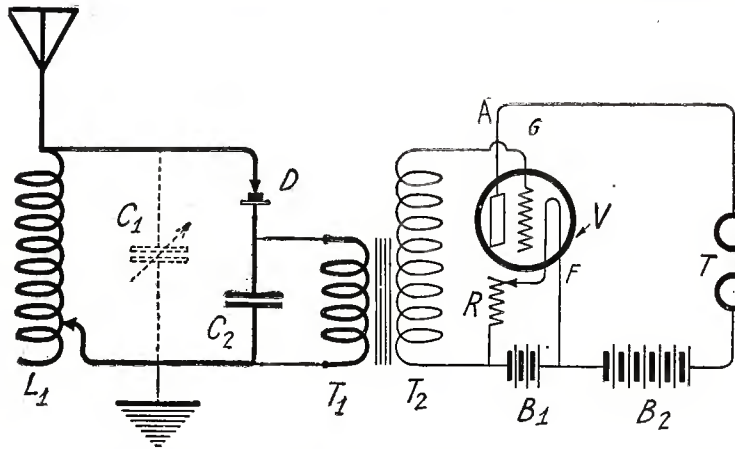

Fig. 1. An Ordinary Crystal Circuit With the Addition of a One-Stage Audio Frequency Amplifier.

only two coils are employed. The aerial coil L_1 may conveniently be a two-slider inductance. The lower slider is for the purpose of adjusting wave-length and the top slider is for adjusting the degree of reaction introduced into the aerial circuit.

Fig. 3 is, in principle, very similar to Fig. 2, but this time the anode circuit of the valve is directly coupled to the aerial circuit, the anode current flowing through a portion of the inductance L_1 and then through the telephones T and the high-tension battery B_2 , and so back to the filament. The coupling between L_2 and L_1 is adjusted to obtain the desired reaction effect. The circuit might be adapted to a circuit using an inductance tuned by means of a variable condenser, in which case a fixed tapping might be taken from a point on the inductance coil or even from the top of the coil.

Fig. 4 shows a circuit in which the crystal detector D and the primary T_1 of a step-up transformer T_1 and T_2 are connected across the anode oscillatory circuit L_2 , C_2 of a three-electrode valve V . The coupling between L_2 and L_1 is adjusted as before to obtain the reaction effect. The secondary T_2 of the transformer T_1 T_2 is shunted by a condenser C_3 ; the condensers C_3 and C_1 may both have a capacity of about 0.002 MF. The valve V is acting not only as a high-frequency reaction amplifier, but also as a low-frequency amplifier, the telephone receivers T being included in the anode circuit of the valve.

It must not be imagined that the crystal detector is obsolete. It will acquire even greater importance when a thoroughly reliable pattern is evolved, that is, one which will not require constant resetting; claims have already in fact been made for such a detector.

The circuits given below not only use crystal detectors in combination with valves, but use the valve in a dual capacity—namely, as a low-frequency amplifier and as a means of either introducing reaction into a circuit or of actually amplifying the high-frequency currents.

IMPROVING THE SINGLE-VALVE CIRCUIT

Fig. 1 shows what is probably the best single-valve circuit of a straight-forward type permissible for the reception of broadcasting. In some cases, the valve is better used as a high-frequency amplifier, but there is little to choose between the two classes of circuits.

It is proposed to improve the efficiency of this circuit by introducing reaction into the aerial circuit. As Fig. 1 stands, there is no reaction effect in the aerial circuit, which, therefore, considerably damps down the incoming signals, which for the moment we may assume are due to radio telephony. I introduce reaction into the aerial circuit by using the valve in an additional capacity. An inductance coil L_2 (Fig. 2) is now included in the grid circuit of the valve V , this coil being in series with the secondary T_2 of a step-up transformer T_1 T_2 . The secondary T_2 should be shunted by a condenser C_3 having a capacity of not less than 0.001 MF. In the anode or plate circuit of the valve is included another coil L_3 , which is connected in series with the telephones T , which now require to be shunted by a condenser C_4 , also having a capacity of not less than 0.001 MF.

When honeycomb or similar coils are used, the aerial coil L_1 may be in the middle and the other two coils arranged one on each side, the two couplings being variable. The size of the coils L_2 and L_3 is important, and the best values must be found by experiment. The circuit is adjusted by coupling L_3 tightly to L_1 and varying the coupling between L_2 and L_1 . The reverse procedure might be adopted. If both coils are tightly coupled to L_1 , the valve will oscillate of its own ac-

cord and continuous wave signals may be received; on the other hand, when spark or telephony signals are to be received, the coupling is such as to obtain the critical reaction effect which gives the loudest signals.

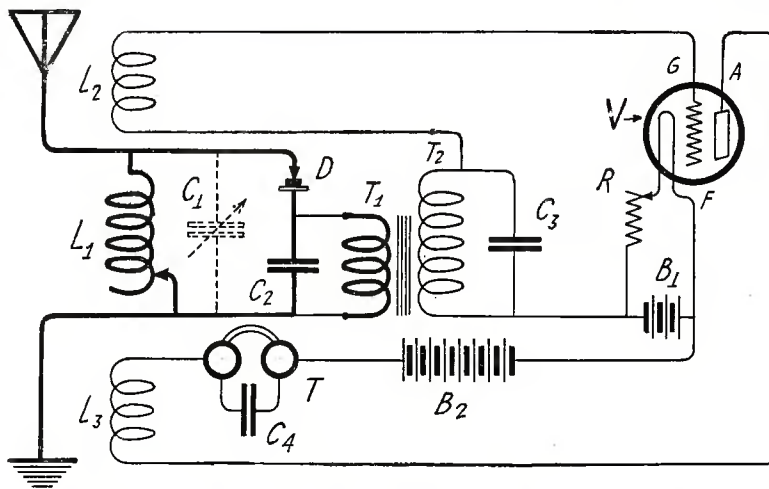

Fig. 2. The Circuit of Fig. 1 is Greatly Improved By Introducing Regeneration, As Shown.

In order to make sure that the reaction effect is being obtained, the leads to one or other of the coils L_2 and L_3 should be reversed. As one of these coils is made to approach L_1 the signal strength should increase considerably.

ANOTHER SINGLE-VALVE CIRCUIT

Fig. 3 shows another valve circuit in which

the first valve acts as a high-frequency amplifier, the high-frequency oscillations in the circuit L_2 C_2 being rectified by the crystal detector D , and the low-frequency resulting current being amplified by the second valve V_2 .

I have greatly improved the results obtainable with such a circuit by introducing re-

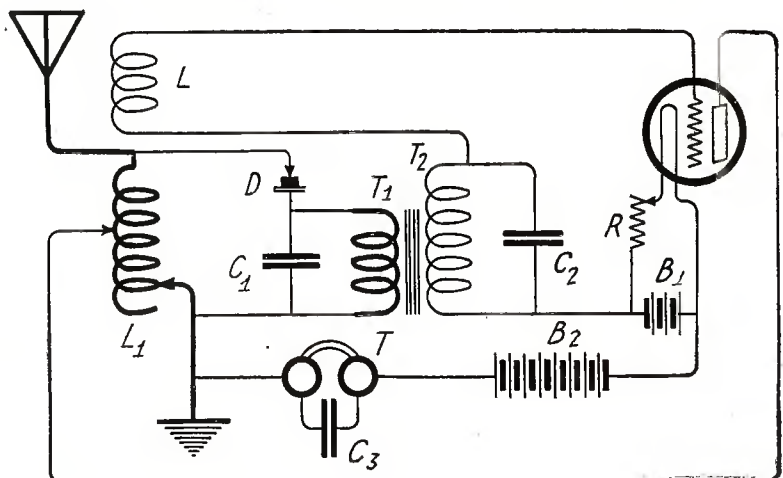

Fig. 3. A Crystal Circuit of the New Type, In Which Two Inductances Are Used.

action into the oscillatory circuit $L_2 C_3$, which is shunted by the crystal detector. The obvious way of introducing reaction into this circuit would be to couple the inductance L_2 to the inductance L_1 in the aerial circuit. As this is forbidden in England when receiving broadcasting, I introduce the reaction by means of the second valve, which is acting as the low-frequency amplifier.

Fig. 6 shows a method of doing this. A fixed inductance coil L_3 is included in the grid circuit in series with the secondary T_3 , which supplies the low-frequency potentials to be amplified. In the anode circuit of the valve V_2 is an inductance coil L_4 which is coupled the right way round to L_2 . In the anode circuit will also be found the telephones T shunted by a by-path condenser C_5 .

When the coils L_2 and L_4 are only very loosely coupled to L_3 , the circuit is, in effect, the same as Fig. 5. As we approach the two coils towards the inductance L_3 , the signal strength increases greatly. The fact that a reaction effect is being got out of the second valve does not appear to impair its effectiveness as a low-frequency amplifier.

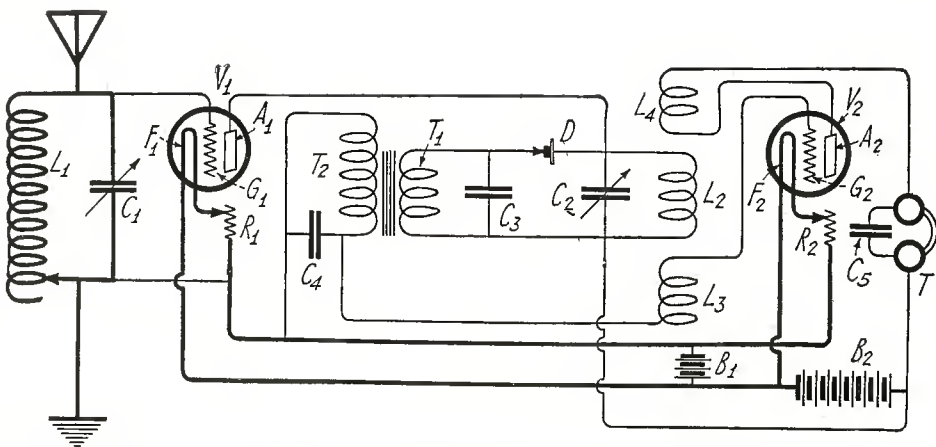

Fig. 6. The Same Circuit As Fig. 5, Modified In a New Manner, Which Greatly Increases the Signal Strength.

Across the circuit $L_3 C_4$ is connected the crystal detector D and the primary T_1 of a step-up transformer $T_1 T_3$. The usual by-path condensers C_5 and C_6 are provided in the position shown. The telephone receivers may be connected either in the position shown between the bottom of L_2 and the positive side of B_2 or between the anode of the first valve and the junction point J . The telephones and telephone condenser are shown in dotted lines. By connecting them in this position certain complications which are liable to occur may be avoided, but, on the other hand, certain disadvantages attend its use in this part of the circuit. If connected next to the high-tension battery B_2 , it is important to see that the condenser C_3 is of small capacity.

This circuit is operated by tuning all the three tuned circuits to the incoming wave-

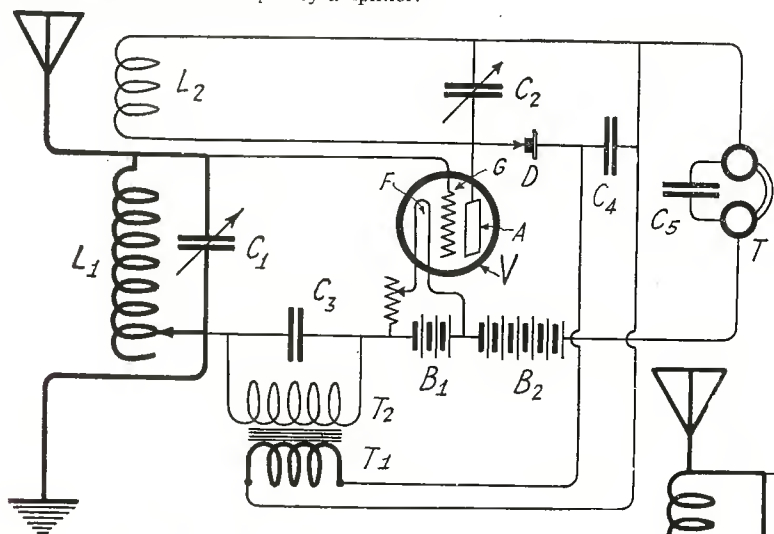
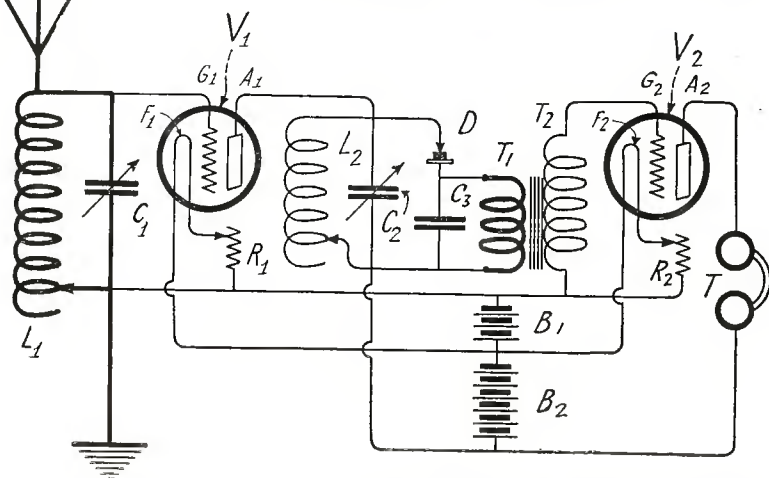

Fig. 4. A Shunt Amplification Circuit Which Has Not Yet Been Fully Tried Out.

ANOTHER CIRCUIT

Fig. 7 shows another circuit in which the now well-known tuned anode circuit with reaction is employed. The circuit $L_2 C_3$ containing the amplified oscillations of the incoming frequency, is connected across grid and filament of the second valve in the manner shown, a condenser C_3 being connected for the purpose of preventing the high voltage of the battery B_2 being communicated to the grid of V_2 . A grid leak R_2 is connected between grid and the negative side of the filament accumulator B_1 . In the anode circuit of the valve V_2 is a tuned circuit $L_3 C_4$, which is also tuned to the incoming frequency.

Fig. 5. A Two-Tube Circuit, In Which Radio and Audio Frequency Amplification Is Accomplished. A Crystal Is Used For Rectification.



length, the brightness of the two filaments not being excessive, as otherwise self-oscillation may be set up. Unless there is sufficient natural reaction between the circuits, the inductance L_3 may be gradually brought up to the inductance L_2 until the maximum signal strength is obtained, all the circuits being readjusted whenever the reaction is varied. Both valves are now acting as high-frequency amplifiers, and the first valve is, in addition, acting as a low-frequency amplifier.

Any of these circuits may be extended by the addition of an extra one or two valves in accordance with the well-known principles. A point worth noting is that when reaction is being introduced into an oscillation circuit associated with the crystal detector, as in the case of Fig. 6, it is not necessary to use the first low-frequency amplifying valve as the valve for introducing reaction. The coils L_3 and L_4 in Fig. 6 might equally well be connected in, respectively, the grid and plate circuit of any subsequent low-frequency amplifying valve provided any transformer windings or telephones in series with the coils are shunted by by-path condensers for

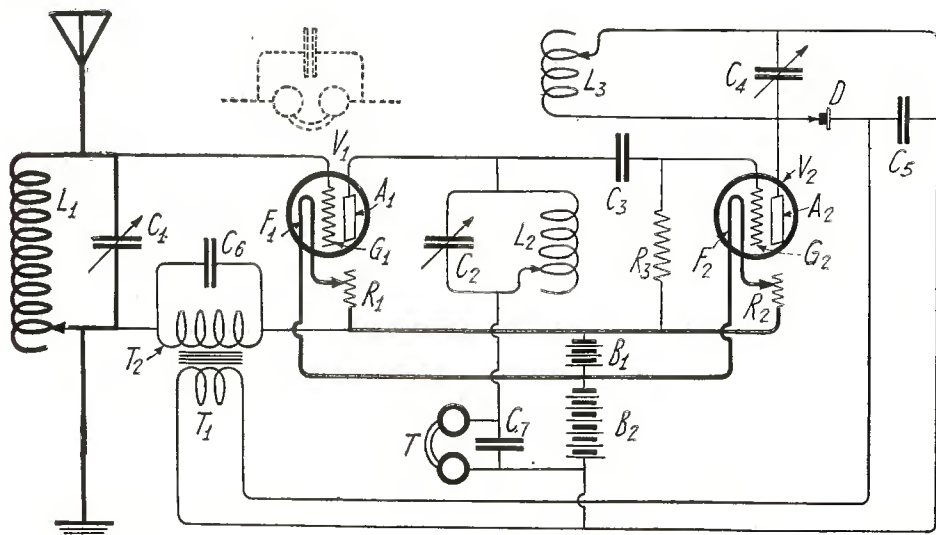

Fig. 7. A Somewhat Complicated Circuit Which Involves Two Radio Frequency Stages, Crystal Rectification and One Stage of Audio Frequency Amplification.

(Continued on page 2140)

Electrons, Electric Waves and Wireless Telephony

By Dr. J. A. FLEMING, M. A., D. Sc., F. R. S.

Part V

ELECTRIC RADIATION FROM OSCILLATORY CIRCUITS

It has already been explained that an electromagnetic wave is created when an electron suddenly changes its speed or is started or stopped in motion.

In the discharge wire of an oscillatory circuit, and also in the dielectric or insulator of the condenser, electrons are dancing back-

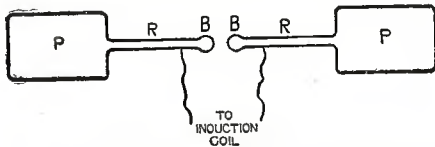

Fig. 51. A Hertz Oscillator or Radiator; PP, Metal Plates; RR, Metal Rods; BB, Spark Balls.

wards and forwards with great rapidity, whilst the oscillations are taking place. Hence an oscillatory current must create electric waves which may be regarded as vibrations or waves propagated along electro-

lines of electric force proceeding from electrons. If, however, we consider the kind of circuit just described in which the metal plates of the condenser are very near to each other and only separated by a thin sheet of dielectric, we shall see that when one plate has its largest charge of extra electrons and the other plate its greatest deficit, which happens twice at each complete oscillation, then, owing to the proximity of the plates, the lines of force which start from electrons nearly all terminate within a short distance upon positive ions or atoms which have lost an electron. Very few of these electro-

lines stretch far out into space. Hence, when vibrations are started along these electro-

lines by the sudden movements of the electrons, very few of these vibrations are propagated entirely away from the condenser. In other words, the arrangement radiates badly because it does not get rid of much of the stored energy in the form of electric vibrations or waves propagated along electro-

lines, which extend far into external space. The oscillatory circuit above described is sometimes called a closed or nearly closed oscillatory circuit and it is a poor electric radiator. In 1887, H. Hertz invented a type of oscillator which has very great radiative power. Instead of placing the condenser plates near together he placed them as far apart as possible by attaching them to the outer ends of two metal rods placed in line with each other, their inner ends being provided with spark balls in proximity to each other (see Fig. 51).

When these rods are connected to the terminals of an induction coil or electrical machine in operation, the plates are charged; one has an excess of free electrons, and is therefore negatively charged, and the other has a deficit and is positively charged. When the electric pressure reaches a value determined by the length of the air gap between the balls, the conductivity of the air breaks down, it is ionized, a spark passes and electric oscillations take place, that is, free electrons vibrate backwards and forwards in the wire or rods.

tion nearly at right angles to them (see Fig. 52).

When the spark discharge takes place the electrons crowded together in the supercharged (negative) rod begin to move suddenly towards the other deficiently charged rod so as to equalize the electron distribution or pressure.

This sudden motion of the electrons produces a "kink" or bend or loop on the electro-

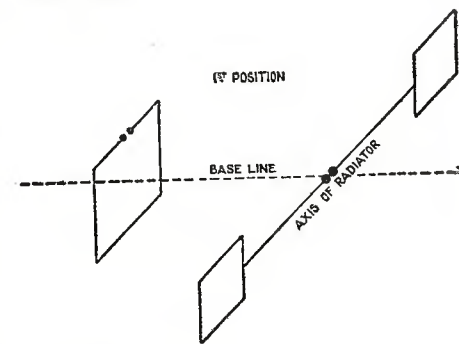
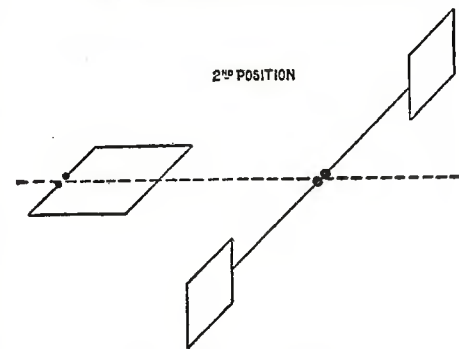
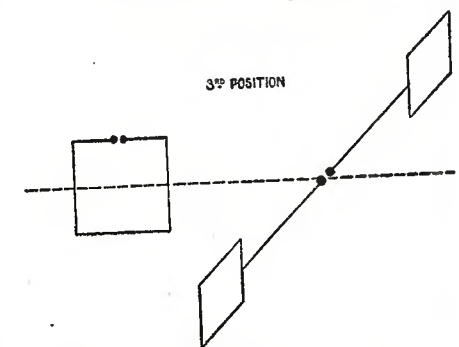

Fig. 54. (A) Sparks Are Seen At Resonator Balls When the Oscillator Is In Action.



(B) No Sparks Seen At Resonator Balls When Oscillator Is In Operation.



(C) No Sparks Seen At Resonator Balls When Oscillator Is In Operation.

The lateral motion of a line of electric force produces a magnetic force which is at right angles to the direction of the line of electric force and to that of its motion. Hence the moving loop of electric force is accompanied by moving loops or lines of magnetic force; the ends on view of these last named lines are represented by the dots in the diagram in Fig. 52.

This combination of lines of electric force and lines of magnetic force at right angles, both sets moving at right angles or perpen-

dicularly to their own direction is called an electric wave.

This wave moves with a velocity of 300,000 kilometers per second in empty space or in air, which is the same as the velocity of light. Otherwise stated, its velocity is 1,000 million feet per second.

Twenty-two years before Hertz began his experiments, Maxwell, in 1865, had theoretically arrived at the conclusion that electric and magnetic forces were propagated through space, not instantly, but with the velocity of light, and had predicted the possible existence of electromagnetic waves, and given reasons for the opinion that visible light and therefore also radiant heat consist of electromagnetic waves of very short wave-

length. Maxwell had not, however, described any mode in which these long electromagnetic waves could be created or detected. The late Professor G. F. Fitzgerald suggested that Maxwell's electromagnetic waves might be created by the oscillatory discharge of a Leyden jar. He had also theoretically investigated the production of electromagnetic radiation by a high frequency alternating electric current in a closed loop of wire.

The late Professor D. E. Hughes had undoubtedly succeeded experimentally in generating Maxwell's electric waves, and what was more important he had empirically discovered a way of detecting them without clearly understanding what he was doing. Hughes' original apparatus is now exhibited in the Science and Art Museum at South Kensington, London.

Hertz invented a simple but not very sensitive method of detecting these Maxwell waves by using a circle of stiff wire, which was interrupted in one place by a small pair of spark balls (see Fig. 53), forming the earliest type of what is now called a *frame aerial*. Hertz used this "resonator" as he called it in the following manner. He placed at one station his open circuit oscillator (see Fig. 51) with its rods in a horizontal position. When this oscillator was in action it sent out electromagnetic waves in which the electric force was in a horizontal direction and on the axial line nearly parallel to the oscillator rods. Also the motion of these created magnetic force disposed in a vertical direction and in the same plane as the electric force. The resonator ring was then placed at a certain distance away from the oscillator with its plane vertical and its spark gap turned so that the line joining the resonator spark balls was parallel to the line joining the spark balls of the oscillator (see Fig. 54).

Under these conditions small sparks are seen at the receiver balls. These are due to the fact that the lines of magnetic force of the electric wave sent out by the oscillator cut through the two sides of the resonator, but do not cut them simultaneously. The result is to produce in the circuit of the ring

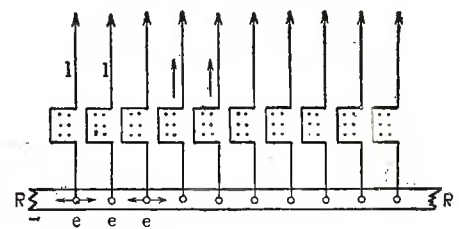

Fig. 52. Vibrations Being Propagated Along Electro-lines L, Proceeding From Electrons e In Oscillation.

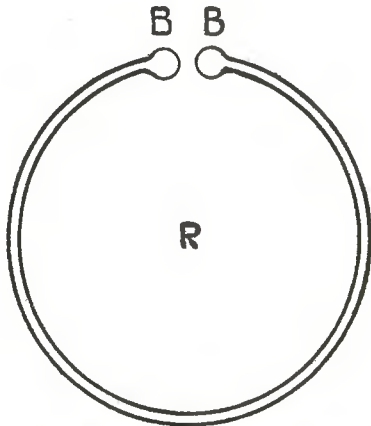

Fig. 53. A Hertz Resonator Ring.

two opposite but unequal electromotive forces which create a current in the ring, and hence a spark at the resonator balls.

This effect needs a little further explanation, and we must therefore explain on the electron hypothesis the nature of the physical operations which produce the induction, as it is called, of electric currents.

Faraday's greatest experimental achievement was his discovery in the autumn days of 1831 that a magnet moved near to a conducting circuit in such manner that the lines of magnetic force proceeding from the poles of the magnet "cut across" the wire circuit.

It is necessary to interpret this effect in terms of the electron theory. Consider two straight copper wires stretched parallel to each other (see Fig. 55). We have seen that an electric current consists in a procession of free electrons in the wire, which though agitated by an irregular motion, yet all struggle forwards in one direction. We have also pointed out that when an electron moves it creates circular lines of magnetic force which lie in planes perpendicular to its line of motion. Again it has been mentioned that these lines of force do not spring into existence suddenly at all distances from the electron but are gradually propagated outwards with the velocity of light just as the circular ripples produced on a pond by casting into it a stone, gradually expand outwards in circles of ever-increasing size (see Fig. 55).

Consider then the case when we start a direct current in a wire *PP*. The electrons in one of the wires then begin to drift forward. The circular lines of magnetic force *LL*, which are thereby generated, grow out from the primary wire *PP*, enlarging gradually in size. These lines therefore in time "cut across" the other parallel wire *SS*.

In a previous section it has been pointed out that when a line of magnetic force moves parallel to itself it creates an electric force which is in a direction at right angles to the line of magnetic force and to the direction of motion of the latter.

We can memorize the relative directions by holding the forefinger, the thumb and the middle finger of the right hand in directions mutually at right angles (see Fig. 56). Let the direction in which the Forefinger points

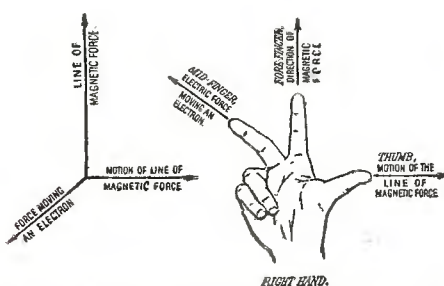

Fig. 56. The Fleming Right-Hand Rule Connecting Electric Force, Direction of Flow of Current, and Direction of Motion Lines by Magnetic Force.

be the direction of the line of magnetic Force, that means the direction in which the pole of a magnet which points to the earth's North Pole would be moved along it.

Let the direction of the thumb represent the direction in which the aforesaid line of magnetic force is moving transversely to its own direction. Then the direction in which the middle finger points will be the direction in which a negative electron, in a conductor, across which this line of magnetic force moves, will be urged by the Electric force created by the motion of the line of magnetic force.

Since the secondary wire contains free electrons, the result is that as the lines of magnetic force generated by the motion of the electrons in the primary wire "cut across" the secondary wire, a momentary electric force will be created in it, which will move the free electrons in the secondary wire in the *opposite* direction to the movement of those in the primary wire. This is called an induced secondary current at "make." It only lasts for a short time, namely, whilst the circular expanding lines of magnetic force are taking up their permanent positions in space.

Suppose then that the current in the primary wire is stopped or that the drifting electrons in it are brought to rest. This implies that the magnetic field round the wire vanishes. It does not, however, vanish at all distances at the same instant, but the circular embracing lines of magnetic force

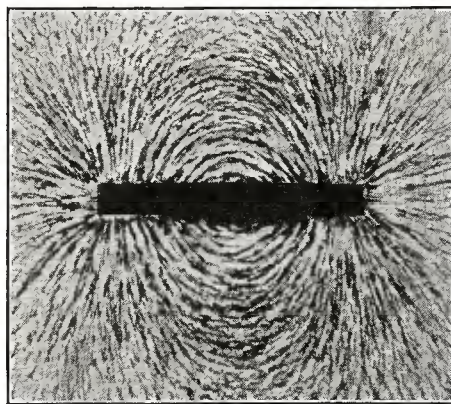

Fig. 58. Lines of Magnetic Force Around a Bar Magnet, Delineated By Sprinkling Iron Filings on a Sheet of Paper Lying Over the Magnet.

are, so to speak, sucked back into the wire. In so doing it will be evident that some of them again "cut across" the secondary circuit, but in an opposite direction to that in their outward course.

It will be clear then from the above explanations that the result of this contraction is to create a momentary electric force which drives the free electrons in the secondary wire in the *same* direction as that of the drift motion of the electrons in the primary wire. This is called the induced current at "break" of primary current.

It will be seen then that if the primary circuit is traversed by an alternating electric current, that is if the free electrons in the primary wire surge backwards and forwards like the ebb and flow of the tide in the mouth of a tidal river, the result will be to produce a similar alternating current in the secondary wire or surging motion of its free electrons which keeps in step with the primary current, but is always in an opposite direction as regards flow.

It is not necessary that the two wires should be straight; they may be both coiled in spiral fashion round a rod or tube of wood or insulating material, only then each wire must be covered with silk, cotton or enamel, to insulate the turns from each other (see Fig. 57).

An arrangement of this kind is called an *Induction Coil* or *Transformer*.

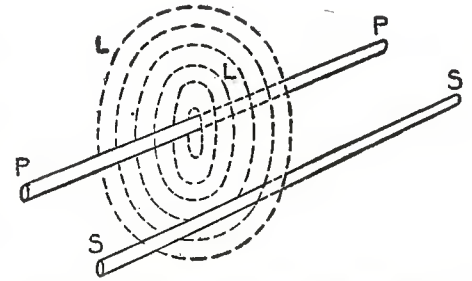

Fig. 55. A Diagram, Showing the Manner In Which Expanding Lines of Magnetic Force Around a primary Circuit PP Cut a Secondary Circuit SS.

When the alternating current is a low frequency current, viz., about 50 to 200 or so reversals of current per second, we can increase the effect by inserting in the tube on which the wires are coiled a bundle of fine iron wires called an iron core. In the case of high frequency current no iron core of the above kind is of advantage.

The induction of electric currents by moving magnets proceeds from similar causes. A permanent magnet, whether bar or horseshoe, carries about with a field of magnetic force, the direction of the lines of which may be rendered evident in the well known manner by sprinkling iron filings upon a sheet of paper laid over the magnet (see Fig. 58).

If then the magnet is moved in any manner so that its lines of force "cut across" a conducting wire, the free electrons in the latter are urged in one direction along the wire for the same reasons as explained in the case of the expanding magnetic field of a primary wire.

This fact is the starting point for the construction of all forms of dynamo electric machines in which a current is generated by moving a coil of wire in a magnetic field of force.

The ordinary spark induction coil, so much used in Roentgen or X-ray work, consists of a bundle of fine iron wires which is wound over with a number of coils of cotton-covered copper wire through which passes the current from a battery which is rapidly interrupted or started and stopped by means of an appliance called a "break." Over this primary coil is wound in sections an immense length of very fine silk-covered copper wire called the secondary coil. When the primary coil is traversed by the primary current the lines of magnetic force due to it are linked with the secondary circuit or pass through it. When the primary current is suddenly stopped these lines contract or shrink up again into the primary circuit. In so doing they "cut through" the secondary circuit and create in it a very high electromotive force, urging the free electrons in the secondary circuit violently in one direction. So much so that they burst forth at one end of the secondary circuit and create a spark discharge.

The electric force or force moving the free electrons in the conducting wire is proportional to the product of the magnetic

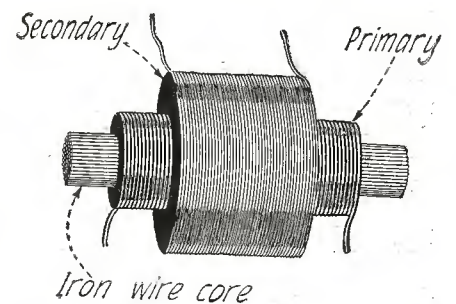

Fig. 57. An Induction Coil, Consisting of Two Insulated Wires, Wound Around a Bundle of Fine Iron Wires As a Core.

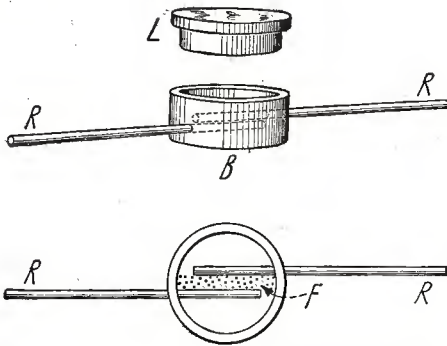

Fig. 59. A Type of Coherer Used By the Author in Hertzian-Wave Experiments. RR, Metal Wires; B, Ebonite Box; F, Nickel Filings Between the Wires in the Box.

force (H) of the moving lines of magnetic force and to the velocity v of these lines resolved perpendicularly to the wire.

If the wire has a length l centimeters then the electromotive force produced by these lines cutting or crossing the wire is proportional to the triple product Hvl .

It does not matter whether the copper wire moves transversely to the field at rest, or whether the lines of magnetic force themselves move, as in the case of an electric wave, so as to cut across a stationary conducting wire. In both cases we have an induced electromotive force created.

We can now return to the consideration of the Hertz oscillator and its corresponding receiving circuit.

It has been explained that when the free electrons in the oscillator rods dance backwards and forwards with great rapidity, the result is to propagate outwards along the electrolines proceeding from the free electrons in them, "kinks" or vibrations which may be conceived to travel along the electrolines just as a "kink" or waves travels along a stretched cord fixed at one end when a sudden jerk is given at the other end.

The "kinks" produced simultaneously on a number of electrolines which are in the same direction run together into a traveling loop of electric force which moves with the speed of light in the direction of the electrolines and is accompanied by lines of magnetic force the directions of which are perpendicular to the electrolines and to the direction of motion of the latter (see Fig. 52).

Suppose next we set up at any distant place another oscillator exactly like the transmitting oscillator comprising two plates at the outer extremities of two rods placed in

line and with a gap in the middle which can be bridged over by some form of conductor. Let this receiving circuit, as it is called, have its rods placed parallel to the rods of the transmitting oscillator. Being of the same form as the transmitter, this receiving circuit has the same natural time period of oscillation. In other words, it is "in tune" with the transmitter.

Hence, as the lines of magnetic force in the electric wave passing over it cut across the rods they will create in them an alternating electromotive force. If the receiving circuit is not in tune with the transmitter, the latter would produce very little effect in creating a current in the former. If, however, it is in tune, the repeated action of the incident waves will soon create an alternating current in the receiver.

The action is closely analogous to the effect of jumping upon a springy plank supported at the two ends like a bridge. The plank has mass and elastic resistance to bending. If a boy stands in the middle of the plank his weight causes it to bend slightly. The plank has, however, a natural time of oscillation. If the boy jumps up and down, but not in time with the natural period of oscillation of the plank, he will not produce much effect in increasing the deflection.

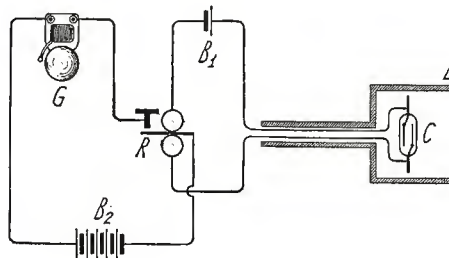

other circuit. It should be noted, however, that when a pendulum or other system capable of vibration receives a single blow or impulse it will, if then left to itself, vibrate in its own natural time period. So in the case of an electric oscillatory circuit, a single strong electromotive impulse due to an electric wave falling upon a properly-tuned receiving circuit will set it in prolonged oscillation provided that this receiving circuit is not too good a radiator.

Thus in the case of Hertz's original experiments, he used the transmitting rod oscillator above described, and a nearly closed receiving circuit made of a circle of wire with a small spark gap in it.

This rod oscillator is a very good radiator, and sends out all its accumulated electric energy in one or two vibrations at most.

On the other hand the closed receiving circuit is a very poor radiator, yet when struck by the electric waves from the transmitter it is set in prolonged oscillation, and there may even be 500 oscillations of current in it before they completely die away.

DETECTION OF ELECTRIC WAVES

It will be clear, then, that to detect electric waves passing through space we have to place at that point an oscilla-

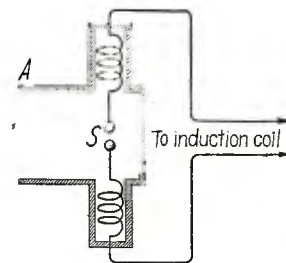

Fig. 61. Apparatus For Experiments With Short Hertzian Electric Waves. S, Oscillator Rods in Open-Mouthed Box A; C, Coherer in Box B; R, Relay; G, Electric Bell.

If, however, he times his jumps so as to agree with the natural time period of flexural vibration of the plank, he will soon find that the bending of the plank at each jump becomes so large that it will probably be in danger of breaking. It is for this reason that a regiment of soldiers are generally ordered to "break step" on crossing a suspension bridge, because if it should so happen that the time period of their marching feet should agree with the natural period of flexural oscillation of the bridge, the safety of the structure might be endangered.

For the same reason we can set in strong oscillation a pendulum consisting of a massive bob suspended by a string by means of little puffs of air or feeble blows with a feather, provided we administer these impulses at intervals of time exactly equal to the natural time period of oscillation of the pendulum. This fact in its widest form covers the principle of the resonance of two vibrating bodies, and is of very great importance in connection with wireless telegraphy and telephony.

We have seen that when two circuits are adjacent to each other an alternating current in one circuit will induce an alternating current in the other circuit. Suppose these two circuits each consist of a condenser of a certain capacity C in series with a wire having a certain inductance L . The natural time period of the circuit is then, as we have shown, proportional to the square root of the product of the capacity of the condenser and the inductance of the wire or to $\sqrt{C.L.}$

This last is called the oscillation constant of the circuit.

If then the two circuits have equal oscillation constants, even though in one the capacity is large and the inductance small, whereas in the other the reverse is the case, these circuits will be in tune with each other, and if placed in proximity free oscillations created in one circuit will induce strong oscillations of equal frequency in the

tory circuit which is generally of the open circuit or rod type, which must have the capacity of its two parts with respect to each other and the inductance of its rod or wire so adjusted that the natural period of oscillation of the oscillator agrees with that of the wave to be detected. Next, that oscillator must be placed with its rods parallel to the direction of the electric force in the wave. If it is a nearly closed or loop receiving circuit, its plane must be coincident with that in which the electric force component of the wave lies.

The incident electric waves then produce in this receiving a feeble oscillatory current of the same type as that in the transmitting circuit.

To complete the detection we have furthermore to associate the receiving circuit with some device called a detector, which is in effect a very sensitive kind of ammeter or voltmeter for detecting high frequency electric currents, and enable us to detect the presence in the receiving circuit of a very feeble electric oscillation.

There are only two types of such detector at present much used, viz., the crystal de-

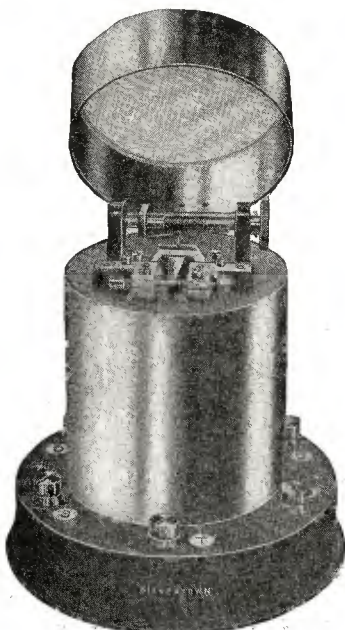
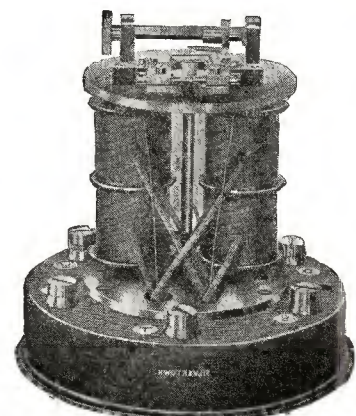

Fig. 60. A Telegraph Relay.



The Same Relay, With Outer Case Removed.

lector and the thermionic valve detector, but we shall mention first the coherer, as this form of detector enables us to show with great ease many of the properties of electric waves which are illustrative of wave phenomena in general.

It had been known for a long period of time that metallic filings formed a conductor of a peculiar kind, and that a glass tube loosely filled with such metallic filings had a conductivity which varied in a very irregular manner.

Professor E. Branly, of Paris, drew attention in 1890 to the fact that an electric spark taking place near such a tube of loose metallic filings caused a sudden increase in its electric conductivity. The same thing appears to have been noticed previously in 1887 or 1888, by Professor D. E. Hughes, the inventor of the microphone.

Sir Oliver Lodge observed in 1893 the improved conductivity a loose or microphonic metallic contact produced when an electric oscillation passed through the contact and named the device a *coherer*.

Without entering into historical developments we may say that the coherer in the form given to it by Marconi, consists of a very minute quantity of metal filings, preferably nickel, with a small percentage of silver, which is contained between two silver plugs included in a glass tube.

The tube is exhausted of its air. The plugs are connected to two platinum wires sealed through the glass.

For certain laboratory and experimental purposes the author has used with advantage another form made as follows: A small ebonite box, like a little pill-box, has two nickel or silver wires passed through holes in the sides so that the wires are not quite in line (see Fig. 59). The wires where they pass through the box must be parallel to each other and about two millimeters or not more than 1/12th of an inch apart. They must otherwise rest on the flat bottom of the box. A very small quantity of fine clean nickel filings is then laid between them and this quantity has to be adjusted until the greatest sensitiveness is obtained. The length of wire which projects beyond the box on each side is about three inches. A little stopper of ebonite is provided to close the top of the box. The two wires and the filings connecting them are joined in series with a single dry voltaic cell, and with the wire circuit of a device called a *relay*.

A relay consists of a pair of soft or pure iron bars round which are coiled many convolutions of fine silk-covered copper wire, through which the electric current from the battery cell can be sent. The iron then becomes a magnet and the arrangement is called an electromagnet. When the iron bars are thus magnetized, which can be done sufficiently with a very feeble electric current, the poles of the electromagnets are caused to attract a pivotted piece of soft iron (see Fig. 60), called an armature, and pull it over against a metal stud which ef-

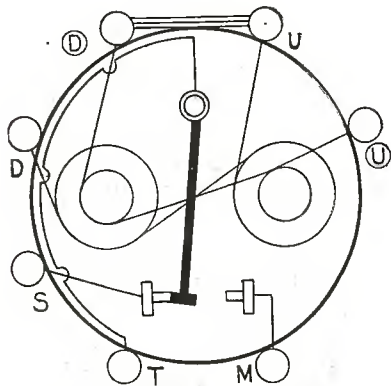

A Diagrammatic Drawing of the Telegraph Relay Mentioned.

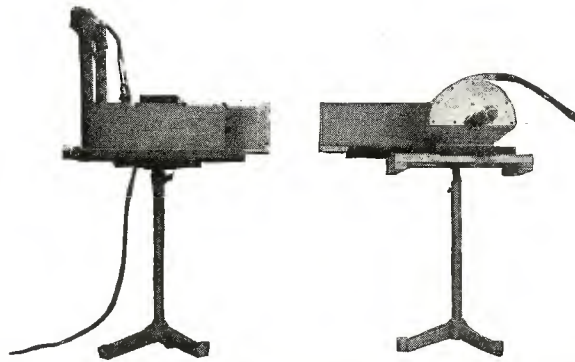

Fig. 62. General View of the Author's Apparatus For Showing Experiments With Short Electric Waves, Illustrating Their Similarity To Light Waves, and the Opacity or Transparency of Various Substances.

fects a contact and completes another electric circuit, which contains a more powerful battery of many cells and some instrument such as an incandescent lamp, an electric bell, or a printing telegraph instrument, which can give a visible, audible or legible signal. The relay is, therefore, a device by which the starting or stopping of a very feeble electric current can cause another very much stronger electric current to be also started or stopped.

Let us suppose then that we have two metal rods each a few inches long, placed in line with polished metal balls on their inner ends, with a small spark gap between them, so as to form a Hertzian oscillator.

It is desirable that this oscillator should be contained in a metal box with one end open (see Figs. 61 and 62).

By means of an induction coil or electrical machine, electric sparks are created between the balls. This results, as already explained, in the production of electric oscillations in the rods and in radiation of electric waves from them.

The wavelength of the waves radiated is approximately twice the overall length of the rods. Hence to obtain short Hertzian waves, that is, not more than a few centimeters in wavelength, the spark balls and the rods must not exceed in length half the desired wavelength.

It is necessary to connect these rods to the spark producing appliance, which is generally a small induction coil, through tightly wound up spirals of indiarubber-covered wire, called choking coils. The object of this is to hinder the electric oscillations generated in them from passing back into the induction coil. Another precaution is to have the spark balls highly polished, as this helps to produce that suddenness of the electric discharge which is a necessary condition for creating electric waves.

The receiving arrangements, comprising the metallic filings, coherer, and the extended wires, are placed in another metal box, open at one end, the two boxes being arranged with open ends facing each other and at a little distance, and the oscillator rods parallel to the collecting wires of the receiver (see Fig. 62).

It is very important that the wires which lead away from the coherer to the relay and voltaic cell and from the relay to the indicating device, whether lamp or bell, should be enclosed in a metal tube and all joints made tight. The object of this is to prevent the electric waves radiated from the transmitter affecting the coherer otherwise than by entering the open mouth of the receiver box.

To control the emission of waves from the transmitter it is necessary to insert in the primary circuit of the spark-producing coil a switch or key so that we can create a spark of short duration between the spark balls by closing this switch for an instant.

A train of electric waves having a wavelength of a few inches then emerges from the open mouth of the transmitter box and en-

ters that of the receiver or coherer box. These waves set up electric oscillations in the collecting wires, which causes metal filings in the box to become highly conductive. The metal particles cling or cohere together. The voltaic cell in series then sends a current through them and through the relay, which in turn operates the detecting device and lights up the indicating lamp or rings the electric bell. This signal then shows that an electric wave has entered the receiving box. If we stop the transmitter spark and give the coherer box a smart tap or blow, this causes the metallic filings to cohere or fall back again into a badly conducting condition and the indicator lamp then goes out or the bell stops ringing.

Provided with this apparatus we can then demonstrate a number of the interesting properties of electric waves having a wavelength of a few inches.

In the first place if we hold between the transmitter and receiver boxes a sheet of metal, even a sheet of tin foil or silvered paper we find that the metal is opaque to these waves, and that the receiver is not affected.

The reason is because the electric waves falling on the metal sheet set up in it oscillatory electric currents, and these are exactly in opposite phase; that means moving in opposite directions to the currents in the oscillator rods which generate the waves. These currents in the metal sheet in turn create waves which, however, being in opposite phase, just nullify the effect of the incident waves on the receiver.

All good conductors are therefore opaque to this type of electric wave.

On the other hand bad conductors are transparent. If we hold a sheet of glass, ebonite or even a thick plank of dry wood between the oscillator and the detector, these electric waves are found to pass through it quite easily.

They pass also through many folds of dry cloth. If, however, the cloth is made wet, even a wet duster will do, it is found to be opaque to them. For this reason the human body, hand, or head, are also opaque, and stop these electric waves on account of the water in the tissues. A number of interesting experiments may be made with flat glass bottles about 6 inches square and an inch in thickness. It will be found that the empty bottle is quite transparent to these waves. If filled with water it is quite opaque. If filled with paraffin oil, olive oil, turpentine or other insulating liquid it is found to be transparent.

Methylated spirit is transparent if quite free from water, but the water-adulterated mixture is semi-opaque.

We learn from these experiments that, generally speaking, good conductors are opaque to long electric waves, and good insulators transparent.

This is not the case so strictly speaking for the very short electric waves which constitute visible light. In the latter case many aqueous solutions of salts called electrolytes, because they can be decomposed by an electric current, are transparent to light, and yet are good conductors. The reason is because in light waves we are dealing with electric displacement currents which are reversed hundreds of billions of times per second, and many substances which are good conductors for low frequency currents are not good conductors for such extra high frequency currents. Another interesting experiment can be shown with a grid of wire. If we wind copper wire round a wood frame so as to lay a number of parallel wires about half an inch apart across the frame in one

(Continued on page 2120)

Principles of the Antenna System

By LOUIS FRANK

IT has been stated of the antenna system that it is the mouth and ear of the radio set; it is the mouth of the transmitting station since it does the talking, as it were, and sends out into space the radio waves; it is the ear of the receiving station, since it reaches out into space to gather in the radio waves. A transmitting and receiving station which is otherwise well designed but which has a poor transmitting and receiving antenna is like a healthy person who is deaf and dumb. That person has the strength to talk and thus reach people, and could utilize in various ways the sounds which are always coming his way, if only his talking and hearing muscles were in commission. So with a radio station. The power for transmission may be available since the transmitter is well designed, but the transmitting antenna does not radiate, is not able to radiate this available power because it is poorly designed. The receiving set would be able to make loudly audible the numerous signals which are always impinging upon the receiving antenna if only the antenna were not so wasteful of energy. No matter how well your other parts of the set may be designed and built, if your antenna is no good it can safely be said that

turn. The first one, namely ohmic losses, is generally fairly constant over a wide range of wave-lengths. There is a small variation of this resistance with wave-length owing to eddy currents and skin effect, but as this variation is small compared to other variations and the total resistance, we may represent this factor as being con-

some tuned circuits in the neighborhood of the antenna circuit, or some dead hanging on ends of coils which are absorbing energy and oscillating at their own natural frequency, or the presence of some other tuned antenna in the neighborhood, or the presence of nearby absorbing metal masts or buildings.

Of the above three components, the first two are wasteful and result in lowering the antenna efficiency, and the last component, namely the radiation resistance, is the useful component. The greater this resistance is the more efficient will the antenna be as a radiator of electric waves. The total power used up in the antenna is given by the product I^2R , where I is the current in the antenna, and R is the total antenna resistance. The useful power delivered by the antenna, namely the total power radiated is given by I^2R_r where I is again the antenna current, while R_r is the radiation resistance. As a result, the efficiency of an antenna as a radiator of electric waves will be given by the quotient of the latter divided by the former which reduces to

$$\frac{I^2R_r}{I^2R} = \frac{R_r}{R} = \text{Efficiency}$$

The problem of the good design of a transmitting antenna is therefore, the problem of making the above ratio as great as possible, increasing the radiation resistance and decreasing the other wasteful resistances, which are the leaks in the antenna system. A certain amount of energy or power is pumped into this antenna system, but the greater part of this leaks out by way of these wasteful resistances. As a result, the efficiency of most antennae is surprisingly small.

stant, and this is shown in Fig. 1, by curve 1, which is a straight line parallel to the wave-length axis. The second factor, losses due to absorption in the imperfect dielectric is due to the fact that the antenna condenser is an imperfect condenser. In the neighborhood of antennae will generally be found such structures as trees, buildings, masts and so on. All of these, while they may not be directly under the antenna, are nevertheless in its electric field. As a result, since these structures are imperfect dielectrics having considerable absorption resistance, much energy will be lost in them. This absorption resistance of dielectrics is found to be directly proportional to the wave-length and hence is represented by the inclined straight line in Fig. 1, namely curve 2. The third factor, namely the radiation resistance, is the useful resistance, and this depends upon a number of factors, such as the shape and type of the antenna, the height of its center of capacity and the wave-length. It is inversely proportional to the wave-length and hence is represented by the hyperbolic curve 3, in Fig. 1. The total antenna resistance which is the sum of these three components, is, therefore, represented by the curve 4 in Fig. 1; The well known fact is thus brought out by this curve that the total resistance of an antenna is not constant, but depends upon the wave-length, and is a minimum at a certain wave-length and increases on either side of this optimum wave-length. It might be pointed out here as interesting information that some antennae show a resistance curve with one or more peaks in it, as in Fig. 2. These peaks showing sudden rises of resistance indicate that at these wave-lengths there is considerable extraction of energy from the antenna circuit (which is equivalent to an increase in antenna resistance), and this extraction may be due to

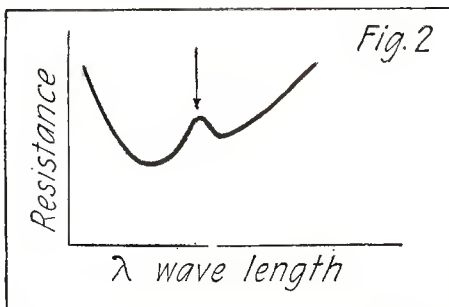

Illustrating a Possible Resistance Curve of an Antenna, Plotted Against the Wave-Length.

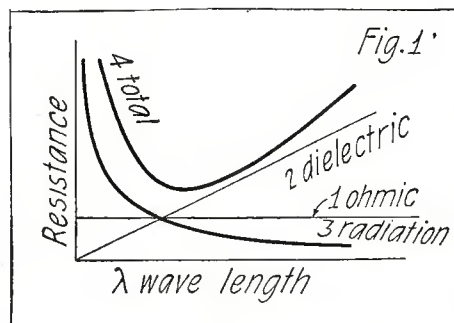

Curves Designating Resistance Losses, Due to Various Factors.

your station is no good. A real antenna and ground system is easily half your station problem solved. It will, therefore, be the object of this article to explain just what is required of a good transmitting and receiving antenna and how these requirements may be fulfilled in practice. The advantages and disadvantages of different practical types of antennae will also be considered.

The requirements for receiving and transmitting antennae are different since their functions are different. The function of the transmitting aerial is to radiate waves into space, while that of a receiving aerial is to gather in these waves. As a result, it is to be expected that their design would be different. As a general rule it may be said that any good transmitting antenna will also make a fairly good receiving antenna. But the converse of this is not a true statement, as pointed out by Mr. Stuart Ballantine in "Radiotelephony for Amateurs." In fact a very good receiving antenna may make an abominable transmitting antenna.

The inefficiency of most antennae is almost always due to too much wasteful resistance made up of a number of different factors which may be enumerated as follows:

1. Resistance due to ordinary ohmic losses as the resistance of the antenna wires, of the lead-in wires, of the ground system.
2. Resistance due to losses in the imperfect dielectric surrounding the antenna.
3. Resistance due to USEFUL losses, namely radiation of energy from the antenna.

Let us consider each of these factors in

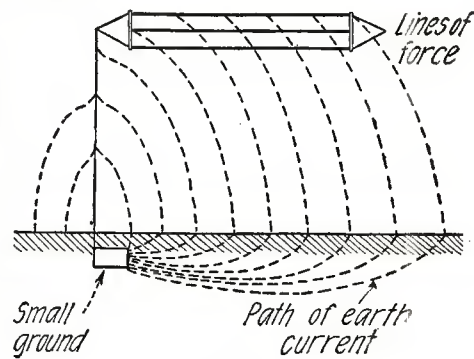

There is a Considerable Loss of Energy When a Small Ground is Employed, Because of the High Resistance Path of the Current Through the Earth.

Now let us see how the wasteful resistance may be reduced. The ohmic resistance makes up a considerable part of this resistance. The current flowing in a transmitting antenna is quite considerable, as currents go, and as a result, the wires heat up, which represents a loss. The first precaution to observe would, therefore, be to use antenna wire having a large surface area. The larger the current in the antenna, of course, the larger should be the area of the antenna wire. Wire having a large diameter is quite satisfactory, although if solid, there is a disadvantage due to the presence of skin effect which raises the resistance. Flat copper strip would be about the best type of wire to use, since it affords sufficiently large area to carry the current, and at the same time it is almost entirely surface, hence reduces the skin effect to a minimum. However, this wire may be somewhat unwieldy to string as an antenna, although it is so

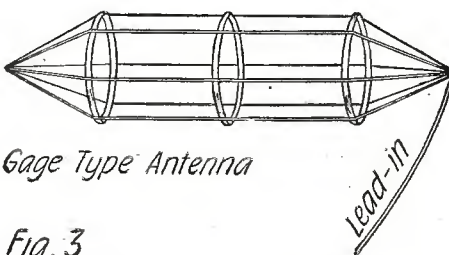

Cage Type Antenna

Fig. 3

The Cage Type Antenna Has Less of the "Skin Effect" Than Others, Due to the Disposition of Its Wires.

use, and, therefore, the next best bet is to use a stranded antenna wire, such as phosphor bronze. This type of wire also reduces the skin effect considerably, and at the same time affords superior mechanical properties to the other types of wire, since it is very much stronger.

There is one type of antenna which reduces the skin effect more than any other, and this is the cage type of Fig. 3. The reason why this particular disposition of the antenna wires reduces the skin effect will be clear from the following. Skin effect crowds the current to the outside of any conductor or system of conductor through which it flows; as a result, the current density on the outside of the wire or system of wires is greatest and an increase of resistance results from this irregular distribution of current density. An antenna is a system of conductors and the same things happen here. When a flat top antenna is used, for example, having more than two conductors, say four, there are two outside conductors and two inside conductors. The result of the skin effect, or edge effect as it is called in Mr. Ballantine's book, in explanation of this phenomenon, is to crowd the current to the two outside wires, thus making the current density non-uniform and hence increasing the resistance. In order to avoid this effect it is necessary to construct the antenna so that its wires are all equi-distant from the center, that is, they are all on the surface of a cylinder. The cage antenna permits of such construction as can be

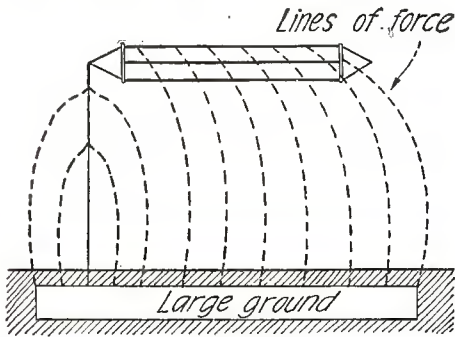
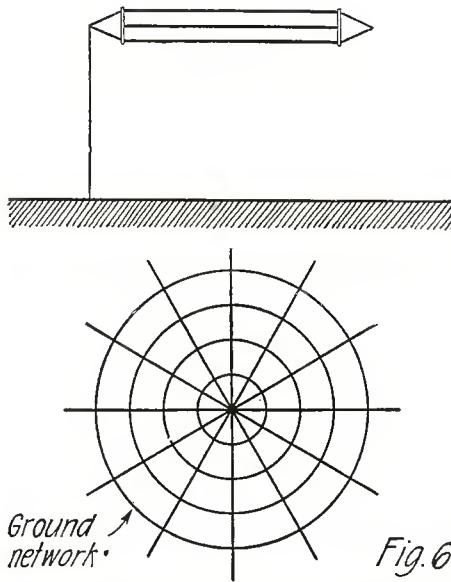

Fig. 5

By Employing a Large Ground of Good Conductivity, the Resistance of the Earth is Not Encountered.

seen from Fig. 3. This explains why the cage antenna has such excellent low resistance properties. There will also be a saving in losses if the lead-in of the antenna is likewise made into a cage.

The second chief source of ohmic losses is in the ground resistance. It may be said with considerable certainty that most of the grounds built by amateurs are good heat generators. An amateur will spend seven days and nights winding an inductance coil in a special way which he thinks is ultra-efficient, and right on top of that he will stick a rod in the ground, connect his set to it and call it a ground. That is no more a ground than if he dug up the earth and stuck the wire from his set into the earth. A good low resistance ground is no less important than an efficient radiating antenna or an efficient hook-up. The losses in the ground are due to non-uniform current density in the ground, and its importance will be plain when one considers that the current at the base of the antenna is the heaviest, and hence heat losses will be heaviest. Fig. 4 shows clearly what happens in the ground. The electric lines of force extend from the antenna outward and downward towards the ground, and through the ground to the ground wire. Now if the ground has very small surface area, say it is a water pipe or a small copper plate the lines of force have to travel over a longer earth path to reach it. As a result there will be a greater



A Low Resistance Ground Can Be Constructed of a Number of Radial Wires, with Connecting Jumpers, as Shown Above.

loss of energy than would be the case if the travel were shorter; and if the earth is poorly conducting, as is very often the case, the ground resistance will be still further increased. Secondly, when the earth has such a small area the current is concentrated in very small space, the current density increases, and the heat losses increase with it. On the other hand if a large ground is used and is symmetrically disposed around the antenna the electric lines of force coming from the antenna will be directly over the ground, and will have a much shorter path to travel through natural earth before they reach the ground wires. Hence the resistance due to this cause will be lower. On account of the large area of the ground the current density will be smaller and losses thereby diminished.

In order to secure shorter earth paths for the ground currents and low uniform current density in the ground it is absolutely essential to use large grounds. This is the only solution. There are two very good types of grounds which will fill the bill. The first is the direct ground in which metallic plates are buried in the earth. The plates should be large and numerous so that they extend along the length of the antenna and overlap it on all sides. The ground should, wherever possible, be symmetrically disposed about the antenna itself. If a number of plates are buried, these should be connected to each other by means of heavy wires soldered to each plate. Another way would be to use a number of large radial wires coming from a center and extending out a little beyond the antenna, and connecting these wires at intervals by means of heavy copper jumpers, as illustrated in Fig. 6. This is quite a common form of ground

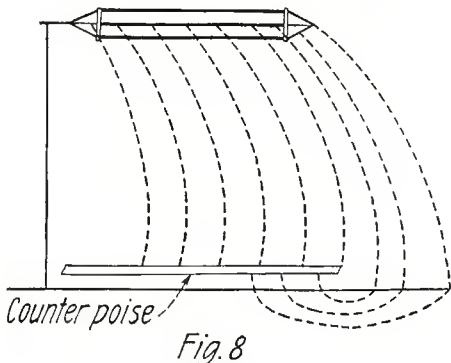

The Counterpoise is extensively Used in Conjunction with C. W. Transmission. There is No Direct Connection to the Ground.

for large stations and gives most excellent resistance properties. A type of direct ground which is about the best so far devised is the so-called "Round Ground" named after H. J. Round of the English Marconi Co. who is supposed to have invented it. This type of ground has been under investigation by the Bureau of Standards and their results point conclusively to the superior advantages of this ground system. It is schematically shown in Fig. 7. A circular trench is dug in the ground about 2 or 3 feet at the greatest depth and about 15 to 20 feet in radius. A metallic cylinder is then made up of a number of galvanized iron plates, or other sheet metal, which need not be soldered together, but which should overlap each other by a few inches. In this construction avoid, wherever possible, any sharp jutting edges. To each plate a heavy wire should be soldered and these wires brought radially to a central point to which the heavy ground cable from the set is brought. The ground should be placed directly under the antenna. This ground is quite easy to make and for those amateurs who have transmitters, will certainly prove an eye-opener, when they consider the results.

The second type of ground which fulfills the necessary requirements for a low resistance ground is the so-called "counterpoise" ground. The counterpoise is essentially a network of wires placed directly above the ground under the antenna and insulated from the ground and antenna. This usually has a very large area and as a result

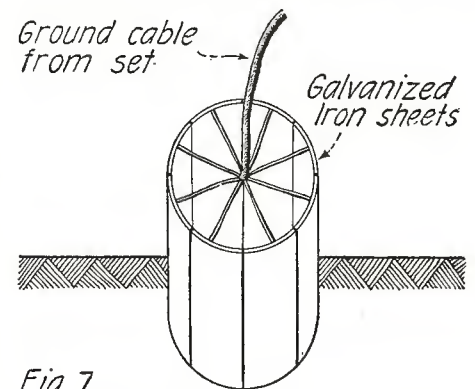

Fig. 7

An Excellent Type of Low Resistance Ground, That is Easily Made. It is Far Superior to the Usual Type of Ground.

gives a uniform distribution of ground current with low current density. Fig. 8 shows the paths of the lines of force from the antenna and the ground currents. It is seen that the lines of force emanating from the antenna go directly to the counterpoise, with the exception of a small percentage on the fringe of the counterpoise. The counterpoise thus eliminates largely the wasteful earth currents, which contribute so largely to the ground losses. It is for this very good reason that the counterpoise ground generally has the lowest resistance of all ground. (Although the recent experiments made at the Bureau of Standards seem to point out that the above mentioned ROUND GROUND is a very close competitor with the counterpoise for first honors).

The construction of a counterpoise ground should be guided by the following practical considerations. First, the area should be as great as conditions permit, and should embrace completely the aerial structure. If possible, it should extend a little beyond the antenna boundaries on all sides. The counterpoise should be placed about 3 feet above the surface of the ground, but the important precaution to observe is that this height should be uniform over the entire counterpoise. Otherwise, if one point is higher than the others, the capacity of the antenna to this point will be greater and there will

(Continued on page 2182)



The Broadcast Listener

Tuning Radio Receivers

An Explanation for the Novice
By **JESSE MARSTEN**

THE problem of the reduction of interference in broadcast reception may be divided into three parts or classes: (1) elimination of spark interference; (2) increasing the number of wave-lengths on which broadcasting is done and (3) proper tuning of receivers. The first is gradually being done but it will be

speeches, concerts, from various stations in the vicinity, and distant from New York; there are also the telegraphic signals coming from the various amateur stations. The radio waves from all these distant and near-

phones if all of these radio waves which thus strike his antenna did get into his receivers and telephones. In many cases this does actually happen and that is what has caused all the trouble about interference.

In all the radio waves that strike the antenna there is one which one desires to receive, but none of the others. It may be that one desires to hear the orchestra playing at WJZ, and does not care a rap about

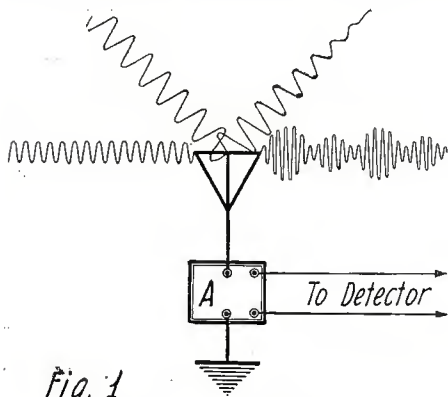

Fig. 1
Showing Numerous Different Radio Waves Impinging Upon an Antenna.

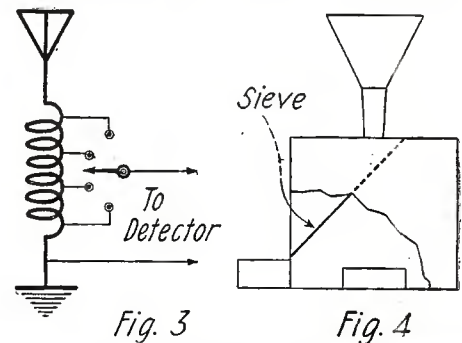

Fig. 3
Fig. 4
A Single-Circuit Tuner and Its Analogy, a Single-Sieve Sand Receiver.

some time before spark apparatus will be completely eliminated. The second is being taken care of at the present time by the radio conference at Washington. The third, namely the matter of receiver tuning, is really the most important, for even if the first two problems were adequately solved, unless the matter of tuning receivers were taken care of there would still be considerable complaint about interference on the part of broadcast listeners.

Much has been written on the subject of receiver tuning, but in the mass of literature the novice or beginner may have been lost in confusion. It is, therefore, the intent of the writer to explain in this article the high lights of the subject of tuning, solely for the benefit of the novice and broadcast listener; (1) what tuning is and what it involves; (2) why some receivers tune better than others, or why multiple circuit receivers tune better and are more selective than other types of receivers; and (3) how to go about tuning the various different types of receivers generally used for broadcast reception. This last gives the practical steps in tuning, telling the novice just what to do to tune his receiver.

In order to appreciate fully what tuning is and what it involves the novice should picture to himself the condition of the ether surrounding his antenna when he begins to listen in. The ether is charged with all kinds of radio waves coming from a large number of radio stations, these waves carrying the signals transmitted by the various stations. Thus in a city like New York there are radio telegraph messages from ships plying their way along the coast; telegraph messages from the Navy Yard and other stations like Bush Terminal; there are radio telephone broadcasting messages,

NOTICE

BEGINNING with this issue, and every month hereafter, we shall run a special department for the Broadcast Listener. These articles will be treated entirely from the viewpoint of the non-technical reader, and will give him a good insight into radio without overburdening him with too technical matter.

You will oblige the editors if you will address them through this department, telling them exactly what articles you would like to see published. We shall strive to give you just exactly what you want.

Simple contributions to this department, from non-technical broadcast listeners, are acceptable, and beginning with the next issue we shall award special prizes for all such contributions.—EDITOR.

by stations strike the antenna, each message making its effort to pass down the antenna into the receiver, in order to actuate the telephones. The novice may well imagine what a bedlam would be heard in his tele-

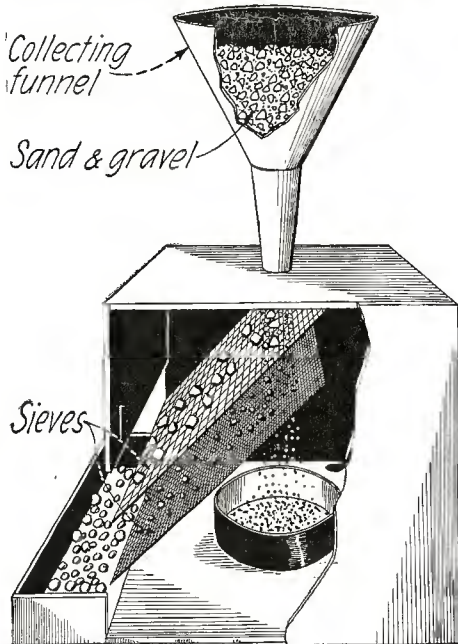

Fig. 2
Showing Various Sizes of Sand Raining in on a Collecting Funnel, Feeding Into a Sieve Receiver.

what is going on at any of the other stations. Or it may be that one prefers on a particular night to hear the violin player at WEA. In order to hear this particular station and enjoy it, one must eliminate all the other radio waves which strike the antenna, except the radio wave coming from the station one desires to hear. That is, one must prevent all the radio waves, except the one desired, from passing into the receiver to the telephones. The method by which this is accomplished is termed "tuning."

Tuning, then, involves adjusting the radio receiver so that it receives only the waves or signals desired and rejects the other waves striking the antenna. The novice knows that radio signals are sent on different wave-lengths. Tuning his receiver requires adjusting the wave-length of his set so that it corresponds to the wave-length of the signal desired. This is accomplished by varying and adjusting the values of the inductances and capacities in the receiving circuit until the wave-length of the receiving circuit equals that of the received wave.

The novice will comprehend this idea of tuning very clearly if he will consider the following analogy. Fig. 1 illustrates the usual receiving antenna upon which a large number of radio waves of various lengths impinge. The antenna is the collector of the radio waves which passes them to the receiver A and thence to detector and telephones. Imagine that the antenna has been transformed into a huge funnel, as in Fig. 2, and that impinging upon this funnel collector is a steady rain of sand and gravel of various degrees of fineness. The collecting funnel corresponds to the collecting antenna, and the rain of sand and gravel of various degrees of fineness corresponds

to the radio waves of various wave-lengths striking the antenna. Just as the antenna collects all the waves which strike it, so the funnel collects all the sizes of sand and gravel which strike it. The sand and gravel pass on to a receiver B in Fig. 2, which receiver consists of sieves; they then pass through these sieves just as the radio waves pass through the receiver A in Fig. 1. The sand which finally emerges from the receiving sieves B, Fig. 2, corresponds to the radio waves which finally come out of the receiver A, Fig. 1, and are applied to the detector and heard in the phones.

If the sand receiver in Fig. 2 is so arranged that it consists solely of a coarse mesh sieve, then sand of all degrees of fineness will pass through it. This condition corresponds to the condition where the radio receiver is broadly tuned. The radio receiver which is broadly tuned permits wide range of wave-lengths to actuate it, just as the coarse sieve permits sand and gravel of varying degrees of fineness to pass through it. If we assume that we desire to receive only a particular wave-length, in our analogy this is equivalent to receiving sand of a particular degree of fineness. This is accomplished by varying the mesh

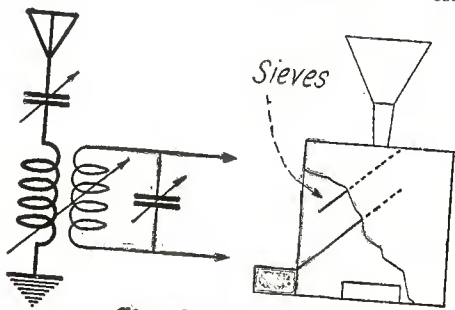
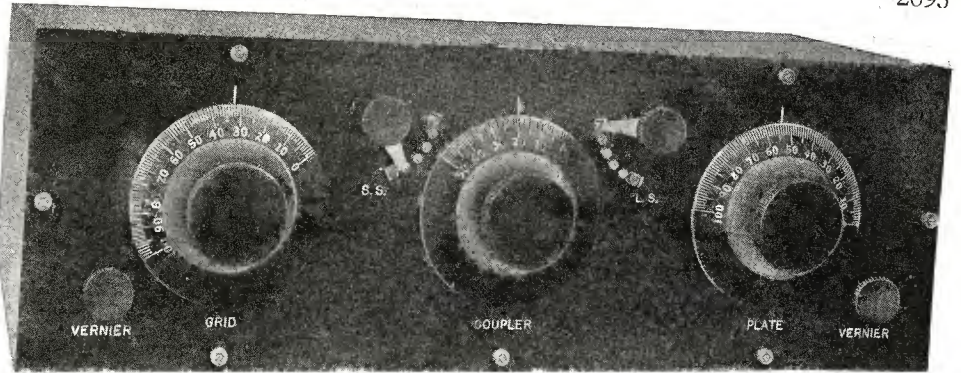

Fig. 5
A Two-Circuit Radio Tuner and Its Analogy, a Two-Sieve Sand Receiver.

of the sieves in Fig. 2, so that the first sieve rejects all sizes of sand above the one desired, while the second lets through all sizes less than the one desired. The size of sand desired falls between the two sieves and is passed on to where it is used. This condition now corresponds to that in which the radio receiver is sharply tuned to a certain desired wave. That is just as the sand receiver is adjusted to reject all sizes of sand except a certain size, so the sharply tuned receiver rejects all wave-lengths except the particular one desired. This process of adjusting the receiver so that it does reject undesired signals is called tuning. If a receiver tunes so that it does not reject very well undesired signals it is said to be "broadly tuned." If it tunes so that it does reject all but the desired signal it is said to be "sharply tuned." A sharply tuned receiver is also called a "selective" receiver, because of its ability to select only the desired signals and reject the others.

Now let us see why some receivers tune more sharply, or are more selective than others. The novice no doubt has heard frequently enough that most of the interference trouble he experiences is due to the fact that he employs a "single circuit" receiver which is broadly tuned. As a result, he receives a wide range of wave-lengths at any given setting of the receiver which causes the interference. He has also heard that if he used a double or triple circuit tuner this interference would disappear. This means that the single circuit receivers are broadly tuned and less selective than the double circuit and triple circuit tuners. He has also heard that if his receiver were coupled loosely to the antenna interference would also be decreased. Let us see why and how.

Fig. 3 illustrates the single circuit tuner.



A Standard Three-Circuit Regenerative Receiver, the Circuit of Which is Shown in 2 of Fig. 12. The Controlling Knobs, from Left to Right, Are, the Grid Variometer, the Variocoupler and the Plate Variometer. Vernier Knobs, for Fine Adjustment, Are Seen in Each Corner. Primary Adjustments Are Made with the Switch-Arms S.S., L.S., and the Coupler Knob. Final Adjustments Are Made by the Simultaneous, Alternate Back-and-Forward Motion of the Grid and Plate Variometer Knobs and Possibly the Verniers.

Some tuners employ a variometer only, others employ a tapped inductance only, still other employ an inductance with a condenser. To all intents and purposes these tuners act alike. We will, therefore, consider the case of Fig. 3, which is typical. This case is practically equivalent to the case in our analogy in which only one sieve is employed in the sand receiver, Fig. 4. We can adjust but one circuit or sieve. As a result, one sieve will reject a large number of sizes of sand but will also pass through it a large number of sizes of sand. In other words, no matter how finely we adjust the mesh of the sieve, there will always be sand of different sizes passing through the receiver when only one sieve is used. In the same way signals of different wave-lengths will force their way through a single circuit radio receiver. The range of wave-lengths thus filtering through the receiver may be decreased to a certain extent by better adjustment of the circuit inductance or capacity, just as the sand sizes passing through the sieve may be limited by careful adjustment of the mesh of the sieve. But no matter how finely the single circuit set is adjusted it will be responsive to a wide range of wave-lengths. It has a certain inherent coarseness like the sieve which cannot be adjusted so that it

passes through only one size of sand. The single circuit tuner is inherently a broadly tuned receiver.

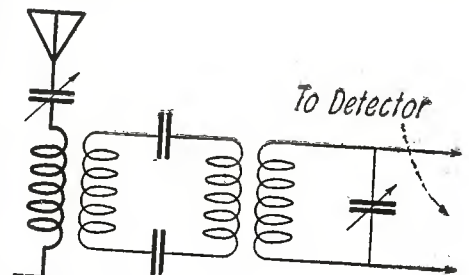

Fig. 7
An Intermediate Circuit Tuner, Which is Capable of Greater Selection.

When we come to the double circuit tuner we immediately strike conditions which make for selectivity or sharp tuning. Fig. 5 illustrates the two circuit radio receiver and Fig. 6 illustrates the analogous two-circuit sand receiver. The second circuit or sieve simply continues the work of the first. The first sieve refines the sand down to certain sizes by rejecting certain other sizes. This is all it can do. The second sieve takes this sand which has been, so to speak, partially tuned, and proceeds further with the work by rejecting certain other sizes bringing the sand closer to the desired degree of fineness. In the same way the second circuit in the radio receiver "refines" still further the received waves which have passed the first circuit. The first circuit in the tuner was able to reject certain wave-lengths and, therefore, passed through all wave-lengths in a wide band. The second circuit being adjusted and tuned also to the desired wave-length is, therefore, able to reject some of the wave-lengths in this band and thus bring the received signal closer to the desired wave-length only. This process is seen to be one of repeated refining, like filtering water. If one filter is used, some of the foreign matter in the water is left behind, the water passing through a little clearer. If this clearer water is now passed through another filter, it will retain a little more of the foreign matter and pass the water through still clearer than before. The more filters are used the clearer the water becomes. Using a second circuit in a radio receiver serves the same purpose, it filters out some more of the undesired wave-lengths when it is tuned to the desired wave-length. If still another circuit were used after the second, this tuning process or "filtering" would proceed further. That is why there are some receiving sets built with intermediate circuits as in Fig. 7. Multiple circuit tuners are, therefore, more sharply tuned than single circuit tuners; they are more "se-

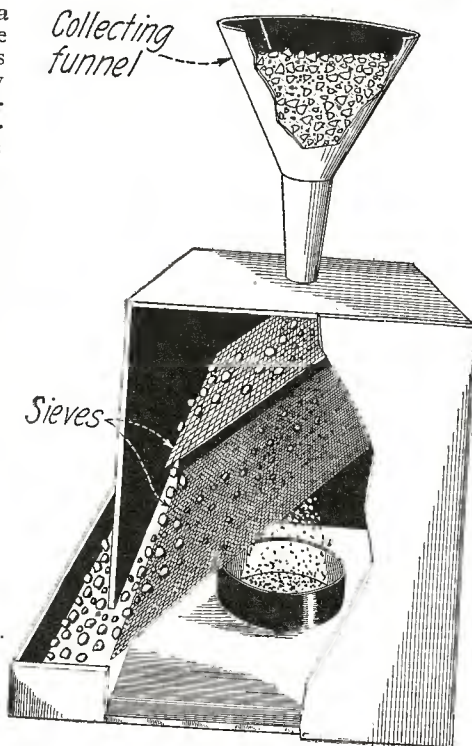
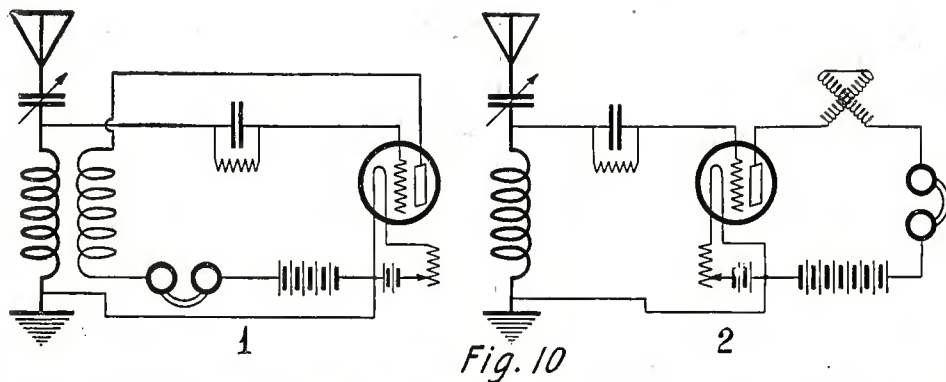

Fig. 8
A Loosely Coupled (Widely Separated) Sand Receiver, Capable of Finer Sieving.



Two Popular Types of Single-Circuit Regenerative Receivers. That of 1 is the Tickler Feedback Variety, While 2 Employs a Plate Variometer to Attain Regeneration.

lective" since the rejecting process continues in each succeeding circuit.

Suppose now that the two sieves in Fig. 6 are very close together. Then the sand which has passed through the first sieve will probably all pass on to the second sieve which will reject some sizes and pass

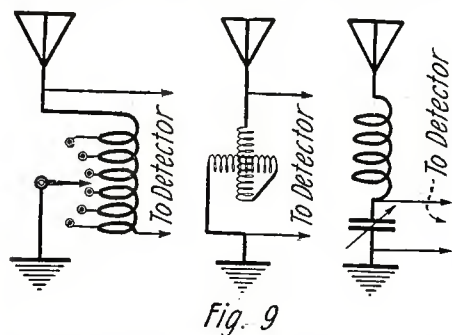

Three Different Types of Single-Circuit Tuners, the First Employing a Tapped Coil, the Second a Variometer and the Third a Fixed Coil, Controlled by a Variable Condenser.

others, as above. That is, when the two sieves are close together there is little or no loss of sand during the passage from one sieve to the other. However, if they are separated considerably as in Fig. 8, there will be a considerable loss of sand during the passage from one sieve to the next. Many of the undesired sizes will probably be thus lost, and hence the separation of the sieves results in a certain weeding out of undesired sand sizes. This condition corresponds to the condition of "loose coupling" in the case of the radio receiver. When the primary and secondary coils of the vario-coupler in Fig. 5 are closely coupled, the condition is analogous to that in which the sieves are close together. The various wave-lengths which pass through the primary circuit are all transmitted to the secondary circuit without much loss, but when they are loosely coupled, as when the sieves are far apart, some of the undesired wave-lengths passing through the primary circuit are lost in the passage to the secondary circuit, and thus sharper tuning is secured. Loose coupling will always yield more selective tuning than close coupling in receivers. Of course it is true, in the case of the sieves being widely separated, that some sand of the desired size will also be lost in the passage from the first to the second sieve. This is equivalent to the signal voltage in the secondary circuit being weaker than that in the primary circuit on account of this loss. This is why loose coupling will give a weaker signal than close coupling, but it has the far greater advantage of sharper tuning.

It was stated above that the single circuit tuner is inherently a broadly tuned receiver. Broad tuning is largely due to resistance in the circuit. The greater the resistance of a circuit the more broadly it tunes. Thus any circuit will tune broadly,

the degree of broad tuning depending upon its resistance. Coils and condensers have resistance, thus they increase the broadness of tuning. In the case of the single circuit tuner there is the additional resistance of the antenna which increases the broadness of tuning. If some means could be devised for counteracting this effect of resistance of circuits, tuning would be sharper. The most important method at our command to-day for counteracting resistance effects is that of "regeneration" as employed in regenerative receivers. The regenerative receiver, in effect, reduces the resistance of the receiving circuit, which, therefore, makes for sharper tuning. This is why the regenerative receiver is more selective than the non-regenerative.

The above explanations will give the novice an understanding as to what tuning accomplishes, how it is accomplished, and why some receivers are more selective than others. The analogies, while not absolutely perfect, will facilitate this understanding. We will now consider briefly just what steps are involved in the tuning of the different and more common types of circuits.

The single circuit tuner is the simplest of all tuners. This is its great advantage, in fact its simplicity is its only *raison d'être*. It has but one wave-length control. Fig. 9 shows the three principle types of single circuit non-regenerative tuners. In all of these sets the control knob, inductance or capacity, is simply varied until maximum signal is heard. This is the only adjustment that can or need be made, and the operator has to rest content with the signal as brought in by this adjustment. He can do nothing further to clear the signal of interference. It will probably be found that the single circuit containing the fixed inductance and condenser is the more selective of the three given.

Fig. 10 illustrates the single circuit regenerative tuner, circuit 1 using tickler feedback coupling, circuit 2 using plate variometer regeneration. The procedure in tuning these sets is as follows: Set the tickler coupling at its minimum and set the plate variometer at zero, that is at minimum

inductance. Tune the antenna circuit by means of the condenser or inductance, as above, until maximum desired signal is heard. Now gradually increase the tickler coupling or plate variometer inductance, as the case may be. An increase in signal strength will be perceptible as this adjustment takes place, up to a point where the signal suddenly becomes mushy or distorted. This is the point where the regeneration is so great that the circuit begins to oscillate. The proper operating point is just a little before this point in tickler coupling or variometer inductance is reached. Move tickler coupling and plate variometer back until the signal is cleared up again. Bring tickler coupling and plate variometer up again just a little before the point where the circuit began to oscillate. Now tune the aerial circuit again until signal is at its maximum. Alternate between adjusting plate coupling and antenna tuning, until the desired signal is at its maximum.

Fig. 11 illustrates a common type of two-circuit tuner. It will be observed that there are two adjustments in the antenna circuit, inductance and capacity, one adjustment in the secondary circuit, capacity, and a coupling adjustment; in all, there are four adjustments. Tuning a set of this description is a little more complicated than single circuit tuners. The procedure is as follows: Set the coupling so that it is tight; if the coupler is a loose coupler, bring the two coils very close together; if it is a vario-coupler set the dial at its maximum reading. Set the secondary condenser at about its middle position, half reading on the condenser dial. Set the inductance switch in the antenna circuit on the middle tap and tune with the antenna condenser until signals are heard. Tune with the secondary

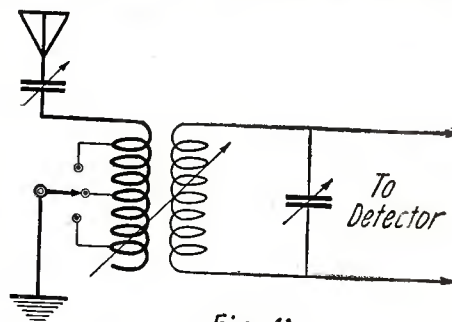
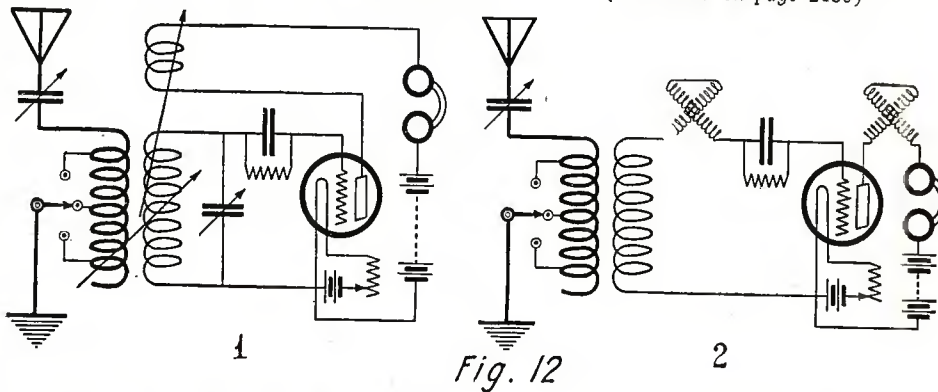

Fig. 11
A Two-Circuit, Non-Regenerative Tuner. The Coils Can Be Those of a Variocoupler, or a Loose Coupler.

condenser until the desired signal is heard in the phones. These preliminary settings and adjustments are merely to get your bearings, but after a little experience the operator will be able to make these preliminary settings and adjustments pretty accurately. If the desired signal does not come in, it may be necessary to tune both primary and secondary condensers together, (Continued on page 2180)



Two Types of Two-Circuit Regenerative Tuners. The First is of the Tickler Feedback Type; the Other Employs a Plate Variometer, to Produce Regeneration.

Complete List Of Broadcasting Stations In the United States

All stations operate on 360 meters except as below.

Those with * on 400; † on 485; o in back of any sign indicates "only," thus to means 485 meters only.

| Call | Name | City and State |
|-------|---|----------------|
| KDKA | Westinghouse Elec. & Mfg. Co., East Pittsburgh, Pa. | |
| †KDN | Leo J. Meyberg Co., San Francisco, Cal. | |
| KDPM | Westinghouse Elec. Mfg. Co., Cleveland, Ohio | |
| KDPT | Southern Electrical Co., San Diego, Cal. | |
| †KDYL | Telegram Publishing Co., Salt Lake City, Utah | |
| KDYM | Savoy Theatre, San Diego, Cal. | |
| KDYO | Carlson & Simpson, San Diego, Cal. | |
| †KDYQ | Oregon Inst. of Technology, Portland, Ore. | |
| KDYS | Great Falls Tribune, Great Falls, Mont. | |
| KDYV | Cope & Cornwell Co., Salt Lake City, Utah | |
| KDYW | Radio Dept. Smith Hughes Machinery Co., Phoenix, Ariz | |
| KDYX | Honolulu Star Bulletin, Honolulu, T. H. | |
| KDYY | Rocky Mountain Radio Corp., Denver, Colo. | |
| KDZA | Arizona Daily Star, Tucson, Ariz. | |
| KDZB | Frank E. Siefert, Bakersfield, Cal. | |
| KDZE | The Rhodes Co., Seattle, Wash. | |
| KDZF | Automobile Club of Southern California, Los Angeles, Cal. | |
| KDZG | Cyrus Pierce & Co., San Francisco, Cal. | |
| †KDZH | Fresno Evening Herald, Fresno, Cal. | |
| KDZI | Electric Supply Co., Wenatchee, Wash. | |
| KDZK | Nevada Machinery & Elec. Co., Reno, Nev. | |
| KDZL | Rocky Mountain Radio Corp., Ogden, Utah | |
| KDZM | E. A. Hollingsworth, Centralia, Wash. | |
| KDZP | Newbery Electric Corps., Los Angeles, Cal. | |
| KDZQ | Wm. D. Pyle Motor Generator Co., Denver, Colo. | |
| KDZR | Bellingham Publishing Co., Bellingham, Wash. | |
| KDZT | Seattle Radio Association, Seattle, Wash. | |
| KDZW | Claude W. Gerdes, San Francisco, Cal. | |
| KDZX | Glad Tidings Tabernacle, San Francisco, Cal. | |
| KDZZ | Kinney Bros. & Sipprell, Everett, Wash. | |
| KFAC | Glendale Daily Press, Glendale, Cal. | |
| KFAD | McArthur Bros. Mercantile Co., Phoenix, Ariz. | |
| KFAE | State College of Washington, Pullman, Wash. | |
| KFAF | Western Radio Corp., Denver, Colo. | |
| KFAJ | University of Colorado, Boulder, Colo. | |
| KFAN | The Electric Shop, Moscow, Idaho | |
| KFAP | Standard Publishing Co., Butte, Mont. | |
| KFAQ | City of San José, San José, Cal. | |
| KFAR | Studio Lighting Service Co., Hollywood, Cal. | |
| KFAS | Reno Motor Supply Co., Reno, Nev. | |
| KFAT | S. T. Donohue, Eugene, Ore. | |
| †KFAU | High School, Boise, Idaho | |
| KFAV | Ahbot Kinney Co., Venice, Cal. | |
| KFAW | Register-Radio-Den-Radiophone, Santa Ana, Cal. | |
| †KFAZ | Virgin Radio Service, Medford, Ore. | |
| KFBB | C. H. Weatherill, Reedley, Cal. | |
| KFBC | F. A. Buttrey & Co., Havre, Mont. | |
| | Normal Heights Station (W. K. Azbill), San Diego, Cal. | |
| KFBD | Mercantile Trust Co., Hanford, Cal. | |
| KFBE | R. H. Horn (Cline's Electric Shop), San Luis Obispo, Cal. | |
| KFBG | First Presbyterian Church, Tacoma, Wash. | |
| KFBH | Thomas Musical Co., Marshfield, Ore. | |
| †KFBK | Kimball-Upson Co., Sacramento, Cal. | |
| KFBL | Leese Bros., Everett, Wash. | |
| KFBM | Cook & Foster & Astoria Hardware Co., Astoria, Ore. | |
| KFBN | Borch Radio Corp. (Portable), San Diego, Cal. | |
| KFBO | Savage Electric Co., Prescott, Ariz. | |
| KFBS | Trinidad Gas & Electric Co. and Chronicle News, Trinidad, Colo. | |
| KFBU | The Cathedral (Bishop Thomas), Laramie, Wyo. | |
| KFBV | Clarence O. Ford, Colorado Springs, Colo. | |
| †KFC | Northern Radio & Electric Co., Seattle, Wash. | |
| KFCB | Nielsen Radio Supply Co., Phoenix, Ariz. | |
| KFCC | Auto Supply Co., Wallace, Idaho | |
| KFCD | Salem Electric Co., Salem, Ore. | |
| KFCF | Frank A. Moore, Walla Walla, Wash. | |
| KFCJ | Electric Service Station, Inc., Billings, Mont. | |

| Call | Name | City and State |
|---------|---|----------------|
| KFCK | Colorado Springs Radio Co., Colorado Springs, Colo. | |
| †toKFCL | Los Angeles Union Stock Yards, Los Angeles, Cal. | |
| KFCM | Richmond Radio Shop, Richmond, Cal. | |
| KFCQ | Motor Service Station, (Norman R. Hood), Casper, Wyo. | |
| KFDA | Adler's Music Store, Baker, Ore. | |
| KFDB | John D. McKee, San Francisco, Cal. | |
| KFDC | Radio Supply Co. (E. B. Craney), Spokane, Wash. | |
| KFDD | St. Michaels Cathedral, Boise, Idaho | |
| KFDF | Wyoming Radio Corp., Casper, Wyo. | |
| KFDH | University of Arizona, Tucson, Ariz. | |
| KFDJ | Oregon Agricultural College, Corvallis, Ore. | |
| KFDL | Knight-Campbell Music Co., Denver, Colo. | |
| KFEB | City of Taft, Taft, Cal. | |
| KFEC | Meier & Frank Co., Portland, Ore. | |
| KFED | Billings Polytechnic Inst., Polytechnic, Mont. | |
| KFEJ | Guy Greason, Tacoma, Wash. | |
| KFEF | Radio Equipment Co., Denver, Colo. | |
| KFFA | Dr. R. O. Shelton, San Diego, Cal. | |
| KFFE | Eastern Oregon Radio Co., Pendleton, Ore. | |
| KFGG | Astoria Budget, Astoria, Ore. | |
| KFGH | Stanford University, Stanford University, Cal. | |
| KFHI | Fallon Co., Santa Barbara, Cal. | |
| KFJ | Earle C. Anthony, Inc., Los Angeles, Cal. | |
| KFV | Foster-Bradbury Radio Store, Yakima, Wash. | |
| KFZ | The Doerr Mitchell Elec. Co., Spokane, Wash. | |
| KGB | Wm. A. Mullins Electric Co., Tacoma, Wash. | |
| KGG | Hallock & Watson Radio Service, Portland, Ore. | |
| KGN | Northwest Radio Mfg. Co., Portland, Ore. | |
| KGO | Altadena Radio Laboratory, Pasadena, Cal. | |
| KGU | Marion A. Mulroney, Honolulu, Hawaii | |
| *oKGW | Portland Morning Oregonian, Portland, Ore. | |
| KGY | St. Martins College, Lacey, Wash. | |
| †KHD | C. F. Aldrich Marble & Granite Co., Colorado Springs, Colo. | |
| †toKHJ | Times Mirror Co., Los Angeles, Cal. | |
| KHQ | Louis Wasmer, Seattle, Wash. | |
| KJC | Standard Radio Co., Los Angeles, Cal. | |
| KJJ | The Radio Shop, Sunnyvale, Cal. | |
| KJO | C. O. Gould, Stockton, Cal. | |
| KJR | Vincent I. Kraft (operated by Northwest Radio Service), Seattle, Wash. | |
| KJS | Bible Institute of Los Angeles, Los Angeles, Cal. | |
| KLB | J. J. Dunn & Co., Pasadena, Cal. | |
| KLN | Monterey Electric Shop, Del Monte, Cal. | |
| KLP | Colin B. Kennedy Corp., Los Altos, Cal. | |
| KLS | Warner Bros., Oakland, Cal. | |
| KLX | Oakland Tribune, Oakland, Cal. | |
| †KLZ | Reynolds Radio Co., Denver, Colo. | |
| KMC | W. W. Lindsay, Jr., Reedley, Cal. | |
| †KMK | San Joaquin Light & Power Corp., Fresno, Cal. | |
| KMO | Love Electric Co., Tacoma, Wash. | |
| KNI | T. W. Smith, Eureka, Cal. | |
| †KNJ | Roswell Public Service Co., Roswell, N. Mex. | |
| KNN | Bullock's, Los Angeles, Cal. | |
| KNT | Grays Harbor Radio Co. (Walter Hemrich), Aberdeen, Wash. | |
| KNV | Radio Supply Co., Los Angeles, Cal. | |
| KNX | Electric Lighting Supply Co., Los Angeles, Cal. | |
| †toKOA | Young Mens Christian Assoc., Denver, Colo. | |
| †KOB | New Mexico College of Agriculture and Mechanic Arts, State College, N. Mex. | |
| KOG | Western Radio Electric Co., Los Angeles, Cal. | |
| KON | Holzwasser, Inc., San Diego, Cal. | |
| KOP | Detroit Police Dept., Detroit, Mich. | |
| KPO | Hale Bros., San Francisco, Cal. | |
| KQI | University of California, Berkeley, Cal. | |
| KQP | Hood River News (Radio Shop of Hood River), Hood River, Ore. | |
| KQV | Doubleday Hill Elec. Co., Pittsburgh, Pa. | |
| KQW | Chas. D. Herrold, San José, Cal. | |
| KQY | Stubbs Electric Co., Portland, Ore. | |
| KRE | Maxwell Electric Co., Berkeley, Cal. | |
| *†KSD | Post Dispatch, St. Louis, Mo. | |
| KSL | The Emporium, San Francisco, Cal. | |
| KSS | Prest & Dean Radio Co., Long Beach, Cal. | |
| KTW | First Presbyterian Church, Seattle, Wash. | |

| Call | Name | City and State |
|----------|--|----------------|
| †KUU | San Francisco Examiner, San Francisco, Cal. | |
| KUS | City Dye Works & Laundry Co., Los Angeles, Cal. | |
| KUY | Coast Radio Co., Inc., El Monte, Cal. | |
| KVO | Sacramento Bee (Jos. McClatchy Co.), Sacramento, Cal. | |
| KWG | Portable Wireless Telephone Co., Stockton, Cal. | |
| †KWH | Los Angeles Examiner, Los Angeles, Cal. | |
| KXD | Herald Publishing Co., Modesto, Cal. | |
| KXS | Braun Corp., Los Angeles, Cal. | |
| KYI | Bakersfield Californian, Bakersfield, Cal. | |
| †KYJ | Leo J. Meyberg Co., Los Angeles, Cal. | |
| KYO | Electric Shop, Honolulu, Hawaii | |
| *†toKYW | Westinghouse Elec. & Mfg. Co., Chicago, Ill. | |
| KYY | Radio Telephone Shop, San Francisco, Cal. | |
| KZC | Public Market & Dept. Stores Co., Seattle, Wash. | |
| †KZM | Preston D. Allen, Oakland, Cal. | |
| †KZN | The Deseret News, Salt Lake City, Utah | |
| KZV | Wenatchee Battery & Motor Co., Wenatchee, Wash. | |
| KZY | Atlantic & Pacific Radio Supply Co., San Francisco, Cal. | |
| WAAC | Tulane University, New Orleans, La. | |
| WAAD | Ohio Mechanics Institute, Cincinnati, Ohio | |
| †WAAP | Chicago Daily Drivers' Journal, Chicago, Ill. | |
| WAAB | Radio Dept. Commonwealth Electric Co., St. Paul, Minn. | |
| WAAC | Eastern Radio Institute, Boston, Mass. | |
| †WAAD | Gimbel Bros., Milwaukee, Wis. | |
| WAAL | Anderson Beamish Elec. Co., Minneapolis, Minn. | |
| WAAM | I. R. Nelson Co., Newark, N. J. | |
| †WAAN | University of Missouri, Columbia, Mo. | |
| †WAAP | United Electric Co., Wichita, Kans. | |
| WAAP | New England Motor Sales Co., Greenwich, Conn. | |
| WAAS | Georgia Radio Co., Decatur, Ga. | |
| †WAAS | Omaha Grain Exchange, Omaha, Neb. | |
| WAAX | Radio Service Corp., Crafton, Pa. | |
| WAAY | Yahrling-Rayner Music Co., Youngstown, Ohio | |
| WAAZ | Hollister-Miller Motor Co., Emporia, Kansas | |
| †WAH | Midland Refining Co., El Dorado, Kansas | |
| WBAA | Purdue University, West Lafayette, Ind. | |
| WBAB | Andrew J. Potter, Syracuse, N. Y. | |
| WBAD | Sterling Electric Co., Minneapolis, Minn. | |
| WBAF | Fred M. Middleton, Moorestown, N. J. | |
| †WBAG | Diamond State Fibre Co., Bridgeport, Pa. | |
| WBAH | The Dayton Co., Minneapolis, Minn. | |
| WBAJ | The Marshall Gerken Co., Toledo, Ohio | |
| WBAN | Wireless Phone Corp., Paterson, N. J. | |
| WBAO | James Millikin University, Decatur, Ill. | |
| *†toWBAP | Wortham-Carter Pub. Co., Fort Worth, Texas | |
| WBAU | Republican Publishing Co., Hamilton, Ohio | |
| †WBAV | Erner & Hopkins, Columbus, Ohio | |
| WBAW | Marietta College, Marietta, Ohio | |
| WBAX | John H. Stenger, Jr., Wilkes-Barre, Pa. | |
| †toWBAY | American Tel. & Tel. Co., New York, N. Y. | |
| WBL | T & H Radio Co., Anthony, Kansas | |
| WBS | D. W. May, Inc., Newark, N. J. | |
| †WBT | Southern Radio Corp., Charlotte, N. C. | |
| WBU | City of Chicago, Chicago, Ill. | |
| *oWBZ | Westinghouse Elec. & Mfg. Co., Springfield, Mass. | |
| WCAB | Newburgh Daily News, Newburgh, N. Y. | |
| WCAC | John Fink Jewelry Co., Fort Smith, Ark. | |
| WCAD | St. Lawrence University, Canton, Ohio | |
| *oWCAE | Kaufman & Baer Co., Pittsburgh, Pa. | |
| WCAG | Daily States Pub. Co., New Orleans, La. | |
| WCAH | Entreklin Electric Co., Columbus, Ohio | |
| †WCAJ | Nebraska Wesleyan University, University Place, Nebr. | |
| WCAK | Alfred P. Daniel, Houston, Texas | |
| WCAL | St. Olaf College, Northfield, Minn. | |
| WCAM | Villanova College, Villanova, Pa. | |
| WCAO | Sanders and Stayman Co., Baltimore, Md. | |
| †WCAP | Central Radio Service, Decatur, Ill. | |
| WCAQ | Tri-State Radio Mfg. & Supply Co., Defiance, Ohio | |
| WCAR | Alamo Radio Elec. Co., San Antonio, Texas | |
| WCAS | Wm. Hood Dunwoody Industrial Institute, Minneapolis, Minn. | |

The Future Of Radio

Address by the Hon. Mohammed Ulysses Socrates Fips, Head Office Boy



Instead of the Ordered 50 Lbs. of Hexagonal Nuts, the Hardware Company Received 50 Lbs. of Pecan Nuts.

Every School-Boy Who Owned a Radio Set Could Receive All the Alcohol From Europe That He Wanted. It Came Near To Being Disastrous To Our Younger Generation



Ladies and Gentlemen:

May I ask your kind indulgence for my somewhat untidy appearance this evening? I have been so overwhelmed with work, during the past three weeks, that I have actually had but eight hours of sleep during that time. The balance of the nights I have been forcibly kept awake by means of the electric Sleep Eliminator. I have not shaved in two weeks, and my only bath was a radio-electric high frequency one while I slept.

So if the radio audience will kindly stop frowning at my wild appearance, I will go on. Thank you SO much—beg pardon?

A gentleman with a huge beard, in the Chicago audience, just asked why I was not shaved while I slept. Hm! True. Probably for the same reason that my questioner grows a hedge on his face while he's awake!

But to resume. My radio brethren know why I am here tonight. When I asked the American Radio Council to broadcast last night the Radio Sirene, and asked to have every radio citizen sit in at the proceedings tonight, I made this request not lightheartedly. Just a moment, please—

My attendant just informs me that you have responded nobly. There are 109 mil-

lion radio citizens sitting in at this radio meeting. Think of it, my friends, 109 million—14 million more than when ex-President Ford made his inaugural speech in 1953, just 20 years ago. Tonight, therefore, will go down in history as the greatest radio assembly ever recorded. I can see you, and hear you applaud, and I congratulate you!

Radio Citizens! You know the reason why I, as President of the American Radio Council, have asked your attendance tonight. I come before you on this historical occasion to urge you to rise against our present oppressor and tyrant, the unspeakable Radio Trust!

This titanic octopus which reaches into the innermost recesses of our homes, nay, our very bodies, there to suck out the life blood of the nations, must be crushed, destroyed, annihilated. You know its history. It started in 1921, innocently enough, with a few broadcasting stations. Our grandfathers of that time had little fault to find with the innocent pastime of listening in to concerts, speeches, and operas. Then, in 1926, when there were over 6,000 radio broadcasting stations in America, the nightly chaos and interference had become so great

that President Bryan signed the Radio Act of 1926, which required that, henceforth, only six super-broadcasting stations would be allowed to operate. These stations, as you probably know, operated on 50,000 Watts, and each one broadcast 24 different forms of entertainment simultaneously. Inasmuch as the Marconi Restricted-Directional Wave System was used by these stations, each station covered exactly to the inch its allocated zone. Thus, if you know your radio history, you will remember that if you were located at San Francisco it was impossible to tune in to the New York district, or, for that matter, any other radio district except your own, due to these Restrictive-Directional Waves. As all the programs, however, were almost identical, this did not matter much, particularly since, by that time, people were no longer interested in long distance reception.

About that year, the control of the six big national stations passed into the hands of the Amalgamated Broadcasting Corporation—the present trust, known only by its initials, the A.B.C. Trust. Then things began to happen. Up to that time the men

(Continued on page 2157)

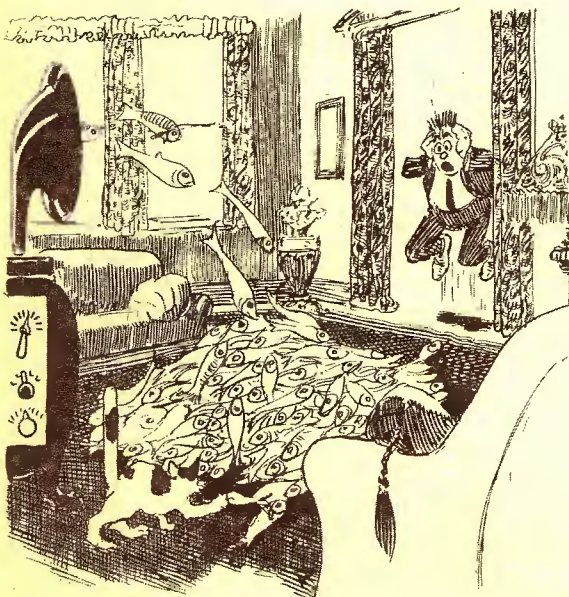

Upon Arriving Home, I Found 200 Lbs. of Herring On the Parlor Rug. Delivered Through Parlor Radio Outfit.

Thus, Katinka's Electric Iron In the Kitchen Would Suddenly Go Cold and Start To Recite a Bedtime Story.



Radio Pictorial



Upper Right Photo Shows Captain A. J. Hillary, Master of the Mail Boat "President," Receiving Information By Radio as to the Number of Bags of Mail on Board an Incoming Liner. Above: A Picture of a One-Kilowatt Ship Type of Quenched Spark Transmitter. This is the Most Efficient Form of Spark Transmitter, But, Due to the Greater Efficiency of C.W., They Are Being Converted Into the Latter. Aside From the Quenched Spark Gap, All the Other Apparatus is Made Use of in the Conversion.

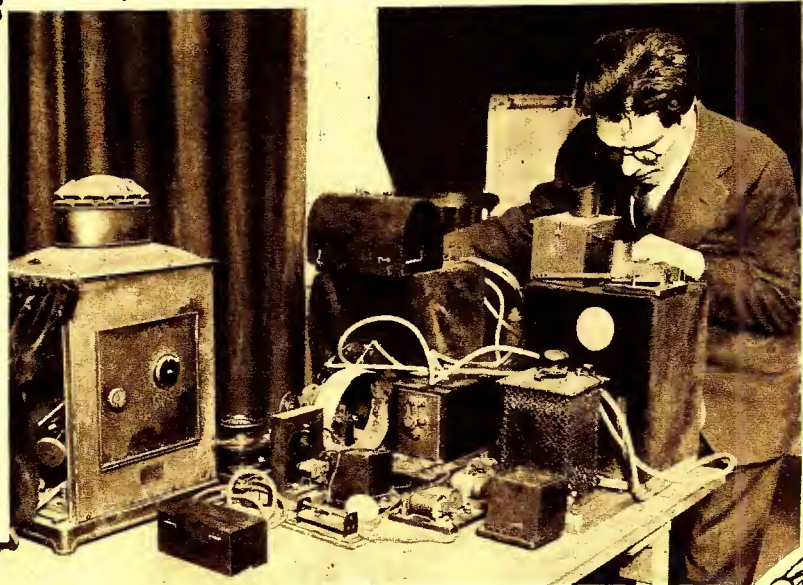

Above is a Photo of Professor Low and the Apparatus With Which He Can Wireless Photographs, Just as a Voice is Wireless. Professor Low Was Granted His First Patent in 1917. Left: A Boy Scout of Troop 501, New York City, Operating a Portable Radio Set While Out On a Hike. The Outfit Both Sends and Receives and Was Perfected by Boy Scouts of the Above Troop. It is Entirely Self-Contained and Uses Both "A" and "B" Batteries With But One Tube.

Mr. Filbert Tunes In

By ELLIS PARKER BUTLER
Author of "Pigs Is Pigs"



"Each Woman Sat In a Porcelain Basin! For Insulation, Sir! The Hair of Each Woman Was Done In Two Braids, and These Were Connected Together In One Long Chain. Those Women, Sir, Were Being Used As An Antenna Made of Human Hair!"

WHILE Mr. Filbert was not utterly and absolutely bald, he was almost that. He had so little hair that his beautifully egg-shaped cranium was like a polished dome, and it glistened with high-lights. He was a very bald man, but neat and dressy, and he wore a slender gold chain with his eye-glasses. He had a well-washed look and gave forth an odor of twenty-five cent toilet soap. Altogether he was a nice little man, doing a fairly good business in the commission hosiery line, but his very appearance showed he thought well of Mr. Filbert. Except for his baldness, which he deeply regretted, Mr. Filbert thought Mr. Filbert was just about all right.

Frequently, after emerging from his morning bath or while shaving, or at other times, Mr. Filbert put his head very close to his mirror and examined the top of his head carefully, looking for fuzz. He had, since his baldness, tried twenty-six varieties of hair restorer, but none had done his head the least good. He had, therefore, sworn never to buy another bottle of hair restorer and, when our

story opens, he was trying the Coué method. In the morning, during the day, and at night he repeated faithfully, "Every day, in every way, I am growing hairier and hairier." Unfortunately, when he looked at the bald top of his head, there was no proof that he was growing hairier—not the slightest! Not even the amount of down that shows on a ripe peach appeared on his head. If Mr. Filbert had wished to utter truth, his chant would have been, "Every d'v, in every way, my dome is growing glossier, and glossier."

Being a small man and nervous, and overburdened with business—for he was doing twice as much as he should have tried to handle—Mr. Filbert was often cross and irritable. He was so on this busy morning, when his office boy interrupted him as he was opening his mail. A large greenish-blue fly had been buzzing about Mr. Filbert's head, alighting on it now and then, and Mr. Filbert had slapped at the fly twenty times. Always he missed the fly. Always his hand smacked down on his own bald head with a sound like that made by a dairymaid when she smacks a pat of butter with the butter paddle. Always the fly buzzed away unharmed and returned to alight on Mr. Filbert's head once more.

"Say, boss," the office boy said, "there's a gink out here wants to sell you something. I guess he's a bootlegger. He's got a valise full o' something that clinks like booze bottles."

"I don't want any!" exclaimed Mr. Filbert angrily. "I won't see him! Kick him out of the office! Tell him to—"

"The question—" said a voice behind the office boy; "the question is this: Are you, or are you not, in tune with the Infinite?"

Mr. Filbert looked up and saw a thin, loose-jointed man, who pushed past the office boy, pushed the office boy out of the office, closed the door, and put a large valise on Mr. Filbert's desk.

"Get out! I don't want any hooch; I don't want any booze; I don't want anything in that line at all! Get out!"

"I am not selling booze, sir," said the stranger. "I came here to ask you one question. I came to ask you: 'Are you in tune with the Infinite?' I see you are not; you are bald. You are, if I may say so, as bald as a billiard ball that has had the mange. You are absolutely, completely, disgracefully bald!"

Mr. Filbert was so angry that even the
(Continued on page 2124)

Newark Apartment Gives Complete Radio Service



© WESTERN ELECTRIC CO.

TO Newark belongs the distinction of being the first city in which apartment house owners give their tenants complete radio service.

This service, which in truth might be said to be the last word in modern improvements, is accomplished by means of an adaptation of the Western Electric Public Address System installed in the pent house atop the Ritz Apartments at 299 Clinton Avenue, Newark, N. J.

In any of the 72 suites, a member of a family, by merely slipping on a headset and inserting a convenient plug, can comfortably sit in his or her home and listen to the country's best radio programs.

F. B. Kopff, the superintendent of the building, says the popularity of this innovation in apartment house service is evidenced by the fact that but comparatively little elevator service is required in the evenings; the greater number of the Ritz tenants prefer to stay in and listen to radio programs.

The operator up in the "Radio Room" on the Ritz roof must needs combine diplomacy with ability when he selects and picks up from the air a program that will suit the preferences of all the people in the 72 apartments. But thus far he has been so successful in his selection that even a loud speaker could not make the complaints audible, for there have been none. However, should such a contingency ever occur, it will be readily taken care of by installing an additional radio receiving set.

The equipment now used gives adequate service. It consists of a radio receiving set and a high-power amplifier. There are four vacuum tubes in the receiver which provide a means of detection, two stages of radio frequency and a single stage of audio frequency amplification. The complete set can be operated on dry batteries.

Because of the set's sensitiveness and selectivity, every city in the Union which has a 500-watt broadcasting station has been heard by the families living in the Ritz apartments.



The Ritz Apartment In Newark, N. J., Is One of the First to Give Tenants Complete Radio Service. A Sensitive Radio Receiver Picks Up the Concerts, Which Are Then Magnified By a Power Amplifier and Carried By Wire Direct to Each Individual Apartment. A Plugging Arrangement in the Walls Makes It Possible For the Tenants to Listen In At Will. The Photo In the Upper Right-Hand Corner Is That of the Receiving Set Installed on the Roof of the Ritz Apartment House.

By means of a specially designed input coil, the radio receiver is connected to a Western Electric amplifier.

Power type tubes provide three stages of audio frequency amplification, the last stage being push and pull.

Incoming radio signals detected by the radio receiver are amplified and thence wired to all the 72 apartments, each of which is equipped with a headset of high

impedance type and with a special receptacle.

The telephone jacks used in these receptacles are so arranged that no matter whether a few or all 72 headsets be used, the quality and volume will be in no wise impaired.

The possibility that apartment houses which provide radio service may become as tumultuous as the Tower of Babel is easily averted. By using headsets rather than loud speaking projectors, there can be no "bedlam," yet each tenant is given clear reception and faithful reproduction of broadcast numbers.

Superintendent Kopff believes in the practical application of the old adage: "All work and no play makes Jack a dull boy." He finds that the workers in the big boiler room of the Ritz perform their tasks with much more zest after intermissions or "recesses for radio." Accordingly, at intervals the workers in the cellar are given the opportunity to listen to what the chap on the roof picks up from the ether. And usually the effect is enlivening.

Ten Commandments for Broadcasting Stations

1. Thou shalt not monopolize the air either individually or in partnership with other nearby stations, but shalt leave some portion of each evening free from local broadcasting.

2. Thou shalt use every endeavor to introduce novelty into thy programs that thy broadcasting days may be long in the land.

3. Thou shalt assure thyself that those who are to make speeches over thy broadcasting outfit wilt have something interesting to say.

4. Thou shalt announce before each number of thy program thy call letter and also thy city.

5. Thou shalt tune thy set carefully to

(Continued on page 2138)

Notes On the WD-11 Tube

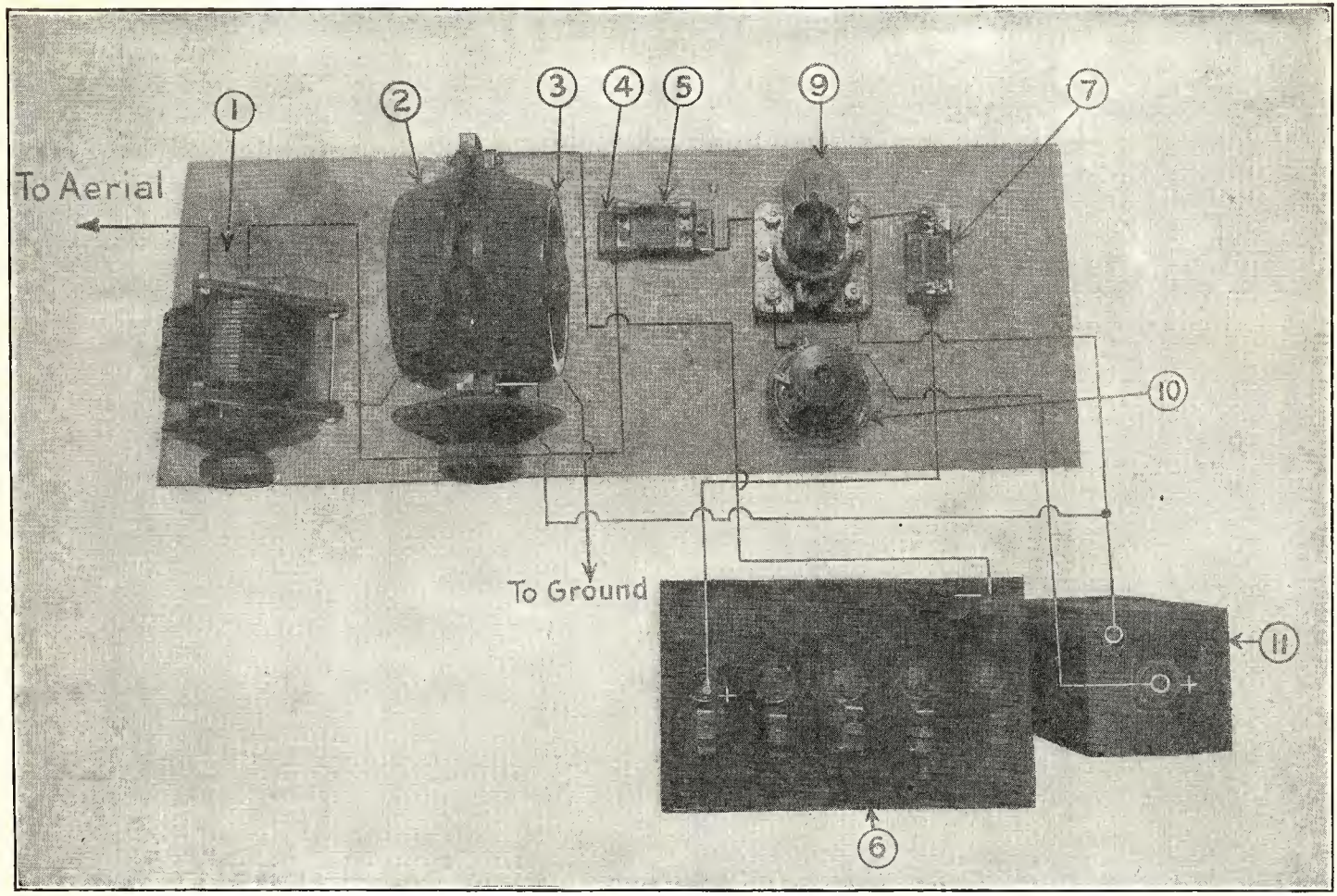

The Conventional Layout of a Single-Circuit Regenerative Receiver. The Rotor of the Variocoupler Is Used As a Tickler Coil. The Phones Connect Directly Onto the Posts of the Phone Condenser "7." This Layout Helps To Give An Idea of How the Apparatus Would Be Placed On a Panel.

AMONG the simple types of vacuum tube receiving sets, that known as the single circuit regenerative receiver is the most widely used. Although it is not as selective as other adaptations, it has become very popular, due to its capability of picking up long distance stations.

The single circuit regenerative receiver is very effective when a WD-11 tube is employed. A circuit of this type is shown in Fig. 1. Feedback for regeneration is obtained by a tickler coil, which in this case is the rotor of a variocoupler, the stationary coil being used as the tuner. To increase the selectivity of the outfit, a variable condenser is placed in series with the aerial and stationary coil of the variocoupler.

The apparatus necessary for this receiver, and their corresponding numbers in the diagram and photograph are: 1, variable condenser (.001 M.F.); 2-3, variocoupler; 4, grid condenser (.00025 M.F.); 5, grid leak (1 megohm); 6, "B" battery (22½ volt); 7, phone condenser (.001 M.F.); 8, phones; 9, WD-11 1½ volt tube; 10, rheostat; 11, 1½ volt dry cell, and a vacuum tube socket.

A convenient layout is shown in the photograph. The apparatus is so placed that the shortest leads are possible. When mounting this apparatus on a panel, the variable condenser should be on the extreme left followed by the variocoupler and the vacuum tube control.

In wiring this set, it is advised that each wire connected be checked up on both the diagram and photograph before proceeding with another.

After the receiver is completely wired, connect in the "A" and "B" batteries and attach the aerial and ground to their proper places. Start by slowly turning on the rheo-

stat until the filament of the vacuum tube burns a cherry red. Next, determine whether the tube will oscillate or not, by tightening the coupling between the tickler coil and the tuning inductance. Tightest coupling is had when the tickler (rotor) is parallel with the tuning inductance (stationary coil). Oscillation is accompanied by a plucking or clicking noise in the phones. Try this at various adjustments of the variable condenser and tuning inductance. If oscillation cannot be obtained the two leads to the tickler coil should be reversed or in the case of a variocoupler in which the rotor can be revolved through 360°, it should be rotated until oscillation does occur.

To operate the set, first adjust the tickler coil to a point below where the tube starts to oscillate. Vary the inductance switch until a station is picked up, then move the condenser and tickler knobs at the same

time until the signals are loudest. Best results will be obtained just below the point of oscillation. Try placing the switch arm on different switch points, and readjusting the circuit as outlined above, for there will be found definite combinations of inductance (the coil) and capacity (the condenser), which will work best on a certain wave-length. If it is desired to use a six-volt vacuum tube such as the U.V. 200 or C. 300, the socket procured should be one that will take a standard type tube. In this case, the 1½-volt dry cell should be replaced by a six-volt storage battery of from 40- to 60-ampere hour capacity.

THAT MYSTERIOUS AMPLIFIER TROUBLE

After operating a single-tube regenerative set for some time, I decided to add a one-step audio frequency amplifier. When all was ready I sat down to listen for an amateur radiophone, expecting to hear it fine and loud. The amplifier would not work.

On the detector alone everything was O. K., but as soon as I switched to the amplifier the set would not oscillate and signals were mushy and only one-fifth as loud as on the detector alone.

Thinking it must be the transformer, I had an electrical engineering firm test it; in fact, so sure was I that the transformer was defective that I asked for a quotation for repairing it! However, they found nothing wrong with it. As I had been looking for the trouble for close on three weeks, I was getting pretty disgusted.

It only then occurred to me that my phones had the usually high resistance of

(Continued on page 2138)

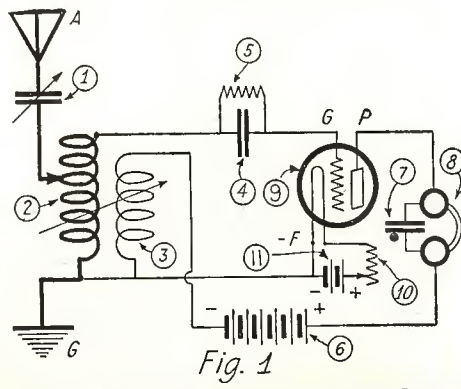

Fig. 1
This Is the Circuit Used With the Receiver Shown Above. The Instruments Are Numbered the Same As In the Photograph.



THIS Department is open to all readers. It matters not whether subscribers or not. All photos are judged for best arrangement and efficiency of the apparatus, neatness of connections and general appearance. In order to increase the interest in this department, we prefer to publish photographs of stations accompanied by a picture of the owner.

We prefer dark photos to light ones. The prize winning pictures must be on prints not smaller than 5 x 7". We cannot reproduce pictures smaller than 3½ x 3½". All pictures must bear name and address written in ink on the back. A letter of not less than 100 words giving full description of the station, aerial equipment, etc., must accompany the pictures.

PRIZES: One first monthly prize of \$5.00. All other pictures will be paid for at the rate of \$2.00 each.

Station 8AZ

Emmanuel Missionary College, Berrien Springs, Michigan

This Month's Prize Winner

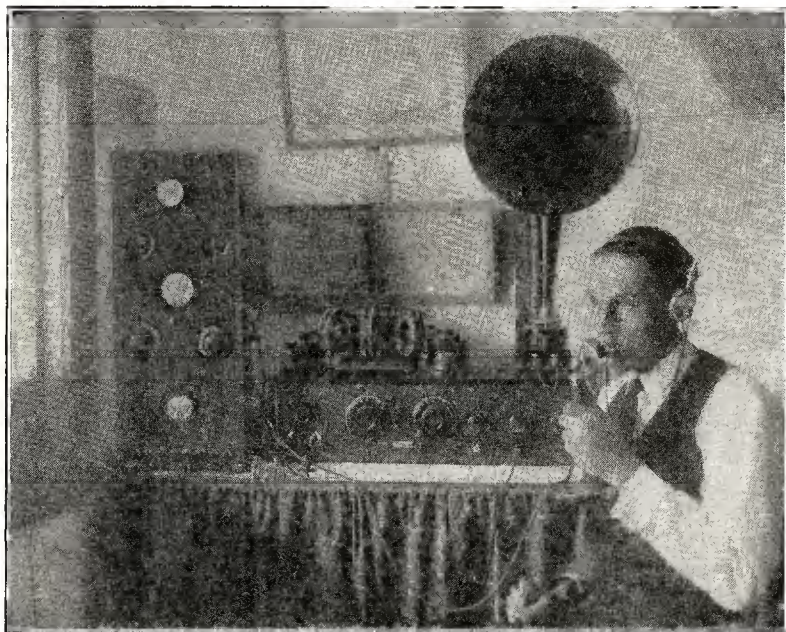

Station 8AZ Is Our Idea of a Good Station. The Fact That It Has Been Heard In France Is Enough To Vouch For Its Efficiency. Mr. Fetzer, the Operator, Is Shown In the Photo.

always given satisfactory service in relay work. The set has been in operation at the Emmanuel Missionary College for the past six months. We have received reports on signals very QSA up to 1,000 miles. The set has been in communication as far east as New York City and some other points scattered throughout the southern and western states. 8AZ does not get in the "calls heard" very much mainly through lack of time to be on the air. The station at present does not operate on the regular schedule, also the wave is very sharp owing to the fact that a motor generator (¼-H.P. motor, driving a 220-volt D.C. motor as a generator), thus the receiving operator must be on the job to tune in my signals. In these days of A.C. on the plate in most C.W. sets, I think that the average operator is becoming careless in his tuning.

The receiving set is the usual three-circuit tuner with detector and two stages of audio. Aside from the short wave set, there is the long wave set on top. This set has received signals up to 6,000 miles. The receiving set is also home-made.

The aerial is 65' high at one end and 45' at the other end. It is a cage consisting of six wires strung on tapering hoops varying from 8" to 18" in diameter. For transmitting, a counterpoise is used. It consists of six wires strung in a fan shape 10' above the ground. I neglected to state, while speaking of the transmitter, that it has been in communication up to 80 miles by voice. Absorption loop modulation is used in conjunction with a low resistance Western Electric microphone transmitter. This station was previously located at Lafayette, Indiana (radio 9FB). While there, it made the same reputation for itself that it has here.

J. E. FETZER,
Operator Radio 8AZ.

THINKING that perhaps you would be interested in hearing from radio station 8AZ, I decided to write you.

I think that this station has made a record to be proud of, noting the fact that it was heard in France by Pierre Louis, station 8RRX, during the A.R.R.L. tests, as given in the March issue of RADIO NEWS. The enclosed picture, at the left, shows the tall panel of the C.W. set that did the business. It is only a ten watter, HI. As can be seen, the two five-watt tubes are visible through the two large holes. The meter at the top

is the radiation ammeter; radiation at the time of the tests was 1.2 amperes. The meter in the center is a 15-volt A.C. type used for filament readings for the tubes. Just below are the two dials; the one on the left controls the filaments while the one on the right controls the 23-plate V.C. The meter at the bottom is a millimeter for plate readings. There is nothing fundamentally new about the circuit, it being the familiar "British Aircraft" circuit employing a grid controlled by a variable condenser. The whole set is home-made throughout, and has

Mr. I.R. Groves' Station 2DX Summit, N. J.

A PICTURE and description of this station appeared in RADIO NEWS for August, 1920. Since then the station has been modernized. The old 1-K.W. stone crusher has given way to a 10-watt C.W. set. The old honeycomb coil receiver is now replaced by a Reinartz improved tuner with one stage of amplification. This receiver works better on C.W. stations than any other tuner tried. Every district, all Canadian districts, and Porto Rico have been logged. A log is only kept of stations over 1,000 miles away.

The transmitter consists of all Radio Corporation parts. It is rated at 10 watts output. The output has been measured and found to be 44 watts delivered to the an-

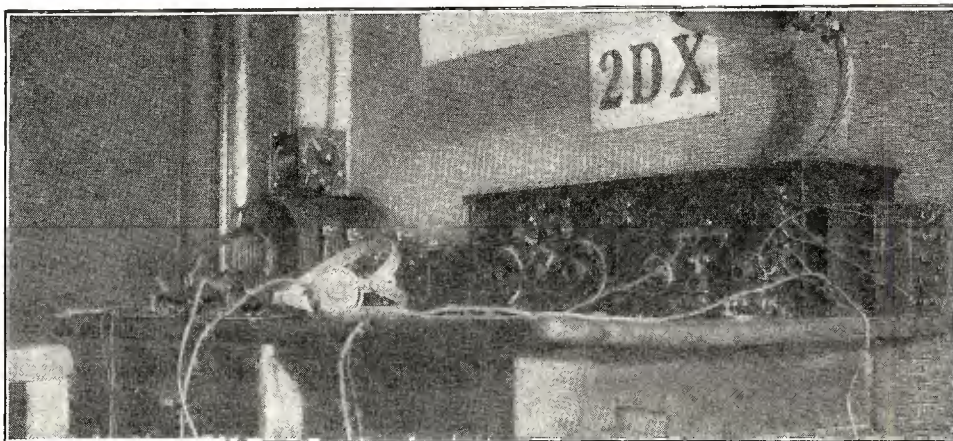

There Is Something Very Impressive About the Appearance of Station 2DX. We Should Like To Bet That Mr. Groves Keeps a Clean Hook.

tenna, with 1,100 volts on the plates. This high voltage does not seem to harm the tubes, as the plate current is kept down. The radiation measured in the antenna lead is 3.1 amperes with 1,100 volts and 2.2 amperes with 550 volts on the plate.

The antenna originally consisted of a 6-wire flat top 80' long, and 55' high. This antenna was destroyed in a storm a few days after C.W. was substituted for spark. The present antenna consists of only one wire 100' long and 20' high. The counterpoise consists of six wires 60' long and about 40' wide.

With the one-wire aerial and counterpoise, C.W. has been reported in 27 states the greatest distance being 1,650 miles. This station is only on the air in the summer and a couple of weeks during the winter, due to the owner being at college.

FRENCH REPORTS ON THE TRANS-ATLANTIC TESTS

By DR. PIERRE CORRET

Owing to the short time allowed the French amateurs for the installation of transmitters, only 10 out of the 23 stations were able to send during the last trans-Atlantic tests. Only one of them, 8AB, was heard in the United States.

Several stations have had considerable trouble on account of the difficulties encountered in the erection and operation of transmitters which were thrown together in haste for the tests. Most of them worked only a few days during one or two hours. We believe that, if the American amateurs had not experienced so much QRM during the second period of the tests, several French stations would have been heard. The only station which was received has a special license and is authorized to use 1 K.W. of power on C.W. Four 250-watt tubes connected in parallel constitute the transmitter which is supplied with 25-cycle A.C. on the plates. The average intensity of the aerial is about 5 amperes on a wave-length of 195 meters. The antenna is formed of three cages 6' in diameter and about 60' long.

RECEPTION

Although the French amateurs have not

been successful at transmitting, they received quite a number of American stations during the first period of the tests. 26 French amateurs and two in Switzerland received 246 amateur stations among which only two were using spark (1BCF and 2RP). Better results were obtained in England by a greater number of amateurs accustomed for a long time to receive on short wave-lengths. However, it is interesting to consider the results obtained in France with various types of receivers. The table below shows the superiority of the super-heterodyne, with which the greatest number of stations was heard. We did not mention the number of stages of audio frequency amplification as this does not very much improve the range and was varied during the tests according to the amount of static which varied from day to day.

Four stations used Reinartz tuners, one with two stages of radio frequency with iron core transformers and the others without any radio frequency at all. With such a tuner, using only one tube, one of the stations was able to receive quite often the programs from the broadcasting station WJZ at Newark, New Jersey, which was also received by several amateurs throughout France.

In concluding, we could say that the recent series of tests demonstrated the possibility of long range communication with short wave-lengths and we hope on this side that during the coming tests, the QRM will decrease sufficiently in the United States to allow some well-equipped amateurs to receive our transmission as we, of course, are very anxious to try our hand at sending.

| Type of Receiver | No. of Stations using it | Stations heard with these receivers |
|--|--------------------------|-------------------------------------|
| Super-heterodyne | 2 | 158 |
| 1 Stage of tuned radio frequency | 7 | 153 |
| No R. F. amplification... | 8 | 102 |
| R. F. with air core transformers | 4 | 59 |
| Several stages of tuned R. F. | 3 | 9 |

DX'S TAKE NOTICE

Mr. J. M. Cook and Mr. F. W. Crannell of Longford, South Dakota, are the joint owners of a Grebe CR-5 and a Grebe CR-8, each plus two audio. They have done some notable work with these combinations and are anxious to arrange DX tests.

Quoting the owners' communication: "Specializing on the receiving end, we have copied amateurs in every district in the United States as well as quite a number of Canadian brass pounders. As for broadcasters, we have over 300 different stations to our credit; we have tuned in as many as 48 in one evening. We use mostly a two-wire aerial 100' long and 60' high. We listen in practically every evening, with the exception of Wednesdays and Saturdays, from about 8 o'clock to well towards midnight. We make a practice of staying up all night at least once in every three weeks. We would be very glad to listen in for any amateur who would care to arrange a test with us. Within a month we hope to be in on the air with a 50-watter. Reports addressed to either of us will be very much appreciated."

J. MERVIN COOK,
FORREST W. CRANNELL,
Longford, South Dakota.

FENCE THEM IN

Some Congressmen seem to think that radio can be laid out like pastures of grazing lands with neat wire fences which would keep the broadcasts and messages within the confines of a State. Two of them actually believe that State rights are involved in the bill before the House and want local radio control left with the state governments. "DX's" take notice!

5AHS

The call 5AHS has been issued to S. T. Donnell, 611 W. 3rd Street, Lampasas, Texas. He would appreciate word from any of those hearing his C. W. signals.

C. W. and Phone Transmitter Contest

THERE are at present any number of C.W., I.C.W. and phone transmitters being used by amateurs, which give more than usual results. There is a wide variety of circuits to pick from, and there are numerous tricks that have proved of great advantage in the attempt to reach out. These little things pave the road to development, but in the average case, they fail to see the light of day, when other than the originator is concerned. Many of you have 5- or 10-watt C.W., I.C.W. or phone sets that are giving excellent results. There are many who would like to get the "dope" on these. In order to help those who have C.W. sets, or are contemplating the building of one, we are starting this contest, and hope to get some real information. Break out with those hidden stunts and let us all know how you made your set, and why you made it that way.

It has been the custom of RADIO NEWS to offer \$10.00 for good suggestions. We are, in this instance, indebted to Mr. E. H. Vance, 5483 Kimbark Avenue, Chicago, Ill., who suggested that we run a C.W. and phone contest.

Rules of Contest

The set to be described should be of the vacuum tube type, using one, or not more than two, 5-watt tubes, and not over

750 volts on the plate. The important part is, that the set must have been actually built; that it is either in use now, or has been in use. Ideas or patent descriptions are strictly excluded from the contest. It is also obvious that, insofar as this contest is conducted chiefly to bring out new ideas, commercial outfits as now sold by several makers are ex-

cluded from the contest. It is necessary to state what instruments are used and, if certain instruments have been bought, the make must be stated. The transmitting distance of the set should be given, i. e., the record distance covered with the set, and DX report cards should be included. These cards should bear a postmark anterior to May 10. A complete diagram

of connections used, executed neatly in ink, is to be furnished. One or two good photographs, not smaller than 4" x 6", giving at least two views of the set, are necessary. The photograph of the builder is also desirable. The sizes, and the kinds of wires used in the construction, must be given, as well as the dimensions and constants of the principal parts. More than one outfit may be entered by any contestant.

The contest is open to everyone (Radio Clubs included) except manufacturers of wireless apparatus. The manuscript should not be longer than 1,500 words; 1,000 words are preferred.

If two contestants should send in the same winning experience, both will receive the same prize. In the event of two or more persons sending in the same as best, second best, etc., each tying contestant will receive the prize tied for.

Prize winning letters will be judged as follows: The first prize will be awarded for the letter giving the oddest or most unusual experience. The second prize to the one considered next best, and so on. All prizes will be paid upon publication.

This contest closes in New York on May 25 and the names of the winners will appear in the August issue of RADIO NEWS

\$100 in Prizes

- First prize \$50
- Second prize \$25
- Third prize \$15
- Fourth prize \$10

cluded from the contest. It is necessary to state what instruments are used and, if certain instruments have been bought, the make must be stated. The transmitting distance of the set should be given, i. e., the record distance covered with the set, and DX report cards should be included. These cards should bear a postmark anterior to May 10. A complete diagram

American Amateurs Heard in New Zealand

WE have a letter from a New Zealand "ham" stating that American Amateur C.W. signals are being heard there fairly regularly, but due to bad static conditions generally prevailing it is difficult to identify call signs. Call signs 8AFD and 8ALT have been identified, but in neither case could it be determined whether this was the station called or the calling station. The distance separating the nearest coast liner is approximately 6,000 miles, so it appears that in the early future there will be good prospects of inter-communication between the two countries.

If there are any skeptics, let them go over the log of Mr. R. Slade, Belfield House, Waimataitai, Timaru, N. Z., which is printed below:

U. S. AMATEURS RECEIVED
By MR. R. S. SLADE
Nov. 5TH
(New Zealand mean time)

6KA calling —
9YAJ calling CQ
9BED calling —
9UW calling —
6BCR calling 9BED
5PX calling CQ
Nov. 7TH
6KA calling — (9:45)
6KA calling 2ZO (9:52)
6KA calling — (10:03)
6KA calling — (10:26)
Nov. 8TH
6KU calling 9AMQ (9:07)
9AJP calling CQ (9:29)
9CNS — (10:02)

Nov. 9TH
6XAD calling 8UM (8:09)
6EN calling — (8:15)
5XAD or XWI (?) calling CQ (8:20)
6XAD calling 5XAD (?) (8:25)

9AWM calling CQ (9:05 and 9:20)
6KA calling 7MZ (9:35)
6KA calling 1BGF (9:42) and at (10:08)
6KA calling — (10:21) and at (10:26)

Nov. 21st
6KA calling —
Nov. 22ND
6KA calling —
5PX calling —
Nov. 25TH
5PX to —

Nov. 26TH
6KA at (9:26) and at intervals to (10:30)
Sigs. faded considerably and heard many other stations but could get none of their calls.

Nov. 30TH
6PD calling 9AN (?) at (8:26) and at (8:29)
Atmospherics very bad for several days following.

DEC. 5TH
6KA calling 8ZY at (8:30)
6KA calling 6ZMC (?) (8:36)
6KA calling — (8:37)
6KA calling — (8:38)
6KA calling — (8:40)
6KA calling — (8:42)
6KA calling 8ZY (8:44)
6KA calling — (8:48)
6KA calling — (8:53)
6KA calling — (8:56)
6KA calling 8ZY (8:58)
6KA calling — (9:01) (9:05) (9:08) (9:10)

DEC. 7TH
8ZY calling — (7:12)
8ZY calling CQ (7:27)
6ZI calling CQ (7:37½) and (7:39½) also at 7:43 and at 7:46 to CQ cast and at 7:49.

DEC. 10TH
Heard stations very faint on about 180 meters 6AVD calling CQ (7:50).

DEC. 16TH
6JD (?) CQ (10:12)
6JD (?) to 5PX (10:13)
Atmospherics bad.

DEC. 17TH
Atmospherics very bad.
6KU to —
6ZND (?) —
6ANH to —
6AWP to —
9BED (?) —

DEC. 19TH
6ZMI (?) to —
7SC to CQ at (8:45)
6JD to CQ
6PD to — (9:44)

DEC. 20TH
9GK to CQ (11:21)
9GK to CQ (11:32)

DEC. 21st
7SC to CQ (7:47)
6AWP to CQ (7:54)
7SC to — (7:55)
6ZZ to 5GR (8:14)
6ZZ to 5GR (8:15)
6ZZ to 5GR (8:17)
6ZZ to — (9:05)
6ANH to 9DQM (8:14)
7GS to 5GR (8:27)
9GK to CQ (9:07)
6ARB to 8CF (9:20)

DEC. 22ND
6BUN to — (10:15 to 5ZAV (10:21) and again to 5ZAV (10:32)
9BSG to CQ (10:48)
(Continued on page 2159)

Calls Heard

3SF, BALTIMORE, MD. (ONE STEP)
Spark—1ARY, 1ACK, 1AKG, 1AMD, 1BOO, 1CDB, 1CHX, 1CIB, 1CKS, 1CM, 1CNI, 1NV, 1RV, 1ST, 2AAF, 2ACF, 2AD, 2AER, 2AJA, 2ARY, 2BK, 2BY, 2BUM, 2CHD, 2CJS, 2CJX, 2CKS, 2CMM, 2CN, 2FP, 2HJ, 2JG, 2JZ, 2KK, 2NS, 2OX, 2SQ, 2ABB, 3AD, 3AEA, 3AJD, 3AHK, 3APL, 3AQZ, 3BEI, 3BJP, 3BOG, 3BTP, 3FP, 3GH, 3HJ, 3KG, 3RW, 3YK, 3ZM, 4BC, 4BI, 4DF, 4FD, 4FG, 4GN, 4HS, 5UP, 5XA, 5AEO, 5AFG, 5AFY, 5AHY, 5AII, 5AKO, 5AMS, 5ANG, 5APM, 5AUV, 5AUG, 5AXN, 5AYI, 5BAH, 5BBY, 5BCH, 5BDA, 5BFY, 5BHY, 5BPG, 5BUM, 5BRL, 5BTG, 5BWW, 5BY, 5BYP, 5BZH, 5CAP, 5CEH, 5CKV, 5CNR, 5COA, 5CSD, 5EB, 5EH, 5EO, 5EV, 5EW, 5FY, 5JL, 5KY, 5LJ, 5OI, 5TC, 5TH, 5VO, 5VW, 5AAW, 5ABM, 5ACN, 5AGG, 5AHO, 5AIR, 5AIU, 5AIW, 5AOJ, 5ARY, 5AU, 5AVP, 5AZE, 5BEC, 5BPI, 5CP, 5CUF, 5DAG, 5DHG, 5DHO, 5DIL, 5DWP, 5DZY, 5GN, 5LF, 5NZ, 5OF, 5ON, 5OR, 5PN, 5TV, 5VZ, 5YL.
C.W.—1ASF, 1BDL, 1BOV, 1CO, 1CKP, 1CPN, 1UM, 1UN, 1XZ, 2FP, 3BOV, 3BWT, 3CM, 3JL, 5DA, 8ANB, 8AWP, 8AXH, 8BZO, 9AAU, 9BZI, 9DYN, 9UM, 9UR.

SCCS, POTSDAM, N. Y.
(1AAW) 1ADJ, 1ADD, 1AGC, 1AGH, 1AKL, 1ANR, 1AOL, 1ARK, 1ARY, 1ATC, 1ANB, 1AUN, 1AWB, 1AWE, 1AXI, 1AY, 1AYG, 1AZW, 1BAS, 1BDI, 1BES, 1BKA, (1BKR), 1BNF, 1BRG, 1BSJ, 1BSZ, (1BVB) (1BVR), 1BWJ, (1CAJ) 1CBI, 1CAR, (1CHP) (1CIB) (1CIJ) (1CIT) (1CJD) (1CIH) 1CMK, 1CMP, 1CNF, 1CPI, 1CRU, 1DF, 1II, 1IL, 1LL, (1MC), 1MY, 1ND, (1PM) 1GP, 1SN, 1SD 1UJ, 1XM, 1XU, 1XZ, 2AEU, 2AFP, 2AJF, 2AJH, 2ANM, 2AUY, 2AUZ, 2AWF, 2AWS, 2AYV, 2AXF, 2BBB, 2BCK, 2BEL, 2BFE, 2BO, 2BOU, 2BSC, 2BYW, 2BVH, 2CIE, 2CKK, 2CKU, 2CKMV, 2COR, 2CGI, 2CGZ, 2CVE, 2FP, 2GK, 2XO, 2ZK, 2ZS, 3AB, 3AF, 3AJG, 3AKR, 3ABN, 3ABU, 3AMW, 3ANO, 3AOR, 3ARO, 3BG, 3BIT, 3BIY, 3BJ, 3BJT, 3BOB, 3BOF, 3BG, 3BRW, 3BUE, 3BVL, 3BX, 3CC, 3CCU, 3CM, 3GL, 3HD, 3HK, 3JG, 3JJ, 3OT, 3PO, 3OV, 3TI, 3TP, 3UD, 3VW, 3WF, 3XM, 3ZO, 4BG, 4BO, 4BD, 4BX, 4CG, 4CY, 4EA, 4EH, 4EL, 4FT, 4GE, 4HW, 4HZ, 4KI, 4KL, 4KM, 4LT, 4NV, 4OI, 4WK, 4YA, 5AGJ, 5AGY, 5DA, 5EK, 5ER, 5AFR, 5FV, 5HL, 5IK, 5KC, 5MO, 5ND, 5NV, 5OI, 5RZ, 5XAD, 5XAJfore, 5XB, 5XK, 5XV, 5ZAK, 5ZAS, 5ZB, 5ZK, 6XAD, 6ZH, 6ZZ, 8ABC, 8ADH, 8AEO, 8ADZ, 8AFN, 8AGR, 8AII, 8AIM, 8AIP, 8AIW, 8AIZ,

8AJL, 8AJT, 8AJX, 8AKD, 8ALE, 8ALO, 8ALT, 8AMZ, 8ANB, 8ANJ, 8AOL, 8AOL, 8APG, 8APN, 8APV, 8APW, 8AQZ, 8ARC (fone) 8ARD, 8ASC, 8ASF, 8ASV, 8ATF, 8AVD, 8AVI, 8AVW, 8AXB, 8AXD, 8AXN, 8BBF, 8BCH, 8BDO, 8BEK, 8BEO, 8BEN, 8BF, 8BFO, 8BFV, 8BGI, 8BIN, 8BJX, 8BLC, 8BLX, 8BOA, 8BOA, 8BOB, 8BOK, 8BRD, 8BRY, 8BUC, 8BUX, 8BW, 8BWW, 8BXF, 8BXH, 8BXT, 8BXX, 8BYA, 8BYO, 8BYT,

9APW, 9ARZ, 9ASE, 9ASO, 9ASW, 9AVN, 9AWF, 9AZA, 9AZP, 9BCF, 9BFM, 9BGC, 9BIJ, 9BIZ, 9BJ, 9BJC, 9BJN, 9BJT, 9BKJ, 9BOG, 9BRM, 9BRX, 9BSO, 9BSZ, 9BTA, 9BTJ, 9BV, 9BVI, 9BVZ, 9BWN, 9BXC, 9BYX, 9BZI, 9CAA, 9CAC, 9CCM, 9CCS, 9CCV, 9CDN, 9CDR, 9CEH, 9CHK, 9CJA, 9CJL, 9CIM, 9CKW, 9CMN, 9CPA, 9CTE, 9CTG, 9CTU, 9CTV, 9CUI, 9CVS, 9CWP, 9CXK, 9CZS, 9CZY, 9DAJ, 9DBF, 9DDY, 9DFB, 9DGE, 9DIO, 9DJO, 9DKK, 9DLF, 9DLR, 9DRI, 9DTI, 9DV, 9DWJ, 9DWK, 9DVE, 9DXC, 9ECE, 9ECI, 9EER, 9EDD, 9EEY, 9EI, 9EP, 9FP, 9IG, 9LH, 9LY, 9MC, 9PF, 9QF, 9QR, 9SL, 9UH, 9UK, 9VK, 9VM, 9XAC, 9YF, 9YI, 9ZN, 9ZT, 9ZY.

\$50.00 IN PRIZES

What is YOUR Most Interesting Electrical Experience? Why not try for a prize? It should be an easy matter to win, particularly for all radio lovers! This, and the following interesting articles will appear in the June issue of

Practical Electricians

Incandescent Lamp Experiments,
By Clyde J. Fitch
Subway Rides De Luxe
Electric Roll Calls
By S. R. Winters
Connecting Measuring Instruments
By Jesse Marsten
New Theory of Magnetism
By T. J. J. See,
Professor of Mathematics,
United States Navy
Electricity in the Poultry Industry

8CAA, 8CAB, 8CCB, 8CCH(fone), 8CCX, 8CEC, 8CGB, 8CGU, 8CIE, 8CIM, 8CII, 8CIV, 8CJZ, 8CKK, 8CNB, 8COK, 8COO, 8CP, 8CPB, 8CPX, 8COH, 8CRB, 8CRW, 8CTN, 8CUM, 8CUV, 8CUU, 8CVC, 8CWC, 8CWP, 8DAE, 8DV, 8EN, 8FM, 8GZ, 8IB, 8IJ, 8JY, 8KC, 8KG, 8NB, 8OM, 8ON, 8PG, 8RJ, 8SL, 8SM, 8SS, 8UC, 8VN, 8WX, 8WY, 8YZ, 8ZAE, 8ZO, 8ZZ, 9AAP, 9ADF, 9AFK, 9AIG, 9AI, 9AIP, 9AMO, 9AMQ, 9AMT, 9AOZ, 9AON,

5AHS, LAMPASAS, TEXAS
C. W. 1BV, 4OZ, 4GE, 4EB, 4SO, 4CL, 5XN, 5VL, 5NN, 5IP, 5OI, 5IA, 5FT, 5HU, 5VY, 5TA, 5SF, 5XV, 5AAM, (5IJ), (5KP), 5HZ, 5AGY, 5PC, 5MB, 5ZU, 5FV, 5ML, 5MY, 5ZR, 5DN, 5AFC, 5PV, 5BW, 5AAT, 5RN, 5XA, 5SS, 5ACF, 5AAR, 5GR, 5UK, 5PX, 5ZAS, 5YK, 5PB, 5AHH, 5VA, 5JM, 5ZA, 5LAE, 5ZAW, 5RH, 5JT, 5PN, 5LU, 5ZAV, 5VO, 5AAR, 5GJ, 5VM, 5OK, 5JS, 5XAJ, 5XT, 5GE, 6ARB, 6ZZ, 6SO, 6APW, 7BH, 8BCH, 8AB, 8CPD, 8BY, 8JW, 8ANB, 8APV, 9BWI, 9BSZ, 9ARZ, 9AOD, 9BXY, 9PS, 9DTU, 9BIU, 9DAH, 9ABH, 9DZY, 9BOG, 9DAF, 9BX, 9ABV, 9DIW, 9BRI, 9ZEY, 9CR, 9BZZ, 9DAN, 9BZI, 9DLR, 9CES, 9ZBF, 9DOM, 9DOF, 9CAA, 9BDS, 9BWM, 9DGR, 9BXN, 9CKM, 9CFK, 9DSD, 9DTM, 9CWC, 9ZL, 9AG, 9AYU, 9CLO, 9UR, 9ECE, 9AAP, 9AHH, 9DSM, 9AAU, 9BOK, 9AOU, 9PE, 9CPA, 9CK, 9AFK, 9XAC, 9ARI, 9AVC, 9BVD, 9AEY, 9AMI, 9EBL, 9SOM, 9CVD, 9EKH, 9CCV, 9CCW, 9BZ, 9CVT.
SPARK—5AD, 5TU, 5XA, 5XAC, 5ADI, 5UZ, 9WNB, 9AQH, 9BLU, 9DAG, 9DEW, 9DXV, 9BTX.
PHONE—5XAJ, 5ADZ, 1XAD, 5ZA, 9ZAF.

W. A. LIPPMAN, JR., 6 THORNBURY PL., ST. LOUIS, MO.

CW: 1ADL, 1AGH, 1AJL, 1AJP, 1AJW, 1AJZ, 1ALZ, 1ANA, 1ANR, 1AOJ, 1ARY, 1AYZ, 1BAS, 1BES, 1BET, 1BEP, 1BKR, 1BLN, 1BWJ, 1CDR, 1CMK, 1CPN, 1CWM, 1BJ, 1GV, 1IL, 1KK, 1RY, 1OP, 1XM, 2AJF, 2AQI, 2AYV, 2BEA, 2BGD, 2BLF, 2BMR, 2BOU, 2BSC, 2BVH, 2BXW, 2BYJ, 2BYW, 2BZS, 2CDD, 2CBF, 2CKN, 2CQI, 2CQZ, 2CUI, 2DA, 2FP.
(Continued on page 2164)

Matching Impedances

By PROF. W. PALMER POWERS
Of the Stevens Institute of Technology

IT is quite generally known that certain vacuum tubes operate exceptionally well with certain amplifying transformers, and it is therefore evident that there is some feature in the design of such transformers which is responsible for this result. There are, of course, many reasons why a certain transformer may operate more satisfactorily. The question of designing a

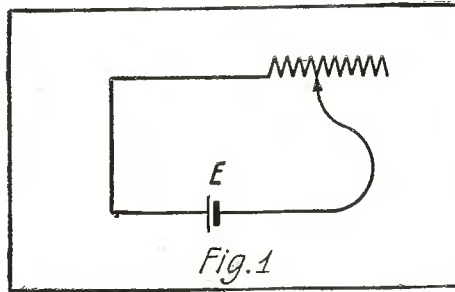

Fig. 1
A Battery Connected To a Variable Resistance. The Current Flow Varies With the Variation of Resistance.

transformer to match a particular tube, however, brings out a fundamental fact which many of us have taken as more or less empirical. We are told that the plate impedance of the vacuum tube must be equal to the input impedance of the transformer for best operation. It is the purpose of this article to point out why this condition is desirable, and to discuss briefly the results when such a condition is not obtained.

Let us consider the case of a battery connected to an adjustable resistance as in Fig. 1.

The battery has a generated voltage of six volts (assumed constant), and an internal resistance of one ohm (assumed constant). Our problem is to determine the resistance of the external circuit for maximum power output. If we assume various values for the external resistance we can compute the total resistance by adding to this the internal resistance of the battery. If we then divide the total voltage by the total resistance, we shall have the current. The corresponding power output (watts) can then be computed by any of the following formulas: where W = power output, E = terminal volts, r = external resistance, and I = amperes.

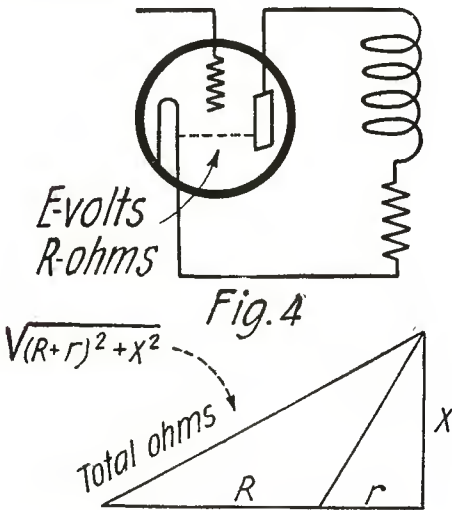
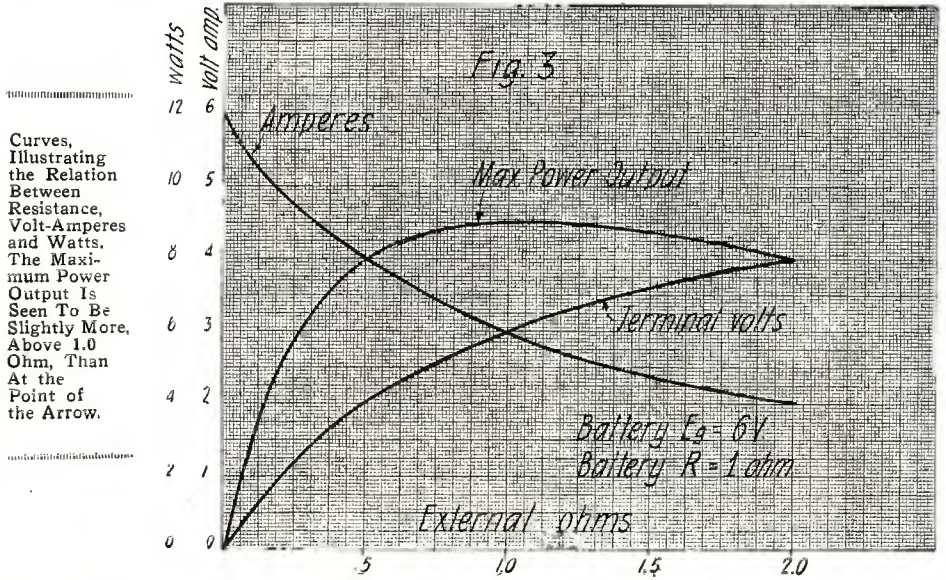

Fig. 4
A Vacuum Tube Feeding Circuit, Containing Resistance and Reactance, and Below It the Relation of the Various Quantities For Such a Circuit.



| External Resistance | Total Resistance | Amperes | Power Output | Load Voltage |
|---------------------|------------------|---------|--------------|--------------|
| .0 | 1.0 | 6 | 0 | 0 |
| .25 | 1.25 | 4.8 | 5.74 | 1.2 |
| .50 | 1.5 | 4.0 | 8.0 | 2.0 |
| .75 | 1.75 | 3.43 | 8.81 | 2.57 |
| 1.00 | 2.0 | 3.0 | 9.0 | 3.0 |
| 1.25 | 2.25 | 2.66 | 8.8 | 3.32 |
| 1.5 | 2.5 | 2.4 | 8.63 | 3.6 |
| 1.75 | 2.75 | 2.18 | 8.3 | 3.82 |
| 2.0 | 3.0 | 2.0 | 8.0 | 4.0 |

$W = E \times I$ Equation No. 1
 $W = I^2 \times r$ Equation No. 2
 $W = E^2 \div r$ Equation No. 3

Fig. 2 shows a table of assumed external resistance with their corresponding values of terminal volts, current and power output.

Fig. 3 shows how these quantities vary with the external resistance and indicates clearly that, for a particular value of external resistance, the output is a maximum. Considerable information can be gained from the study of this output curve. The output is expressed by the three equations given, and one should notice that they are identical statements. Equation 2, and equation 3 are readily reduced to equation 1. The curve of Fig. 3 brings out the fact that maximum power-output results when the external resistance equals the internal resistance. Just why this occurs can best be determined by inspection of the expression for power-output and noting how each factor varies with a change in external resistance.

Balancing the external resistance against the internal resistance produces a maximum power output. This is not the condition of maximum efficiency, but nevertheless it is desirable in many cases where output at any cost is wanted. It is interesting to note that when this adjustment is made, the losses equal the output and the voltage falls to one-half of its maximum value. This question of matching resistances comes up in many engineering problems, and one should not get

the impression that it is applicable only to vacuum tube work.

The problem of a vacuum tube feeding a transformer is not vastly unlike a battery feeding a resistance. The tube may be considered as a source of voltage (E); this voltage operates through the plate circuit, the impedance being considered constant.* The impedance of the tube is equivalent to the internal resistance of the battery. The external circuit is equivalent to a resistance for power considerations. The maximum output (for a given voltage) will occur when the external ohms are equal to the internal ohms if the circuit is of the nature of a resistance. By inspection of the curve in Fig. 3 we see, however, that there is no serious loss in output if this value (equal to internal resistance) is exceeded. It is true that the external ohms may be twice the internal ohms without serious loss in output. In fact, most operators are familiar with the fact that when two telephone sets are connected in series the signal strength is only slightly reduced. This is due to the fact that the high impedance reduces the current; the reduction in current causes an increase in terminal voltage of the tube. Hence the energy per telephone set is not reduced to one-half of the original value. The terminal voltage is equal to the vector difference of the generated voltage and the loss of voltage in the tube. The loss in the tube (as in the battery) is equal to the current times the internal resistance.

Fig. 4 shows a diagram of a vacuum tube feeding a circuit which is general; that is, the load circuit contains resistance and reactance. Fig. 5 indicates the relations of the various quantities (resistance and reactance ohms) for such a circuit.

In Fig. 5, r represents the equivalent resistance of the load, and x represents the equivalent reactance of the load. The true power delivered is given by the following equation which is simply the current squared times the resistance:

$$\text{Output} = E^2 r / (R + r)^2 + x^2$$

If x is reduced to zero the output will be increased. If we then make the external resistance equal to the internal resistance

*While manufacturers give approximate values of tube impedance, they are not strictly constant in value. For the purpose of study, however, we may to advantage consider the tube impedance as constant.

(Continued on page 2140)



The Radio Constructor

Construction of D-Shaped Variometers

By D. R. CLEMONS*

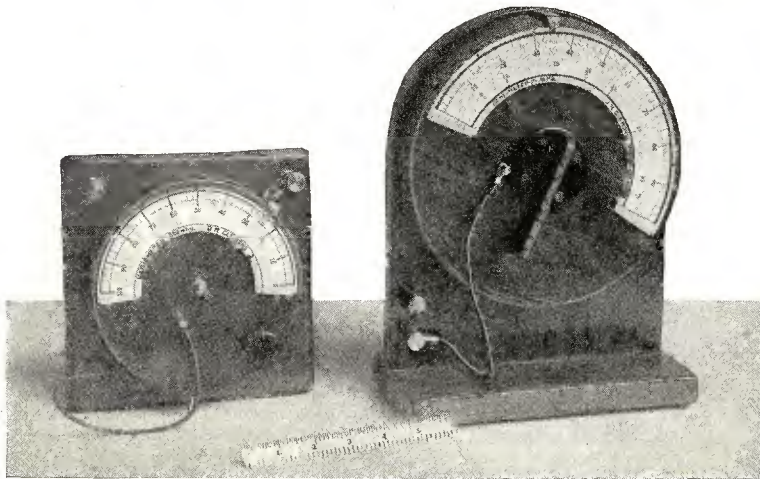

Two Views of Completed D-Shaped Variometers. The Large Wooden Discs Containing the Graduated Scales Also Support the Movable Windings of the Instruments.

A MAGNETIC field is established about a wire carrying an electric current. This field may be considered as an accumulation of magnetic energy extending into considerable space, and formed of rotational lines or strands enclosing and revolving about the axis of the wire. Ampere's right-hand-rule showing the direction of field rotation about a wire may be applied by grasping a wire with the right hand; the thumb pointing the direction of current, the four fingers then show the direction of field motion. Fig. 1A is an imaginary sketch of a field's position about a wire-carrying a current away from— and B the current moving toward—the observer, thus following the rule.

When current begins moving in a wire, a field moves outward as the current increases, or returns with decreasing current, but it assumes a fixed position and strength after the current becomes constant. Hence, magnetic flux changes with the current producing it. If a wire is long and straight the field is distributed through a considerable volume of space, but if a wire were bent into a circular ring, then all of the lines produced must pass through a much smaller area; hence, in a loop of wire, lines enter and depart from a space enclosed by a winding giving a definite direction of field projection establishing its magnetic poles. Fig. 1 shows how space enclosed by a loop is threaded by a downward propagation of each line. If two parallel conductors

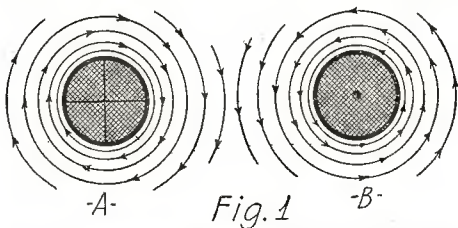

"A" Is An Imaginary Sketch of a Field's Position About a Wire Carrying a Current Away From the Observer, While That of "B" Is Moving Towards the Observer.

carry currents in the same direction, their respective fields rotate in a common direction also; and if both wires are far apart, the fields remain quite separate, but as the wires become more closely related the fields interlink, until they may finally enclose both wires as one field. Thus, if several turns

The Same Variometers As They Appear Unassembled. The Stationary and Movable Coils Are Revealed, Furnishing a Good Idea As To the Method of Their Construction.

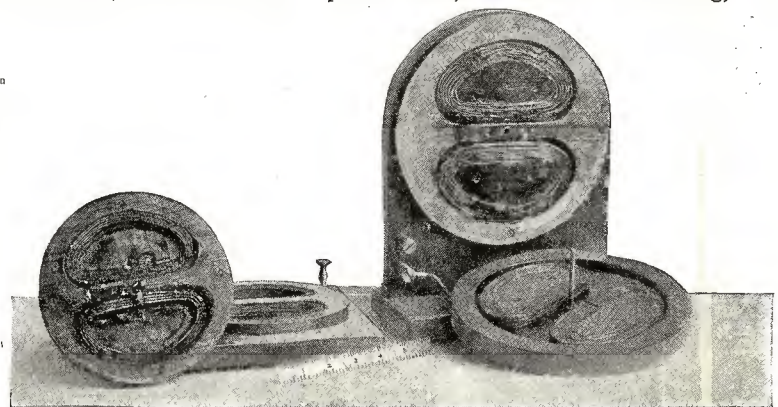

are wound into a compact coil, Fig. 2D, the enclosed space is threaded by one field—a results of the several turns contributing. Now, if two coils are related with each field projected in the same direction, the fields will again interlink and increase the field, as shown in Fig. 2; but if the two equal fields are opposed, they will not unite, Fig. 2A.

The field about a current-carrying conductor opposes an increase of current, and later, prolongs or retards the time during which the current is decreasing. A field does not instantly establish itself in the magnetic circuit but requires appreciable time for its outward movement to its final position. Now, if a current is passed through a coil of several turns, the field, due to each turn, on moving outward to establish the resultant field, cuts through the turns of the coil, and in doing so generates in them a voltage opposing that potential which established the current. Thus, as the current rises, the increasing flux in radial motion

generates a counter E.M.F. that tends to oppose an increase of current. If the current is decreasing in a circuit, the flux returning to the circuit moves through the turns in an opposite direction and the induced potential, being in the same direction as the current, tends to prolong the time interval during which the current moves, i. e., increases the period. This effect of a field upon such an electric circuit is called "self induction." Since this is evidently a counter voltage related to a circuit, the coefficient of self inductance is expressed in a unit called the Henry. A coil has one henry of self inductance; if, when the current through it is changing at the rate of one ampere per second, the induced counter E.M.F. is one volt. Since the flux in air-cored coils used in radio work varies directly with the current, the coefficient of self inductance is a constant independent of the current, but dependent upon geometrical dimensions of the winding, shape, turns, etc.

If two inductances are placed with their fields interlinking, as in Fig. 2, the flux of each coil induces a counter E.M.F. in itself, and also induces a counter E.M.F. in the neighboring coil; so if two inductances are placed close, with fields interlinking, the

total counter voltage in the entire circuit will be the two self-induced voltages plus an additional voltage in each coil caused by the adjacent coil's field. Hence, if the coils are very close together the inductance will be much greater than the sum of the two

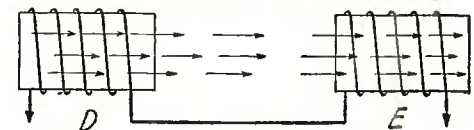

Fig. 2

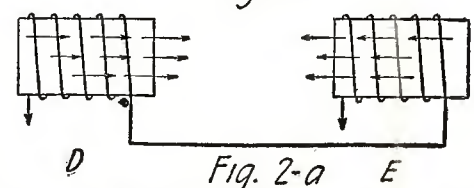
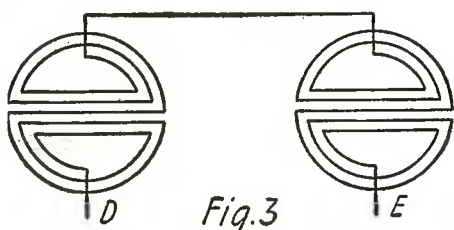

Fig. 2-a

In Fig. 2 the Fields of the Two Series Coils Are Assisting Each Other, While in Fig. 2-a They Are Opposing Each Other.

*Radio Instructor, Dodge Radio Institute.



Method of Connecting Up the Stationary and Movable Coils of the Variometer Described. It Will Be Noted That They Are Both Wound In the Same Direction.

inductances; and, if the coils are moved apart, less interlinkage is effective and additional counter voltages decrease until, finally, if both fields do not interlink at all, the inductance of the circuit becomes a sum of both self inductances. This action of one part of magnetic circuit upon another part is called "mutual inductance," which is positive if the resultant inductance is greater than the sum, and is negative if less than the sum of the two inductances.

When two coils are placed with fields opposing, flux from one coil extends through the adjacent coil and induces a potential in the same direction as the impressed potential. Thus a counter E.M.F., due to self induction, is decreased by the induced voltage through mutual induction, and since this resultant is much less than the inductance before the coils were reversed, the mutual inductance is negative. Mutual inductance evidently varies with the relationship of the fields, being positive for additive fields; zero when the fields do not interlink, and negative when fields are opposed. So an effective inductance changes as the relative position of coils are altered.

Now, in radio-frequency circuits combinations of inductance and capacity are used. Inductance tends to prolong the time interval during which currents flow, but condensers act oppositely, tending to lead the current. If a condenser and inductance are in series, there is one alternating current frequency at which these two opposite effects neutralize admitting currents of that frequency. This is the tuned frequency or wave-length at which a circuit responds. Changing the inductance varies the period of a circuit; likewise, capacity may be varied for tuning. In many types of equipment both capacity and inductance are varied, and where capacity may be inherent as in the vacuum tube, the circuit is tunable by employing variable inductances called variable "inductors" or variometers. Best known types of variometers operate as previously described, two windings being in close relationship, one, generally a ball, is turned about for variation of the mutual inductance. Ball type variometers have the following characteristics: Movable inductance is of 220 microhenries, stationary winding 230 microhenries. When placed at right angles, the mutual inductance is zero and the inductance of the arrangement is 450 microhenries. By opposing the fields, a negative mutual inductance obtains 50 microhenries, and reversing the ball increases the inductance to 960 microhenries. Thus, values between 49 and 961 microhenries are obtainable by turning the ball.

Variometers, popular in radio today, are suitable for short-wave tuning; however, variable inductors may also be made large to serve for long wave-length reception. A type of variometer suitable for short and very long wave work is illustrated. This principle has long been employed in foreign

equipment and is also manufactured in America as a precision instrument. The windings are mounted in a flat plane, as shown in Fig. 3. All coils are placed in pairs connected so that their electric rotation is opposite; i. e. adjacent polarities are opposite, so a field of force extends upward through one coil and downward through the adjacent coil. If another similar set of coils is placed over these with interlinking fields, the flux passes through all four coils. By revolving one set of coils through 180 degrees, opposing fields establish a condition of minimum inductance. The larger variometer was prepared for laboratory work and long-wave reception. The smaller instrument was designed for use on short wave-lengths such as broadcast receiving, the electrical values being similar to the small ball-type variometers of the better types.

The large variometer is mounted upon a neat base and support sketched in Fig. 4. All windings are form-wound for mounting in openings cut in a 3/8" thick wooden disc mounted as shown in Figs. 4 and 6. Three

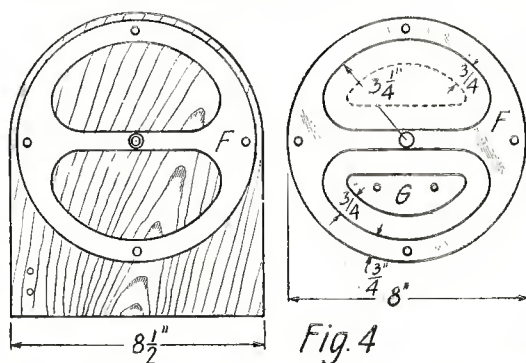

Fig. 4

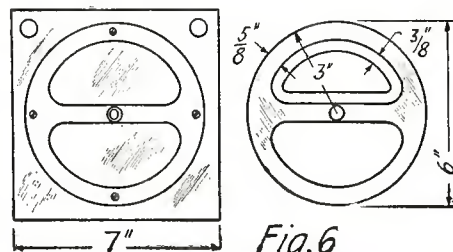

Fig. 6

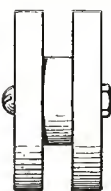

Fig. 5

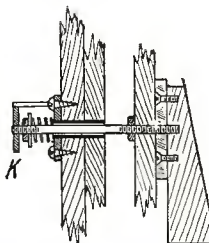

Fig. 7

Constructional Data For Making the Stationary and Movable Forms of the Variometer. These Are Made of Well Seasoned Hard Wood. Fig. 7 Shows the Arrangement of the Shaft.

large discs 8" in diameter are cut from 3/8" cypress, using a scroll saw. Openings for the coils are scrolled out, after which the parts are attached by a good glue and screws. Pieces removed from the discs are later used as end pieces of a winding form H in Fig. 5. Four wooden cores G in Fig. 4 are cut as shown, allowing a winding depth of 3/4". Four coils are then carefully layer-wound, filling up the form. About 1 1/4 pounds of No. 22 double cotton wire allow about 200 turns in each winding. These coils should be as nearly alike as possible and are secured by attaching their wooden cores to the discs by small brass screws, after which they are heavily varnished. A special bushing of brass and bakelite handle are made up as sketched in Fig. 7, where K is a bronze spiral for perfect contact with the moving shaft, which forms one terminal of moving coils.

The small horizontally mounted variometer is similarly made. Here each coil has 36 turns of No. 22 double cotton wound to a depth of 3/8", and is simply forced into place and varnished. The form used for these coils is comprised of the parts cut from the discs, as before. The illustrations should be quite clear as details appear there in photographs and sketches showing dimensions. Each form-wound coil of the larger instrument is 5 millihenries; inductance of the instrument is 5.98 to 36.8 henries maxi-

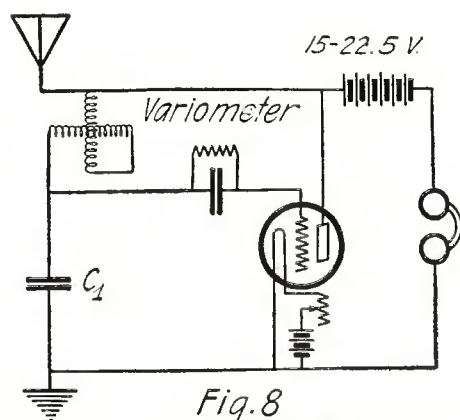

Fig. 8

Suggested Circuit For Use With the D-Shaped Variometer. This Is An Adaptation of the Colpitts Oscillator Circuit.

imum. The smaller instrument's value varies from a minimum of 185 to 1000 microhenries, each coil 130 microhenries with 275 microhenries for each pair or couple. Inductance in both instruments varies almost linearly and by designing the coils for that condition, a straight line variation is obtainable.

Fig. 8 shows a method of using the single large variometer in conjunction with a vacuum tube for long-wave reception. C1 may be a fixed or variable condenser of 0.001 or 0.002 mfd, the arrangements forming the essential parts of a Colpitts oscillator responding to stations transmitting on wave-lengths between 4,000 and 18,000 meters by adjusting the rotary coils.

ARMY OFFICER PER-FECTS RADIO IMPROVEMENTS

A device for operating airplanes, tanks, or trolley cars from a point 50 or 100 miles away, another which outdoes the amplifier in making clear a wireless telegraph message, and a third which operates a signaling device in wireless telephone or telegraph apparatus recently have been perfected by Captain Harold G. Webbe, of the department of military science at Ohio State University, Columbus, Ohio.

All three of the inventions are patented by Captain Webbe under the authority of the war department. They mark the application of a novel and unique principle in radio, namely, that of the common musical tuning fork.

The latter two inventions are outgrowths of the first. Experimentations now being carried on by Captain Webbe and students in the Signal Corps of the Reserve Officers' Training Corps at the University will result in more developments, he predicts. Descriptions of this research are being forwarded from time to time to the department of war, which requested it be notified of any progress when news of the first patent reached it.

"The device is quite simple," Captain Webbe explained. "We first thought of it when making a little wagon to be operated by wireless, for use in demonstrating a lecture on the possibilities of radio. While constructing the wagon, it was noticed the apparatus used to relay the electric impulse was easily disturbed and thrown out of order.

"Improvements on the method were sug-
(Continued on page 2154)

A Spark Coil C. W. Set

By FRED A. BURGESS

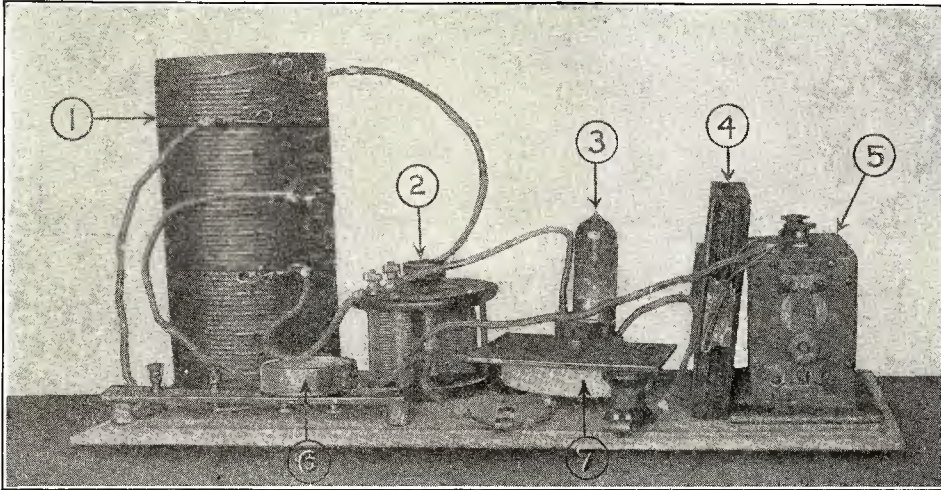

A Photo of Mr. Burgess' Spark Coil C.W. Set. The Transmitter Consists of An Inductance (1), a Variable Condenser (2), a Low-Power Vacuum Tube (3), a Large-Capacity Condenser (4), a $\frac{1}{2}$ " Spark Coil (5), An Ammeter (6) and a Rheostat (7). The Grid Condenser and Leak Cannot Be Seen.

It has been definitely established that for low power, short wave communication, a vacuum tube transmitter is vastly superior to any other type. Yet many amateurs are prevented from using C.W. transmitters because of the difficulties encountered in obtaining the high voltage current for the plate circuit of transmitting tubes. In the present article the writer wishes to describe how he built a vacuum tube transmitter operated entirely on a 6-volt storage battery. This storage battery served both to light the filament of the tube and operate a $\frac{1}{2}$ " spark coil that supplied the high voltage plate current. The signals sent out by the set were, of course, of the I.C.W. variety, but they had a very agreeable musical note which could be varied by varying the adjustment of the spark coil vibrator, and they could be picked up on a crystal receiver, which cannot be done with a pure C. W. transmitter.

A general idea of the appearance of the outfit can be gained from Fig. 1. As is clearly evident, no consideration has been given to appearances. It is an experimental set rather than an exhibition set. All the instruments are mounted on a flat board 22" long and 10" wide, and are connected by means of flexible lamp cord. The connections are readily accessible and can be changed at a moment's notice, thereby allowing a variety of different hook-ups to be tried out without undue trouble. Such a degree of flexibility is never possible with a cabinet type of transmitter.

The spark coil is mounted at the right hand edge of the board. Beside it stands a large glass plate condenser. Next comes a filament rheostat with the transmitting tube mounted behind it. To the immediate left of these is a .001 microfarad variable condenser. Behind this condenser, and hidden from view by it, is mounted a .005-microfarad fixed grid condenser and a 10,000-ohm grid leak. The left-hand end of the board is occupied by the tuning inductance. In front of this there is a strip of bakelite $1\frac{1}{2}$ " wide, 6" long, and $\frac{1}{8}$ " thick, supported above the base by means of two small wooden blocks. On this insulating strip is mounted a .5-ampere hot wire ammeter, and two binding posts, one for the aerial connection and the other for the ground.

The tuning inductance consists of 60 turns of No. 14 bare copper wire wound on an insulating tube 9" long and $4\frac{1}{2}$ " in diameter, with connecting lugs every second turn. After a bakelite tube of the required

size had been bought, it was taken to a machine shop where a 60-turn spiral groove was chased around it. Then 80' of No. 14 bare copper wire were procured and wound tightly in the groove around the tube. The final operation was to solder onto the coil 31 connecting lugs (one lug every two turns). These lugs consisted of $1\frac{1}{4}$ " pieces of No. 14 bare copper wire bent at right angles at the middle, so as to be the shape of the letter L, and soldered to the wire on the inductance at the required spots.

The tube shown in Fig. 1 is a low-power English transmitting valve requiring a fila-

ment potential of six volts and a plate potential of 1,000 volts. The filament current is supplied by a 6-volt storage battery and controlled by a 10-ohm rheostat. The same 6-volt battery also operates the $\frac{1}{2}$ " spark coil that supplies the high voltage plate current. The secondary potential of the spark coils is of the order of several thousand volts, so a fairly large condenser must be connected across the secondary terminals in order that the voltage may be reduced to a value that will not cause possible damage to the tube. In the present case the condenser consisted of 11 sheets of

tinfoil separated by glass photographic plates 7" long and 5" wide. If an American 5-watt tube is used, some alterations will have to be made in the set. An 8-volt storage battery will be needed since the filament potential required by these tubes is about $7\frac{1}{2}$ volts. A heavier rheostat will also be needed to pass the 2.35-ampere filament current. A 1" spark coil can be used with safety instead of the $\frac{1}{2}$ " coil, but a much larger condenser will be needed because of the fact that the normal plate potential is only 350 volts.

A hook-up that seemed to give very fair results with this set is shown in Fig. 2. A .001-mfd. variable condenser was used, but a .0005-mfd. condenser will give just as good results. It may be found that a 60-turn tuning inductance is unnecessarily large since under all ordinary circumstances more than 30 or 40 turns are rarely ever required.

Not every type of spark coil will work successfully with a set of this kind. A three-terminal coil (in which one end of the primary and one end of the secondary are connected to the same binding post) will not give results when the same battery is used both for lighting the filament and operating the coil. Either a four-terminal spark coil must be used or separate batteries must be used for the filament and the coil.

The way in which the secondary of the spark coil is connected to the plate circuit of the transmitting tube also has a considerable effect upon the success or failure of the set. The secondary output of a spark coil is not pure alternating current. It is stronger in one direction than another. Hence, to all intents and purposes it is interrupted direct current, and the secondary

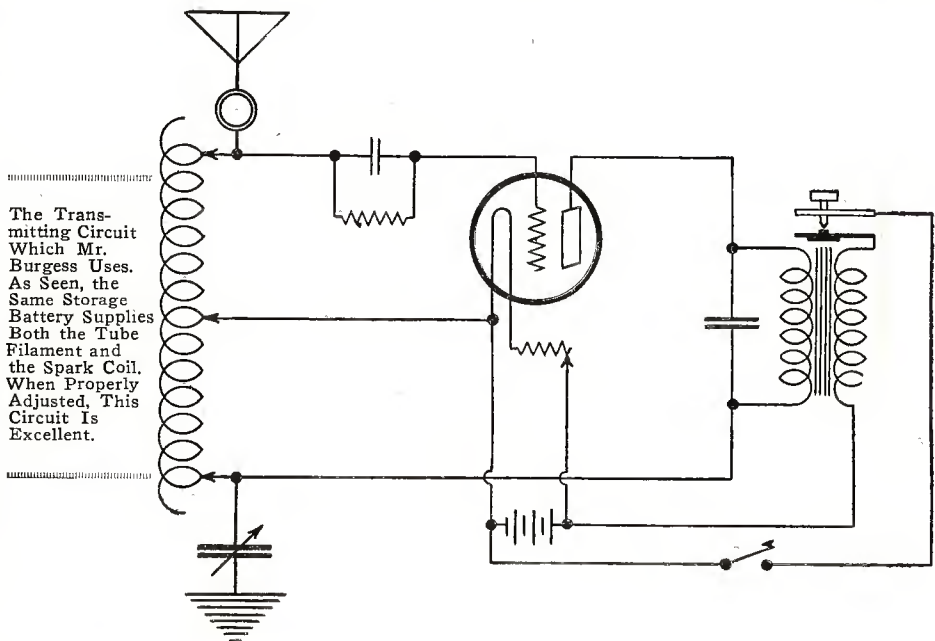

The Transmitting Circuit Which Mr. Burgess Uses. As Seen, the Same Storage Battery Supplies Both the Tube Filament and the Spark Coil. When Properly Adjusted, This Circuit Is Excellent.

ment potential of six volts and a plate potential of 1,000 volts. The filament current is supplied by a 6-volt storage battery and controlled by a 10-ohm rheostat. The same 6-volt battery also operates the $\frac{1}{2}$ " spark coil that supplies the high voltage plate current. The secondary potential of the spark coils is of the order of several thousand volts, so a fairly large condenser must be connected across the secondary terminals in order that the voltage may be reduced to a value that will not cause possible damage to the tube. In the present case the condenser consisted of 11 sheets of

may be said to have a positive and a negative terminal. Of course, it is essential to have this so-called positive terminal connected to the plate of the transmitting tube. The only way to find the correct connection is by experiment. Connect the set up in one way and try it out, then reverse the leads from the secondary and try again. The connection that gives the greater aerial current is the correct one.

With a three-wire aerial 80' long and 42' high, and a four-wire counterpoise, the set shown in the illustration gives an aerial current
(Continued on page 2142)

A Three Tube Reflex Receiver

By J. R. BALSLEY

THE Reflex circuit, although well known by this time, is not extensively used. The average person has fought shy of this latest development probably due to the lack of practical information covering the characteristics, design and operation of this combination. The author who has built a number of these sets and has obtained

ened to the bottom of this shelf and the DX transformer mountings are screwed into tap holes on the edge of the shelf, as shown in the rear view of the set. In coupling the radio and audio frequency transformers so close together, the necessity for shields was obviated by grounding the frames of the audio transformers. WD-11 tubes can be used with the set if desired, although the use of either A.P. or Radiotron tubes will give greater volume. The hook-up of this set is shown in Fig. 1. It will be noted that a choke coil is placed in the grid circuit of the second tube. This was found necessary to keep the radio frequency currents from leaking through the

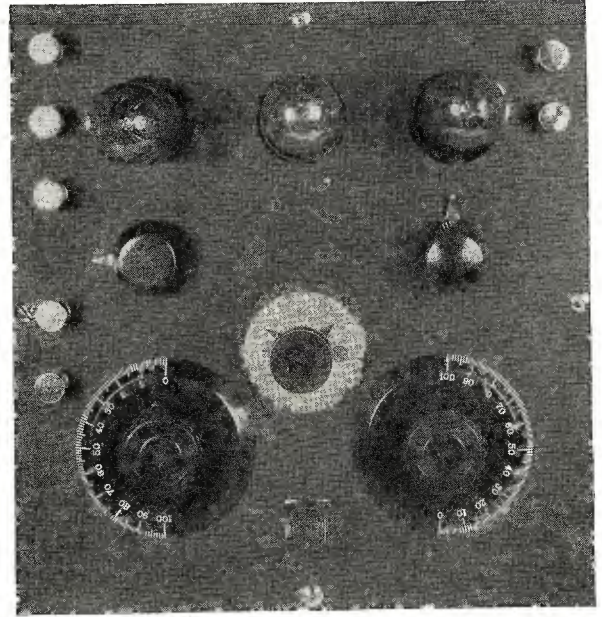

A Top View of the Three-Tube Reflex Receiver Described In This Article. A Gold Grain Crystal Detector Is Mounted Between the Two Large Dials.

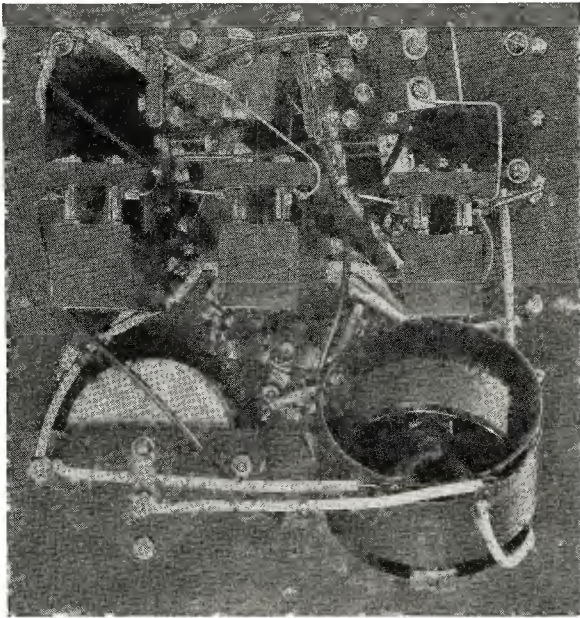

An Inside View of the Outfit. As Will Be Seen, the Main Tuning Units Consist of a Variable Condenser and a Variocoupler. The Radio Frequency Transformers Are Mounted Directly Behind These Units.

audio frequency transformer and between parallel wiring. A rheostat for the control of the filament current is not absolutely necessary since the tubes must be heated to the maximum allowable for the best results. With A.P. tubes greater amplification is obtained with about 100 volts on the plates. With

this receiver, I have heard on the loud speaker in Philadelphia a total of 74 broadcasting stations from Havana to Montreal and Toronto including Dallas and Fort Worth, Texas, and Denver, Colorado. This set was designed for use with a loop aerial although an out-door antenna can be used if desired. In this case it is best to use a vario coupler and a condenser in series with the antenna.

gratifying results, feels that a description of his present receiver would not be out of place.

Referring to the photographs, the set is of the horizontal type, that is, the panel is parallel to its setting instead of perpendicular as is usually the case. The dial on the right controls a variable condenser and the left one, the variocoupler. The "Gold Grain" detector is mounted between them. The double knob in the center of the panel controls the single and multiple turn taps of the 180° variocoupler. The knob directly above the condenser dial is that of the potentiometer and the other knob, the rheostat. The panel is 10½" by 12" and requires a cabinet 6¾" deep.

In constructing this set, a piece of hard wood ½" thick was used as the panel in which the holes for the tubes were drilled on 2⅝" centers, the holes themselves being 1½" in diameter. Three Atwater-Kent sockets are supported by a strip of bakelite 2½" by 8¾" by ¼". This serves as a shelf which is shielded from the bottom of the panel by wood screws and brass tubing for spacers. Two 3YQ audio transformers are fast-

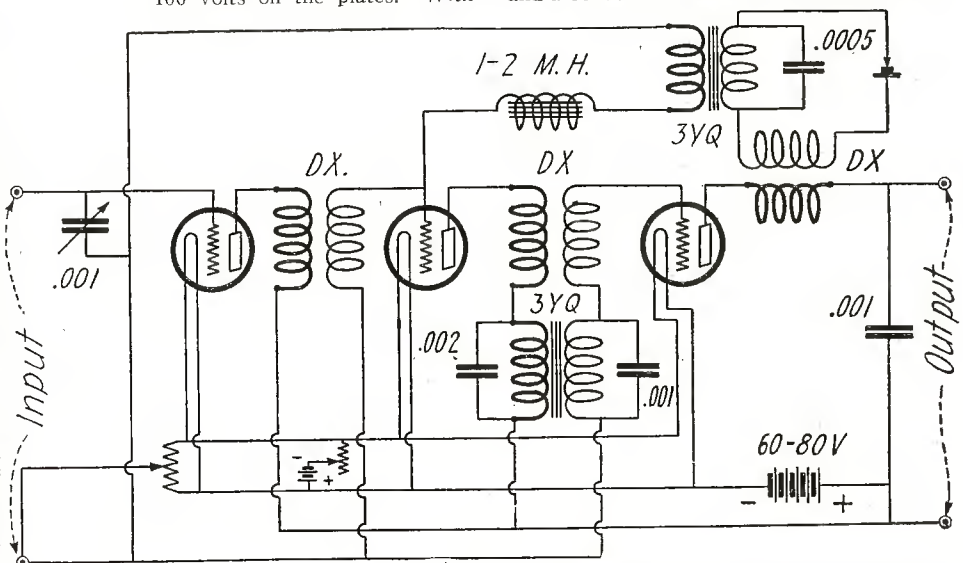

The Three-Tube Reflex Circuit As Employed With This Receiver. A Radio Frequency Choke Is Connected In Series With the Secondary of the First Audio Frequency Transformer.

A Filter Circuit for High-Tension Supply

By G. P. KENDALL, B. Sc.

LIKE most other amateurs, I spent a good deal of time (and, alas! a certain amount of cash) in my early valve days seeking a satisfactory solution of the high-tension supply problem, and came to the conclusion that there wasn't one. I have since devoted myself to devising methods of minimizing the defects of the dry-cell battery. A device which I have tested of late has proved so successful in reducing noises due to bad cells that I am moved

to advise readers of RADIO NEWS to give it a trial. No great novelty is claimed for this device, since something like it is used in nearly every transmitter, and it is merely a somewhat elaborate filter circuit, whose components may be obtained very cheaply.

The chokes can be made by winding each with an ounce of No. 0 S.S.C. wire on a 3" by ½" iron core. The capacity values are given in the diagram, which shows the arrangement of the filter circuit.

I find this device of special benefit in low-frequency amplification, for it removes a good deal of the hissing and rustling often heard with two or three stages of amplification (sometimes unjustly put down to parasitic or microphonic effects in the valves, but very generally caused by slight imperfections in the high-tension supply). It is liable, however, to introduce distortion if the inductance of the choke L_2 is too high, or
(Continued on page 2122)

Awards Of the \$50 Radio Wrinkle Contest

First Prize A COMPACT VARIABLE CONDENSER BY HORACE B. PHELPS

A variable condenser is an instrument that the experimenter usually has to buy, and it is rather an expensive proposition too, especially when several of them are required.

The condenser illustrated above is easily made, the only cost being that of one 3" or 4" dial and a sheet of mica. The idea is to make the rotary plate integral with the dial, and the stationary plate with the panel. It, therefore, takes up no space behind the panel, allowing for a more compact set with shorter leads.

The rotary plate is a semi-circle of tin or copper foil, cemented to the back of the dial. The part extending over the hole in the dial, you will notice, is not cut away, but is left in, so that it will be bent into the hole and will make contact with the pivot screw.

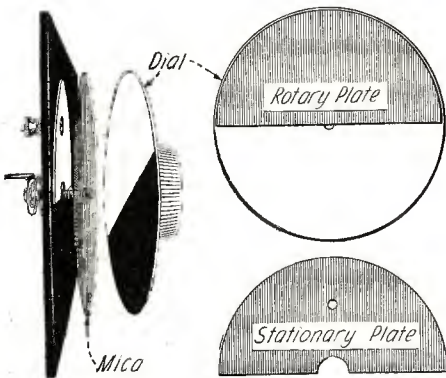

Here Is An Easily Constructed Variable Condenser. A Knob and Dial, Some Tinfoil and a Mica Circle Are the Required Materials.

One terminal is soldered to the lug on the other end of this pivot screw, and the other is brought to the binding-post, which makes contact with the stationary plate. This plate is another piece of foil cemented to the panel. The pivot screw is either screwed into the dial as far as it will go, or else nipped with the set screw, as the case may be. It is advisable to cut the plates about $\frac{1}{16}$ " less in radius than the mica disc, so they will not touch at the edges. Use a very thin sheet of mica if you want your condenser to have a high capacity.

Second Prize A HOME-MADE AUDIO FRE- QUENCY TRANSFORMER BY OTTO C. STEINBERGER

The accompanying photograph shows in detail the component parts and completely assembled audio frequency transformer, made from that old stand-by of the amateur, the discarded Ford spark coil.

Very little, if any, charge is made for the old coil by garage keepers.

The principle of utilizing spark coil secondaries is not new, but the method described herewith, which eliminates all guess work and simplifies construction, should commend itself to every novice or amateur.

The finished coils have been tested out in comparison with three of standard manufacture and deliver results to equal any of them.

Constructional details are as follows: Carefully remove the secondaries from the Ford coil; find both leads to each of them; each secondary has 35 layers of 350 turns each.

Take one secondary and starting with the outside lead remove 28 layers. This will leave a coil of 7 layers for the primary.

Prize Winners

FIRST PRIZE \$25

A Compact Variable Condenser

By MR. HORACE B. PHELPS,
Rensselaer Polytechnic Institute,
Troy, New York.

SECOND PRIZE \$15

A Home-Made Audio Frequency Transformer

By MR. OTTO C. STEINBERGER,
Indian Lake,
Vicksburg, Michigan.

THIRD PRIZE \$10

A Carbon Pile Rheostat

By MR. AMASA S. TRACY,
49 Green Street,
Concord, N. H.

From the other coil start at the inside lead and remove 7 layers, which will leave a 28-layer secondary.

The ratio in layers is 4 to 1, but due to the difference in circumference of the primary and secondary coils the ratio is approximately 4.2 to 1 which is about correct for the average vacuum tube.

Upon the ends of your primary and secondary windings solder a lead of heavier wire (No. 30 is about right), secure the leads to their respective parts by medical adhesive tape, and insert the primary into the secondary, being sure that the windings run in the same direction on both of them.

Cut lengths of empire tubing the length desired for insulation of leads. Split one end back about $\frac{1}{4}$ " into a crows-foot; these can then be slid over the leads and securely fastened to the coil by shellac or other means. The crows-foot is your insurance that the leads will not pull out during the assembling of the transformer, and also allows the core wires to be bent snugly against the leads.

Insert a length of cardboard or fibre tub-

An Audio Frequency Amplifying Transformer, Constructed From Parts of a Ford Spark Coil.

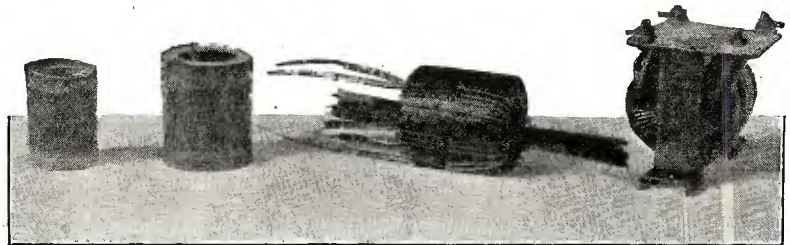

ing in the core space as added protection to the primary winding.

Coat thinly with hot paraffin.

The iron core consists of the bundle of iron wires taken from the spark coil. These are bent around the coil so that the ends meet; do not overlap them. Insert one wire at a time and securely bend it around the coil. A small portion of wire ends should be clipped off with pliers to prevent lapping (see photograph).

Wind a layer of tape over the core wires on the outside of the coil to hold them securely.

The mounting consists of fibre end pieces, fibre rod through coil, celluloid plate for binding posts and a scrap aluminum strap for mounting to panel or table.

Transformers of other ratios may be easily constructed on the same principle by figuring ratio from original coil of 35 layers.

Following the procedure outlined here will give you an efficient, durable, compact and good looking unit.

Third Prize

A CARBON PILE RHEOSTAT BY AMASA S. TRACY

The following wrinkle is nothing radical in rheostats but possesses two advantages that recommend it to the radio bug who builds his own. First it occupies but little space, and second, the resistance is determined by the position of the screws and does not fluctuate when the screw is pressed sideways, as so many of the commercial ones do.

The accompanying sketch shows the construction mounted on a panel. The resistance elements (A) are drilled and sawed into washers $\frac{1}{8}$ " thick from a battery carbon. The supporting rod (B) is the glass post from a Mazda type B lamp bulb. The

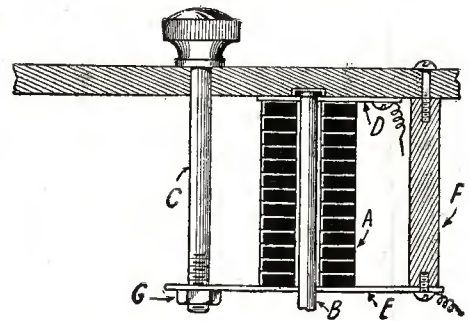

A Very Cleverly Constructed Carbon Pile Rheostat. It Has the Advantage of An Evenly Distributed Pressure.

screw (C) should have a fine thread, conveniently a 10-32 which permits the use of a standard knob with a $\frac{3}{16}$ " hole. The spring (E) is spring bronze, and has a nut (G) soldered to one end, and is fastened with two screws (at the other end) to the post (F) of $\frac{1}{4}$ " fibre, which, in turn, is screwed to the panel with two screws. The contact plate (D) is of brass and is held in

place with a screw which also serves to bind the wire, as does also a screw holding the spring. Dimensions are purposely left out, as they are not at all rigid. The longer the spring, and the more carbon washers used, the less sensitive will be the adjustment.

A SEA SHELL LOUDSPEAKER

Having tried all kinds of horns, funnels and electric heaters for the amplifying of speech and music I finally found something which I think has an advantage over others as a loudspeaker. This "something" is no less than a large sea shell of the variety that in the past held a high place in the family "curio cabinet." I am using a regenerative set with a Western Electric phone and through this shell the concerts are audible 40 feet away. The seashell has

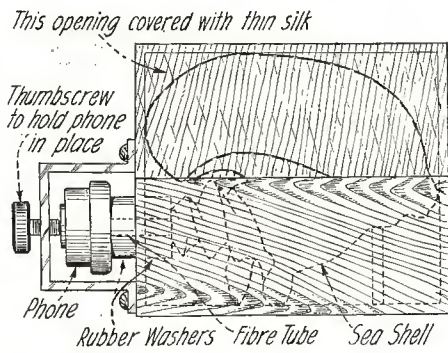

A Very Good Loud Speaker, Made Out of a Large Sea Shell. It is Conveniently Mounted In a Cabinet.

the volume of a large horn, does not take up much room and, thanks to nature, has no tinney sound.

The shell I have is 8 inches high and 8½ inches long but they vary in size according to their age. By sawing off one half of the tip on the left hand side, a spiral channel is opened which runs around to the large opening, or mouth.

I am using a large rubber washer between the phone and this opening. A cabinet can be built to accommodate the shell with very little work and the same will appear as good looking as any loud-speaker on the market. The sketch shows clearly the details of the complete instrument. A piece of silk is stretched over the opening to improve the appearance.

No dimensions are given on the sketch, since the shells vary in size.

Contributed by Frank E. Jensen.

A SIMPLE TUNER

The all-around efficiency and compactness of pancake coils should appeal to the average amateur constructor.

A very simple tuner can easily be made from these coils, a description of which follows:

The primary is wound with 50 turns of No. 26 wire and the secondary with 40 turns. The primary coil is mounted directly on the rear of the panel. A circular path on the coil is scraped free of insulation. A switch is procured and the lever is taken out of its regular place and mounted in back of the switch bushing. The lever is so arranged as to slide over the bare place on the copper wires of the primary. The secondary or movable coil is mounted directly behind the stationary coil, as shown in the diagram. This is connected to a knob in front of the panel and is kept in any desired position by using a tight panel bushing. Using a single circuit regener-

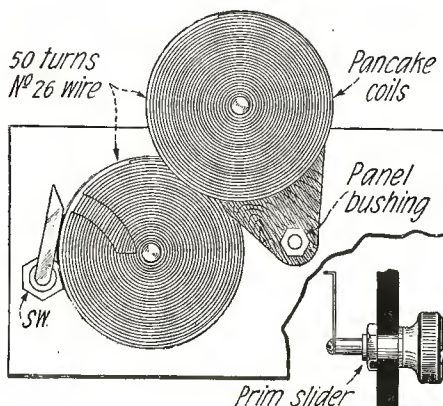

A Unique Tuner, Employing Pancake Coils. Inductance Variation Is Accomplished By Means of a Switch-Arm Slider.

ative receiver, the writer has obtained excellent results, having heard KSD, St. Louis, Missouri, several times. This is over 2,000 miles away.

Contributed by Robert Muff.

SALVAGING WORN-OUT "B" BATTERIES

Here is a stunt which I heard of recently and which will be of benefit to the radio bugs, and the writer of this being an ardent bug himself.

It frequently happens that the "B" battery runs down at an inconvenient time. If, when the first battery plays out, it should be put in some warm place, say on top of the steam radiator for from 24 to 36 hours, the compound becomes soft. This, in some manner, recuperates the battery. After cooling, it is again ready for use. I was a little skeptical of the stunt so I tried it out on a "B" battery that was absolutely good. After a treatment of heat, I tested it out with the standard voltmeter and was surprised to note a reading of 22½ volts between terminals. This stunt only holds good where the zincs are not eaten through. The same idea is also applicable to dry batteries and flashlight batteries of the ordinary type. Should you have any batteries that are dead, this method of bringing them back is well worth trying.

Contributed by M. M. Hewett.

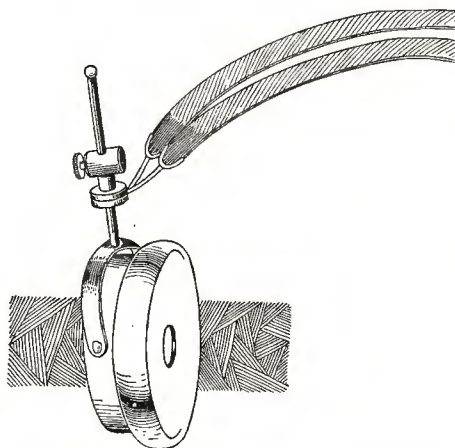

Here Is An Idea. A Binding-Post Is Soldered To the Headband Adjuster and Used As a Lock Nut.

PHONE ADJUSTER LOCK NUTS

Many of you have adjustable head phones that, although convenient, have the disadvantage of lacking lock nuts. Without these, a desired adjustment cannot be held. Simple lock nuts can be made from ordinary binding posts, as shown in the sketch.

Obtain two of these and redrill the holes so that they are large enough to easily slide down the adjuster rod. File them both on one side so that they will fit snugly against the original adjuster. These posts are then soldered to the adjusters, the binding post nuts replaced and the job is finished.

Contributed by Thomas Cannariato.

WIRE TERMINALS USED AS MINERAL CUPS IN NOVEL CRYSTAL DETECTOR

Procure three old wire soldering lugs (terminals) and bend them as shown in Figs. 1 and 2. In a piece of round brass drill three holes, A, B and C, as in Fig. 3. Thread these holes to fit screws and screw the three lugs on, as shown. Drill also the hole D and put a bolt with washer through the base, bringing over a wire to the binding post, as shown by dotted line. Mount a piece of spring steel

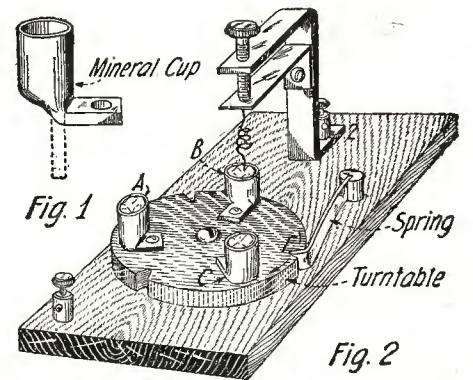

A Three-Cup Crystal Detector. The Cups Are Made From Wire Lugs. The Mounting Table Turns, Thus Affording Selection.

as shown in Fig. 3. Bend a strip of brass as shown XYZ in Fig. 3 and tap a hole at E. Bolt on at Y a piece of steel soldered to the cat-whisker. Insert thumbscrew EX. As each cup is under the cat-whisker in the most convenient position place a mark at F wherever the spring steel touches the rim. File out a V-shaped piece; this keeps the turntable rigid. All three crystals are thus available for use by merely turning the turntable to the next notch.

Contributed by Maurice Goldstein.

A TREATISE ON A HANDY-HANDLED CLIP

For use in experimental hook-ups I use clips on my wire terminals. I find these efficient and commendable for readily changing, one instrument to the other, without inconvenience. Needless to say, the results are sometimes gratifying.

After numerous tests I found my clips sometimes bent and worn through thus breaking the connections. I was able finally to devise a remedy in the following manner:

When making the connection, instead of using the single connection between the wire and clip (see illustration), obtain a short length of No. 12 or No. 16 copper wire and solder this to the clip at the same time, when making the regular connection.

Strap a coat of electrician's tape over the job and the clip connection will last indefinitely, and will lend to the attractive appearance and handiness. To obviate stickiness, rub a very little talcum powder (flour, etc.) over the taped handle.

Provided with a stout nickle-plated clip and a bit of lamp cord this idea will well answer in place of the modern plug (somewhat more expensive) feature on many of the up-to-date instruments.

Will add that I have found this carried to good advantage on the phone terminals, the aerial, ground, most conveniently on battery terminals, and loading and amplifying transformers.

Contributed by H. Z. Wilson.

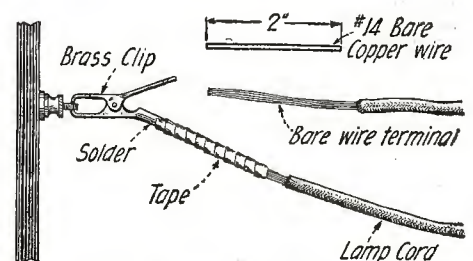

Lengths of Wire, With Clips On Each End, Are Indispensable To the Experimenter. This Is a Good Method of Fixing Them Up.



Apparatus Awarded Certificates

WILLARD RADIO "B" BATTERY TYPE CRB

Unlike the battery below, this storage "B" battery, which is manufactured by the same company, is designed for heavier service, and comprises 24 two-volt units, giving a total of 48 volts. The mechanical construction is more elaborate than the 24 volt

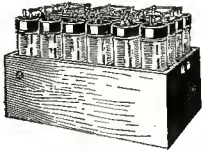

type. Each cell comprises two plates, a positive and a negative, in a cylindrical glass container having a threaded top on which is screwed a hard rubber cover. The terminals protrude through two holes in the cover, while a third hole with a hard rubber plug allows for measuring the density of the electrolyte and also for adding distilled water. A small vent hole allows for free ventilation and the escape of gases generated in the cell. The active area of the plates is about $4\frac{3}{4}$ square inches, and the normal charging rate is $\frac{1}{4}$ ampere for 20 to 30 hours. Separators between the plates prevent short circuiting. Connections between the individual cells are made similar to those on the 24 volt battery. This battery has also fulfilled the manufacturer's claims.

Arrived in excellent packing.
AWARDED THE RADIO NEWS LABORATORIES CERTIFICATE OF MERIT NO. 157.

WILLARD RADIO "B" BATTERY TYPE CRS

This lead storage "B" battery, manufactured by the Willard Storage Battery Co., of Cleveland, Ohio, is made up of 12 two-volt cells, connected so as to give a total of 24 volts. The cells are placed in a wooden

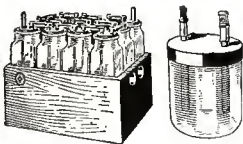

box finished in black acid proof paint. The overall dimensions of the battery are 5 inches by $6\frac{1}{2}$ inches by $5\frac{3}{4}$ inches high. Each cell comprises two plates in a $1\frac{1}{4}$ inch square glass bottle having a round opening. A hard rubber cap is attached to the opening of the bottle with battery sealing compound, the terminals of the positive and negative plates protruding through this cap. A vent hole is also placed in the cap which allows for testing the electrolyte and also for adding distilled water to compensate for evaporation. The active area of the plates is about two square inches. The plates are of very rugged construction and are separated by porous separators so as to prevent any possibility of short circuiting. Connections are made between the individual cells with heavy lead strips which are forced on the terminals of the cells, thus affording great mechanical

strength as well as allowing for voltage variation by connecting to the lead strips with a metal clip. The normal charging rate of the battery is $\frac{1}{10}$ amperes; from 20 to 30 hours are required to fully charge the battery at this rate. This type of "B" battery maintains a very constant voltage, which is highly desirable in vacuum tube radio receiving sets. This battery has fulfilled all the claims advertised by the manufacturers.

Arrived in excellent packing.
AWARDED THE RADIO NEWS LABORATORIES CERTIFICATE OF MERIT NO. 156.

WILLARD COLLOID RECTIFIER

As it is necessary to use direct current for charging storage batteries, and as only alternating current is available in many localities, the Willard Storage Battery Co. have placed on the market their Colloid Rectifier, by the use of which their storage "B" batteries may be charged from the alternating current lamp socket. The rectifier is of the aluminum valve type, and is connected in series with the battery and a 110 volt lamp to the lighting mains. This allows the battery to slowly charge at a low rate. The rectifier consists of a lead and an aluminum rod immersed in an electrolyte. The rods are firmly attached to the hard rubber cover which screws on to the glass jar. A vent hole in the cap allows for ventilation. Lead covered clips spring over the terminals where they are clamped, and in addition to being acid proof, afford a large area of contact. The glass jar is $3\frac{1}{2}$ inches in diameter and 4 inches high.

Arrived in excellent packing with a carton of chemical salts for the electrolyte and complete instructions and diagrams.

AWARDED THE RADIO NEWS LABORATORIES CERTIFICATE OF MERIT NO. 158.

REINARTZ COIL

The Reinartz coil which we illustrate is wound spiderweb fashion on a mahogany finished wooden disc $2\frac{1}{2}$ inches in diameter having 17 wooden spokes, the outside diameter of the finished coil being $5\frac{1}{4}$ inches. There are a total of approximately 100 turns of green silk covered wire; the wire is wound by skipping every two spokes, that is, by winding over two spokes, and then under two spokes, etc., until the coil is complete. Three independent sets of tap connections are brought out: one set for the

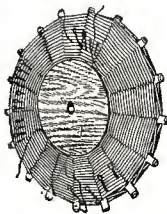

antenna circuit, one set for the grid circuit, and one set for the plate circuit. With a .0003 M.F. variable condenser connected across the maximum number of turns available in the grid circuit section of the coil, which is the size of condenser specified by the manufacturer, the maximum wave-length was

525 meters. This was reduced to 310 meters with the condenser at the zero position. Of course much lower wave-lengths can be reached by means of the taps. The coil would allow for regeneration and oscillation throughout the entire wave-length range. A hole through the center of the wooden disc provides for mounting. The compactness of the coil makes it highly desirable, as no other coils are required in the circuit, two variable condensers providing the tuning.

This coil is manufactured by the Hudson-Ross Co., 123 W. Madison Street, Chicago, Ill.

Arrived in excellent packing.
AWARDED THE RADIO NEWS LABORATORIES CERTIFICATE OF MERIT NO. 159.

RADIO VARIOMETER

This variometer, manufactured by the Radio Products Co., Box 10, Westport,

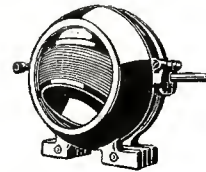

Conn., is of the ball rotor type and presents a pleasing appearance in addition to being of rugged and accurate mechanical design. The form is of a reddish brown moulded composition having legs moulded on the bottom for mounting purposes. No arrangement is provided for panel mounting. The shafts are $\frac{1}{4}$ inches in diameter, and pass through metal bearings, by means of which connections are made to the inside coil. The binding posts of unique construction are mounted on the rear for connections. This variometer was connected to a vacuum tube detector in series with a standard variocoupler secondary coil of 30 turns, and responded to a wave-length range of from 210 meters minimum to 475 meters maximum.

Arrived in excellent packing.
AWARDED THE RADIO NEWS LABORATORIES CERTIFICATE OF MERIT NO. 161.

COLUMBIA VARIOMETER TYPE 109

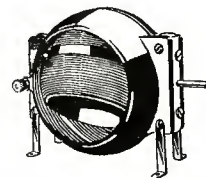

Following the conventional variometer design, the Columbia Radio Co., of 2756 Diversity Avenue, Chicago, Ill., has submitted for test the ball type variometer shown in the illustration. This variometer is of black hard rubber and has four metal legs which allow for mounting on a table or base, and also tapped holes in front with flat head machine screws for panel mounting. The shafts are of $\frac{1}{8}$ -inch metal.
(Continued on page 2195)



PROCESS AND APPARATUS FOR WIRELESS TELEGRAPHY AND TELEPHONY

(Patent No. 1,438,290. Issued to William E. Beakes of New Orleans, La. Ptd. Dec. 12, 1922.)

In order to receive signals of a given wavelength, the antenna of the receiving station must be tuned or adjusted so that its natural wavelength corresponds more or less closely with the wavelength of incoming signals, and likewise, since the wavelength of outgoing signals at a transmitting station depends upon the natural period of the antenna, the antenna is made adjustable in such a manner as to vary its natural period in accordance with the wavelength which it is desired to transmit.

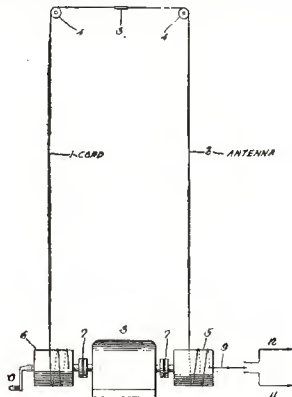

A suitable apparatus for carrying out this invention is illustrated in the accompanying drawing, in which 1 represents a line composed of any non-conducting material, such as silk or hemp, and 2 a line of any good conducting material, such as copper or silver, which acts as a part of the antenna circuit. These two lines are connected together by a joint, 3, and are conveniently arranged to pass over a pulley or pulleys, 4. The line, 2, is attached to a metallic drum, spool or other device upon which it may be wound by turning the drum in one direction and from which it is unwound when the drum is turned in the reverse direction. The drums are rotated either by means of the motor, 8, or by manipulation of the hand crank, 10.

ELECTRON-DISCHARGE DEVICE CIRCUITS

(Patent No. 1,437,021. Issued to John C. Schelleng of East Orange, N. J. Ptd. Nov. 28, 1922.)

The principal object of this invention is to provide means for the reduction of undesired oscillations in vacuum tube systems. It has been found that the parasitic oscillations are stopped by the introduction of a small inductance coil in the individual circuits of several vacuum tubes in a parallel or other system. It may be sufficient to place such inductance coils in the circuits of less than the whole number of tubes of a group.

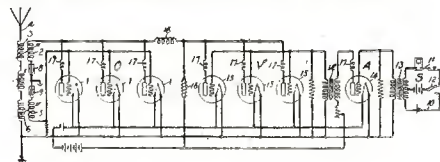

Preferably, the inductance coils are located in the plate circuits of the several tubes. In the case of 50-watt tubes in parallel for radio transmission, it has been found sufficient to use an inductance having a value of the order of 10 microhenries. Larger inductances may be used in tubes which normally handle currents of low frequency such as speech frequencies. The means described for preventing the production of undesirable oscillations is useful in amplifying and modulating, as well as in oscillating systems of vacuum tubes, and hence the invention in its broad aspect is not limited in applicability to vacuum tubes utilized for any particular purpose.

RECEIVING APPARATUS FOR RADIO SIGNALS

(Patent No. 1,438,347. Issued to Roy A. Weagant of Douglas Manor, N. Y. Ptd. Dec. 12, 1922.)

This invention relates to systems for receiving radio signals, and particularly to systems which comprise a plurality of antenna or current collecting devices situated at a distance from each

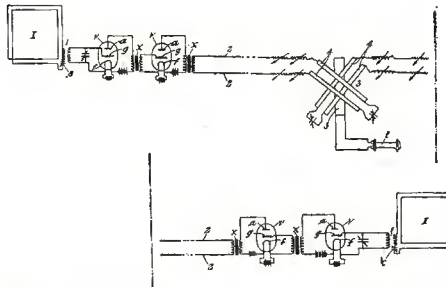

other and connected to a common indicating device.

Referring to the drawing, it will be seen that two loop collectors are provided for collecting the signal currents from the ether waves. These loops are preferably located in the line of signal propagation and should be separated an appreciable distance of a wavelength from each other. Associated with each loop and located at the loop, there is provided an amplifier of the vacuum tube type, that shown being a well known two-stage arrangement. The amplified currents are transmitted through the long horizontal leads, 2, to a radiogoniometer, 3, comprising fixed coils, 4, and movable coil, 5. The telephone, T, is connected to the movable coil, 5, and operates to make the signals audible.

RADIOTELEPHONY

(Patent No. 1,427,832 Issued to Frederick S. McCullough of Cleveland, Ohio. Ptd. September 5, 1922)

The object of this invention is to provide uniform and regular electric oscillations with small

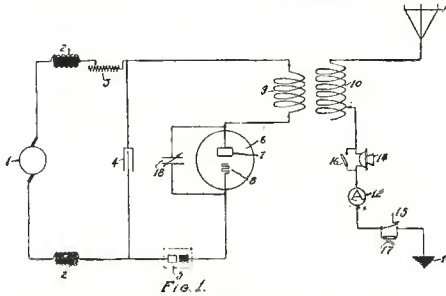

damping and having abundant power and, moreover, to furnish these oscillations by means of a simple, compact, economical and continuously reliable apparatus which operates with freedom from inherent vibrations of audible frequency and is, therefore, especially applicable to radiotelephony.

The present invention provides a means to make use of a spark gap and at the same time to eliminate its objectionable features. In this case, an arc is employed containing a sealed tube filled with an inert gas such as argon, but is not limited to any particular gas. This arc is placed in series with the high frequency spark gap and acts as a stabilizer or filter or equalizer for the irregular oscillations emanating from the spark gap. In this way, high frequency oscillations of great power and yet of smooth and regular form are produced and can be used for any kind of radio transmission. The diagrammatic sketch represents one arrangement of circuits and a view of one form of oscillator stabilizer.

TRANSMITTER FOR TELEPHONY

(Patent No. 1,441,029. Issued to Henry Joseph Round of London, England. Ptd. Jan. 2 1923)

This invention relates to improvements in the telephone transmitters of the types employing

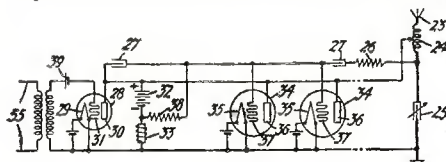

thermionic generators and its object is to provide an arrangement whereby regeneration of the continuous waves upon which the sound vibrations are impressed, is controlled by the voice.

According to this invention, means are provided whereby the voice itself causes both direct and alternating current to be fed to the thermionic

generator, the direct current starting with the voice and stopping with the voice, causing continuous waves to be generated while the alternating current causes the amplitude of these waves to be varied. This invention is illustrated by the accompanying drawing which shows it as applied to wireless telephony.

ELECTRON TUBES

(Patent No. 1,437,607. Issued to Eugene L. Mueller of Chicago, Ill. Ptd. Dec. 5, 1922)

This invention relates to electron tubes, and more particularly to electron tubes wherein the source of electrons comprises an arc. The electron tubes consist of an evacuated bulb containing a source of electrons, a metal plate member and a grid member consisting of a perforated metal

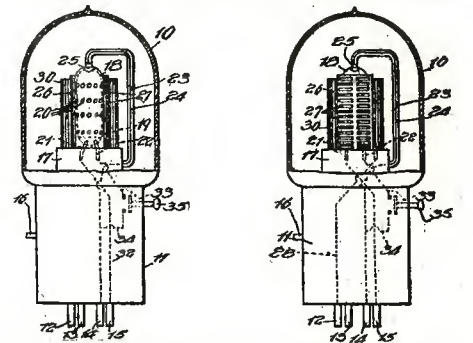

sheet interposed between the source of electrons and the plate member. The object of this invention is to provide an electron tube having an arc for a source of electrons, the arc being confined in the tube containing a vaporized material.

Another object of this invention is to provide an electron tube capable of sustained and prolonged usage. In continuous wave telephone work, the filament of the oscillator and modulator is subject to a great strain from the high voltage and amperage in the grid and plate surface so that the life of the tube is very short.

In this device, the filament is done away with, thus increasing the life of the tube.

RADIO CIRCUIT

(Patent No. 1,433,599. Issued to Ralph Brown of East Orange, N. J. Ptd. Oct. 31, 1922.)

This invention relates to radio circuits of the type desired to simultaneously send and receive as is necessary in the case of radio telephony.

In accordance with the present invention, it is proposed to introduce another method of separation than that usually employed and which will be obtained upon the time basis by associating the radio receiving channels alternately with the local low frequency line or other type of signalling circuit. Preferably the switching will take place at

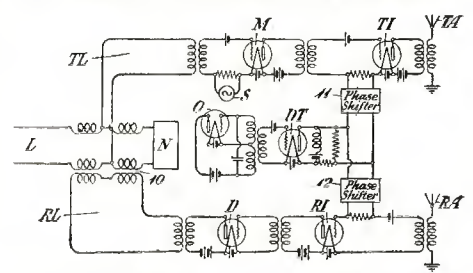

a frequency higher than the signalling frequency and lower than the radio frequency involved. Advantage is taken of the switching functioning of a vacuum tube which has the desirable characteristics of substantial inertia as compared with mechanical switching means. In general, the commutating or switching operation can take place at three different points; (a) in the audio frequency part of the system before modulation in the transmitting channel and after demodulation in the receiving circuit; (b) in the radio frequency part of the system after modulation in the transmitting channel and before demodulation in the receiving channel, and (c) in the circuits leading to the carrier frequency source for supplying the modulator and demodulator.

In considering a pair of interconnecting radio stations, it is desirable to apply the method of high frequency commutating but to one of the stations, as, for example, to a ship station for it

(Continued on page 2156)

Correspondence from Readers

ANSWER TO ALDEMAN'S LETTER

Editor RADIO NEWS:

For many months the two of us have enjoyed many mirthful moments in reading some of the articles that have appeared in your "Correspondence from Readers" columns, but when we read Mr. A. D. Aldeman's elucidation of ignorance in the March number of RADIO NEWS, we thought that it was time something was said from an unprejudiced and intelligent point of view.

Mr. Aldeman presumes in his letter to tell the Government inspectors and amateurs how things should be run when he doesn't claim to have been in the game for any length of time, or to know anything about Radio. In any park you will find soap-box orators who know just how the government should be run. We do not claim to be Radio experts, but both of us are Commercial operators and have had considerable experience in the operation of Amateur, Experimental, Broadcasting, and Commercial sets, and, therefore, believe that we read Mr. Aldeman's letter from an unprejudiced standpoint.

In answering Mr. Aldeman's letter, we take it for granted that he was in earnest in what he said, and that he did not write it as a satire or as a mirth provoker.

Without re-printing his whole letter we would like to comment upon some of the preposterous statements that Mr. Aldeman made.

He says: Code transmission has long since been perfected, H. I. Never before in the history of radio has code transmission made such great strides as in this last winter.

He says: Amateurs aren't all code hounds. He means all "Novices" aren't code hounds,—yet.

He says: The broadcast listeners are the bosses and that their desires shall be catered to in the end. It seems to us that the Government of the U. S. A. is the boss, and they still seem to be issuing licenses to the amateurs, and we think that if he will look at the number of active broadcasting stations he will find they have decreased considerably since last winter.

Next, he very eloquently boasts of having a three-tube set over which he has actually heard the great number of 51 stations within a radius of the great distance of 400 miles, all within the excruciatingly short time of six months, and then condescends to challenge the amateur to equal, with a code outfit, his wondrously magnificent record. (We nearly died from laughter when we read that). He must have been doing the Rip Van Winkle stunt for the last few years. The average nightly reception of the ordinary amateur greatly exceeds Mr. Aldeman's semi-annual reception in both quality and quantity. We surmise that he doesn't realize that an amateur in this very city has been heard in Hawaii, France, China, Australia, Canada, Alaska, Mexico, South America, England, besides every state in the union except two, (almost 1,400 miles.)

Next, he says that his wonderful concerts are ruined because of the "outlaws and near-reasonable hams," (evidently there aren't any reasonable ones; at least he doesn't mention any such thing.) using their sets to the detriment of the public. Does he realize that three-fifths of all the very numerous broadcasting stations he has ever heard were operated by amateurs, and that if it weren't for that detrimental ham who he says is pathetic, selfish, a kid, an outlaw, a narrowback, he would not have the privilege of saving a two dollar seat at the show by sitting back in his easy chair and listening to the concert over the Radio in his home?

Next, he pats himself upon the back and becomes indulgently generous. He says,

"Here's what I, a phone listener, think very generous. We will give the code sender all hours except 7:00 P. M. to 11:00 P. M. and Sunday afternoons." Thanks very much. Considering that the time isn't yours to give, we cannot help but believe that the amateur greatly appreciates the great generosity with which you give it.

Next, he tries to explain to us the inefficiency of the government officials. We will say nothing more about that. We don't believe in meddling with things that are none of our own business.

As space is limited, we will not mention anything more about the letter; however, if the person who wrote it wishes to discuss the matter to any fuller extent, he may reach us through the columns of RADIO NEWS.

"How-to-Make-It" issue of Science and Invention

The June issue of SCIENCE AND INVENTION will be the great "How-To-Make-It" number. In this issue will appear about 50 articles, all of a "How-To-Make-It" nature, of every description.

This issue will be simply "chock full" of all sorts of articles so dear to the heart of every experimenter and every dabbler in the various arts. Don't miss it!

In the June number also, the following important radio articles will appear:

Hunting Trouble in Radio Sets.

By H. Winfield Secor.

The de Forest Talking Movie.

How to Build a DX Peanut Tube Receiving Set.

Reflex Sets Save Vacuum Tubes—How to Build Them. By A. P. Peck.

Radio in the Apartment House—How Seventy-two Loud Speakers Are Operated From One Radio Receiving Set.

Radio Broadcast Stations.

Radio For the Beginner—Lightning Protection. By Armstrong Perry.

In closing, we wish to state that we heartily believe the keynote to the situation lies in the word CO-OPERATION, between amateurs, citizens and the Government. If the present legislation before Congress goes through, the friction will be materially lessened. There are outlaw amateurs that QRM the broadcast listeners, and badly operated broadcasting sets that QRM the amateurs; however, these are in the minority and should cause the citizen, amateur, and Government to co-operate more fully, rather than to cause antagonism.

Yours for better co-operation in Radio, collectively and personally,

ARCHIE WADE, JR.

GEORGE F. HUTCHINS.

Los Angeles, California.

P. S. Probably if Mr. Aldeman had spent his \$200 on a phonograph instead of a receiving set, he would have spent it to greater advantage to everyone. After he has the detrimental amateur banned he will probably exterminate the QRN and QSS menace; we hope he does.

MR. ALDEMAN EXPLAINS

Editor, RADIO NEWS:

Inasmuch as I have in the past written to some extent against amateur interference, I am going to qualify my statements somewhat and show you I am game anyhow.

I admit that I was mistaken on some things. For instance, I am convinced that

95 per cent of the amateurs are the salt of the earth, the best fellows in the world, and the best boosters of radio. All I know has been learned from them. More power to 'em and may Congress give them all the room they need. The other 5 per cent, those who are doing the most harm to radio, are commencing to feel the presence of the experienced listener and the firmer presence of the aforementioned 95 per cent amateurs. The thing that will do more to help the amateur along than anything else is patience, courtesy, willingness and no ridicule toward the novices and listeners. Use exhaustive persuasion toward the small percentage of real interference from your own ranks and if that will not work, do not hesitate to turn them in to the inspector. Be active and aggressive for the right—that's the answer. The man who will send broadly tuned spark or broad C.W. signals during an entire evening from 7 P. M. to 2 A. M. should get little sympathy.

We are sorry for the spark sets, but they seem to be doomed. Cannot most of the equipment be used in a C.W. set? Of course, it would be hard to ask an abrupt change, but crowded conditions seem to indicate a need for C.W. telegraphy only. This seems to be the desire of most amateurs. However, I am not as yet qualified enough in code to state how much interference the spark sets do make. The code amateur must get busy, be ready and willing to arbitrate fairly and instruct, and his position will not only be insured but it will be greatly strengthened. This is from a previous "narrow back" listener who has become so converted by reason of becoming well acquainted with the 95 per cent variety. He intends to do C.W. work and hang out his shingle in the blue sky, but—he will be one of these ops who will always respect the rights of the listeners until 10:30 if his C.W. interferes, and one who will not hesitate to turn in real offenders who cannot be reasoned with. Come on boys, let's go out and convince the listeners that amateur interference is negligible, by being active instead of passive in our community. Help to get the real offenders.

Hoping I have done my little bit toward "saving the amateurs," I will close..... dah dah dit dit dit dit dit dah dah.

A. T. ALDEMAN, Holyoke, Mass.

WORD FROM THE SIXTH DISTRICT

Editor, RADIO NEWS:

The undersigned "Amateurs" desire to answer the "straight talk" of A. D. Aldeman, page 1752, March RADIO NEWS, and feel that they can not only point out several mistaken claims, but also a rather "pathetic and selfish attitude."

First, why continue code work after we have done so much in developing the phone? Because, Mr. Aldeman, C.W. code work is at least three times as efficient as phone, causes but one-sixth the interference, and gives much more satisfaction than flat, stale voice communication which requires no skill on the part of the operator. Furthermore, spark work is practically as efficient as phone. While it is dying a natural death (Note-ail the undersigned have sparks), it should cause but little interference to the great majority of phone listeners. As in practically all sections of the U. S. they are off the air between 7 and 10 P. M. Thus, here in the West, what spark interference there is comes from Government stations only. Hundreds of broadcast listeners have given vent to their indignation against amateurs when the real trouble lay with inefficient Government stations. We here can proudly say that in the past four years there

(Continued on page 2195)

Radio Humor



A "Two Slide Tuner"



A "Lead In"



A "Coherer"



A "Binding Post"

Radiobugitis

BY G. B. ASHTON

THE Radio Bug bit me last month. He bit me good and hard. I guess the reason why he did's, 'cause I wasn't on my guard. But anyhow I went and bought the stuff to build a set. I worked and fussed and swore, and labored 'till I sweat. At last I got the thing hooked up like I thought it ought to be, I put the phones on both my ears with much expectancy. * * * * * Couldn't hear a thing but buzzes and it surely made me warm. I thought the bees

in the "B" bat. had started in to swarm. The noise was something awful; just what it was, can't tell. Folks tell me it was Static, but I think I tuned in H—. Or it might have been the stock-yards, I never thought of that; or it might have been a first-class fight between a dog and cat. I thought my aerial was too short, but such audacity, a fellow told me all it needs is more capacity. My old condenser would not condense, I know, I took a peek and didn't see a drop of hootch come from that old grid-leak. They said I had a tickler but I wasn't tickled yet, for all I'd done

was cuss and swear, and fuss and fume and fret.

At last I bought a RADIO NEWS and read it through and through and found the part, "I Want To Know" and knew just what to do. I wrote and told them all about my set n'everything and back he comes and tells me how to make the old set sing. The Radio Bug sure bit me hard and now I'm mighty glad. I now have music every night, the best I ever had. And if you do not watch your step the Bug will soon bite you and then you'll be the same as I and have Radiobugitis too.



A CHEAP CRYSTAL SET



By P. McGinnis.

TRY THIS ON YOUR CHEF MENU

- | | |
|---|-------------|
| RADIO | Grill |
| ENTREES | |
| Rheostat Salad with Thousand Hook-up Dressing | |
| Antennae with Galena Sauce | |
| Grid Leak Soup with Spaghetti Tubing | |
| DRINK | |
| Super-Heterodyne 100 per cent (Efficiency) | |
| MEAL | |
| Baked "B" Batteries | |
| Boiled Binding Posts | |
| Mashed Variometers | |
| Hook-ups à la Bunk | |
| Scrambled Wire | Socket Hash |
| Piece de Resistance | |
| Crushed Vacuum Tubes | |
| Regenerative Sets à la Loose Connections | |
| DESSERT | |
| Current Pie | |
| TO ORDER | |
| Hot Filaments on Toast | |
| Singed Catwhiskers on Hot Name Plates | |
| Flap-Jacks and Plugs | |
| Asparagus Cord-tips | |
- Contributed by J. Burns-Phillips.



My Experience With Radio Compass

By JOSEPH E. ENGSTROM

EVER been in New London, Conn., OM? No? Well I used to run there on the old Fall River Line for the International Radio Co. It was my thirteenth ship on a third renewal ticket so I was well broken into the game. But to begin my story, it was a fine Sunday morn in April. I arrived there with orders to report to Mr. Burns (that's not his real name but will do in this case), the Chief of W. L. C. New London Coast Station, for some extra work. The ship did not leave till nine that night and besides it meant a few more eagles on payday; I arose early with the cook and set out to find W. L. C. After getting on two wrong trolleys and one right one I found myself inside a lumber yard and after scaling over a dozen piles of lumber, iron chains and large anchors, I finally arrived before a shack which bore a sign Scotts Wrecking Co. and was just about to ask the watchman for correct bearings when I heard the crashes of a rotary coming from the upper floor, so up I goes and the sign on the door told me I stood before the door of New London Radio Station so in I goes. I ran into a sleepy-looking op. who had the graveyard from midnight to eight A. M., and after peeping him my orders, he pointed to another door and I went in. There were three men inside well known to the radio game, who were bending over a three-tube set which was attached to a loop and all were too deep in thought to take any notice of me. Then one grabbed the loop and holding it one side of the room said, "Power" and then the other side of the room saying "Western Union," meaning of course the different lines that ran into the building. After waiting about ten minutes someone spies me and comes over and says "Are you from the Richard Peck," meaning my boat. I says, "Yes," and after introducing me to the other two as the man who will hold the loop, I became one of the party. After dabbling with the loop for a few minutes we all sat down to lay out plans for the day.

It seems there was a very bad induction ring in the receiver at certain periods of the day, which would ring for two hours at a time. It was impossible for the receiving operator to get any DX traffic and it meant

quite a loss to the company. So the New York office had arranged this Sunday for the test and were sending down two of their engineers, also a car and the necessary equipment. They had no one to hold the loop while testing so that is where I came in. Well after arguing as to how many laundrys in town with induction motors and garages with mercury arc rectifiers for charging, we finally got started.

They had found that the induction had come in through the power lines and the first stop was the power house. The set and all were in the car and the loop was attached with a long flexible cord. I gets out with the loop and holds it parallel to the over-head wires while our engineer went into the power house and requested the engineer there to throw each section switch, one at a time. This kept up till he pulled a certain one and the induction stopped and the op. at the set yelled "That's it!" So it was finally traced and it was found to lead directly into Main Street before it was tapped, so off we goes to Main Street.

It was about one o'clock Sunday afternoon when we arrived at the right spot and it turned out to be a big square with a statue in the center and it was quite crowded with people, all dressed up account of it being Sunday. The side curtains were all pulled down tight on the car to keep as much noise as possible from the op. at the set. So I takes the loop and its long lead and steps out bravely. Before I had left the ship I had thought that the job was putting up an aerial so I had working clothes on and my army shirt. Mr. Burns sat in the front seat telling me just where to go by waving his hand beside the windshield. Well I was from line to line all over the square holding this four foot loop high above my head. This kept up for a few minutes and I noticed everywhere I went, the crowd went like "Mary and her lamb." Heard some whispering "Poor man" and all had that blank look like this—?????!!!!

Others said, "what's he trying to catch with that swatter?" and I looked around and saw a cop scratching his head with that same look as the others. Well around and around that square I ran holding hard to the loop and the crowd right behind me with the cop leading. Everything would

have been all right but someone yelled, "Call an ambulance!" and there was a wild rush for me. The flexible cord was torn from the loop, and Boy! I did use my feet. Ever chased by a mob? Some sensation! They kept hollering "Crazy man, stop him!" and what not. I sure did look like one after running about three blocks. No hat and my hair standing up and pumping for wind and still holding that immense fly-swatter. Well, I got two more blocks when another cop jumps at me, and we went sprawling, loop and all. So the crowd gathers all around some to see their first lunatic and wondering if I got away during the fire over on Wards Island. I tried to explain, but I was out of breath and the cops started to examine the loop. All the while the people kept saying, "It's a shame, he is so young," and "Yes, he's off his nut" a newsboy yelled, "The roof on my attic blew off;" I finally got my breath and asked for the car. They thought I meant the loop and that made matters worse, for they looked at one another and said, "Yep, I guess he's gone, I'll get the wagon."

Well just about this time the gang in the bus came to and that Honk! Honk! sure did sound good. After battling their way through the crowd they got to me, and talk about explaining, we did nothing else, but, so they agreed to reduce the charge to disorderly conduct, so up to the police station we went, car, loop and all. It took some more explaining to convince the desk captain that a man running around on a peaceful Sunday with a large fly swatter held over his head was not to be held for observation. So we all got away but were warned not to try any more funny business in the town of New London.

We were all mad when we arrived back at the station, but after thinking it over we all had the greatest laugh of our lives. I hate to tell you what the papers said about me the next day about coaxing radio bugs off the wires, but I was safely in New York again where I promptly changed boats to a different port.

WARNING: All salesmen with loop aerial receivers keep away from New London, Conn.

MORAL: When in New London do as the New Londonites do.

Printing the Newspaper Of the Sea

By C. A. REBERGER

WHAT would the world be if the newspaper were suddenly taken away? One does not have to possess a vivid imagination to realize what the results would most likely be, for we should stop to consider that the newspaper is now a necessity. This fact is well demonstrated when I say that the newspaper is not only wanted on land, but is also looked for on sea. It is educating the people and bringing them in

closer contact with the remainder of the world, and realizing this, they could hardly do without it. Were it taken away, the world would be put back at least 50 years. It is not at all absolutely necessary to emulate its great value; broad-minded individuals can realize it.

Both the newspaper of the land and the newspaper of the sea are very interesting. On land the news items are collected by a staff of correspondents, but

not so with the paper of the deep. For its outside data it must rely solely on the wireless. Therefore, the radio room aboard ship is not only a place where messages are sent and received, but a small newspaper office, as well. Each night the radio operators copy the many press reports as broadcast by the great high power stations on shore. This data is soon after printed and the following morning is in

(Continued on page 2142)

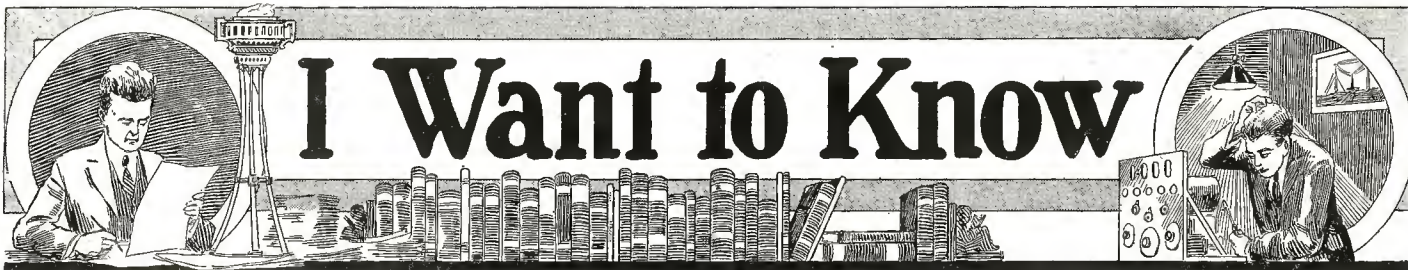

THIS Department is conducted for the benefit of our Radio Experimenter. We shall be glad to answer here questions for the benefit of all, but we can publish only such matter as is of sufficient interest to all.

1. This Department cannot answer more than three questions for each correspondent.
2. Only one side of the sheet should be written upon; all matter should be typewritten or else written in ink. No attention paid to penciled matter.
3. Sketches, diagrams, etc., must be on separate sheets. This Department does not answer questions by mail free of charge.
4. Our Editors will be glad to answer any letter, at the rate of 25c for each question. If, however, questions entail considerable research work, intricate calculations, patent research, etc., a special charge will be made. Before we answer such questions, correspondents will be informed as to the price charge. You will do the Editor a personal favor if you will make your letter as brief as possible.

EFFECT OF STEEL BUILDINGS

(679) Mr. John L. Lloyd, Lansford, N. D., wants to know:

Q. 1. Do buildings covered with sheet metal have any effect on receiving sets operated in them, and, if so, what precaution must be taken to minimize the interference?

A. 1. A building built largely of steel will absorb, to a certain degree, some of the signal energy that would otherwise go into the receiving set. This will be particularly noticeable when a loop aerial is used and, in this case, the directional effect of the loop cannot be relied upon. There will be very little effect on a set using an outside antenna, unless it is in the midst of many steel buildings.

Q. 2. Will a condenser, in series with the antenna, do anything to minimize static?

A. 2. A condenser in this position will have no effect on static whatsoever. It will only reduce the wave-length of the antenna and set, and will give finer tuning than could be obtained by means of switches.

A. 2. The secondary can be removed, if desired, but as good results will be obtained if the transformer is left open.

Q. 3. If a lower-plate voltage were used, would it be necessary to change the constants of the circuit from those given?

A. 3. If a lower-plate voltage is used, it will be necessary to change the voltage of the "C" battery in the grid circuit of the last tube. This will vary in proportion to the change in the plate-voltage. If a plate-voltage of 150 were used, the "C" battery would be about 15 volts.

DATA ON 30 HENRY CHOKE COIL

(683) Wm. T. Golden, New York City, requests:

Q. 1. Please give full directions how to make a choke coil of 30 Henrys, to use in a power amplifier.

A. 1. A diagram will be found in these columns, wherein all the necessary data will be found for this coil.

Q. 2. May a Murdock 43-plate variable con-

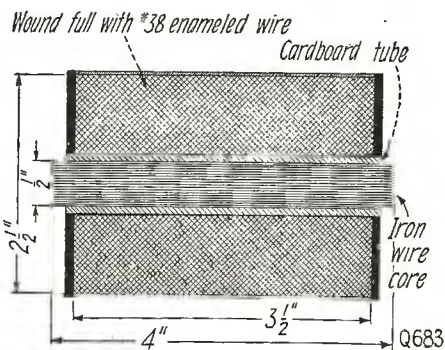

Constructional Details of a 30 Henry Iron Core Choke Coil To Be Used In a Power Amplifier Circuit.

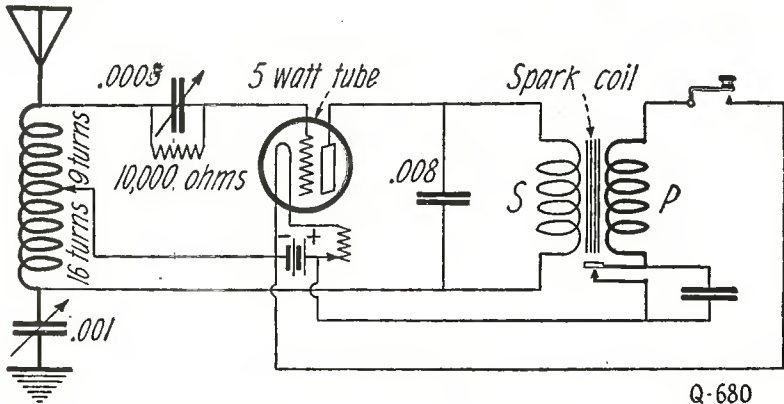

Very Good Results Will Be Obtained With the I.C.W. Transmitter. A Spark Coil Is Used To Supply the Plate Potential.

Q-680

SPARK COIL "C. W."

(680) Mr. Eddie Ross, Antigo, Wisc., asks: Q. 1. What is the voltage and amperage of the average 1/4-inch spark coil, using eight volts on the primary?

A. 1. This would depend upon the type of spark coil used and the adjustment of the vibrator. The secondary voltage would be about 7,000 volts, with an amperage of about two or three milliamperes.

Q. 2. Give hook-up of a 5-watt C. W. transmitter, using a spark coil.

A. 2. This circuit appears herewith. The same storage battery is used to light the tube and operate the coil. Better results would be obtained with a separate battery of eight or ten volts on the primary of the spark coil.

TUBE RHEOSTATS

(681) Mr. R. W. Lourie, Hudson, Ohio, requests:

Q. 1. Will you kindly tell me if it makes any difference if you use one rheostat on three tubes?

A. 1. If the three tubes are hard tubes, of the same make, and are used in an amplifying circuit, one rheostat may be used to control the filaments. The rheostat should, of course, be designed to carry the necessary amperage that the tubes will draw. The detector tube should always have its own rheostat, as the filament current is, as a rule, critical and should have some means of varying it.

QUERIES ON POWER AMPLIFIER

(682) Mr. W. E. Ravens, Tekoa, Wash., wants to know:

Q. 1. Can a 30 Henry choke coil required in the power amplifier shown in answer to Question 341, in the April-May, 1922, issue, be bought? If not, please give instructions how to make one.

A. 1. The specifications for a 30 Henry choke will be found in answer to Question 683, of this issue. We know of no concern which sells choke coils of this size at the present time.

Q. 2. If a Wayne bell-ringing transformer is used, should the secondary be left intact or removed?

denser be used with success in the wavemeter described in the February, 1923, issue?

A. 2. This condenser may be used in this wavemeter, if desired. The wavemeter should, of course, be calibrated, if accurate results are to be obtained.

Q. 3. Where may I procure English Mullard valves?

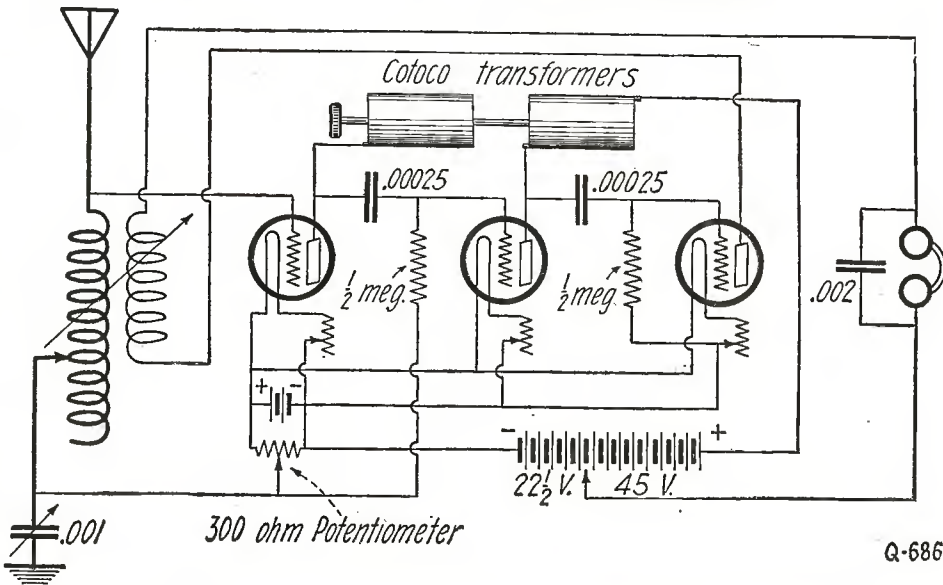

Q-686

The Multi-Range Coupler Used With Two Stages of R. F. Amplification. Two Cotoco Transformers Are Used and a Grid Condenser Must Be Employed in the Grid Circuit of the Second R. F. Tube.

A. 3. We would suggest that you get in touch with John Firth & Co., 18 Broadway, New York City.

CRYSTAL HOOK-UPS

(684) Mr. Leo Grossman, Jersey City, N. J., desires:

Q. 1. Kindly publish a hook-up, using one variocoupler, one 23-plate condenser and one crystal detector, with the resonance coil shown in answer to Question 622, in the March issue.

A. 1. This hook-up will be the same as shown in Question 622, with the addition of the variable condenser shunted across the secondary.

Q. 2. What is spaghetti used for, and could I use it on the set described above?

A. 2. Spaghetti is used as an insulator, and should be used on bare wires, where there is danger of their touching. Where wires are separated, this tubing is not necessary.

Q. 3. I have made three fixed crystal detectors. Can I use them all in this set?

A. 3. Only one crystal detector is used at a time. The three can be used in conjunction with a three-point switch, so that any detector may be cut into the circuit at will.

CALCULATION OF CONDENSER CAPACITY

(685) Mr. W. L. Alkennan, Philadelphia, Pa., requests:

Q. 1. Please publish formula for calculating the capacity of condenser.

A. 1. This formula follows herewith:
 $C = \frac{A \times K}{4 \times 3.1416 \times T \times 900.000}$

C = Capacity in mfd.

A = Area in sq. centimeters of one set of plates or surface.

K = Dielectric constant, or specific inductive capacity of the dielectric used.

T = Thickness of the dielectric between the plates, surface measured in centimeters.

The dielectric constant may be found in any good text-book of radio.

RADIO FREQUENCY AMPLIFICATION

(686) Mr. J. Thompson, Montreal, Canada, asks:

Q. 1. Will you please publish a hook-up of a multi-range coupler, used with two stages of radio frequency amplification, with coto-coil transformers?

A. 1. This hook-up will be found in these columns.

R. F. AMPLIFICATION WITH REINARTZ CIRCUIT

(687) Mr. M. L. Flynn, Chicago, Ill., requests:

Q. 1. Kindly show a hook-up of the Reinartz tuner with one stage of radio frequency amplification.

A. 1. This hook-up will be found in these columns. Tuned radio frequency must be used in

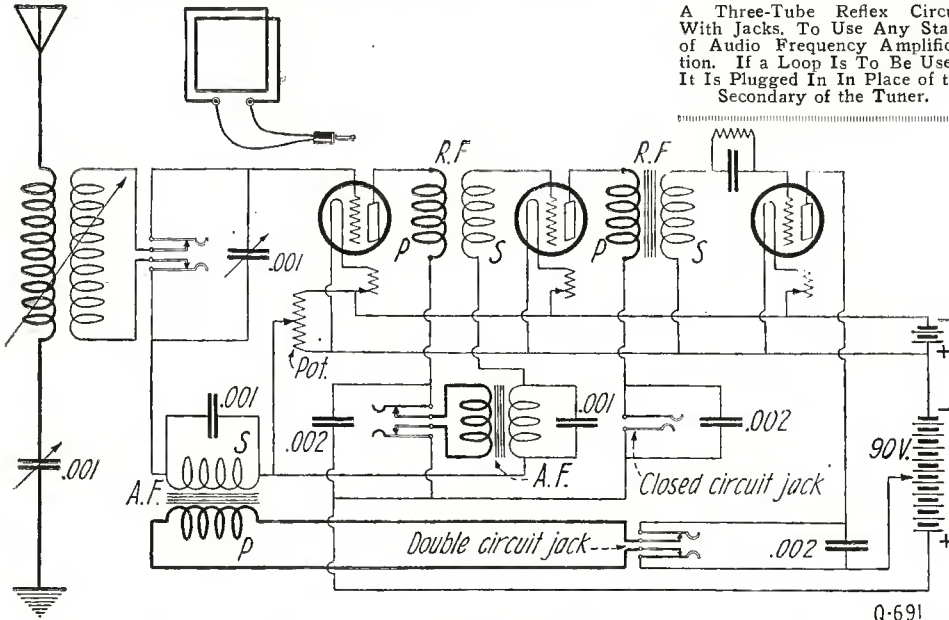

Q-691

this circuit. The primary of a variocoupler may be used for this purpose. A variometer can be substituted for the coil and condenser, if more convenient. We would suggest that the tickler winding be reversed, for best results.

W. D. 11 AMPLIFICATION

(688) Mr. C. Carder, Letts, Ind., wants to know:

Q. 1. Do they make a special W. D. 11 tube for amplification, or is the same tube used for detector and amplifier?

A. 1. No. The W. D. 11 will, however, give very good results when used for this purpose.

Q. 2. Is a special transformer manufactured for these tubes?

A. 2. Any good audio or radio frequency transformer may be used with success with these tubes.

RADIO AND AUDIO FREQUENCY

(689) Mr. Elwood Ford, Seaboard, N. C., asks:

Q. 1. I am about 400-600 miles from broadcasting stations. If head-phones are used, what combination of amplification would be best, using 3 tubes?

A. 1. For this distance, we would suggest one stage of tuned radio frequency and one stage of audio frequency.

Q. 2. Please publish a circuit, showing a variocoupler with this arrangement.

A. 2. A circuit showing one stage of tuned radio frequency will be found, in answer to Question 668, in the May issue of RADIO NEWS. One stage of audio frequency amplification may be added in the conventional way.

Q. 3. How many ohms resistance has No. 22-gauge copper wire?

A. 3. This size copper wire has a resistance of 16.25 ohms per thousand feet, or 62.236 feet per ohm.

RECEIVING RANGE

(690) Mr. Harmon Briner, East Orange, N. J., writes:

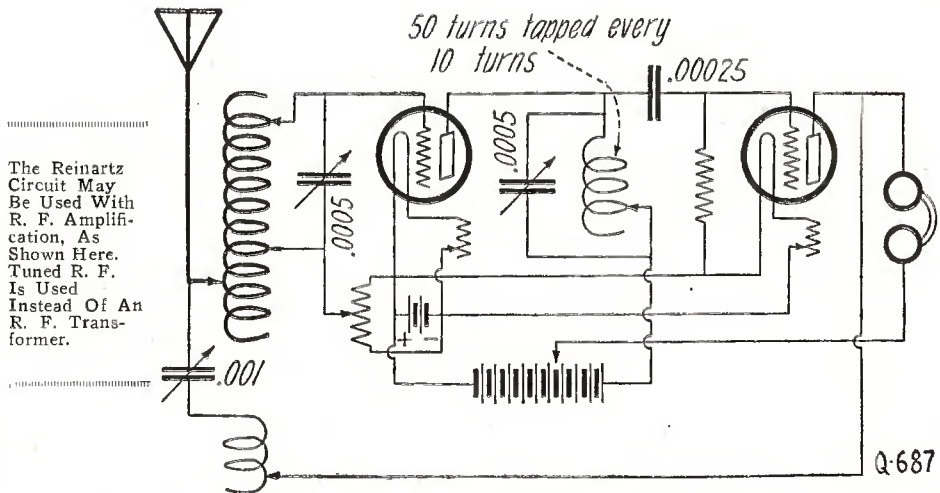

The Reinartz Circuit May Be Used With R. F. Amplification, As Shown Here. Tuned R. F. Is Used Instead Of An R. F. Transformer.

Q-687

Q. 1. I have a standard three-circuit regenerative receiver, and have received stations 800 miles distant with an inside antenna. Am I obtaining maximum efficiency with this equipment?

A. 1. A distance of 800 miles with an indoor antenna is very good, and you may rest assured that you are getting maximum results.

A Three-Tube Reflex Circuit With Jacks. To Use Any Stage of Audio Frequency Amplification. If a Loop Is To Be Used, It Is Plugged In In Place of the Secondary of the Tuner.

antenna circuit, to help sharpen the tuning. A 43-plate condenser, however, would be better in this position.

JACKS WITH REFLEX CIRCUIT

(691) Mr. S. R. Jenkins, Milwaukee, Wis., requests:

Q. 1. Please show a hook-up, showing how jacks may be inserted in a three-tube reflex circuit, using a variocoupler as a tuner. Also show how a loop may be used in this hook-up.

A. 1. This hook-up will be found in these columns. Two double-circuit and one closed-circuit jack are used. A double-circuit jack is also used in the secondary circuit, so that the loop may be plugged in. The loop may consist of eight turns of wire, on a four-foot square frame.

ROTOR MOUNTING IN 180 DEGREE COUPLER

(692) Mr. Wesley Nelson, Huntley, Ill., wants to know:

Q. 1. Please let me know how the rotor is mounted in a variocoupler to rotate 180 degrees.

A. 1. The rotor in this form of coupler does not rotate 180 degrees, but is so mounted that it moves only one degree for every two degrees moved on the dial. It is mounted at an angle of 45 degrees to the shaft, to accomplish this. We would refer you to the "Wrinkle Contest," in our February issue, wherein this is fully explained.

LONG-WAVE COUPLER

(693) Mr. N. F. Pavelec, East St. Louis, Ill., asks:

Q. 1. On a long-wave coupler, is the section that is wound for short waves on the upper or lower end of the tube?

A. 1. The short-wave winding is wound on the end of the tube which contains the rotor.

Q. 2. By three-layer bank-winding, do you mean three separate layers of wire?

A. 2. We would refer you to the answer to Question 642, in the April issue of RADIO NEWS, where this is fully explained.

Q. 3. Does the rotor of these couplers (when graduated dial is at zero) also stand 180 degrees?

A. 3. We refer you to the answer to Question 692, of this issue.

MYERS TUBES IN "SUPER"

(694) Mr. Wm. J. Lait, Alta, Canada, wants to know:

Q. 1. Please let me know if I can use Myers High-Mu audions, in place of Western Electric (Continued on page 2152)

Q. 2. Is there any advantage in placing the phones between the "B" battery and plate?

A. 2. This will not increase the efficiency of the set any, but will prove of advantage when audio frequency amplification is added. If placed in this position, the "B" battery can be used to supply plate voltage for both detector and amplifying tube.

Q. 3. Where can I use a 25-plate condenser to advantage in this set?

A. 3. If the primary inductance is not controlled by two switches, it may be placed in the

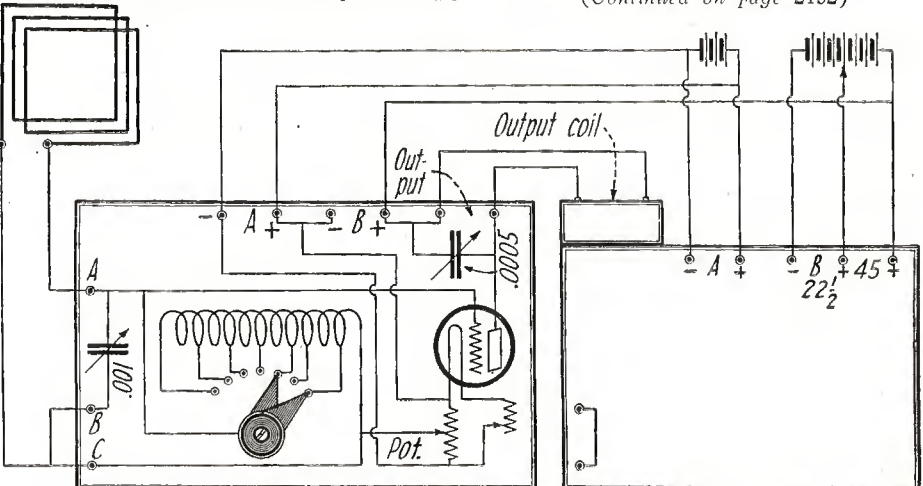

RORN

CR9

Q-695

The Method of Connecting the RORN Tuned R. F. Amplifier to the C. R.-9 Receiver. If An Outdoor Antenna Is Used, It Is Connected Directly To "B" and "C."



Don't tear 1923 in half

How a loop and ACME for amplification make radio a pleasure the whole year round

IS YOUR radio set good for just about six months of the year? Do you want to find a way to get distant stations clearly and distinctly the entire year; to get these stations without the usual amount of interference from government and other spark transmitting stations, from your neighbor's radiating receiving set, or from our old foe "summer static"? Then here's a way.

Use a loop and Acme for amplification

TEAR down your antenna, put on a loop and use Acme for Amplification (preferably with dry battery tubes) and reduce your interference troubles to a minimum. By using Acme for Amplification you get more than mere amplification—you get distance and volume without distortion. There's the Acme Radio Frequency Amplifying Transformers (R-1-2-3-4) for distance and the Acme Audio Frequency Amplifying Transformer A-2 for volume and the Acme Kleerspeaker for clearness. Use Acme in the set you build and look for it in the set you buy. You can buy this standard Acme Apparatus at any radio or electrical store.

A special booklet has just been prepared explaining exactly how to avoid interference and to secure distant stations clearly and distinctly. The booklet includes wiring diagrams and other serviceable information. It will be sent postpaid anywhere in the United States, Canada or Mexico on receipt of ten cents or its equivalent in American money. This small charge is made in order to be certain that the booklet is placed in the hands of radio owners and experimenters and that it will not be wasted upon mere curiosity seekers. *The coupon is for your convenience.*

ACME APPARATUS COMPANY
(Pioneer radio engineers and manufacturers)
Cambridge, Mass., U. S. A.
Sales offices in principal cities

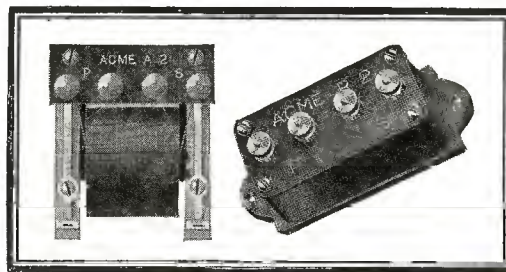

Acme A-2 Audio Frequency and Acme R-2 Radio Frequency Amplifying Transformers. Price \$5 each, east of Rocky Mountains.

ACME APPARATUS COMPANY
Cambridge, Mass., U. S. A.
Gentlemen:—Enclosed find 10 cents in (coin) (stamps) for which send me your booklet on wiring diagrams and complete information on Acme Apparatus.

Name

Street

City State

ACME ~ for amplification

I Pay Your Railroad Fare



B. W. COOKE, President

to the Great Shops of COYNE

Chicago

The Electrical Center of the World

We pay your railroad fare to Chicago — the Electrical Center of the World — from any place in the United States. Grasp the opportunity to see the country at our expense. Come to Coyne — learn electricity in 3 months. The largest electrical school in the country specializing in electrical instruction only. Get a complete training so you can make big money as Power Plant Operator, Superintendent, Telephone man, Construction worker, auto, truck or tractor electrician, battery man, radio expert, or you can go into business for yourself as electrical contractor, dealer, auto ignition or battery expert and make from \$3,000 to \$20,000 a year. Hundreds of our graduates today are making big money and you can do the same if you grasp this opportunity — act now.

Learn Electricity In 3 Months

No books or useless theory. You are trained on \$100,000 worth of electrical equipment. Everything from door bells to power plants. You work on motors, generators, house-wiring, autos, batteries, radio, switch-boards, power plants — everything to make you an expert ready to step right into a position paying from \$45 to \$100 a week.

Radio Course FREE

We include the following free with the regular course; (1) A complete course in auto, truck and tractor electricity and storage batteries. Greatest outlay of auto, electrical and battery equipment in the country. (2) Course in Radio — the marvel of the age. Constructing, installing and operating. You can build your own wireless telephone set. (3) A life scholarship in the Coyne school. You can stay as long as you wish and return for further training at any time in the future.

Earn While You Learn

We help students to secure jobs to earn a good part of their expense while studying.

Send Coupon Now

Don't delay a minute — send that coupon in right now for our big free catalog and full particulars of Free Railroad Fare offer. Act now!

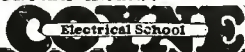

Endorsed by Electrical Industry

1300-1310 W. Harrison St., Dept. A-594

B. W. Cooke, Pres., Coyne Electrical School, Dept. A-594 1300-1310 W. Harrison St., Chicago, Ill.

Dear Sir: Please send me free your big catalog and full particulars of your special offer of Free Railroad Fare and two extra courses.

Name _____

Address _____

Electrons, Electric Waves and Wireless Telephony

(Continued from page 2089)

direction (see Fig. 63), we find that this grid is opaque to the electric radiation when the frame is held between the receiver and transmitter with the grid wires parallel to the oscillator rods, but is transparent when it is turned into a position such that the wires are perpendicular to the oscillator rods, the plane of the frame in both cases being perpendicular to the line joining the spark balls and the coherer.

The reason is because in the former case electric currents are set up by the electric

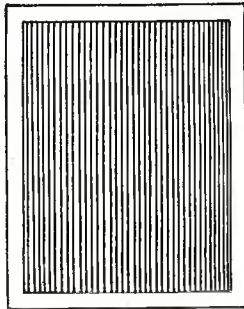

Fig. 63. A Grid, Formed By Winding Wires Around a Wooden Frame.

waves in the grid wires, and in the latter case they are not.

The waves emitted are therefore said to be plane polarized; that means the vibrations are confined to one particular plane. This is the case with light waves when they have been transmitted through certain crystals such as tourmaline.

We can next exhibit the reflection and refraction of these invisible electric waves, and show that they behave like waves of light.

If we turn the transmitter and receiver boxes with their open ends in nearly the same direction, but placed not quite near each other, it is possible to find positions in which the emitted waves do not enter the receiver box and affect the coherer. If,

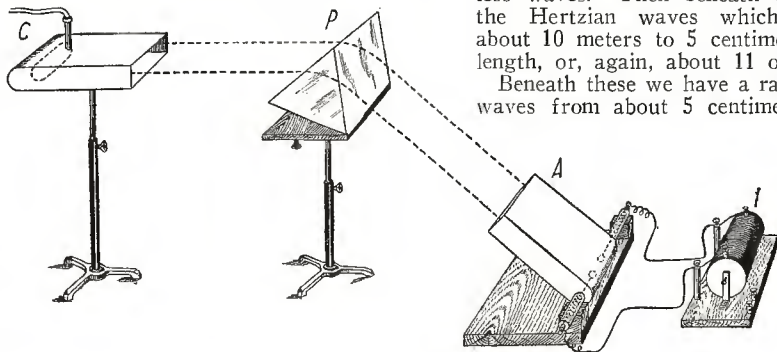

Fig. 64. An Experiment with the Apparatus Shown in Fig. 62. To Illustrate the Refraction of Short Electric Waves by a Paraffin Prism.

however, we hold a sheet of metal we can reflect the invisible electric beam into the mouth of the receiver box and so affect the coherer.

Moreover, we can do the same thing with a wet duster, and also with the grid of wires provided we hold the grid in such a position that its wires lie in the same plane as the rods of the oscillator.

We shall see later on in speaking of wireless telephony that we can in this manner construct reflectors for electric waves which are not very cumbersome or costly, and especially do not offer much surface to wind.

We can also refract or bend the direction of these waves by means of prisms made of paraffin wax (see Fig. 64).

Again it is possible to produce, as Hertz did, interference effects and to cause two

sets of waves to augment or to destroy each other just as in the case with waves on water or waves in air.

In short, we can exhibit with this invisible electric radiation similar phenomena to those with which we are so familiar in the case of light, viz., opacity, transparency, reflection, refraction, polarisation, and interference. Great experimentalists, following Hertz's initiative, have therefore built up a body of irrefutable proof that in this invisible electric radiation of long wavelength we are dealing with an agency identical in nature with light, except that it cannot affect our eyes but can only influence certain artificial eyes called aerials and detectors.

This is perhaps the best place to mention the range of these known and also of the unknown wave-lengths which are comprised by this electric-radiation. It will be convenient to adopt a term from the science of music and call an octave of radiation all those waves which are included between a certain particular wavelength and a wavelength of exactly double or else half that length.

We may, then, compare the electric waves of different frequency, extending over a great range, with the keyboard of some large organ in which each key corresponds to a different wave-length. In the case of an organ a compass of eight or nine octaves includes all the range of musical sounds, but in the case of electric waves we are acquainted with wave-lengths extending over nearly 50 octaves, ranging from the longest ethereal billows of 20,000 meters in wave-length down to the tiny ripples of less than 1 angstrom unit in wave-length which constitute a certain class of X-ray.

Beginning, then, with the longest electric waves, we can say that the range of wave-length of waves used in wireless telegraphy and telephony extend from 20,000 meters to 10 meters, or, say, over 11 octaves of wireless waves. Then beneath these we have the Hertzian waves which range from about 10 meters to 5 centimeters in wave-length, or, again, about 11 octaves.

Beneath these we have a range of electric waves from about 5 centimeters in wave-

length to 0.3 millimeters, or about 8 octaves of radiation, which has not yet been created and are therefore unknown.

Again below these, we find the dark heat-waves stretching from 300 microns (μ) or $1/3$ of a millimeter in wave-length to about 0.8μ or 8,000 Angstrom units (A.U.) These 7 or 8 octaves of radiation can make themselves evident by their heating action on sensitive thermometers, but do not affect our eyes as light. Extending in wave-length merely 1 octave from 0.8 to 0.4 in wave-length, we have that small range of electric waves which can affect the human eye as light. Beyond the violet rays there is a range of 3 or 4 octaves or more of invisible light, which cannot affect our eyes but can impress a photographic plate, and produce other effects. These are called the ultra violet waves, and their wave-

You Need Not Experiment With Untried Radio Products Unless You Want To

Model C3 Radak Described Below is the Product of America's Oldest Radio Manufacturer

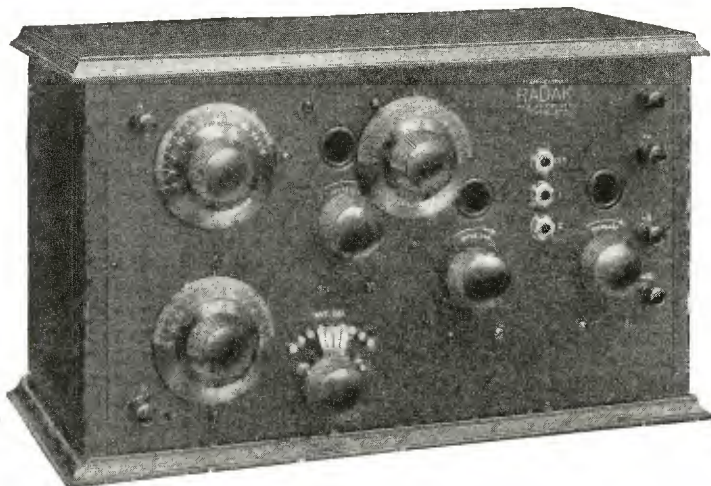

Licensed under Armstrong U. S. Patent No. 1113149

Read What This Man Says:

Melrose, Mass.,
March 28, 1923.

Clapp-Eastham Co.,
Cambridge, Mass.
Gentlemen:—

You will be interested to know that last Saturday morning, March 24th, at 1:15 A.M. Boston time, I tuned in on Station KYQ—Electric Shop, Honolulu, Hawaiian Islands, and listened for about ten minutes; while yesterday morning with a witness, we again tuned in on the same station at the same time and succeeded in holding them for thirty-five minutes. When we first tuned in, they were broadcasting a Bed Time Story; records were later played, among them "When Hearts are Young" and "Running Wild."

This was done with your Clapp-Eastham Tuner and HZ two-stage Amplifier.

Very truly yours,

M. H. HALL.

Model C3 RADAK is a regenerative receiver and two stage amplifier combined in a beautiful walnut cabinet. All tuning controls are equipped with the new RADAK vernier dials, and the new RADAK vernier rheostat is employed for filament control. Price \$100.00.

THIS IS OVER 5,000 MILES

We have received thousands of testimonial letters from satisfied users of RADAK RECEIVING SETS and many letters from dealers who are pleased with our merchandising proposition, one of which, received a few days ago, reads as follows:

Clapp-Eastham Company,
Cambridge, Mass.
Gentlemen:—

Leavenworth, Kan.

After going over the ground carefully, we feel that your line, terms and other considerations suit us better than any we have investigated. We have tried many lines; some of them are not well made or do not give results; some the list is too high or the discount not satisfactory; some fill the bill as to quality, results, list and discounts, but they seem to have no established reputation. Another thing we like is your trade-name, RADAK.

THIS IS THE ANALYSIS OF A SUCCESSFUL MERCHANDISER to which we add—RADAK is cleverly designed, well built and extremely efficient. The list price is as low as good quality will permit. Our large discounts REFLECT PROFIT TO THE DEALER.

Radak equipment is so simple anyone can operate it and get good results. We have a set to meet every pocketbook.

RADAK

Reliable Radio Equipment

CLAPP-EASTHAM COMPANY

107 MAIN STREET

CAMBRIDGE, MASS.

709 Mission Street
San Francisco, Cal.

395 Broadway
New York, N. Y.

33 S. Clinton Street
Chicago, Ill.

422 First Avenue
Pittsburgh, Pa.

Dots and Dashes—

Looping the loop —or loops?

I dropped in at the radio store of an old friend the other day. It was the first real hot spell we'd had. Harry was mopping his brow and fiddling and fussing around a demonstration set. In fact he was about as much fussed over its cantankerous howlings and yowlings as a young father on the first night his offspring sits up and commences to take notice.

"I might as well shut up shop" he moaned at last. "No one's going to buy radio in the summer with all this static. It's going to be just like last year. I might as well shut the door until October and go fishing. Oh! Oh! Oh!" and a lot more. Harry, though otherwise a sane and sound business man, had let the "summer slump" bugaboo play loop the loop with his good judgment.

Now I don't claim to be any Marconi or Armstrong, but just the same I saw what was kicking up most of the commotion in Harry's favorite set. He had an antenna about a mile long, and no radio frequency. "Harry," I said, "for the love of Mike, Sam and Pete, cut out this looping the loop and just use a loop."

Harry took another wild swipe at his perspiring front piece and gulped out, "What do you mean, use a loop. This is bad enough without monkeying with anything else."

Well, I didn't argue much, but rolled up my sleeves, unhooked that antenna, got some radio frequency amplification units out of a corner, took a loop from his counter and started work. Half an hour later that outfit of his sounded like a well mannered house cat instead of a howling hyena. Because I'm only human I rather gloated over this. But friend Harry got the point. About all he seems to be able to talk about now is loops and radio frequency. And his store seems to be pretty well occupied with gentlemen itching to dispose of perfectly good cash for something to put the kibosh on summer static.

Get the point, gentle reader? A post card to me care of North American Radio & Supply Corporation, 7 Columbus Circle, New York, will bring any radio dealer some interesting dope on how to wallop the summer slump. Of course, you know we're hankering to sell you some stuff, but it's all nationally advertised so you needn't get gun shy on that account. Let's see what kind of a fist you write.

Ray Myre

lengths extend from about 4,000 A.U. down to perhaps 500 A.U. or less.

Below these there is another gap of unknown or unproduced wave-lengths, and then we come to the region of X-rays and Y-rays, which are electric waves with wave-length of the order of 1 A.U. or less.

We are therefore acquainted with the properties of a vast gamut of electric waves with, however, two gaps in it of unknown waves, but covering on the whole about 50 octaves of radiation. For all we know there may be in the economy of nature waves of still greater or still less wave-length as yet unproduced. (To be continued)

A Filter Circuit for High-Tension Supply

(Continued from page 2109)

the capacity of the condenser C_3 is too low. Hence, if distortion results from the constructed unit, increase C_3 , or remove some of the wire from L_2 . Once this adjustment is made, no ill effects can be detected, but instead there is a very pleasing absence of crackle or rustle.

The unit is particularly useful when working off D.C. mains. The circuit is the same, but the high-tension battery shown in dotted lines is replaced by leads from the D.C. sup-

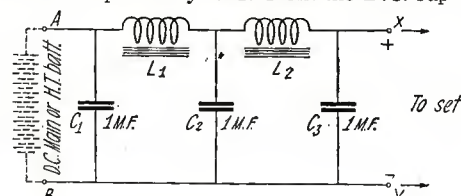

A Filter System That Will Take Those Disagreeable Cracking Noises Out of the Loud Speaker.

ply. A potentiometer (which must be capable of carrying, without heating up, the amperes obtained by dividing the mains' voltage by the resistance of the potentiometer) is preferably employed, so that a variation of anode voltage is obtainable. An ordinary 25-watt lamps should also be inserted on one of the leads as a protective device.

WASHINGTON GETS R.C.A. BROADCASTING STATION

Practically the whole continent will be able to hear a new broadcasting call, as yet unassigned, when the R.C.A. station at Washington opens up in June. Other than that the station will be of the highest order and latest type, the Radio Corporation refuses to state.

The new station is located at 14th Street and Park Road, known in Washington as Mount Pleasant.

Through the co-operation of the Riggs National Bank and Chas. H. Tompkins, two 100' fabricated steel towers have been erected on the roofs of the Riggs and Tompkins Buildings in the highest section of Washington where they will serve as new and modern landmarks for the Capital.

Their construction is unusual, in that they have three legs instead of the more customary four. This reduces wind resistance and makes for stability. A 36' cross-arm near the top of each tower supports four antenna wires each 12' apart. The distance between the towers is 220' and the effective radiating length of the antenna 160'.

The studio, the reception, transmitting and apparatus rooms are on the second floor of the building. Two motor generator units will insure an adequate power supply and two tube transmitters will make possible flexible, smooth running programs. It is hoped that the station will be in operation and ready to serve Washington and the surrounding territory within two months.

A New Radio Pleasure

LOCATE ships at sea, trace amateur stations to their hiding places, direct your receiving in the full path of broadcasting stations.

THE B 2537 or type BL 2520 Warren Radio Loop, the most compact, efficient, attractive loop aerial, is all you need add to your set. Our new Bulletin T102 explains the fascinating art of direction finding and gives hookups.

A Type For Every Set At The Best Dealers

- Type A-737 (300-700 meters) 6 inches square—non-directional\$10
- Type A-7236 (175-1000 meters), 6 inches square—non-directional 12
- Type B-2537 (300-700 meters), 18 inches square—directional 20
- Type BL-2520 (200-18,000 meters), with honeycomb coil, 18 inches square—directional 25

V-DE-CO RADIO MFG. CO.
ASBURY PARK, N. J.
Dept. N

The "WAVE TRAP" will eliminate interfering broadcasting stations and enable you to listen to your favorite station.

It will work on any set, greatly increase its selectivity and clearness, and eliminate code and spark stations.

It is mounted on a Formica panel in a handsome mahogany finished cabinet 6 x 5 x 6. It is a high grade instrument throughout and a valuable addition to the operation and appearance of any set. It comes to you complete and there are no extras to buy. It is installed in a minute by changing only one outside connection.

Use the "WAVE TRAP" for real results.

850 Ferbend Electric Co.
25 E. SOUTH WATER ST.
CHICAGO

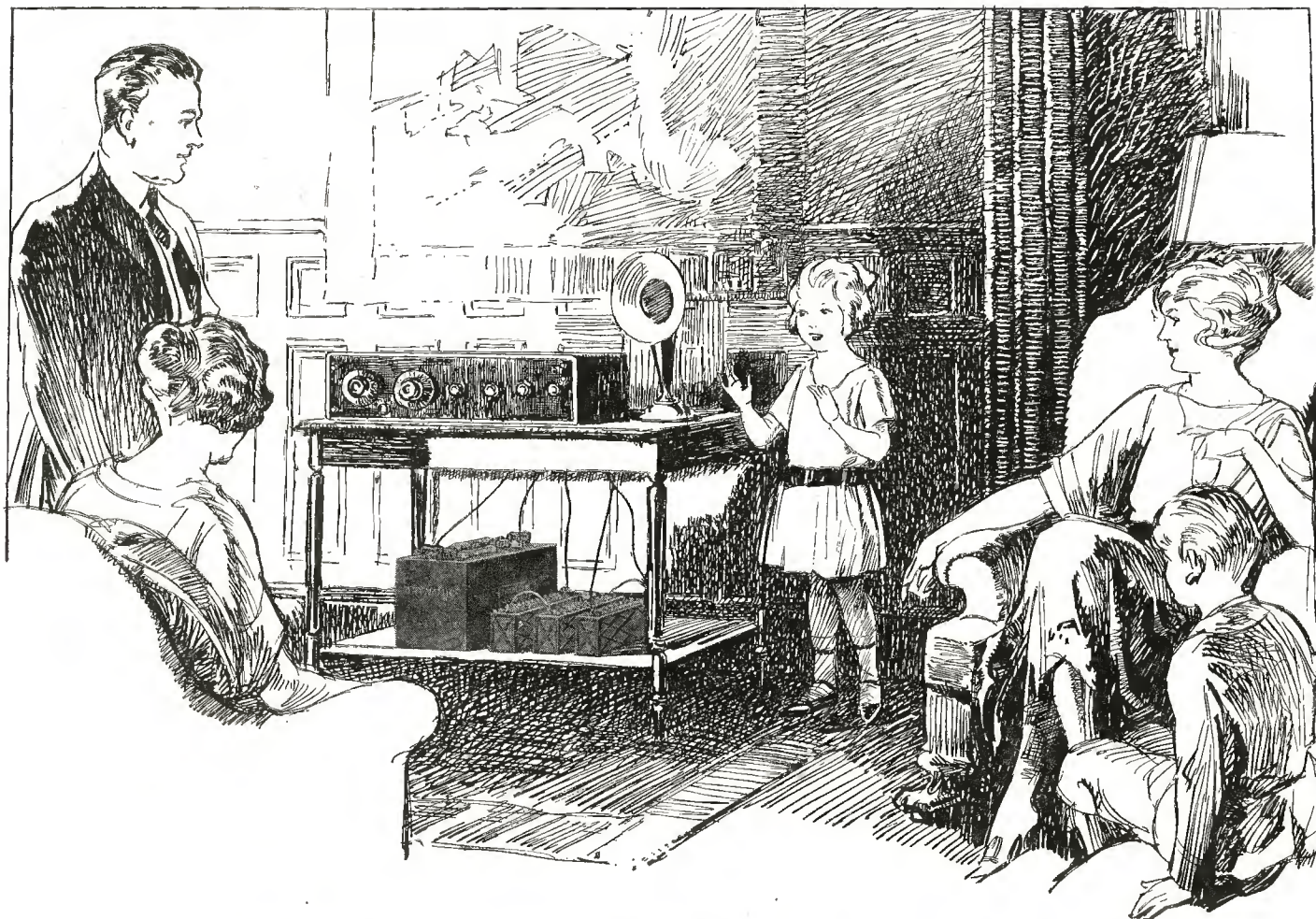

“Daddy! Daddy!—It’s Cuba”

A new and far-off station—hundreds of miles further than you ever picked up before! That’s the romance—the new thrill—of radio made possible by your new Philco Drynamic STORAGE Batteries.

Thousands of radio owners every day are getting new pleasures—increasing the range and tonal purity of their radio reception—by replacing their dry-cell batteries with Philco Drynamic Storage Batteries.

Philco Radio “A” Batteries, with their tremendous excess capacity, give a strong, continuous uniform flow of current over long periods. This means great amplifying power—noiseless service—no frequent, troublesome adjustments.

Philco Radio “B” Batteries—by reason of their scientific design, uniform voltage and perfect insulation—free your radio from the frying, cracking dry-battery noises so frequently blamed on static.

Charged DRY at the factory, the life of a Philco Drynamic Battery doesn’t start until you pour in the Philco Electrolyte. No initial charging. No paying for battery life lost on the dealer’s shelf or in the barrel.

You’ll want to know more about these remarkable Radio “A” and “B” Batteries. See your radio dealer or the nearest Philco Battery Service Station.

PHILADELPHIA STORAGE BATTERY COMPANY

PHILADELPHIA

Makers of the famous Philco Slotted-Retainer Batteries for automobiles, electric passenger cars and trucks, mine locomotives and other high-power, heavy-duty battery service.

PHILCO
 DRYNOMIC RADIO
 BATTERIES



Just Out

4th Edition \$1.00



Over 20,000 Call Letters and Map-size 2x3ft

Indispensable to every radio owner. Contains up-to-date list of over 20,000 Amateur, Commercial, Army, Navy, Transoceanic High Powered, and Broadcasting Stations in the United States and Canada; International Morse Code and Convention Signals; the construction and operation of the

Reinartz Tuner, Detector, and One-Stage Amplifier

also an abundance of other useful information.

Included with the book is a splendid two-color map of the United States and Canada, 2 x 3 ft., showing radio district boundaries, standard time lines, geographical location of broadcasting stations, etc.

The greatest dollar value on the radio market. At your dealers or direct by mail. Use check or money order. Do not send stamps.

Buy the Book with the Blue Cover

Radio Directory and Publishing Co.,
45-C Vesey Street, New York City

Send me a copy of the Amateur Radio Call Book and Map, Fourth Edition, for which I enclose \$1.00.

Name

Street Address

Town and State.....

AMATEUR
RADIO CALL BOOK

Mr. Filbert Tunes In

(Continued from page 2099)

top of his bald head turned crimson. He was so angry he could not speak.

"Sir," continued the stranger, taking advantage of Mr. Filbert's inability to speak, "have you a radio in your home? No? I am sorry. My name is Enderbury Cloomtz. I am a radio fan. I am never ten feet from my radio outfit. It is in my valise here at this moment. When, after the steamer *Isabella* had gone on the so, as bald as a billiard ball that has had the mange. You are absolutely, completely, disgracefully bald!"

rocks, I found myself on the lonely isle of Tulula, my right hand clasped the bag containing my radio outfit. My wife was drowned in that wreck, sir, but I let her go; my three children were drowned, but I let them go; my money was lost, sir, but I let it go; I clung to my radio outfit and saved it. Why?

"Because, sir," continued the stranger, "since my earliest days I have never gone to bed without hearing one of the well known Uncle Brittle-bat Bedtime Tales. My mother read them to me when I was a child; when radio came to be, I listened to them as they came through the air. Unless I hear my evening's Uncle Brittle-bat Bedtime Tale I cannot sleep. Insomnia attacks me; I lie and groan; my health fails; death approaches. For that reason, sir, my radio outfit is a necessity to me; without my regular Uncle Brittle-bat Bedtime Tale, I must perish."

Mr. Filbert made a gurgling sound and turned a dull purple. Perhaps maroon is nearer the color; I am not a color expert.

"No man," said the stranger severely, "can be happy and contented and highly successful unless he has hair!"

"I don't want—" Mr. Filbert gurgled, but the stranger did not heed him.

"Why," asked the stranger, "are women happier than men? Why are women more religious than men? Why are women quicker to receive the uplifting impulses from the Beyond? Why are women more often in tune with the Infinite? The answer is—hair! They have more hair! Why are hairy headed men happier than bald men? Because they can tune in with the Infinite! Pardon me a moment."

The stranger took a large blue handkerchief from his pocket and wiped his eyes.

"Excuse me for weeping," he said in a voice of emotion. "When I recall those first moments after I was cast ashore on the coral reef of Tulula Island I always weep. Why? Because, sir, I wept then. And why did I weep? I wept because, when I examined my radio outfit, I discovered, sir, that my antenna wires had been lost in the cruel sea. Yes, my dear friend; although I had my radio receiving outfit unharmed, I had lost my antenna wires. I had not two feet of copper wire with me. Imagine, my dear sir, the horror of my position; I was cast away on that coral reef, and I had no wire. Never again could I tune in and receive from WPJX those sweet and soothing Uncle Brittle-bat Bedtime Tales. For me that meant death by slow torture. Never again could I sleep. Night after night I must lie awake until I withered away or went mad from sleeplessness.

"Where I lay on the coral reef the waves dashed salt spray over me without pause. The reef was like a coral ring; inside of it was the narrow, circular lagoon; in the center of the lagoon was the tiny island of Tulula, a low hill en-

USE A C H SHARP TUNER DIALS

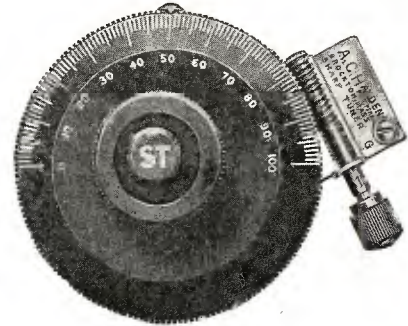

Your Choice of

Rough tuning with dial or one thousandth of an inch in either direction with the Sharp Tuner Knob. Both controlled by center Knob ST.

Eliminates a vernier condenser. Locks instrument automatically. Dial grounded, reducing body capacity.

Guarantee

If purchased direct and you find the ACH Dial does not warrant your own personal award of merit, return it and we will refund your money, what better guarantee can we give.

Regular fitting 5/16" hole, 1/4" and 3/16". Bushings, 5c. each extra. 10c. for all.

Price of ACH 3" Dial Complete..... \$2.50
With ACH Condenser 4.00
ACH Condenser without Dial 2.50

Free Plan with mail orders on request.

A. C. HAYDEN RADIO & RESEARCH CO.

BROCKTON, MASS., U. S. A.
Mail Orders sent prepaid in U. S. A.

Panel Service

We offer to the amateur and dealer **Real Panel Service**. Our panels are cut to your order. Only genuine Bakelite or Formica used.

1/8" per square inch .02
3/16" " " " .02 1/2
1/4" " " " .03

We also carry a full line of radio essentials. Dealers will find it profitable to have our latest price list and discount sheet.

PITTSBURGH RADIO AND APPLIANCE CO., INC.

"Pittsburgh's Radio Shop"

DESK A
112 Diamond St., Pittsburgh, Pa.

"Use Copper"

In Bulletin No. 32, the U. S. Bureau of Standards says: For all wiring—antennae, grounds, etc.—use Copper.

COPPER & BRASS RESEARCH ASSOCIATION

25 Broadway • New York

Variable Grid Leaks \$.45 each
Tubular Grid Leaks (all resistance)50 each
Tubular Grid Leaks mounting35 each
Single V. T. Sockets Type S-1090 each
Triple V. T. Sockets Type S-4 2.70 each
Bakelite WD-11 Sockets50 each

RADIO SERVICE & MFG. CO.

(Established 1918)

Factory—Lynbrook, L. I.

We carry a Complete Line of Radio Apparatus

When the Chemist Harnessed the Thunder-bolt!

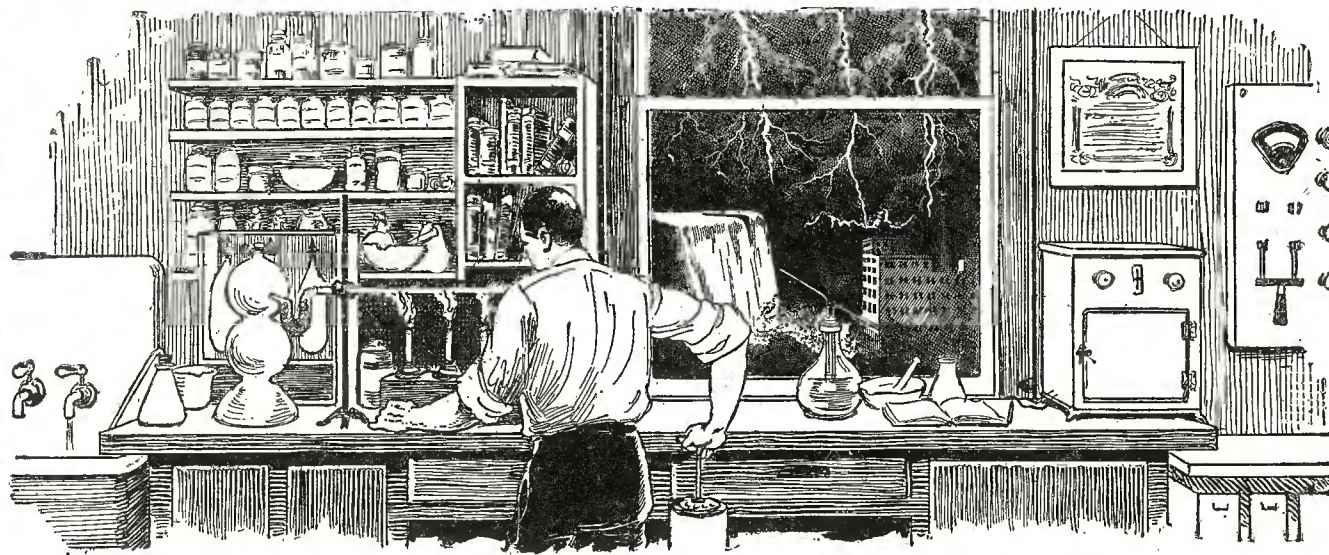

MAN and beast react with electric speed to a warning of danger, if the alarm is immediate and personal. Self-preservation is the first law of Nature. Yet subtle perils far more disastrous than any we expect to meet lurk in the shadow of our fancied security. They are the dreaded ogres of Famine and Disease.

A few years ago the world faced a famine more terrible than any in history. Nitrates, the most essential materials for enriching the soil, were being rapidly exhausted, and universal starvation seemed inevitable. Everyone knows that plants must feed, and if the ground is not replenished with the chemicals they have consumed, vegetation will eventually die out. Nature's way of making up the deficit is too slow for our concentrated population, and farmers have resorted to artificial fertilizers for ages. Europeans, always more receptive to the teachings of Chemistry than we, raise more than twice as much grain per acre as Americans, owing to their greater use of fertilizing chemicals.

The principal substance used for this purpose is sodium nitrate, better known as Chile saltpetre, because of the large deposits of it in that country. Millions of tons of this precious chemical were being mined annually, for vast quantities are consumed in making explosives and in other industries, besides that required for agriculture. Chile kept getting richer, but her nitrate beds got continually poorer until their inevitable exhaustion became a grisly prospect. *And there was no other source of supply!*

It was here that electro-chemists stepped in and devised a way of making nitrates from the air! They stole a trick from Nature, using an artificial bolt of lightning, the electric arc, to change the nitrogen and oxygen into nitric acid. This is indeed what happens during a thunder-storm, though to a very slight extent. Other methods followed, and thanks to Chemistry the air-made nitrates can now be sold for less than the saltpetre of Chile. Better still, the supply is unlimited.

Today we are confronted with similar crises. There are impending shortages of other important raw materials. Yet so great is the general confidence in chemistry to solve such problems, little anxiety is felt. A wealth of opportunity awaits the chemist of the present, particularly in the fascinating field of Electro-chemistry. In many industries there are hundreds of chemists employed by a single company. Thousands of concerns have chemists supervising the quality of their output and of the materials they buy. In countless capacities a knowledge of Chemistry is essential.

You Can Learn Chemistry at Home Dr. T.O'Connor Sloane Will Teach You

Dr. Sloane, Educational Director of the Chemical Institute of New York, is one of this country's foremost authorities on chemistry. He was formerly Treasurer of the American Chemical Society and is a practical chemist with many well-known achievements to his credit. Not only has Dr. Sloane taught chemistry for years, but he was for a long while engaged in commercial chemistry work.

The Chemical Institute of New York was originally founded to fill a long-felt need in the Educational field. Thousands of young men and young women, realizing the wonderful opportunities for the chemist produced by the recent war and the assumption by the United States of world leadership, were keenly anxious to enter this promising field. Many of these prospective students, however, were unable to give up their regular occupations to devote the necessary time to their training. Correspondence study at home was the only solution.

Dr. Sloane will teach you Chemistry in a practical and intensely interesting way. Our home study course written by Dr. Sloane himself is thorough, logical and remarkably fascinating. It is illustrated by so many experiments that are performed right from the start that anyone, no matter how little education he may have, can thoroughly understand every lesson. Dr. Sloane teaches you in your own home with the same individual and painstaking care with which he has already taught thousands in the class room.

The Personal Help of Dr. Sloane

Dr. Sloane will personally examine and correct all of your examination papers, pointing out your mistakes and correcting them for you. He will, in addition, give you any individual help you might need in your studies. This personal training will be of inestimable value to you in your future career.

Easy Monthly Payments

You can pay in small monthly amounts as you go along. The price of our course is very reasonable, and includes everything. There are no textbooks to buy extra, and the chemicals and apparatus used for experiments are supplied to the student *without additional charge*. Our plan places an education in chemistry within the reach of everyone.

Experimental Equipment

Given to Every Student Without Additional Charge

We prepay even the shipping charges on the outfit. It comprises 42 pieces of apparatus and 17 chemicals and reagents. The fitted, heavy wooden case serves not only as a carrying case, but also as a laboratory accessory for performing experiments.

Special 30-Day Offer

For a short period we are making a special offer that will be worth your while to take advantage of. Write for our free book, using the coupon below or simply a postal card. This will not obligate you in the least. Do not wait until tomorrow. Send the coupon now while you think of it, and let us tell you our story.

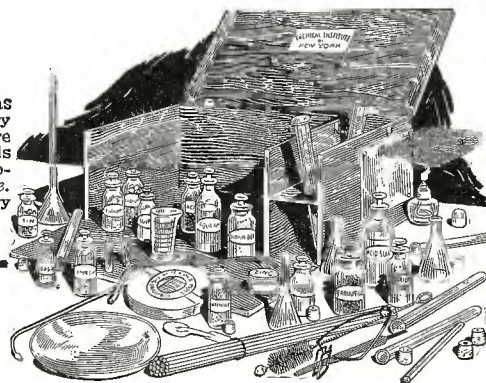

CHEMICAL INSTITUTE OF NEW YORK, Inc.
Home Extension Division 6,
66-R-West Broadway, N. Y. City.

Please send me at once without any obligation on my part, your free Book "Opportunities for Chemists," and full particulars about the Experimental Equipment furnished to every student. Also please tell me about your plan of payment and your special 30 day offer.

NAME

ADDRESS

CITY

STATE

R.N., 6-23

Chemical Institute of New York, Inc.
Home Extension Division 6 66-R-West Broadway, New York City

Multiply your ideas of Fibre Service by three



WE have such confidence in Vul-Cot Fibre that we guarantee it to be free from impurities. We know that Vul-Cot Fibre is good fibre. From the selection of the rag stock to the completion of the finished tubes and sheets we have had its production under our own supervision.

You can drill Vul-Cot

on the same machines and with the same drills as are used for metal. The drill cuts clean. Even in drilling holes close together you will find that the thin dividing wall is almost as solid and firm as steel.

You can stamp Vul-Cot

Nearly everything that can be stamped out of metal can be stamped out of Vul-Cot. Here again the same machines that were used for metal will serve.

You can thread Vul-Cot

as easily as wood or metal—making it the ideal material for threading the various kinds of connections where high-grade insulating material is required.

You can turn Vul-Cot

much more easily than steel and with far better results than wood. Vul-Cot can be turned with an accuracy as fine as 5/1000 of an inch.

Three huge factories manufacture Vul-Cot Fibre and Vul-Cot Fibre parts—with three times ordinary facilities for speedy production and delivery. Let us confer with you about the use of Vul-Cot Fibre in your business.

**National
Vulcanized Fibre Company**

Wilmington, Del.

2 "Chi-Rod" Specials

1. Willard miniature, 1½ volt, threaded insulation, storage batteries—special for W. D. 11 tubes.

Willard Charged \$7.50
Willard Dry 6.50

2. Willard miniature, 8 volt, threaded insulation, storage batteries—special for pure D. C. for C. W. Transmitters. Brand new, regular threaded rubber Willards! Dry until ready to charge. Better than a generator because no filter is necessary. Cheaper.

In lots of 40 (320 volts),
each \$4.00
(Better price on larger quantity)

Specify dry or charged when ordering.

Chicago Radio Apparatus Co.
407 S. Dearborn St. Chicago

tirely covered with palm trees. With weary limbs I crept a few feet farther from the edge of the sea and sat on the sand. Here the salt spray was less annoying; it was like warm water sprayed on me with an atomizer, but I had only a moment to realize this when I saw a hundred canoes approaching me from the palm-covered island. Savages! Perhaps cannibals! I resigned myself to probable torture and death, but as the savages landed on the reef they ran to me with eager shouts. They hailed me with joy. The fat chief kissed me on both cheeks and cried questioningly, in the native tongue, 'Hoopi laba dikum beejack?' which, translated, means, 'Boss, our radio set won't work, can you fix it?'

"Sir," continued the stranger, smiling now that he saw Mr. Filbert was calmer, "those poor savages had but one means of keeping in touch with the outer world. Only once in ten years did a vessel touch their shores. On radio they were dependent for all that makes life worth living—for weather reports, baseball scores, jazz tunes, lectures on 'What Will Be Worn This Summer,' stock quotations and Uncle Brittle-bat's Bedtime Tales. And their receiving set was out of order! When I whispered that I could indeed repair their set they danced for joy. They lifted me on their shoulders, crying 'Kalo riff fik ka nine!' which, translated, means 'Hot dog!' Their joy was wonderful to see, but my exhaustion was so great that I fainted.

"Sir," continued the stranger, "they laid me in a canoe and took me to the chief's house, which stands on the level top of the hill in the middle of the island. A day and a night I was unconscious, but when I opened my eyes the sight that met them was the strangest ever seen by mortal man. From the spot where I lay I could see the entire circular coral reef that surrounded the little isle of Tulula. But this was not what amazed me, sir. No!

"Sir," continued the stranger, "seated on the sand of the coral reef, hand clasped in hand so that they made a complete circle close to the edge of the sea, were the women of the tribe. There they sat, where the salt spray wet their hair, and I saw that from this circle other women, seated in anchored canoes, formed a hand-in-hand chain across the lagoon, while others sat on the island beach, on the soft soil of the palm-shaded isle, and, indeed, at my very feet. It was, sir, a hand-clasped chain of women that encircled the reef and reached into the very house of the chief. Two thousand women, perhaps, sir! But that was not what amazed me most.

"Sir," continued the stranger, "far more amazing was the fact that each of the women sat in a porcelain wash basin! For insulation, sir. And, sir, still more amazing was the fact that the hair of each woman was done in two braids, and the end of the left-hand braid of each woman tied to the end of the right-hand braid of the next. Those women, sir, were being used as an antenna made of human hair!"

"My goodness!" Mr. Filbert gasped. "You don't mean to tell me!"

"I do tell you!" said the stranger. "And what is more, sir, each woman who was not sitting in the salt spray of the reef had a female slave at her side who sprayed her hair with salt water from a perfume atomizer. Dry hair, sir, is one of the best insulators. In order to make the hair conductive it was necessary to wet it, and the moistener had to be saline or salty, for a solution of salt is a very good conductor. Sir, those intelligent savages, having no copper wire, were using the hair of the heads of their women as an antenna!"

"Doesn't that beat all!" exclaimed Mr. Filbert with awe.

An Amazing Offer!

2200 Ohm Double Headsets



Special Price
on GUARANTEED
Radio
Headsets
in Lots
of 3 or More

\$4.80 FOR ONE **\$12 for 3** **WHY PAY MORE?**

Form a club of 3 or more and save money on extra high grade headsets for your Radio. Let 'em all "listen in"!

Equal to Any \$15 Set

By ordering at once, you can have the extra headsets you need at less than one-third the price of other headsets of equal quality. Then you can share the pleasure of your Radio with others and get more enjoyment from it yourself.

Satisfaction Guaranteed

The EDSON is light in weight, has tungsten steel magnets, hard rubber caps and other desirable features. It reproduces all sound waves perfectly. Fully guaranteed.

SEND NO MONEY!

*Simply send your name and address
and pay Postman when he delivers
the sets you order.*

EDSON RADIO SALES CO.

Dept. 12, Elmwood,

Providence, R. I.



NA-ALD
Special Socket
No. 411

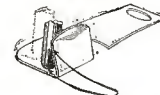

NA-ALD
De Luxe No. 400

It's the contact that counts

The dual-wipe contact strips of the Na-ald De Luxe socket avoid the troubles experienced with the socket of conventional design. Because of thorough cure and high dielectric properties this socket keeps plate to grid losses at a minimum (of particular importance in Flewelling Circuit or in Radio Frequency).

Price 75c

The Na-ald Special Socket No. 499 is a sturdy little socket for the G. E. No. 199 dry-cell tube. It has special slot construction, and is moulded of genuine Bakelite. The heat from soldering connections will not affect these sockets.

**Price 75c
After May 20, 50c**

Booklet with wiring design and instructions for Hazeltine's Neutrodyne circuit, together with other selected circuits, packed with each Na-ald product or sent in exchange for cover taken from any Na-ald carton.

Alden Manufacturing Co.
Formerly Alden-Napier Co.
Dept. k 52 Willow Street
Springfield, Mass.

NA-ALD
Radio Products

OLD MONEY WANTED

\$2 to \$500 EACH paid for hundreds of old or odd coins. Keep ALL old money, it may be VERY VALUABLE. Send 10 cents for New III's COIN VALUE BOOK, size 4x6. Get Posted. We pay Cash. CLARKE COIN CO., Ave. 79, Le Roy, New York

OLD COINS

large Spring selling catalogue of coins for sale, free. Catalogue quoting prices paid for coins, 10c.

William Hesslein, 101C Tremont St., Boston, Mass.

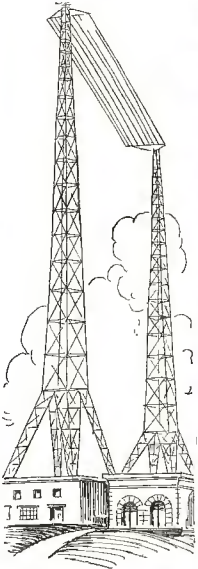

GRADE NUMBER
5505
The United States of America
DEPARTMENT OF COMMERCE
BUREAU OF NAVIGATION
LICENSE
RADIO OPERATOR, COMMERCIAL FIRST CLASS

This is to certify that --- **ALFRED HENRY BARTLETT** ---

has been examined and passed, pursuant to the Radiotelegraphic Convention, in

(a) adjustment, operation, and care of apparatus;
 (b) transmitting and sound reading, at a speed of not less than twenty words a minute, Continental Morse;
 (c) use and care of storage battery or other auxiliary;
 (d) knowledge of international regulations and Acts of Congress to regulate radio communication.

and is hereby licensed, as required by law, a Radio Operator, Commercial, First Class, for two years. The candidate's practical knowledge of adjustment, was tested, in a

THEORETICAL *set of apparatus. His knowledge of other systems, is shown, below*

Code speed *Percentage*

20 WORDS PER MINUTE. **82.3%**

Notary Public **HERBERT HOOVER,**
Secretary of Commerce

Radio Inspector. **D. B. CARSON,**
Commissioner of Navigation.

Place **Baltimore, Md.** *Date* **June 24th 1922.**

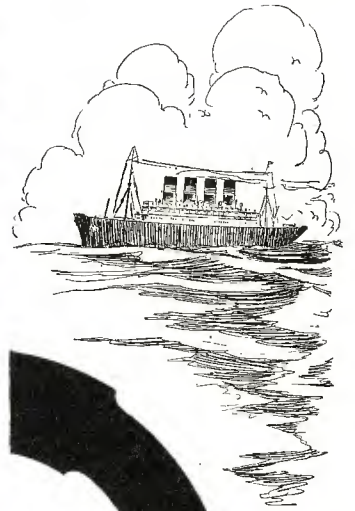

This Certificate Opens the Way to the Best Radio Positions

Get It - You Can Earn Big Money With It

No previous experience in electricity or Radio is necessary. In a few short months, you can easily win this certificate and qualify for one of the splendid, big money positions in Radio.

Edwin L. Powell is an Expert Radio Aid at the Washington Navy Yard and earns **Big Money**. Leo Goldblatt is earning a Big Salary and all expenses paid as a radio operator. James F. Nicholls is earning \$150 a month and all expenses as a radio instructor at Walter Reed Government Hospital. Harry Ruck has made **big money** manufacturing radio sets. Hundreds of other men are occupying equally attractive positions after winning our Certified Radio-trician certificate.

Read in the panel of the fine salaries paid in all the wonderful radio positions for which you can qualify once you have this certificate.

Easy Now to Become a Certified Radio-trician

No other work in the world today offers such opportunities, such big money, such rapid advancement, such a promising future as does Radio. And the Expert Radio-trician is the man who is in a position to choose the best of these opportunities—to jump farthest ahead in this newest and fastest growing industry.

Become an Expert Radio-trician. You can—easily and quickly. The National Radio Institute, America's first and largest Radio School, has devised a remarkable method that makes it easy for anyone to qualify right at home during spare time. Prominent radio experts give you personal advice and instruction through the mail. They grade your papers, answer your questions, and in every possible way help you in your work. And you learn the practical, wonderful side of radio by actual practice on patented instruments we send you. The Certified Radio-trician Certificate awarded you on the completion of your course is **government**

recognized, counting for 5 to 10 points on all government license examinations.

Instruments Loaned to Students

An extraordinary feature of this course is the use of four patented instruments, owned exclusively by us, which give practical training in radio operation, installation, maintenance and repair—all of which you must have to become an Expert Radio-trician.

Among these instruments is the wonderful Natrometer, said by experts to be the perfect device for teaching the Radio Code. All of these instruments are loaned to students during the course.

Send For Free Radio Book.

Thousands of positions are open to Certified Radio-tricians. Find out what your opportunities are in this fascinating profession. Send for interesting book, "How to Learn

Radio at Home," which gives complete details on plan by which the National Radio Institute quickly qualifies you at home in spare time as a Certified Radio-trician sent without obligation. Mail the coupon or a postcard for book NOW.

NATIONAL RADIO INSTITUTE

Dept. 13F

1345 Pennsylvania Ave. N.W., Washington, D.C.

NOTE: These opportunities open only to men and boys eighteen and over. High school boys and others under eighteen years of age interested in Radio can make big money in spare time after school hours through our special spare time radio course. If you want information simply sign the coupon and send it to us.



Radio Operator



Radio Mechanic



Radio Salesman

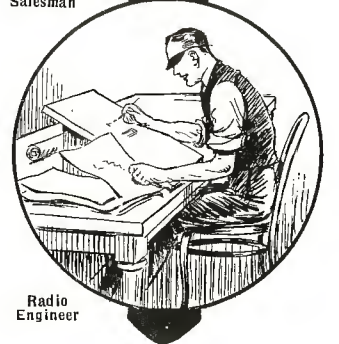

Radio Engineer

NATIONAL RADIO INSTITUTE,
 Dept. 13-F, 1345 Pennsylvania Ave., Washington, D. C.

Send me your book, "How to Learn Radio at Home," with full particulars about the opportunities in radio, and how you will quickly train me in my spare time at home to win a Certified Radio-trician Certificate. Also tell me how your Employment Service will help me to a position.

Name..... Age.....
 Street.....
 City..... State.....

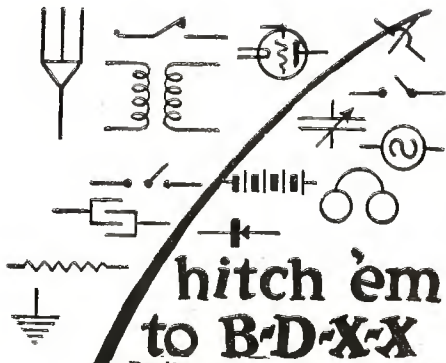

hitch 'em to B-D-X-X

Radio units work best on Bakelite-Dilecto (xx grade) panels and bases. This wonder-material gives absolute insulation and has tremendous mechanical strength.

bakelite dilecto!!

(A Laminated Phenolic Condensation Product)

Highest in dielectric strength. Tough, durable; yet readily machined. Keeps its shape, color and glossy finish always. Resists heat, water, steam, fumes and solvents. Used in the U. S. Navy and Signal Corps over EIGHT YEARS!

Don't rush ahead with "just anything" for a panel. Get real Bakelite-Dilecto (xx grade) and you'll get best results.

The Continental Fibre Co., Factory: Newark, Delaware.

Dealer Service From:
New York, 233 Broadway
Pittsburgh, 301 Fifth Ave.
Chicago, 332 S. Michigan Ave.
San Francisco, 75 Fremont St.
Seattle, 95 Connecticut St.
Los Angeles, 411 S. Main St.

30 Days' Free Trial

Select from 44 styles, colors and sizes, famous Ranger bicycles. Delivered free on approval, express prepaid, at Factory Prices. You can easily save \$10 to \$25.

12 Months to Pay if desired. Parents or ten advance first deposit. Boys can earn small payments.

Wheels, lamps, horns, equipment at half usual prices. Send No Money. Write for our marvelous prices and terms.

Mead Cycle Company Write us today for free catalog
Dept. D 116 Chicago



AMERICAN TIME CLOCK REPAIR & SUPPLY CO.

SECOND HAND TIME CLOCKS

Bought, Sold, Repaired and Exchanged

ALL WORK GUARANTEED

We Carry a Full Line of Supplies

489 Broadway, near Grand St., Phone, Canal 7951

"It does. If I had not seen it with my own eyes I never would have believed it," said the stranger. "But, sir, have you ever paused to think why men and women have hair? Hair, sir, is the antenna that is placed upon our heads to receive the vibrations from the Infinite. From the Vast Beyond, the Waves of Harmonic Unity are coming every moment and our hair receives them. Why are women more closely in touch with the Great Harmonic Elsewhere? Because they have more hair. The waves of Beneficent Influence, arriving from the Big Beyondness, are received by the hair, conducted by it to the brain cells, transformed there into Thought, Emotion, Action and Success. Thus harmony with the universe is established. Why was Sampson a success? Hair! Why is Paderewski a success? Hair! Why were Washington, Franklin, Buffalo Bill great? Hair! They were in touch with the Infinite. Why are nine-tenths of the spirit mediums women? Hair! I see, sir, that you are convinced. You feel the lack of hair every day. You feel that something is wrong. You are easily agitated, easily irritated, easily aggravated. Hair, sir! Lack of hair! A human being is a living outfit; a human being without hair is a radio set without antenna. You, sir, cannot tune in with the Infinite. You're bald; you're as bald as an egg."

"Balder," said Mr. Filbert with a groan. "Well, no," said the stranger, running his hand over Mr. Filbert's head. "Not balder than an egg; just about as bald as an egg."

He bent down and picked up his valise and set it on Mr. Filbert's desk. He put his hand on its catch.

"When I connected my radio receiving set with the end of the free braid of the chief of Tulula's favorite wife—for she was the end of the human hair chain—and put the ear phones to my ears," said the stranger, "I instantly heard New York, Newark, Los Angeles, Atlanta and London. Voices and music came with greater strength and clarity than over any copper wire antenna. There was no static. The chief explained this. If any static noises developed, his chief executioner immediately sought out the woman whose hair was responsible and her funeral was the next day.

"For three months," continued the truthful stranger, "all went well. Each night I slept like a log, escorted to dreamless and refreshing sleep by the Uncle Brittle-bat Bedtime Tales that came so clearly to my ears. The entire tribe was happy and contented, dancing the days and nights away to the jazz that spurted from the loud-speaker. One and all grew wiser and nobler as they listened to lectures on 'How to Feed the Dicky Birds' and 'Should That Bum Tooth Be Filled or Pulled?' And then, slowly but surely, our noble feast of radio offerings began to fail and fizzle. Fainter and fainter they grew; we could hear nothing but the highest screams of the soprano soloists and the drum thuds of the jazz bands. From Atlanta we got only the 'ting! tong!' of the bronze gong, but not the final 'tung!' And then the night came when I heard nothing of an entire Uncle Brittle-bat Bedtime Tale but 'And the Tootsy-Wootsy Hop Toad said to Mr. Slippery-Wippery Weasle'—and then silence! Sir, an awful thing had happened! The ladies of the human antenna chain were going bald!

"Yes, my dear and esteemed friend, in a month from that time every woman on Tulula Island was as bald as you are—which is the limit. Shortage of animal fats, lack of exercise, prevalence of dandruff, alkali in the air—a dozen things caused their hair to lose vitality, die at



Layer Wound and Layer Insulated

Stromberg-Carlson Radio Head Sets

are wound a layer at a time, with insulation wrapped between each layer. This is the reason why Stromberg-Carlson Head Sets stand up under high plate voltages.

Other features of the Stromberg-Carlson Head Sets are—

- The receivers are balanced as to volume—both ears get the message.
- The ear caps cover the ears—excluding outside noises.
- The adjustment rod telescopes and therefore does not catch the ladies' hair.

Ask your Dealer

STROMBERG-CARLSON TELEPHONE MFG. CO. Rochester, N. Y.

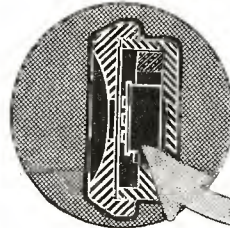

Convert Your Crystal Set Into Tube Set at Small Cost

You can now enjoy wider range, greater volume of sound and purer tone and do away with feeling around for a sensitive spot, if you make a Tube Set out of your Crystal Set by adding the Peanut Tube W.T. 501 and a few other inexpensive accessories. Full directions packed with every W.T. 501. Not necessary to discard old apparatus.

Welsh

PEANUT Detector Tube W.T. 501

Can be used on three dry cells or one regular 6-V. "A" battery. Consumes less than half as much current as ordinary tubes, consequently does not use up batteries as fast.

Nickel-plated socket, moulded base, double-spring contacts, 40c extra. Adaptor for standard V. T. Socket, 75c extra.

If not at your dealer's, send us his name and address with money order and we'll see that you are supplied. Include 10c extra for registration.

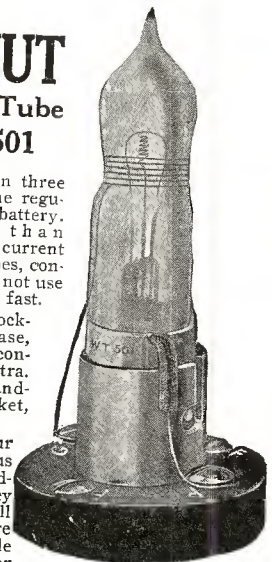

Radio Research Guild
40 Clinton Street
Newark, N. J.

\$2.00 Immediate Delivery

THINK of your Radio receiving set as a kind of camera whose "film" is sensitive to sound waves instead of light.

Developing this "film" into real "sound pictures" is the whole art of Radio usefulness and enjoyment.

For this, no apparatus has ever been evolved which gives results equal to those produced by Magnavox Equipment.

R2 Magnavox Radio
(With 18-inch horn)

This instrument is intended for those who wish the utmost in amplifying power; for clubs, hotels, dance halls, large audiences, etc. It requires only .6 of an ampere for the field. Price \$60.00

R3 Magnavox Radio
(With 14-inch horn)
As illustrated

The ideal instrument for use in homes, offices, amateur stations, etc. Same in principle and construction as Type R2.

Price \$35.00

Model C Magnavox Power Amplifier
As illustrated

For use with the Magnavox Radio and insures getting the largest possible power input.

AC-2-C, 2-stage, \$55.00
AC-3-C, 3-stage, \$75.00

Magnavox Reproducers and Power Amplifiers can be used with any receiving set of good quality. Without Magnavox, no receiving set is complete.



These two devices have revolutionized Radio"

The Magnavox Reproducer and the Magnavox Power Amplifier

THE efficiency of Magnavox Radio apparatus is best realized by comparison with other instruments constructed on less modern scientific principles.

Magnavox products can be had of good dealers everywhere. Send for copy of unusual booklet.

The Magnavox Co., Oakland, California
New York: 370 Seventh Avenue

MAGNAVOX
Radio
The Reproducer Supreme



Gould

Radio "B" Battery

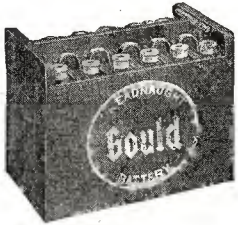

The compact Gould Radio "B" Battery, (patent applied for) is designed to prevent grounds between cells, thus doing away with noise in headset. 24 volts in variable 2-volt steps. Non-slipping hard rubber case. Will not detract from the appearance of the finest set. \$3.50 f. o. b. factory.

Essential for Clear Reception

Noiseless operation is the goal of every radio enthusiast. Much of the noise attributed to static is actually developed in the "B" batteries. Especially is this true after the batteries have been in use for a period of time. The reason is due to the internal construction of the dry battery and other types of storage batteries not properly designed to prevent external grounds between cells. Freedom from noise of the Gould "B" battery is due to its internal construction and the external design of the case which makes grounding between cells practically impossible. (Patent applied for). By the use of the Gould "B" battery not only is noise eliminated, but its constant non-fluctuating voltage throughout the greater part of its discharge results in clearer reception and increased range. Costing but a few cents for recharging, the Gould Radio "B" battery is more economical and will give most satisfactory results.

On sale by Radio Dealers and over 3000 Gould Service Stations.

GOULD STORAGE BATTERY CO.

30 East 42nd St. New York Plant: Depew, N. Y.

Gould

Radio "A" Battery



Gould Radio "A" Batteries are used by the various Radio Branches of the U. S. Government. Built for continuous service. Made in sizes from 60 A.H. to 160 A.H. \$18.00 to \$33.00, f. o. b. factory.



Equipment Cord Tip Jack

This R.T.S. Cord Tip Jack leads the way in quality, service and price. Constructed of spring phosphor bronze, highly nickelled. Wiping spring contact insures clean, positive contact at all times. Where others sell from \$1.00 to \$2.50, this R.T.S. Cord Tip Jack Retail at pre paid 50c

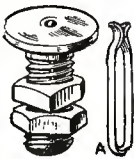

RADIO TESTING STATION

Dept. R-6, 25 Sturgis St. Binghamton, New York

ENINGER WILL SAVE
BIG MONEY SAVINGS FOR YOU
 Used and rebuilt motorcycles; single and twins, \$25 to \$100. Used bicycles, \$5.00; tandems, \$10. All machines guaranteed in good working order. New bicycles and motorcycles at factory prices. You save dealers' profits. Motorcycle and automobile tires too, \$3.00. Complete line of parts and supplies.
 Eninger Cycle Co., Rochester, N.Y.
YOU 25 TO 50 DOLLARS

the roots and fall out by handfuls. At the end of the month, one and all were as bald as you are. And that, sir, if I may say so, is hideously bald. No offense meant."

"It's true," Mr. Filbert groaned miserably. "I am indeed hideously bald."

"The chief," said the stranger, opening his valise, "wished to have the entire female population of the island executed. He wished to do away with those worthless ladies who were as bald as door knobs. But what happened?"

"What did happen?" asked Mr. Filbert eagerly.

"When the chief came to me, weeping like a little child, and said life had lost all joy and that he guessed he would jump into the deeper and wetter part of the ocean and end it all," said the truthful stranger. "I spoke to him as man to man, just as I am speaking to you, sir. I said, 'Chief, don't do it! Don't give up in this weak and unworthy manner. Be brave. Have hope. You have lost your hair-antenna, but why? What causes baldness? Baldness is a disease of the hair and scalp. And what should be done with a disease? Cure it! Chief,' I said, 'on this island you have some of Nature's wonderful plants. You have here the hango-pango plant, the dingo-bingo berry, the umpy-gumpy root, and the klaggo-paggo bark. By combining these with salt water—of which you have an oceanful at your feet—"

Here the truthful stranger took from his valise a large square bottle which he set on Mr. Filbert's desk.

"By combining these marvelous roots and herbs, chief," I said, "the truthful stranger continued, "under a process known only by me, there can be produced an infallible hair restorer that will cure dandruff, give life to dry and wiry hair, prevent falling hair, restore the color, double the conductivity of this human antenna and grow hair on the baldest head, or your money refunded. Simply apply the lotion to the head with the palm of the hand, rubbing briskly two or three times each day, price five dollars a bottle, six bottles for twenty-five dollars, six bottles being enough to grow hair on the baldest head, remove dandruff, give the hair a rich and glossy appearance and cause no harm to the tenderest skin."

"I've tried so many—" Mr. Filbert began.

"When I said this to the chief," the truthful stranger said, paying no heed to Mr. Filbert, "he instantly sent his men to gather the needed roots and herbs. In three hours the heads of all the ladies had been anointed with Perkins' Infallible Hair Restorer. In three days each and every head showed a thick fuzz. In one month—one month, sir!—from the first application, I was hearing Uncle Brittlebat's Bed Time Tales better and clearer than ever before, and the hair of the human antenna ladies was so much longer and thicker than ever before that three hundred and sixty-two were excused from antenna duty.

"And now, sir," said the truthful stranger, "I ask you as a simple business proposition whether you can afford to be a human radio without antenna? Can you afford, as a business man, to remain in a condition that prevents you from receiving the Sweet Messages of Harmonic Strength? Can you afford to remain out of touch with the Infinite? I ask you, will you tune in?"

Mr. Filbert looked the stranger firmly in the eye.

"You mean, don't you," he asked, "Will you cough up?"

"Five dollars a bottle, six bottles for twenty-five dollars," said the stranger.

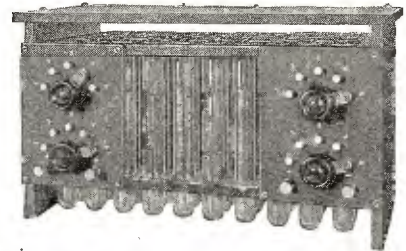

KICO Radio Storage "B" Batteries for EFFICIENT Receiving

THINK over the following FACTS before buying again.

1. KICO "B" batteries allow single cell variations by means of switches on mounted panels. (The first in the market with this feature.)
2. Alkaline type.
3. One charge lasts from three to six months in the detector plate circuit.
4. Rechargeable from your 110-volt A. C. line in connection with the rectifier supplied.
5. Neat, efficient and compact.
6. Unlimited life.
7. Your money back if unsatisfied within a 90-day trial.

| | (Plain) | (With Panels) |
|-------------------|---------|---------------|
| 16 cell 22 volt | \$8.50 | |
| 24 cell 32 volt | 8.00 | \$12.00 |
| 36 cell 48 volt | 10.00 | 14.00 |
| 50 cell 68 volt | 12.00 | 17.00 |
| 78 cell 100 volt | 16.00 | 21.00 |
| 108 cell 145 volt | 21.00 | 26.00 |

Literature gladly furnished

KIMLEY ELECTRIC CO.

1355 Fillmore Ave. Buffalo, N. Y.

PRICES SLASHED!

BUY HERE FOR MUCH LESS
 All Merchandise Sold on a "Money Back" Basis

| FONES | |
|--|---------|
| \$6.00 Manhattan 2000 Ohm Fones | \$ 8.95 |
| 12.00 Nathaniel Baldwin Type C Double | 8.35 |
| 6.00 Nathaniel Baldwin Type C Single | 3.95 |
| 9.00 Trimm 3000 Ohm Fones | 5.95 |
| TUBES | |
| U.V. 200 List \$5.00 | 3.85 |
| U.V. 201 List \$6.50 | 5.45 |
| U.V. 201A | 5.85 |
| Improved Detector Tubes | 2.45 |
| Mercury 1 1/2 Volt—guaranteed better than WD11 | 5.85 |
| MISCELLANEOUS | |
| \$45.00 Magnavox Loud Speaker Type R3 | 28.95 |
| 25.00 Atlas Loud Speaker | 19.95 |
| .50 Dials 2 and 3 inch | .23 |
| 1.10 Dayton Rheostats | .79 |
| 7.50 Moulded Dayton Variocouplers | 4.95 |
| 7.25 Moulded Dayton Variometers | 4.75 |
| 1.00 Erla Sockets | .49 |
| 1.00 Dayton Dials | .45 |
| Switch Levers 50c Value (adjustable Radius) | .25 |
| Mounted Hot Spot Crystals 35c Value | .20 |
| \$2.00 Grewol Enclosed Crystal Detector | 1.65 |
| \$25.00 6 Volt 100 Ampere hour batteries | 13.95 |
| A Two Year Guarantee With Every Battery Sold. | |
| "If It's in Radio We Have It." | |
| WE GUARANTEE ALL MERCHANDISE PURCHASED FROM US. | |
| Mail Orders Receive Prompt Attention. | |
| Buy Here For Much Less. | |
| Federal Sales Co., Masonic Temple, Chicago, Ill. | |

THE NEW R T-8

Radio Frequency Transformers are specially designed by the Radio Service LABORATORIES for maximum efficiency when used with any low current consumption tubes on the market.

For Audio Frequency, the new RT-A2 will give you 100% Tone Quality and High Amplification without distortion. For best results on both tone and distance, use Radio Frequency RT-8 (for all stages) in the black case, retail price \$6.00, and Audio Frequency RT-A2 in brown case, retail price \$6.50. For sale at all reliable electrical or Radio Stores. If your dealer cannot supply you, order direct.

Order by type number, accept no substitute, and remember that all Radio Service Laboratories' Transformers are individually triple tested and unconditionally guaranteed.

Send ten cents for booklet on Radio Frequency with schematic diagrams—a most valuable and helpful publication for the radio amateur and expert.

RASLA SALES CORPORATION

Wholesale Distributors
 Dept. A, 10 E. 43rd St., New York City



Uniform current cuts out the noise

EVERY radio amateur knows how disastrous battery noises are to clear receiving. You can avoid this annoying interference by getting the battery that insures a steady flow of filament current. That battery is the Exide Radio Battery.

This specially designed radio battery does its work uncomplainingly, and never requires much attention. The rasping, snarling noises often caused by fluctuating current in ordinary batteries do not exist in the Exide Battery. It delivers uniform filament current for every type of vacuum tube. You can count on the Exide for dependable, long-lasting service.

Exide Batteries are used in a majority of the government and commercial wireless stations and in every industry where a battery's response to the call of duty must not fail.

Any dealer in radio equipment will sell you an Exide Radio Battery, or you can get one at the nearest Exide Service Station.



Exide
BATTERIES

THE ELECTRIC STORAGE BATTERY CO.
Philadelphia, Pa.

Service Stations Everywhere
Branches in Seventeen Cities

Read'em Binding Posts



The Marshall-Gerken Co. Toledo

Irremovable Knobs

WITH "Read 'em" Binding Posts you know exactly what you are doing in making a hook-up. Abbreviations of the different names are engraved on the face of each post. Knobs are irremovable. Anyone can "read 'em." One always knows which post is which.

"Read 'em" Binding Posts are popular all over the world. You can buy them anywhere. Price 15c.

Other Marshall-Gerken products

| | |
|-------------------------------------|--------|
| S12 Bakelite Socket | \$1.00 |
| CDS Bakelite Dial | .90 |
| R90 Bakelite Rheostat 3 ohms | 1.10 |
| R91 Bakelite Rheostat 16 ohms | 1.10 |
| R92 Bakelite, 300 ohms | 1.50 |
| 9-B Double Binding Posts | .12 |

If your dealer cannot supply you, write us direct. Please address Department A.

Dealers—Write for Proposition.

THE MARSHALL-GERKEN CO.
Manufacturers
Toledo

"Look here!" said Mr. Filbert, putting his hand in his pocket. "You are a liar, and a big liar, and I'll bet fifty dollars you never saw that island, and that there never were any women with radio hair, but I've tried every other thing on the market and I might as well try six bottles of this. Is it any good? Honestly, now, is it?"

The stranger put five more bottles on Mr. Filbert's desk, and folded the five-dollar bills and put them in his pocket.

"Well, I'll tell you, friend," he said, as he picked up his valise. "If it ain't it ought to be—it costs enough. And I'll guarantee it'll do you as much good as the other dope you've used."

"But did anybody ever use human hair as an antenna?" insisted Mr. Filbert.

"That's what I'd like to know," said the stranger as he ducked down the stairs.

A Modern Liner Radio Outfit

(Continued from page 2076)

other type, and besides, are far more efficient. The C.W. outfit is rated as 5 kilowatts and radiates about 17 amperes into the antenna. A motor-generator located in an adjoining room supplies the 4,000 volts for the plates of the four tubes. Two of the bulbs are employed as oscillators, while the others are rectifiers.

For the reason that the big transmitter was made in France, and is very different in design from our American sets, its construction will prove interesting. The parts of the outfit, such as bulbs, transformers, etc., are located in an attractive cabinet, having a hard rubber panel. On the panel where such things should always be, are mounted meters, rheostat knobs, etc. There are also two small "windows" and by glancing in these openings, the operator can see how bright the bulbs are burning. Just on top of this cabinet is situated the big oscillation transformer. By simply turning a switch, the wave-lengths can be varied. Provisions are made so that transmission can be carried on anywhere from 2,000 to 2,800 meters. Filament voltage comes from a bank of storage batteries which may be charged at will. With this set, the liner is never out of touch of land and finds it very easy to work the big station at Chatham, Mass. (WCC), even though she be at Bordeaux. The vessel nearly always works schedules with WCC on a wave-length of 2,400 meters and during the course of a voyage, some 2,000 messages are passed between these two stations.

The spark transmitter aboard the FGG is of ½-k.w. power and is of the quench gap type. Since the spark transmitter is known to cause considerable interference, the operators refrain from using it as much as possible. It is only put into use when entering or leaving port or when talking with nearby ships. The little set is highly efficient and has a daylight range of more than 400 miles. Since the regular ship's antenna is too long to insure efficiency with this set, the operators have erected a small two-wire antenna on the boat deck, about 15' above the tops of the lifeboats. The big aerial is a one-wire affair, 325' long and nearly 175' above the water's edge.

The *Paris* also boasts a ½-kilowatt telephone transmitter, having a daylight range of about 400 miles. This set is not used for the transaction of the ship's business, but mainly for carrying on experiments. The theory at present is that radiophone transmitting sets are soon to be found aboard all large liners and the experiments are being carried out for the purpose of ascertain-

(Continued on page 2137)

Make Your Own Sets With Killoch Quality Equipment

| | |
|------------------------|--------|
| Variometer | \$2.50 |
| Variocoupler | 2.50 |
| Socket V.T. | .25 |
| Rheostat | .25 |
| Paper Condenser | .15 |
| Variable Condenser— | |
| 23-Plate | 1.65 |
| 43-Plate | 2.00 |
| Acme Transformer | 3.75 |
| 2000-ohm— | |
| Killoch Phone | 3.50 |
| Baldwin Phone | 10.00 |



Send For This
FREE
Catalogue

DAVID KILLOCH COMPANY
57 Murray Street New York City

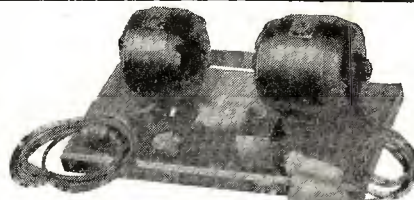

THE OHIO BATTERY CHARGING MOTOR GENERATOR

This Set is made up of the celebrated Ohio A. C. Motor and D. C. Generator wound for 6-10 volts. Ohio Motors and Generators have ball bearings and are otherwise of highest grade. They are regularly used on some of our best domestic and mechanical appliances. The ball bearings eliminate lubrication troubles. The set is good for continuous operation, is practically noiseless and has no parts which will wear out or depreciate. It eliminates the troubles common to all the cheaper charging sets and will last a lifetime. It is fully capable of rapidly charging any three-cell automobile or Radio "A" battery. It is furnished complete on a substantial base with ammeter and field rheostat to adjust the charging rate from 1-20 amperes.

At the price quoted the motor is for 60 cycle, 110 volt service and is complete with 10-foot cord and attachment plug, so, when received, the set is ready for instant connection to any lamp socket or receptacle and to charge your battery. Plain instructions are provided so anyone can operate it and even if you do connect wrong to battery, it will still charge correctly. Price \$38.50 F.O.B. Cleveland, Ohio. Sent by express C.O.D. Weight 50 lbs. NOTE—If your service is other than 60 cycle, 110 volt, ask for special price.

The Ohio Electric & Controller Co., Cleveland, Ohio

The How and Why of Radio Apparatus

By H. W. SECOR, E.E.



This newest book on radio matters fills a distinct gap in wireless literature. While the treatment is made as understandable and as free from mathematics as possible, it at the same time incorporates a wealth of technique and instruction for the Radio Amateur—the Radio Operator—the Installation and Designing Expert—as well as teachers and students of the subject in general.

A very broad field has been covered by the author, giving a great amount of information not found in other text-books. If you are engaged in any branch of the Radio or allied arts you will surely need this latest contribution to radio literature.

This newest of Radio Work has 180 pages, 6 x 9 inches. Hundreds of illustrations and tables. Cloth bound in Vellum de Luxe, stiff covers, hand-sewed, gold stamped, each..... **\$1.75**

The Experimenter Publishing Co.
53 Park Place, New York

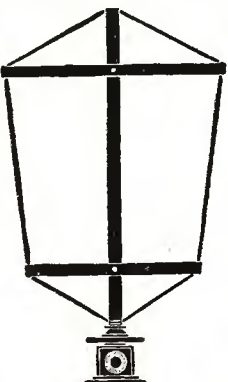

STATIC and Interference is Reduced to a Minimum

Better Reception with the NASSAU



TRADE MARK

Pat. Pending
Price \$35.00

Jobbers and Dealers
Write for Proposition
Eliminates Aerial and Ground.

The Secret is in the Patented Winding
1500 MILES ON LOUD SPEAKER
With 2 stages radio and
2 stages audio frequency amplification.
Write for Circular "R"
Manufactured by

NASSAU RADIO CO., Inc.
60 Court St., Brooklyn, N. Y.

RICO
PRODUCTS

RICO
PRODUCTS

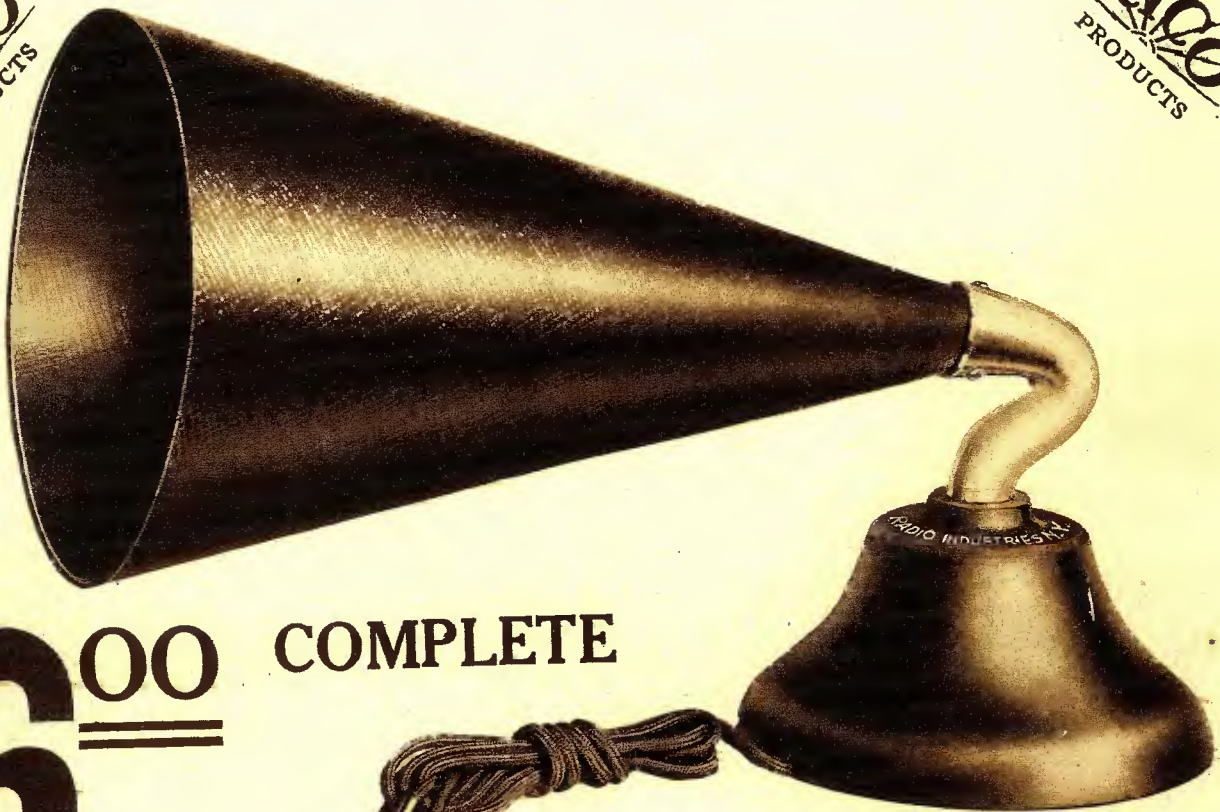

\$6.00 COMPLETE

No. 250

The "Rico" TUNED Melotone Speaker

THIS loud speaker is the outcome of several thousand experiments, and we present it to the American radio public in full confidence that we have produced the lowest priced and at the same time the highest class loud speaker on the market today.

The "RICO" TUNED MELOTONE SPEAKER is not a makeshift, not a toy, but a high grade scientific instrument, built in very large quantities in order to give the public the advantage of our low manufacturing costs.

These are the specifications:

- Adjustable and tuned "RICO" Loud Talker, fitted in cast metal base, handsomely finished, with two coats of baked enamel;
- Nickel-plated and polished gooseneck;
- Full fibre horn;
- Five-foot attachment cord.

THE TUNED FEATURE

Our cross-section diagram shows our new adjustable feature, by which it is possible to make this loud talker give out almost any sound within reason. The MELOTONE SPEAKER can not possibly shatter nor rattle under any circumstances.

The new development comprises a specially-formed, pure Para Rubber Gasket, accurately made, upon which the diaphragm rests. By tightening or loosening the shell of the receiver its diaphragm approaches or recedes the desired distance toward or away from the pole pieces. So remarkable is this adjustment, and so wonderfully exact does it work, that any sound volume or quality can be readily obtained.

For instance, a given adjustment will bring in certain qualities of sound heretofore unobtainable. It is in your power to TUNE the MELOTONE SPEAKER in such a manner that if you wish, a moderate amount of sound you can readily obtain it, or if you wish volume, as, for instance, band concerts, the adjustment can be made instantaneously.

By means of this new adjusting feature, the diaphragm can be moved to or from the pole pieces from .006" to .025". To make the adjustment, simply screw the case within the base of the speaker slightly backward or forward. No screws, no nuts, no fussing, no damaged diaphragm.

ACOUSTIC FEATURES

After you have listened to all of the expensive loud talkers, all we request is that you give ours a trial. You will find that it compares favorably with the most expensive loud speakers on the market.

The "RICO" MELOTONE SPEAKER gives quality and volume, without distortion, due to the tuned feature.

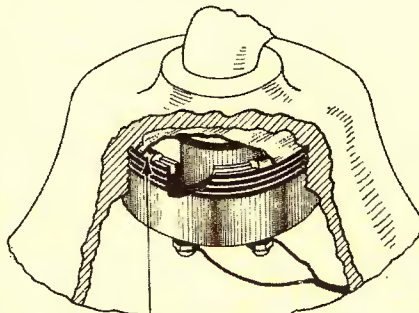

RUBBER GASKET

On two or three stages of amplification, any good radio outfit with the "Rico" Melotone Speaker will bring in the sounds loud and clear to fill a large room or hall. The fibre horn gives the mellow tone that is sought by every radio enthusiast. There is a richness of sound that compares most favorably with the most expensive horns on the market today.

In appearance, the "RICO" MELOTONE LOUD SPEAKER is a rich-looking and accurately, as well as scientifically-constructed instrument, that looks rich anywhere, among the best furnishings. Yet the size is not so large that the apparatus will appear cumbersome. Base is equipped with felt, to overcome resonance effects and to prevent the marring of table tops.

The dimensions are as follows: Length overall, 14½ inches; Length of horn, 11½ inches; Diameter of bell, 6¾ inches; Total height of instrument, 9 inches; Diameter of base, 5 13/16 inches; Total net weight, 3 lbs.

Each MELOTONE SPEAKER is enclosed in a heavy corrugated box, and we guarantee safe delivery to you.

Order from your dealer or direct from us.

SPECIAL OFFER

We are so convinced that you will be enthusiastic about this loud speaker that we make this unusual offer:

Try the MELOTONE loud speaker for five days, and simply consider the money you are sending in to us a deposit. If, at the end of five days, you are not convinced that it is the best loud-talker you have ever seen or heard, return it to us and your money will be promptly refunded.

\$6.00 SEND NO MONEY

USE COUPON BELOW

Note: The "RICO" TUNED MELOTONE Loud-Speaker No. 250 'Phone must be used in connection with a 1- or 2-stage amplifier or more.

Send for free illustrated literature of "Rico" Head-phones; "Rico" Phonoadapters; "Rico" tuned loud-speaker phones; fibre "Ricohorns."

SEND NO MONEY

COUPON

R.N.-6

Radio Industries Corporation
131 Duane Street, New York

Gentlemen:—Please send me by Parcel Post one "Rico" TUNED Melotone Speaker for which I will pay the postman the amount of \$6.00 plus charges. If within five days I do not find the instrument all you claim for it, or if for any reason I am not satisfied, I may return same to you in good condition and you will refund the full purchase price.

NAME

STREET AND NO.

CITY STATE

RADIO
INDUSTRIES
CORPORATION

131 Duane Street, New York City

California Address: Ricotrade, New York.

California, Washington and Oregon Distributors:

Western Agencies, Inc., 711 Mission St., San Francisco, Cal.

**NOW
\$1.00**

ANNOUNCEMENT

SINCE we placed the NATIONAL AIRPHONE "GOLD-GRAIN" DETECTOR on the market, six months ago, it has taken the country by storm. Thousands upon thousands of radio fans, amateurs and experimenters are now using "GOLD-GRAIN" DETECTORS for Crystal outfits, for Reflex Sets and for many other radio purposes.

The demand for "GOLD-GRAIN" DETECTORS has been so tremendous that we have been enabled to effect vast economies in our manufacturing processes. This has made it possible for us to make sweeping price reductions in these detectors.

**NOW
\$1.50**

NATIONAL AIRPHONE "GOLD-GRAIN" DETECTORS

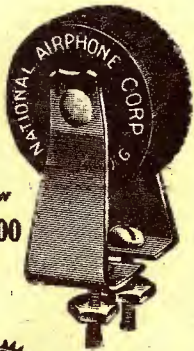

Now
\$1.00

After you have fussed with catwhiskers, springs, balls and adjustment handles, and after you have almost become a nervous wreck, hunting for "the elusive sensitive spot"—you will welcome with open arms our 100 per cent. GOLD-GRAIN DETECTOR.

This Detector is not a fixed Detector, but is foolproof; it has no catwhiskers, no springs, no balls, no adjusting handles; no fussing. The Detector is Entirely enclosed in hard rubber composition cartridge.

A special crystal is used, while contact elements are made of pure gold. There is always a multiplicity of contacts. The Detector is sealed hermetically. The contact with the crystal is always perfect.

This detector has been pronounced by experts as the greatest detector in existence. It reproduces voice, and music in natural color of tone, without distortion. You will be surprised at the wonderful results and satisfaction it gives.

**Actual Size
FOR PANEL
MOUNTING**

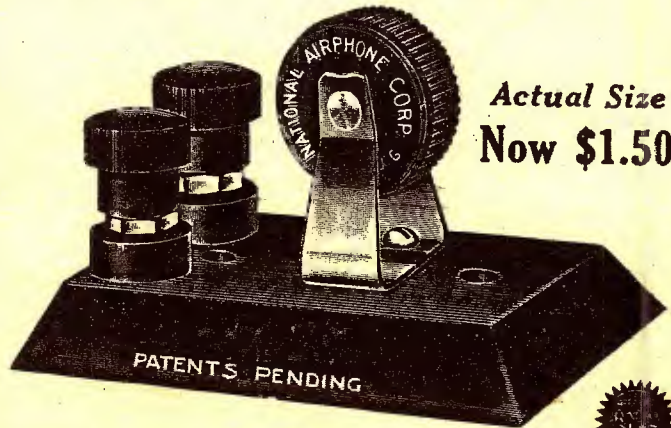

**Actual Size
Now \$1.50**

YOU ARE PROTECTED BY THIS GUARANTEE

Should any National "Gold-Grain" Detector not be in first-class condition when purchased and within 10 days you return it to us unopened, or in unbroken condition, we will repair it or send you a new one free of charge. Order from your Dealer—or direct from us.

HOW TO MAKE A REFLEX SET

With the reflex circuits illustrated, and with the values as given, it is now possible, with a single tube and a NATIONAL AIRPHONE "GOLD-GRAIN" DETECTOR, to receive distances over 1500 miles on a small aerial.

The price of the parts as shown in the illustrations should not come higher than from \$20.00 to \$22.00 (excluding Vacuum tube and phones).

The results are really remarkable, and by using a WD-11 Tube it is not even necessary to use a storage battery. A small "B" Battery and a dry cell can be used.

An ideal portable outfit can be constructed quite readily with the

Reflex, and for local stations, within a radius of 50 miles, an outdoor aerial is not required. A small two-foot loop may be used, and it becomes then possible to obtain a moderate volume of sound on a loud speaker.

The Reflex outfit as shown in the circuit herewith has been constructed by our engineering department and we shall be glad to demonstrate it to the radio fraternity. The extraordinary results obtained with this circuit are in part due to the NATIONAL AIRPHONE "GOLD-GRAIN" DETECTOR. Recent changes made in this Detector have improved it to such an extent that it is now entirely automatic and will stay put with an occasional adjustment.

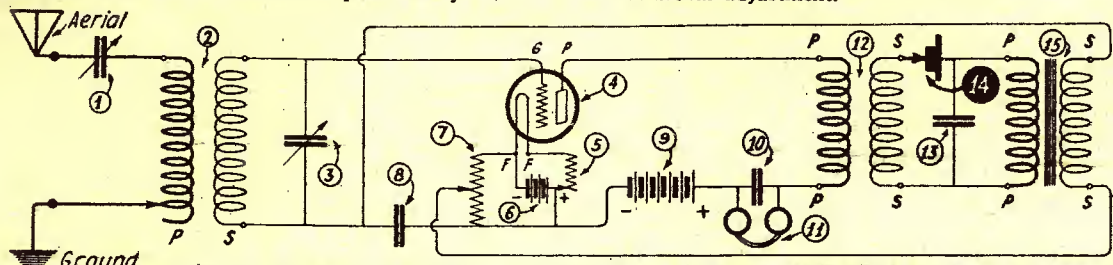

1= var. cond. .001 mfd. 43 plates. 2= variocoupler. 3= var. cond. .0005 mfd. 23 plates. 4= vacuum tube (amp) 44=NATIONAL AIRPHONE GOLD GRAIN DETECTOR 5= rheostat. 6= A' batt. (DRY CELL FOR WD-11) 7= 200-400 Ohm potentiometer. 8= fixed mica cond. .001 mfd. 9= batt. 45v. 10= fixed mica cond. .001 mfd. 11= phones. 12= mu rad. radio freq. transf. 13= .001 mfd. F.C. 15= federal audio freq. transf.

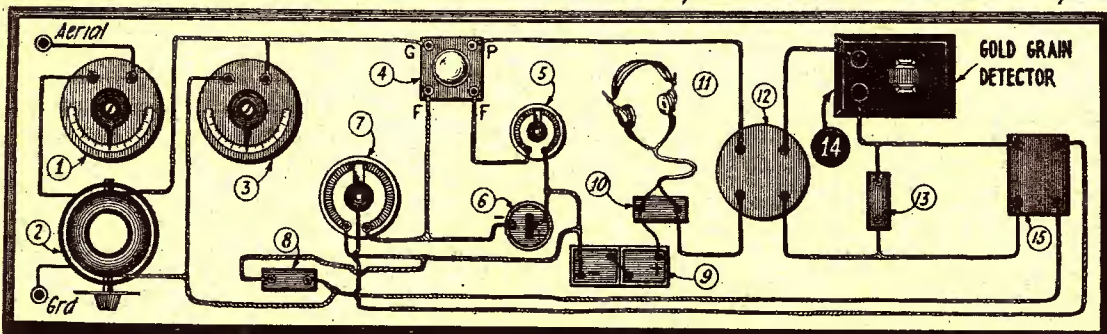

**NATIONAL
AIRPHONE
CORPORATION**

Distributors—Write for Territory.

Dealers—Write for Discounts.

18 HUDSON ST.

NEW YORK

(Continued from page 2132)

ing how the scheme would possibly work out. The vessel, on every trip, conducts a series of tests with the great stations at Eiffel Tower and Bordeaux, all of which prove satisfactory. At one time the Eiffel Tower station heard the voice from the *Paris*, while the vessel was about 600 miles off the French coast. The set consists of six tubes, the necessary plate voltage coming from a special type of motor-generator. A bank of storage batteries supplies the 10-12 volts for lighting the filaments. Up-to-date arrangements have been made so that conversation can only be carried on, on the 600-meter wave. A similar transmitter is also installed aboard the *France*, another vessel of the same steamship line.

On ocean liners like the *Paris*, special attention must be given the receiving outfits which are installed. In addition to receiving messages, weather reports, obstruction reports, etc., the operators must also copy lengthy press reports. All this is transmitted on different wave-lengths and so there must be a receiver adopted to intercept signals broadcast on such wave-lengths. To insure missing nothing in the way of news, messages, etc., the *Paris* carries two different types of receivers, either of which may be used in conjunction with a detector and six-stage amplifier, by simply throwing a switch.

The large set, though seemingly complicated, is simple and has a wave-length range of from 200 to 25,000 meters. It consists of two loose couplers, a loading coil, variable condensers, etc., and is so connected that one who is unacquainted with its operation would have difficulty in getting results. The other set is a short-wave receiver, of no unusual type. Conveniently located, is a double-pole, double throw switch, for the purpose of connecting either set with the detector and amplifiers. The amplifiers are of special design and highly efficient. By consulting one of the accompanying photos we will be able to get a better idea of the design of the receiving unit, how the tubes (French) are mounted, etc. The reader will note that the detector and two-stage amplifier is in a separate unit from the four-stage amplifier. These tubes require 45 volts on the plate and five volts for the filament before they will function properly.

Were it not for the radio, travelers would be in the dark as to what is taking place in their native lands, for through this lane comes news every day. People demand news while they are at sea just as well as if they are ashore, and for this reason a newspaper is published every day by the three radio men. Much of the press items are received from Chatham, Mass., Eiffel Tower and Bordeaux, France. It is transmitted on high waves and the large receiver aboard the ship proves suitable for just such work as this. There is hardly a day when every square inch of the ocean newspaper is not jammed with interesting news and during a trip, many thousands of copies are sold, at an attractive profit to the concern controlling the ship's radio.

Newspaper stories of the past, describing disasters at sea, have led many steamship companies to equip their large lifeboats with a complete radio receiving and transmitting set. The *Paris* carries two 40' lifeboats with such equipment, and tests have demonstrated their value. The transmitter is rated at 1/4 k.w. and has a daylight range of nearly 250 miles. The receiving outfit is a very efficient one, having a detector and two-stage amplifier. It is capable of intercepting signals over a distance of 700 miles. Both lifeboats aboard this ship carry the same equipment. The aerial used is a four-wire affair, one end being supported by a 25' pole. The aerial can be easily



If He Had Passed It Up

He would still be a laborer at \$2.00 a day. No money, nothing ahead but hard work, longer hours—and regrets.

But He Didn't Pass It Up. He decided to learn MECHANICAL DRAWING. He buckled down to work with the Columbia School of Drafting. When he had a quiet half hour to spend he spent it—as a wise man spends money—to get full returns.

Made \$275 Extra in 3 Days. He recently received \$275 for one drawing that only took him three days to draw.

Now How About You? Are you working up hill or down? Count the money in your pay envelope next pay day. You'll find the answer there.

Make \$35 to \$100.00 a Week. We will train you to be an expert draftsman in your spare time at home by mail. There's lots of room for you if you act now.

Promotion is Quick. WE'LL QUALIFY YOU for a high-salaried position in the drafting field and keep you in touch with openings for draftsmen in the big machine shops, industrial plants and United States Government departments. Men who start

as draftsmen are often advanced to Chief Draftsman, Chief Engineer, Production Manager and so on.

Get the Right Training. Mr. Clafin, the founder and director, stands personally in back of the Columbia School of Drafting. You spend no time in long-winded theories—useless and expensive to you. You start on actual drawing work the day you receive your first lesson.

You Need No Previous Training. The course is easy to understand and easy to follow. Many students are qualified even before they complete the course.

Success Calls Men of Action Only. If you are a man of action clip the coupon now and show that you are a man of action. Keep right on top of this opportunity to make real money. Don't go looking for a pair of scissors. Tear the coupon off and mail it right now. We have a special offer for those who reply promptly. Get started now.

What You Get FREE

Practical Problems. You are carefully coached in practical drafting work.

We Help You Get a Job. We help you get a position as a practical draftsman as soon as you are qualified.

Free Training as a Drafting Specialist. After completing the course in mechanical drawing we'll train you free in your choice of one of our special elective courses.

Draftsman's Equipment. We give you Free a full set of drafting equipment as shown in the picture below.

Consultation Privileges. You are free to write us any time for advice and suggestions regarding your success.

Diploma. The diploma we give you on completing the course attests to your proficiency as a draftsman. It is an "entering wedge" to success.

Free Subscription to Draftsman's Publication "The Compass"

U. S. Civil Service Commission Calls for Draftsmen
A few of many positions constantly open in Government departments.

Salaries are starting salaries, subject to increase. Practically all of them carry a bonus of \$240 a year additional.

ARCHITECTURAL DESIGNER—\$4,000.

CHIEF DRAFTSMAN (Aeronautical)—Naval Aircraft Factory, \$15.04 per day.

AERONAUTICAL DRAFTSMAN—Field Service of Navy Department, \$5.20 per day to \$12.00 per day.

Free Book Send in this coupon today. Immediately

on receiving it we'll send you our book, "Drafting—Your Success." It tells you all about our new method of teaching mechanical drawing and gives full details of our offer:

COLUMBIA SCHOOL OF DRAFTING

ROY C. CLAFIN, Pres.

Dept. 2004, 14th & T Sts.

Washington, D. C.

FREE Drafting Outfit

We give you free with your course this professional drawing outfit. It's yours to keep.

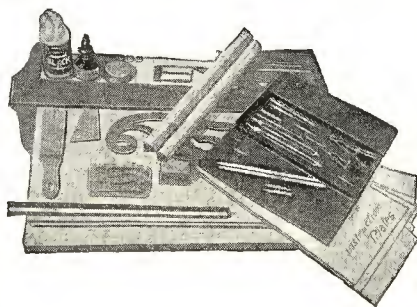

FREE BOOK COUPON

COLUMBIA SCHOOL OF DRAFTING
Dept. 2004, Washington, D. C.

Enter my name for a subscription to "The Compass" and without obligation to me, please send me your illustrated book on Drafting, telling how I can secure your complete home study course and your help in securing a position as Draftsman.

Name Age

Address

City State

RADIO this SUMMER?

IT'S UP TO YOU



It entirely depends on yourself whether you continue your interest in radio this summer. Here are four very good reasons why you should get maximum enjoyment from the air at all times.

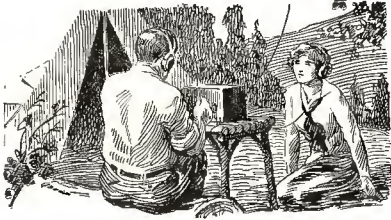

1 Perfection of portable receiving sets now makes possible their use outdoors. They can be carried on camping trips, boating cruises or automobile tours.

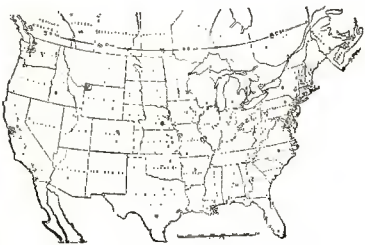

2 Last year there were only 137 broadcasting stations. Today there are over 500 licensed stations in operation. They are so well distributed over the country that with one exception no place is farther than 150 miles from a good station.

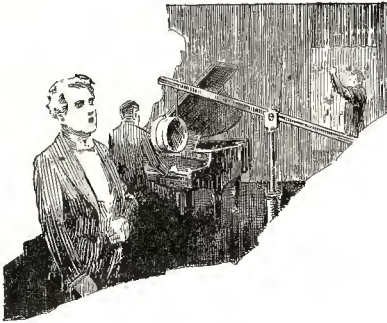

3 Improvements in transmission equipment and methods of sending, together with a higher state of perfection in receiving sets, have greatly reduced the static and other air disturbances. Now about the only difference in summer is the lessening of long range receiving.

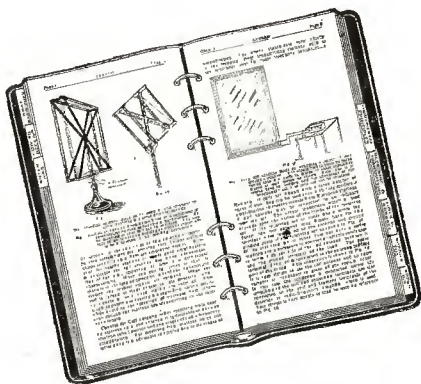

4 Here is the foundation on which to build your radio enjoyment. The Lefax Radio Handbook will start you right and keep you that way. It is written by the two chiefs of the Radio Department, U. S. Bureau of Standards. It is a loose leaf pocket-size book, bound in beautiful imitation black Morocco leather. Lefax Radio Handbook never grows old because a monthly service called "Radiofax" goes with it. Radiofax contains all the latest and best information with instructions and diagrams on the most practical hook-ups. Lefax Radio Handbooks are sold by leading radio dealers and stationers. Price \$3.50 including Radiofax for one year.

LEFAX, Incorporated

147 South 9th Street

Philadelphia, Pa.

and quickly raised or lowered by simply raising or lowering the pole. Cabins are not to be found on these little ships and the wireless apparatus is housed in a small canvas shelter in the forward part of the boat.

Company officials and officers of the big liner are keen to have these little boats in readiness at all times. Especially do they take an interest in the radio, and each voyage, when the ship arrives at her berth in the Hudson River, tests are conducted. The boats proceed about 30 miles up the river and then communicate with the man in the radio cabin aboard the mother ship, lying in her dock. The encouraging of these tests indicates the interest taken by company officials and officers of the ship, who doubtlessly believe that a day will come when they will save many lives by means of the radio on their vessels and so bring joy and restfulness to untold numbers.

Ten Commandments for Broadcasting Stations

(Continued from page 2100)

thine assigned wave-length and shalt use all means to eliminate noise in thy equipment.

6. When thou art broadcasting an orchestra number thou shalt exercise great care and judgment in placing thy players before the microphone lest thy selection degenerate into a saxophone solo.

7. Thou shalt make thy announcements promptly, clearly and briefly.

8. If thy set bucks while thou art concerting, thou shalt announce that fact, for a multitude of thy listeners art cussing receiving sets.

9. Thou shalt command thy listeners "do not kill the local amateur who talks to old man during a concert nor him who opens up on a spark set as an announcement is being made." These will be sufficiently punished in the hereafter.

10. Thou doth broadcast for advertising purposes. When thou doth fill up the ether for thine own benefit thou doth assume certain obligations towards all listeners. Think carefully of these commandments.

That Mysterious Amplifier Trouble

(Continued from page 2101)

8,000 ohms, while the resistance of the primary of the amplifying transformer was only 900 ohms. My detector tube, a soft one of Dutch manufacture, was marked for a plate voltage of 25 to 30, and I had always used a 30-volt battery. Now the phones would drop the voltage quite considerably by reason of their high resistance, but the drop across the transformer would be very little (on account of its lower resistance) and consequently the plate voltage on the detector would be higher with the transformer in the circuit.

An excessive plate voltage paralyzes a tube and could thus render the entire apparatus inoperative. I accordingly cut open a portion of the cardboard covering of my 30-volt "brick" and with a drop of solder fixed a lead to the side of the third cell from the positive end, this giving me about 26 volts. I hooked up my 26 volts, and the set worked perfectly right away.

Contributed by K. McLean.

MU-RAD RECEIVERS SUPREME

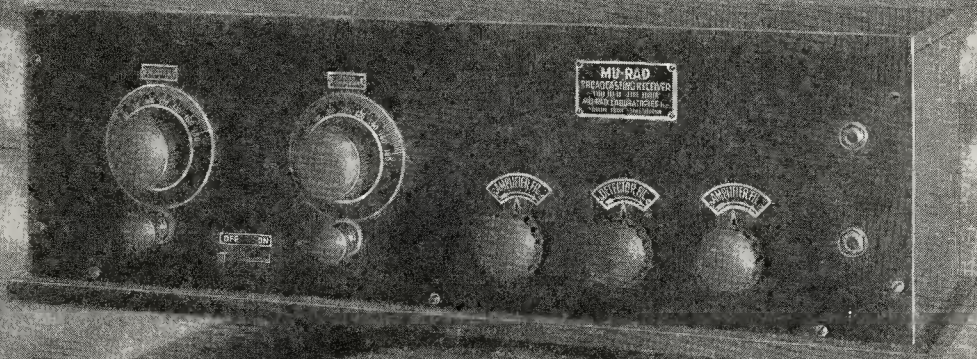

LIKE THE POWERFUL TELESCOPE that makes us neighbors to the stars, MU-RAD Receivers annihilate distance with delightful ease. Honolulu is as near to St. Louis by MU-RAD reception as New York.

SO MARVELOUSLY SENSITIVE that it requires only a two-foot loop aerial. Distinct reproduction. Hair breadth selectivity and yet easy for even a novice to operate. Conservatively guaranteed for 1000 miles.

Write for Literature

The New
Star in
the Radio
World



MU-RAD LABORATORIES, INC.
801 FIFTH AVE. ASBURY PARK, NEW JERSEY

GIBLIN-REMLER COILS

Maximum Inductance. Minimum Distributed Capacity for a given number of turns

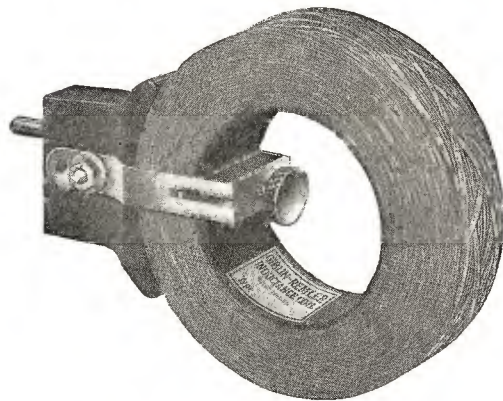

Maximum Selectivity of tuning. Maximum signal strength and a minimum of interference

Reducing Interference to a Minimum

THE special form of winding used in the Giblin-Remler Coil results in maximum inductance, minimum distributed capacity and minimum high frequency resistance for a given number of turns of wire. These are the three features essential in obtaining the highest degree of selectivity.

A sharply tuned circuit is one that has an extremely low resistance to a current of the particular frequency to which it is tuned, and a high resistance to currents of all other frequency. In any receiving circuit there are two kinds of resistance—one, the straight high frequency of the coil, and the other, the resistance caused by the impedance of the coil and the condenser used with it. The first remains fairly constant over a small range of wave lengths. The second resistance is zero at one particular wave length and increases as the wave length varies in either direction;

hence, it is easily seen that when the inductance of the coil is extremely high in proportion to the high-frequency resistance, which is the case in the GIBLIN-REMLER COIL, the circuit in which it is used may be made to have practically no resistance to signals on one particular wave length, and yet have a proportionally high resistance to signals on all other wave lengths. This condition, which is always obtained in circuits using the GIBLIN-REMLER COIL, results in a SHARPLY TUNED CIRCUIT, that is, one giving MAXIMUM SIGNAL STRENGTH on the desired wave length, with a MINIMUM OF INTERFERENCE from signals on any other wave length.

Write for Bulletin N, giving complete information, table of constants and prices on Giblin-Remler Coils.

REMLER RADIO MANUFACTURING COMPANY

Factory and Home Office
248 First Street, San Francisco, Cal.

Eastern Sales Office
154 W. Lake Street, Chicago, Ill.

Try This New Duo-Vertical Winding

(Continued from page 2081)

side in a vertical line, doing it in such a manner that the inductance effect is the same as with one coil.

Winding clockwise, he first completed one full turn on the disc nearest him as he held the double form in his left hand. He wove the wire in one slot and out the next, alternately crossing in front of and behind the various sections. Then, instead of continuing on for the second turn on the first disc, he crossed over to the second disc and completed the first full turn on that. Then he came back and made another turn on the form nearest him, crossing to the rear to do the same to the disc in back. Back and forth, in and out, first a turn on this disc, then a turn on that, until the required number had been made.

This duo-vertical winding is not hard. The only thing about which to be careful is to see that the winding on both halves of the double form goes in the same direction. This direction, incidentally, should be the same as that of the primary and secondary windings.

The result of this novel method of coil construction is a compact and efficient coil, which can be readily handled and which gives better results than the cumbersome 7½" "solo-vertical" winding.

Some New Dual Amplification Circuits

(Continued from page 2085)

allowing the high-frequency currents to flow readily through them. Considerable development work is still possible with these circuits and modifications of them, and experimenters will find here an interesting field of work.

Matching Impedances

(Continued from page 2105)

($R=r$) the output will be a maximum. One may easily determine this fact by assuming various values for the external resistance, having assigned constant values for the voltage (E) and the internal resistance (R).

For the case of a load circuit of constant reactance the output will be a maximum when the external resistance is equal to the square root of the sum of the squares of the internal resistance and the reactance of the load. $r = \sqrt{R^2 + x^2}$. This also may be seen if one assigns fixed values for E, R, and x in the above equation. It is interesting to note that this indicates also that the resistance values are to be made equal when there is no reactance.

For the case of constant power factor in the load (x and r being proportional) the maximum power output will result when the internal resistance is equal to the impedance of the load. This is quite a usual case, for example, a reactance coil of fixed winding space and fixed space factor. In such a coil, the reactance varies with the resistance. If the number of turns are doubled, the inductance is approximately four times the original value, the resistance is also increased four times because of the double length and the reduction in area by one-half.

In applying this idea of balanced impedance to the use of vacuum tube amplifiers, it

HOMMEL
Wholesale Exclusively
DISTRIBUTORS FOR

| | | |
|-----------------------|---------------|------------------|
| Radio Corp of America | Clapp-Eastham | Kennedy |
| Westinghouse | Cutler-Hammer | Klosnor |
| General Electric | Dubittier | Murdoch |
| Ame | Fada | Pacent |
| Atwater-Kent | Fahnestock | Radio Service |
| Baldwin | Frost | Radiall |
| Brach | General Radio | Remler |
| Brandes | Hipwell | Rhamstine |
| Burgess | Homcharger | Tuska |
| Chelsea | Kellogg | Western Electric |

Hommel's Illustrated Encyclopedia 225¢ free to Dealers. We Sell to no Others.

LUDWIG HOMMEL & CO
530-534 FERNANDO ST. PITTSBURGH, PENNA.

RADIO Catalogue
FREE!

One copy of this complete Catalogue of Radio outfits, parts, dictionary of Radio terms and instructions—one copy is yours FREE.

It quotes the lowest prices, amazingly low prices, on everything for the expert and the amateur. Every improved part, the most up-to-date outfits, everything that is needed—at the lowest possible prices.

Send for your copy of this FREE Radio Catalogue. Address Department No. 2-R.

MONTGOMERY WARD & CO.
Chicago Kansas City St. Paul
Portland, Ore. Ft. Worth

Try the Bradleystat on Your Radio Set, to-night

A New Thrill Awaits You!

Pull in those distant stations that you lose with Wire Rheostats

Does your receiving range enable you to pick up concerts over great distances? If not, try the Bradleystat.

Read this interesting letter from Chas. H. M. White of Massachusetts Institute of Technology at Cambridge, Massachusetts:

"I have tried the Bradleystat on my radio set. The improvement is really remarkable and beyond all my expectations. Previously I only picked up local stations and WJZ, but on my first trial with the Bradleystat I heard KYW (Chicago), WOC (Davenport) and many other stations."

Get the Bradleystat, today, from your nearest radio dealer and get more enjoyment from your radio set. Insist on the genuine Bradleystat.

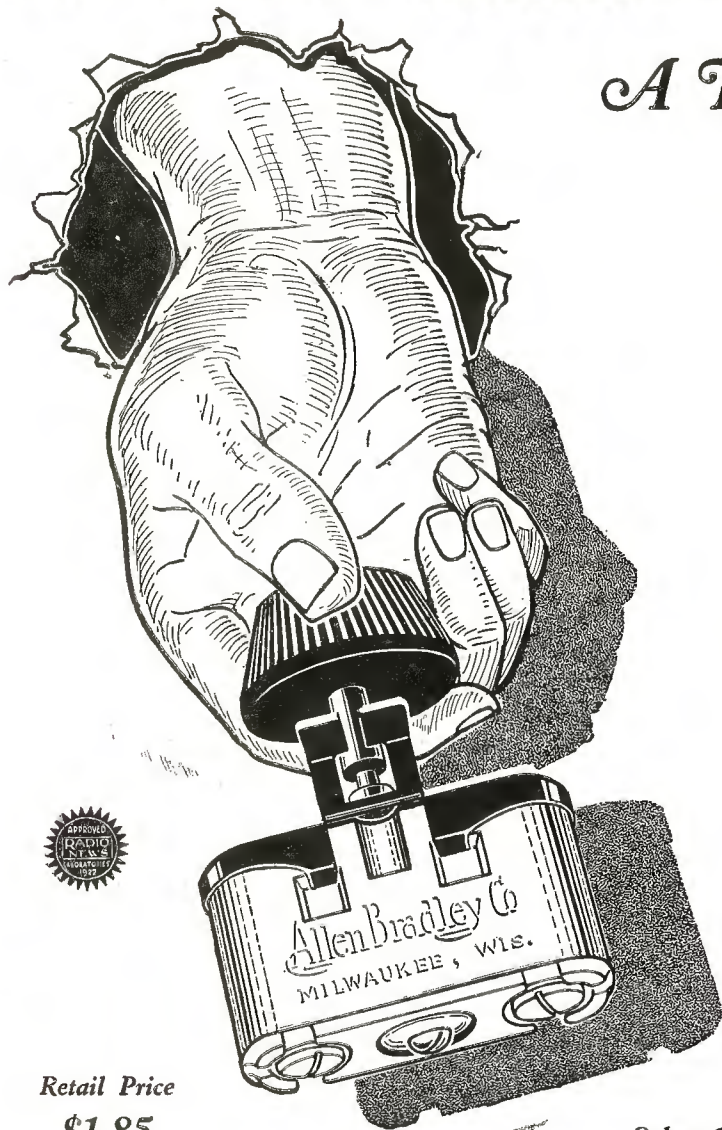

Allen-Bradley Co.
Electric Controlling Apparatus

287 Greenfield Avenue • Milwaukee, Wisconsin
Member of the National Radio Chamber of Commerce

Retail Price
\$1.85
P.P. 10c extra

Other Radio Products
The Bradleyometer, a perfect potentiometer and the Bradley-adaptor for the WD-11 tubes are two new radio products equal in quality to the Bradleystat.

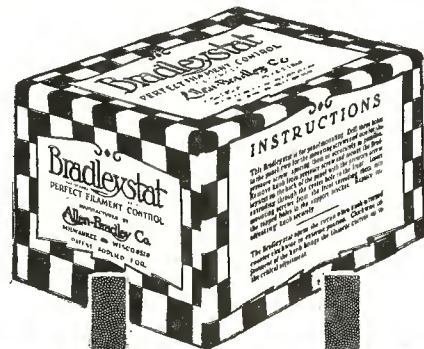

Bradleystat

REGISTERED U. S. PAT. OFF.

PERFECT FILAMENT CONTROL

"American Beauty"

Electric Soldering Iron



The Best Iron Made

For Soldering all connections, parts, etc. Ready for use by attaching to any electric light socket. The cost of operation is insignificant.

Many thousands in use by amateurs, engineers, manufacturers, telephone companies and many others.

For radio, telephone and all light work our latest Model No. 3138 is ideal; also two larger sizes for doing heavier work.

For twenty-eight years our name and trade mark have been a guarantee of quality and dependability.

AMERICAN ELECTRICAL HEATER COMPANY
DETROIT, U.S.A.

Oldest and largest exclusive makers. Established 1894

is well to keep in mind that the desired result is *power* amplification. The tubes are ordinarily used as *power* amplifiers and are so arranged as to deliver maximum power. The voltage amplification is ordinarily obtained by the use of transformers, the transformer, of course, not being a *power* amplifying device. For minimum distortion, it is advisable to have no reactance in the load circuit. It is then apparent that the external load equivalent resistance should be equal to the resistance of the plate circuit of the tube.

To obtain the maximum output we must arrange this balance between the internal and external ohms. Many circuits behave like simple resistance circuits for a certain frequency because of the fact that they are operating at resonance. Any tuned circuit comes under this classification. A tuned transformer (tuned radio frequency), or a simple tuned reactance coil operate as resistance units. It is possible to treat such circuits as resistances when matching them against a tube, the problem being solved once the equivalent resistance of the combination is determined. The equivalent resistance of a tuned reactance coil, is determined by obtaining the conductance of the combination (coil and condenser in parallel) and then taking the reciprocal of this term. The equivalent resistance of a tuned radio-frequency transformer (referred to the primary circuit) is found by obtaining the conductance of the secondary (condenser and coil); taking the reciprocal and then dividing by the transformation ratio squared.

A Spark Coil C.W. Set

(Continued from page 2108)

rent of about .5 amperes. The normal working range is from 75 to 150 miles. By using an American 5-watt transmitting tube and a 1" spark coil, the aerial current can be raised to nearly an ampere. This increases the range to several hundred miles or more.

The advantage of a set of this type is that it combines the simplicity of a spark coil transmitter with the sharpness of wavelength and distance covering ability possessed only by a vacuum tube set. To the amateur who hasn't a great deal of money to invest in valve equipment, a spark coil type of I.C.W. set certainly offers a splendid means of overcoming the high voltage plate-supply problem at very little cost.

Printing the Newspaper of the Sea

(Continued from page 2116)

the hands of the passengers or crew, thus notifying them of happenings ashore during the past 24 hours. In this way, seagoers do not find it difficult to keep up with the latest scandal or diplomatic questions on land, although they be many miles from shore. By this service the Continents are brought into closer proximity, the voyage seemingly shortened and ocean-traveling made more enjoyable.

Shipowners and operators have likewise realized the value of this service and today there are many large liners that have small print shops just for carrying out this work. If we will but stop to consider that the big boats carry hundreds of passengers, we can readily see that it is a necessity. Were the wireless man compelled to print several hundreds of these "ocean news" by hand, in conjunction with attending to his other duties, he would find his position far from enjoyable. A wireless operator aboard a big passenger boat is generally

FLEWELLING CIRCUIT

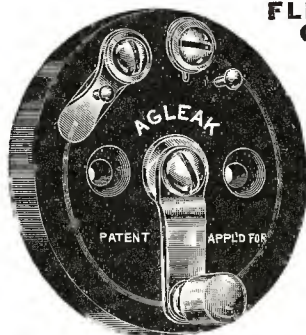

A continuously variable grid leak over a wide range of resistance is the most essential and critical instrument required in this circuit. The BUNNELL VARIABLE GRID LEAK with a range of 1/4 to 6 megohms fills the bill. Furnished complete with japanned metal cover and screws for mounting. Sample by mail, 80 cents.

Liberal discounts in quantities. Send stamp for catalogue No. 45-R.

J. H. BUNNELL & COMPANY
32 Park Place New York City

PERMANITE. The Wonder Crystal

An absolute innovation in the radio crystal field. Permanite Synthetic Crystal is invariably sensitive on EVERY PART OF ITS SURFACE. Lasts two years. No loss of sensitivity through spark reception. Sold on money-back guarantee.

PERMANITE and SPECIAL CAT WHISKER 75c.

Sole Distributors

P. M. DREYFUSS CO., Inc.

150 Chambers Street, New York City

BARKELEW

RADIO ACCESSORIES

Antenna Equipment

Four Phone Plugs and Posts

LIGHTNING ARRESTER
Required on the antenna of every Receiving Station.
Cat. No. 606 Price \$2.00



LIGHTNING ARRESTER SWITCH
For Receiving Stations
Demanded by those who want the best.
Cat. No. 602 Price \$3.50

GROUND SWITCH
Required on all Transmitting Stations. Built of 60 Ampere copper.
Cat. No. 600 Price \$2.50

GROUND SWITCH
Required on all Transmitting Stations Built of 100 Ampere copper.
Cat. No. 601 Price \$3.15

To Radio Distributors and Dealers

Trade discounts to Radio Distributors and Dealers who have established standing or can prove their status.

Local distribution is through Dealers where available.

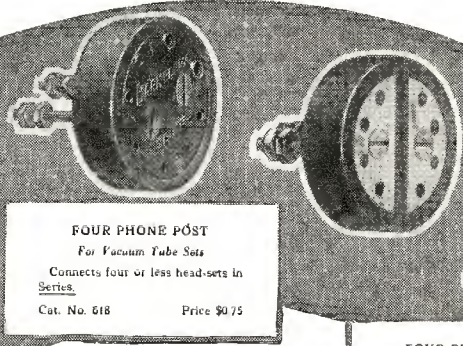

FOUR PHONE POST
For Crystal Sets
Connects four or less head-sets in Multiple.
Cat. No. 615 Price \$0.75

FOUR PHONE POST
For Vacuum Tube Sets
Connects four or less head-sets in Series.
Cat. No. 618 Price \$0.75

FOUR PHONE PLUG
Connects four or less head-sets in Series to any Radio Set using telephone jacks.
Cat. No. 616 Price \$1.50

FOUR PHONE PLUG
Connects four or less head-sets in Multiple to any Radio Set using telephone jacks.
Cat. No. 614 Price \$1.50

In this grouping of Radio Accessories, we present to the radio trade a variety of parts which are in keeping with the reputation of BARKELEW Products.

The Four Phone Plugs and Posts shown at the right are of unique design, compact and practical. On old sets they are easily applied by anyone. Manufacturers are installing them on new sets to meet the public demand.

Accessories of Merit and Quality

Our Lightning Arrester Switch No. 602 is recognized by Radio Engineers as the most effective device yet developed for that purpose. All of our switches and Lightning Arresters are approved by the Underwriters' Laboratories.

Insulators and Pedestals meet the best Radio Engineering practice as well as the latest requirements of the National Electric Code.

All radio material is packed in paper boxes and labeled, making excellent shelf stock.

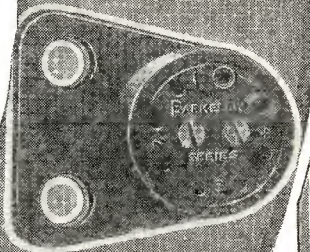

FOUR PHONE POST
Adapted for Arviola Senior
For four or less head-sets in Series. Remove nuts and slip over phone posts.
Cat. No. 617 Price \$1.00

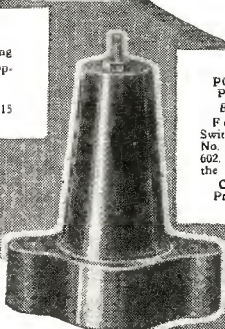

PORCELAIN PEDESTAL
Brown Glaze
For spacing Switches No. 600, No. 601 and No. 602. 5" out from the wall.
Cat. No. 611 Price \$0.50 pr



"LEAD IN" INSULATOR
For Receiving Stations
Spaces the "Lead In" Wire 5" out from the wall.
Cat. No. 612 Price \$0.50

"LEAD IN" INSULATOR
For Transmitting Stations
A large petticoat insulator on a treated wood pin.
Cat. No. 613 Price \$1.00

To Customers

Try your Dealer first; if he cannot furnish write our Middletown Office for name of one who will.

THE BARKELEW ELECTRIC MFG. CO.

MIDDLETOWN, OHIO

15 S. Clinton St., CHICAGO
75 Fremont St., SAN FRANCISCO
411 Main St., LOS ANGELES

603 Century Bldg., PITTSBURGH
1487 Broadway, NEW YORK CITY
Denham Bldg., DENVER

Export Department, 29 Broadway, NEW YORK CITY

RADIOGEM

The Dollar Radio Receiving Set
The Simplest Radio Outfit Made
—Yet as Practical as the Most Expensive!

You need know absolutely nothing about wireless to operate and enjoy the RADIOGEM. It is so sturdy, so simply constructed that it is small wonder radio engineers who have tested it have pronounced the RADIOGEM a brilliant achievement. The RADIOGEM is a crystal radio receiving set for everyone at a price anyone can afford.

Why The RADIOGEM Can Be Sold For Only \$1

Here's the secret: The RADIOGEM Construction eliminates all unnecessary trimmings, cabinets and the like, which do not play any part in the operation of a set. You receive the RADIOGEM unassembled, together with a clearly written instruction book, which shows you how to quickly and easily construct the set, using only your hands and a scissor. The outfit comprises all the necessary wire, contact points, detector mineral, tube on which to wind the coil, etc., etc. The instruction book explains simply and completely the principles of radio and its graphic illustrations make the assembling of the RADIOGEM real fun. Remember the RADIOGEM is a proven, practical radio receiving set and will do anything the most expensive crystal set will do.

The RADIOGEM is the Prize Winner of the Age

Out of hundreds of radio models submitted recently in a great nation-wide contest, radio engineers, the judges, unanimously chose the RADIOGEM as the winner—the simplest radio-receiving set made! And the RADIOGEM costs you nothing to operate; no form of local electricity is required.

Sent Postage Prepaid on receipt of \$1 —stamps, money-order or check.

Order Your Radiogem To-day—
or send for Free Descriptive Circular

DEALERS

The RADIOGEM is the wonder item of the radio age. It is storming the country, for the RADIOGEM'S price is so low everyone is able to buy one. Write immediately for full particulars before that shop across the street beats you to it.



Hear the programs of the Broadcasting Stations on the RADIOGEM



\$1 without PHONE or AERIAL
 (Patent Pending)

What They Say About RADIOGEM

I am enclosing herewith \$1.00 to pay for the Radiogem. I had it carefully wound by our wireless operator and find that it works beautifully—fully as good as any crystal set we know of.

Radiogem received, which we assembled and were very much astonished at results obtained and the clearness and volume of tone produced.

The greatest distances I heard on one of your sets is 1000 miles, having heard WOCY at Schenectady, N. Y. I think your set is the best I have ever sold at any price.

On an aerial 160 feet long and 20 high one of my customers has heard WOC and WEB, KSD, WMC on one of your sets using a Peerless headset.

Herewith P.O.M.O. amt. \$1.00 for another "RADIOGEM". The one received is O.K. Placed about 15 ft. of picture cord under front porch and grounded to a gas meter, and heard the Sacramento Bee and Sacramento Broadcasting Union much better than with my large crystal set.

Your RADIOGEM RECEIVER is a wonder. I have received every station in Philadelphia with it much louder than with a high-priced crystal set.

Your two Radiogem sets received last night, and one was wired up for testing. WOC is about 40 miles away, and their signals could be heard with headphones on table. After they quit KYW at Chicago about 170 miles east was heard. Every word could be plainly heard here. WMC at Memphis, Tenn., could also be easily heard and understood.

We find that this set does a great deal more than you claim for it. We took WEAR on our audion set last night; this being the Baltimore American Broadcasting station, and then out in the Radiogem and got excellent results. After the Baltimore concert was over, we continued to use the audion set and about ten o'clock were listening to WVEAF—New York—and a little later we disconnected the audion set entirely and hooked up the Radiogem, very clearly hearing both piano music and announcement of name of station and its location.

You claim a radius of 20 miles over your "Radiogem" is sometimes a possibility. You should adhere to the truth. I constructed one for my mother, installed it with an aerial, and she listens not once in a while, but at her will, to Schenectady, Newark, New York, or Providence, R. I., and her home is Atholboro, Mass. I can't give your set too much praise. (Names and Addresses on Request)

very busy from the time the boat leaves the dock until she reaches her destination. The passengers or crew demand "news" while the boat is plowing her way through the water and it is the radio man's duty to give it to them, for he is the only one who is in touch with the outside world.

So much in demand is the "ocean news" aboard vessels at the present day that there will doubtlessly come a time when the biggest ships will carry a man who will devote all his time to getting out a good sized newspaper every day during the voyage, a paper that will nearly rank with those ashore.

On a large number of boats at the present time, the wireless set is almost a derelict, disgusting to view and far from efficient. On vessels where this condition exists, we can easily imagine what the radio man is up against and what he will have to contend with. Being barely able to function, signals with such a set cannot be copied over a great distance and for this reason the "ocean news" fails to make its appearance sometimes for days. Being responsible for its appearance, the passengers and crew generally look to the operator for an explanation when such cases occur. Most often they fail to agree with him, if he informs them that the receiving outfit is useless when the ship is out of port a few days. The majority of them are of the opinion that the radio man can copy these press reports no matter how far away from the transmitting station or the condition of the set he must use. On ships where the radio is in such a deplorable condition the wireless operator is given a good opportunity to display his newspaper publishing ability.

The paper must make its appearance every day and in the absence of items from the shore stations something else must be used to fill up the required columns of reading material. If the radio man is far-sighted he will encounter no difficulty in getting other data. In emergencies of this sort, the captain, chief engineer, or probably the ship's physician is consulted in regards to writing a short article for the "news." These officers, if shown respect by the wireless man, will voice no objections to assisting him in such a way and their long experiences on the sea supplies them with an enormous amount of material on which to write. The master of the vessel would not find it hard to tell of some of his experiences while before the mast, or write on some phase of navigation which would interest the passengers. Why not let the doctor tell about seasickness and how to get relief. There are countless subjects to write on so the "publisher" of the ocean newspaper should really have no trouble in getting news items. There are many voyagers who would prefer to read such articles than the brief press reports, as sent through the air.

I am acquainted with one passenger vessel whose radio operators each trip reap an attractive profit from the printing and selling of the "ocean news." The receiver aboard the boat is by no means one of the best and there are days at a time when not a word is intercepted from any of the great press broadcasting stations. By inaugurating a system of their own, they find it very easy to sell the paper. They attribute much of their sales to the "Who's Who On the Passenger List," articles which appear nearly every day. In these articles is found the biography of the most prominent people aboard the ship. In addition to this is printed their port of destination, the concern they represent and a short quotation on any important subject of the day which they may feel inclined to

SERCO
\$4.25

Beats Them All! A Real Audio-Frequency Amplifying Transformer, with Ratio of 10-1, for the WD 11-12 Dry Cell Tube. Get our 1923 Catalogue covering every phase on the Radio World. We are the Largest Manufacturers in Pittsburgh.

SCHEIB ELECTRIC RADIO CO.
 6243 Station Street Pittsburgh, Pa.

GERMAN MAUSER
 Reg. price \$25.00
\$12.75

Guaranteed Genuine Latest model 9 shot automatic. Shoots Standard cartridges—lies flat in the pocket—World's famous Luger 25 cal. \$19.95—Hand Ejector Revolver, swing out cylinder 32 cal. \$16.75, 38 cal. \$17.75. All brand new latest models—guaranteed genuine imported.

SEND NO MONEY Pay postman on delivery plus postage. Satisfaction guaranteed or money promptly refunded.

\$6.75 25 cal. Vest Pocket Automatic—25 cal. Blue Steel Army Automatic \$8.25, 32 cal. \$10.25, Military Trench Automatic—32 cal. 10 shot, extra magazine FREE, \$11.45. Imported Top Break Revolver, 32 cal. \$8.45, 38 cal. \$8.75.

IMPORT SALES CO., 942 Broadway, Dept. 109, New York

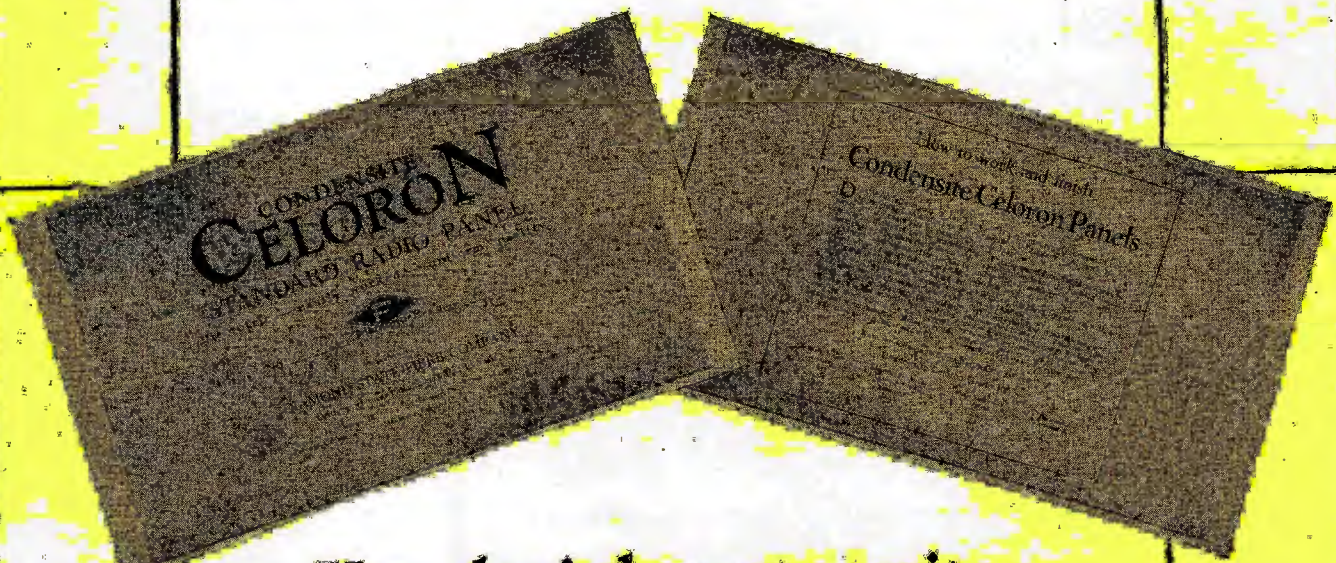

You don't have to wait—

YOU need a radio panel and you want it immediately. But you go to a dealer expecting a delay while your panel is being cut.

He, however, turns to his shelf and hands you a Condensite Celoron Radio Panel, cut and ready to carry home. All this is in a few seconds from the time you enter the store.

This isn't fiction. You can now get Celoron Radio Panels cut in standard sizes. No longer will you have to wait and pay the extra cost for having your panel cut from sheet stock.

Each panel is a separate package, cut, trimmed, and wrapped in glassine paper to protect the surface. On every one are full instructions for working and finishing.

You can obtain from your dealer any of the following sizes:

- | | |
|------------------|-------------------|
| 1.—6 x 7 x 1/8 | 5.—9 x 14 x 3/16 |
| 2.—7 x 9 x 1/8 | 6.—7 x 21 x 3/16 |
| 3.—7 x 12 x 1/8 | 7.—12 x 14 x 3/16 |
| 4.—7 x 18 x 3/16 | *8.—7 x 46 x 3/16 |

*This size for cutting special sizes. Not wrapped in glassine.

While we feature these standard sizes, Celoron comes in full-size sheets and we can supply special sizes if desired.

Condensite Celoron has long been used in connection with electrical and radio work because of its high insulating qualities, high dielectric strength, and low dielectric losses. It is easily worked, machined, drilled and tapped, and will engrave evenly without feathering. It is a laminated phenolic condensation product used by many of the leading manufacturers of radio equipment.

Select the size you need for your set. Should your radio dealer not yet have them in stock, ask him to order for you. Or write direct to us designating by number the size you need.

Send for free booklet

We have prepared an attractive booklet, "Tuning in on a New World," which tells more about Celoron and gives lists of leading broadcasting stations in the United States and Canada, symbols used in reading radio diagrams, and several highly efficient radio hook-ups. This booklet will be of use to every radio fan and will be sent to you free of charge upon your request. Write today.

To radio dealers: Write for special dealer price list showing standard assortments

Diamond State Fibre Company

BRIDGEPORT (near Philadelphia) PENNSYLVANIA

BRANCH FACTORIES AND WAREHOUSES

BOSTON CHICAGO SAN FRANCISCO

Offices in Principal Cities

In Canada: Diamond State Fibre Company of Canada, Limited
245 Carlaw Ave., Toronto

CONDENSITE CELORON

STANDARD RADIO PANEL

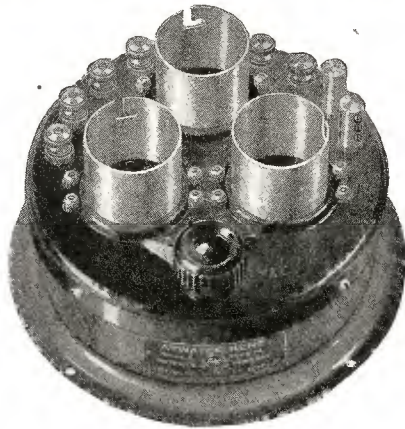

Appearance as a Mark of Quality

The excellent appearance of Condensite molded phenol resin is but one of its many unique advantages

Booklets—

describing phenol resin and its remarkable fitness for Radio apparatus will be sent anywhere upon request.

Its clean sharp lines, smooth glossy surface, and lasting color have made possible the manufacture of complete units, pleasing in appearance, compact in design, and superior in performance.

And then it is a permanent material, one which cannot warp, is non-absorbent, resists high temperatures, does not fade, and it never loses its high dielectric strength. These properties are found in both molded and laminated phenol-resin products—obtainable only under the trade marks, Bakelite—Condensite—Redmanol.

Write for a copy of Booklet B.

BAKELITE CORPORATION

Address the Divisions

Bakelite, Condensite, and Redmanol are the trademark names for the phenolic resin materials manufactured by the several Divisions of the Bakelite Corporation. Each Division maintains a research laboratory which will gladly cooperate with manufacturers in the working out of new applications.

Divisions of
BAKELITE CORPORATION

BAKELITE
General Bakelite Co.
8 West 40th St. New York

Condensite
Condensite Co. of America
Bloomfield, N. J.

REDMANOL
Redmanol Chemical
Products Co.
636-678 West 22nd St.
Chicago, Ill.

The Material of a Thousand Uses

JUNE

The June bride is as popular as ever and the beautiful custom of remembering wedding anniversaries becomes more popular every year.

In making wedding anniversary gifts, our service is very helpful. If you do not know the name of the anniversary just tell us what one—first, second, etc. and we will know what to have presented for you.

No charge for our service.

Amsterdam Service Exchange

Amsterdam
O H I O



is a complete Radio Detector. Clearer tone, greater volume, longer life than other detectors. Adjusted and tested to music. PERMANENT, but can be readjusted. If detector is unsatisfactory on arrival, return for refund.

For Sale at your dealers or we will send one P.P. for a dollar and your dealers name.

Manufacturers of crystal sets,
SPECIAL OFFER

Dealers and Jobbers, write!

TOWNER RADIO MFG. CO.
2620 VICTOR ST., M. KANSAS CITY, MO.

REFERENCE:
Fidelity National Bank & Trust Co., K. C. Mo.

make. Through this scheme passengers become better acquainted, mingle together more freely and so the voyage is made more pleasant for them. More than once the operators have been congratulated by both passengers and officers of the ship for carrying out so novel a plan. By adopting this idea others will likewise profit in more than one way. It is well worth trying.

Let us now take up the matter of printing these press items aboard the freight ship. These slow-moving vessels very often go off on trips lasting months and for this reason the crew would know very little about happenings in their native land, were it not for the wireless. But, does the radio man aboard this type of boat always give the crew these press reports? Generally the wireless operator on this type of ship considers this information of no importance. He is not confronted with the same problems as his friend aboard the passenger-carrying vessel. For one reason he is not compelled to get this data. That is why the cargo ship wireless man very often neglects this work. In this case he soon discovers that he does not profit by taking such a stand. The officers, as well as the remainder of the crew, lose all regard and respect for him. They insult him and the profession, regarding him as one who is useless aboard ship and the profession as being fit for only those who are lazy and shiftless.

Mainly for this reason the wireless operator aboard the freight ship should put forth every effort to see that the crew gets the "news" each day. He should remember that they are civilized, like himself, and anxious to know what is going on ashore. By doing this, the radio man is showing them some respect and they will doubtlessly realize it. It means that he is working for the betterment of the profession—a thought that every wireless operator should have in his mind. The chap who constantly refrains from copying these press reports is injuring the profession and such fellows as these are soon discovered and boosted out of the "game," to make room for someone really worthwhile.

Atlantic Ferry Happenings

NOTES OF THE MONTH
By Q. G. MARCH

The past month has been a boisterous one at sea, and in consequence, distress calls have been frequent. Fortunately no great casualty has been reported, the accidents, generally speaking, being defects in the machinery and of a repairable nature. The manner in which a distress call is circulated from Coast to Coast is well illustrated by a call made from a vessel off the American coast. This was repeated from ship to shore and within a short space of time the whole of the North Atlantic was advised of the happening.

It has been noted that frequently SOS calls are made more for machinery defects than for actual peril to life.

The Ether has not been as free of static as is customary for this time of the year. Several nights "X's" have been troublesome for long distance working, although good conditions have prevailed. The American station at Chatham is creating records for night work for that class of station. Chatham works to ships at sea, and on January last he had another "go" at Transatlantic work, communicating with Bergen, Norway. This outdistances his previous intercommunication with Devizes, England and Lisbon, Portugal. In the same month traffic to and from the White Star liner *Adriatic*, then off Algiers, was cleared by WCC. There is no doubt among seagoing operators that Chatham, Mass., holds the undisputed title of being the premier station

Insure your copy reaching you each month. Subscribe to Radio News—\$2.50
a year. Experimenter Publishing Co., 53 Park Place, N. Y. C.

The Receiver that Satisfies Telmaco Type B-R Receiver

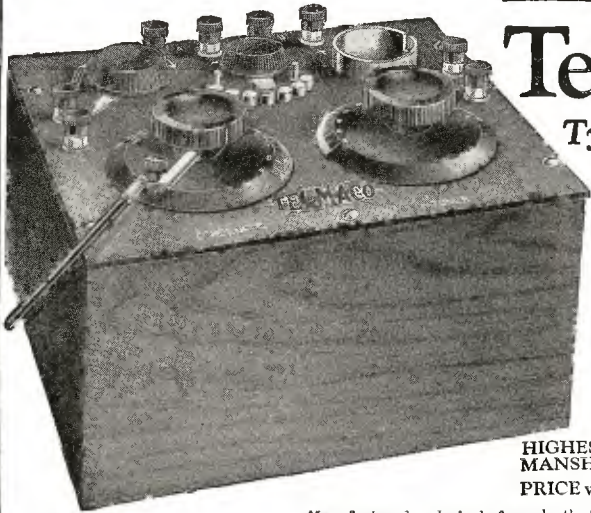

fully meets the requirements of the discriminating purchaser because of the following features:

EFFICIENCY OF OPERATION: Securing volume, distance (1500 miles with single tube is not unusual), selectivity. Broadcasting stations one-half mile distant are tuned out by a slight turn of condenser dial.

EASE OF OPERATION enabling the novice to secure satisfactory results.

HIGHEST QUALITY OF WORKMANSHIP AND MATERIALS.

PRICE within the reach of everybody.

Manufactured exclusively for us by the Tri-City Radio Electric Supply Co., licensed under Armstrong U. S. Patent No. 1113149, October 6th, 1914.

Specifications:

Panel—Formica, grained and machine engraved. **Vario-Coupler**—Telmaco special silk wound with loading inductance. **Condenser**—Special 13-plate with Bakelite ends. **Rheostat**—Single knob control. **Socket**—Highly nicked shell, Bakelite base. **Dials**—are polished, presenting pleasing contrast with dull panel. **Telmaco Adjustable Vernier Handle**—secures extremely fine tuning and entirely eliminates body capacity effects. **Workmanship**—manufactured according to Telmaco's rigid specifications. **This Guarantees Your Satisfaction.** Either 6 volt or 1½ volt tube may be used.

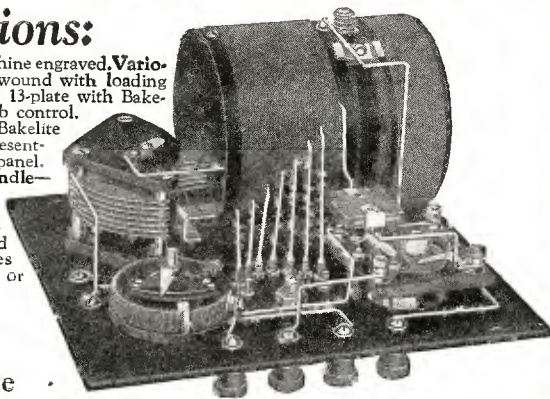

TELMACO Type B-A Two Stage A. F. Amplifier

Matches the above in size and construction. The greatest Amplifier value on the market. Price \$20.00.

RADIO DIVISION

TELEPHONE MAINTENANCE CO.
20 S. Wells Street, Dept. B Chicago, Illinois

Price \$25

The ultimate in value



Quality Radio Exclusively

Bona Fide Jobbers

If our salesmen have not reached you with our proposition, write or wire for it today

LEARN THE CODE AT HOME

"Just Listen—The Omnigraph will do the teaching"

with the

OMNIGRAPH

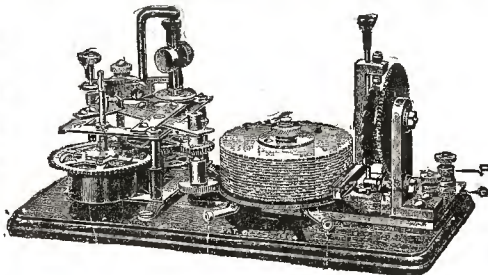

THE **OMNIGRAPH** Automatic Transmitter will teach you both the Wireless and Morse Codes—right in your own home—quickly, easily and inexpensively. Connected with Buzzer, Buzzer and Phone or to Sounder, it will send you unlimited messages, at any speed, from 5 to 50 words a minute.

THE **OMNIGRAPH** is not an experiment. For more than 15 years, it has been sold all over the world with a money back guarantee. The **OMNIGRAPH** is used by several Depts. of the U. S. Govt.

—in fact, the Dept. of Commerce uses the **OMNIGRAPH** to test all applicants applying for a Radio license. The **OMNIGRAPH** has been successfully adopted by the leading Universities, Colleges and Radio Schools.

Send for **FREE** Catalog describing three models, \$14 to \$30. **DO IT TODAY.**

The Omnigraph Mfg. Co., 20 Hudson St., New York City

If you own a Radio Phone set and don't know the code—you are missing most of the fun

engaged in shore to ship work. Louis-berg, N. S., is a good second, but appears to get more interference than Chatham experiences.

The wireless phone aboard the steamship *America* has once again proved its utility. The S.S. *Algonquin*, nearby, desired immediate medical advice for an injured sailor. This was furnished verbally by Dr. Woods of the *America*. Dr. Woods is getting quite a reputation for his radio prescriptions to vessels that are without a medical officer aboard.

The big *Berengaria* has had her arc transmitter replaced by a valve transmitter for long-wave work, and will shortly have a Siemens quenched gap installation for 600 meter work.

By the bye, operators who desire to give service by delivering a variety of useful weather reports should listen for **NANTES—UA**—at 12:30 P. M. G.M.T. This station using a wave of 2,800 meters sends a concise report of the weather conditions—barometric pressures and forecasts for the whole of the North Atlantic from America to Europe. The report is in French, but does not present any very great difficulties in the way of translation. Nantes uses spark and has a good range.

The French steamship *Jacques Cartier*, when on the North Atlantic lane may be relied upon for an embracing weather report of the conditions in the North Atlantic on 600 meters sent about noon and midnight. This vessel, FTJ, is designated the "Ocean Branch of the French Meteo Service," and also carries an observer of the U. S. Hydrographic Bureau. The *Jacques Cartier* keeps in touch with Bar Harbor and France by continuous wave, and is thereby kept fully advised in regard to weather conditions.

How many operators listen for UA at 9 P. M. G.M.T.? That station broadcasts traffic at that time, using spark on 2,800 meters. And don't forget that, if you do happen to get one for your vessel, in this particular case your ship tax has to be collected from the unfortunate addressee! So be tactful!

Norddeich, Germany, KAV, has quite a good C.W. installation now. He may be heard in daylight when south of Cape Race on 2,400 meters.

Easthampton, WSA, is doing wonders as regards distances to the south of him on 600- and 450-meter spark and is unequalled by any other coast station for working in that direction. The other night he worked the steamship *Pan-America*, then off Rio. We hear he has worked the Lampont and Holt *Vandyck* even farther south. You've some "Cigar Box" WSA—what's in it?

The Radio Corporation station, situated in New York, WNY, is now trying out interrupted C.W. on 600 meters. He will also work pure C.W. on this wave, if requested to do so.

The British Post Office station at Devizes is now transmitting calibration waves during the day and night on 2,100 meters. This is to enable vessels to tune each other to the standard wave. A good idea, but hardly practicable. What about the time when we do all get that 2,100-meter wave exactly? Will we not interfere with one another terribly and lose the advantage of being able to utilize the slight differences in wavelength in the elimination of interference? After all, it surely isn't difficult for an operator awaiting a call to "search around with his tuning devices."

S.S. MAJESTIC HAS HIGH SPEED TRANSMITTER AND RECEIVER

On the last voyage of the White Star Liner *Majestic*, the world's greatest steamship, radio messages were exchanged with shore stations of Radio Corporation of America at speeds of over 80 words per minute when the vessel was 1,000 miles at

WORKRITE

NEW SUPER VERNIER RHEOSTAT

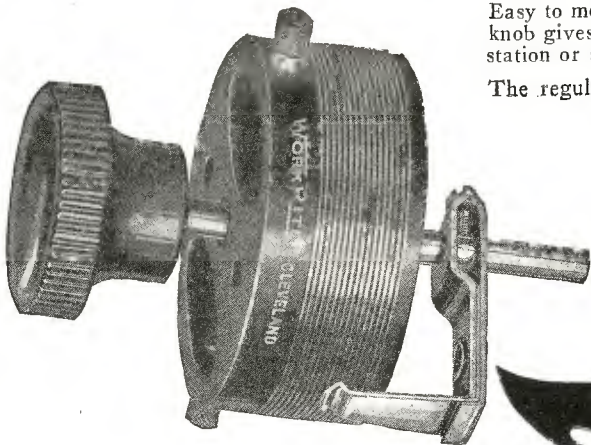

Here is an instrument that is the last word in Rheostats. 50,000 adjustments for \$1.00. The drum is moulded and cannot shrink. No danger of the wires loosening. Easy to mount on panel. Pushing the knob way in turns off filament. Turning the knob gives the very finest adjustment. Often a turn of 1/32 inch will clear up a station or separate two stations.

The regular Rheostat has 6 ohms resistance. We furnish this Rheostat with 12 ohms resistance if you require it at a price of \$1.10. For the 201A tubes 6 to 12 ohms resistance is necessary to get best results.

A WorkRite Super Vernier Rheostat on your Detector Tube will double the efficiency of your set. Try it and see. Put a WorkRite Rheostat on each of your tubes and get perfect adjustments.

WorkRite New Super Vernier Rheostat
(With 12 ohm resistance \$1.10)

\$1.00

WorkRite Tuner Team

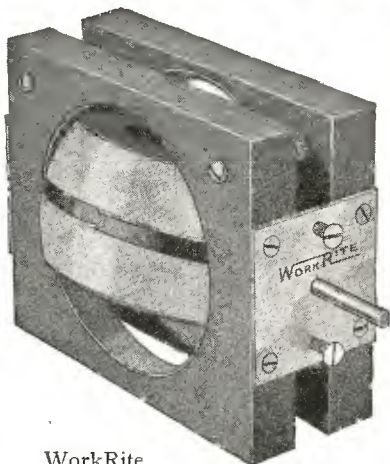

WorkRite Super Variometer

Tunes Out Local Stations and Gets the Station You Want

Two WorkRite Variometers and one WorkRite Variocoupler make up the Famous WorkRite Tuner Team about which the whole country is talking. No difficulty to separate stations and bring in the one you want clear and loud. The coupler is made from moulded Bakelite and wound with green silk. The Variometer is made from polished Mahogany; has a range of 200 to 760 meters. Make up a set with WorkRite parts and see what a real set is like.

WorkRite Super Variometer each **\$3.50**
WorkRite 180° Super Variocoupler each

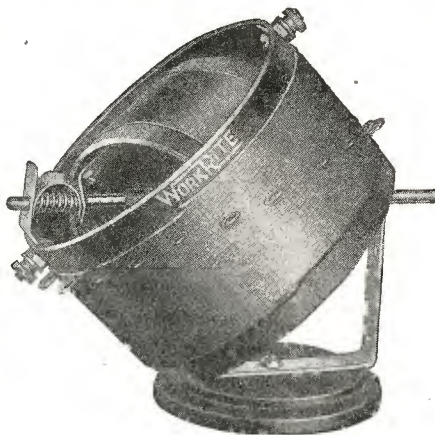

WorkRite 180° Super Variocoupler

Read What One WorkRite Radio Fan Writes

Dayton, Ohio, Mar. 12, 1923.

Last August I assembled a radio set using your WorkRite Parts, employing your hookup. With this outfit I have heard voices from every State in the Union with the exception of Nevada and Mississippi, from each border province of Canada, from Cuba, from Porto Rico, and upon three occasions from Hawaii. Pacific Coast stations come in nightly; I have heard 28 of them, etc.

RALPH C. McSHERRY, 114 N. Western Ave.

Other WorkRite Radio Products

| | | | |
|------------------------------|---------|--------------------------------|--------|
| WorkRite E-Z-Tune Dial | 75c | WorkRite Concert Headset | \$6.00 |
| WorkRite Concertola Jr. | \$12.00 | WorkRite Switch Sets | 50c |
| WorkRite Concertola Sr. | \$24.00 | WorkRite Hydrometers | 75c |

WorkRite Radio Parts WorkRite

THE WORKRITE MANUFACTURING CO.

5511 EUCLID AVENUE

CLEVELAND, OHIO

Branch Office, 2204 Michigan Ave., Chicago

When you Amplify— Simplify!

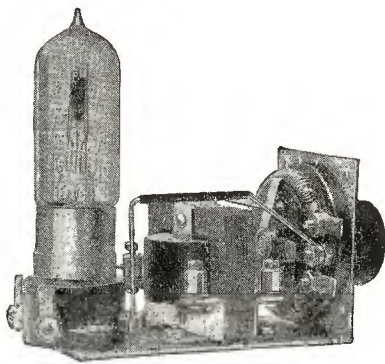

Put a General Radio Type 300 Amplifier Unit along side your detector set. Works equally well with crystal or tube detectors. Can be used for either table or panel mounting. No storage battery required. A compact unit, wired ready for external connections. Two or more units may be used together to obtain multi-stage amplification.

Type 300-A Amplifier Unit for WD-11 Tube is built around our 231-A amplifying transformer. Mounted on a nickel finish brass bracket. Price...\$7.50
Type 300-B Amplifier Unit, for use with standard 6 volt Tubes. Price..\$8.00

Ask for Bulletin 914Q.

General Radio type 231-A Amplifying Transformer gives the maximum amplification possible without distortion.

Faint signals, high-pitched and low-pitched notes alike, are delivered undistorted to the grid of the Amplifying tube. "Howling" in the audio frequency circuit is never caused by a Type 231-A. Design, material and construction are in keeping with the General Radio Company's standard—a standard established by eight years of designing and building the highest grade of laboratory radio apparatus for leading Universities and Technical Schools.

Every General Radio Amplifying Transformer is guaranteed and will be replaced if winding defects ever develop. Send for Bulletin 912N.

GENERAL RADIO CO.

Manufacturers of

Radio and Electrical Laboratory Apparatus

Massachusetts Avenue and Windsor St.
Cambridge 39 Massachusetts

Standardize on General Radio Equipment Throughout

STANDARD APPARATUS

At Attractive Prices. Read This Column Carefully. It Will Pay You Complete Parts to Build Your Own Tube Set, \$15.00

- | | | |
|-----------------------|------------------------------|----------------------------------|
| Shamrock Variocoupler | Socket | Switch Lever and Switch Points |
| 3 inch dial | Grid Leak and Grid Condenser | 23 Plate Variable Condenser |
| 7 x 12 Bakelite Panel | Rubber Binding Posts | (Made by John Firth) |
| Klosner Rheostat | 12 feet Buss Bar Wire | Complete book of latest circuits |

A GUARANTEED 1 1-2 Volt TUBE FREE with Above Parts

CABINETS These are carefully constructed of genuine mahogany, hand rubbed. The tops are hinged for easy access to interior. They are made to fit your parlor. 7x10—\$3.35 7x12—\$3.50 7x14—\$3.75 7x18—\$4.00 7x24—\$4.50.

PHONES N. & K., German manufacture, 6000 ohms Resistance. Nowhere at any price can you equal the supreme sensitiveness of these phones and we stand ready to demonstrate this claim to your satisfaction. **\$5.75**

HEAD SETS

| List Price | Our Price |
|------------------------------|-----------|
| \$8.00 Brandes Superior | \$5.50 |
| 8.00 Dictograph | 5.75 |
| 8.00 Federal 2200 Ohms | 4.95 |
| 7.50 Stromberg Carlson | 4.75 |
| 6.00 Frost 3000 Ohms | 4.25 |
| 6.00 Royalphone | 3.75 |
| 5.50 Murdock Type 57 | 4.10 |
| 12.00 Western Electric 509W | 9.50 |
| 12.00 Baldwin Type C, Master | 8.50 |
| 6.00 Baldwin Type C, Single | 4.00 |

LOUD SPEAKERS

| | |
|---------------------------|----------|
| \$161.00 Western Electric | \$145.00 |
| 55.00 Western Electric | 50.00 |
| 45.00 Magnavox (New Type) | 31.50 |
| 40.00 Callophone | 30.00 |
| 20.00 Dictograph | 15.00 |
| 15.00 Britannia | 12.50 |

AUDIO TRANSFORMERS

| List Price | Our Price |
|----------------------------|-----------|
| \$7.00 Federal | \$5.60 |
| 6.50 Radio Corp. U. V. 712 | 5.60 |
| 6.50 Rasta | 5.10 |
| 4.50 Thordarson | 3.00 |
| 6.00 Amplex W. D. 12 | 3.95 |
| 5.00 General Radio | 4.35 |
| 6.00 Jefferson | 5.00 |
| 7.00 Amertram | 5.95 |
| 5.00 Acme | 4.10 |

PANELS

| BAKELITE—3/16 inch Stock | |
|--------------------------|--------|
| 7 x 10 | \$1.35 |
| 7 x 12 | 1.45 |
| 7 x 14 | 1.85 |
| 7 x 18 | 2.50 |
| 7 x 24 | 2.95 |
| HARD RUBBER—Grade A | |
| 7 x 10 | \$0.90 |
| 7 x 15 | 1.35 |
| 7 x 18 | \$1.45 |
| 7 x 24 | 1.90 |

MISCELLANEOUS SPECIALS

| | | | | | |
|--------------------------|--------|--------------------------|--------|--------------------|--------|
| Firth 23 Plate Condenser | \$1.30 | Firth Crystal Detectors | \$1.00 | 180° Variocoupler | \$2.79 |
| Firth Triple Sockets | .90 | Firth Lightning Arrestor | 1.25 | Variometers | 2.75 |
| Firth Double Sockets | .70 | Buildog Phone Plugs | 1.00 | Vernier Rheostats | 1.35 |
| Millard Rheostats | .45 | Three Coil Mountings | 3.50 | 11 Plate Condenser | 1.35 |
| Double Phone Cords | .60 | Two Coil Mountings | 2.75 | 43 Plate Condenser | 2.15 |
| Fada Type Switch Levers | .23 | Single Coil Mountings | .50 | W D 11 Sockets | .30 |

Full Line of ALL STANDARD SETS and ACCESSORIES at Greatly Reduced Prices.

Write for Our Quotations.

All Mail Orders Shipped on same day as received. Send Money Order including Postage.

STUYVESANT RADIO CORPORATION

15 East 14th Street, between 5th Avenue and Union Square, New York City

sea. Ordinarily speeds in excess of about 25 words per minute cannot be attained by hand sending and in order to meet the demands of increasing radiogram traffic created by the large passenger liners, machine sending must be used in which case a given message can be sent and received in one-third the time required by manual methods.

The earlier experiments aboard the *Majestic* permitted only one way high speed transmission, namely, from ship to shore, there being no apparatus on board the vessel capable of receiving high speed transmission. In order to effect *two-way* high speed telegraphic service on the vessel during its last voyage to New York, it was equipped by the Marconi Company with a high speed receiver which worked most satisfactorily. High speed signals were also received from "Paris" at a distance of eight hundred (800) miles at a speed of 80 words per minute. Wireless press was completely and perfectly recorded by the automatic receiver through medium static from the station of the R. C. A. at Chatham, Mass. At the same time that this automatic high speed reception was carried out it was possible for the operator on watch to listen in on the ordinary ship's wave-length for general "ship to ship" wireless.

Not only does the use of automatic high speed receiving and sending apparatus enable operators to handle more traffic in less time and thereby provide freedom of the ether for other vessels to operate their radio sets but in addition secrecy of communication is maintained, owing to the great rapidity with which the dots and dashes are transmitted. It is difficult for the average operator to copy over 30 words per minute for any length of time, consequently when working at double speed the telegraph characters follow in such rapid succession that they cannot be deciphered.

While the tests so far made by the Marconi International Marine Communication Co. and the Radio Corporation of America have proved highly successful, the principal benefits will be derived from this new apparatus when installed on all vessels of the larger type and which handle great volumes of traffic.

What Radio Is Doing for the Blind

(Continued from page 2082)

whirring sounds, to designate a certain city or sending station the moment the sound is heard.

The writer knows a number of the announcers by their voices, just as he recognizes the voice of a friend who greets him.

It is easy for the blind to distinguish records from real orchestras or other selections.

On a few occasions the writer has heard a watch ticking in the hands of an announcer who was giving the time as he signed off. It was easy to tell that the announcer took out his watch and lowered his head as he looked to see the time.

It is possible for the writer to listen in and make a very accurate forecast of the weather before the regular Government forecast is given, as high and low barometric conditions seem to leave an impression on the elements that bring in the matter being broadcast, and from the way the set receives, it is often possible to accurately foretell the changes in the weather.

A BATH BY RADIO

Bathing by radio is one of the last broadcasts from the Public Health Service, but whether *ether waves* were recommended was not made known.



Federal

Is A Large User of Formica

THE Federal Telephone and Telegraph Company of Buffalo is a large factor in the radio industry and has an excellent reputation for the quality of its product.

It is a very extensive user of Formica insulation not only in the complete sets which it produces but in the radio parts, variometers, variocouplers, head sets of which it is a large manufacturer.

A list of users of Formica reads like a directory of the leading independent radio manufacturers. So many of the best informed radio men in America cannot be mistaken in their opinion that Formica is most uniform, the best looking, and the most efficient radio insulation.

Dealers and amateurs can safely follow these great concerns in selling or using Formica.

Formica dealers can supply you promptly with panels in all standard sizes. They can also supply special sizes when you want them.

THE FORMICA INSULATION COMPANY
4618 Spring Grove Ave.,
CINCINNATI, O.

SALES OFFICES

50 Church St., New York, N. Y.
422 First Avenue, Pittsburgh, Pa.
1042 Granite Bldg., Rochester, N. Y.
415 Ohio Bldg., Toledo, Ohio

1210 Arch St., Philadelphia, Pa.
1819 Lyndale Ave., South, Minneapolis, Minn.
Sheldon Bldg., San Francisco, Calif.
Whitney Central Bldg., New Orleans

414 Finance Bldg., Cleveland, Ohio
9 S. Clinton St., Chicago, Ill.
313 Title Bldg., Baltimore, Md.
47 King St., Toronto, Ontario

FORMICA

Made from Anhydrous Redmanol Resins
SHEETS TUBES RODS

Are Your B Batteries Depleted?



**SEND TODAY
For Booklet J.**

It gives full information on Weston Voltmeters, Ammeters, Milliameters, Thermo-Ammeters and Thermo Galvanometers for amateur, advanced experimenter or commercial station.

B Battery depletion is often the answer to the question:

"What's wrong with my reception?"

A Weston Filament Voltmeter is the only positive source of information that a B Battery is so depleted it should be discarded.

Also needed to prolong tube life. Indicates under-voltage which causes tungsten filaments to become brittle and break. Shows over-voltage which shortens tube life—often causing premature burnouts. Permits rapid duplication of results.

The Weston is the "lifetime" Voltmeter with high resistance and absolute dependability.

WESTON ELECTRICAL INSTRUMENT COMPANY
173 Weston Avenue :: :: Newark, N. J.
Electrical Indicating Instrument Authorities since 1888

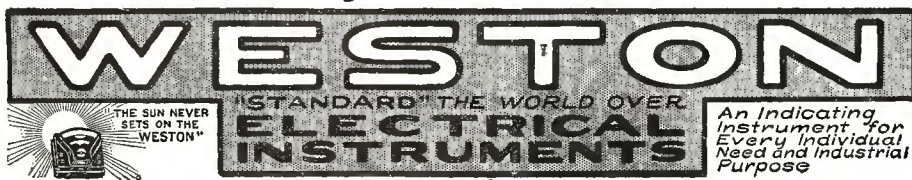

Red Seal Sparker
—steel clad—
for every outing



This summer let the Red Seal Sparker—steel clad—supply dependable power for your outing needs. A fat, full spark for your motor-boat ignition—a quick, sure start for your car—lighting up your camp lantern—Red Seal is always on the job, long lived, efficient.

For tractors, stationary engines, and so forth, farmers, also find Sparkers—steel clad—stand all kinds of hard knocks.

The Red Seal Sparker—steel clad—is made in three sizes: 4 cells, 6 v.; 5 cells, 7½ v.; 6 cells, 9 v. Be sure to ask for it by name—Red Seal Sparker—steel clad.

MANHATTAN
ELECTRICAL SUPPLY CO., INC.
NEW YORK CHICAGO ST. LOUIS SAN FRANCISCO

RADIO CATALOG
FREE TO EVERYONE
Although we would appreciate 10c in stamps to pay printing and mailing.
ERNEST ELECTRIC CO.
4847 Easton Ave.,
ST. LOUIS, MO.

— FREE —
A book on how to get "Better Results from Radio"—Write to Willard Storage Battery Company, 281 East 131st St., Cleveland, Ohio
Willard

STATEMENT

Of the Ownership, Management, Circulation, Etc., Required by the Act of Congress of August 24, 1912, of Radio News published monthly at Jamaica, L. I., N. Y., for April 1, 1923.
State of New York }
County of Queens } ss.

Before me, a notary public in and for the State and county aforesaid, personally appeared Hugo Gernsback, who, having been duly sworn according to law, deposes and says that he is the Editor of Radio News, and that the following is, to the best of his knowledge and belief, a true statement of the ownership, management (and if a daily paper, the circulation), etc., of the aforesaid publication for the date shown in the above caption, required by the Act of August 24, 1912, embodied in section 443, Postal Laws and Regulations, printed on the reverse of this form, to wit:

1. That the names and addresses of the publisher, editor, managing editor, and business managers are: Publisher, The Experimenter Publishing Co., Inc., 53 Park Place, New York, N. Y.; Editor, Hugo Gernsback, 53 Park Place, New York, N. Y.; Managing Editor, Robert E. Lacault, 53 Park Place, New York, N. Y.; Business Manager, R. W. DeMott, 53 Park Place, New York, N. Y.

2. That the owners are: (Give names and addresses of individual owners, or, if a corporation, give its name and the names and addresses of stockholders owning or holding 1 per cent or more of the total amount of stock.) The Experimenter Publishing Co., Inc., 53 Park Place, New York, N. Y.; Hugo Gernsback, 53 Park Place, New York, N. Y.; Sidney Gernsback, 53 Park Place, New York, N. Y.; R. W. DeMott, 53 Park Place, New York, N. Y.; H. W. Secor, 53 Park Place, New York, N. Y.; Dr. T. O'Connor Sloane, 53 Park Place, New York, N. Y.; Mrs. Catherine Major, 53 Park Place, New York, N. Y.; and M. M. Finucan, 720 Cass St., Chicago, Ill.

3. That the known bondholders, mortgagees, and other security holders owning or holding 1 per cent or more of total amount of bonds, mortgages, or other securities are: (If there are none, so state.) None.

4. That the two paragraphs next above, giving the names of the owners, stockholders, and security holders, if any, contain not only the list of stockholders and security holders as they appear upon the books of the company but also, in cases where the stockholder or security holder appears upon the books of the company as trustee or in any other fiduciary relation, the name of the person or corporation for whom such trustee is acting, is given; also that the said two paragraphs contain statements embracing affiant's full knowledge and belief as to the circumstances and conditions under which stockholders and security holders who do not appear upon the books of the company as trustees, hold stock and securities in a capacity other than that of a bona fide owner; and this affiant has no reason to believe that any other person, association, or corporation has any interest direct or indirect in the said stock, bonds, or other securities than as so stated by him.

5. That the average number of copies of each issue of this publication sold or distributed, through the mails or otherwise, to paid subscribers during the six months preceding the date shown above is (This information is required from daily publications only.)

H. GERNSBACK, Editor.

Sworn to and subscribed before me this 24th day of March, 1923.

(SEAL) JOSEPH H. KRAUS.

Notary Public, Queens County Register's No. 2951; New York County Register's No. 3337; New York County Clerk's No. 439. (My commission expires Mar. 30, 1923.)

I Want to Know

(Continued from page 2118)

"E" tubes, in the super-regenerative set described on page 620 of the October issue of RADIO NEWS.

A. 1. These tubes may be used satisfactorily in the circuit you mention without any other change of the values in the set.

THE RORN CIRCUIT

(695) Mr. E. F. Goodwin, St. Paul, Mich., requests:

Q. 1. Please publish the correct hook-up of the RORN tuned radio frequency amplifier, showing also how to connect it to a CR 9 receiver.

A. 1. This hook-up will be found in these columns. This amplifier is supplied with a number of output coils, so that it can be used efficiently up to 3000 meters. This output coil is placed in inductive relation to the tuner in the receiving set.

SUPER-HETERODYNE QUERIES

(696) Mr. J. C. Lawler, Denver, Colo., inquires:

Q. 1. Do you consider the resistance coupled super-heterodyne receiver, shown on page 1664 of the March issue, better for receiving long-distance broadcasting than transformer coupled?

A. 1. This receiver can be used with R. F. transformers, instead of resistances, with a decided increase in amplification. Less tubes may be used to obtain the same results. In this case, the transformers should be designed to work efficiently between 2500 and 5500 meters.

Largest Radio Store in America

RADIO BARGAINS

Largest Radio Store in America

Buying Direct—in Quantities—for Cash, and operating on a "Small Profit—Big Sale—Quick Turn" basis Makes Possible These Values
Radio Supplies Purchased Here are Sold Under a Positive Guarantee of Satisfaction. We Carry the Largest New Stock of First Quality New Merchandise.

COMPLETE PARTS FOR ULTRA AUDION CIRCUIT, \$11.90 (Known as the Wonder Circuit)

| Consisting of: | Reg. Price | Our Price |
|--|------------|-----------|
| 9x10 1/2 Formica Panel | \$1.42 | \$1.20 |
| 23-Plate Condenser | 3.30 | 1.45 |
| Bakelite Socket (Remler) | 1.00 | .45 |
| Special Ultra Audion Coil, plain or bank wound with tape | 3.00 | 1.95 |
| 1 Howard Vernier Rheostat | 1.50 | 1.35 |
| GRL Grid Leak | 1.50 | .95 |
| .0005 Micon Condenser | .35 | .25 |
| 2 Switch Levers | .70 | .50 |
| 18 Switch Points | .50 | .30 |
| 2 Switch Stops | .10 | .05 |
| 8 Binding Posts | .80 | .40 |
| Genuine Solid Mahogany Cabinet, size 9x10 1/2, with hinged top | 5.00 | 2.95 |
| 25-ft. Hookup Wire | .20 | .10 |
| Regular Price | \$19.37 | |

Each order includes complete instructions for drilling, assembling and wiring. These construction plans are not drawn in a schematic form but are drawn so that any one without any technical knowledge can follow with ease. Our price **\$11.90**

Freund's Wonder Circuit \$13.20

KHG, KFI and KYY received from Chicago on one tube

| Consisting of: | Reg. Price | Our Price |
|---|------------|-----------|
| 9x10 1/2 Formica Panel | \$1.42 | \$1.20 |
| 9x10 1/2 Genuine Solid Mahogany Cabinet with hinged top | 5.00 | 2.95 |
| Bakelite Dial | .75 | .25 |
| Variometer | 5.00 | 1.95 |
| 43-Plate Vernier Condenser | 7.00 | 3.45 |
| Remler Bakelite Socket | 1.00 | .45 |
| 8 Binding Posts | .80 | .40 |
| GRL Variable Grid Leak | 1.50 | .95 |
| .0005 Micon Condenser | .35 | .25 |
| Howard Vernier Rheostat | 1.50 | 1.35 |
| Regular Price | \$24.32 | |

Complete instruction for drilling, assembling and wiring furnished with each order. Written so that any one without any technical knowledge can understand. Our Price **\$13.20**

\$10.00 Value Long Range Headpost \$3.60

Switch Levers 20c
Double Phonograph Adapters \$1.35
Head Bands .50c
Phone and Grid Condensers at 10c
Ground Wire, foot 1c
500 Ohm Potentiometers . . \$1.45

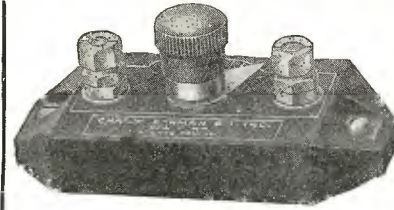

Freshman Variable Grid Leak and Condenser, \$1.00 value **65c**

Cabinets
6x7 3/4 by 6 inches deep \$1.95
6x14 by 6 inches deep \$2.45
6x16 1/2 by 6 inches deep \$2.95
6x22 by 6 inches deep \$2.95
9x12 by 6 inches deep \$3.95
9x10 1/2 by 6 inches deep \$2.95

U.S.A. SIGNAL CORPS, Aviation Type 194-W WESTERN ELECTRIC PHONES, \$7.95
Each Phone Cap is covered with large soft rubber ear cushions, and an aviation leather helmet goes with each set! These are the only phones to pass the Government specifications for sensitiveness and loudness, the requirements called for in aircraft reception.

SIGNAL CORPS SUPER SENSITIVE MICROPHONE TRANSMITTERS, \$2.45
THORDARSON AMPLIFYING TRANSFORMERS, \$4.50 Value, NOW \$2.95

Complete Parts for Single Tube Reflex Circuit \$32.65

| Consisting of: | Reg. Price | Our Price |
|---|------------|-----------|
| 43-Plate Vernier Variable Condenser | \$7.00 | \$3.95 |
| Radion Loop Aerial | 7.00 | 5.95 |
| Cunningham C301-A Tube | 9.00 | 5.95 |
| Grewel Glass Enclosed Oetector | 2.00 | 1.65 |
| All American Radio Frequency Transformer | 4.50 | 3.45 |
| All American 5 to 1 Radio Audio Frequency Transformer | 4.75 | 3.95 |
| 2-.001 Micon Condensers | .70 | .50 |
| 1-.002 Micon Condenser | .45 | .35 |

| Consisting of: | Reg. Price | Our Price |
|---|------------|-----------|
| Howard Potentiometer | \$1.50 | \$1.35 |
| Howard 25 Ohm Rheostat | 1.10 | 1.00 |
| 8 Binding Posts | .80 | .40 |
| 9x10 1/2 Formica Panel | 1.42 | 1.20 |
| 9x10 1/2 Genuine Solid Mahogany Cabinet with hinged top | 5.00 | 2.95 |
| Complete instructions for drilling, assembling and wiring furnished so that any one with no technical knowledge can easily follow. Regular price, \$45.22. Our Price \$32.65 | | |

COMPLETE PARTS FOR REINARTZ CIRCUIT

Includes 7x18 Formica Panel, 1 Bakelite Socket, 1 Howard Vernier Rheostat, 23 Plate Condenser, 11 Plate Condenser, 3 Switch Levers, 2 Ozen Switch Points, 1 Reinartz Wound Coil, 1 Variable Grid Leak, 8 Binding Posts, 25 Feet Tinned Wire, 1 Base for Coil, 1 Mounting Baseboard and 1 Diagram to construct this set complete. **\$11.45**

COMPLETE KROCKED-DOWN RECEIVING SETS

This includes 2 Mahogany Variometers, 1 Coupler, 3 Dials, 1 Howard Rheostat, 1 Bakelite Socket, 1 Mahogany Cabinet, 7x18 Formica Panel, 6 Binding Posts, 1 Switch, Switch Points, 2 Stops and 1 Diagram to construct this set. Set is capable of receiving 1,000 miles if installed with outdoor aerial; priced for tomorrow **\$13.45**

ORIGINAL BALDWIN PHONES

These are the Genuine Nathaniel Baldwin "Mica Diaphragm" Phones, complete with silk cord and headband. Special at. \$9.95
Genuine Baldwin "Mica Diaphragm" Type "C" Loud Speaking Units—Special. \$4.65

VARIABLE CONDENSERS

| | |
|--------------------------------|--------|
| 7x10 value, 43 Plate Vernier | \$3.95 |
| \$6.50 value, 23 Plate Vernier | 3.45 |
| \$6.00 value, 11 Plate Vernier | 2.95 |
| \$1.75 value, 3 Plate Vernier | 1.15 |
| \$4.30 value, 43 Plate now | 1.75 |
| \$3.70 value, 23 Plate now | 1.45 |
| \$3.30 value, 11 Plate now | 1.35 |
| \$2.25 value, 5 Plate now | 1.25 |

RHEOSTATS

| | |
|-----------------------|--------|
| Framingham | .35c |
| Klossner Vernier | .85c |
| Oe Forest | .85c |
| Remler | .45c |
| Cutler-Hammer Vernier | \$1.35 |

VARIOMETERS

| | |
|----------------------------------|--------|
| Diamond Lattice | \$2.95 |
| Moulded | \$3.65 |
| \$5.00 value Mahogany Variometer | \$1.95 |

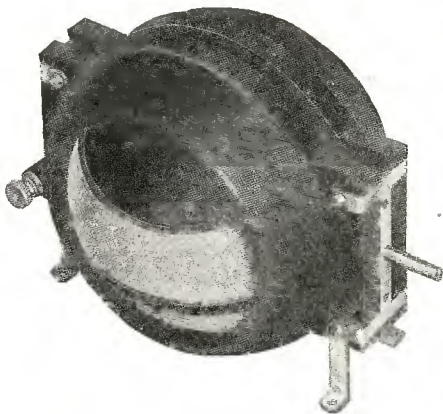

Complete Parts for Flewelling Circuit

Consisting of 6x14 Panel, 23 Plate Condenser and Dial, Socket, Howard Vernier Rheostat, 2 Coil Mount, 2 Honeycomb Coils, 2 Coil Plugs, 3 Micon .006 Condensers, Freshman Variable Grid Leak and Con., Remler Grid Leak, 8 Binding Posts, Baseboard for mounting and instructions to construct and wire this set **\$12.45**

Complete Parts for 2-Step Amplifier

Consisting of two Thordarson Transformers, high and low ratio; two Howard Rheostats, 2 Bakelite Sockets, 2 Double Circuit Jacks, 1 Single Circuit Jack, 12 highly polished Nickel or Bakelite Topped Binding Posts, 1-7x10 Formica Panel, 1 Baseboard for mounting and complete instructions to assemble and wire this set; priced at **\$12.45**



Master Baldwin Phones

Type "C" with Head Band and Cord.

\$6.95

Type "C" Unit, **\$3.95**

Jacks

Patent Single Circuit 35c
Patent Double Circuit 50c
Federal Single Circuit Filament Control . . 35c
Federal Double Circuit Filament Control . . 50c
Capt. Schonhoven Reinartz Coils . . \$1.95
King Amplitone Loud Speakers 4.95
Connecticut Amplifying Units 7.45

Honeycomb Coils

| | |
|---|--------|
| 1,500 Turns, Coto-Coils | \$1.50 |
| 1,250 Turns, Coto-Coils | 1.50 |
| 1,000 Turns | 1.25 |
| 750 Turns | 1.00 |
| 250 Turns, Coto-Coil | .75 |
| 150 Turns | .60 |
| 100 Turns | .50 |
| 75 Turns | .40 |
| 50 Turns | .40 |
| 35 and 25 Turns | .40 |
| Rubber Spaghetti Tubing, yd. | .10 |
| Antenna—Use Electric Light Socket for aerial | 1.15 |
| 22 1/2-Volt B Batteries (stock replenished every day) | 1.65 |
| Dials—2, 3 and 3 1/2 inch | .25 |
| Ultra-Audion Bank Wound Coils | 1.95 |
| Grewel Oetectors | 1.45 |

Variocouplers



180 degree Coupling \$1.75
90 degree Coupling \$1.95

Moulded Couplers, 180 degrees, at \$3.45

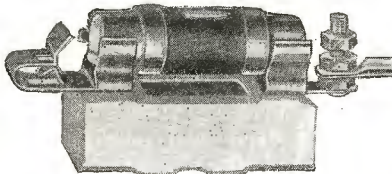

Brach's Lightning Arrester 95c

Approved by underwriters; fully protects your home from danger of injury by lightning.

Magnavox
Type R-3 New Style **\$27.45**

Formica Panel BLACK OR BROWN 1/2 Inch Thick Square Inch 1 1/2c

| | | | |
|---|---|--|---|
| Double Phone Cords, at 50c. | Solid Copper Wire, 100 feet 35c. | Aerial Battery Clips 10c. | Mueller Universal \$2.65 |
| Spaghetti Tubing, Phone Caps, for mostly all phones 25c. | priced at, yard 10c. | 3-Coil Honeycomb Mountings, with knobs, at \$3.95 | Lightning Switches, \$2.65 |
| Composition Binding Posts 5c. | Potentiometers 95c. | Crystal Detectors 25c. | Sterling Silver Cat Whiskers at 10c. |

We Guarantee All Merchandise Purchased of Us
Mail Orders Receive Immediate Attention

CHICAGO SALVAGE STOCK STORE

509 SOUTH STATE ST.

Dep't RN.

CHICAGO, ILL.

Here's a Pair of Winners

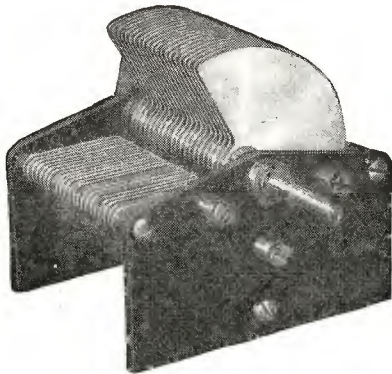

The Wimco Condenser

Made to meet a demand for quality—highest efficiency, 3 plate, 23 plate and 43 plate sizes.



The Carco Coupler

Just the thing for the popular receiving set. Bakelite tube, and rotor, silk covered wire, perfect contacts.

We invite Dealer and Jobber inquiries.

Send for literature and prices on Wimco Socket for WD11 tube.

THE WIRELESS MFG. CO., CANTON, OHIO
 MANUFACTURERS DISTRIBUTORS

New "United" Vernier Dial Assembly

More Power and Far Greater Selectivity

Large capacity, due to the large area of the mica-insulated copper vernier plates.
 Great Fineness of tuning, due to the delicate screw thread adjustment of Vernier.
 Short-circuiting rendered practically impossible. Note that the opposing circuits are located in the Knob and Dial—a new and better way.

DIAL ASSEMBLY

This new United Vernier Dial Assembly can be attached to any plate condenser, it being necessary to drill only one hole.

Price, Postpaid\$2.50

UNITED VARIABLE CONDENSERS WITH NEW TYPE VERNIER DIAL ASSEMBLY

43 plate \$6.50 23 plate \$6.00 11 plate \$5.50
 5 plate \$5.00 3 plate \$4.75

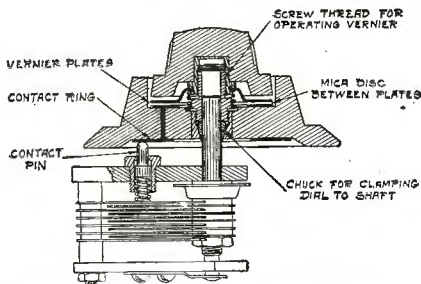

"UNITED" AMPLIFYING TRANSFORMER

Audio Frequency, magnetically shielded. Fine piece of precision workmanship. Ratio 5-1. Each\$4.50

All United Products are sold under a positive money-back guarantee. When you remit or write for circular, give us the name and address of your favorite Radio dealer.

United Mfg. & Distributing Co.
 536 Lake Shore Drive, Chicago, Ill.

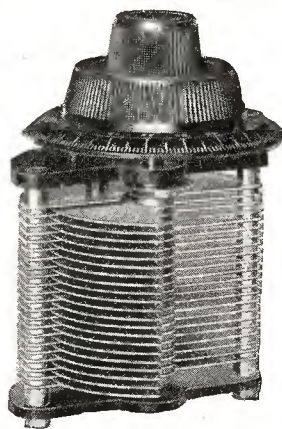

Parts and Accessories for makers of radio apparatus



Details and Prices on request
GENERAL RADIO CORPORATION
 Mfrs. & Distributors of
First Quality Radio Equipment
 including **MUSIC MASTER RADIO AMPLIFIER**
 624-628 Market St. Philadelphia

A QUALITY BATTERY

Always Dependable

Marko Storage Battery Company
 1404 Atlantic Ave.
 Brooklyn N. Y.



Q. 2. Would a three-stage radio, detector and three-stage audio amplifier give equal results to this circuit?

A. 2. Such a receiver would, no doubt, give a larger volume of sound than the super-heterodyne, but for real long-distance work and all-around efficiency it would not be so good.

Q. 3. Should there be a small variable condenser across the secondary and tickler coils in the honeycomb circuit on page 1663 of the March issue?

A. 3. A variable condenser of about .0005 mfd. should be used in shunt with the secondary coil in this circuit. No condenser is needed for the tickler.

NEGATIVE "B" CONNECTION

(697) Mr. O. Ingmar Oleson, Ambrose, N. D., wants to know:

Q. 1. What determines whether the negative "B" battery is connected to the positive or negative of the "A" battery?

A. 1. It is the common practice to connect the negative "B" to the positive "A," but good results will be obtained either way.

Q. 2. Should the filament rheostat be placed in the positive or negative lead of the "A" battery?

A. 2. It will prove best if the rheostat is placed in the negative lead of the "A" battery, especially if the tube used is a U. V. 201-A.

POLARITY OF PHONES

(698) Mr. George S. Hunt, San Francisco, Cal., asks:

Q. 1. Will you please inform me how to determine the polarity of a telephone receiver. I have a Baldwin and a Western Electric phone.

A. 1. Unscrew the cap of the Western Electric and place a compass over the pole pieces of the magnets. The compass needle will swing around and the north pole of the needle will point to the south pole of the magnet. The same procedure is followed with the Baldwin, except that the mechanism must be taken out and the compass held over the single magnet, when it is held in a vertical position, with the poles of the magnet at the top.

Army Officer Perfects Radio Improvements

(Continued from page 2107)

gested and we finally hit upon the common tuning fork to solve the problem. A tuning fork, vibrated by electricity, will give off a humming noise, the pitch of which is determined by the number of vibrations per second. If this fork is placed in front of a radio transmitter, and a fork which has the same number of vibrations placed near the diaphragm of the receiving outfit, the second fork will vibrate in unison with the first, the hum, of course, being carried just as music in broadcasting. We place a connection near the prong of the fork, so that when it vibrates, a contact is made which closes an automatic circuit, lighting a light, starting a motor, in fact, initiating almost any operation which may be done by electricity.

"There was still this difficulty. When the transmitting fork was stopped, the receiving one kept on vibrating for a short time. To obviate this, we use a fork of a different pitch at the transmitting station, which sets another fork of this latter pitch vibrating at the receiving end. This fork, by means of a relay, shuts the motor off, or stops whatever operation is started by the other. Using several sets of forks, each with a different pitch, any number of operations may be completed."

Captain Webbe improved on this idea, however. He stretched a wire E string across a transmitter on a receiving apparatus. This served in as good stead as did the tuning fork. On this wire, he placed a screw for tightening or loosening it, thus changing the pitch, just as a violin string may be tuned. If this wire is tuned in with the pitch of a telegraph message coming through the ether, it increases the volume of the signals, so that they may be heard in all parts of the radio room, at the same time eliminating all other signals and all static or other interfering noises. A recent experiment at the station at Fort Hayes, Columbus, on a night when static was par-



The Height of Efficiency

Crosley Model X. Price \$55

Clearly, distinctly, as though given in the same room, messages from WLW Broadcasting Station, Crosley Mfg. Co., Cincinnati are heard in all parts of America if a Crosley Model X—a four tube radio frequency set—is used. This remarkable instrument, very easy to tune, simple and beautiful in construction, has repeatedly brought in messages over 4900 miles away.

Other Crosley Models, like the Model VIII, three tube set—price \$48, and the Model VI, two tube set—price \$28, have given exceptional results to thousands of satisfied users everywhere.

Write For Catalog Showing Complete Crosley Line.

For Sale By Best Dealers Everywhere.

Besides a complete assortment of receivers, Crosley manufactures parts for replacement or home construction. Jobbers and Dealers will be interested in the Crosley Proposition.

CROSLEY MANUFACTURING COMPANY

Better - Cost Less Radio

622 ALFRED STREET

CINCINNATI, OHIO

New York Office: C. B. Cooper, 1803 Tribune Bldg., 154 Nassau St. Boston Office: B. H. Smith, 929 Blue Hill Ave., Dorchester.
Chicago Office: 1311 Steger Bldg., 28 E. Jackson Blvd.—R. A. Stamm, Mgr.

**Remarkable
Regenerative
Receivers**

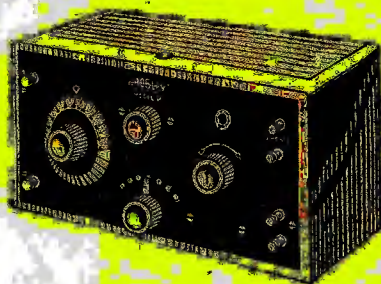

**ACE Model V
\$20**

Formerly known as
Crosley Model VC

This one tube receiver is astounding the radio world with its wonderful achievements. Stations more than 1000 miles away are being regularly copied on this set. In comparison to its price, there is no receiver on the market today to equal it in performance.

Because of its size and price the ACE Model V is a great summer seller.

Licensed under Armstrong U. S. Patent No. 1,113,149.

Live Jobbers and Dealers are eagerly taking advantage of the sales this instrument and the rest of the Precision Instruments and parts bring them.

Free Catalog on Request.

THE PRECISION EQUIPMENT CO.

Powel Crosley Jr. President

622 GILBERT AVENUE

CINCINNATI, OHIO



CONTINENTAL

"New York's Leading Radio House"

Radiola V Ready for Operation

Complete radio set including 3 Radiotrons WD-12, 3 dry cells, 2 B batteries, a pair of sensitive head telephones, and a telephone plug, all for the new low price: \$142.50. Radiola V is a sensitive long range receiver and can be operated by anyone. Its simplicity and sturdy construction ensure long service, and its beauty at once catches popular eye, and ensures a ready market. Write for further information.

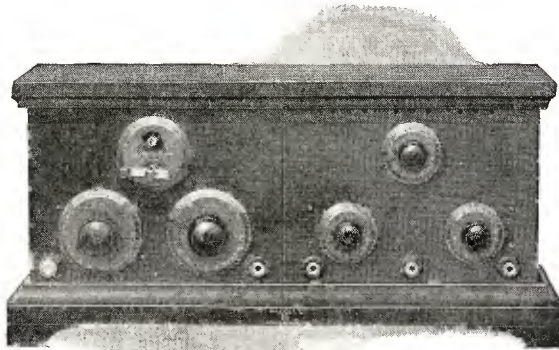

Price \$142.50

"Modern Radio"—A two hundred and eight page catalog of our Radio equipment, supplies and apparatus sent for twenty-five cents.

2033-Q

CONTINENTAL RADIO and ELECTRIC CORPORATION
SIX and FIFTEEN WARREN STREET, NEW YORK, U. S.

FRESHMAN PRODUCTS—ACCURATE AND DEPENDABLE

VARIABLE RESISTANCE LEAK

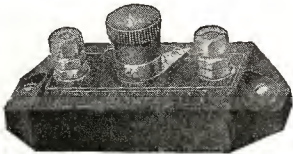

With .00025 mfd. MICON Con- denser Combined **\$1** Without Condenser **75c**
Unbroken range—Zero to 5 Megohms—clarifies signals, lowers filament current, increases battery life, eliminates hissing.

"MICON" Tested Mica CONDENSERS



| Size | Price |
|--------|-------|
| .00025 | \$.35 |
| .0005 | .35 |
| .001 | .40 |
| .002 | .40 |
| .0025 | .50 |
| .005 | .75 |
| .006 | 1.00 |
| .01 | 1.50 |

Assure absolute noiselessness—clarity of tone—accuracy—constant fixed capacity.

ANTENELLA

No antenna or aerial needed. Eliminates all the inconveniences in radio, operates from any light socket. Price only \$2.00.

At your dealer's—otherwise send purchase price and you will be supplied postpaid.

Freshman products are standard and can be used successfully with practically any circuit.



\$2

CHAS. FRESHMAN CO., Inc., 106 Seventh Ave., NEW YORK

New Radio Patents

(Continued from page 2113)

will usually be found that at one of the stations equivalent results may be obtained by separating the receiving and transmitting antenna. By applying the scheme to but one of the interconnecting stations, the necessity of commutating at a plurality of stations in synchronism is obviated.

MODULATING METHOD AND SYSTEM
(Patent No. 1,439,134. Issued to Leon J. Sivan of East Orange, N. J. Ptd. Dec. 19, 1922.)

This invention relates to methods of modulation involving generation of oscillations having an amplitude which varies according to a desired wave form and to systems operating in accordance with such methods.

An object is to enable the control of a high power oscillator, or a number of oscillators in parallel, by a modulating device carrying relatively small current.

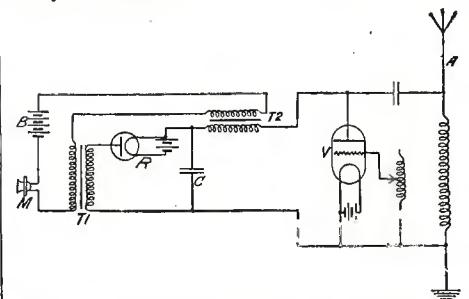

A feature of this invention is the provision of a high impedance control element associated with the oscillatory circuit of an electronic oscillator in order to prevent variations in the frequency of the oscillations produced. Also an arrangement whereby the electromotive force impressed upon the input circuit of a thermionic device used as an oscillator, is directly under the control of a transmitting device.

The accompanying drawing illustrates the arrangement of the oscillator applied to a radio system.

RADIOTELEGRAPHY

(Patent No. 1,427,833. Issued to Frederick S. McCullough of Cleveland, O. Ptd. Sept. 5, 1922.)
This invention relates to systems of radiotelegraphy, and more particularly to systems for deter-

RADIO SCHOOL

All our graduates are placed. Shortage still exists.

Send for Catalog

MASSACHUSETTS RADIO & TELEGRAPH SCHOOLS Inc.
18 Boylston St. Boston, Mass.
G. R. ENTWISTLE, Radio Director

HYGRADE SPECIALS

- 200 ft. 7 strand No. 22 Copper aerial wire... \$1.40
- Morse Eureka Test Clips, per dozen... .50
- Nathaniel Baldwin Head Sets (Type C)... 9.50
- No. 763 Eveready 22½ V. Variable B. Bat... 1.25
- No. 766 Eveready 22½ V. Variable B. Bat... 2.25
- No. 767 Eveready 45 V. Variable B. Battery... 4.25
- 2000 Ohm Murdock No. 56 Head Sets... 4.49
- 3000 Ohm Murdock No. 56 Head Sets... 4.98
- Federal or Brandes 2200 Ohm Head Sets... 6.50
- Dietograph 3000 Ohm Head Sets... 6.92
- Fada or Framingham Rheostats... .65
- Acme Amplifying Transformers (new type)... 4.25
- Acme R. F. Transformers, Types R2—R3—R4... 4.25
- 6 Volt Marko Storage Batteries... 8.95

All orders must include Parcel Post charges
Hygrade Electrical Novelty Co.,
41 West 125th Street New York, N. Y.

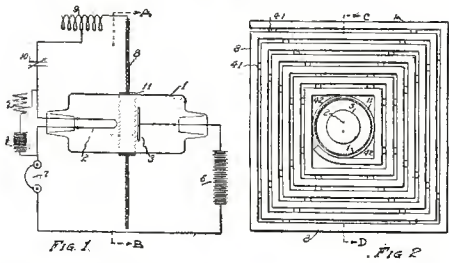

mining the direction of distant transmitting stations. Also to systems for detecting the incoming electromagnetic waves.

While directional loops of usual size may answer for permanent land stations, it can be readily seen that there are grave objections to them for portable stations such as small boats and more particularly on aircraft. For the latter, it is essential to have the apparatus in as compact form as possible, and this system provides means of small size which satisfactorily determines the direction of transmitting radio stations. Together with direction finding, means for the detection of the incoming electrical oscillations is provided.

In the drawings, which are largely diagrammatic, Fig. 1 shows one form of invention with one of the elements shown in cross-section, detection being taken on the line C-D, in Fig. 2.

The Future Of Radio

(Continued from page 2097)

behind the trust had kept back important inventions, chief among which was the famous Belin Television Patent.

Soon the trust saddled our existence with these now-indispensable apparatus, and now collects from all of us 1 3/4 billion dollars a year in rentals. At least this is the last available figure, the one for the year 1970. But that is only a mild feature. The trust is entitled to the money it makes, for, after all, in all fairness, the service is moderate. You who sit comfortably in your homes, and can see and hear me talk at this moment—some of you 3,000 miles away—do not mind spending \$6 a month for the use of the telephone. Also when over 150 million people can listen in, and at the same time actually see the performers at the Metropolitan Opera House at New York, such a service is worth the small monthly rental.

But when this same A.B.C. Trust improves the selfsame Television Machine to such an extent that their engineers can secretly—SECRETLY—I say—watch every private action of every citizen they choose to spy upon, in the very sanctity of his home, then I say to you my radio brethren, this sort of thing must stop! I can see by your faces that most of you have not as yet learned about this latest outrage. Why, my friends, I know of an actual case where they looked into a room of a poor subscriber, and found him smoking bootleg cigars. This poor devil was behind in his payment to the Trust for only three months. So, under threat to report his illegal cigars to the Internal Revenue Department, they actually blackmailed him into paying his arrears. As soon as the Television Machines had become a necessity, the Trust introduced Radio Light, Heat and Power. The same six broadcasting stations which supplied our schools with education and our homes with entertainment, along about 1938 began supplying the nation with Radio Light, Heat, and Power. You will remember the curious things that used to happen before the system was perfected. As you know, the power waves sometimes mixed with the entertainment waves. Thus, Katinka's Electric Sad Iron in the kitchen would suddenly go cold, and start to recite a bedtime story. Or, conversely, the loop aerial on your radio receiving outfit would, in the midst of an opera, begin to smoke, then become white hot, finally to burn out, while the molten copper wire burnt holes in your Alaska rugs.

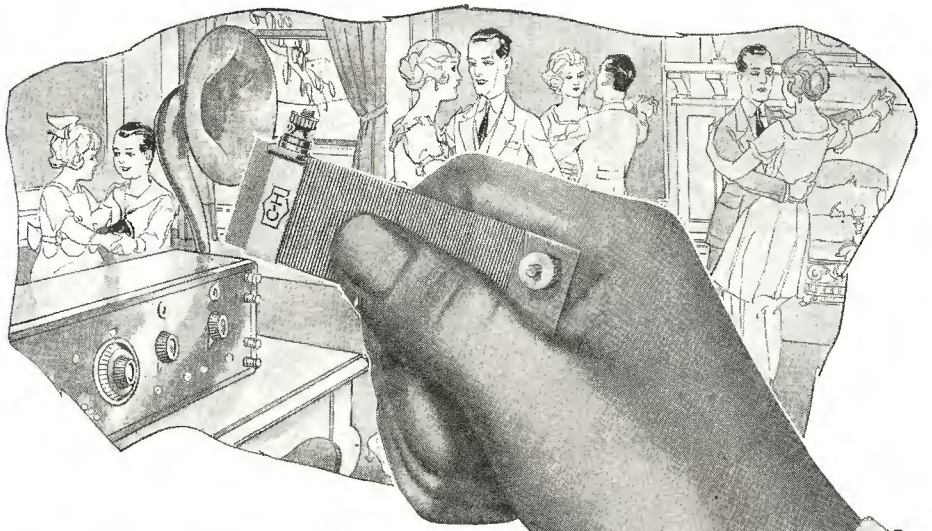

Use the New Tubes With Your Present Rheostats

The resistance of each of your present rheostats (4 to 6 ohms) is too low to control the new quarter ampere tubes (UV201A and C301A).

Cutler-Hammer engineers, however, have come to the assistance of the radio man once more and offer a small adjustable 25 ohm unit that can be attached to one of the posts of your present rheostat and with very little, if any, wiring, and no loss of time, make it possible to use these new and better tubes for maximum results. It makes "junking" of your present rheostats unnecessary and saves the trouble and expense of redrilling your panel for new ones.

The C-H Radio Resistance Unit is arranged for use with all makes of rheostats and for panel mounting. This new unit increases the range of your 0-5 ohm rheostat to 0-30 ohms, the slider being adjustable over the entire range to care for changes in battery potential. After once set, this adjustment requires practically no attention and regulation of the tube is obtained entirely by turning the rheostat knob.

Carried by dealers everywhere.

If yours has not been supplied, send 25c direct plus 10c for mailing

THE CUTLER-HAMMER MFG. CO.

Member Radio Section,
Associated Manufacturers of Electrical Supplies
MILWAUKEE, WISCONSIN



C-H Unit attached to panel mounted rheostat. No extra wiring required

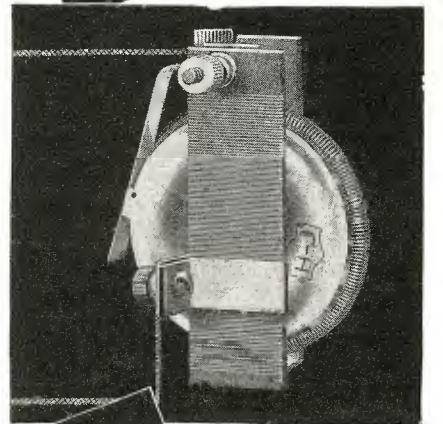

C-H Unit attached to standard C-H Rheostat

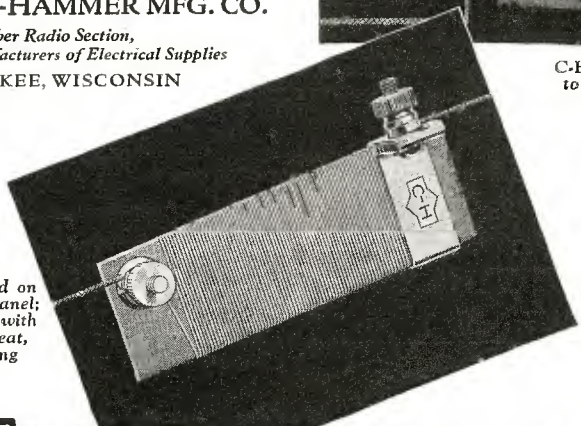

C-H Unit mounted on post fastened to panel; then wired in series with rheostat. Easy, neat, effective mounting



RESISTANCE UNIT
FOR RADIO RHEOSTATS

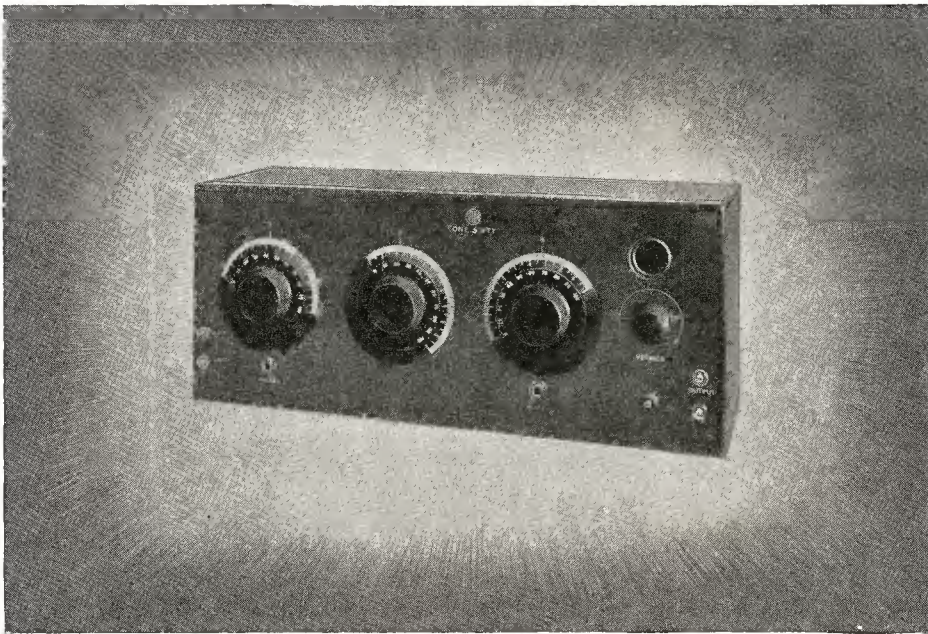

NEUTRODYNE

is the name given to a marvelous new radio receiver circuit invented by Professor L. A. Hazeltine, of Stevens Institute of Technology, Hoboken, N. J., and used in the FADA "ONE-SIXTY" receiver.

Only four vacuum tubes are used. The selectivity is remarkable and yet the dials can be easily adjusted to receive distant stations.

The FADA "ONE-SIXTY" will receive broadcasted concerts from the Atlantic to the Pacific and with loud speaker intensity.

Denver, Colo., San Antonio, Texas, Havana, Cuba, and Los Angeles, Calif., are some of the far distant stations listened to from New York City, using only a small indoor antenna.

*The Fada "ONE-SIXTY" is the
Ideal Receiver—the Cost \$120.00*

F. A. D. ANDREA, Inc., 1581-A Jerome Ave., N. Y. City



MODEL RFAA-60

This wonderful new CLEARSTONE development represents the greatest opportunity for the purchase of high class merchandise at a reasonable price that has yet been offered to the general public. So simple that any child can operate it and yet so efficient that results far surpassing any regenerative set may be obtained by anyone. The set comprises tuner, one stage of Radio Frequency amplification, detector and two stages of audio frequency amplification in that beautiful CLEARSTONE solid mahogany cabinet that is so famous by this time that it needs no description.

The list price of this astonishing new CLEARSTONE creation, *without tubes and accessories*, is only \$60.00. At this price a four tube set embodying the well known principle of radio frequency amplification is within the reach of all.

So confident are we that you will find this set all that we claim for it and even more, that we will ship it anywhere in the United States, C. O. D., subject to your inspection before you pay for it.

Attractive proposition to dealers.
Model RFAA-60 code word "abroad" **\$60.00**

THE CLEARSTONE RADIO COMPANY

McMILLAN and ESSEX PLACE

CINCINNATI, OHIO, U. S. A.

RADIO HOOK-UPS

By M. B. SLEEPER

Radio Editor of Everyday Engineering Magazine

For the amateur who builds his own receiving or transmitting set. 86 hook-ups, no freaks, crystal, tube, radio, audio, spark, buzzer, etc. Suitable explanation with each diagram. A 75c book for 50c postpaid. (Not stamps). Your money back if not satisfied.

RAY DOBBINS

Indianapolis, Ind. 146 W. 27th Street

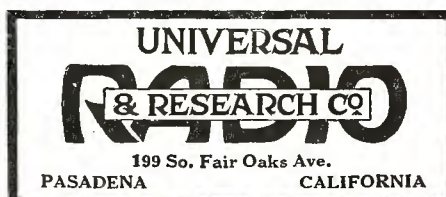

That finished your evening's entertainment; nor would the Trust make good the damages. As usual, their Law Department blamed it on the Static, and got away with it!

Then came the historic fight between the A.B.C. Trust and the Radio Transport Corporation. The latter had acquired all the Sossnoffsky Patents by means of which it became possible to send solids through space by radio. Thus, a carload of cement could be disintegrated at the manufacturing plant, and sent from Pittsburg to London in 8 $\frac{1}{4}$ minutes, for the small sum of \$1.98—or a trainload of timber could be radioed from Seattle to Boston in 14 $\frac{1}{3}$ minutes, for \$1.21. During that year, in 1953, the 18th Amendment was revoked, because Europe was sending wines and hard liquor by radio at such an alarming rate that it proved cheaper to allow the nation to buy its alcohol at stores, rather than let itself be drowned in a flood of illegal intoxicants. Moreover, our trade balance had been adversely affected by this traffic—as we had nothing to compete with the European liquor exports. If the 18th Amendment had not been revoked, we would have drunk ourselves to death. Every schoolboy who owned a radio set could receive all the alcohol from Europe that he wanted. It is true that he had to pay tribute—to the amount of \$2.75 a month—to the secret agents of the Radio Transport Corporation, who supplied the correct wave-length code information for every hour of the day. Without this key, nothing could be received. An additional charge for consumed liquor was also made, of course.

But we squared ourselves with Europe soon after, by sending them cheap synthetic rye and whiskey. Thus the trade balance was eventually re-established.

Soon thereafter, the A.B.C. Trust and the Radio Transport Corporation began to lock horns. The latter had become too powerful, and threatened to do all the profitable business. Railroads and ships no longer existed. How could they, when all the materials of the world were shipped by radio? Live stock, live plants, and human beings, who even today can not be sent through space by radio, went by air liners far more quickly and cheaply than by rail or by water.

The A.B.C. Trust tried for many years to consolidate with its rival, but to no avail. The latter, who owned all of the radium supply of the world, saw no advantage to combine with the A.B.C. clique. This radium, by the way, as you all know, is used to disintegrate the materials before they can be sent through space.

Then, about three years ago, the A.B.C. Trust's engineers produced synthetic radium. By that time, the Sossnoffsky Radio Transport Patents had expired. So the A.B.C. Trust started to compete in earnest with the Radio Transport Corporation, and you know the result. It is a fight to the bitter end, but who is injured? As usual, YOU, my brethren! It is always the innocent bystander who gets the worst of it.

You know the outrages that have been committed since that time by the A.B.C. Trust. How often have you had your orders from your supply stores interfered with? You order 5 lbs. of ground coffee from the National Radio Food Stores, and you receive the coffee mixed with oysters! You order 2 lbs. of onions, and 1 lb. of cheese, by radio, and when the order arrives, the onions smell like cheese, and the cheese tastes like onions! Or you order a quart of cream, and it arrives mixed with pickles. Or, as happened in my own house last night when I ordered 2 lbs. of Frankfurters—they looked innocent enough until they were served. Imagine my anger when I cut open one of them, and found it to contain—guess what!—Limburger Cheese! And the boiling had not improved the perfume either! \downarrow

ask you, my brethren, how much longer will you stand for this sort of thing? You know, of course, that it is the A.B.C. Trust that does this, simply by first listening in to your order, and then sending out their own material, on exactly the same wave length as that used by its rival. Interference is the result, and YOU are the victim! So far, the Radio Transport Trust has not been able to stop the nefarious work, while the A.B.C. Trust pleads innocence, blames the static, and accidental mis-tuning by their operators. And now the A.B.C. crowd makes interference on a wholesale scale. And that is the reason why I called this meeting, my friends!

Yesterday I received 153 telegrams from all sections of the country. Except for the wording, they read all alike. Here is a typical one:

Urge immediate legislation against Radio Trust.

Ordered 10 bushels of new potatoes delivered through cellar antenna. Upon arrival home, found 200 lbs. of chopped herrings on parlor rug, delivered through parlor radio outfit.

Here is one from Heinz, the big Pittsburg packers:

Radio Trust simply must be stopped. Ordered two carloads of fresh mushrooms from Kansas City, and we received a carload of mushrooms, mixed with a carload of vile fertilizer. Total loss.

To show you that the mischief is not accidental, I can cite a classical case if proof is wanted.

The Chicago Hardware Company sent a radio to a New York firm for "50 lbs. of nuts, same as last shipment." The last shipment, by the way, was No. 14 Brass Hexagon nuts. Now the A.B.C. Trust's operator listened in, and you can just about guess what the Hardware Company received. Yes, you are right; 50 lbs. of Pecan nuts!

Then there is the outrage perpetrated upon the National Garlic Extract Company, who, by mistake, sent to the Violetta Perfume Company—

(Here the alarm went off and aroused "Tips" from his pleasant dreams. Too bad.)

American Amateurs Heard In New Zealand

(Continued from page 2104)

DEC. 24TH

6JD to CQ (11:09)
 6IF to 8CWP (?) (11:12) and again to 8APW (?) (11:20)
 6JD to 9BP (11:23)
 6IF to 9AMB (11:28) and again to 9AMB (11:40)
 6IF to — (11:32)
 6IF to 9BP (11:44)
 6IF to 8ABM (11:49)
 6IF to CQ (11:57) to (12:00).

DEC. 28TH

9YAJ to IGV (8:03)
 9YAJ to — (8:14) and again at (8:26 and 8:30) (8:36 and 8:45).

DEC. 31ST

6KA at (10:01 and at intervals to 12:14.

JAN. 10TH, 1923

6AJF to — (8:55)
 6AJF to 8BK (8:58)
 6AJF to — (9:20)
 6JD to 5DI (10:05)

JAN. 16TH

5ZAK to CQ West (7:40) also to (7:54) (7:56)
 5ZAK to 6JNB (8:00).

JAN. 26TH

9DSG to — (8:18)
 6XWI to — (8:25)
 6JD to — (8:31).

Atmospherics bad.

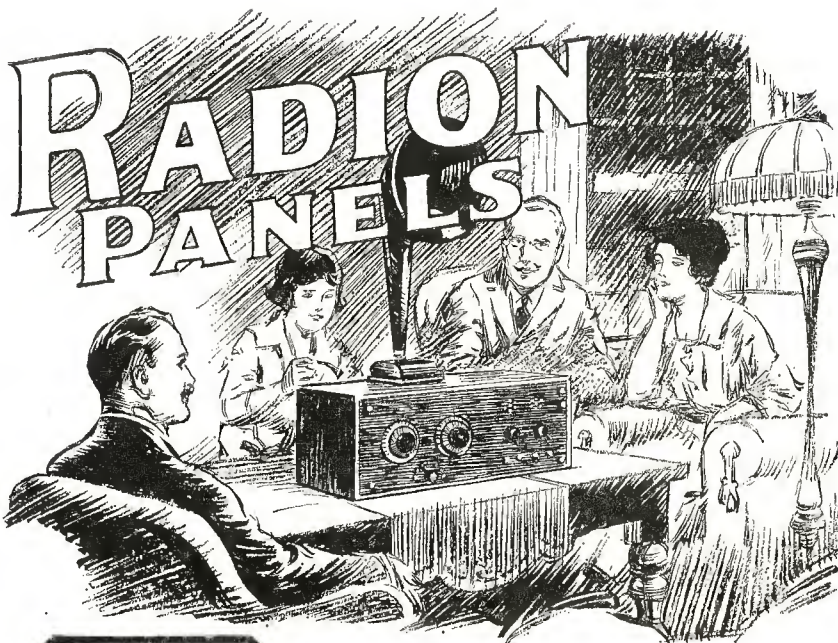

More economical— better results

RADION Panels, both black and mahogany, are made in 18 stock sizes—a sufficient range to meet every need WITHOUT waste. Nothing to cut off and throw away hence Radion is economical. Each panel is packed in a heavy manila envelope to protect the beautiful finish and complete directions for use are printed on the outside.

Radion is a superior grade of hard rubber developed exclusively for radio use.

Radion excels all other insulations in the four most important characteristics required for radio use, viz: (1) low phase angle difference, (2) low dielectric constant, (3) high resistivity and (4) moisture, gas and acid repelling properties. Tests by competent authorities establish these claims beyond question.

Radion is mechanically better than other insulations because it will not warp under normal conditions and because it is so easily sawed, drilled, countersunk, sanded and engraved with simple tools at home. It will not chip or crack when being worked.

Radion is made in two colors, black and mahogany. The latter resembles closely fine old mahogany. Both colors have a beautiful satin-like finish comparable to the finest ever put on hard woods.

Radion costs no more, in most cases less than the ordinary insulation materials.

Radion is also furnished made up into dials, knobs, sockets, antennae insulators, condenser ends, etc.

Radion panels and parts are marked Radion to protect you against inferior substitutes.

Radion is procurable at most dealers where the better class of radio products are sold. In case your dealer cannot supply you write us direct giving us his name. We shall also be pleased to forward descriptive folder to all who request it.

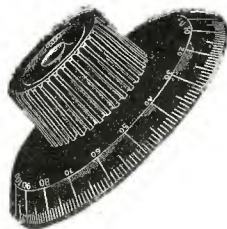

American Hard Rubber Co.
11 Mercer Street. New York

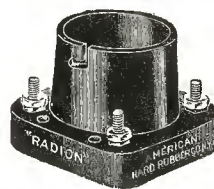

RADION

WHY METRO HEADPHONES ARE SUPERIOR



TRADE MARK
METRO

ACTUATING COIL CORES

Metro Headphones faithfully reproduce every sound variation so that reception is always clear and natural. The magnetic current which operates the diaphragm is transmitted by the actuating coils through the soft Armco Iron Cores, which allow a ready change of magnetic strength.

It is this remarkable ability of the actuating coil cores to react faithfully to every magnet impulse that helps to produce Metro sensitivity. A small detail but perfection is made up of such details. Insist upon Metro Headphones because you can be sure that every detail is as it should be.

\$6

Little Giant Receiving Set—A surprisingly compact set. Simplest tuning device. Complete with Metro Headphones. **\$14.00**
Metro Wave Selector—Makes any set highly selective. Completely separates 280 from 400 **\$7.50** meters.

Metro Electrical Co., Inc.
 70 Goble Street
 Newark, N. J.

JAN. 28TH

5XT to — (6:45)
 9UU to 9XP (7:06)
 8BXX to — (7:12)
 6ZZ to — (7:23 and at (7:35) and at (8:53)
 5PB to CQ (7:25)
 9BED to CQ (7:28)
 9XAC to — (7:31)
 6BQC to 8CYU (7:34)
 9ANS to CQ (7:58)
 7ZU to CQ (7:59)
 5ZAK to 7ZU (8:07)
 7ZU to 5ZAK (8:08)
 5GJ to 9AOD (8:13)
 6IF to 7ZU (8:15) (8:18) (8:23)
 9DPD to CQ (8:16)
 5SF to CQ (8:20)
 5XAJ to — (8:29)
 5XAJ to CQ (8:34)
 5PX to CQ (8:41) and at (8:58) (8:59) and (11:03).

JAN. 31ST

1EL to 6XWI (8:37)
 6JD to 9BVM (8:43)
 6XAD to 6KA (9:07)
 7LR to 8APW (9:09)
 — to 6UAD (9:32)

This station was a spark station and the first one I had heard.
 6JD to NOF (9:47)

FEB. 4TH

6KA to 8XE (7:21)
 9DGE to CQ (7:52)
 6GG to — (8:02)
 9CXP to — (8:04)
 9AYU to 5KC (8:11)
 6VM to — (8:16)
 6BO to CQ west (8:22)
 9LG to CQ (8:31)
 6TI to — (8:54) and to 9ZN (9:47)
 8CEI to — (9:02)
 2FP to 6XAD (9:37)

Peculiar note—like mashed spark.
 7LR to 5KC (10:15).

Two Accessories That Make Radio More Satisfactory

A comfortable headphone and a battery charger that requires no attention.

THE LEICH NON TUNE RECTIFIER is safe to leave on charge day or night. Contacts do not stick, and relay lock positively prevents discharge of battery if the power current is interrupted.

Very economical, takes only 36 watts. Will charge 28 hours at a cost of one K.W. No expensive repairs required.

Thousands of satisfied customers unconditionally endorse the Non Tune.





WITH LEICH HEADPHONES, incoming music or voice is very clear, regardless of strength of the signal. Special design and exacting accuracy in manufacturing make reception over the entire scale distinct. Loud signals will not cause "tinny" sounds nor cause the diaphragm to strike the pole pieces.

THE EUREKA HEADBAND used on a LEICH HEADPHONE holds the phones firmly but lightly in place. Special holding clips prevent tangling of cords and makes it unnecessary to adjust each time set is worn.

LEICH Phones are extremely light in weight and very comfortable to wear.

Jobbers and Dealers—Get our prices.
 Bulletin 101-C on request.

LEICH ELECTRIC CO., Genoa, Ill.

AMATEURS INCREASE 601 BEGINNING JANUARY 1ST

There is still great interest in amateur radio telegraphy. This fact is shown by the increase in general and restricted amateur licenses issued by the Department of Commerce since January 1, which number 601. On January 1, there were 17,102 amateur licenses in effect, and on March 1, there were 17,703.

These figures do not include 617 other non-commercial stations, which comprise 134 technical and training school stations, 297 experimental and 186 special amateur stations.

The distribution of special amateur licenses by districts is as follows, showing the Chicago district, including northern peninsula of Michigan, Wisconsin, Illinois, Kentucky, Indiana, Minnesota, Iowa, Missouri, North and South Dakota, Nebraska, Kansas and Colorado, first:

| District | Headquarters | Total March 1 |
|----------|---------------|---------------|
| 1 | Boston | 2,490 |
| 2 | New York | 2,589 |
| 3 | Baltimore | 1,919 |
| 4 | Norfolk | 420 |
| 5 | New Orleans | 825 |
| 6 | San Francisco | 2,019 |
| 7 | Seattle | 863 |
| 8 | Detroit | 2,749 |
| 9 | Chicago | 3,729 |

Total Special amateurs 17,603

SOME GOOD O.T. DOPE

By MALCOLM GAGER, 8BYH

The diagram here is the Hartley circuit with a self rectified supply. The O.T. is the novel point. I made them up of 1" copper ribbon on mica or formica supports. They have 15 turns each and should be mounted so that they can be coupled

BRASS Rods in round and square. Machine screws, any size. Tubing and sheet. Nuts. Small drills and taps. Knobs and dials.

ANGIERS, U. S. A.
STREATOR, ILL. BRUCE ST. PLANT

The AMERTRAN

American Transformer Co., Newark, N. J.
 super audio frequency amplifying transformer
 —Audibility amplification, 38.6—
 without distortion

Perfect tone Price \$7. Maximum volume

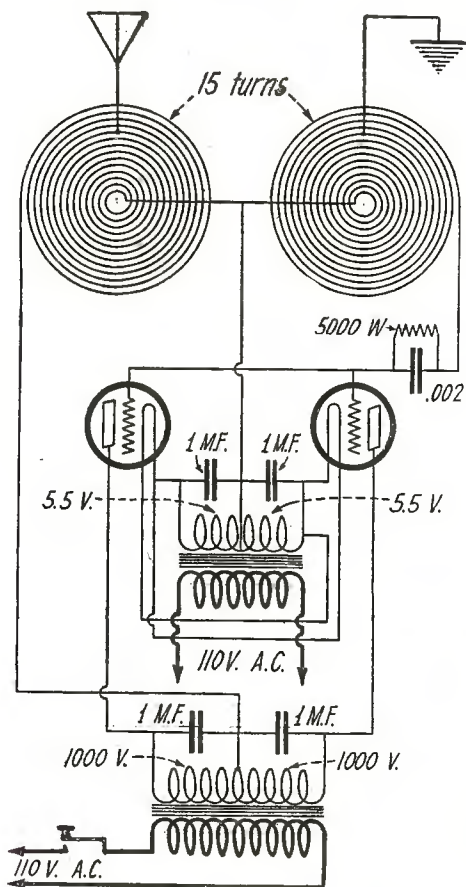

The Circuit That 8BYH Uses. Note That the O. T. Is Connected In Variometer Fashion.

close to each other. It will be found that the radiation meter will "jump" when the right coupling of the coils is reached. I found that this circuit could be made to oscillate on low wave-lengths with tight coupling and clipped down so that there are but a few turns between antenna and ground taps—or just enough to insure maximum "kick."

Using one 50 watter on each side of the cycle as in the accompanying hook-up I push 4.2 amperes into the antenna system with 10 volts A.C. on the filaments and 1,000 volts on the plates. With 1,500 volts on the plates I get over the 5 ampere mark.

The above circuit is F.B. and I think that the hams should use this type of O.T. because it is cheap and has a low resistance. It will get the T.C.A.'s into that network of theirs if nothing else will. I have worked all but the 6th and 7th districts with this outfit and have been reported heard in the 6th.

9 DEX

The call 9 DEX has been re-issued to Mr. Leo A. Ochs, 451 West 4th Street, Hoisington, Kansas.

Mr. Ochs operates a 10-watt C.W. set and will appreciate QSL's on his sigs.

AMATEUR EFFORTS CRIPPLED BY CHINESE GOVERNMENT RESTRICTION

An absurd position exists in China for radio amateurs owing to the severe restriction of the government under which all radio material is contraband.

Like all other countries, China has been invaded by the radio and the many amateurs in the Treaty Ports are among the foremost to recognize the value of this new form of communication. The Government, however, appears to regard the radio as its monopoly and amateur efforts have been submitted to such slights and restrictions as to dampen the ardor of any but the most enthusiastic.



Brandes

It is a fifteen-year-old tradition of the Brandes factory that the development of radio depends on the precision of our work. And while that will always be our thought, it means maximum clarity, maximum strength of reception, maximum pleasure and entertainment to over 500,000 users of Brandes Matched Tone Radio Headsets.

Send ten cents in stamps for the "Beginner's Book of Radio." It explains radio in terms that anyone can understand.

Made in Canada and England by Canadian Brandes, Limited, Toronto and London
Distributed in Canada by Perkins Electric, Limited
Toronto — MONTREAL — Winnipeg

C.Brandes, INC. - 237 Lafayette St., N.Y.C.

Matched Tone Radio Headsets

LETTER THAT RADIO SET!



Engrave your Radio Set with ELCO TRANSFERS. Make the most amateurish set look like a professional job. Come in card of 35 different words and characters; everything necessary for the most complete receiving set. Letter panel in Five Minutes. Elco transfers come in gold with black letter; enhance appearance of your set 100%. Are indestructible.

Price per Card, with Directions (in coin) 35c
If your Dealer cannot supply you, send us 35c with his name and address.
DEALERS AND MANUFACTURERS Write for samples and discounts.
ELCO RADIO CO. 937 LIBERTY AVENUE
PITTSBURGH, PA.

Hit it anywhere!

MAGNETITE
RADIO-CRYSTAL

The most sensitive Crystal Detector on the world market. Unaffected by handling or moisture and will render efficient service indefinitely. Price 50 cents at ALL DEALERS—or mailed direct. GUARANTEED by

GIBBONS-DUSTIN RADIO MFG. CO.

OWNERS AND NATIONAL DISTRIBUTORS

518 WEST 9TH STREET

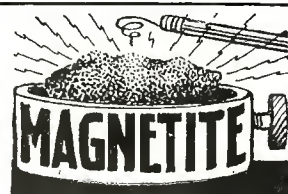

LOS ANGELES, CALIF., U. S. A.

"ESCO" Battery Chargers

To meet an insistent demand for RUGGED—RELIABLE NEVER FAILING MOTOR-GENERATORS.

For charging Batteries in Wireless Operation.

We have developed a complete line of MANY SIZES.

With or without panel boards.

ESCO quality thruout.

You know what that means.

Ask for Bulletin 242

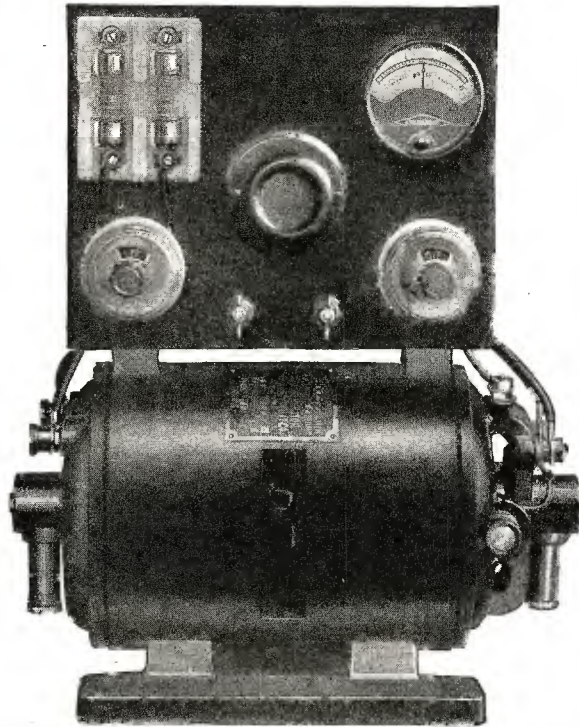

ELECTRIC SPECIALTY CO.

211 South Street

STAMFORD, CONN., U. S. A.

Pioneers in Developing Quality Wireless Apparatus

RADIO "A" & "B" STORAGE BATTERIES CHARGED, AT HOME, FOR FEW CENTS, WITH "PATENTED FULL WAVE" 100-130 Volt, 60 Cycle A. C. AUTOMATIC MAGNETIC TAPER CHARGING

F-F BATTERY CHARGER

Eventually You Will Buy An F-F CHARGER Why Not Now? The Sooner You Buy It The More You Save. A-B.

CHARGES All 6 Volt RADIO "A" & AUTO Batteries; & All RADIO "B" & LOUDSPEAKER Storage Batteries Up To 120 Volts In Series Inductively At Home OVERNIGHT. Disconnecting & Multiple Connections Unnecessary. Charging Circuits Separate. Nothing Like It Made. No Chance For Grounds Or Short Circuits. No Skill Required. AMMETER Eliminates Guess Work. It Costs You Less To Buy An F-F CHARGER than To Be Without One. You PAY for ONE Whether You Buy One Or Not, for it Costs An Average Of \$2. for CHARGING & Rentals Every Time An Auto Battery Is Charged By Others, but Only A Few Cents When You Charge Your Own From A Lamp Socket With An F-F Battery Boosting CHARGER. If You Have Never Known The Delightful Feeling Of Having Your Storage Batteries Always Fully Charged for RADIO & AUTO You Will Experience A New Thrill When You Have An F-F CHARGER Which Gives You A Fully Charged Battery Overnight At A Cost of A Few Cents & A Pleasant Feeling Of Things Well Done. Those Who Own Them Feel Their F-F CHARGER is Their Faithful Friend. It Charges Automatically & Being Clean Can Be Placed Anywhere. Nothing To Stop Over Be Filled Burn Out Need Attention Or Cause Trouble. Both Waves Are Rectified Thru Infusible Carbon Rectifying Brushes, Maintaining Constant Efficiency Uninterruptedly. While Its FULL WAVE Delivers RAPID TAPER CHARGE recommended By All Storage Battery Manufacturers. The F-F CHARGER is A Complete Compact Portably Handy Charging Unit. Delivers Service Day & Night Automatically & Will Charge Dead Battery. Do Not Think Battery is Dead & Worn Out Simply Because It Will Not Start Your Car. Buy an F-F RADIO CHARGER & Fill it With LIFE. It SAVES MORE than Its Cost & Lasts Lifetime. Leave Your Battery In Car, Or Where Ever It Is, Without Even Disconnecting It. Screw CHARGER Plug In Lamp Socket, Snap CHARGER Clips On Battery Terminals; Turn Switch & Battery Will Be Charged In Morning At Cost Of Few Cents. Is It Not Gratifying To Be Ready For All RADIOPHONE BROAOCAST Music Sermons & News When Friends Call? Never Having To Be Careful Of, or Tell Friends Your Batteries Are Dead & to Feel Your Car Respond Like A Greyhound, Spinning Engine With Power When You Throw In STARTER? Fully Charged Battery Starts Car Quick & Requires Fewer Expensive Replacements. INSIST ON THE F-F CHARGER. Built By A Master Of The Art in 7 TYPES. So Many Thousands Are Being Sold It Has Made Possible These POPULAR PRICES



\$15

RADIO & AUTO BATTERIES Patented. The Lower 3 are Large TYPES Built For Heavy Batteries, or Where Time Is Limited. SHIPPING WEIGHTS Complete With AMMETER & BATTERY CLIPS 11 to 15 Lbs. Purchase From Your DEALER Or Mail Check for Prompt Express Shipment. If Via PARCEL POST have Remittance Include Postage & Insurance Charges, or WRITE Us To Ship TYPE Desired C. O. D. Other F-F Battery Chargers Charge Batteries From Farm Lighting Plants & O.C. Circuits & for GROUP CHARGING Economy Use Our 8 Ampere 12 Battery Capacity Automatic Full Wave F-F ROTARY CHARGER described in ROTARY BULLETIN 32A. OROER Now, or WRITE Immediately for FREE Descriptive RADIO, AUTO & ROTARY CHARGER BULLETINS 32A & 32

FRANCE MFG. CO., CLEVELAND, OHIO, U.S.A.

Tientsin amateurs have taken the lead in forming a Radio Association, and Shanghai amateurs ought not to be tardy in following their example. United action will undoubtedly lead the Government to remove or modify the restrictions, and open up this remarkable invention to all in China. Radio has come to stay and Associations in Shanghai and Tientsin will be in a position to utilize it as it is being utilized in Great Britain and America. A member of the Tientsin Association, in his article below, tells of the present position and the steps taken by the Tientsin Association. Emulation of their efforts by Shanghai amateurs is awaited.

The enthusiasm with which "Broadcasted" concerts, lectures, etc., are received in America has resulted in more than could possibly have been foreseen by the promoters. Probably more than two million people listen in each night to high class music, church services, and other programs, who would not have had that pleasure were it not for the radio receiving set. Its popularity has spread to Britain, where, taking advantage of the experience of others, the authorities have from the beginning controlled the broadcasting stations and put them on a paying basis. There can be no doubt that what has happened in other countries will eventually happen in China, that is, as far as Radio is concerned. What is the position here just now and what has been done already in preparation for the time when listening in will be the principal evening amusement?

Abstract from Shanghai Times.

A REMARKABLE BILL

The text of a rather remarkable bill is published herewith. This bill was introduced by Mr. White of Maine, and the text speaks for itself.

There has been much talk about price-fixing, as well as restricting the manufacturer of radio apparatus in the United States, by some of our leading radio corporations.

Although such a law, if enacted, would be a boon for the radio industry, we doubt very much if it will ever come to it.

House Calendar No. 312.
H. RES. 548.

IN THE HOUSE OF REPRESENTATIVES
February 21, 1923.

Mr. White of Maine submitted the following resolution; which was referred to the Committee on the Merchant Marine and Fisheries and ordered to be printed.

February 22, 1923.

Referred to the House Calendar and ordered to be printed.

RESOLUTION

Resolved, That the Federal Trade Commission be, and it is hereby, requested to investigate and to report to the House of Representatives at the convening of the Sixty-eighth Congress, or as soon thereafter as practicable, the facts relating to (a) the ownership of patents covering radio apparatus used in interstate and/or foreign commerce and to all assignments or other contracts concerning such patents; (b) contracts, leases, or agreements in whatsoever form the same may be, or practices, the purpose, tendency, or effect of which is to control or restrict the manufacture, sale, resale, or use within the United States of such radio apparatus or to control or fix the price therefor; (c) contracts, leases, or agreements in whatsoever form the same may be, or practices, the purpose, tendency, or effect of which is to give exclusive rights or special privileges in the reception and transmission in interstate and/or foreign commerce of messages by radio; and (d) such other facts, as in the opinion of the commission, may aid the House of Representatives in determining whether, in the foregoing respects or otherwise on this or related subjects, the antitrust statutes of the United States have been or now are being violated by any person, company, or corporation subject to the jurisdiction of the United States; and (e) such other facts as in the opinion of the commission may aid the House in determining what further legislation may be advisable.

NEW GET-RICH-QUICK METHOD

"Have they arranged to send money by radio yet?" asked a fan.

"Probably not," replied his wife, "too many people would 'pick it up'."

VULCANIZED FIBRE

Be sure and specify "WILMINGTON FIBRE"

Sheets, Rods, Tubes, Washers, Etc., Specialties

Wilmington Fibre Specialty Co., Wilmington, Del.
Branch Offices "Everywhere"

Chaslyn

SINK OR SWIM

Tests your battery instantly by the way the Balls sink or swim in the acid.

Outfit, including Hydrometer, Depth Gauge, and Water Filler. Postpaid \$1.00 Circular Free.

Chaslyn Co., Dept. 1, 4315 Kenmore Ave., CHICAGO

Hydrometer



Federal Standard Head Sets are made with 2200 Ohms and 3200 Ohms resistance.

Federal makes a complete line of Standard Radio apparatus—all reasonably priced. Write for latest catalog.

Federal Standard Head Sets are Endorsed by Experts

WHEN you buy Federal Head Sets you obtain the lasting satisfaction that comes with Radio equipment universally endorsed by engineers and experts.

Years of experience in making communication apparatus enabled Federal to enter the Radio field with Head Sets and other Radio apparatus unsurpassed for efficiency in operation.

Permanent magnets, specially treated steel, and precision machining of metal parts are some of the outstanding features of construction that make Federal Standard Head Sets the best you can buy.

Ask your dealer for Federal Standard Head Sets. If out of stock he can get them from our nearest office. Accept no substitute.

Federal Telephone and Telegraph Company

Oldest and largest manufacturers of a complete line of Radio Equipment

BUFFALO, N. Y.

Armstrong Super Heterodyne Receiver

"The Rolls Royce Method of Reception"—E. H. Armstrong.

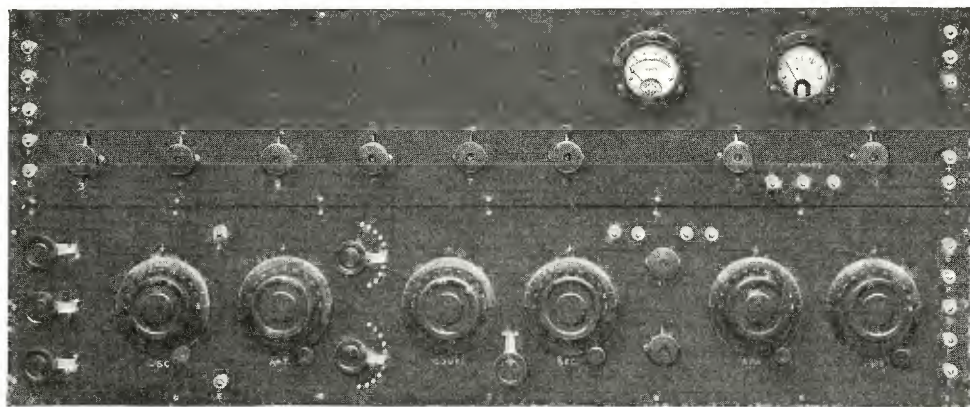

Obtainable Exclusively Through

EXPERIMENTERS INFORMATION SERVICE

Designers of the Highest Class Radio Apparatus in the World

531 West 46 St.,

New York City

NEW CATALOG READY No. 26

FROST

No. 162—2000 Ohm Set

\$5.00

FONES

No. 163—3000 Ohm Set

\$6.00

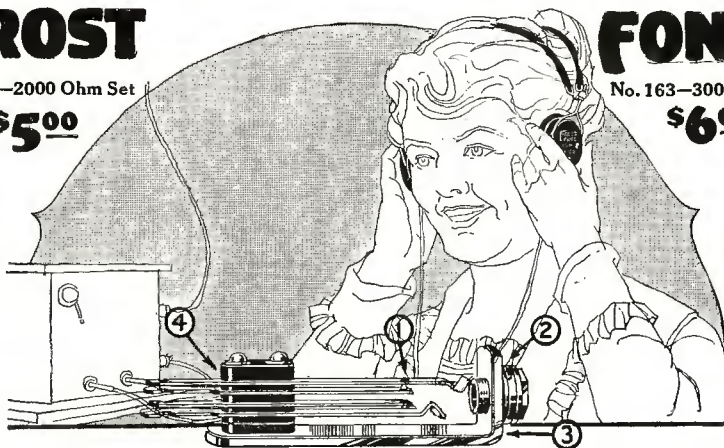

“Wonderfully Convenient!”

THAT'S what every one says who has installed Frost Radio Jacks and Plugs on his receiving set. Even mother can operate the set with ease when it is equipped with these convenient accessories.

Four Big Frost Jack Advantages

Note these big Frost Jack features: 1. Contact points of 99% pure silver. 2. Three thickness washers to fit panels of varying thicknesses. 3. Frames are pure electric brass, triple nickel plated and hand buffed. 4. Insulation is Formica sheet—immensely hard and of highest dielectric qualities. When building your set equip it with Frost Radio Plugs and Jacks for best results. Your dealer has adequate stocks—see him today.



HERBERT H. FROST, Inc.
154 WEST LAKE STREET, CHICAGO, ILLINOIS.

Calls Heard

(Continued from page 2104)

2GK, 2HO, 2OM, 2QV, 2SQ, 2TP, 2WR, 2XZ, 2ZL, 3ACV, 3ADT, 3AFBdalte, 3AJJ, 3ALN, 3ALU, 3ANJ, 3APB, 3AQR, 3ARO, 3ASM, 3ASP, 3ATB, 3AUU, 3BDT, 3BEC, 3BEI, 3BFE, 3BFU, 3BHL, 3BIJ, 3BLE, 3BNU, 3BOB, 3BRE, 3BSS, 3UC, 3BVA, 3BVC, 3BYW, 3CBM, 3AS, 3BG, 3BJ, 3BZ, 3CC, 3CM, 3FK, 3FR, 3GK, 3HK, 3HL, 3HX, 3JJ, 3LK, 3MB, 3MO, 3OD, 3OH, 3PZ, 3RF, 3SM, 3TJ, 3VW, 3WF, 3XM, 3YH, 3ZO, 3ZS, 4BB, 4BD, 4BK, 4BX, 4BY, 4CY, 4DC, 4EA, 4EB, 4EH, 4EL, 4EN, 4ER, 4FG, 4JK, 4KC, 4KL, 4KU, 4LJ, 4LW, 4ME, 4NV, 4OB, 4XR, 4A, 4ZC, 5AAH, 5AAM, 5ABA, 5ABY, 5ADE, 5ADO, 5AEC, 5AEF, 5AGN, 5AGY, 5AHD, 5AHT, 5AB, 5BE, 5BM, 5BW, 5CP, 5CY, 5DP, 5EK, 5ER, 5ES, 5FU, 5GJ, 5IA, 5IX, 5JL, 5K, 5KE, 5KN, 5KP, 5LF, 5ME, 5ML, 5MO, 5ND, 5NS, 5NV, 5OK, 5OV, 5PV, 5PX, 5PB, 5OI, 5OM, 5OS, 5RN, 5SD, 5SF, 5SK, 5TC, 5TJ, 5TM, 5UJ, 5UK, 5SU, 5VO, 5WB, 5XAJ, 5XK, 5XR, 5ZU, 5ZAA, 5ZAF, 5ZAG, 5ZAS, 5ZA, 5ZB, 5XH, 5XV, 6AWT, 6BUM, 6CAJ, 6CC, 6JD, 6ZZ, 7AFW, 7LN, 7LU, 7XF, 7ZU, 8's and 9's too numerous. Canadians: 3CO, 3KO, 3NI, 3ZS, 4CN, 4DK, 4HH, 9BX.

SPARK: 4BI, 4FD, 4GN, 4MY, 5JD, 5TU, 5UP, 5XA, 8BBY, 8BDA, 8BRY, 8BYO, 5VV, ANNISTON, ALABAMA

C. W.—1AYS, 1BAS, 1BES, 1CY, 2AYV, 2BMR, 2CCD, 2CGT, 2CPD, 2EL, 2FP, 2NZ, 2XAO, 2ZK, 2ZL, 3AFT, 3AJJ, 3ALN, 3APR, 3ARO, 3BZ, 3BFU, 3BIJ, 3BLF, 3BRF, 3BSS, 3BUC, 3BVC, 3HD, 3HJ, 3HW, 3IW, 3JJ, 3OT, 3PZ, 3SU, 3TJ, 3XN, 3YO, 3YV, 3Z, 4BB, 4BK, 4BO, 4BW, 4BY, 4CD, 4CU, 4CY, 4DO, 4EB, 4EH, 4EL, 4EU, 4BI, 4FT, 4GH, 4HZ, 4IR, 4JH, 4ME, 4OD, 4OI, 4YA, 4ZE, 5AAM, 5AAR, 5AAT, 5ABA, 5ADE, 5AEC, 5AGN, 5BE, 5CI, 5DA, 5EK, 5CF, 5FV, 5GA, 5GJ, 5GR, 5IQ, 5IR, 5IX, 5JL, 5K, 5KN, 5KP, 5LJ, 5LZ, 5MB, 5ML, 5MO, 5MY, 5MD, 5NJ, 5NK, 5NN, 5NV, 5NZ, 5OV, 5PB, 5PD, 5PO, 5PV, 5OI, 5OM, 5RH, 5RN, 5RZ, 5SF, 5SS, 5TC, 5TP, 5UK, 5VY, 5XA, 5XAJ, 5XB, 5KZ, 5VZ, 5Y, 5ZA, 5ZAK, 5ZAS, 5ZB, 7AD, 7SO, 7ZU, 8AAF, 8ADD, 8ADZ, 8AFD, 8AIM, 8AJX, 8ALF, 8ALT, 8AMX, 8ANB, 8APV, 8ASC, 8ASV, 8ATC, 8ATX, 8AWR, 8AWZ, 8AXC, 8AZO, 8BCH, 8BDA, 8BEN, 8BEO, 8BFM, 8BFY, 8BK, 8BKE, 8BKK, 8BNI, 8BO, 8BOG, 8BOO, 8BRC, 8BRD, 8BRT, 8RY, 8BSY, 8BTL, 8BUH, 8BVR, 8BYO, 8BYS, 8BYT, 8CEI, 8CF, 8CGH, 8CIA, 8CJZ, 8CMI, 8CRB, 8CUR, 8CUU, 8CV, 8CVE, 8CWP, 8CPX, 8CXW, 8CZC, 8DAG, 8ER, 8FU, 8JJ, 8JY, 8KG, 8LH, 8LS, 8MZ, 8NN, 8RC, 8SB, 8WP, 8WY, 8XAK, 8XAO, 8XE, 8ZAE, 8ZD, 8ZC, 8ZW, 8ZGG, 9AAD, 9AAP, 9AAU, 9ABV, 9ACB, 9ACP, 9AEP, 9AEY, 9AFU, 9AIX, 9AJP, 9AI, 9AMI, 9AMT, 9AOG, 9AOJ, 9AON, 9AOU, 9APS, 9APW, 9AQM, 9ARG, 9ARR, 9ARK, 9ARZ, 9ASE, 9ATN, 9AUS, 9AYL, 9AZA, 9BAK, 9BBF, 9BCB, 9BCF, 9BDB, 9BDS, 9BED, 9BEY, 9BGW, 9BIJ, 9BJR, 9BJV, 9BKO, 9BMN, 9BRE, 9BRK, 9BRS, 9BSQ, 9BSZ, 9BTA, 9BTT, 9BXY, 9BY, 9BZ, 9CBA, 9CCM, 9CCV, 9CDU, 9CEH, 9CGK, 9CHK, 9CJA, 9CKP, 9CKW, 9CLO, 9CLW, 9CM, 9CPY, 9CSN, 9CTE, 9CTG, 9CTS, 9CTV, 9CUC, 9CVO, 9CVT, 9CWR, 9CWV, 9CX, 9CXH, 9CYM, 9CZF, 9DBL, 9DCR, 9DDY, 9DFV, 9DGE, 9DG, 9DGO, 9DIO, 9DJB, 9DKQ, 9DKY, 9DOM, 9DOU, 9DRI, 9DS, 9DTA, 9DTS, 9DVL, 9DVW, 9DWF, 9DWK, 9DWO, 9DXC, 9DXE, 9DYN, 9DYO, 9ECE, 9ED, 9EHT, 9EI, 9EKF, 9EP, 9HK, 9HZ, 9II, 9IO, 9LZ, 9MC, 9OR, 9OX, 9PE, 9PF, 9RC, 9UC, 9UR, 9UT, 9VM, 9WA, 9WC, 9XAC, 9ZF, 9ZY.

Phone—4XE, 9JD.

Canadian—3DH.

Spark—4FT, 4GN, 5JD, 5SB, 5SM, 5TU, 5UD, 5WO, 5XAB, 5XAC, 5ZR, 8BDA, 9AAS, 9AAW, 9AFL, 9AHQ, 9AOP, 9BEO, 9CFK, 9CIV, 9DQ.

9BXT, GILTNER, NEBR.

C. W.—1MC, 1QP, 1QR, 1RV, 1SN, 1WC, 1XU, 1ABB, 1AJP, 1AJX, 1ALZ, 1APC, 1AZL, 1BAN, 1BKQ, 1BOE, 1CAK, 1CMK, 2EL, 2FF, 2GK, 2HJ, 2KF, 2NZ, 2RM, 2RBZ, 2ALJ, 2BMR, 2BOH, 2BRB, 2CCD, 2CGT, 2COZ, 2CXL, 3FO, 3HG, 3HS, 3JJ, 3KM, 3PZ, 3ZU, 3WF, 3XM, 3AJJ, 3ALN, 3ALT, 3ARO, 3BJY, 3BLF, 3BYV, 4AG, 4BK, 4BX, 4CO, 4CY, 4DB, 4DO, 4EB, 4EH, 4EL, 4FA, 4FG, 4FT, 4GZ, 4HW, 4HZ, 4IK, 4JH, 4KL, 4YU, 4LO, 4MB, 4OD, 4OI, 4YA, 4YD, 4ZC, 4ZN, 5BF, 5BW, 5DE, 5DI, 5EK, 5EN, 5FV, 5HH, 5HO, 5IQ, 5JB, 5JL, 5JN, 5JS, 5KC, 5KI, 5KK, 5KW, 5MO, 5NN, 5NS, 5NV, 5NZ, 5OV, 5PB, 5PX, 5OI, 5RN, 5SP, 5SR, 5SS, 5TA, 5TC, 5TJ, 5UK, 5UO, 5US, 5XB, 5AAG, 5AAM, 5AAO, 5AAR, 5ABM, 5ABY, 5ADB, 5ADE, 5ADF, 5ADO, 5AEC, 5AOF, 5AGN, 5AHD, 5AIB, 5AJC, 5XAC, 5XAJ, 5ZAE, 5ZAF, 5ZAK, 5ZAW, 6EA, 6JX, 6KU, 6OL, 6TI, 6WM, 6XK, 6ZH, 6ZN, 6ZT, 6ANH, 6AOP, 6AOW, 6ASJ, 6AUU, 6AWT, 6AWX, 6BBV, 6BCJ, 6BCL, 6BJO, 6BOE, 6BOG, 6BQC, 6BSG, 6BUY, 6BVF, 6BVG, 6CAJ, 6CC, 6XAD, 7BJ, 7HM, 7LN, 7LU, 7NF, 7OT, 7SC, 7WE, 7ZF, 7ZN, 7ZV, 7ABB, 7ADO, 7AFO, 7AIV, 8AA, 8AG, 8EF, 8EO, 8FC, 8GZ, 8HC, 8HN,

BRACH VACUUM RADIO PROTECTOR

Ask Your Insurance Agent

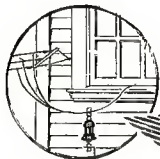

The Choice of the Foremost Engineers for over 17 years.

Approved by National Board Fire Underwriters

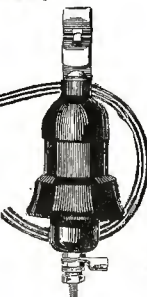

\$3.00

SOLDERALL

The Only Convenient Metal Solder
Every Electrical Connection Needs
SOLDERALL for Perfect Reception

L. S. BRACH MFG. CO.
NEWARK, - - NEW JERSEY



PHANTOM - CIRCUIT

Build Your Own. This marvel of mystery, using no loop, no aerial and no ground brings in music instead of interference. We have heard stations 950 miles distant on one tube. By using WD-11 tube set can be entirely self contained. Very easy to build from our instructions, use your own spare parts, nothing complicated like radio frequency or super regenerative. Only one tuning control. Complete instructions, with hookup and photo of circuit mailed to you for 60 cents. Stamps accepted. Vesco Radio Shop Box RN-704 Vacaville, Calif.

CUT RATE RADIO

Standard apparatus only. Write for 54 Page Catalog of Bargains.

| | |
|---------------------------------|--------------|
| Baldwin Type "C" Phones |\$10.25 |
| Brandes Super Phones |6.45 |
| Radotron U V 200 Detector Tubes |4.25 |
| Acme Audio Transformers |4.45 |

Everything for Radio at less. Immediate Delivery.

Federal Radio Electric Co., Dept. A
1233 GRAND AVE. KANSAS CITY, MO.

Tune into results with this new and better device the **Marco Tuner**

TYPE 300-A

Body Capacity Practically Eliminated

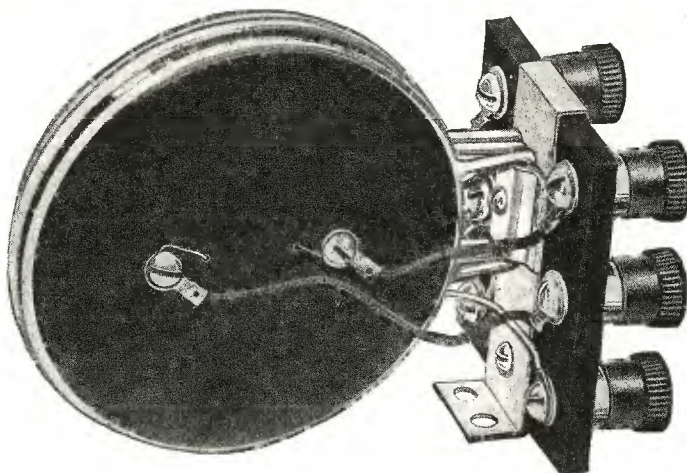

AS A SINGLE OR DOUBLE CIRCUIT TUNER, this instrument is most useful, particularly for tuning simple, efficient regenerative sets.

AS A RADIO FREQUENCY TRANSFORMER, it is the most generally satisfactory piece of apparatus on the market today, providing in itself an aerial tuning inductance and an intertube coupling impedance which is variable, compensating for changes in wave length or differences in inter-electrode tube capacities, allowing suc-

cessful operation with any of the new low amperage tubes.

IN THE FLEWELLING CIRCUIT, all the interesting phenomena of super-regeneration may be observed through the use of this device.

IN ANY COMBINATION REQUIRING SMALL INDUCTANCES, this arrangement of coils will provide the necessary values for broadcasting reception, and will work well, with a pleasing lack of body capacity effect in adjustment.



MARTIN-COPELAND COMPANY
PROVIDENCE, R. I.



RADIO MERCHANDISE

F. D. PITTS COMPANY

(Incorporated.)

219 COLUMBUS AVE., BOSTON, MASS., U. S. A.

Wholesale Only

Distributors for

- A. H. Grebe and Co.
- Acme Apparatus Co.
- American Eveready Works
- American Radio and Research Corp.
- Atwater Kent Mfg. Co.
- Baldwin, Nathaniel Co.
- Burgess Battery Co.
- Chelsea Radio Co.
- Clapp-Eastham Co.
- De Forest Tel. and Tel. Co.
- Dubilier Condenser Co.
- Electrose Mfg. Co.
- Fada.
- Fahnestock Elec. Co.
- Federal Tel. and Tel. Co.
- France Mfg. Co.
- Frost, Herbert H. and Co.
- General Radio Co.
- Jewell Elec. Inst. Co.
- Magnavox Co.
- Mitchell, R. and Co.
- Murad Laboratories
- Murdock, Wm. J. Co.
- Pacent Elec. Co.
- Radio Corp. of America
- Remler Radio Mfg. Co.
- Signal Elec. Mfg. Co.
- Western Elec. Co.
- Weston Elec. Inst. Co.
- Wireless Press



"GREBE RADIO"

- Grebe CR-3 Receiver, 150-1000 meters. \$65.00
- Grebe CR-5 Receiver and Vacuum-tube Unit, 150-3000 meters. \$80.00
- Grebe CR-8 Receiver and Vacuum-tube Unit, 150-1000 meters. \$80.00
- Grebe CR-9 Receiver, Detector and Two-stage Amplifier, 150-3000 meters. \$130.00
- Grebe CR-10 Radiotone Concert Receiver, Detector and Three-stage Amplifier, Victrola type. \$315.00
- Grebe RORK Two-stage Amplifier. \$55.00
- Grebe RORD Detector and Two-stage Amplifier. \$75.00
- Grebe RORN Tuned Radio Frequency Amplifier. \$60.00

"Without going out of doors," said Lao-Tzu, "one may know the whole world." "Let a GREBE RECEIVER bring the whole world to your evening fireside."

DEALERS—Attractive discounts and immediate deliveries from stock! Send for Our Latest Price List, No. 3.

"F. D. PITTS CO. NEW ENGLAND DISTRIBUTORS OF GREBE RADIO"



CHELSEA REGENERATIVE RECEIVER

A real Broadcast Receiver

Range 150 to 800 meters

¶ Perfection in design
¶ Pleasing appearance
¶ Simple and accurate tuning

\$40.00

A Chelsea product, embodying Chelsea equipment throughout.
Licensed under Armstrong U. S. Pat. No. 1113149. For amateur use only

Write for our new No. 7 catalogue

CHELSEA RADIO COMPANY

179 Spruce Street Chelsea, Mass.

8JJ, 8KH, 8KJ, 8ON, 8PJ, 8RJ, 8RR, 8TX, 8UF, 8VQ, 8WX, 8WY, 8XE, 8YK, 8YY, 8ZD, 8ZN, 8ZO, 8ADG, 8ADZ, 8AFD, 8AIG, 8AIM, 8AMP, 8ANB, 8AOL, 8APV, 8AQC, 8AOV, 8ASV, 8ATC, 8ATN, 8AWZ, 8AXN, 8AZG, 8BDA, 8BDV, 8BEK, 8BEN, 8BEO, 8BFB, 8BFO, 8BFX, 8BGL, 8BJZ, 8BRQ, 8BRY, 8BXA, 8BXH, 8BXZ, 8BYO, 8CAA, 8CAB, 8CBC, 8CDZ, 8CFO, 8CGJ, 8CHB, 8CIK, 8CJC, 8CJZ, 8CKV, 8CLK, 8CON, 8COW, 8CPB, 8CPX, 8CPY, 8CRT, 8CUO, 8CVX, 8CXF, 8CXW, 8CYT, 8CYU, 8CZC, 8DAG, 8DAI, 8DAT, 8ZAF, Nines too numerous. Can.: 2AF, 3IN, 3JL, 3KO, 3NI, 3TA, 3ZS, 4AB, 4BV, 4CN, 4DK, 4DQ, 4HH, 9BF, 9BX.

JOHN F. PORTER, ALAMOGORDO, N. M.
(DET. 1 STEP)

1GM, 2JN, 3AA, 3EI, 3TA, 4AB, 4AC, 4AE, 4AW, 4IS, 4MA, 4MP, 4MT, 5AAA, 5AAC, 5AAR, 5ABR, 5ACD, 5AE, 5AEK, 5AET, 5AG, 5AJ, 5ATA, 5AM, 5AP, 5AS, 5ASM, 5AT, 5ATR, 5AW, 5CR, 5DM, 5EM, 5EN, 5EK, 5ES, 5ET, 5FF, 5GG, 5GN, 5GR, 5GW, 5IM, 5IN, 5JZ, 5KA, 5KC, 5LK, 5MA, 5MD, 5ME, 5MG, 5MK, 5MT, 5MW, 5NG, 5NK, 5NZ, 5PR, 5PY, 5QA, 5RA, 5RH, 5RM, 5RR, 5SA, 5SG, 5SM, 5SN, 5SS, 5ST, 5TK, 5TN, 5TR, 5TT, 5UA, 5UW, 5VG, 5WN, 5XAJ, 5XG, 5YF, 5ZA, 5ZAD, 5ZADA, 6AAA, 6AAR, 6AAW, 6ACC, 6ACF, 6ACO, 6AE, 6AFP, 6AFR, 6ALP, 6AP, 6AR, 6ARA, 6ARE, 6ARK, 6ARR, 6ART, 6AS, 6ASR, 6AST, 6ATN, 6BEZ, 6BIJ, 6BM, 6BUN, 6CAJ, 6CO, 6CR, 6EM, 6EN, 6IA, 6KA, 6MF, 6NI, 6OW, 6RA, 6RO, 6SS, 6ST, 6TC, 6TO of Hawaii, 6TR, 6UO, 6XC, 6ZZ, 7AD, 7AFW, 7AT, 7ATT, 7GD, 7HJ, 7MA, 7RK, 8NG, 8SM, 9AAL, 9AAR, 9AAT, 9ABB, 9ACO, 9ACR, 9ACV, 9AEB, 9AEC, 9AGE, 9AIS, 9AJ, 9ALR, 9AMF, 9AMU, 9AMW, 9AOD, 9AOG, 9AOI, 9AOJ, 9APR, 9AOK, 9ASA, 9ATK, 9AWA, 9AYV, 9BAV, 9BCJ, 9BCK, 9BED, 9BEJ, 9BJC, 9BJX, 9BKK, 9BSK, 9BSM, 9BST, 9BVI, 9BVZ, 9BXD, 9BXN, 9BXZ, 9CAK, 9CAL, 9CCA, 9CCN, 9CCV, 9CEO, 9CGC, 9CIS, 9CJM, 9CK, 9CMI, 9CNC, 9CR, 9CRE, 9CSA, 9CTK, 9CV, 9CWC, 9CWR, 9DAA, 9DAC, 9DAS, 9DHO, 9DSO, 9DXC, 9EA, 9EJ, 9EK, 9ET, 9GA, 9GG, 9GM, 9GR, 9GT, 9JI, 9KE, 9KH, 9KR, 9KL, 9LY, 9MA, 9MI, 9MR, 9ND, 9NI, 9OE, 9OO, 9OS, 9OO, 9RS, 9SA, 9SS, 9ST, 9TA, 9TC, 9TE, 9XAC, 9YA. New Calls heard, 9EAR, 9EAY, 9EBT, 9ECA.

8CFK PORT HURON, MICH., (1 TUBE)

Spark—9BOO.
CW—1RV, 1YD, 1ADT, 1AHZ, 1APJ, 1BRV, 2BM, 3MF, 3JG, 3YO, 3ACV, 3ADP, 3BMR, 3BTL, 4AG, 4FT, 4IK, 4JC, 5NQ, 5AEC, 7OL, 7ZL, 8AB (fone), 8FO, 8GP, 8HH, 8KJ, 8MZ, 8NB, 8OI, 8PU, 8QM, 8OO, 8SL, 8ZF, 8VO, 8VY, 8YN, 8ZA, 8ZO, 8ACT, 8AEA, 8AEG, 8AEM, 8AEM, 8AEY, 8AGR, 8AIW, 8ALF, 8ALN, 8AOG, 8AOP, 8APN, 8APT, 8ASX, 8ATN, 8ATX, 8AWN, 8AZO, 8BBE, 8BDB, 8BDM, 8BEO, 8BGT, 8BJS, 8BNY, 8BOT, 8BRT, 8BSF, 8BVW, 8BWA, 8CAG, 8CAN, 8CAV, 8CAZ, 8CCU, 8CDD, 8CJY, 8CPD, 8CRN, 8CVE, 8CXP, 8CYU, 8DAG, 8DAT, 9BJ, 9CE, 9DW, 9FP, 9IG, 9MO, 9OF, 9ON, 9OR, 9OF, 9SR, 9UL, 9US, 9UU, 9VM, 9WX, 9ZT, 9ZY, 9AAD, 9ABV, 9ADF, 9AEC, 9AEY, 9AFK, 9AMB, 9AMU, 9AOP, 9ARI, 9ARZ, 9ATC, 9ATI, 9AUA, 9AVC, 9AWF, 9AYL, 9BAK, 9BAM, 9BCE, 9BCE, 9BDR, 9BGE, 9BHI, 9BIF, 9BIL, 9BJK, 9BKH, 9BRI, 9BXC, 9BXM, 9BYC, 9BZI, 9CBF, 9CDB, 9CCV, 9CCX, 9CDU, 9CEV, 9CFI, 9CFK, 9CGD, 9CIN, 9CIT, 9CJC, 9CKM, 9CKX, 9CLO, 9CMN, 9CNV, 9CPY, 9CRY, 9CTE, 9CTG, 9CTV, 9CVG, 9CXC, 9CFZ, 9DAH, 9DAS, 9DCR, 9DGE, 9DGV, 9DHU, 9DOU, 9DTA, 9DUQ, 9DWF, 9DXC, 9DXM, 9DXN.

Canadian—3JL, 3NB, 3ADV.

4CA, RIO PIEDRAS, P. R.

CW—1AJH, 1AJP, 1BAS, 1BES, 1BET, 1BKA, 1BOE, 1BOQ, 1BWU, 1BU, 1BYU, 1CDR, 1CKM, 1CNF, 1CNK, 1CRO, 1II, 1IL, 1ZL, 2AJJ, 2ALN, 2ARS, 2AWS, 2BLF, 2BMR, 2BRU, 2BUE, 2CC, 2CCD, 2CCK, 2CIM, 2CKA, 2CM, 2CMV, 2FP, 2HK, 2JTO, 2NZ, 2OM, 2PZ, 2RF, 2TB, 2WR, 2ZC, 2ZL, 3AJJ, 3APB, 3AQR, 3ARO, 3AS, 3BEC, 3BFU, 3BIJ, 3BJ, 3BLF, 3BO, 3BRU, 3BVA, 3BVJ, 3CC, 3CCC, 3CCD, 3FH, 3FS, 3HD, 3IDT, 3II, 3IL, 3JT, 3KM, 3OT, 3TJ, 3WAR, 4BX, 4DA, 4EA, 4EH, 4EL, 4FT, 4IZ, 4JE, 4JY, 4JZ, 4KM, 4OI, 4YA, 4YD, 5ABY, 5EA, 5FV, 5JT, 5KC, 5KTA, 5MD, 5ND, 5YA, 5ZAR, 5ZC, 5ZS, 6ABX, 8ADZ, 8AFV, 8AIC, 8AIM, 8ALT, 8ASC, 8AWZ, 8BCH, 8BFG, 8BRT, 8BYO, 8BYO, 8CBX, 8CDD, 8COO, 8CUU, 8ER, 8FG, 8FU, 8IY, 8LF, 8LS, 8MZ, 8RV, 8UC, 8UE, 8UF, 8US, 8YD, 8ZO, 9ABY, 9AFT, 9AJH, 9AI, 9AMT, 9APY, 9AR, 9BCH, 9BCY, 9BJ, 9BJH, 9BRE, 9BRK, 9BZ, 9CCM, 9CCN, 9CD, 9CHE, 9CJC, 9CT, 9CTE, 9CFZ, 9DAH, 9DIO, 9DKY, 9DRI, 9DVK, 9EP, 9II, 9LP, 9OR, 9PS.

MAJOR A. W. FORD, CHICAGO, ILL.
KDKA, KDYX, KSD, KGN, KYW, WAEF, WBAP, WCAJ, WCAU, WCZ, WDAF, W DAN, WDAP, WEA, WFAA, WHG, WGN, WGY, WHAS, WHAZ, WHB, WIAO, WJAZ, WJX, WLAG, WHAQ, WOC, WOR, WSB, WWJ, CFCA, KHJ.

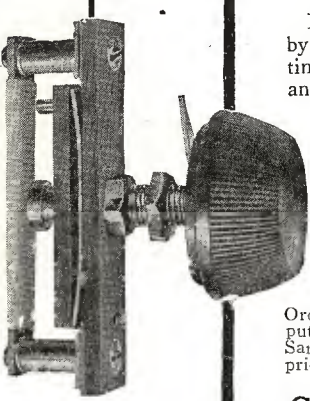

Adjustable Grid Leak (with condenser)
Construction Fully Patented

Kill the "Squeal"

Equip your set with a CRL Adjustable Grid Leak and, by getting the benefit of your full signal strength at all times, you'll be able to tune a little sharper and kill that annoying "squeal."

CRL Adjustable Grid Leaks

are not of the pencil-mark type but are built with a permanent resistor strip, so arranged that a turn of the polished black knob will provide just the right amount of resistance desired. The entire construction, which is fully patented is far superior to any now on the market.

Retail Prices in U.-S. A.

No. 106 (without condenser)\$1.50
No. 107 (with grid condenser) 1.85

Order from your dealer or, if he has none in stock, we'll gladly put you in touch with our nearest Factory Representative. Samples may be obtained direct from the Factory for the retail price plus 10c for packing and postage.

CENTRAL RADIO LABORATORIES

303-16th Street
MILWAUKEE WISCONSIN

WALNART Trouble-Proof RADIO Apparatus

The New Walnart Condensers

New patented construction prevents sagging and loosening. Guaranteed trouble-proof, cannot get out of line because stator plates are inserted into supporting studs at 3 points and firmly locked by punch-press. Plates of 20 gauge, high conductor aluminum. Strongest, most durable and finest tuning adjustment. Bake-lite end plates. Electric break-down tested. You can pay more, but you cannot buy more service and quality. Vernier type, for extra fine tuning, includes Vernier Knob and extra plate.

| LIST PRICES | | | |
|---------------|------------------|------------|--------------|
| No. of Plates | Micro F Capacity | Plain Type | Vernier Type |
| 3 | .0006 | \$1.50 | — |
| 5 | .0010 | 1.60 | — |
| 13 | .0025 | 2.25 | \$4.25 |
| 23 | .0005 | 3.25 | 5.00 |
| 43 | .001 | 4.00 | 6.00 |

WALNART ELECTRIC MFG. CO.

Dept. 206 1251-5 W. Van Buren Street, CHICAGO

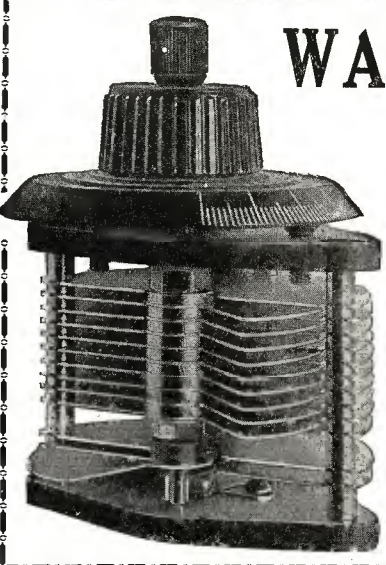

RUSSELL DAVIS, SPOFFORD, TEXAS
(ONE TUBE)
WWJ, KSD, WHB, WOC, WOS, KYW, KHJ,
KFAF, WAAC, WEAY, WBAP, WFAA, WOAI,
WSB, WHAS, WAAW, KOB, WKY, WGM.
HOWARD ROHN, COLUMBUS, OHIO

(CRYSTAL)
WGY, KDKA, WSY, WOR, WHAQ, WOC,
WDAF, WGM, WHB, WBAP, WWI, WHAS,
KYW, WHAZ, WJZ, WHK, WOH, WID,
WCAH, WBAV, WEAQ, WPAL, WMAN,
WVZ.

H. R. GRASSKOPF, SAN ANTONIO, TEXAS
(ONE TUBE)
WAAJ, WGY, WBAP, WHAG, WWJ, WJAZ,
KOG, PWA, WHAS, KSD, WHB, WDAF,
KFAF, WAAC, WOI, WOC, WCAT, WOS.

DAVID NASH, PITTSBURGH, PA.
(ONE TUBE)
Local—KDKA, KOV, WJAS, WCAE.
Distant—WHB, WSB, WOH, WIZ, WDAP,
KYW, WMAQ, KSD, WGY, WEAP, WBAY,
WBAN, WOR, WOC, WHAS, WHAZ, WWJ,
KOP, WCX, 2XI, WRA, WHK, WJAX, KADD,
SALO, 4PKO, WBT, WFDA, WJAF, KYZ,
WBAB, WGM, 3XW.

NOEL KEEFER, ANDREWS, INDIANA
(CRYSTAL)
8WH, KDKA, KSD, KYW, NOF, PWX,
WBAP, WCAE, WCX, WDAF, WDAJ, WDAP,
WEAF, WGAZ, WGM, WGY, WHA, WHAS,
WHAY, WHAZ, WHB, WIAQ, WJAF, WJAF,
WJZ, WIAG, WLK, WLW, WMAK, WMAQ,
WOC, WOH, WOS, WOR, WOZ, WSB, WWJ.

ROBERT COLE, ROCKFORD, MICH.
(ONE TUBE)
WSY, WEAP, KFAF, KLZ, DN4, KHJ,
WQB, WDM, NOF, WEAF, WDAL, WSB,
WGM, WDAJ, WGAK, WOH, WLK, WGAZ,
KYW, WJAZ, WDAP, WGA, WBU, WGAS,
WAAF, WHAQ, WJAN, WOC, WOI, WGF,
WAAA, WOAS, WZAF, WAAP, WAAS, WBL,
WHAS, WQAR, WAAC, WQAF, WWJ, WCX,
KOP, WWJ, WKAR, WHAL, WHAX, WAAL,
WLAG, WLB, WCE, WAAH, WCAL, WJAP,
WMAI, KSD, WEW, WCK, WHB, WOS, WBZ,
WNAC, WMAF, WGO, WHAU, WDAG, WBT,
WMAH, WNAZ, WNAL, WAAW, WEAF,
WWZ, 2XI, WGY, WMAK, WGY, WJZ,
WHAM, WHAF, WMAC, WDAB, WLW, WHK,
WBB, WBAJ, WFO, WAG, WCAQ, WBAL,
WKG, WMAI, WDAV, KDKA, WPB, WCAE,
WCAE, WOO, WIP, WFO, WCAU, WQAA,
WEAN, WEAJ, WFAZ, WKN, WNAV, WBAP,
WPA, WFAA, WCM, WJAZ, WEAG, WKAL,
KZN, WLAJ, WCAG, WAAK, WHAD, WQAO,
WHA, WJZ, WOR, 2XAI, WWS, 9XI, 8XS,
9GG, 2OAG, WIOG.

DELTA

GOLD STRIPE RADIO HEADSET

Pronounced
the **BEST** by
all users—
Both in Qual-
ity and in
Price—Fact
is **DELTA** is
the **BEST**
Headset at
any price.



Reproduces
Clearly and
Naturally.
There's no
"fuzz" or
"tinny tone."
DELTA Head-
sets are known
to be extreme-
ly sensitive.
**ORDER SAM-
PLES TODAY.**

DELTA ELECTRIC COMPANY

470 DELTA BLOCK, **MARION INDIANA** MARION, INDIANA



Standard Makers of Radio Apparatus, Bicycle Lamps, Auto Spotlights,
Lanterns, Flashlights and All Kinds of Dry Batteries.

NEW YORK **SAN FRANCISCO** **WINNIPEG**

REDUCED PRICES

| | Regular Price | Our Price | | Regular Price | Our Price |
|---------------------------------------|---------------|-----------|---------------------------------------|---------------|-----------|
| Radiotrons UV 200 | \$ 5.00 | \$ 4.00 | Ammeter Jewell 0-1 D. C. | \$ 7.50 | \$ 5.25 |
| Radiotrons UV 201 | 6.50 | 5.20 | Ammeter Jewell 0-5 Thermo | 12.00 | 8.40 |
| Radiotrons UV 201 A | 6.50 | 6.00 | Ammeter Jewell 0-7½ Thermo | 12.00 | 8.40 |
| Radiotrons WD-11 | 6.50 | 5.90 | Ammeter Jewell 0-10 Thermo | 12.00 | 8.40 |
| Radiotrons UV 202 | 8.00 | 7.20 | Voltmeter Jewell 0-15 A. C. | 7.50 | 5.25 |
| Radiotrons UV 203 | 30.00 | 27.00 | Voltmeter Jewell 0-10 D. C. | 7.50 | 5.25 |
| Audio Amplifying Transformers UV 712 | 7.00 | 5.30 | Thompson Levering Variometer | 6.00 | 4.20 |
| Radio Amplifying Transformers UV 1714 | 6.50 | 5.30 | Sleeper Variometer Moulded | 7.50 | 4.75 |
| Baldwin Phones | 12.00 | 9.00 | Atwater-Kent Variocoupler | 8.50 | 6.80 |
| Western Electric Phones | 12.00 | 9.60 | 3" Dial and Knob Moulded | .90 | .44 |
| Brandes Superior Phones | 8.00 | 6.25 | 4" Dial and Knob Moulded | 1.50 | .91 |
| Western Electric Loud Speaker | 55.00 | 45.00 | Variable Condenser Unmounted, .001 MF | 4.00 | 2.80 |
| Western Electric Loud Speaker | 161.00 | 129.00 | Black Formica Panels 19x6½x3/16" | 3.80 | 2.60 |
| Western Electric 216A Tubes | 12.00 | 9.60 | African Mahogany Cabinets 19x6½x6¾" | 11.00 | 6.10 |
| Eveready 22½-volt B Battery 766 | 3.00 | 1.80 | Black Formica Panels 19x8x¼" | 4.62 | 3.31 |
| Eveready 45-volt B Battery 767 | 5.50 | 3.30 | African Mahogany Cabinets 19x8x6¾" | 10.50 | 7.10 |
| Bradleystats | 1.85 | 1.65 | Porcelain Antenna Insulator 2½" diam. | .25 | .08 |
| Magnavox R-3 | 45.00 | 37.50 | No. 14 Bare Copper Wire, per ft. | .01 | ½c |
| Storage Battery 6-volt 110 amp. hour | 20.00 | 16.00 | No. 12 Tinned Copper Wire, per ft. | .02 | .01 |
| Homecharger | 18.00 | 16.00 | R. C. Rheostats PR 536 | 3.00 | 2.40 |
| Tungar Charger 2 Amp. | 18.00 | 16.90 | R. C. Potentiometers | 2.00 | 1.65 |
| Tungar Charger 5 Amp. | 28.00 | 25.90 | Open Jacks | .70 | .45 |
| Ammeter Jewell 0-100 Milliamp. D. C. | 7.50 | 5.25 | Two Circuit Jacks | 1.00 | .70 |
| Ammeter Jewell 0-250 Milliamp. D. C. | 7.50 | 5.25 | Plug, two pairs phones | 1.50 | 1.00 |
| Ammeter Jewell 0-500 Milliamp. D. C. | 7.50 | 5.25 | Antenna Protector UQ1310 | 2.00 | 1.60 |

ALL NEW MATERIAL IMMEDIATE SHIPMENTS

No C. O. D.'s. Add Parcel Post

Offered Subject to Prior Sale

J. GEIGER Suite 612, Candler Building
TIMES SQUARE, NEW YORK CITY

Miraco Gets 'em 1500 Miles Away

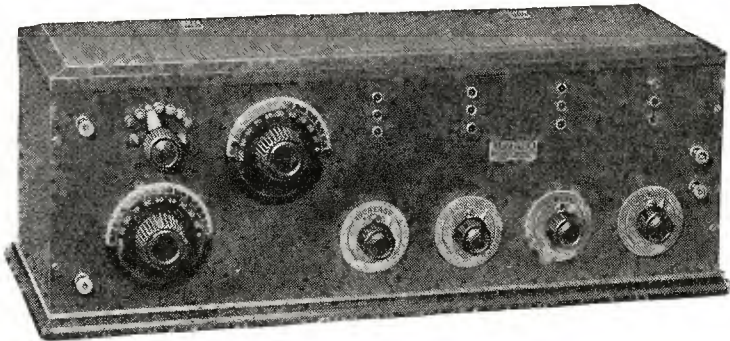

Users of the MIRACO Radio Frequency Broadcast Receiver report wonderful results. St. Louis hears Schenectady—Davenport hears Newark—Cincinnati hears San Francisco. Reception is clear and distinct, tuning is very sharp, and there's practically no interference. MIRACO sets may be used with either WD 11 tubes and 1½ volt dry cell or 6 volt tubes and 6 volt storage battery.

Order your MIRACO set TODAY and be sure to specify tubes to be used.

Retail Price — \$54.50

DEALERS—When you get our proposition in detail—you'll WANT TO PUSH THE MIRACO LINE.

AGENTS wanted everywhere.

THE MIDWEST RADIO CO.

804 Main Street

Cincinnati, Ohio

FRANCIS CONNELL, LINCOLN, NEB.

KZN, WAAF, WAAG, WAAP, WAAW, WAAZ, WBAH, WBAJ, WCAL, WCAV, WCX, WDAF, WOAP, WDAJ, WDV, WEAH, WFAA, WFAT, WFAV, WGF, WGM, WHAW, WHAF, WHAS, WHAZ, WHE, WHS, WIAK, WIAS, WIAZ, WJAB, WJAK, WKAC, WKN, WLK, WNL, WLW, WNAD, WOLA, WOC, WOH, WOI, CKCK, CFCA, 5AAZ, 7TU, 9YS, 9YBJ, 9AMF, KDKA, KFAF, KDYS, KHJ, KOB, KDS, KYW, WOS, WPL, WRR, WSE, WWJ.

MINTER SHERRITT, PLEASANT HILL, MO.
 WOI, WSB, WAAP, WAH, WDAX, WDAC, DD5, WDM, WDAP, WOH, WAAZ, WDAN, WOS, WDAF, WHB, WOO, WPE, WMAJ, KSD, WAAW, WGY, KDKA, WWJ, WDAO, WGX, WHAG, 9BHC, WWI, KDEN, 9NJ, WRR, WRK, KOP, WEH, WLW, WFAD, WCAO, WHAS, WOC, WAAL, WEY, WFAA, WGI, WIAT, WPA, KZN, WJAO, WEAB, DN4, WBL, WAAC, WDAY, 5XW, WHAB, WLB, KFAF, WFAV, WMAH, WDAK, WCM, WBAJ, WFG, WOAI, WHAV, WBAP, CIG, WMAQ, WIP, CKCK, 9CEE, WFAZ, WFAV, WOAJ, 5NS, 5ML, 5ADZ, 5MA, 5AJ, 9BEY, WKY, WJD, WLAS, WJAG, WCAE, WDAL, WNAF, WLAG, WDL, WCAL, 9CL, WLHA, KDOW, WAT, WDAJ, KLZ, WLK, 9ZAF, WEAY, WDAW, WIAK, KHJ, WCAZ, WGM, KWX, WBAH, WOK, WBN, KYW, WMAC, PWX, KUO, WAAF, 2XI, WMAK, WDAW, WJZ, 9BAH, 9BAG, WSAS, KJC, WEAJ, WNAV, WJAX, WMAZ, WKAR, WLAF, WIAT, WPAV, WKAC, 4AP, WJAP, WNAD, WBAC, WOAL, WPAG, CFCA, WNAS, 5NO, WNAP, WDAC, WSY, WAAS.

Radio Regulation in Cuba

(Continued from page 2077)

| Class | Wave length (meters) | Maximum power (Kilowatts) |
|---|----------------------|---------------------------|
| A*—Amateurs | 200 | ½ |
| B—Educational institutions experimenters... | 225-275 | ½ |
| C—Colleges State institutions in general | 300-360 | ½ |
| D—State institutions only | 400 | ½ to 1 |
| E—Meteorological stations only | 485 | ½ to 1 |

*All receiving sets are rated Class A, regardless of type or size.

RULES FOR REGISTRATION

All owners of stations coming within any of these five classes must register with the Director General of Communication before March 16, 1923. After that date no station may be used unless the proper permit has been issued by the office mentioned. The permits are for a term of one year in the case of classes A, B, and C, and for five years in the other two classes. Applicants must pass an elementary examination, but it is not believed that this requirement will in any way hamper the issuance of licenses. The decree further provides that the Government may, under specified circumstances require transmitting stations of any of the five classes to cease operation without claiming indemnity from the Government. Transmitting stations of any class are made subject to the regulations of the International Radio Convention signed in London in 1912. The decree also prohibits the transmitting of the international distress call S.O.S. either as a special signal or in the course of any general text. Penalties are provided for the disclosure of any public or government message intercepted by any station. Only apparatus capable of transmitting a pure, continuous wave may be used, and the frequency must be constant so as to avoid oscillation.

Dress Up Your Set with "PIONEERS"

And Watch It Perform

Pioneer Instruments will give your set a "class" that will make you the envy of all your set-owning friends, even before they hear it perform: And when you show them some real tuning: the stations coming in clear, strong, positive, clean-cut, they'll realize that you have discovered something very much worth while.

Variocoupler \$7.00
 Variometer 6.50

Look like well-dressed fashionable "twins," in their Circassian Walnut Bakelite Molded Shells, and rich green silk, (not cotton) wire-winding. Close-coupling and precision workmanship insure uniformly excellent results. Send for circular.

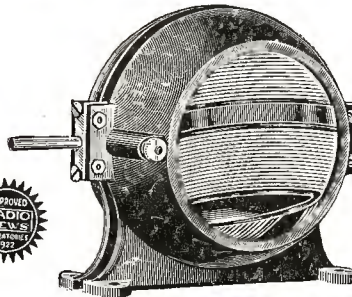

"Pioneer" Variometer
 Price, each, postpaid \$6.50

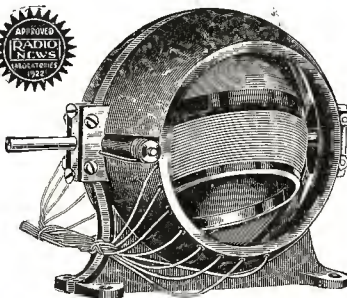

"Pioneer" Variocoupler
 Price, each, postpaid \$7.00

PIONEER RADIO CORPORATION

GALESBURG, ILL., U. S. A.

EISEMANN

RADIO UNITS
 Made to the highest electrical and mechanical standards.
 EISEMANN MAGNETO CORP'N
 Chicago BROOKLYN, N. Y. Detroit

KLOSNER RADIO PRODUCTS

Send for free literature.
 KLOSNER IMPROVED APPARATUS CO.
 2024 BOSTON ROAD NEW YORK CITY

MORE SPEED WANTED

Despite the general use of radio and the millions of fans informed as to the reception of broadcasts, some remain ignorant of possibilities. The other day in the National Press Club, one member suggested that the set be "speeded up," saying the music coming in was "too slow."

Recommendations of the National Radio Committee

(Continued from page 2079)

ference that the Secretary of Commerce in licensing stations has the authority under the present law to regulate hours and wave-lengths of operation of stations, and to revoke or withhold licenses of stations when such action is necessary to prevent interference detrimental to the public good.

The committee also urged that the fullest co-operation be given by those who operate broadcasting stations and by the public with the Department of Commerce in the co-operative adjustment of local broadcasting problems in order to realize the fullest possibilities of the recommendations outlined.

The following is the membership of the Radio Committee:

Maj.-Gen. George O. Squier, War Department.

Com. D. C. Bingham, U. S. N., Navy Department.

W. A. Wheeler, Department of Agriculture.

John W. Sutherin, Post Office Department.

F. P. Guthrie, United States Shipping Board.

Edwin H. Armstrong, Columbia University, New York.

Dr. Alfred N. Goldsmith, Secretary, Institute of Radio Engineers.

Prof. L. A. Hazeltine, Stevens Institute of Technology.

John V. L. Hogan, Consulting Radio Engineer, New York.

C. B. Cooper, C. B. Cooper Company, New York.

Hiram Percy Maxim, President, American Radio Relay League.

Prof. C. M. Jansky, University of Minnesota.

A. H. Griswold, American Telegraph and Telephone Company.

Leo Fitzpatrick, Radio Editor, Kansas City Star.

D. B. Carson, Department of Commerce, Bureau of Navigation.

W. D. Terrell, Department of Commerce, Bureau of Navigation.

J. H. Dellinger, Department of Commerce, Bureau of Standards.

L. E. Whittemore, Department of Commerce, Bureau of Standards.

L. J. Heath, Treasury Department.

RECOMMENDED WAVE ALLOCATIONS

| Wave Frequency, Kilocycles per second | Wave Length, Meters | Service |
|---------------------------------------|---------------------|---|
| Above 2300 | Below 130 | Reserved. |
| 2300 | 130 | Government, C.W., exclusive. |
| 2300 | 130 | Reserved. |
| 2100 | 143 | |
| 2100 | 143 | Government, C.W., exclusive. |
| 2100 | 143 | Reserved. |
| 2000 | 150 | |
| 2000 | 150 | Amateur, C.W., I.C.W., Ph., exclusive. |
| 1700 | 176 | |
| 1700 | 176 | Special Amateur, C.W., I.C.W., Ph., Spk., exclusive. |
| 1500 | 200 | |
| 1500 | 200 | Special amateur, and technical training schools, C.W., exclusive. |
| 1350 | 222 | |

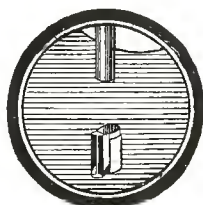
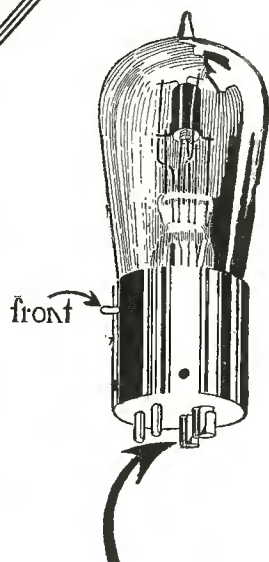

CAUTION

Do not force fuse on filament terminals. If contact solder is rough, file or sand-paper down so that fuse slips on easily. Filament terminals are the two farthest from the locking projection on base of tube.

Different tubes require different capacity fuses. When ordering state exactly what tube fuses are for.

Inviting Calamity

You are waving \$5 or more in the face of Misfortune every second you operate without the

RADECO SAFETY FUSE

(Patent Pending)

—a needless risk when this tiny device makes it absolutely impossible for you to “blow” out a tube, even by accident.

The RADECO Safety Fuse, the only fuse that gives absolute protection for vacuum tubes, fits directly on the filament terminals of the tube itself where excess current simply cannot get by.

Attached in a second, the RADECO Safety Fuse does not affect the efficiency of your set. Fits any standard bulb, used in any standard socket. Special sizes for

WD11, WD12 or 201A, 50c. each

For other tubes, 4 for \$1

In standard packages

Buy at your dealers' or by mail

NEW STYLE PHONE ADAPTERS

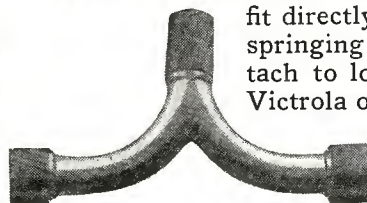

fit directly on phones without springing headpiece and attach to loud speaker of \$2 Victrola or Grafonola -

Add postage on 2 lbs.

RADIO EQUIPMENT CO.

630 WASHINGTON ST., BOSTON, MASS.

New England's Oldest Exclusive Radio House

“ALL SENSITIVE” A REAL 100% CRYSTAL ELIMINATES all your TROUBLES



Awarded Highest Honors
RADIO NEWS, EVENING MAIL, N.Y. TRIBUNE

At All Reliable Dealers

GALENA CRYSTAL MFG. CO.

2894 Fulton Street, Brooklyn, N. Y.
Dealers write us for Special Offer

Super-Sensitiveness!



THE crystal is the “bull’s-eye” of your crystal receiving set. Unless it is super-sensitive you are wasting time and entertainment and cannot “hit” the combination for best results. Insist upon the genuine original Arlington Tested NAA Detector Minerals. They are carefully selected from bulk stock, individually tested and guaranteed super-sensitive.

Galena, Silicon or Goldite price per crystal, 25c. Same mounted in brass cup, 40c. Obtainable at your dealer's or sent direct (post-paid) on receipt of price..

The Newman-Stern Co.

Newman-Stern Building

Cleveland

ATWATER KENT

Receiving Sets and Parts

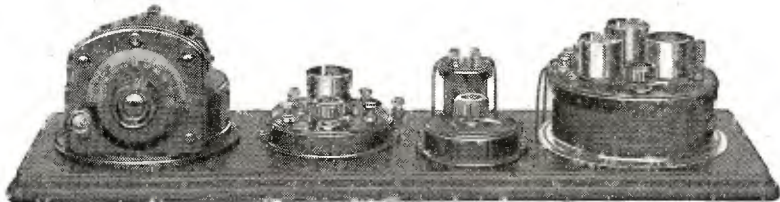

This is one of several sets made up in various combinations of parts. All sets and parts are described in an illustrated folder.

ATWATER KENT sets and parts are ideal for summer use due to their compact and rugged construction and the fact that they are moisture-proof. They are made mostly of condensite and are thoroughly water-proofed.

They sell on appearance; they stay sold on quality of performance.

Send for the illustrated folder

ATWATER KENT MANUFACTURING COMPANY

4943 STENTON AVE. Radio Dept. PHILADELPHIA, PA.

MAKE PERFECTION YOUR SELECTION

Every Product Sold on A MONEY-BACK GUARANTEE—Perfection Pays Parcel Post.

| LOUD SPEAKERS | | List Price | Our Price | VARIOMETERS | | List Price | Our Price |
|---|-------|------------|-----------|--|-------|------------|-----------|
| Bristol | | \$22.50 | \$17.50 | Fisher Mahogany | | \$5.00 | \$2.50 |
| Pathe | | 22.00 | 17.50 | Franco Mahogany | | 5.00 | 2.50 |
| Magnavox | | 45.00 | 28.75 | Pathe Moulded | | 6.00 | 3.50 |
| Woodchorn, Newest Model | | 7.50 | 5.95 | Eagle, Red Moulded Bakelite | | 8.00 | 5.50 |
| Western Electric Type 10B | | | 55.00 | | | | |
| HEAD SETS | | | | VARIOCOUPERS | | | |
| Rico, 3000 ohms | | \$7.00 | \$4.25 | Franco Mahogany, Silk Wound, Fibre Tubing | | \$5.00 | \$2.25 |
| Dictograph, 3000 ohms | | 12.00 | 5.95 | Fisher Mahogany | | 5.00 | 2.50 |
| Baldwin Type C, Nath. Baldwin | | 12.00 | 9.75 | Fisher, 180 Degrees | | 5.00 | 2.50 |
| Baldwin Single Phone Type C | | 6.00 | 4.45 | Pathe, Moulded, Silk Wound | | 6.00 | 3.50 |
| N & K, 6000 ohms, made in Germany. The best phones made | | 16.00 | 6.50 | Eagle, Moulded, Red Bakelite, the Best Made | | 8.50 | 5.75 |
| | | | | Franco, 180 Degrees, Bakelite, Silk Wound | | 5.00 | 2.75 |
| TRANSFORMERS | | | | BATTERIES | | | |
| Thordarson Audio Frequency | | \$4.50 | \$3.25 | Exide "A" Storage Battery, 6 V., 80 Ampere Hours, Type 3 LXL-9 | | \$23.10 | \$19.00 |
| WD-12 Audio Frequency | | 5.00 | 4.00 | Exide "A" Storage Battery, 6 V., 120 Ampere Hours, Type 3 LXL-13 | | 31.50 | 25.00 |
| Aemie Type A2S | | 5.00 | 4.25 | Bright Star "B" Battery, 2 1/2 V. | | 1.75 | 1.10 |
| | | | | Bright Star "B" Battery, 5 Positive Terminals, 2 1/2 V., Variable | | 3.00 | 2.00 |
| | | | | Bright Star "B" Battery, 7 Positive Terminals, 4 1/2 V., Variable | | 5.00 | 3.50 |
| VARIABLE CONDENSERS | | | | MISCELLANEOUS | | | |
| Franco, 43 Plate, Variable, with Vernier | | \$7.70 | \$4.45 | Homecharger, DeLuxe Model, for Alternating or Direct Current | | \$18.50 | \$14.95 |
| 23 Plate, Moulded Ends, .0015 | | 3.00 | 1.50 | Post Electric Soldering Iron | | 6.00 | 4.75 |
| 43 Plate, Moulded Ends, .001 | | 4.00 | 2.00 | | | | |
| Franco, 23 Plate, Variable, with Vernier | | 6.60 | 3.95 | PANELS (3/16 inch thick) | | | |
| | | | | Hard Rubber, Unbreakable, 7 x 10, Now | | \$0.85 | |
| FILAMENT RHEOSTATS | | | | Hard Rubber, Unbreakable, 7 x 18, Now | | 1.50 | |
| Moulded, Fada Type, 6 ohms, 1 1/2 Amperes | | \$1.00 | \$0.40 | Hard Rubber, Unbreakable, 7 x 24, Now | | 1.95 | |
| Klosner, Vernier | | 1.50 | .75 | Bakelite, 7 x 10 | | 1.25 | |
| Ameco Potentiometers, 360 ohms Resistance | | 1.75 | 1.00 | Bakelite, 7 x 18 | | 2.25 | |
| | | | | Bakelite, 7 x 24 | | 3.25 | |
| JACKS | | | | RECEIVING SETS | | | |
| Firco Open Circuit | | \$0.70 | \$0.35 | \$50.00 Tuska Regenerative Armstrong Circuit One Tube Set, Special | | \$22.50 | |
| Firco Closed Circuit | | .85 | .45 | 125.00 Cutting & Washington 3 Tube Regenerative Armstrong Circuit Set, Will Receive Over 2000 Miles, Special | | 59.50 | |
| PLUGS | | | | | | | |
| Flat Plugs | | \$1.00 | \$0.50 | | | | |
| Round, Bulldog Grip | | 1.25 | .60 | | | | |
| DIALS AND KNOBS | | | | | | | |
| 3" Composition Dial and Knob, 1/4" Brass Bushing | | \$0.75 | \$0.30 | | | | |
| 3 1/2" Unbreakable Dial and Knob, 1/4" Hole | | 1.00 | .50 | | | | |
| 4" Composition Dial and Knob, 1/4" Hole | | 1.25 | .50 | | | | |
| 3" Composition Dial, and Knob, 1/4" Hole, Tapered Knob | | 1.00 | .40 | | | | |
| V. T. SOCKETS | | | | | | | |
| Single Sockets, Brass Tubing | | \$1.00 | \$0.40 | | | | |
| Double Sockets, Brass Tubing | | 2.00 | .90 | | | | |
| Triple Sockets, Brass Tubing | | 3.00 | 1.35 | | | | |
| Single Sockets, Red Moulded Condensite | | 1.00 | .55 | | | | |
| WD-11 Sockets, Extra Fine Quality | | 1.00 | .35 | | | | |

Perfection Radio Corp. of America

123 WEST 23rd STREET

NEW YORK CITY

Stores also located at 59 Cortland Street and 128 Chambers Street, New York City.

DENVER
COLORADO
REYNOLDS RADIO CO.
1534 Glenarm St.
LARGE RADIO DISTRIBUTORS

RADIO HEAD SETS
TRIMM PROFESSIONAL
Retail for \$7.65
DEPENDABLE
Retail for \$5.00
TWO WONDER VALUES
TRIMM RADIO MFG. CO.
Dept. 43, 24-30 S. Clinton St. Chicago, Ill.

| | | |
|------|------|---|
| 1350 | 222 | Aircraft, C.W., I.C.W., Ph, |
| 1300 | 231 | non-exclusive. |
| 1350 | 222 | Class B broadcasting, Ph, |
| 1050 | 286 | non-exclusive. (See Note 1.) |
| 1050 | 286 | Reserved. |
| 1040 | 288 | |
| 1040 | 288 | Class A broadcasting, Ph, |
| 1000 | 300 | exclusive. (See Note 2.) |
| 1000 | 300 | Marine, C.W., I.C.W., Spk., non-exclusive. (See Note 3.) |
| 1000 | 300 | Class A broadcasting, Ph, exclusive. (See Note 2.) |
| 667 | 450 | Marine, C.W., I.C.W., Spk., exclusive. (See Note 4.) |
| 667 | 450 | Class A broadcasting, Ph, exclusive. (See Note 2.) |
| 550 | 545 | Marine and aircraft, C.W., I.C.W., Spk., exclusive. |
| 500 | 600 | Marine and aircraft, C.W., I.C.W., excl. (See Note 3.) |
| 500 | 600 | Marine and aircraft, C.W., I.C.W., Spk., exclusive. |
| 445 | 674 | Government, C.W., non-excl. |
| 445 | 674 | Marine and aircraft, C.W., I.C.W., Spk., exclusive. |
| 375 | 800 | I.C.W., Spk., exclusive. |
| 375 | 800 | Radio compass, C.W., I.C.W., Spk., exclusive. |
| 375 | 800 | Marine, Ph, exclusive. |
| 315 | 952 | Government, C.W., I.C.W., Spk., exclusive. |
| 315 | 952 | Reserved. |
| 300 | 1000 | Radio beacons, C.W., I.C.W., Spk., exclusive. |
| 300 | 1000 | Reserved. |
| 285 | 1053 | |
| 285 | 1053 | Marine, Ph., exclusive. |
| 275 | 1091 | Government, C.W., I.C.W., non-exclusive. |
| 275 | 1091 | Marine, Ph., exclusive. |
| 250 | 1200 | Government, C.W., I.C.W., non-exclusive. |
| 250 | 1200 | Marine, Ph., exclusive. |
| 250 | 1200 | Marine, Ph., exclusive. |
| 235 | 1277 | University, college, and experimental, C.W., I.C.W., exclusive. |
| 230 | 1304 | Government, C.W., I.C.W., Spk., exclusive. |
| 190 | 1579 | Marine and point-to-point, non-government, C.W., I.C.W., Spk., exclusive. |
| 120 | 2500 | Government, C.W., I.C.W., Spk., exclusive. |

NOTES

Note 1.—Not more than six C.W. amateur stations to be licensed to use wave frequencies above 1050 kc/s (wave-lengths below 286 meters), for communication across natural barriers.

Note 2.—A class A broadcasting station is a station of sufficient power to serve an extensive territory. Fifty territorial wave frequencies approximately 10 kc/s apart are to be assigned by Department of Commerce to local areas throughout the United States without duplication. The ten such areas within each of five national zones are to have wave frequencies separated by approximately 50 kc/s.

Note 3.—The 1000 and 500 kc/s (300 and 600 meter) waves are for calling and distress purposes, with a minimum of traffic.

DESIGN AND CONSTRUCTION OF AUDIO AMPLIFYING TRANSFORMERS

Radio and Audio Frequency Type
This book will be of great interest to all radio amateurs. The transformers have never before been described in print. The possessor of vacuum tubes cannot afford to do without this book. It will enable him to build the necessary amplifying transformers very readily. The book is printed on good paper and has an attractive cover in two colors. Paper bound. Size, 5 inches by 7 inches. Contains many illustrations, diagrams and working data.
Price 25 Cents Postpaid

EXPERIMENTER PUBLISHING CO.
53 Park Place New York City

Note 4.—Mobile service on the 667 kc/s (450 meter) wave is to be stopped between 7 and 11 p. m. local standard time, and to be transferred in so far and as soon as practicable, to wave frequencies between 500 and 375 kc/s (wave-lengths between 600 and 800 meters).

Complete List of Broadcasting Stations in the United States

(Continued from page 2096)

| Call | Name | City and State |
|-------|---|---------------------|
| WMAF | Round Hills Radio Corp., | Dartmouth, Mass. |
| WMAJ | Tucker Electric Co., | Liberal, Kans. |
| WMAH | General Supply Co., | Lincoln, Nebr. |
| †WMAJ | Drovers Telegram Co., | Kansas City, Mo. |
| WMAK | Norton Laboratories., | Lockport, N. Y. |
| WMAJ | Trenton Hardware Co., | Trenton, N. J. |
| †WMAJ | Beaumont Radio Equipment Co., | Beaumont, Texas |
| WMAN | Broad St. Baptist Church, | Columbus, Ohio |
| WMAJ | Utility Battery Service., | Easton, Pa. |
| WMAQ | The Fair Corp. & Chicago Daily News | Chicago, Ill. |
| WMAJ | Waterloo Electrical Supply Co., | Waterloo, Iowa |
| †WMAJ | Paramount Radio Corp., | Duluth, Minn. |
| †WMAJ | Alabama Polytechnic Inst., | Auburn, Ala. |
| WMAJ | Wahpeton Electric Co., | Wahpeton, N. Dak. |
| WMAJ | K & K Radio Supply Co., | Ann Arbor, Mich. |
| WMAJ | Kingshighway Presbyterian Church, | St. Louis, Mo. |
| WMAJ | Mercer University..... | Macon, Ga. |
| WMAJ | Auburn Electrical Co., | Auburn, Me. |
| †WMAJ | Precision Equipment Co., | Cincinnati, Ohio |
| WMAJ | Doubleday-Hill Electric Co., | Washington, D. C. |
| WMAJ | Park City Daily News, | Bowling Green, Ky. |
| WMAJ | Shepard Stores..... | Boston, Mass. |
| WMAJ | Oklahoma Radio Engineering Co., | Norman, Okla. |
| †WMAJ | Enid Radio Distributing Co., | Enid, Okla. |
| WMAJ | Rathert Radio & Electric Shop, | Cresco, Iowa |
| WMAJ | Wilkes-Barre Radio Repair Shop, | Wilkes-Barre, Pa. |
| WMAJ | Benson Co..... | Chicago, Ill. |
| WMAJ | Manhattan Radio Supply Co., | Manhattan, Kan. |
| WMAJ | R. J. Rockwell..... | Omaha, Nebr. |
| WMAJ | Ideal Apparatus Co., | Evansville, Ind. |
| WMAJ | Syracuse Radio Telephone Co., | Syracuse, N. Y. |
| WMAJ | Wittenberg College., | Springfield, Ohio |
| WMAJ | Charleston Radio Electric Co., | Charleston, S. C. |
| WMAJ | C. C. Rhodes..... | Butler, Mo. |
| WMAJ | Texas Radio Corp. & Austin Statesman | Austin, Tex. |
| WMAJ | Lennig Bros. Co., | Philadelphia, Pa. |
| WMAJ | Peoples Telephone & Telegraph Co., | Knoxville, Tenn. |
| WMAJ | Peninsular Radio Club, | Fort Monroe, Va. |
| WMAJ | Dakota Radio Apparatus Co., | Yankton, S. D. |
| WMAJ | Ship Owner's Radio Service, | Baltimore, Md. |
| WMAJ | Shotton Radio Mfg. Co., Inc., | Albany, N. Y. |
| WMAJ | Wireless Telephone Co. of Hudson County, N. J., | Jersey City, N. J. |
| WMAJ | Dr. Walter Hardy..... | Ardmore, Okla. |
| WMAJ | Valley Radio..... | Grand Forks, N. D. |
| WMAJ | Maus Radio Co..... | Lima, Ohio |
| WMAJ | Friday Battery & Elec. Co., | Sigourney, Iowa |
| WMAJ | Midland College..... | Fremont, Nebr. |
| WMAJ | Tyler Commercial College, | Tyler, Texas |
| WMAJ | Apollo Theatre..... | Belvedere, Ill. |
| WMAJ | Palmetto Radio Corp., | Charleston, S. C. |
| WMAJ | Southern Equipment Co., | San Antonio, Tex. |
| WMAJ | Ervin Electrical Co., | Parsons, Kan. |
| WMAJ | Collins Hdwe. Co., | Frankfort, Ky. |
| WMAJ | Wm. E. Woods, Webster Groves, Mo. | Lawrenceburg, Tenn. |
| WMAJ | Vaughn Conservatory of Music, | Lawrenceburg, Tenn. |
| WMAJ | Lyradion Mfg. Co., | Mishawaka, Ind. |
| WMAJ | Kalamazoo College., | Kalamazoo, Mich. |
| WMAJ | Portsmouth Radio Assoc., | Portsmouth, Va. |
| WMAJ | Henry P. Lundskow., | Kenosha, Wis. |
| WMAJ | Bailey's Radio Shop, | Middletown, Conn. |

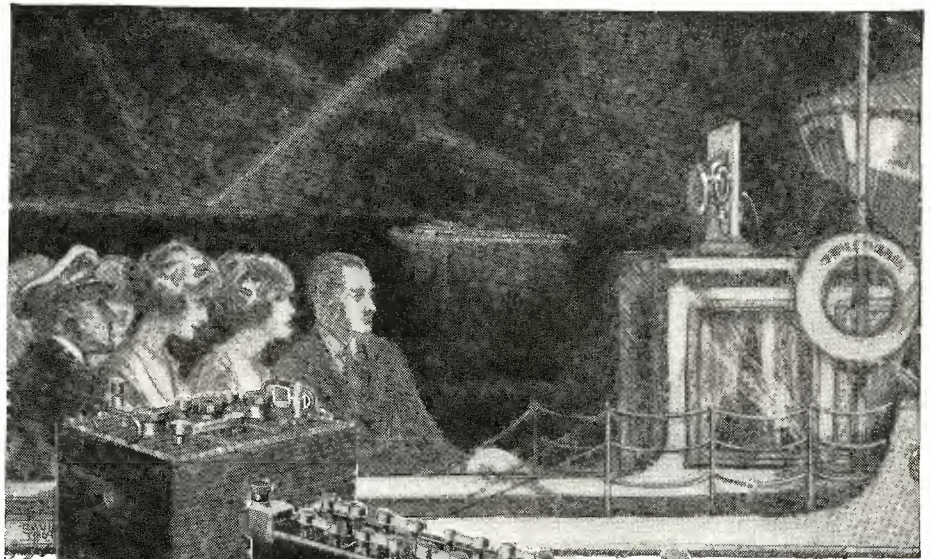

Many summer radio difficulties are often traceable to inefficient batteries rather than to static or instruments.

Westinghouse Radio Batteries, with their superior construction and engineering principles, give you that steady, noiseless, full-powered, even-discharging current so essential to real radio results. They last indefinitely and can be re-charged repeatedly. They are not only the most satisfactory, but the most economical in the long run. Sold by radio dealers and Westinghouse Battery Service Stations everywhere.

Westinghouse "A" Batteries. Slow discharge; long life; 4, 6, 8 volt sizes with 5, 9, and 13 plates per cell to meet various filament requirements. \$16.75 up.

Westinghouse "B" Batteries. The Westinghouse 22-MG-2 (22 volts) is a marvel for positive, quiet, full-powered service. Glass case; visible interior; sealed-in tops. \$8.00. Other styles, too.

WESTINGHOUSE UNION BATTERY CO.
Swissvale, Pa.

WESTINGHOUSE

Radio "A," "B" and "C"

BATTERIES

LOUD SPEAKER FOR ANY CRYSTAL SET

By using the STEINMETZ amplifier you can fill the whole room with music and can increase your range up to 1000 miles. \$8.50, remit by check or money order.

Specials for Limited Time Only
Radiotron UV200 Detector Tube, \$3.75. Amplifier tubes, \$4.75. 1½ volt dry cell tubes, \$4.75. Sockets for standard tubes, 50c. Sockets for 1½ volt dry cell tubes, 50c. Standard 2000 ohm phones, \$3.90. 3000 ohm, \$4.90. SUPERIOR crystal sets, \$3.90. Novo 22½ volt "B" Batteries, \$1.50. Rheostats, 50c. Vacuum tube detector sets, \$5.50. Amplifier sets, \$8.50.

This add must accompany order.
Complete instructive catalog 5c at your dealer or Steinmetz Wireless Mfg. Co. 5706 Penn Ave. Pittsburgh, Pa.



The Only Quality
3000-Ohm Guaranteed
Head Set for
\$5.00
\$5.00

TRUE - TONE RADIO MFG. CO.
188 No. La Salle Ave. CHICAGO, ILL.

BETTER PARTS

We call them "Better" because all who use them insist that they are.

Bulletin 105 fully describes and illustrates our Complete line.

Jobbers! Dealers! Manufacturers! Write for quantity discounts!



BETTER SETS

Reliable Dealers declare "Master" Receivers to be worthy of their name.

Bulletin 104 illustrates and gives complete details of our Receivers.

Distributed by the best jobbers and dealers everywhere.

Radio Division

UNION CONSTRUCTION COMPANY

Manufacturers "MASTER" Radio Products
Oakland, California



TRADE MARK

The Radio Guild, Inc.

pioneer manufacturers of
RADIO FREQUENCY AMPLIFYING RECEIVERS

invite radio amateurs and dealers to send for a **FREE COPY** of the new Radio Guild Publication

With scores of illustrations and photographs this book explains in a simple manner the principles of design and construction of radio receivers which result in selective long-distance reception. Full particulars are given, with operating instructions of Radio Guild receivers and parts, including the

NEUTRODYNE—The howl-less wonder.
VOX HUMANA—The receiver with the Living Voice. Self-Contained in Period Cabinet.
THE R.G. 510—Thousand Miles Every Night on the Loop.
MULTI-RANGE COUPLER. Receive the higher wave-lengths.

Send 10c. to cover cost of mailing you a copy.

Read This New Book by **KENNETH HARKNESS**
(Chief Engineer, The Radio Guild)
"The Theory and Practice of Radio Frequency Amplification"

By the author of "The Construction and Operation of Super-Regenerative Receivers." Tells in simple and direct language the theory of radio frequency amplifying circuits. The most complete work on radio frequency ever published. Shows how to construct various types of R. F. amplifiers and receivers including the new NEUTRODYNE receiver. Illustrated with scores of photographs, hook-ups and drawings. Tells you how to make an oscillator covering all wave-lengths. For the first time complete details are given, with photographs, of the construction of the best types of R. F. transformers. Send for your copy today. Price \$1.00.

The Radio Guild, Inc. 256 West 34th St., New York, N. Y.

RHAMSTINE*

VICTOPHONE

A New Loud-Speaker



Price

\$7.50

Complete with Phone Cord

The Victophone is a correctly designed loud-speaking receiver—it requires no battery to operate it. It can be used with any type of horn but it is especially designed to be attached to the tone-arm of various phonographs.

It possesses these superior qualities:

1. Adjustable poles.
2. A venturi opening in the cap correctly designed to increase volume.
3. Rubber gasket between the tone-arm flange and the cap to reduce metallic vibrations.

The Victophone is nickel-plated and highly polished. It bears the name Rhamstine*, assuring you of satisfaction in your purchase. Order yours today. Dealers write for discount.

Manufactured by

J. THOS. RHAMSTINE*

2162 E. Larned Street, Detroit, Michigan
**Maker of Radio Products*

The H. K. Switch



Pat. Pending

The H. K. Multipoint Switch does away with the difficulty of drilling holes in a panel for switch points, only takes a few minutes to mount. Assures good contact. Is neat in appearance. Contacts are arranged so wires can be attached with ease. 2½ in. Dial, calibrated to show contact in use.

PRICE COMPLETE WITH DIAL \$2.00

Awarded Certificate of Merit 38 by Radio News Laboratories.

Special prices to Dealers and Jobbers.

KNOOP & PENCE CO.
PEOTONE, ILL.

| Call | Name | City and State |
|---------|--|------------------|
| WOAT | Boyd M. Hamp... | Wilmington, Del. |
| WOAU | Sowder Bolling Piano Co., Evansville, Ind. | |
| WOAV | Second Battalion, 112th Inf., P.N.G., Erie, Pa. | |
| WOAW | Woodmen of the World, Omaha, Nebr. | |
| WOAX | Franklyn J. Wolff (Monument Pottery Co.)... Trenton, N. J. | |
| WOAY | John M. Wilder... Birmingham, Ala. | |
| WOAZ | Penick Hughes Co... Stamford, Texas | |
| *to WOC | Palmer School of Chiropractic, Davenport, Iowa | |
| WOE | Buckeye Radio Service Co., Akron, Ohio | |
| WOH | Hatfield Electric Co. Indianapolis, Ind. | |
| †WOI | Iowa State College... Ames, Iowa | |
| WOK | Arkansas Light & Power Co. (Pine Bluff Co.)... Pine Bluff, Ark. | |
| *to WOO | John Wanamaker... Philadelphia, Pa. | |
| †WOQ | Western Radio Co... Kansas City, Mo. | |
| *o WOR | L. Bamberger & Co... Newark, N. J. | |
| †WOS | Missouri State Marketing Bureau, Jefferson City, Mo. | |
| †WOU | Metropolitan Utilities District, Omaha, Nebr. | |
| †WOZ | Palladium Printing Co. Richmond, Ind. | |
| †WPA | Fort Worth Record... Fort Worth, Tex. | |
| WPAA | Anderson & Webster Elec. Co., Wahoo, Nebr. | |
| WPAB | Pennsylvania State College, State College, Pa. | |
| WPAC | Donaldson Radio Co... Okmulgee, Okla. | |
| WPAD | W. A. Wieholdt & Co... Chicago, Ill. | |
| WPAF | Peterson Radio Co. Council Bluffs, Ia. | |
| WPAG | Central Radio Co... Independence, Ill. | |
| to WPAH | Wisconsin Department of Markets, Waupaca, Wis. | |
| WPAJ | Doolittle Radio Corp., New Haven, Conn. | |
| †WPAK | North Dakota Agricultural College, Agricultural College, N. D. | |
| WPAL | Superior Radio & Tel. Equipment Co., Columbus, Ohio | |
| WPAM | Auerbach & Guettel... Topeka, Kans. | |
| WPAP | Theodore D. Phillips... Winchester, Ky. | |
| WPAQ | General Sales & Engineering Co., Frostburg, Md. | |
| WPAR | R. A. Ward... Beloit, Kans. | |
| WPAS | J. & M. Electric Co. Amherst, N. Y. | |
| WPAT | St. Patrick's Cathedral, El Paso, Texas | |
| †WPAU | Concordia College... Moorhead, Minn. | |
| WPAV | Paul Tinetti & Sons... Laurium, Mich. | |
| WPAW | Radio Installation Co., Wilmington, Del. | |
| WPAX | S W Radio Co. (J. R. Shumate, Jr.), Thomasville, Ga. | |
| WPE | Central Radio Co... Kansas City, Mo. | |
| WPG | Nushawg Poultry Farm, New Lebanon, Ohio | |
| WPI | Electric Supply Co... Clearfield, Pa. | |
| WPI | St. Joseph College... Philadelphia, Pa. | |
| WPM | Thomas J. Williams, Washington, D. C. | |
| WPO | United Equipment Co. Memphis, Tenn. | |
| WQAA | Horace A. Beale, Jr. Parkesburg, Pa. | |
| WQAB | Southwest Missouri State Teachers College... Springfield, Mo. | |
| WQAC | E. B. Gish... Amarillo, Tex. | |
| WQAE | Moore Radio News Station (Edmund B. Moore)... Springfield, Vt. | |
| WQAK | Appel-Higley Electric Co., Dubuque, Iowa | |
| WQAL | Coles County Telephone & Telegraph Co... Mattoon, Ill. | |
| WQAQ | West Texas Radio Co... Abilene, Texas | |
| WQAY | Gaston Music & Furniture Co., Hastings, Nebr. | |
| WRAA | Rice Institute... Houston, Texas | |
| WRAN | Black Hawk Electrical Co., Waterloo, Iowa | |
| WRAR | Jacob C. Thomas... David City, Nebr. | |
| WRAU | Amarillo Daily News... Amarillo, Tex. | |
| WRAY | Radio Sales Corp... Scranton, Pa. | |
| WRK | Doron Bros. Elec. Co. Hamilton, Ohio | |
| WRL | Union College... Schenectady, N. Y. | |
| WRM | University of Illinois... Urbana, Ill. | |
| WRP | Federal Institute of Radio Telegraphy... Camden, N. J. | |
| †WRR | City of Dallas, Police & Fire Signal Dept... Dallas, Texas | |
| WRW | Tarrytown Radio Research Laboratory... Tarrytown, N. Y. | |
| WSAJ | Grove City College... Grove City, Pa. | |
| WSAS | Bureau of Markets, State Dept. of Agr... Lincoln, Nebr. | |
| WSAT | Plainview Electric Co. Plainview, Tex. | |
| WSAV | Clifford W. Vick Radio Const. Co., Houston, Texas | |
| *to WSB | Atlanta Journal... Atlanta, Ga. | |
| WSL | J & M Electric Co... Utica, N. Y. | |
| WSN | Ship Owners Radio Service, Inc., Norfolk, Va. | |
| WSX | Erie Radio Co... Erie, Pa. | |
| †WSY | Alabama Power Co. Birmingham, Ala. | |
| WTAC | Penn Traffic Co... Johnstown, Pa. | |
| WTAU | Ruegg Battery & Electric Co., Tecumseh, Nebr. | |
| WTAW | Agricultural & Mechanical College, College Stations, Tex. | |
| to WTG | Kansas State Agricultural College, Manhattan, Kansas | |
| WTP | George M. McBride... Bay City, Mich. | |
| WWAC | Sanger Bros... Waco, Texas | |
| WWAD | Wright & Wright, Inc., Philadelphia, Pa. | |
| WWAX | Wormser Bros... Laredo, Texas | |
| WWB | Daily News Printing Co. Canton, Ohio | |
| WWI | Ford Motor Co... Dearborn, Mich. | |

| Call | Name | City and State |
|---------|------------------------|------------------|
| *to WWJ | Detroit News..... | Detroit, Mich. |
| WWL | Loyola University.. | New Orleans, La. |
| WWT | McCarthy Bros. & Ford. | Buffalo, N. Y. |
| WWZ | John Wanamaker.. | New York, N. Y. |

An additional list of new broadcasting stations licensed since the date of this revised list, appear on page 2176 of this issue.

A CLEVER STUNT

Radio reception has been greatly simplified in Backus, Minnesota. If the Backus resident is a telephone subscriber he just takes his telephone receiver from the hook and music, drama, sermon or lecture pours out. He has no need to worry about run-down batteries, weak tubes, the intricacies of hook-up or the length or height of his antenna.

Miss Anna Ozier, chief operator for the Backus Telephone Company, recently wrote WGY, the radio broadcasting station of the General Electric, at Schenectady, as follows:

"We have a receiving station here and by putting the horn close to the transmitter and connecting up the farm lines, I have a system now by which the subscribers on our farm lines who have never had an opportunity of getting concerts direct from the air have passed many of these winter evenings enjoying themselves by turn and turn about at the telephone.

"I know of several cases where three or four people have listened in on the same receiver at once. In one case I was surprised by being materially recompensed by a lady who was so much pleased by the concert and the part she thought I took in it, that she brought me a dozen eggs. As she said, it was her way of saying 'thank you'."

MISSISSIPPI RIVER IS LIMIT BETWEEN W AND K CALLS

The Mississippi River is now the dividing line between the "K" calls of the West and the "W" calls of the East, as far as broadcasting stations are concerned. All new calls issued to broadcasting stations east of the Mississippi will begin with "W" and those west with "K," so the stations can be immediately identified as Atlantic or Pacific when the initial letter is heard. The stations already listed under "K" including KDKA will retain their original calls.

ESSAY CONTESTS ON SUBJECTS OF VITAL IMPORTANCE TO THE RADIO INDUSTRY

Valuable Prizes Awarded By American Home and City Beautiful Association Exposition Management.

The management of the American Home and City Beautiful Association Exposition, to be held on the Million Dollar Pier, Atlantic City this summer, has completed arrangements for conducting a nationwide essay contest on the following subjects:

THE BEST WAY TO EDUCATE THE PUBLIC ON RADIO, WHY RADIO SHOULD BE IN EVERY HOME, AND HOW IT CAN BE DONE, WHO SHALL CARRY ON AND PAY FOR FUTURE BROADCASTING, AND THE COMPLETE RADIO SET AS THE LOGICAL INSTALLATION.

The following men prominently identified with the radio industry have been invited to be represented on the Board of Judges for awarding prizes to winning contestants:

Dr. De Forest of De Forest Company of Newark, N. J.

Paul Godley, Adams Morgan Company, Upper Montclair, N. J.

A. H. Grebe, The Grebe Company, Jamaica, L. I.

General J. G. Harvard, Radio Corporation of America.

David Sarnoff, Radio Corporation of America.

P. Boucheron, Radio Corporation of America.

M. P. Rice, General Electric Company.

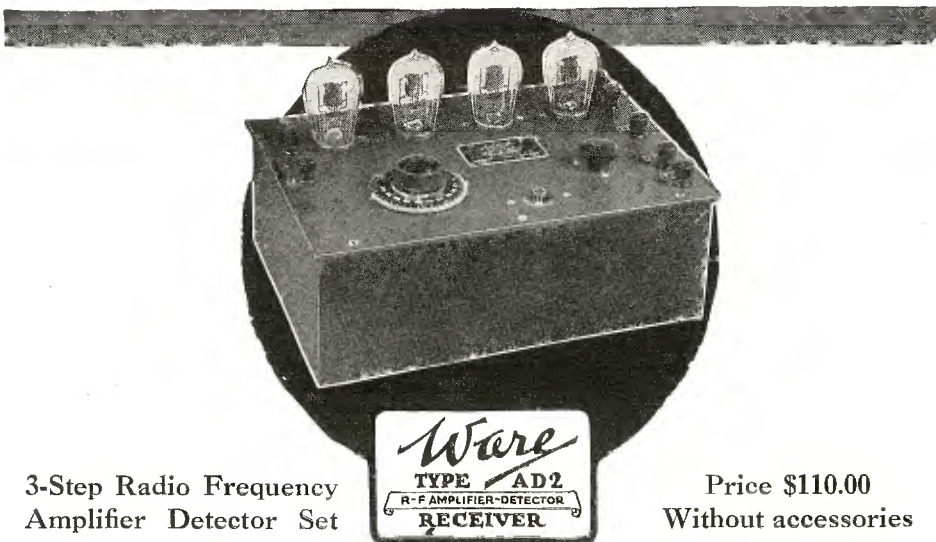

3-Step Radio Frequency Amplifier Detector Set

Price \$110.00 Without accessories

Be Sure to Hear the Ware AD2 Before Buying a Receiver

The WARE AD2 Receiver is so simple in operation that the novice masters it with ease, yet so scientifically designed that it meets every demand of the most critical radio expert.

Special Features:

- Reproduces the finest tone qualities.
- Famous for its remarkable sensitivity. Catches the faintest signals from great distances on indoor loop, in many cases up to 3000 miles.
- Eliminates interference to an amazing degree.
- Only two simple operating adjustments.
- Distinctly a loop receiver, but may be used with outdoor aerial.
- Every instrument fully guaranteed.

It is not an experiment, but has stood successfully the most exacting tests. Operates with any style of loop, UV201A vacuum tubes, and with head telephones or any standard audio-amplifier and loud speaker.

See it at Your Dealers—or Send for Descriptive Folder. If your dealer has none in stock, order direct from us.

TO THE DEALER: If you are not acquainted with the Ware AD2 Receiver, let us send you full information. Its ready sale makes it a profitable dealers' proposition.

WARE RADIO CORP'N
Dept. A 160-162 Duane St. New York, N. Y.



DUCK - Radio Pioneer
Announces Startling Reductions

The Leading Line Since 1909 At Prices to You Less Than Dealers' Cost

FREE Illustrated pamphlet comprising sixty-two Duck radio instruments and sets with reductions averaging 30% mailed on request. Send postal today. Any old time radio amateur will tell you who we are and our reputation. Only a few years ago almost one-third of the radio instruments sold at retail, exclusive of sales in only a half dozen large cities, were sold by Duck.

A Few of the Many Duck Products at Startling Prices: Rheostat, 70c; Bakelite Moulded Positive contact, 70c; Bakelite Moulded dial, 55c; superselective moulded variometer, \$4.65, worth \$8.00; radio frequency potentiometer, \$1.15; solid mahogany form variometer, \$3.60; 43-plate panel-type variable condenser, pigtail connection, \$3.15; detector panel, \$5.25; receiving set, mahogany cabinet, detector and two stages of audio frequency, \$59.50; radio frequency receiving set with one-step radio and detector, \$29.75.

Send 25 Cents in coin or money order for our big 256 pp. combined Radio Catalog and Text Book. For radio information and hook-ups it is worth many times the retainer asked.

THE WILLIAM B. DUCK COMPANY
231-233 Superior St., Toledo, Ohio

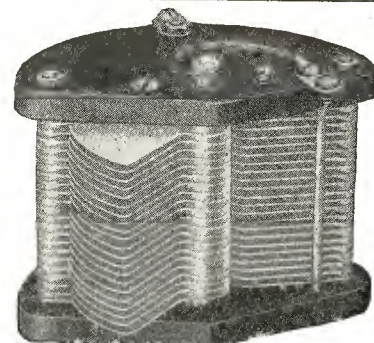

DUCK'S NEW PANEL TYPE VARIABLE CONDENSER

acclaimed by all that have seen it to be the peer of any on the market. Pigtail connections, i. e., no sliding contacts. Base and top moulded bakelite. Aluminum separators, i. e., even spacing and simple means of adjusting plates. Mounting screws furnished. Overlaid by dial. Brass bearings: 1/4" shaft.

Your Dealer "All-American" Probably Has **All-American** Amplifying Transformers

(RADIO and AUDIO Frequency)

If he has thus far missed these highly important aids to clear strong radio reception, tell him you will buy "ALL-AMERICAN" or nothing.

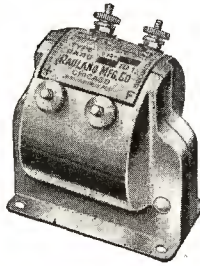

They cost no more; and your set is entitled to the best the art has produced. Our Radio Frequency Transformers should be used to amplify the radio frequency impulses before they reach the detector tube and the audio frequency Transformer, to strengthen the detected signals. The combination of the two forms the ideal long-distance radio reception hookup for either headphone or loudspeaker reproduction.

"ALL-AMERICAN" AMPLIFYING TRANSFORMERS

- R-10—Radio Frequency (150-550 meters).....\$4.50
- R-12—Audio Frequency (Ratio 3 to 1)..... 4.50
- R-13—Audio Frequency (Ratio 10 to 1)..... 4.75
- R-21—Audio Frequency (Ratio 5 to 1)..... 4.75

Ask your dealers first, before you write. If none of them can supply you, send order to us with name and address of Dealer you wish to favor, and transformers will be sent you postpaid at the prices named.

FREE Hand Book of Radio Hookups—25 up-to-date diagrams of Successful Circuits. Send 2c stamp to cover postage.



RAULAND MFG. Co.
200 No. Jefferson St., Chicago, Ill.

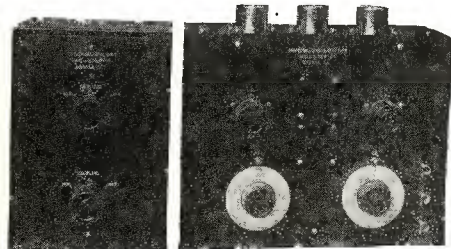

Universal Radio Receiver and Coil Unit

This radio receiver meets all the demands of the most discriminating buyer. Here are 14 vital points to be found in this set: 1.—Simple to operate. 2.—Receives signals without distortion. 3.—Eliminates outside interference. 4.—Tunes sharply with condensers and vernier. 5.—Will tune out local stations and tune in distant stations over 1,000 miles range. 6.—Built of General Radio and Western Electric parts. 7.—Mahogany cabinet and shielded Bakelite panels. 8.—Wave-length range, 180-6,200 meters. 9.—Binding posts for connections on rear of units. 10.—Receives signals over 2,000 times as loud as over a crystal set. 11.—Uses a detector and two amplifier tubes. 12.—All inductance coils bank wound. 13.—Light weight and compact. 14.—Complete outfit designed by a Bureau of Standards Radio Engineer. Fully guaranteed. Universal Radio Receiver \$85.00. Universal Coil Unit \$15.00.

HAYES & NEWTON

Machinists and Manufacturers of
Scientific Instruments and Testing Machines

115 North Market Street,

URBANA, ILLINOIS

Radio Supplies at Cut Prices

| | |
|-------------------------------------|--------|
| Federal Headsets | \$5.98 |
| Murdock 2000 ohm | 3.95 |
| Western Electric (Navy Type) | 7.25 |
| Ace Amplifying Transformers | 3.98 |
| Thoradson Amplifying Transformers | 3.49 |
| Federal Amplifying Transformers | 5.49 |
| Eveready Variable B Battery No. 763 | 1.25 |
| Eveready Variable B Battery No. 766 | 2.25 |
| Eveready Variable B Battery No. 767 | 3.98 |
| Fireo (Bull Dog Grip) Phone Plugs | .98 |
| 43 Plate Variable Condensers | 2.00 |
| 23 Plate Variable Condensers | 1.75 |
| 3 inch Dials | .35 |
| 4 inch Electrode Dials | .98 |
| .002 Fixed Condensers | .25 |
| .005 Fixed Condensers | .45 |
| .00025 Grid Leak Condensers | .35 |

Mail Orders Promptly Filled. No Checks. No Stamps.
Send money order or cash and include postage.
KENSINGTON RADIO SUPPLY CO.
4417 18th Ave., Brooklyn, N. Y.

☸ RADIO ☸

Complete Stock—Both Sets and
Parts—All Makes

ROSE RADIO SUPPLY

129 CAMP STREET
New Orleans, La.

Send 10c for latest catalog

PHONE SPECIALS

| | | | |
|---------------------|--------|--------------------|--------|
| 3000-Ohm Simplex | \$3.45 | 3000-Ohm True-Tone | \$3.95 |
| 3000-Ohm Dictograph | \$5.95 | 2200-Ohm Federal | \$5.95 |
| Western Electric | \$9.15 | Brandes Superior | \$5.85 |

Write for complete price list.
Simplex Radio Co., 1806 Lafayette Ave., St. Louis, Mo.

Dr. W. H. Easton, Westinghouse Electric Company.
Paul Findley, Western Electric Co.
Major General Squier, Chief Signal Officer, U. S. A.

Dr. A. N. Goldsmith, Director of Research, City College of New York.

H. Gernsback, Editor, RADIO NEWS.
Major J. Andrew White, Editor, Wireless Age.

Kendall Banning, Editor, Popular Radio.
Boland Park Hennesy, Editor, Radio World.

Henry M. Shaw, President, Radio Trade Association.

Lawrence A. Nixon, Editor, Radio Dealer, Sec. Radio Trade Association.

Jack Binns, New York Tribune Radio Section.

Those who compose the Board of Judges also have been appointed as the Radio Committee for the Radio Exhibit, an important section of the American Home and City Beautiful Association Exposition devoted to leading American industries, which will be conducted June 16 to Sept. 8, 1923, at the world's greatest resort.

The above committee will also direct the essay contest and award prizes to winners on a contest in which only radio fans, or those who listen to broadcasting are eligible to submit essays on the subject:

WHAT WE WANT TO HEAR OVER RADIO

The radio fan contest promises to be extremely interesting from many viewpoints.

The exposition management is taking the utmost precaution to obviate obstacles which have been noticeable in other exhibits for radio demonstration, to prevent interference with radio reception, to have sufficient areas erected over the exposition structure, and make all necessary provisions for successful operation of radio sets, and in avoiding annoyances of having several loud speaking sets in operation simultaneously by allotting periods to each exhibitor, and providing sound proof booths.

The leading manufacturers will be given opportunity to exhibit and all rules insuring most satisfactory results to exhibitors will be subject to their recommendation and approval. Price cutting will not be tolerated and only concerns of high standing in the industry will be invited to participate.

Orders may be taken by exhibitors for sales to individuals or to dealers and wholesalers in any part of the country. No over the counter retail deliveries will be permitted, however, provision being made for delivery service in any part of Atlantic City and to guests stopping at the hotels which will make counter deliveries unnecessary.

DANCING BY RADIO

A specially constructed dance floor in a beautiful hall in connection with the exposition will be devoted to dancing by radio. This is sure to be an unusually interesting feature of the exposition.

RADIO INFORMATION SERVICE

The following statement has been made by the exposition management outlining the scope of the big national exposition which will be conducted to advance the publicity and sales promotion of leading American products:

Exposition management will supply free information regarding radio publications and literature to exposition visitors and will maintain a service for that purpose.

UNIQUE TRANSMITTER

Millions of radio fans will be benefited by a new radio transmitter invented by Dr. Phillips Thomas, research engineer of the Westinghouse Electric & Manufacturing Co. The new transmitter makes

GREEN SEAL
AIR-WAY RADIO Equipment appeals to the discriminating user for its genuine quality at fair prices. Write for Free Air-Way Bulletin of Complete Sets and Standard Parts. Attractive dealer proposition.
Air-Way Electric Appliance Corporation, Toledo, Ohio.

possible the broadcasting of music and other sounds exactly as produced. It has been used at the Westinghouse broadcasting station KDKA within the past few months, which explains the clarity and strength of that station's signals.

The basis of Dr. Thomas's invention is the elimination of the diaphragm now used in all transmitters in practical service. This diaphragm consists of a thin disk of metal or other substance and operates by being vibrated by the sound waves which strike it. But because of its inherent inertia, no material diaphragm is capable of vibrating in perfect sympathy with the entire range of audible sounds. If it can transmit low notes successfully, it will fail on high notes and vice versa. The ordinary diaphragm is designed with reference to the middle register, and it, therefore, does not transmit extremely high and extremely low notes satisfactorily. The piano is a case in point. The radio audience hears the highest notes as a series of clicks and the very bass notes as a roar.

In the Thomas transmitter, a minute

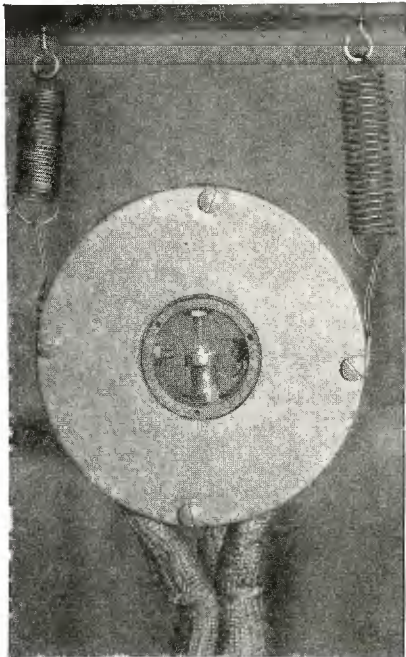

A Photo. of the Recently Developed Glow Discharge Transmitter. This Instrument Will Probably Take the Place of the Present Microphone Transmitter.

electrical discharge takes the place of the mechanical disk. This discharge flows between two points, separated by a very small fraction of an inch. It is affected by sound waves, just like the diaphragm, but being non-material and having no perceptible inertia, it responds equally well to all vibrations. Hence, music broadcast by means of it is transmitted in all its original purity.

Dr. Thomas has recently been experimenting with his transmitter at the Westinghouse Pittsburgh Station, KDKA. Listeners all over the country have noticed from time to time the great improvement in the quality of the voice of this station, but have naturally been unaware of the cause. Within the near future, all Westinghouse stations will be regularly equipped with this device and the art of broadcasting will take another step forward.

In appearance, the Thomas transmitter resembles a large watch, with the front and back covered by wire gauze. On looking into it, a point of light can be seen, caused by the flow of the electric energy against one of the terminals. From this fact it is called the glow discharge transmitter.

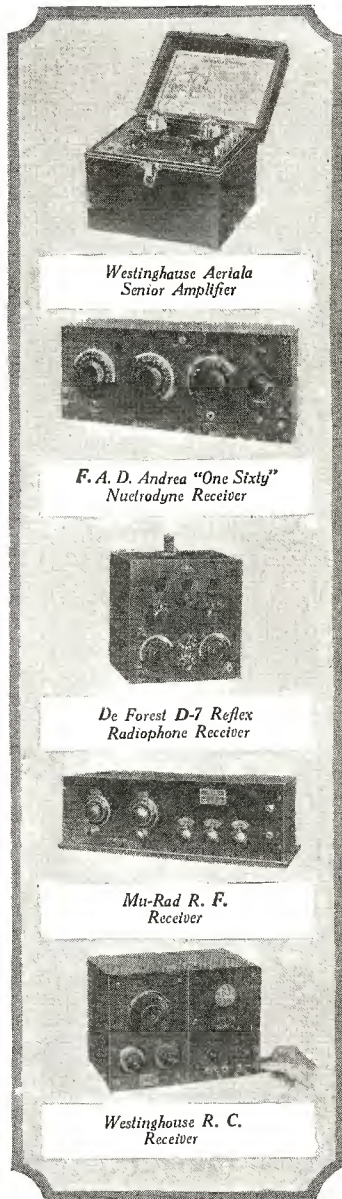

PACENT JACKS

Standard With Leading Set Manufacturers

The sets shown are just a few of those whose makers standardize on PACENT Jacks. The set maker's reputation rests as much on what he buys as what he builds. Therefore, he buys jacks with a reputation for honest quality and satisfactory performance—PACENT Jacks. Present price revisions mean increased VALUE.

PACENT JACK PRICES

| | | |
|--------|-----------------------------|-------|
| No. 61 | Open Circuit Jack..... | \$.60 |
| No. 62 | Closed Circuit Jack..... | .75 |
| No. 63 | Double Circuit Jack..... | .85 |
| No. 65 | 3 Spring Automatic Jack.... | .90 |
| No. 66 | 5 Spring Automatic Jack.... | 1.00 |
| No. 67 | 7 Spring Automatic Jack*.. | 1.00 |

*(Hazeltine Circuit)

PACENT Jacks are just one item in the line of PACENT Radio Essentials, every one of which is designed to efficiently fill a definite radio need.

Write for Descriptive Bulletin N-6

DON'T IMPROVISE—"PACENTIZE"

PACENT ELECTRIC COMPANY, Inc.

22 Park Place, New York, N. Y.
Sales Offices: Chicago, Philadelphia, St. Louis, Minneapolis,
Washington, D. C., San Francisco

Canadian and British Licensees:
Colonial Radio, Ltd., Hamilton, Can.



Pacent RADIO ESSENTIALS



WOC--TRESKO

Licensed Armstrong U. S. Patent
No. 1113149

Two things that made Davenport Famous. The world's best records made with our long distance Armstrong Regenerative tuners and amplifiers made to use with any make tube on market, dry cell or storage battery operation. Circulars free.

Cheapest and Best Made.

Tri City Radio Electric
Supply Company

TRESKO—Box 148
DAVENPORT IOWA

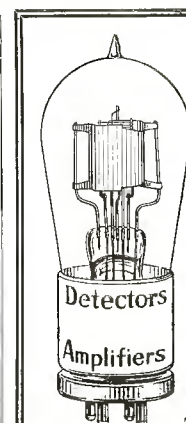

Those Broken and Burned-Out
VACUUM TUBES
Can Be
Repaired

and Guaranteed Too!
If your dealer does not know, send direct to us.
W.D.I. not accepted for repairs

Harvard Radio
Laboratories

P. O. Box 1781
BOSTON, MASS 9
Tubes returned P.F., C.O.D.

WHY BLAME "STATIC"

When It's Probably Your Battery!



This is the
READ-EASY

"Static" is often blamed for many noises in the receivers that are due to low or discharged storage batteries. And when a storage battery charge gets low you are damaging it very badly. Keep it fully charged all the time. *Know* the condition of your battery every day.



Read-Easy Hydrometer

is a professional instrument made for the amateur. It is simple to read and always works.

**For Your Battery's Sake
Do Not Accept Substitutes**

The *Read-Easy* sells for \$1.25 at all good supply stores. If you can't get it, send your order direct to us. We will mail post paid and insured.

ALA MFG. CO., 401-417 S. Sangamon St., Chicago

Read-Easy Hydrometer

tells at a glance the exact condition of every cell in your battery. No guess work. Absolutely accurate.
No dripping — no slopping — no sticking with a Read-Easy

RADIO



PRODUCTS

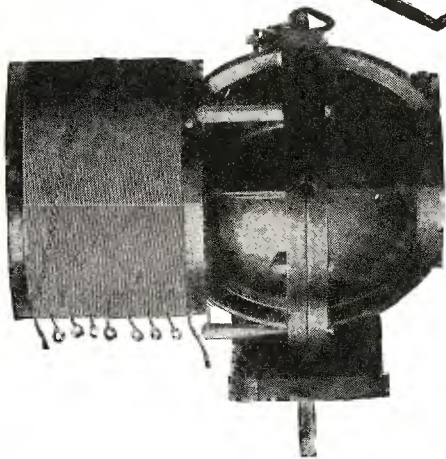

SE-AR-DE Molded RADIOMETER

Build Your Own Single Circuit Tuner

CATALOGUE No. 165

\$13.00

Range 180-3100M
" 300-3280M

R. MITCHELL & CO.

255 ATLANTIC AVENUE

BOSTON, MASS.

DO YOU?

Do you want to save 20 to 40 per cent on all your purchases of standard radio apparatus?
Do you want the personal advice and counsel of the greatest radio authorities in the country in solving your problems?
Do you want to receive free of charge a quarterly publication giving you a digest of the latest findings of radio science, telling you how to construct and operate both simple and advanced radio receivers and transmitters, together with a fund of other useful information?

OF COURSE YOU DO!

Then send us a post-card immediately, asking for Booklet R-6, describing our Co-operative Service Plan.

The Radio Guild, Inc., Co-operative Service Bureau
256 WEST 34th STREET NEW YORK CITY

NEW BROADCASTERS LICENSED

Call—Station—Power

- WDAH—Trinity Methodist, Church, El Paso, Tex.—200 watts.
 - KNX—Electric Lighting Supply Co., Los Angeles, Calif.—250 watts.
 - KFFP—First Baptist Church, Moberly, Mo.—100 watts.
 - KFEZ—American Society of Mech. Engrs., St. Louis, Mo.—500 watts.
 - WRAL—Northern States Power Co., St. Croix Falls, Wis.—100 watts.
 - KFHR—Star Electric & Radio Co.; Seattle, Wash.—100 watts.
 - WDAR—Lit Brothers, Philadelphia, Pa.—500 watts. (Class B, 400 meters).
 - KFHH—McCue, Ambrose, Neah Bay, Wash.—50 watts.
 - KFEY—Bunker Hill & Sullivan Mining & Const. Co., Kellog, Idaho—10 watts.
 - KQP—Apple City Radio Club, Hood River, Oregon—10 watts.
 - KFHB—Boardwell, P. L., Hood River, Oregon—10 watts.
 - KFFV—Graceland College, Lamoni, Iowa—250 watts.
 - KFDZ—Iverson, Harry, O., Minneapolis, Minn.—5 watts.
 - KDZQ—Pyle & Nichols, Denver, Colorado—100 watts.
 - WRAH—Read, Stanley N., Providence, R. I.—10 watts.
 - KFDY—South Dakota State College of Agri. & Mech. Arts, Brookings, S. D.—100 watts.
 - KFHA—Colorado State Normal School, Gunnison, Col.—50 watts.
 - KFDX—First Baptist Church, Shreveport, La.—200 watts.
 - WQAZ—Greensboro Daily News, Greensboro, N. C.—300 watts.
 - WQAQ—Portsmouth Kiwanis Club, Portsmouth, Va.—15 watts.
 - WQAX—Radio Equipment Co., Peoria, Ill.—20 watts.
 - KFFO—Smith, Dr. E. H., Hillsboro, Oregon—5 watts.
 - WRAP—Winter Park Elect. Const. Co., Winter Park, Florida—20 watts.
 - WSAC—Clemson Agricultural College, S. C.—500 watts.
 - KFDV—Gilbrech & Stinson, Fayetteville, Ark.—100 watts.
 - WWAY—Marigold Gardens, Chicago, Ill.—500 watts.
 - WRAB—Savannah Board of Public Education, Savannah, Ga.—100 watts.
- The 13 stations which were dropped during February follow:
- Call—Station
- KFED—Billings Polytechnic Inst., Polytechnic, Mont.
 - WKAG—Bruce, M. D., Edwin T., Louisville, Ky.
 - WIAX—Capital Radio Co., Lincoln, Neb.
 - WNAF—Enid Radio Distributing Co., Enid, Okla.
 - WOH—Hatfield Electric Co., Indianapolis, Ind.
 - WLAJ—Johnson Radio Co., Lincoln, Neb.
 - WDAR—Lit Brothers, Phila., Pa.
 - WLAR—Mickel Music Co., Marshalltown, Iowa.
 - WDY—Radio Corp. of America, Roselle Park, N. J.
 - WHAF—Radio Electric Co., Pittsburgh, Pa.
 - WJK—Service Radio Equipment Co., Toledo, Ohio.
 - WJAE—Texas Radio Syndicate, San Antonio, Tex.
 - WDV—Yeiser, Jr., John, O., Omaha, Neb.

A. R. R. L. TO CHECK UP ON INTERFERENCE

Due to the great amount of talk concerning amateur interference on broadcast wavelengths, the American Radio Relay League has planned to hold a test in order to determine the exact nature of the majority

of interference, and whether any of it is caused by amateur stations.

There will be some 600 odd observers, all of whom will be experts and most of them presumably A. R. R. L. star stations. Their duty will be to keep continual watch each night from 7 to 10:30 P. M. on waves between 360 and 400 meters.

Every class of interference will be recorded and weekly reports sent to headquarters. It is the general opinion among the amateurs that the bulk of the interference on 360 and 400 meters originates from commercial transmitting stations, a number of which are known to have very broad waves.

The eventual reports will evidently lead to the clearing up of the present difficulty that the average broadcast listener has in reception. These reports will be of technical value also.

Instruction in International Code Signaling for Use in Self Studies and Exercises

By S. L. TOPLITZ

PART 2

LESSON NO. 4

In the fourth lesson the opposite signals are continued and in addition the reverse of signals are to be memorized.

Note:—Letter L is the opposite of letter Y, but is the reverse of letter F.

Example: Letter F
 " L
 " Q
 " Y

Letter F is opposite of letter Q and reverse of letter L.

Letter Q is opposite of letter F and reverse of letter Y.

| | |
|-------------------------------|-----------|
| | Letter |
| Dot, Dash, Dash | W |
| Dash, Dot, Dot, Dot | B |
| Dot, Dash, Dash, Dot | P |
| Dot, Dot, Dash, Dot | F |
| Dash, Dash, Dot, Dash | Q |

VOCABULARY EXERCISES

Four, Off, Fly, Paw, Wolf, Beef, Flow, Flap, Quaff, Dwarf, Blow, Probe, Quick, Whip, Bowl, Pawn, Few, Quail, Waffle, Prowl, Query, Equal, Copy, Always, Worship, Abrupt, Profile, Flew, Quality, Lawful, Before, Perform, Quilt, Affably, Furrow, Bluff, Pillow, Workshop, Quibble, Buffalo, Piquant, Afterward, Wallop, Comply, Acquit, Briefly, Fowl, Probably, Quality, Wrap, Blowpipe, Aqueduct, Bequest, Awkward, Wrong, Downfall, Drawback, Woodpecker, Palfrey, Pacify, Fireworks, Fifty, Bomb, Playful, Brow, Fibre, Bellow, Quiet, Plump, Benefit, Follow, Below, Quell, Fife, Fabric, Pelf, Forward, Bankrupt, Quarrel, Fable, Perfect, Brawl, Qualm, Perquisite, Forfeit, Beware, Quart, Fawn, Perfume, Forewarn, Knowledge, Frown, Brew, Barefoot.

SENTENCE EXERCISES

Flap waffles quickly before we bawl for more. Qualify the question we quote quite quaintly. The whelps whimpered where-upon the wolf wallops them well. The baby badger balks the barefoot boy by bluffs. Beware of ballads babbling of brooks and balmy ocean billows. Fast fades the flickering flame of feeble fire when poorly fed with wood. Pulp properly prepared permits publishers to print papers. From pulpit platforms we praise the prophets by prayers



The Secret of A Successful Set

Is as much a matter of buying the best units, as of the proper wiring of your circuit. Knowing that quality of materials and character of workmanship have as much to do with the effectiveness of an instrument as the excellence of its design—

We not only maintain one of the most complete Radio Research Laboratories in the country, but require our production department to follow the same specifications, work to the same standards, and meet the same exacting requirements as govern our engineers in their development work.

So, in considering Connecticut Radio, if you find some slight difference between its cost and that of the ordinary kind, just remember that there are all kinds of a difference in the results it gives.

For instance in the
CONNECTICUT VARIABLE CONDENSER
 You find these advantages

- Compactness
- Long scale (350° against 180°)
- Low losses—less waste of signal energy—due to small quantity and high quality of insulating material
- Slight capacity change with dial movement
- No rubbing contact from shaft to bearing
- No balance required to make it stay put
- No short circuits—impervious to jars or rough handling with a given dial movement
- Perfectly shielded from outside fields—absence of body capacity when tuning
- Resistance—0.2 ohm

Portable Type J-107 \$6.00 Panel Type J-108 \$5.00 Audio Frequency Type J-121 \$5.00

If your dealer cannot supply you, write direct. Booklets on request

And in the
CONNECTICUT TRANSFORMER
 The following superiorities

- Highest grade silicon steel core (such as used on largest power transformers) to secure efficiency
- Designed to match and give the best results with amplifier tubes; windings impregnated to keep out moisture, have a turns ratio of 1.25 to 1
- Carefully shielded to prevent stray fields
- Convenient terminals, well spaced, mounted on CETEC insulating materials
- Low losses, due to carefully tested windings and best grade of materials
- Perfect balance between input and output circuits.

RADIO DIVISION

CONNECTICUT TELEPHONE & ELECTRIC COMPANY
 MERIDEN CONNECTICUT

Radio Goods at Bargain Prices

- 1½ Volt Dry Cell Tubes, fit Standard Sockets (Loudest Dry Cell Tube made) \$5.25
- \$5.00 Detector Tubes (6 Volt) 3.00
- \$5.00 Amplifier Tubes (6 Volt) 3.50
- \$8.00 Brandes Superior Phones 6.95
- 2½ Volt Cyclone B Battery 1.00

Many other bargains in our free price list sent upon request. Goods shipped postpaid promptly upon receipt of money order or registered cash.

All Merchandise Guaranteed.

BERGEN RADIO SUPPLY CO.

Mail Order Dept.

306 BERGEN AVE., NEW YDRK CITY

HEAR ATLANTA ON CRYSTAL

We receive programs from Atlanta, Minneapolis, Davenport, Fort Worth, Madison, Los Angeles, Dallas, Kansas City, St. Louis, Denver and San Antonio on crystal without batteries. Your crystal set requires only easy inexpensive changes. Send stamp for further information or \$1.00 for copyrighted drawings and instructions. Everything clearly explained. Satisfaction Guaranteed.

LEDN LAMBERT
 595 So. Volusia Wichita, Kansas

TWO SUPERSENSITIVE CIRCUITS

(Both Copyrighted)

My Highly Improved Reintartz brings in all important stations on both coasts and Mexican border, loud, clear and without distortion. We dance to music from Atlanta received on one loud Baldwin unit. Build one of these wonderful sets from my blueprints and specifications, price 50c, or with a perfect and complete double wound spiderweb coil, \$3.00 by mail. No other windings used.

Photo of my set on a glass panel with every order. My W. D. H. Circuit is especially designed for use with the "Pickle" tube and brings out the full value of that little tube as no other circuit can. Stations 1000 miles away come in clearly on one tube. This set is small, complete, portable. For the man who wishes the highest efficiency this is the set to build. Price of blueprint and specifications 50c, or with complete and perfect windings \$3.00. Photo of set with every order.

Either set is cheap and easy to build, easy to operate. Everything clearly shown.

S. A. Twitchell, 1927 Western Ave., Minneapolis, Minn.

CHARGE YOUR BATTERY

(RADIO OR AUTO)

at HOME for a NICKEL

The HOMCHARGER

POPULARLY PRICED—PAYS FOR ITSELF

SEND FOR THE AUTOMATIC ELECTRICAL

FREE BOOK 118 W THIRD ST.—CINCINNATI, OHIO.

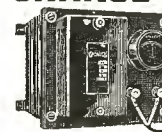

Compare These Prices

WHY PAY MORE WHEN YOU CAN GET ROCK BOTTOM PRICES FROM US

Just glance over our list and send us your Money Order. Twenty-four hours after receiving your order it is on its way to you.

| LIST PRICE | OUR PRICE |
|---|-----------|
| 5.00 Radiotrons UV-200 | \$ 4.25 |
| 6.50 Radiotrons UV-201 | 5.75 |
| 16.00 Baldwin Phones, type C | 12.00 |
| 7.75 Baldwin Units Loud Speakers | 6.00 |
| 8.00 Federal 2200 Ohm Phones | 6.00 |
| 8.00 Brandes Superior Phones | 7.00 |
| 5.00 Acme Transformers | 4.25 |
| 1.00 Double Jacks | .60 |
| .70 Single Jacks | .50 |
| 2.50 Bull-Dog Plugs | 1.25 |
| Contact Points, per doz. | .15 |
| Switch Levers, 1 1/2" radius | .25 |
| 45.00 Magnavox | 38.00 |
| 1.50 100 ft. Stranded Aerial Wire | .60 |
| .50 Aerial Insulators | .20 |
| 1.00 100 ft. Solid Aerial Wire | .40 |
| 75.00 Paragon RA-10 Set | 68.00 |
| 25.00 90 ampere guaranteed Storage Battery | 18.00 |
| 1.00 Rheostats | .75 |
| 1.00 Fada Rheostats | .75 |
| 1.00 Vacuum Tube Sockets | .65 |
| 18.50 Homchargers | 15.50 |
| 3.50 B. Batteries volt meters 0-50 V. | 2.75 |
| 55.00 Western Electric New Style Loud Speakers | 42.75 |
| .75 Rheostats | .60 |
| 3.00 B. Batteries | 2.25 |
| 2.50 B. Batteries | 2.00 |
| 1.75 B. Batteries | 1.10 |
| 1.50 Dials | .75 |
| 1.00 Dials | .40 |
| 2.75 De Forest Detectors | 1.95 |
| .75 Sockets | .60 |
| 4.50 Thordarson Transformers | 3.75 |
| 2.00 Potentiometers | 1.25 |
| 1/2 Megohm Grid Leaks | .60 |
| 1 1/2 Megohm Grid Leaks | .65 |
| 1.00 Grid Leak Holders | .65 |
| 1.00 Double Phone Cords | .60 |
| .50 Single Phone Cords | .35 |
| Duplex Phone Adapters, fits Edison, Victor or Columbia | 1.75 |
| Genuine Bakelite Panels, per sq. in. | .02 |
| Spaghetti, per ft. | .09 |
| 12.00 Genuine Western Electric Signal Corps V.T.-2 Tubes | 9.00 |
| 112.00 De Forest type Honeycomb Set, special Mahogany Cabinet | 65.00 |
| 3.00 Racony Electric Light Aerial | 2.00 |
| 35.00 Audmix Loud Speakers | 18.50 |
| 6.50 Turney 3,000 Ohm Phones | 4.25 |
| 4.50 Diamond 2,000 Ohm Phones | 3.75 |
| 5.00 Fischer Variometers | 3.75 |
| 6.00 Fischer Variometers | 4.75 |
| 5.00 Fischer VarioCouplers | 3.75 |
| 6.00 Fischer VarioCouplers | 4.75 |
| 8.00 Atwater-Kent Variometers | 7.00 |
| 8.00 Atwater-Kent VarioCouplers | 7.00 |
| 5.00 Pathe Variometers | 3.75 |
| 14.00 Atwater-Kent Mounted VarioCouplers | 11.75 |
| 16.00 Atwater-Kent 2-step amplifier | 13.75 |
| 8.50 Everet Head Phones, 3,000 Ohms | 4.95 |
| 1.50 Thordarson Rheostats | 1.15 |
| Bus Wire for wiring sets, per ft. | .02 |

Honeycomb coils, all sizes, 20% discount. Space being limited, we are obliged to omit many items.

Write for our Quotations

Cut Rate Radio Co.

Dept. A

P. O. Box 472

Newark, N. J.

25c Brings Big 3 ft. Telescope

(In 5 Sections)
See people and objects miles away just like they were close, see Moon and Stars as you never did before. Brass bonnd, useful and entertaining. "Could tell color of aeroplane 4 miles away" - Mrs. Yarborough. "Watch my boy arrive at school 2 miles away" - Mrs. Horn. "Read numbers on freight cars in 1/2 mile" - C. Palmer. Thousands pleased. SPECIAL OFFER - send only 25c with order. On arrival deposit \$1.75 with postman. Or if you prefer, send \$1.85 with order in full payment. Sent postpaid. Satisfaction guaranteed or money returned.
FERRY & CO., 75 W. Van Buren, Dept. 3920 Chicago.

You can be quickly cured, if you

STAMMER

Send 10 cents for 288-page book on Stammering and Stuttering, "Its Cause and Cure." It tells how I cured myself after stammering 20 yrs. B. N. Bogue, 887 Boone Bldg., 1147 N. 111. St., Indianapolis

RADISCO RADIO PRODUCTS
THE RADIO DISTRIBUTING COMPANY
Newark, New Jersey

and psalms. Four fowls flew from the furrow, flapping their wings fearfully. Tranquilly twirling the lariat he threw a buffalo. Perishable produce requires prompt disposal. Sharp saws work well in antique shop or at forest bowers. Squalid sprawling spots spoil splendid quiet places. Stalwart efforts inspire adequate approbation. Shrewd inquiring bespeaks forewarned precautions. A Republic's welfare requires equitable platforms. Equal opportunity requires no benefiting weapons. Abrupt queries breed warfares fearful quarrels.

LESSON NO. 5

The fifth lesson finishes the alphabet and there is only a repetition of the previous method. Letter Z is distinctive, the others are opposites or reverse of previous letters.

Letter J is opposite of letter B.

Letter V is reverse of letter B.

Letter X is opposite of letter P.

Letter

Dot, Dot, Dot, Dash... V - -
 Dot, Dash, Dash, Dash... J - -
 Dash, Dot, Dot, Dash... X - -
 Dash, Dash, Dot, Dot... Z - - - . .

VOCABULARY EXERCISES

Fox, Vex, Jaw, Eve, Buzz, Coax, Vow, Job, Czar, Lax, Zero, Jay, Quiz, Wax, Joke, Zone, Viper, Axle, View, July, Razor, Apex, Size, Sex, Jury, Zouave, Vortex, Joyful, Zigzag, Valve, Jovial, Whiz, Mix, Object, Next, Ivy, Juggle, Squeeze, Fizzle, Lazy, Improve, Envy, Anvil, Civilize, Dizzy, Except, Affix, Jolly, Approval, Dozen, Anxiety, Twelve, Equinox, Prize, Vanquish, Tweezer, Unveil, Luxury, Oxygen, Lizard, Puzzle, Vapor, Lozenge, Wave, Syntax, Vixen, Buxom, Fixture, Gazelle, Froze, Serve, Rivet, Recognize, Virgin, Rejoice, Value, Weave, Verify, Zodiac, Vivid, Vocalize, Adjacent, Velvet, Variety.

SENTENCE EXERCISES

A captive fox in jeopardy bravely drove off a dozen buzzards. Every victory over vice vindicates vigorous virtues. The jovial judge jestingly jokes with the July jury. Examples expertly explain executing existing exercises exactly. Brazen amazons seize lazy dozing gazelles. Zephyr breezes zealously zigzag hazy drizzles away. Axioms express that "sex texts perplex anxious experts." Bronze prize puzzles amaze piazza patronizers. Squeeze violently backward every provoking frivolous paroxysm. Civilization rejoices over every vanquished expiring evil. The captive jaguar expresses his agonized fears by savage snarls. Equivalent value just equalizes even exchange. Dexterous cavalry evolutions excite favorable huzzas. With zeal the wizards jingle jaunty jewels jealously. Abject groveling provokes mixed feelings of sympathy and disgust.

LESSON NO. 6

The sixth and final lesson is the numerals which are quite simple being composed of five each.

They are divided into two sets of five; the first set starting with one dot and the other four dashes and increasing the dots; and the other set starting with one dash with the other four dots and increasing the dashes.

Number

Dot, Dash, Dash, Dash, Dash... 1 - -
 Dot, Dot, Dash, Dash, Dash... 2 - -
 Dot, Dot, Dot, Dash, Dash... 3 - -
 Dot, Dot, Dot, Dot, Dash... 4 - -
 Dot, Dot, Dot, Dot, Dot... 5 - -
 Dash, Dot, Dot, Dot, Dot... 6 -
 Dash, Dash, Dot, Dot, Dot... 7 -
 Dash, Dash, Dash, Dot, Dot... 8 -
 Dash, Dash, Dash, Dash, Dot... 9 -
 Dash, Dash, Dash, Dash, Dash... 0 -

All other numerals are signaled by compounding these primary figures.

There are in addition to the alphabet special code word signals but as the purpose of these lessons is only to gain the primary instructions, they are not given here.



World Radio Batteries
SAVE YOU 50%
WRITTEN 2YR. GUAR.

Simplified production resulting in lower operating costs make possible the remarkably low prices that we quote below and the proved worth of the World Battery warrants the iron-clad guarantee that we give to every purchaser.

To Insure Satisfaction Buy World Radio "A" Batteries A Better Battery Cannot Be Built

The best of material—careful construction by schooled mechanics—makes it a battery that will give a long life of hard service. A written 2-year guarantee. You take no chances with the World Battery.

Radio "A" Wooden Case Battery Prices

6 volt, 80 Amps.....\$10.00
 6 volt, 80 Amps..... 12.50
 6 volt, 100 Amps..... 14.50
 6 volt, 120 Amps..... 16.00
 Will ship C.O.D. subject to inspection or allow 5 per cent discount for cash with order. All orders shipped same day as received. Be sure to specify Wooden Case.

SOLID RUBBER CASE WORLD RADIO BATTERIES Designed Especially for Radio

The World noiseless, radio battery was designed with the special requirements of radio operation in mind. It is not an experiment! It is made by an old established company that for years has been making the very highest type of batteries. Remember that the success or failure of your set depends upon the quality of battery that you buy. The correct construction of the World Battery makes it non-leak, non-conductive, non-deteriorating; and prevents hissing and frying noises. We back these statements with a 2-year guarantee.

Solid Rubber Case Radio Battery Prices

6 volt, 60 Amps.....\$12.50
 6 volt, 80 Amps..... 15.00
 6 volt, 100 Amps..... 17.00
 6 volt, 120 Amps..... 19.50
 Will ship C.O.D. subject to inspection, or allow 5 per cent discount for cash with order. All orders shipped same day as received. Be sure to specify Rubber Case.

SAVE 50% ON YOUR NEXT BATTERY

No other manufacturer offers such high quality radio batteries at such a low price. Save 50 per cent on your next battery and get better and longer service. Buy a World Radio Battery. Write To-Day—now.

WORLD BATTERY COMPANY

Dept. 10

1219 S. Wabash Ave., Chicago, Ill.

Tune in to

WDAP

The powerful broadcasting station at

The DRAKE

LAKE SHORE DRIVE AND UPPER MICHIGAN AVE. CHICAGO

From Porto Rico to lonely ranches in Alberta and Saskatchewan, from sunny San Diego to Quebec, and even a thousand miles out in the Atlantic and Pacific Oceans, programs from THE DRAKE are picked up. You'll be particularly well repaid by tuning in Tuesday, Thursday, Saturday, and Sunday evenings—concerts include selections by THE DRAKE Ensemble Orchestra.

WDAP Station is but a single interesting feature of THE DRAKE, Chicago's finest hotel. When in Chicago be sure to stop at THE DRAKE. See how concerts are broadcast, and enjoy the world famous service and surroundings of this wonderful hotel. Information on request.

Under The Blackstone Management, the world's standard in hotel service.



VARIABLE CONDENSERS

5-Plate Vernier\$0.75
 23-Plate .0005 Mfd. . . 1.75
 48-Plate .001 Mfd. . . . 2.25
 24-Plate Balanced Cond. 3.75
 44-Plate Balanced Cond. 4.75
 Aluminum Plates, accurate spacing. Please send 10c additional for postage. Money back if you are not satisfied.

MONTROSE MFG. CO
1200 Bedford Ave., Brooklyn, N. Y.

FINIS

Complete alphabet sentences for practice exercises.

Knowledge proofs are quite above hazy mixed conjectures. Beware complex justifying adventure's quick hazards. We could amaze jokers, vexing them by qualified replies. The judge quickly affixes brave woman's prize. The brave woman joyfully coaxed the quizzing pickets. We signify extra prompt zeal by the adjective "Quick." Prize market exchanges would justify by equal value. Quick adjournment vows help bag crazy fox. Sympathizing would fix Quaker objective. Zest of known examples vanquish bigotry prejudice.

STATION WHAZ ESTABLISHES ANOTHER WORLD'S RECORD IN LONG-DISTANCE BROADCASTING

A new world's record for long distance radio broadcasting of spoken words and music has been established by Station WHAZ at the Rensselaer Polytechnic Institute, Troy, N. Y., according to a cablegram just received from Invercargill, New Zealand. The distance from Troy to Invercargill is 9,577 miles, or more than one-third the way around the earth, which is twice as far as any radio concert broadcast has been heard heretofore. The previous mark was recently set by the Troy Polytechnic station when its midnight international program was heard at three points in the Hawaiian Islands, a distance of approximately 4,887 miles.

The latest broadcasting record was not a mere chance occurrence, as the sending tests were made on seven successive mornings from 5 to 7 o'clock and according to the cablegram from a Mr. Steele at Invercargill, the WHAZ broadcast was distinctly heard on the first and "three subsequent transmissions." Atmospheric and interference from 450-meter spark stations made the remaining transmissions indiscernable. One of the most remarkable features was that the receiver used only a single tube set without amplification.

The series of trans-Pacific tests were conducted under the direction of Prof. Wynant J. Williams of the radio engineering department of America's oldest engineering school, the actual broadcasting being done by Harry R. Mimno and Leonard S. Inskip, radio engineering instructors, who operated the station on alternate mornings, announcing and broadcasting player piano and phonograph selections.

This remarkable feat presents a whole train of interesting suggestions. Troy is located at about latitude 42.45 north and longitude 74 west, while New Zealand is about 45 degrees south latitude and 170 degrees east longitude. Six o'clock in the morning in Troy is about 11 o'clock at night in Invercargill, so that the radio messages crossed the international date line in mid-Pacific—the dividing line of the new day. The New Zealand town is farther south of the Equator than Troy is north so the message passed from early Spring here to late Autumn there with the speed of light. While broadcasting here was under favorable atmospheric conditions the broadcasting waves passed through the Torrid Zone and into a season of the worst climatic conditions for the purpose. New Zealand is as far away from Troy as the South Pole or China. The early morning tests were heard in the Panama Canal Zone, according to reports received, and other messages are expected by mail from the Pacific stations.

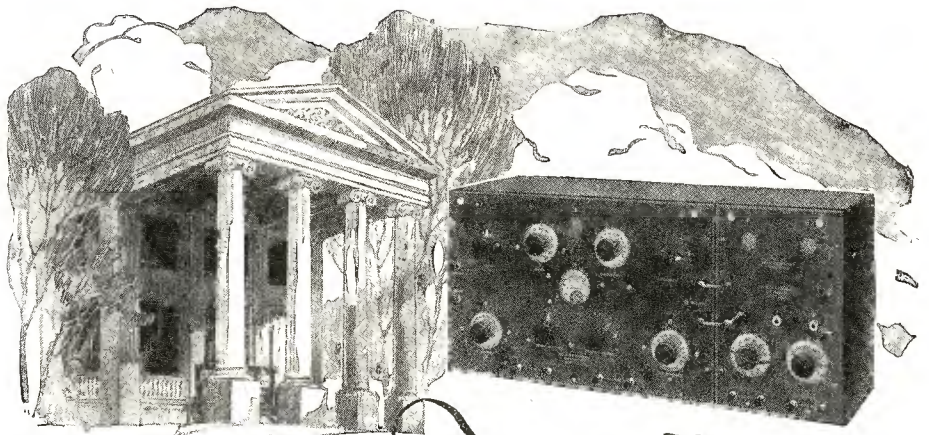

In the Finest Homes



That the Kennedy "Universal" set is a wonderful example of mechanical excellence is shown by this interior view. It can be made to detect, regenerate or oscillate over its entire range of 200 to 25,000 meters.

All Kennedy Regenerative Receivers are licensed under Armstrong U. S. Patent No. 1,113,149.

IT IS but natural that Kennedy Receiving Sets are found in the finest homes. The same appreciation of artistry that is responsible for beautiful home surroundings sees in a Kennedy a fitting example of craftsmanship that belongs with the finest.

Again—the clarity of reception, freedom from extraneous noises, and greater elimination of interference made possible by a Kennedy appeals to the true lover of music and the finer things of life. The long range places the music of the continent within your reach.

And last—the owner of a Kennedy knows that others will admire it. Its possession reflects good taste and judgment.

Arrange with your local dealer for demonstration, or write us direct for descriptive literature.

THE COLIN B. KENNEDY COMPANY
SAINT LOUIS SAN FRANCISCO

K E N N E D Y



MEMORIZE IN ONE HOUR

BKUMA YRLSBUG
TRADE MARK REG. U. S. PAT. OFF.

Attentive Beginners Who Use

DODGE TWO DOLLAR RADIO SHORT CUT SMASH ALL RECORDS

Best NINE Records reported by NINE Beginners in NINE Districts (all now Licensed Operators) AVERAGE 37 MINUTES.
For ONE DIME will mail Records by many Beginners in all Districts who easily became Licensed Operators, and to help enlighten and encourage others, have told the story of their Quick Success.

C. K. DODGE

Dept. N, Mamaroneck, N.Y.

Prices Reduced

ON
Saturn TRADE MARK **Products**

HAVING had more than the anticipated success in the sale of our goods, we are pleased to inform the trade that the correspondingly larger output caused lower production cost, and consequently we are now in a position to lower our list prices.

THIS reduction is for the United States only and will be effective after February 28th.

The New Prices Are:



The Saturn Automatic Radio Plug

The Plug with the RED SEAL

\$1.25

The Saturn "PERFECT Jack"



- No. 1. Single Circuit, Open \$0.50
- No. 2. Single Circuit, Closed 0.55
- No. 3. Double Circuit, Closed 0.70
- No. 4. Single Filament Control 0.75
- No. 5. Double Filament Control 0.80

Now the best at the price of common goods

The Saturn Mfg. & Sales Co., Inc.

Dept. R.N.
 48 Beekman Street
 New York, N. Y.

BECOME A PROFESSIONAL PHOTOGRAPHER



EARNING \$35 TO \$125 A WEEK
 Three to six months' course. Motion Picture, Commercial, Portraiture. Practical instruction. Modern equipment. Ask for Catalog No. 56.

N. Y. INSTITUTE OF PHOTOGRAPHY
 NEW YORK CHICAGO BROOKLYN
 141 W. 36th St. 630 S. Wabash Ave. 505 State St.

WHY NOT spend Spring, Summer and Fall gathering butterflies, insects? I buy hundreds of kinds for collections. Some worth \$1 to \$7 each. Simple outdoor work with my instructions, pictures, price-list. Send 10c (not stamps) for my illustrated Prospectus before sending butterflies.
 Mr. Sinclair, Dealer in Insects, Dept. 33, Ocean Park, Calif.

FREE

Complete price list of radio parts.
 Write Aitken Radio Co.,
 504 Superior St., Toledo, Ohio.

Tuning Radio Receivers

(Continued from page 2094)

one dial in each hand, until the signal is located. When this has been done, try setting the inductance switch at different taps, and then retuning with both condensers. Observe which inductance setting gives best results and come back to it. Retune with condensers until loudest signal is heard. Now slowly loosen coupling, by decreasing the reading of the vario-coupler dial, or by separating the two coils of the loose coupler. Retune your primary and secondary circuits at this new coupling position until the best signal is secured. It will be observed that the tuning is sharper and that the signal is being heard without interference. Loosen the coupling between the antenna and the secondary circuits still further, and again retune both circuits. Do this alternately until the loosest coupling is employed consistent with signal strength. The looser the coupling the less interference will be experienced. When headphones are used, the signal does not have to be extremely loud. Novices make a mistake in trying to make the signal in headphones exceedingly loud. This desire is often the fault of considerable interference, since they tighten up their coupling tremendously to secure loud signals, thereby increasing interference. Where headphones are used, a low signal is sufficient.

Fig. 12 illustrates two of the most common and important types of two-circuit regenerative tuners, circuit 1 being the tickler feed-back type, circuit 2 being the grid and plate variometer arrangement. The grid variometer in circuit 2 takes the place of the secondary condenser in circuit 1, that is, it is the tuning element in its circuit. In tuning these sets the procedure is really a combination of that in tuning the above non-regenerative two circuit tuner and in tuning the feedback circuit of the single circuit regenerative tuner. The regenerative element is set at its minimum position, that is the tickler feed-back coupling is set at zero, and the plate variometer also at zero, as the case may be. The primary and secondary circuits are then tuned in the same manner that the above two-circuit non-regenerative set is tuned. Only in the case of the grid-plate variometer circuit we use the grid variometer in place of the secondary condenser. Otherwise the procedure is the same. After the circuits have been tuned with the regenerative element at its minimum position, the feed-back or plate circuit is varied in the same manner described for the single circuit regenerative tuner. Thereafter, alternate tuning circuits and adjusting the feed-back or plate circuit until best results are secured.

Tuning is largely a matter of experience. After a short while at the business, the novice will find that he will be using both hands in tuning, each hand adjusting some circuit, and he will shift quickly from one circuit to the next. In radio, as in every other field, practice makes perfect. The above explanations and brief instructions will, however, give the novice a good send-off in the business of tuning his radio set.

A GOOD ARGUMENT

An Admiral of the Navy, in objecting to the suggested licensing of all service radio operators under commercial regulations, said it would be as sensible to require that he and some 6,000 other navigators in the Navy take the Department of Commerce's examination for a Master's license before they would be permitted to carry any passengers on Naval vessels or transports. Which seems to be a good argument.

Hear them all. all the time

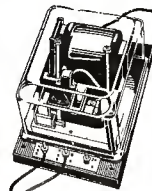

Don't miss a program
 Charge your
 A and B Batteries at
 home with a
Valley
 Battery Charger

Simple:

Plugs in on a light socket just like a lamp. Clamps to battery terminals.

Safe:

Cannot overcharge your battery. Ammeter immediately indicates incorrect connections.

Quick:

Will charge the ordinary radio battery from bedtime one night to listening-in time the next.

At radio dealers—or write us.

Valley Electric Co.
 St. Louis, Mo.



WOI WMC WDAP KDYX PWX

CUT PRICES

To Consumers

| | Regular List | Our List |
|--|--------------|----------|
| 1½-volt Tube | \$ 6.00 | \$ 4.50 |
| 1½-volt Amp. Tube... | 6.75 | 4.75 |
| Baldwin type C Phones | 16.00 | 13.00 |
| Magnavoxes | 45.00 | 37.00 |
| Murdock Phones, 2000 | | |
| Ohm | 5.00 | 4.20 |
| Murdock Phones, 3000 | | |
| Ohm | 6.00 | 4.90 |
| Acme Transformers ... | 5.00 | 4.20 |
| Plugs | 1.50 | .59 |
| Rheostats | 1.00 | .50 |
| Moulded Sockets | .75 | .45 |
| B Batteries, 22½-volt.. | 1.25 | .80 |
| Crystal Detectors | 1.00 | .69 |
| Contact Points, per doz. | .35 per doz. | .15 |
| Switches, tapered knob | .35 | .20 |
| Honeycomb Coils, all sizes 25% discount. | | |
| Paragon Ra 10..... | 110.00 | 68.00 |
| Variometers | 3.50 | 2.50 |
| Variocouplers | 1.50 | 1.10 |
| Dreyfuss Phones | 8.00 | 7.00 |
| 3-inch Dials | .75 | .30 |
| Rheostat Dials | .50 | .23 |
| No. 14 Hard-drawn | | |
| Aerial Wire, C ft.... | .60 C ft. | .38 |

We give a discount of 10% on all standard merchandise not listed.

MAIL ORDERS ONLY No STORE TRADE

Mail check or money order.
 No stamps or currency.

RADIO CUT PRICE CO.

320 Broadway, New York City

KY
W
NA
AF
I
WM
WA
CA
KY
J
WB
B
WV
Y
GA
A
WB
A
P
KE
A
WA
F
WA
A
WA
A
W
Y

The Vario-Aerial

(Continued from page 2083)

- 2 Terminals.
- 6 (or more) small spacer washers.
- 1 Piece flex about 10 in. long.
- 2 Blind laths.

One of the hoops having been reduced in size, leaving about $\frac{3}{4}$ in. clearance all round when placed inside the other, they are both provided with cardboard "tyres" $2\frac{1}{2}$ in. in width. These tyres are made by cutting strips from the cardboard sheet and fastening them round the hoops with small brass tacks.

At opposite points in the circumferences of the hoops holes are bored through the cardboard and wood to take the brass spindles. The piece of 3-in. ebonite is drilled and screwed, as shown in Fig. 3, to the outside of the larger hoop near the hole for the spindle (see A, Fig. 5). This is shown in the photograph with the wire passing over the ebonite.

The two 2-in. pieces of ebonite are screwed inside the smaller hoop as indicated in Fig. 4 and at B and C in Fig. 5 and also in the photograph, which, however, shows pieces 3 in. long, though 2 in. will prove quite sufficient.

The winding of the larger hoop is started from a terminal fixed in one of the end holes of the ebonite strip. Wind on fifty-eight turns, and finish off on a piece of rod 1 in. long put through the other hole in the ebonite, with two nuts and washers on each side. (A cheese-head screw will do equally well.)

The winding of the smaller hoop is started from a piece of rod assembled through the hole in one of the ebonite strips with nuts and washers as before. Fifty-eight and a half turns are wound on, and the wire is finished off at a terminal fixed in the piece of ebonite opposite the starting point.

At the beginning and end of the windings the wire should be secured by threading through holes punched near the edge of the cardboard before attaching it to the terminals. If wound fairly tightly the wire should not slip off, but if it shows a tendency to do so the hoops may be bound spirally with silk or thread.

The two hoops are now assembled as shown in Fig. 5. Spacer washers are used between them in preference to nuts as there is not room to fit lock nuts satisfactorily and single nuts work loose. Even the lock nuts provided at the inner and outer ends of the spindles are apt to loosen, but it is a simple matter to screw them up with the fingers every now and then. The two coils are connected by the flex as shown at A B (Fig. 5). This diagram gives all details except the first terminal, which lies at the far end of the ebonite strip at A.

The completed instrument is suspended from two blind laths (one will not bear the weight) by a piece of rod with the necessary nuts and washers. As the hoops are seldom perfectly circular there may not be sufficient clearance to allow of this method of suspension. If this is the case, drill a transverse hole through the outer hoop and make a yoke of wire, which can be fastened to the spindle above.

The laths can be put across the picture moulding in a corner of the room, where the vario-aerial will function quite well although theoretically not far enough away from the walls. Alternative methods of mounting can be devised easily and might give increased efficiency.

TUNING

Tuning is rather critical, and it is as well to use a small variable condenser in parallel, preferably with vernier.

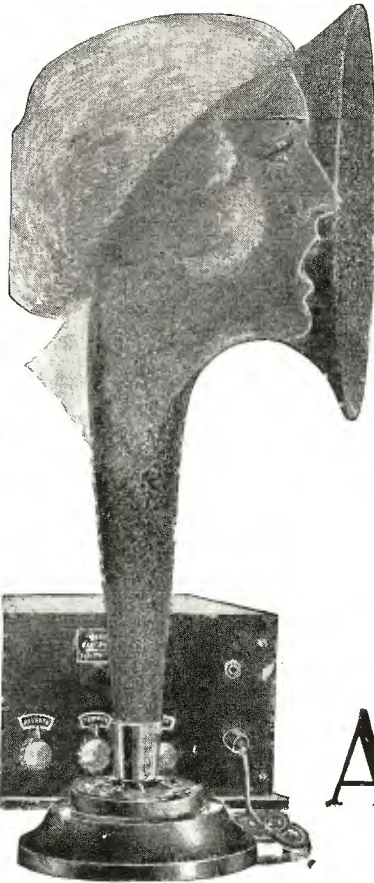

A Real Musical Instrument

ACTUAL re-PRODUCTION of the artist's music, as broadcasted, is at last attained in the Atlas Amplitone Loud Speaker, without blast or distortion. The artist's personality breathes again in the full, natural, vibrant tones of the Amplitone RE-PRODUCTION. Musical critics and radio fans, who have heard the Amplitone, agree that, at last, the musical superiority of even the finest phonographs has been surpassed. Embodies exclusive acoustic principles including the marvelous double diaphragm.

Atlas AMPLITONE LOUD SPEAKER

No loud speaker is perfect unless it can be adjusted to your own individual set. The Atlas Amplitone is adjustable to any set. Complete with connecting cord.

\$25

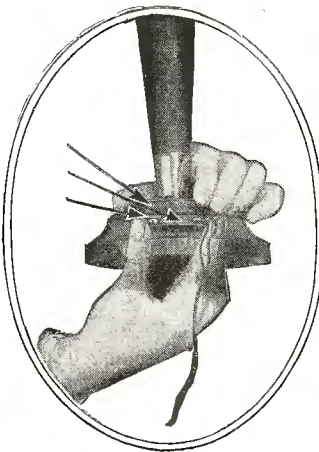

Atlas Amplitone Unit

The Atlas Amplitone Unit, (without base or horn), with Grafonola Attachment, for use with your own horn or base or to convert any phonograph (except the Brunswick) into a loud speaker with attachment. . . . **\$13.50**

Write for illustrated booklet and the name of your nearest Amplitone dealer. No other loud speaker can take the place of the Amplitone.

Multiple Electric Products Co., Inc.

3 Orange Street, Newark, N. J.

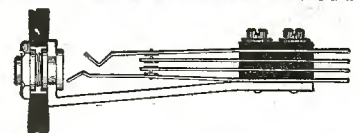

CARTER "TU-WAY" Plugs and "HOLD-TITE" Jacks

Carter "TU-WAY" Plug takes ONE to FOUR ANY kind of terminal. Price \$1.50.

Carter "HOLD-TITE" Jack; wide frame, heavy phosphor-bronze springs; no spacer washers. One to five springs. Price 70c to \$1.10.

NEW CARTER VERNIER CONTROL RHEOSTAT. Price (6 ohms) \$1.50; (20 ohms) \$1.75. NEW CARTER AUTOMATIC PLATE CIRCUIT CONTROL RHEOSTAT eliminates change-over switches, filament control jacks, and first and second stage jacks. Price (6 ohms) \$2.25; (20 ohms) \$2.50.

NEW CONTROL SWITCHES OF ALL TYPES—"Carter for Quality—Others for Quantity" Sold by all good electrical and Radio Jobbers. Write for bulletin on these and other Carter products.

CARTER RADIO CO.

209 S. State Street

CHICAGO

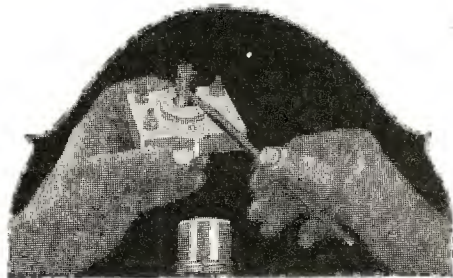

FROST-RADIO PROTECTOR

\$1.50

The perfect protector with the "sawtooth" gap

NOTICE the sawtooth edge of the Frost Radio Protector element. This edge provides scores of metal points which pull away from the carbon block after fusion, making the Frost protector positively self-cleaning. Does not interfere with radio reception. May be mounted indoors. Approved by Underwriters' Laboratories. Money cannot buy a more efficient protector for your radio set. Order today from your dealer.

Note that protector elements are closely spaced in accordance with new rules

protector for your radio set. Order today from your dealer.

DEALERS: Your trade is demanding Frost Radio Protectors

Order a stock today from your jobber. With the return of summer hundreds of thousands of Frost Protectors will be sold. Get your share of this business. Remember: every receiving station must use a protector approved under new rules of National Board of Underwriters.

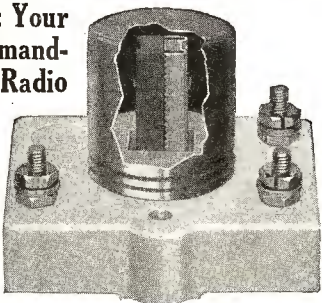

HERBERT H. FROST, Inc.
154 WEST LAKE STREET, CHICAGO, ILLINOIS

FREE VACUUM TUBE RADIO SET

The Set you always Wanted, FREE

A real RADIO SET — Listen in on Concerts, Lectures, Singing, etc. Can receive 75 to 100 miles and more.

RUSH your name and address and we will tell you HOW you can get a VACUUM TUBE RADIO SET

ABSOLUTELY FREE

Don't delay. Write today, for FREE RADIO PLAN.

Home Supply Co.
Dept. 464
131 Duane St., New York

TELEGRAPHY

(Morse and Wireless) and RAILWAY ACCOUNTING taught thoroughly. Big salaries; great opportunities. Oldest, largest school. Endorsed by Telegraph, Railway, Radio, and Government officials. Expenses low — opportunities to earn large portion. Catalog free. **GODGE'S INSTITUTE,** 17 Street, Valparaiso, Ind.

As already stated, Eiffel Tower telephony can be heard plainly in headphones with five valves (and probably four), regeneration being used in the plate circuit. Paris time signals and other Morse transmissions are sufficiently strong to work a small loud speaker.

(Abstract from our English Contemporary Amateur Wireless.)

Principles of the Antenna System

(Continued from page 2091)

be a greater current density at this point resulting in non-uniform distribution of current with consequent rise in resistance. A network of wires should preferably be employed, radiating from a common circle, and these should be connected together at intervals by means of soldered jumpers, as in the direct ground network. Where wooden stakes are used to support these wires great care should be taken that they be very well seasoned, for if they are not, there is going to be considerable loss due to leakage to the ground. Wires should not be directly connected to the stakes, but should, of course, be well insulated by non-hygroscopic insulators. Long glazed porcelain insulators will do quite well. Under no circumstances use unglazed porcelain. More will be said about insulation later. There has been some talk about grounding the counterpoise and securing better results than with the counterpoise alone, but it is best to avoid this, by all means. Unless it is properly done, the effect of grounding the counterpoise may be to vitiate entirely the desired action of the counterpoise, the object of which is to do away with the ground. So the best advice is to keep hands off this stunt until you are more familiar with the ways of counterpoise antennae.

Finally, with regard to ohmic losses, the question of joints and connections arises. The novice is always apt to be careless about this, largely because he does not know and because he is ignorant of the effects of poor joints. It is very difficult from the writer's experience anyway, to convince the novice that a poor joint may work havoc with his set. **SOLDER ALL JOINTS** as a matter of principle. The experience of years proves this is important. This, then covers the causes for high ohmic resistance antennae, how they may be reduced, and also covers the good design and construction of the most important types of grounds.

We now come to a consideration of losses due to dielectric absorption in the imperfect dielectrics surrounding the antenna. This factor is probably most often overlooked by amateur and novice alike. They can understand and see where wires offer a resistance, but either do not understand or consider unimportant the fact that there may be large losses in the insulating dielectric around the antenna. When a voltage is applied to a condenser, the condenser receives its normal instantaneous charge, but right after this experiment shows that there is a small additional charge which piles on the condenser. The first instantaneous charge may be recovered by discharging the condenser. The second small additional charge cannot be recovered, but is lost in the condenser as heat. That energy is wasted. This is due to what is called dielectric absorption. This loss may, therefore, be considered as the result of a wasteful series resistance in the condenser. The more imperfect the insulating dielectric is, the greater is its resistance. This is exactly what we have in the case of our antenna. The antenna and ground or coun-

Solder it with a

LENK AUTOMATIC BLOW TORCH

No Pumping
No Priming

THE ONE THAT BLOWS ITSELF

The handiest tool ever devised for soldering connections on Radio sets, repairing wiring in your house or on your car. Produces a 1400° needle-point flame instantly. Fine for close, careful work. Used by electricians and mechanics everywhere.

60" coil self-fluxing (acid or rosin core) solder 25c
Lenk Super (mouth blow) torch..... 75c
Lenk Jumbo (mouth blow) torch..... \$1.00
Marvel Soldering Kit—one Lenk Automatic Blow Torch and two coils self-fluxing solder—one acid and one rosin core, in neat leatherette case \$2.00

If your dealer doesn't sell them, order direct.
LENK MFG. CO., 38 Portland St., Boston, Mass.

NEON LAMP LIGHTNING ARRESTER

Screwed into any standard lamp socket connected with the aerial and ground is guaranteed to discharge over 220 volts. Can be placed either inside or outside receiving set. Can also be used as rectifier for small currents.

Approved by the Underwriter

Price \$1.50

Neon Lamp Works, Inc.
62 West 14th St., N. Y. City

ENGRAVING MACHINES

For **RADIO PANELS**
And Other Radio Engraving

ENGRAVERS & PRINTERS MACHINERY CO.
Sag Harbor, New York

Design and Construction of Audion Amplifying Transformers

Radio and Audio Frequency Type

This book will be of great interest to all radio amateurs. The transformers have never before been described in print. The possessor of vacuum tubes cannot afford to do without this book. It will enable him to build the necessary amplifying transformers very readily. The book is printed on good paper and has an attractive cover in two colors.

Paper bound. Size, 5 in. by 7 in. Contains many illustrations, diagrams, and working data.

Price 25 Cents

Postpaid to any address upon receipt of price.

Dealers Write for Wholesale Discounts.

Experimenter Publishing Co.
53 Park Place New York City

terpoise constitute the plates of a condenser, and the medium in between, and surrounding it is the dielectric. It is obvious that this medium will be far from perfect and must therefore entail considerable losses due to absorption. Even if a very poor dielectric such as wooden buildings is not directly near the antenna system there may result considerable absorption losses in it. The electric field of the antenna extends over a considerable distance around the vicinity of the antenna and may extend far enough to be influenced by poor dielectrics. It is of course, out of the power of the amateur to change the antenna dielectric, but a certain amount of reasonable care can be exercised by him when constructing his antenna.

In the first place he should erect it, as far as circumstances permit, in the most open place possible, removed from tall structures and trees, but if structures are near, the matter cannot be helped, and the antenna should then be very well insulated from them. This business of erecting antennae near trees or with their help ought to be exploded. Some of these new radio companies issuing instruction leaflets generally tell the purchaser to use a tree for a support wherever possible. As a matter of fact, the advice ought to be wherever possible do *not* use a tree. Keep away from trees, for they are a very important source of dielectric loss. If trees *must* be used as one of the means of supporting an antenna, the antenna wires should be kept as far away from the tree as possible. Use long insulators in series to keep the wires away from the trees.

We now come to one point in this matter of dielectric losses, which is unknown to a large number of amateurs, and this is the matter of insulation. Every bit of insulation used in or near your antenna increases the possibilities of dielectric losses, for an insulator is a dielectric and as such will absorb energy. It is for this reason that in high grade work and in commercial practice designs are made so that air insulation is used as much as possible. Thus spiral inductances in commercial practice are wound on a bakelite back, but this bakelite panel is drilled with a few 3-inch and 4-inch holes, so that air insulation is prevalent. So in antenna structure use insulators wherever necessary only. Now the fact that a certain material will insulate against certain voltage does not necessarily mean that it is a good insulator, as is so commonly supposed. A good insulator for radio purposes must satisfy a number of conditions: (1) it must be insulated well; (2) it must have a low capacity between its terminals; and (3) it must be a good dielectric. What most amateurs do not know is that a certain material may be a good insulator without being a good dielectric. It may insulate well and still have large dielectric absorption. There are enough good insulating products which at the same time are good dielectrics on the market today, and there is no excuse for using poor material. In general materials which absorb moisture are extremely bad, and such materials are wood, fibre and unglazed porcelain. Electro-se, bakelite and hard rubber are all good materials and they are sufficiently reasonably priced to warrant their use.

Wherever metal may be used as well as insulation, the metal should be employed, in this way helping to reduce the possibilities of dielectric absorption. Thus in the case of the cage antenna, the wires are supported by hoops. Now, as these wires are electrically connected at the lead-in anyway, they may, without hurting the operation, be connected by a metallic hoop, say of copper. In this way the use of six or seven insulating hoops is avoided and the absorption losses no doubt considerably decreased. In the case of a flat top antenna, spreaders are used. Rather than employ green, unseasoned wood, which would result in considerable loss, the spreaders could very well be made of metal-

CALDBECK Tool & Mfg. Co.

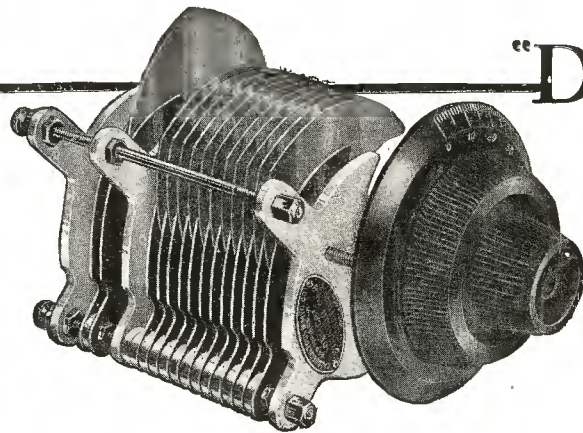

The "Demcal"

The variable condenser with a straight line wave length curve

Great Advantage!

in the *Straight line wave length curve*

Quoted from
Physics
Department of
Iowa State
University

"The 'Demcal' condenser shows a perfect straight line wave length curve. It has a maximum capacity of 365 M m f and a range in wave length through 80% of the scale of 265 meters—This is a range of .87 meter per micro-microfarad.

"The 'Demcal' condenser with a capacity of 365 M m f has as great a range in wave length as a semi-circular plate condenser of 587 M m f."

Approximately zero capacity when plates are disengaged

Approximately zero capacity when plates are disengaged

Capacity increases as to square of angular displacement

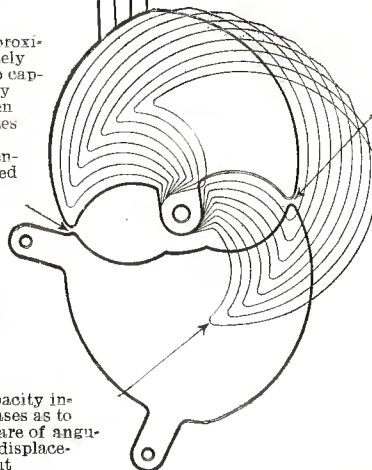

List Price

- 3 plate DEMCAL Variable Condenser, \$2.50
- 11 plate DEMCAL Variable Condenser, 3.50
- 11 plate DEMCAL Variable Vernier Condenser, - - - - - 6.50
- 23 plate DEMCAL Variable Condenser, 5.00
- 23 plate DEMCAL Variable Vernier Condenser, - - - - - 8.00
- 43 plate DEMCAL Variable Condenser, 6.50
- 43 plate DEMCAL Variable Vernier Condenser, - - - - - 10.00

Manufactured by

CALDBECK Tool & Mfg. Co.

208-210 E. Walnut Street

Des Moines, Iowa

PATENTS If You Have an Invention and Desire to Learn How to Secure a Patent

Send for our Free Guide Book, **HOW TO GET YOUR PATENT**. Tells our terms and methods. Send model or sketch and description of your invention and we will give our opinion as to patentable nature. Our documentary **PROOF OF INVENTION** is intended for your protection and will be sent you without charge. Write for it.

RANDOLPH & CO.

Dept. 459 Washington, D. C.

NAME

STREET

CITYSTATE.....

U.S. PATENTS



SEND FOR THIS FORM

Don't Lose Your Rights

Before disclosing your invention to anyone send for blank form "Evidence of Conception" to be signed and witnessed. A sample form together with printed instructions will show you just how to work up your evidence and establish your rights before filing application for patent. As registered patent attorneys we represent hundreds of inventors all over the U. S. and Canada in the advancement of inventions. Our schedule of fees will be found reasonable. The form "Evidence of Conception" sample, instructions relating to obtaining of patent and schedule of fees sent upon request. Ask for them,—a postcard will do.



270 OURAY BLDG., WASHINGTON, D. C.
"Originators of form Evidence of Conception"

PATENTS

To the Man with an Idea

I offer a comprehensive, experienced, efficient service for his prompt, legal protection and the development of his proposition. Send sketch, or model and description, for advice as to cost, search through prior United States patents, etc. Preliminary advice gladly furnished without charge. My experience and familiarity with various arts frequently enable me to accurately advise clients as to probable patentability before they go to any expense.

Booklet of valuable information and form for properly disclosing your idea free on request.

Write today.

RICHARD B. OWEN
PATENT LAWYER
2 Owen Building, Washington, D. C.
2276A Woolworth Bldg., New York City

Starting a Company?

Save expenses and taxes by organizing on the popular, COMMON LAW plan under a pure DECLARATION OF TRUST. No experience required to fill in DEMAREE STANDARD FORMS, issue shares and begin doing business at once. Genuine DEMAREE FORMS are nationally known, approved by attorneys and utilized by successful concerns throughout the United States. Send for large, free pamphlet D-40 containing valuable information that you may need. C. S. DEMAREE, legal blank publisher, 708 Walnut, Kansas City, Missouri.

PATENTS Secured

Prompt service. Avoid dangerous delays. Send for our "Record of Invention" form and Free Book telling How to Obtain a Patent. Send sketch or model for examination. Preliminary advice without charge. Highest References. Write TODAY. Jacobi & Jacobi, 414 Ouray Bldg., Washington, D. C.

PATENTS

As one of the oldest patent firms in America we give inventors at lowest consistent charge, a service noted for results, evidenced by many well known Patents of extraordinary value. *Book, Patent-Sense, Free.* Lacey & Lacey, 431 F St., Wash., D. C. Estab. 1869.

lic tubing, around which the individual wires are wrapped, since the wires are connected together at the ends. Wherever possible, then, use metallic material instead of insulating material, unless the chances of eddy current losses are too great. In the cases outlined above, these losses would be negligible.

Good insulation must be employed in certain places to reduce losses due to induction. Thus guy wires must be broken up by means of insulators and it is very desirable when setting up metallic masts to mount them on an insulating base. The larger the number of insulators used in breaking up the guy wires, the better the results will be. The antenna itself should be as far away from the supporting metallic masts as possible.

This covers quite thoroughly the chief causes for wasteful resistance of the antenna. If the above explanations and precautions are carefully followed, and the methods above advanced are put into practice the amateur will find that he has reduced his wasteful resistances as low as possible. This is, however, only part of the problem. The above applies equally well to transmitting and receiving antennae, since a good transmitting antenna will generally make a good receiving antenna. However, for transmission his problem is only partly solved. Having reduced his wasted energy as low as possible, an effort must now be made to increase his useful radiated power. In other words, how can we design or operate our antenna so that its radiation resistance is a maximum?

TRANSMITTING ANTENNAE

The radiation resistance of an antenna is found to depend upon two factors: (1) the effective height of the aerial, that is, the height of the center of capacity of the antenna; and (2) the wave-length of transmission. This radiation resistance is given by the equation

$$R = K \frac{h^2}{\lambda^2}$$

in which K is a constant, h the effective height of the antenna, and λ is the wave-length. It will thus be seen that the greater the wave-length, the lower is the radiation resistance, and the higher the antenna the greater is the radiation resistance. What we require therefore for transmission is great height. When we come to the question of wave-length and radiation we strike another point on which the amateur often lacks information. What is required for good work is a maximum of energy to be radiated. Most amateurs confuse this requirement with maximum current in the antenna. Maximum current in the antenna does not necessarily mean that you are radiating at maximum efficiency. Maximum radiation takes place at a certain definite wave-length for each antenna, and this wave-length is the fundamental wave-length of the antenna. If it were possible to design the antenna so that it radiated at its natural wave-length without the insertion of extra coils or condensers, the antenna would be operated at maximum efficiency. It is true that more current could be obtained from the antenna at another wave-length, but the radiation would not be as efficient as at the fundamental. The antenna should, therefore, be designed so that its natural wave-length is right near the fundamental. Of course it may be necessary, in fact it will be necessary, to use some loading inductance for coupling purposes, hence the antenna should be operated with a series condenser to bring the operating wave-length on the fundamental.

Antennae built in accordance with the foregoing will be good transmitter aeriels, as the foregoing has been written from the transmission point of view. However, they are also of good design for reception, and

Radio PATHFINDER & Wall Map



"Pathfinder Gauge is all the Rage"
How far will your set reach?

Air-Line "DISTANCE" in Meters and Miles from your HOME anywhere to all Broadcasting stations in the U. S. The PATHFINDER GAUGE does it. Use the GAUGE and "Tune in" the Station. Gauge complete with Wall Map 36"x24" showing location, call letters and wave length of Broadcasting Stations, Standard Time Zones, radio districts, and other valuable information. No set complete without this outfit. Mailed prepaid, rolled in tube with full instructions.

Heavy paper \$1.00
Cloth Mounted \$2.00
(DO NOT SEND STAMPS)

RADIO MEASUROGRAPH

231 Tribune Annex
Dept. N. MINNEAPOLIS - MINN.

65% Have This Gland Trouble At Middle Age



Do you suffer with sciatica, pains in back, legs or feet, frequent nightly risings, bladder or kindred trouble; have you lost the old pep and aggressiveness; do you have blues or mental depression?

Scientists and medical authorities agree that 65% of all men past a certain middle age (thousands younger) have a disorder of the prostate gland, often responsible for these annoying conditions.

Simple Home Treatment

But a new treatment has been discovered by a member of the American Association for the Advancement of Science. Already over 10,000 men have used this method with astonishing success. It has saved many of them from the surgeon's knife. Yet the method is so simple that it can be used by anyone—no drugs, lessons, electric rays. Nothing to pay unless you get immediate relief. If you have prostatic trouble, or any of the symptoms mentioned,

Free Book send immediately for a Free Book, "Why Many Men Are Old at 40," which tells all about this method—and the truth about glands. No obligation. Just give name and address. Write immediately to The Electro-Thermal Company, 6020 Main Street, Steubenville, Ohio.

PATENTS

Procured. Send sketch or model today for examination, prompt report and advice. No charge for preliminary advice. Write for free Booklet and blank form on which to disclose your idea. Highest references.

CLARENCE A. O'BRIEN
Registered Patent Lawyer
1051 Southern Building Washington, D. C.

PATENTS

C. L. PARKER
Formerly Member
Examining Corps,
U. S. Patent Office.
PATENT - LAWYER
McGill Bldg., Wash., D. C.

Patents, Trade Marks, Copyrights, Patent Litigation
Handbook for Inventors, "Protecting, Exploiting and Selling Inventions," sent upon request.

ARE YOU SELF-CONSCIOUS?

Embarrassed in company, lacking in self-control? Let me tell you how you can overcome these troubles. M. VERITAS, 1400 Broadway, New York City

can be used for both, but where special antennae are required for reception, other considerations enter. While it is desirable to reduce all antennae losses to as low a figure as possible, and is essential for transmission, this is not so important when it comes to reception. If there are some losses they can easily be made up by amplification. The chief and special requirement of receiving antennae is to overcome the effect of disturbing atmospherics or static. The response of an antenna to a signal divided by the response of the same antenna to static is called the "signal-static" ratio. The larger this ratio is, the better will the antenna be, since the effect of static is then small. Considerable research has been done and is still being done by all large companies to develop an antenna which will make this "signal-static" ratio as great as possible. Some of the simpler solutions to this problem will be given in brief detail.

For reception only the simplest type of an antenna for the novice is the single wire antenna. When stretched a length of about 100' and about 30' to 40' high, quite good results will be obtained. This type of aerial has no special constructional features, but should be well insulated at the ends. It has a strong directional effect on the horizontal wire.

A special application of the single wire antenna is the so-called Beverage wire, named after its inventor. This type of antenna is shown in Fig. 9 and is a simple wire equal in length to one wave-length, say 200 meters, one end of which is grounded through a non-inductive resistance of value equal to the "Surge Impedance" of the antenna which is theoretically, $R = \sqrt{L/C}$, where L and C are the inductance and capacity of the antenna per unit length. The resistance is placed at

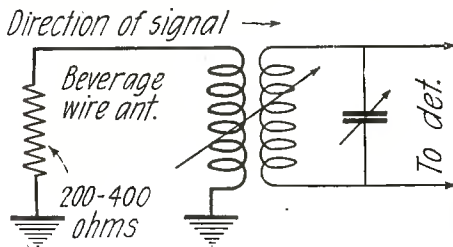

Fig. 9

A Modified Form of the Beverage Antenna. It Consists of a Single Wire, One Wave-Length in Length, and Grounded at its Free End Through a Resistance.

the end of the antenna nearest the transmitting station. At the other end of the antenna the usual coupling coil is placed, to which is coupled the receiving set. The value of the surge impedance for most one- or two-wire antennae is generally between 200 and 400 meters. This antenna has a marked directional characteristic, receiving best signals coming from the direction shown by the arrow in Fig. 8. Furthermore it reduces the effect of static considerably and provides a very favorable signal-static ratio. We cannot go into the theory of the Beverage antenna at this point, but it may be stated that the action of this antenna, when its length equals one wave-length, is such that the signal builds up to a maximum at the receiver end, and a minimum at the resistance end, while static builds up to a maximum at the resistance end where it is run to earth, and a minimum at the receiver end, thus securing a high signal-static ratio. It was with this type of receiver antenna that Godley first picked up in England the amateur trans-Atlantic signals.

One of the most important, simple and practical types of receiving antennae is the loop antenna. The loop antenna, as far as picking up signals goes, is far less efficient than the outdoor aerial, since the signal voltage in the outdoor aerial is easily 50 times as great as that picked up by the loop.

Dependable Radio Sets and Service



Can always be had from local dealers who have been honored with the

M. R. C. FRANCHISE

For Three Reasons:

- 1: Franchise is granted only to merchants of standing and financial responsibility, with sufficient technical experience to render intelligent service.
- 2: "Michigan" Radio Sets are the finest examples of correct Regenerative radio engineering, expressed in superlatively good workmanship.
- 3: The Michigan Guarantee is as valid as a Bond. For back of it stands the strongest independent Radio manufacturing concern in the United States.



"SENIOR" SET

M. R. C. Regenerative Receiving Sets

are built under Armstrong License (U. S. Pat. 1,113,149 and letters patent No. 607,388). This means that they embody the latest development in Regeneration—the soul of radio.

Long Distance Wonder Workers

The "Senior Set" includes both detector and amplification, and can be used with either headphones or loud speakers or both.

The "Junior Set," a detector unit only, is limited to headphone reception. It can however, be hooked up with the Michigan Amplifier unit for loud-speaker reception.



"JUNIOR" SET

Send for the M. R. C. Circular, giving full information on both sets and parts, and telling of some of the long-distance triumphs of M. R. C. set owners.

MICHIGAN RADIO CORPORATION

GRAND RAPIDS, MICHIGAN

ANNOUNCING THE NEW ARISTOCRAT Spirola COMPLETE CABINET LOUD SPEAKER



BUILT TO FILL THE DEMAND FOR THE VERY UTMOST IN HIGH QUALITY SPEAKERS POSSIBLE TO PRODUCE AT ANY PRICE

It is easy to get clear natural reproduction in a headset. The difficulty comes when this sound is amplified to fill a large space. The finest of high grade amplifying receiving sets is as good as wasted if the loud speaker is not of equal quality. This new SPIROLA is built to accompany the finest receiving sets—it takes ANY power and converts it into the maximum volume of sound without adding the slightest trace of foreign noise or tone distortion. Claims of "no distortion or tinniness" have been much abused, but an actual trial on your own set will convince you that this statement is not in the slightest exaggerated.

Double size spiral cabinet tone chamber with built-in Morrison "C" reproducer. Complete with cord ready to attach—no "A" battery drain. The fine mahogany finish and graceful lines make this the most beautiful speaker imaginable. **\$20**

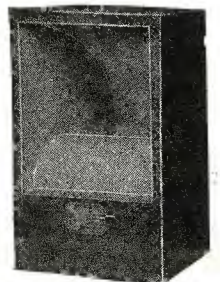

At dealers in high grade apparatus or postpaid (C. O. D. if preferred). Fully guaranteed. L. H. DONNELL MFG. CO., Dept. A, Box 70, ANN ARBOR, MICH.

Just Consider

—the essential features necessary to make an audio frequency transformer a good one—

1. High Amplification.
2. Minimum Distortion.
3. Low Interstage Linkage.
4. Convenient Mounting.
5. Compactness.

Cotoco transformers make these ideal features facts. And the finish will surely please you.

"Built First to Last"
\$5.00
At Your Dealer's

Pacific Coast Branch
329 Union League Bldg.
Los Angeles

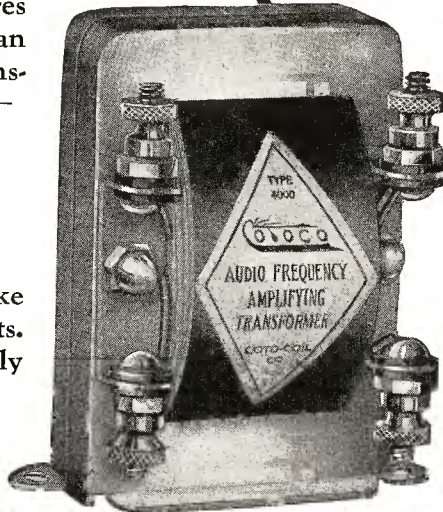

COTO-COIL CO. PROVIDENCE

W. L. DOUGLAS

NAME AND PORTRAIT is the best known shoe Trade Mark in the world. It stands for the highest standard of quality, style and workmanship at the lowest possible cost.

W. L. DOUGLAS shoes are actually demanded year after year by more people than any other shoe in the world

BECAUSE W. L. Douglas for forty-six years has been making surpassingly good shoes. The smart styles are the leaders everywhere. When you are looking for the best shoes for your money examine W. L. Douglas \$7.00 and \$8.00 shoes. They are exceptionally good value for the price. **WEAR W. L. DOUGLAS SHOES AND SAVE MONEY.**

\$5. \$6. \$7. \$8. & \$9. SHOES FOR MEN & WOMEN



NO MATTER WHERE YOU LIVE shoe dealers can supply you with W. L. Douglas shoes. If not convenient to call at one of our 116 stores in the large cities, ask your shoe dealer for W. L. Douglas shoes. Protection against unreasonable profits is guaranteed by the name and price stamped on the sole of every pair before the shoes leave the factory. Refuse substitutes. The prices are the same everywhere.

IF NOT FOR SALE IN YOUR VICINITY WRITE FOR CATALOG.

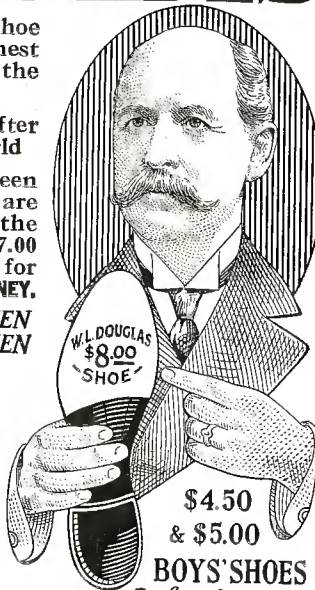

\$4.50 & \$5.00

BOYS' SHOES

W. L. Douglas
President
W. L. Douglas Shoe Co.
172 Spark Street, Brockton, Mass.

TO MERCHANTS: If no dealer in your town handles W. L. Douglas shoes, write today for exclusive rights to handle this quick-selling, quick turn-over line.

PATENTS TRADE-MARKS AND COPYRIGHTS

Before disclosing an invention, the inventor should write for our blank form "RECORD OF INVENTION". This should be signed and witnessed and if returned to us together with model or sketch and description of the invention we will give our opinion as to its patentable nature. Radio and Electrical cases a specialty.

Our illustrated Guide Book, "HOW TO OBTAIN A PATENT," sent Free on request. Highest References Prompt Attention Reasonable Terms

FREE COUPON

VICTOR J. EVANS & CO., Patent Attorneys

Chicago Offices: 1114 Tacoma Bldg. Pittsburgh Offices: 514 Empire Bldg. Philadelphia Offices: 714-715 Liberty Bldg. San Francisco Offices: Hobart Bldg. New York Offices: 1001 Woolworth Bldg.

MAIN OFFICES: 919 NINTH, WASHINGTON, D. C.

Name Address

However, due to the fact that we are able to amplify these weak signals greatly, it does not matter very much that its efficiency is small. It is only in the transmitting aerial, where amplification is out of the question that we must have aerial efficiency. The loop requires that radio frequency amplification be used, for the signal voltage is so low that it will not operate the tube detectors. In order to bring up the voltage to the value required for operating the detector it is necessary to amplify by radio frequency methods. The loop has remarkable directional properties, receiving best in the direction of its plane, and very poorly in other directions. As a result this enhances its value from the point of view of static reduction. For static is a phenomenon which strikes the antenna from all directions. If then the loop receives from only one direction, it can be influenced only by the static in coming from that direction. Furthermore although it receives signals poorly, it also receives static poorly, and as a result it has a good signal-static ratio. For these reasons the loop is finding quite a deal of favor these broadcasting days, and is being adopted by a great many people.

In the construction of a good receiving loop for the low wave-lengths, the following must be considered. The tuning condenser is connected across the ends of the loop. What is desired is that the maximum voltage be developed across the condenser for operating the amplifier tubes. In the first place the larger the inductance the greater will be the voltage, hence it is desirable to design the loop so that it will operate with a low capacity. Of course a smaller loop and larger capacity will also tune to the received wave-length, but a lower voltage will be developed across the condenser, for the voltage is directly proportional to inductance and inversely proportional to capacity. We must, therefore, work the loop with small capacity, say about 0.0002 mfd. The voltage induced in a loop is proportional to the area of the loop and the number of turns. Hence the larger the area and the number of turns the greater the induced voltage. In order to keep both factors large it will be found necessary to space the loop wires considerably apart. A loop in the low wave-length range, say between 200 and 500 meters, would consist of approximately five turns wound on a form 5' to 6' square, the turns being spaced about 2 inches.

When a novice or amateur builds an antenna solely for receiving purposes he will find the single wire type or loop type the most convenient and the best for his purpose. If he also wants to use it for transmission, he will have to use one of the following types.

DIFFERENT TYPES OF PRACTICAL ANTENNAE COMPARED

The very first type of antenna used for transmission was the vertical one. Later developments all led to some form of large area surface being employed in conjunction with a vertical wire, as for example the flat top, or fan, or umbrella, etc. The reason for this was that these proved better radiators. The explanation is as follows: The distribution of current along a plain vertical antenna is as shown in Fig. 10. It is seen that the current distribution is not uniformly strong, it being a maximum at the earth and a minimum at the upper end. Now the radiation from an antenna is directly proportional to the current in the antenna, assuming uniform current distribution. If the distribution is not uniform, the radiation must be necessarily weaker than that calculated for the current at the base of the antenna. The addition of a large area surface has the effect of making the distribution more uniform, as shown in one instance by Fig. 11. Hence for the same current at the base of the antenna the large area antenna

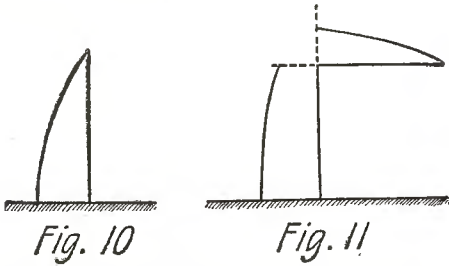

Showing the Distribution of Current Along An Aerial of the Vertical Type, In Comparison With the Current Distribution In a Horizontal Aerial.

will radiate better than the vertical. A second reason why the large area improves the antenna is the following. It was stated previously that for maximum efficient radiation the antenna should be operated at its fundamental or very near it. Now in a vertical antenna the fundamental wave-length is about four times its height. In order to operate such an antenna at its fundamental without putting too much loading coil in (which would reduce efficiency) the antenna would have to have an enormous height. Thus suppose we wanted to operate at 200 meters. In order that the fundamental of the antenna be 200 meters, the vertical antenna would have to be 50 meters or over 160' high, which is entirely out of the question. The effect of the large area is to increase the capacity and, therefore, the fundamental wave-length, thus enabling the effective height of the masts to be considerably reduced. Finally since the large area increases the capacity of the antenna, it will require a smaller voltage to produce a given current in the antenna than with the vertical wire, or in other words a given voltage will produce a larger radiation current for the large area antenna than for the plain vertical wire affair. All these considerations point to the large area antenna in preference to the simple straight wire antenna.

The simplest types of antennae most commonly used are the inverted L and T types. These are indicated in Fig. 12 and derive their names from their similarity to the shapes of an inverted L and a T. Both these types of

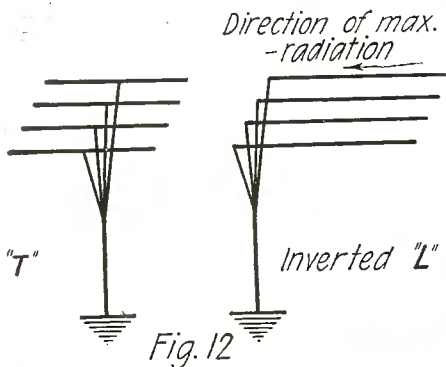

Antennae of the Inverted "T" and "L" Types. They Are Both Good Radiators.

antenna act very much the same and there is little choice between them, except that one is more convenient to install than the other in certain places. They are largely used on board ships, in fact almost exclusively. The chief difference between these two types is that the inverted L has some directional effect, maximum radiation occurring in the direction shown by the arrow in Fig. 12. This effect is not very pronounced when the length of the flat top is not much greater than the vertical height. However, when the horizontal portion is made large compared to the vertical portion, the directional effect is very pronounced. This directional effect is utilized by the large trans-Atlantic stations which point away from the station to which they are transmitting and thus se-



"I bore holes" Says Mr. Punch

"I've found the way to make clean holes through hard wood without splitting it, through soft wood without mushing it, through plaster without cracking it."



Mr. Punch is the Goodell-Pratt Automatic Drill. Inside the handle are eight different size drill points varying from 1/16 to 11/64 inch. You pick out the size you want, fit the point into the chuck, and Mr. Punch, the Automatic Drill, bores the hole in a jiffy.

All exposed metal parts are polished, nickel-plated and buffed. A handsome, simple, practical tool, ideal for radio work. Length, 10 inches; weight, 8 ounces.

Sold by good hardware stores everywhere. If your dealer hasn't it, write us.

Mr. Punch—the Automatic Drill, No. 185 Price, \$2.50

Write for Catalog No. 15. It illustrates and describes the entire list of Goodell-Pratt Tools—many of which every radio enthusiast needs.

GOODELL-PRATT COMPANY

Toolsmiths

Greenfield, Mass., U. S. A.

GOODELL-PRATT
1500 GOOD TOOLS



THE WORLD'S GREATEST RADIO CRYSTAL

THIS REMARKABLE CRYSTAL

is revolutionizing the possibilities of Crystal Sets. Unsolicited testimonials from all parts of the country report records of from 600 to 1200 miles with ordinary sets equipped with

M.P.M. (Million Point Mineral) CRYSTALS

Don't discard your Crystal Set until you have given M. P. M. a trial. Send 25c. and name of your Radio Dealer for sample unmounted crystal—35c. for mounted. Beware of Imitations.

M. P. M. SALES CO., Dept. N. 247 S. Central Ave., Los Angeles

Get a Handy Binder for your RADIO NEWS. Holds and preserves six issues, each of which can be inserted or removed at will. Price 65c. Experimenter Pub. Co., Inc., Book Dept., 53 Park Place, New York.

KNOW WHO IS SENDING

Get twice the pleasure and usefulness out of your receiving set. Look up the name and location of any ship or land station whose messages you pick up—learn the name and address of that amateur whose sending set you just heard.

4th Edition of the

CONSOLIDATED RADIO CALL BOOK

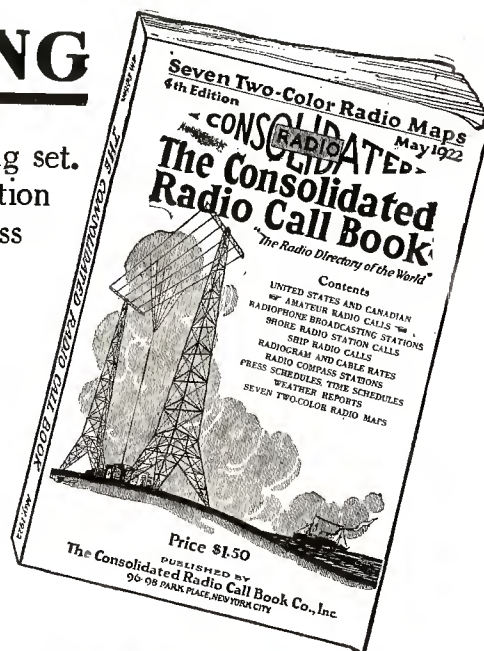

7 Two-Color Radio Maps

Five of them are Continental Maps showing all stations throughout the world handling commercial traffic, with their calls; one showing the amateur radio districts of the United States and the principal radiophone broadcasting stations with their calls; and a map of the United States Weather Forecast Zones. Seven wonderful, two-color radio maps with a wealth of information that will give you a great deal of pleasure and knowledge.

Ninety-five per cent of all Amateur Calls in the U. S. and Canada are Listed Besides Other Valuable Information Contained in This Book

Amateur Radio Calls of the United States and Canada; Every Vessel, Coast Station, and Radio-Compass Station in the World; Radiophone Broadcasting Stations of the United States; Every High-Power Station in the World; Special Land Stations of the United States; Time Signals, Hydrographic and Weather Reports of the United States and Principal Foreign Countries; International Abbreviations; Assignment of International Calls; Press Schedules; Radiogram Rates; Cable Rates; International Morse Code and Continental Signals; and Complete General Information covering Distress Calls, International Safety Signal, Use of 800-Meter Wave Length, Amendments

\$1.50
Prepaid

and Changes in Various Governmental Regulations, How to Determine Charges on Radiograms, Free Medical Advice by Radio to Vessels, and much other useful information.

And every vessel and land station in the world is represented and listed alphabetically, according both as to name of vessel or land station, and to call letters. The Consolidated Radio Call Book is the only book in print officially listing all the Radio calls as issued by the Bureau of Commerce. And the New Radiophone Broadcast Section is particularly complete and gives all available information concerning calls, wave lengths, PROGRAMS, etc.

Published by

Consolidated Radio Call Book Co., Inc.
96-98 Park Place, New York City

Great 40-page Supplement FREE to all who have the 4th Edition Call Book

cure maximum effects at the receiving end. The chief advantage of this type of antenna for the amateur is the ease and convenience of construction and the low cost. Results obtained with this type of antenna when the proper precautions outlined in the beginning are observed and when used with a good ground are very satisfactory. This is a good type of antenna for the beginner to try, and after he has had some experience with this he can go to the other more advanced ones. For transmission it is preferable to use the inverted L rather than the T, since a greater effect is produced by the use of the complete flat top in the L type than by the use of only half as in the T type.

The practical antenna nearest in shape to the above flat types is the cage type shown in Fig. 3. This has a number of advantages over the above and others which make it a great favorite among advanced amateurs. In the first place it has excellent resistance properties as explained in a previous paragraph owing to the disposition of the antenna wires as the elements of a cylinder, thereby reducing the skin effect. In the second place it offers a very high capacity top which is advantageous to good radiation. In bringing down a lead-in from such an antenna it is desirable to use a cage lead-in of the form shown in Fig. 13. This lead-in again

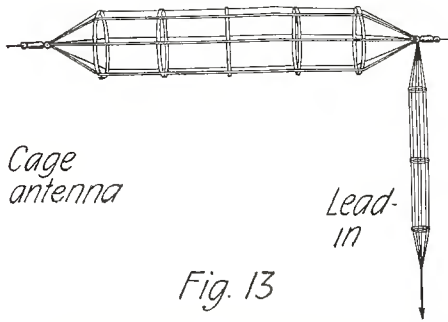

Cage antenna

Lead-in

Fig. 13

A Cage Antenna, with a Cage Lead-in. Having Its Capacity Concentrated at the Top, Makes it an Efficient Radiator.

reduces the skin effect, and at the same time, due to the tapering form, keeps the center of capacity high where it belongs. The capacity of the cage is proportional to the diameter of the cage, and due to the taper, the high capacity is at the top while the low capacity is at the bottom. Amateurs have obtained some remarkable results with this form of antenna, especially when used in conjunction with a counterpoise ground.

A less common type of antenna which is beginning to come into some use by amateurs is the fan type shown in Fig. 14, the name being due to its shape. The disadvantage of this type is that the current distribution is very irregular and hence its radiating properties are not as good as those above. However, it has the advantage of having low

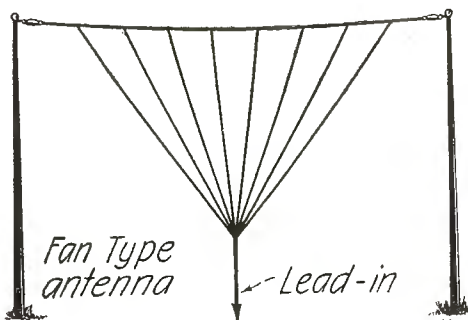

Fan Type antenna

Lead-in

Fig. 14

A Fan Type Antenna. These Are Very Good Radiators, if They Are Designed Correctly. They Have the Advantage of a Comparatively Low Resistance.

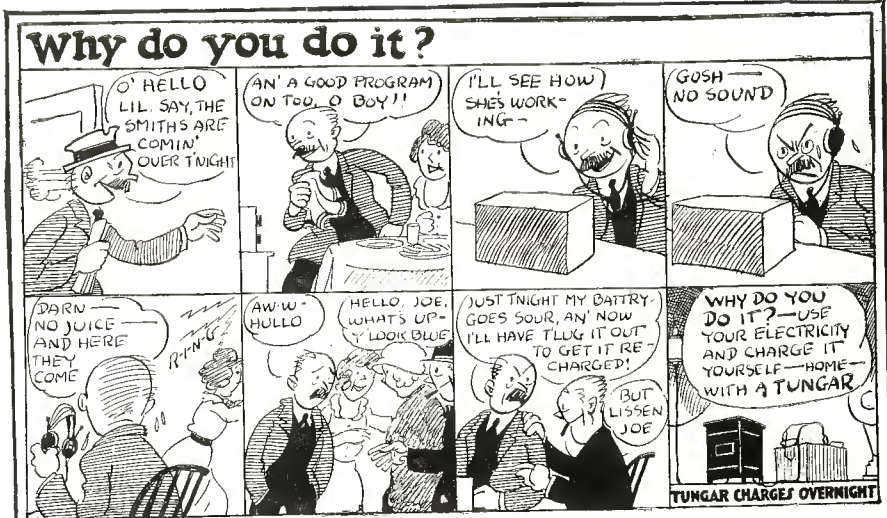

Is your battery always fully charged and fit?

Is it always toned up for best results, whenever friends happen in—throughout every concert? Keep it at full strength and prolong its life—the simple, easy, inexpensive Tungar way. Tungar—the go-between from house-lighting circuit to storage battery—attaches wherever there is a lamp or convenience outlet. You don't have to move the battery. Just connect Tungar, and leave it—any time, day or night.

Tungar is certain, clean, quiet. No moving parts to get out of order or make noise. Good for the auto battery too—the same Tungar. See one at any good electrical store, or write for literature. Address Section RA6.

Tungar Battery Charger. Operates on Alternating Current.
 2 Ampere Outfits—\$18.00
 5 Ampere Outfits—\$28.00
 (Prices east of the Rockies)
 Special attachment for charging 12 or 24 cell "B" Storage Battery—\$3.00—fits either size Tungar.

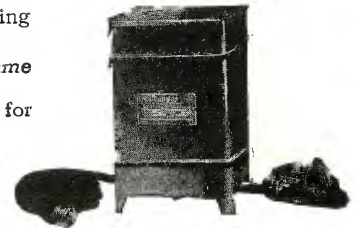

Merchandise Department
 General Electric Company
 Bridgeport, Connecticut



Charge 'em at Home, with

Tungar

BATTERY CHARGER

A GENERAL ELECTRIC PRODUCT

Two "Little Wonder" Radio Books

Every Radio Fan Should Have

How to Make Wireless Receiving Apparatus



The 20 radio constructors who wrote the book know how articles should be made from simple materials.

Only modern apparatus is described, such as Receiving set without aerial or ground, magnetic detector, wireless relay, wireless lecture set, etc., etc. Book has 100 pages, each 5 x 7 inches, 90 illustrations, many full pages, paper bound, in two colors.

Price 35 Cents

Either of these books sent to any address postpaid upon receipt of price.

Dealers Write for Wholesale Discounts.

How to Make Wireless Sending Apparatus



Contains information on how to make 30 different pieces of wireless sending apparatus from materials, easily obtained.

Tells How to Make an Experimental Arc Set, Speaking Arc, Quenched Gap, 1/4 K. W. Transformer, Oscillation Transformer, Photo Phone, etc., etc.

Book has 100 pages (size, 7 x 5 inches), 88 illustrations, paper cover printed in two colors.

Price 35 Cents

EXPERIMENTER PUBLISHING CO., 53 Park Place, N. Y. City

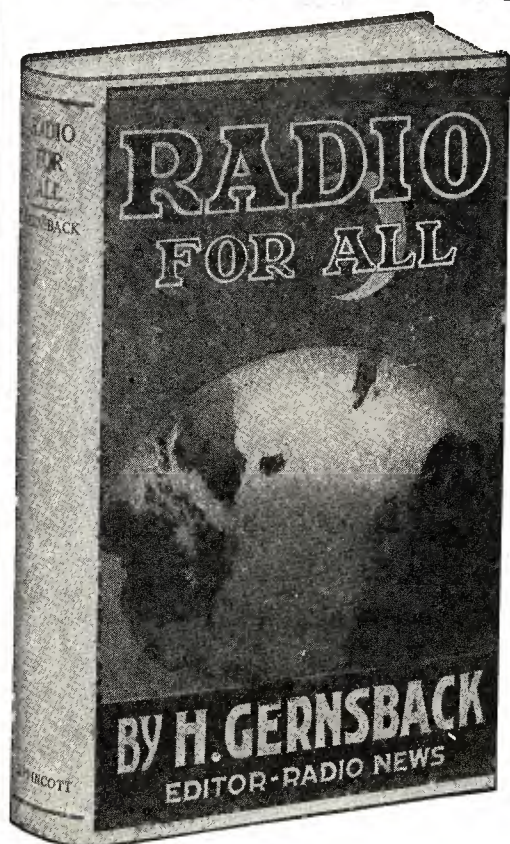

RADIO FOR ALL

By H. GERNSBACK

Editor "Radio News," "Science and Invention" and "Practical Electrics"

With over 130 illustrations and diagrams, and 12 photographs, 300 pages, size 8 1/4" x 5 1/2".

What the novice in radio needs is a book in which he can get all the information necessary for him to understand radio telephony and telegraphy, to make or buy a receiving set suitable to his means, to know how to operate his set, and after he has an understanding of the radio art, information that will enable him to advance and get the most out of his outfit. All this must ordinarily be dug out of text-books, pamphlets and government publications, but the aim of this book is to have all the data and information that the beginner will need from the time that he takes up radio. It is a permanent, comprehensive reference book for the dyed-in-the-wool dabbler in Radio.

What the Book Is.

A combination of a radio course for the novice in radio telegraphy and telephony with a reference book for the more experienced amateur. Half a dozen books in one.

For the Beginner.

- The theory of radio carefully explained with drawings.
- Description of and instruction for operating instruments of receiving and sending sets, with all picture diagrams of the wiring of the apparatus.
- How to make your own receiving set, costing from \$3.00 to \$50.00.
- How to read diagrams; for every picture diagram there is a corresponding technical diagram using the symbols instead of drawings.
- How to tune sharply and eliminate interference from other stations.
- How to protect your set from lightning and the laws regarding installation.
- Explanation of time and weather signals.

For the More Experienced Amateur.

- How to make a practical vacuum tube detector, two stage amplifier set costing less than \$50.00, that will work.
- How the radio compass works.
- All about underground aerials, loop aerials and directional aerials.
- Formulae for finding wave length; miscellaneous formulae for finding capacity of condenser and other instruments. Tables of wire resistances, wave lengths and their corresponding frequencies, approximate wave lengths for different aerials, tuning coil data, and much more invaluable information.

Special Features.

- Lists of all the broadcasting stations in the United States and Canada for concerts, time signals, weather reports, press, stock market reports, etc., with their call, wave length and time of sending.
- Detailed description of Washington weather signals and their translation.
- Description of a modern broadcasting station and its operation.
- Large map showing location of all U. S. radio telephone broadcasting stations suitable for hanging up in radio room.
- Collection of miscellaneous radio information for the amateur.

In Other Words.

The information that you ordinarily have to dig out of government publications, text-books, pamphlets, etc., is handily combined in this one book.

The Complete Book of All Radio Information

PRICE POSTPAID

\$2.00

PRACTICAL ELECTRICS COMPANY

53 PARK PLACE, NEW YORK CITY

Each a Leader In Its Field

Science & Invention

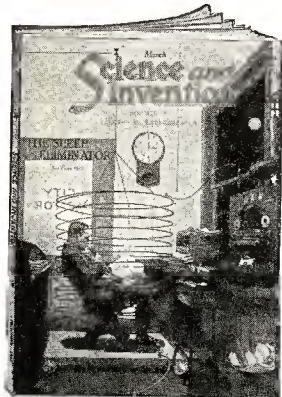

Is one of the most interesting magazines published. It is more interesting than fiction.

It is profusely illustrated and covers in word and picture the latest achievements in the sciences—in Invention, Astronomy, Physics, Chemistry, Electrics, Mechanics, etc.

It has a large section devoted exclusively to Radio. SCIENCE & INVENTION has the distinction of being more often quoted than any other magazine in the world.

More than 100 large pages—with over 300 illustrations, drawings, etc.

Special prize contests are offered each month. On all newsstands, 25c a copy.

Radio News

"The 100 Per Cent Wireless Magazine"

The Largest Radio Magazine in the World

Is read by more than a million Radio enthusiasts each month.

Its position as the leader of all Radio publications is universally recognized by dealers, radio manufacturers and every branch of the radio industry and its pages reflect their confidence.

RADIO NEWS contains more articles by Radio Experts—more specific information—detailed drawings—illustrations and news—than is published in any other magazine.

More than 200 large pages monthly. Profusely illustrated.

On all newsstands, 25c a copy.



Subscription Prices

| | |
|---------------------|---|
| Science & Invention | } One Year 12 Issues \$2.50 Each |
| Radio News | |

(Add 50c to the cost of each magazine for Canada or Foreign)

FREE PRESENTS FOR SUBSCRIPTION RAISERS.

Write for our Premium Catalog containing valuable rewards given away **FREE.**

Premium Dept.
Experimenter Pub. Co.
53 Park Place, N. Y.

Experimenter Publishing Co., Inc., 53 Park Place, New York, N. Y.

resistance and the large number of wires in parallel give it a very high capacity which results in large currents for any given voltage. Another disadvantage is that although it has a high capacity, its center of capacity is too near the earth, which is bad for radiation. Then there is the difficulty of installing such an outfit, although it requires only two masts. It is, nevertheless, quite good, although the cage type is to be recommended in preference to it.

Finally we have the umbrella type of antenna shown in Fig. 15. This has also the

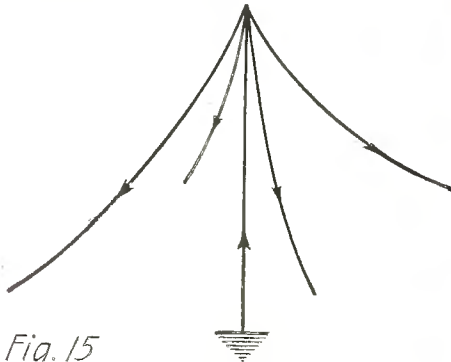

Fig. 15

An Antenna of the Umbrella Type. It Has a High Capacity, Therefore Good Radiation Qualities.

advantage of high capacity, which gives it a very good current distribution curve and high radiation current for a given exciting voltage. However, these advantages are somewhat neutralized by the following effect. The exciting current flows up the central vertical wire and down the side spreaders, as shown by the arrows in Fig. 15. Thus there is a partial opposing effect of these currents and radiation effect is thereby decreased. However, the other two advantages make up largely for this, and this type of antenna is largely used abroad in high power stations. For amateur work it is not recommended, as it is awkward and difficult to construct properly and takes up entirely too much space. One field of use in which it has found great favor is for portable antennae.

All in all, from a consideration of the foregoing, the best types of antennae for the amateur to construct, if he is going to transmit and receive, is the cage type or the flat top type. Of the two, the cage type will be found the better. A good cage type antenna should have the following construction: Six No. 7 x 18 phosphor bronze wires spaced around a circle 3' in diameter. Length of the top portion should be about 75', if possible, and as high as conditions permit. The lead-in should also be a cage tapered very strongly so that the diameter half way down is very small, say about 6 inches.

SPECIAL TYPES OF ANTENNAE

In conclusion, a word should be said about some recent developments of special types of antennae. The Beverage wire antenna is one, but this has already been discussed. Another recent development is the use of loop antennae for transmission. The loop in reception is quite old, but using the loop for transmission is a new phase. Fairly good radiophone transmission has been accomplished at the Boston Radio Show. The loop being a closed circuit has very poor radiating properties as compared to an open oscillator like an antennae. However, for short distance work it has been found that the loop will transmit quite well, and in fact distances as great as 50 miles have been covered. The importance of this lies in the fact that in it there may be a solution of the interference problem, since the directional effect of the loop may be employed in transmission as well as in reception.

Another type of antenna, which has been

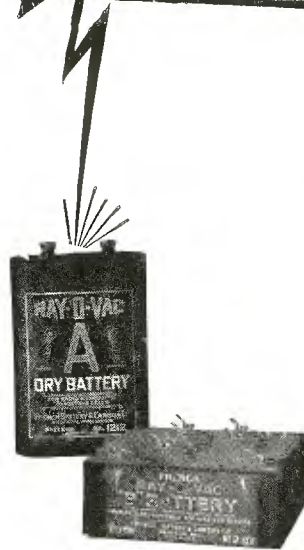
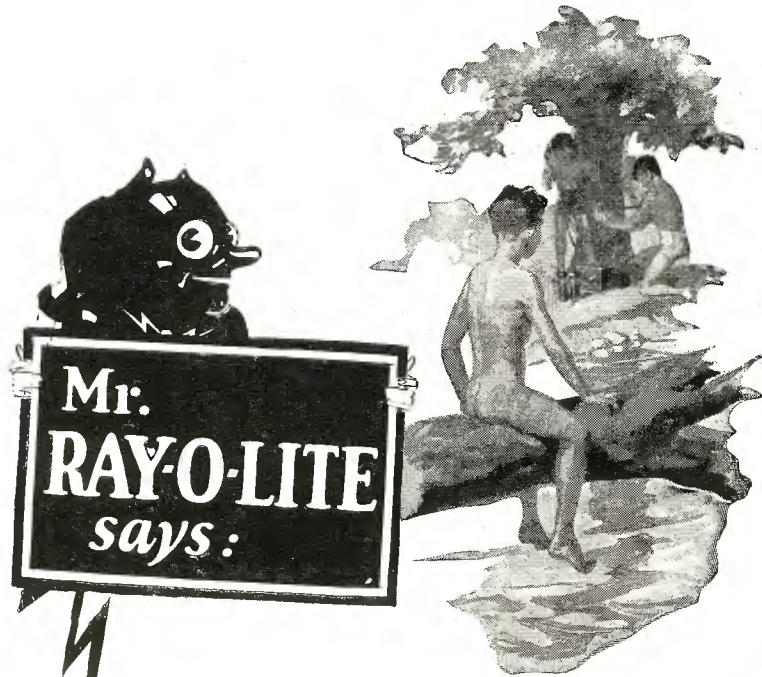

Ray-O-Vac "A" Batteries come in 1, 2, 4 and 6 cell units. Ray-O-Vac "B" Batteries are famous for sustained voltage and elimination of noise

Make Sets Portable With Dry "A" Battery

Miles from care and worry—close to nature—still within ear shot of the whole nation. Truly a wonderful development is the dry battery tube and the compact dry battery. With this combination most any set is made portable. A 4-pound dry cell replaces a 40-pound storage battery.

Take your set with you this summer. The Ray-O-Vac Book "How to Get the Most Out of Radio" tells how to make your set portable.

Also tells how Ray-O-Vac 2-cell "A" Batteries are good for 200 hours of use, how they make reception clearer and cost less to operate than storage batteries. Send now for the Ray-O-Vac booklet.

Ask your dealer for the new Ray-O-Vac "A" Battery

French Battery & Carbon Company
Madison, Wisconsin

Atlanta Dallas Denver Chicago New York
Minneapolis Kansas City

RAY-O-VAC
The Battery that Completes Radio

FREE Radio Catalog



Our big stock of standard makes of radio sets, parts and supplies enables us to make prompt shipment from stock. Play safe—buy standard equipment from a reliable house.

No cut price material. Send \$5.00 for Murdock Complete Loud Speaker, 70c for "A" Battery Switch, 80c for pair Rubber Ear Muffs.

Dealers—Build a Reputation Every dealer should have our big illustrated catalogue of reliable apparatus. Write for it and our discount sheet.

JULIUS ANDRAE & SONS CO.
In business since 1860
117 Michigan Street, Milwaukee, Wis.

RUSONITE
CRYSTAL RECTIFIER

MULTIPOINT (Patent Pending)
A Synthetic CRYSTAL DETECTOR sensitive over its entire surface.

Eliminates all detector troubles. Extraordinary clearness and volume. Endorsed by Radio experts and press. Sold in Sealed Packages only. Join the ever increasing Rusonite fans.

Price, Postpaid, mounted **50c**
Sensitive guaranteed

RUSONITE CATWHISKER
14 Karat Gold Multiple Contact Super Sensitive **25c**

Order from your dealer or direct from us.
RUSONITE PRODUCTS CORP.
15 Park Row, N. Y. Dept. "N"

WANTED—Back numbers of Radio News, Sept., Oct., Nov. and Dec., 1921, Jan. and Feb., 1922. Experimenter Publishing Co., 53 Park Place, New York City.

Get These Wonderful Radio Books

These Dealers Carry Our Books:

- Albany, N. Y., Albany Radio Corp.
- Albany, N. Y., Schroeder Elec. Co.
- Allentown, Pa., F. & W. Grand 5-10-25 Cent Stores.
- Astoria, L. T., M. Eberhardt & Sons Co.
- Atchison, Kansas., Low & Blythe Co.
- Attleboro, Mass., Sweet Accessory Shop.
- Atlantic City, N. J., Paramount Radio Supply.
- Baltimore, Md., Wilbur Electric Co.
- Baltimore, Md., Bacharach Radio Co.
- Baltimore, Md., F. & W. Grand 5-10-25 Cent Stores.
- Baltimore, Md., W. W. Hentzschel.
- Batavia, N. Y., H. F. Smith.
- Billings, Mont., Torgerson Bros.
- Bluefield, W. Va., Burgess Elec. Co.
- Boston, Mass., Williams Book Stores.
- Boston, Mass., J. B. Hunter & Co.
- Brooklyn, N. Y., Abraham & Strauss.
- Brooklyn, N. Y., O. Olsen.
- Brooklyn, N. Y., Bklyn. Elec. Lamp & Nov. Co.
- Brooklyn, N. Y., F. & W. Grand 5-10-25 Cent Stores.
- Brooklyn, N. Y., Globe Radio & Battery Shop.
- Brooklyn, N. Y., Haag & Vince Co.
- Brooklyn, N. Y., S. S. Kresge.
- Brooklyn, N. Y., G. Kleintsch.
- Brooklyn, N. Y., C. G. Rosewall.
- Brooklyn, N. Y., J. Staff.
- Burlington, N. J., Burlington Elec. & Nov. Co.
- Canton, Ill., Frank White & Bro.
- Centerville, Iowa, H. E. Luther.
- Champaign, Ill., H. Swannell & Son.
- Charleston, W. Va., John R. Koch.
- Charleston, S. Carolina, So. Carolina Radio Shop.
- Chicago, Ill., Izenstark Radio Co.
- Chicago, Ill., Follett Book Co.
- Chicago, Ill., McArthur Electric Co.
- Chicago, Ill., P. O. News Co.
- Cincinnati, Ohio, Murray Spring Co.
- Cincinnati, Ohio, Reuter Elec. Co.
- Cincinnati, Ohio, Radio Electric Shop.
- Cleveland, Ohio, Radio Engineering & Sales Co.
- Cleveland, Ohio, Oliver C. Schroeder.
- Coronopolis, Pa., T. C. O'Donovan.
- Dallas, Tex., Radio Equip. Co.
- Dayton, Ohio, Wilkie News Co.
- Denton, Texas, Dvora Hardware Co.
- Denver, Colo., Electrical Auto. App. Co.
- Denver, Colo., Pratt Book Store.
- Denver, Colo., Reynolds Radio Co.
- Des Moines, Iowa, H. W. King.
- Detroit, Mich., McCaulay Bros.
- Easton, Pa., F. & W. Grand 5-10-25 Cent Stores.
- Fergus Falls, Minn., Grand & Seither.
- Flushing, L. I., The Electric Shop.
- Fort Worth, Texas, H. C. Meacham Co.
- Galveston, Texas, Galveston Wireless Supply Co.
- Gloucester, N. J., Lenny's Variety Store.
- Greensburg, Pa., H. Hamilton.
- Hartford, Conn., F. & W. Grand 5-10-25 Cent Stores.
- Havana, Cuba, Diamond & Co.
- Holyoke, Mass., Haskell Elec. Co.
- Honolulu, Hawaii, The Electric Shop.
- Jacksonville, Fla., Southern Electric Co.
- Jersey City, N. J., F. & W. Grand 5-10-25 Cent Stores.
- Johnson City, Tenn., Bishop Elec. Co.
- Kansas City, Mo., Yeanizars Supply Co.
- Los Angeles, Cal., Radio Concert & Equip. Co.
- Los Angeles, Cal., Natick Book Store.
- Lowell, Mass., G. A. Hill Co.
- Memphis, Tenn., Street Electric Co.
- Milwaukee, Wis., Dewey Sporting Goods Co.
- Milwaukee, Wis., Badger Radio Co.
- Minneapolis, Minn., Peeries Elec. Co.
- Minneapolis, Minn., Sterling Elec. Co.
- Nashville, Tenn., Zibart Bros.
- Newark, N. J., S. S. Kresge Co.
- Newark, N. J., F. & W. Grand 5-10-25 Cent Stores.
- Newark, N. J., Bannister & Pollard.
- New Brunswick, N. J., Schneider Bros.
- New Brunswick, N. J., The Electric Shop.
- New York City, Acme Radio Co.
- New York City, Broadway Radio Corp.
- New York City, P. M. Dreyfus Co., Inc.
- New York City, Delta Elec. Co.
- New York City, Fordham Radio & Spec. Co.
- New York City, F. & W. Grand 5-10-25 Cent Stores.
- New York City, Herbert & Huesgen.
- New York City, J. L. Lewis & Co.
- New York City, Live Wire Elec. Co.
- New York City, Marks Elec. & Radio Co.
- New York City, Models - 5 Stores.
- New York City, Phillips Sport Shop.
- New York City, Wehman Bros.
- Norristown, Pa., E. M. Law.
- Ottawa, Ont., Can. Photographic Stores.
- Patterson, N. J., F. & W. Grand 5-10-25 Cent Stores.
- Patterson, N. J., S. S. Kresge Co.
- Phila. Pa., Ross Frankford Music Co.
- Phila. Pa., F. & W. Grand 5-10-25 Cent Stores.
- Phila. Pa., E. P. Noll & Co.
- Phila. Pa., Phila. Sporting Goods Co.
- Phila. Pa., Roberts Bros. Elec. Co.
- Phila. Pa., G. W. Snell Co.
- Phoenix, Ariz., Nielsen Radio Supply Co.
- Pittsburgh, Pa., F. & W. Grand 5-10-25 Cent Stores.
- Plainfield, N. J., F. & W. Grand 5-10-25 Cent Stores.
- Plattsburgh, N. Y., H. E. Atwater.
- Portland, Me., Chisholm Brothers.
- Portland, Ore., Hynson Elec. Co.
- Providence, R. I., F. & W. Grand 5-10-25 Cent Stores.
- Providence, R. I., B. & H. Supply Co.
- Providence, R. I., W. A. Huse & Son.
- Reading, Pa., F. & W. Grand 5-10-25 Cent Stores.
- Rochester, N. Y., B. Schmidt & Co.
- Rochester, N. Y., E. G. Sykes & Co.
- Rock Island, Ill., Beasley Spec. Co.
- Rock Island, Ill., Valle Co.
- San Francisco, Cal., Conrad Richter.
- St. Joseph, Mo., Empire Elec. Co.
- St. Joseph, Mo., Mannschrecks Book Store.
- St. Louis, Mo., Ernest Elec. Co.
- St. Louis, Mo., Posters Book & Cigar Co.
- St. Louis, Mo., Linza Elec. Sup. Co.
- St. Louis, Mo., Security Auto Supply Co.
- St. Louis, Mo., Stewart's.
- St. Paul, Minn., St. Paul Book & Sta. Co.
- Seattle, Wash., Archway Book Store.
- Sallwater, Okla., Stillwater Elec. Shop.
- Schenectady, N. Y., Finch & Hahn.
- Sydney, Australia, N. S. W. Bookstall.
- Terre Haute, Ind., National Auto Supply Co.
- Trenton, N. J., Radio Chain Stores.
- Troy, N. Y., F. & W. Grand 5-10-25 Cent Stores.
- Tyler, Texas, R. E. Bryan.
- Uniontown, Pa., Frederick Piano Co.
- Watertown, N. Y., F. A. Emsall & Co.
- Waco, Texas, Jackson's Radio Eng. Lab.
- Washington, D. C., Continental Elec. & Supp. Co.
- W. Hoboken, N. J., The Heraco Exchange.
- Wheeling, W. Va., Gee Electric Co.
- Yonkers, N. Y., F. & W. Grand 5-10-25 Cent Stores.
- York, Nebr., Bullocks.

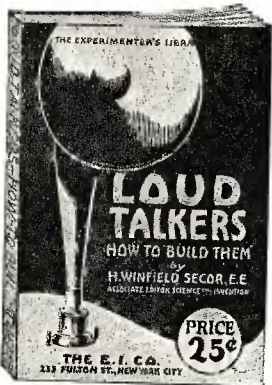

LOUD-TALKERS

HOW TO BUILD THEM

By H. WINFIELD SECOR

Associate Editor of Science & Invention

This book describes how to build two distinct and different types of radio loud-talkers, which can be built with either electro-magnetic field to be excited from storage battery, as well as permanent magnet field requiring no separate battery excitation. The third chapter deals with improvised loud-talkers and gives clear and complete instructions on how to build suitable horns for use with radio receivers of the Baldwin and other types. Several elaborate hook-ups are given of the author's own radio receiving set, comprising one stage of radio-frequency, detector and three stages of audio-frequency amplification, together with all the connections for the loud-talker.

Complete data is given for all the parts of the loud-talkers, including the field magnet windings, as well as the diaphragm or moving coil windings, and also the step-down transformer to be connected between the vacuum tube amplifier and the loud-talker proper.

In preparing these designs the point has been constantly kept in mind to use the simplest parts possible, so that practically anyone can build a successful loud-talker equivalent to the commercial types costing \$40.00 or more.

Even where the experimenter does not possess the skill or the time to make all the parts himself, which are really few in number, he may save a great deal of money, or at least half the price of a commercial loud-talker, by having the difficult parts made in a local machine shop, and then assembling them and winding the coils himself. Circuit connections and data for the size of wire, etc., are given for placing the loud-talker on a separate floor or in another part of the house not occupied by the radio receiving set. A very valuable book, giving data which cannot be obtained anywhere else and which has not been published before.

64 pages, 25 illustrations, bound in beautiful two-color cover, size 5 1/2 x 7 1/2 inches; Price prepaid, 25 cents.

HOW TO MAKE RADIOPHONE RECEIVING SETS

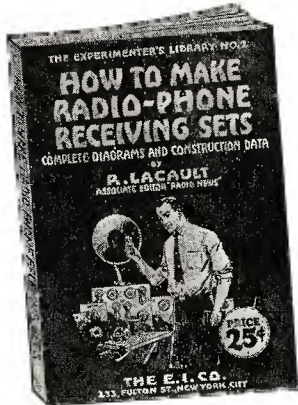

EVERY RADIO ENTHUSIAST SHOULD HAVE A COPY OF THESE BOOKS WRITTEN BY THE FOREMOST AUTHORITIES IN EVERY BRANCH OF THE SUBJECT

RADIO FREQUENCY AMPLIFIERS AND HOW TO MAKE THEM

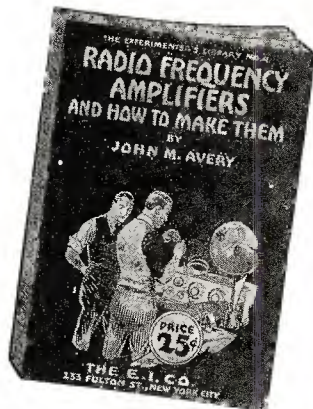

A non-technical book for the beginner. Gives complete constructional data on the building of a complete Crystal Detector Set, Tuning Coil, Loose Coupler and a Single Audion Tube Set with Amplifying Units. It furnishes all dimensions and working drawings of every part that must be constructed by the amateur. Written in plain, simple language that anyone can understand. The opening chapter gives a complete description of the theory of radio and tells what it's all about, teaching the principles of wireless so that the constructor knows what he is doing.

25c. Each

Postage Prepaid

48 Pages, 26 Illustrations
Bound in Beautiful Two-Color Cover
Size, 5 1/2 x 7 1/2 inches. Prepaid 25c.

This book is for the more advanced amateur, showing the construction of the Radio Frequency Amplifying Transformer and giving complete constructional data. It shows the application of Radio Frequency to amplifying units that the amateur may already possess and gives 15 hook-ups showing practically every use Radio Frequency Amplifying Transformers can be put to.

32 Pages, 15 Illustrations
Bound in Beautiful Two-Color Cover
Size, 5 1/2 x 7 1/2 inches. Prepaid 25c.

Order from your dealer—or direct from us

THE E. I. COMPANY 233 FULTON STREET
NEW YORK CITY, N. Y.

Dealers: Write for our attractive wholesale proposition.

developed recently, is the condenser type. This consists of two large metallic areas either in the form of metal plates or a number of wires, closely spaced, each set of wires forming one plate of the condenser. The lower plate may very conveniently be the metallic top of a roof on a house. The advantage of this type of antenna is that since the condenser plates are so large, the electric field is concentrated in the space within these plates thus producing low dielectric losses. However, the radiation resistance of such an antenna is extremely low, hence for good results it is necessary to have a lead-in of very low resistance and the loading inductance must likewise be a very low resistance affair. Although there is not very much detailed information on these, some experimenters are said to have radiated almost as effectively with the condenser antenna as with the open type.

In concluding this article it is hoped that the explanations of antenna theory and practice will be of some assistance to those contemplating building stations.

Public Education by Radio

(Continued from page 2074)

ing or educational methods for those 22,000,000 children can be brought about except with the consent of public opinion since public education cannot progress any faster than the state of public opinion about education."

Commissioner Tigert of the Bureau of Education visualizes radio telephony as an avenue whereby popular education may form an intimate contact with the man on the street. He says, to quote him at length: "It is time for the educator to come out from his cloistered retreat and learn to talk with the man on the street, since it is only by educating the man on the street that we can educate our children.

"Education has gone through many phases in this country. In the beginning, the educator was the philosopher who worked in his study on the theory of education. Then came the leaders who stirred and inspired the great mass of teachers of the country to new and modern methods of teaching. This meant that the educator had emerged from his study, but only to the extent of talking with those of his own kind. The time has now come when it is important, in fact essential, that we reach not only the teachers, but the great mass of common people if our experiment in popular education is to be successful. In our pride in our advance in the technique of education we are liable to forget that no progress can be lasting which is not founded upon the intelligent understanding of the mass of the people.

"But how to reach the people with our message has been a question very difficult of solution. Because of changed social and industrial conditions,—the tremendous increase in population in this country, the pace at which we live, the rapidity with which changes are brought about, and the need of disseminating information quickly,—a new situation in education has arisen and a new method of meeting it must be employed.

"Radio furnishes that method. It is not a substitute for printing, but a new means of meeting modern educational conditions which hitherto the Bureau of Education has not been able to meet, with the tools at its command.

Insist On New York Coil Company's Radio Products and Avoid Disappointments

Exceptionally reasonable in price, considering quality of workmanship, material and design. Backed by eighteen years' experience in this particular class of work insures universal satisfaction.

The line includes:—

- Standard 90 degree Variocouplers
- 180 degree Variocouplers
- Amplifying Transformers
- Variometers
- "Famous" New York Variable Condensers.

Our No. 10 Receiver at \$18.00 is a wonder. By connecting a few wires any one may enjoy Radio Concerts from both near and far distant points.

Write for literature on this Receiver, as well as our new Vernier Condenser, and Inductance Switch. Three of the most widely needed and latest additions to Radio.

NEW YORK ENTERTAIN-A-PHONE RECEIVING SET NO.2—Complete with detector and two stages of amplification, all in one cabinet. Contains a non-regenerative two circuit hook-up with two stages audio amplification. Results are

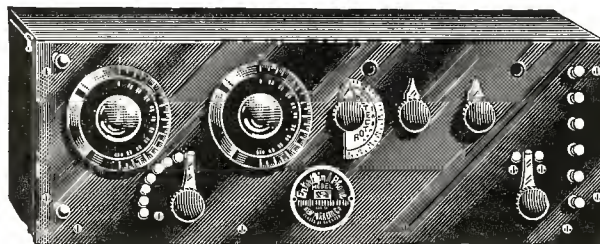

simply a revelation. It must be operated and heard to be appreciated. Workmanship and design and material of exceptional character throughout. Of unusual interest to the jobber. Price \$50.00 fully guaranteed.

NEW YORK COIL COMPANY, Inc.

338 Pearl Street

New York City, N. Y.

EXPERIMENTAL ELECTRICITY COURSE IN 20 LESSONS

By S. GERNSBACK and H. W. SECOR, E.E.



Every phase of experimental electricity is treated comprehensively in plain English. New Experiments are described and explained and nearly every application of Electricity in modern life is given in simple language.

A masterpiece. Explains every electrical device from a push button and bell to the biggest generator made. Worth its weight in gold for the man who wishes to know about electricity, and to the experimenter it is still more valuable because of its many facts, tables, etc.

The Best Electrical Text-Book on the Market. Size of Book is 6x9". The book contains 128 pages, and more than 400 illustrations.

Cloth bound, stiff covers, hand-sewed, green and black stamped, each... \$1.25
EXPERIMENTER PUB. CO., Inc.
53 Park Place, New York City

Novo "B" Batteries

with insulated binding posts and 7" Copper wire connectors.

Novo Mfg. Company

424 W. 33rd St. New York

531 S. Dearborn St. Chicago

STOP THAT NOISE!
SAVES YOUR TUBES
AUTOMATIC FILAMENT CURRENT ADJUSTER
EXPELS ALL TUBE TROUBLES
ELIMINATES NOISY RHEOSTATS
FROM YOUR DEALER OR RADIALL COMPANY
59 WARREN STREET NEW YORK \$1.10 MOUNTING

50c EACH THE BIGGEST SUCCESS IN RADIO: **EACH 50c**
CONSOLIDATED RADIO CALL BOOK CO.'S
PATTERNS and DIAGRAMS

Complete Patterns, Diagrams and Instructions
How to Make Your Own
SHORT WAVE REGENERATIVE
RADIOPHONE SET

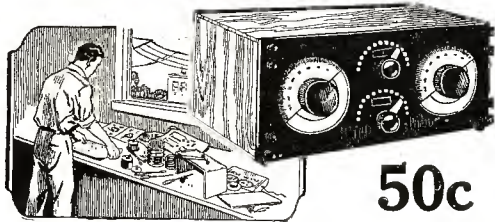

50c

One of the foremost Radio engineers constructed this set for us; it's simple to follow our patterns and assemble the parts comprising this set with which spark, C. W. signals and Radiotelephony may be received. We don't only give you pictures of how the apparatus looks, but each pattern is full size and printed on heavy blue print paper. Only standard parts are used.

PATTERN No. 1

Consisting of a Five-Page Illustrated Direction Pamphlet, size 8½x11½ inches, One Blue-Print pattern, size 16x22 inches and One Blue-Print pattern, size 17½x22 inches, all contained in a heavy Two-Color printed Envelope, 9x11 inches.

SENT POST-PAID

DETECTOR and AMPLIFIER
RADIO UNITS

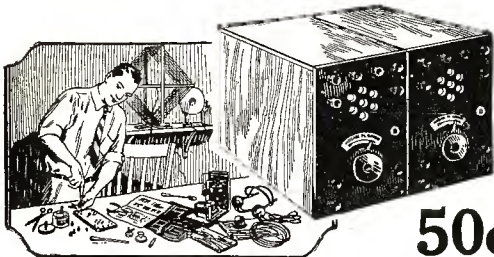

50c

You can build this detector and the amplifier units anywhere in your house; no machine shop is needed. When built they may be used with any type of Regenerative Receiver or short wave set, with which spark, C. W. Signals and Radiotelephony may be received. We've tested these patterns by actually building the outfit—they're perfect! Only standard parts are used in making the outfit.

PATTERN No. 2

Consisting of a Four-Page Illustrated Direction Pamphlet, size 8½x11½ inches, One Blue-Print pattern, size 16x18 inches, and One Blue-Print pattern, size 13½x15 inches, all contained in heavy, Two-Color Printed Envelope, size 9x12 inches.

SENT POST-PAID

RADIOPHONE CRYSTAL SET

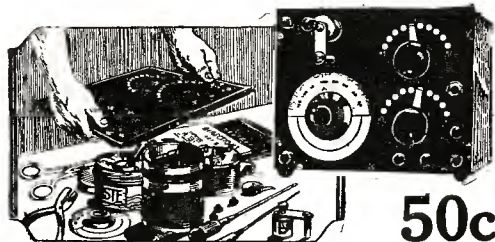

50c

We designed these patterns especially for those who are without technical knowledge but who are sufficiently abreast of the times to desire a radio receiving set in their homes. An instruction pamphlet comes along with the blue prints and all you have to do is follow the simple instructions. This radio set can be tuned in from stations within 30 miles. Standard materials only are used.

PATTERN No. 3

Consisting of 4-page illustrated Direction pamphlet, size 8½x11½ inches, one Blue-Print pattern size 16x22 inches. All contained in two-color printed envelope, 9x12 inches.

SENT POST-PAID

14 RADIO FORMULAE
AND DIAGRAMS



Usefulness!

Economy!

Pleasure!

50c

With this packet of radio knowledge you need never worry about schematic wiring diagrams, measurements and radio tables. All formulas and diagrams are printed on heavy paper in black and blue; and contained in two-color printed envelope, 9x12 inches.

SENT POST-PAID

ALL ABOUT AERIALS

12 Diagrams How to Construct and Erect
All Types of Aerials



RECEPTION
 and
 TRANSMISSION
 ALL FOR

50c

THESE ARE DIAGRAMS THAT EVERYONE with a radio set wants and needs. These blue prints were made after practical erection of each aerial, and point out to you how simple it is to erect not only the proper aerial for your particular need, but how to erect this aerial in the most practical manner and at the least expense.

Consists of 12 blue prints 8½x11 inches and one four-page instruction pamphlet 8½x11 inches. All contained in a heavy two-color printed envelope 9x12 inches.

SENT POST-PAID

20 Radiophone Diagrams and
Hook-Ups of

Crystal and Audion Receiving Circuits, Amplifier Circuits,
Regenerative Circuits, Sending Circuits

with

Key Chart of Symbols and Pamphlet
"How to Read Diagrams"



50c

These diagrams show how to get the best possible efficiency from the instruments you make or purchase. They cover hook-ups from the simplest to the most complicated, in a way that any amateur can understand and follow without difficulty. Get this set, and hook up right.

All 20 diagrams are printed on heavy paper, each sheet size 8½x11½ inches, and together with KEY CHART OF SYMBOLS and pamphlet "HOW TO READ DIAGRAMS" are contained in a heavy two-color printed envelope, size 9x12 inches.

SENT POST-PAID

ORDER FROM YOUR DEALER—or direct from us
CONSOLIDATED RADIO CALL BOOK CO., Inc.
 98 Park Place PUBLISHERS NEW YORK CITY

"Radio is cheaper than printing; it reaches its audience more quickly; it interests a mass of people who will not read printed articles; it has the advantage of intimate contact between speaker and audience; and, above all, it can be continuous in service. The thing that educates the public best is continuous education. Radio can be the means of such continuous education.

"For these reasons I consider the inauguration of this radio service one of the most important pieces of work that the Bureau of Education has ever undertaken."

Radio News Laboratories

(Continued from page 2112)

journalled to thick metal bearings, by means of which connections are made to the inner coil. The leads are brought out to two binding posts at the rear. The coils are wound with green silk covered wire, of approximately 120 turns total. When connected in series with a standard variocoupler secondary of 30 turns, the whole being connected to a vacuum tube detector, a wavelength range of from 195 meters minimum to 450 meters maximum was obtained. The variometer is of rugged construction and of accurate mechanical design.

Arrived in excellent packing.
AWARDED THE RADIO NEWS LABORATORIES CERTIFICATE OF MERIT NO. 160.

Weather Forecasts Are Broadcast By Radio- phone From NAA

(Continued from page 2075)

used. Comments and suggestions for the improvement of the service will be welcomed.

SUMMARY OF SCHEDULES

10:05 a. m.—Daily, Sundays and holidays included: State forecasts and general forecast for the 24 hours beginning at 8 p. m.; storm, flood, cold wave, frost, and other warnings.

Wednesdays only, March 15 to November 30, inclusive: Summary of effect of weather on crops during the preceding week.

3:45 p. m.—Daily, except Sundays and holidays: State forecasts for 24 hours beginning at 8 p. m.; special warnings of storms, floods, cold waves, frosts, etc.

Saturdays only, general weather outlook for the next week.

10:05 p. m.—Daily, Sundays and holidays included: State forecasts and general forecasts for 36 hours beginning at 8 a. m. the next day; storm, flood, cold wave, frost, and other warnings.

Correspondence From Readers

(Continued from page 2114)

have been few or no cases of amateur sparks above 220 meters.

Secondly, allow us to point to far better records than those "sarcastically" produced in the above letter. Spark stations 6KA, 6LC, 6JD, 6EA, 6EN, have all transmitted 3,000 miles. 6AJH and 6AHF 2,300 miles. 6BJU 2,100 miles. These latter are complete sending and receiving equipments that cost less than \$200. Many a lad here can point to concert receiving records far bet-

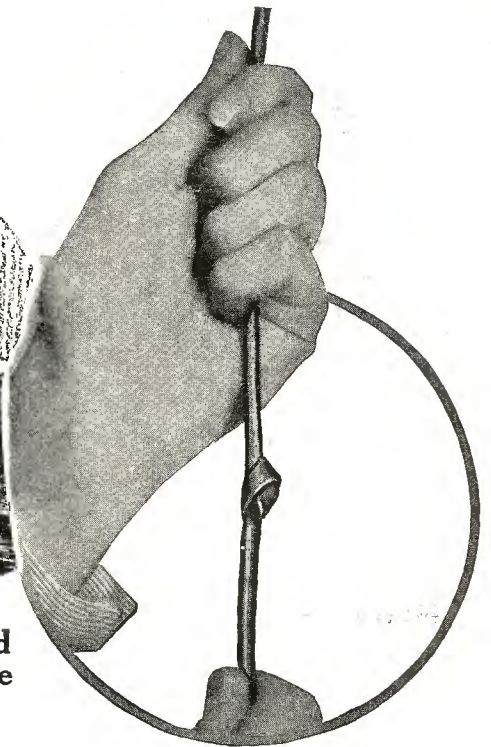
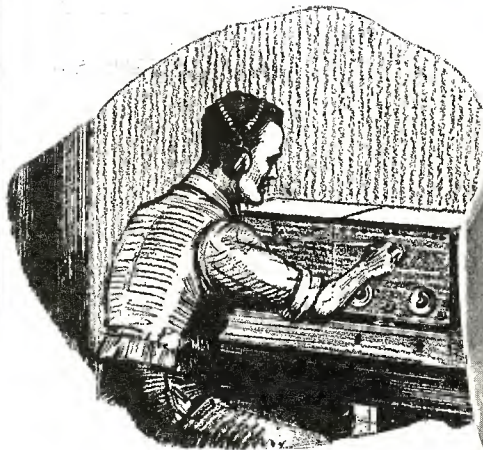

G-E Flexible Varnished Tubing is used in the better radio sets

The flexible varnished tubing (or "spaghetti") used in high grade professionally built radio equipment is now available for the use of those who are building or reassembling their own sets.

This tubing is of high mechanical and dielectric strength and is so flexible that it will not crack even when tied into a knot. Furthermore, it retains this flexibility indefinitely.

Ask for "G-E" when you buy tubing—you will get assured quality. G-E flexible varnished tubing is finished in red, green, yellow and black and sold in two-foot lengths.



General Electric Company
 Merchandise Dept., Bridgeport, Conn.

Insulations

Use them when you build—demand them for repairs

49G-15

PROTECTION

TELERADIO FILAMENT PROTECTORS

For detector and amplifying tubes.
 Price, Single Pole 60c.
 Double Pole 80c.
 Renewal fuses 10c each.

TELERADIO LIGHTNING ARRESTERS

Electrical No. 5837

The only ARRESTER approved by National Board of Fire Underwriters, which retails for \$1.00.

At your Dealers—Otherwise Send Purchase Price and Give Dealer's Name.

Teleradio Engineering Corp.

486 Broome St., New York

Makers of Teleradio Supersensitive Phones



SABCO

2 The

HEAT

with variable heat control for most accurate Radio Construction. Order yours today.

STRAUSS & BLUM, INC.

251½ West 41st Street New York City

BUTTON CONTROL FOR INCREASING HEAT

\$6.00

ELECTRIC SOLDERING IRON

CIRCULATION 60,000 COPIES



This magazine is
edited by
H. GERNSBACK
also Editor of
RADIO NEWS
and
**SCIENCE and
INVENTION**

100 Articles
Over
100 Illustrations

FOR SALE AT
ALL NEWS STANDS

20c. the Copy
\$2.00 a Year
Canada and Foreign
\$2.50 a Year

SEND FOR
FREE
SAMPLE COPY
TODAY

See Coupon Below
for **SPECIAL OFFER**

"The Electrical Magazine for Everybody"

PRACTICAL ELECTRICS is probably the most novel magazine of its kind ever conceived. It is personally edited by H. Gernsback, editor of SCIENCE & INVENTION and RADIO NEWS. Mr. Gernsback, who founded the old "Modern Electrics," as well as the "Electrical Experimenter," knows thoroughly what his readers want and have wanted for many years. PRACTICAL ELECTRICS, the 100% electrical magazine eclipses the best that was in "Modern Electrics" and "Electrical Experimenter."

Electricity covers such a tremendous field that the man who does not keep abreast with it does himself a great injustice. PRACTICAL ELECTRICS covers that field from every angle. It is written in plain every-day language that all can understand. It portrays the entire electrical development of the month faithfully in non-technical language. It caters to everyone interested in electricity, be he a layman, an experimenter, an electrician or an engineer—each will find in this magazine a department for himself and plenty more.

The May issue now on the news-stands contains 48 pages and over 100 different articles and over 100 illustrations, with an artistic cover in three colors. Professor T. O'Connor Sloane, Ph.D., is associate editor of the magazine.

Interesting Articles in May "Practical Electrics"

The Loud Talking Heart, by Clyde J. Fitch;
Speaking Kinematograph;
Ultra Violet Rays;
Laboratory Tesla Coil;
Awards of the \$50.00 Special Prize Contest;
Electric Drying Oven;
Electricity and Crime;
Electric Prevention of Fires.

PRIZES

This magazine offers a number of prizes, as follows:

Our \$50.00 Prize Contest for Junior Electricians and Electrical Experimenters includes as its elements simplicity, as great a degree of novelty as possible, and practicability.

\$3.00 for the best picture of your electrical workshop.

\$3.00 for the best article on Elec-Tricks, the new department.

\$3.00 for the best "short-circuit," the semi-humorous department.

In addition to this, the magazine pays high prices for all electrical experiments, electrical articles, etc.

See Current Issue for Full Details.

This issue also contains articles by some of the greatest electrical writers, workers and students. The magazine will prove a revelation to any one interested in electricity.

Every issue besides its many other features contains the following departments:

- "New Things Electric"
- "Experimental Electrics"
- "Electrical Digest"
- "Junior Electrician"
- "Elec-Tricks"
- "Motor Electrics"
- "Short Circuits"

"How and Why" (Questions and Answers.)

Make all checks payable to: "Practical Electrics Co."

SPECIAL OFFER

Gentlemen:

Although your regular price is \$2.00 per year, you will accept my subscription at \$1.75 per year (Canada and foreign \$2.25). I enclose the money herewith and I have written my name and address in margin below.

R. N. 6-23

PRACTICAL ELECTRICS CO., 53 Park Place, New York

ter than those of Mr. Aldeman and on much less costly equipment. Would the fascinating study that develops the mind at a time of life that he might otherwise be on the street with temptation there surrounding him, for the sake of one more hour of entertainment (if such it may be called) late in the evening?

Then, regarding proposed legislation. The broadcasters had best improve the quality of their programs first. Then the Government stations should be remodeled for C.W. work in so far as practical. C.W. would make it possible for them to do ship work from 600 to 700 meters with 20-meter skips to get around interference. Long distance work could be carried on above 1,100 meters. This would leave from 400 to 600 meters for low power broadcasting and from 700 to 1,100 meters for high power stations. The amateur C. W. would utilize the band between 150 to 400 meters, while spark would remain on 200 for a short while. Spark would also be off the air from 7 to 10 P. M., as they are now voluntarily doing here.

We believe that only a feeling of mutual coöperation between public, amateur, and Government will solve the present problems and that the public is maintaining a useless attitude in praising the amateurs for their past work on one hand and threatening to further limit them on the other. Many broadcast listeners consider themselves important personages and amateurs as ten year old children. They forget that most are over 17 and many marred men of reputable professions, such as physicians, lawyers, engineers, etc. Nevertheless we admit that a few amateurs now and then disregard others by coming in before they should, and we appeal to their sense of justice in asking them to refrain from this.

E. KINNEY, 6AGK, Spk.
R. DOBLER, 6BJU, Spk. and C.W.
L. PICKER,
6AJH, 6ZH, KFN, C.W. and Spk.
D. CHAMBERS,
6AHE, 6ANH, C.W. and Spk.
Members A. R. R. L.,
San Diego, Calif.

"FORCED OSCILLATIONS" DID IT
Editor, RADIO NEWS:

I am writing this note as an appreciation of the "Forced Oscillations" on your December cover. It first got and held my attention at a railway newsstand early in December last. Up to that time, I had taken no interest in and had sought no information about radio.

"Forced Oscillations" meant nothing to me, but by sheer curiosity, I invested two bits in the "175 illustrations" and rested myself looking at the pictures and advertisements. Next I investigated. Armed with about 100 postal cards and a fountain pen, I wrote to the advertisers requesting literature and in a few days circulars began to arrive. Strange, they did not find a lodging place in the waste basket. I read them, sorted them and soon found I had a first-class radio library. Then I proceeded to discern that my three boys knew a thing or two about radio and we started in to build our home-made set, buying such apparatus as they did not make. We had a single-wire antenna and loudspeaker attachment to the Victrola. The whole family with friends and neighbors were constantly dropping in at night to enjoy the concerts, lectures and bed-time stories. By the time the January issue appeared, we were all taking our watches in hand at 9:55 to set them with the final dash of the Arlington time signals and before the February issue appeared, I had been "loose coupled" myself about "three o'clock in the morning." I guess I have joined the ranks to stay.

DR. WALTER W. ROACH,
Philadelphia, Pa.

Operate a Loud Speaker on One Tube

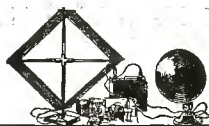

Erla Radio Transformers Make This Possible

The entire family listens to broadcasting, with the new Erla Duo-Reflex circuit, the most powerful single-tube circuit ever built. Through a loud speaker, ample tone volume is provided, except for the most distant stations. And, for local reception, a loop aerial is effectively employed.

The cost of this circuit is so modest as to make it available to every American home. Also it is so simple to construct and operate as to present no difficulties for even the most inexperienced individual.

Tuning is extremely sharp and selective, undesired stations being eliminated almost at will. Remarkable as well is the purity and clarity of tone, achieved through perfect modulation, plus the effective damping of parasitic noises.

The heart of this and other guaranteed Erla circuits is the Erla radio frequency transformer. Overcoming the high capacitance of domestic vacuum tubes in unique degree, and with lowest inherent capacitance, it provides unequaled magnification without distortion.

Our bulletin No. 13, giving diagrams and instructions for building the Duo-Reflex circuit may be obtained gratis from leading radio dealers. Or write us direct.

Electrical Research Laboratories
Dept. C 2515 Michigan Ave., Chicago

E R L A



Erla radio frequency transformers are at the forefront of radio progress, assuring best results. Price: Types AB1, 2, 3, \$4; Reflex, \$5



Erla bezels are finished in bright nickel or dull black enamel. Telescoping rim fits any 3/8" to 1/2" panel. Made in 1" and 1 1/2" sizes. Price, 20c



Erla fixed condensers offer material improvement over present standards, adhering most closely to their rating. Eleven sizes, 35c to \$1 each

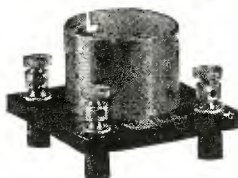

Erla sockets stand alone in quality of workmanship and beauty of finish. All parts triply nicked. Polished Radion base. Price each, \$1

24 HOUR SERVICE

No order too small. No Dealer too far away.
We ship everywhere.
COMPLETE STOCK
Radio Standard Sets and Parts
LARGEST Complete Stock
of Standard Supplies in Middle West.
Write for 64 Page Catalog No. D10
DEALERS Greater Discounts
Better Profits
AMERICAN RADIO MFG. CO.,
107 E. 13th ST., Dept. A KANSAS CITY, MO.

RADIO DEALERS
In addition to carrying the usual Radio Corporation products, we are now distributors for New York State of the well-known Paragon Radio products, famous throughout the world.
Write for latest bulletin and price discounts.
20th Century Radio Corporation
565 Fifth Avenue, New York City

Radio Operators See The World
A radio operator's job will carry you over the world. You will be treated as an officer and will receive more salary than the average man makes ashore. Our complete course, including Arc, Spark and Vacuum Tubes, trains you quickly for such a job. Write for booklet.
Y. M. C. A. RADIO SCHOOL
158 East 86th Street, New York City
"Best Radio School in the East"

KEEP A RECORD
A great interest will be added if you record important matters received.
RADIO LOG
A well designed Record Book. Indexed and arranged to record all details.
No Advertising. 50c post paid.
RADIO PRINT Tiffin, Ohio 216 Circular St.

OPPORTUNITY AD-LETS

Follow these advertisements every month. Reliable advertisers from all over the country offer their most attractive specials in these columns.

Classified advertising rate fifteen cents a word for each insertion. Ten per cent discount for 6 issues, 20 per cent discount for 12 issues. Name and address must be included at the above rate. Cash should accompany all classified advertisements unless placed by an accredited advertising agency. No advertisement for less than 10 words accepted.

Objectionable or misleading advertisements not accepted. Advertisements for the August issue must reach us not later than June 1st.

THE CIRCULATION OF RADIO NEWS IS OVER 224,000

EXPERIMENTER PUBLISHING CO., INC., 53 Park Place, New York, N. Y.

Agents Wanted

Agents Wanted in every city and town to sell standard radio apparatus. Attractive discounts given. If interested, write us at once stating age and radio experience. Wilmington Electrical Specialty Co., Inc., 912 Orange St., Wilmington, Delaware.

Agents—Household necessities galore, food products, toilet preparations, extracts, remedies, soaps; two big lines; catalogues free. Western Products, 606 N. Oakley, Dept. AW, Chicago.

Free Book Start little Mail Order business. Home employment evenings. Pier, Dept. 191-A, 74 Cortland St., N. Y.

Lightning—Electrolyte starts the world. Charges discharged batteries instantly. Eliminates the old method. Gallon free to agents. Lightning Co., St. Paul, Minn.

We want Salesmen and Agents, either whole or side line, to sell our low priced radio books to the trade. Excellent proposition for live wires. The E. I. Company, Publishers, 233 Fulton Street, New York City.

We Wish Representatives in every community to secure subscriptions for Radio News, Science and Invention, and Practical Electrics. This is a wonderful opportunity for Amateur Radio Enthusiasts to make big money quickly. Write Experimenter Publishing Co., Inc., 53 Park Place, New York City.

Radio Salesmen Wanted to sell Elco Radio Panel Transfers as side line. Sell on sight. Write for proposition. Elco Radio Co., 937 Liberty Ave., Pittsburgh, Pa.

Amateur Agents Wanted in every city and town to sell radio apparatus. A few stocking agencies still open. Delfelco, 12 Meeting Street, Pawtucket, R. I.

Big Money and fast sales. Every owner buys gold initials for his auto. You charge \$1.50; make \$1.35. Ten orders daily easy. Write for particulars and free samples. American Monogram Co. Dept. 133, East Orange, N. J.

American Made Toys

Manufacturers on Large Scale, also homeworkers, wanted to manufacture Metal Toys and Novelties. Millions needed of Barking Dogs, Wag Tail Pups, Wild Animals, Automobiles, Indians, Cowboys, Baseball Players, Cannons, Toy Soldiers, Crowing Roosters, Statues of Liberty, Miniature eastings of Capitol, Bathing Girl Souvenirs and others. Unlimited possibilities. Guaranteed Casting forms furnished manufacturers at cost price from \$5.00 up, with complete outfit. No experience or tools necessary. Thousands made complete per hour. We buy goods all year and pay high prices for finished goods. Cash on delivery. Contract orders placed with manufacturers. Catalog and information free. Correspondence invited only if you mean business. Metal Cast Products Co., 1696 Boston Road, New York.

Automobiles

Automobile owners, garagemen, mechanics, send today for free copy America's most popular motor magazine. Contains helpful articles on over-hauling, repairing, ignition, carburetors, batteries, etc. Automobile Digest, 528 Butler Bldg., Cincinnati.

Batteries

Batteries—Edison Storage "B" Battery Elements, 5c per pair; 18 will make one 22.5 volt battery. Gilman's Battery Shop, Chelsea Sq., Chelsea, Mass.

Business Opportunities

Sell us your spare time. You can earn Fifteen to Fifty dollars weekly writing showcards at home. No canvassing, pleasant profitable profession easily, quickly learned by our simple graphic block system, artistic ability unnecessary. We instruct you and supply work. Wilson Methods, Limited, Dept. J, Toronto, Canada.

Become a Landscape Architect. Dignified, Exclusive Profession. Little competition. \$5,000.00 to \$10,000.00 income for experts. Easy by our method. Begin earning 3 weeks after you enroll. Write today. American Landscape School, 11R, Newark, N. Y.

Chemistry

Learn Chemistry at Home—Dr. T. O'Connor Sloane, noted educator and scientific authority, will teach you. Our home study correspondence course fits you to take a position as chemist. See our full page ad on page 2125 of this issue. Chemical Institute of New York, 66 West Broadway, New York City.

Correspondence Courses

Dollars Saved—Used correspondence courses of all kinds sold, rented and exchanged. List free. (Courses bought.) Lee Mountain, Pisgah, Alabama.

Electric Supplies and Appliances

Electric Tattooing Outfits. Illustrated Catalogue, 10c. Waters Mfg., 1050 Randolph, Detroit.

Books

Electricians' Examination book of questions and answers with diagrams, symbols, tables, notes and formulas, for preparation for licenses \$1.25. Aaron Shapiro, 296 Broadway, New York.

Radio Log Book. 125 pages. Designed by practical radio operators. 50c postpaid. Sample pages free. Radio Printing Co., Ware, Mass.

"Lights, Colors, Tones and Nature's Finer Forces", including Vibration, covering Electromagnetism; Odic-auras; Radio; Goldlights; Inventions; Marvelous Opportunities. Illustrated; 250 pages, \$2.00. Table contents free. Stevens Publishers, 242 Powell, San Francisco, Calif.

How to Make Radio Frequency Amplifiers. This book is for the more advanced amateur, showing the construction of the Radio Frequency Amplifying Transformer and giving complete constructional data. It shows the application of Radio Frequency to amplifying units that the amateur may already possess and gives 15 book-ups showing practically every use Radio Frequency Amplifying Transformers can be put to. 32 pages, 15 illustrations; bound in beautiful two-color cover. Prepaid 25c. The E. I. Company, 233 Fulton St., New York City.

Major Armstrong's New Epoch-Making Invention Will Solve Your Loop Antenna Problem. The New Armstrong Super-Regenerative Circuit is a means now that is made possible with two vacuum tubes and an indoor loop antenna to receive broadcasting music up to 100 miles distant. Our engineering department has compiled a pamphlet that gives an exposition of the theory of operation with full working directions, etc. A large blue-print is included with this pamphlet. Your dealer cannot supply you with these pamphlets. Send us 25c and we will mail you this wonderful exposition prepaid. Tell your dealer to ask us for our proposition. The E. I. Company, 233 Fulton St., New York City.

Wireless Course in 20 Lessons. By S. Gernsback, A. Lescaurba and H. W. Secor, E. E. Tells you everything you want to know about "Wireless"—theory, practice and history. A clear, concise course on every phase of this subject. 160 pages—350 illustrations, 30 tables. Stiff cloth cover, \$1.75, postpaid. Experimenter Publishing Co., Book Dept. 53 Park Place, New York.

How to Make Wireless Receiving Apparatus. 100 pages—90 illustrations. Only strictly modern radio apparatus are described in this book and the illustrations and descriptions are so clear and simple that no trouble will be experienced in making the instruments. Paper covered, 35c, postpaid. Experimenter Publishing Co., Book Dept., 53 Park Place, New York City.

How to Make Wireless Sending Apparatus.—100 pages—88 illustrations. Written and published entirely for the wireless enthusiast who wants to make his own radio apparatus. Contains more information on "how to make it" than any other book we know of. Paper bound, 35c, postpaid. Experimenter Publishing Co., Book Dept. 53 Park Place, New York City.

Experimental Electricity Course in 20 Lessons. By S. Gernsback and H. W. Secor, E. E. A course of the theory and practice of Electricity for the Experimenter. Every phase of experimental electricity is treated comprehensively in plain English. New experiments are described and explained and nearly every application of Electricity in modern life is given. 160 pages—400 illustrations. Flexible cloth cover, 75c, postpaid. Stiff cloth cover, \$1.25, postpaid. Experimenter Publishing Co., Book Dept., 53 Park Place, New York City.

The How and Why of Radio Apparatus; by H. W. Secor, E. E. This newest book on radio matters fulfills a distinct gap in wireless literature in that, while the treatment is made as understandable and as free from mathematics as possible, it at the same time incorporates a wealth of technique and instruction for the Radio Amateur—the Radio Operator—the Installation and Designing Expert—as well as teachers and students of the subject in general. A very broad field has been covered by the author, at the same time giving a great deal of information not found in other text books. If you are engaged in any branch of the Radio or allied arts at all you will surely need this latest contribution to radio literature, which is destined to be found on every radio man's book shelf before long. A glance at the following list of chapters gives but a very scant idea of the extensive and useful radio knowledge provided in its text: The Induction Coil; The Alternating Current Transformer; Radio Transmitting Condensers; The Spark Gaps; Radio-Transmitting Inductances; Radio Receiving Tuners; Radio Receiving Condensers; Detectors; Telephone Receivers; Radio Amplifiers; Construction of a Direct Reading Wavemeter and Decimeter; Antenna Construction; The Calculation and Measurement of Inductances; Appendix containing very useful tables, covering all subjects treated in this very unusual book. This newest of Radio Works, cloth bound in Vellum de Luxe, Gold Stamped and Hand Sewed, has 160 pages. Size of book 6x9 inches. The How and Why of Radio Apparatus. Postpaid, \$1.75. Experimenter Publishing Co., Book Dept., 53 Park Place, New York City.

For Men

Pipedream. Pipe cleaner, Patent. Samples 10c. Vinograd Co., 229 Summit, Jersey City, N. J.

Exchange

Amateur Agents wanted in every city and town to sell radio apparatus. A few stocking agencies still open. Delfelco, 12 Meeting Street, Pawtucket, R. I.

Grebe CR5 and three step, \$110. C. G. Williams, Oswego, N. Y.

R2 Magnavox, used one hour, \$75 cash. Eugene Volz, Winamac, Indiana.

Special Offer—One Step Amplifier, \$8.00. Two Step, \$15.00. Albert Stein, Cold Spring, Minn.

For Sale—Two Stage Regenerative Receiver in 2 Walnut Cabinets, \$75.00. Bulbs included. Hugo Meyer, 709 Chestnut, Joplin, Mo.

Edison Elements for Storage B Batteries. Six to ten cents per pair, postpaid. (Depending solely on size of order). I handle strictly first grade elements only. A. J. Hanks, 608 Montgomery Street, Jersey City, N. J.

Microscope Wanted for storage battery set. Value \$125.00. Box 115, Radio News.

Ford Owners

Sport Cars, fast, saucy, hug the turns and stick to the road—make you glad you're a Ford owner. Can easily be built by aid of life-size "Bed-i-Kut" patterns and picture instructions. The "Pal" system delivered complete with pressed metal streamline tail for \$6.40. Garage men make big money building them. Send 5-cent coin for prospectus on making sport cars—"Jifty" Tops and "Gosum" Windshields. Kuempel Co., 318 Kuempel Bldg., Guttenberg, Iowa.

For Inventors

Unpatented ideas can be sold. I tell you how and help you make the sale. Particulars free. Write W. A. Greene, 106 The Atlantic, Washington, D. C.

For Sale

2—12" Inductance Coils. These coils throw a spark 12" long, and originally cost over \$300.00 each to build. They are excellent for X-ray work and other research work where a large spark coil is required. Coils have independent magnetic vibrators and can be used for many different purposes. These inductance coils will be sold at a very low price, as the owner no longer requires them. For further particulars address Box 86, in care of this publication.

Health

Tobacco or Snuff Habit Cured or no pay; \$1 if cured. Remedy sent on trial. Superba Co., S.B., Baltimore, Md.

Diseases and Their Innate Healer. Book 50c. Arthur J. Stevens, Wauseon, Ohio.

Help Wanted

We want Salesmen and Agents, either whole or side line, to sell our low priced radio books to the trade. Excellent proposition for live wires. The E. I. Company, Publishers, 233 Fulton Street, New York City.

Get posted. Good prices paid for butterflies, insects. See Sinclair display advertisement, page 2180.

Earn \$25 Weekly, spare time, writing for newspapers, magazines. Experience unnecessary; details free. Press Syndicate, 5665, St. Louis, Mo.

All men, women, boys, girls, 17 to 60, willing to accept Government Positions, \$117-\$190, traveling or stationary, write, Mr. Ozment, 251, St. Louis, immediately.

Be a Landscape Architect! Earn \$5,000 yearly; interesting work, easily learned. Write Landscapeers, 425 Union League Building, Los Angeles, California.

Be a Mirror Expert, \$3-\$10 a day; spare time home at first; no capital; we train, start you making and silvering mirrors. Free method. Free prospectus. W. R. Derr, Pres., 26 McKinley St., Baldwin, N. Y.

Detectives Needed Everywhere. Work home or travel. Experience unnecessary. Write, American Detective System, 1903 Broadway, N. Y.

Insects Wanted

Get posted for Spring—Good prices paid for butterflies, insects. See Sinclair display advertisement, page 2180.

Instruction

Learn Chemistry at Home—Dr. T. O'Connor Sloane, noted educator and scientific authority, will teach you. Our home study correspondence course fits you to take a position as chemist. See our full page ad on page 2125 of this issue. Chemical Institute of New York, 66 West Broadway, New York City.

Used Correspondence Courses only one quarter original price. Free bargain price list 1000 courses. Courses bought. Students' Exchange, 45 West 42d St., New York.

Mouth-Organ Instructor, 25c. Play in one hour. Elsea Co., Bowling Green, Ohio.

Languages

World-Romie System. Masterkey to All Languages. Primers, 23 languages, \$1.94 each language: Arabic, Bohemian, Bulgarian, Cantonese, Chindau, Danish, Dutch, English, Scotch English, French, German, Hungarian, Italian, Japanese, Latin, Panjabi, Polish, Portuguese, Rumanian, Russian, Sechuan, Spanish, Swedish. Pronunciation Tables, 94 languages 30c each language. Languages Publishing Co., 8 West 40th Street, New York.

Mail Order Business

Advertise. Newspapers, magazines. List on request. Pennell Company, Covington, Kentucky.

Manufacturers Representative

Representatives of standing wanted to sell Radio Reinartz and honeycomb coils, and Radio soldering sets. Pranstchil Radio Service Company, Highland Park, Ill.

Miscellaneous

Get posted. Good prices paid for butterflies, insects. See Sinclair display see advertisement, page 2180.

I. C. S. Electrical Engineering Course and 8 volumes of Practical Electricity, cheap. Robert Mueller, South Saint Paul, Minnesota.

Examinations by mail for what you already know. All branches of Electricity, Automotive and Engineering. Certificate issued. Let us increase your pay. Illinois Practical Technicians Institute, Du Quoin, Illinois.

Crystal Gazing. An art. Can you scry? Lessons 50c. Explanatory Book 75c. Also Crystals. Crystal Gazing Company, 522 Station "B," Kansas City, Missouri.

Motorcycles—Bicycles

Don't buy a Bicycle Motor Attachment until you get our catalog and prices. Shaw Mfg. Co., Dept. 6, Galesburg, Kansas.

New Radio Game

Play Radio Golf and get a new pleasure out of your receiving set. Our Radio Golf outfit will enable you to keep accurate score day by day of the number of stations you hear and the total number of miles they represent away from your home, also helps you to see how your receiving is improved. Send \$1.00 today and the entire outfit will be shipped you by return mail. Money refunded if not satisfactory. Radio Golf Association of America, Dept. RGI, Washington, D. C.

News Correspondents

Earn \$25 Weekly, spare time, writing for newspapers, magazines. Experience unnecessary; details free. Press Syndicate, 566, St. Louis, Mo.

Office Devices

Save half on office machines, equipment, addressers, Multigraphs, Duplicators, Dictaphones. Pruitt Company, 172 North Wells, Chicago.

Old Money Wanted

\$2 to \$500 Each paid for hundreds of old or odd coins. Keep All Old Money, it may be very valuable. Send 10 cts. for new Illustrated Coin Value Book, 4x6. Get posted. We pay cash. Clarke Coin Company, Ave. 80, LeRoy, N. Y.

Patent Attorneys

Inventors: Protect your invention through A. M. Wilson, Inc., Washington, D. C. Over 25 years of efficient, expert, confidential service. Skilled in Radio-Electrical, Chemical and Mechanical fields. Our new illustrated Patent Book, giving much necessary and very useful information which every inventor should know, will be sent free upon request. Prompt and careful attention. Highest references. Moderate fees. Send sketch or model for our careful opinion and preliminary advice. Write today to A. M. Wilson, Inc., (Radio 3 ARH), 325 Victor Bldg., Washington, D. C.

Patent applications filed on partial payment plan. Trade-marks, copyrights. Milo B. Stevens & Co., 692 F Street, N. W., Washington, D. C.

Patents and Trade-Marks, 64-page Book free. Excellent references. 23 years' experience. Robb, Robb & Hill, 1409 Hanna Bldg., Cleveland, Ohio, 938 McLachlan Bldg., Washington, D. C.

Patents procured. Send sketch or model today for examination, prompt reply and advice. No charge for preliminary advice. Write for free Booklet and blank form on which to disclose your idea. Highest references. Promptness assured. Clarence A. O'Brien, Registered Patent Lawyer, 751 Southern Building, Washington, D. C.

Inventors—Record invention legally before disclosing to others. Our Invention-Record and Data Sheet shows how. Sent free and valuable information given on patent procedure, costs, etc. Report on patentability includes copies of patents nearest your idea. O'Connell & O'Connell, 402 7th St., N. W., Washington, D. C.

Patent Sense. The Book the Inventor Keeps. Free. See Lacey's ad, page 2184.

Patents—Send for form "Evidence of Conception" to be signed and witnessed. Form fee schedule, information, free. Lancaster and Allwine, 2699 Ouray Bldg., Washington, D. C.

Herbert Jenner, Patent Attorney and Mechanical Expert, 624 F Street, Washington, D. C. I report if patent obtainable and exact cost. Send for circular.

Patents Secured. Prompt service. Avoid dangerous delays. Send for our "Record of Invention" form and Free Book telling How to Obtain a Patent. Send sketch or model for examination. Preliminary advice without charge. Highest references. Write today. Jacoby & Jacoby, 413 Ouray Bldg., Washington, D. C.

Patent. Electrical cases a specialty. Pre-war charges. B. P. Fishburne, 340 McGill Bldg., Washington, D. C.

Patent Attorneys continued

Patents—Inventors should write for Free Guide Books and Record of Invention Blank before disclosing invention. Send model or sketch of your invention for our Free opinion of its patentable nature. Radio Electrical, Chemical, Mechanical and Trade-Mark experts. Victor J. Evans & Co., 922 Ninth, Washington, D. C.

Patents. Send drawing or model for examination and report as to patentability. Advice and booklet free. Highest references. Best results. Promptness assured. Watson E. Coleman, Patent Lawyer, 624 F Street, Washington, D. C.

Millions spent annually for ideas. Hundreds now wanted! Patent yours and profit! Write today for free books—tell how to protect yourself, how to invent, ideas wanted, how we help you sell, etc., 301 Kresge Bldg., American Industries, Inc., Washington, D. C.

Patents

Free Search of Patent Office records to determine patentability of your invention. Save \$10.00 on your patent. Particulars free. Write M. C. Johnston & Company, Washington, D. C.

Inventions Commercialized. Patented or unpatented. Write Adam Fisher Mfg. Co., 278, St. Louis, Mo.

Patents promptly procured. Booklet and advice free. James N. Lyles, 734 E. 8th St., Washington, D. C.

Personal

Lonesome—Join our club—make acquaintances everywhere. Big illustrated book with descriptions and photos, sent in plain wrapper for ten cents. Bonafide Co., Dept. 98, Kansas City, Mo.

Astrology Reveals. 2,000 word trial reading 25c. Two personal questions considered free. State Birthdate. Prof. Audrey, Dept. 8-R-P, Box 834, Washington, D. C.

Scenery to Rent

Settings spent Opera, Plays, Minstrels. Plush Drops. Address Amelia Grain, Philadelphia.

Telegraphy

Radio ——— Chart teaches code quicker. Satisfaction guaranteed. \$1 prepaid. John Percival, 2115 York, Des Moines, Iowa. Boy Scouts write for special offer.

Wanted—Young men and women to learn Morse and Wireless Telegraphy. Railroads and Wireless Companies in great need of operators. We teach you quickly, and procure positions at big salaries. Great opportunities for advancement. All expenses low; can earn part. Write today for free catalog. School established 1874. Dodge Telegraph Institute, M Street, Valparaiso, Indiana.

Wanted to Buy

Full Value Paid for Old Gold Jewelry, Watches, Diamonds, crowns, bridges, dental gold, silver, platinum, gold or silver ore, magneto points, old false teeth. Packages returned if our offer is not satisfactory. United States Smelting Works (The Old Reliable), 120 So State St., Dept. 16, Chicago, Ill.

Cash for Old Gold, Platinum, Silver, Diamonds, Liberty Bonds, War, Thrift, Unused Postage Stamps, False Teeth, Magneto Points, Jobs, any valuables. Mail in today. Cash sent, return mail. Goods returned in ten days if you're not satisfied. Ohio Smelting Co., 304 Hippodrome Bldg., Cleveland, Ohio.

Wireless

Stronberg-Carlson Phones. The professional headset at the amateur's price. Super-sensitive, comfortable, durable. Impedance correct for phone work with modern vacuum tubes. Equipped with five-foot polarity indicating, moisture-proof silk cords. A real radio headset for \$7.50. Carrollton Radio Shop, Carrollton, Missouri.

Tube Renewals—Radiotron, Cunningham, DeForest, etc., at \$3.00. Detectors, \$3.50; Amplifiers, 5 day service. U.V. 202, W-D 11 at \$4.00. Prompt deliveries and satisfactory results guaranteed. S. Strobel & Co., 4401 N. 6, Philadelphia, Pa.

Boys! Don't Overlook This. The "Rasco" Baby Detector. Greatest detector ever brought out with molded base. Fully adjustable. See former advertisements in this publication, or our catalog. Detector with Galena Crystal, complete 50c. the same detector with Radiotele Crystal, 75c. prepaid. Send for yours today. Radio Specialty Company, 96-98 Park Place, New York City.

Attention!—50 Vacuum tube hook-ups. The greatest collection of vacuum tube circuits ever brought under two covers at such insignificant cost. These diagrams will be found in the great "Rasco" catalog, which contains raw materials and parts in a greater profusion than any other catalog. 15c in stamps, or coin, will bring the catalog to you. Radio Specialty Co., 96-98 Park Place, N. Y.

For Immediate Delivery—Tubes, Magnavox, Westinghouse Receiving Sets, Phones, Condensers, Rheostats, Variometers, Couplers, Panels, Transformers, V. T. Sockets, Dials, Switch Points, and full line of parts. R. B. Electric Co., Galva, Ill.

Pacific Coast Stations are heard in Pittsburgh with vario-coupler and two Rogers Receiving Radiometers (Condensable molded variometers). Radiometers \$4.00 each. Postage prepaid. Rogers Radio Company, No. 5133 Woodworth St., Pittsburgh, Pa.

Radio Frequency Amplification—Get the best results with radiophone reception. Long distance reception, purity and volume of tone reproduction, static reduction, and selectivity. We have working plans, blue prints, with exact specifications of parts to assemble to construct a three tube set. Gives marvelous results. Save worry and experimentation in building one of these sets. Any amateur can build. Guaranteed performance. Sent for \$1.00 postpaid. Research Laboratories, Carthage, Mo.

Automatic Regenerative Receiver—1,000 to 1,500 miles on 1 tube, 1 control. 150 to 25,000 meters. No rheostat, storage battery, vario-coupler, variometer, 3 coil mounting, variable inductance, taps or radio frequency. Complete information and hookup \$1. Nothing to guess about. Build and save 50 per cent or more and get better results. Radio Experimental Laboratory, Box 194G, Berkeley, California.

Wireless continued

Build your own electrolytic storage battery charger. Plates and complete instructions, \$1.00. Descriptive circular free. Peerless Electrical Parts Co., 105 Harris, Rochester, N. Y.

Radio Generators—500 Volt 100 Watt \$23.50—High Speed Motors—Federal Phones \$3.50—Battery Chargers \$12.50. Motor Specialties Co., Crafton, Pittsburgh, Penna.

Western Elec. Change Over Switch—Panel Mounting with Knob and Pointer, 1 Pole Double Throw \$3.00. 2 Pole Double Throw \$1.50. 3 Pole Double Throw \$3.00. 6 Pole Double Throw \$2.50. W. E. Phone Plugs \$.35. W. E. Carbon Cup Microphone \$.50. Larvite Resistance Unit 18,000 Ohms, \$.50. D. X. two stage Amplifier \$48.00. List \$28.00. Standard Radio Goods 15 per cent off list price. H. & H. Radio Supply Co., 2442-44 Ogden Ave., Chicago, Ill.

Motors—G. E. 1/4 HP. \$16.50. 1/2 HP. \$29.50. 5 HP \$35.50. Generators, 8 Volt 1.50. 32 Volt 500 Watt \$29.50. Write for Catalog. Motor Specialties Co., Crafton, Pittsburgh, Penna.

Sockets for WD-11 dry cell tubes 50 cents. Franklin Radio Mfg. Co., 711 Penn Avenue, Wilkensburg, Pa.

Free—One Loud Speaker—to introduce. Write for it. American Metal Letter Co., Bloomfield, N. J.

Radio Crystals—As loud and clear as galena, but sensitive in many spots. Guaranteed. The best crystal for detector. Atrial convices, unmounted 35 cents. J. H. Hastings, 133 Ida Ave., Donora, Pa.

How to Make Wireless Receiving Apparatus. 100 pages—90 illustrations. Only strictly modern radio apparatus are described in this book and the illustrations and descriptions are so clear and simple that no trouble will be experienced in making the instruments. Paper covered, 35c. postpaid. Experimenter Publishing Co., Book Dept., 53 Park Place, New York City.

The How and Why of Radio Apparatus, by H. W. Secor, E. E. This newest book on radio matters fills a distinct gap in wireless literature in that, while the treatment is made as understandable and as free from mathematics as possible, it at the same time incorporates a wealth of technique and instruction for the Radio Amateur—the Radio Operator—the Installation and Designing Expert—as well as teachers and students of the subject in general. A very broad field has been covered by the author, at the same time giving a great deal of information not found in other text books. If you are engaged in any branch of the Radio or allied arts at all you will surely need this latest contribution to radio literature, which is destined to be found on every radio man's book shelf before long. A glance at the following list of chapters gives but a very scant idea of the extensive and useful radio knowledge provided in it: The Detector Coil; The Alternating Current Transformer; Radio Transmitting Condensers; The Spark Gaps; Radio-Transmitting Inductances; Radio Receiving Tuners; Radio Receiving Condensers; Detectors; Telephone Receivers; Radio Amplifiers; Construction of a Direct Reading Vavemeter and Decremeter; Antenna Construction; The Calculation and Measurement of Inductances; Appendix containing very useful tables, covering all subjects treated in this very unusual book. This newest of Radio Works, cloth bound in Velum de Luxe, Gold Stamped and Hand Sewed, has 160 pages. Size of book, 6x9 inches. The How and Why of Radio Apparatus. Postpaid, \$1.75. Experimenter Publishing Co., Book Dept., 53 Park Place, New York City.

Experimental Electricity Course in 20 Lessons. By S. Gernsback and H. W. Secor, E. E. A course of the theory and practice of Electricity for the Experimenter. Every phase of experimental electricity is treated comprehensively in plain English. New experiments are described and explained and nearly every application of Electricity in modern life is given. 160 pages—400 illustrations. Flexible cloth cover, 75c. postpaid. Stiff cloth cover, \$1.25 postpaid. Experimenter Publishing Co., Book Dept., 53 Park Place, New York City.

Wireless Course in 20 Lessons. By S. Gernsback, A. Lescarboura and H. W. Secor, E. E. Tells you everything you want to know about "Wireless"—theory, practice and history. A clear, concise course on every phase of this subject. 160 pages—350 illustrations, 30 tables. Stiff cloth cover, \$1.75, postpaid. Experimenter Publishing Co., Book Dept., 53 Park Place, New York.

How to Make Wireless Receiving Apparatus. 100 pages—90 illustrations. Only strictly modern radio apparatus are described in this book and the illustrations and descriptions are so clear and simple that no trouble will be experienced in making the instruments. Paper covered, 35c. postpaid. Experimenter Publishing Co., Book Dept., 53 Park Place, New York City.

How to Make Wireless Sending Apparatus. 100 pages—88 illustrations. Written and published entirely for the wireless enthusiast who wants to make his own radio apparatus. Contains more information on how to make it than any other book we know of. Paper bound 35c. postpaid. Experimenter Publishing Co., Book Dept., 53 Park Place, New York City.

How to Make Radio Frequency Amplifiers. This book is for the more advanced amateur, showing the construction of the Radio Frequency Amplifying Transformer and giving complete constructional data. It shows the application of Radio Frequency to amplifying units that the amateur may already possess and gives 15 hook-ups showing practically every use Radio Frequency Amplifying Transformers can be put to. 32 pages, 15 illustrations; bound in beautiful two-color cover. Prepaid 25c. The E. I. Company, 233 Fulton St., New York City.

Major Armstrong's New Epoch-Making Invention Will Solve Your Loop Antenna Problem. The New Armstrong Super-Regenerative Circuit is a means now that is made possible with two vacuum tubes and an indoor loop antenna to receive broadcasting music up to 100 miles distant. Our engineering department has compiled a pamphlet that gives an exposition of the theory of operation with full working directions, etc. A large blue print is included with this pamphlet. Your dealer cannot supply you with these pamphlets. Send us 25c and we will mail you this wonderful exposition prepaid. Tell your dealer to ask us for our proposition. The E. I. Company, 233 Fulton St., New York City.

Science and Invention Bound Volume No. 9, May 1921-April 1922; contains 1200 pages with over 1500 illustrations and over 700 articles by the foremost American and Foreign writers. We have also a limited amount of the following Bound Volumes of Science and Invention (Electrical Experimenter) Vol. No. 8—May 1918 to April 1919; Vol. No. 7—May 1919 to April 1920; Vol. No. 6—May 1920 to April 1921. Each volume bound in stiff board covered with green vellum and gold stamped. Price for volume No. 9—\$2.25. Price for volume No. 6, 7 or 8—\$2.00. All four volumes \$7.00, sent express collect. Experimenter Publishing Co., 53 Park Place, New York City.

LOWEST RADIO PRICES

SAVE MONEY—no matter what you need for your Radio Outfit you will find you can save money if you buy from the Standard Radio Corporation.

PHONES

Genuine Frost Double Head Set. 2000 Ohms, K-175\$3.95
 3000 Ohms, K-176 4.25
 Brandes Head Set, Superior Type. 2200 Ohms, K-185\$5.95
 Murdock Head Set.

2000 Ohms, K-189.....\$4.25
 3000 Ohms, K-190..... 4.50
 Genuine Baldwin Head Set. \$12.00 Value, Type "C".....\$7.98
 Baldwin Type "C" Unit..... 4.95

HONEYCOMB COIL MOUNTING

Can be used for panel or base mounting, connecting leads furnished. Constructed of Bakelite, metal parts nickel plated.

K-140 3-coil mounting\$3.85
 K-150 2-coil mounting 2.85
 K-160 Single coil mounting..... 40

HONEYCOMB COILS

Honeycomb duo-lateral on coils completely mounted with plug and strap.

| Number of Turns | Wave Lengths | Price Mounted |
|-----------------|--------------|---------------|
| K-25 25 | 125-250 | \$.80 |
| K-35 35 | 175-450 | 1.85 |
| K-50 50 | 240-720 | .90 |
| K-75 75 | 390-910 | .95 |
| K-100 100 | 500-1450 | 1.05 |

Any of the above sizes unmounted 45c each.

HOMECHARGER BATTERY CHARGING RECTIFIER

You can charge your battery at home for a few cents. Connects directly to 110 Volt 60 Cycle Light Circuit attached directly to your socket. Complete with cord, plug battery clips and cords. Deluxe Type, \$18.50 Value.
 K-250 Homecharger\$13.65

BINDING POSTS

Binding posts and contact points are brass nickel finished. Per doz.

K-10 N.P. Binding Post, Large Size\$0.40
 K-20 H.R. Binding Post, Large Size60
 K-30 N.P. Contact Point, 2 Nuts15
 K-40 Solder Lugs to fit Contact Points10

STORAGE BATTERIES

A high grade storage battery fully guaranteed for two years 100 ampere hour. This is an exceptional value.
 K-950 100 amp. hr. storage battery\$13.95

RADIO PANELS

Condensite Celeron Panel a high grade material for mounting your set. Nationally advertised.

| | |
|------------|-------------|
| 6x9, 1/2 |\$0.70 |
| 6x7, 1/2 |50 |
| 6x14, 1/2 | 1.00 |
| 7x9, 1/2 |80 |
| 7x12, 1/2 | 1.05 |
| 7x18, 3/16 | 2.30 |
| 9x18, 1/2 | 2.35 |
| 9x14, 3/16 | 2.35 |
| 7x21, 3/16 | 2.60 |
| 6x21, 1/2 | 1.80 |
| 9x21, 1/2 | 2.80 |

ATWATER-KENT RADIO

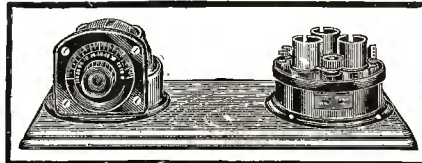

Atwater-Kent Set. Tuner, Detector and two stages of Audio Frequency, complete, special at\$29.50
 Atwater-Kent Set. Tuner, one radio frequency, amplifier detector and two stages of audio frequency, complete, special at\$58.00
 Atwater-Kent Set. Tuner, two stages radio frequency, amplification, detector and two stages of audio frequency, amplification special\$68.00
 All the above Atwater-Kent Sets are fully guaranteed will pick up long distance broadcasting. We will gladly forward information regarding the above sets.

VARIABLE CONDENSERS

These condensers are fully guaranteed and are of the highest grade workmanship. The vernier types are furnished with dial and knob.

| | |
|-----------------------|-------------|
| 43P—Vernier Condenser |\$3.50 |
| 23P—Vernier Condenser | 2.95 |
| 14P—Vernier Condenser | 2.80 |
| 43P—Plain Condenser | 1.85 |
| 23P—Plain Condenser | 1.65 |
| 14P—Plain Condenser | 1.50 |
| 5P—Plain Condenser | 1.10 |
| 3P—Plain Condenser |95 |

VARIOMETERS

High grade variometer, mahogany frame, accurately wound, exceptional value.
 K-85 Mahogany variometer\$1.95
 Excellent moulded variometer, high di-electric can't warp, a real buy
 Highest grade moulded variometer, wave length 180 to 600 meters, exceptional bargain.
 K-105 Supreme Variometer\$4.95

VARIOCOUPLER

Exceptional vario coupler 180 degree bakelite tubes, wound with green silk wire, metal parts nickel plated.
 K-350 Premier Variocoupler\$2.75
 Standard vario coupler, bakelite tube, wooden rotor, brass parts.
 K-325 Standard Vario coupler\$1.95

MISCELLANEOUS

| | |
|---|-------------|
| Spaghettil Tubing, per yd. |\$0.10 |
| No. 14 Copper Tinned Connecting Wire, per ft. |01 |
| Solderall, per tube |25 |
| Tape, 3/4 lb. roll |20 |
| Sliders, 1/4 or 3/16 |12 |
| Slider Paste, per can |12 |
| Battery Clips, each |20 |
| Galena Crystal (mounted and tested) |25 |
| Galena Crystal (unmounted but tested) |25 |
| Radiocite (unmounted but tested) |25 |
| Radiocite (mounted and tested) |35 |
| Silicon (unmounted but tested) |25 |
| Grewol Permanent Crystal Detector | 1.65 |
| RW Adjustable Detector | 1.50 |

RADIO CABINETS

Mahogany finished cabinets built sturdy adds to the appearance of any radio set, hinged top, takes panel of sizes listed below:

| | |
|--------------|-------------|
| K-1 6x7 |\$2.10 |
| K-2 6x10 1/2 | 2.60 |
| K-3 6x14 | 2.75 |
| K-4 6x21 | 2.95 |
| K-3 1/2 7x18 | 2.95 |
| K-4 1/2 7x21 | 3.30 |

MAGNAVOX

Genuine Magnavox, type R-3, has 14-inch horn, the ideal speaker for home, office, church, theatre and etc. Sells everywhere for \$45.00 our special price \$29.50



B BATTERY

Large size 2 1/2 volt battery sells for \$3.00 our price very special.
 K-400 2 1/2 volt large battery\$1.75
 K-500 45 volt large battery 3.25
 K-600 2 1/2 volt small battery 1.10

ALL AMERICAN TRANSFORMER

The genuine All American Shielded Transformer, an exceptional saving.
 K-610 3-1 Ratio All American\$3.95
 K-620 5-1 Ratio All American 3.95
 K-630 10-1 Ratio All American 3.95



THORDARSON AMPLIFYING TRANSFORMER

The genuine Thordarson Aluminum case transformers.
 K-710 3-1 Ratio Thordarson\$3.50
 K-720 7-1 Ratio Thordarson\$3.85

ERLA RADIO FREQUENCY TRANSFORMER

The genuine Erla Transformer nationally advertised, complete with pamphlet for instruction and hook ups, is furnished in three types for first, second and third stage.
 K-810 1st stage Erla Transformer\$3.65
 K-820 2nd stage Erla Transformer 3.65
 K-830 3rd stage Erla Transformer... 3.65

Grebe Set CR-9 Detector and two stages of amplification, the well-known set advertised everywhere \$130.00, our price very special at\$115.00
 Western Electric Loud Speaker, power amplifier and 216A tubes sold everywhere for \$161.00; our price very special at \$145.00



SWITCH LEVER

An excellent switch lever for a radio set, bushing lever with nickel plated switch arm.
 K-72 Switch Lever \$0.25
 K-74 Switch Lever (cheaper grade)19

Visit either of our two big stores at any time Our Experts will be glad to help you with your problems. This advice is absolutely FREE at any time.

VACUUM TUBES

We carry the standard tubes in stock, Radiotron and Cunningham and will ship which ever we have on hand.
 K-910 UV-200 Detector Tube\$4.05
 K-920 UV-201A Amplifier Tube 5.65



SOCKETS

Bakelite Socket for VT Standard Tube \$5.50
 Bakelite Socket for WD-11 Tube... .50
 Metal Socket for VT Standard Tube... .50
 High grade metal shell bakelite base, exceptional value75
 Composition VT Socket for Standard Tube30

RHEOSTATS

Cutler-Hammer Rheostats, exceptional values.
 K-304 Vernier Type CH Rheostat\$1.29
 K-305 Plain Type CH Rheostat80
 Howard Rheostats
 K-306 Vernier Type\$1.15
 K-307 Plain Type95
 Cheaper grade Rheostats, exceptional value.
 K-309 Standard Rheostat\$0.45

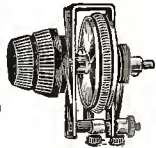

DIALS

High grade black dials, bushed for 3/4-inch shaft.
 K-729 2-inch dial\$0.25
 K-730 3-inch dial25
 K-731 3 1/2-inch dial35
 K-732 4-inch dial45

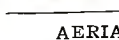

AERIAL EQUIPMENT

Stranded Antenna Wire No. 14 (7-22) per 100 ft.\$0.60
 No. 14 Solid Copper Aerial Wire per 100 ft.45
 No. 14 RC Lead-in Wire per 50 ft.65
 Porcelain Aerial Insulator each05
 Composition Insulator (Like cut) each10
 Ground Wire Insulator each10
 Lightning Protector for Radio set... 1.50



FIXED CONDENSERS

| | |
|--------------------------------------|-------------|
| .00025 Mica Fixed Condenser |\$0.25 |
| .0005 Mica Fixed Condenser |25 |
| .001 Mica Fixed Condenser |30 |
| .002 Mica Fixed Condenser |30 |
| .0025 Mica Fixed Condenser |45 |
| .005 Mica Fixed Condenser |65 |
| .006 Mica Fixed Condenser |80 |
| .00025 Paper Condenser for Grid Leak |10 |

GRID LEAKS

Pencil Marked Variable Grid Leak\$0.15
 Freshman Variable Grid Leak and Condenser75
 Durham Variable Grid Leak and Mounting95
 CRL Variable Grid Leak..... 1.25



ORDERS PROMPTLY FILLED

We guarantee to fill your orders accurate and exactly the same day received and we guarantee your complete satisfaction on everything purchased from us.

STANDARD RADIO CORPORATION

227-229-231 W. MADISON ST. 410-412-414 SO. WABASH Av.

TWO BIG STORES CHICAGO ILL.

Read this again!!

Filkostat Proven Best Filament Control

1830

Radio World, April, 1923

Comparison of Fine Adjustment Control Range of Filkostat With Rheostats and Other Filament Controls. Clearly Indicates Filkostat Superiority, as it Permits Perfect and Gradual Current Increase With Infinite Adjustments.

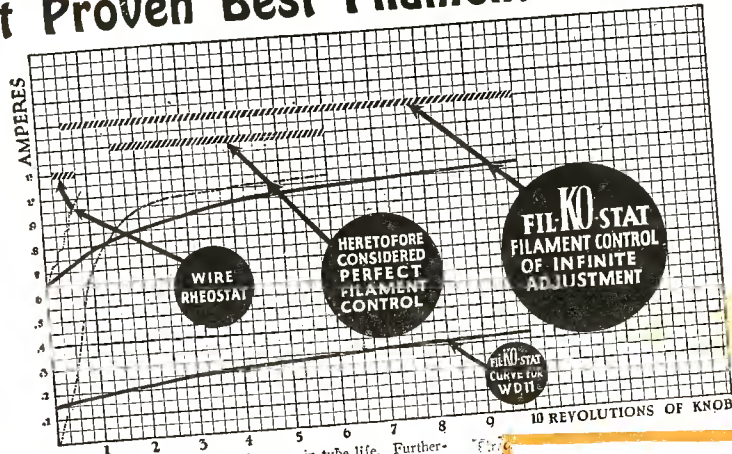

IN the Filkostat, a new filament control just perfected by S. R. Hipple, well known as an inventor of apparatus for the control of electric currents, there is at last presented an instrument which is distinctly designed to utilize the great tuning possibilities of the vacuum tube itself. Radio set builders, amateurs and manufacturers have been looking forward to the advent of just such a device. They have realized that all rheostats and other so-called filament regulators, are merely adaptations of pre-radio day devices, not capable of adjusting the infinitesimal gradations of filament HEAT which adjustments are essential to perfect tuning.

PERFECT TUBE CONTROL

The Filkostat permits perfect regulation of filament heat. Since the heat emitted varies as the square of the current, fine current regulation becomes extremely necessary to accomplish. This governs the flow of electrons. Proper control of the electronic flow in the tube permits the very finest tuning conceivable. The fine adjustment of the Filkostat starts slightly before the tube begins to function. With other filament controls, what minute adjustment there is, starts when the filament is almost at maximum heat. Between 1800 degrees—

considerable increase in tube life. Furthermore the extreme degree of fineness in increase and decrease of electronic flow by infinitesimal variations, makes the Filkostat control ideal.

The perfection of design including ample internal contact is the cause of this new instrument being non-microphonic, absolutely silent, and free from all noises.

IDEAL FOR WDTI'S AND DX WORK

The lower curve on the graph above is eloquent testimony as to the Filkostat's adaptability to any dry cell tube. These tubes using only a fraction of an ampere demand an instrument that is so finely adjusted that this fractional current can be perfectly regulated. This the Filkostat accomplishes.

OTHER FILKOSTAT FEATURES

The Filkostat has a definite off. It is so designed that the filament extinguishes abruptly indicating that the A battery supply is completely disconnected.

At Full On the Filkostat resistance is practically zero.

The Filkostat consists of a hollow cylinder containing the special resistance material placed between two large adjustable contacts controlled by turning the knob.

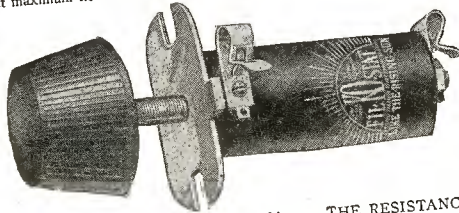

The Filkostat is to all purposes "fool proof". It is compact in form, takes very little space on the panel and so mountable that it can replace any other control without re-drilling.

dull red glow—and 2050 degrees—white heat—the Filkostat control is so fine that increases of temperature of fractions of a degree, with corresponding variations of electronic flow from the filament to the plate, are obtainable.

LONGER TUBE LIFE; NO NOISES

The initial inrush of current prevents the crystallization of the filament which so many experts claim occurs when the current is fed too slowly at first as is done in other forms of filament controls. This means

THE RESISTANCE ELEMENT is so finely divided that no further division is possible. There are no disks to break or chip.

THE RESISTANCE remains CONSTANT at any position eliminating current variations once set. Such variations are not apparent to the person tuning excepting in "fading out" of stations and noises. But in the laboratory, where such a test as that shown on the above graph can be made by anyone, this feature and all the other points of superiority of the Filkostat are immediately apparent.

The filament control of infinite adjustment
FIL-KO-STAT
CURRENT INCREASE PERFECT AND GRADUAL
LIKE THE RISING SUN

\$2.00

—and here's why you need it!!

Designed For Vacuum Tube adjustment and not just an old method adapted to it.

NOT a Rheostat

—but a REAL Filament Control.

Infinitesimal Control—of filament heat and therefore of electronic flow.

Very Finest Tuning for DX is realized with Fil-Ko-Stat.

Controls Fractional Currents

—making it ideal for use with any dry cell tube.

Fine Adjustment Starts

—where tube commences to function increasing the AREA OF FINE ADJUSTMENT CONTROL.

Definite Off—

an important feature indicating complete 'A' Battery disconnection.

Resistance Practically Zero

at "full on" there is practically no resistance in circuit.

No Disks To Break or Chip

Resistance Element is so finely divided further division impossible.

Absolutely Silent

The Fil-Ko-Stat is non-microphonic and operates free of all noises.

Fahnestock Clips

and solder contacts on connection posts.

Adjustable Mounting

—no re-drilling of panel necessary

GUARANTEED

The FIL-KO-STAT is to all purposes "fool proof". Each instrument is packed with the maker's guarantee that it will be replaced if broken within one year.

Replace Old Style Current Controls with the NEW FIL-KO-STAT a real Filament Control

ON SALE AT RADIO DEALERS EVERYWHERE

Manufactured By

DX INSTRUMENT CO.
HARRISBURG PA.

If your dealer has none in stock yet send \$2.00 and his name direct to

SOLE INTERNATIONAL DISTRIBUTORS

RADIO STORES CORPORATION
Dept. R.N.-6 218-222 West 34th Street, New York

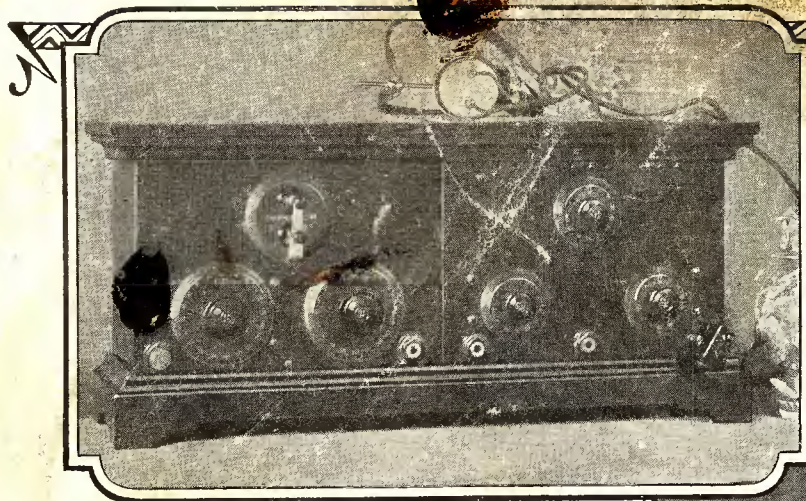

Radiola V

Radiola V is built for a life time—solidly—ruggedly. In principle and performance, it is the same as Radiola RC—detector with two stages of audio amplification. With the same long distance reach. And the same keen sensitiveness. A pleasing and unobtrusive piece of furniture in its neatly finished casing. Dependable always—and simple enough for anyone to operate.

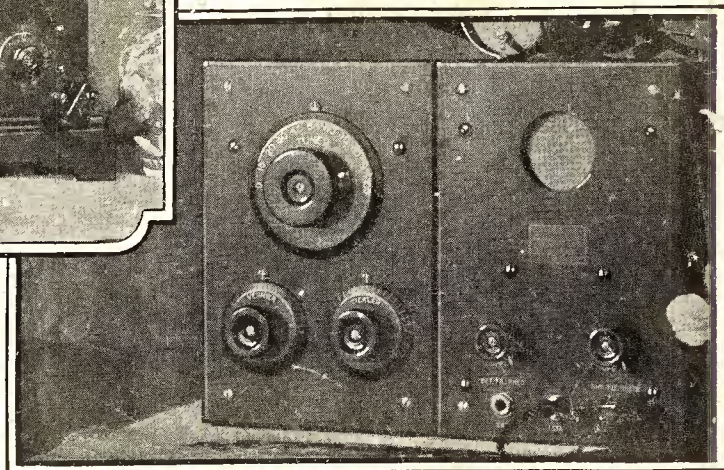

Radiola RC

Radiola RC is one of the nation's most popular long distance receivers. Compact—efficient—with a sensitive detector, and two stages of amplification, for louder, clearer reception of distance. Finely made—and attractively finished—of solid mahogany.

Long Distance — On Dry Batteries!

Good news — Radiotron WD-12 (same as WD-11, with standard base) converts Radiola RC and Radiola V into dry battery receivers. Now every vacuum tube Radiola from Radiola Sr. at \$65—to Radiola Grand, the fine art cabinet receiver at \$350 operates on dry batteries. No more messy, bulky storage battery for record distance reception—clear-toned and sensitively tuned. A big price saving—made bigger by the new combination offer for either of these great sets—Radiola V or Radiola RC—complete!

"There's a Radiola for every purse"

DEALERS! Be sure to stock these two great sets. The whole country is being told about them through national magazines and every fan will want one. Write us today.

Radiola

REG. U. S. PAT. OFF.

Radio Corporation of America

Sales Department
233 Broadway
New York

District Sales Offices
10 So. LaSalle Street Chicago, Illinois
433 California Street San Francisco, California



This symbol of quality
is your protection

Radiola V or Radiola RC Complete \$142.50

The New Way: Complete for dry battery operation, including three WD-12 Radiotron vacuum tubes; head telephones; "A" battery consisting of three dry cells; "B" battery consisting of three 22½ volt units. \$142.50.

The Old Way: The price of Radiola V or Radiola RC when equipped for storage battery operation, formerly came to \$207.50.

Send for this Free Booklet

If you can't have a \$350 Radiola—want something bigger than a \$25 Radiola—write for the booklet. Plenty of in-between sets. The booklet tells all about them.

RADIO CORPORATION OF AMERICA
Dept. 2065, 233 Broadway, New York
Please send me your free Radio Booklet.

Name _____
Street Address _____
City _____ R. F. D. _____
State _____