

CIRCULATION LARGER THAN THAT OF ANY OTHER RADIO PUBLICATION

# RADIO NEWS

REG. U.S. PAT. OFF.

25 Cents

June

1924

Over 200 Illustrations

Edited by H. GERNSBACK

## THE ENCHANTING TREE

### IN THIS ISSUE:

Dr. J. A. Fleming, F. R. S.  
Prof. J. M. Morecroft, E. E.  
Prof. C. B. Bazzoni  
Prof. W. P. Powers  
Prof. René Mesny  
John L. Reinartz  
Ellis Parker Butler  
Howard S. Pyle  
W. L. Hatry

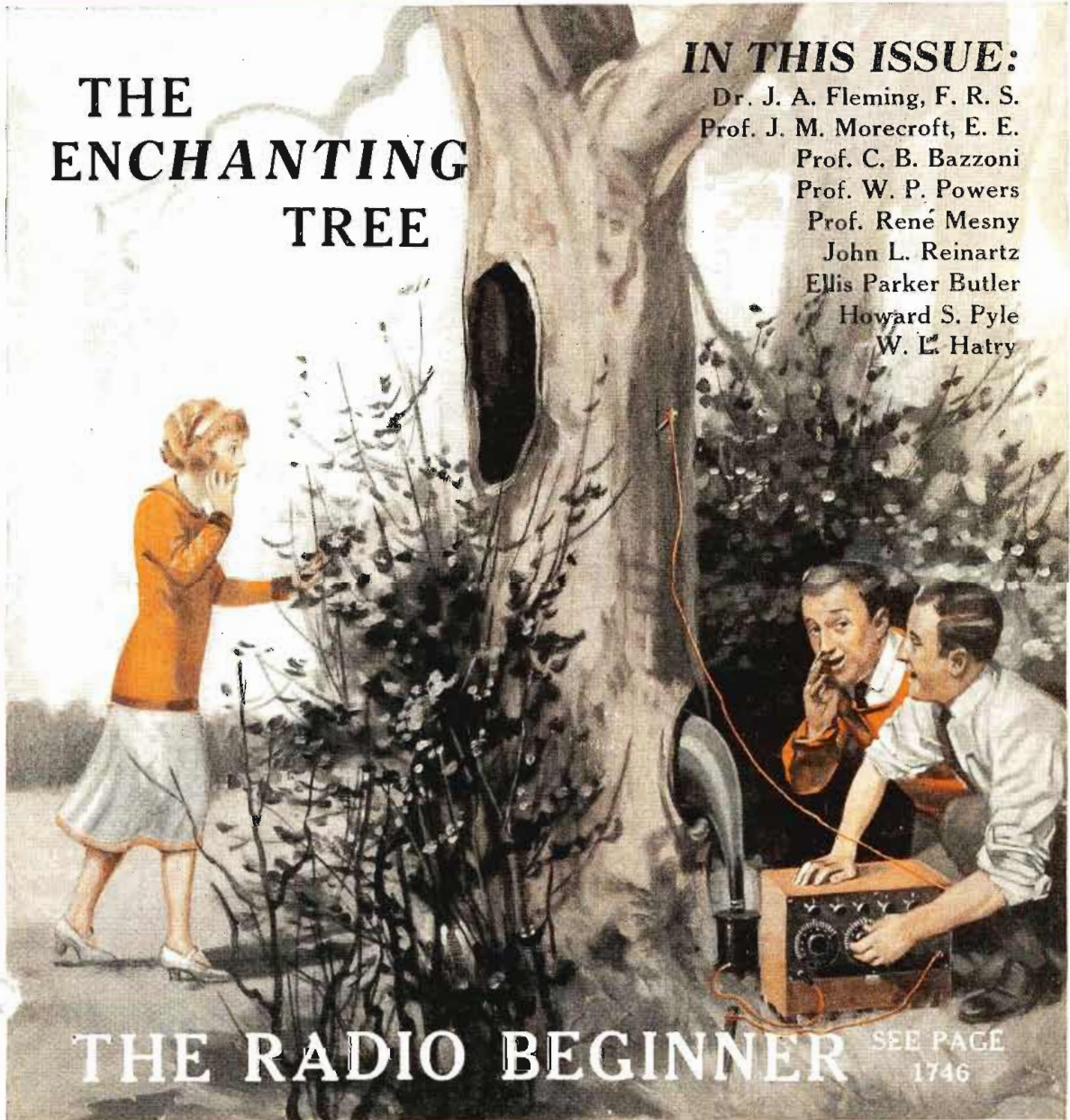

THE RADIO BEGINNER SEE PAGE 1746

THE 100% RADIO MAGAZINE

EXPERIMENTER PUBLISHING COMPANY, NEW YORK, PUBLISHERS OF  
SCIENCE and INVENTION PRACTICAL ELECTRICS MOTOR CAMPER & TOURIST



# Cunningham

## RADIO TUBES

The Standard Tube for all makes of  
Radio Receiving Sets

IT is the Vacuum Tube that has made possible the broad and far-reaching application of radio telephony, and that plays the most important part in the operation of your receiving set.

Radio messages from government leaders—from the heads of the world's greatest educational institutions or from those who stand foremost in the arts of the world will serve to bring the human race into closer contact. Cunningham Vacuum Tubes, standard for all makes of receiving sets—built by one of the world's largest manufacturers with unlimited resources—are the product of years of manufacturing experience and the creative genius of the engineers of that great scientific organization, the Research Laboratory of the General Electric Company.

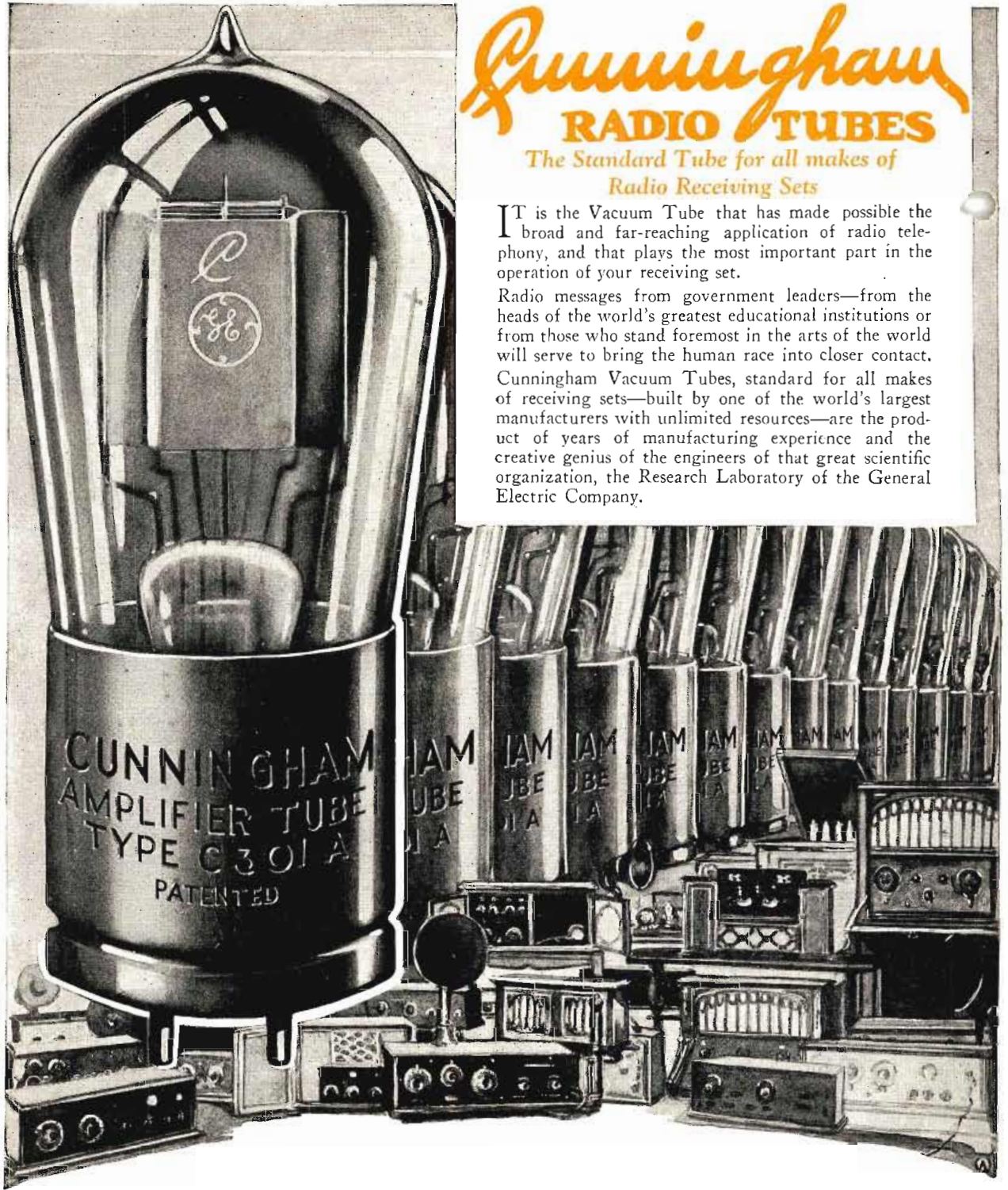

### PATENT NOTICE

Cunningham tubes are covered by patents dated 2-13-08, and others issued and pending. Licensed for amateur, experimental and entertainment use in radio communication.

Any other use will be an infringement.

The care and operation of each model of Receiving Tube is fully explained in our new 40-page "Radio Tube Data Book." Copies may be obtained by sending ten cents to our San Francisco office.

*E. J. Cunningham Inc.*

HOME OFFICE:  
182 Second Street  
SAN FRANCISCO

154 W. Lake Street  
CHICAGO

30 Church Street  
NEW YORK

### PRICES ON CUNNINGHAM RADIO TUBES

Now in Effect  
C-301A—5 Volts 1-ampere filament..\$5.00  
C-299—3 Volts .06 amp. Dry Battery Det. & Amp. ....\$5.00  
C-300—5 Volts Gas Content Detector..\$5.00  
C-11—1.1 Volts .25 amp. Dry Battery Det. and Amp. Special Base .....\$5.00  
C-12—Similar to C-11 with stand. base..\$5.00

# Brooklyn Hears Great Britain on the DICTOGRAND!

*51 Hall Ave.  
Brooklyn N.Y.  
July 16, 1924*

*Dictograph Products Corp.*

*Dear Sir,  
Kindly send me your  
large package of "Applause  
Cards" as advertised in  
the Radio News.  
I have a Dictogrand  
loud speaker and received  
station W-CO and three other  
English stations all on the  
test. I have tried all makes  
and found yours to be the best.*

*Respectfully yours  
J. J. Hall  
51 Hall Ave.  
Brooklyn*

*Max-Q-Lite Co.  
8430 Juncos Ave.  
Woodhaven N.Y.*

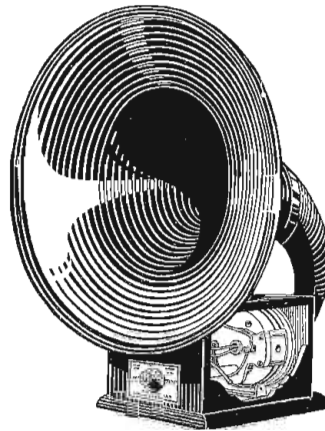

The Master Instrument That Made the Record

1. Operates without extra batteries.
2. Adjustable dial controls volume.
3. Handsomely compact in construction.
4. Finished in a rich ebony; set off by a glistening silvered rim on the bell.
5. Fully guaranteed.

ONLY  
**\$24.50**

Ready to Operate

## The "Aristocrat" Dictograph Headset

1. 3,000 ohms
2. 10 ounces (None lighter)
3. Head-fit headband
4. Cup-curved ear pieces
5. Finished in black and orange
6. Guaranteed fully



Another record!

First, San Francisco heard Japan and Newark on the Dictogrand. Now, Brooklyn hears Great Britain on the Dictogrand.

Amazing? Not to owners of this incomparable instrument. For Dictogrand users in every state are familiar with the thrill of listening to far distant stations—night after night—right on the loud-speaker.

And they have found that this marvelous mechanism, so magically sensitive to faint impulses from the other side of the world, is startlingly life-like on local stations!

Ask your radio shop to demonstrate the Dictogrand!

### The Dictograph "Phono-Unit"

Makes a loud speaker of your phonograph!

1. Uses no extra batteries
2. Has adapters to fit any make of phonograph
3. Attached and detached in a moment
4. Calibrated dial on back controls volume
5. Finished in nickel
6. Fully guaranteed

**\$10.00**

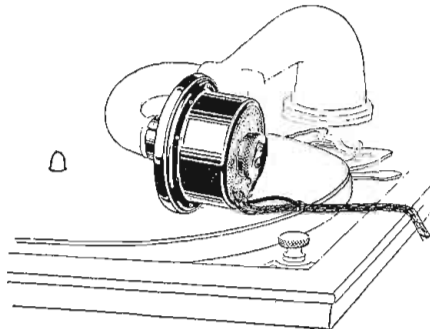

# FREE "Applause Cards"\*

"—Station W-D-A-P signing off. If you have enjoyed the artist's program, won't you write in and tell them?"

By all means! Quickly and easily with "Applause Cards."\* They're handsomely printed mailing cards. All ready for you to fill in with your comments, sign, and drop in the mail box.

Keep a pack of them near your receiving set. You can use "Applause Cards" liberally because they are FREE AT YOUR RADIO DEALER'S.

"Applause Cards" were originated by this Company, makers of the popular Dictogrand Loud Speaker and the Aristocrat Dictograph Headset. The only "Applause Cards" are Dictograph Copyrighted "Applause Cards."\*

A big FREE package of them awaits you at your dealer's. Or if he has not yet stocked, write us, and we'll ship you a generous supply of "Applause Cards" free, prepaid direct, provided you give us your dealer's name. Dept. D-6.

## DICTOGRAPH PRODUCTS CORP.

220 West 42nd Street, New York City  
\*Copyrighted



# RADIO NEWS

Published by EXPERIMENTER PUBLISHING COMPANY, INC.,  
 Publishers of "Radio News," "Science and Invention," "Practical Electrics" and  
 "Motor Camper & Tourist"  
 Publication Office: 52 39th St., B'klyn, N. Y. Editorial and General Offices: 53 Park Pl., N. Y. C.  
 H. GERNSBACK, President. S. GERNSBACK, Treasurer. R. W. DEMOTT, Secretary.

MEMBER: AUDIT BUREAU OF CIRCULATIONS

## VOL. 5 CONTENTS FOR JUNE NO. 12

### 1924

	Page		Page
Editorial.....	By H. Gernsback 1723	Standard Hook-Ups .....	1751
Radio Broadcasting in Great Britain	By Dr. J. A. Fleming 1724	With the Amateurs.....	1753
Daylight Broadcasting.....	By Ray A. Sweet 1727	Calls Heard.....	1755
How Radio Relay Linked Six Stations.....	1728	Straightening Out the Radiation Tangle	By Ralph Batcher 1756
The History of Radio.....	1730	The Transmitter at F8EK.....	1757
Will the Future Broadcast Station Be Buried?	By S. R. Winters 1733	List of British Amateur Stations.....	1757
New Army Control Station at Fort Leavenworth	By Capt. R. B. Woolverton 1734	The Reinartz All Wave Tuner	By John L. Reinartz 1758
Hearings on the Radio Bill	By Carl H. Butman 1736	The Transmitter at KFGD	By John M. Baldwin 1759
Courtesy of the Air.....	By S. M. Kintner 1737	A Resonance Coupled Amplifier	By Clyde J. Fitch 1760
Too Much Waves.....	By Ellis Parker Butler 1738	Simple C. W. Sets for the Novice	By L. W. Hatry 1761
The Radio Quack.....	By Roscoe I. Smith 1739	C. W. and Radiophone Transmitters	By L. R. Felder 1762
Vacationing With Radio....	By Marius Logan 1740	The Standard Wavemeters of the Bureau of	Standards .....
The Radio Receiver in Camp	By W. Palmer Powers 1741	Awards of the \$50 Radio Wrinkle Contest....	1764
Are You a Radio Engineer?	By Howard S. Pyle 1742	Radio Humor.....	1766
Directed Radio Rays, Part 2	By Prof. René Mesny 1743	Radioties .....	1766
Detecting Music with a Nitrogen Tube	By C. B. Bazzoni 1744	Correspondence From Readers.....	1767
French Radio Novelties....	By Yves Dropper 1745	Radio News Laboratories.....	1768
The Antenna System.....	By A. P. Peck 1746	Radio Trade Notes.....	By L. N. Allen 1769
The Vacuum Tube and How It Works, Part 2	By Prof. John H. Morecroft 1748	New Radio Patents.....	1770
Hints on Receiving Sets.....	By Louis Frank 1750	I-Want-To-Know .....	1771
Index to Advertisers.....	1712		

Publishing Office, 52 39th Street, Brooklyn, N. Y. Advertising and Subscription Offices, 53 Park Place, New York City. Western Advertising Representatives, Fineman & McCutcheon, 720 Cass Street, Chicago, Ill. Kansas City Representative, Geo. F. Dillon, Republic Bldg., Kansas City, Mo. Pacific Coast Advertising Representatives, A. J. Norris Hill Co., Hearst Bldg., San Francisco, Cal.

RADIO NEWS is published on the 10th of each preceding month. There are 12 numbers per year. Subscription price is \$2.50 a year in U. S. and possessions. Canada and foreign countries, \$3.00 a year. U. S. coin as well as U. S. Stamps accepted (no foreign coins or stamps). Single copies, 25 cents each. A sample copy will be sent gratis on request. Checks and money orders should be drawn to order of EXPERIMENTER PUBLISHING CO., INC.

All communications and contributions to this journal should be addressed to Editor, RADIO NEWS, 52 39th Street, Brooklyn, New York, and 53 Park Place, New York, N. Y. Unaccepted contributions cannot be returned unless full postage has been included. All accepted contributions are paid for on publication. A special rate is paid for novel experiments; good photographs accompanying them are highly desirable.

RADIO NEWS. Monthly. Entered as second-class matter at the Post Office, at Brooklyn, N. Y., under the act of March 3, 1879; formerly entered at Jamaica, N. Y. Title registered U. S. Patent Office. Copyright, 1923, by E. P. Co., Inc., New York. The Experimenter Publishing Co., 52 39th Street, Brooklyn, New York, and 53 Park Place, New York. The Contents of this magazine are copyrighted and must not be reproduced without giving full credit to the publication. Copyright in Germany. Publication and reproduction of articles in Germany is reserved for Radio, Berlin 42, Germany.

RADIO NEWS is for sale at all newsstands in the United States and Canada, also at The International News Co., Ltd., Bream's Building, London E. C. 4, England, and at Brentano's, 37 Avenue de l'Opera, Paris.

HOW TO SUBSCRIBE FOR RADIO NEWS. Send your name, address and remittance to Experimenter Publishing Co., 52 39th Street, Brooklyn, New York, and 53 Park Place, New York. Mention the name of the magazine you are ordering. We also publish SCIENCE AND INVENTION, PRACTICAL ELECTRICS and MOTOR CAMPER & TOURIST. Write early.

RATES AND TERMS. The subscription rate for RADIO NEWS is \$2.50 per year. (12 numbers). When remitting do so by check, money order, or registered letter if cash is enclosed. Avoid sending cash through the mail if possible. Subscriptions for less than one year are not accepted. Subscription may be made in combination with SCIENCE AND INVENTION or PRACTICAL ELECTRICS.

POSTAGE. We prepay postage in all parts of the United States, Mexico and island possessions. For foreign or Canadian subscriptions we require 50 cents in addition to the subscription price for additional postage charges.

CHANGE OF ADDRESS. Notify us as far in advance as possible. It requires several weeks to make an address change on our records. Always write clearly.

ON EXPIRATION of your subscription we enclose a renewal blank in our last number to you; we stop our delivery to you on expiration.





# The GREBE TANGENT WHEEL VERNIER

*A Device found only  
on GREBE Receivers*



*"The accomplishment of  
great things consists in do-  
ing small things well."  
—Confucius*

*Perfection of detail is a  
big factor in the success of  
the Grebe Receivers.*

*Doctor Mu*

Grebe Regenerative  
Receivers are licensed  
under Armstrong U. S.  
Pat. No. 1,113,149

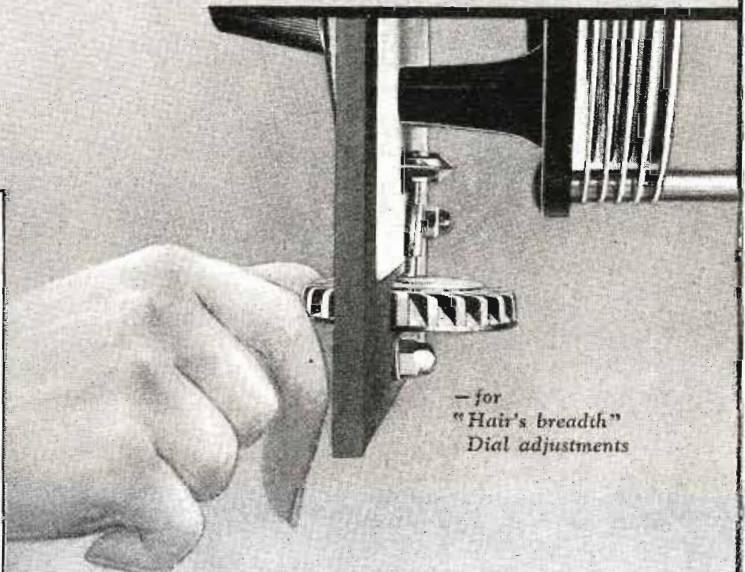

*— for  
"Hair's breadth"  
Dial adjustments*

**T**HE man who has once operated a Grebe Receiver reaches instinctively for the Tangent Wheel Verniers on every other receiver he thereafter tunes.

This and other details of Grebe craftsmanship are fully covered by patents granted and pending. Inspect these details at your dealer's today.

**A. H. GREBE & CO., Inc.**  
Van Wyck Blvd. Richmond Hill, N. Y.  
Western Branch: 451 East 3rd Street, Los Angeles, Cal.



# Index to Advertisers

Name	Page	Name	Page	Name	Page
<b>A</b>					
Ackerman Bros. Co., Inc.	1792	Dubilier Condenser & Radio Corp.	1858	Kimley Electric Co.	1846
Acme Apparatus Co.	1722	Duck Co., The, Wm. B.	1829	Klaus Radio & Electric Co.	1774
Acorn Radio Mfg. Co.	1844	Durkec-Thomas Products Co.	1853	<b>L</b>	
Adams-Morgan Co.	1836	<b>E</b>			
Adams Radio Mfg. Co., The	1825	E. I. Co.	1864	Lacey & Lacey	1780
Albright & Co., J. E.	1790	Eagle Radio Co.	1788	Lambert, Leon	1858
Alden Mfg. Co.	1830	Eastern Radio Mfg. Co.	1842	Lancaster & Allwine	1776
Allen, Inc., L. B.	1868	Eisemann Magneto Corp.	1843	Lee Electric Mfg. Co.	1863
Allen-Bradley Co.	1844	Electrad, Inc.	1796	LeFax, Inc.	1800
American Art Mache Co.	1776	Electrical Research Laboratories	1795	Leich Electric Co.	1867
American Hard Rubber Co.	1834	Electric Service Supplies Co.	1842	Liberty Mail Order House	1867
American Radio Mfg. Co.	1838	Electric Specialty Co.	1810	Liggett & Myers Tobacco Co.	1863
American Specialty Co., The	1828	Electrotype Blocking Co.	1846	Lincoln Mfg. Co., The	1806
American Standard Electric Co.	1796	Elgin Radio Supply Co.	1840	<b>M</b>	
American Transformer Co.	1792	Erie Fixture Supply Co.	1854	Magnavox Co., The	1773
American Writing Machine Co.	1857	Evans & Co., Victor J.	1850	Manhattan Radio Co.	1856
Amplex Instrument Lab.	1832	<b>Information Service</b>			
Anderson Co., R. G.	1825	1716-1717-1791			
Andrea, Inc., F. A. D.	1813	<b>F</b>			
Atlantic & Pacific Radio Co.	1776-1782-1794	Fahnestock Electric Co.	1828	Marle Engineering Co.	1780
Atwater Kent Mfg. Co.	1817	Fansteele Products Co., Inc.	1851	Martin-Copeland Co.	1779
Automatic Electrical Devices Co., The	1836	Federal Telephone & Telegraph Co.	1827	Marvel Radio Specialty Co.	1847
<b>B</b>					
Bakelite Corporation	1839	Ferbend Electric Co.	1794	Mason Fenwick & Lawrence	1850
Barkwik Co., The	1718-1719	Ford Mica Co.	1820	May Rubber Co.	1818
Barklew Electric Mfg. Co.	1798	Formica Insulation Co., The	1783	Mead Cycle Co.	1836
Bel-Canto Mfg. Co.	1800	Fox Mfg. Co.	1852	Michigan Radio Corporation	1859
Bell Mfg. Co.	1796	French Battery & Carbon Co.	1834	Midwest Radio Co.	1832
Benco Mfg. Co.	1854	Freshman Co., Inc., Chas.	1786-1816-1842-1865	Mitchell & Co., R.	1867
Benson Engineering Co.	1848	Friedlander-Kopple Radio Service	1857	Modern Electric Mfg. Co., The	1824
Beta Battery Co., Inc.	1826	Frost, Inc., Herbert H.	1790	Montrose Mfg. Co.	1782
Blue Seal Mfg. Co.	1828	<b>G</b>			
Bogue, B. N.	1834	General Radio Winding Co.	1806	Morrison Laboratories, Inc.	1776
Boice, W. & J.	1808	General Research Laboratories	1841	Mozart-Grand Co.	1849
Boonton Rubber Mfg. Co.	1847	Giiflan Bros., Inc.	1840	Multiple Electric Products Co.	1821
Box 233	1836	Golden-Leutz Corporation	1797	Mu-Rad Laboratories, Inc.	1830
Brach Mfg. Co., L. S.	1824	Goldschmidt Corporation Th.	1721	Murdock Co., Wm. J.	1781
Brady Co., A. C.	1838	Gould Storage Battery Co.	1790	Music Master Corporation	1775
Brandes, Inc., C.	1720	Graham Co., Alfred	1838	Myers Co., Ltd., E. B.	1788
Branson, Inc., Chas. A.	1844	Grat Lakes Radio Co.	1830	<b>N</b>	
Breakers, The	1867	Grebe & Co., Inc., A. H.	1711	Nassau Radio Co., Inc.	1830
Bremer-Tully Mfg. Co.	1858	Grewol Mfg. Co.	1838	National Airphone Corp.	1789
Bristol Co., The	1822	Gunn Furniture Co., The	1816	National Carbon Co.	1799
Brown & Co., Thos.	1858	<b>H</b>			
Brownlie, Roland	1843	H. & H. Radio Co.	1849	National Radio Institute	1811-1842
Bunnell & Co., J. H.	1850	Haldorson Co.	1800	Nazeley Co., J.	1848
Burlington Watch Co.	1846	Hammer Radio Co., S.	1844	Newman-Stern Co., The	1826
<b>C</b>					
Cannon & Miller Sales Corp.	1838	Hammerlund Mfg. Co.	1786	N. Y. Institute of Photography	1854
Carter Radio Co.	1818	Handycap Mfg. Co.	1852	N. Y. Radio Co.	1830
Chalfonte-Haddon Hall	1782	Harvard Radio Laboratories	1845	Norden, Hauck & Co.	1846
Chemical Institute of New York, Inc.	1819	Hayden Radio & Research Co., A. C.	1856	<b>O</b>	
Chicago Salvage Stock Store	1831	Haynes-Griffin Radio Service, Inc.	1833	Omnigraph Mfg. Co., The	1865
Chicago Solder Co.	1828	Heath Radio & Electric Mfg. Co.	1839	O'Neil Mfg. Co.	1780
Clapp-Eastham Co.	1835	Herbert, Inc., Harold	1838	Owen, Richard B.	1850
Clearstone Radio Co., The	1798	Holtzer-Cabot Electric Co., The	1784	Ozarka, Inc.	1784
Connecticut Telephone & Electric Co.	1822	Home Supply Co.	1808	Ozment, C. J.	1828
Consolidated Instrument Co. of America, Inc.	1859	Hommel & Co., Ludwig	1802	<b>P</b>	
Conrad Co., Inc., The	1807-1809	Howard, Mr.	1792	Pacent Electric Co.	1852
Continental Fibre Co., The	1848	Hudson-Ross	1840	Pal Radio Corp.	1832
Continental Radio & Electric Corp.	1802	Hygrade Electrical Novelty Co.	1822	Parker, C. L.	1850
Cooper Corporation, The	1806	<b>I</b>			
Cosmopolitan Phusiformer Corp.	1855	International Correspondence Schools	1850	Pathe Phonograph & Radio Corporation	1845
Coto-Coil Co.	1852	<b>J</b>			
Coyne Electrical School	1834	Jewett Radio & Phonograph Co.	1782	Perfection Radio Corp.	1841
Cressman, Inc., Russell B.	1822	Johnson Smith & Co.	1794	Phenix Radio Co.	1837
Crosley Radio Corp., The	1793	Jones, Howard B.	1843	Phoenix Tube Co.	1778
Cross Gear & Engine Works	1816	<b>K</b>			
Cunningham, Inc., E. T.	1816	K Electric Co.	1840	Pioneer Radio Corporation	1857
Inside Front Cover					
<b>D</b>					
D. X. Radio Research Laboratories, The	1844	Kellogg Switchboard & Supply Co.	1787	Precision Coil Co., Inc.	1848
Daven Radio Co.	1836	Kennedy Co., The Colin B.	1790	Precision Electric Co.	1837
Dey's Radio Service	1852	Kilbourne & Clark Mfg. Co.	1834	Press Guild, Inc., The	1778
Diamond Electric Specialties Corp.	1867	<b>L</b>			
Dictograph Products Corp.	1709	Lacey & Lacey	1780	Primary Mfg. Co.	1820
Dieterich, Albert E.	1850	Lambert, Leon	1858	Progress Press	1836
Dixie Supply Co.	1831	Lancaster & Allwine	1776	Pyramid Products Co.	1818
Dodge Radio Shortkut	1788	Lee Electric Mfg. Co.	1863	<b>O</b>	
<b>E</b>					
1716-1717-1791					
<b>F</b>					
1816-1842-1865					
<b>G</b>					
1806-1841-1840-1797-1721-1790-1838-1711-1838-1816-1840-1822					
<b>H</b>					
1849-1800-1844-1786-1852-1845-1856-1833-1839-1838-1784-1808-1802-1792-1840-1822					
<b>I</b>					
1850					
<b>J</b>					
1782-1794-1843					
<b>K</b>					
1840-1787-1790-1834					
<b>L</b>					
1780-1858-1776-1863-1800-1867-1867-1863-1806					
<b>M</b>					
1773-1856-1780-1779-1847-1850-1818-1836-1859-1832-1867-1824-1782-1776-1849-1821-1830-1781-1775-1788					
<b>N</b>					
1830-1789-1799-1842-1848-1826-1854-1830-1846					
<b>O</b>					
1865-1780-1850-1784-1828					
<b>P</b>					
1852-1832-1850-1845-1841-1837-1778-1857-1848-1837-1778-1820-1836-1818					
<b>Q</b>					
1838-1816-1837-1856					
<b>R</b>					
1867-1829-1823-1714-1715-1820-1846-1858-1851-1822					
<b>S</b>					
1806-1833-1839-1826-1830-1840-1835-1854-1804-1836-1856-1838-1780-1810-1802-1854-1774-1852-1856-1788					
<b>T</b>					
1818-1780-1815-1854-1858-1804-1778-1827-1798-1830					
<b>U</b>					
1851-1846-1867-1861-1778-1812-1846					
<b>V</b>					
1852-1774-1840					
<b>W</b>					
1828-1842-1851-1798-1834-1894-1800-1777-1856-1774-1850-1825-1834					
<b>X Y Z</b>					
1856-1803					



# RADIO NEWS READERS' BUREAU

## Time and Postage Saver

**I**N every issue of RADIO NEWS you undoubtedly see numerous articles advertised about which you would like to have further information.

To sit down and write an individual letter to each of these respective concerns, regarding the article on which you desire information, would be quite a task.

As a special service to our readers, we will write the letters for you, thus saving your time and money.

Just write the names of the products about which you want information, and to avoid error the addresses of the manufacturers, on the coupon below and mail it to us.

If the advertiser requires any money or stamps to be sent to pay the mailing charges on his catalogue or descriptive literature, please be sure to enclose the correct amount with the coupon.

We will transmit to the various advertisers your request for information on their products.

This service will appear regularly every month on this same page in RADIO NEWS.

If there is any Manufacturer not advertising in this month's issue of RADIO NEWS from whom you would like to receive literature, write his name, address and the product in the special section of the coupon below.

TEAR ALONG THIS LINE

**READERS' SERVICE BUREAU,**  
Experimenter Publishing Co., Inc., 53 Park Place, New York, N. Y.

Please advise the firms listed below that I would like to receive detailed information on their product as advertised in the.....issue of RADIO NEWS.

NAME	ADDRESS	List here specific article on which you wish literature.	If Catalogue of complete line is wanted, check in this column
.....	.....	.....	.....
.....	.....	.....	.....
.....	.....	.....	.....
.....	.....	.....	.....
.....	.....	.....	.....
.....	.....	.....	.....
.....	.....	.....	.....
.....	.....	.....	.....
.....	.....	.....	.....
.....	.....	.....	.....

If you desire any special information from a manufacturer whose advertisement does not appear in this month's issue, use this space.

.....  
.....  
.....

Your own name here.....  
Address.....  
City.....State.....





Let It Tell Its Story Itself

No Batteries Required.

Operates on one or two stages of amplification

HEIGHT 24 INCH  
LARGE BELL

Nationally Advertised

**RICO**

The Mark of Guaranteed Products

Like the human voice comes the reproduction through the—

**GRAND OPERA LOUD SPEAKER**

Without doubt, the peer in its class, fully equal to many that are listed at a higher price. *No metal can touch the diaphragm*, a feature not found in any other unit but the RICO GRAND OPERA.

Fully adjustable by means of the new VOLUMETER. A simple slide to the right or left produces light, medium or loud volume.

Its purchase is a SOUND investment, worth its weight in gold, and at the exceptionally low price of \$15.00.

**\$15.00**

**No. 120**

Patented Dec. 25, 1923

Absolutely the last word in Loud Speakers and we guarantee every word we say. Sold on the usual RICO money-back plan.

The name RICO is your guarantee and protection. Do not accept substitutes. If your dealer cannot supply you we will serve you direct. You can have the best by actual test.

WE KEPT YOU WAITING until we could give you the best that can be produced. That is why we call it "The BIG Wonder at the Little Price."

Insist on This Speaker for

**STONE CLARITY VOLUME**

VOLUMETER

# RICO GRAND OPERA LOUD SPEAKER

SEND NO MONEY

Radio Industries Corp., R.N. 6  
131 Duane St., New York City.

Gentlemen—Please send me by Parcel Post 1 RICO GRAND OPERA LOUD SPEAKER No. 120, for which I will pay the postman the amount of \$15.00.

Name.....  
Street.....  
City..... State.....

**RADIO INDUSTRIES CORPORATION**  
131 DUANE STREET, NEW YORK

MR. RADIO FAN: If your dealer cannot supply you then order direct and use coupon on opposite side.

Cable Address: Ricotrade, New York

# The "RICO" Grand Opera Loud Speaker Unit

Patented Dec. 25, '23

You have read and heard no doubt that every loud-speaker is positively the best one ever manufactured. We could with very little effort make similar claims—on paper—and perhaps go the other "ad" writer one better. Modesty, however, forbids. For that reason, we make the following statement:

GET A "RICO" GRAND OPERA LOUD-SPEAKER UNIT FROM YOUR DEALER OR DIRECT FROM US. COMPARE IT WITH ANY LOUD-SPEAKER THAT YOU HAVE NOW OR THAT YOU HAVE EVER HEARD. MERELY CONSIDER THAT THE MONEY YOU HAVE PAID IS ON DEPOSIT WITH YOUR DEALER OR WITH US. IF AFTER 5 DAYS YOU FIND THAT THE "RICO" GRAND OPERA LOUD-SPEAKER UNIT DOES NOT GIVE YOU GREATER VOLUME, DOES NOT GIVE YOU GREATER CLARITY OF SOUND, DOES NOT GIVE YOU GREATER JOY, THAN ANY OTHER LOUD-SPEAKER UNIT, THEN OUR DEALERS OR OURSELVES WILL BE GLAD TO REFUND THE PURCHASE PRICE.

DESCRIPTION: This loud-speaker unit is ideal for phonographs. By means of this unit, you can turn your phonograph into a loud-speaker. Any good horn, however, can be attached to it. (Speaker does not work with crystal sets, only on vacuum tubes.)

**\$7.50**

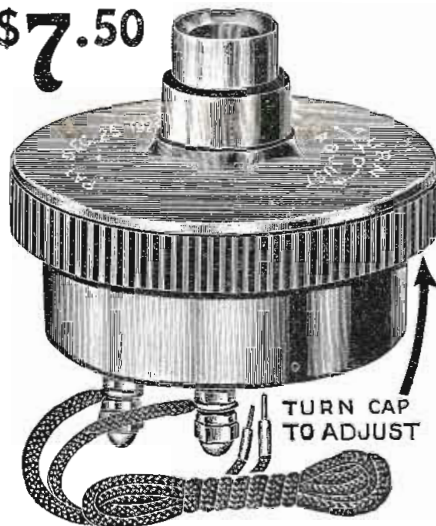

TURN CAP TO ADJUST

## No Metal Can Touch the Diaphragm

Patented Dec. 25, '23

This is a feature not found in any loud-speaker except in the "RICO" GRAND OPERA LOUD-SPEAKER UNIT. Diaphragm cannot rattle. Metallic, harsh sounds are entirely eliminated

AND  
The "RICO" GRAND OPERA LOUD-SPEAKER

UNIT IS FULLY ADJUSTABLE. For light or soft tones, simply turn the milled rim for best results. With this arrangement you can get either tremendous volume or soft tones as desired by you. Aluminum shell and cap highly nickel-plated and polished. Five-foot green cord furnished. No. 75 "RICO" GRAND OPERA LOUD-SPEAKER UNIT as described. Price \$7.50.

# THE "RICO" STRAIGHT LINE CONDENSER

This condenser marks a revolution in condenser building. It is the simplest and most practical type of condenser as yet developed for broadcast and amateur work. This condenser has been developed by our engineers after considerable research work and has been pronounced perfect by experts.

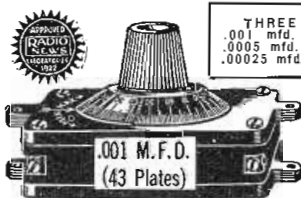

NEW TYPE

**This Replaces This**

BOTH INSTRUMENTS ARE DRAWN TO SCALE

The "Rico" condenser weighs 6 oz. The old style weighs 15 oz. "Rico" vernier type has only one dial. Old type requires difficult mechanism.

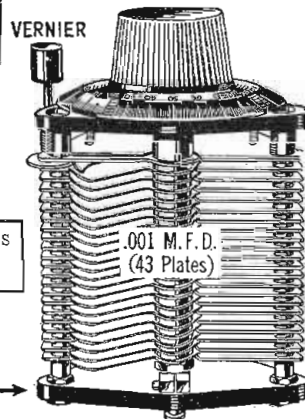

OLD TYPE

Now manufactured in three types, to replace 43 plates, 23 plates and 11 plates.  
No. 450 "Rico" Condenser .001 mfd. (43 plate capacity) \$1.75  
No. 423 "Rico" Condenser .0005 mfd. (23 plate capacity) \$1.75  
No. 411 "Rico" Condenser .00025 mfd. (11 plate capacity) \$1.75  
All above types without dial \$1.50

## Here are Some of the Outstanding Points:

- 1—Large capacity.
- 2—Replaces all standard condensers.
- 3—Uses a minimum of space size, 3 1/2" x 2 1/2" x 1 3/4".
- 4—For panel mounting or for table mounting—universal in its scope.
- 5—One complete revolution of dial adjusts condenser from minimum to maximum.
- 6—Vernier effect.
- 7—Absolute straight line curve.
- 8—Accumulates no dust between plates as is the case with air condensers.
- 9—Light weight. Condenser only weighs 3 oz.
- 10—Less than 1-10th amount of parts as used in old style mesh plate condenser.
- 11—Can never get out of order.
- 12—Impossible to short circuit.
- 13—Works in any position, vertical or horizontal. No counterweights needed.
- 14—Lowest in price for high class condenser.
- 15—Compactness. Size only 3 1/2" x 2 1/2" x 1 3/4" ever all.

The "Rico" Straight Line Condenser must be seen to be appreciated. Made of the best materials that money can buy. Stands in a class by itself. All metal parts finished in nickel plate.

We will refund your money if this condenser is not all we claim for it.

Dealers and Jobbers  
Write or Wire for  
Territory that is Still  
Open for Proposition

**RADIO INDUSTRIES CORPORATION**  
131 Duane St. New York

Cable Address: Ricotrade, New York

SEND NO MONEY. R.N.-6  
Radio Industries Corp.,  
131 Duane St., New York City.  
Gentlemen:—Please send me by Parcel Post....  
for which I will pay the postman the amount of  
Name .....  
Street .....  
City ..... State .....

RICO RICO RICO RICO RICO RICO RICO RICO RICO RICO



# SUPER-HETERODYNE AMPLIFYING TRANSFORMERS

DESIGNED TO GIVE:—

1.8 times the voltage amplification per stage over  
any other type.

3 meter selectivity at 300 meters.

Maximum possible regenerative amplification.

Practically no audio amplification.

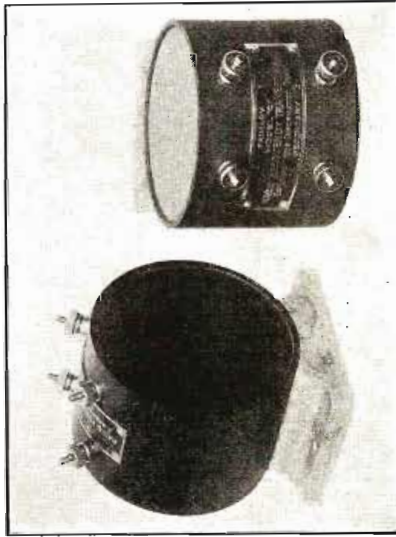

Model C Transformer

Price

Per Set of 3

Matched Transformers

**\$25.50**

*Postpaid*

## E-I-S. INC.

476 BROADWAY

NEW YORK CITY

NOTE:—The Experimenters Informative Service, Inc., no longer handles any parts business, all orders for standard or special parts should be forwarded to E-I-S, Inc., 476 Broadway, New York City

# TUNED RADIO FREQUENCY AMPLIFIER

AN ADDITION FOR YOUR PRESENT SET

## TWICE THE DISTANCE TWICE THE VOLUME

USE  
RADIOTRONS  
UV201A  
or  
UV199

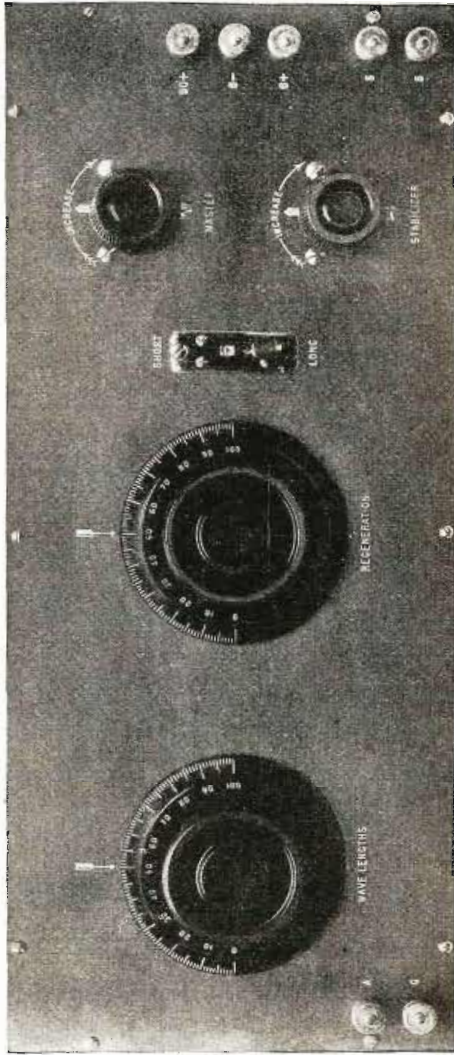

MODEL "J" TUNED RADIO FREQUENCY AMPLIFIER

Use with following  
Receivers  
SINGLE CIRCUIT  
TWO CIRCUIT  
THREE CIRCUIT  
or with  
MODEL "C"  
SUPER-HETERODYNE

This new unit consists of two stages of tuned radio frequency amplification, and can be attached to any standard receiver, allowing at least twice the receiving range and double the volume from stations now within range. Practically uniform efficiency is obtained on all wave lengths from 160 to 625 meters. Amplification factor 14 per stage

Complete Constructional Blue Prints 2 Sheets 52"x26" \$2.00 Postpaid.

### EXPERIMENTERS INFORMATION SERVICE, Inc.

*Designers of the Highest Class Radio Apparatus in the World*

476 Broadway

New York City



# BUILD YOUR SET BETTER-AT LOWER COST

**SUPERIOR 180° VARIOCOUPLER**  
 X521 Each...\$1.10  
 X522 Variometer—same style. Each \$1.10

A wonderful value. Produces excellent results. Green silk windings on black fibre tubes. Rigid mounting support for table or panel mounting. Primary tapped for fine tuning. 1/4 inch shaft. Range 200 to 600 M.

**SUPERIOR VARIOCOUPLER**  
 X523 Each...\$3.35

A handsome instrument of superior design and construction. Stator tube and rotor ball of moulded red brown bakelite. Large size green silk windings insure highest efficiency. Table or panel mounting. 1/4 inch shaft. Superior results in circuits for 180 to 650 meters. Tapped primary for finest tuning. Noiseless contacts. X526 Special single circuit type...\$3.75

**SUPER MOULDED VARIOMETER**  
 X412 Each...\$2.48

Polished black moulded rotor and stator forms. Maximum inductance with greatest efficiency and minimum distributed capacity. A high grade instrument that will get the best results.

Wave length 180 to 600 meters.

**EXCEL MOULDED VARIOMETER**  
 X524 Each...\$3.95

A wonderful value at our price. Proprietary designed and constructed. Polished black bakelite rotor and stator forms. Large size green silk wire insures greatest efficiency. 1/4 inch shaft. Noiseless digital connection. Table or panel mounting. Split stator winding with binding post connections.

**SUPERIOR VARIOMETER**  
 X525 Each...\$3.68

Forms moulded of red brown bakelite. A neat handsome instrument. Green silk windings calculated for highest efficiency. 1/4 inch shaft. Noiseless digital connections. Table or panel mounting. Produces superior results in any type circuit 180 to 650 meters.

**SPIDER WEB COIL FOR REINARTZ CIRCUIT**  
 X296 Each...\$1.30

Lists for \$1.75. A very unusual bargain. Made of green silk covered wire, spider web wound to produce greatest efficiency and lowest losses. 21 taps so arranged that crossing is avoided. Two fibre strips and wooden rod furnished permit various styles of mounting. With this coil a high grade set can be built at a low cost. Directions included.

**ULTRA AUDION COIL**  
 X297 Each...85c

Spider web wound of green silk covered wire. Four taps. Produces wonderful results. Fibre strips and wooden rod for mounting and directions included.

**COOKADAY COILS**  
 X298 Per Set...\$1.95

Complete set coils for Cookaday circuit. Properly calculated and made to give best results on this new wonder circuit.

**NEUTRODYNE TRANSFORMERS**  
 X571 Each \$1.75. Per set of three, \$4.95

An air core transformer for use in neutrodyne method of reception. Can also be used for tuned radio frequency or as a fixed coupler with condenser secondary. Proper design for results and efficiency. Green silk windings on bakelite tubes with adjustable mounting brackets to fit most any condenser.

**NEUTRALIZING CONDENSERS**  
 X572 Per set of two...40c

Simple, inexpensive, effective precision type. Micrometer adjustment is attainable.

**STANDARD NEUTRODYNE PARTS**  
 X851 Licensed Neutrodyne (combined transformer and condenser). Each...\$4.78  
 X852 Licensed Neutrodyne Kit. \$14.95  
 Includes 3 WorkRite Neutroformers, 2 WorkRite Neutrodons, panel layout, paper template and book of instructions.

**X853 Licensed Neutrodon. Each...43c**  
 A very accurate and easily adjusted condenser for neutralizing tubes.

**SPIDER WEB COILS**  
 X290—25 turn 30c X292—50 turn 47c  
 X291—35 turn 42c X293—75 turn 54c  
 X294—100 turn. Each...68c

A new popular type of inductance of highest efficiency. Lowest distributed capacity and lowest high frequency resistance. Firm green silk windings with fibre mounting strips.

**YOU SAVE MONEY WHEN YOU BUY FROM US**  
 We Pay Transportation Charges in U.S. East of the Rockies  
 THE PRICES QUOTED DELIVER THE GOODS TO YOUR DOOR  
 FAST SERVICE—TRY US AND BE CONVINCED  
 THIS GUARANTEE PROTECTS YOU—Examine the goods we ship you. They must suit you in every respect. If you are not satisfied with your purchase return the goods at once and we will refund the price you paid.

**OUR SPECIAL VARIOMETER AND VARIOCOUPLER**

Build into your set reliable instruments. You can depend on this variometer and variocoupler to give you the best results in any circuit working from 180 to 650 meters. In design and construction they are the best. Only the highest grade materials are used. The prices quoted save you 30 to 40 per cent.

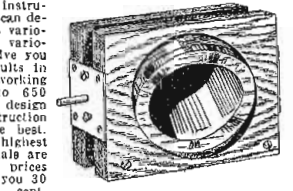

**X418 Variocoupler. Each...\$2.45**  
 The most efficient type of coupler, insures better tuning and louder signals. Primary and secondary wound on natural uncolored genuine bakelite tubes. Primary tapped for fine tuning. Can be panel or table mounted. 3-1/2 inch shaft.

**X410 Variometer. Each...\$2.10**  
 Perfect in design and construction. Accurate wood forms thoroughly seasoned. Inductor independent ratios. Solid baked windings. Plenty of large sized wire insures highest efficiency. A strong high grade instrument that will give you lasting service, 8/16 inch shaft.

**SOLID BARE COPPER WIRE**  
 Solid bare copper wire for aerials, leads or wiring instruments.

Solid Bare Copper Wire, size 14.  
 X240 100 ft. coil...48c  
 X242 500 ft. coil...\$2.25

**TINNED COPPER "BUS BAR" WIRE**  
 Size 14 tinned copper wire. For wiring sets. Best size for neat job and easy soldering.

X957 Square. Ten feet for...12c  
 X958 Round. Ten feet for...14c

**SPAGHETTI**  
 For covering connecting wires in sets. For size 12 and 14 wires.  
 X955 Finest quality braided and saturated with best baked lustrous transparent insulating varnish, 3 feet for...19c  
 X956 Best quality braid and covered with black insulating compound, 3 feet for...3c

**STRANDED ANTENNA WIRE**  
 Cabled of fine copper strands. Very flexible. High tensile strength. Best for aerials.  
 X248 100' coil 58c X249 500' coil \$2.75

**PORCELAIN BASE SWITCHES**  
 Fine white porcelain bases. Copper contacts and blades. Can be used as antenna switches.

X385 Single Pole Single Throw. Ea. 20c  
 X383 Single Pole Double Throw. Ea. 32c  
 X384 Double Pole Double Throw. Ea. 50c

**MAGNET WIRE**  
 Insulated copper wire. Best quality even drawn wire, one piece to a spool. Prices quoted are for 8 oz. spools unless otherwise stated. Note, our prices are prepaid.

Double Cotton Covered	Enameted Insulation	Single Green Silk-Covered
Number X990	Number X992	Number X991
Gauge Price	Gauge Price	Gauge Price
18 ..... 39c 20 ..... 35c 20 ..... 50.75	20 ..... 48c 22 ..... 45c 22 ..... 80	24 ..... 1.05
22 ..... 60c 24 ..... 50c 24 ..... 1.05	26 ..... 65c 26 ..... 55c 26 ..... 1.15	
26 ..... 80c 30 ..... 60c 30 (4 oz.) .90	28 ..... 95c 32 ..... 65c 32 (4 oz.) 1.00	
30 ..... \$1.15 36 ..... 85c 36 (4 oz.) 1.30		

**ANTENNA INSULATORS**  
 X260 Size 1x3 1/4. Composition, metal eyelets. Two for...17c  
 X263 Ribbed Porcelain Ins. 17c  
 X260 Size 2x1/2 in. long. Ea. 55c  
 Dozen...\$6.50  
 X265 Ribbed porcelain insulator—1/2 inches long. Each...15c

**RADIO SOLDER SET**  
 X538 Complete...\$3.00  
 Handy for soldering radio connections or for general small repair jobs. Consists of soldering copper with handle, sal ammoniac, soldering salts, solder and sand paper.

**RADIO SOLDERING IRON**  
 X540 \$1.35  
 Soldered connections in radio sets produce better results. This guaranteed iron is exactly right for radio work. A neat solid connection quickly and easily made. Operates on any heating current 100 to 120 volts. 6 ft. cord with attaching plug. Length 13 inches. Heats quickly, will not overheat.

**LEAD-IN INSULATORS**  
 X270 For 4 inch walls or less...42c  
 X271 For 2 inch walls or less...69c  
 The only practical lead-in insulator for aerial wires. Small, neat, effective, durable. Fits 1/8 inch nuts. Securely locked by two adjustable nuts.

Heavier irons for general repair work. Wonderful values at our prices.  
 X541 Medium size...\$3.48  
 X542 Large size...4.25

**OUTDOOR LIGHTNING ARRESTER**  
 X980 Price...\$1.24  
 Protect your instruments with this lightning arrester. Weatherproof bakelite case. Air gap type. Permanent. Durable. Underwriters approved.

**MIGNON VERNIER VARIABLE CONDENSERS**  
 X827 .0003 M.F. Each...\$2.30  
 X828 .0005 M.F. Each...2.70  
 X829 .001 M.F. Each...2.95  
 Highest grade instruments. Accurate rating. Extremely low dielectric losses. Independent friction control insures perfect positive adjustment. 1/4 inch shaft. No dial included.

**JEWEL LIGHTNING ARRESTER**  
 X981 Each...95c  
 A dependable protector, always on guard. Small and compact. Weatherproof porcelain case. Easily fastened and connected. Underwriters approved. Lists for \$1.10.

**PANEL MOUNTING VARIABLE CONDENSERS**  
 These are especially high grade condensers and we guarantee them to be mechanically and electrically perfect. Fine polished end plates of heavy bakelite. Shafts 1/4 inch diameter. Sturdy, heavy aluminum alloy plates perfectly spaced to insure smooth, even, reliable capacity. Our low prices save you money. These condensers are of the very best make and are not to be compared with many inferior, cheap condensers offered. We guarantee them to please you or your money back. The vernier style has one separately controlled plate which permits of the finest tuning. Quality considered, these values are unapproached by others.

**REGULAR STYLE**  
 X815—3 plate...58c  
 X816—5 plate...58c  
 X817—1 plate .00025 mfd...\$1.48  
 X813—21 plate .0005 mfd...1.27  
 X812—43 plate .001 mfd...1.47

**VERNIER STYLE**  
 Including Dial and Knobs  
 X825—14 plate .0025 mfd...\$2.45  
 X824—26 plate .0005 mfd...2.70  
 X826—46 plate .001 mfd...2.95

**ANTENNA LEAD-IN**  
 X259 Each...25c  
 Solves a hard problem. With it you can bring the antenna wire without drilling a hole for an insulator. Place on window sill and window can be closed down tight and locked as before. Takes but a minute to install. Perfectly insulated. Can be bent into any shape. Made of copper strip properly insulated. Neat and durable.

**FAHNESTOCK CONNECTORS**  
 X366 Single. Dozen...25c  
 X367 Double. Dozen...39c  
 Handy and convenient for connecting wires or making connections on binding posts or other parts of instruments. Wires held firmly in spring grip but may be instantly removed.  
 X368 Antenna Connector. Each...8c  
 Requires no soldering. Makes connection in a few seconds.

**LIGHT SOCKET ANTENNA**  
 X251 Each...97c  
 Fits into any light socket. Replaces the regular outdoor antenna. Very satisfactory for nearby stations and under favorable conditions will bring in distant stations. Easy to install. No danger. Gives clear reception with little static interference. Ideal for people in apartment buildings.

**TINOL**  
 X969 Per tube 19c  
 A combined solder and flux in handy form. Put a little on the connection, heat with a match, torch or solder iron and you have a neat electrical and mechanically perfect joint.

**AUTOMATIC BLOW TORCH**  
 X543 Each...\$1.19  
 Burns denatured alcohol. Automatically generates pointed flame in a few seconds. Easy to solder joints in hard places. Lights with a match. Burns 20 minutes on one filling. 5 1/2 inches high, 7/8 inch diameter cylinder. Works fine with Tinol listed above.

**OTHER STANDARD BRANDS AUDIO FREQUENCY TRANSFORMERS**  
 Fresh Clean Stock in Original Containers  
 X232 THORADSON Ratio 3 1/4 to 1 \$3.30  
 X233 THORADSON Ratio 6 to 1 3.70  
 X553 Acme. Each...4.20  
 X554 Cmo. Each...4.45  
 X555 Federal No. 228 Each...4.45  
 X712 Radio Corp. Each...5.70  
 X234 All American 10 to 1 Shielded 3.80  
 X236 All American 5 to 1 Shielded 3.80  
 X231 All American Push Pull...5.10

**TRICOIL RADIO FREQUENCY AMPLIFYING TRANSFORMER**  
 X560 For 201A or 301A Tubes...\$1.58  
 X561 For 199 or 11 or 1.58  
 This transformer will produce wonderful results in any type of regular or reflex radio frequency circuit. Perfect for one, two or three stages. Compact, convenient form, easily mounted. Range 175 to 600 meters.

**OTHER STANDARD BRANDS RADIO FREQUENCY TRANSFORMERS**  
 X568 Our special—as good as any of them  
 X562 Dubilier. Each...\$ .48  
 X563 Acme. First stage. Each...3.48  
 X565 Acme. First stage. Each...4.45  
 X566 Acme. Second stage. Each...4.45  
 X567 Acme. Third stage. Each...4.45  
 X714 Radio Corp. Each...1.05  
 X995 All American. Each...3.95  
 X975 Erla. First stage. Each...3.45  
 X576 Erla. Second stage. Each...3.45  
 X577 Erla. Third stage. Each...4.45  
 X578 Erla. Reflex No. 1 or 2. Ea. 4.35



# WITH BARAWIK QUALITY RADIO GOODS

## VACUUM TUBES

Standard Brands—Cunningham, Radiotron. Every one guaranteed new and perfect. We will ship brand in stock unless you specify otherwise.

X105 Detector UV200 C300 Each . . . . . \$4.45  
 X112 Amplifier, UV201A C310A Each . . . . . 4.45  
 X118 5-Watt Transmitter 7.70  
 X107 WD11 C11. Each 4.45  
 X101 WD12 C12. Each 4.45  
 X102 UV199 C299. Each . . . . . 4.45  
 X104 UV199 Adapter fits 199 tube to standard socket . . . . . .35  
 X108 WD11 Socket. Each . . . . .30  
 X109 WD11 Adapter. Each . . . . .42

## BAKELITE TUBE SOCKET

X140 Standard base. 39c  
 X141 UV199 base. . . . .39c  
 Moulded of genuine red brown bakelite. Blending post connections. For table or panel mounting. Neat and strong.



## 199 SOCKET

X145 Each . . . . .59c  
 Moulded of high insulating material. Spoons rubber base prevents ringing in tube. Plainly marked binding post connections. Neat and compact.

## STANDARD TUBE SOCKET

X150 Each . . . . .76c  
 Bakelite base. Polished nickel-plated tube. Highest quality socket on the market. Best insulation. Positive contact. No terminal terminals. For base or panel mounting.



## FILAMENT CONTROL RHEOSTATS

X132 6 ohm. Each. . . . .38c  
 X129 20 ohm. Each. . . . .40c  
 X130 30 ohm. Each. . . . .44c  
 X135 6 ohm. Vernier. 90c  
 Best grade. Will give real service. Durable and lasting. High heat resisting base. Diam. 2 1/2 in. Tapered polished black 1 1/2 in. Potentiometers. Match above rheostats. Same high grade construction.  
 X151 200 ohm. . . . .50c  
 X152 400 ohm. . . . .50c

## OTHER STANDARD BRAND RHEOSTATS and POTENTIOMETERS

X207 Filostat. Each . . . . .1.30  
 X208 Bradleystat. Each . . . . .1.74  
 X209 Bradleystat 200 ohm. Each 1.89  
 X210 Bradleystat 400 ohm. Each 2.89  
 X211 Howard 6 ohm Ver. Rheo. Ea. 1.25  
 X212 Howard 6 ohm Ver. Rheo. Ea. 1.25  
 X213 Howard 25 ohm Plain Rheo. Ea. .85  
 X214 Howard 25 ohm Ver. Rheo. Ea. 1.25  
 X215 Howard 40 ohm Plain Rheo. Ea. .85  
 X216 Howard 40 ohm Ver. Rheo. Ea. 1.25  
 X217 Howard 200 ohm Potentiometer. Each . . . . .1.25  
 X218 Howard 400 ohm Potentiometer. Each . . . . .1.89  
 X219 Klosser 6 ohm Vernier. Each 1.19  
 X221 Klosser 30 ohm Vernier. Each 1.45  
 X222 Amperite with mounting. . . . .95c

## SUPERIOR RHEOSTATS

X153 6 ohm. Each. . . . .89c  
 X154 20 ohm. Each. . . . .70c  
 X155 30 ohm. Each. . . . .83c  
 The finest rheostat. Smooth, even action. Best design, best workmanship. Supplied with attractive dial and knob.  
 Potentiometers to match above rheostats with dial and knob.  
 X156 300 ohm. . . . .98c

## UNIVERSAL CONTROL DIAL

X918 For 3/16 inch shaft. . . . . \$1.15  
 X919 For 1/4 inch shaft. . . . . 1.15  
 Replaces ordinary knob or dial. Gives perfect vernier control on scale, variometer, variocoupler, tickler, etc. Positive easy action. Looks fine. Easily installed. Especially desirable in tuning neodyne sets.

## COMPOSITION DIALS

X921 Diam. 2 in. for 3/16 in. shaft. Ea. 16c  
 X922 Diam. 2 in. for 1/4 in. shaft. Ea. 16c  
 X923 Diam. 3 in. for 3/16 in. shaft. Ea. 22c  
 X924 Diam. 3 in. for 1/4 in. shaft. Ea. 22c  
 X925 Diam. 3 1/2 in. for 3/16 in. shaft. Ea. 27c  
 Handsome dials moulded in one piece of polished black composition. 2 inch size has 270° scale marked 0 to 100 finely engraved in contrasting white enamel. 3 and 3 1/2 inch size have 150° scale marked 0 to 100.

## BAKELITE DIALS

X931—2 in. Diam. for 3/16 in. shaft. Each. . . . .35c  
 X932—2 in. Diam. for 1/4 in. shaft. Each. . . . .35c  
 X933—3 in. Diam. for 3/16 in. shaft. Each. . . . .39c  
 X934—3 in. Diam. for 1/4 in. shaft. Each. . . . .39c  
 X935—4 in. Diam. for 3/16 in. shaft. Ea. 48c  
 Moulded in one piece of genuine bakelite in polished black finish. Finely engraved in contrasting white enamel. Sure grip knob that fits the fingers. Higher grade dials for good sets. Match perfectly.

## VERNIER DIAL ADJUSTER

X941 Each . . . . .19c  
 Easily installed at edge of dial, gives finest vernier adjustment of condenser or inductance. A great value. Polished black knob.

## WE PAY TRANSPORTATION CHARGES IN U. S. East of the Rockies PRESERVE THESE PAGES—ORDER FROM THEM AND SAVE MONEY FAST SERVICE—TRY US AND BE CONVINCED

THE PRICES QUOTED DELIVER THE GOODS TO YOUR DOOR HANDS ONLY the best goods, carefully tested and checked by expert radio engineers. You are assured of getting guaranteed apparatus that will give superior results. And while our goods are best, our prices are lowest. Our goods equal or surpass the claims we make for them. We do not attempt to deceive or mislead. Our reputation for fair dealing is our most valued asset.

HOW TO ORDER—Write your Order plainly, state Article Number, Description and Price. Items wanted. Send Postoffice Express Receipt, Certified Check or Bank Draft for Total of Order. Prompt Shipment is assured when these directions are followed.

## CABINETS

Fine looking cabinets solidly built. Elegant hand rubbed dark mahogany finish. You will be proud of your set mounted in one of these cabinets. Hunged tops. Front rabbeted to take panels. Panels not included. Prices are transportation paid. Note that our prices are prepaid.

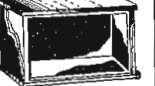

Panel Size	Inside Dimensions High   Wide   Deep	Art. No.	Price Each
6x7	5 1/2"   10"   7"	X420	\$1.95
6x10 1/2	5 1/2"   10 1/2"   7"	X421	2.45
7x11 1/2	6 1/2"   11 1/2"   7"	X422	2.60
7x11 1/2	6 1/2"   11 1/2"   7"	X423	3.05
7x11 1/2	6 1/2"   11 1/2"   7"	X424	3.20
7x11 1/2	6 1/2"   11 1/2"   7"	X425	3.85
7x21 1/2	6 1/2"   20 1/2"   7"	X426	3.85
7x21 1/2	6 1/2"   20 1/2"   7"	X427	4.35
7x26	6 1/2"   25 1/2"   7"	X428	5.50
9x14	8 1/2"   13 1/2"   10"	X431	3.55
12x14	11 1/2"   13 1/2"   10"	X430	4.00
12x21 1/2	11 1/2"   20 1/2"   10"	X432	5.05

## CRYSTAL DETECTORS

The latest development in Crystal Detectors. Give better results and more reliable than old style. Used in Reflex circuits.

X742 Crowl Detector. Each. . . . . \$1.48  
 X743 Metal Detector. Each. . . . . 1.39  
 X744 B Metal Crystal. Each. . . . . .45  
 X741 Gold Grain Detector. Each. . . . . .83  
 X745 Yellow Tip Detector. Each. . . . . 1.75  
 X746 Du-Tec Crystal. Each. . . . . .27

## SUPERIOR VARIABLE GRID RESISTANCE

X167 Each . . . . .80c  
 X168 With .00025 Condenser . . . . .98c  
 Eliminates variable star-line signals. Capacity smoothly varied from 0 to 6 megohms by half turn of knob. Easily mounted on any panel.

## RADIO "BAKELITE" PANELS

Notice our very low prices on this fine quality material. Others ask as much for hard rubber panels which are worth much less. We supply genuine Bakelite. Condensate tolerant or Formica, all of which are materials with practically identical mechanical, chemical and electrical properties. Machines well without chipping. Won't warp. Waterproof. Highest mechanical and dielectric strength. Attractive natural polished black finish which can be sanded and oiled. Note that our prices are prepaid.

Panel Size Inches	1/4" thick	3/16" thick	1/2" thick
	Art. No.	Art. No.	Art. No.
6x7	X450 \$1.55	X460 \$1.89	X470 \$1.15
6x10 1/2	X451 \$1.86	X461 \$1.10	X471 \$1.73
7x11 1/2	X458 \$1.88	X468 \$1.73	X472 \$1.66
7x18	X453 \$1.78	X463 \$2.27	X473 \$3.56
7x21	X457 \$2.05	X467 \$2.65	X477 \$5.10
7x24	X459 \$2.42	X469 \$2.97	
7x26		X462 \$2.95	
9x14	X454 \$1.85	X464 \$2.35	X474 \$3.56
12x14	X455 \$2.42	X465 \$2.97	X475 \$4.78
12x21 1/2	X456 \$3.62	X466 \$4.25	X476 \$7.13

## GRID LEAKS

X177 Freshman back of panel type. . . . .59c  
 X178 Freshman back of panel style with .00025 Condenser 79c  
 X179 Freshman base mounting type with .00025 Condenser. 79c  
 X172 Durium Variable Grid Leak with Mounting . . . . .89c  
 X173 C.R.L. Variable Grid Leak \$1.19  
 X175 C.R.L. Variable Grid Leak with grid condenser. . . . . \$1.48

DUBILIER MICAODN TYPE GO

X502 .0001	.28c	X507 .0025	.32c
X503 .00025	.28c	X508 .003	.40c
X504 .0005	.28c	X509 .004	.40c
X505 .001	.32c	X510 .005	.48c
X506 .002	.32c	X511 .006	.60c

## BARAWIK QUALITY HEADSETS

X770 Per Set. . . . . \$2.60  
 These headsets have proven rigid tests to be one of the very best on the market. The tone quality is excellent with an unusual volume. Skilled workmen make them from only the best selected materials. The receiver cases are fine polished finish with polished black ear pieces. Fabric covered headband constructed and quickly fitted to the head. Supplied with 5-foot cord. These sets were designed to sell for much higher prices than we ask, and at our price are a wonderful bargain. We guarantee that you will be pleased with them and agree that they are the best value by far yet offered. If they don't suit you we will cheerfully return your money.

X754 Baldwin Type C with universal jack plug \$10.45  
 X756 Western Elec. \$9.50  
 X757 Murdock 56, 2000 ohm. \$5.78  
 X758 Brandes, 2000 ohm. \$5.25  
 X759 Brandes, 3000 ohm. \$6.95

## SUPERIOR RADIO JACKS

Finest grade jacks. Improved design. Best materials. Phosphor bronze springs. Silver contact points. Nickel finish. Mount on panels 1/2 to 3/4 in.  
 X390 Open circuit. Each. . . . .36c  
 X391 Closed circuit. Each. . . . .45c  
 X392 Two circuit. Each. . . . .54c  
 X393 Single circuit filament control. . . . .52c  
 X394 Two circuit filament control. . . . .68c

## STANDARD JACKS AND PLUGS

X387 Open circuit jack. Each. . . . .27c  
 X388 Two circuit jack. Each. . . . .25c  
 X396 Plug takes two sets of phones. 35c  
 Well made, durable, smooth working, nickel finished frame. Well insulated.

## SUPERIOR RADIO PLUGS

X395 With Set Screws for fastening cord. Each. . . . .35c  
 X397 Two-way—takes two pair any style cords. Lists for \$1.00. Each. . . . .59c  
 Highest grade plugs. Fit any standard jacks. Polished round barrels.

## SWITCH CONTACT POINTS

Brass polished nickel finish. All have 3/4 in. long size 6-32 screws and two nuts. All prices the same.  
 Dozen 15c Hundred \$1.00  
 Order by Article Number.  
 X360 Head. 1/4" diam.; 1/2" high  
 X362 Head. 3/16" diam.; 1/2" high  
 X363 Head. 3/16" diam.; 1-1/8" high  
 Solder Lugs to Fit Contact Points  
 Also for connecting wires to binding posts, etc.  
 X365 Dozen 8c Hundred 30c

## SWITCH LEVER STOP

Brass polished nickel finish.  
 X386 Dozen 18c Hundred \$1.05

## SWITCH LEVERS

Very neat polished black composition knob. Exposed metal parts polished nickel finish. Fitted with panel bushing and two set nuts. A high grade switch.  
 X381 1 1/2" Radius. Each 14c

## INDUCTANCE SWITCH

X288 Price including knob and dial. \$1.18  
 Mounts switch points and contact lever behind panel. Only one hole needed to mount 15 switch points, any number of which may be used.

## BINDING POSTS

Brass, polished nickel finish. Washer and 6-32 in. screw extending 1/2 in.  
 X370 Large size—barrel and knob 1/2" long. Dozen . . . . .70c  
 X372 2-4 X32 Smaller size X376-8  
 X374 Large size with composition knob. Dozen . . . . .45c  
 X375 Large size with hole for phone tip or wire. Dozen. . . . .80c  
 X378 Small size with hole for phone tip or wire. Dozen. . . . .35c

## SUPERIOR INDUCTANCE SWITCH

X288 Each . . . . .85c  
 Quick and securely mounted by drilling one hole. Only knob and pointer show in front of panel. Connections can be soldered before fastening switch, making assembly much easier.

## STANDARD BRAND HEADSETS

X764 Frost, 2000 ohm \$3.30  
 X765 Frost, 3000 ohm \$3.95  
 X759 Federal \$5.50  
 X751 Murdock 56, 2000 ohm. \$5.25  
 X752 Murdock 56, 3000 ohm. \$3.90

## PLATE CIRCUIT "B" BATTERIES

You can make real savings on these batteries. We guarantee them to equal any on the market regardless of price. Extra long life. Don't throw away your money on cheaper inferior useless batteries.

X180 Signal Copps type, small size. 15 cells, 2 1/2 volts. Each. . . . . \$1.10  
 X182 Large size, 5 taps, 16 1/4, 18, 19 1/2, 21 and 22 volts. Each. . . . . \$1.45  
 X184 Variable Large Navy size, 6 1/2 x 4 1/2 inches, 5 taps, giving range from 16 1/2 to 22 1/2 volts in 1 1/2 volt steps. Each \$1.70  
 X188 Combination Tapped 45 volts, 30 cell, 13x4x3 battery. Tapped to give 45, 39 1/2, 21, 19 1/2, 18 and 16 1/2 volts. Handled both detector and amplifier tubes. Ea. \$3.28

## "B" BATTERY METER

X189 Each . . . . .98c  
 Reads 0 to 50 volts. Accurately tells you the exact condition of your "B" battery. Convenient watch size. Polished nickel case with wire lead.

## STORAGE "A" BATTERY

A high grade battery. Guaranteed for three years. Made of best new materials. Full capacity. The best battery buy on the market. Try one of these batteries on your set for 10 days. If at the end of that time you are not fully satisfied with the battery return it and we will refund the purchase price.  
 X194 6 volt, 60 amp. size. Each \$9.90  
 X196 6 volt, 100 amp. size. Each \$13.25

## HOMECHARGER

Charge your battery at home overnight for a few cents. Simply connect to any 110 volt 60 cycle light socket. Turn on current and rectifier does the rest automatically. Will work for years without attention. Simple connections. Give a tapering charge which batteries love. You can make it pay a profit charging your friends' batteries. Long connecting cords with pair of battery clips.

## BATTERY CHARGING RECTIFIER

X201 For 6 volt battery. . . . .95c  
 X203 For 12 volt battery. . . . .12.95

## HYGROMETER

X190 Each . . . . .48c  
 Accurately tells you the condition of your storage battery. Helps you keep your battery in best condition.

## BATTERY CLIPS

X198 Two for . . . . .28c  
 Clip onto storage battery terminals, lead cord. Make positive non-corrosive contact at all times.

## WIRE CONNECTING CLIPS

X199 Per dozen . . . . .30c  
 Small connecting clips for quickly fastening leads on to binding posts, etc. Handy and useful. Every radioist should have at least a dozen.

## RUBBER COMPOUND PANELS

Made of a special compound having a rubber base. Equal in appearance and in all essential points to any other class of panels. Fine smooth polished finish. Can be drilled or cut without chipping. Guaranteed not to warp and to be a perfect insulator for radio use. Smooth clean edges. Thickness 3/16 inch. Size given is in inches.  
 X481 7x12. . . . . \$ .80  
 X482 7x12. . . . . \$ .90  
 X483 7x14. . . . . \$ 1.08  
 X484 7x18. . . . . \$ 1.38  
 X485 7x21. . . . . \$ 1.93  
 X486 7x29. . . . . \$ 1.95

## STANDARD BRAND LOUD SPEAKERS AND UNITS

XG10 Murdock Loudspeaker . . . . . \$2.75  
 XG13 Barwik with Baldwin unit. . . . . 9.75  
 XG15 1" tube Loudspeaker . . . . . 15.95  
 XG16 Atlas Loudspeaker . . . . . 22.50  
 XG12 Magnavox R3 Loudspeaker. . . . . 29.50  
 XG14 Magnavox M1 Loudspeaker. . . . . 29.50  
 XG17 Music Master Loudspeaker. . . . . 27.00  
 XG15 Genuine Baldwin type C unit \$1.00  
 XG19 Murdock Special Unit. . . . . 2.00  
 XG18 Brandes Table Talker. . . . . 9.25  
 XG20 Baldwin Loud Speaker. . . . . 22.50  
 XG28 Atlas Unit. Each. . . . . 10.75  
 XG07 Western Electric Unit. Each. 10.75

## RADIO SWITCH

X287 Each . . . . .28c  
 Cuts current on and off instantly by a push or pull. Very neat. Well made. Durable. Saves tubes and batteries.

## BEZELS

X399 Diameter 1/2 inch. Each. . . . .15c  
 X400 Diameter 1 1/2 inch. Each. . . . .35c  
 Polished nickel finish. Finest quality. Fit any thickness panel. Greatly improve appearance of any set.



# Radio Reception

## —more perfect this summer!

*Tremendous improvements in sending and receiving  
combine with better programs to provide  
the best of radio fun!*

This is indeed a radio summer! The vital interest of the presidential campaign—waged right in your own home. The glorious and inspiring church services. The important sporting events, market reports, home hints, intensely interesting talks, gay music—all these diversions are brought directly to you.

### *Why Sending Is Better*

Last summer many high power broadcasting stations operated on a single wave length. This summer they are spread over a wave band. You may choose at your will. Sending stations have greatly increased their power and are spreading their programs over many more miles. Broadcasting from interconnected stations includes many people who would formerly have been deprived of the unlimited pleasures of radio.

*For sixteen years the Brandes name has consistently stood for service —for skill—and dependability.*



*Table-Talker . . . \$10.00  
50¢ additional west of the Rockies  
In Canada . . . 14.00*



*Navy Type Headset . . . \$ 8.00  
In Canada . . . 11.00*



*Superior Headset . . . \$6.00  
In Canada . . . 7.00*

### *Why Reception Is Clearer*

Sets have been vastly improved. They are more keenly selective, more sensitive, more satisfactory generally. Vacuum tubes have been re-designed, new circuits have been developed. New loudspeakers, assuring accurate and true reproduction, have been put on the market. In fact, the combination of finer programs, stronger sending and clearer reception now makes the marvels of radio an active part of every day life.

*All Brandes Products are sold under a money-back guarantee by reliable dealers everywhere.*

# Brandes

*The name to know in Radio*

# clearer Tone!

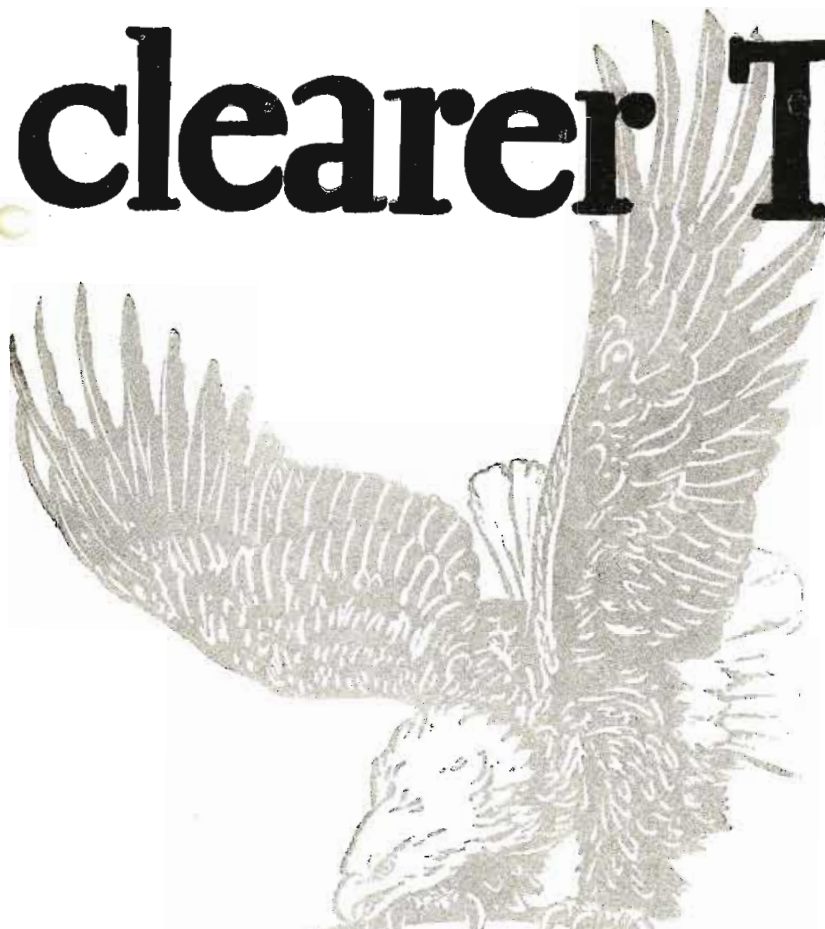

## PHONES

DEALERS:



N & K Phones are being backed by a wide advertising campaign that is already bringing a big increase in sales. Get in on these profits! N & K comes packed in cartons of ten with advertising display cards for window and counter and leaflets. If your jobber cannot supply you, write us today.



N & K Phones are designed for just one purpose — the *natural reproduction* of musical tones. They are sold under a guarantee to reproduce both high and low tones more clearly, with greater naturalness and mellowness. They will not increase the loudness of weak signals—because *all* the tones, high and low, have to be kept in *natural proportion*, to secure such mellowness as N & K gives. Volume is the job of your *receiving set*.

Fans and mere beginners alike are enthusiastic over N & K's wonderful clearness. Out of several hundred amateur stations that tested N & K Phones last year, fully 90 per cent pronounced them the best they had ever used.

"Entirely free from mechanical sounds" says station 1PX. . . . "Exclude noise of visitors moving around operating room" says station G. R. R. . . . "Tone soft and clear as a bell" says 1FI; and so on. We will gladly send you our new folder reproducing other comments from fans and telling the real *reasons why* N & K Phones reproduce more clearly than other phones. *Write now.*

TH. GOLDSCHMIDT CORP.  
Dept. R6, 15 William St., New York, N. Y.

*N & K Head Set, Model D, 4000 ohms, is a remarkable example of skillful workmanship. Made of nicked brass with hard rubber ear cups, accurately machine threaded to insure proper seating of diaphragm. A special device insures uniform spacing between diaphragm and magnet poles. Magnets of finest German steel, wound by entirely new method. Sanitary headband, covered with genuine leather. Six foot cord. Price, \$8.50.*



# —To the man who buys his radio “ready made”

## These set makers use ACME Transformers

THE BRISTOL CO.                      WM. J. MURDOCK CO.                      POWR RADIO CO.  
 AMPLIFEX RADIO CORP.              PENN. WIRELESS MFG. CO.              SEARS MANUFACTURING CO.  
 SLEEPER RADIO CO.                      STANWOOD ELECTRIC SPECIALTY CO.

**W**HEN you buy a radio set, choose one which uses Acme Amplifying Transformers. Amplification is the key to radio. Amplification builds up the tiny sound waves that reach your set and makes them loud enough for you to hear. To hear radio “loud and clear,” be sure to have transformers that give maximum amplification without distorting the sound. Distortion makes squeals and howls out of broadcasting that should be clear and distinct.

*How to get amplification without distortion*

THE Acme Apparatus Company, specializing in the manufacture of

transformers, has perfected amplifying transformers which are famous among radio owners for giving the greatest amplification without distortion. Eight manufacturers of complete sets use Acme transformers for best results. Thousands of amateurs who have built their own, insist on Acme to be sure of getting the greatest possible range and getting it “loud and clear.”

*Send for booklet*

SEND for our booklet “Amplification without Distortion” which explains amplification and the importance of using the right amplifying apparatus.

ACME APPARATUS COMPANY, Dept. 28,

CAMBRIDGE, MASS., U. S. A.

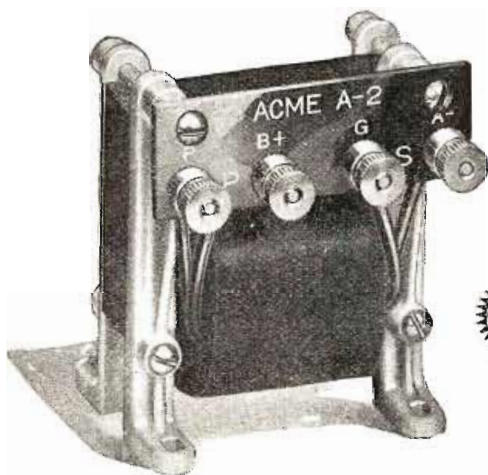

# ACME

## ~for amplification

ACME APPARATUS COMPANY  
 Dept. 28, Cambridge, Mass., U. S. A.  
 Gentlemen: I am enclosing 10 cents (U. S. stamps or coin) for a copy of your book, “Amplification without distortion.”

Name .....

Street .....

City ..... State .....



# RADIO NEWS

H. GERNSBACK—Editor and Publisher  
ROBERT E. LACAULT, Associate Editor

EDITORIAL AND GENERAL OFFICES, 53 PARK PLACE, NEW YORK

Vol. 5

JUNE, 1924

No. 12

## Money in Radio

By H. GERNSBACK

**D**URING 1923, according to the latest figures available, the radio business went above \$250,000,000 in total sales for the year. Very conservative estimates for 1924 seem to indicate that the total radio sales will probably be in the neighborhood of 400 million dollars. Tremendous as this amount is, it is small compared to what it will be five or ten years hence. Always remember that there are 110,000,000 persons in the United States and that we have only sold, so far, about two or three million sets, whereas there is a potential market for at least 25,000,000 sets. This does not mean that once we sell 25,000,000 sets the market will be saturated. Quite the contrary. Years ago when the automobile industry was in the same position radio is today, it was thought that the saturation point in automobiles would soon be reached. It was forgotten, however, that the average life of a car is only two years and that it means nothing by way of statistics for future sales if a man owns a car, because in two years or less he will own a new one.

The same holds true in radio. The average life of a radio outfit is barely one year, in other words, we have not yet even scratched the surface.

### RADIO IN COUNTRY STORES

**F**OR the past few years, ever since the inception of radio, sales always decreased during the summer for no reason at all. As a matter of fact, theoretically, trade activities should be more active in the summer than in the winter, and during the next two or three years that condition will be reached. The writer predicts that fortunes will be made this year in radio from altogether unsuspected sources. *A large percentage of sales will shift from the city to the country.* Nearly everybody who has a car this year and goes motor camping or touring will take along a radio set, and it will be the country store that will be benefitted to a very large degree. If country stores will install receivers and loud speakers, and put in a supply of radio essentials, such as dry cells, "B" batteries, aerial wires, tubes, grounding rods and other radio essentials, they will find a brisk trade on their hands.

This is an entirely new field for the trade and it is surprising that the radio manufacturers have not pushed this source heretofore. Every automobile accessory manufacturer knows that the country store and country garage as well as road service stations are a most productive source of sales in the summer. The radio trade has not as yet awakened to this possibility.

Road Houses, Inns, etc., should also take advantage of radio and install good outfits with loud speakers to attract customers. People are getting used to radio and are beginning to miss it when they do not hear the latest news that is being broadcast daily. It is a wise Inn-

keeper who appreciates this feeling. If city restaurants install radio loud speakers, is there any reason why those in the country cannot do likewise? This summer particularly, all baseball returns will be broadcast far and wide. A loud speaker in a store or Inn will surely attract people by the hundreds.

### HALF A MILLION FOR AN INVENTION

**A**N official of one of our big manufacturing corporations recently, in a conversation, mentioned to the writer that his Company would gladly pay a half million dollars for a real static eliminator. Just think of that, you experimenters: think what you could do with a half million dollars! One of these days someone is going to invent a static eliminator that will be sold for \$5 or \$10 and then summer radio will be on for good.

The problem should not be hard to solve. It seems to the writer that here is the most fruitful field for research work that you can tackle this summer, instead of putting your outfit away in the cellar during the hot spell. Work it for all it is worth and then try and think up ways and means of doing away with the bothersome static. The harder you work on this problem, the greater radio will be. The writer predicts that the man who invents such a device will go down in history as one of the outstanding radio inventors of the age.

Here are a few tips on static elimination: Dr. Harris Rogers, who has worked along these lines, has found that static can be reduced considerably by burying the aerial in the ground, in other words, an underground aerial. The same result can be obtained by submerging an aerial in water. Then, of course, we have the loop which reduces static quite a good deal, although not enough to make it really worth while. The experimenter will find a wide field in this direction by experimenting with special coupled and balanced circuits, resistance units and other similar means, all of which cut down the static. Then we have the much neglected condenser aerial. This also reduces the static quite a good deal. It may even be possible to construct a special sort of aerial that may be made static-proof.

Some years ago the writer experimented with such an aerial, which was nothing but a heavy rubber insulated wire, No. 14 B. & S. gauge; over the rubber there was wrapped tinfoil, or copper ribbon, covering the entire length of the wire. By grounding the outside metallic covering static was eliminated to some extent. The connections can be switched so that the outside metal covering may be used as the antenna, while the center wire is grounded. Additional experiments may be made by inserting a condenser in series with the grounded connection. Due to lack of time the experiments were never completed.

All of these are suggestions that are well worth while and may lead to bigger things.



# Radio Broadcasting in Great Britain

By Dr. J. A. Fleming, M.A., D. Sc., F.R.S.

PROFESSOR OF ELECTRICAL ENGINEERING, UNIVERSITY OF LONDON

*Dr. Fleming's description of radio broadcasting in Great Britain is indeed very interesting and will satisfy the curiosity of the American radio fan as to how they of England manage their system. The radio fan of Great Britain is enjoying the freedom of the air the same as we but under slightly different conditions.*

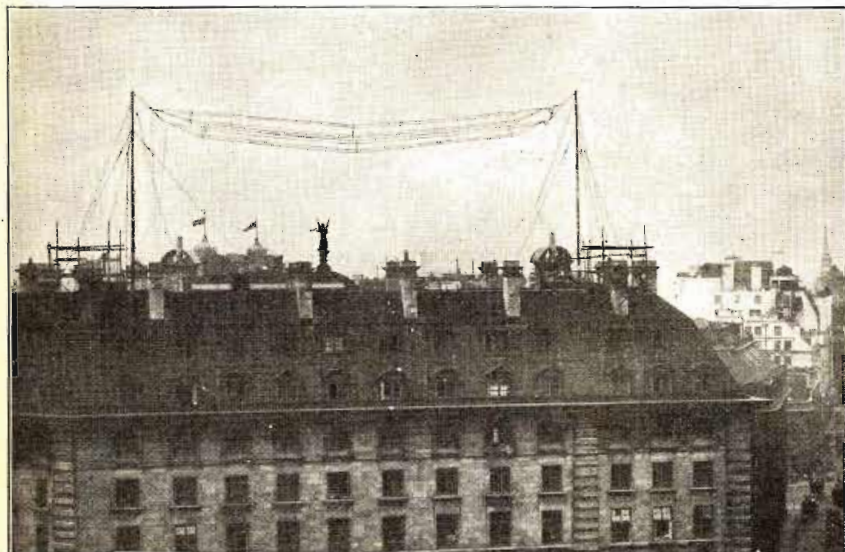

(Courtesy of Marconi's Wireless Telegraph Co., Ltd.)  
Fig. 2. The cage aerials on the roof of Marconi House, Strand, London, from which the London (2LO) broadcasting by radio telephone takes place.



(Courtesy of Marconi's Wireless Telegraph Co., Ltd.)

Fig. 6. The microphone and its stand in the broadcast studio of station 2LO, London. This is supported on a soft rubber cushion which absorbs all vibration.

**T**HE upgrowth of radio broadcasting in Great Britain is rather more recent than that in the United States, but owing to the care with which it has been controlled it is being conducted very efficiently and along right lines. As ordinary telegraphy and telephony are under the control of the State in Great Britain, so also are radio telegraphy and telephony. Nevertheless, to conduct radio broadcasting, a separate incorporated limited public company was formed, called the British Broadcasting Company (B.B.C.). The trouble at the outset was to regulate matters so that funds could be provided for the remuneration of musicians and entertainers, and for the erection and maintenance of the broadcast stations. This has been done by making it compulsory on every listener-in, or radio-operator to procure a license from the General Post Office costing \$3.75 and to use only special types of apparatus. According to statistics furnished by the Post-Master General, there were in force on January 31, 1924, 636,000 wireless receiving licenses in Great Britain. The majority of these are simply licensed to use receiving apparatus bought complete, and stamped B.B.C., but a large number of the licensees hold experimental licenses which permit them to build their own receiving sets with parts manufactured in Great Britain. A few possess transmitting licenses also.

The B. B. C. has established, up to the present, eight main broadcast stations the call letters and wave-length in meters of which are: London 2LO-365, Bournemouth 6BM-385, Birmingham 5IT-475, Glasgow 5SC-420, Manchester 2ZY-375, Cardiff 5WA-353, Newcastle 5NO-400 and Aberdeen 2BD-495. In these stations thermionic valve (vacuum tube) transmitters of 1,500 watts output are installed.

These transmitters are shown in Fig 1, and comprise four panels: The first contains the rectifying or Fleming valves; the second, the drive panel; the third, the main

oscillator valves; and the fourth, the modulating valve. The above named four panels are as shown from left to right in Fig. 1. These valves are made with all-glass bulbs and two-inset tubes of the type manufactured by The Marconi-Osram Valve Co. The anode cylinders are of molybdenum and the

filaments, drawn tungsten wire. The oscillator valves are nominally of six-kilowatt power. The anode voltage is 10,000, supplied from low frequency alternating current and rectified by the Fleming valves in the first panel. The filament power is 10 to 15 amperes supplied at 15 to 20 volts. The condensers, inductances and regulating resistances are included in the angle-iron frame work forming the panels. The oscillating

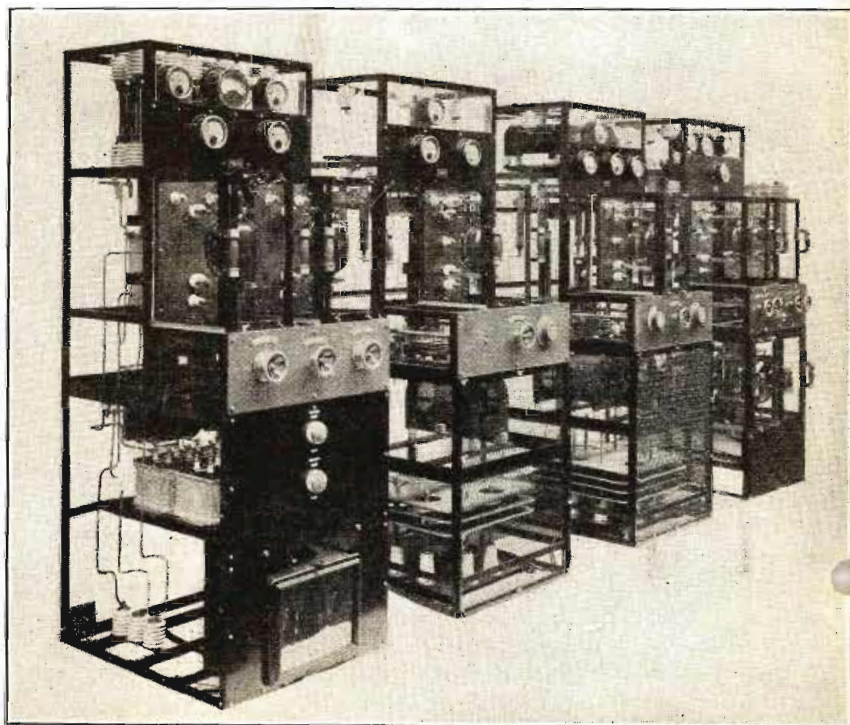

(Courtesy of Marconi's Wireless Telegraph Co., Ltd.)

Fig. 1. The vacuum tube transmitter employed in the British Broadcasting Company's Radio Stations. The four panels from left to right are respectively, the rectifier, amplifier, oscillator and modulator.



valves supply carrier-wave currents to the cage aerials on the roof of the transmitter station.

Fig. 2 shows the aerials on the roof of Marconi House, Strand, London.

**A TYPICAL PLANT**

Fig. 3 shows the valve transmitting plant of the Bournemouth station and is typical of the plant supplied to the other stations. Low frequency alternating current is supplied for rectification by the rectifier valves after being stepped up by static reformers. Direct current for filament heating is obtained from suitable generators.

Fig. 4 shows a view of these generators in the Bournemouth Station, England. The broadcast studio, where the actual speaking or musical performances take place, is not always in the same building, as the transmitter and aerial.

The London 2LO, the headquarters and chief offices of the B.B.C., are at 2 Savoy Hill, on the Thames Embankment, and are perhaps a quarter of a mile from Marconi House, Strand, where the transmitter is located. At the top of the main offices is a

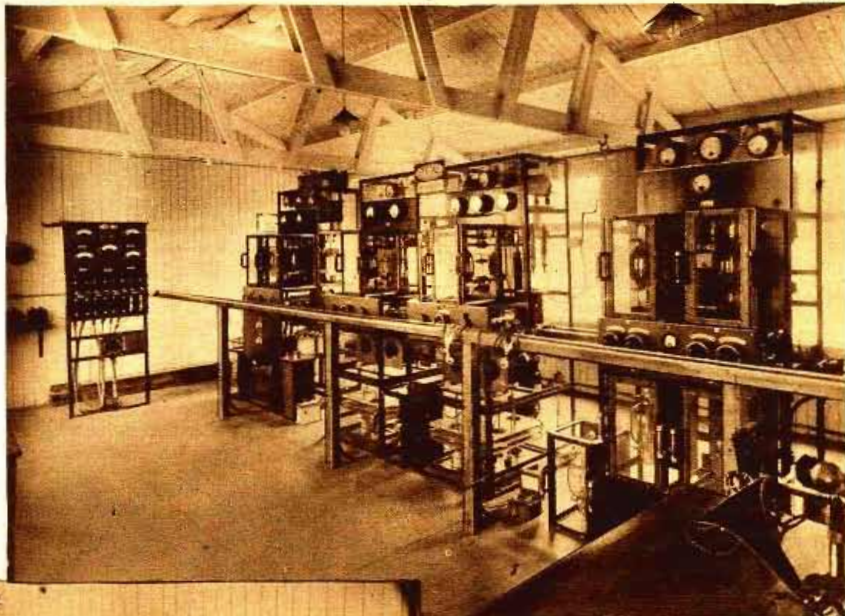

(Courtesy of Marconi's Wireless Telegraph Co., Ltd.)

Fig. 3. The vacuum tube transmitter in the Bournemouth station of the British Broadcasting Company, Ltd. This is the standard pattern for all other British broadcast stations.

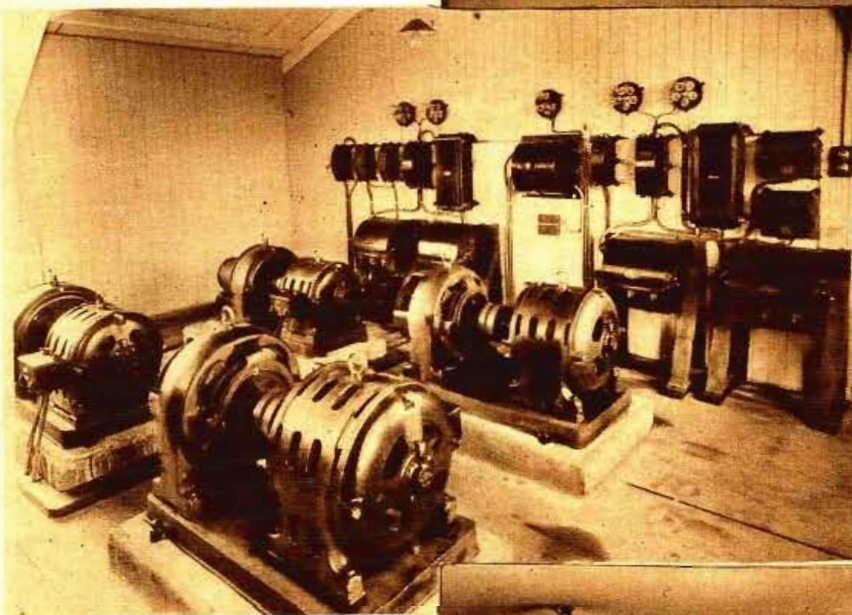

(Courtesy of Marconi's Wireless Telegraph Co., Ltd.)

Fig. 4. Motor generators and rotary converters in the Dynamic room of the Bournemouth station, England.

room for artists or performers, awaiting their turn to broadcast and adjoining this, is a sound-proof studio (see Fig. 5). Besides the grand piano, the chief article of furniture here and the most important is the microphone, which is placed on a wooden stand on rubber tired wheels so as to be easily moved about. The actual microphone (see Fig. 6) is suspended in an anti-vibration cradle. Various types of microphone of the carbon granule type and also of the magneto of Bell telephone type have been in use. The one favored at present is the magnetophone in which a strong radial magnetic field is created between two electromagnets with similar poles facing each other. In this field moves a flat coil of wire on an aperiodic diaphragm, which is set in vibration by the sound waves.

The currents from the microphone are amplified by a series of amplifying valves (see Fig. 7) and conveyed to the grid of the modulator valve in the transmitter and thence impressed on the carrier wave.

In those cases in which a speech or lecture is broadcast or opera or play from a distance, suitable microphones are placed in front of the speakers or on the theatre stage

or lecture table at that place and the speech currents from these, after being amplified by valves, are transmitted by underground or overhead Post Office telephone lines to the headquarters of the B. B. C. at Savoy Hill, and thence to the London transmitter. In order that simultaneous broadcasting of important speeches or performances may be carried out all over Great Britain, all eight stations are connected by telephone lines with the B. B. C. headquarters where they terminate on a switchboard with a suitable amplifier, (see Fig. 8). In this way all the stations can be connected to the London microphone so that the program can be broadcast simultaneously from each of the stations on its own wave-length. The interconnecting switchboard is so arranged

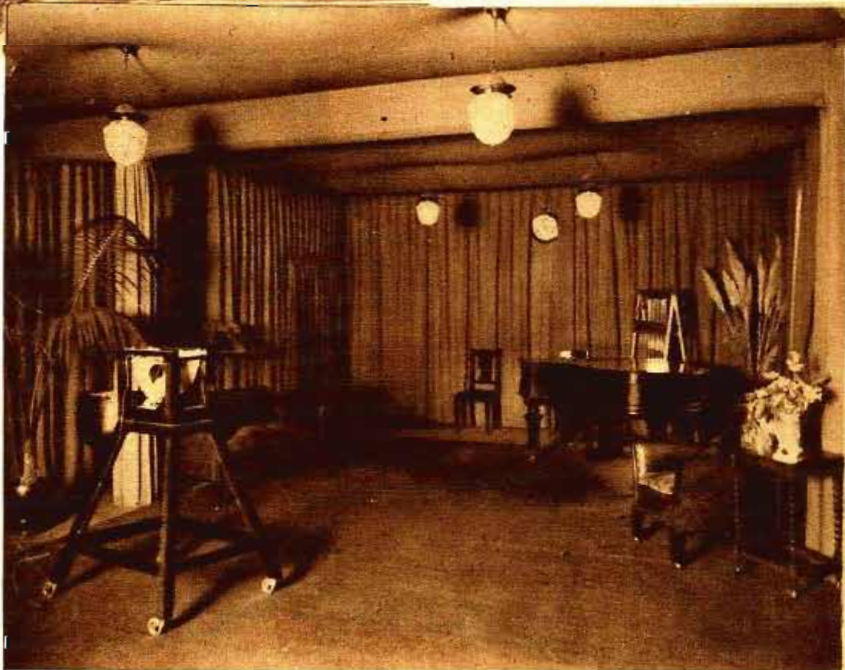

(Courtesy of Marconi's Wireless Telegraph Co., Ltd.)

Fig. 5. The studio of broadcast station 2LO at Savoy Hill, London. Note the microphone in the foreground.



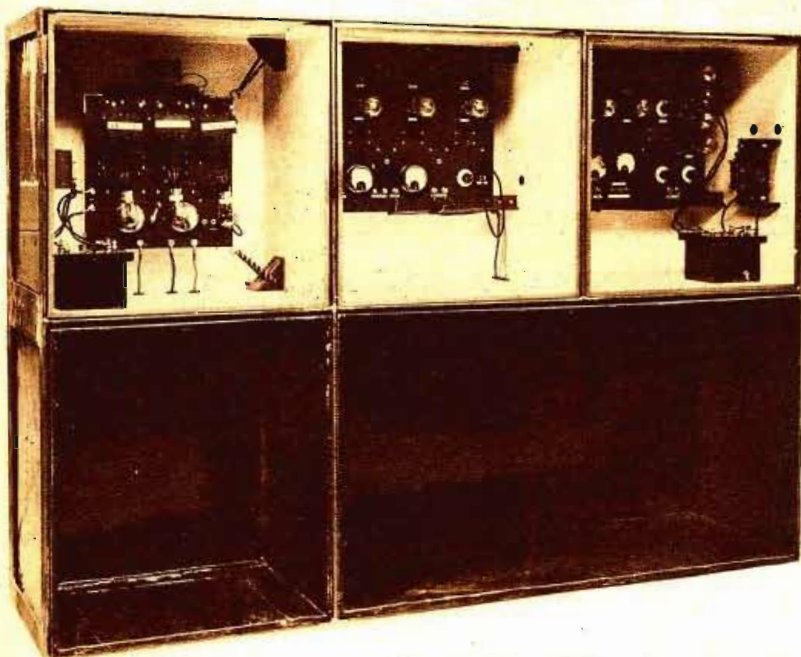

(Courtesy of Marconi's Wireless Telegraph Co., Ltd.)  
Fig. 7. The vacuum tube voice amplifier as used in the broadcast stations of the British Broadcasting Company, Ltd.

that the program may originate at any one of the stations.

Thus, if a speech or song is being given at Aberdeen, Scotland, and it is desired to broadcast it also from Glasgow, Scotland, at the same time, the current from the microphone amplified at Aberdeen (or part of it) is transmitted over the Post Office trunk telephone line to London to B. B. C. headquarters. The current employed on this trunk transmission is five milliamperes at five volts. It is then transmitted back to Glasgow and, after amplification, operates the Glasgow modulators.

#### RE-BROADCASTING EXPERIMENTS

In some cases special programs are transmitted from the course by radio-waves and not along telephone wire. Thus there is in London a famous old theatre called the "Vic" (short for Victoria) and it has been the scene lately of much Shakespearean play revival. An opera performed there was recently distributed. A small radio plant of about 100-watt power was installed at the theatre and collecting microphones were placed on the stage; the small transmitting plant radiated on a short wave-length the music and songs. These radiations were picked up at Marconi House on a frame aerial and re-broadcast on the wave-length of 2LO. The performance was heard perfectly and with a pleasing absence of the distortion and inductive noises which sometimes mar reception when the speech currents have to travel over Post Office telephone lines.

For the broadcasting of the concerts at Pittsburgh radio station, Pennsylvania, U. S. A. (KDKA), the B.B.C. erected an aerial on Biggin Hill, Kent, England and picked up there the Pittsburgh waves of 100 meter wave-length. The currents were then strengthened by a six-valve amplifier and transmitter to the London station by special telephone wire, and thence also to the other British stations. The listening-in in Great Britain began at 11 p. m. on Saturday, February 23, but was much marred by strong atmospherics. Nevertheless, the writer distinctly heard some of the songs. The experiment was repeated on Saturday, March 1, at 11 p. m., and was more successful. Having regard to the period of the year and the five hours difference in longitude, the broadcast would probably

have been better received if it had been given a couple of hours later.

There is no doubt that under favorable atmospheric conditions the American broadcast will be well heard in England.

#### RELAY STATIONS

In order to meet the case of those listeners who can only afford a crystal detector or single valve, the B.B.C. has arranged to establish a number of relay stations in Great Britain. These are to be small transmitting stations radiating 100 watts in place of the 1,500 watts of the main stations. These stations will be connected by telephone wire with the studio of the nearest large station. These relay stations will cover a radius for simple crystal detectors up to about five miles. This will encourage

the use of inexpensive receivers and home-made apparatus.

One of these relay stations has already been established at Sheffield and is fed from the Birmingham main station. Another is under construction at Plymouth and others are to be opened at Edinburgh, Liverpool, Hull and Leeds. The wave-lengths of these relay stations will be between 300 and 350 meters.

It is expected that these stations will be of extreme importance in connection with the proposed wide use of radio broadcasting in the public elementary schools.

The educational authorities in Great Britain are fully alive to the great value of radio telephony by means of which a single eminent teacher can give a lecture or lesson to hundreds of thousands of children simultaneously. The Glasgow School-Board was one of the first to make such radio teaching a feature in the public schools. Other cities will no doubt follow. By means of a good loud speaking telephone, a class of 30 children can take up a lesson on any subject which admits of being taught without appeal to the eye, such as literature, history or economic science. It is certain that in broadcasting by radio telephony we have a most powerful engine for popular and attractive education.

There are two important improvements which loom large in the immediate future in connection with British broadcasting. These are the establishment of a high power broadcasting station and the employment of the "Radio Beam" in connection with long distance re-transmission.

The B.B.C. is said to be contemplating the erection of a station outside of London of 25-kilowatt radiating power. (16 to 17 times that of the present stations). The radiation would be on a carrier wave-length of 1,600 meters so that it could not interfere with the present band of broadcast waves of 300 to 500 meters.

#### REFLECTED WAVES

The idea of this station is to enable it to reach districts which are badly served by the present stations for small receivers. With this new station crystal receivers could be used up to 100 miles and single valve receivers up to 200 miles and this would bring in a large number of new listeners.  
(Continued on page 1828)

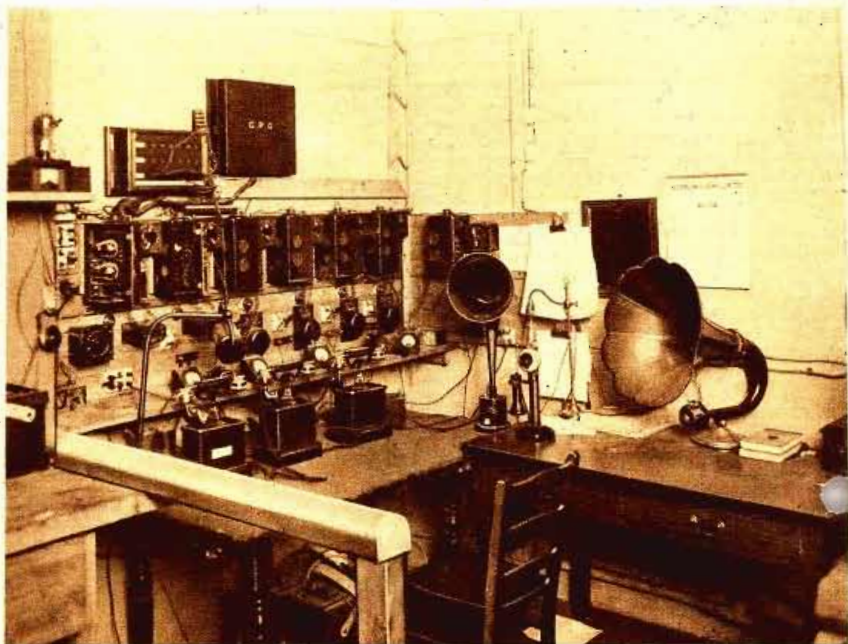

(Courtesy of Marconi's Wireless Telegraph Co., Ltd.)  
Fig. 8. The interconnecting switchboard at the headquarters of the British Broadcasting Company by means of which all the British broadcast stations can be connected for simultaneous broadcasting.



# Daylight Broadcasting

By RAY A. SWEET\*

In view of the increased interest in daylight broadcasting, a series of tests have just been concluded by station WLAG at Minneapolis and St. Paul. In the following article Mr. Sweet sums up the result of the tests and tells of the problems, advantages and disadvantages of broadcasting in daylight and at night.

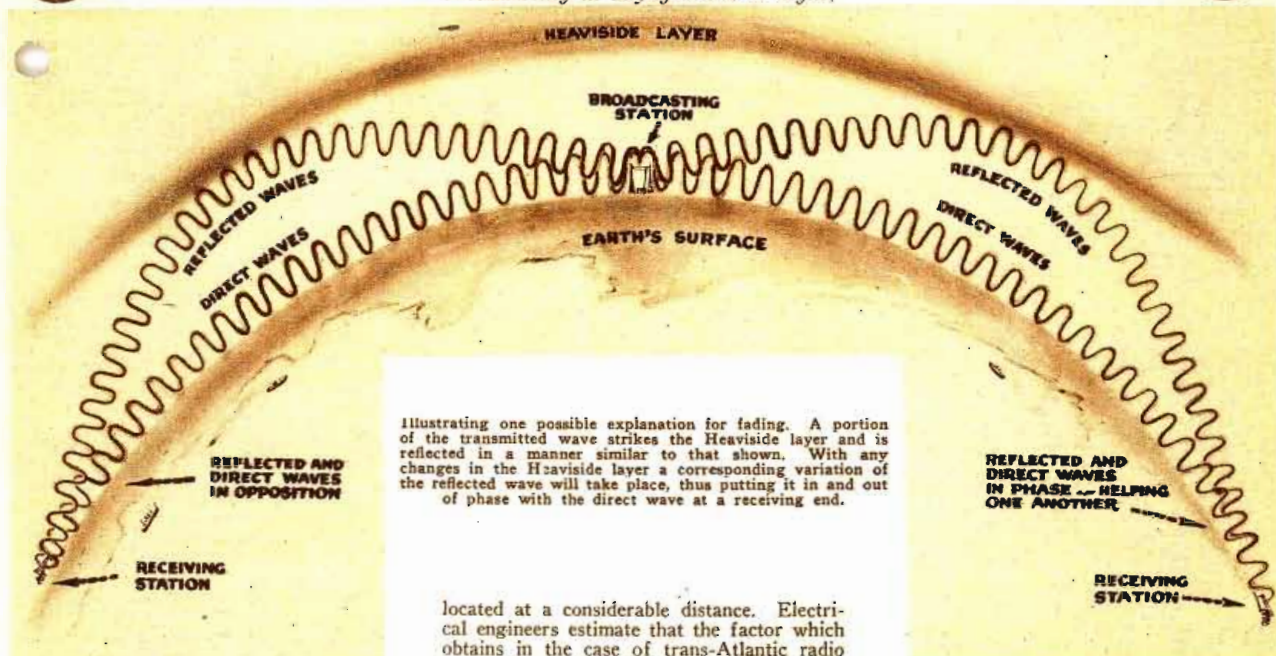

Illustrating one possible explanation for fading. A portion of the transmitted wave strikes the Heaviside layer and is reflected in a manner similar to that shown. With any changes in the Heaviside layer a corresponding variation of the reflected wave will take place, thus putting it in and out of phase with the direct wave at a receiving end.

located at a considerable distance. Electrical engineers estimate that the factor which obtains in the case of trans-Atlantic radio telegraphy, is 5,000 to one.

Many theories have been advanced to explain this phenomenon. By far the most satisfactory hypothesis attributes the result to ionization of the air. Radio waves are propagated by means of stresses, electromagnetic, and electrostatic, which exist in space above the earth. These stresses are influenced by a number of factors, such as the power of the broadcast station, the distance of the point of reception from the transmitter, the height of the point from the ground, and by the conductivity of the air. This latter factor, it is thought, is the seat of the difficulty in daylight broadcasting. It is believed that the ultra-violet rays of light emitted by the sun, when they strike the atmosphere, cause the molecules of the air to ionize and become conductive. In this way, the stresses above mentioned, are allowed to "leak" off to the ground and become diminished. This phenomenon of diminution takes place not only at the receiving installation, but also in the vicinity of the broadcast station, and during the entire course of propagation of the radio waves. In other words, a wave of great amplitude at the broadcast station is wasted and diminished during its entire course, and when it arrives at the receiving installation, it is no longer sufficiently powerful to actuate a radio receiver.

This theory is generally accepted as the most plausible of all by radio engineers. It is, however, by no means fully established. For example, it is not known quantitatively how the above mentioned stresses are diminished by the conductivity of the air, nor can the effect of shielding the area of propagation from light rays be determined.

Another theory advanced by authoritative radio engineers compares the action of the ether to that observed in the case of magnetization of iron. It is well known that the degree of magnetization in an iron core such as that contained in a transformer does not vary directly with the magnetizing field due to the current in the coil. When this current has been increased to a certain ex-

tent, it is found that the increase of magnetization in the iron core becomes less and less for each successive increase of current, until finally the current in the surrounding coil may be increased to an indefinite extent without adding to the magnetization of the iron. At this point, the iron is said to be "saturated." In other words, it has produced as many magnetic lines of force as it is capable of under any conditions and an increase in the magnetizing field will fail to increase this number of lines of force. It is thought that radio propagation is similar to this case of the magnetization of iron. Waves of light given off by the sun and radio waves are identical except in frequency. Both radio waves and light waves depend upon the ether for their propagation. Accordingly, it is believed that the light waves saturate the ether in the same manner that the current passing through the coil in the transformer saturates the core, so that no further vibratory activity of a similar nature may be established. This theory is regarded by the majority of radio engineers as questionable, but ingenious.

## HEAVISIDE LAYER THEORY

On the other hand, daylight broadcasting offers some advantages which do not obtain during the dark hours. One of these advantages is the absence of fading. Radio fans who have actually succeeded in obtaining satisfactory reception from long distance stations during the day will have found that this reception does not "fade" or "swing," as is the case in night reception. This brings us to a consideration of the theory of fading. Two possible explanations seem to exist for this phenomenon. One theory depends upon the existence of a stratum of air known as the "Heaviside layer" located at a distance of approximately 30 miles above the earth. This "Heaviside layer" is a film of highly ionized air. When a radio wave traveling from the earth

(Continued on page 1820)

**T**HE possibility of successful broadcasting during the daylight hours is a question which is occupying, to an increasing extent, the attention of radio engineers. As conditions exist, extensive radio service is curtailed to a space from eight to fourteen hours during the period when the sun's rays do not strike the portion of the earth over which radio transmission is being carried.

Average receiving installations located 200 miles or more from a broadcast station are practically useless during the daytime; and in fact, many of the less sensitive radio receivers are able to receive at no greater distance than 50 miles during the day. It is a problem for the radio engineer to find means whereby great numbers of radio fans located, at present, at distances too far away to obtain satisfactory daylight reception, may be furnished with the radio entertainments and information available to those in or near cities.

## BAFFLING PROBLEM

It is an extremely baffling problem to meet, for very little is known concerning actual causes of this unsatisfactory behavior of radio during the day. It is only known that the audibility of a given station at a given distance during the night, is many times greater than the audibility of that same station during the light hours. A conservative estimate applicable to ordinary broadcast reception, places the factor of superiority at 100 to one. In other words, for cases where the receiving installation is located within a few hundred miles of the broadcast station, the audibility during the night-time will be approximately 100 times as great as the audibility during the day. The factor varies, however, with the distance between the broadcasting and receiving installations. It is the common experience of every radio fan to be unable to hear at all during the day, certain stations which are received very satisfactorily at night. These stations are, in general,

\* Chief Engineer, C. & W. station WLAG.



# Radio Relay Makes World

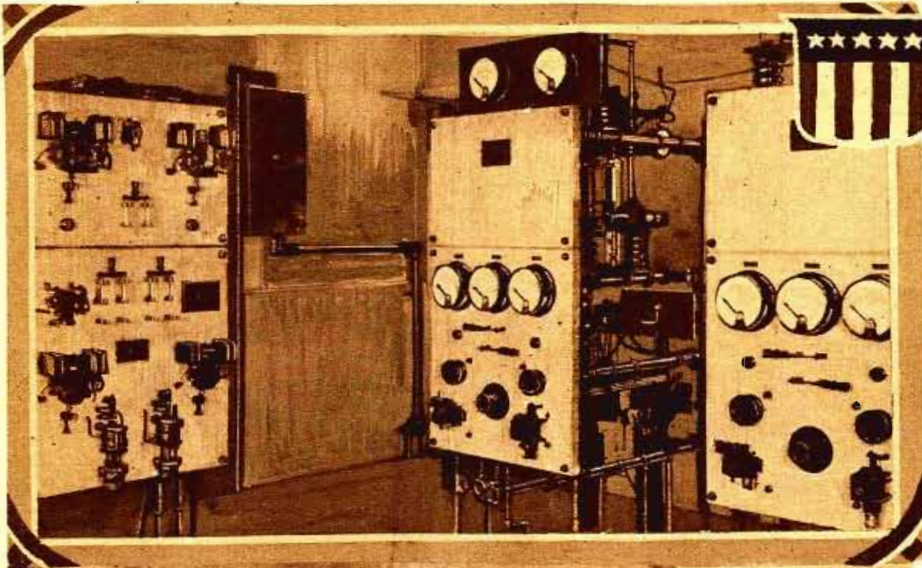

To the left is shown the short wave relay transmitter at KDKA, East Pittsburgh, the waves of which are picked up at KFXX, Hastings, Nebraska, and re-broadcast for the West Coast listeners. To the right is shown the receiving set at station 2LO, London, England, which was used during the first tests, to pick up the programs from KDKA. The sketch below shows how the first tests were carried out.

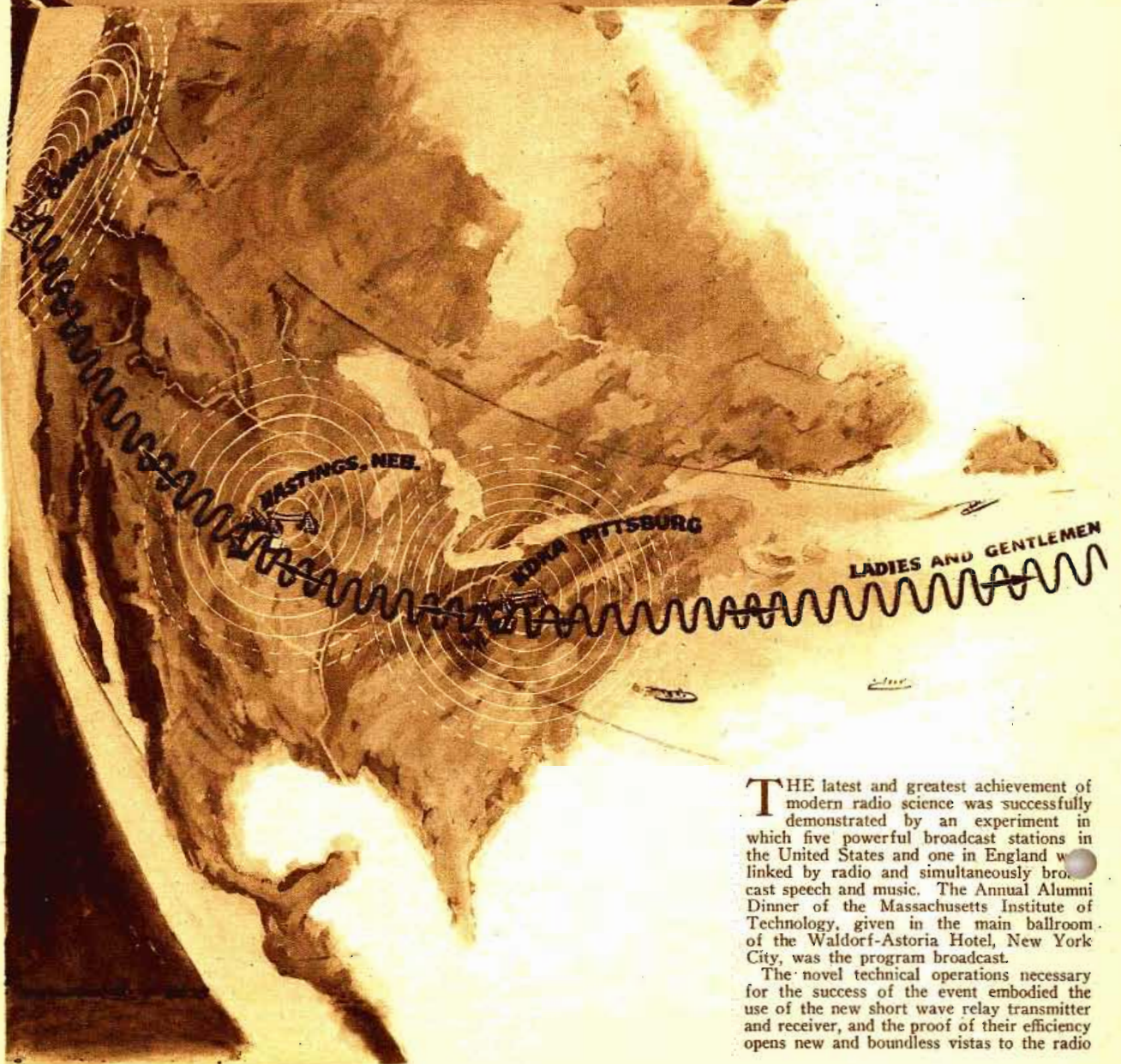

**T**HE latest and greatest achievement of modern radio science was successfully demonstrated by an experiment in which five powerful broadcast stations in the United States and one in England were linked by radio and simultaneously broadcast speech and music. The Annual Alumni Dinner of the Massachusetts Institute of Technology, given in the main ballroom of the Waldorf-Astoria Hotel, New York City, was the program broadcast.

The novel technical operations necessary for the success of the event embodied the use of the new short wave relay transmitter and receiver, and the proof of their efficiency opens new and boundless vistas to the radio



# Wide Broadcasting Possible

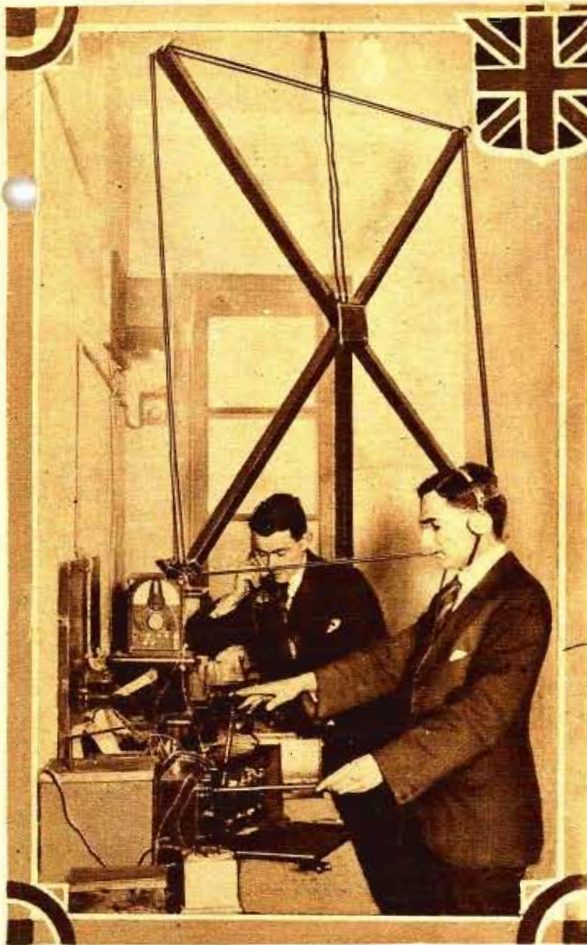

public. In detail, the simultaneous broadcasting was accomplished in the following manner:

Station WJZ of the Radio Corporation of America, in New York City, had its microphones installed upon the speaker's table and beside the musicians' rostrum at the Waldorf-Astoria. The program was carried to the control room at Broadcast Central by direct wire. Station WJZ broadcast the program on its usual wave-length of 455 meters, while a tap-off wire from the amplifier panel in the control room carried the speech and music to station WGY of the General Electric Company in Schenectady. From WGY the program was sent out by two different

transmitters, once on the customary wave-length of 360 meters and again on a specially designed short wave transmitter, on a wave-length of 100 meters. This 100-meter signal, inaudible to the ordinary listener-in, was received on a special receiver at station KDKA of the Westinghouse Company in Pittsburgh. From that receiving set the program was again transferred to two separate transmitters, one broadcasting on KDKA's usual wave of 326 meters and the other sending on a 98-meter wave. This 98-meter wave served as a carrier in similar fashion as did the 100-meter radio link between WGY and KDKA. It linked KDKA with stations KFKX in Hastings, Nebraska, and ZAC in

Manchester, England. ZAC, in turn, was linked with seven other English stations. Station KFKX also served as a radio relay station, sending the speech on a 104-meter wave to station KGO, Oakland, California, which rebroadcast the received signals for local reception on the West Coast.

The speed with which the radio waves travel is so terrific that ZAC was broadcasting the same sounds as KGO at practically the same instant, there being an inappreciable time loss in the jump from the Waldorf to Manchester or to Oakland.

Listeners-in from England to California were amazed to hear the announcement, "This

(Continued on page 1802)



# The History of Radio

*This interesting review shows how Radio was made possible by the inventions of several men and how long ago some fundamental discoveries were made*



Faraday discovered the phenomenon of induction or transfer of energy between two circuits which were in no way connected to each other.

1827.—Savary found that a steel needle could be magnetized by the discharge from a Leyden jar.

1831.—Faraday discovered electromagnetic induction between two entirely separate circuits.

1837.—The first patent for an electric telegraph was taken out by Cooke and Wheatstone (London) and by Morse (United States).

1838.—Steinheil discovered the use of the earth return.

1840.—Henry first produced high frequency electric oscillations and pointed out that the discharge of a condenser is oscillatory.

1842.—Morse made wireless experiments by electric conduction through water.

1843.—Lindsay suggested that if it were possible to provide stations not more than 20 miles apart all the way across the Atlantic there would be no need of laying a cable.

1845.—Lindsay made experiments in transmitting messages across the River Tay by means of electricity or magnetism without submerging wires, using the water as a conductor.

1849.—Wilkins revived the same suggestions for wireless telegraphy.

Dr. O'Shaughnessy succeeded in passing intelligible signals without metallic conduction across a river 4,200 feet wide.

1862.—Heyworth patented a method of conveying electric signals without the intervention of any continuous artificial conductor.

1867.—Maxwell read a paper before the Royal Society in which he laid down the theory of electromagnetism, which he developed more fully in 1873 in his great treatise on electricity and magnetism. He predicted the existence of the electric

waves that are now used in wireless telegraphy.

1870.—Von Bezold discovered that oscillations set up by a condenser discharge in a conductor give rise to interference phenomena.

1872.—Highton made various experiments across the River Thames with Morse's method.

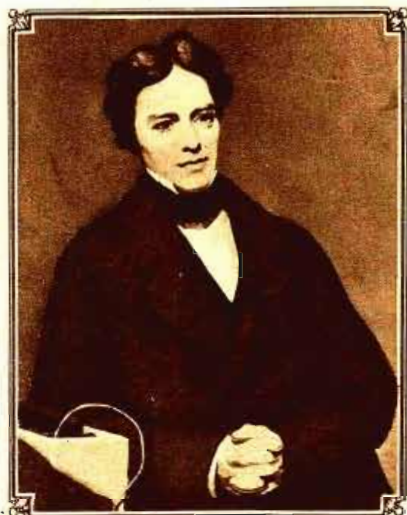

MICHAEL FARADAY

1879.—Hughes discovered the phenomena on which depend the action of the coherer. The coherer was later used practically by Marconi.

1880.—Trowbridge found that signaling might be carried on over considerable distances by electric conduction through the earth or water between places not metallically connected.

1882.—Bell's experiments with the Trowbridge method on the Potomac River resulted in the detection of signals at a distance of 1½ miles.

Professor Dolbear was awarded a United States patent in March, 1882, for wireless apparatus in connection with which he made the statement that "electrical communication, using this apparatus, might be established between points certainly more than one-half mile apart, but how much farther I can not say." It appeared that Professor Dolbear made an approach to the method that was, subsequently in the hands of Marconi, to be crowned with success.

1883.—Fitzgerald suggested a method of producing electromagnetic waves in space by the discharge of a conductor.

1885.—Edison, assisted by Gilliland, Phelps and Smith, worked out a system

of communication between railway stations and moving trains by means of induction and without the use of conducting wires. Edison took out only one patent on long-distance telegraphy without wires. The application was filed May 23, 1885, at the time he was working on induction telegraphy, but the patent (No. 465971) was not issued until December 29, 1891. In 1903 it was purchased from him by the Marconi Wireless Telegraph Co.

Preece made experiments at Newcastle-on-Tyne which showed that in two completely insulated circuits of square form, each side being 440 yards, placed a quarter of a mile apart, telephonic speech was conveyed from one to the other by induction.

1886.—Dolbear patented a plan for establishing wireless communication by means of two insulated elevated plates, but there is no evidence that the method proposed by him did, or could, effect the transmission of signals between stations separated by any distance.

1887.—Hertz showed that electromagnetic waves are in complete accordance with the waves of light and heat, and founded the theory upon which all modern radio signaling devices are based.

Heaviside established communication by telephonic speech between the surface of the earth and the subterranean galleries of the Broomhill Collieries, 350 feet deep, by laying above and below ground two complete metallic circuits, each about 2¼ miles in length, and parallel to each other.

1889.—Thompson suggested that electric waves were particularly suitable for the transmission of signals through fogs and material objects.



HEINRICH HERTZ



JAMES CLERK MAXWELL





SIR WILLIAM CROOKES

1891.—Trowbridge suggested that by means of magnetic induction between two separate and completely insulated circuits communication could be effected between distances.

1892.—Preece adopted a method which united both conduction and induction as the means of affecting one circuit by the current in another. In this way he established communication between two points on the Bristol Channel and at Lochness in Scotland.

Stevenson of the Northern Lighthouse Board, Edinburgh, advocated the use of an inductive system for communication between the mainland and isolated lighthouses.

Branly devised an appliance for detecting electromagnetic waves, which was known as a coherer.

1894.—Rathenau experimented with a conductive system of wireless telegraphy and signaled through three miles of water.

1895.—Smith established communication by conduction with the lighthouse on the Fastnet.

Marconi's investigations led him to the conclusion that Hertzian waves could be used for telegraphing without wires.

1896.—Marconi lodged his application for the first British patent for wireless telegraphy. He conducted experiments in communicating over a distance of  $1\frac{3}{4}$  miles successfully.

The first demonstration of directional wireless using reflectors was given in England. Experiments were conducted to determine the relative speed of propagation



JOSEPH HENRY

of light waves and the electric vibrations which actuated a receiver at a distance of  $1\frac{1}{2}$  miles between reflectors.

1897.—March: Marconi demonstrated communication being established over a distance of 4 miles.

March 17: Balloons were first used for the suspension of wireless aerials.

July 10-18: Marconi maintained communication between the shore and a ship at sea at distances up to 10 miles.

September and October: Apparatus was erected at Bath, England, and signals received from Salisbury, 34 miles distant.

November 1: First Marconi station erected at the Needles, Alum Bay, Isle of Wight. Experiments were conducted covering a range of  $14\frac{1}{2}$  miles.

December 6: Signals transmitted from shore to a ship at sea, 18 miles distant.

December 7: First floating wireless station was completed.

1898.—June 3: The first paid radiogram was transmitted from the Needles (Isle of Wight) station.

July 20-22: Events of the Kingstown regatta in Dublin reported by wireless for a Dublin newspaper from the steamer *Flying Huntress*.

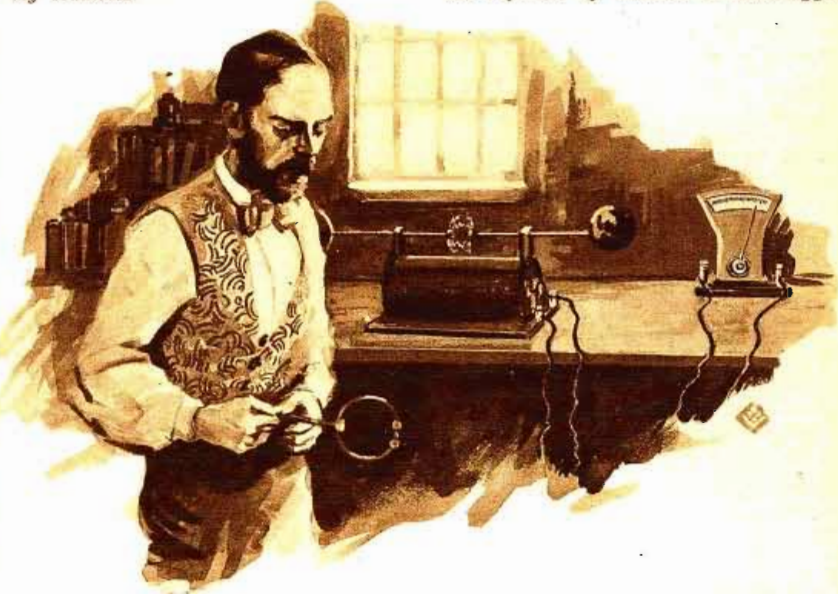

1899.—April 22: The first French gunboat was fitted with wireless telegraph apparatus at Boulogne.

July: During the naval manoeuvres three British warships equipped with Marconi apparatus interchanged messages at distances up to 74 nautical miles (about 85 land miles).

The international yacht races which took place in September and October were reported by wireless telegraphy for the *New York Herald*. At the conclusion of the races, series of trials were made between the United States cruiser *New York* and the battleship *Massachusetts*, signals being exchanged between the vessels at distances up to 36 miles. On the return journey from America Marconi fitted the steamship *St. Paul* with his apparatus, and on November 15, established communication with the Needles station when 36 miles away. Reports of the progress of the war in South Africa were telegraphed to the vessel and published in a leaflet entitled *The Transatlantic Times*, printed on board.

1900.—February 18: The first German commercial wireless station was opened on Borkum Island.

February 28: The first German liner fitted with wireless apparatus communicated with Borkum Island over a range of 60 miles.



EDOUARD BRANLY

November 2: The first wireless land station in Belgium was finished at Lapanne.

Between 1900 and 1905 Dr. De Forest was granted numerous patents in the United States and other countries for inventions connected with wireless telegraphy.

1901.—January 1: The bark *Medora* was reported by wireless as waterlogged

In 1887 Hertz found that electromagnetic waves produced effects at a distance and that they were similar to light waves.



SIR OLIVER LODGE





This heretofore unpublished photograph was taken in 1906 and shows Professor R. Fessenden and his staff at the Brant Rock, Mass., station. It was at this station that he carried out most of his experiments with continuous waves and radio telephony.

on Ratel Bank. Assistance was immediately sent.

January 19: The *Princesse Clementine* ran ashore, and news of the accident was telegraphed to Ostend by wireless.

February 11: Communication was established between Niton Station, Isle of Wight, and the Lizard station, a distance of 196 miles.

March 1: A public wireless telegraph service was inaugurated between the five principal islands of the Hawaiian group, viz. Oahu, Kauai, Molaki, Maui, and Hawaii.

October 15: The first fan aerials were erected for experiments between Poldhu and Newfoundland.

December 12: The letter "S" was received by Marconi from Poldhu, England, at St. John's, Newfoundland, a distance of 1,800 miles.

Prof. R. A. Fessenden applied for United States patent on September 28 for "Improvements in apparatus for the wireless transmission of electromagnetic wave, said improvements relating more espe-

cially to the transmission and reproduction of words or other audible signals." It appears that in connection with this apparatus there was contemplated the use of an alternating-current generator having a frequency of 50,000 cycles per second. Professor Fessenden, was granted a number of United States patents between 1899 and 1905 covering devices used in connection with radio telegraphy.

1901-1904.—During this period Dr. John Stone was granted more than 70 United States patents covering radio telegraphy.

1901-1905.—More than 40 United States patents were granted to Harry Shoemaker covering certain apparatus used for radio communication.

1902.—February: Steamship *Philadelphia*, American Line, received messages a distance of 1,551½ statute miles and received Morse signals up to a distance of 2,099 statute miles from Poldhu station, Cornwall, England.

June 25: The first moving wire magnetic detector actuated by clockwork was installed on the Italian cruiser *Carlo Alberto*.

July 14-16: Marconi received messages from Poldhu on the Italian cruiser *Carlo Alberto*, lying at Cape Skagen, a distance of 800 miles; and at Kronstadt, 1,600 miles.

December: On the 17th the first wireless message was transmitted across the Atlantic. On the 18th, wireless messages were despatched from Cape Breton station to King Edward VII.

1903.—January 19: President Roosevelt sent a trans-Atlantic radiogram to King Edward via Cape Cod and Poldhu stations.

March 30: First trans-oceanic radiogram was published in the *London Times*.

August 4: First International Radio-telegraphic Conference was held at Berlin.

Poulsen patented the improved arc oscillation generator, using a hydrocarbon atmosphere and a magnetic field.

1904.—January 20: The first press message was transmitted across the Atlantic.

August 15: The wireless telegraph act of Great Britain was passed.

November 16: Dr. J. Ambrose Fleming took out his original patent No. 24850 for thermionic valves.

1905.—In October of this year erection of Clifden, Ireland, high-power radio station was begun.

1906.—Doctor De Forest was granted a patent on January 18 for a vacuum rectifier, commercially known as the audion.

Second International Radiotelegraphic Convention was held at Berlin, and a convention was signed by a majority of the principal countries of the world.

Dunwoody discovered the rectifying properties of carborundum crystals and Picard discovered the similar properties of silicon crystals. These discoveries formed the basis of the widely used crystal detectors.

1907.—October 17: Trans-Atlantic stations at Clifden and Glace Bay were opened for limited public service.

1908.—February 3: Trans-Atlantic radio stations were opened to the general public for the transmission of messages between the United Kingdom and the principal towns in Canada.

In carrying out his invention Professor Fessenden constructed a high-frequency alternator with an output of 2.5 kilowatts at 225 volts and with a frequency of 70,000 cycles per second. Later Professor Fessenden reported successful wireless telephonic communication between his station, located at Brant Rock, Mass., and Washington, D. C., a distance of about 600 miles.

1909.—The steamship *Republic*, after colliding with the steamship *Florida* off the coast of the United States on January 23, succeeded in calling assistance by wireless, with the result that all her passengers and crew were saved before the vessel sank.

1910.—The steamship *Principessa Mafalda* received messages from Clifden at a distance of 4,000 miles by day and 6,735 miles by night. On April 23 the Marconi Transatlantic (Europe-America) service was opened.

(Continued on page 1816)



DR. LEE DE FOREST

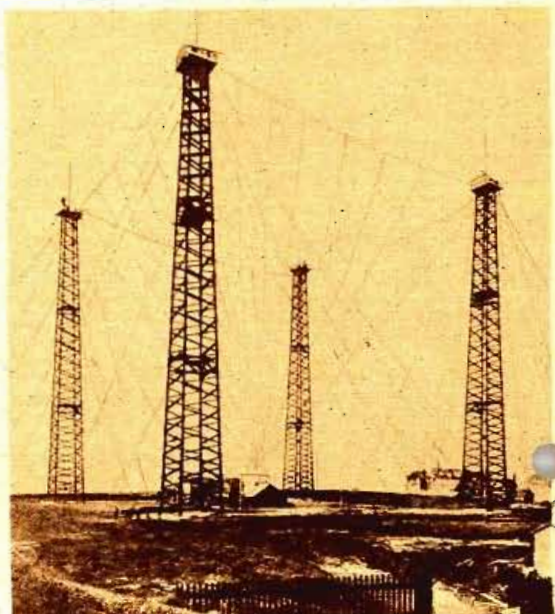

The first high power station installed by Marconi at Poldhu, England. The wooden towers supported an inverted pyramid aerial.



# Will the Future Broadcast Station Be Buried?

By S. R. WINTERS

*Dr. J. H. Rogers, the originator of the underground antenna system, has spent a number of years experimenting with them. This article describes his activities and the success he has attained in the transmission of radio signals from underground antennae*

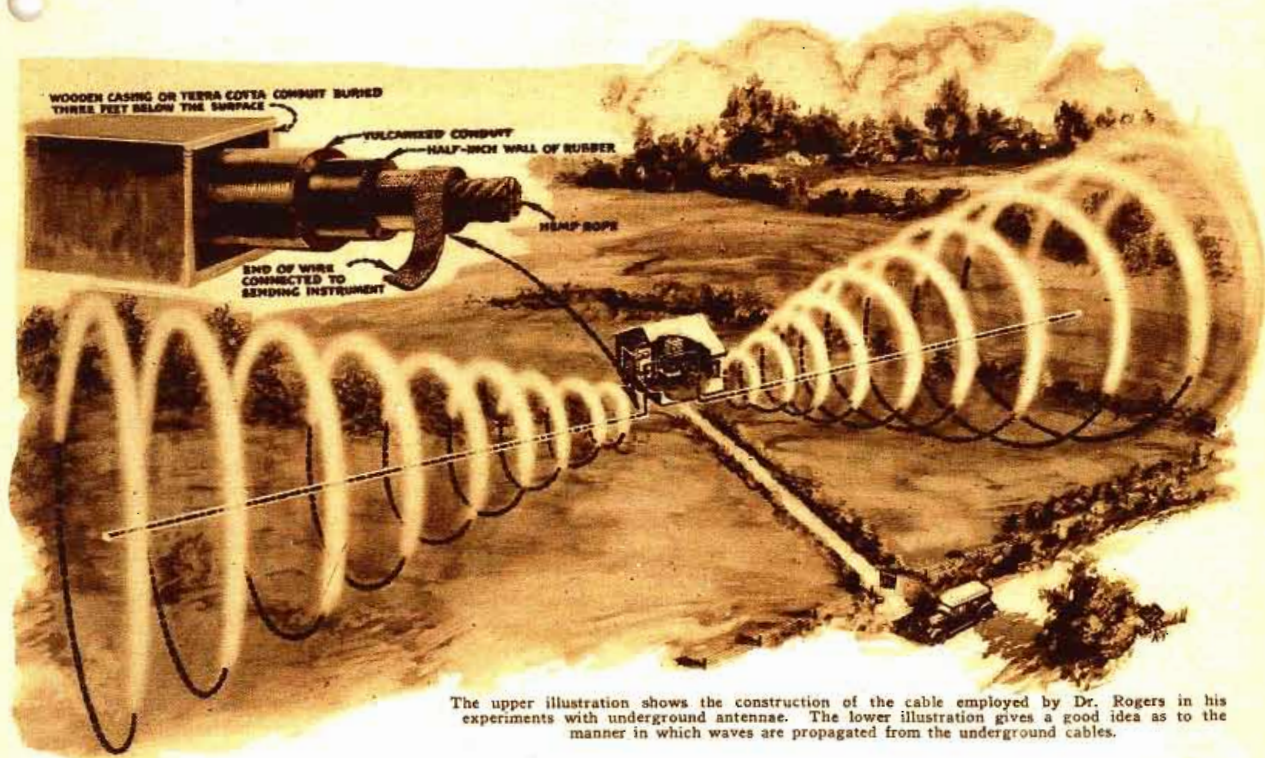

The upper illustration shows the construction of the cable employed by Dr. Rogers in his experiments with underground antennae. The lower illustration gives a good idea as to the manner in which waves are propagated from the underground cables.

**T**HE conventional thing in the erection of broadcast stations is to place the transmitting antennae hundreds of feet in the air, supported on towering masts. More recently, antenna systems for radiating electro-magnetic waves have been built atop skyscrapers.

These examples of elevating antenna systems to considerable heights are responsive to the accepted theory that there is a direct relationship between the proportional height of the transmitting antenna and the effective radius over which electric energy is dispersed. This theory is supported by the best engineering practice. However, in striking contrast with the invariable tendency to rear transmitting antennae skyward are the recent experiments of Dr. J. Harris Rogers, of Hyattsville, Maryland, in submerging the electric-radiating system in the earth.

He convincingly demonstrated, during the World War, his claims that electro-magnetic waves travel under the surface of the earth. The ability of the Hyattsville inventor in intercepting radio communications from Europe when the receiving antenna was buried was an epochal achievement. Not until recently, however, did Dr. Rogers conduct practical experiments in the transmission of radio signals with the antenna planted under the earth. The sending of messages by the subterranean route is an achievement that at once is calculated to arrest the popular imagination and foreshadow a time when probably some broadcast stations will be buried rather than built as obstructions to aircraft in flight.

The antenna under the surface of the earth, in these recent pioneer experiments, was comprised of copper wire braided over

a hemp rope. The latter was insulated by means of rubber, the wall of which was one-half inch thick. This rubber was further insulated and supported within a vulcanized conduit which was suspended in a wooden casing. The whole was buried three feet in the soil.

The vulcanized conduits were built in 100 feet lengths. The series of experiments in transmitting radio underground involved three different arrangements of the transmitting apparatus, with respect to the conducting medium. In one instance, a single conduit of 100 feet was used, the transmitter being "grounded." In another case, 100 feet of conductor was employed at each end of an ungrounded transmitting outfit. The third arrangement involved the placement of 100 feet of vulcanized conduit at each end of the transmitting station, with the transmitter connected to the ground in the usual way for operating transmitting and receiving equipment. The latter circuit was more efficient than the other two arrangements.

The transmitting equipment proper consisted of three 5-watt oscillators, placed in parallel. The plate voltage was 500 volts. The maximum distance over which this arrangement worked, according to reports to the Rogers Radio Research Laboratory, was approximately 400 miles. The use of greatly increased power in subsequent tests is expected to increase the range to thousands of miles instead of hundreds—possibly across the Atlantic Ocean.

The results of this departure in propagating electromagnetic waves afforded proof of there being virtually no fading of the radio signals at the receiving stations. Moreover, the conditions favoring transmis-

sion after nightfall in preference to daylight sending, which is widely recognized when elevated antennae are used, were not apparent when the electric energy was dispersed through the earth. That is to say, the radius covered by the signals transmitted during the day and after nightfall were the same, both with respect to the distance embraced and the absence of fading at the receiving points.

The underground antenna tests were received at Villanova College, Pennsylvania, with no fading reported. Receiving stations located in Parkersburg, West Virginia, and Richmond, Virginia, made similar favorable reports. These signals, traveling under the crust of the earth, were heard as far distant as New Hampshire, although the postal card to Dr. Rogers acknowledging reception of the message did not state whether or not there was an absence of fading. Generally speaking, however, reports concerning these tests were received from points within a radius of 400 miles.

The success of these tests is responsible for Dr. Rogers advancing a somewhat revolutionary theory with respect to the phenomenon of fading. He is of the opinion that conditions in effect at the transmitting station influence fading. "The electrostatic lines of force do not, at all times, embrace a uniform area, but this field of energy is constantly expanding and contracting," he states. "The result is that the strength of the electromagnetic waves radiated from the elevated antenna varies in proportion to this contraction and expansion."

"This elastic condition in the electrostatic field may be attributed to changes in the

(Continued on page 1839)



# New Army Control Station at Fort Leavenworth

By Capt. R. B. WOOLVERTON, S. C., Fellow, I.R.E.



*With the installation of the new radio station at Fort Leavenworth, the U. S. Army is independent of all other channels of radio communication and is able to handle coast to coast traffic at all times either direct or by relay from one station to another*

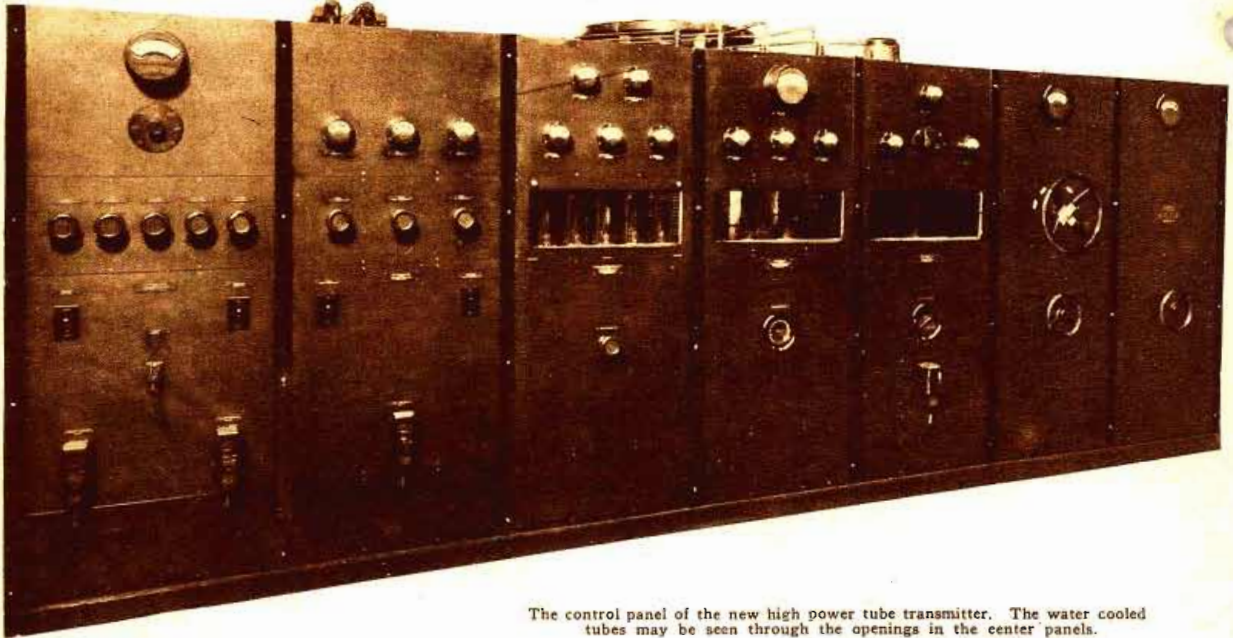

The control panel of the new high power tube transmitter. The water cooled tubes may be seen through the openings in the center panels.

**T**HE new Fort Leavenworth station came into the War Department radio net March 26. After a trial period of 24 hours, it was designated by the Chief Signal Officer of the Army as the Traffic Control station of the War Department radio net.

The War Department net, consisting of 75 stations located at or near all of the more important cities of the United States, has had its traffic controlled heretofore from the War Department station at Washington. It became apparent that effective control could not be maintained from the Washington station because the distances involved were too great. Very frequently during periods of unfavorable weather conditions, stations in the far west became inoperative without the immediate knowledge of the control station at Washington. This complicated traffic routing, and caused delays of several hours. In view of these conditions, therefore, plans were made nearly a year ago for the installation at Fort Leavenworth, Kansas, of a high powered vacuum tube transmitter capable of communicating directly with every primary station of the War Department in the United States. No expense was spared to insure installation of a station representing the last word in modern radio equipment.

A brief recital of the outstanding features

incorporated in the transmitter and its controls will serve to illustrate the high degree of development reached by the art in radio transmitting equipment.

Not less than 10 kilowatts in the antenna are radiated on all wave frequencies between 300 and 50 kilocycles (1,000 to 6,000 meters) when employing continuous wave telegraph transmission.

Not less than five kilowatts in the antenna are radiated when radio telephone transmission is employed on all wave frequencies between 300 and 60 kilocycles (1,000 to 5,000 meters).

Automatic regulating devices are provided in the tube filament circuits which limit the voltage variation to two per cent of normal at .85 power factor.

The transmitter is of the constant frequency type, employing a master oscillator, a modulator for telegraph and voice control, and a power amplifier.

The power supply to the transmitter tubes consists of a split three phase, three tube rectifier with water cooled tubes.

The power amplifier employs two water cooled tubes equipped with filament transformers.

## DISTANT CONTROL

The wave change switch can be operated from the remote control station, several miles distant, by means of relays. It is provided with an interlock which prevents operation of the switch unless power is disconnected from the transmitter.

A push button at the remote control station, several miles distant, starts and stops the transmitter automatically.

The transmitter, when sending code, transmits at speeds up to 160 words per minute. The transmitter radiates no harmonics that can be heard one mile from the station, using a six-stage receiving amplifier.

Filters for the rectified plate voltage reduce the ripple to a value not exceeding one per cent.

Alarms are provided which give audible warning of excessive water temperature, trip

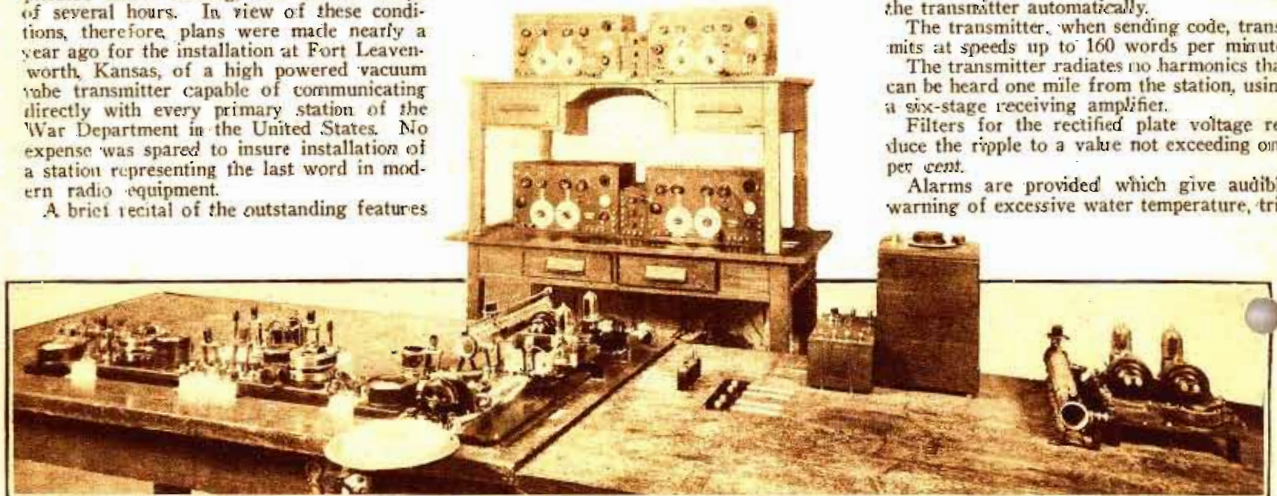

The high speed recorders and amplifiers may be seen on the table. In the background, on the tables, are two of the five receivers employed for multiplex reception.



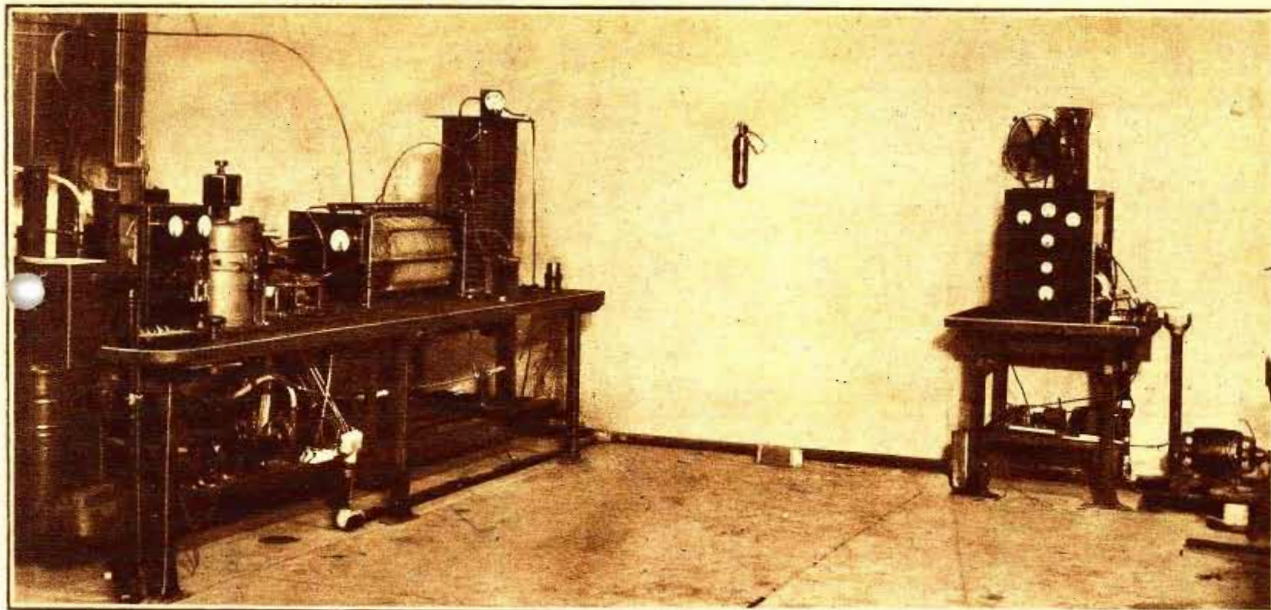

Two additional transmitters are used for transmitting simultaneously on different wave-lengths and for short range work. The one on the left is a 5-K.W. arc, and on the right is a 50-watt tube transmitter

the power circuit breaker if water circulation falls below safe limits, give warning and trip circuit breaker if a filament burns out, and sounds if oscillations in the master oscillator cease.

From the above it will be seen that the transmitter attendant has practically nothing to do but listen for an alarm which informs him of anything irregular in the operation of the set, since complete and instant control of the transmitter is constant at the remote control station.

The antenna and ground system was specially designed to offer a minimum resistance. The resistance at 60 kilocycles (5,000 meters) is about three ohms, with the result that at this frequency 64 amperes are radiated at normal full load. An overall efficiency, from outside power lines to antenna, of approximately 50 per cent. is secured. This is a very high value for a radio transmitting plant, and evidences the care exercised by the manufacturer of the equipment, and of the installing engineer of the Signal Corps in the construction of the antenna and particularly of the ground system.

In addition to the transmitter described above, the station has a five-kilowatt arc and a 50-watt continuous wave tube transmitter. These two are also controlled from the remote control station, and are used for distribution of traffic to stations in the middle west. All three transmitters can be operated simultaneously, and while messages are being transmitted to three stations, traffic can be received from four stations.

#### NOVEL RELAY SYSTEM

Probably the most interesting feature of the Fort Leavenworth station is the use of two special relays of the Creed type, permitting Washington, Fort Douglas (Salt Lake City, Utah), and Fort Sam Houston (San Antonio, Texas), to control the Leavenworth transmitter by radio for through traffic. To make the operation of this relay system clear, it should first be explained that at Leavenworth one receiver is always set for Fort Douglas, one for Fort Sam Houston, and one for Washington. If, for example, Washington has several messages for Fort Douglas, Washington transmits the conventional signal for "relay," followed by the Fort Douglas call letters "WVX." Leavenworth immediately switches one Creed relay to the receiver set for Fort Douglas and the other relay to the receiver set for Washington, both relays being cut into the transmitter control circuit. Leaven-

worth then signals "K" (go ahead), and Washington calls Douglas. Washington's signals operate the Leavenworth transmitter by means of the relay. Upon hearing the call, Douglas replies through the Leavenworth transmitter by means of the second relay, and Washington proceeds to transmit his traffic to Douglas by means of the Leavenworth transmitter. Douglas is, of course, always able to break Washington, because all War Department net stations are remotely controlled. Thus it is clear that even an experienced amateur, listening to the Fort Leavenworth transmitter, will hear the station sign "WVC" (Leavenworth) one moment, "WVX" (Fort Douglas) a little later, and if he continues to listen he will be certain to hear the same station signing "WVA" (Washington) and "WVB" (Fort Sam Houston). About the time he decides that he is hearing stations all over

the country, the Department of Agriculture at Kansas City will be given control of the transmitter over their leased control line, and he will hear their live stock market broadcast and will call it a good day's work.

The radiophone feature of the transmitter will perform no peacetime function in the War Department net, but its presence in nearly the exact center of the United States, as one of the most powerful radiophone transmitters in the country, offers emergency possibilities the importance of which is easily conceivable.

The receiving, or remote control element of the station, is equipped with receiving apparatus designed to meet the particular requirements of the station. The antennae, each about a mile in length, are employed, one directional toward Washington, one toward Fort Sam Houston, and the third toward Fort Douglas. The receivers con-

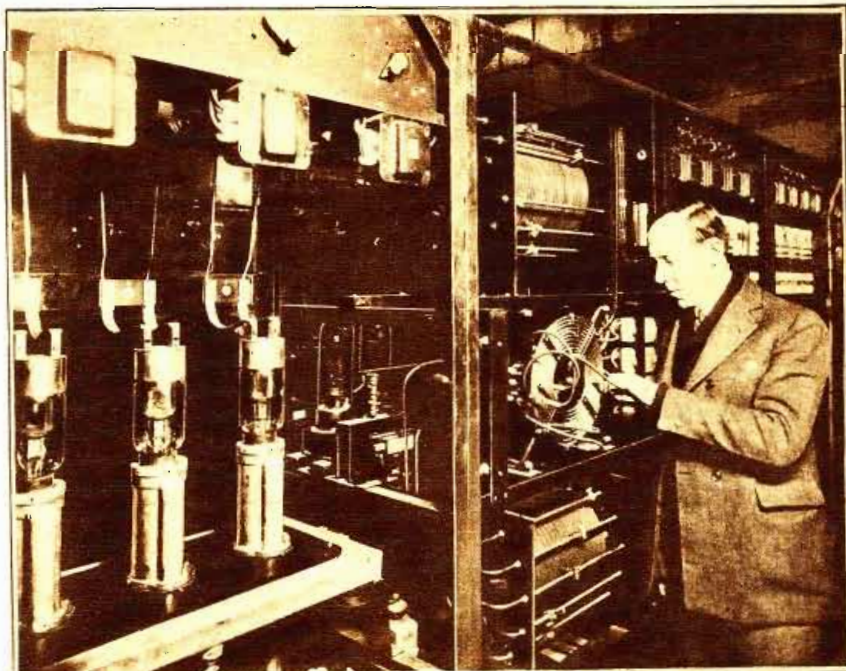

Back view of the high power tube transmitter. Mr. F. C. Ryan, engineer in charge of the installation, is seen adjusting the circuit.



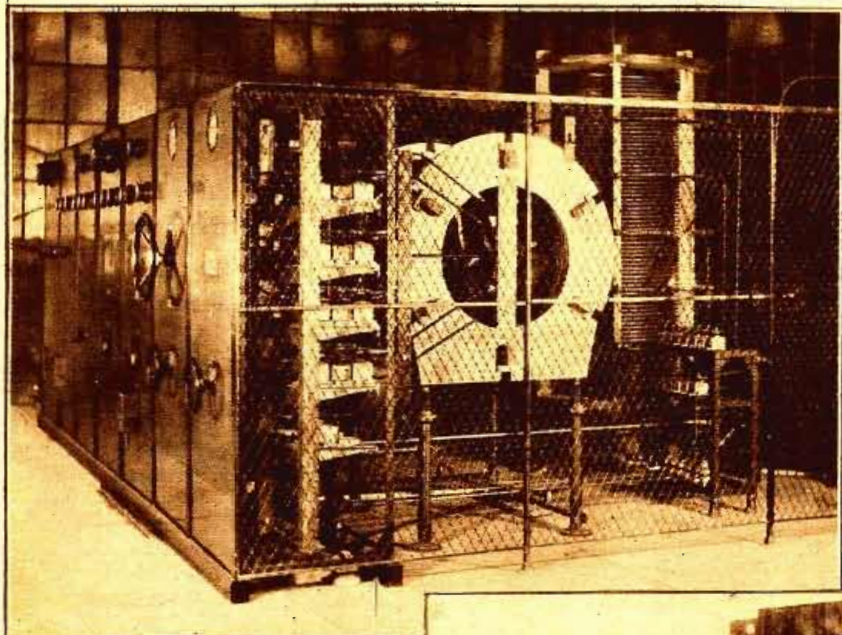

of flexible design, is held in reserve, to be cut in on any antenna in the event of temporary failure of one of the regular sets.

The remote control station building is distant from all power lines and other possible sources of interference.

Commercial telegraph circuits are provided so that radiograms may be forwarded by wire to points not served by radio, or in event of failure of a station due to local thunderstorm or other cause.

In conclusion, members of the A. R. R. L., and radio fans in general who have continuous wave receivers that will reach 5 meters are invited to listen in on "WVC" and discover what Signal Corps soldier operators can do with a real station. They will not understand much of what they hear, because most of it will be skipping along at the rate of about 60 words per minute, and some of it will be unintelligible at any speed because of secret methods of transmission, but they will find it interesting nevertheless.

This side view of the transmitter shows the two large inductances of the 10-K.W. tube set.

The control desk of the station. The switch-board on the wall permits relay work through 10 different lines. The meter on top of the cabinet shows the antenna radiation.

ected to these three antennae each employ one tuned radio stage, three untuned radio stages, one tuned radio stage, one oscillating detector and two audio stages, all in the order given. When the high speed tape recorders, or the Creed relays are in use, a two stage power amplifier is added. An audio frequency filter is used at all times, regardless of whether telephone or tape reception is being used, or the Creed relays are being operated for radio control from Washington, Fort Douglas or Fort Sam Houston.

The three receiving systems are practically fixed, in their frequency adjustments, within very narrow limits. This is possible because the three stations involved, each use a single transmitting frequency with each other. No separate calling wave frequency is employed, each station maintaining a constant watch on the wave frequency of each of the other stations. A fourth receiver, of flexible design, is used for receiving from the various mid-western stations, and is connected to a loop antenna. A fifth receiver,

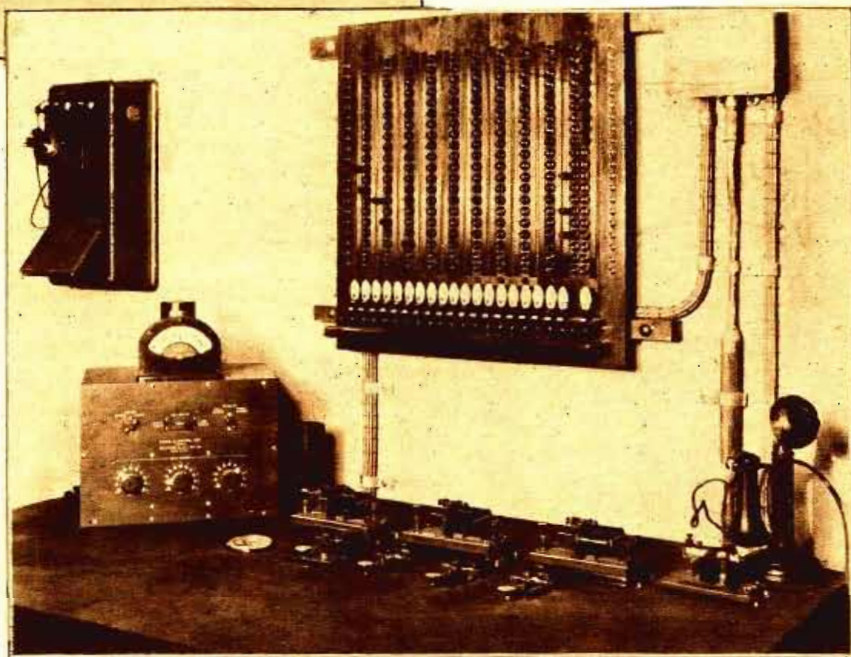

## Hearings on the Radio Bill

By CARL H. BUTMAN

CONGRESSMAN WALLACE WHITE's radio bill stood up well under fire of several objectors during a four-day hearing before the radio sub-committee of the House Merchant Marine and Fisheries Committee. It is the general impression that the sub-committee will now report favorably to the full committee and that early action in the House will follow. Secretary Hoover is sanguine as to the eventual passage of the needed legislation by the House, but no one dares prophesy on the attitude of the Senate, due to the multiplicity of investigation and urgent measures before that body. Following the conclusion of the hearings last week, Secretary Hoover said there seemed to be a general "unanimity of opinion" that the bill was a good one basically.

Appearing before the sub-committee at the opening of the session, Secretary Hoover read a report reviewing the radio situation

and indicating the legislation needed by the department if proper administration were to be continued. Chairman White of Maine, author of the bill, presided at the hearings, assisted by Representatives Lehlbach, Free, Bacon, Davis, Bland and Larsen.

### SECRETARY HOOVER SPEAKS

Pointing out the imperative need for legislation, although admitting that no law would be a "panacea," Secretary Hoover said in part: "The tremendous development in electrical communications is to a large extent due to the fact that individual initiative has not only been unhampered by the Government, but has been encouraged to the extent of the Government's ability and regulated so as to give the maximum service. The further legislation needed should in my view regulate only to the extent that is necessary in public interest for the development of the science itself; for the service of those who

make use of it. It seems to me, therefore, that the fundamental thought of any radio legislation should be to retain possession of the ether in the public and to provide rules for orderly conduct of this great system of public communication by temporary permits to use the ether. It should be kept open to free and full individual development, and there should be assurance that there can be no monopoly over distribution of material.

"Radio communication is not to be considered as merely a business carried on for private gain, for private advertisement or for entertainment of the curious. It is a public concern impressed with the public trust and to be considered primarily from the standpoint of public interest to the same extent and upon the basis of the same general principles as our other public utilities."

He also indicated the need for definite authority for the Secretary of Commerce to

(Continued on page 1846)



# Courtesy of the Air

By S. M. KINTNER

MANAGER RESEARCH DEPARTMENT WESTINGHOUSE ELECTRIC AND MANUFACTURING COMPANY.

*There is no excuse in claiming ignorance of a law. There is no good will in this world towards an individual showing a lack of courtesy. We have reached the point in radio where acts of ignorance or intentional discourtesy are inexcusable. Courtesy of the air is no less desirable than courtesy in social realms*

**I**NTERFERENCE, its causes and results, is now a most popular topic of conversation among radio fans. Interference from one cause or another has been experienced by every radio fan, but few of them know the real reasons for this trouble and how to take measures that will assist in reducing it.

These interferences are caused by: (1) A broadcast transmitting station so close to the receiver or so powerful as to make it difficult to "tune out"; (2) a transmitting station operating on a wave-length so near to the one being received as to cause interfering beats at a beat frequency which is sufficiently low to bring it within the audible range; (3) a nearby amateur transmitting station operating on a spark set, or an A. C. tube set; (4) atmospheric disturbances, called "static" and particularly apt to be present during the summer months; and (5) the interference caused by "birdies", so-called on account of their supposedly bird-like character of sound. While there are times when quick "tweet" sounds may be heard, I have always thought that the "howling of winter winds" or the "wail of lost souls" was more truly descriptive of the sensations produced by this type of interference.

As "birdies" is the interference produced by one listener with another I will direct your attention to it in order that you may better understand the cause of it and adopt a plan of tuning which will cause you to interfere with your neighbor as little as possible. Remember that a radio listener tuning in late on a program can be just as much of an annoyance to those near him as can one arriving late at the theatre in the middle of an act when carelessly stumbling over things and making a lot of unnecessary noises while finding his seat.

An antenna at a receiving station re-radiates a certain part of what it picks up. This is true, in varying degrees, of all such an-

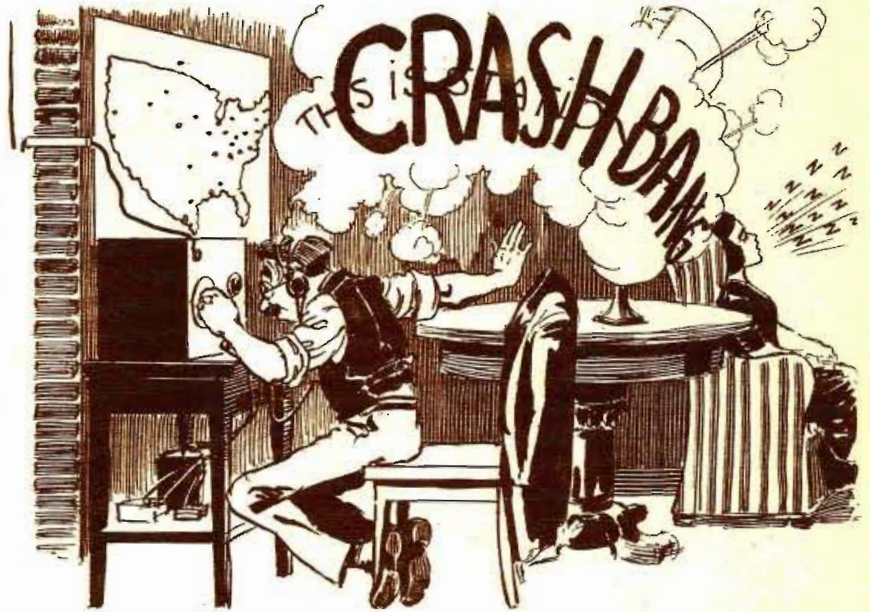

This "distance hound" is trying to squeeze the maximum amount of regeneration out of his set with the result that—

tennae. When, however, one permits a detector tube to oscillate, which results from too much regeneration, the radiating tendencies of an antenna are increased many fold. When the tube is oscillating, the receiving station becomes a transmitting station sending out waves of a frequency at which the tube is oscillating.

As the tube oscillation frequency is controlled by the tuning of the set, it is apparent that when the tuning of the set is changed

while the tube is oscillating, the radiations sweep over that band of waves just as the note of a siren is changed as its speed is altered.

This sweeping across a wave to which someone else may be listening causes the kind of interference known as "birdies". A radiating receiver will affect sets within a mile of it. In the majority of instances the operator of such a set is unaware that he or she is causing a disturbance.

### COURTESY NEEDED

It is hard to believe that anyone would knowingly drag across the various wave bands to find the beat of a desired carrier wave any more than one would drag an arm over the heads of the occupants of seats in a theatre in order to more easily find the empty one. Each act is equally rude, although the radio tuner may for a time be excused on the score of ignorance.

The care that need be exercised in tuning to avoid annoying your neighbors depends upon where you live. If you are in the country where radio receiving sets are miles apart, little or no thought need be given to it as a possible cause of interference. If, however, you are in a city where there are many radio receiving sets near you, you should, as an act of courtesy and consideration, use every care against tuning while your tube is oscillating.

You will want to know two things in your efforts to carry out such a plan of tuning: (1) How to know when your tube is oscillating; and (2) how to find the distant station without the carrier beat note.

You can always tell when your tube is oscillating by a peculiar change that takes place at the beginning of oscillations. There is a slight swish or rustling noise as the

(Continued on page 1825)



—This poor bird who has been listening contentedly to a good program from a local station gets the full force of the other bird's manipulations.



# Too Much Waves

By ELLIS PARKER BUTLER

Author of "Pigs Is Pigs"

A FEW days ago I noticed in the newspaper a brief item saying that my old friend William Pethcod was in New York and stopping temporarily at the Biltright Hotel, so I went around to see him. One reason was that I always liked an hour or so with Pethcod because he was such a big fat jolly fellow, and the other was that I am always on the lookout for news items for RADIO NEWS, and the last time I saw Pethcod he had just inherited \$200,000 and was going out west to Alacamar, in the state of Califorzonnia, to buy out the newspaper known as the *Alacamar Times*. What interested me was that Pethcod had told me he was going to put some life into that broken-down newspaper and jazz it up and make it a hot rival for the *Coboya Star*, which was the most popular newspaper out there. The one thing that interested me most had been that Billy Pethcod intended to install an up-to-date radio broadcasting outfit on the roof of the *Alacamar Times* building—just as so many up-to-the-minute newspapers have done in other parts of the country. He was sure it would help tremendously to build up the circulation of the *Alacamar Times*.

"You see, Butler," he said, "we've only got these two big towns out there—Alacamar and Coboya—but it is a big territory. And

Alacamar is not getting her share of the newspaper business. Why, those towns are 500 miles apart and, do you know, there are more copies of the *Coboya Star* sold right in Alacamar than there are copies of the *Alacamar Times* altogether. And to my mind the only possible way to get the *Alacamar Times* known quickly and thoroughly throughout all that territory and right into Coboya itself, is to put in a broadcasting outfit. I'm going to do it, and I'm going to broadcast the very best stuff I can, and every three minutes my announcer will say 'This is Station JKIX, the *Alacamar Times*, Alacamar, Califorzonnia,' and you just watch me! If I don't build up the *Alacamar Times* until it is as fat as a ham you can call me a hand-embroidered noodle! I don't say I can wipe that *Coboya Star* completely off the earth, but if I don't have it trimmed down to the size of a thumb-tack in one year you can call me a silver-plated peanut!"

I could not guess what had brought Billy Pethcod back to New York only a year after his departure, unless he had come back to buy a half dozen big rotary presses or a bigger and better broadcasting outfit for his roof, but I went to see him. When the elevator took me up to his room and I set my eyes on him I could hardly believe them! Billy Pethcod was as tall as ever, but he

looked as if he had melted off about 150 pounds. He was as thin as a rail and he looked worried and careworn and fretful and depressed. His face lit up a little when he saw me, but it almost instantly fell back into sadness. It was an awful change I saw in him and, before I thought, I asked him what was the matter. He shook his head and sighed.

"Everything!" he said. "Radio, newspaper—everything! I'm busted—I haven't a cent of money. I'm cleaned out. I'm discouraged and sore and mad and disillusioned."

"Tell me about it," I said, knowing I would get a truthful story, for Billy Pethcod never exaggerated.

"Did you ever hear of Mount Takalaw?" he asked.

"No," I said.

"Did you ever hear of the Pingak Cave?"

"Never," I admitted.

"Did you ever hear of Orlando P. McFutz?"

"No," I said.

"Did you ever hear of One-eye Billings or Peter Duss?" he asked.

"No, neither of them. Why? What have they got to do with it?"

"Did you ever read a piece in the paper saying radio messages could not be sent from  
(Continued on page 1806)



The ether waves washed against the iron ore mountain and splashed over the top and into the sanatorium where the nerve-wracked patients eagerly inhaled the spray.



# The Radio Quack

By ROSCOE I. SMITH

During the youth of every new scientific idea, while it is popular and before the public is educated sufficiently in it, some sharp one always capitalizes this popular interest through quackery. The following article tells of the latest method used to mulct the public.

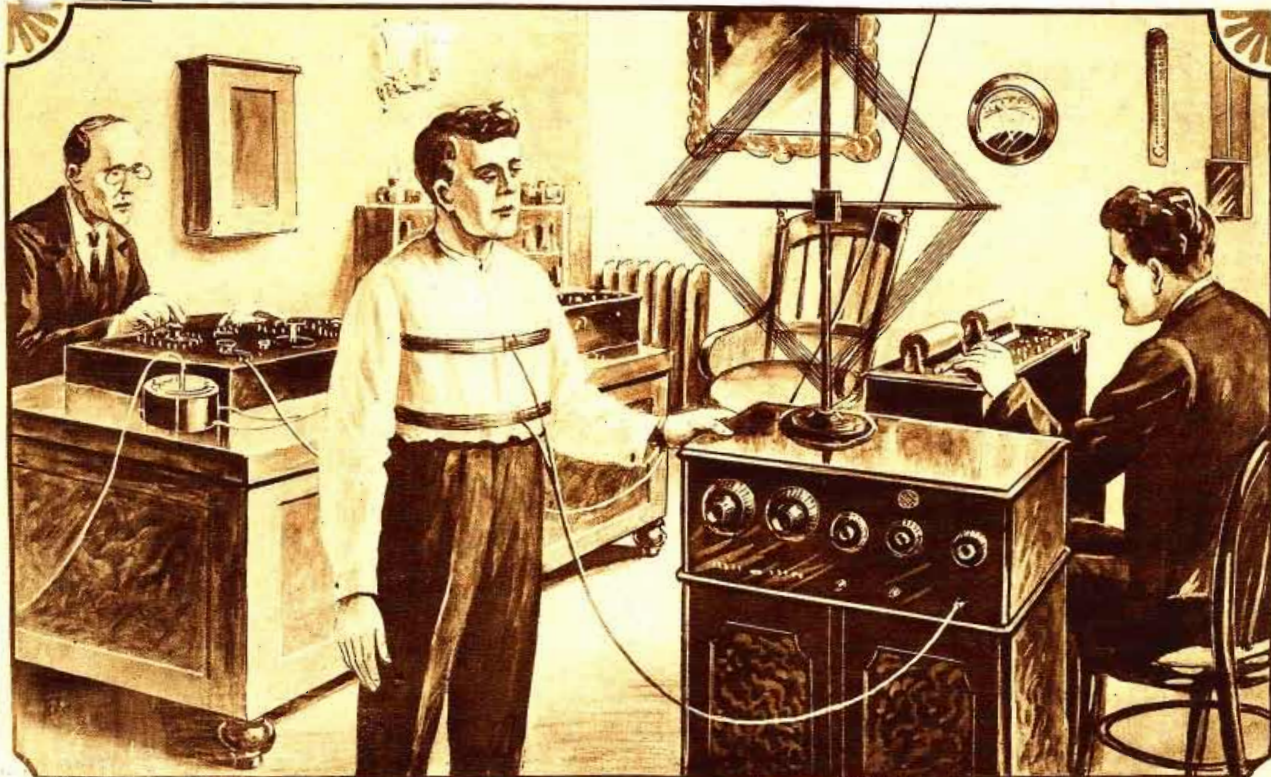

A system supposed to immediately determine a patient's troubles and likewise to work a cure. That every disease has a definite vibration and that it can be cured by another and stronger vibration is the basic idea presented.

**V**IBRATION has long been a mysterious and powerful thing. As with every other force, quacks wishing to profit by the general ignorance are capitalizing on this property.

That every disease has a vibration and that it can be cured by another stronger vibration is the latest quack scheme to cure all the human ills. Radio is vibration, ergo: it is only necessary to build a radio generator which will radiate the proper kind of vibrations to release the human body from all disease. This is the burden of the new cult which hopes to ride to success—and incidentally to collect a fortune from a gullible public—on the present spread in the popularity of radio.

There was a great deal of the most gorgeously complicated "scientific" discussion of the subject given at the recent session of the American Association for Medico-Physical Research held in Chicago. A number of papers were read dealing with the new method of healing and diagnosis, but to an engineer accustomed only to work with microfarads and decrement they were, for the most part, unintelligible. Of course, that was to be expected.

One of the papers read by a more or less prominent Eastern physician talked of galvanism. This medico, working from a basis of the Abrams system of diagnosis pointed out that it is only necessary to measure the energy of a disease and to use the human reflexes to effect cures. He gave an illustration of the reflex, citing the well known trick of striking the knee when

the legs are crossed. The result is that the lower part of the leg jumps sharply. The author of the paper stated that there are reflexes of the same type in the blood and that they may be put to good use in curing disease.

To prove the reflex in the blood, he placed a metal electrode on the forehead of a patient. This electrode was connected to some sort of a weird machine which was supposed to generate energy from a bit of blood taken from a cancer sufferer. Following the placing of the electrode, the physicians assembled "listened in" at the patient's abdomen and heard an increase in the percussion note.

Of course, we may be wrong, but our family doctor tells us that an unexpected noise or a sudden flash of light will cause the same thing, that fear, joy, anxiety will cause it. Also, we are certain that if we were confronted by a table full of august and awful apparatus and had a physician, white coated, and a very efficient looking trained nurse in attendance, we should be—shall we say—perturbed.

From the engineer's point of view, one thing we could not understand was how the energy—if it be electric, and we take it that it must have been, since there was power in the circuit—was transferred to the body of the patient from the electrode to the skin through the rubber insulation. It was not explained.

Going upon the theory that every disease has a vibratory rate, the new system has invented a machine called the dynamizer

through the aid of which the energy of the disease may be measured. This measurement is taken with the aid of a rheostatic ohmmeter. The strength of the disease is measured in ohms. Here is another point that is a little over the engineer's head. The engineering school teaches us to measure the strength of a current in amperes and with an ammeter. It is possible that the medicos have discovered a system which is superior to that in use in power sub-stations, however.

After having made a diagnosis of the disease with the aid of the dynamizer, the method of treatment and cure is a comparatively simple matter. There is a machine known as the "Oscilloclast," which will generate "vibratory rates" of any count. When once the nature of the disease is discerned it is only necessary to consult a table giving the combative rate, set the Oscilloclast at this rate, turn on the current and give the patient time to absorb its healing properties.

They illustrate the effectiveness of this method of cure by telling the old story of how Caruso broke the wine glass by singing a note which was the same as that given by the glass. He struck the glass with a knife so that it gave a musical note. Then he let out his own powerful voice at that pitch and the glass fell to bits. This, say the psychophysicians, is exactly what happens when the vibration from the oscilloclast meet up with the disease. The disease "just simply busts."

(Continued on page 1774)



# Vacationing With Radio

By MARIUS LOGAN

**R**ADIO fans such as I, addicted to spring fever, no matter how strong the influence of radio in the winter months may be, are more apt, when spring arrives, to put away "old faithful," pack the grips and hit for the seashore, the mountains or the north woods, as best fits the disposition. I have done this for quite a few years, always having felt that any extra luggage would prove an impediment to my annual "back to nature movement." I glory in the mountains; they jibe with my temperament. Far from civilization, I glide through green forests, laugh at

life, inhale fresh air and work up an appetite that would honor five men. I delight in my loss of contact with worldly affairs, consequently, why a radio?

Before the spring of last year, my partner in these expeditions came to me in all seriousness and proposed that a radio accompany us on our next outing. "Where," I asked, "is the logic in hitting trail for the tall timber if only to sit around a radio set when we arrive and listen to the very things we attempt to break away from?" "Quite a logical argument," he replied—"theoretically, but from the practical standpoint it is like the sieve—it won't hold water. Now," he said, "consider last year. What, may I ask, did we have to do in the evenings but sit around camp, chew on sticks, or lie flat on our backs and look at the moon? It wasn't what you would call a roaring success for either of us, in the way of amusement. Now suppose we had had a radio with us? Wouldn't that have been worth while? Wouldn't that have made those evening hours less restless? Aye—verily—" and he talked on for about an hour, until I gave up in despair.

The result was we started for camp last year with a portable radio receiving set. It was a simple affair, with one dry cell vacuum tube in a regenerative circuit contained in a

cabinet, in the rear of which was a compartment for both the "A" and "B" batteries. A handle on the top made it easy to carry, only, as it happened, we stuffed the whole set in my pack. A 100-foot length of aerial wire, two insulators, a few feet of bell wire, a large spike to make a ground connection and two pair of head-phones completed the outfit.

I had expected to find the set a heavy affair and consequently was greatly relieved to find that it added but little weight to my 80 pounder. We arrived at our camp site some days later in the highest of spirits.

Jim, my partner, was more of a radio bug than I and was for putting up the aerial the first thing. I quenched his enthusiasm by pointing to gathering clouds and stressing the importance of making shelter in haste. This we did and finished just in time to duck a cloudburst.

In the morning though, Jim got to work stringing the aerial wire between two trees. It was impossible to make it more than 50 feet long, due to obstructions in other directions, but he managed to get it 40 feet above earth, a good height. He then drove the

(Continued on page 1813)

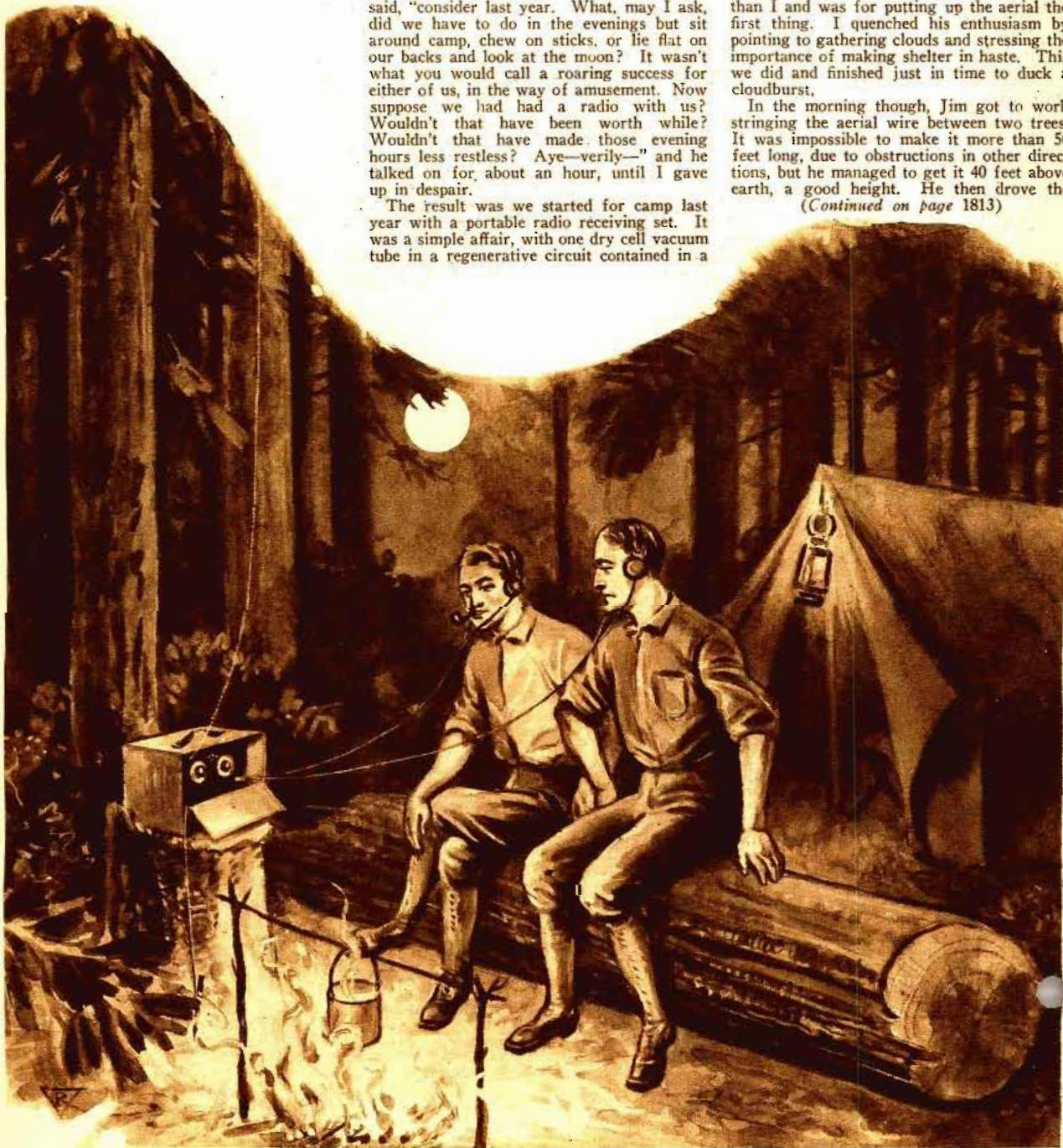

Our little camp fire burned on merrily, the tops of the monstrous trees waved lazily in the soft breeze above; the moon cast wavering shadows and WGY played "Ava Maria." At the end it seemed as though the whole world stood still, breathless, in expectation of a miracle.



# The Radio Receiver in Camp

By W. PALMER POWERS'

ASSISTANT PROFESSOR OF ELECTRICAL ENGINEERING, STEVENS INSTITUTE OF TECHNOLOGY

If you expect to take a radio with you on your camping trip this summer, by all means read this article. Mr. Powers has described a number of simple ways to erect aeri- als and make ground connections, as well as many practical hints regarding the installation and operation of a set.



WITH the summer season almost upon us, we find ourselves again confronted with the question of forsaking radio for the great out-of-doors. Most of us are not permitted to spend a very great amount of time in the open, and are, therefore, not inclined to devote much of it to, what appears to be,

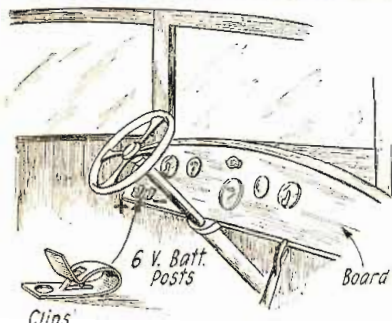

Fig. 1

Two spring-clip binding posts mounted on the dashboard of your car and connected to the storage battery provides a convenient source of "A" battery current for the vacuum tubes of the radio set.

our greatest indoor sport. After carefully considering the question of carrying along the radio set with all of its auxiliaries, we dismiss the subject as impossible. There are, to be sure, a few real radio enthusiasts who will decide to remain true to radio, and will even go so far as to make their entire vacation plans center around the radio set. A man's decision of this most important question immediately places him in one or the other of our two classes of radio enthusiasts; he is either a genuine dyed-in-the-wool radio fan, or just one of the ordinary every-day variety. It is the purpose of this article to mention some of the very simple and practical points relating to radio in camp, with the hope that more may be induced to join the ranks of the genuine radio fans and derive the extreme enjoyment which is provided by radio while otherwise out of touch with civilization.

### TYPE OF RECEIVER

In selecting the receiver for out-of-door use, several points should be carefully considered. The location will, in general, determine the required amplification, and hence the number of stages. Because of the prevailing static conditions during the summer months, one should not expect to enjoy the distant stations, as is the usual practice during the winter. Static is the limiting obstacle of our receivers today, and any receiver which, due to its extreme sensitiveness, picks up too much static, is just as unsatisfactory as the simpler receiver which is not sensitive enough to bring in the desired signal. In general, a two or three tube set using telephone receivers will be found quite satisfactory. One or two stages of radio frequency amplification with a detector and no audio frequency amplification, will prove satisfactory. A stage of audio frequency can be added for loud speaker work if desired, but comparative freedom from static will be experienced if the audio frequency is omitted. The tuned radio-frequency stages

produce a high ratio of signal to static; the audio frequency stages amplify all low frequency disturbances, including static impulses, and are to be avoided.

Because of the noise usually prevalent in camp, the loud speaker is not satisfactory. If static conditions are good, and there are no extraneous noises, it may prove a success, but even the slightest crackling of a campfire is usually sufficient to render the results very unsatisfactory. Several telephone sets can be connected in series and inserted in the output circuit of the detector tube with very good results.

For portable sets, the dry-cell tubes are by far the most convenient. They operate well on radio frequency, and if audio frequency is omitted, there is no danger of overloading. The six-volt tubes are satisfactory for camp if there is an automobile available.

If the set is to be used in or near the car at all times, the filaments can be operated on the regular car battery. It will be found convenient to mount two binding posts on the dash, and to attach these directly to the car battery terminals. These binding posts can then be used whenever six volts are in demand. The spotlight, or trouble light can be attached to these posts, and a line run to a tent for lighting purposes; or the extra battery can be connected to the posts for charging while on the road. These two posts will be found very useful as a permanent attachment, being employed for the operation of countless six-volt devices. These binding posts should be of the spring clip type, hav-

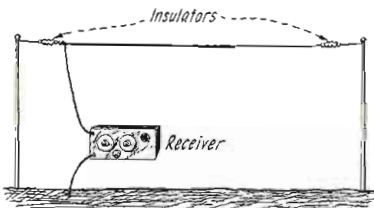

Fig. 2

With the lead-in connected to the extreme end of the aerial, the higher wave-lengths can be reached.

ing no parts to rattle loose, due to vibration. Fig. 1 shows such an installation.

### THE AERIAL

For receiving, the single wire aerial is most satisfactory. The aerial can be either "T"

or "inverted L" type; the only precautions to be observed are to make sure that the aerial is fairly well insulated, and that it hangs free from surrounding objects. In setting up the aerial it is well to keep in mind its directional characteristics. The "inverted L" aerial will receive best in the direction away from the free end; that is, the lead-in should be nearest to the station which is to be received.

The "T" type of aerial, being equivalent to a combination of two "inverted L" aeri- als, will do its best work in the direction of the

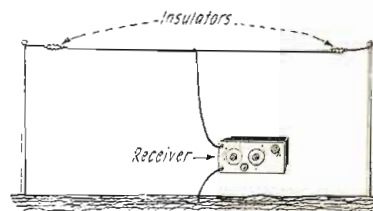

Fig. 3

When the lead-in is connected to the center, the wave-length of the aerial is reduced and the low wave-lengths can be received.

horizontal wire. These effects may, of course, be obscured by other influencing factors, but it is well to keep the point in mind, and to place the aerial accordingly. Fig. 3 shows the construction method of a "T" aerial.

For portable sets, it will be found well worth while to arrange the aerial wire on a reel. One end of the wire can be permanently attached to the reel, and some form of connector provided for the electrical connection from the reel to the receiver. A large fishing reel, or a home-made affair, will be quite satisfactory. The wire for the aerial should be small in diameter and of soft copper (bare). The free end of the aerial wire is provided with a length of good fishing cord of suitable length to properly anchor the aerial. To erect the aerial, it is only necessary to attach the reel to the car (as high as possible), or to any other convenient point, pull out the aerial wire and attach the cord to a neighboring tree. It is well to get as much elevation as possible, and it may be necessary to throw a rope over a limb of a tree and then, by this means, pull the free end of the aerial into place. Keep the actual wire well away from trees and foliage, as

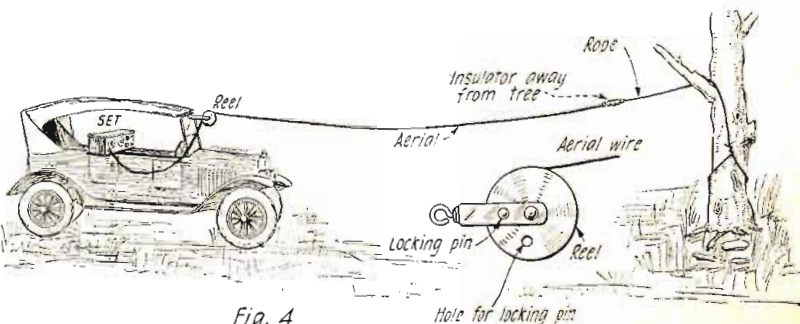
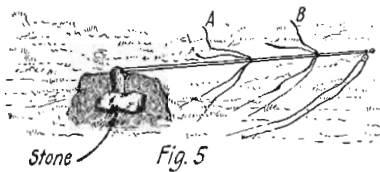

Fig. 4

A fish reel filled with wire provides a portable aerial that can be used in any location. This illustration shows the manner in which it is stretched.





Outfitting the aerial mast preparatory to raising it.

such objects will lower the efficiency of the aerial.

For the permanent camp it may be advisable to erect a pole. This will be necessary in the flat open country or at the beach, where suitable trees are not available. The problem of erecting a pole is not as serious as one would expect. The pole need not be heavy, since it has comparatively little compression duty. It must be stiff to a certain degree, and this feature can be obtained by suitable guys. After selecting the pole, decide how many guys are to be used, and just where they are to be located. If the pole is slender, it should have at least two sets of guys. The guys should be made of 1/4-inch rope, preferably boiled in tar. Wire guys will reduce the efficiency of the aerial and should, therefore, not be used. The guys can be cut very close to their correct lengths by first making some simple measurements.

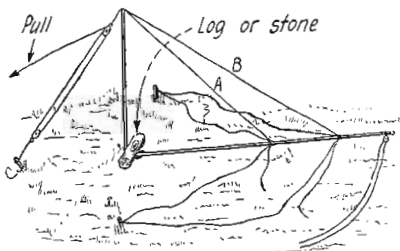

Fig. 6

A simple method of raising a mast by the use of two pulleys and some rope.

The method of erection about to be described is quite simple and enables one man to accomplish the task alone, although operations will go much faster if two men are available. First lay the pole flat on the ground with its base at the desired point. Attach a pulley at the very top and pass a

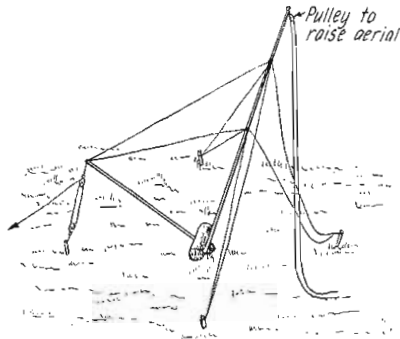

Fig. 7

The mast nearly in place, employing the method of raising depicted in Fig. 6.

cord through the pulley, allowing a length of cord equal to twice the length of the pole. Tie the two ends of this cord together forming a loop. This cord will be used for raising the aerial wire when the pole is erect. Now attach all guys to the pole and make all guys, except A and B, fast to their respective points on the ground. (See Fig. 5.)

Arrange guys A and B so that they pass over a short upright pole (gin pole) and thence through a block and tackle to a suitable anchoring point C. The pole is now ready for erection and one man pulling on the block and tackle rope (See Fig. 6) can easily raise a pole 40 or 50 feet long. There can be no danger attached to this procedure because of the fact that the pole is restricted at all times by the eight guys. As the pole approaches a vertical position, it drops into a hole provided at the base. The gin pole may be done away with as the pole

approaches the vertical position; it merely falls out of the way allowing guys A and B to pull directly to point C.

The aerial and ground function as huge condenser plates. With this idea in mind, it will seem that the antenna capacity could be properly arranged by a suitable electrical conductor near the earth and having a surface area at least as great as the aerial. A system so arranged is called a "counterpoise," and is indeed very convenient for the camper. A suitable counterpoise can be made by stretching a wire, similar to the aerial wire, along the ground directly under the aerial. This wire may or may not be elevated from the ground. It makes little difference whether the wire is bare or insulated. (See Fig. 8.)

A metal plate having a total surface of 10 square feet if buried in moist soil will furnish a suitable ground connection. A similar metal plate (or coil of bare wire) if thrown into a body of water will furnish an excellent ground. On shipboard, the metal surface of the ship is used for the ground connection. Reception is even possible if a ground connection is obtained by electrical connection to nails driven into the base of neighboring trees.

With good aerial and ground connections and proper receiver, there can be no doubt about the pleasure derived from radio while in camp. The weather reports, time signals, and last-minute news items are only a few of the valuable features on our broadcast programs.

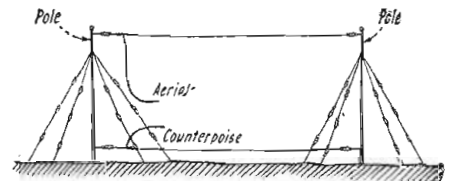

Fig. 8

If a good ground connection cannot be made a counterpoise should be used and strung as shown, directly underneath the aerial.

## Are You A Radio "Engineer"?

By HOWARD S. PYLE, A. M. I. R. E.\*

IN glancing through the radio sections of a prominent Sunday paper recently, the name of the editor conducting the section, followed by the words, "Radio Engineer", in bold type, arrested my attention. It started a train of thought that caused me to examine carefully the radio advertisements appearing in the same section. I found no less than four cards of obscure little radio repair shops, each reading something like this: "Smith & Jones, Radio Engineers. Expert repair work on all makes of sets" or "Johnson's Drug Store—an experienced Radio Engineer in charge of our Radio Department."

Carrying the investigation still farther, I scanned the radio sections of several other prominent Sunday papers and found a total of three radio editors, boasting the title of "Radio Engineer" and 11 ads worded similarly to those aforementioned. Tom Smith, down in Umptyville, became interested in radio a year ago while engaged in the battery business. Buying standard parts for a simple broadcast receiver, he actually secured results of a kind and, being a pioneer in the neighborhood, was immediately termed the "Radio King" of that section. After building a few sets for flattering friends, and repairing (by the simple process of soldering a loose joint) several others, the thing grows on him and he is finally led to believe that he has a Heaven-sent skill in the new art that is almost uncanny. He accordingly read a few books and after read-



The bird who palms himself off as a Radio Engineer.

ing of frequencies, capacities and inductances, tells the world that what science doesn't yet know about radio, he long since forgot. Then Tom soon picks up several little jobs building and repairing broadcast receivers. He soon sees a profitable business in parts and services and accordingly arranges for discounts from a few mail order supply houses and hangs out his shingle as "Radio Engineer."

Similarly, Ed Jones, a struggling young reporter on some small newspaper, feels the sting of the radio bee and builds himself a replica of some popular broadcast receiver, carefully shielding his use of the one gas-jet for soldering purposes in his attic bedroom, from the prying eyes of the landlady. Enthusiasm on his remarkable results to the other boys in the office brings him eventually to the notice of the editor who wants to "get a radio section going." He accordingly grabs Eddie, shoves him into a chair and says, "You're Radio Editor." The result is very often a new "Radio Engineer" in the field.

Just what is a Radio Engineer? Is there nothing more to radio than just the few coils and condensers comprising a modern broadcast receiver? Would our engineer-battery man or our engineer-editor be right at home in the transmitter room of a 20-KW tube station, or a 30-KW arc or even with a 1/2-KW marine spark set? Could they measure frequencies, plot resonance curves, determine decrement?

(Continued on page 1829)

\* Asst. U. S. Radio Inspector, 8th District.



# Directed Radio Rays

By Prof. RENÉ MESNY

Part 2



The experiments described in this article were carried out to determine whether or not electromagnetic waves are reflected on the Heaviside layer. From the results obtained it seems that reflection occurs as well as some other phenomena.



THE attention of the experimenters was attracted by the efficiency of the short wave-lengths at the same time that successful transmission was accomplished on long waves. However, the efficiency of the system was rather doubtful since it was necessary with long wave-lengths to use a great amount of energy to obtain a steady and constant contact between the transmitter and the receiver. On account of atmospheric disturbances it was necessary to increase the power in great proportion so that the signal strength would be sufficiently greater than static at any time of the year, to insure reliable and accurate reception.

It is easy to understand that the efficiency of the long wave system is very low and that most of the energy sent into the antenna is lost in useless radiation. On the other hand, at the time short wave transmission was first considered Zenneck and Sommerfeld pointed out that the short wave-lengths would be rapidly absorbed when traveling over certain parts of land. The theory of a reflecting ceiling—the Heaviside layer—used to explain the success of long distance communication, showed the possibility of avoiding, to a great extent, the loss of energy through the ground. It was necessary to radiate the energy, not in waves directed on the ground level as is now done with ordinary antennae, but following an inclined direction so as to project them away from the ground and toward the layer of ionized air. Commander Chaulard, working under the direction of General Ferrié, undertook the work of demonstrating the theory which seems logical enough and requires only a modification of the antenna construction. The theory is that in a ground which is a perfect conductor a variable antenna vibrating with a node at its center produces no radiation in the horizontal direction. Fig. 1 shows in dotted lines the diagram of radiation from an antenna vibrating in quarter wave, and in full line the radiation of an antenna vibrating in full wave. The vector lines M and N give the value of the radiated field in corresponding directions.

One may find in a study of the subject by Van der Pol, Jr. (1917), a complete series of diagrams corresponding to various positions of antennae which may be employed. He used at the time various types of antennae to verify the existence of a reflecting layer. Of course a great many combinations are possible, but the main fact is that the inclination of the beam may be varied at will. One solution which seemed quite attractive was the possibility of replacing the transmission of long wave-lengths from high power stations by a concentrated beam of short waves properly directed in a vertical direction so as to elim-

inate the losses on the ground around the transmitter.

A great many objections to the possibility of this system were considered and it was necessary to prove the theory by actual experiments. It was a new field for research and the scientific interest was very great, since it was necessary to show the possibilities of facts which certainly play an important part in a great many terrestrial phenomena.

An amateur trans-Atlantic test tried out in 1922 demonstrated beyond doubt the possibility of long distance transmission at short wave-lengths. No actual scientific measurements were made during these tests and they were too short to check the consistency of the results. For this reason it was necessary to try some short wave transmissions in order to assemble a sufficient amount of data to prove the theory. A method devised by Commander Chaulard consisted in measuring at various distances from the transmitters, the intensity of signals radiated by two transmitting stations having the same antennae frequency and the same wave-length, but with two different sizes of antennae. One of them was made to vibrate in quarter waves while the other was on an harmonic producing a beam, the intensity of which was maximum in a direction inclined

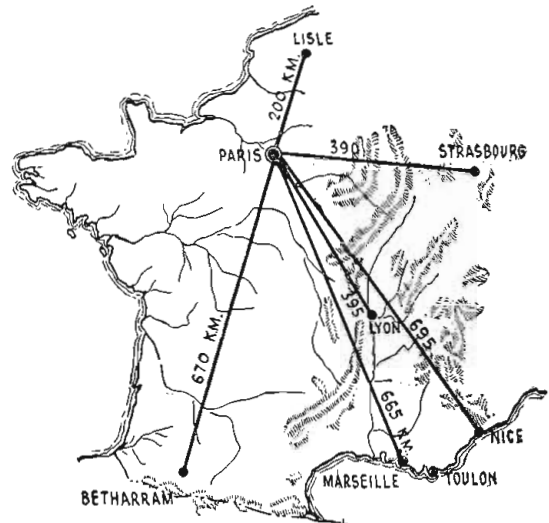

This map of France shows the distances at which the 45-meter signals were heard. Most of the observations were made North, East and South of Paris.

receiving stations installed at various distances from the transmitters and receiving all at the same time the signals to be measured, and it was then that General Ferrié had the idea of calling upon the amateurs.

The experiments, although successful, did not produce all the data expected, on account of the difficulties encountered in installing the transmitting equipment. It would have been necessary, in order to have very accurate results, to install the transmitters in an ideal location having an antenna erected at a distance from any conducting object capable of producing troublesome radiation, by absorption or distortion.

For various reasons and in order to reduce the difficulties in the construction of the sending apparatus, a wave-length of 45 meters was used; however, the ideal conditions were not realized as it was necessary to install all the equipment on grounds belonging to the Government which were not the best for such scientific research work. In fact it was found so difficult to obtain the proper equipment that a wave-length of nine meters was substituted for the original one, so that a self-supporting antenna could be used. The experiments with the nine-meter wave were tried out for only a short time and over short distances and no definite data has as yet been assembled.

Before mentioning the results obtained we shall describe the apparatus. It was decided that for the antenna vibrating on an harmonic a single vertical wire AB, in Fig. 3, should be used. This wire was about 45 meters long and terminated at the base in a horizontal extension BC very close to the ground. The horizontal part vibrated in quarter wave and the vertical part in full wave. For the ordinary transmission, the antenna consisted of a single wire about nine meters high. The transmitting apparatus consisted of the circuit described in the first part of this article

(Continued on page 1852)

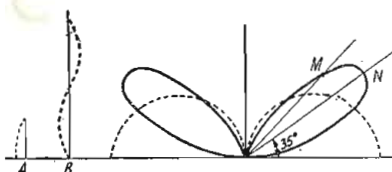

Fig. 1

Showing the field radiated from an antenna in various directions.

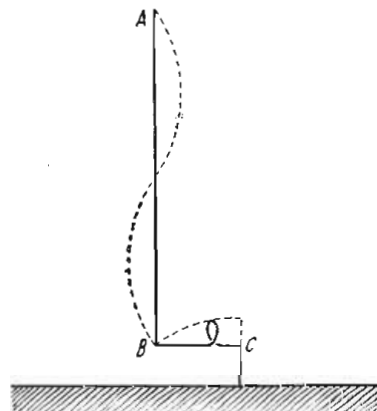

Fig. 2

Type of antenna used for transmission on harmonic.

35 degrees on the horizontal, and zero on the horizontal plane. According to the theory and considering the possibility of the reflecting layer the signal intensity from the first station was to decrease with the distance while that of the other was to be zero at a short distance, then increase and pass through a maximum.

It was necessary in order to obtain conclusive results to have a great number of



# Detecting Music With a Nitrogen Tube

By C. B. BAZZONI

PROFESSOR OF EXPERIMENTAL PHYSICS, UNIVERSITY OF PENNSYLVANIA

Experiments are being carried out in several countries with new gas content tubes which seem to be more efficient than the standard vacuum tubes. Mr. Bazzoni describes in this article a nitrogen tube which seems to have great possibilities for radio work.

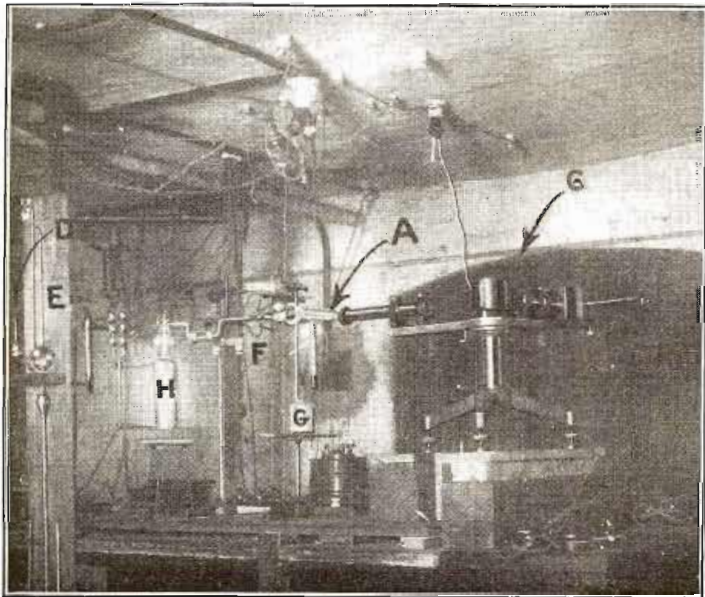

The complete apparatus used in the research section of the Randall Morgan laboratory of physics at the University of Pennsylvania.

the current will instantly cease. A gap of this sort between a hot filament and a cool plate is evidently a rectifier of the most efficient kind. If an alternating potential passing from positive to negative values and back again at intervals is put on the plate, the current passed in the plate circuit will be pulsating direct current—one pulse for each time the plate becomes positive.

### PLATE ATTRACTS THE ELECTRONS

The electrons which evaporate from the filament come out with so little velocity that we may regard them as at rest prior to the application of a potential to the plate. When the plate is charged positively by closing the "B" battery switch, the electrons fall across to the plate and, in falling, acquire energy just as a brick would acquire energy in falling from the roof of a house. That this energy of motion is released when the electron is brought to rest is evidenced by the well known fact that the plate will heat up and hot or even melt if too high a potential is applied to it. This heating of the plate is due entirely to the electrons striking it. Receiving tubes are, of course, always designed with enough radiating surface on the plates to keep them fairly cool under bombardment by electrons drawn over by the normal operating plate voltage.

We may liken the electron shooting across from the filament to the plate to a bullet shot from a gun against the plate as a target. If the electron bullet strikes anything before it reaches the target it will give up its energy to the thing struck. In tubes which contain any appreciable amount of gas, as air, or of vapors, as of mercury or sodium, the electrons may strike atoms of the gas

(Continued on page 1834)

**T**WENTY-FIVE years ago electricity was commonly looked on as a property of matter—nowadays it is more usual to look on matter as a property of electricity. Recent researches in physics have pretty well demonstrated that the atoms,—those ultimate particles which make up all forms of matter—are composed of positive and negative electricity grouped together in a generally stable fashion. The positive electricity is concentrated at the center of the atom into a very small fraction of the whole volume and around it the negative electricity is distributed in separate particles, all exactly alike, called electrons. We are thus justified in saying that matter is electricity in a certain state of aggregation. A great deal has been printed in the general press in recent months about the constitution of atoms so that most people now know that atoms can, in a sense, be compared to solar systems, the positive electricity being the sun around which the negative electrons move more or less like planets. Since it is now thought

Conducting materials, like metals, differ from insulating ones, like rubber or bakelite, in that the conductors have in them electrons, which are movable under the influence of charges of electricity, while in the insulators the electrons are fixed in position. If one end of a metal wire is kept negatively charged and the other end positively charged, there will be a flow of electrons through the wire from the negative end to the positive end. This flow is an electric current. The rate of flow is small, about one two hundred and fiftieth of an inch per second in the filament of an ordinary vacuum tube. If the charges are removed from the ends of the wire the flow ceases, but the electrons do not cease to move. Due to the heat contained in the metal at all ordinary temperatures the electrons fly about in an entirely haphazard way with speeds which average around 35 miles per second.

### SPEED INCREASE WITH TEMPERATURE

These speeds increase with the temperature. At room temperatures, the energy of this motion is not sufficient to carry the electrons out through the surface of the wire but, if the wire is heated to a bright red or white heat the energy of electronic motion is so increased that the electrons begin to fly out of the wire; that is, negative electricity begins to "evaporate" from the filament. This is what happens in a two or three electrode tube when the "A" battery switch is closed. In fact, the only use of the "A" battery is to maintain this evaporation. The electrons liberated from the filament are drawn over to the plate by the positive charge from the "B" battery and constitute the plate current.

The current from the filament to the plate is thus seen to be made up of electrons evaporated from the filament and drawn to the plate by the "B" battery potential, which is arranged to be positive. This current is obviously unidirectional; if the plate becomes negative the electrons, being negative electricity themselves, will be repelled and

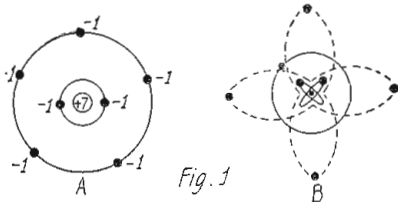

This diagram shows the arrangement of the electrons in an atom.

that all the chemical and physical properties of matter must depend on and alter with the arrangement of electrons in the atoms, physicists throughout the world are at present trying to find out exactly what this arrangement is, for each of the chemical elements.

This electron which occurs as a universal constituent of all atoms is the same electron with which the radio amateur is so familiar.

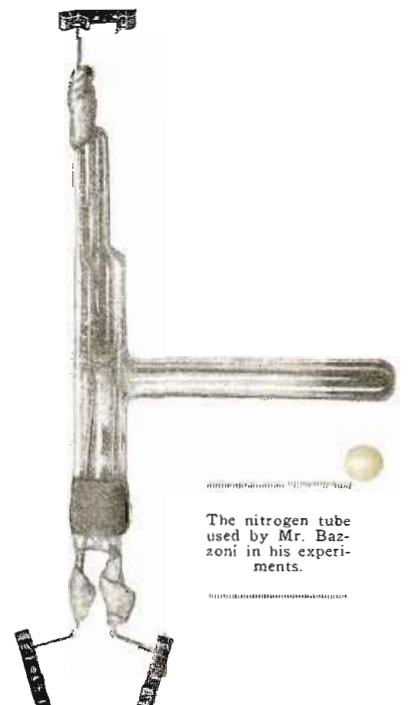

The nitrogen tube used by Mr. Bazzoni in his experiments.



# French Radio Novelties

By YVES DROPPER

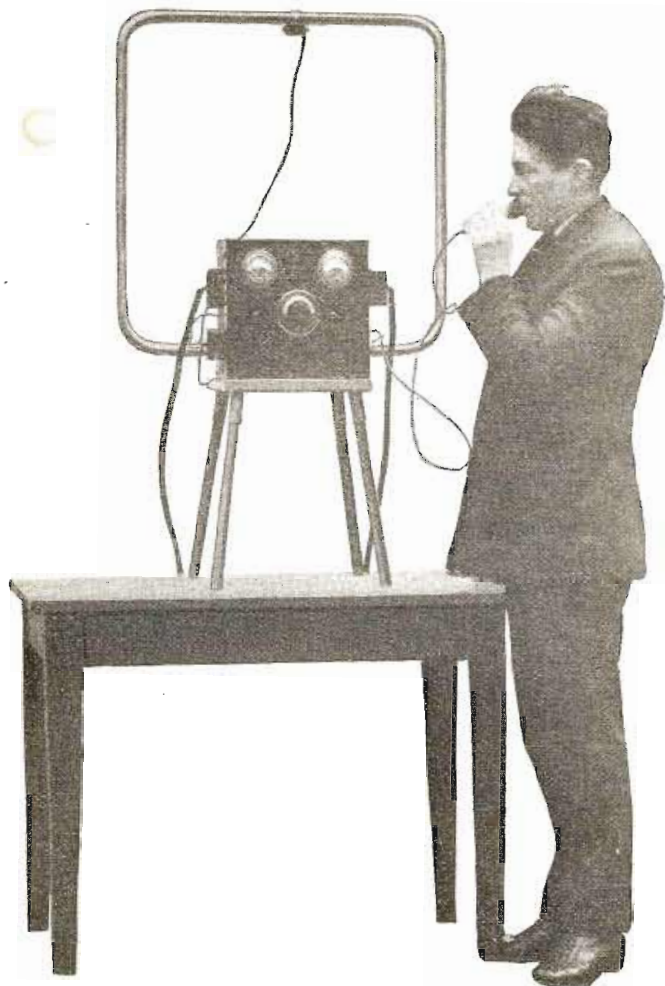

One of the most interesting novelties seen at the Radio Show, recently held in Paris, was the portable short wave radiophone and C.W. transmitter and receiver, shown on the left. The oscillating circuit composed of one turn acts as the loop for sending and receiving. It is operated from a storage battery which makes it practical for use on board automobiles, motor boats, etc. or for amateur work. On the right is a new powerful loud speaker, which may be heard several miles away when used with a power amplifier.

may easily be carried in an automobile or on a small boat for short distance communication. This transmitting set, illustrated in the photograph, uses a loop made of a copper tube rigidly mounted on the cabinet inside of which are all the controls, tubes, etc. This transmitter works on wave-lengths ranging from 40 to 60 meters and has a consistent range of about 25 miles in telephony and 60 miles in telegraphy. A small machine supplied by an ordinary storage battery furnishes the plate voltage for the transmitting tubes which are of a novel type, consuming very little current. There is no separate oscillating circuit in this transmitter, as the loop itself constitutes the inductance shunted by a very good variable air condenser. A clip which can slide along the upper portion of the loop is used to vary the wave-length. The same loop is used for reception with a radio frequency amplifier especially designed to function on very short wave-lengths which were found much more efficient on account of the absence of static disturbances.

Several types of vacuum tubes similar to the well-known American types with thoriated filaments were exhibited, the only difference being in the construction of the



base which is designed to fit into special plugs.

Among the receivers shown was a new type functioning directly on alternating current without any filament or plate battery. These receivers, made in different types, with radio and audio frequency amplification, are provided with a plug which may be inserted in any lamp socket and are provided with a proper filtering system to cut out any hum or noises. This type of apparatus is already quite popular in France and is entirely practical. A particularly interesting feature to be noted is the use of the rectified alternating current to supply not only the amplifying tubes, but also the detector. Such sets are entirely fool-proof and may be handled by the most inexperienced persons.

**S**OME very novel and unique radio apparatus was displayed at the mammoth physical and Radio Show recently held in Paris. This exhibition was very successful and was attended by a great number of persons interested in scientific matters. Besides the radio section, which occupied the larger part of the show, there were exhibits of physical and electrical apparatus. Actual demonstrations were given of electrical and radio phenomena which attracted a great deal of attention. One of the features of the exposition was the loud speaking apparatus in-

stalled on the roof of the Grand Palais housing the show, through which music and speeches were transmitted and made audible for the crowd outside. This loud speaking apparatus was so powerful that it could be heard plainly at a distance of one-half mile in spite of the noises of the street. Inside of the building, other loud speakers were used to reproduce music received from various broadcast stations. This system was remarkable for its clearness of reproduction.

Among the most interesting novelties introduced may be mentioned the new magnetic modulator which produces, without distortion, a very efficient modulation of a carrier wave. The sketch, Fig. 1, shows the connections of this apparatus which may be employed to modulate any amount of power with practically the same amount of efficiency. It has been found during the test carried out with this instrument, that the modulation of 80 per cent. of the average intensity may be obtained in radio telephony. With one of these modulators used in conjunction with a transmitting station of 15 kilowatts, the losses do not exceed 300 watts.

Another novelty which attracted considerable attention was the new high power loud speaker which produces a tremendous volume without distortion and may be supplied with powers as high as 25 or 30 watts. Of course, a special power amplifier is necessary for this loud speaker.

The most interesting transmitting set exhibited was the small loop transmitter which

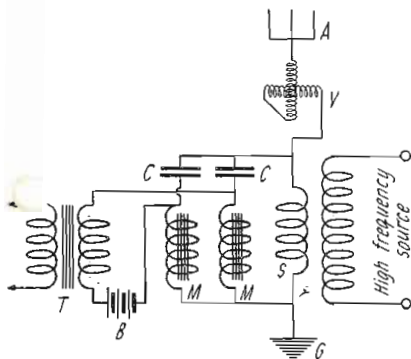

Fig. 1. Diagram of the magnetic modulator for radio telephony. This system has a very high efficiency and produces very good modulation.



# The Antenna System

By A. P. PECK



This is the first of a series of articles for the radio beginner by Mr. Peck. We are sure that the readers of this section will benefit by this one as well as the ones to follow.



**S**INCE all signals heard in a radio receiver must come into it through the antenna, it is most important that this part of the set be constructed for highest efficiency if the best results are to be obtained. Very few beginners realize the importance of this unit of the

deal with in radio work is a more or less imaginary substance, the existence of which is conceded by the majority of scientists, but denied by others, more radical in their work. We will accept the theory that it is present. The ether pervades everything, no matter how solid the substance may seem. It is present in stone and wood as well as in liquids, metals and other things with which we are all familiar. In fact, it is everywhere, and since radio waves are set up in it, it is easy to see that radio waves can penetrate almost every imaginable place. The only main objection to saying that they do go everywhere is because they do not penetrate large masses of metals, such as large steel buildings, very readily. This, however, is because such structures seem to short circuit the waves or provide a path to earth, which they follow very readily and, therefore, we find reception in a steel building with an indoor aerial to be poor.

Now let us get back to the transmitting aerial. We find radio waves going off from it into the ether and traveling through space at a speed equal to that of light; 186,000 miles a second. Just think of the last time you saw a stone drop in water. Remember how little ripples went out from the point where the stone landed? That is just what happens in radio. Here the waves are in

frequency and the same in all respects as the current in the transmitting aerial. Except that it is very much weaker. Here is the meat of our problem and the reason for erecting a receiving aerial.

Therefore, we see that when the radio wave strikes our aerial, we will have an electrical current flowing therein. Thus the receiving aerial may be likened to the human ear in that it collects impulses and passes them on to that point where they are made audible. The ear collects sound waves from the air and the aerial collects radio waves from the ether. In the case of the ear, these waves are passed on to the ear drum where they are made audible, while in radio, the current set up or induced in the aerial by the radio waves is passed on to the receiving set, where various changes take place and the electrical currents are so changed in character that they become audible to the ear and are reproduced so that the sounds or music are the same as those formed at the transmitting station.



FIG. 1

For receiving purposes a simple one-wire aerial strung between the house and a tree or mast is the best.

receiving set, as may be witnessed by viewing the nondescript aeriels erected in any community.

An aerial may be defined as any metallic object suspended in space for the purpose of collecting ether waves. Since every impulse that acts upon the receiving set must pass through—yes, must be picked up by—this agency, it is obvious that a set may be only as efficient as the aerial from which it draws its energy. Both the strength of the signals received and the distance from which they come are directly dependent upon the efficiency of the antenna.

In order that the novice may know the best methods to follow in the construction of his collecting agency, and the best methods of installing it, it will be well to go into a discussion of the function of aeriels in general and to explain as clearly as possible the points in their plan that directly affect efficiency.

## THE AERIAL

Let us first look into the function of the aerial. To do this, we must start at the origin of the radio message, the transmitting station. Here, through various electrical devices, music and speech are transformed into vibrations of an electrical current which vibrations are led to the transmitting aerial. Just what changes these currents go through before they reach this point will not be discussed here, because to do so would involve many technicalities. It will suffice to start with a current of electricity in the aerial of the transmitting station. This current is alternating in character. This means that the current changes its direction of flow a certain number of times per second. In other words, the polarity shifts from positive to negative (+ to -) at a certain frequency, the frequency being the number of times that this change takes place in a second. The current in the transmitting aerial is said to be of radio frequency since its polarity changes so rapidly. The current is also referred to as oscillating.

This current has the property of setting up waves in the ether in much the same manner as a stone thrown into a pond sets up waves in the water. Therefore, we have our transmitting station as the power behind the stone, our oscillating current as the stone and the ether as the water. Do not confuse the term ether with the material used by surgeons for inducing unconsciousness during an operation, as it is something entirely separate and distinct. The ether we

the ether and are of a certain length, which dimension is expressed in meters. The length is from the crest of one wave to that of the next and the number of meters between these two points is called the wavelength. The meter is the European unit of measure of length and is equal to 39.37 inches in our system. The broadcast stations operate on various wave-lengths from 220 to 550 meters. The reason for the differences will be discussed in a future article.

So far, we have our transmitted wave carrying music or speech into the ether and it is hurtling through space towards our receiving station. The character of these waves is such that when they strike, or rather pass through, a metallic object or conductor of electricity, they set up therein, an electrical current. A conductor is any material which will carry an electrical current, an insulator being the opposite or a material which will not carry a current. There are good and bad conductors and insulators. For carrying current, use the best conductor obtainable, and for insulation, the best insulator. Copper is an excellent conductor, while bakelite and other compounds of a like nature are good insulators. The current in the receiving aerial is of the same

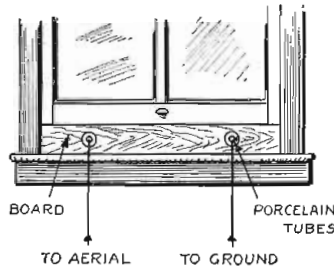

FIG. 2

One manner of leading the aerial and ground wires to the receiving set without making holes in the window sash. The window can be raised and lowered without disturbing the wires.

## ENERGY COLLECTOR

Now let us get down to a few hard facts regarding the aerial so that we can realize the necessity of observing the precautions that are advised below in the erection of an aerial or collector of energy from the ether. While there is an enormous amount of electricity used in a transmitting station, still the losses encountered by the waves while traveling through the ether are so great that only a very minute fraction of the same current is set up in the receiving aerial. Electricity is measured in four ways—namely quantity, pressure, the amount which will pass through a standard one ohm resistance in one second, and the product of the last two. The amount of electricity is designated by the term coulomb, in the same manner that the quantity of water in a tank is measured in gallons. Water, when released from a tank, rushes out at a certain pressure which is measured in pounds. Similarly, the pressure exerted on a current of electricity is termed the voltage. An ampere of current is the accepted unit of current which will flow through a one ohm resistance under a one volt force in one second. Multiplying the amperes by the volts flowing in a certain circuit, we obtain a figure which is expressed in watts. This is the unit of electrical activity or the rate of work performed by electricity.

There is found in the antenna only a very small fraction of an ampere being impelled by a very low voltage. Knowing this, we can insure ourselves against poor reception because of a poor aerial. With very small currents it is very easy to lose some of it because of faulty insulation. If the wires which compose the aerial touch any object that can conduct the electricity to the ground, much of our very small current will

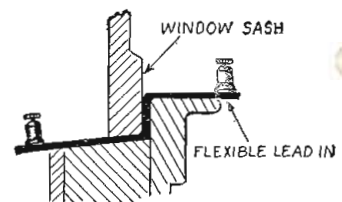

FIG. 3

An easy way to lead the aerial wire into the receiving set. A piece of well insulated copper ribbon is employed.



leak off and consequently our reception will be poor. All metals are conductors, as are also wet wood and paper and some kinds of paint. Therefore, if you erect your aerial out of doors, use the best insulators obtainable for the money you can spend, and take care that the wires touch nothing but well insulated objects.

The aerial and ground together are called the antenna system, so a few words on the ground connection will next be given. Some writers say: "Connect your ground lead or to a water pipe." They let it go at that. It is not sufficient to do only this, but you must be sure that the water pipe you connect to eventually goes to the earth and makes a good contact thereto. Most all city water supply pipes do this, but it is well to investigate before making the connection. If you live where it is possible to do so, obtain a six or eight-foot length of one-inch galvanized iron pipe and drive it into the earth in a moist spot. Before driving it, place a pipe cap on the upper end so that the pipe will not close up under the blows of the hammer. Remove this cap after driving, and occasionally pour a pail or two of water into and around the pipe.

**THE GROUND**

The actual ground connection, that is between the wire and the pipe, may be made in one of two ways, but no other. Either the wire may be soldered to the pipe, or a ground clamp must be used. In either case, the pipe must be scraped perfectly clean at the point of contact. This can best be done by rubbing vigorously with coarse sandpaper until the metal of the pipe shines brightly. Then if the joint is to be soldered, wrap the wire around the pipe several times, drawing it as tight as possible. Then apply the flame of a gasoline blow torch to the pipe, and wire until the junction is thoroughly heated to a point where solder will melt when touched to the pipe. Use resin core solder and apply to the joint, at the same time keeping it heated. The solder will be seen to flow into the crevices between the wire and pipe, forming a perfect connection. If it does not do this, but forms in small lumps of the consistency of putty, the pipe is not hot enough. If the solder flows freely, but does not "sweat" into the joint, either the wire or the pipe is not clean. It is practically impossible to solder a joint of this type with a soldering iron, so a blow torch of some kind must be used.

The use of a ground clamp instead of using solder is sometimes necessary because of the location of the pipe to which the connection is to be made. Here, also, scrape the pipe clean and wrap the clamp around it. Draw it up as tightly as possible, so as to make a solid connection and fasten the wire to it. This joint must also be tight. Failure to observe these points will often cause a great deal of trouble, and so it pays to do the job right in the first place to avoid having to do it over again.

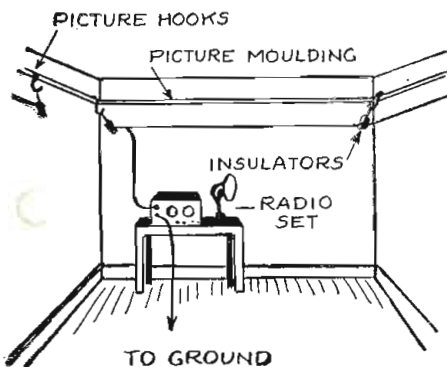

**FIG. 4**

When one must confine his aerial to a single room it is best to mount it along or behind the picture moulding so as to obtain the greatest length of wire possible.

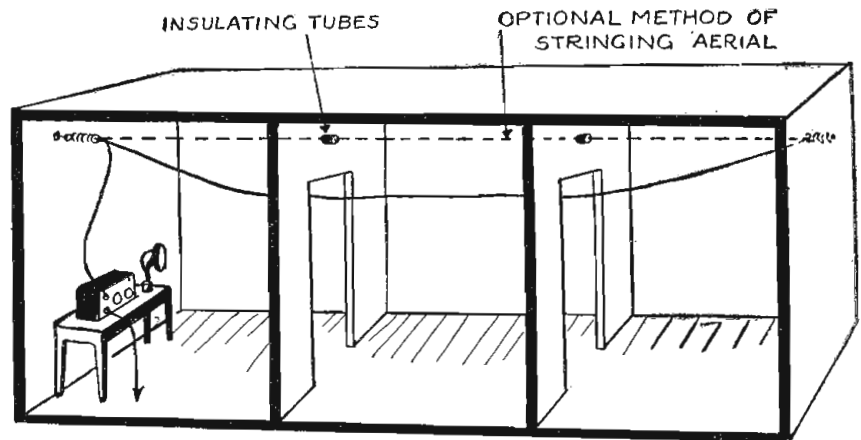

**FIG. 7**

An indoor aerial, contrary to the opinion of some people, works very well providing it has sufficient length. The above illustration shows two methods of installing indoor aerials.

An aerial and ground are necessary adjuncts to any but the most sensitive and expensive receiving sets, so put up the best aerial you can, considering your location, and install a good ground. Time spent on these points will never be regretted.

To cover the subject of aerials properly it is necessary to divide locations into two classifications. The first is that where the novice has plenty of room to erect an out-

door aerial 60 to 80 feet long, exclusive of the lead-in or wire connecting the aerial proper to the receiving set. The second class is that where the aerial must be put up indoors. We often hear that indoor aerials do not give as good results as those located outside. This is usually true, but if the reason is not explained, it is liable to lead to wrong impressions, one of which is that the windows must be opened to let the waves in, because they cannot penetrate the walls. Put this sort of stuff down as pure "bunk" except when steel buildings are under discussion. The drawbacks to this type of structure were mentioned in a former part of this article. The true reason for the low efficiency of an aerial located inside is that a sufficiently long stretch of wire cannot usually be put up. Most types of indoor aerials are limited to 30 or 40 feet in length overall, including the lead-in or wire from the aerial to the set. These wires, not being of sufficient length to pick up a very great amount of current, do not supply the receiving set with enough electricity to yield loud signals, or music and voice reproduction.

**DIMENSIONS**

We will first devote a few words to the subject of outdoor aerials, saving the larger part of our allotted space for the treatment of the subject of indoor types. Most of us have seen many types of outdoor aerials and can form our own opinions of the type which we can best erect in our available space. However, we show here-with in Fig. 1 one of the best types. A pole 30 to 40 feet long is secured (unless a nearby tree is convenient) and solidly fixed in the ground. Before putting it up, place a pulley at the top with a rope through it, long enough to reach to the ground. This is to be used to hoist one end of the aerial to the top after the pole is erected. Also place several wires of sufficient length at the top; these are to be fastened to stakes driven in the ground and which serve to support the mast firmly. These last mentioned wires are called guy wires, and should be provided with an insulator in the center of each one, as shown. Before the aerial is pulled to the top of the mast with the rope provided, place an insulator at the end of the wire, fastening the other end of the insulator to the rope. The best insulators for aerials are made of a composition called Electro-se or of glazed porcelain.

At the other end of our aerial, we fasten another insulator, connecting the latter to the house with another piece of wire. Before doing this, the lead-in or wire to the set must be soldered to the aerial. The best wire for the aerial is that known as seven-strand phosphor bronze, No. 14. Solid copper wire of the same size is also good, but not as strong. The lead-in may be of the same material, although some prefer insulated wire which is made with a water-proof cover and designed to be used for outdoor work.

Bringing the lead-in into the house is another problem. Figs. 2 and 3 show us two good and convenient methods. In the

(Continued on page 1855)

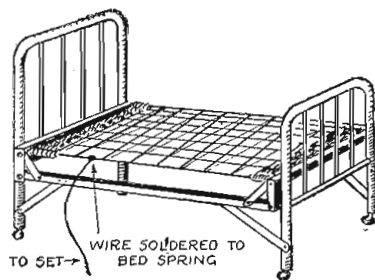

**FIG. 5**

A bed spring makes a fair aerial, particularly if it is well located. Distant reception, however, is doubtful with such an arrangement.

door aerial 60 to 80 feet long, exclusive of the lead-in or wire connecting the aerial proper to the receiving set. The second class is that where the aerial must be put up indoors. We often hear that indoor aerials do not give as good results as those located outside. This is usually true, but if the reason is not explained, it is liable to lead to wrong impressions, one of which is that the windows must be opened to let the waves in, because they cannot penetrate the

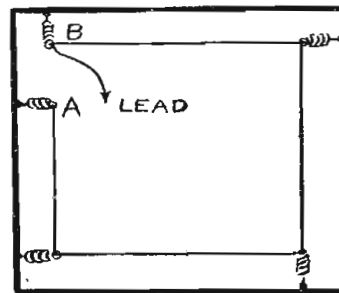

**TOP VIEW OF AERIAL**



# The Vacuum Tube and How It Works

By Prof. John H. Morecroft, E. E.

ASSOC. PROFESSOR OF ELECTRICAL ENGINEERING, COLUMBIA UNIVERSITY

## Part 2



This is the final installment of Professor Morecroft's interesting story of the vacuum tube. In this article he takes up the application of the vacuum tube to transmitting and receiving circuits and amplifiers.

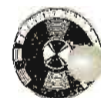

ONE of the most important roles played by the triode in radio work is that of increasing the strength and making audible signals that would otherwise be too weak to affect the receivers. It is this use of the triode as amplifier which makes it possible to telephone, by wire, from New York to San Francisco. By the use of proper amplifying tubes a speaker in one place may be heard from loud-speaking horns, by thousands of people gathered in halls many miles away. It is perfectly possible today for a political candidate to address at the same time hundreds of meetings, and the people in each of the halls where the loud-speaking horns and vacuum tube amplifiers are located may hear him more distinctly than if the speaker himself were in the hall with them. Actually he may be in his study at home.

### HOW THE VACUUM TUBE AMPLIFIES

By using a very small amount of power to affect the potential of the grid of a tube, large amounts of power may be controlled in the plate circuit. The large amount of energy controlled does not come into the receiving circuit from the receiving antenna but from the "B" battery in the tube circuit. The flow of this large amount of energy through the loud-speaking horns makes no noise as long as the flow is uniform, but if a signal is impressed on the grid of the amplifying tube the flow of energy from the "B" battery is made to fluctuate and the form of the fluctuations resembles the signal voltage, and so the voice which is to be reproduced.

*Resistance Amplifier.*—In Fig. 13 is given the elementary idea of amplification using a resistance in the plate circuit of the tube. The signal voltage to be amplified is impressed between the grid and filament of the tube, and, as we know, the variation in the grid potential will produce a corresponding variation in the value of the plate current. This pulsating plate current flows through the resistance *R* and so will produce pulsating voltage across the terminals of this resistance.

This variation in voltage drop through the resistance *R* is very much like the variation

in the loss of pressure when water flows through a piece of pipe or hose. If the water system to which the pipe is attached has a pressure of 100 pounds per square inch there will also be this much pressure at the end of the piece of pipe, provided no water is flowing through the pipe; that is, if the valve at the end of the pipe is closed. But if the valve at the end of the pipe is open, so that water can flow, the pressure at the open end of the pipe will now be less than 100 pounds, because of the loss of pressure in the pipe itself. This loss of pressure will depend directly upon the amount of water which is allowed to flow through the pipe; if the valve is nearly closed so that but little water can flow, the pressure at the end will be nearly 100 pounds, but if the valve of the pipe is opened wide so that much water can flow, the pressure at the end of the pipe will be almost nothing. But if the pressure at the end of the pipe is less than 100 pounds the difference must have been used up in forcing water through the pipe. So we get the idea that the drop in pressure through the pipe is proportional to the amount of water flowing through it. In the same way the drop in electrical pressure, or voltage, through the resistance *R* of Fig. 13 is proportional to the plate current which is flowing through it.

### ADDING TUBES TO OBTAIN GREATER AMPLIFICATION

If the tube circuit given in Fig. 13 is operating properly the pulsation in voltage across *R* will be of the same shape as the signal voltage but much larger; with the ordinary tube and suitable resistance, about four times as large. The amount of power used by the grid in changing the plate current, it must be remembered, is practically nothing. Much the same action might be produced with a flow of water instead of a flow of electrons. If a fire hose were equipped with a valve about the same as the ordinary faucet it would be very easy to shut off or start the powerful stream of water. A small child, by vibrating the valve handle, could produce corresponding pulsations in the stream of water, and the power in the pulsations of the water stream would

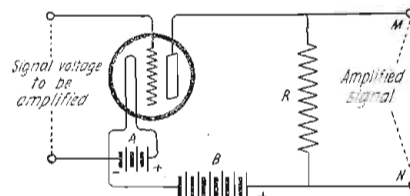

Fig. 13

The elementary idea of an amplifier; the variation of grid voltage makes the plate current, through resistance "R", vary and thus produces at terminals M-N the voltage impressed on the grid, much amplified.

be thousands of times as great as the child could possibly exert. The grid in the triode performs the same function as the valve, permitting weak voltages to control powerful streams of electrons.

Instead of being satisfied with the amount of voltage amplification which can be obtained from one tube, it is quite feasible to connect points *M-N* of Fig. 13 to the grid and filament of another tube. The voltage impressed on the grid of the second tube would be then four times as great as the voltage of the signal which was impressed on the grid of the first tube. The points of the resistance of the second tube, corresponding to points *M-N* of the first, may be connected to the grid and filament of a third tube. As the voltage impressed on the grid of the third tube has been increased four times by the first tube and then again four times by the second tube, the third tube will have impressed on its grid a voltage 16 times as large as the original signal voltage.

Such a scheme is shown in Fig. 14; the whole arrangement is called an *amplifier*, and some such arrangement is used in every good receiving set. An amplifier is said to be "two-stage," or "three-stage," etc., according to the number of tubes used. The one shown in Fig. 14 consists of one detector tube and two amplifying tubes, or we might say of a detector and a two-stage resistance coupled amplifier.

By such an arrangement it is evident that the signals, which, with a one-tube receiving set, are entirely inaudible, may be made very loud. This question will at once occur to the reader: If such a connection of tubes will amplify weak signals a hundred times or more, why not use more of the same arrangement and amplify signals several million times instead of a few thousand times, as is the practice?

*By How Much Can We Amplify?*—By means of such an amplifier just described it should be theoretically possible to amplify the sound made by a fly walking on the diaphragm of a telephone receiver, so that it would sound like the blow of a trip hammer, and such is really possible if necessary. In radio receiving sets it does not pay to amplify more than a certain amount because not only is the signal voltage amplified by the tubes but also all similar voltages, from any cause whatever.

There are continually present in the air electrical disturbances which resemble, to some extent, the electro-magnetic waves of

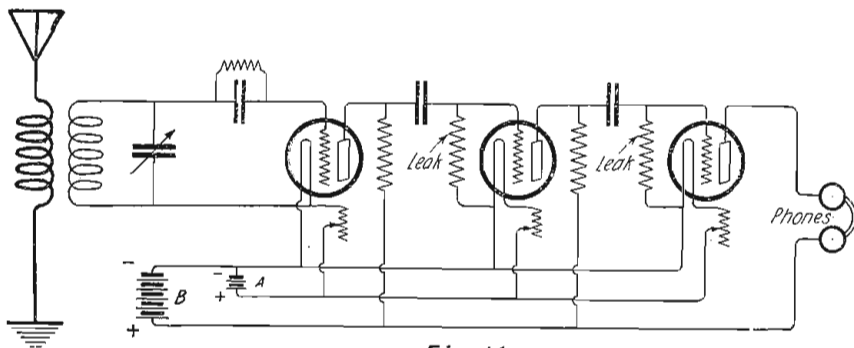

Fig. 14

A resistance coupled amplifier, used to increase signal strength. This combination is called a detector and two-stage audio frequency amplifier.



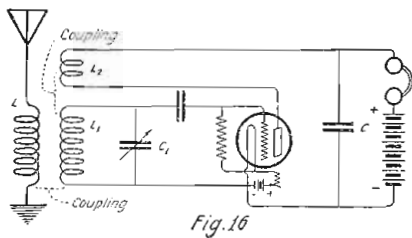

Fig. 16

A simple method of using Armstrong's "feedback" idea. The tickler coil  $L_2$  by reacting back in the grid circuit, gives a very large amplification to the signal.

radio. The wind blowing through the tree tops generates electrical signals and sends them out in all directions. Whenever moisture in the upper atmosphere condenses to form clouds, electrical impulses are sent out in all directions. Whenever one wind runs contrary to another, so that there is friction between the two air currents electrical impulses are also generated and sent out. Of course a lightning flash sends out tremendously powerful radio waves, so that even if it is several thousand miles away it may give appreciable currents in a receiving antenna.

All these electrical signals that Nature is continually generating produce noises in the telephone receivers which, if loud enough, will drown out the real radio signal. The currents set up in the ordinary antenna by these natural electrical disturbances, generally called "static," are small compared to those set up by a neighboring transmitting station, so that we only know they exist by a hissing and crackling which can be heard when there is no signal coming in.

But now suppose we want to hear a signal from a distant transmitting station, which, because of the distance, can set up but feeble currents in the receiving antenna. It may well be that these signals are so weak as to be inaudible, and so we have to resort to an amplifier of some kind to make them audible. The noises due to static will also be amplified, and it may be that "static" is so much stronger than the signal that the signal itself remains inaudible no matter how much amplification is used.

The question is often asked: How much can we usefully amplify? The answer is: It depends entirely on the amount of static and other disturbing effects present. The writer has an amplifier that can increase the signal strength 2,500,000,000 times and even this is not the limit, by any means. If the amplifier were properly connected to other higher powered tubes and a loud speaking horn, it could be increased thousands of times more.

But such amplification would be of no real value because of the excessive crackling, hissing, etc., which atmospheric disturbances would produce. And even if there were no static at all, such a great amplification would result in received signals or speech of poor quality, because of noises due to the irregularity with which the electrons boil off from the filament of the first tube of the amplifier. Yes, it is possible to hear the tumult of electrical activity as the electrons are violently ejected from the surface of the hot filament. Just as soapy water bubbles off steam in spurts, so the surface of a hot metal gives off electrons in spurts and thus makes the plate current in the first tube vary to a slight extent even though no voltage at all is being impressed on the grid. This slight irregularity will be amplified in the successive stages of the amplifier until it produces audible noises in the telephone receivers at the end of the amplifier. Also, as the electrons move over from the hot filament to the plate of the first tube they bump violently into the air molecules that happen to get in their path, and this bumping

will also produce irregularities and disturbances that will produce audible noises.

We have spoken about irregularities in the first tube of the amplifier. The same thing is going on in all the tubes, but the effect is amplified more for the first tube. Hence in this first tube most of these "internal noises" originate.

The question might well be asked:—How can the electrons bump into air molecules if the tube has been evacuated, and so freed from air? It must again be pointed out that with the very best evacuation possible today, using the most modern and thorough methods for getting out all the gas, there is still so much gas left that each cubic centimeter of space in the tube still contains about 100,000,000 molecules of air—certainly enough to permit many collisions with the rapidly moving electrons.

HOW AMPLIFICATION SOMETIMES DISTORTS RECEIVED SPEECH

If a radio broadcast station is properly adjusted so that the signal being sent out does accurately represent a voice, let us say, then a small crystal receiving set within perhaps 25 miles of the sending station will give remarkably clear reproduction of the voice, much better, for example, than would be the case if the voice were transmitted the 25 miles by ordinary wire telephony. Frequently the writer, when listening to radio signals, has recognized the voice of one of his former students in the first few words of conversation; the enunciation of words and syllables is much clearer than is the case with ordinary telephony.

Now when we use an amplifier and loud speaking horn for giving out the signal, the results are generally disappointing. Although much more volume is obtained than when using a crystal receiving set, the quality of the speech is very much poorer. This is due to the fact that the complex shaped electric waves, representing the voice, have their shape changed as they go through the amplifier. Not only is the magnitude of the current increased by the tubes, but the complex forms are so altered (unintentionally of course) that the resulting voice sounds are much modified. This effect is called distortion.

*Transformer Amplifier*—The type of amplifier shown in Fig. 14 is called a resistance amplifier because a resistance is used in the plate circuit of each tube, the variation of voltage drop across this resistance being used to supply the exciting voltage of the next tube of the series. Another type, more frequently used, is shown in Fig. 15: in this circuit there is a small transformer between each tube in place of the resistance of Fig. 14. The signal voltage, impressed on the grid of the first tube makes the plate current of this tube vary; this variation of current in the one coil of the transformer (called the primary) will produce a voltage at the terminals of the secondary coil of the transformer. This secondary voltage is theoretically of the same form as that im-

pressed on the grid of the first tube, but it may be much larger, using the ordinary transformer sold for such use, with the ordinary amplifying tube, perhaps 10 to 15 times as great.

This secondary winding of the transformer is connected to the grid circuit of the second tube and so causes fluctuation in the plate current of this tube. In the plate circuit of this second tube is another transformer which supplies the voltage for the grid of the third tube, and in the plate circuit of this third tube are placed the telephone receivers.

A transformer amplifier is more effective than a resistance amplifier, two tubes with transformers giving as much increase in signal strength as three or four tubes connected with resistances in their plate circuits. The distortion is generally greater, however, with a transformer amplifier and there is more likelihood of the amplifier's generating internal noises of its own, resulting sometimes in a shrill squealing noise in the telephone receivers even when no signal at all is coming in. If a transformer amplifier is to be much good, care must be taken in getting a transformer suited to the tubes used; a transformer which works well with one type of tube may not amplify at all when used with another.

RADIO OR AUDIO FREQUENCY AMPLIFICATION

As has been pointed out several times, the current set up in the receiving antenna by the power from the transmitting antenna is of very high frequency, so high that even if the telephone diaphragm could vibrate at the same speed the note would be so high that no human ear could detect any sound. Such high frequency currents (from 10,000 to 3,000,000 oscillations per second) are said to be of *radio frequency*. The amplitude, or strength, of the radio frequency current varies at a lower frequency, in fact at the same frequency as the voice sound which actuates the transmitter; such a low audible frequency is said to be of *audio frequency*.

So far, in our discussion of the reception of radio signals, we have shown that the action of the vacuum tube is to rectify the high frequency current in such a manner that the current through the telephones in the plate circuit of the detecting vacuum tube is not of radio frequency but of voice frequency. This voice-frequency or audio-frequency current is then sent through a series of tubes and amplified.

It is possible, although not easy, to amplify the radio-frequency current, before rectifying it: such a scheme is said to use *radio frequency amplification*, which has at least two great advantages over audio frequency amplification; it is distortionless and it is somewhat selective, amplifying the high frequency signal more than it does atmospheric disturbances. It may then be wondered why radio frequency amplification is not used more extensively than it actually is. All of the reasons cannot be analyzed

(Continued on page 1782)

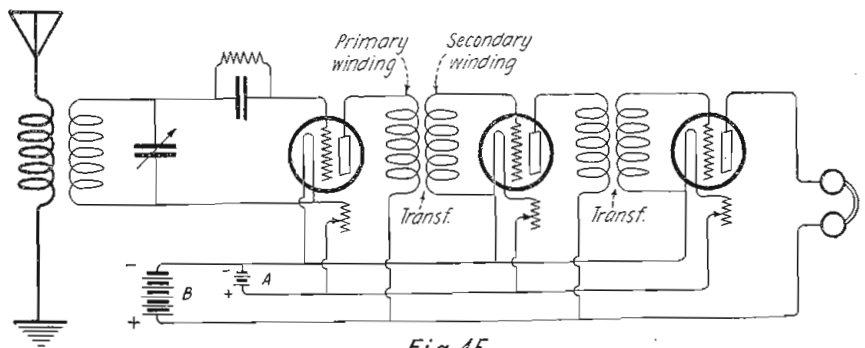

Fig. 15

Instead of coupling the successive tubes by resistances in the plate circuit, transformers are more generally used.



# Hints on Receiving Sets

By LOUIS FRANK

*Are you obtaining the best results possible from your receiving set? If not the reason is more than likely due to one of the many mistakes in receiver design that Mr. Frank covers in this article, written in plain words that everyone can understand.*

**T**HE hobby of receiver construction is greatly on the increase, far beyond anything the amateurs ever dreamed of. A large number of the broadcast listeners are potentially amateurs and experimenters, which may account for all the different types of receivers which we read about in the magazines and newspapers. Just because of this enormous activity in the building of receivers it becomes essential to stress a few of the fundamental principles to be observed in such construction. So much energy is being expended in the devising of novel and unusual circuits, that people lose sight of the fact that by taking proper precautions and attending to fundamentals, simple circuits may be made more efficient and will bring in signals which, otherwise, would require more sensitive receiving apparatus to detect.

At present, the owner of a receiver is after one or both of two things. First, he wants to receive good, husky loud speaker signals for the real enjoyment of broadcast programs. Second, he wants to reach out and get long distance. Instead of discarding the present receiver, which does not satisfactorily give either or both these results, and building a new circuit, see whether the present receiver cannot properly be modified to give satisfaction. Often a simple standard circuit properly constructed will give almost the same satisfaction as some of these so-called sensitive and complex ones. One might say that "it's all in the way it's built."

## COIL CONSTRUCTION

Coil construction is the first consideration. A bad coil may completely spoil an otherwise perfect set. The first thing the constructor ought to do is get away from using tapped coils. The modern tendency is to use fixed tuning coils and do all the tuning with the variable condenser. The tapped coil is bad for the following reasons: The reason for tapping a coil is to enable a part of it to be used. When a part of the coil only is used, the other part which hangs on (called the "dead end") increases the resistance of the small part used; it may be hard to believe, but it is a fact. Ten turns of wire all alone give a certain resistance, but the moment we add a few turns to the 10 and again measure the resistance of the original

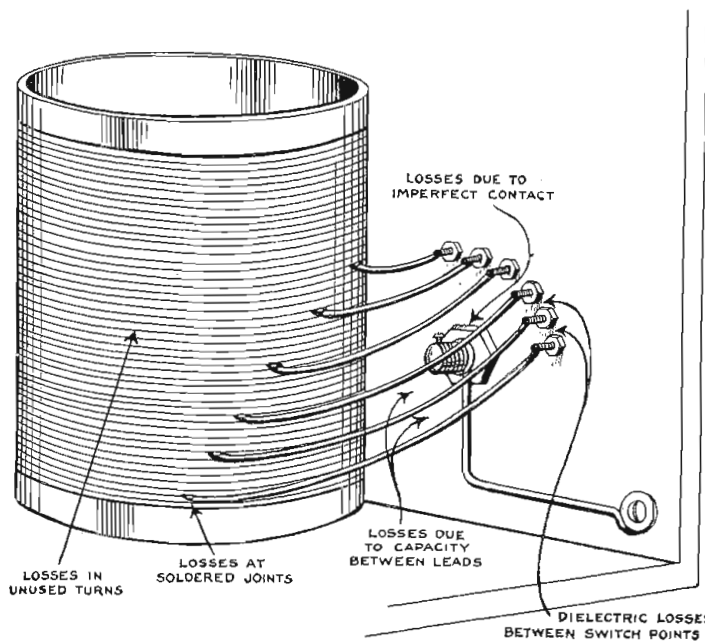

The use of a tapped coil with the leads running to switch points introduces serious losses in the circuit. The accompanying sketch shows exactly where such losses are located.

10 turns, we find the resistance higher. The mere presence of additional turns is sufficient to cause such a resistance rise. This resistance rise, due to hanging on turns, causes a loss of energy called "dead end loss" which cuts down local signal strength and prevents long distance work. Again when a coil is tapped numerous joints must be soldered, two for each tap, one at the coil, and one on the switch stud. Every soldered joint introduces the possibility of a bad connection with increased resistance and losses again. Furthermore the switch studs to which these coil taps are brought must be imbedded in some dielectric, generally it is the panel. This again causes a rise in coil losses due to losses that occur in the insulating panel where these studs or taps are fixed. This loss, called the "dielectric loss," is due to the imperfections which exist in all insulating material, and they actually exist. For these reasons the tapped coil is passing into ob-

livion. Use only fixed coils and tune with variable condenser.

In connection with energy losses which occur in the dielectric of the panel, a similar remark holds for the insulating material on which the coil is wound. The presence of insulating material in the electric field of a coil results in losses through it. It is often difficult to make people believe or realize this, because they feel that if the panel or tube is an insulator, no losses can occur in them. This is true enough when we deal with ordinary commercial currents like direct currents or lamp lighting currents. Radio frequency currents, however, are different and they do many things not done by ordinary currents. They cause currents to flow in insulating material of a radio set which increase losses and thereby make the set inefficient. Therefore, if an insulating tube is used, see that it is made only of the best material, as for example hard rubber, phenol resin, etc. Avoid, wherever possible, fibre and composition material. These do not stand the severe tests imposed on them by radio currents. Better still, use, if possible, coils which have considerable air insulation. Air is the best insulator for radio frequency currents. Thus spider-web coils have air insulation, which explains their low losses. The honeycomb type of coil is likewise a good type.

Coil terminals are generally soldered, and here is where trouble generally enters. A coil, like a chain, is no stronger than its weakest link, and if a coil is otherwise perfect, a poor soldering job may make it worse than useless. Care should be taken that a clean, solid connection is made. Avoid spreading soldering flux over the coil itself. It causes leaks, and increases the resistance. As for the type of wire to use, there are current suggestions to use special kinds of wire such as Litzendraht. This idea should

(Continued on page 1776)

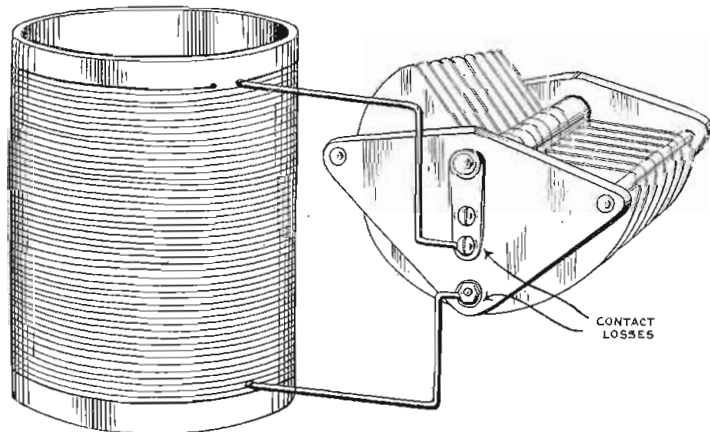

By constructing a coil with the correct number of turns to cover the broadcast wave-lengths when shunted by a variable condenser, circuit losses are considerably reduced. The contact losses do not amount to a great deal.





































































# STANDARD HOOK-UPS

EVERY month we present here standard hook-ups which the Editors have tried out and which are known to give best results. This leaf has perforation marks on the left-hand margin and can be cut from the magazine and kept for further reference. These sheets can also be procured from us at the cost of 5c to pay for mailing charges.

RADIO NEWS has also prepared a handsome heavy cardboard binder into which these sheets may be fastened. This binder will be sent to any address, prepaid, on receipt of 20c. In time there will be enough sheets to make a good-sized volume containing all important hook-ups. Every year an alphabetical index will be published enumerating and classifying the various hook-ups.

## Handy Reference Data for Radio Experimenter

KEY-CHART TO RADIO SYMBOLS		
 AERIAL		 RESISTANCE (VARIABLE) FILAMENT RHEOSTAT
 AERIAL (LOOP)		 RESISTANCE
 ALTERNATOR		 SWITCH
 AMMETER		 TRANSFORMER (RADIO FREQUENCY)
 ARC		 TRANSFORMER (AUDIO FREQUENCY)
 BATTERY "A"		 TRANSMITTER
 BATTERY "B"		 TRANSFORMER (AUDIO FREQUENCY)
 BUZZER		 VACUUM TUBE
 CHOKE COIL		 VARIOMETER
 COIL		 VARIO-COUPLER
 COIL (HONEYCOMB)		 RECEIVER (TELEPHONE)
 COIL (SPIDERWEB)		 VOLTMETER
 COIL (TUNING) (VARIABLE INDUCTANCE)		
 CONDENSER (FIXED)		
 CONDENSER (VARIABLE)		
 CONNECTION		
 DETECTOR (CRYSTAL)		
 DYNAMO OR MOTOR		
 GAP (SPARK)		
 GAP (QUENCHED)		
 GROUND		
 GRID LEAK		
 JACK		
 KEY		
 LOOSE COUPLER COUPLED COILS WITH VARIABLE COUPLING		
 NO CONNECTION		
 POTENTIOMETER		

SINGLE COIL RECEIVER

Diagram No. 1 shows a crystal detector circuit using a two slide tuning coil as the tuning element. The antenna is connected to one of the sliders and the ground to the other so that the distance between them may be varied. This arrangement permits the antenna circuit to be tuned and also the coupling between the primary and secondary circuits to be changed to increase the selectivity. The secondary circuit is composed of the section of the coil comprised between the top of the coil and the slider connected to the ground. The condenser C is a by-pass condenser of about .001 MF. capacity. The sliders as shown, the coupling is tight.

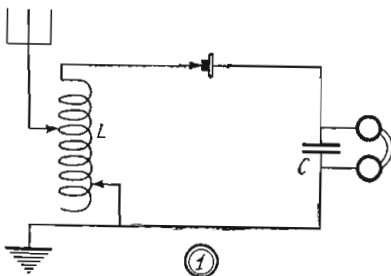

DOUBLE CIRCUIT RECEIVER

The circuit No. 2 is that of a crystal receiving set using a variocoupler or loose coupler for tuning. The two circuits are separate and the secondary coil may turn or slide inside of the primary, which may be varied either by means of a sliding contact or switch and switch points connected to taps on coil L. The secondary L<sub>1</sub> is fixed and has the proper number of turns to receive over the desired wave bands when tuned by means of the variable condenser C. C<sub>1</sub> is the by-pass condenser of .001 MF. capacity. To tune this circuit, couple coils tightly, set condenser C at zero and vary the primary for signal. Then vary C until signal is loudest.

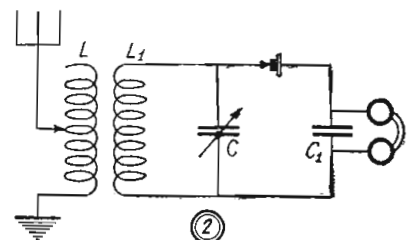



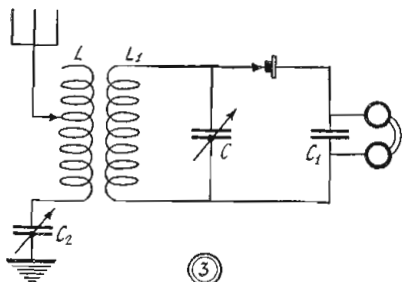

DOUBLE CIRCUIT RECEIVER WITH CONDENSER TUNING

The receiver No. 3 is similar to the circuit No. 2 except for the addition of the variable condenser in the antenna circuit. This condenser permits finer tuning and also allows wave-lengths shorter than the natural wave-length of the antenna to be received. The variable condenser C 2 shown between the primary coil and the ground permits extremely sharp tuning and has the effect of shortening the natural wave-length of the antenna exactly as if some wire were cut out of the antenna itself. With such a receiver there are four tuning controls, the primary tuning switch, the primary condenser, the coupling between coils L and L 1, and the secondary condenser C. The tuning of such a receiver is the same as that of the circuit No. 2 and the antenna variable condenser should be set at maximum while tuning. When the desired signal is tuned in the primary condenser is readjusted to obtain selectivity and finer tuning. Needless to say, the crystal detector should be adjusted before tuning. This may be done with a buzzer or by listening on some local station which is easily tuned in.

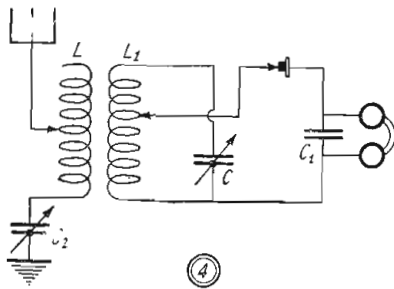

IMPROVED DOUBLE CIRCUIT RECEIVER

The circuit No. 4 is the same as No. 3 with another additional improvement consisting in the tuning of the detector circuit by means of a switch or slider on the secondary coil. This arrangement provides an extra circuit for the detector and telephones which increases the signal strength and selectivity. Since this control is not critical the tuning is the same as that of the circuit No. 3, the slider contacts on coil L 1 being adjusted after the desired signal is tuned in.

The two coils L and L 1 may be wound on tubing or spider web fashion, with taps every 10 or 15 turns to vary the amount of inductance in the circuit. The number of turns on each coil varies, of course, with the wave-length to be tuned in. If only the broadcast range is to be received, about 50 or 60 turns of No. 20 D. C. C. wire should prove suitable. The coupling between the two coils should be variable so as to increase the selectivity of the receiving system whenever necessary. The two coils may be mounted on a rod so as to slide along the same axis, or they may be mounted on a hinge to vary the angle between them.

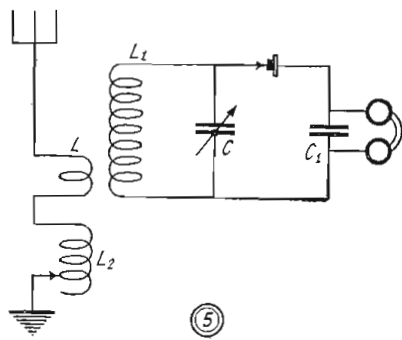

RECEIVER WITH FIXED COUPLING

The double circuit receiver No. 5 is a simplification of the other circuits in that the number of controls is reduced without sacrificing much of the selectivity. In this arrangement coil L 1, composing with the condenser the secondary circuit, is tightly coupled with coil L composed of a few turns wound directly over coil L 1. In order to tune the primary circuit a separate coil L 2 mounted at right angle or at a distance from L 1 and variable, is used to tune the primary or antenna circuit. In this arrangement there are only two controls, that is, the switch or slider on coil L 2 and the variable condenser C.

This circuit, on account of its simplicity, is recommended to the beginners who do not know how to tune the more complicated receivers. It may be constructed as follows: Coil L 1 should consist of 60 turns of No. 20 D. C. C. wire wound in a single layer on bakelite or hard rubber. Directly over this winding should be wound 6 turns of the same wire composing coil L. Coil L 2 is similar to L 1 but with a tap every 5 turns.

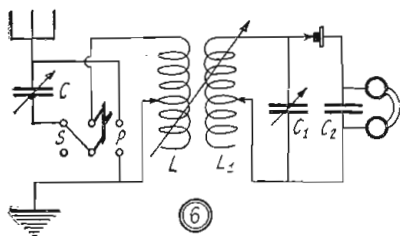

DOUBLE CIRCUIT RECEIVER WITH SERIES PARALLEL SWITCH

When it is desired to receive long and short wave-lengths the use of a series parallel switch is useful to connect the primary condenser in series or in parallel with the primary coil. In such an arrangement the two coils L and L 1 should be variable in steps or should be honeycomb or duo-lateral coils of various sizes which may be plugged in a special mounting. With such inductances any desired wave-length may be tuned in.

If one contemplates the improvement of the receiver at a later date, it would be best to buy a 3-coil mounting, the third mounting being used for the plate coils of the vacuum tube detector when one is used. The two variable condensers C and C 1 should be of the 43 plate type having a capacity of .001 mfd., preferably equipped with vernier. The telephone condenser C 2 is an ordinary .001 mfd. fixed condenser. In this circuit the antenna variable condenser C is used in series to receive the short wave-length in parallel with the primary coil to tune in the long ones. The series parallel switch in this circuit enables the set to tune over a much wider range of wave-length than would otherwise be possible. In this circuit, as in the ones above, it is best to tune the primary circuit first and then adjust the secondary for loudest signals.

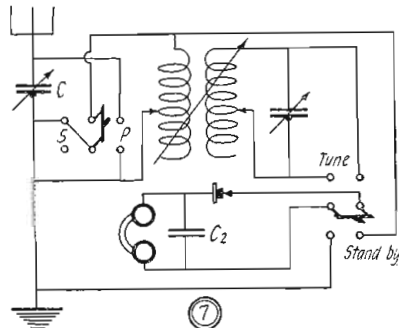

COMBINATION SINGLE AND DOUBLE CIRCUIT TUNER

The receiver No. 7 is similar to No. 6 but with an extra double pole double throw switch connecting the detector and telephones either across the primary or the secondary. This system simplifies the tuning considerably, especially when the wave-length of a station to be received is not exactly known. When in the stand-by position the switch connecting the detector and telephones across the primary transforms the receiver into a single circuit set and permits the operator to easily tune in a station by merely varying the variable condenser C which may be placed in series or parallel with the primary coil to receive short or long wave-lengths, since the single circuit arrangement is not very selective. Then the operator throws the secondary switch to the tune position and adjusts the secondary circuit and coupling for greater selectivity. This method is used in the majority of commercial receivers.

For the reception of short wave-lengths the two coils may be composed of a standard variocoupler or loose coupler having about 60 turns 3 inches in diameter on each coil, or the equivalent.

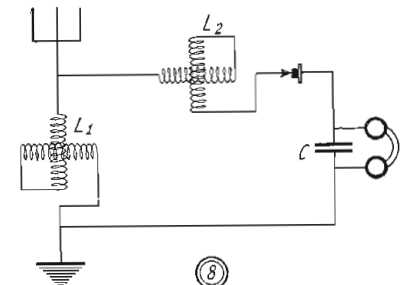

SIMPLE RECEIVER WITH VARIOMETER TUNING

For experimental purposes, or when great selectivity is not necessary, the circuit No. 8 may be employed. In this circuit two variometers are used for tuning instead of variable condensers or tapped coils. The first one, L 1, tunes the antenna circuit, and the other L 2, the secondary circuit. This circuit is merely shown as a possible application of two variometers for tuning, but is not recommended unless the receiver is located at a certain distance from any transmitting station, since this set is not very selective.

The best circuits recommended to be used with a crystal detector are the Nos. 3, 4, 6 and 7, which, although slightly more complicated, are much more efficient than the others.

If standard apparatus is used for the construction of these receivers, the same instrument may be later employed in some more efficient receivers using vacuum tubes. These coils and condensers may be designed for table or panel mounting, but they should be of good quality in order to insure best results.

The importance of using standard apparatus cannot be overestimated. Especially is this the case with the beginner. Results are dependable only when such instruments are used.





## Hamitorial

When You Do It, Do It Right

**T**HERE are a number of ways of doing most things, but the two that really count are right and wrong; the rest are merely variations and degrees. It must be admitted too that we all have our own definitions of these, but I believe, the dividing line is definite enough.

For instance: Jim builds a transmitter, bread board style, wired up with fairly heavy wire, and, all in all, it is fairly efficiently made, but is mounted in such a manner that a jar tumbles over a condenser, disturbs a choke, or gives his wave-length a flip to the unknown. Or, he can't take a tube out of its socket without using both hands and getting tangled up in enough wires to have discouraged a Ham offensive. He spends 15 minutes persuasively bending two enthusiastically springy wires, trying to discourage their seemingly magnetic affinity for each other. He gets them separated and then disturbs the coupling of two round coils which, curiously enough, seem to be affected by the action of gravity and an oppressive amount of rollability. He tries to control a variable the spring contacts of which are tight, as they should be to make good connection and to stay put, and finds it takes two hands, whereupon he makes the two wires touch again, knocks a meter cross-wise, and has to start the whole business over again, if he hasn't lost his patience. Then he consoles himself with the thought that the job is temporary anyhow. This is all wrong. Such incidents would disturb the complacency of a Saint and rock the very foundations of society. Less has



Station 7IT, 7ACP owned and operated by Ashley C. Dixon, Stevensville, Montana. His station is located in a valley and without commercial "juice." A 12-volt storage battery drives a 500-volt, 100-watt Dynamotor, which furnishes the pep for the 10-watt C.W. transmitter. This station has been heard in London, England, a distance of about 5,500 miles and has been reported at 1,500 miles on five watts.

started wars. On top of all that, it destroys the operator's effectiveness.

Why should he stand for it? There is no need, no reason, no excuse. A nail here, a screw there, a drop of solder elsewhere, and the job is done in a permanent fashion that gives you a very good idea as to whether your results may be depended upon or are obtained by guess work. A breath of wind, then, can not disturb your handiwork, nor a vagrant gesture destroy it.

The Leaning Tower at Pisa is a darn good example of what I believe to be the right sort of constructive job. They built it, it leaned, and because they had done a good job, it stayed with them. It's dog-gone few amateur jobs you could say that about, figuratively or otherwise. (However, I may as well admit that I think the guy who hunted for the location of that building didn't do a good job, or else was vamped by the dutiful daughter of some lucky landholder.)

I read somewhere about a fence builder (stone, not wire, as this was before our day) who became well known for the fences he built because, it seemed, he did not feel that the final dissolution of a fence and the slogan "Eventually, why not now?" were synonymous. On the contrary, he figured that when he wanted a fence he wanted a good one, so his fences are still standing. One day a neighbor wanted him to build a cheap fence at a low price for him, and he took the job. The neighbor was amazed at the fence that was built and grew excited, fearing overcharge, and berated him for building such a good stone wall. "I build a good fence or none at all," was our hero's reply and as a result he prospered.

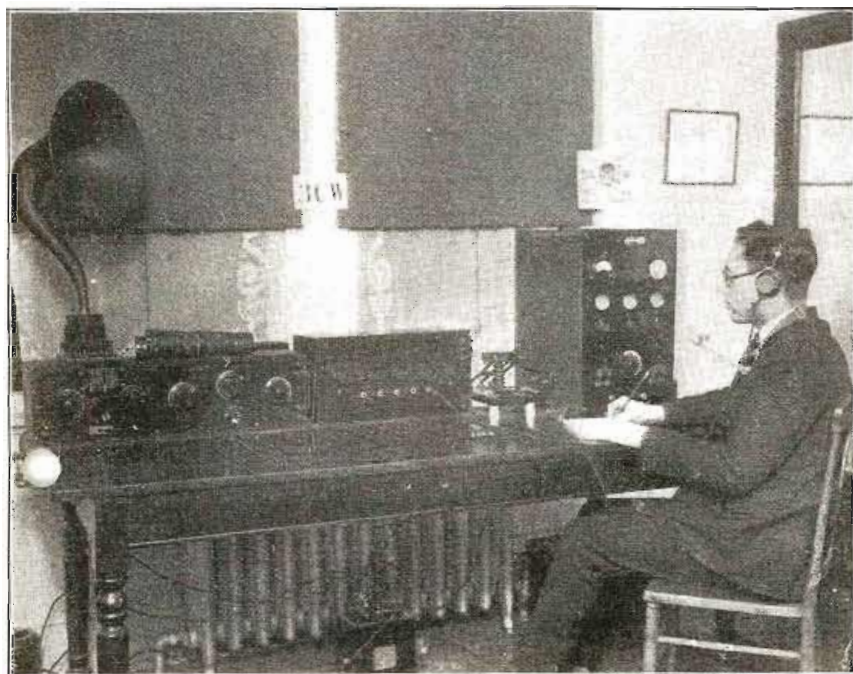

Station 3CW, owned and operated by Bernard Ellman, Philadelphia. 3CW was recently heard by an Alaskan amateur while using very low power.

© Underwood & Underwood.



The same thing applies to anything you do: build a good fence or don't build any.

Don't say that you can't do it with your present finances, or make other excuses, because mostly you can. I have seen excellent jobs done by birds with no facilities and deplorable jobs done by those with lots of them.

Get the idea into your head that the job is to be permanent and it will be easy to do it right. The only trouble with most of us is that we tell ourselves the job is only for an hour or so, or only until tomorrow or next week, and if someone were to return a month later they would find the same botch still carrying on, wasting time and patience.

To do a job half way because it might be temporary is wrong. To do it thoroughly and thereby enjoy its temporary advantages is right.

Nowhere does this dope hold true more than in experimental work. It is only from a "right" job that you know your conclusions are correct.

L. W. HATRY.

### ANOTHER RECORD BROKEN IN NEW ZEALAND

The remarkable progress of radio is demonstrated by the fact that a concert taking place in California was distinctly heard in Invercargill, New Zealand, by a radio enthusiast, Mr. F. Acton, when he picked up an American amateur station at Oakland.

What is claimed to be a world's record for the reception of American amateur radio stations heard in New Zealand, has been established by Mr. I. S. MacDonald, of Waiwera South. Quite recently, using a detector and one step of audio frequency amplification, he logged no fewer than 62 different stations. The previous record was claimed by Mr. F. G. Bell, 4AA, Shag Valley, with 17 stations in one evening. A remarkable fact is that one of the stations was operating on spark, this being the first time an American spark station ever has been heard in this part of the Pacific. Three of the stations heard were operating on telephony, and the musical items were heard quite clearly, although the human voice was somewhat obscured. The other stations were operating on telegraph. The 62 calls were heard between 7 a. m. and midnight, and calls were still coming in when



The laboratory of Jos. D'Agostino at Morgantown, W. Va. We see some very familiar apparatus on the table in the form of an O.T., a transmitting condenser and a (?) K.W. transformer. Them was the days!

Mr. MacDonald closed down. *A remarkable fact is that some of the stations were heard in bright sunlight, under which condition it is usually considered very difficult to carry on radio reception.*

### NEW QRA'S

**9AKO**—A. Houston Barnett, 202 Masterson Avenue, Fort Wayne, Ind.

**2AEN**—William T. Golden, 680 West End Avenue, New York City. (Not Bloomfield, N. J.) 10 and 20 watts C.W. All crds answered.

**6EJ**—Frank W. Clark, 2805 Cherry Street, Berkeley, Calif.

**9DIB**—Thomas S. Wildman, Nichols, Iowa. 5 watt C.W. All crds answered.

**Can. 3GO**—Leonard Walker, 143 Simpson Street, Sault Ste. Marie, Ontario, Can. 10 watt C.W. QSL's appreciated. All crds answered.

**9BQK**—Malcolm McGregor, 815 Clark Street, Warsaw, Ill. QSL's appreciated. All crds answered.

**5AAN**—R. H. Whitt, Tipton, Okla. All crds answered.

**4ZD**—Paul G. Watson, 830 East Park Avenue, Savannah, Ga. 100 watt C.W.

**6COU**—H. L. Smith, 711 D Street, Oxnard, Calif. All QSL's appreciated and answered.

**8CPY**—(Change of address) Jas. A. Wilson, 911 Lay Boulevard, Kalamazoo, Mich.

**9BST**—R. Albright, P. O. Box 472, Kearney, Neb. 5 Watts C.W. All crds answered.

**9CEN**—Charles M. Couley, Seibert, Col. 10 watt fone and C.W. QSL's appreciated.

**5ANP**—Ferdinand A. Pecoul, Mississippi City, Miss. QSL's appreciated.

**5TO**—D. Cason Mast, Nacogdoches, Tex.

**8DNT**—Robert Mitchell, 401 North Chestnut Street, Barnesville, Ohio. 5 watts C.W. All crds answered.

**9CEF**—Herbert Settle, 462 East Burkhardt Street, Moberly, Mo. 10 watts C.W. All crds answered.

**9ADD**—(Re-assigned) Alva J. Cox, 2347 E. Grand Avenue, Des Moines, Iowa. Would appreciate QSL's. All crds answered.

**1HA**—E. S. Davis, P. O. Box 71, Bradford, Vt. 5 watts C.W. and I.C.W. Please QSL. All crds answered.

**3JF**—Fred. Robinson, 614 Virginia Avenue, Norfolk, Va. Please QSL.

**9AMX**—Roy Walters, 713 Mound Street, Atchison, Kan.

**9CVL**—Milton L. Johnson, 938 South Fourth Street, Atchison, Kan.

**8BST**—Clyde M. Fuller, 4078 Tireman Avenue, Detroit, Mich. 10 watts C.W. and fone. Please QSL. All crds answered.

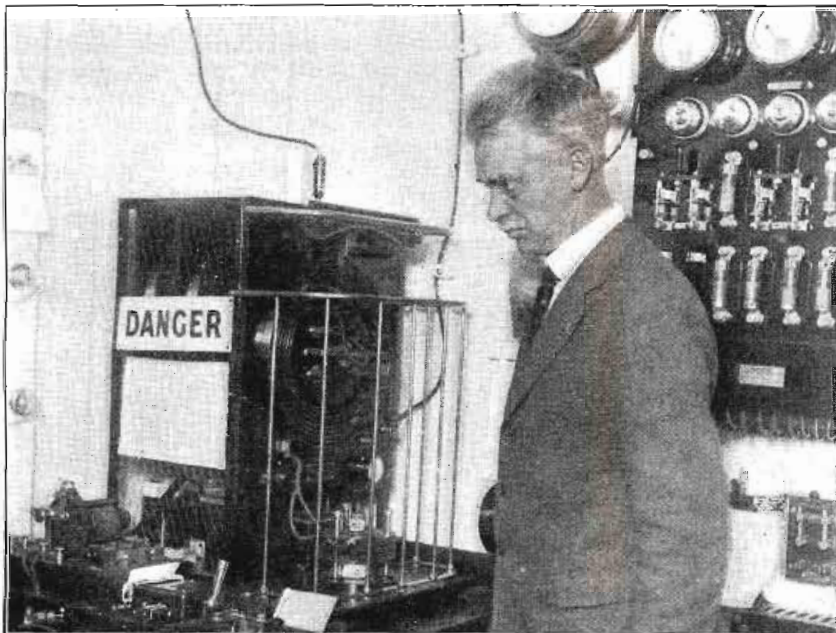

Hiram Percy Maxim, President of the American Radio Relay League, photographed in the radio room of the S. S. Belgenland on his arrival from abroad where he has been studying foreign radio conditions in connection with amateur radio relay around the world. © Foto Topics



# Calls Heard

6COU, OXNARD, CAL.  
 C. W.—2CJ, 2RK, 4EG, 4FS, 4HS, 4IR, 4JR, 4PB, 4SA, 5AAW, 5ADO, 5AJJ, 5ALR, 5GJ, 5KC, 5MI, 5MO, 5QD, 5QL, 5SP, 5TJ, 5VM, 5XA, 5ZA, 7ACF, 7AEK, 7AFU, 7AJD, 7CO, 7EM, 7EN, 7FT, 7FY, 7GR, 7HW, 7KE, 7FZ, 7LN, 7NO, 7PJ, 7PZ, 7QD, 7RD, 7RY, 7WB, 7WO, 7ZU, 8AK, 8APT, 8ART, 8BY, 8BZD, 8DAT, 8DDC, 8DIA, 8DJD, 8EKY, 8ER, 8HV, 8JY, 8NB, 8VQ, 8YAU, 9AAV, 9ABC, 9AJY, 9AMU, 9AOL, 9APE, 9AZG, 9BED, 9BEZ, 9BFB, 9BFF, 9BLY, 9CAA, 9CCG, 9CFC, 9CIU, 9CKA, 9C, 9CKI, 9CNV, 9CTG, 9CVO, 9CVT, 9CWJ, 9C, 9DXX, 9DTE, 9DUG, 9DUN, 9DXN, 9EAC, 9EFH, 9EKY, 9ELV, 9EQ, 9LZ, 9RC, 9SS, 9XBE, 9YAM, 9YAU.  
 Can.—4DK.

51B, CHICKASHA, OKLA. (1 TUBE)  
 1BCR, 1BOA, 1CMN, 1ER, 1KA, 1KC, 1OI, 1PY, 1VO, 2ATZ, 2AWF, 2BGI, 2BSL, 2BUQ, 2CEE, 2CLA, 2KU, 2MU, 2WR, 2XNA, 3AJS, 3ADV, 3CCX, 3CEZ, 3BX, 3DT, 3GC, 3IHH, 3HS, 3MO, 3QV, 4AF, 4LL, 4MY, 4SH, 6BQX, 6BUR, 6CCY, 6CGW, 6CNR, 6GT, 6TN, 7ADS, 7ALD, 7AKK, 7BS, 7FA, 7W, 7LY, 7UT, 7UZ, 8AOK, 8ARV, 8BCU, 8BNH, 8CAB, 8CAO, 8CED, 8CDI, 8CRD, 8CKE, 8CPI, 8CUN, 8CYI, 8CZZ, 8DGF, 8BF, 8IK, 8JY, 8OP, 8WP.  
 Can.—4DQ, 4EA.

COOPER WALKER, CORTLAND, IND.  
 All Phone—2RB, 5ANA, 5ALJ, 5PA, 5QJ, 8CCI, 8CCS, 8DCU, 9ABX, 9AHO, 9AJO, 9AJE, 9AKE, 9BEN, 9BMU, 9CEA, 9CCI, 9CHE, 9CLD, 9CLY, 9CLH, 9DZO, 9CAO, 9EBI, 9BC, 9MA, 9QZ, 9WB.  
 Dailite—9CA, 9ARP, 9MM, 9QI.

6TD, BERKELEY, CALIF. (1 TUBE)  
 2AET, 4CB, 4DY, 4ER, 4FN, 5ADB, 5ADO, 5AIF, 5AIR, 5AIU, 5AJF, 5AJJ, 5AKN, 5GA, 5GI, 5GO, 5JL, 5LG, 5LR, 5NA, 5UO, 5XA, 5XD, 5ZAV, 6AAN, 6ADH, 6AFD, 6AGE, 6AIU, 6ALQ, 6AMN, 6AMW, 6ANP, 6AOL, 6APS, 6AOD, 6AQM, 6ARF, 6ASB, 6ASV, 6ATN, 6AVN, 6AVV, 6BBF, 6BIC, 6BJJ, 6BLH, 6BNF, 6BRF, 6BUO, 6BVF, 6CBB, 6CBF, 6CBI, 6CBU, 6CCY, 6CDO, 6CEF, 6CEN, 6CFM, 6CFY, 6GG, 6GL, 6GNF, 6CNG, 6CNL, 6EB, 6GG, 6IT, 6MH, 6NB, 6OZ, 6PE, 6PI, 6PL, 6ZH, 7ABB, 7ACF, 7ACI, 7ACN, 7ADG, 7ADI, 7ADO, 7ADS, 7AEL, 7AFK, 7AFO, 7AGI, 7AGZ, 7AHA, 7AHN, 7AHS, 7AJD, 7AKE, 7AKK, 7ALD, 7ALI, 7AQ, 7BY, 7CO, 7DI, 7DI, 7DZ, 7EA, 7EI, 7FD, 7FS, 7FT, 7FY, 7GO, 7GR, 7GS, 7GV, 7GW, 7IO, 7IU, 7IV, 7KE, 7KR, 7KS, 7KV, 7KZ, 7LH, 7LN, 7NF, 7NI, 7NO, 7OB, 7OT, 7PI, 7PN, 7QD, 7QU, 7RD, 7RP, 7SH, 7TD, 7TO, 7TQ, 7VC, 7VM, 7VN, 7WE, 7WM, 7WP, 7ZL, 7ZU, 8AQQ, 8ART, 8BKN, 8CPD, 8DJD, 8ES, 8JJ, 8JY, 8ZZ, 9AAQ, 9AAU, 9AFM, 9AKE, 9AMB, 9AM, 9AP, 9ATF, 9AVN, 9AVU, 9AWV, 9AZG, 9BEU, 9BEZ, 9BFW, 9BIZ, 9BLY, 9BOZ, 9BR, 9RTH, 9RUN, 9BXA, 9CAA, 9CCG, 9CCZ, 9CGA, 9CJC, 9CJY, 9CKA, 9CKJ, 9CLD, 9CNV, 9CVC.



A photograph of a section of the recent radio exhibition held in New Zealand, given over to the display of home-made amateur transmitting and receiving sets. The number of sets exhibited tells something of the progress radio has made in Australasia. As time goes on New Zealand and Australia are becoming more prominent in the radio world and judging by the results obtained by some of the most eminent Hams, they are running us a close race. American amateurs are heard regularly in this part of the world. Australasian amateurs hold the record for DX transmission on low powers.

9CWJ, 9CYW, 9CZM, 9DBF, 9DCP, 9DFH, 9DHz, 9DKQ, 9DOT, 9DTE, 9DUN, 9DWN, 9DXU, 9DYR, 9FBT, 9EFP, 9EI, 9EKY, 9ELV, 9LZ, 9MC, 9QR, 9SS, 9VK, 9WC.  
 Hawaiian—6CEU.  
 Canadian—4CO, 4IO, 5AH, 5EP, 5GO, 5HK, 9BP.

CARL W. BEESE, 146 MARKET STREET, HAMILTON, CANADA (DET. AND 2 A. F.)  
 C.W.—1AAF, 1AEL, 1AST, 1ARF, 1JY, 2AUR, 2ADU, 2ER, 2AAL, 2WWP, 3LG, 4ER, 4NC, 5ALY, 5AIR, 5OM, 5VC, 8ACY, 8AOL, 8AK, 8BCU, 8BY, 8BPL, 8BNC, 8CKO, 8CN, 8CR, 8DM, 8DIE, 8DAI, 8DCY, 8DBL, 8GN, 8OU, 8RV, 8HV, 8PL, 8ON, 8TD, 8YM, 9ACI,

9AAL, 9AWF, 9BCK, 9BPV, 9BON, 9CCW, 9CEA, 9DR, 9DHR, 9EQ, 9EJ, 9MC, 9TG.  
 Phone—1XAL, 2RB, 8AXU, 8DAP, 8KG, 8XBO, 9AHJ, 9AHZ, 9BDE, 9BPT, 9MM.  
 Can. C.W.—3AV, 3ML, 3BM, 3PZ, 3RG, 3MS, 3QO, 3ZT.  
 Can. Phone—3BA, 3BG.

5AHD, ALTUS, OKLA.  
 1AAC, 1JV, 1MY, 2PV, 2XAN, 3ADB, 3AWF, 3BDI, 3BJ, 3HH, 3JG, 3JYS, 4BZ, 4EH, 4IR, 4C, 6AAQ, 6ADH, 6ADT, 6AII, 6AFT, 6AMW, 6ASQ, 6AVR, 6AWC, 6BCL, 6BDT, 6BFF, 6BH, 6AII, 6BON, 6BPM, 6BQ, 6BUI, 6BUR, 6CIV, 6CKA, 6CMU, 6CNC, 6CNH, 6FP, 6NB, 6OF, 6TV, 6NH, 6XAD, 7ACZ, 7AFO, 7AJD, 7AJT, 7FQ, 7FR, 7HW, 7KR, 7KZ, 7MC, 7OT, 7ZU, 8ACY, 8AGO, 8AIT, 8AJI, 8BMB, 8BNN, 8BYI, 8BYN, 8BZD, 8CHY, 8CKE, 8CTP, 8CXU, 8CZC, 8DGI, 8DGO, 8DGP, 8DIE, 8DMC, 8RJ, 8XAN, 8ZK, 9ACN, 9AEP, 9AMB, 9APD, 9AQC, 9ARI, 9AVN, 9AYP, 9AZO, 9AZN, 9BCW, 9BHX, 9BLW, 9BPM, 9BCH, 9BUN, 9BVV, 9BWW, 9BZH, 9CAA, 9CIM, 9CJY, 9CKP, 9CLD, 9CMK, 9DAP, 9DHR, 9DKX, 9DNG, 9DPX, 9DTE, 9DYV, 9EAM, 9EDO, 9REA, 9EHY, 9ELD, 9QW, 9XV, 9XAX.  
 Can.—3NI, 4EA.  
 Mexico—BX.

9CFK, LEWISTON, ILL.  
 C.W.—6RH, 6BM, 6CC, 6GT, 6GO, 6JA, 6IP, (6ND), 6OF, 6PL, 6PY, 6RN, 6TU, 6VK, 6ZH, 6AAO, 6AHP, 6AJA, (6AKW), 6ALK, 6ATJ, 6AUR, 6AVR, 6AVV, 6BBC, 6BBW, 6BCL, 6BCU, 6BDI, 6BDT, 6BLG, 6BQA, 6BWP, 6CBE, 6CBU, 6CDG, 6CIH, (6CIX), 6CIB, 6CIV, 6CMU, (6CNG), (6CNL), 6CQE, 6ZAH, (6ZBU), 7CO, 7EL, 7EM, 7FD, 7FO, 7FS, 7HW, 7IH, 7KE, 7KZ, 7OB, 7QD, 7AGZ, 7AHO, 7AKH.

MAX WIRTZ, CASILLA 64, VALPARAISO DE CHILE (DET. AND 2 A. F.)  
 All C.W.—1AF, 2BOH, 3LG, 3OM, 5GM, 5VU, 5QL, 5YW, 5LA, 7ZU, 7GM, 9BOZ.  
 On Jan. 30th, 5ZAV. Very QSA.

9BBN, OGDEN, ILL. (DET. 1 AUDIO)  
 C. W.—1AA, 1AAP, 1AP, 1FB, 1WR, 2HS, 2CXW, 2VZ, 3AB, 3ADB, 3BA, 3BHA, 3BHL, 3JW, 3LG, 3QS, 3QV, 4AF, 4AI, 4AP, 4BA, 4BW, 4CA, 4CO, 4DB, 4EB, 4EL, 4FN, 4FS, 4TB, 4XC, 5AH, 5AAQ, 5AAW, 5AF, 5AGA, 5AGT, 5DA, 5DY, 5EK, 5JN, 5MI, 5NI, 5NV, 5NW, 5OM, 5SI, 5TI, 5TQ, 5TS, 6TV, 6UZ, 6ZZ, 7AAR, 7GS, 7U, 8AC, 8AEG, 8AMP, 8ARB, 8AWN, 8BH, 8BGL, 8BKN, 8BNH, 8BOG, 8BOM, 8BRG, 8BU, 8BUM, 8BV, 8BY, 8CDD, 8CGL, 8CHY, 8CIK, 8CPP, 8CR, 8CSX, 8CUR, 8CUS, 8CWR, 8DK, 8DKY, 8FT, 8OM, 8PA, 8PL, 8OK, 8RI, 8SU, 8TH, 8ZP, 9AAL, 9AAR, 9AAU, 9ABY, 9ADY, 9AGB, 9AGL, 9AHT, 9AHR, 9AIS, 9ANI, 9AOA (ORA), 9ARU, 9AUP, 9AXS, 9BAB, 9DCS, 9BEB, 9BED, 9BFL, 9BHR, 9BHY, 9BDE, 9BIB, 9BKW, 9BPA, 9BQK, 9BZE, 9CBA, 9CEH,  
 (Continued on page 1863)

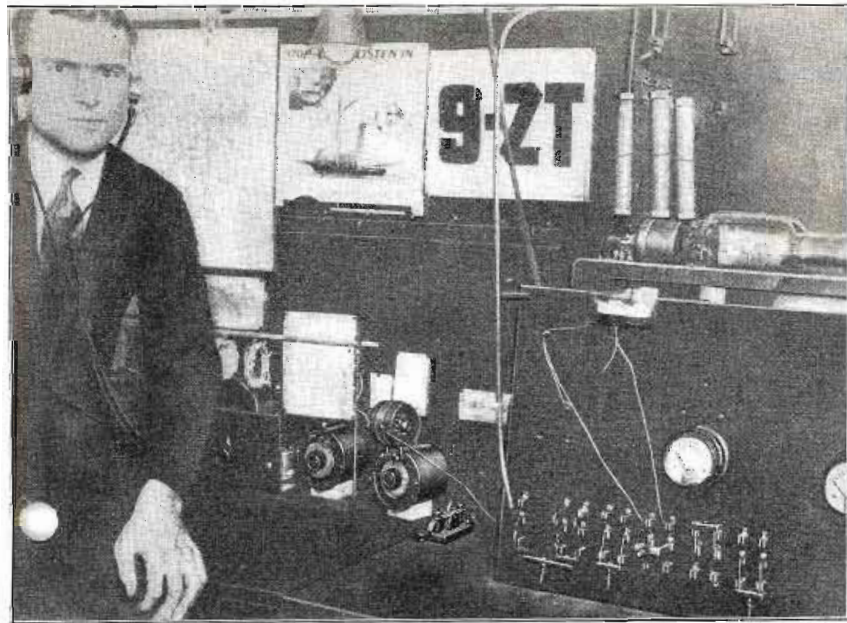

© Photo Topics.

Donald C. Wallace, owner and operator of station 9ZT, the winner of the 1923 Hoover Cup, presented annually to the owner of the best all around amateur station. We congratulate and praise Mr. Wallace for his work in the amateur field, and for his success. 9ZT holds records for both DX and traffic dispatch. He has done considerable work on short waves and in mentioning this we wish to call your attention to the short wave receiver at the left of the photo, with the form wound coils suspended from a rod by silk threads. The transmitter, to the right, employs a 250-watt bottle.



# Straightening Out the Radiation Tangle

By RALPH BATCHER, E. E.\*

The description of a new system that eliminates radiation from regenerative receivers and at the same time increases the selectivity and sensitivity of the set itself.

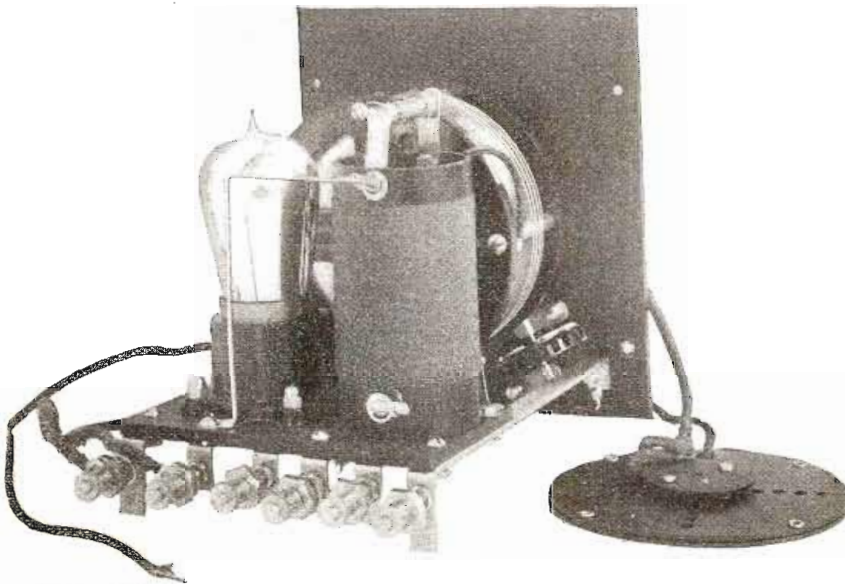

Fig. 1. A rear view of the Clarifier. The aerial tuning inductance is situated to the right of the vacuum tube. The small equalizing condenser is mounted directly atop this coil.

As a result of the publicity given certain recommendations made at a meeting of the Radio Club of America, the problem of receiver radiation has been the subject of much controversy ever since. Not that this radiation interference is worse than before, because in most locations this disturbance is not as bothersome as a year ago.

As a result, as many "solutions" have appeared as there have been self-appointed "Committees of One" to take up the investigation. For all the prevalence of the trouble that is reported, there seems a great lack of actual data on the subject. Actual comparative tests with various receiver circuits are necessary before any particular circuit can be condemned as the worst offender. In all probability the effect of radiation will be heard with a fairly sensitive receiver within an area having a radius of 100 to 500 feet, from the center of radiation, but the instances of radiations of over a half mile are doubtful. But in thickly populated areas a disturbance extending for even 100 feet may cause a considerable amount of interference.

All interference that is unnecessary, however, should be minimized as much as possible for the good of the art, since there are plenty of sources of interference which cannot be done away with. Before any "solution" is foisted upon the public it should be carefully investigated from all angles. The majority of receiver owners are willing to try some plan once, but after taking up one or two plans which prove to be false alarms, they are bound to become skeptical and refuse to try other schemes.

The plans that have received most publicity are the following (some of which are more or less related):

1. Doing away with single circuit receivers.
2. Doing away with regenerative receivers.
3. Adding a resistance to the antenna circuit.

4. Using special antenna coupling coils.
  5. Using a "blocking" tube.
- All these plans have been found unsuccessful, the use of a blocking tube being

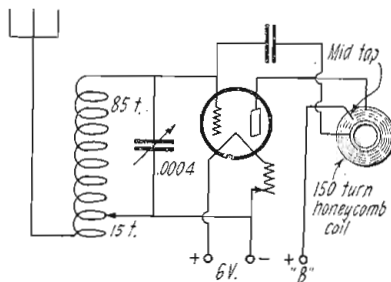

Fig. 3. The circuit diagram of the Clarifier. The small condenser connected from the grid of the tube to the mid tap of the honeycomb coil is semi-adjustable.

the only arrangement that has given any relief. This system, however, is by no means perfect.

The benefits which the general use of a

non-radiating device would give to the art will be great. To gain favor which will promote its general adoption by the public, the device should:

1. Absolutely prevent radiation from any regenerative receiver.
2. Give a gain in signal intensity.
3. Present no greater tuning difficulties.
4. Add considerable selectivity.
5. Increase quality of signals or at least the device should not impair quality.
6. Extend distance range.

Any device which fulfills all of the above items requires considerable experimenting and laboratory testing, so that details of the "Clarifier" a unit which was recently developed in the laboratory of a prominent manufacturer may prove of interest to readers.

Besides the above six requirements this unit was designed to take care of five additional items:

7. Must work with available types of tubes.
8. Must be adaptable to all types of receivers, without wiring changes.
9. Must cover the entire broadcasting wave-lengths range without resorting to taps on the inductance coil.
10. Must work with both long and short aeri-als.
11. The setting for each particular wave-length must not change from day to day.

Fig. 1 is a rear view of the unit complete, showing its general appearance. The circuit in this equipment comprises the balanced output type of circuit so that the instrument will not oscillate under any wave-length, "B" battery or filament current condition.

Fig. 2 shows a front view of the instrument. The output coil is connected by a flexible cord so that it may readily be placed in inductive relation with the grid coil or variometer of the receiver proper by laying it on top of the cabinet. The coupling here is not critical and need not be varied while tuning. When used in conjunction with a single circuit receiving set, in which the antenna is part of the grid oscillatory circuit, it is necessary to short circuit the antenna and ground posts on the receiver and connect the antenna to the instrument.

For the benefit of those who are interested in constructional details and the methods used whereby the instrument was made to fulfill the 10 requirements listed above they will be taken up.

(Continued on page 1830)

Fig. 2. A front view of the Clarifier and its output coupling coil.

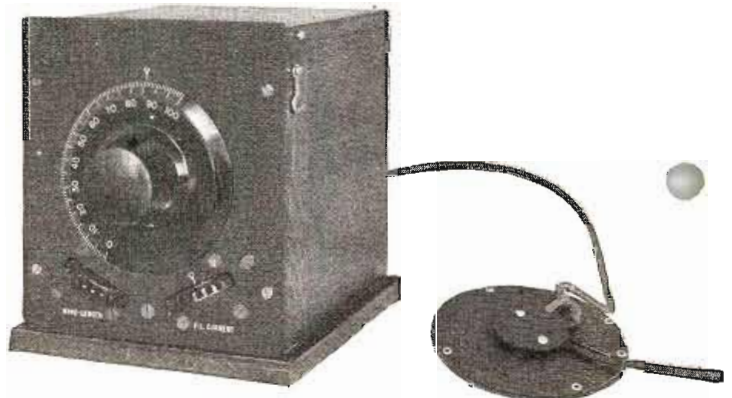

\* Research Engineer, A. H. Grebe & Co., Inc.



# The Transmitter at F8EK

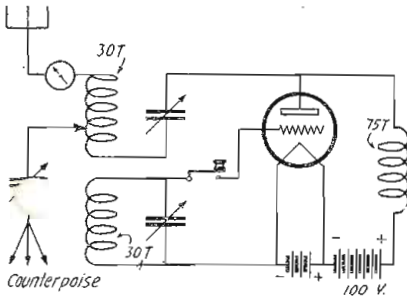

The Lemouzy circuit is a departure from the conventional hook-ups used by most hams.

THE transmitting set shown in the photograph is that of French 8EK-8LY, who obtained remarkable results with it. The circuit used is rather novel and is illustrated

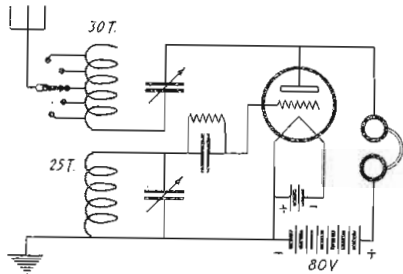

The same circuit applied to the receiver.

here. He was heard several times in this country while transmitting with only 35 watts in the antenna. With only three watts he was able to carry on a two way communi-

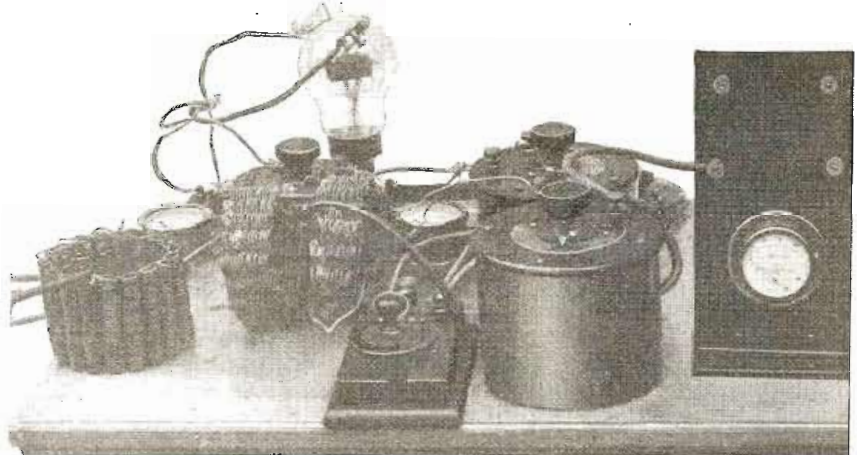

F8EK has his transmitter mounted bread board fashion, but it seems that it delivers the goods just the same.

cation with Amsterdam, Holland, a distance of 350 miles.

The antenna used with this transmitter is a cage four feet in diameter composed of 11 wires. The antenna is 100 feet long and 75 feet high. A counterpoise is used directly under the antenna which runs in a North and South direction. The natural wave-length is about 285 meters, but it is possible, with a series condenser, to go down to 160 meters and still retain efficiency.

LEMOUZY,  
42 Avenue Philippe Auguste,  
Paris, France.

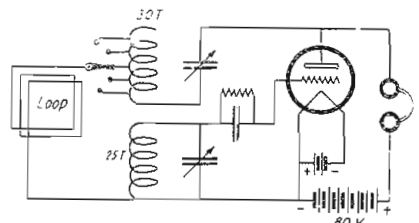

Showing the use of a loop with the same circuit.

## List of British Amateur Stations

(CONTINUED FROM THE MAY ISSUE)

- |     |   |     |   |     |  |
|-----|---|-----|---|-----|--|
| 5CF | F. G. S. Wise, 12, Crouch End Hill, Hornsey, N. 8.                        | 5FM | R. Stone, Hon. Sec., Camberwell and District Wireless Club, 3d, Bushey Hill Road, Camberwell. | 5IF | J. Featherstone, A.M.I.E.E., 3, Cumberland Gardens, Tunbridge Wells.     |
| 5CG | F. L. W. Dean, 54, Pill Street, Cogan, Glam.                              | 5FR | J. L. Jeffrey, F.R.A.   | 5IG | J. E. Sheldrick, "The Brambles," Third Avenue, Deville, Havant, Hants.   |
| 5CJ | J. Balderson, 6, Clough Terrace, Barnoldswick, via Colne.                 | 5FS | W. A. Andrews, 1, Balmoral Mansions, St. Andrews Park, Bristol.                               | 5IK | B. L. Stephenson, 12, Sheringham Road, Withington, Manchester.           |
| 5CK | L. H. Pearson, Long Row, Nottingham.                                      | 5FU | University College, Nottingham.   | 5IO | R. H. Brown Wireless Equipment, Ltd., 10, Coverdale Road, London, W. 12. |
| 5CP | D. V. L. Fellows, 26, North Common Road, Felling.                         | 5FV | S. I. Holt, St. Albans Road, St. Annes-on-Sea.  | 5IP | Robert H. Knox, 25, Bridge Street, Berwick-on-Tweed.                     |
| 5CS | G. R. Garratt, 35, Abbey Road, St. John's Wood, N.W. 8.                   | 5FX | Gent & Co., Ltd., Faraday Works, Leicester.   | 5IS | I. S. Foorl, 43, Herne Hill, London.                                     |
| 5CU | J. A. Walslaw, Garnet Villa, Otley.                                       | 5FZ | Lincoln Wireless Society, Lincoln.  | 5IT | B. B. C. Station, Birmingham.  |
| 5CV | R. J. Harrison, "Blacklands," Sidney Road, Watton-on-Thames.              | 5GB | Leonard Humphries & Co., 61, Geraint Street, Windsor, Liverpool.                              | 5IY | J. Wym, The Knoll, Widney Manor, Solihull, Warwickshire.                 |
| 5CW | A. H. S. Coochrook, Sharbourne Street, Birmingham.                        | 5GF | H. Stoper, 14, Johnson Terrace, Cricklewood, N.W. 12.   | 5IZ | W. G. Sherratt, 11, Bath Road, I.O.W.                                    |
| 5CX | A. Hinson, 161, Cotton Tree Lane, Colne, Lancs.                           | 5GI | R. Horrocks, 65, Leander Road, Thornton Heath, Surrey.  | 5JC | Ivor Morris, The Compton, Cemnaes Bay, Anglesey.                         |
| 5CV | L. Gordan, 133, Old Street, Ashton-under-Lyme.                            | 5GJ | J. Bovis, Radex Villa, Linford Estate, near Stanford-le-Hope, Essex.                          | 5JD | F. Bulmer, 4, Carlton Terrace, Scarborough.                              |
| 5DA | G. Gore, 24, Brucegate, Berwick.  | 5GP | J. E. Simpson, "Baskerville," Epsom Road, Guildford, Surrey.                                  | 5JG | R. F. Longley, Kibworth, 81, Langdale Road, Thornton Heath.              |
| 5DB | C. H. P. Nutter, 243a, Selhurst Road, S.E. 25.                            | 5GQ | F. W. Nightingale, Pitsford School, Northampton.  | 5JH | E. C. Wobblington, 171, Great Horton Road, Bradford.                     |
| 5DC | W. T. Aked, "Kasanki," Devonshire Road, St. Annes-on-Sea.                 | 5GN | P. G. Tyeis, 30, Mildred Avenue, Watford.   | 5JJ | L. D. Goldie-Morrison, Cults House, Cults, near Aberdeen.                |
| 5DD | Capt. M. H. Barnes, "Akabo," Ainsdale, Southport.                         | 5GY | G. H. Horwood, Buckland, 557, Lordship Lane, S.E. 22.   | 5JK | North of Scotland Wireless Co., 13, Bridge Street, Aberdeen.             |
| 5DG | C. H. Stephenson, Penn Manor, Wolverhampton.                              | 5HC | John Alex Beveridge, "Dunelm," 3 Cluny Drive, Edinburgh.                                      | 5JM | W. Woods, 8, Brighton Street, Barrow-in-Furness.                         |
| 5DI | C. J. Matthews, 450, Cranbrook Road, Ilford.                              | 5HD | H. St. John Ward, Bleasheim Chambers, 1, Crowtree Road, Sunderland.                           | 5JN | S. Wilkinson, c/o Bew & Co., Burslem, Stoke-on-Trent.                    |
| 5DM | A. N. S. Leg, Grove House, Albert Grove, Nottingham.                      | 5HI | Lawrence W. Birch, 30, Limesford Road, Waverley Park, S.E. 15.                                | 5JR | W. C. P. Hepworth, Moorings, Dovercourt, Essex.                          |
| 5DN | Capt. L. A. K. Halcomb, 106, Millhouses Lane, Sheffield.                  | 5HL | G. E. Wyles, St. Leonards, Hooley Street, Sherwood, Nottingham.                               | 5JS | Percy R. Solden, 76, Albert Road, Alexandria Park, London, N. 22.        |
| 5DO | E. J. Watts, 6, Ashley Road, Salisbury.                                   | 5HN | D. R. Etchells, "Kingsley," Oaken, near Wolverhampton.  | 5JV | Capt. J. H. B. Hampson, 477, Earlham Rise, Norwich.                      |
| 5DP | F. L. Stollery, Sea Scouts H. Q., "Fairmead," Vista Road, Clacton-on-Sea. | 5HP | Cunningham, Ltd., 169-171, Edgware Road, W. 2.  | 5JX | M. G. Scroggie, 37, Clung Gardens, Edinburgh.                            |
| 5L  | C. H. Stephenson, Penn Manor, Wolverhampton.                              | 5HQ | E. A. Pollard, Spring Bank, Limefield, Blackburn.   | 5JZ | H. J. Cheney, 263, Thimble Mill Lane, Nechells, Birmingham.              |
| 5DS | Arthur W. Fithian, 51, St. James Road, S.W. 17.                           | 5HW | National Physical Laboratory, Teddington, Middlesex.  | 5KA | G. C. Buddington, "Stagsden," West Cliff Road, Bournemouth.              |
| 5DV | D. Whittaker, 56, Park Road, St. Annes-on-Sea.                            | 5HX | C. H. Gardner, Brooklands Track and District, For Motor Cars. For address see 2WQ.            | 5KF | W. Bird, Llangrove, Hedgesford Road, Cannock, Staffs.                    |
| 5DY | The Chelmsford Radio Eng. Co., Rainsford End, Chelmsford, Essex.          | 5HY | B. Honri, Cromwell Hall, E. Finchley, N. 2.   | 5KL | Gordon M. Wood, "Dingle Cottage," Simondley, Glossop, near Manchester.   |
| 5FF | H. Anson, 13, Nottingham Place, Marylebone, London, W. 1.                 | 5IC | F. C. Harney, Sunset Avenue, Woodford Green, Essex.   | 5KN | E. J. Farnshaw, 95, Mayfield Road, Sandstead.                            |
| 5FH | L. H. Lee, 155, Rosefield Road, Smethwick, Birmingham.                    | 5ID | P. D. Coates, 55 Ennismore Street, Burnley.   | 5KO | F. W. Higgs, 45, Howard Road, Westbury Park, Bristol.                    |
| 5FI | H. D. Webb, 59, Bradford Street, Walsall.                                 |     |   |     |  |
| 5FL | T. W. Pevensey, Lewisham, S.E.  |     |   |     |  |

(Continued on page 1858)



# The Reinartz All Wave Tuner

By JOHN L. REINARTZ



It is with a great deal of pleasure that we present to our readers Mr. Reinartz's latest development in receiving circuits. He has given detailed information in this article on the construction and operation of the set.

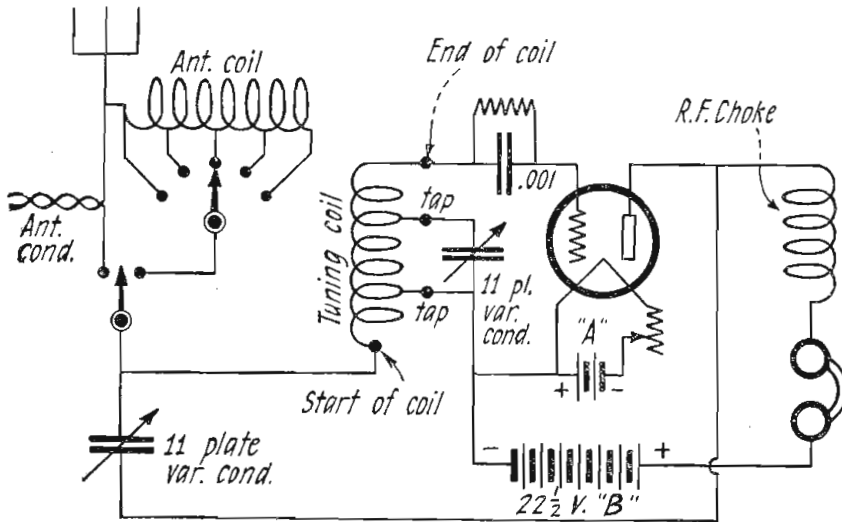

Fig. 1

The circuit diagram of the Reinartz All Wave Tuner. This is similar to the original Reinartz circuit but constitutes a number of improvements.

NOW that we have become used to transmitting on the shorter wave bands and have found them worth while, it is proper that we turn our attention to a tuner which will allow us to tune down to these short waves and lower. The future trend in amateur transmission will be down and yet further down in the wave-length scale.

Most of you are familiar with the tuner; therefore, it is not necessary that we go over any part except its application to any of the shorter wave-lengths.

Fig. 1 shows the circuit diagram. You will note the absence of the plate coil and the addition of a coil in the antenna, which is for the purpose of detuning the antenna circuit so that its effect on the tuning will be zero. Through this means the tuner can be calibrated before being connected to the antenna and its calibration will remain constant regardless of the size or type of antenna to which it may be connected. The greatest use of any tuner is not only to react to a signal, but also to be capable of calibration so that the signal may be found at a point corresponding to the calibration at the transmitter. A distinct advantage of this detuning coil is that it cuts receiver radiation to zero. This alone should bring it into favor.

The antenna coil is connected to one point of a two-contact switch. The second point of the switch connects to a small fixed series condenser. This allows either the coil or condenser to be used. The selectivity of the tuner can be judged from the fact that a 1-K.W. 500-cycle transmitting station 1,000 feet away can be eliminated by a five-meters change on the tuning dial, using the small series condenser. At station 1XAM communication has been carried on with French stations when ICKP was in operation. The calibration of the tuner is unaffected when the series condenser is in use. You may, therefore, change from one to the other if interference is experienced when using the detuning coil without losing the signal of the station being worked.

Passing on to the choke coil in the lead to the plate connection of the detector tube, we have come to an important necessity. This choke is to prevent any radio frequency current from traversing that circuit which is part of the audio frequency connection and is there for the same reason that you place a radio frequency choke coil in your plate connection in a transmitting circuit. The main coil of the circuit has four ends; the start of the coil is the antenna connection, the first tap is the ground connection, the next tap goes to the tuning condenser and the end is connected to the grid condenser. It is apparent that if we provide four binding posts we can change our coil as often as we wish, which will disclose the reason for the term, "All Wave Tuner." There is no reasonable limit to which you can tune without any other trouble than to change the coil to the one desired for the wave-length range.

This brings us to the tuning condenser. One should bear in mind that this must be a real condenser for good results. There are

a number of good condensers on the market. Always connect the rotary plates to the grounded part of the circuit, and if the condenser used has insulating end plates, use a shield. This is not needed with some of the late types of condensers, as the end plates are a part of the rotating element and arc in the ground part of the circuit, thereby eliminating capacity effects entirely. The variable condenser in the plate circuit must be a good one as far as its resistance is concerned, since it has the plate battery potential across it as applied to the detector tube. If hard tubes are used, this may amount to 45 volts or more; a bad condenser will, therefore, allow a current flow which in time will run down your "B" batteries. Its size is also 11 plates, although you may deviate from this size if you have a larger one on hand, but do not use one with more than 11 plates for tuning purposes.

### THE PLATE CHOKE COIL

Not all of us have the tools needed to make a really neat coil. In most cases good looks do not add to the result value of a coil, therefore take an ordinary sized drinking glass, which should be smooth of surface so the coil may be slipped off. One that is about 2½ inches in diameter will do. Wind this with 75 turns of No. 24 D.C.C. wire in jumble fashion. Slip off and wind a few turns of thread around the coil turns so that it will stay whole. If you must have a neater coil, wind it to the equivalent of the one described. Connect it as close to the plate connection on the socket as you can, consistent with good mounting practice. This coil should not be mounted near any of the other coils.

### THE DETUNING COIL

Around the same drinking glass wind, with the same size wire, 50 turns, with a loop at every 10 turns for a tap. Again in this case, make the coil in any fashion you desire, as long as it remains the equivalent of the one described. This coil is mounted on the tuner panel near the antenna connection. It is connected to a switch lever with six switch points, the lever being connected to the antenna connection of the tuning coil. The antenna wire is connected to the beginning of the detuning coil, which is connected to the first switch point.

(Continued on page 1823)

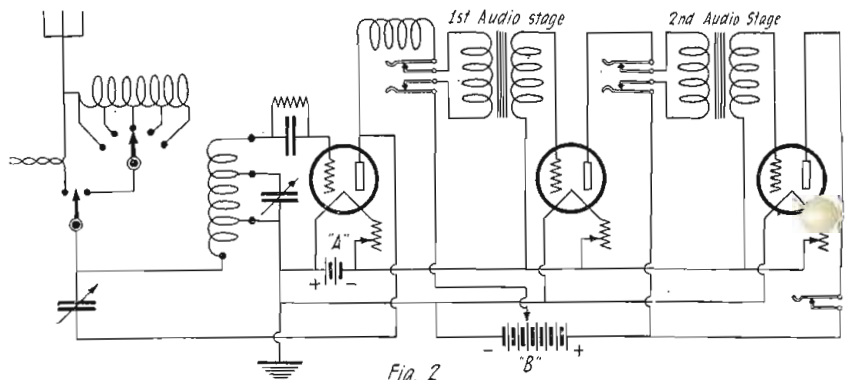

Fig. 2

The circuit of the Reinartz All Wave Tuner in conjunction with a two-stage audio frequency amplifier.



# The Transmitter at KFGD

By JOHN M. BALDWIN

A description of the master oscillator and power amplifier system employed in the circuit of the transmitter at KFGD, Chickasha, Oklahoma. Detailed information is given for those who might care to build a similar outfit for C.W. or phone work

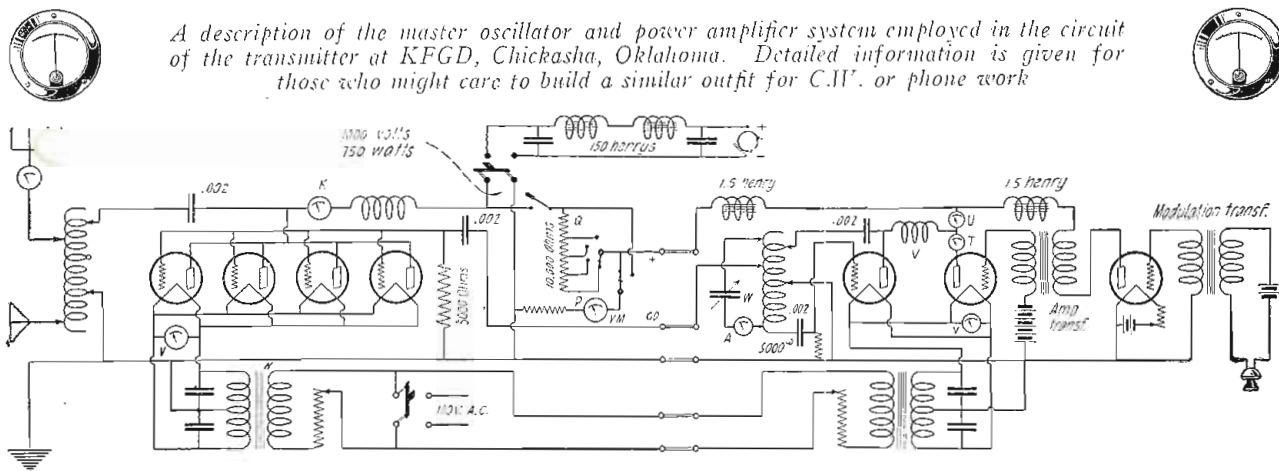

The circuit diagram of the transmitter at KFGD. From right to left the tubes are: speech amplifier, modulator, master oscillator and the four power amplifiers. The parts are K—0-750 milliammeter. V—0-15 voltmeter. N—300-watt filament transformer. O—30-turn coil. P—0-1000 voltmeter. Q—Two 5,000-ohm grid leaks. A—0-2.5 hot wire ammeter. T—0-100 milliammeter. U—0-250 milliammeter. W—0.001 variable condenser. Aerial ammeter 0-8 T.C. ammeter.

THE accompanying diagrams comprise the hook-up of the transmitter at station KFGD, which has been in use since the middle of November, 1923. It has given exceptional results, and is being described in these columns for the benefit of anyone who contemplates building an up-to-date transmitter.

In making the plans for the transmitter, the writer had to choose between several different types, with the result that the standard Hartley-Heising was rejected as requiring too many tubes, and all of the common self-excited oscillators were found subject to variation in frequency by changes in the constants of the antenna systems caused by swinging and moving objects in electrostatic field. So after consideration of several other types, the master oscillator was selected as being most suitable for broadcasting purposes, although little information as to its characteristics was available. Considerable experimentation was necessary before a workable combination was evolved, but the set was finally constructed, and after some few modifications, completely fulfilled all expectations.

Continuous use for about 90 days demonstrated the following:

## TUNING THE TRANSMITTER

Contrary to general opinion, the set is easily tuned. The output frequency is absolutely steady and no matter how badly the antenna may swing in the wind, it remains steady. Contrary to general opinion, two 5-watters, one used as oscillator and one as modulator, were of sufficient power to completely control the output of four 50-watt tubes, working at 10 per cent underload.

Modulation pronounced from good to exceptionally good by listeners—in all parts of the country, thus proving that the five-watt modulator is on the job, and big enough for this work. A considerable saving in construction cost was effected.

The master oscillator could be controlled by key in such a way as to successfully transmit C. W. telegraphically so that oscillations in the amplifier could be readily started and stopped, without any harmful results to the tubes.

Its general characteristics were such as to make it a highly desirable circuit for use in amateur stations, as it emits a perfectly steady unvarying C. W. signal.

The diagram is practically self-explanatory, and as standard apparatus was used

throughout, there should be no difficulty in construction.

Contrary to the generally accepted notion that the master oscillator circuit is hard to tune, the above described set was tuned without much difficulty, although it took a little more time and patience than is required for tuning the common self-excited hook-ups.

The main requirement in tuning is to adjust the oscillation constant of both oscillator and amplifier to exactly the same frequency, for if they are not in exact resonance, the amplifier tubes will run hot, and radiation will be practically nil. In tuning the output circuit, the correct amount of inductance to use, can be determined only by cut and try methods. There are several ways of adjusting for a specified wavelength, but the following is perhaps the simplest. An arbitrary amount of inductance is selected and the clips placed, approximately as indicated in the diagram. The master oscillator inductance was clipped in the center, for the neutral or nodal point, and the plate and grid clips set 13 and 1, turns respectively on either side of the ground clip. Then the two clips which connected to the artificial antenna, or dummy system, which consisted of a variable capacity and a radiation ammeter, were placed seven turns on either side of the ground clip, making the connections as shown on the diagram. Then the grid tap to the amplifier tubes was set arbitrarily—in this case between the plate and dummy clip.

The master oscillator was then started and wave-length readings were taken to ascertain the maximum and minimum waves over which the circuit would oscillate. Various values of capacity were used at W, and readings taken; the maximum wave was 440 meters, and as the minimum wave to which the wave-meter would respond was 180 meters, it was impossible to obtain the minimum range of the oscillator. It, however, oscillated readily down to 180 meters. From this, it appeared that the clips were set about right, as the highest readings of current in the dummy circuit were obtained between 200 and 300 meters. It was unnecessary to vary the position of the plate and grid taps, as the frequency was varied. The best position for the amplifier grid clip was also obtained by a cut and try method, although it is not difficult to find, as the most efficient place is indicated by a very noticeable increase of antenna current.

After all the clips had been placed on the master oscillator, and the plate, counterpoise, antenna and ground clips adjusted approximately on the output circuit, the amplifier and oscillator tubes were lighted and the plate voltage applied. The first result was, it appeared, that four "fifties" were in immediate danger of extinction; the plates were white hot, and the generator indicated that an excessive overload was being applied. But by the immediate varying of the condenser W in the dummy circuit, a point was found where the antenna current began to look respectable, and the tubes looked more like business, exchanging their white hot appearance for a cherry red. A wave-length reading was then taken, with the result that the wave, as can be expected, was considerably off that required, in our case 248 meters. In case the resulting wave is in excess of the allotted one, less amounts of inductance should be used in the output circuit; if the wave is too low, more inductance should be used. A few such trials should, and did in our case, suffice to bring the transmitter down to the required wave-length, and the amplifier grid tap was adjusted by fractions of a turn until the maximum antenna current was obtained.

## SOME NOTES ON THE TUNING

In conclusion, I wish to again emphasize the fact that one 5-watter can completely excite four 50-watt amplifier tubes, and that by modulating the five-watt master oscillator, the modulated wave applied to the grids of the amplifiers will, in turn, cause them to emit a wave of the same per cent, modulation as obtained with the 5-watter. However, it will be necessary to use considerable speech amplification before applying the microphone output to the grid of the modulator tube.

If the oscillator and amplifier are not tuned to exact resonance, a disagreeable growl, strongly suggestive of motor hum, will be emitted. This growl is caused by the interaction of the two frequencies, which produces an audible beat note. It can only be eliminated by extremely careful tuning. In the final adjustments, the inductance should be varied by fractions of a turn, and especially in the case of the antenna and counterpoise clips in the output circuit. Arrange the power wiring so that the plate voltage is applied to the oscillator first, and then to the amplifiers. In our case, the plate voltage is 1,000 normal, and a 10,000-ohm

(Continued on page 1828)



# A Distortionless Resistance Amplifier

By CLYDE J. FITCH



*For distortionless amplification of broadcast programs, the resistance coupled audio frequency amplifier is supreme. Three stages are required to obtain sufficient amplification, but to the fan desirous of the best, this is no disadvantage.*

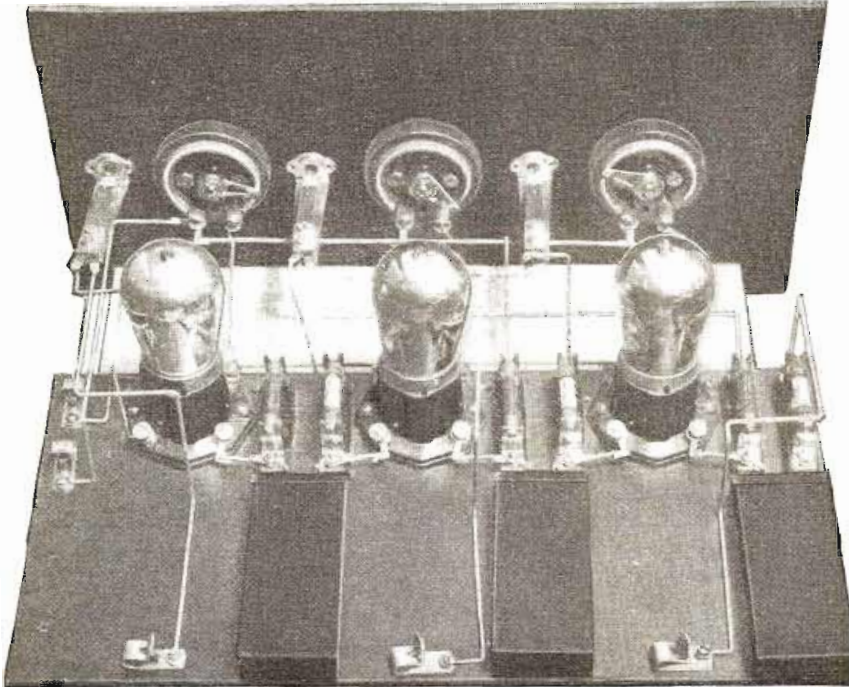

A rear view of the resistance coupled amplifier showing the exact location of each part. The condensers are seen mounted to the rear and the resistances between the tube sockets.

**D**ISTORTION is without doubt the greatest bugbear in modern radio receiving outfits. It is distortion that makes it difficult to understand the announcer and distortion that makes the music sound like noise and the noise sound like more noise. This, more than anything else, has discouraged many from purchasing expensive radio outfits. Therefore, in designing and building radio receiving sets, extreme care should be taken to eliminate as much of it as possible.

Distortion in the average radio receiver manifests itself in many different forms. The received waves are first distorted in the radio frequency amplifier, or, if none is present, they are distorted by regeneration in the detector circuit, when the set is adjusted very close to the oscillating point. This form may be eliminated by proper tuning. The rectifying action of the detector also causes more or less distortion. Crystal detectors apparently cause less distortion than vacuum tube detectors, although when properly adjusted the vacuum tube will give very clear reproduction. Next we have poor reproduction in the audio frequency amplifiers and loud speakers. Only distortion in the audio amplifiers will be taken up in detail in this article.

## TRANSFORMER COUPLED AMPLIFIERS.

The usual transformer coupled audio frequency amplifier, although very efficient as an amplifier, is very poor when it comes to faithful amplification of the audio currents. The distortion that is present in the amplifier is not caused by the vacuum tubes, but by the transformers. The transformers do not operate uniformly over the entire speech and musical band of frequencies encountered in broadcast reception. The majority of

transformers now on the market are very inefficient on the lower frequencies, while the higher ones pass through with little difficulty. Rather than attempt to design a distortionless transformer, one might better make use of a different type of amplifier, an amplifier that uniformly amplifies all audio frequencies from zero extending up into the ultra-audio or radio frequency range. Such an amplifier is the resistance coupled amplifier. As far as amplification is concerned, this type is not as efficient as the transformer coupled amplifier; it takes three stages of resistance coupled amplification to do the work of two stages of transformer coupled amplification. This is the reason why manufacturers do not install resistance amplifiers in their sets. But why hesitate at the cost of an extra tube in an already expensive receiver when distortionless amplification is

guaranteed? Resistance coupled amplifiers are employed in the broadcast stations for amplifying the sounds from the studio. Why not use them in the receiving stations also?

The actual cost of a resistance coupled amplifier is very little more than that of a transformer coupled one. An extra tube is required, to be sure, but in place of the two expensive amplifying transformers, moderately priced resistances and condensers are all that are needed. In fact the first cost is about the same, the only additional expense being in the maintenance of the extra tube.

The illustrations show the simplicity of the resistance coupled amplifier. The unit shown is complete in itself, although this type of amplifier may be incorporated in a receiving set. Three tubes are used, with three filament rheostats to match the tubes employed. The circuit works well with both dry cell and storage battery tubes. Jacks are also provided for connecting the loud speaker or telephones into any of the stages.

In order to employ only one set of "B" batteries, grid blocking condensers are used for each tube. These condensers have a capacity of one microfarad each and are commonly known as telephone condensers. They are made up of long strips of tinfoil and waxed paper, about 4 inches wide, tightly rolled up and sealed in a metal case. It is not advisable to attempt to construct them by hand on account of the large amount of tinfoil and waxed paper required.

With the use of grid condensers, grid leaks are usually necessary. The grid leaks,  $R'$ , should have a resistance of one to five megohms. After building the amplifier, several sizes should be tried, as most grid leaks vary considerably from their rated values and in some cases grid leaks will not be necessary. The negative charges that accumulate on the grids, due to the rectifying action of the tubes, in this case, leak off through the condensers, through the tubes or through poor insulation in the tube sockets and connections.

The most important and critical parts of the resistance coupled amplifier are the resistances  $R$ . For maximum efficiency, these should be equal to about three times the average plate to filament resistances of the vacuum tubes. For the average amplifier

(Continued on page 1804)

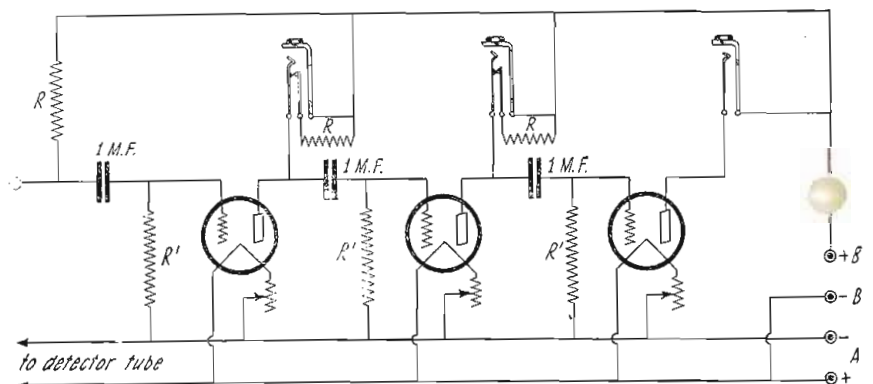

The circuit diagram of the resistance coupled amplifier. The large fixed condensers prevent the high "B" battery voltage from being impressed on the grids of the vacuum tubes.



# Simple C.W. Sets for the Novice

By L. W. HATRY, 5XU

A detailed description of four simple single-tube transmitting circuits that the novice can easily construct and operate. Mr. Hatry has eliminated all reference to the technical side of the subject, yet he has explained the necessary details in an elementary manner.

THE radio craze has brought into being a great mob of erstwhile BCL's who, having extracted all of the kick they could from the receiving end of the game, are now interested in getting gently introduced to the transmitting end, C.W. telegraphy. So enthusiastic are some of them that they have inserted a key in the ground lead of their single-circuit receivers and pounded the brass, thereby introducing some of their friends to the chirp-chirp end of radio without—and if you had heard some of the friends, you would know

phone of its "thing you talk into" and, Lo! you have a radiophone.

Just a few more forewords and then to business. It is decidedly advisable to have some sort of an antenna ammeter, because nothing else will be of much use to you. Obtain a meter with a 1/2-ampere range and be sure it is for radio frequency amperes. Then the sets will be very simple to adjust. Four are described and each has only one variable element so that all you have to do is to hold down the key and vary the variable factor until the antenna current is at a maximum. After that, push the key to your heart's content. The antenna current will run from .1 to .2 amperes, depending on your local conditions, so you needn't be afraid that the meter will be of too low a range.

sary, so that the correct number of turns needed on L<sup>1</sup> would fit on the rotor without difficulty. Silk covered wire can also be used in these sets, as well as different sizes of wire than I have specified.

A variation of this set is shown in Fig. 3. L is the same as before with a 10-turn antenna coil tap. L<sup>1</sup> is only 20 turns wound on the same form, but in the opposite direction to L, and using a 23-plate variable con-

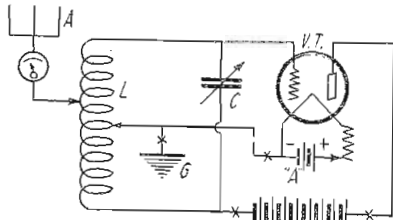

Fig. 1

The Hartley circuit is the most simple arrangement for the beginner. The key or microphone can be inserted at any of the points marked by a cross.

beyond dispute it was without—"benefit of clergy." Hence this article, which, if followed, will introduce you gently to C.W. and its idiosyncrasies. After you've tried it once, you won't care what it costs you thereafter.

The directions and dimensions included in this article are intended for the UV-201A vacuum tube with from 45 to 90 volts on the plate and normal filament current, mixed up with a feeling of doing something foolish, but anyhow—doing it. Other tubes can be used successfully, the table below showing why the UV-201A is the preferred tube for a cheap, low-powered set:

Tube	Filament Current	Output
UV201A—C301A	.25 amp.	Good
UV-199—C-299	.06 amp.	Very low
UV-202—C-302	2.35 amp.	Good
VT1 (WE)	1 amp.	Not quite good
VT2	1.3 amp.	Good

In other words, tubes that give the same antenna output, approximately, require from four to eight times more the filament current required by the UV-201A. (Same output approximately at 90 volts on the plate.)

Also, the sets are designed for antennae the total length of which, from the far end and including lead-in and ground-lead, is not more than 140 feet. Excessive insulation is not necessary, but care, at least in construction, is necessary to see that the insulation really insulates and that all joints are actually connections.

All the diagrams used to illustrate this article you will find small x's at certain places in the circuits. These indicate where the key must be inserted (yet giving you an opportunity to pick and choose) so that telegraphy is possible. These enigmatic x's also indicate the various places where you can insert a microphone and thus converse directly with anyone whom you can browbeat into listening to you; for all that is necessary to have radio telephony with a simple set like one of these, is to rob the nearest tele-

The first circuit I am giving is, I believe, the simplest, and it is justly popular among the more experienced amateurs throughout the country. It is known as the Hartley (see Fig. 1). L is a 45-turn coil of No. 18 D.C.C. wire, wound on a 3-inch diameter form and is tapped at the 15 and 25 turns from the grid end of the coil. The 15 turn tap is for the antenna. A and the 25 for the filament center tap and the ground. This places 10 turns in the antenna circuit, 25 turns in the grid circuit, and 20 turns in the plate circuit. The variable condenser C can have 11, 23, or 43 plates, the lower capacities being preferable.

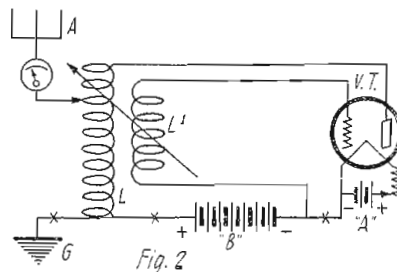

Fig. 2

Another simple transmitting circuit that the novice can use to advantage. This is known as the IDH (reversed feed-back circuit).

The vacuum tube and "A" battery are standard and the "B" battery voltage has already been mentioned. Of course, the condenser C is the variable element in this arrangement.

A second circuit that is very famous and popular is the well known IDH and is shown in Fig. 2; this is a sure-fire circuit. It is, as you no doubt have noticed, very similar to your single circuit receiver with the position of the coils reversed, so that its operation will, no doubt, be familiar to you. The antenna plate inductance L is of 30 turns of No. 18 D.C.C. wire wound on a 3 to 4-inch form and tapped at 10 turns from the ground end of the coil for the antenna. The tickler is of 35 turns of No. 22 D.C.C. wire wound on a length of the form that L is wound on, but with a slot of 1/2-inch or more, so that when the wire is wound on it the edges come together, making a smaller diameter coil and one that will just slide inside of L giving you the variable factor, the coupling. The set of coils could also be wound on a standard variocoupler form and the size of the tickler wire reduced if neces-

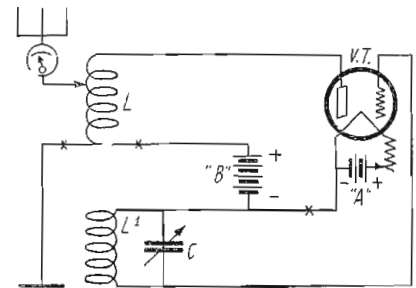

Fig. 3

Another form of the reversed feed-back circuit employing a variable condenser shunted across the tickler coil for the purpose of fine adjustment.

denser, C, in shunt with it. This construction is simpler, and usually presents a neater job and works about the same.

The last circuit I'll give is the Meissner, which is a coupled set and one which should be much more popular than it is. This is shown in Fig. 4. The three coils are wound all on the same form with only sufficient spacing to make the job mechanically and electrically decent, for they must be coupled. L<sup>1</sup> is wound first and is 30 turns of No. 22 S.C.C. wire. L comes next, being the antenna coil, and is wound with No. 18 D.C.C. wire to the total of 10 turns. L<sup>2</sup>, the grid coil, is the last, and is wound with 25 turns of No. 22 S.C.C. wire and is shunted with the 23-plate variable condenser C, which provides the means of adjusting the circuit. In connecting the set, remember this: Assuming a current coming from the plate of the tube, it must travel in the same direction that a current coming from the antenna to ground would travel through its coil; whereas a current coming from the grid must travel in the

(Continued on page 1826)

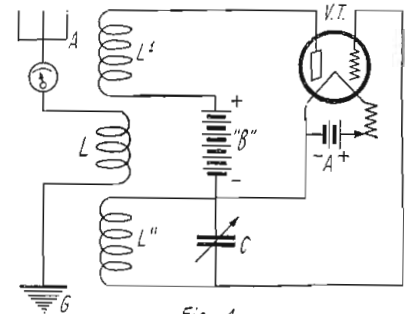

Fig. 4

The Meissner circuit, although a bit more complicated in construction than the others, is considerably easier to adjust.



# C. W. and Radiophone Transmitters

By L. R. FELDER

PART VII.



Single or multi-tube oscillator systems that directly excite the antenna are slowly giving way to the Master oscillator system. This is a very important advance in C. W. transmission. Mr. Felder gives in this article valuable information on the master oscillator system



IN a series of articles on the above subject, which were published in RADIO NEWS, the principles underlying the design and construction of oscillating and modulation circuits were taken up and their application to the problem of radio telephone broadcasting systems was considered. In these articles a single oscillating circuit was assumed to be exciting the antenna. When such an oscillating system is applied to an antenna, the wave-length of the system is subject to considerable variation for any given adjustment of the circuit. This result is imminent since the antenna capacity is subject to variations on account of such disturbances as swaying of the antenna, differences in weather conditions and so on. This is the reason why, in receiving such C. W. stations, the setting on the receiver often requires a small change to keep it in resonance with the transmitted wave. This is, of course, a disadvantage.

A second disadvantage of such a system is that changes such as those described above may result in instability of oscillations, with the possibility of oscillations stopping entirely. Consider the circuit of Fig. 1. For a given antenna capacity and inductance we know that a certain coupling is required between plate and grid coils and antenna coil for maximum output. As soon as there is a change in any of the antenna constants it is necessary to make a corresponding change in the various couplings to secure maximum output. If this is not done, the output decreases, and if the change in antenna capacity becomes too great oscillations may stop abruptly until the couplings are properly adjusted. In other words, the antenna constants are so closely related to the oscillating requirements of the circuit that small changes make the circuit unstable. Antenna capacity changes are in general not great enough to completely stop oscillations, but they do decrease the output and render the circuit unstable.

For the above reasons, circuits which excite the antenna directly should be avoided if possible. Where one or two tubes, at most, are used, it is satisfactory to use the direct antenna excited circuit of Fig. 1. But where a number of tubes are used in parallel, the disadvantages of such a circuit increase,

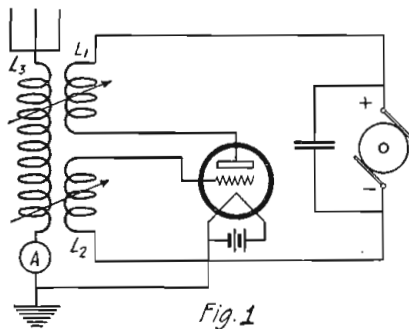

Fig. 1  
A self excited Meissner oscillator circuit. A variation of the antenna capacity will materially affect the oscillator, consequently the wave-length.

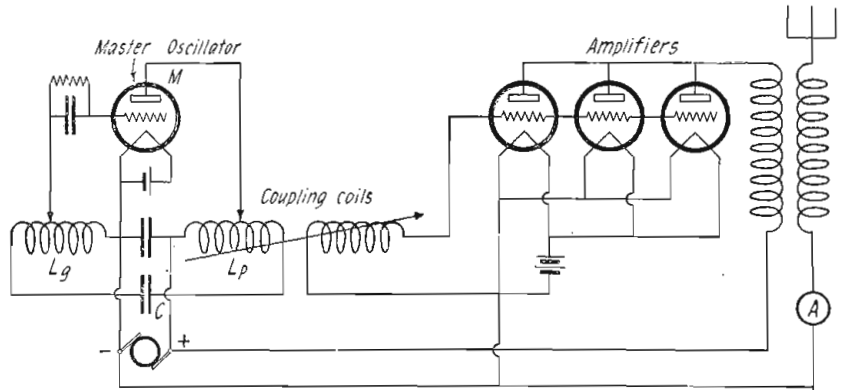

Fig. 2  
Transmitting circuit employing a master oscillator for exciting three power amplifiers. A variation of antenna capacity will not affect the oscillation circuit.

and in this case a very efficient substitute may be found. The necessity for using a number of tubes in parallel often arises when it is desired to transmit at higher powers. The plate voltage which any given tube is able to sustain is limited, hence to increase power it is necessary to add tubes in parallel. Where 5-watt tubes are used as oscillators, it is necessary to use five tubes in parallel to secure a power of 25 watts. Suppose it is desired to transmit speech with such an oscillator. With the Heising system of modulation it is necessary that the power of the modulator tubes be at least equal to that of the oscillator tubes. Thus in the above case where 5-watt tubes are employed, and five are used in parallel, it will be essential to use a 25-watt modulator, which may be made up of five 5-watt tubes in parallel also. This makes the number of tubes employed excessive, and the set extremely bulky.

### THE MASTER OSCILLATOR SYSTEM

These disadvantages of the direct antenna excited oscillators and of multiple tube oscillators may be very efficiently overcome by the use of a system called the "master oscillator-amplifier" system. Fig. 2 illustrates the circuit employed in this method. We have a master oscillator tube M, to which is connected a complete oscillating circuit. The design of this circuit is similar in all details to those described in the first articles of the series, except that this oscillating circuit is not coupled or connected to the antenna. By means of the condenser C and the inductances Lg and Lp we can adjust the wave-length of the oscillating circuit. Between the coils is a by-pass condenser for the high frequency oscillations, thus affording protection to the generator. It should be about 1 mfd. Coupled to the plate coil Lp we have another coil which feeds the grids of four tubes in parallel. These four tubes act as high power radio frequency amplifiers. The master oscillator furnishes the power to excite the grids of the four tubes in parallel, and since the grid losses are generally very small a single master oscillator

is fully capable of supplying these losses in addition to its own. Thus by coupling to the master oscillator, we can excite the grids of a number of tubes in parallel. These tubes then act as radio frequency amplifiers and produce in the output or plate circuit the amplified radio frequency. By coupling the plate circuit of the amplifier to the antenna, this amplified output is fed into the antenna and radiated.

### ADVANTAGES OF MASTER OSCILLATOR

Let us now examine the advantages of such a system as against the system employing all five tubes as self-excited oscillators feeding into the antenna directly. In the latter case we saw that a great disadvantage arose due to wave-length variation when the capacity of the antenna altered. In the case of the master oscillator amplifier system, variations in the antenna capacity do not affect the radiated wave-length. This is determined solely by the wave-length of the master oscillator circuit which is invariable for any setting since its capacity and inductance are not affected by outside influences. This wave-length is impressed on the amplifiers which are untuned, and the amplified output is again impressed on the antenna which radiates it. No matter how the capacity of the antenna may change, due to swaying, sleet or other conditions, the same frequency is impressed on it and radiated.

For the same reason it will be apparent that instability of oscillations cannot arise. Since the oscillations are generated by the master oscillator, which has fixed constants, any variations in antenna capacity cannot alter the oscillation adjustments. No matter how the antenna capacity may vary, the oscillation circuit undergoes no variations, and no additional adjustments will be necessary as in the case of the self excited oscillators of Fig. 1.

### POWER OUTPUT

The question of power output in both these systems is an important one. In the case of the self-excited oscillator of Fig. 1,



if we have five similar tubes operating, the total output will be five times that of one tube. In the case of the master oscillator amplifier system we have one master oscillator feeding four power amplifiers, as in Fig. 2, and the output given to the antenna is that of the four amplifiers, or four times the power output of one tube, if they are connected in parallel. At first glance it would seem that as far as power output is concerned the self-excited system of Fig. 1 is better. But actually this is not the case. The reason is that it is possible to work amplifier tubes at greater efficiencies than oscillator tubes. In oscillators, as has been explained before, it is necessary to adjust the grid voltage and plate voltage for maximum output. When the plate inductance is varied it is necessary to make a compensating variation in the grid inductance to secure maximum output and efficiency. The voltage which may really be obtained on the grid of an oscillator tube is limited to a considerable extent by the voltage which may be applied on the plate. This does not hold in the case of the amplifier. In Fig. 2 the amplifier grids are supplied voltage from an independent external master oscillator circuit. The voltage which may be applied to the grids of the amplifiers is dependent solely on the power output of the oscillator and the coupling between  $L_p$  and  $L_g$ . The master oscillator has sufficient output to care for any power drawn by the amplifier grids. In this manner it is possible to give the amplifier grids any voltage which is required for maximum output. Any voltage which is applied to the amplifier grids can produce no undesirable reaction, such as may be produced in a self-excited oscillator, where oscillations may cease if the grid voltage is not of correct value. It is for this reason that an amplifier may be worked at higher efficiencies than a self-excited oscillator; hence an amplifier tube will give more output than an oscillator tube. For this reason it is possible to secure as much output from four amplifier tubes which are excited by a master oscillator as from five oscillators working in parallel. In point of power there is no loss in using the master oscillator amplifier system as opposed to the parallel oscillator design. In fact, where the number of tubes in parallel becomes high, there may be a large gain in output due to the much higher efficiencies at which amplifiers work.

**RADIOPHONE COMMUNICATION**

We next come to the question of radiophone communication when employing the master oscillator amplifier system. Here a tremendous advantage is secured. As stated below, when employing the Heising system of modulation it is necessary to use as many modulator tubes as oscillator tubes. Fig. 3 illustrates the Heising system where three oscillator tubes are used, necessitating three modulator tubes of equal power, requiring a

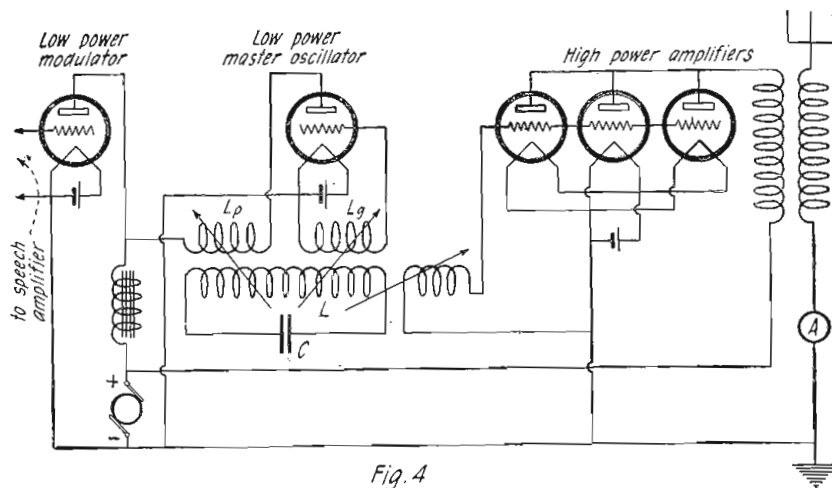

Fig. 4  
When using the master oscillator amplifier system, only a small tube is necessary to modulate the oscillator, the modulated output being amplified by any number of amplifier tubes. This system is preferable to the one of Fig. 3.

total of six tubes. Since we are modulating the high power directly, all the preceding speech amplifier equipment must be of correspondingly high power. Obviously if we modulate 100 watts we require more elaborate and more powerful speech amplifiers than if we modulated only five watts.

Consider Fig. 4 which shows the master oscillator amplifier system employed for radiophone communication. In this system we have a small master oscillator which supplies grid voltage to a power amplifier. It is a simple matter to modulate a small oscillator by means of a correspondingly small modulator tube of equal power. Hence in the circuit LC we have modulated radio frequency power. This is amplified by the power tubes in parallel, and modulated radio frequency is, therefore, radiated from the antenna. The advantages of this system are at once evident. The problem of efficiently modulating higher powers is simplified. In this system we modulate at low power, namely, the master oscillator, which requires less elaborate and less powerful speech amplifiers than if it were necessary to modulate the high power directly as in the self-excited system. For a given power we effect a large saving in the number of tubes employed. In the case illustrated above a total of six tubes is required in the self-excited system of Fig. 3 to secure modulated output for three oscillator tubes. In the case of the master oscillator amplifier system of Fig. 4, we require only five tubes in order to secure the same output. For much more power we effect a saving of one tube. Of course, the saving of tubes increases with the number of tubes used. Furthermore the set is not as bulky and there is a considerable

saving in renewals since fewer tubes are employed.

The amateur will find that if he uses a number of tubes in parallel, the master oscillator system will prove considerably superior and more efficient. Operation at low powers and conversions at low powers are always simpler than at high powers. It is much simpler to generate radio frequency oscillations at low powers as in the master oscillator system, than it is at high powers, as must be done with the self-excited oscillator system. Also it is simpler and less expensive to modulate radio frequency at low powers than at high ones.

A few words of precaution in conclusion. When using a number of tubes, as in this system, it is always advisable to shift tubes until the best balance is secured. As in receiving sets and amplifiers some tubes work best as detectors while others work best as amplifiers. Similarly here, one tube may prove to be the most efficient oscillator while another may prove to be a good modulator, and so on. Vary the coupling between the power amplifiers and the master oscillator until maximum radiation is secured. Then vary the coupling between the output of the amplifier and the antenna until maximum radiation is secured. Alternate between these two adjustments until the best settings are reached. It is always advisable to have a plate ammeter in circuit so that adjustments may be secured which will give maximum radiation with minimum plate current, for we are after maximum efficiency also. Instead of using inductive coupling between the power amplifier and the master oscillator as in Fig. 4, conductive coupling may be employed. Inductive coupling is, however, preferable because it permits varying the coupling without having to stop oscillation enabling better adjustment.

**THE STANDARD WAVEMETERS OF THE BUREAU OF STANDARDS**

To serve as a standard of radio frequency, the Bureau of Standards has two especially constructed wavemeters covering the frequencies in more general use from 18 to 4,600 kilocycles per second (16,650 to 65 meters). These standard wavemeters are used in calibrating wavemeters belonging to the Radio Inspection Service, manufacturers, colleges or others in need of standards of frequency.

Each standard wavemeter consists of a variable air condenser of special design, four fixed mica condensers, a number of interchangeable inductors or coils, and a resonance indicating device. The majority

(Continued on page 1804)

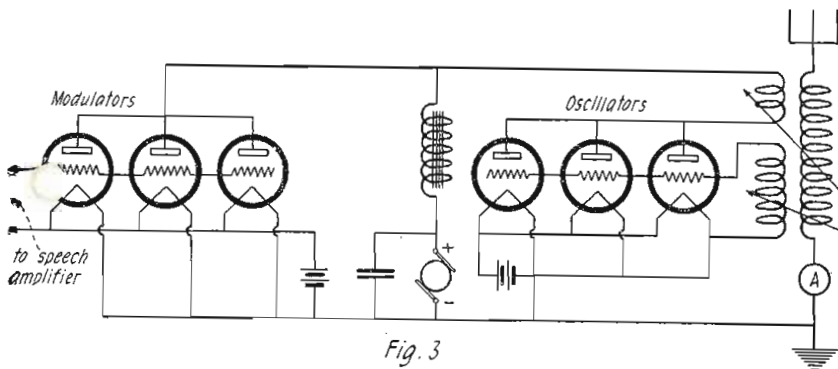

Fig. 3

A typical constant current circuit. The same number of oscillator and modulator tubes is necessary in order to efficiently modulate the output.



# Awards of the \$50 Radio Wrinkle Contest

## First Prize

### A SIMPLE BATTERY CHARGER

By GEO. SCHUCHMAN

Here is a home-made "B" battery charger that will prove welcome to those who wish to charge their own storage "B" batteries. This charger operates on the same principle as the well known Tungar rectifier.

All that is required is a small toy transformer and a double filament headlight bulb of the type used on Ford cars. This bulb has two filaments, the smaller of which should be burned out. This can be done by connecting 10 or more volts across the proper terminals. As this bulb has two contacts on the bottom and the third is made to the brass shell, the wrong filament can very easily be burned out by mistake. The brass shell is the common terminal for both filaments. The other terminal of the smaller

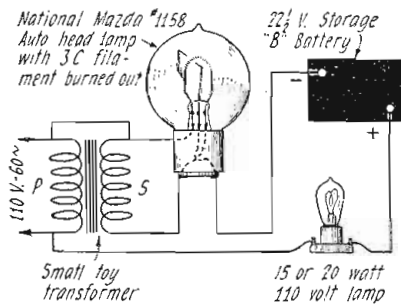

Why use a messy electrolytic rectifier to charge your storage "B" battery? A Ford bulb will do the trick if connected as shown.

filament can be found by connecting one terminal of a six-volt storage battery to the shell and touching the other storage battery terminal to one and then the other contact on the bottom of the bulb. The filament that burns dimly is the one that should be burned out.

The connections for the charger are clearly shown in the diagram. A 15- or 20-watt lamp is connected in the battery circuit to limit the current flow. A larger lamp should not be used, for then the wire acting as the plate will melt down rapidly, thereby increasing the distance between it and the filament until the rectifier ceases to function. When the charger is operating correctly, the 110-volt lamp will glow dimly.

## Second Prize

### A COMBINATION BEARING AND MOUNTING FOR VARIOMETERS OR VARIOCOUPERS

By W. H. GORDENIER

Herein is described a combination bearing and mounting for a home-made variometer or variocoupler which can be built very easily and will prove quite efficient. The sketch is self-explanatory, but a description of the mounting may prove helpful.

A variometer or variocoupler, light in weight, preferably made of thin bakelite tubing or cardboard, should be used in conjunction with this mounting.

The mounting consists of a 1/4-inch brass tube about two inches long, with an inside diameter large enough for a 1/8-inch brass rod to rotate freely inside, this rod to be about 1/4 inches longer than the tube. The tube should be threaded at both ends for about 3/4 of an inch. A brass washer should be threaded to fit the 1/4-inch tube. A nut and a plain washer are now placed on one end of the tube, and the tube is inserted through the panel from the rear, through a

## Prize Winners

**FIRST PRIZE \$25**

*A Simple Battery Charger*

By Geo. S. Schuchman  
5719 N. Maplewood Ave.,  
Chicago, Ill.

**SECOND PRIZE \$15**

*A Combination Bearing and Mounting for Variometers or Variocouplers*

By W. H. Gordenier  
955 De Soto St.,  
St. Paul, Minn.

**THIRD PRIZE \$10**

*A High Capacity Fixed Condenser*

By B. Kellam  
364 Ossington Ave.,  
Toronto, Ont., Canada

1/4-inch hole. The threaded washer should be screwed on the projecting tube so that the end is flush with the face of the washer. The nut on the inside is now tightened and the tube is rigidly held at right angles to the panel. Two nuts are now screwed on the other end of the tube with the primary of the variometer or coupler between them, but these nuts are not tightened until the secondary is in place. To mount the secondary, the rod is inserted in the tube from the outside and the secondary securely fastened on it between two nuts. The secondary can be centered in the primary by moving the nuts on the tube backward or forward. When the correct position is found, these nuts are tightened. A bushing is made of a piece of

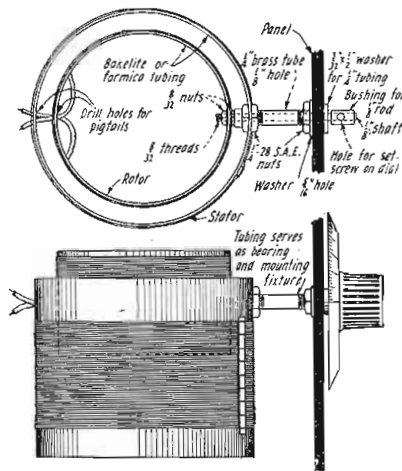

A neat method for mounting a variometer or variocoupler. Only one hole is drilled in the panel.

1/4-inch brass tube, 1/2-inch long, to be slipped on the rod so a standard dial may be employed. This bushing should have a small hole drilled through one side so the dial set screw may be fastened on the rod beneath.

## Third Prize

### A HIGH CAPACITY FIXED CONDENSER

By B. KELLAM

The following is a method for making a condenser of considerable capacity for use in preventing sparking of vibrators in recti-

fiers, where not too high a voltage is employed. Get some scrap soft rubber such as rubber corks, tubing, or elastic bands and dissolve them in benzine (highly inflammable). The solution should have a consistency of thin mucilage. Take a piece of canvas slightly more than twice as large as the condenser in length, and in the center paint a thin layer of rubber. In a few minutes this will be dry. Then place a sheet of thin tinfoil on the layer, the size of the tinfoil being such as to leave a 1/4-inch margin of rubber around, and a one-inch lead projecting. Paint another thin layer of rubber on the tinfoil and when dry, repeat the whole process, alternating the rubber and foil. When the height has reached about 1/2 inch, apply pressure to the condenser. A small screw press will prove very handy for this. Then proceed again with the rubber and tinfoil. When you think you have made enough layers, the thickness of the condenser

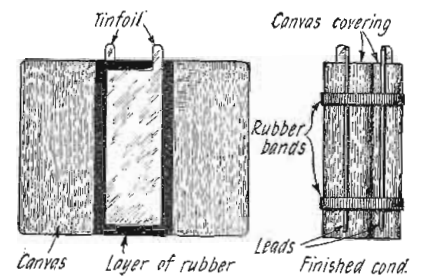

A condenser of any capacity can be made by using a rubber solution as the dielectric.

being optional with the maker, fold the condenser up in the projecting ends of the canvas and place two rubber bands over the canvas to keep it in place. The connecting studs are then carefully soldered each to a lead and the wire brought under the elastic bands so as to reduce pull on the foil projecting, as shown in the diagram. If the solution is made thicker, and also the layers of rubber, the condenser can be made to withstand higher voltages.

### CHARGING BATTERIES FROM DIRECT CURRENT SOURCES

WHERE direct current is available, "A" batteries can be charged by the following method. Fig. 1 will serve to indicate the scheme. Lay out the arrangement as indicated, using a wooden base four inches by eight inches. The polarity of the battery binding posts should be clearly marked as explained later. The polarity of the attachment plug need not be marked providing it is always attached to the same socket, and is not a reversible plug (one which can be plugged in in either of two directions). Such a panel will conveniently hang on a nail and may be used continually wherever and whenever a table lamp, floor lamp, vacuum cleaner or other device is desired.

The only precaution which must be observed is to determine the proper polarity for the attachment plug, and to see that this does not change when the charger is in some other location.

To determine the proper polarity, connect the circuit as indicated in Fig. 1, with battery in place and a lamp as a load, and turn on the current. Note the brilliancy of the lamp. Now turn off the current, reverse the battery connection and turn on the current again. Note the brilliancy of the lamp. The connection giving the darker lamp is the correct connection. The battery binding posts should now be marked with proper



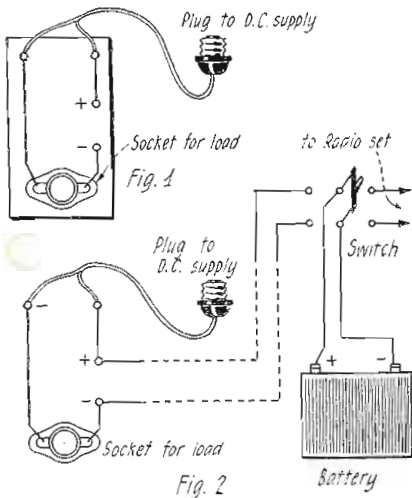

Arrangement for charging a storage battery from the D.C. line.

polarity. If the attachment plug is of the Edison screw plug type, no difficulty will be experienced in the future. However, if it is possible to "plug in" in the wrong direction (because of the type of plug), it is readily seen that the wrong connection may result. If you have one of these reversible plugs, mark it in some manner so that it will always be used correctly.

A simple polarity indicator can be made by adding a slight amount of salt to a glass of water. If the two electrodes are immersed in the solution, bubbles will rise from the negative electrode. This test should never be made without some sort of protective resistance, such as a lamp, in circuit.

Having determined the polarity of the leads to which the battery is to be attached, connect positive to positive and negative to negative.

It is interesting to note that an electric flat-iron, if not continually in use, usually becomes too hot if permanently connected to the line. With this device, it is quite likely that the iron will operate at the proper heat continuously and will, at the same time, supply a very reasonable charge for the battery. Ordinarily two or three hours per week of charging with the electric iron will suffice to keep the battery in good condition. The circuit arrangement shown in Fig. 2 will be found very convenient for those who prefer the permanent installation.

Contributed by W. P. Powers.

**AN IMPROVED SPIDERWEB FORM**

The conventional wooden spider web coil form with its round wooden center and radial wooden spokes is rather difficult to construct, for the wooden center has a tendency to split when the rather large holes that are to take the spokes are bored into it. If the wood spokes are made so small that the holes bored in the center-piece are small enough not to split the wood, they will not be strong enough to support the winding of the coil, and they will be likely to break if the form is not handled with care. All

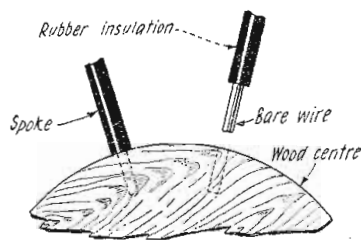

Rubber insulated wire is used for the spokes of this spider-web form.

these difficulties, and many others, are overcome by using lengths of rubber-covered No. 12 or 14 wire for the spokes. The pieces of wire are cut 1/2-inch longer than necessary for the spoke, the insulation on this extra half-inch of wire is cut away, and the bare part inserted in the hole bored to receive it in the wooden center disc. The bare end of the wire can be firmly held in the hole with a little glue. The holes in the center-piece need be only large enough to receive the bare wire. They may be almost a driving fit for the wire.

The advantages of the wire over the wooden spokes are numerous. The winding on the form sinks slightly into the insulation on the wire spokes and holds it in place without paint or other treatment. The insulation also holds the turns of the winding apart, assisting in insulating them from each other. Last but not of least importance, a form constructed with the wire spokes is much easier to build and is stronger than the all-wood form.

Contributed by Charles F. Felstead.

**A SIMPLE BATTERY CHARGING SCHEME**

Wherever there is commercial direct current, it is a very simple matter to charge storage batteries. If the battery is charged directly from the line, a resistance must be used in series to cut down and control the current flow. This resistance usually takes the form of a bank of lamps. But why go

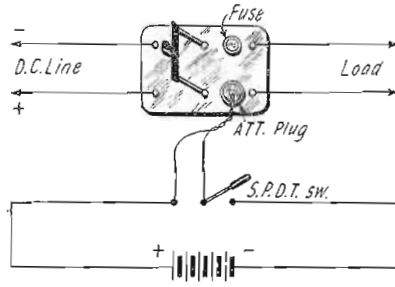

By using this scheme your storage battery will always be fully charged.

to any extra expense to charge the battery? Why not charge it at the same time the house lights are used and thus save money? This is a very simple matter if the scheme shown in the diagram is followed. A fuse block and double pole switch are inserted between the house lights and the line. One fuse is removed and an attachment plug is inserted in its place. The two wires from the plug are run to a S.P.D.T. switch, which is in turn connected to the battery. When the switch is thrown to the left, the battery is out of the circuit and when it is thrown to the right and any lights are being used, all of the current is flowing through the battery and charges it at the rate of current flow. The lights will be slightly dimmed as the battery uses part of the current that would ordinarily go to light the lamps. If one 100-watt lamp is being used, the battery is being charged at about one ampere. The battery will consume approximately eight watts, which is deducted from that consumed by the lamp and will consequently cause the lamp to be slightly dimmed, which, however, is no inconvenience, as it is hardly noticeable.

Contributed by D. E. Crabb.

**A COMPACT RECEIVING SET**

The accompanying illustration of a compact receiving set employing a spider-web coil as the tuning unit is, I believe, original. Tuning is done by means of the two switch arms which are used as sliders, the switch blades making contact with the wire of the coil. By mounting a crystal detector in the center of the coil form and binding posts

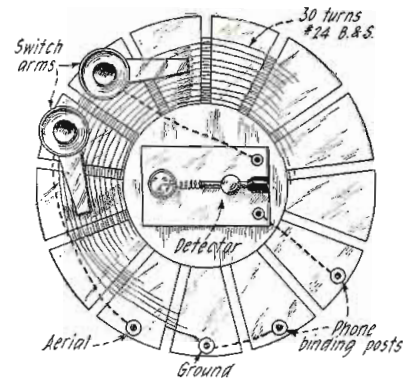

A simple crystal receiving set can be made on a spider-web coil.

on the edges, a complete receiving set is had. The wiring is shown in dotted lines which should be followed closely.

Contributed by J. Raymond Derby.

**CONSTRUCTION OF AN INSULATION TUBE FOR COIL WINDING**

Sheet celluloid, such as old photographic films, when rolled and cemented together with collodion, or a cement made by dissolving some scrap celluloid in acetone, or in equal parts of alcohol and ether, makes a first class tube upon which to wind inductance coils.

These old films, which range in size up to 12 inches by 14 inches, can be had for the asking from most any photographer, or from some doctor friend who does X-ray work.

First remove the gelatine emulsion from them by soaking in hot water and scraping. Hang them by two corners so they will be smooth when dry. Get a smooth round stick or bottle or mailing tube with a diameter a little less than the tube you wish to make. Wrap the celluloid tightly and smoothly around this core, and when one complete turn has been made, quickly smear a light coat of the cement over the whole surface. Then make another turn, keeping the entire outside face lightly coated with the cement. When you have from four to six layers, depending upon how thick you wish the tube to be, wrap the whole thing tightly in a cloth or towel and lay aside to dry for a few hours.

Remember to wrap tightly and smoothly and to apply only a light smooth coat of cement and you will have not only an efficient insulating tube but one that is neat in appearance.

Contributed by Dr. William H. McKie.

**A CHEAP TUBE SOCKET**

Many ideas of tube sockets have been shown from time to time, but for cheapness and simplicity of construction the socket described here cannot be beaten. The parts required for this socket are four soldering lugs, four small screws and a piece of quarter-inch wood about two or three inches square.

Contributed by Reginald Harvey.

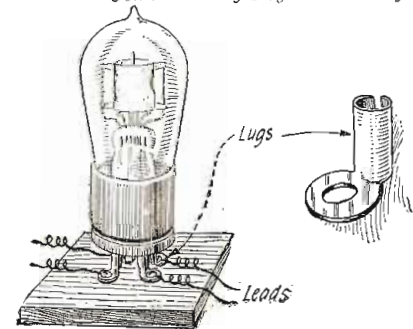

The cheapest tube socket. The cost is about two cents.



# Radio Humor

## Queer Queries and Ready Replies

BY I. R. TANNEHILL

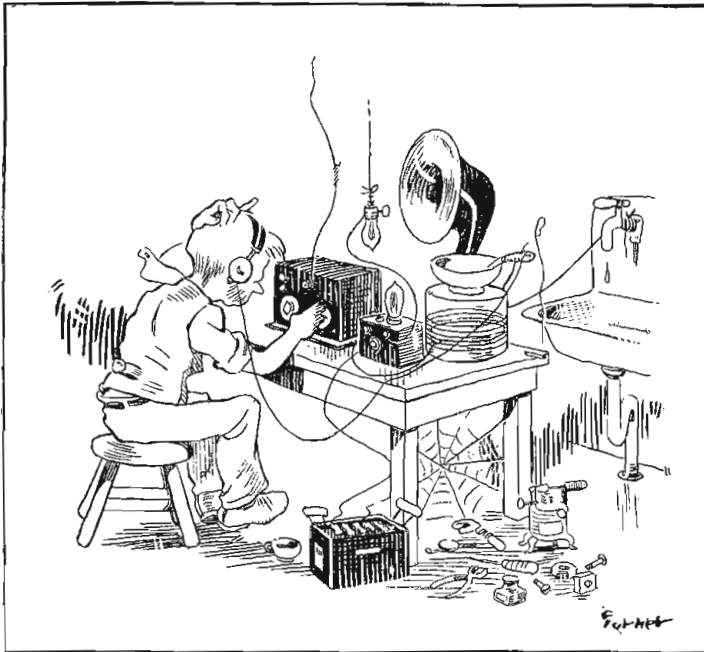

A n efficient receiving set made of odd odds and ends.

these to receive local broadcasting? Puzzled.  
 A. Solder the light socket to the ice-water can. Wrap the light wire around the can 20 times and around the water pipe 10 times. Place a wooden bowl on top of the water can and place an iron spoon in the bowl. Connect the spoon to the water pipe and connect the phones and detector in parallel with the can. To increase wave-length throw spoons in the bowl. To decrease the wave-length, drink the ice-water. The average stomach

(Continued on page 1822)

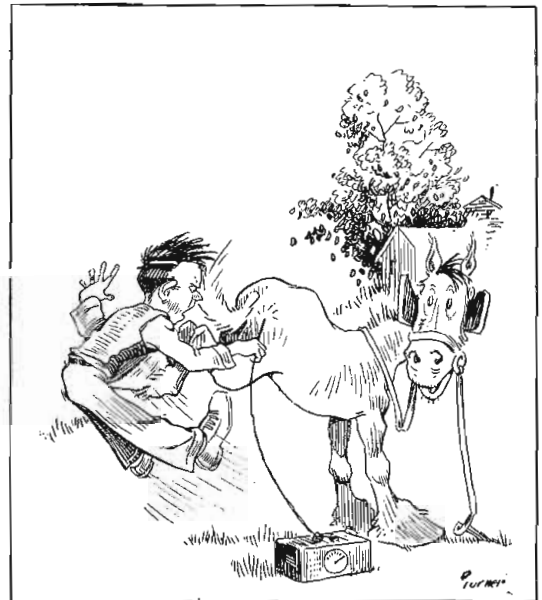

A most simple and efficient means of demonstrating "lines of force" with a horseshoe.

**Q**UESTIONS addressed to this Department will receive answers as pointed as a jab in the eye with a sharp stick. Useless questions preferred. Use two-sided paper written on one side. No attention will be paid to questions not accompanied by money, postage, chewing gum, radio apparatus or smoking tobacco.

**Q.** How can I improve the appearance of my knob and dial? Fastidious.

**A.** Get a haircut and shave.

**Q.** Which is a better lead-in, a conductor or an insulator? I. N.

**A.** A conductor is much better; if a conductor is not available, try a motorman.

**Q.** I have received music from every state in the Union. Can this record be improved? Longfellow.

**A.** Yes, apply to Congress immediately for a few additional states.

**Q.** I have a crystal, a soldering iron and a pair of telephones. How can I connect

## Radiotics

**W**E will publish in this Department every month humorous misprints as they occur in the press. We ask our correspondents to send us such misprints, but we cannot accept them unless they are accompanied by the original, which may be

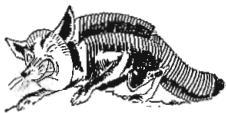

Meet the latest radio instrument—the Foxed Condenser.

clipped from the periodical, newspaper, book or magazine wherein the mistake occurred. We will pay \$2 apiece for each Radiotic and the more idiotic it is, the better chance it has to be reprinted by us. We will also print the name of the scout who discovers it. Address all Radiotics to Editor, Radiotic Department, care of this publication.

We have with us this month an advertisement of Gimbel Brothers, New York, picked from the New York Times of March 5, in which they advertised a new Neutrodyne set. In the text we find "DUBILIER FOXED CONDENSERS." We always had an idea that Dubilier was rather foxy, but his going

**RADIOTICS**

Beginning with this issue we are starting our new RADIOTIC Department. If our readers happen to see any humorous misprints in the press, we shall be glad to have them, clip them out and send to us. No RADIOTIC will be accepted unless the printed original giving the name of the newspaper or magazine is submitted. We shall pay \$2.00 for each RADIOTIC that is accepted and printed here. A few humorous lines from each correspondent should accompany each RADIOTIC. The most humorous ones will be printed. Address all RADIOTICS to:

Editor RADIOTIC DEPARTMENT,  
 c/o Radio News,  
 New York City

into the manufacture of Foxed Condensers is the foxiest thing he ever did.

We also pick the following little posey from the New York Evening

And here we have the 200-ton Rheostat, to be installed shortly on top of the Woolworth Building.



World, Mid-Week Radio Magazine, issue of Wednesday, March 5. The article is entitled—"Here is a Standard Regenerative Set Which Gives Excellent Results." One of the paragraphs is as follows: "In our

Here is the man with a mahogany finish. He goes well with the latest mahogany parlor outfit.



case a UV-201A was used as a detector, operated from a 6-volt storage battery and a 200-TON RHEOSTAT. No wonder Silbersdorff's set gives excellent results. It certainly should. We have always maintained that most rheostats did not carry enough weight with the users. Personally, we would like to see the set in which this baby is installed.

**His Finish—WANTED—**Three-tube set by man with a mahogany finish.—Classified ad in the New York Telegram and Evening Mail Radio Section.



# Correspondence From Readers

## RADIO CORRESPONDENCE SCHOOLS

Editor, RADIO NEWS:

In reading the current number of your magazine I note an article by a man formerly connected with the Radio Inspection Service in which the correspondence schools for operators are thrown into disrepute. I should like a word on the subject in order to correct a mistaken attitude that may work badly for some reputable schools of this sort.

At present I am a radio operator on the S. S. *Cuba*, plying between Tampa, Fla., and Havana, Cuba. As a matter of fact I have been going to sea as a radio op. for some time. My foundational knowledge of radio was gained through a correspondence course and when I went to the office of the local Supervisor at New Orleans I knew that there was such a thing as the International Morse Code and that most of the radio operators were expected to at least have a passing acquaintance with it. As a matter of fact, I knew that there were examinations on the reception of code included with the technical examination.

The apparatus aboard the *Cuba* is controlled by the Radio Corporation of America and I might say that I knew the difference between the transmitting and receiving set when I stepped into the shack.

As to the correspondence schools I might say that there are black sheep among them even as there are among banks, lawyers, doctors and stocks. There are also reputable ones that are doing a good service for those whose means do not permit them to take a regular day school course in the art. In the field I have met several ops. who gained their knowledge from the despised correspondence schools and I have never met anyone who had a bad word to say against them. The man who would expect to get a full radio course for \$5 is the kind of a man who would buy wild-cat oil stock. Neither of them would investigate the oiliness of the salesman or the ad.

There are those in every line who will be taken in, and it is those who have been imposed upon that the former Supervisor was speaking about. But because some fall for a confidence scheme of this sort is no reason for condemning the whole list of correspondence schools, some of which have been doing a good work for a number of years. Radio is a wonderful occupation, but like everything else, one must be educated in its technicalities. The correspondence method has its difficulties, but it is a means that brings the technical education within the reach of a number of men who would otherwise have to remain in unskilled positions.

JOSEPH L. CRUSOE,  
1025 Eaton St.,  
Key West, Fla.

## RE—THE MENACE TO RADIO BROADCASTING

Editor, RADIO NEWS:

I have just finished reading Mr. Muhleman's article "The Menace to Radio Broadcasting" and being a reader of your magazines since the days of the old E. I. Co., am going to ask you what you think of this suggestion.

I have a radio receiver and, like most of the BCL's, am annoyed by the squeals and whistles produced by the ignorant operation of the numerous types of radiating receivers.

Now I am sure that there are a great many of the aforesaid BCL's who would be willing to try to minimize this nuisance, therefore, why not conceive some scheme whereby we can get together and be a "big brother" to those who unknowingly cause this disturbance?

Such an organization in cities throughout the United States, which would give, free

of charge, help and advice to those who own receiving sets, would bring about a better understanding of radio and help to make broadcasting a greater pleasure.

I have noticed that there are two classes of broadcast listeners: First those who are interested enough in radio to find out what takes place in their receivers and to further their knowledge concerning radio and are usually enthusiastic in the reception of "DX." Second, come those who care only to listen to the local broadcast stations.

The first class usually own regenerative sets, and to this class such an organization as I have suggested would be helpful in the successful operation of this type of receiver or in helping him in the addition of radio frequency amplification to get the long distance reception. The second class would benefit by using a non-regenerative type of

work that this portion of the magazine has been eliminated.

It was the only medium through which the problems and troubles of the sea-going operator could be dealt with in print. Some may think that a ship man does not have problems and troubles to be dealt with, but almost any operator, especially one on the average freight steamer, will have some kink on hand to be straightened out, some experience to tell of, or some helpful hint to save others trouble. These things in print would be well worthwhile.

W. C. ELLSWORTH,  
Opr. SS. *West Wawa*, USSB.  
Trosdal Plant & Lafonta SS. Co.  
New Orleans, La.

## ANOTHER INQUIRY

Editor, RADIO NEWS:

I am writing these few lines in regard to a certain section of your magazine called "With the Sea Going Ops." which I find does not appear in the latest edition.

I am what is termed a "Commercial Operator" and am employed aboard the Shipping Board vessel *West Durfee*. I have been a ship operator for several years and to my knowledge the introduction of the section in *RADIO NEWS* devoted to the ship operator has helped to bring together the views and ideas of operators employed as such, more than anything else. In fact, it has been the only source, with the exception of a publication issued by one of the radio service companies, by which men in this class of work have been able to express themselves.

As a reader of your magazine I do hope to find that section herein mentioned, continued in the near future.

THOMAS NUGENT.

[We have not forgotten the *Sea-going Operator*. We have him much at heart, but truly, how are we to continue this Department without material? The Department was created for the *Sea-going Operator*, but it is up to you fellows to keep it going. Out of its hibernation it comes if you boys will supply the breath. What say? Will you send us some good dope, and continue to send it, so this Department can once more thrive? EDITOR.]

## JOHN BULL ANSWERS US WITH A BRICKBAT

Editor, RADIO NEWS:

I read with considerable amusement your editorial on "Future Developments of Radio" in the March issue. You really are the dyed in the wool humorous fellow when it comes to writing about the conditions of radio in England. We have in our station here a previous article of yours on "Radio in England." I read it to listeners when testing speech. It is quite the funniest thing they ever heard. Someone should say "Hi" to you, and that quick. Come, sir, get down out of the high air before you criticize the results of the government control of radio in this country. Better still, read the letters of H. B. Newall, Starkey, Tetley and Woodward in the same issue of your paper. Pay one of those gentlemen's fare over here and let him see for himself the one country where radio is so controlled that exactly what the listeners want according to their letters is what they have. It is true that we have only a few stations. We don't need more transmitters. We certainly don't need half a dozen broadcasters in one town all turning out mediocre programs which all come in together on whatever wave you're tuned to. As for bootleg stations, we don't have 'em. We certainly do have pirates who do

(Continued on page 1839)

## Interesting Articles to Appear in June Issue of "Practical Electrics"

Historic Incandescent Lamps (Concluded).  
By T. O'Connor Sloane, Ph.D.

Electricity Detects Counterfeit Paintings.  
By M. Bayle, Director of Bureau of Identification, Paris.

Experimental Microphone.  
By Frank W. Godsey, Jr.

Electric Boilers.

Utilizing Solar Heat.

Dry Cells from Wet Batteries.  
By C. A. Oldroyd, Barrow-in-Furness, England.

Electro-Magnetic Induction.  
By Harold Jackson.

Hudson River Vehicular Tunnel.  
Stunts with Static. By Harry R. Lubcke.

receiver which would not cause himself and his neighbors a lot of disturbance; here the organization would be helpful to him by converting a regenerative set into the non-regenerative type, which is easier to handle and gives good results on local reception.

Of course I know that there are radio clubs which carry on work along this line, but are more or less for the advanced and transmitting amateur.

There are numerous radio fans throughout the country who would be only too glad to help in such a plan, thereby helping their neighbors and gaining knowledge themselves in doing so. The fans, I am sure, would get together and do the work free of charge, only charging for parts if they were necessary.

The broadcast stations themselves could help to decrease this interference menace and make known an organization such as I have mentioned.

JAMES EWART,  
55 William St., Orange, N. J.

## THE SEA-GOING OP'S. DEPARTMENT

Editor, RADIO NEWS:

In the last few issues of *RADIO NEWS*, the "With the Sea-going Op's" Department has been discontinued. I have talked with several operators and believe it is with much regret to those who are really sincere in their





**R**ADIO manufacturers are invited to send to RADIO NEWS LABORATORIES, samples of their products for test. It does not matter whether or not they advertise in RADIO NEWS, the RADIO NEWS LABORATORIES being an independent organization, with the improvement of radio apparatus as its aim. If, after being tested, the instruments submitted prove to be built according to modern radio engineering practice, they will each be awarded a certificate of merit, and a "write-up" such as those given below will appear in this department of RADIO NEWS. If the apparatus does not pass the Laboratories tests, they are returned to the manufacturers with suggestions for improving them. No "write-ups" sent by manufacturers are published on these pages, and only apparatus which has been tested by the Laboratories and found to be of good mechanical and electrical construction is described. Inasmuch as the service of the RADIO NEWS LABORATORIES is free to all manufacturers whether they are advertisers or not, it is necessary that all goods to be tested must be forwarded prepaid, otherwise they cannot be accepted by the Laboratories. Address all communications and all parcels to RADIO NEWS LABORATORIES, 53 Park Place, New York City.

## Apparatus Awarded Certificates of Merit

### BRANSTON THREE-COIL MOUNTING

The Branston type R-73 three-coil mounting is designed for use with standard honeycomb or duo-lateral coils. It is the front of panel type with control knobs attached directly to the two outside receptacles so that direct control of the coupling is obtained. The mechanical construction is very simple and rugged. Manufactured by Charles A. Branston, Inc., Buffalo, N. Y.

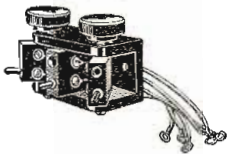

Arrived in excellent packing. AWARDED THE RADIO NEWS LABORATORIES CERTIFICATE OF MERIT NO. 412.

### BRANSTON THREE-COIL GEAR MOUNTING

When it is desired to mount the honeycomb or duo-lateral coils behind the panel, the Branston type R-62 coil mounting may be used. This mounting is similar to the type R-73 mounting described above, except that it is designed for back of panel mounting and the receptacles are geared to the control knobs. In this way the coupling is controlled from the front of the panel. Manufactured by Charles A. Branston, Inc., Buffalo, N. Y.

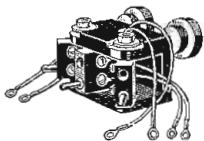

Arrived in excellent packing. AWARDED THE RADIO NEWS LABORATORIES CERTIFICATE OF MERIT NO. 413.

### BRANSTON D.L. INDUCTANCE COIL

Charles A. Branston, Inc., manufactures a complete line of D.L. inductance coils. The 250-turn coil is shown in the illustration. This coil is of standard construction and fits the Branston coil mountings, also described in these columns. Arrived in excellent packing.



AWARDED THE RADIO NEWS LABORATORIES CERTIFICATE OF MERIT NO. 414.

### BRANSTON SINGLE COIL MOUNTINGS

Quite often it is desirable to mount single coils on a panel or to

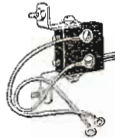

mount two or more coils in inductive relation to each other on the same panel. This is easily accomplished by using the types R-77 and R-68 single coil mountings. Type R-77 is fixed, and the other is hinged so that coupling between the coils may be varied. These mountings are also manufactured by Charles A. Branston, Inc.

Arrived in excellent packing. AWARDED THE RADIO NEWS LABORATORIES CERTIFICATE OF MERIT NOS. 415 and 416.

### BRANSTON LIGHTNING ARRESTER

The type R-51 radio lightning arrester shown in the illustration is



an approved vacuum gap type designed for the protection of receiving sets against lightning discharges or other high voltage surges. It is enclosed in a moulded bakelite form of neat appearance. Manufactured by Charles A. Branston, Inc.

Arrived in excellent packing. AWARDED THE RADIO NEWS LABORATORIES CERTIFICATE OF MERIT NO. 417.

### MIDLAND VARIOCOUPLES

The Midland Electric Manufacturing Co., Indianapolis, Ind., sub-

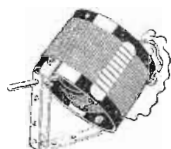

mitted samples of three types of its variocouplers. The instruments differ slightly in design; only one is shown in the illustration. One is equipped with a honeycomb coil secondary winding. The other two are similar to each other except for the mounting brackets. The primaries are provided with 10 taps, and have a 180-degree coupling. The shafts are 3/16 inch in diameter. The instruments are compact and of pleasing appearance.

Arrived in excellent packing.

### AWARDED THE RADIO NEWS LABORATORIES CERTIFICATE OF MERIT NO. 418.

### MIDLAND DETECTOR CRYSTALS

These are very sensitive galena crystals known as the "soft sensitive" type. They are securely mounted in a deep metal cup with a low melting alloy. The deep cup protects the crystal from injury and also allows for easily removing it from the standard detector receptacle. The crystals were received well packed in paper boxes. Manufactured by the Midland Electric Mfg. Co., Indianapolis, Ind.

### AWARDED THE RADIO NEWS LABORATORIES CERTIFICATE OF MERIT NO. 419.

### FOUR CIRCUIT TUNER

This tuning unit is designed for use in the well known Cockaday

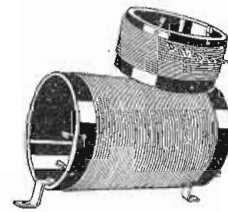

four-circuit receiver. The unit is well constructed and of very neat appearance. The windings are provided with terminals for making the connections and so arranged that the unit may be conveniently mounted behind the panel. This coil is manufactured by the Precision Coil Co., Inc., 209 Center Street, New York City.

Arrived in excellent packing. AWARDED THE RADIO NEWS LABORATORIES CERTIFICATE OF MERIT NO. 420.

### TUNE SHARP FORM WOUND VARIOCOUPLER

The Tune Sharp Radio Equipment Co., 6222 So. Vermont Avenue, Los Angeles, Calif., has designed tuning units that are very efficient electrically because a minimum of insulating material is used in their construction. The windings are treated with a lacquer that makes them self-



supporting. The type A-100 variocoupler shown in the illustration is of the standard size. The moulded

form is designed for panel and base mounting and is equipped with rugged binding posts.

Arrived in excellent packing. AWARDED THE RADIO NEWS LABORATORIES CERTIFICATE OF MERIT NO. 421.

### BANK FORM WOUND VARIOCOUPLER

The bank form wound variocoupler shown in the illustration is also



manufactured by the Tune Sharp Radio Equipment Co., Los Angeles, Calif. The windings of this instrument are of unusual interest. The primary is bank wound and treated with a lacquer that makes it self-supporting and mechanically strong. The secondary is also form wound and self-supporting. The moulded form that supports the windings is designed for both panel and base mounting. This instrument is ideal for use where a minimum of losses are desired with consequent increase in selectivity.

Arrived in excellent packing. AWARDED THE RADIO NEWS LABORATORIES CERTIFICATE OF MERIT NO. 422.

### FORM WOUND VARIOMETER

This variometer is of the same general construction as the Tune

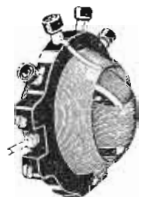

Sharp Company's form wound variocouplers. The windings are self-supporting. Tuning with this instrument is also exceptionally sharp due to the small amount of losses in the windings. When used in conjunction with the variocoupler described above, the entire broadcast wavelength is covered.

Arrived in excellent packing. AWARDED THE RADIO NEWS LABORATORIES CERTIFICATE OF MERIT NO. 423.

### SCOTT COMBINATION CRYSTAL DETECTOR

A sensitive adjustment is obtained with this crystal detector with very little trouble. It is of the combination type employing two different



crystals in contact with each other. One is attached to the shaft of the control knob and the other is fixed inside the glass tube, which protects



both crystals from injury. It may be mounted on the front of the panel or inside of the set. This detector is manufactured by the Scott Combination Crystal Detector Co., 342 Union Avenue, New York City. **AWARDED THE RADIO NEWS LABORATORIES CERTIFICATE OF MERIT NO. 424.**

**RIBBON ANTENNA**

A very efficient and easily installed receiving antenna that consists of 1/2 inch copper ribbon equipped with snap hooks at each end is shown in the illustration. This antenna is furnished in various lengths rang-



ing from 50 to 200 feet. It is manufactured by the Acron Radio Mfg. Co., 1806 S. Racine Avenue, Chicago, Ill.

Arrived in excellent packing. **AWARDED THE RADIO NEWS LABORATORIES CERTIFICATE OF MERIT NO. 425.**

**TRU FIX DIAL**

Many well designed radio sets have been spoiled in appearance by the use of inaccurate dials. If the shaft is not accurate, the dial will not run true on the panel. This fault may be eliminated by using the dial shown in the illustration. Although the shaft may not be true, this dial will always run true. The dial is of metal and is flexibly at-



tached to the large knob so that the dial will rub on the panel although the knob may be slightly out of alignment. It is manufactured by the Tru Fix Radio Products Co., 42 Maverick Square, E. Boston, Mass.

Arrived in excellent packing. **AWARDED THE RADIO NEWS LABORATORIES CERTIFICATE OF MERIT NO. 426.**

**KEYSTONE LIGHTNING ARRESTER**

The Keystone radio lightning arrester is an improved type for indoor or outdoor use. It is furnished with a bracket for mounting and the arrester unit is well sealed in a bakelite container. It is designed especially for the protection of receiving sets against lightning or other high voltage discharges. Manufactured by the Electric Service Supplies Co., 17th & Cambria Sts., Philadelphia, Pa.



Arrived in excellent packing. **AWARDED THE RADIO NEWS LABORATORIES CERTIFICATE OF MERIT NO. 428.**

**MEXICAN STEEL GALENA**

H. D. Hatfield & Son, 2735 W. 38th Avenue, Denver, Colo., submitted samples of their genuine Mexican steel galena detector crystals. These crystals were found very sensitive and are mounted in a metal base equipped with a flange on top that prevents the crystal from sliding down too deeply into the detector cup.

Arrived in excellent packing. **AWARDED THE RADIO NEWS LABORATORIES CERTIFICATE OF MERIT NO. 429.**

**VERNIER RHEOSTAT**

This rheostat is manufactured by the X Laboratories, 25 W. 45th



Street, New York City. It has a double coil resistance element of six ohms resistance and is equipped with a vernier adjustment obtained by means of a sliding contact on a single resistance wire inside. The form is of bakelite that will not soften should the rheostat be overloaded and heated. The knob is 1 1/2 inches in diameter.

Arrived in excellent packing. **AWARDED THE RADIO NEWS LABORATORIES CERTIFICATE OF MERIT NO. 430.**

**KLOSNER RHEOSTATS**

The Klossner 6- and 30-ohm rheostats are of very accurate mechanical construction and of pleasing appearance. They are 2 1/4 inches in diameter and may be furnished with

either knob or knob and dial. They are very smooth running and have a uniform contact. Manufactured by the Klossner Improved Apparatus Co., 2024 Boston Road, New York City.

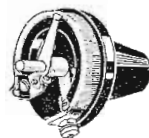

Arrived in excellent packing. **AWARDED THE RADIO NEWS LABORATORIES CERTIFICATE OF MERIT NO. 431.**

**RELIANCE VARIABLE CONDENSER**

The 22-plate vernier type variable condenser shown in the illustration is manufactured by the Reliance Die & Stamping Co., 501-11 La Salle Street, Chicago, Ill. This condenser

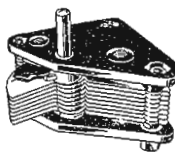

is a very efficient instrument. The dielectric losses at 1,000 cycles are equivalent to a series resistance of 80 ohms. The maximum capacity is .000409 mfd. and the minimum capacity is .0000114 mfd.

Arrived in excellent packing. **AWARDED THE RADIO NEWS LABORATORIES CERTIFICATE OF MERIT NO. 432.**

**NON-INDUCTIVE POTENTIOMETER**

A non-inductive potentiometer is often required in radio frequency circuits. The Central Radio Laboratories, 303 16th Street, Milwaukee, Wis., manufacture these instruments in resistances of 400 and 2,000 ohms. The type 110 instrument has a resistance of 400 ohms and the type 111 has a resistance of 2,000 ohms. The resistance element is enclosed and well protected. Contact is made by means of a flat plate that presses against the resistance. The control is very uniform and the instrument is quiet in operation.



Arrived in excellent packing. **AWARDED THE RADIO NEWS LABORATORIES CERTIFICATE OF MERIT NOS. 433 and 434.**

**PROTECTO TUBE**

Many vacuum tubes have been accidentally burned out by coming in contact with the "B" battery circuit. The device shown in the illustration is designed to protect all makes of receiving tubes from being burned out by the "B" battery. It consists apparently of a resistance of about 800 ohms, connected in the negative lead of the "B" battery and limits the current flow. This resistance has very little effect on the efficiency of the set. It is especially recommended while trying different circuits, as the tubes will then be safe. Manufactured by J. E. McLaughlin, 7068 No. Ashland Blvd., Chicago, Ill.



Arrived in good packing. **AWARDED THE RADIO NEWS LABORATORIES CERTIFICATE OF MERIT NO. 435.**

**FOUR CIRCUIT TUNER**

The tuning unit shown in the illustration is designed for the well-known Cockaday four-circuit receiver. This unit is complete, being furnished with mounting brackets and binding posts for each winding, and it also has the single turn of bus bar wire around the grid circuit coil. The workmanship on this coil is very good. Green silk insulated wire is used throughout, making the instrument of very neat appearance. It is manufactured by the General Radio Winding Company, 214 Fulton Street, New York City.

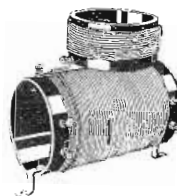

Arrived in excellent packing. **AWARDED THE RADIO NEWS LABORATORIES CERTIFICATE OF MERIT NO. 408.**

**A-1 CRYSTAL DETECTOR**

This crystal detector is of the standard mounted construction and is very sensitive. It has a rough surface and the cat-whisker adjustment is not easily jarred out. Each crystal is furnished with a small fine wire cat-whisker. Manufactured by Harry Grant, Jr., 904 Oak Grove Avenue, Burlingame, Calif.

**AWARDED THE RADIO NEWS LABORATORIES CERTIFICATE OF MERIT NO. 427.**

**Radio Trade Notes**

By L. N. ALLEN\*

**I**N the very near future a new element may be expected in the radio trade, the element of the broadcasting advertising by powerful stations, operating both through the air and over lines of the telephone or electric light companies. The possibility of this is brought to light through the announced intention of the American Telephone and Telegraph Co. to license other broadcast stations to operate for hire, a prerogative heretofore reserved only for their stations.

At the time of this writing no such station has been licensed, and the telephone company may hold off on the licensing of such stations for some time, no definite date for their operation having been set.

Studying the effect this would have on the radio trade, some are disposed to become alarmed, but the White Radio Bill, now in Congress will easily take care of

this, as no station broadcasting advertising will be permitted to dominate the air, under the terms of this bill, and this may result in the end, in there being considerably more broadcasting than there is at present with a consequent greater variety of programs for the listener to pick from.

**WIRED WIRELESS**

The steady developments in the matter of wired wireless is also attracting considerable trade notice, but after the true facts of the case are fully understood this also points to better trade conditions.

Electric light and power companies have found that the furnishing of home entertainments through radio increases the power used, and consequently increases their profits. The broadcasting of programs over light mains will bring little revenue from the current used, if any, through the operation of these sets, but will bring considerable revenue from the other current used, incident to the enjoyment of the programs.

The possibilities of advertising programs over light lines may, in time, make it possible for the power companies to support elaborate programs, broadcasting on two or three different wave-lengths furnishing news, music, entertainment on one or two waves, and advertising on a third and fourth. This would have no objectionable features, and would place the advertising where the listener could find it, if interested.

The rental of sets for wired wireless reception is rather doubtful at the present time; if any charge is made it will be for a special type of tuner which will convert the longer waves sent over the wires into something that can be received and amplified by the ordinary short wave radio set as used for air reception. Likely programs at first would be broadcast during the daylight hours when the air stations are not plentiful.

The operation of this type of broadcast-  
(Continued on page 1824)

\* Associate Editor, The Radio Dealer.



# New Radio Patents

## CURRENT REGULATOR

(Patent No. 1,483,629. Issued to Samuel Ruttenberg and Meyer F. Leibowitz, of New York, N. Y., Feb. 12, 1924.)  
 The object of this invention resides in the provision of a device by which the proper quantity of current is passed through the vacuum tube at all times, without the necessity of providing the usual wire-wound rheostat, which, while acting satisfactorily in many ways, is liable through misadjustment, to pass too much current and cause the tungsten filament to be burned out.



A highly important feature in the production of such a device is to so prepare the filament as to prevent oxidation and to accomplish this result, the iron filament prior to being introduced into the capsule, is preferably dipped in a mixture of alcohol and phosphorus. Any other suitable method or material may be employed which will produce the desired results. After introduction into the capsule the device is connected so that an initial current is passed through the filament and its temperature raised to approximately 500 degrees C. This action causes the phosphorus to unite with the oxygen in the tube, thus preventing the filament from oxidation when in use.

## RADIO RECEIVING APPARATUS

(Patent No. 1,484,189. Issued to John A. Proctor, of Lexington, Massachusetts, Feb. 19, 1924.)  
 This invention relates to receiving systems for wireless signals and particularly to such systems in which a closed or coil aerial is associated with an open aerial or antenna, in the manner disclosed in Fig. 3 of United States Patent No. 876,996 to G. W. Pickard. In such systems, there is a combination of loop action and open antenna action, and the combined effects of the currents in the loop and in the open antenna, in proper phase relation, are brought to bear on a receiving instrument. Such systems have great value in their capacity to eliminate both the effect of static and other atmospheric disturbances and the effect of interference from other stations than the one from which it is desired to receive signals.

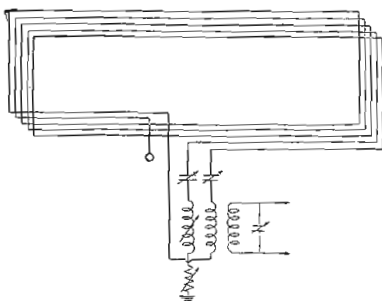

The object of this invention is to modify or improve upon such systems in a manner to improve the directional effects thereof, and thereby to improve the action in eliminating interference and static.

In systems comprising a combination of open and closed aeriels, it is very difficult to arrange the aeriels electrically symmetrically relative to each other or one part of the loop aerial electrically symmetrically relative to another part to avoid undesirable currents, such as "antenna effect" in the loop, due to this unbalanced or unsymmetrical relation. This unbalancing is especially noticeable where the closed aerial constitutes a part of the open aerial and where the part of the open aerial to ground or counterpoise is connected to the loop electrically unsymmetrically. The undesirable currents above referred to, which are out of phase with the loop currents, tend to blur or distort the directional effects, so that sharply directional indications or signals are not received. The present invention relates to means for overcoming or neutralizing such undesirable currents in the system which results from an electrically non-symmetrical or unbalanced relation of an aerial or aeriels.

## RADIO RECEIVING SYSTEM

(Patent No. 1,481,945. Issued to Julius Weinberger, of New York, N. Y., Jan. 29, 1924.)  
 This invention relates to radio communication and aims to provide means for eliminating interference.

Since all electromagnetic waves reaching a receiving antenna produce an effect to a greater or less extent, it is necessary to adopt means for eliminating or reducing the effects of all waves but the ones proceeding from the desired sending station. Various means have been proposed for this purpose, the most common probably involving the tuning of the antennae and receiving circuits to the wave-length to be received. This is more or less successful when the desired wave and the interfering waves are of the same order of strength and of widely different frequencies, but it is of little use when the interfering waves are much stronger than the desired waves and of nearly the same frequency. Interference of this nature is encountered when the receiving station is near to an interfering transmitting station as compared to its distance from the transmitting station being received.

The aim of this invention is to overcome relatively strong interference of this kind, though it may be used for the prevention of interference regardless of the strength of the interfering current.

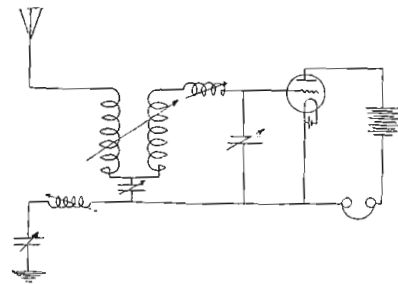

tively strong interference of this kind, though it may be used for the prevention of interference regardless of the strength of the interfering current.

## SIGNALING SYSTEM

(Patent No. 1,484,405. Issued to Arthur A. Oswald, of East Orange, New Jersey, Feb. 19, 1924.)

The present invention relates to signaling systems and is particularly adapted for use as a call-signal in a radio or other signaling system. The invention relates broadly to circuit arrangements for electrically controlling a distant responsive device and for preventing the device from being actuated or controlled by false signals or electrical disturbances whether the device is in a radio system or in some other electrical system.

An object of the invention is to provide a call-signal which will respond only to signaling currents intended for its actuation and which will positively cease to respond when the application of the signaling current ceases. A defect in the usual radio call-signal is that the signaling means is liable to respond to false signals such as atmospheric disturbances, or having been actuated by a signal current, it is liable to continue to respond after the signaling current ceases if disturbing current is present. This invention removes this difficulty by making the signal respond only to persistent current of given characteristics and by providing

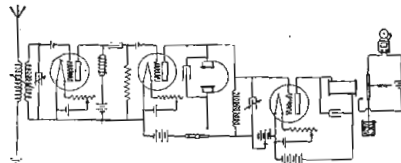

means requiring the application of current of practically the same strength to maintain the signal actuated as is necessary to initiate its response.

## AMPLIFYING SYSTEM

(Patent No. 1,484,967. Issued to John C. Schelling, of East Orange, New Jersey, Feb. 26, 1924.)  
 This invention relates to electric wave amplifying systems, and more particularly to systems of amplifying or generating waves in which the magnitude of the amplified or generated waves is determined by variations in the internal impedance, or resistance of the amplifying device.

One of the requirements for a high efficiency vacuum tube amplifier is that the greater portion of the space current should flow in a time  $2t$  such that

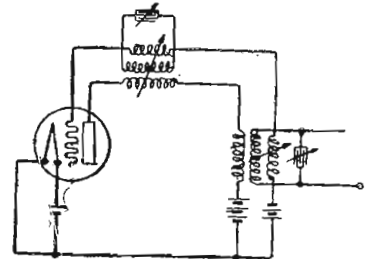

$\cos \frac{2\pi t}{T}$  does not differ greatly from unity, where

$T$  represents the period of the wave to be produced in the output circuit, or in other words, this space current should flow in a time which is very small as compared to the time of one cycle of the output wave.

According to the present invention, a system is provided in which the space current will flow in accordance with the above described relation, this result being accomplished by combining with the fundamental wave, a first harmonic wave, in such phase relation that the maximum positive potential of the given wave coincides in phase with a maximum positive potential of the first harmonic wave. The amplitude of the first harmonic wave is preferably less than that of the fundamental wave, and may be chosen to have approximately one-quarter the amplitude of the fundamental wave. The resultant wave of potential produced by this combination has a much sharper peak than a single sine wave of fundamental frequency having an equivalent effective value. It has been found that by applying this resultant wave to the control circuit of a thermionic amplifier, waves in amplified form are produced in the output circuit of the amplifier

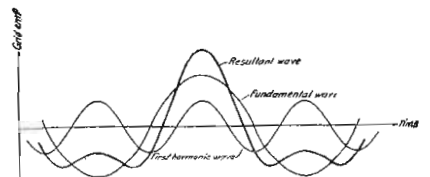

much more efficiently than if a sine wave of the frequency to be amplified and of equivalent effective value to that of the resultant wave previously mentioned, were alone applied to the control circuit.

## MEANS FOR FLATTENING THE CURRENT WAVES OF PULSATING DIRECT CURRENT

(Patent No. 1,485,076. Issued to Coenraad A. A. Haighton, of The Hague, Netherlands, Feb. 26, 1924.)  
 The invention relates to means for flattening the current waves of pulsating direct current and more particularly of direct current as is produced by rectifiers, the object of the present invention being to obtain a direct current which is adapted for use in such cases, in which a more constant direct current is required for guaranteeing a satisfactory working, e.g. for telephone purposes.

According to the invention a so-called loose contact is placed in the circuit, the resistance of said contact being controlled by an electromagnet, which is energized with the frequency of the pulsations of the current, the excitation of the magnet taking place in such a way that the resistances of

(Continued on page 1800)

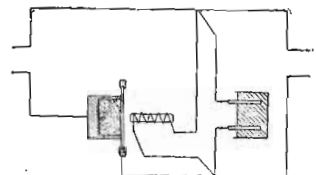





**I** HIS Department is conducted for the benefit of our Radio Experimenter. We shall be glad to answer here questions for the benefit of all, but we can publish only such matter as is of sufficient interest to all.

1. This Department cannot answer more than three questions for each correspondent.
2. Only one side of the sheet should be written upon; all matter should be typewritten or else written in ink. No attention paid to penciled matter.
3. Sketches, diagrams, etc., must be on separate sheets. This Department does not answer questions by mail free of charge.
4. Our Editors will be glad to answer any letter, at the rate of 25c. for each question. If, however, questions entail considerable research work, intricate calculations, patent research, etc., a special charge will be made. Before we answer such questions, correspondents will be informed as to the extra charge. You will do the Editor a personal favor if you will make your letter as brief as possible.

**D.C. SUPPLY TRANSFORMERS**

(930) Mr. Frederic Howell, Montford, Wis., asks:

Q. 1. What is the design for a transformer to deliver a secondary plate voltage of 250 and a secondary filament voltage of 8 from a 32-volt, direct current source?

A. 1. Transformers operate only from an alternating current supply. It would be necessary to know what voltage and amperage supplied, if it was intended to operate the transformer in conjunction with a converter or generator.

**SUPER-HETERODYNES**

(931) Mr. Lawrence Rickey, McMechon, W. Va., wants to know:

Q. 1. What is the advantage of heterodyning to produce a high wave beat, or intermediate frequency, as used in super-heterodynes?

A. 1. Radio frequency currents are amplified much more efficiently at high wave-lengths than at low ones. Amplifying at long wave-lengths permits the use of tubes having a greater amplification factor, producing a stronger impulse. At short wave-lengths, capacity between the elements of the tube produces a short circuit that limits the amount of amplification. The main advantage, however, is that every station received is raised to a certain fixed wave length where the radio frequency transformers amplify at maximum efficiency.

Q. 2. What determines the wave-length range a super-heterodyne will cover?

A. 2. The wave-length range of the input grid circuit and of the oscillator circuit are the controlling factors. Most super-heterodynes are designed to cover the broadcast wave-lengths, by having a range of 200 to 600 meters.

**CHANGING NEUTRODYNE**

(932) Mr. Edward M. Schoenvorn, Jr., Columbus, Ohio, requests:

Q. 1. What is the simplest way to add a detector and oscillator to a five-tube neutrodyne set?

A. 1. The super-heterodyne system cannot be employed with a five-tube neutrodyne receiver. The neutrodyne, by means of tuned transformers, amplifies efficiently on all of the low wave-lengths for which it is designed.

**MODULATION SYSTEMS**

(933) Mr. Eugene Lorea, Santiago, Chile, asks:

Q. 1. Can a galvanometer be used in place of

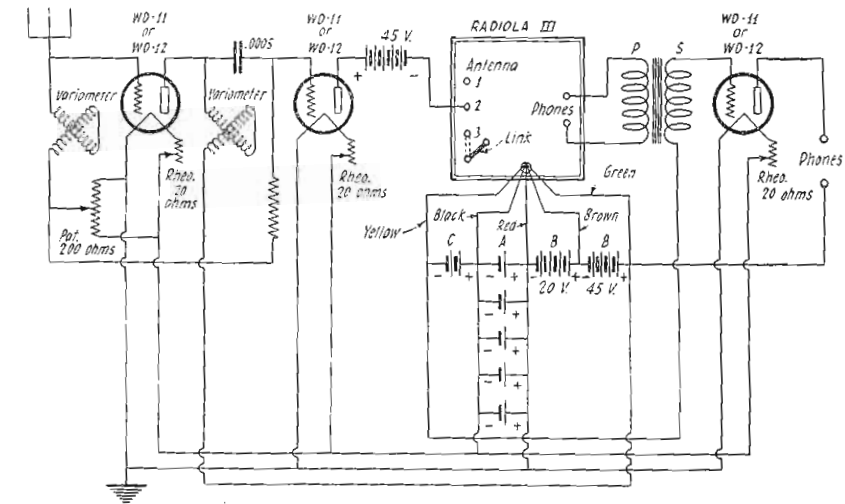

Q. 939. The Radiola III used in conjunction with a two-stage tuned impedance radio frequency amplifier and an extra stage of audio frequency amplification. Note that there are five tubes altogether and that for every tube there is a dry cell.

the hot-wire ammeter in a one-tube transmitting set?

A. 1. A galvanometer could be used, but it would be necessary to use a comparatively low-resistance shunt in order to control the current in the galvanometer circuit. A galvanometer would probably function if connected across a short length of the lead-in or ground wire, current sufficient to operate the galvanometer being picked up due to the difference of potential existing between the two points of the lead-in or ground to which connection was made. This instrument, however, is not recommended for this purpose.

Q. 2. Which form of modulation is best, grid, plate, antenna or absorption?

A. 2. Very good results have been secured with practically all the systems named. The actual system to be used depends upon the particular

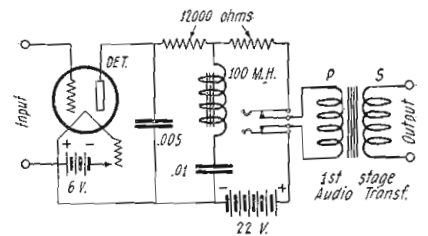

Q. 947. A filter system consisting of two resistances, two fixed condensers and a choke coil will help materially to eliminate stray noises in any form of receiving set.

transmitting circuit employed, some sets producing better results with one method than with another. Plate, or constant current and grid modulation are generally conceded to be the two best systems.

Q. 3. Please give construction data for a Kennedy type 110 commercial receiver.

A. 3. This information is not available.

**BRISTOL POWER AMPLIFIER**

(934) Mr. Donald Adams, Yuba City, Calif., wants to know:

Q. 1. Please publish the circuit of the Bristol power amplifier unit, as added to a standard receiving set using one stage of straight audio frequency amplification.

A. 1. This circuit is shown in these columns. It is seen to employ an auto-transformer having a ratio of 2:1.

Q. 2. How could the conductively coupled transformer used in this power amplifier be made?

A. 2. The primary of a push-pull output transformer, or the secondary of a push-pull input transformer, should work well in this set. The primary is left unconnected. Two standard audio frequency transformers could be tried also, their secondaries are connected in series, furnishing a center tap as required by this circuit.

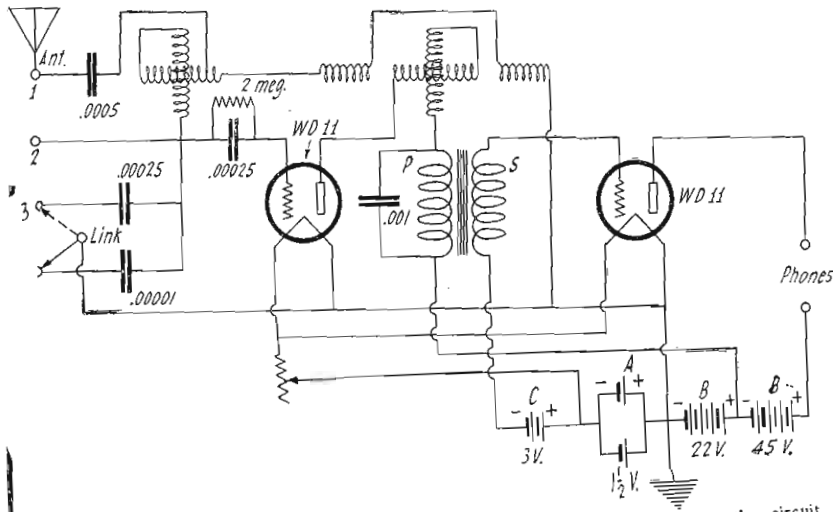

Q. 939. The circuit diagram of the Radiola III receiving set. This is a regenerative circuit with a detector and one stage of audio frequency amplification. Employing WD-11 vacuum tubes, two dry cells will be sufficient for lighting the filaments.



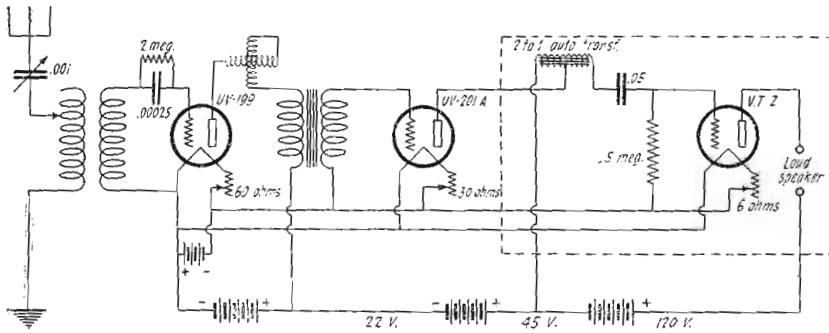

Q. 934. A regenerative circuit with a two-stage audio frequency amplifier. The second stage is a power amplifier and employs an auto transformer. A high "B" battery voltage is essential.

**HOT-WIRE AMMETER**

(935) Mr. Arthur Bromley, Tohatchi, N. M., asks:

Q. 1. Is it advisable to short circuit the hot-wire ammeter in a transmitting set, when not required for readings?

A. 1. The ammeter constitutes a resistance in the circuit and should be short circuited when not being used.

The effect would be more noticeable the nearer the inside aerial is to the lightning rods.

**RADIOLA III DIAGRAM**

(939) Mr. George Bomhag, East Orange, N. J., writes:

Q. 1. What is the wiring diagram of the Radiola III receiving set?



**ULTRADYNE BLUEPRINTS**

(936) Mr. G. Jaquette, Philadelphia, Pa., requests:

Q. 1. Where can blueprints and construction data be obtained for a set capable of receiving a distance of 3,000 miles on a loud speaker, under practically all conditions?

A. 1. Such a circuit is not obtainable at the present time. A close approach to such a set would be the Ultradyne. (See Feb., 1924, issue of RADIO NEWS.) Complete blueprints...

**"Wouldn't Trade My THOROPHONE**

TRADE MARK REG. U.S. PAT. OFFICE

**For a Rolls-Royce"**

Says HARRY H. HECKMAN



High Power Model S-5 \$45.00

**C**OMPARISON tells. Listen to the Thorophone and learn how perfect a loud speaker can be. Every tone, every note is given its true value. You would think speaker or musician were right before

**The Radio Quack**

(Continued from page 1739)

How the oscillations are generated is another matter and one that is not understandable, so far as the engineer is concerned. It looks very much like a big electric buzzer. The power which actuated the machine was a used dry battery.

It is reported that the vibratory rate of streptoxemia was 60, of cancer 50, and of tuberculosis 42. It is these figures at which the oscilloclast is set for the treatment of the diseases.

The most interesting development by this school of medicine is, however, their discovery of the psora, or universal taint which is at the root of all mankind's diseases. This is susceptible to treatment by a special kind of apparatus, say the doctors. Further, it is susceptible to treatment whether the patient is in the doctor's office or a thousand miles away.

The implication is that there is some sort of transmitting method by which the alleged healing waves may be released into space in much the same manner as radio waves. In fact, an article which was published on the subject shortly after the close of the Chicago convention and which was on the order of an exposition of the method stated that it would be entirely possible to broadcast the healing wave and that all within the range of it and equipped with the necessary receiving apparatus might take advantage of its curative qualities. The broadcast program of the healing station might read something like this: 10 a. m., cancer; 11 a. m., tuberculosis; noon, chicken-pox, etc. It would then only be necessary for the local physician to bring around the receiving apparatus, attach it to the patient in the proper method and tune in the transmitting station. No note was given, in the article, as to what might happen in the event of strong local interference or what the heterodyning of pneumonia and measles curative waves might result in. When asked about these slight matters it was said that as yet this branch of the science is in a more

The sharp milling on the inside holds the nut in a can't-slip grip.

and now-  
**STEVENS Spintite WRENCHES**  
for round nuts

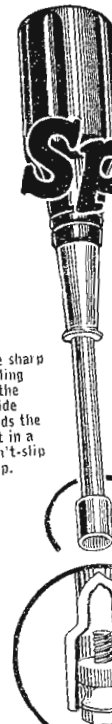

Thousands of radio fans who are enthusiastic users of Spintite Hex Nut Wrenches have been waiting eagerly for the Round Nut type. The wrench that works into the "blind" corners where pliers won't reach, enabling you to make quicker and better connections.

With these handy little tools, all your connections will now be as tight as if soldered.

- Set of 3 Spintites for round nuts... **\$1.00**
- Set of Spintites for Hex Nuts, 3 most popular sizes... **\$1.00**
- Stevens Panel Cutters for making clean-out holes. Sizes 3/8", 7/8", 1", 8/8", 1 1/2"... **\$1.00.**

Stevens Speedalamp Pliers for quickly bending perfect lamp terminals... **\$1.50**

At your Dealers, or if he can't supply you, send his name and order direct from us.

Write for Radio Tools Booklet.

**STEVENS & CO.**  
Toolsmiths since 1890  
375 B'way, N. Y.

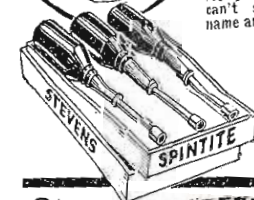

**Stevens SPEED UP Tools**







**I** HIS Department is conducted for the benefit of our Radio Experimenter. We shall be glad to answer here questions for the benefit of all, but we can publish only such matter as is of sufficient interest to all.

1. This Department cannot answer more than three questions for each correspondent.
2. Only one side of the sheet should be written upon; all matter should be typewritten or else written in ink. No attention paid to penciled matter.
3. Sketches, diagrams, etc., must be on separate sheets. This Department does not answer questions by mail free of charge.
4. Our Editors will be glad to answer any letter, at the rate of 25c. for each question. If, however, questions entail considerable research work, intricate calculations, patent research, etc., a special charge will be made. Before we answer such questions, correspondents will be informed as to the extra charge. You will do the Editor a personal favor if you will make your letter as brief as possible.

**D.C. SUPPLY TRANSFORMERS**

(930) Mr. Frederic Howell, Montford, Wis., asks:

Q. 1. What is the design for a transformer to deliver a secondary plate voltage of 250 and a secondary filament voltage of 8 from a 32-volt, direct current source?

A. 1. Transformers operate only from an alternating current supply. It would be necessary to know what voltage and amperage supplied, if it was intended to operate the transformer in conjunction with a converter or generator.

**SUPER-HETERODYNES**

(931) Mr. Lawrence Rickey, McMechon, W. Va., wants to know:

Q. 1. What is the advantage of heterodyning to produce a high wave beat, or intermediate frequency, as used in super-heterodynes?

A. 1. Radio frequency currents are amplified much more efficiently at high wave-lengths than at low ones. Amplifying at long wave-lengths permits the use of tubes having a greater amplification factor, producing a stronger impulse. At short wave-lengths, capacity between the elements of the tube produces a short circuit that limits the amount of amplification. The main advantage, however, is that every station received is raised to a certain fixed wave length where the radio frequency transformers amplify at maximum efficiency.

Q. 2. What determines the wave-length range a super-heterodyne will cover?

A. 2. The wave-length range of the input grid circuit and of the oscillator circuit are the controlling factors. Most super-heterodynes are designed to cover the broadcast wave-lengths, by having a range of 200 to 600 meters.

**CHANGING NEUTRODYNE**

(932) Mr. Edward M. Schoenvorn, Jr., Columbus, Ohio, requests:

Q. 1. What is the simplest way to add a detector and oscillator to a five-tube neutrodyne set?

A. 1. The super-heterodyne system cannot be employed with a five-tube neutrodyne receiver. The neutrodyne, by means of tuned transformers, amplifies efficiently on all of the low wave-lengths for which it is designed.

**MODULATION SYSTEMS**

(933) Mr. Eugene Lorca, Santiago, Chile, asks:

Q. 1. Can a galvanometer be used in place of

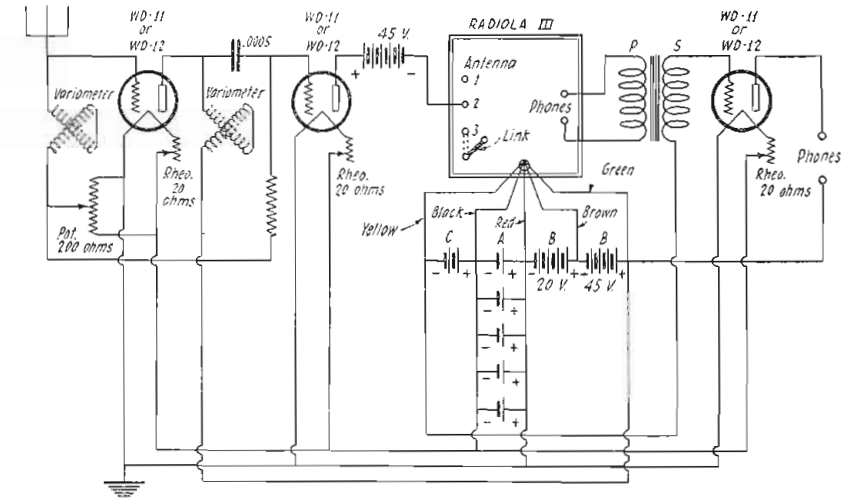

Q. 939. The Radiola III used in conjunction with a two-stage tuned impedance radio frequency amplifier and an extra stage of audio frequency amplification. Note that there are five tubes altogether and that for every tube there is a dry cell.

the hot-wire ammeter in a one-tube transmitting set?

A. 1. A galvanometer could be used, but it would be necessary to use a comparatively low-resistance shunt in order to control the current in the galvanometer circuit. A galvanometer would probably function if connected across a short length of the lead-in or ground wire, current sufficient to operate the galvanometer being picked up due to the difference of potential existing between the two points of the lead-in or ground to which connection was made. This instrument, however, is not recommended for this purpose.

Q. 2. Which form of modulation is best, grid, plate, antenna or absorption?

A. 2. Very good results have been secured with practically all the systems named. The actual system to be used depends upon the particular

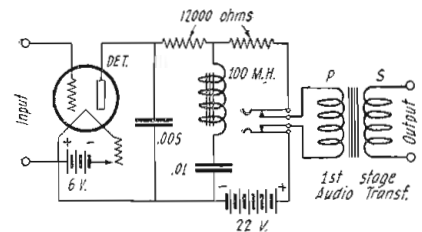

Q. 947. A filter system consisting of two resistances, two fixed condensers and a choke coil will help materially to eliminate stray noises in any form of receiving set.

transmitting circuit employed, some sets producing better results with one method than with another. Plate, or constant current and grid modulation are generally conceded to be the two best systems.

Q. 3. Please give construction data for a Kennedy type 110 commercial receiver.

A. 3. This information is not available.

**BRISTOL POWER AMPLIFIER**

(934) Mr. Donald Adams, Yuba City, Calif., wants to know:

Q. 1. Please publish the circuit of the Bristol power amplifier unit, as added to a standard receiving set using one stage of straight audio frequency amplification.

A. 1. This circuit is shown in these columns. It is seen to employ an auto-transformer having a ratio of 2:1.

Q. 2. How could the conductively coupled transformer used in this power amplifier be made?

A. 2. The primary of a push-pull output transformer, or the secondary of a push-pull input transformer, should work well in this set. The primary is left unconnected. Two standard audio frequency transformers could be tried also; their secondaries are connected in series, furnishing a center tap as required by this circuit.

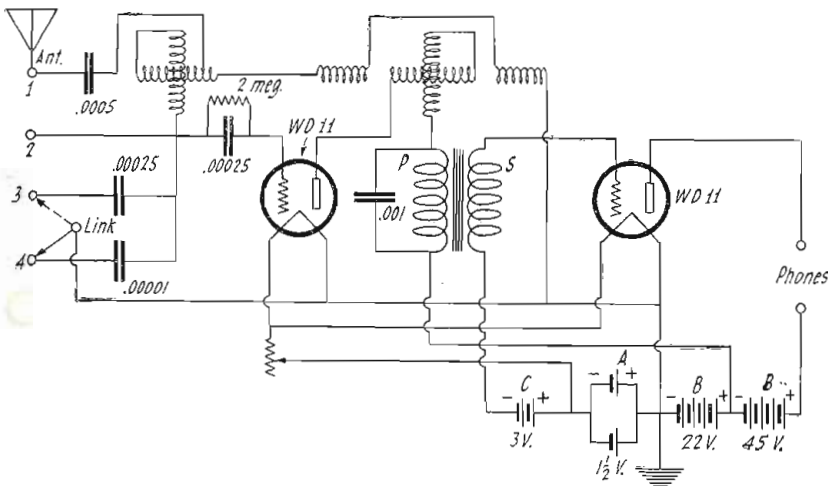

Q. 939. The circuit diagram of the Radiola III receiving set. This is a regenerative circuit with a detector and one stage of audio frequency amplification. Employing WD-11 vacuum tubes, two dry cells will be sufficient for lighting the filaments.



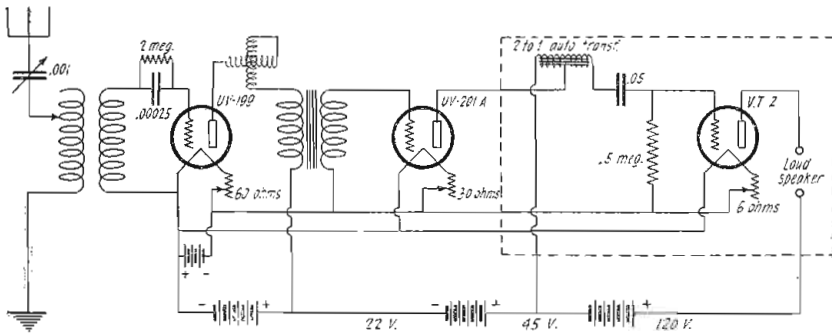

Q. 934. A regenerative circuit with a two-stage audio frequency amplifier. The second stage is a power amplifier and employs an auto transformer. A high "B" battery voltage is essential.

**HOT-WIRE AMMETER**

(935) Mr. Arthur Bromley, Tohatchi, N. M., asks:

- Q. 1. Is it advisable to short circuit the hot-wire ammeter in a transmitting set, when not required for readings?  
 A. 1. The ammeter constitutes a resistance in the circuit and should be short circuited when not being used.

**ULTRADYNE BLUEPRINTS**

(936) Mr. G. Jaquette, Philadelphia, Pa., requests:

- Q. 1. Where can blueprints and construction data be obtained for a set capable of receiving a distance of 3,000 miles on a loud speaker, under practically all conditions?  
 A. 1. Such a circuit is not obtainable at the present time. A close approach to such a set would be the Ultradyne. (See Feb., 1924, issue of Radio News.) Complete blueprints and constructional data may be obtained from the Consrad Co., 233 Fulton St., New York City.

**NON-TECHNICAL RADIO BOOK**

(937) Mr. D. W. Mead, Kalamazoo, Mich., writes:

- Q. 1. Where can one get information about how to read diagrams, how the various radio instruments are used, why they function, what the advantages and disadvantages of the various instruments are, etc.?  
 A. 1. "Radio For All," by H. Gernsback, which may be obtained from the Experimenter Publishing Co., 233 Fulton St., New York City, gives all the information about radio that it is possible to convey in non-technical terms, and will probably be just the source of information you need.

**THE EFFECT OF LIGHTNING RODS**

(938) Mr. Joseph A. Hudek, Pocahontas, Iowa, wants to know:

- Q. 1. My aerial points north and south, paralleling a high voltage line on the west side. The separation is about 400 feet. Would that prevent reception from the west?  
 A. 1. It might reduce reception from the west when arranged as you mention. It is doubtful, however, if a high-tension wire at that distance would greatly affect reception.  
 Q. 2. How could reception from the west be improved?  
 A. 2. Try running a wire in an easterly direction for a length equal to that of your north-and-south aerial. The lead-in is taken off at the west end.  
 Q. 3. Do lightning rods on a house interfere with reception when using a large indoor loop or attic aerial?  
 A. 3. The lightning protection system of a house, if properly installed, might somewhat reduce the range of radio sets using indoor aerials.

The effect would be more noticeable the nearer the inside aerial is to the lightning rods.

**RADIOLA III DIAGRAM**

(939) Mr. George Bonhag, East Orange, N. J., writes:

- Q. 1. What is the wiring diagram of the Radiola III receiving set?

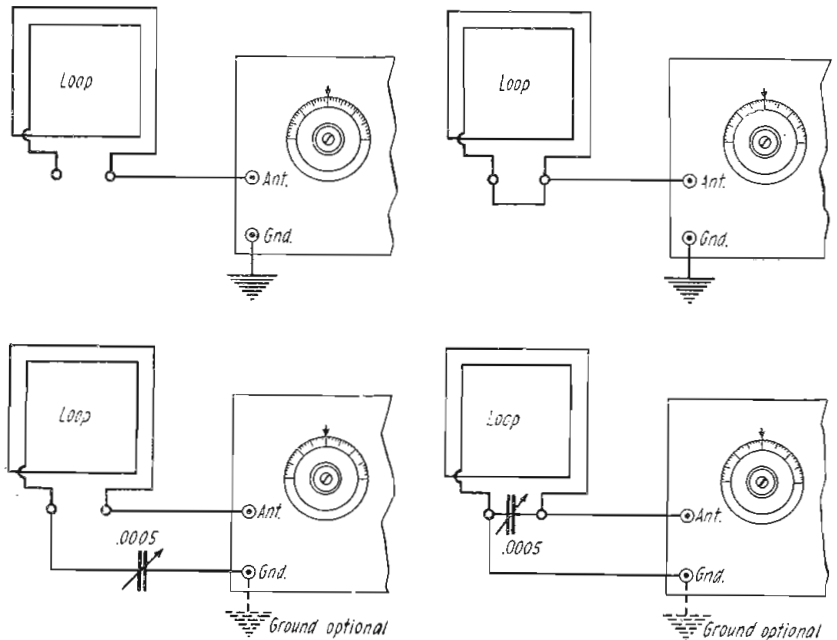

Q. 952. Showing a number of different methods of employing a loop aerial with a Neutrodyne receiver. The use of a ground connection will reduce the directional effect of the loop aerial considerably.

- A. 1. We are showing the wiring diagram of the Radiola III in these columns. The bar marked "link" may be placed on posts three, or four, or left unconnected to either. The link is only used when extra sharp tuning is necessary. This circuit is seen to be that of the standard single circuit regenerative receiver with a few refinements.  
 Q. 2. How may dry battery tubes be added

to the Radiola III so as to increase the range and volume?

A. 2. A diagram showing a method by which this can be done is shown. It will be noticed that a separate "B" battery is required for the second stage of R.F. amplification. This circuit uses five tubes arranged as two stages of tuned impedance radio frequency amplification, detector and two stages of audio frequency amplification. Five standard dry cells (one for each tube used) are shown, all being connected in parallel. The "link" may be tried in various positions for best results. An aerial series condenser may be required, depending upon the size of the aerial used. Directions for the construction of a suitable tuning unit will be found in the April, 1923, issue of Radio News. It appeared in the "I Want to Know" department in answer to question No. 637.

**WAVE-LENGTH RANGE**

(940) Mr. W. W. O'Donovan, Baltimore, Md., asks:

- Q. 1. Will the circuit described on page 1256 in the March, 1924, issue of Radio News, work satisfactorily on all waves (approximately 175 to 20,000 meters), if the proper coils are used in the tuned radio frequency and coupling units?  
 A. 1. The Weagant circuit should function on all waves if all circuits are properly balanced with the correct inductances.  
 Q. 2. What dry battery tubes will work best in this circuit?  
 A. 2. Any dry battery tube should give good results in this circuit. We believe best results will be had by the use of a UV-200 detector tube. While this tube consumes four times as much cur-

rent as most tubes, it usually gives better results as a detector.

**TICKLER COIL**

(941) Mr. H. J. Mitchell, Elgin, Illinois, wants to know:

- Q. 1. My tickler coil does not make much difference in the action of my set. What could be done to cause it to function?  
 A. 1. A fixed condenser of about .0005, connected to both sides of the tickler coil should cause your set to oscillate. A phone condenser of about .001 mfd. capacity will also improve the reception. Try reversing the lead to the tickler.

**SELENIUM CELLS**

(942) Mr. A. S. Morrison, Butler, Pa., writes:

- Q. 1. Can you give me the name of a manufacturer of selenium cells?  
 A. 1. These cells are manufactured by Selenium Laboratories, Goodground, L. I.  
 Q. 2. Where may information be had on the design and construction of vacuum pumps as used for the development of experimental vacuum tubes?  
 A. 2. An exceptionally good two-part article will be found in *Science and Invention* magazine. The first part appeared in the April, 1923, issue and the second part appeared in the following one. Earlier numbers of that magazine (October, 1921, and November, 1922, issues) also contain articles on vacuum pump construction.  
 Q. 3. Where do the color marked cords of the Atwater Kent model 9 receiver connect?

(Continued on page 1849)

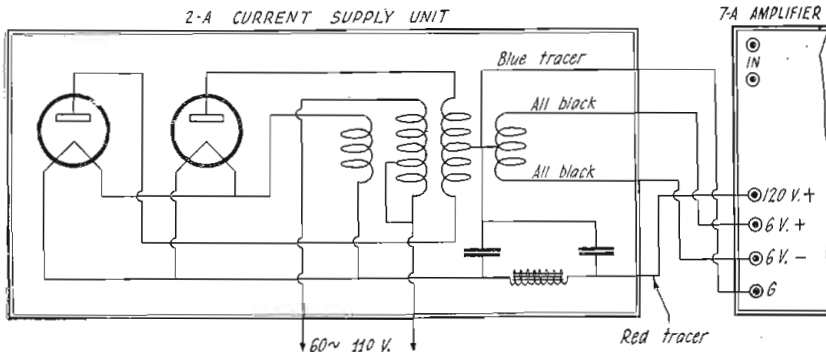

The circuit diagram of the Western Electric No. 2-A current supply unit. Two 2-element vacuum tubes are employed for rectifying the alternating current from the lightning mains.



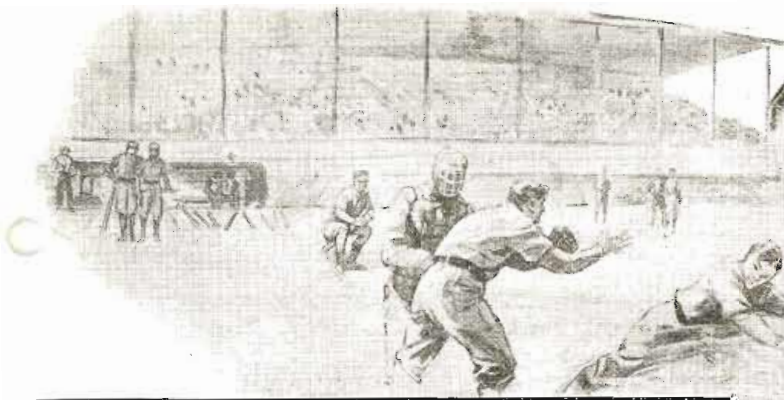

# MAGNAVOX

Radio Reproducer

## M1 - \$35.00



The highest quality of radio reproduction ever achieved with an instrument which requires no battery for its operation.

**I**N developing this reproducer, Magnavox engineers drew upon unequalled experience and resources, and no higher tribute can be paid the M1 than to point out that its instant success has paralleled that of the famous Magnavox electro-dynamic Reproducers R2 and R3.

M1 reproduces with perfect fidelity the entire register of broadcast music and speech—without requiring a battery for its operation.

Owners of M1 have been gratified to note also that this quality of reproduction is maintained without the slightest deterioration after long and constant use.

Definite features responsible for this efficiency are:—

1—The diaphragm being correctly designed cannot become

stretched and useless, as flat metal diaphragms will.

2—There are no moving levers or joints to become worn and cause distortion.

3—Extreme sensitivity is assured by the use of an unusually high resistance winding.

4—The semi-dynamic reproducing unit is an exclusive feature.

5—The horn is indestructible, not affected by climatic changes, and does not add or subtract any component of sound.

Magnavox Radio Reproducer M1 is designed for operation with any vacuum tube radio set and is particularly desirable for use with dry cell sets.

Magnavox Radio Reproducers, Combination Sets and Power Amplifiers can be had of good dealers everywhere. Illustrated catalog on request.

**THE MAGNAVOX CO. OAKLAND, CALIF.**  
New York Office: 350 WEST 31st STREET  
Canadian Distributors: Perkins Electric Limited, Toronto, Montreal, Winnipeg



The whole vivid exciting game — played by Radio in your own home

Why wait for the sporting page to serve it warmed over when Magnavox recreates every play as real as it can be told?

Whatever type of receiving equipment you may have — or however you make use of it — to get full satisfaction have it Magnavox equipped.



There is a **MAGNAVOX** for every receiving set.



*"Wouldn't Trade My  
THOROPHONE  
TRADE MARK REG. U.S.PAT. OFFICE*

*For a Rolls-Royce"*

Says HARRY H. HECKMAN



High Power Model S-5 \$45.00

**C**OMPARISON tells. Listen to the 'Thorphone and learn how perfect a loud speaker can be. Every tone, every note is given its true value. You would think speaker or musician were right before you.

Make the Thorphone your permanent loud speaker investment—you'll never want to change it. The Thorphone makes any set sound better.

Made by America's oldest manufacturers of loud speaking devices. A power horn, taking only one ampere from a 6-volt storage battery. It actually amplifies weak signals, yet handles the greatest possible volume with the same natural quality—quality that satisfies.

Write for Booklet

**WINKLER-REICHMANN Co.**  
4801 S. MORGAN STREET CHICAGO, ILL.

**The Radio Quack**

(Continued from page 1739)

How the oscillations are generated is another matter and one that is not understandable, so far as the engineer is concerned. It looks very much like a big electric buzzer. The power which actuated the machine was a used dry battery.

It is reported that the vibratory rate of streptococci was 60, of cancer 50, and of tuberculosis 42. It is these figures at which the oscilloclast is set for the treatment of the diseases.

The most interesting development by this school of medicine is, however, their discovery of the psora, or universal taint which is at the root of all mankind's diseases. This is susceptible to treatment by a special kind of apparatus, say the doctors. Further, it is susceptible to treatment whether the patient is in the doctor's office or a thousand miles away.

The implication is that there is some sort of transmitting method by which the alleged healing waves may be released into space in much the same manner as radio waves. In fact, an article which was published on the subject shortly after the close of the Chicago convention and which was on the order of an exposition of the method stated that it would be entirely possible to broadcast the healing wave and that all within the range of it and equipped with the necessary receiving apparatus might take advantage of its curative qualities. The broadcast program of the healing station might read something like this: 10 a. m., cancer; 11 a. m., tuberculosis; noon, chicken-pox, etc. It would then only be necessary for the local physician to bring around the receiving apparatus, attach it to the patient in the proper method and tune in the transmitting station. No note was given, in the article, as to what might happen in the event of strong local interference or what the heterodyning of pneumonia and measles curative waves might result in. When asked about these slight matters it was said that as yet this branch of the science is in a more or less theoretical state.

The point of this whole affair is that there is profit in the manufacture of the various machines which are used in the cures. Of course, these physicians have a high code of ethics and work only for the good of the human race. However, a doctor too must live, and so the machines are manufactured and sold at a profit. And there are lots of them being shipped every day.

One radio doctor, doing a land office business, said recently there was no question but what waves of short wave-length have healing properties brought about by an ionizing effect upon the circulation of the blood and in the next breath this authority referred to "some Indians we know, when wearing copper bracelets, were cured of rheumatism." The explanation of this apparent miracle was that the copper bracelet acted as an aerial and "accepted electrons from the air and transmitted them to the Indian's body, having an ionizing effect upon the circulation, thus bringing about a relief from the pain." But the philanthropic act of acceptance of electrons on the part of the bracelet was hardly less remarkable than the story of the stimulation of growth among garden truck varieties by erecting an aerial over them.

That the therapeutic value of radio for the treatment of disease lies more in the auto-suggestive curricula than in the real oscillatory effect of any electronic impulse induced by the new apparatus now being sold at an amazing profit and used by quack doctors, is the prevailing opinion among

*and now-*  
**STEVENS  
Spintite  
WRENCHES  
for  
ROUND  
nuts**

The sharp milling on the inside holds the nut in a can't-slip grip.

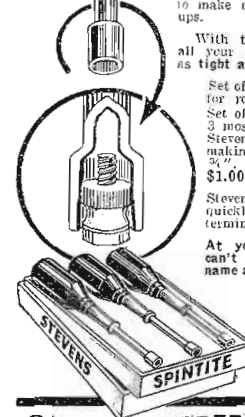

Thousands of radio fans who are enthusiastic users of Spintite Hex Nut Wrenches have been waiting eagerly for the Round Nut type. The wrench that works into the "tight" corners where fillers won't reach, enabling you to make quicker and better hook-ups.

With these handy little tools, all your connections will now be as tight as if soldered.

Set of 3 Spintites for round nuts... \$1.00  
Set of Spintites for Hex Nuts, 3 most popular sizes... \$1.00  
Stevens Panel Cutters for making clean-cut holes. Sizes 3/8", 7/8", 1", 85c; 1 1/2", \$1.00.

Stevens Speedloop Pliers for quickly bending perfect loop terminals... \$1.50

At your Dealers, or if he can't supply you, send his name and order direct from us.

Write for Radio Tools Booklet.  
**STEVENS & CO.**  
Toolsmiths since 1899  
375 B'way, N. Y.

**Stevens SPEED UP Tools**

**KLAUS**

Complete Stock of

**Broadcast Receivers**

Ready for shipment, KLAUS carries a complete stock of the latest and best broadcast receivers. All apparatus distributed by KLAUS is manufactured by the best manufacturers and bears the KLAUS GUARANTEE. Get our prices on amateur receiving and transmitting equipment.

**KLAUS RADIO BULLETIN  
for Dealers—Do You Get It?**

Expert advice regarding radio problems, latest information about new equipment, and hints on radio merchandising which helps dealers make more money, is in every issue of the KLAUS RADIO BULLETIN. If you are not on our mailing list of dealers receiving the bulletin, send us your name and also receive our trade discount lists.

**KLAUS RADIO & ELECTRIC CO.**  
Authorized Distributors  
Dept. 200 EUREKA, ILL.



**One Charger  
for All Batteries**

Charges 2-volt peanut tube batteries, 6-volt A Batteries, 6- and 12-volt automobile batteries, and 1 to 4 B Batteries. It's the

Valley Type ABC Battery Charger  
**VALLEY ELECTRIC CO., St. Louis, Mo.**



# New Radio Patents



### CURRENT REGULATOR

(Patent No. 1,483,629. Issued to Samuel Ruttenberg and Meyer F. Leibowitz, of New York, N. Y., Feb. 12, 1924.)

The object of this invention resides in the provision of a device by which the proper quantity of current is passed through the vacuum tube at all times, without the necessity of providing the usual wire-wound rheostat, which, while acting satisfactorily in many ways, is liable through misadjustment, to pass too much current and cause the tungsten filament to be burned out.

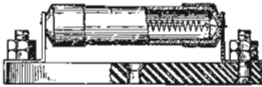

A highly important feature in the production of such a device is to so prepare the filament as to prevent oxidation and to accomplish this result, the iron filament prior to being introduced into the capsule, is preferably dipped in a mixture of alcohol and phosphorus. Any other suitable method or material may be employed which will produce the desired results. After introduction into the capsule the device is connected so that an initial current is passed through the filament and its temperature raised to approximately 500 degrees C. This action causes the phosphorus to unite with the oxygen in the tube, thus preventing the filament from oxidation when in use.

### RADIO RECEIVING APPARATUS

(Patent No. 1,484,189. Issued to John A. Proctor, of Lexington, Massachusetts, Feb. 19, 1924.)

This invention relates to receiving systems for wireless signals and particularly to such systems in which a closed or coil aerial is associated with an open aerial or antenna, in the manner disclosed in Fig. 3 of United States Patent No. 876,996 to G. W. Pickard. In such systems, there is a combination of loop action and open antenna action, and the combined effects of the currents in the loop and in the open antenna, in proper phase relation, are brought to bear on a receiving instrument. Such systems have great value in their capacity to eliminate both the effect of static and other atmospheric disturbances and the effect of interference from other stations than the one from which it is desired to receive signals.

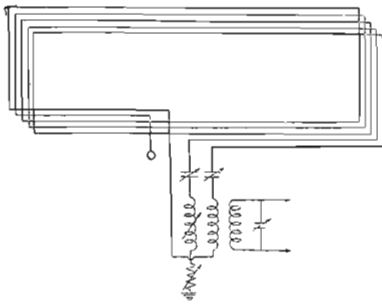

The object of this invention is to modify or improve upon such systems in a manner to improve the directional effects thereof, and thereby to improve the action in eliminating interference and static.

In systems comprising a combination of open and closed aeriels, it is very difficult to arrange the aeriels electrically symmetrically relative to each other or one part of the loop aerial electrically symmetrically relative to another part to avoid undesirable currents, such as "antenna effect" in the loop, due to this unbalanced or unsymmetrical relation. This unbalancing is especially noticeable where the closed aerial constitutes a part of the open aerial and where the part of the open aerial to ground or counterpoise is connected to the loop electrically unsymmetrically. The undesirable currents above referred to, which are out of phase with the loop currents, tend to blur or distort the directional effects, so that sharply directional indications or signals are not received. The present invention relates to means for overcoming or neutralizing such undesirable currents in the system which results from an electrically non-symmetrical or unbalanced relation of an aerial or aeriels.

### RADIO RECEIVING SYSTEM

(Patent No. 1,481,945. Issued to Julius Weinberger, of New York, N. Y., Jan. 29, 1924.)

This invention relates to radio communication and aims to provide means for eliminating interference.

Since all electromagnetic waves reaching a receiving antenna produce an effect to a greater or less extent, it is necessary to adopt means for eliminating or reducing the effects of all waves but the ones proceeding from the desired sending station. Various means have been proposed for this purpose, the most common probably involving the tuning of the antennae and receiving circuits to the wave-length to be received. This is more or less successful when the desired wave and the interfering waves are of the same order of strength and of widely different frequencies, but it is of little use when the interfering waves are much stronger than the desired waves and of nearly the same frequency. Interference of this nature is encountered when the receiving station is near to an interfering transmitting station as compared to its distance from the transmitting station being received.

The aim of this invention is to overcome rela-

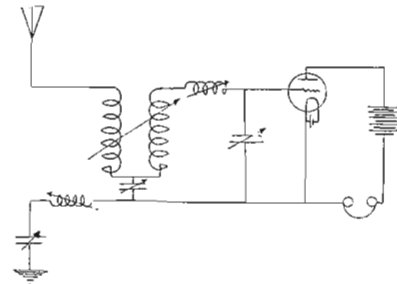

tively strong interference of this kind, though it may be used for the prevention of interference regardless of the strength of the interfering current.

### SIGNALING SYSTEM

(Patent No. 1,484,405. Issued to Arthur A. Oswald, of East Orange, New Jersey, Feb. 19, 1924.)

The present invention relates to signaling systems and is particularly adapted for use as a call-signal in a radio or other signaling system. The invention relates broadly to circuit arrangements for electrically controlling a distant responsive device and for preventing the device from being actuated or controlled by false signals or electrical disturbances whether the device is in a radio system or in some other electrical system.

An object of the invention is to provide a call-signal which will respond only to signaling currents intended for its actuation and which will positively cease to respond when the application of the signaling current ceases. A defect in the usual radio call-signal is that the signaling means is liable to respond to false signals such as atmospheric disturbances, or having been actuated by a signal current, it is liable to continue to respond after the signaling current ceases if disturbing current is present. This invention removes this difficulty by making the signal respond only to persistent current of given characteristics and by providing

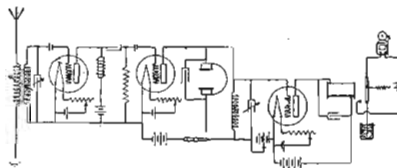

means requiring the application of current of practically the same strength to maintain the signal actuated as is necessary to initiate its response.

### AMPLIFYING SYSTEM

(Patent No. 1,484,967. Issued to John C. Schelling, of East Orange, New Jersey, Feb. 26, 1924.)

This invention relates to electric wave amplifying systems, and more particularly to systems of amplifying or generating waves in which the magnitude of the amplified or generated waves is determined by variations in the internal impedance, or resistance of the amplifying device.

One of the requirements for a high efficiency vacuum tube amplifier is that the greater portion of the space current should flow in a time  $2\pi t$  such that

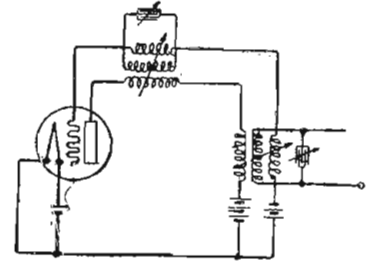

$\cos \frac{2\pi t}{T}$  does not differ greatly from unity, where

$T$  represents the period of the wave to be produced in the output circuit, or in other words, this space current should flow in a time which is very small as compared to the time of one cycle of the output wave.

According to the present invention, a system is provided in which the space current will flow in accordance with the above described relation, this result being accomplished by combining with the fundamental wave, a first harmonic wave, in such phase relation that the maximum positive potential of the given wave coincides in phase with a maximum positive potential of the first harmonic wave. The amplitude of the first harmonic wave is preferably less than that of the fundamental wave, and may be chosen to have approximately one-quarter the amplitude of the fundamental wave. The resultant wave of potential produced by this combination has a much sharper peak than a single sine wave of fundamental frequency having an equivalent effective value. It has been found that by applying this resultant wave to the control circuit of a thermionic amplifier, waves in amplified form are produced in the output circuit of the amplifier

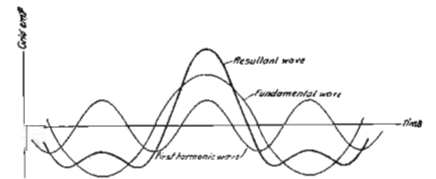

much more efficiently than if a sine wave of the frequency to be amplified and of equivalent effective value to that of the resultant wave previously mentioned, were alone applied to the control circuit.

### MEANS FOR FLATTENING THE CURRENT WAVES OF PULSATING DIRECT CURRENT

(Patent No. 1,485,076. Issued to Coenraad A. A. Haighton, of The Hague, Netherlands, Feb. 26, 1924.)

The invention relates to means for flattening the current waves of pulsating direct current and more particularly of direct current as is produced by rectifiers, the object of the present invention being to obtain a direct current which is adapted for use in such cases, in which a more constant direct current is required for guaranteeing a satisfactory working, e.g. for telephone purposes.

According to the invention a so-called loose contact is placed in the circuit, the resistance of said contact being controlled by an electromagnet, which is energized with the frequency of the pulsations of the current, the excitation of the magnet taking place in such a way that the resistances of

(Continued on page 1800)

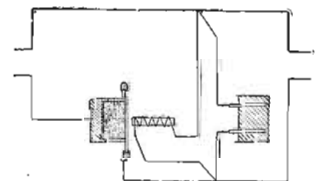



crystals in contact with each other. One is attached to the shaft of the control knob and the other is fixed inside the glass tube, which protects

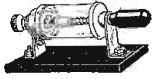

both crystals from injury. It may be mounted on the front of the panel or inside of the set. This detector is manufactured by the Scott Combination Crystal Detector Co., 342 Madison Avenue, New York City. AWARD THE RADIO NEWS LABORATORIES CERTIFICATE OF MERIT NO. 424.

**RIBBON ANTENNA**

A very efficient and easily installed receiving antenna that consists of 1/2-inch copper ribbon equipped with snap hooks at each end is shown in the illustration. This antenna is furnished in various lengths rang-

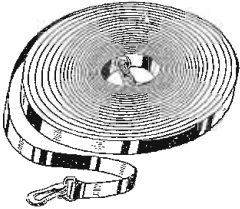

ing from 50 to 200 feet. It is manufactured by the Acron Radio Mfg. Co., 1806 S. Racine Avenue, Chicago, Ill.

Arrived in excellent packing. AWARD THE RADIO NEWS LABORATORIES CERTIFICATE OF MERIT NO. 425.

**TRU FIX DIAL**

Many well designed radio sets have been spoiled in appearance by the use of inaccurate dials. If the shaft is not accurate, the dial will not run true on the panel. This fault may be eliminated by using the dial shown in the illustration. Although the shaft may not be true, this dial will always run true. The dial is of metal and is flexibly at-



tached to the large knob so that the dial will rub on the panel although the knob may be slightly out of alignment. It is manufactured by the Tru Fix Radio Products Co., 42 Maverick Square, E. Boston, Mass.

Arrived in excellent packing. AWARD THE RADIO NEWS LABORATORIES CERTIFICATE OF MERIT NO. 426.

**KEYSTONE LIGHTNING ARRESTER**

The Keystone radio lightning arrester is an improved type for indoor or outdoor use. It is furnished with a bracket for mounting and the arrester unit is well sealed in a bakelite container. It is designed especially for the protection of receiving sets against lightning or other high voltage discharges. Manufactured by the Electric Service Supplies Co., 17th & Cambria Sts., Philadelphia, Pa.

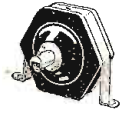

Arrived in excellent packing. AWARD THE RADIO NEWS LABORATORIES CERTIFICATE OF MERIT NO. 428.

**MEXICAN STEEL GALENA**

H. D. Hatfield & Son, 2735 W. 38th Avenue, Denver, Colo., submitted samples of their genuine Mexican steel galena detector crystals. These crystals were found very sensitive and are mounted in a metal base equipped with a flange on top that prevents the crystal from sliding down too deeply into the detector cup.

Arrived in excellent packing. AWARD THE RADIO NEWS LABORATORIES CERTIFICATE OF MERIT NO. 429.

**VERNIER RHEOSTAT**

This rheostat is manufactured by the N Laboratories, 25 W. 45th

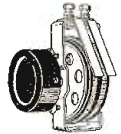

Street, New York City. It has a double coil resistance element of six ohms resistance and is equipped with a vernier adjustment obtained by means of a sliding contact on a single resistance wire inside. The form is of bakelite that will not soften should the rheostat be overloaded and heated. The knob is 1 1/2 inches in diameter.

Arrived in excellent packing. AWARD THE RADIO NEWS LABORATORIES CERTIFICATE OF MERIT NO. 430.

**KLOSNER RHEOSTATS**

The Klosner 6- and 30-ohm rheostats are of very accurate mechanical construction and of pleasing appearance. They are 2 1/4 inches in diameter and may be furnished with

either knob or knob and dial. They are very smooth running and have a uniform contact. Manufactured by the Klosner Improved Apparatus Co., 2024 Boston Road, New York City.



Arrived in excellent packing. AWARD THE RADIO NEWS LABORATORIES CERTIFICATE OF MERIT NO. 431.

**RELIANCE VARIABLE CONDENSER**

The 22-plate vernier type variable condenser shown in the illustration is manufactured by the Reliance Die & Stamping Co., 501-11 La Salle Street, Chicago, Ill. This condenser

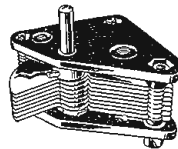

is a very efficient instrument. The dielectric losses at 1,000 cycles are equivalent to a series resistance of 80 ohms. The maximum capacity is .000409 mfd. and the minimum capacity is .0000114 mfd.

Arrived in excellent packing. AWARD THE RADIO NEWS LABORATORIES CERTIFICATE OF MERIT NO. 432.

**NON-INDUCTIVE POTENTIOMETER**

A non-inductive potentiometer is often required in radio frequency circuits. The Central Radio Laboratories, 303 16th Street, Milwaukee, Wis., manufacture these instruments in resistances of 400 and 2,000 ohms. The type 110 instrument has a resistance of 400 ohms and the type 111 has a resistance of 2,000 ohms. The resistance element is enclosed and well protected. Contact is made by means of a flat plate that presses against the resistance. The control is very uniform and the instrument is quiet in operation.



Arrived in excellent packing. AWARD THE RADIO NEWS LABORATORIES CERTIFICATES OF MERIT NOS. 433 and 434.

**PROTECTO TUBE**

Many vacuum tubes have been accidentally burned out by coming in contact with the "B" battery circuit. The device shown in the illustration is designed to protect all makes of receiving tubes from being burned out by the "B" battery. It consists apparently of a resistance of about 800 ohms, connected in the negative lead of the "B" battery and limits the current flow. This resistance has very little effect on the efficiency of the set. It is especially recommended while trying different circuits, as the tubes will then be safe. Manufactured by J. E. McLaughlin, 7068 No. Ashland Blvd., Chicago, Ill.

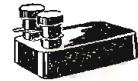

Arrived in good packing. AWARD THE RADIO NEWS LABORATORIES CERTIFICATE OF MERIT NO. 435.

**FOUR CIRCUIT TUNER**

The tuning unit shown in the illustration is designed for the well-known Cockaday four-circuit receiver. This unit is complete, being furnished with mounting brackets and binding posts for each winding, and it also has the single turn of bus bar wire around the grid circuit coil. The workmanship on this coil is very good. Green silk insulated wire is used throughout, making the instrument of very neat appearance. It is manufactured by the General Radio Winding Company, 214 Fulton Street, New York City.

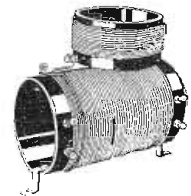

Arrived in excellent packing. AWARD THE RADIO NEWS LABORATORIES CERTIFICATE OF MERIT NO. 408.

**A-1 CRYSTAL DETECTOR**

This crystal detector is of the standard mounted construction and is very sensitive. It has a rough surface and the eat-whisker adjustment is not easily jarred out. Each crystal is furnished with a small fine wire eat-whisker. Manufactured by Harry Grant, Jr., 904 Oak Grove Avenue, Burlingame, Calif.

AWARD THE RADIO NEWS LABORATORIES CERTIFICATE OF MERIT NO. 427.

**Radio Trade Notes**

By L. N. ALLEN\*

**I**N the very near future a new element may be expected in the radio trade, the element of the broadcasting advertising by powerful stations, operating both through the air and over lines of the telephone or electric light companies. The possibility of this is brought to light through the announced intention of the American Telephone and Telegraph Co. to license other broadcast stations to operate for hire, a prerogative heretofore reserved only for radio stations.

At the time of this writing no such station has been licensed, and the telephone company may hold off on the licensing of such stations for some time, no definite date for their operation having been set.

Studying the effect this would have on the radio trade, some are disposed to become alarmed, but the White Radio Bill, now in Congress will easily take care of

this, as no station broadcasting advertising will be permitted to dominate the air, under the terms of this bill, and this may result in the end, in there being considerably more broadcasting than there is at present with a consequent greater variety of programs for the listener to pick from.

**WIRED WIRELESS**

The steady developments in the matter of wired wireless is also attracting considerable trade notice, but after the true facts of the case are fully understood this also points to better trade conditions.

Electric light and power companies have found that the furnishing of home entertainments through radio increases the power used, and consequently increases their profits. The broadcasting of programs over light mains will bring little revenue from the current used, if any, through the operation of these sets, but will bring considerable revenue from the other current used, incident to the enjoyment of the programs.

The possibilities of advertising programs over light lines may, in time, make it possible for the power companies to support elaborate programs, broadcasting on two or three different wave-lengths furnishing news, music, entertainment on one or two waves, and advertising on a third and fourth. This would have no objectionable features, and would place the advertising where the listener could find it, if interested.

The rental of sets for wired wireless reception is rather doubtful at the present time; if any charge is made it will be for a special type of tuner which will convert the longer waves sent over the wires into something that can be received and amplified by the ordinary short wave radio set as used for air reception. Likely programs at first would be broadcast during the daylight hours when the air stations are not plentiful.

The operation of this type of broadcast-  
(Continued on page 1824)

\* Associate Editor, The Radio Dealer.





**APPROVED  
RADIO NEWS  
LABORATORIES  
1922**

# RADIO NEWS LABORATORIES



**R**ADIO manufacturers are invited to send to RADIO NEWS LABORATORIES, samples of their products for test. It does not matter whether or not they advertise in RADIO NEWS, the RADIO NEWS LABORATORIES being an independent organization, with the improvement of radio apparatus as its aim. If, after being tested, the instruments submitted prove to be built according to modern radio engineering practice, they will each be awarded a certificate of merit, and a "write-up" such as those given below will appear in this department of RADIO NEWS. If the apparatus does not pass the Laboratories tests, they are returned to the manufacturers with suggestions for improving them. No "write-ups" sent by manufacturers are published on these pages, and only apparatus which has been tested by the Laboratories and found to be of good mechanical and electrical construction is described. Inasmuch as the service of the RADIO NEWS LABORATORIES is free to all manufacturers whether they are advertisers or not, it is necessary that all goods to be tested must be forwarded prepaid, otherwise they cannot be accepted by the Laboratories. Address all communications and all parcels to RADIO NEWS LABORATORIES, 53 Park Place, New York City.

## Apparatus Awarded Certificates of Merit

### BRANSTON THREE-COIL MOUNTING

The Branston type R-73 three-coil mounting is designed for use with standard honeycomb or duo-lateral coils. It is the front of panel type with control knobs attached directly to the two outside receptacles so that direct control of the coupling is obtained. The mechanical construction is very simple and rugged. Manufactured by Charles A. Branston, Inc., Buffalo, N. Y.

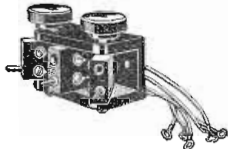

Arrived in excellent packing.

AWARDED THE RADIO NEWS LABORATORIES CERTIFICATE OF MERIT NO. 412.

### BRANSTON THREE-COIL GEAR MOUNTING

When it is desired to mount the honeycomb or duo-lateral coils behind the panel, the Branston type R-62 coil mounting may be used. This mounting is similar to the type R-73 mounting described above, except that it is designed for back of panel mounting and the receptacles are geared to the control knobs. In this way the coupling is controlled from the front of the panel. Manufactured by Charles A. Branston, Inc., Buffalo, N. Y.

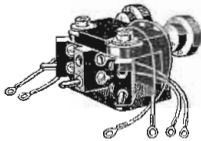

Arrived in excellent packing.

AWARDED THE RADIO NEWS LABORATORIES CERTIFICATE OF MERIT NO. 413.

### BRANSTON D.L. INDUCTANCE COIL

Charles A. Branston, Inc., manufactures a complete line of D.L. inductance coils. The 250-turn coil is shown in the illustration. This coil is of standard construction and fits the Branston coil mountings, also described in these columns.

Arrived in excellent packing.

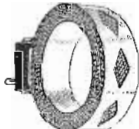

AWARDED THE RADIO NEWS LABORATORIES CERTIFICATE OF MERIT NO. 414.

### BRANSTON SINGLE COIL MOUNTINGS

Quite often it is desirable to mount single coils on a panel or to



mount two or more coils in inductive relation to each other on the same panel. This is easily accomplished by using the types R-77 and R-68 single coil mountings. Type R-77 is fixed, and the other is hinged so that coupling between the coils may be varied. These mountings are also manufactured by Charles A. Branston, Inc.

Arrived in excellent packing.

AWARDED THE RADIO NEWS LABORATORIES CERTIFICATES OF MERIT NOS. 415 and 416.

### BRANSTON LIGHTNING ARRESTER

The type R-51 radio lightning arrester shown in the illustration is



an approved vacuum gap type designed for the protection of receiving sets against lightning discharges or other high voltage surges. It is enclosed in a moulded bakelite form of neat appearance. Manufactured by Charles A. Branston, Inc.

Arrived in excellent packing.

AWARDED THE RADIO NEWS LABORATORIES CERTIFICATE OF MERIT NO. 417.

### MIDLAND VARIOCOUPLES

The Midland Electric Manufacturing Co., Indianapolis, Ind., sub-

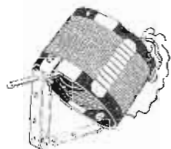

mitted samples of three types of its variocouplers. The instruments differ slightly in design; only one is shown in the illustration. One is equipped with a honeycomb coil secondary winding. The other two are similar to each other except for the mounting brackets. The primaries are provided with 10 taps, and have a 180-degree coupling. The shafts are 3/16 inch in diameter. The instruments are compact and of pleasing appearance.

Arrived in excellent packing.

AWARDED THE RADIO NEWS LABORATORIES CERTIFICATE OF MERIT NO. 418.

### MIDLAND DETECTOR CRYSTALS

These are very sensitive galena crystals known as the "soft sensitive" type. They are securely mounted in a deep metal cup with a low melting alloy. The deep cup protects the crystal from injury and also allows for easily removing it from the standard detector receptacle. The crystals were received well packed in paper boxes. Manufactured by the Midland Electric Mfg. Co., Indianapolis, Ind.

AWARDED THE RADIO NEWS LABORATORIES CERTIFICATE OF MERIT NO. 419.

### FOUR CIRCUIT TUNER

This tuning unit is designed for use in the well known Cockaday

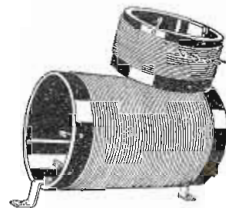

four-circuit receiver. The unit is well constructed and of very neat appearance. The windings are provided with terminals for making the connections and so arranged that the unit may be conveniently mounted behind the panel. This coil is manufactured by the Precision Coil Co., Inc., 209 Center Street, New York City.

Arrived in excellent packing.

AWARDED THE RADIO NEWS LABORATORIES CERTIFICATE OF MERIT NO. 420.

### TUNE SHARP FORM WOUND VARIOCOUPLER

The Tune Sharp Radio Equipment Co., 6222 So. Vermont Avenue, Los Angeles, Calif., has designed tuning units that are very efficient electrically because a minimum of insulating material is used in their construction. The windings are treated with a lacquer that makes them self-

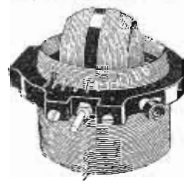

supporting. The type A-100 variocoupler shown in the illustration is of the standard size. The moulded

form is designed for panel and base mounting and is equipped with rugged binding posts.

Arrived in excellent packing.

AWARDED THE RADIO NEWS LABORATORIES CERTIFICATE OF MERIT NO. 421.

### BANK FORM WOUND VARIOCOUPLER

The bank form wound variocoupler shown in the illustration is also



manufactured by the Tune Sharp Radio Equipment Co., Los Angeles, Calif. The windings of this instrument are of unusual interest. The primary is bank wound and treated with a lacquer that makes it self-supporting and mechanically strong. The secondary is also form wound and self-supporting. The moulded form that supports the windings is designed for both panel and base mounting. This instrument is ideal for use where a minimum of losses are desired with consequent increase in selectivity.

Arrived in excellent packing.

AWARDED THE RADIO NEWS LABORATORIES CERTIFICATE OF MERIT NO. 422.

### FORM WOUND VARIOMETER

This variometer is of the same general construction as the Tune

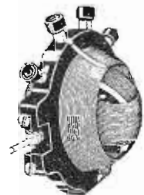

Sharp Company's form wound variocouplers. The windings are self-supporting. Tuning with this instrument is also exceptionally sharp due to the small amount of losses in the windings. When used in conjunction with the variocoupler described above, the entire broadcast wavelength is covered.

Arrived in excellent packing.

AWARDED THE RADIO NEWS LABORATORIES CERTIFICATE OF MERIT NO. 423.

### SCOTT COMBINATION CRYSTAL DETECTOR

A sensitive adjustment is obtained with this crystal detector with very little trouble. It is of the combination type employing two different



# Correspondence From Readers

## RADIO CORRESPONDENCE SCHOOLS

Editor, RADIO NEWS:

In reading the current number of your magazine I note an article by a man formerly connected with the Radio Inspection Service in which the correspondence schools for operators are thrown into disrepute. I should like a word on the subject in order to correct a mistaken attitude that may work badly for some reputable schools of this sort.

At present I am a radio operator on the S. S. *Cuba*, plying between Tampa, Fla., and Havana, Cuba. As a matter of fact I have been going to sea as a radio op. for some time. My foundational knowledge of radio was gained through a correspondence course and when I went to the office of the local Supervisor at New Orleans I knew that there was such a thing as the International Morse Code and that most of the radio operators were expected to at least have a passing acquaintance with it. As a matter of fact, I knew that there were examinations on the reception of code included with the technical examination.

The apparatus aboard the *Cuba* is controlled by the Radio Corporation of America and I might say that I knew the difference between the transmitting and receiving set when I stepped into the shack.

As to the correspondence schools I might say that there are black sheep among them even as there are among banks, lawyers, doctors and stocks. There are also reputable ones that are doing a good service for those whose means do not permit them to take a regular day school course in the art. In the field I have met several ops. who gained their knowledge from the despised correspondence schools and I have never met anyone who had a bad word to say against them. The man who would expect to get a full radio course for \$5 is the kind of a man who would buy wild-cat oil stock. Neither of them would investigate the oiliness of the salesman or the ad.

There are those in every line who will be taken in, and it is those who have been imposed upon that the former Supervisor was speaking about. But because some fall for a confidence scheme of this sort is no reason for condemning the whole list of correspondence schools, some of which have been doing a good work for a number of years. Radio is a wonderful occupation, but like everything else, one must be educated in its technicalities. The correspondence method has its difficulties, but it is a means that brings the technical education within the reach of a number of men who would otherwise have to remain in unskilled positions.

JOSEPH L. CRUSOE,  
1025 Eaton St.,  
Key West, Fla.

## RE—THE MENACE TO RADIO BROADCASTING

Editor, RADIO NEWS:

I have just finished reading Mr. Muhleman's article "The Menace to Radio Broadcasting" and being a reader of your magazines since the days of the old E. I. Co., am going to ask you what you think of this suggestion.

I have a radio receiver and, like most of the BCL's, am annoyed by the squeals and whistles produced by the ignorant operation of the numerous types of radiating receivers.

Now I am sure that there are a great many of the aforesaid BCL's who would be willing to try to minimize this nuisance, therefore, why not conceive some scheme whereby we can get together and be a "big brother" to those who unknowingly cause this disturbance?

Such an organization in cities throughout the United States, which would give, free

of charge, help and advice to those who own receiving sets, would bring about a better understanding of radio and help to make broadcasting a greater pleasure.

I have noticed that there are two classes of broadcast listeners: First those who are interested enough in radio to find out what takes place in their receivers and to further their knowledge concerning radio and are usually enthusiastic in the reception of "DX." Second, come those who care only to listen to the local broadcast stations.

The first class usually own regenerative sets, and to this class such an organization as I have suggested would be helpful in the successful operation of this type of receiver or in helping him in the addition of radio frequency amplification to get the long distance reception. The second class would benefit by using a non-regenerative type of

work that this portion of the magazine has been eliminated.

It was the only medium through which the problems and troubles of the sea-going operator could be dealt with in print. Some may think that a ship man does not have problems and troubles to be dealt with, but almost any operator, especially one on the average freight steamer, will have some kink on hand to be straightened out, some experience to tell of, or some helpful hint to save others trouble. These things in print would be well worthwhile.

W. C. ELLSWORTH,  
Opr. SS. *West Wauna*, USSB.  
Trosdal Plant & Lafonta SS. Co.  
New Orleans, La.

## ANOTHER INQUIRY

Editor, RADIO NEWS:

I am writing these few lines in regard to a certain section of your magazine called "With the Sea Going Ops," which I find does not appear in the latest edition.

I am what is termed a "Commercial Operator" and am employed aboard the Shipping Board vessel *West Durfee*. I have been a ship operator for several years and to my knowledge the introduction of the section in RADIO NEWS devoted to the ship operator has helped to bring together the views and ideas of operators employed as such, more than anything else. In fact, it has been the only source, with the exception of a publication issued by one of the radio service companies, by which men in this class of work have been able to express themselves.

As a reader of your magazine I do hope to find that section herein mentioned, continued in the near future.

THOMAS NUGENT.

[We have not forgotten the Sea-going Operator. We have him much at heart, but truly, how are we to continue this Department without material? The Department was created for the Sea-going Operator, but it is up to you fellows to keep it going. Out of its hibernation it comes if you boys will supply the breath. What say? Will you send us some good dope, and continue to send it, so this Department can once more thrive? EDITOR.]

## JOHN BULL ANSWERS US WITH A BRICKBAT

Editor, RADIO NEWS:

I read with considerable amusement your editorial on "Future Developments of Radio" in the March issue. You really are the dyed in the wool humorous fellow when it comes to writing about the conditions of radio in England. We have in our station here a previous article of yours on "Radio in England." I read it to listeners when testing speech. It is quite the funniest thing they ever heard. Someone should say "Hi" to you, and that quick. Come, sir, get down out of the high air before you criticize the results of the government control of radio in this country. Better still, read the letters of H. B. Newall, Starkey, Tetley and Woodward in the same issue of your paper. Pay one of those gentlemen's fare over here and let him see for himself the one country where radio is so controlled that exactly what the listeners want according to their letters is what they have. It is true that we have only a few stations. We don't need more transmitters. We certainly don't need half a dozen broadcasters in one town all turning out mediocre programs which all come in together on whatever wave you're tuned to. As for bootleg stations, we don't have 'em. We certainly do have pirates who do

(Continued on page 1839)

## Interesting Articles to Appear in June Issue of "Practical Electrics"

Historic Incandescent Lamps (Concluded).

By T. O'Connor Sloane, Ph.D.

Electricity Detects Counterfeit Paintings.

By M. Bayle, Director of Bureau of Identification, Paris.

Experimental Microphone.

By Frank W. Godsey, Jr.

Electric Boilers.

Utilizing Solar Heat.

Dry Cells from Wet Batteries.

By C. A. Oldroyd, Barrow-in-Furness, England.

Electro-Magnetic Induction.

By Harold Jackson.

Hudson River Vehicular Tunnel.

Stunts with Static. By Harry R. Lubcke.

receiver which would not cause himself and his neighbors a lot of disturbance; here the organization would be helpful to him by converting a regenerative set into the non-regenerative type, which is easier to handle and gives good results on local reception.

Of course I know that there are radio clubs which carry on work along this line, but are more or less for the advanced and transmitting amateur.

There are numerous radio fans throughout the country who would be only too glad to help in such a plan, thereby helping their neighbors and gaining knowledge themselves in doing so. The fans, I am sure, would get together and do the work free of charge, only charging for parts if they were necessary.

The broadcast stations themselves could help to decrease this interference menace and make known an organization such as I have mentioned.

JAMES EWART,  
55 William St., Orange, N. J.

## THE SEA-GOING OP'S. DEPARTMENT

Editor, RADIO NEWS:

In the last few issues of RADIO NEWS, the "With the Sea-going Op's" Department has been discontinued. I have talked with several operators and believe it is with much regret to those who are really sincere in their



# Radio Humor

## Queer Queries and Ready Replies

BY I. R. TANNEHILL



An efficient receiving set made of odd odds and ends.

these to receive local broadcasting? Puzzled.

A. Solder the light socket to the ice-water can. Wrap the light wire around the can 20 times and around the water pipe 10 times. Place a wooden bowl on top of the water can and place an iron spoon in the bowl. Connect the spoon to the water pipe and connect the phones and detector in parallel with the can. To increase wave-length throw spoons in the bowl. To decrease the wave-length, drink the ice-water. The average stomach

(Continued on page 1822)



A most simple and efficient means of demonstrating "lines of force" with a horseshoe.

QUESTIONS addressed to this Department will receive answers as pointed as a jab in the eye with a sharp stick. Useless questions preferred. Use two-sided paper written on one side. No attention will be paid to questions not accompanied by money, postage, chewing gum, radio apparatus or smoking tobacco.

Q. How can I improve the appearance of my knob and dial? Fastidious.

A. Get a haircut and shave.

Q. Which is a better lead-in, a conductor or an insulator? I. N.

A. A conductor is much better; if a conductor is not available, try a motorman.

Q. I have received music from every state in the Union. Can this record be improved? Longfellow.

A. Yes, apply to Congress immediately for a few additional states.

Q. I have a crystal, a soldering iron and a pair of telephones. How can I connect

## Radiotics

WE will publish in this Department every month humorous misprints as they occur in the press. We ask our correspondents to send us such misprints, but we cannot accept them unless they are accompanied by the original, which may be



Meet the latest radio instrument—the Foxed Condenser.

clipped from the periodical, newspaper, book or magazine wherein the mistake occurred. We will pay \$2 apiece for each Radiotic and the more idiotic it is, the better chance it has to be reprinted by us. We will also print the name of the scout who discovers it. Address all Radiotics to Editor, Radiotic Department, care of this publication.

We have with us this month an advertisement of Gimbel Brothers, New York, picked from the New York Times of March 5, in which they advertised a new Neutrodyne set. In the text we find "DUBILIER FOXED CONDENSERS." We always had an idea that Dubilier was rather foxy, but his going

**RADIOTICS**

Beginning with this issue we are starting our new RADIOTIC Department. If our readers happen to see any humorous misprints in the press, we shall be glad to have them, clip them out and send to us. No RADIOTIC will be accepted unless the printed original giving the name of the newspaper or magazine is submitted. We shall pay \$2.00 for each RADIOTIC that is accepted and printed here. A few humorous lines from each correspondent should accompany each RADIOTIC. The most humorous ones will be printed. Address all RADIOTICS to:

Editor RADIOTIC DEPARTMENT,  
c/o Radio News,  
New York City

into the manufacture of Foxed Condensers is the foxiest thing he ever did.

We also pick the following little posey from the New York Evening

And here we have the 200-ton Rheostat, to be installed shortly on top of the Woolworth Building.



World, Mid-Week Radio Magazine, issue of Wednesday, March 5. The article is entitled—"Here is a Standard Regenerative Set Which Gives Excellent Results." One of the paragraphs is as follows: "In our

Here is the man with a mahogany finish. He goes well with the latest mahogany parlor outfit.



case a UV-201A was used as a detector, operated from a 6-volt storage battery and a 200-TON RHEOSTAT. No wonder Silbersdorff's set gives excellent results. It certainly should. We have always maintained that most rheostats did not carry enough weight with the users. Personally, we would like to see the set in which this baby is installed.

His Finish—WANTED—Three-tube set by man with a mahogany finish.—Classified ad in the New York Telegram and Evening Mail Radio Section.



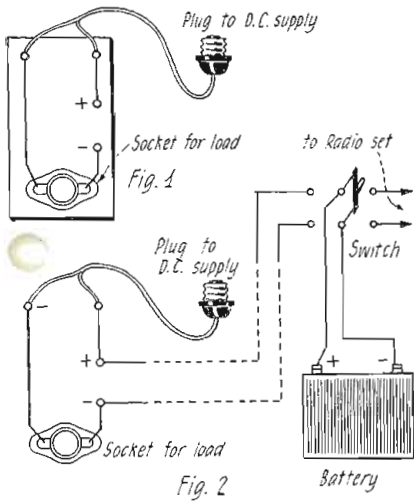

Arrangement for charging a storage battery from the D.C. line.

polarity. If the attachment plug is of the Edison screw plug type, no difficulty will be experienced in the future. However, if it is possible to "plug in" in the wrong direction (because of the type of plug), it is readily seen that the wrong connection may result. If you have one of these reversible plugs, mark it in some manner so that it will always be used correctly.

A simple polarity indicator can be made by adding a slight amount of salt to a glass of water. If the two electrodes are immersed in the solution, bubbles will rise from the negative electrode. This test should never be made without some sort of protective resistance, such as a lamp, in circuit.

Having determined the polarity of the leads to which the battery is to be attached, connect positive to positive and negative to negative.

It is interesting to note that an electric flat-iron, if not continually in use, usually becomes too hot if permanently connected to the line. With this device, it is quite likely that the iron will operate at the proper heat continuously and will, at the same time, supply a very reasonable charge for the battery. Ordinarily two or three hours per week of charging with the electric iron will suffice to keep the battery in good condition. The circuit arrangement shown in Fig. 2 will be found very convenient for those who prefer the permanent installation.

Contributed by W. P. Powers.

### AN IMPROVED SPIDERWEB FORM

The conventional wooden spider web coil form with its round wooden center and radial wooden spokes is rather difficult to construct, for the wooden center has a tendency to split when the rather large holes that are to take the spokes are bored into it. If the wood spokes are made so small that the holes bored in the center-piece are small enough not to split the wood, they will not be strong enough to support the winding of the coil, and they will be likely to break if the form is not handled with care. All

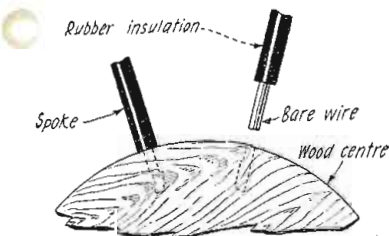

Rubber insulated wire is used for the spokes of this spider-web form.

these difficulties, and many others, are overcome by using lengths of rubber-covered No. 12 or 14 wire for the spokes. The pieces of wire are cut 1/2-inch longer than necessary for the spoke, the insulation on this extra half-inch of wire is cut away, and the bare part inserted in the hole bored to receive it in the wooden center disc. The bare end of the wire can be firmly held in the hole with a little glue. The holes in the center-piece need be only large enough to receive the bare wire. They may be almost a driving fit for the wire.

The advantages of the wire over the wooden spokes are numerous. The winding on the form sinks slightly into the insulation on the wire spokes and holds it in place without paint or other treatment. The insulation also holds the turns of the winding apart, assisting in insulating them from each other. Last but not of least importance, a form constructed with the wire spokes is much easier to build and is stronger than the all-wood form.

Contributed by Charles F. Felstead.

### A SIMPLE BATTERY CHARGING SCHEME

Wherever there is commercial direct current, it is a very simple matter to charge storage batteries. If the battery is charged directly from the line, a resistance must be used in series to cut down and control the current flow. This resistance usually takes the form of a bank of lamps. But why go

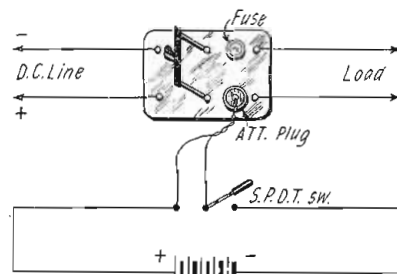

By using this scheme your storage battery will always be fully charged.

to any extra expense to charge the battery? Why not charge it at the same time the house lights are used and thus save money? This is a very simple matter if the scheme shown in the diagram is followed. A fuse block and double pole switch are inserted between the house lights and the line. One fuse is removed and an attachment plug is inserted in its place. The two wires from the plug are run to a S.P.D.T. switch, which is in turn connected to the battery. When the switch is thrown to the left, the battery is out of the circuit and when it is thrown to the right and any lights are being used, all of the current is flowing through the battery and charges it at the rate of current flow. The lights will be slightly dimmed as the battery uses part of the current that would ordinarily go to light the lamps. If one 100-watt lamp is being used, the battery is being charged at about one ampere. The battery will consume approximately eight watts, which is deducted from that consumed by the lamp and will consequently cause the lamp to be slightly dimmed, which, however, is no inconvenience, as it is hardly noticeable.

Contributed by D. E. Crabb.

### A COMPACT RECEIVING SET

The accompanying illustration of a compact receiving set employing a spider-web coil as the tuning unit is, I believe, original. Tuning is done by means of the two switch arms which are used as sliders, the switch blades making contact with the wire of the coil. By mounting a crystal detector in the center of the coil form and binding posts

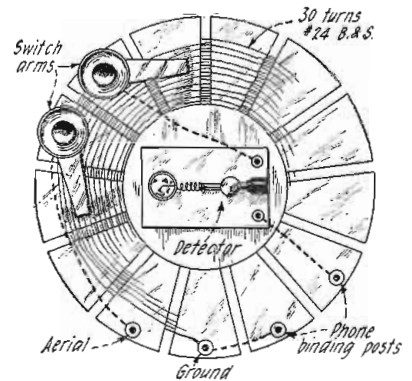

A simple crystal receiving set can be made on a spider-web coil.

on the edges, a complete receiving set is had. The wiring is shown in dotted lines which should be followed closely.

Contributed by J. Raymond Derby.

### CONSTRUCTION OF AN INSULATION TUBE FOR COIL WINDING

Sheet celluloid, such as old photographic films, when rolled and cemented together with collodion, or a cement made by dissolving some scrap celluloid in acetone, or in equal parts of alcohol and ether, makes a first class tube upon which to wind inductance coils.

These old films, which range in size up to 12 inches by 14 inches, can be had for the asking from most any photographer, or from some doctor friend who does X-ray work.

First remove the gelatine emulsion from them by soaking in hot water and scraping. Hang them by two corners so they will be smooth when dry. Get a smooth round stick or bottle or mailing tube with a diameter a little less than the tube you wish to make. Wrap the celluloid tightly and smoothly around this core, and when one complete turn has been made, quickly smear a light coat of the cement over the whole surface. Then make another turn, keeping the entire outside face lightly coated with the cement. When you have from four to six layers, depending upon how thick you wish the tube to be, wrap the whole thing tightly in a cloth or towel and lay aside to dry for a few hours.

Remember to wrap tightly and smoothly and to apply only a light smooth coat of cement and you will have not only an efficient insulating tube but one that is neat in appearance.

Contributed by Dr. William H. McKie.

### A CHEAP TUBE SOCKET

Many ideas of tube sockets have been shown from time to time, but for cheapness and simplicity of construction the socket described here cannot be beaten. The parts required for this socket are four soldering lugs, four small screws and a piece of quarter-inch wood about two or three inches square.

Contributed by Reginald Harvey.

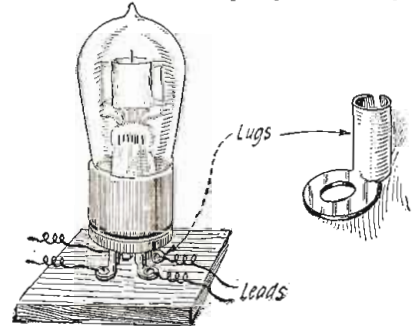

The cheapest tube socket. The cost is about two cents.



# Awards of the \$50 Radio Wrinkle Contest

## First Prize

### A SIMPLE BATTERY CHARGER

By GEO. SCHUCHMAN

Here is a home-made "B" battery charger that will prove welcome to those who wish to charge their own storage "B" batteries. This charger operates on the same principle as the well known Tungar rectifier.

All that is required is a small toy transformer and a double filament headlight bulb of the type used on Ford cars. This bulb has two filaments, the smaller of which should be burned out. This can be done by connecting 10 or more volts across the proper terminals. As this bulb has two contacts on the bottom and the third is made to the brass shell, the wrong filament can very easily be burned out by mistake. The brass shell is the common terminal for both filaments. The other terminal of the smaller

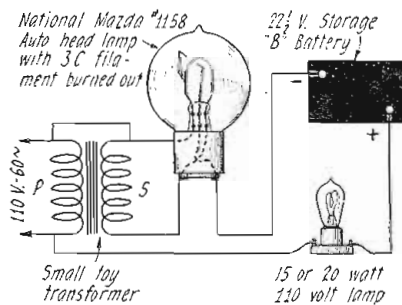

Why use a messy electrolytic rectifier to charge your storage "B" battery? A Ford bulb will do the trick if connected as shown.

filament can be found by connecting one terminal of a six-volt storage battery to the shell and touching the other storage battery terminal to one and then the other contact on the bottom of the bulb. The filament that burns dimly is the one that should be burned out.

The connections for the charger are clearly shown in the diagram. A 15- or 20-watt lamp is connected in the battery circuit to limit the current flow. A larger lamp should not be used, for then the wire acting as the plate will melt down rapidly, thereby increasing the distance between it and the filament until the rectifier ceases to function. When the charger is operating correctly, the 110-volt lamp will glow dimly.

## Second Prize

### A COMBINATION BEARING AND MOUNTING FOR VARIOMETERS OR VARIOCOUPLES

By W. H. GORDENIER

Herein is described a combination bearing and mounting for a home-made variometer or variocoupler which can be built very easily and will prove quite efficient. The sketch is self-explanatory, but a description of the mounting may prove helpful.

A variometer or variocoupler, light in weight, preferably made of thin bakelite tubing or cardboard, should be used in conjunction with this mounting.

The mounting consists of a 1/4-inch brass tube about two inches long, with an inside diameter large enough for a 1/8-inch brass rod to rotate freely inside, this rod to be about 1 1/4 inches longer than the tube. The tube should be threaded at both ends for about 3/4 of an inch. A brass washer should be threaded to fit the 1/4-inch tube. A nut and a plain washer are now placed on one end of the tube, and the tube is inserted through the panel from the rear, through a

## Prize Winners

**FIRST PRIZE \$25**

*A Simple Battery Charger*

By Geo. S. Schuchman  
5719 N. Maplewood Ave.,  
Chicago, Ill.

**SECOND PRIZE \$15**

*A Combination Bearing and Mounting for Variometers or Variocouplers*

By W. H. Gordenier  
955 De Soto St.,  
St. Paul, Minn.

**THIRD PRIZE \$10**

*A High Capacity Fixed Condenser*

By B. Kellam  
364 Ossington Ave.,  
Toronto, Ont., Canada

1/4-inch hole. The threaded washer should be screwed on the projecting tube so that the end is flush with the face of the washer. The nut on the inside is now tightened and the tube is rigidly held at right angles to the panel. Two nuts are now screwed on the other end of the tube with the primary of the variometer or coupler between them, but these nuts are not tightened until the secondary is in place. To mount the secondary, the rod is inserted in the tube from the outside and the secondary securely fastened on it between two nuts. The secondary can be centered in the primary by moving the nuts on the tube backward or forward. When the correct position is found, these nuts are tightened. A bushing is made of a piece of

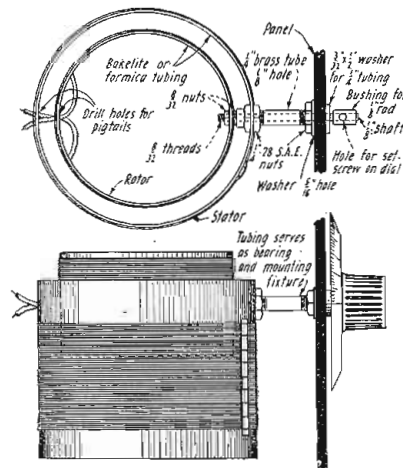

A neat method for mounting a variometer or variocoupler. Only one hole is drilled in the panel.

1/4-inch brass tube, 1/2-inch long, to be slipped on the rod so a standard dial may be employed. This bushing should have a small hole drilled through one side so the dial set screw may be fastened on the rod beneath.

## Third Prize

### A HIGH CAPACITY FIXED CONDENSER

By B. KELLAM

The following is a method for making a condenser of considerable capacity for use in preventing sparking of vibrators in recti-

fiers, where not too high a voltage is employed. Get some scrap soft rubber such as rubber corks, tubing, or elastic bands and dissolve them in benzine (highly inflammable). The solution should have a consistency of thin mucilage. Take a piece of canvas slightly more than twice as large as the condenser in length, and in the center paint a thin layer of rubber. In a few minutes this will be dry. Then place a sheet of thin tinfoil on the layer, the size of the tinfoil being such as to leave a 1/4-inch margin of rubber around, and a one-inch lead projecting. Paint another thin layer of rubber on the tinfoil and when dry, repeat the whole process, alternating the rubber and foil. When the height has reached about 1/2 inch, apply pressure to the condenser. A small screw press will prove very handy for this. Then proceed again with the rubber and tinfoil. When you think you have made enough layers, the thickness of the condenser

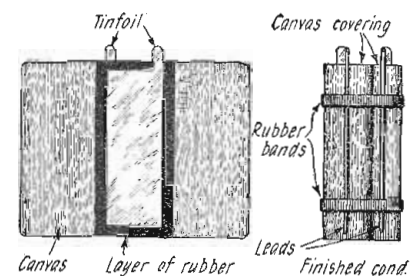

A condenser of any capacity can be made by using a rubber solution as the dielectric.

being optional with the maker, fold the condenser up in the projecting ends of the canvas and place two rubber bands over the canvas to keep it in place. The connecting stubs are then carefully soldered each to a lead and the wire brought under the elastic bands so as to reduce pull on the foil projecting, as shown in the diagram. If the solution is made thicker, and also the layers of rubber, the condenser can be made to withstand higher voltages.

## CHARGING BATTERIES FROM DIRECT CURRENT SOURCES

WHERE direct current is available, "A" batteries can be charged by the following method. Fig. 1 will serve to indicate the scheme. Lay out the arrangement as indicated, using a wooden base four inches by eight inches. The polarity of the battery binding posts should be clearly marked as explained later. The polarity of the attachment plug need not be marked providing it is always attached to the same socket, and is not a reversible plug (one which can be plugged in in either of two directions). Such a panel will conveniently hang on a nail and may be used continually wherever and whenever a table lamp, floor lamp, vacuum cleaner or other device is desired.

The only precaution which must be observed is to determine the proper polarity for the attachment plug, and to see that this does not change when the charger is in some other location.

To determine the proper polarity, connect the circuit as indicated in Fig. 1, with battery in place and a lamp as a load, and turn on the current. Note the brilliancy of the lamp. Now turn off the current, reverse the battery connection and turn on the current again. Note the brilliancy of the lamp. The connection giving the darker lamp is the correct connection. The battery binding posts should now be marked with proper



if we have five similar tubes operating, the total output will be five times that of one tube. In the case of the master oscillator amplifier system we have one master oscillator feeding four power amplifiers, as in Fig. 2, and the output given to the antenna is that of the four amplifiers, or four times the power output of one tube, if they are connected in parallel. At first glance it would seem that as far as power output is concerned the self-excited system of Fig. 1 is better. But actually this is not the case. The reason is that it is possible to work amplifier tubes at greater efficiencies than oscillator tubes. In oscillators, as has been explained before, it is necessary to adjust the grid voltage and plate voltage for maximum output. When the plate inductance is varied it is necessary to make a compensating variation in the grid inductance to secure maximum output and efficiency. The voltage which may really be obtained on the grid of an oscillator tube is limited to a considerable extent by the voltage which may be applied on the plate. This does not hold in the case of the amplifier. In Fig. 2 the amplifier grids are supplied voltage from an independent external master oscillator circuit. The voltage which may be applied to the grids of the amplifiers is dependent solely on the power output of the oscillator and the coupling between  $L_p$  and  $L_g$ . The master oscillator has sufficient output to care for any power drawn by the amplifier grids. In this manner it is possible to give the amplifier grids any voltage which is required for maximum output. Any voltage which is applied to the amplifier grids can produce no undesirable reaction, such as may be produced in a self-excited oscillator, where oscillations may cease if the grid voltage is not of correct value. It is for this reason that an amplifier may be worked at higher efficiencies than a self-excited oscillator; hence an amplifier tube will give more output than an oscillator tube. For this reason it is possible to secure as much output from four amplifier tubes which are excited by a master oscillator as from five oscillators working in parallel. In point of power there is no loss in using the master oscillator amplifier system as opposed to the parallel oscillator design. In fact, where the number of tubes in parallel becomes high, there may be a large gain in output due to the much higher efficiencies at which amplifiers work.

**RADIOPHONE COMMUNICATION**

We next come to the question of radio-telephone communication when employing the master oscillator amplifier system. Here a tremendous advantage is secured. As stated below, when employing the Heising system of modulation it is necessary to use as many modulator tubes as oscillator tubes. Fig. 3 illustrates the Heising system where three oscillator tubes are used, necessitating three modulator tubes of equal power, requiring a

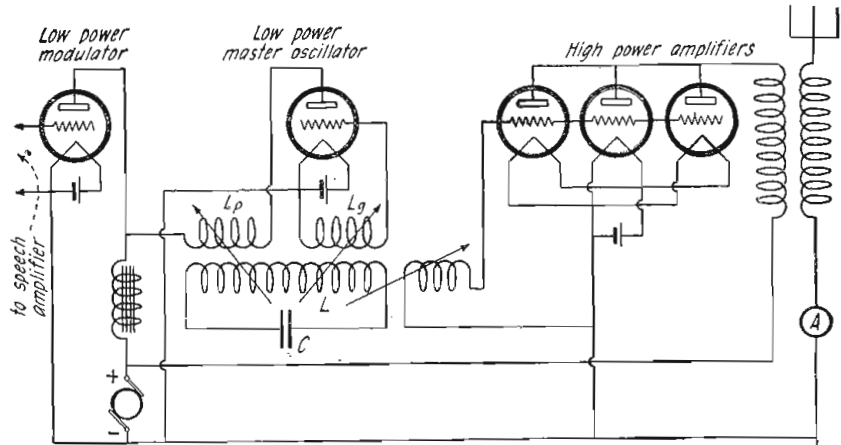

Fig. 4

When using the master oscillator amplifier system, only a small tube is necessary to modulate the oscillator, the modulated output being amplified by any number of amplifier tubes. This system is preferable to the one of Fig. 3.

total of six tubes. Since we are modulating the high power directly, all the preceding speech amplifier equipment must be of correspondingly high power. Obviously if we modulate 100 watts we require more elaborate and more powerful speech amplifiers than if we modulated only five watts.

Consider Fig. 4 which shows the master oscillator amplifier system employed for radiophone communication. In this system we have a small master oscillator which supplies grid voltage to a power amplifier. It is a simple matter to modulate a small oscillator by means of a correspondingly small modulator tube of equal power. Hence in the circuit LC we have modulated radio frequency power. This is amplified by the power tubes in parallel, and modulated radio frequency is, therefore, radiated from the antenna. The advantages of this system are at once evident. The problem of efficiently modulating higher powers is simplified. In this system we modulate at low power, namely, the master oscillator, which requires less elaborate and less powerful speech amplifiers than if it were necessary to modulate the high power directly as in the self-excited system. For a given power we effect a large saving in the number of tubes employed. In the case illustrated above a total of six tubes is required in the self-excited system of Fig. 3 to secure modulated output for three oscillator tubes. In the case of the master oscillator amplifier system of Fig. 4, we require only five tubes in order to secure the same output. For much more power we effect a saving of one tube. Of course, the saving of tubes increases with the number of tubes used. Furthermore the set is not as bulky and there is a considerable

saving in renewals since fewer tubes are employed.

The amateur will find that if he uses a number of tubes in parallel, the master oscillator system will prove considerably superior and more efficient. Operation at low powers and conversions at low powers are always simpler than at high powers. It is much simpler to generate radio frequency oscillations at low powers as in the master oscillator system, than it is at high powers, as must be done with the self-excited oscillator system. Also it is simpler and less expensive to modulate radio frequency at low powers than at high ones.

A few words of precaution in conclusion. When using a number of tubes, as in this system, it is always advisable to shift tubes until the best balance is secured. As in receiving sets and amplifiers some tubes work best as detectors while others work best as amplifiers. Similarly here, one tube may prove to be the most efficient oscillator while another may prove to be a good modulator, and so on. Vary the coupling between the power amplifiers and the master oscillator until maximum radiation is secured. Then vary the coupling between the output of the amplifier and the antenna until maximum radiation is secured. Alternate between these two adjustments until the best settings are reached. It is always advisable to have a plate ammeter in circuit so that adjustments may be secured which will give maximum radiation with minimum plate current, for we are after maximum efficiency also. Instead of using inductive coupling between the power amplifier and the master oscillator as in Fig. 4, conductive coupling may be employed. Inductive coupling is, however, preferable because it permits varying the coupling without having to stop oscillation enabling better adjustment.

**THE STANDARD WAVEMETERS OF THE BUREAU OF STANDARDS**

To serve as a standard of radio frequency, the Bureau of Standards has two especially constructed wavemeters covering the frequencies in more general use from 18 to 4,600 kilocycles per second (16,650 to 65 meters). These standard wavemeters are used in calibrating wavemeters belonging to the Radio Inspection Service, manufacturers, colleges or others in need of standards of frequency.

Each standard wavemeter consists of a variable air condenser of special design, four fixed mica condensers, a number of interchangeable inductors or coils, and a resonance indicating device. The majority

(Continued on page 1804)

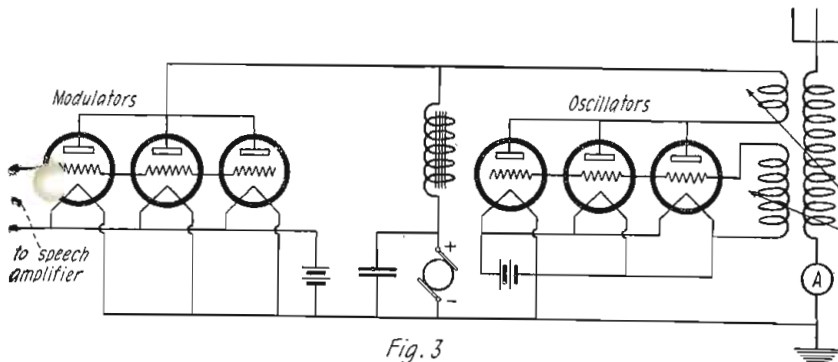

Fig. 3

A typical constant current circuit. The same number of oscillator and modulator tubes is necessary in order to efficiently modulate the output.



# C. W. and Radiophone Transmitters

By L. R. FELDER

PART VII.



Single or multi-tube oscillator systems that directly excite the antenna are slowly giving way to the Master oscillator system. This is a very important advance in C. W. transmission. Mr. Felder gives in this article valuable information on the master oscillator system



**I**N a series of articles on the above subject, which were published in RADIO NEWS, the principles underlying the design and construction of oscillating and modulation circuits were taken up and their application to the problem of radio telephone broadcasting systems was considered. In these articles a single oscillating circuit was assumed to be exciting the antenna. When such an oscillating system is applied to an antenna, the wave-length of the system is subject to considerable variation for any given adjustment of the circuit. This result is imminent since the antenna capacity is subject to variations on account of such disturbances as swaying of the antenna, differences in weather conditions and so on. This is the reason why, in receiving such C. W. stations, the setting on the receiver often requires a small change to keep it in resonance with the transmitted wave. This is, of course, a disadvantage.

A second disadvantage of such a system is that changes such as those described above may result in instability of oscillations, with the possibility of oscillations stopping entirely. Consider the circuit of Fig. 1. For a given antenna capacity and inductance we know that a certain coupling is required between plate and grid coils and antenna coil for maximum output. As soon as there is a change in any of the antenna constants it is necessary to make a corresponding change in the various couplings to secure maximum output. If this is not done, the output decreases, and if the change in antenna capacity becomes too great oscillations may stop abruptly until the couplings are properly adjusted. In other words, the antenna constants are so closely related to the oscillating requirements of the circuit that small changes make the circuit unstable. Antenna capacity changes are in general not great enough to completely stop oscillations, but they do decrease the output and render the circuit unstable.

For the above reasons, circuits which excite the antenna directly should be avoided if possible. Where one or two tubes, at most, are used, it is satisfactory to use the direct antenna excited circuit of Fig. 1. But where a number of tubes are used in parallel, the disadvantages of such a circuit increase,

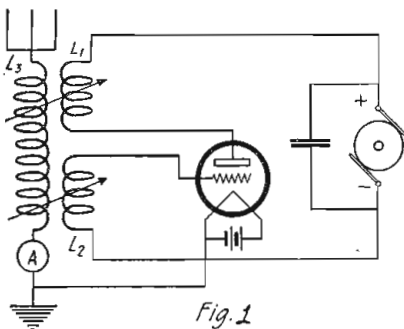

Fig. 1

A self excited Meissner oscillator circuit. A variation of the antenna capacity will materially affect the oscillator, consequently the wave-length.

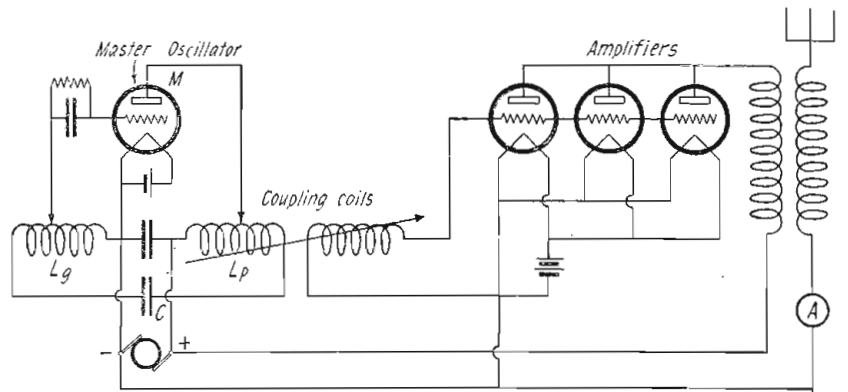

Fig. 2

Transmitting circuit employing a master oscillator for exciting three power amplifiers. A variation of antenna capacity will not affect the oscillation circuit.

and in this case a very efficient substitute may be found. The necessity for using a number of tubes in parallel often arises when it is desired to transmit at higher powers. The plate voltage which any given tube is able to sustain is limited, hence to increase power it is necessary to add tubes in parallel. Where 5-watt tubes are used as oscillators, it is necessary to use five tubes in parallel to secure a power of 25 watts. Suppose it is desired to transmit speech with such an oscillator. With the Heising system of modulation it is necessary that the power of the modulator tubes be at least equal to that of the oscillator tubes. Thus in the above case where 5-watt tubes are employed, and five are used in parallel, it will be essential to use a 25-watt modulator, which may be made up of five 5-watt tubes in parallel also. This makes the number of tubes employed excessive, and the set extremely bulky.

### THE MASTER OSCILLATOR SYSTEM

These disadvantages of the direct antenna excited oscillators and of multiple tube oscillators may be very efficiently overcome by the use of a system called the "master oscillator-amplifier" system. Fig. 2 illustrates the circuit employed in this method. We have a master oscillator tube M, to which is connected a complete oscillating circuit. The design of this circuit is similar in all details to those described in the first articles of the series, except that this oscillating circuit is not coupled or connected to the antenna. By means of the condenser C and the inductances  $L_g$  and  $L_p$  we can adjust the wave-length of the oscillating circuit. Between the coils is a by-pass condenser for the high frequency oscillations, thus affording protection to the generator. It should be about 1 mfd. Coupled to the plate coil  $L_p$  we have another coil which feeds the grids of four tubes in parallel. These four tubes act as high power radio frequency amplifiers. The master oscillator furnishes the power to excite the grids of the four tubes in parallel, and since the grid losses are generally very small a single master oscillator

is fully capable of supplying these losses in addition to its own. Thus by coupling to the master oscillator, we can excite the grids of a number of tubes in parallel. These tubes then act as radio frequency amplifiers and produce in the output or plate circuit the amplified radio frequency. By coupling the plate circuit of the amplifier to the antenna, this amplified output is fed into the antenna and radiated.

### ADVANTAGES OF MASTER OSCILLATOR

Let us now examine the advantages of such a system as against the system employing all five tubes as self-excited oscillators feeding into the antenna directly. In the latter case we saw that a great disadvantage arose due to wave-length variation when the capacity of the antenna altered. In the case of the master oscillator amplifier system, variations in the antenna capacity do not affect the radiated wave-length. This is determined solely by the wave-length of the master oscillator circuit which is invariable for any setting since its capacity and inductance are not affected by outside influences. This wave-length is impressed on the amplifiers which are untuned, and the amplified output is again impressed on the antenna which radiates it. No matter how the capacity of the antenna may change, due to swaying, sleet or other conditions, the same frequency is impressed on it and radiated.

For the same reason it will be apparent that instability of oscillations cannot arise. Since the oscillations are generated by the master oscillator, which has fixed constants, any variations in antenna capacity cannot alter the oscillation adjustments. No matter how the antenna capacity may vary, the oscillation circuit undergoes no variations, and no additional adjustments will be necessary as in the case of the self excited oscillators of Fig. 1.

### POWER OUTPUT

The question of power output in both these systems is an important one. In the case of the self-excited oscillator of Fig. 1,



# Simple C.W. Sets for the Novice

By L. W. HATRY, 5XU

A detailed description of four simple single-tube transmitting circuits that the novice can easily construct and operate. Mr. Hatry has eliminated all reference to the technical side of the subject, yet he has explained the necessary details in an elementary manner.

THE radio craze has brought into being a great mob of erstwhile BCL's who, having extracted all of the kick they could from the receiving end of the game, are now interested in getting gently introduced to the transmitting end, C.W. telegraphy. So enthusiastic are some of them that they have inserted a key in the ground lead of their single-circuit receivers and pounded the brass, thereby introducing some of their friends to the chirp-chirp end of radio without—and if you had heard some of the friends, you would know

phone of its "thing you talk into" and, Lo! you have a radiophone.

Just a few more forewords and then to business. It is decidedly advisable to have some sort of an antenna ammeter, because nothing else will be of much use to you. Obtain a meter with a  $\frac{1}{2}$ -ampere range and be sure it is for radio frequency amperes. Then the sets will be very simple to adjust. Four are described and each has only one variable element so that all you have to do is to hold down the key and vary the variable factor until the antenna current is at a maximum. After that, push the key to your heart's content. The antenna current will run from .1 to .2 amperes, depending on your local conditions, so you needn't be afraid that the meter will be of too low a range.

sary, so that the correct number of turns needed on L' would fit on the rotor without difficulty. Silk covered wire can also be used in these sets, as well as different sizes of wire than I have specified.

A variation of this set is shown in Fig. 3. L is the same as before with a 10-turn antenna coil tap. L' is only 20 turns wound on the same form, but in the opposite direction to L, and using a 23-plate variable cou-

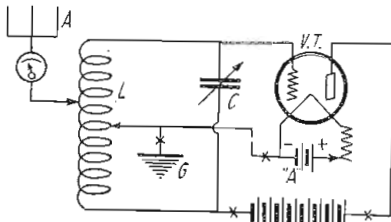

Fig. 1

The Hartley circuit is the most simple arrangement for the beginner. The key or microphone can be inserted at any of the points marked by a cross.

The first circuit I am giving is, I believe, the simplest, and it is justly popular among the more experienced amateurs throughout the country. It is known as the Hartley (see Fig. 1). L is a 45-turn coil of No. 18 D.C.C. wire, wound on a 3-inch diameter form and is tapped at the 15 and 25 turns from the grid end of the coil. The 15 turn tap is for the antenna. A, and the 25 for the filament center tap and the ground. This places 10 turns in the antenna circuit, 25 turns in the grid circuit, and 20 turns in the plate circuit. The variable condenser C can have 11, 23, or 43 plates, the lower capacities being preferable.

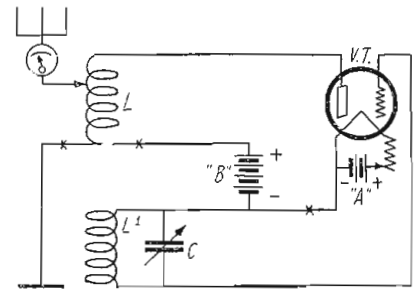

Fig. 3

Another form of the reversed feed-back circuit employing a variable condenser shunted across the tickler coil for the purpose of fine adjustment.

beyond dispute it was without—"benefit of clergy." Hence this article, which, if followed, will introduce you gently to C.W. and its idiosyncrasies. After you've tried it once, you won't care what it costs you thereafter.

The directions and dimensions included in this article are intended for the UV-201A vacuum tube with from 45 to 90 volts on the plate and normal filament current, mixed up with a feeling of doing something foolish, but anyhow—doing it. Other tubes can be used successfully, the table below showing why the UV-201A is the preferred tube for a cheap, low-powered set:

Tube	Filament Current	Output
UV201A—C301A	25 amp. Good	
UV-199—C-299	.06 amp. Very low	
UV-202—C-302	2.35 amp. Good	
VT1 (WE)	1 amp. Not quite good	
VT2	1.3 amp. Good	

In other words, tubes that give the same antenna output, approximately, require from four to eight times more the filament current required by the UV-201A. (Same output approximately at 90 volts on the plate.)

Also, the sets are designed for antennae the total length of which, from the far end and including lead-in and ground-lead, is not more than 140 feet. Excessive insulation is not necessary, but care, at least in construction, is necessary to see that the insulation really insulates and that all joints are actually connections.

All the diagrams used to illustrate this article you will find small x's at certain places in the circuits. These indicate where the key must be inserted (yet giving you an opportunity to pick and choose) so that telegraphy is possible. These enigmatic x's also indicate the various places where you can insert a microphone and thus converse directly with anyone whom you can browbeat into listening to you; for all that is necessary to have radio telephony with a simple set like one of these, is to rob the nearest tele-

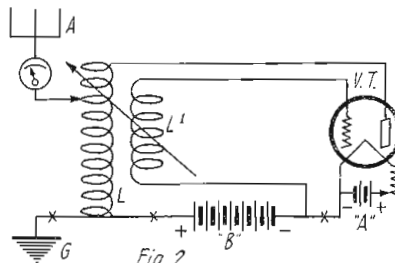

Fig. 2

Another simple transmitting circuit that the novice can use to advantage. This is known as the IDH or reversed feed-back circuit.

The vacuum tube and "A" battery are standard and the "B" battery voltage has already been mentioned. Of course, the condenser C is the variable element in this arrangement.

A second circuit that is very famous and popular is the well known IDH and is shown in Fig. 2; this is a sure-fire circuit. It is, as you no doubt have noticed, very similar to your single circuit receiver with the position of the coils reversed, so that its operation will, no doubt, be familiar to you. The antenna plate inductance L is of 30 turns of No. 18 D.C.C. wire wound on a 3 to 4-inch form and tapped at 10 turns from the ground end of the coil for the antenna. The tickler is of 35 turns of No. 22 D.C.C. wire wound on a length of the form that L is wound on, but with a slot of  $\frac{1}{2}$ -inch or more, so that when the wire is wound on it the edges come together, making a smaller diameter coil and one that will just slide inside of L giving you the variable factor, the coupling. The set of coils could also be wound on a standard variocoupler form and the size of the tickler wire reduced if neces-

denser, C, in shunt with it. This construction is simpler, and usually presents a neater job and works about the same.

The last circuit I'll give is the Meissner, which is a coupled set and one which should be much more popular than it is. This is shown in Fig. 4. The three coils are wound all on the same form with only sufficient spacing to make the job mechanically and electrically decent, for they must be coupled. L' is wound first and is 30 turns of No. 22 S.C.C. wire. L comes next, being the antenna coil, and is wound with No. 18 D.C.C. wire to the total of 10 turns. L'', the grid coil, is the last, and is wound with 25 turns of No. 22 S.C.C. wire and is shunted with the 23-plate variable condenser C, which provides the means of adjusting the circuit. In connecting the set, remember this: Assuming a current coming from the plate of the tube, it must travel in the same direction that a current coming from the antenna to ground would through its coil; whereas a current coming from the grid must travel in the

(Continued on page 1826)

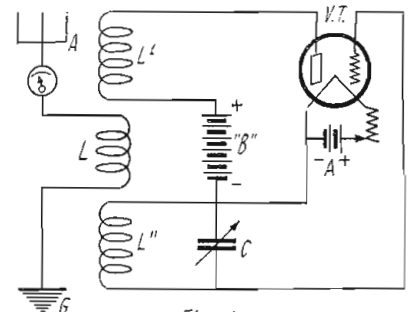

Fig. 4

The Meissner circuit, although a bit more complicated in construction than the others, is considerably easier to adjust.



# A Distortionless Resistance Amplifier

By CLYDE J. FITCH



*For distortionless amplification of broadcast programs, the resistance coupled audio frequency amplifier is supreme. Three stages are required to obtain sufficient amplification, but to the fan desirous of the best, this is no disadvantage.*

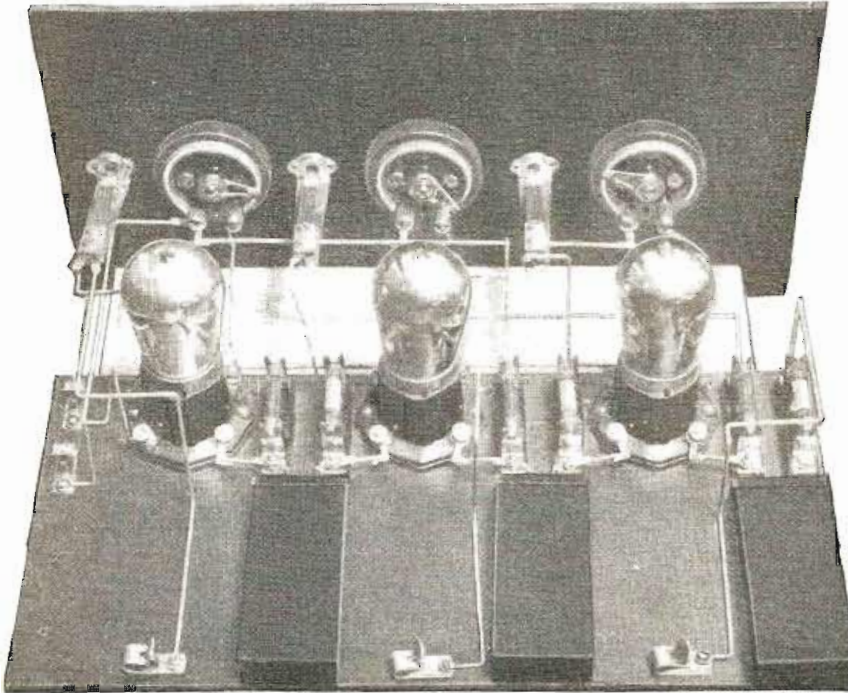

A rear view of the resistance coupled amplifier showing the exact location of each part. The condensers are seen mounted to the rear and the resistances between the tube sockets.

**D**ISTORTION is without doubt the greatest bugbear in modern radio receiving outfits. It is distortion that makes it difficult to understand the announcer and distortion that makes the music sound like noise and the noise sound like more noise. This, more than anything else, has discouraged many from purchasing expensive radio outfits. Therefore, in designing and building radio receiving sets, extreme care should be taken to eliminate as much of it as possible.

Distortion in the average radio receiver manifests itself in many different forms. The received waves are first distorted in the radio frequency amplifier, or, if none is present, they are distorted by regeneration in the detector circuit, when the set is adjusted very close to the oscillating point. This form may be eliminated by proper tuning. The rectifying action of the detector also causes more or less distortion. Crystal detectors apparently cause less distortion than vacuum tube detectors, although when properly adjusted the vacuum tube will give very clear reproduction. Next we have poor reproduction in the audio frequency amplifiers and loud speakers. Only distortion in the audio amplifiers will be taken up in detail in this article.

### TRANSFORMER COUPLED AMPLIFIERS

The usual transformer coupled audio frequency amplifier, although very efficient as an amplifier, is very poor when it comes to faithful amplification of the audio currents. The distortion that is present in the amplifier is not caused by the vacuum tubes, but by the transformers. The transformers do not operate uniformly over the entire speech and musical band of frequencies encountered in broadcast reception. The majority of

transformers now on the market are very inefficient on the lower frequencies, while the higher ones pass through with little difficulty. Rather than attempt to design a distortionless transformer, one might better make use of a different type of amplifier, an amplifier that uniformly amplifies all audio frequencies from zero extending up into the ultra-audio or radio frequency range. Such an amplifier is the resistance coupled amplifier. As far as amplification is concerned, this type is not as efficient as the transformer coupled amplifier; it takes three stages of resistance coupled amplification to do the work of two stages of transformer coupled amplification. This is the reason why manufacturers do not install resistance amplifiers in their sets. But why hesitate at the cost of an extra tube in an already expensive receiver when distortionless amplification is

guaranteed? Resistance coupled amplifiers are employed in the broadcast stations for amplifying the sounds from the studio. Why not use them in the receiving stations also?

The actual cost of a resistance coupled amplifier is very little more than that of a transformer coupled one. An extra tube is required, to be sure, but in place of the two expensive amplifying transformers, moderately priced resistances and condensers are all that are needed. In fact the first cost is about the same, the only additional expense being in the maintenance of the extra tube.

The illustrations show the simplicity of the resistance coupled amplifier. The unit shown is complete in itself, although this type of amplifier may be incorporated in a receiving set. Three tubes are used, with three filament rheostats to match the tubes employed. The circuit works well with both dry cell and storage battery tubes. Jacks are also provided for connecting the loud speaker or telephones into any of the stages.

In order to employ only one set of "B" batteries, grid blocking condensers are used for each tube. These condensers have a capacity of one microfarad each and are commonly known as telephone condensers. They are made up of long strips of tinfoil and waxed paper, about 4 inches wide, tightly rolled up and sealed in a metal case. It is not advisable to attempt to construct them by hand on account of the large amount of tinfoil and waxed paper required.

With the use of grid condensers, grid leaks are usually necessary. The grid leaks,  $R_1$ , should have a resistance of one to five megohms. After building the amplifier, several sizes should be tried, as most grid leaks vary considerably from their rated values and in some cases grid leaks will not be necessary. The negative charges that accumulate on the grids, due to the rectifying action of the tubes, in this case, leak off through the condensers, through the tubes or through poor insulation in the tube sockets and connections.

The most important and critical parts of the resistance coupled amplifier are the resistances  $R$ . For maximum efficiency, these should be equal to about three times the average plate to filament resistances of the vacuum tubes. For the average amplifier

(Continued on page 1804)

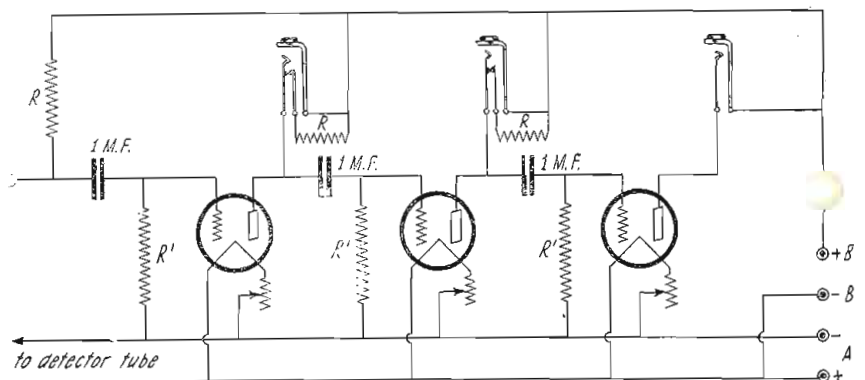

The circuit diagram of the resistance coupled amplifier. The large fixed condensers prevent the high "B" battery voltage from being impressed on the grids of the vacuum tubes.



# The Transmitter at KFGD

By JOHN M. BALDWIN

A description of the master oscillator and power amplifier system employed in the circuit of the transmitter at KFGD, Chickasha, Oklahoma. Detailed information is given for those who might care to build a similar outfit for C.W. or phone work

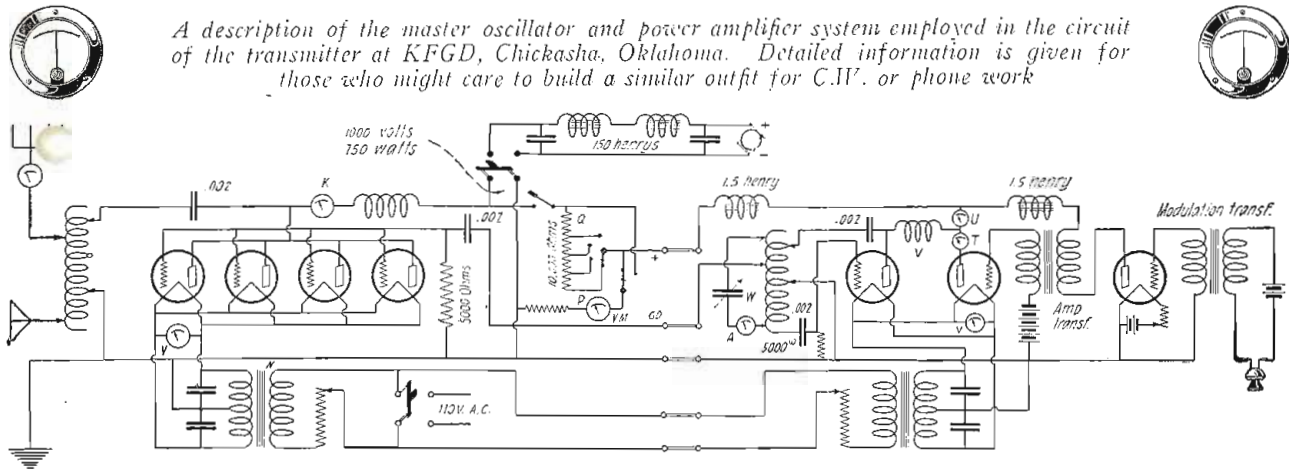

The circuit diagram of the transmitter at KFGD. From right to left the tubes are: speech amplifier, modulator, master oscillator and the four power amplifiers. The parts are K—0-750 milliammeter. V—0-15 voltmeter. N—300-watt filament transformer. O—30-turn coil. P—0-1000 voltmeter. Q—Two 5,000-ohm grid leaks. A—0-2.5 hot wire ammeter. T—0-100 milliammeter. U—0-250 milliammeter. W—.001 variable condenser. Aerial ammeter 0-8 T.C. ammeter.

THE accompanying diagrams comprise the hook-up of the transmitter at station KFGD, which has been in use since the middle of November, 1923. It has given exceptional results, and is being described in these columns for the benefit of anyone who contemplates building an up-to-date transmitter.

In making the plans for the transmitter, the writer had to choose between several different types, with the result that the standard Hartley-Heising was rejected as requiring too many tubes, and all of the common self-excited oscillators were found subject to variation in frequency by changes in the constants of the antenna systems caused by swinging and moving objects in electrostatic field. So after consideration of several other types, the master oscillator was selected as being most suitable for broadcasting purposes, although little information as to its characteristics was available. Considerable experimentation was necessary before a workable combination was evolved, but the set was finally constructed, and after some few modifications, completely fulfilled all expectations.

Continuous use for about 90 days demonstrated the following:

## TUNING THE TRANSMITTER

Contrary to general opinion, the set is easily tuned. The output frequency is absolutely steady and no matter how badly the antenna may swing in the wind, it remains steady. Contrary to general opinion, two 5-watters, one used as oscillator and one as modulator, were of sufficient power to completely control the output of four 50-watt tubes, working at 10 per cent underload.

Modulation pronounced from good to exceptionally good by listeners-in in all parts of the country, thus proving that the five-watt modulator is on the job, and big enough for this work. A considerable saving in construction cost was effected.

The master oscillator could be controlled by key in such a way as to successfully transmit C. W. telegraphy so that oscillations in the amplifier could be readily started and stopped, without any harmful results to the tubes.

Its general characteristics were such as to make it a highly desirable circuit for use in amateur stations, as it emits a perfectly steady unvarying C. W. signal.

The diagram is practically self-explanatory, and as standard apparatus was used

throughout, there should be no difficulty in construction.

Contrary to the generally accepted notion that the master oscillator circuit is hard to tune, the above described set was tuned without much difficulty, although it took a little more time and patience than is required for tuning the common self-excited hook-ups.

The main requirement in tuning is to adjust the oscillation constant of both oscillator and amplifier to exactly the same frequency, for if they are not in exact resonance, the amplifier tubes will run hot, and radiation will be practically nil. In tuning the output circuit, the correct amount of inductance to use, can be determined only by cut and try methods. There are several ways of adjusting for a specified wave-length, but the following is perhaps the simplest. An arbitrary amount of inductance is selected and the clips placed, approximately as indicated in the diagram. The master oscillator inductance was clipped in the center, for the neutral or nodal point, and the plate and grid clips set 13 and 1, turns respectively on either side of the ground clip. Then the two clips which connected to the artificial antenna, or dummy system, which consisted of a variable capacity and a radiation ammeter, were placed seven turns on either side of the ground clip, making the connections as shown on the diagram. Then the grid tap to the amplifier tubes was set arbitrarily—in this case between the plate and dummy clip.

The master oscillator was then started and wave-length readings were taken to ascertain the maximum and minimum waves over which the circuit would oscillate. Various values of capacity were used at W, and readings taken: the maximum wave was 440 meters, and as the minimum wave to which the wave-meter would respond was 180 meters, it was impossible to obtain the minimum range of the oscillator. It, however, oscillated readily down to 180 meters. From this, it appeared that the clips were set about right, as the highest readings of current in the dummy circuit were obtained between 200 and 300 meters. It was unnecessary to vary the position of the plate and grid taps, as the frequency was varied. The best position for the amplifier grid clip was also obtained by a cut and try method, although it is not difficult to find, as the most efficient place is indicated by a very noticeable increase of antenna current.

After all the clips had been placed on the master oscillator, and the plate, counterpoise, antenna and ground clips adjusted approximately on the output circuit, the amplifier and oscillator tubes were lighted and the plate voltage applied. The first result was, it appeared, that four "fifties" were in immediate danger of extinction; the plates were white hot, and the generator indicated that an excessive overload was being applied. But by the immediate varying of the condenser W in the dummy circuit, a point was found where the antenna current began to look respectable, and the tubes looked more like business, exchanging their white hot appearance for a cherry red. A wave-length reading was then taken, with the result that the wave, as can be expected, was considerably off that required, in our case 248 meters. In case the resulting wave is in excess of the allotted one, less amounts of inductance should be used in the output circuit; if the wave is too low, more inductance should be used. A few such trials should, and did in our case, suffice to bring the transmitter down to the required wave-length, and the amplifier grid tap was adjusted by fractions of a turn until the maximum antenna current was obtained.

## SOME NOTES ON THE TUNING

In conclusion, I wish to again emphasize the fact that one 5-watter can completely excite four 50-watt amplifier tubes, and that by modulating the five-watt master oscillator, the modulated wave applied to the grids of the amplifiers will, in turn, cause them to emit a wave of the same per cent modulation as obtained with the 5-watter. However, it will be necessary to use considerable speech amplification before applying the microphone output to the grid of the modulator tube.

If the oscillator and amplifier are not tuned to exact resonance, a disagreeable growl, strongly suggestive of motor hum, will be emitted. This growl is caused by the interaction of the two frequencies, which produces an audible beat note. It can only be eliminated by extremely careful tuning. In the final adjustments, the inductance should be varied by fractions of a turn, and especially in the case of the antenna and counterpoise clips in the output circuit. Arrange the power wiring so that the plate voltage is applied to the oscillator first, and then to the amplifiers. In our case, the plate voltage is 1,000 normal, and a 10,000-ohm

(Continued on page 1828)





Vincent Lopez and his Hotel Pennsylvania Orchestra

# From one who knows

VINCENT LOPEZ praises and endorses the rich, clear, natural quality of MUSIC MASTER reproduction. His Hotel Pennsylvania Orchestra is heard over the radio by untold thousands.

Even the most delicate and fugitive impulses from distant stations are caught by the precision instrument of MUSIC MASTER hidden in the art metal base. These impulses are developed into full, natural tones, free from blast and distortion, in the tapered tone chamber of heavy cast aluminum—which also imparts a quality of brilliancy to the reproduction.

MUSIC MASTER is an enduring musical instrument. Hear it and see it at your dealer's, or have him send one to be tried and proved with your own set.

Dealers Everywhere

## Music Master Corporation

(Formerly General Radio Corporation)

Makers and Distributors of High-Grade Radio Apparatus  
S. W. Cor. 10th and Cherry Streets

Chicago PHILADELPHIA Pittsburgh

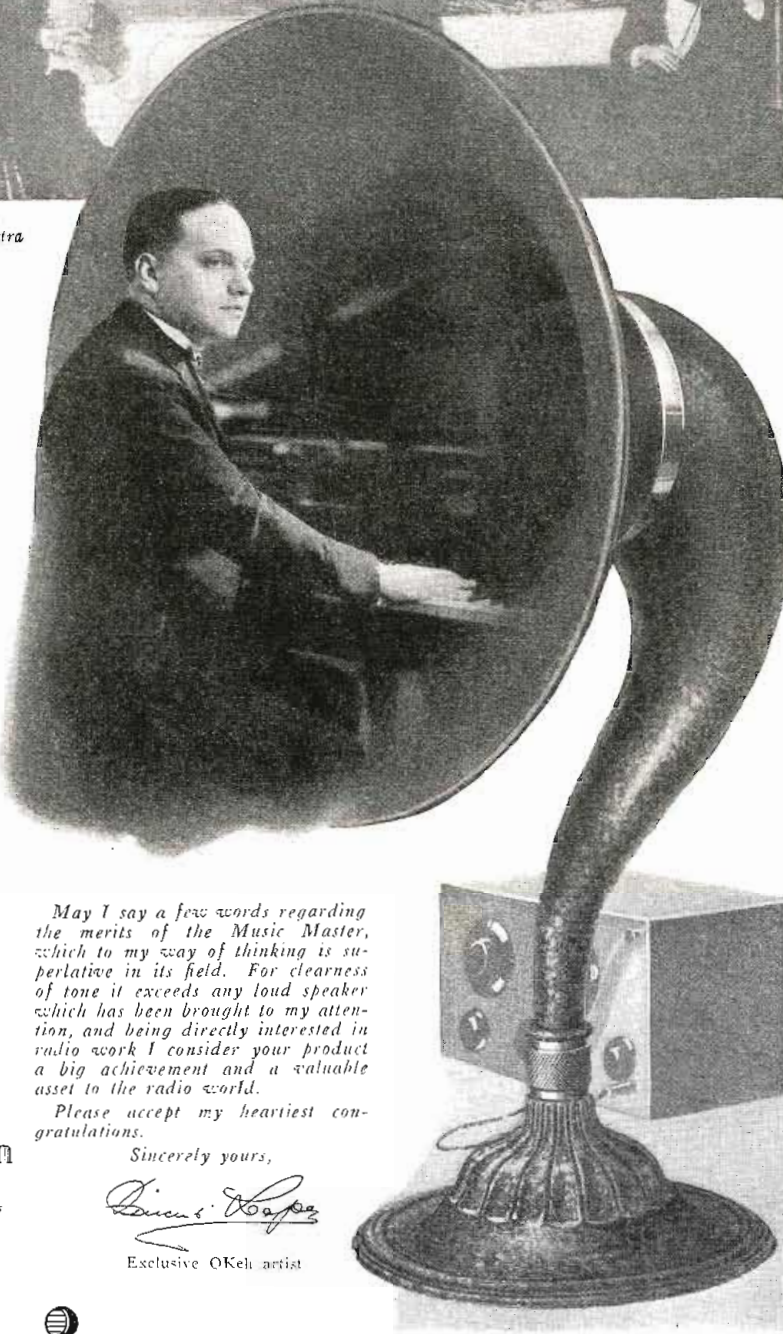

May I say a few words regarding the merits of the Music Master, which to my way of thinking is superlative in its field. For clearness of tone it exceeds any loud speaker which has been brought to my attention, and being directly interested in radio work I consider your product a big achievement and a valuable asset to the radio world.

Please accept my heartiest congratulations.

Sincerely yours,

Exclusive OKeh artist

# Music Master

RADIO REPRODUCER

Connect Music Master in place of headphones. No batteries required. No adjustments.

14-inch Model, for \$30 the Home

21-inch Model, for \$35 Concerts and Dancing



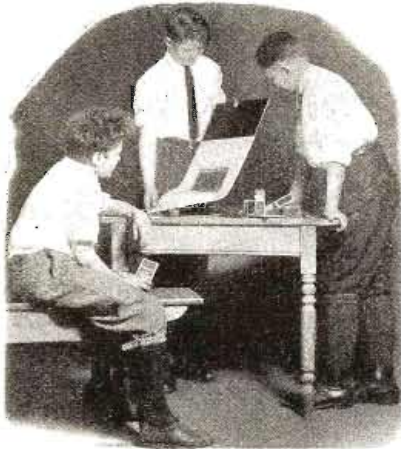

## Performance plus Beauty

Choose your panel for its insulating value as well as for its appearance.

### MAHOGANITE Radion Panels

give you both the supreme insulation and the beauty of polished mahogany. For Mahoganite is not a surface finish but a material which extends from one side of the panel to the other.

#### 21 Stock Sizes

Mahoganite and Black

6 x 7	7 x 14	8 x 26
6 x 10 1/2	7 x 18	9 x 14
6 x 14	7 x 21	10 x 12
6 x 21	7 x 24	12 x 14
7 x 9	7 x 26	12 x 21
7 x 10	7 x 30	14 x 18
7 x 12	7 x 48	20 x 24



Look for this stamp on every genuine Radion Panel. Beware of substitutes and imitations.



# RADION

The Supreme Insulation

## PANELS

Dials, Sockets, Knobs and Insulators  
At All Good Radio Shops  
or write to

American Hard Rubber Co.

11 Mercer St.

New York

western medical authorities who have studied radiotherapy and principles of electricity. Concerning cancer therapy a few inherited traditions must be disposed of. Obviously, the accumulation of cells called cancer, or sarcoma, are subject to the same biophysiological laws as any other cells. So far as the human body is concerned there must be certain stimulating forces, self regulative forces. When these are interfered with, certain parts of the body will show giant growth because of disbalance of equilibrium between stimulating forces and regulative forces. This is uttered as a warning to those who tamper with high frequency currents.

The strongest indictment yet uttered against the wave of radio cures, so called, and against quack doctors using such apparatus, comes from a leading Chicago scientist who claims that the small percentage of cures effected by X-Rays, or the short wave, by skilled practitioners, shows that results are obtained only because the energy obtained is transformed into heat, that the cathode rays produce heat, and these short waves, or rays now known to science are the X-Rays. They must have a tremendous voltage to go through the tube, sometimes as high as 200,000 volts. These rays are of extremely short vibration. The application of high frequency current is not a direct electrical phenomena. It is simply using heat. Diathermy is not an electrical application, for heat is produced by the electric current, thus eliminating all the physiological effects of electricity.

For application in a medical way it may be said that X-Rays have but one characteristic, namely, to penetrate all substances which light cannot do. This impetus of electrons may produce various kinds of waves. Some ether waves are one mile or one and one-half miles long. These are called the Hertzian waves used in wireless telegraphy and radio. They are the longest ether waves known. Shorter waves are used for other purposes and the shortest rays known are those used for the X-Rays. The shorter the vibration of X-Rays the greater is the penetrating power. The development of this vibration depends upon original impetus. For therapeutic purposes the X-Rays are used because they are very short. In order to produce the X-Rays of very short oscillation, a tremendous velocity of the original electrons is necessary because a tremendous voltage must go through the tube.

Since the subject has been discussed by national scientific journals, radio doctors and vendors of radio cure equipment have become chary of interviewers and prominent medical authorities are reported to be conducting a quiet investigation of the activities of the new crop of radio doctors in the Middle West.

### Hints on Receiving Sets

(Continued from page 1750)

be abandoned for two reasons. First, at very high frequencies such as those employed in broadcasting, the radio frequency resistance due to skin effect is so great that even the employment of special wires does not reduce it very much. It is just as well to use simple solid wire which is very easily obtainable. Second, the use of special Litz wire introduces the possibility of increased resistance, for it consists of a large number of very fine wires stranded together, these wires having enamel insulation on them. In order that the Litz wire be used to advantage, it is necessary to use all these strands unbroken; if one or a number are not used, the resistance goes up, which may very easily

## IMPROVED AND PRACTICAL SUPER-HETERODYNE

"The Rolls Royce of Radio"

The improvement worked out by our Chief Radio Engineer and his staff has definitely established the superiority of our Super-Heterodyne because:

1. It is easy to control.
2. It has only two dials for tuning (which can be calibrated).
3. It employs a tuned intermediate wave amplifier—so
4. It is more selective and more sensitive than other S.H. sets.
5. No potentiometer is used, thereby eliminating a very critical control. Moreover,
6. Balancing of tubes is entirely unnecessary, and
7. Filament control is not at all critical.
8. Regeneration and oscillation on intermediate wave amplifier is controlled by a small feed back condenser that can be permanently set at most sensitive point.
9. Tuned plate system at the first tube gives additional Short Wave Radio Frequency Amplification.
10. Any regenerative or Radio Frequency tuner may be used with the oscillator and intermediate wave amplifier.

A complete description of this improved circuit appeared in the New York Evening Mail Radio Magazine of January 19, 1924. A copy of this editorial will be sent FREE on request.

### This Famous 8-Tube Set

built in a beautiful piano finish solid mahogany cabinet. Unconditionally guaranteed for one year. . . . . \$150

All parts for this

### 8-Tube Set

Every part needed is included and Each part is absolutely guaranteed. \$75

When ordering by Mail Include Postage with Order

Atlantic & Pacific Radio Co.  
223 West 34th St., New York City

## Morrison



Loud Speaker

## YOU CAN RELY ON MORRISON

for a true reproduction of all broadcasting at all times.

Simply turn the little dial to find suitable volume.

Many of America's most critical fans tell us Morrison has no equal as a fine loud speaking unit. It is for that reason we can afford to sell Morrison on a money-back guarantee.

\$10.00

Complete With Five Foot Cord

Order from your dealer or direct from factory.

Let us send you a beautiful color catalog.

DEALERS

You can sell Morrison the year 'round. Ask for our merchandising plan.

MORRISON LABORATORIES, INC.  
339 East Jefferson Ave., Detroit, Mich.

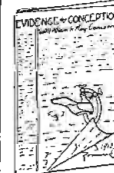

## PATENTS

DON'T LOSE YOUR RIGHTS  
Before disclosing your invention to anyone send for blank form "EVIDENCE OF CONCEPTION" to be signed and witnessed. Form and information concerning patents free.  
LANCASTER & ALLWINE  
270 O'Quay Bldg., Washington, D. C.  
Originators of the form "Evidence of Conception"



# “Leave Those Dials Alone You’re Spoiling the Music”

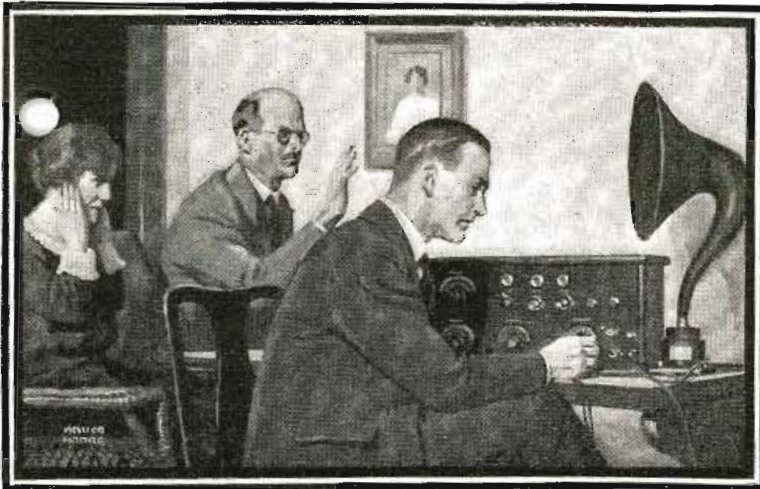

“For goodness, sake, leave those dials alone. You’re spoiling the music.”

Doesn’t it just make you boil over to have this said to you, just when you are struggling your hardest to give the family a good concert?

Willard Rechargeable B Batteries will help you hold those out-of-town stations without constant retuning.

It’s no reflection on your skill as an operator that you find it difficult to tune when your B Battery current is shaky.

To get the real benefit out of the finer adjustments on your set you need Willard B’s.

Just hook up with them once and listen to the difference.

And a block of Willard B’s is the sweetest thing you can have when it comes to maintenance. Just snap on the little Willard Colloid Rectifier when you want to re-charge.

If kept charged they will work at top efficiency four or five years.

That makes them mighty inexpensive batteries to own.

WILLARD STORAGE BATTERY COMPANY, CLEVELAND, OHIO  
In Canada, Willard Storage Battery Company of Canada, Limited, Toronto



Willard B Batteries

Willard Rechargeable B Batteries are made in two types, one of 2,500 m. a. h. the other of 4,500 m. a. h. capacity. Each of these types can be purchased in 24 or 45 volt units. Glass jars enable you to see the condition of your battery at all times and help prevent electrical leakage.



Willard A Batteries

Good A Batteries are as important as good B Batteries. There are several types of Willard A Batteries in a range of prices, including the Willard All-Rubber A Battery, with rubber case and Threaded-Rubber Insulation. Sizes up to 150 a. h.



The Willard Dealer will be glad to give you a copy of the interesting booklet, “Better Results from Radio”; or send direct to Willard Storage Battery Company, Cleveland, O.

# Willard

## Rechargeable Batteries for

# Radio





# YOU CAN LEARN NEWSPAPER WORK

**Experienced Editor Will Teach You  
How to Become a  
Reporter**

**FASCINATING WORK--GOOD PAY**

**Only a Few Months' Work Required  
To Qualify You for a  
Better Position**

Regular reporters earn from \$40 to \$125 a week. Good deskmen on a daily paper are paid from \$60 to \$100 a week. A "Star" Reporter can command his own salary. Hundreds of ambitious men and women enhance their income materially by corresponding for newspapers or writing for magazines in their spare time.

### We Will Teach You at Home

We can develop your talent for writing and lead you into this well paying profession. Our Practical Course in Journalism was personally prepared by Henry J. Brockmeyer, Assistant City Editor of the New York Evening Post. Mr. Brockmeyer has trained hundreds of men and women, many of whom have, under his guidance, developed into front rank reporters or feature writers.

Mr. Brockmeyer's course will teach you what it would take years of actual newspaper work to learn. It consists of six comprehensive lessons just brimful of everything a reporter must learn. The following are only a few of the subjects covered.

Starting in Journalism. What is a Newspaper? What is News? Start and Finish of a News Story. Technical Terms. The Type Point System. Styles of Type, Proof Reading. Capitalization and Punctuation. A Late Fire Bulletin. Court Stories. Libel Laws, Copyright. Hints to Reporters. Personal Conduct. Re-Writing and Condensing Stories. Paragraphs and Short Items. Good and Bad Styles. Broadening the Vocabulary. Aids to Good Style. Special Stories. Suggestions for Stories. Rhetoric. Preparing Your Story. Don'ts for Writers. Office Organization. Syndicated Matter. Business Office. Mechanical Department. Hints for Headline Writers. The Make-Up. The Country Correspondent, etc., etc.

### Use Coupon—Save 50%

Although the price for the entire course is \$10, entitling the student to full consulting services directed by Mr. Brockmeyer personally, we will accept enrollments, if the coupon below is used before July 20, at \$5—exactly half price.

### Five Days' Trial

Just pin a check, money order or five dollar bill to the coupon below and mail. Then take five days after the course arrives to decide whether you want to keep it. If not, return it at our expense and your money will be immediately refunded.

THE PRESS GUILD, Inc., 66-R West Broadway, N. Y.

THE PRESS GUILD, Inc. (Expires July 20, 1924)  
66-R West Broadway, New York City.

Enclosed find \$5 for which you are to ship me at once, prepaid, Henry J. Brockmeyer's complete course in Practical Journalism with the distinct understanding that if I return the course in five days my full \$5 will be refunded and no questions asked.

(Name) .....

(Address) .....

(City) .....

happen. When soldering the wire, it is necessary to remove the enamel from each individual wire, otherwise the latter will be insulated from each other. If the enamel is off all but a few, the resistance of the wire goes up. If some of the strands are broken, which is very likely to happen since they are so small, the resistance again goes up. In other words, Litz is very difficult to work with; so it is best to stick to the readily obtainable, simple and easily worked solid wire.

### CONDENSER DETAILS

The next logical part of the receiving set to consider is the condenser. Not much need be said here about the construction of it, however, as this subject was covered in detail in the March, 1924, issue of RADIO NEWS in an article on "Modern Radio Apparatus: Condensers." But a word should

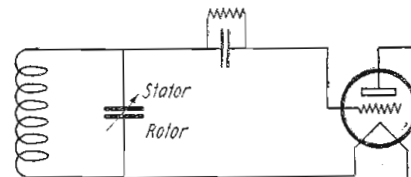

Fig. 1

Always connect the rotor plates of the variable condenser to the filament. This eliminates body capacity effects.

be said about the method of using condensers and connecting them in receivers. A condenser has a rotor and a stator. The rotor is connected to the handle which is turned by the operator; the body of the operator is thus capacitively coupled to the condenser. The rotor plates should under no circumstances be connected to the grid or the vacuum tube, for the capacity of the body when tuning will affect the grid and give different tuning. Thus, if the rotor is connected to the grid, the signals may decrease when your hand approaches for tuning the condenser, and they may increase when the hand is removed, which makes tuning difficult. By connecting the rotor plates to ground or filament, this is avoided. Stator plates, for best results, should be connected to the grid as in Fig. 1.

When connecting a condenser to the input side of the detector tube, namely to the grid, through a grid condenser and leak, care should be taken to connect the return circuit

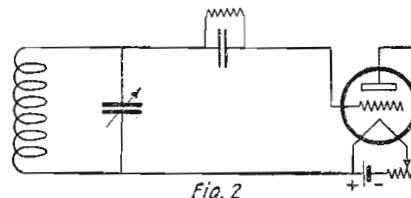

Fig. 2

Always connect the grid return circuit of the detector tube to the positive leg of the filament. This insures maximum detector sensitivity.

to the positive leg of the filament, not to the negative. A detector tube with grid condenser and leak is much more sensitive this way, because its action depends upon the grid being given a small positive potential, which may easily be secured by connecting in the manner described and shown in Fig. 2. On the other hand, the return circuit of both radio and audio frequency amplifiers should always be connected to the negative leg of the filament.

### GRID BIAS ON AMPLIFIERS

One of the most frequent mistakes in the construction of sets (unfortunately even some commercial sets have it) is the omission of a grid bias or "C" battery on the



### SIMPLE SIMON

A new regenerative tuner using no switches and only one control. Three thousand miles has been conservative range during winter. This set works on a loop up to hundreds of miles, or with a ground wire only, without either aerial or loop. Just the thing to stop re-radiation. Priced at \$15.00. Add P.P. on 9 pounds. SS tuner with one-step amplifier... \$15.50 This set works with any "B" battery.

### 3000 MILE RADIO TRESCO TYPE X REGENERATIVE RECEIVER



Licensed under Armstrong U. S. Patent No. 1113119. For resale in amateurs only. Thrifty customers report receiving Scotland during Radio Week. A complete 3,000-mile Armstrong Regenerative tuner for \$25. Use it with any make bulb WD11 or 12, or any battery operation as well as storage battery. Complete with bulb, batteries, phones, etc. . . . \$37.50 Circular for 2 cents. This set received "Chicago American" Regional prize of \$500.

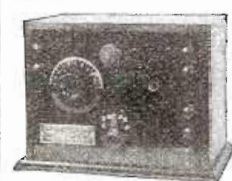

### 500 to 1000 MILE Regenerative Tuner

Two controls at \$12.50 only. Add P.P. on 9 pounds. This set is portable and uses any type tube.

Send Stamp for Circular

TRESCO, DAVENPORT, IOWA

# SAMSON TUBES

**\$3.50** buys a good  
201-A Type Tube

Specialists make the SAMSON TUBE, using the most up-to-date mechanical and scientific devices known together with the greatest care and years of manufacturing experience.

**Mail Orders Promptly Filled,  
with Money Back Guarantee**  
Dealers' and Jobbers' Trade Solicited

### PHOENIX TUBE CO.

23 E. 26th St. New York City

### UNITY VERNIER RHEOSTAT



The Highest Type  
Instrument Made  
Any Resistance \$2.00  
"Hear a Set  
That Uses One"

### ELIMINATE THE NOISES IN YOUR SET

The book "TUBE CONTROL," written for the amateur, and for the benefit of Radio Reception, by J. Elliott Jenkins, Engineer of Broadcasting Station W. D. A. P. will tell you how to clear up your signals.

Every set owner should have this book.

10c at your dealers, or 14c postage to  
UNITY MFG. CO., 224 N. Halsted St., Chicago



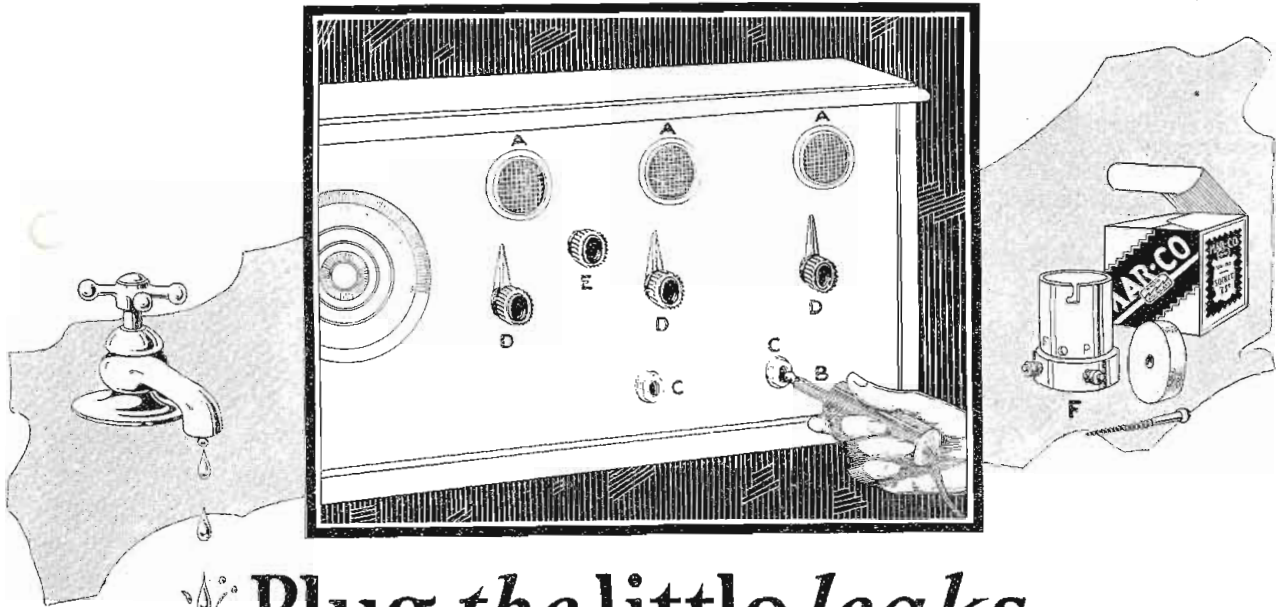

## Plug the little leaks and save the DX stations

**Y**OU EXPERIMENT with circuits . . . you study the design of your transformers . . . you select your tuning instruments with care . . . you keep your batteries fresh . . . and still you just miss DX stations you particularly want to get!

Why do you miss them? Why must others, using the same circuit, continue to make records you can't equal?

Is it because there are unexpected leaks in your equipment? Are some of the smaller parts—the "little things" you don't pay much attention to—are they draining energy away?

Why man, there's not the slightest little switch, the most unimportant little accessory, that doesn't influ-

ence your results. Every place where there's a connection offers radio energy a chance to escape. And every small part offers you an opportunity to make your results better . . . to make your DX list longer!

MAR-CO small parts will help you—if you'll use them wherever you can—and insist on getting MAR-CO when you buy. Skilled craftsmen make MAR-CO small parts . . . and they make them with the precision of scientific instruments. They make them to stop the little energy leaks . . . to add miles to your range.

It will cost you no more, frequently less, to say MAR-CO—and you'll know you're getting leak-proof service!

# MAR-CO

PLUGS · JACKS · RHEOSTATS · SOCKETS



SWITCHES · NEUTRALIZING CONDENSERS

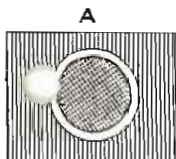

Nothing adds the professional touch to the home-made set like the striking beauty of MAR-CO gold-plated bezels 35 cents. Black finish 25 cents. Nickel 20 cents.

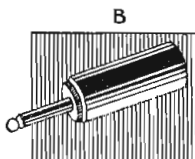

Its name sums up MAR-CO SHUR-GRIP plug. No tools needed to change tips instantly—to make leak-proof connections permanently. In flashing black and nickel for 75 cents.

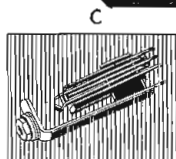

Eliminate short circuits with MAR-CO SHUR-GRIP jack. Formica insulation, arcing silver contacts, hooked terminals for quick, leak-proof connections—60 cents to \$1.00 and well worth it.

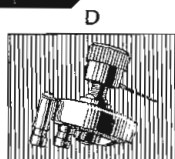

Filament control must be not only critical, but steady! And it is—when you use compact MAR-CO ARMOR CLIP 30 ohm rheostats—a big one dollar's worth.

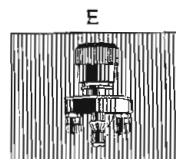

Snap—and all is silent! Snap again—and reception continues instantly. Make your set convenient—tonight—with a MAR-CO filament battery switch, only 30 cents at your dealers.

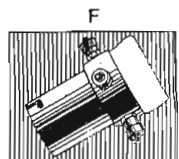

MAR-CO U.V. 199 sockets, with pressure contacts, with Bakelite base, with single mounting screw and heavy felt cushion supplied—give REAL tube protection for 75 cents.



# Radio Fans GET THIS!

- new efficiency
- greater distance
- better selectivity
- finer tone quality

—on YOUR set NOW!

with the new

## TERLEE VARIO COUPLERS

By a special new winding and better insulation, they reduce all losses of energy formerly found in vario couplers. There are no dead end losses on taps not in use. They have low dielectric, low distributed capacity and a consequent increase in selectivity and range. No varnish and cement are used for coil insulation. Terlee's are arranged for either panel or table mounting.

If you want better all 'round results, use a Terlee Vario Coupler—Type "S" for crystal or audion circuits—Type "R" for radio frequency regenerative or non-regenerative circuits. Type "S," \$6.00; Type "R," \$7.50.

### Ins-ur-ize

Your Tubes With A  
TERLEE

### INS-UR-TUBE

Absolutely prevents accidental burning out of expensive hard-to-get tubes. Red label for storage battery tube. Green label for battery or peanut tubes. Price \$1.00 and worth a lot more.

If you want the best results, remember that there are no real substitutes for Terlee Products. If your dealer cannot supply you, write to us.

## Terlee Electric & Mfg. Co.

Dept. A-6, 443 S. Dearborn Street  
Chicago, Ill.

"Makers of Radio's Best for Better Radio Results"

## MARLE TRANSFORMERS The Heart of a Good Receiver

Uniform amplification all frequencies up to as many as 3,500 cycles without distortion or howl!

Speak to Your Dealer about

Marle Transformers

Marle Engineering Co.

Orange

New Jersey

## INVENTORS

who derive largest profits know and heed certain simple but vital facts before applying for Patents. Our book *Patent-Sense* gives those facts; sent free. Write **LACEY & LACEY**, 631 F St., Washington, D. C. Established 1869.

amplifier tubes. Amplifier tubes generally are worked with over 90 volts on the plate. When a tube is worked with more than 50 volts on the plate, it should have connected in the grid circuit a negative potential. This is important for three reasons: First, it prevents grid currents from flowing and thus decreases the losses which otherwise occur. In the second place, by using a suitable negative potential on the grid, the tube is worked on the straight portion of its characteristic curve, which results in maximum amplification. Without this suitable bias less than maximum amplification is secured. In the third place, and perhaps the most important as far as broadcast reception goes, the grid bias helps secure best quality of speech and music. Without a grid bias we have grid currents which result in distorting the received speech and music. If most of the available commercial sets which give poor quality speech and music are examined, it will be found that nine times out of ten there is no grid bias battery. This is a fundamental principle of amplifier construction which all builders of their own sets should remember: No bias battery means poor quality. The best value of grid bias to use depends upon the type of tube and the plate voltage. The higher the plate voltage the greater should be the bias. Adjust the grid bias until speech and music reception is best. For UV-201A tubes, a grid bias of 4½ volts should be used with 90 to 100 volts on the plate. If over 100 volts is used, this should be increased to about 7 to 9 volts negative. For UV-199 tubes, plate voltages higher than 80 or 90 should not be used and for these voltages the grid bias should be 4½ volts.

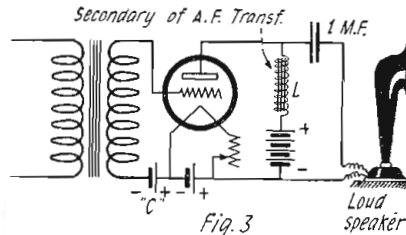

The proper way to connect a loud speaker to the last amplifier tube to secure best quality of speech and music.

### CONNECTING THE LOUD SPEAKER

As implied above, in broadcast reception the listener is most interested in good quality. When he listens to a stringed orchestra he wants to hear a stringed orchestra and not a jumble of sounds which are like music, but still are not music. There are numerous places in the receiver where the quality of the received speech or music may be destroyed. One of these was mentioned above, namely lack of bias battery. Another and equally important place is in the loud speaker. Best service is derived from a loud speaker when nothing but alternating currents flow through it. The instant direct current passes into it, distortions make their appearance, since the direct current tends to demagnetize the windings when the loud speaker is not connected properly in circuit. Although rules are given for connecting the loud speaker properly, they are not always followed. Also the presence of the direct current saturates the magnets and thus produces distortion. The easiest way out of this morass is to connect it so that direct current cannot flow through it. This means the use of two additional pieces of apparatus, but the results are well worth it since through their use the loud speaker magnets will never be injured, and the quality of the loud speaker will be at its best. This method of connection is shown in Fig. 3. L is a very high inductance, and C is a 1 mfd. condenser. The condenser prevents direct cur-



## O'NEIL AUDIPHONE

Years ahead of the average loud speaker. The long experienced of phonograph perfection has been brought to radio reproduction by phonograph craftsmen and radio acoustic engineers. The AUDIPHONE production challenges comparison with the original of the broadcasting program. All of the music and speech re-vivified by the "laminated voice core." Adjustable from the exterior. Your money refunded, unless the Audiphone satisfies you. Nothing could be fairer. At your dealers or direct, if you mention his name.

No extra batteries needed  
Complete, with connecting cord

ART MODEL  
Beautiful Antique Bronze  
Finish

**\$30**

14 Inch Horn \$5 Additional

Write for literature

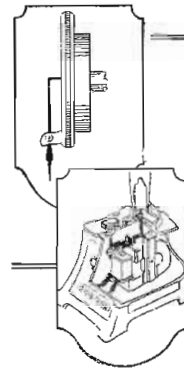

Note the similarity of construction between the phonograph reproducer (illustrated in the upper panel) and the reproducer of the O'Neil AUDIPHONE (below); both have a mica diaphragm set in a sound-chamber actuated by an elbow stylus bar.

O'Neil  
Mfg. Co.

719 Palisade Avenue  
West New York, New Jersey

## SURE-FIRE D-X CRYSTAL

**THE MARVEL OF ALL SYNTHETIC CRYSTALS**

Extraordinarily supersensitive all over. Ideal Reflex circuits. Tested, sealed, guaranteed. Dorsed by N. Y. Mail and Tribune.

50c. Mtd. at all dealers or sent postpaid.

Specialty Service Co., 9 Hanson Pl., Bklyn, N. Y.  
Radio, Ltd., Montreal, Can. Canadian Distributors.

Insure your copy reaching you each month. Subscribe to Radio News—\$2.50 a year. Experimenter Publishing Co., 53 Park Place, N. Y. City.



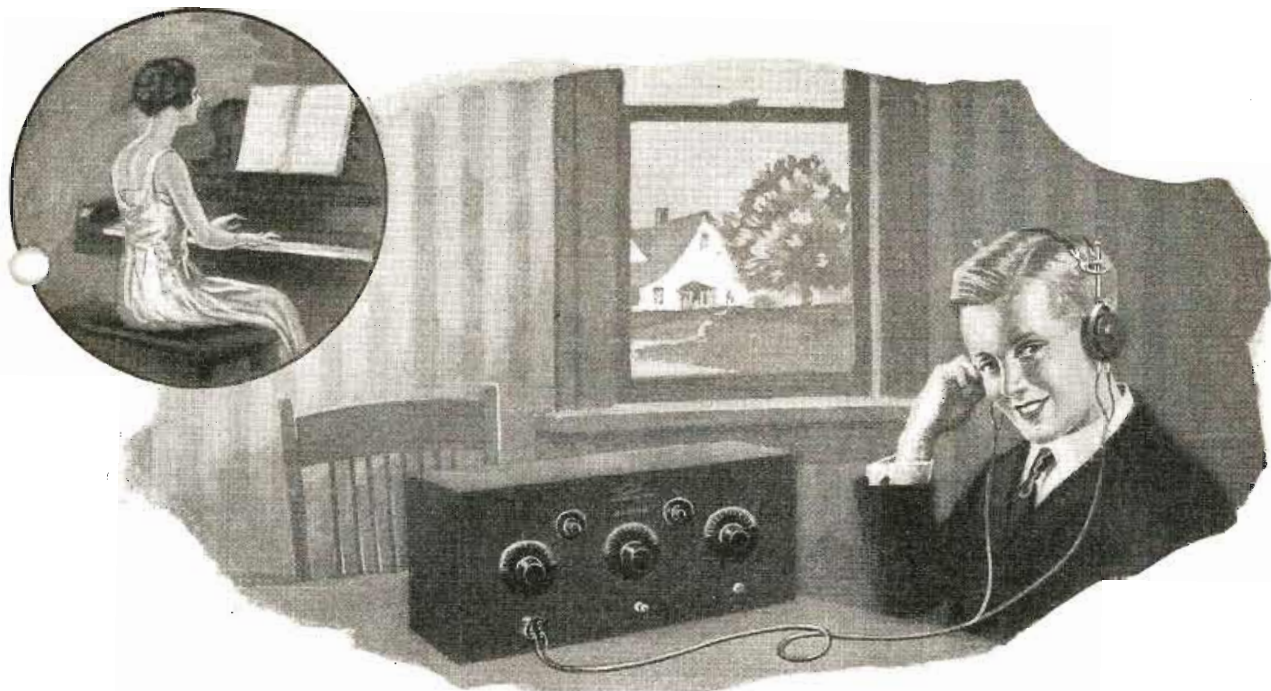

## You hear each note as if you were right there

**N**O MATTER how fine a receiving set you have—it is no better than the headphones you use. Connect a pair of Murdocks to your receiver—and tune-in on local or distant stations. It's the real thing. Voices and music come in mellow and true—clearly and with wonderful volume. Just as if you were in the same room.

Murdock Radio Phones represent the highest acoustical efficiency. Particular attention is given to the proper seating and clamping of the diaphragms. This prevents distortion. The sensitive diaphragms translate radio signals into the natural sounds of voice and music.

*Murdocks weigh only  
13 ounces*

THEIR extremely light weight enables the user to wear Murdocks for hours without discomfort. The head-band is of new design, flat and yielding, and will not bind the head. Ear caps are especially designed to

exclude outside noises. A unique feature—there are no screws on the head-band or adjusting rods, which means added comfort to the wearer.

Murdock Radio Phones are the result of 20 years of research and effort to make a high grade headphone that sells at a moderate price. Over 1,000,000 Murdocks are in use today. Quantity production has enabled us to standardize our quality and price—so that when you buy a Murdock you are sure of getting the best possible 'phone value. Buy a Murdock today and test it out. They are fully guaranteed.

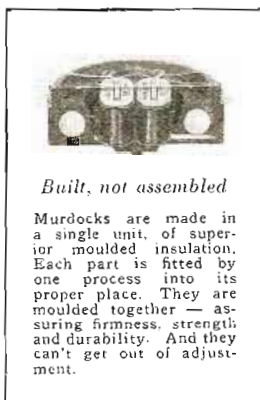

*Built, not assembled*

Murdocks are made in a single unit, of superior moulded insulation. Each part is fitted by one process into its proper place. They are moulded together—assuring firmness, strength and durability. And they can't get out of adjustment.

### *Murdock Multiple Plug Jack*

THE best plug jack value on the market today. Permits the use of one to four 'phones at the same time. Get one—and let the whole family listen in.

*The Murdock Five Tube Neutrodyne Set* (illustrated above) is now ready. See this new type at your dealer's.

*Murdock Phones and Plugs at your nearest dealer*

WM. J. MURDOCK COMPANY

363 Washington Avenue, Chelsea, Mass.

Branch Offices: Chicago and San Francisco

# MURDOCK RADIO PHONES

**Standard since 1904**

*Mail coupon for free booklet*

WM. J. MURDOCK CO.,  
363 Washington Ave., Chelsea, Mass.

Gentlemen: Please send me, without obligation, your free booklet, "The Ears of Radio"—which explains the importance of radio 'phones to efficient radio reception.

Name .....

Street .....

City..... State.....



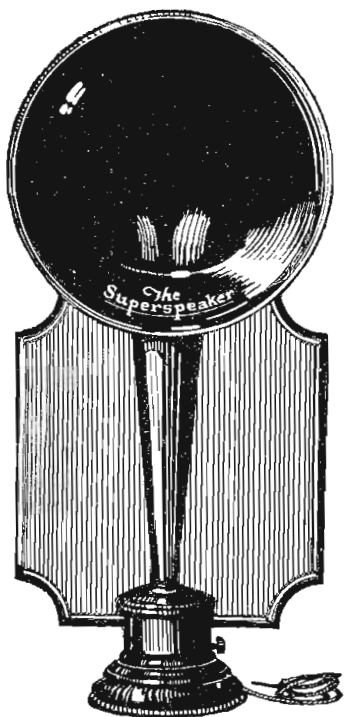

## GIVE YOUR SET A REAL CHANCE

to show the tone and volume it can develop with this sensationally successful, long range reproducer! Exclusive micrometer adjustment means more stations, better values, real music. No extra batteries or coils—natural reproduction.

## Superspeaker

Costs no more than others but yields results that can't be equalled—As fine in appearance as in performance—A big, substantial, well finished musical instrument—any dealer can be proud to stand back of it.

**JEWETT RADIO &  
PHONOGRAPH COMPANY**  
5680 Twelfth Street  
**DETROIT MICHIGAN**

rent from flowing through the loud speaker but permits the audio frequency currents to flow uninterrupted. The secondary of any audio frequency transformer may be used with the primary open at L. Insulate the primary terminals so that they cannot be short circuited, for if they are, no signals will be received. This method of connection will give the best results. Incidentally it will give the maximum amplification which the last tube is able to produce, which is not secured with the loud speaker connected directly in the plate circuit because the inductance of the loud speaker is small.

All of these points are fundamental and may seem trivial, but every radio set is really made up of a large number of what appear to be trivial things. It only takes a trifle to spoil a set, and likewise proper care of trifles will make a good set.

One must always give consideration to small details if their goal be distant reception and clear reproduction of speech and music. One turn more or less on a tickler coil may make all the difference in the world insofar as reliable operation of the receiver is concerned. Other trifles are just as important.

## The Vacuum Tube and How It Works

(Continued from page 1749)

here, but the fact may be taken for granted that to get a certain amount of amplification of the signal voltage requires about three times as many tubes, with their associated apparatus, if the amplification is to be at radio frequency than if it is to be at audio frequency. Certain features of a tube which have a negligible effect at audio frequency limit very much the usefulness of the tube when used at a million cycles. This difficulty in high frequency amplification is so marked that an amplifier may apparently be designed correctly, but so far from failing to increase the high frequency current as much as expected will give actually less signal strength after it has gone through the amplifier than at the beginning!

The best receiver circuit for ordinary radiophone amplification uses about five stages of radio frequency amplification, then a detector, and then two stages of audio frequency amplification. Such a receiving circuit requires eight tubes, rheostats, etc., and is, therefore, more expensive than the average radio listener cares to obtain. If a loud-speaking horn is to be operated from the set still another tube is advisable, this tube having its characteristics adapted to the horn that it is to operate. The ordinary detector tube cannot furnish enough power to operate a loud speaking horn without causing considerable distortion.

### THE ARMSTRONG REGENERATIVE "FEED-BACK" CIRCUIT

It is possible to make a special connection in the ordinary single tube receiver and by proper adjustments to increase its sensitiveness perhaps 25 times. In this special connection the plate circuit of the tube is connected to the grid circuit in such a way that the changes in plate current tend to reinforce the signal itself. The idea was developed and patented by E. H. Armstrong, and is known to all as the Armstrong "feed-back" circuit.

One of the easiest ways of using Armstrong's idea is given in the connection scheme of Fig. 16. It will be seen that this connection is practically the same as has been previously given with the exception that there is now an extra coil placed in

*For Happy Days by the Sea*  
HOSPITABLE, HOMELIKE  
**CHALFONTE-  
HADDON HALL**  
ATLANTIC CITY

For more than fifty years these two hotels, now combined in ownership and management, have been the choice of cultivated, interesting people—bent on happy, health-giving days by the sea.

*American Plan Only. Always Open.  
Write for illustrated folder and rates*

**LEEDS AND LIPPINCOTT  
COMPANY**

## NEUTRODYNE

5 TUBE KNOCK-DOWN  
NEUTRODYNE SET

with blue print, drilled and engraved panel. Every part needed to build this set is included as follows:

**\$25.95**

ENCLOSE POSTAGE WITH ORDER

3 Neutro-Coils, silk wire wound on all genuine Bakelite tubes, 3 Variable Condensers, high grade capacity .000275; 6 Mounting Brackets—Neutralizing Condensers (sets of parts with glass Dielectric), 5 Bakelite Sockets, One 20 ohm Rheostat, One 6 ohm Rheostat, Two shielded Audio Transformers, 3 Diats, 3 Mica Fixed Condensers (capacities .006, .001, .00025), 1 Tubular Grid Leak and Mounting, 9 Binding Posts, Lugs, 9 lengths Bug Bar, 2 lengths Spagheul, 1 Panel (drilled and neatly engraved), Blue Print (large, with complete and simple diagrams), 1 Copper Sheet, 1 Print for placing parts.

We guarantee these parts to be the best quality money can buy, irrespective of price.

NEWS ITEM FROM  
"FINANCE and COMMERCE"

At last, however, the price objection has been overcome. Naturally it was one of the oldest of radio firms, one of the substantial units in the radio world, that brought this about.

The Atlantic & Pacific Radio Company set its technical department to work upon this problem of producing a neutrodyne set to be sold at moderate cost. The radio world, as a result, has just welcomed the announcement by the Atlantic & Pacific radio stores of complete parts for a neutrodyne set, the "Set of Heart's Desire" at the incredibly low price of \$25.95.

**Atlantic & Pacific Radio Co.**  
223 West 34th St., New York City

Ask Your Dealer For a  
**MONTROSE VERNIER  
CONDENSER**

The condenser with genuine bakelite end pieces. Has positive contact between the vernier plate and main shaft. Will get the results where others fail, guaranteed to give entire satisfaction.

**MONTROSE MFG. CO.**  
1333 Fulton St., Brooklyn, N. Y.  
Phone Oeatur 7382



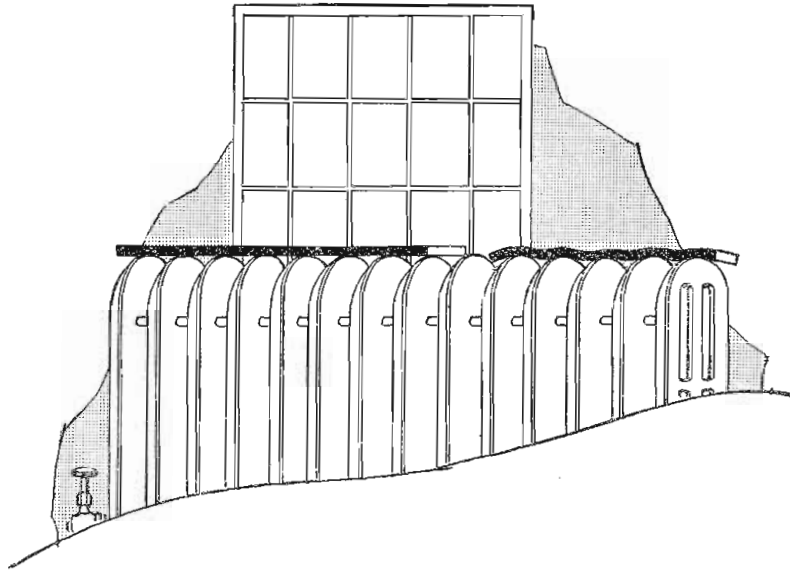

## Formica does not sag warp or cold flow!

**I**T has none of the other tricks associated with rubber compounds. It does not discolor in the sunlight; it does not soften at temperatures of 95 or 100 degrees; its insulation strength gets better, instead of weakening with age.

Those are some of the chief reasons why 125 manufacturers of the best known radio sets made in America use Formica. No other form of Bakelite has so fine a finish either in black, natural brown, or mahogany. None is so free from pit marks on the surface.

When you insist on Formica you are getting the best panel, or tube sold in America today — and the best informed buyers in the industry back up your judgment by buying it themselves.

*Dealers:* Formica prestige and advertising help you sell panels and tubes. Formica is known and demanded.

### THE FORMICA INSULATION COMPANY

4618 Spring Grove Avenue, Cincinnati, Ohio



#### Sales Offices

50 Church St., New York, N. Y.  
422 First Ave., Pittsburgh, Pa.  
1042 Granite Bldg., Rochester, N. Y.  
415 Ohio Bldg., Toledo, Ohio

1210 Arch St., Philadelphia, Pa.  
1819 Lyndale Ave., S. Minneapolis, Minn.  
Sheldon Bldg., San Francisco, California  
Whitney Central Bldg., New Orleans

516 Caxton Bldg., Cleveland, Ohio  
9 S. Clinton St., Chicago, Ill.  
313 Title Bldg., Baltimore, Md.  
47 King St., Toronto, Ontario

---

# FORMICA

Made from Anhydrous Bakelite Resins

## SHEETS TUBES RODS

---





NEWS OF

MARATHON

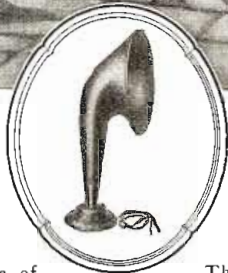

**A**FTER the great battle of Marathon, 490 B. C., between the Athenians and Persians, a runner named Phidippides carried news of the Greek Victory to Athens about 25 miles away. So great were his exertions that, delivering the message, he fell dead. Our annual Marathon race commemorates this event.

Radio now enables us to learn of great events almost instantaneously.

This great agency of enlightenment is available to anyone possessing a receiving set, but for its true enjoyment, only the best in Radio instruments should be used.

The Holtzer-Cabot Electric Company has spent years in scientific experiment and development, so that its Loud Speakers and Headphones faithfully reproduce the messages which come to us through the air.

- |                                    |         |
|------------------------------------|---------|
| Holtzer-Cabot Loud Speaker         | \$25.00 |
| Loud Speaker Phonograph Attachment | 10.00   |
| No. 2 Universal Headphones         | 9.50    |
| No. 4 National Headphones          | 6.00    |

*Write for booklets explaining how the exclusive features of these instruments enable you to enjoy the wonders of Radio*

**THE HOLTZER-CABOT ELECTRIC CO.**

125 Amory Street, Boston, Mass.  
6161-65 South State Street, Chicago, Ill.  
Dept. D1.

*Holtzer-Cabot*  
BUSINESS ESTABLISHED 1875

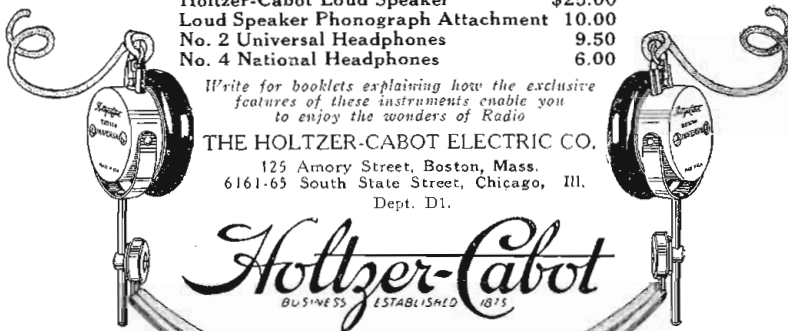

the plate circuit. This coil, known as the "tickler" coil, is connected magnetically to the coil in the local tuned circuit. By "connected magnetically" we mean that the two coils are placed in such positions with respect to each other that when the magnetic field of one changes, it induces a voltage in the other.

It will be noticed that this tickler coil is connected in the plate circuit directly next to the plate. In many homemade sets using tickler coils this coil is put between the filament and the telephone, so that either the "B" battery or the telephones are connected directly next to the plate. This should not be done, because it makes the tuning of the set much more erratic. It is because of this connection that peculiarities of tuning are noted. A friend of the writer reported that to get the best tuning in his receiving circuit he had to place his feet a certain distance from the radiator! The effect he reported was not a fake effect, but one which will always be obtained if the tickler coil is not placed directly next to the plate. The effect is due to the electrostatic capacity of the operator's body. With the telephones connected next to the plate, the capacity of the operator's body has an appreciable effect in tuning the circuit, so that getting closer or more distant from the radiator the circuit was actually being tuned. If the circuit is connected, as shown in Fig. 16, no such peculiarity in the tuning of the circuit will be found.

HOW THE TICKLER COIL WORKS

A simple explanation of the action of the tickler coil is as follows: Signal currents flowing in the antenna induce voltages in the local tuned circuit  $L_1-C_1$ , which is tuned to the signal frequency. Current is thus caused to flow in the  $L_1-C_1$  circuit and it is to be remembered that this current is really caused to flow because of the effect of the changing magnetic field, set up in  $L$  by the signal current, acting on coil  $L_1$  to produce voltage in  $L_1$ . The grid potential will go up and down at the same frequency as the signal current and so will cause the plate current to rise and fall correspondingly. This changing plate current, flowing through coil  $L_2$  will give here a correspondingly changing magnetic field which reaches out from  $L_2$  into  $L_1$  because of their proximity. This changing magnetic field in  $L_1$ , from  $L_2$ , will so act as to give a voltage in  $L_1$ , which helps out the voltage induced in  $L_1$  by the signal current in the antenna. In other words, the changing plate current, caused indirectly by the signal current in the antenna, so acts as to help the signal current in the antenna to produce bigger currents in  $L_1-C_1$ . It is the amount of current in  $L_1-C_1$  which determines the strength of signal heard in the telephones.

The "regenerative action," as it is called, is controlled in amount by the proximity, or relative positions, of coil  $L_1$  and the tickler coil  $L_2$ . The closer these two coils are together the greater is the regenerative action and the louder is the signal, up to a certain limit. If the magnetic coupling of  $L_1$  and  $L_2$  is made too tight the tube circuit may give all kinds of queer noises, sometimes a series of "clucks" at the rate of one or more per second, or singing, or squealing noises, depending principally upon the size of the grid condenser and grid leak. If such noises are obtained the coupling between the tickler coil and  $L_1$  should be reduced until they disappear.

Another scheme which uses Armstrong's idea, which is an extremely sensitive circuit for receiving short waves, is given in Fig. 17. Besides the coil  $L_1$  for coupling the tube circuit to the antenna, two variometers are used,  $L_2$  and  $L_3$ ; one in the grid circuit and one in the plate circuit. When these variometers are each adjusted to just the right amount, the signal is increased to a wonderful degree.

Radio Wherever You Go  
Vacation — Outing — Touring

This year go with Radio. Camp, fish, hunt, tour with Radio. Make your vacation complete. Listen up the rainy days and long, dull evenings. Take the new, wonderful Ozarka Portable, Long-Distance Receiver with you. Get the sports returns—the concerts—the special features of hundreds of broadcasting stations. And best of all you'll have it for home use when you return. Ozarka is built for long distance—1000 miles is not unusual. Simple to operate. Convenient and light to carry. Only weighs 15 lbs. complete. Case is 16x10x5 inches. Completely equipped with aerial, "A" and "B" Batteries, three No. 199 tubes, and one set of head phones. Ready for instant use. Price complete ready to listen in, \$65.00. Extra phones, \$5.50. Big demand. Order at once. Send \$10.00, pay balance on delivery. Satisfaction guaranteed.

Local Representatives Wanted

Ozarka Radio offers the greatest opportunity to make money. Big market—easy sales. Over 1,000 Ozarka Agencies now doing wonderful business. Some territory now open. You're interested, so write today for the "Ozarka Plan." Don't fail to give name of your county.



**OZARKA, Inc., 63 North Peoria Street, Chicago**



*Supremacy Proven by Every Test*

# FIL-KO-STAT

THE SCIENTIFICALLY CORRECT  
RADIO RHEOSTAT

Why The **FIL-KO-STAT** Is  
Unconditionally Guaranteed  
To Give Satisfaction!!!

Millions of radio fans think they are getting 100 per cent. results from their sets. We know they are not. We want them to try **FIL-KO-STAT** and learn what perfect reception means; how ability to "tune your tube" gets DX Stations you never heard before—makes tubes function noiselessly and controls regeneration, preventing squeals.



Write for a free copy of our new booklet, "Improved Reception Through Scientific Tube Tuning". Address Dept. R. N. 6



**Radio Stores Corporation**  
Sole International Distributors  
Home Office, 220 West 34th St.  
New York, N. Y.

BRANCHES IN LEADING CITIES



*Unconditionally  
Guaranteed*

BY THE MAKERS

**IDX INSTRUMENT CO.**

HARRISBURG, PA.

Price  
**\$2** AT YOUR DEALER  
IN CANADA  
**2.75**

**FOR  
ALL  
TUBES**



# The Stamp of Approval the World Over

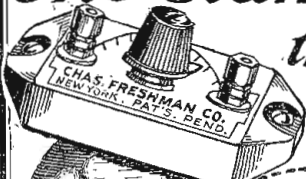

## FRESHMAN Variable Grid Leak

The Standard Unit for Every Tube Set

EVERY tube and every circuit requires a different grid leak resistance. The method employed in the Freshman Variable Grid Leak permits you to adjust your circuit to any resistance you wish, from 0 to 10 megohms in an unbroken range of 180 degrees.

The Freshman Variable Grid Leak and Condenser combined takes the place of a grid condenser, leak mounting and grid leak—and, in addition, permits an adjust-

ment to the correct amount of resistance. The Freshman Variable Grid Leak is the most compact, the most perfect, the most efficient, the most readily adapted to all grid circuits—and the only one which is entirely sealed and always remains unaffected by any climatic conditions. It is the

### ORIGINAL VARIABLE GRID LEAK

Either Base or Panel Type Complete with .00025 or .0005 m.f. Freshman Condenser \$1.00  
Either type without Condenser, 75c

Ask your dealer or write for our free diagrams of Neutrodyne, Tri Flex, Kaufman, Heterodyne circuits.

**Chas. Freshman Co. Inc.**  
Radio Condenser Products

106 SEVENTH AVE., NEW YORK, N. Y.

At your dealer's—otherwise send purchase price and you will be supplied without further charge.

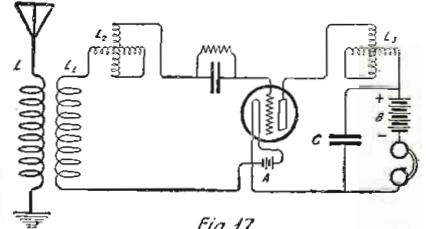

Fig. 17

Another scheme using the feed-back or generative system for amplifying signals.

This is a rather more difficult circuit to adjust than that given in Fig. 16, but is generally a more sensitive one for short wave receivers.

A suitable regenerative connection, properly adjusted, will give an amount of amplification equal to that obtained by between one and two steps of a transformer repeating, audio-frequency amplifier.

#### RECEIVING CONTINUOUS WAVES

The connection schemes shown in Figs. 16 and 17 are both useful for receiving continuous wave (generally abbreviated C. W.) telegraph signals. In such transmission there may be sent out from the transmitting station a high frequency current of continuous strength as long as the key is held down. It will be noticed that this is different from spark telegraphy (or damped wave telegraphy) which sends out a series of high-frequency wave-trains as the key is held down, the number of wave trains per second being fixed by the number of sparks per second at the transmitter, generally about 1,000. The ordinary vacuum-tube receiver, when used for spark reception gives a musical note in the telephones, the pitch being determined by the number of transmitter sparks per second.

If such a receiver is used in listening for straight C. W. signals (sometimes another scheme for C. W. than that assumed above is used) nothing will be heard because there is no such thing as spark frequency to determine the pitch of the received signal; the current in the receiver is one of constant amplitude high frequency and therefore inaudible. To make it audible its amplitude (or strength) must change at regular intervals so that its changes will give in the telephones an audible note.

**The Heterodyne Effect.**—This can be done by a scheme due to R. A. Fessenden, known as the heterodyne, or beat, method of reception. If the incoming signal has a frequency of 1,000,000 cycles per second and if there is continually in the receiver circuit another current of frequency either 1,001,000 cycles or 999,000 cycles per second, this local high frequency current and the current set up by the signal will act together to give a combination high frequency current, the amplitude of which changes 1,000 times per second. But if there is in the local tuned circuit a high-frequency current the amplitude of which is changing at audible frequency the tube so acts (as previously explained), that there is heard in the telephones a musical note, the pitch of which is fixed by the frequency of the amplitude variation. Hence in the above case the continuous wave signal of 1,000,000 cycles would, with the assistance of the other high-frequency current, produce a musical note in the telephones of 1,000 cycles per second. As soon as the signal stopped coming in there would be present only one high frequency current, beats could not be formed, and so nothing would be audible in the telephones.

By those who have studied the operation of the ordinary pipe organ it will be recalled that the low notes are produced in a manner similar to that just described for the continuous wave receiver. To get a musical

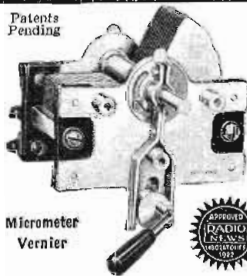

#### Prices for Panel Mounting

43 Plate .001 Mfd.	\$7.00
23 Plate .0005 Mfd.	6.00
17 Plate .00025 Mfd.	5.75
11 Plate .00025 Mfd.	5.50
3 1/2" pure Bakelite Dial.	.75
4" pure Bakelite Dial.	1.00

WRITE FOR DESCRIPTIVE CIRCULAR

**HAMMARLUND MFG. CO.,** 144 W. 18th St., New York, N.Y.

#### IMPROVED MODEL "B"

### Hammarlund Condensers

Grounded Rotor—Brass Plates

Increase Your Volume and Distance!

The Model "B" Hammarlund is a laboratory product of the highest type of precision. Its use will be of material advantage in increasing volume, reaching out for distance, eliminating interference, and in the quality reception of broadcasting in general.

- |  |                              |
|--|------------------------------|
| (1) Lowest losses (too small to measure) | (5) Adjustable cone bearings |
| (2) Micrometer Vernier                   | (6) Double wiping contacts   |
| (3) Soldered brass plates                | (7) Takes any size dial      |
| (4) Rotor grounded to frame              |                              |

At your dealers, otherwise send purchase price and you will be supplied postpaid.

Insure your copy reaching you each month. Subscribe to Radio News—\$2.50 a year. Experimenter Publishing Co., 53 Park Place, N. Y. C.



# PULLING POWER

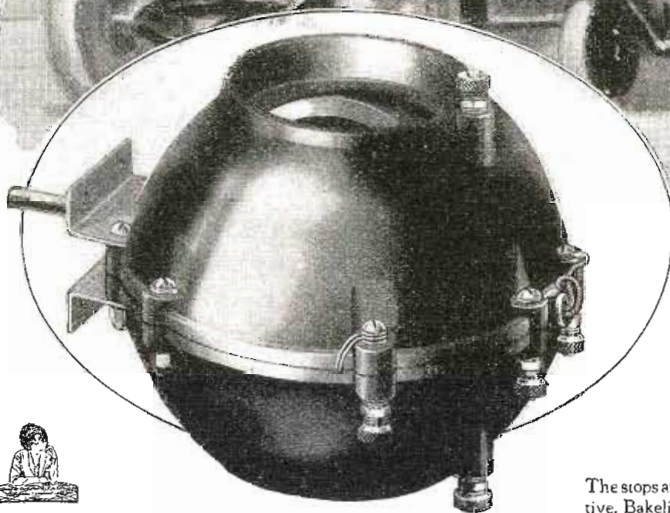
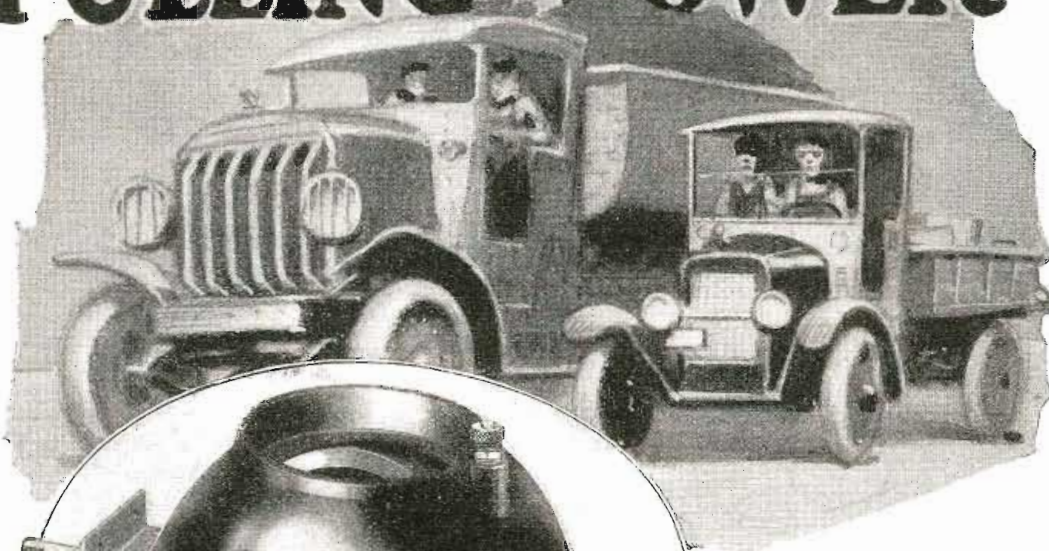

Heavy Bakelite shells of rich brown color. Windings of correct gauge wire and properly proportioned for best reception. Large bearings assure smooth operation and long life. No sliding contacts; rotor connections made with special flexible wires, through hollow shaft to binding posts on stator shell.

The stops are a part of the stator and rotor and are positive. Bakelite especially treated to prevent distributed capacity. Arranged for either panel or base mounting.

## VOLUME!

**T**HE variometer or variocoupler is responsible for the strength of the signals received. Therefore, the size, shape, gauge of wire and number of turns in the Kellogg variometers and variocouplers are the result of exhaustive tests for equipment that will give the best radio reception.

Therefore, it is to your advantage to demand Kellogg variometers and variocouplers and know that you will receive better reception, resulting in maximum entertainment, and value from your radio set.

If your dealer does not handle Kellogg, communicate direct with us.

### KELLOGG SWITCHBOARD & SUPPLY CO.

1066 West Adams Street, Chicago





## Eagle Neutrodyne Balanced! RADIO RECEIVER

**E**VERYWHERE the EAGLE leads! Its perfect balance—like that of the structural iron worker—is the sum total of infinite skill and years of experience. Until others can successfully duplicate the exceptional skill in balancing and testing of each receiver, there can be no real rival of the EAGLE. A product of "quality" rather than quantity production. Stations located instantly by turning dials *always* to the same points. Easy to operate as a phonograph. Unreservedly guaranteed.

Licensed by Independent Radio Manufacturers, Inc., under Hazeltine Patent No. 1,450,080, dated March 27th, 1923, and other patents pending.



20 BOYDEN  
PLACE

Write for Literature

note of pitch 32 (that is 32 vibrations a second) two other notes are sounded in unison, say 64 and 96; the combination of these two gives a beat note, the pitch of which is equal to the difference between the two notes sounded, in this case the desired pitch of 32 vibrations per second.

The local high-frequency current required for C. W. reception is obtained by using a scheme like that of Fig. 16, increasing the magnetic coupling between  $L_1$  and  $L_2$  somewhat more than usual. In such a case the tube, when acting properly, will generate high frequency currents in circuit  $L_1-C_1$ , the frequency of these currents being fixed by the natural period of the circuit. The tube is said to be "oscillating."

By changing the setting of condenser  $C_1$ , the frequency of the local oscillations can be changed at will, and hence the pitch of the musical note heard in the phones will correspondingly change. This interaction of the incoming signal and the local oscillation gives rise to a peculiar whistling noise as  $C_1$  is continually changed, if some radio station is sending out continuous wave radiation at the time.

As  $C_1$  is varied, from very small value up, a very high note is heard which, as  $C_1$  is changed very slowly, comes down the whole musical scale and below it, passing below the audible range. As the increase in the value of  $C_1$  is slowly continued the note again appears, very low in pitch, and then ascends through the whole musical scale, finally disappearing into the inaudible range of frequencies above 15,000 vibrations per second. This whole change in the pitch of the note will generally take place as  $C_1$  is changed over perhaps only two or three of the smallest divisions on its scale.

**Zero Beat Frequency.**—If the value of  $C_1$  is set to be in the middle of the region where the beat note is below audibility, the local frequency is the same as the incoming frequency. Hence there are no beat notes: this is said to be the condition for "zero beat frequency." The detecting tube is generating high frequency currents but they are inaudible as they have the same frequency as the signal. If, with this condition, the coupling between  $L_2$  and  $L_1$  is decreased as much as possible, still keeping the tube in the oscillating condition, the detector is set in its most sensitive condition for reception of radiophone signals. To determine whether or not the tube is oscillating with the coupling used,  $C_1$  should be increased a very little; if a low note is heard from the radiophone transmitting station, besides the music or conversation, the tube is oscillating and  $C_1$  can be safely decreased to make the beat note go below audibility with the tube still oscillating.

If the receiving station is close by the transmitting station from which the beat notes are being obtained, low-pitched beat notes are in general impossible; as  $C_1$  is changed, the beat note decreasing from high values, there will be found a value of  $C_1$  below which no beat note is audible. Thus a certain setting of  $C_1$  gives a beat note of 1,000; somewhat less gives a note of 400 and if  $C_1$  is further decreased, the note suddenly disappears completely. This is because the powerful, near-by station is trying to make the little receiver tube oscillate at the same frequency as itself and when the frequency of the little tube gets too close to that of the transmitter station such a condition results; the frequency of the current in the  $L_1-C_1$  circuit suddenly changes from that fixed by  $L_1$  and  $C_1$  to that of the transmitter station, and so the beat note at the same time disappears.

### USING THE TUBE TO GENERATE ELECTROMAGNETIC WAVES

As has been mentioned in the previous section, if the plate circuit of a tube is suitably coupled to the grid circuit, there will be

# 30 STATIONS in one hour!

—heard with one Myers Tube (name and address furnished on request). The remarkable results being obtained with Myers Tubes are due, largely to the elimination of socket with its bunched leads.

## Myers Tubes

(practically unbreakable) give you distance with clarity. They add 50% to the efficiency of any set by reducing interference.

See that you get the New Improved Myers. Others are not guaranteed. Insist on Myers at your dealers—otherwise send purchase price and be supplied postpaid.

Two types: Dry Battery and Universal (for storage battery). Write for free circuit diagrams.

**\$5** EACH, complete with clips ready to mount on your set; no sockets or other equipment necessary.

**E. B. Myers Co. Ltd.**  
*Radio Vacuum Tubes*  
240 CRAIG STREET, W.  
MONTREAL, CANADA



Actual Size

### Write for introductory offer Radio Console

An attractive piece of Furniture. Will hold Atwater-Kent or any size Vertical Panel Set, with Acid Proofed Compartments for Batteries and Charger, likewise on Neutrodyne and Superneutrodyne Cabinets.  
**STURM RADIO CABINET FACTORY**  
Dept. 1, 319 S. Jefferson St. WAB 7871 Chicago

Code Instructions That Instruct Only \$2.00. Students now licensed mastered Code 15 Minutes. Ten word speed 3 Hours. Information free. Dodge Radio Shortkut, Dept. N, Mamaroneck, N. Y.



# TWO RADIO LEADERS

*Each Supreme In Its Class*

### Testimonial

National Airphone Corp.,  
18 Hudson Street,  
New York City.

March 29, 1924.

Gentlemen:

It might interest you to know that when I received your MONODYNE tube set, I thought it was a toy and could not think it possible for such a small instrument to receive radio broadcast from distances your set is reputed to perform.

I have since learned that good things come in small packages and am happy to acquaint you with the marvelous results and the inconceivable distances of reception that I heard, and what is most marvelous of all, is the clarity, distinctness and volume. I heard Oakland, Calif., just as clear as KDKA Pittsburgh. I got Denver, Colo.; Davenport, Iowa; Cleveland, Cincinnati, Columbus, Buffalo, Philadelphia, Atlanta, Ga.; 2KW Cuba, all the stations in New York and Newark; Springfield, Providence, Boston, also Montreal, Toronto, Canada; and this may be the biggest surprise to you when I truthfully state that I heard London, England, for four nights in succession. I heard some lectures from London rather faint but very audible.

Also heard a message wireless from a U. S. warship from Tahiti Island in the Pacific Ocean.

All of the above stations were received from my country home at Lake Placid. My aerial is constructed of a single wire 155 feet long erected on the peak of a mountain using a 125 feet lead in.

Being a Chemical Engineer by profession and having been associated with Mr. Steinfeltz of the General Electric Co., at Schenectady, N. Y., and at present being connected with the Peters Process Co., you will appreciate my interest in the art of radio sciences and you will be further pleased to learn that I have been unable to accomplish anywhere near the distances with four and five tube sets costing fifteen to twenty times the amount of your MONODYNE; and anyone that may doubt these facts may communicate with me care of Peters Process Co., at Austerlitz, N. Y.

Yours very truly,

(Signed) S. Sanford Peters



**\$10.00**

Without  
Tube

**NATIONAL**

**MONODYNE**

FAT. TRADE MARK PDG.

**TUBE SET**

MODEL GT-1

**MADE BY MASTERS  
OF RADIO ENGINEERING**



**\$8.50**

Without  
Tube

The Monodyne Amplifier while designed for use with the Monodyne receiver can be utilized with any set. Perfect amplification of voice and music without howling or distortion—two will operate a loud speaker on any set—one or more stages can be added as desired.

Designed and built by acknowledged leaders, the Monodyne receiver marked a new point in radio history.

It meets the insistent demand for all the amusement and education that radio broadcast affords at a price within reach of all.

The knowledge and experience gained by years of intimate association with the development of radio has placed the Monodyne firmly

**IN A CLASS BY ITSELF**

Cost of complete Monodyne Tube Set including Tube, Headphones, Batteries and Antenna Outfit, ready to receive broadcast \$22.

Order from your dealer or sent postpaid to any address in U. S. Dealers: Write for exclusive agency proposition.

**NATIONAL  
AIRPHONE  
CORPORATION**

18 HUDSON ST.

NEW YORK

**SEND NO MONEY**

National Airphone Corporation,  
18 Hudson Street, New York City, N. Y.

R. N. 6-24

Gentlemen:

Send prepaid the articles — National Monodyne.  
marked, for which I will pay — National Amplifier.  
postman upon delivery the — Interference Eliminator.  
Advertised Price.

NAME .....

STREET .....

CITY..... STATE.....



# FROST-RADIO

No. 312  
30 Foot  
**\$2.50**



## The Extension Cord Par Excellence

**FROST-RADIO** has developed in its line of Extension Cords the ideal means of connecting receiving set and loud speaker, even when in separate rooms. Furnished in handy lengths from 10 to 100 feet, in either tinsel cord or twisted pair, the former slightly higher in price. Beautifully made—finely finished. If you have a loud speaker you should secure one of these Extension Cords today.

Ask Your Neighborhood Dealer

**HERBERT H. FROST, Inc.**  
154 WEST LAKE STREET, CHICAGO, ILLINOIS  
NEW YORK CITY KANSAS CITY, MO.

# FACTS! NOT CLAIMS

Have made this MARTINOLA one tube set the pride of hundreds of people. A REAL RADIO SET—BUILT as you have wanted it to be—of PROVEN QUALITY parts, mounted on a GENUINE BAKELITE panel and in a GENUINE MAHOGANY cabinet.

MARTINOLA TYPE I

**PRICE \$15.00**

Without Tube

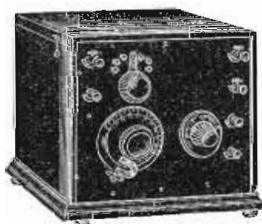

A DEPENDABLE,  
CLEAR, SELECTIVE  
AND DISTANCE  
**RECEIVER**

TYPE I may be easily attached to TYPE II (a two stage amplifier) forming a three tube set of superior quality. TYPE II may also be readily attached to any standard one or two set on the market. Type II (withour tubes), Price \$20.00.

Your order will receive prompt attention. Remit by money order or certified check.

**J. E. ALBRIGHT & CO.**

825 Broadway, New York, N. Y.

BUY DIRECT FROM US, the Manufacturer, and save the Difference.

# KENNEDY

The Royalty of Radio



See your dealer for demonstration of Kennedy receiving sets or write us for descriptive literature.

THE COLIN B. KENNEDY CO.

Saint Louis
San Francisco

Operate your radio from your lamp socket with a

## Gould Unipower Battery

For complete information address

**GOULD STORAGE BATTERY CO.,**  
30 East 42nd Street, New York

set up in the grid circuit high-frequency alternating currents, the frequency of which is fixed by the natural period of the grid circuit, that is, by the  $L$  and  $C$  in this circuit. To the student who has mastered the first principles of electrical engineering it seems very strange that a source of continuous current power, the "B" battery, can generate alternating current power, and indeed a really accurate explanation requires a fairly exhaustive analysis.

It is possible to point out, however, instances of common occurrence in which a nearly similar phenomenon is taking place. What makes a violin string vibrate? How does the continuous steady drawing of the bow across the string make it oscillate back and forth (the mechanical equivalent of an alternating current) a thousand or more times a second? Certainly the violinist is not actually pulling the string back and forth with that frequency. He merely gives a uniform, steady pull to the bow, and this steady pull of the bow corresponds to the steady, continuous current power supplied to the vacuum tube by the "B" battery. Analysis of the action of the violin string shows that the changing of the steady pull of the bow into the vibratory motion of the string is due to the peculiar friction between the resin-covered bow and the stretched string. The string, it will be noticed, vibrates at its natural frequency, that is, at the frequency with which it vibrates when plucked and left free to vibrate by itself. This corresponds exactly to the fact that the frequency of the alternating current generated by an oscillating vacuum tube is fixed by the natural frequency of the oscillating circuit.

Another instance from every-day life is the motion of the balance wheel of a watch. The mainspring can evidently push the balance wheel in only one direction, yet the wheel continually works back and forth—oscillates. In this case the essential feature in the problem is the action of the escapement; this allows the mainspring to push the balance wheel in one direction and then prevents it from pushing against the balance wheel when it is on the other part of its swing.

A flexible stick in a smoothly running stream of water provides another illustration. When canoeing in a swift, smoothly running river the writer has often noticed sticks, anchored at the lower end in the bed of the stream with the top projecting above the surface, continually oscillating back and forth, for hours at a time. In this case the peculiar friction between the smoothly flowing water and the stick permits the uni-directional push of the river water to maintain the stick in its oscillatory motion.

A uni-directional flow of steam through a whistle sets the air into vibratory motion, the frequency of the vibration being fixed by the length of the whistle tube. The wind, blowing through tightly stretched telegraph wires, gives the humming noise with which we are all familiar.

So we see that there are many cases in every-day life in which a source of continuous power is able to maintain a body in vibratory motion. These cases differ from that of the oscillating triode only in the fact that they are more difficult, to the trained scientist, to explain and solve accurately; to one skilled in the art the operation of an oscillating tube is an exact and predictable phenomenon.

*The Triode as a Power Generator.*—The amount of alternating current power developed by the small detecting tube used to receive continuous wave signals, is only a small fraction of one watt. To develop much alternating current the tube must be supplied with more power than the ordinary "B" battery can give and be able to absorb this greater power without overheating, or suffering other injurious effects. So, tubes



# SUPER-HETERODYNE

## The World's Best Radio Receiver

BY PERFORMANCE

### ADVANTAGES NO OTHER RECEIVER CAN EQUAL

- 1. UNIFORM EFFICIENCY** over the entire wavelength range of 160 to 850 meters. This means that all stations, Radio-telephone Broadcasting, Amateur and Commercial within this wavelength range, will be received with maximum intensity. This very desirable feature is not obtainable by any other practical method using Radio Frequency amplification.
- 2. SELECTIVITY** by this system, greatly exceeds that obtained in all other methods of reception. Using the Model "C" with a loop in the Suburbs of New York, WOR 15 miles distance, operating on 405 meters, can be completely eliminated, and PWX 1300 miles distance operating on 400, can be received on a loud speaker. This holds true on an average cool night. There is no telegraphic interference from 200 meter amateur stations or 600 meter ship stations.
- 3. SIMPLICITY** to change from one station to another, there are only two dials to vary. The two dials can be calibrated for all the various stations, as there is only one best position for each station.
- 4. AMPLIFICATION** is much greater than obtainable in any other standard receiver. Total is as follows: 1st the Heterodyne Amplification in the 1st Detector; 2nd, the Regenerative Amplification in the 1st Detector; 3rd the 3 stages of Tuned Regenerative Radio Frequency Amplification; working at a low advantageous frequency; 4th, the second Detector action, and 5th, the two stages of low ratio distortionless audio frequency amplification.
- 5. RECEIVING RANGE** other factors correct, the receiving range is in proportion to the effective radio frequency amplification applied. As this receiver has much greater effective radio frequency amplification than all others, the range is proportionally greater.

Complete Constructional Blue Prints Consisting of Two Sheets 50x21" and Two Sheets 27x21" and Two Sheets 30141-145. \$2.00 Postpaid.

**Experimenters Information Service** 476 Broadway :: :: *Designers of the Highest Class Radio Apparatus in the World* :: :: New York City



"THE ROLLS-ROYCE OF RECEPTION"



MODEL "C" SUPER-HETERODYNE

Wavelength Range 160 to 850 meters. Tubes, 2 Detectors, Oscillator, 3 Tuned Radio Freq. Amplifiers, 2 Audio Amplifiers.

The Super-Heterodyne is the most efficient method of short wave radio frequency amplification known. It is used extensively by the Commercial radio companies and various governments, when it is necessary to receive over extremely long distances, without interference from near-by stations. The remarkable results are due to the Super-Heterodyne action, which is briefly as follows: the incoming signal, which may be any wave from 160 to 850, is changed thru the use of a local oscillator, to a wavelength of 10,000 meters. At this wavelength an exact duplicate of the original signal is amplified at radio frequency with the very highest efficiency possible, rectified and amplified at audio frequency.

During this change a very high degree of selectivity is secured, due to the amplifier, which is designed to pass nothing but 10,000 meters. Accordingly while there may be ten or more signals in the loop, only one will be received at a time, the one that the oscillator heterodynes thru the amplifier.



**Ackerman**  
REG. U. S. PAT. OFF.

# LOUD SPEAKER

Complete. Ready for Immediate Use. **\$9.50** Delivered Anywhere in the U. S. A.

A Loud Speaker for thousands of Radio Fans who are looking for a moderate-priced speaker with quality.

Special (non-vibrating) metal horn, 21 inches high, bell 11 inches in diameter, complete with special loud speaking unit and 5 foot cord.

An ideal speaker for home use, reproducing voice and music in perfect mellow tone, with plenty of volume.

No extra batteries required.

Connects to receiving set in place of headphones.

Made in four finishes: Plain Black or Brown Satin; also Special Alligator grain in Black and Green or Black Crystalline.



This speaker has been selected as the best value by one of the largest selling organizations in the country.

**MODEL "A" LOUD SPEAKER UNIT.** for use with horn or phonograph, complete with 5 foot cord and rubber coupling. **\$4.00**

At your dealers or sent prepaid on receipt of Price.

Jobbers and Dealers Wanted—Write for Discounts.

## Ackerman Brothers Co., Inc.

301 West 4th St. Dept. R.N. New York City



designed to give enough power to operate a transmitting station are much larger and better evacuated than are the tubes used for detectors and amplifiers. The filaments are much larger, use much more power for heating and evaporate a much greater number of electrons. The plate circuit is supplied with power, not from a few small dry cells, but from a small direct current generator, to give an appreciable fraction of an ampere at from 300 to 1,000 volts. These figures are for the small tubes used in amateur stations; the commercial stations, using triode oscillators, have tubes using as much as 100 watts or more to heat the filament, and in the plate circuit are used direct current generators which give many amperes of current at as high as 15,000 volts or more. The amount of power generated by a small tube at an amateur station is about five watts, whereas the large tubes mentioned can each generate a kilowatt (1,000 watts) or more.

*Efficiency of Tubes as Generators.*—The efficiency of the small tube is about 25 per cent., that is, of the amount of power supplied by the generator in the plate circuit about one quarter is changed into high frequency, alternating current, power. If we allow also for the power used in heating the filament of the tube, generally supplied by a storage battery, the efficiency of the small tube is only about 10 per cent. The larger tubes, using much higher plate voltage, have efficiencies as much as 60 per cent. to 80 per cent., depending upon the voltage used; the higher the voltage of the plate

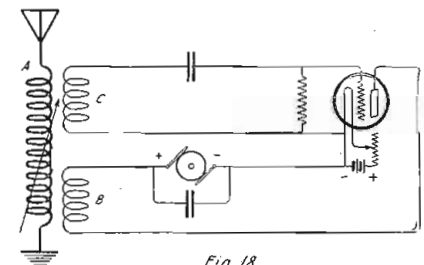

Fig. 18  
A commonly used circuit for making a triode generate sufficient high frequency power to excite a transmitting antenna.

**Announcing** TYPE AF-7  
—Turn ratio 3½—

Improve your set with an AmerTran



**AMERTRAN**  
TRADE MARK REG. U.S. PAT. OFF.

Type AF-6 (Turn ratio 5)  
Type AF-7 (Turn ratio 3½)  
Price, either type, \$7  
At your Dealer's.  
Send for Circular.

Henceforth, then, it is possible to obtain a low ratio AmerTran audio transformer, which insures perfect tone quality and full amplification of low notes when used in combination with an AmerTran AF-6 in the first stage.

Type AF-7 (Turn ratio 3½), is now, after long study and experiment, offered in response to the demand for a companion transformer designed expressly for second or third stage amplification. In this use AF-7 decreases the tendency to overload the last amplifying tube on loud signals.

American Transformer Company, 177 Emmet St., Newark, N. J.  
Designers and builders of radio transformers for over 22 years.

## RUSONITE

### FIXED DETECTOR

TONE ADJUSTER - BAKELITE BASE

Guaranteed. Price, \$1.25.  
RUSONITE PERFECT RADIO CRYSTAL  
Supersensitive. Price mounted, 50c  
Rusonite Catwhisker 14K Gold 25c  
Rusonite Products Corp., 15 Park Row, New York, N. Y.

## RADIO FANS

Would you like to get a start as salesman or dealer in the radio field? We manufacture one of the best receiving sets and parts on the market. We want local representatives in your district. We show you how to get started in the radio business. If you are familiar with radio you can earn a big income immediately. This is open to part time men. Write to

**Mr. Howard, 1249 Wilson Ave.,  
Chicago, Ill.**

circuit machine the more efficient is the tube as a converter of the continuous current power into alternating current power.

*Heating of the Plates.*—Anyone who has worked with transmitting tubes knows that the plates of the tubes are likely to get red hot, when in operation. What causes this heat? We have previously said that the temperature of a body is fixed entirely by the amount of agitation of its molecules. The more rapidly they are bumping back and forth the hotter is the body. If several hundred volts are used in the plate circuit of a vacuum tube oscillator, the attraction of the plate for the electrons evaporating from the filament is so great that when they arrive at the plate they are moving with an almost inconceivable velocity, measured in many thousands of miles per second.

These high-speed electrons are stopped when they bump into the plate, and in stopping they naturally stir up the molecules of the plate with which they collide. The collisions result in an increase in the zigzag motion of the molecules of the plate. Hence the plate is heated. It is perfectly possible to get a metal so hot by this bombardment of electrons that it melts.

*Typical Circuits Used.*—Various circuits have been used to excite an antenna by an oscillating triode. They are all nearly equally good if the proper adjustments are made for each case. Fig. 18 shows one in which the tube is not directly connected to



Radio News for June, 1924

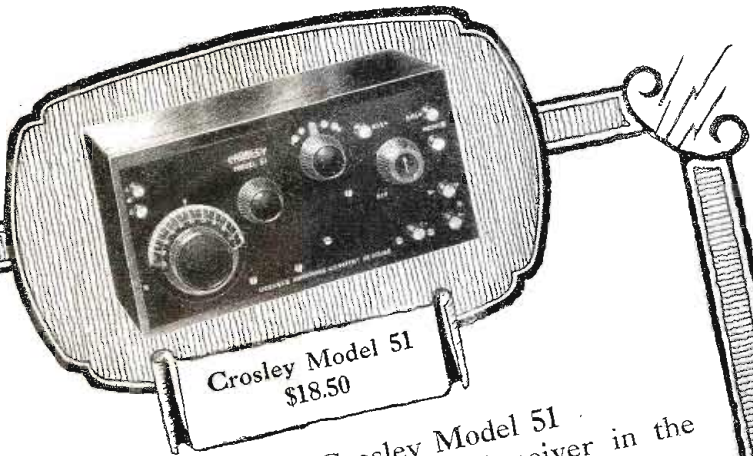

**Crosley Model 51**  
\$18.50

**In 24 Days the Crosley Model 51  
Became the Biggest Selling Radio Receiver in the  
World!**

On Monday morning, February 4th, Powel Crosley, Jr., returned to his desk after a two weeks' hunting trip in Mississippi. He brought with him the idea of an entirely new Radio Receiving Set to be added to the Crosley line.

A short conference with his engineers followed. On Tuesday morning, February 5th, a model had been completed and tested. These sets were put into production immediately after the model was approved.

On Tuesday afternoon, February 5th, night letters were sent to the leading distributors of The Crosley Radio Corporation announcing this new model which had been called MODEL 51. Wednesday afternoon the orders commenced coming in, showing the faith of the distributors in anything brought out by this Company. Announcements were made in leading metropolitan newspapers of the country on Saturday and

Sunday, February 9th and 10th. Shipments commenced about February 13th, and were immediately followed by an avalanche of complimentary letters and orders, and have increased steadily ever since.

Production started at 50 a day—was increased to 200—then 300—and on February 28th, just 24 days after the thought of this set had been put into being, the production reached 500 a day. Orders were received on February 28th for 1,115 of these sets—every effort being made to increase the production to 1,000 sets per day to supply the phenomenal demand for this new model.

This message was written on February 29th in the face of promises of an even greater record than is indicated here. The demand for this set has not in any way lessened the sale but has increased the orders on various other models in the Crosley line.

**Now What Is This Set That Has Made Such an Envious  
Record, Which in 24 Days Has, We Believe, Become the  
Biggest Selling Radio Receiving Set on the Market?**

It incorporates a tuning element made famous in the Crosley Model V, the \$16.00 set used by Leonard Weeks of Minot, N. D., in his consistent handling of traffic with the MacMillan Expedition at the North Pole—a genuine Armstrong regenerative tuning and detective circuit.

Now, to this has been added a one stage of audio frequency amplification. With the well-known Crosley Sheltran 9 to 1 ratio transformer, giving an unusual volume. Thus, this set uses 2 vacuum tubes.

It is the ideal all-around receiver. For local and nearby broadcasting stations, it will operate a loud speaker, giving phonograph volume in the home. Under reasonably good receiving conditions, it will bring

in stations up to 1,000 miles, with sufficient volume for the average-sized room. When receiving conditions are bad, however, head phones should be used on distant stations.

This Receiver is unusually selective—it incorporates standard sockets so that all makes of tubes can be used. The various units are mounted on beautifully engraved grained panels, and mounted in a hardwood, mahogany finished cabinet, which completely encloses all parts and tubes.

A glance at this beautiful instrument sells it, and the results it gives create many friends for it. Perhaps the most startling thing of all is its price—\$18.50. (Add 10% West of the Rocky Mountains.)

Licensed under Armstrong Regenerative Patent No. 1,113,149

**THE CROSLLEY RADIO CORPORATION**  
Powel Crosley, Jr., President  
Formerly  
The Precision Equipment Company and Crosley Manufacturing Company  
622 ALFRED STREET  
CINCINNATI, OHIO





**\$200**  
**SELECTIVITY**  
 for  
**\$8.50!**

# Make Every Night Silent Night!

## TRAP OUT THE INTERFERENCE

Selectivity—which is merely the ability to cut out interference—is the dominating difference between the very expensive sets and the moderately priced ones. Why pay \$50.00 to \$200.00 extra for increased selectivity, when for \$8.50 you can get a FERBEND WAVE TRAP which will absolutely cut out any interfering station, no matter how loud, how close by or how troublesome.

### Add a Ferbend Wave Trap to Your Set

You will find it a valuable addition. It is designed and manufactured complete by us, after years of careful experimenting. It is not to be confused with imitations hastily assembled from ordinary parts. The price is \$8.50. Shipment is made parcel post C. O. D. plus a few cents postage. If you prefer, you can send cash in full with order and we will ship postage prepaid. Send us your order today.

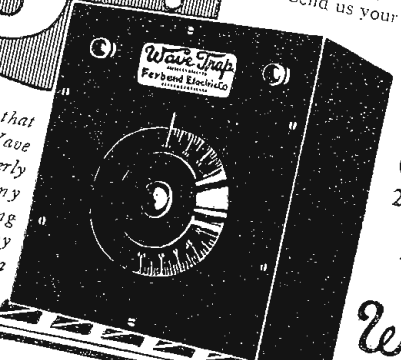

**FERBEND ELECTRIC COMPANY**  
 25 E. South Water St.  
 CHICAGO

Descriptive Folder on Request  
**FERBEND Wave Trap**  
 PATENT OFFICE FOR

We guarantee that the Ferbend Wave Trap, when properly connected to any workable receiving set, will tune out any interfering station

# NEUTRODYNE

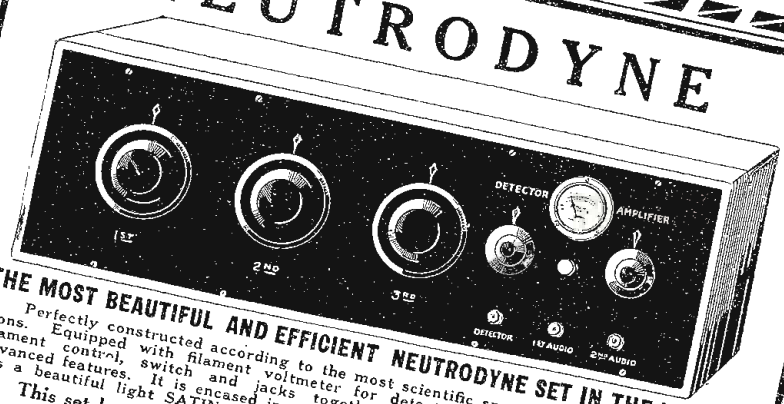

**THE MOST BEAUTIFUL AND EFFICIENT NEUTRODYNE SET IN THE WORLD**

Perfectly constructed according to the most scientific specifications. Equipped with filament voltmeter for detector, automatic filament control, switch and jacks together with many other advanced features. It is encased in a solid mahogany cabinet that has a beautiful light SATIN FINISH.

This set has become famous for LONG DISTANCE AND CLARITY Fully guaranteed to WORK PERFECTLY for ONE YEAR

SEND CHECKS OR MONEY ORDERS WHEN ORDERING BY MAIL  
**ATLANTIC & PACIFIC RADIO CO.**  
 223 WEST 34th ST., NEW YORK CITY

**\$97.50**

Tubes, Batteries and Loud Speaker, Extra

## CHARGING BATTERY

**\$8.75**

Rate of four amperes per hour. Cannot possibly overcharge. Electrolytic bulbs to get out of order. No contact points in handily enameled metal housing. Get one now, at  
**Rubber Mold Company**  
 Radio Dept.  
 W. 19th St., Chicago

## BLANK CARTRIDGE PISTOL



Protection against Burglars, Tramps, & Dogs  
**PRICES 50c. \$1.00**  
 POST-PAID  
 With made and engraved on base of revolver. It is a small piece of metal which is enough to scare a burglar. When loaded it makes a noise effective as a real revolver. Without danger to life. It takes about 10 minutes to load. Price 50c. Superior quality \$1.00 post-paid. Blank cartridges, by express, 50c per 100.  
**JOHNSON SMITH & CO., Dept. 125 Racine, Wis.**

Radio News for June, 1924

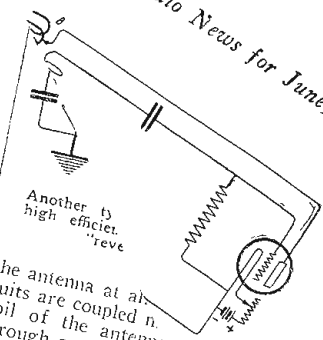

the antenna at all circuits are coupled through a grid condenser of which must be the type of tube used. a grid connection with being overheated during use. do get too hot gas comes out of them. less the vacuum, and the tube may be completely spoiled.

In Fig. 19 one coil is used in the antenna circuit and another is coupled magnetically to it for exciting the grid. In this circuit the wave-length sent out from the antenna is controlled by the position of contact A, while contact B has to be properly adjusted to get maximum output from the tube. The key by which signals are sent out is shown in the grid circuit. Because of this is always the best circuit in which to introduce the sending key; with the smaller tubes, however, it is possible to open the main oscillating circuit itself by a small hand key, if desired. A small Morse key in the grid circuit of a large power tube may safely be used to control several kilowatts of power.

A scheme used extensively by amateurs for short wave generation is that shown in Fig. 20. The plate is supplied with power from the "B" machine through an iron-core choke-coil, the function of which is to maintain the current furnished by the "B" machine as uniform as possible (hence called "choke" as it chokes out variations in this current). The wave-length is controlled primarily by the position of contact A, and the maximum output of the tube is obtained by changing both the capacity of condenser C and the position of contact B. The condenser C, should, for the average tube, be about twice the capacity of the antenna tube, be frequency of oscillation is controlled directly by the capacity of the antenna; if this changes so does the wave length radiated and hence the wave-length of the station will vary as the wind blows. This has a very serious effect in limiting the transmission

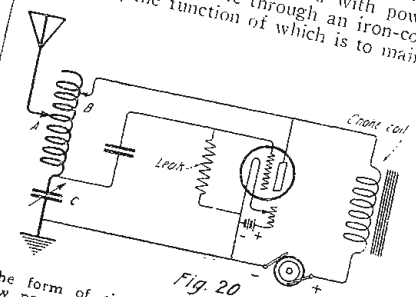
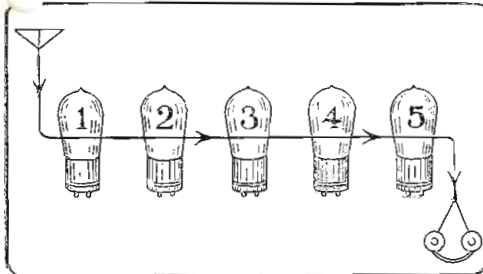

Fig. 20 The form of circuit generally employed for low power radio telephony. The choke coil current constant, a requirement in radio tele- phone outfits.



# Why Burn Five Tubes To Do the Work of Three?



Three tubes, duo-reflexed as shown at the right, are fully equal to five tubes in conventional sequence.

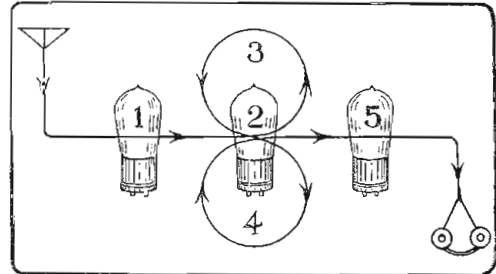

The most important advance in coupling methods of late years is ERLA Selectoformer, materially improving range, selectivity and volume. \$5

**F**IVE stages of amplification with only three tubes—this is the secret of the amazing coast-to-coast loud speaker range of the Erla three-tube Duo-Reflex circuit, surpassing all but the most elaborate hook-ups in sensitiveness and volume.

Erla Duo-Reflex action (patent applied for) enables vacuum tubes to do triple duty, as simultaneous amplifiers of received radio frequency, reflexed radio frequency and reflexed audio frequency currents, tremendously increasing efficiency while reducing cost.

Indispensable to the practical application of this principle, and the foundation of its success, are Erla synchronizing radio and audio transformers.

Accurately superimposing (1) received and reflexed radio, and (2) rectified radio and reflexed audio currents, in their coincident passage through amplifying tubes, they eliminate all trace of distortion. Only those who have actually heard Erla performance can realize the vast improvement in tone quality resulting.

Other exclusive Duo-Reflex advantages, for example, the fool-proof tuning control, giving an accurate log of stations together with complete freedom from radiation, have equally scientific origin.

Erla Selectoformer, tested capacity condensers, and fixed crystal rectifier spell outstanding advancement in their respective fields.

For complete Erla circuits, ask your dealer for Bulletin No. 20; or write, giving your dealer's name.

**Electrical Research Laboratories**  
Dept. C 2500 Cottage Grove Ave., Chicago

# ERLA



Unduplicated sensitiveness, range and volume, from 200 to 700 meters, are assured through employment of Erla reflex transformers. List \$5



Erla Push-Pull transformers handle output of five-watt power tubes, using as high as 350 volts on the plate, without distortion. Pair \$10



Even three stages fail to impair the distortionless performance of Erla audio transformers, an achievement unduplicated. List \$5

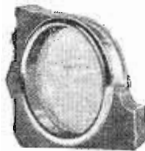

Any panel is improved 100% by Erla bezels, finished in bright nickel or dull enamel, with telescoping rim to fit 1/8" to 1/4" thick material. 20c



End crystal troubles with Erla fixed crystal. Highest rectifying value and non-oxidizing contact point guarantee satisfaction. \$1



Exclusive, double, tilting springs of Erla Sockets give clean, wiping contact essential to low amperage tubes. List 65c and 75c



The words "tested capacity," found exclusively on the labels of Erla condensers, provide positive assurance of correct value. 35c to 75c

Dealers and Jobbers—Erla dependable radio products provide surest guarantee of speedy turnover and volume of sales, in season and out



**IT'S THE CONTACT THAT COUNTS**

**NA-ALD SOCKETS**

For 200 Tubes  
 No. 400, Price 75c  
 No. 401, Price 35c  
 Three for \$1.00  
 For U.V. 199  
 No. 499, Price 50c  
 No. 429, Price 75c  
 For W.D. 11  
 No. 411, Price 75c

The best radio engineering practice of today calls for the elimination of as much material as possible in the neighborhood of those parts of the set which carry the radio frequency current. This applies not only to metallic substances, but to insulating materials as well.

Na-ald Sockets provide for this by having uniform walls of Bakelite, giving the material its highest dielectric properties.

"Frying" noises, often attributed to B batteries, are in reality caused by poor connection. Na-ald De Luxe contacts not only press on the bottom of tube terminals, but cut into the sides, automatically making a bright, perfect connection.

No. 400 De Luxe is the standard for Neutrodyne and Superheterodyne Sets.

Send 15c or cover of Na-ald dial or socket carton for new Rolography Booklet, "What to Build."

**ALDEN MANUFACTURING COMPANY**  
 DEPT. K 52 WILLOW STREET SPRINGFIELD, MASS.

range of the station. To cover much distance with a low powered station the receiving circuit must be very sensitively tuned and if the frequency of the transmitting station is varying this cannot be done.

The best stations set their frequency by a small oscillating tube connected to a closed tuned circuit, which has a frequency entirely independent of any changes in the antenna capacity. The grids of the tubes furnishing power to the antenna get their excitation by magnetic coupling to this closed oscillating circuit. Both the antenna circuit and that of the small excitation tube (called the master oscillator) must be accurately tuned to the wave-length it is desired to radiate.

**VOICE MODULATIONS WITH TUBES**

In radio telephony it is necessary to vary the amplitude of the high frequency current in the antenna according to the voice-frequency which it is desired to transmit. This is best accomplished by using an extra tube as a so-called modulator; the function of the extra tube is really to use up more or less power from the oscillating tube and hence to make the antenna current vary. The best arrangement for this purpose is shown in Fig. 21; it is due to Heising and is the well-known Heising scheme for modulation.

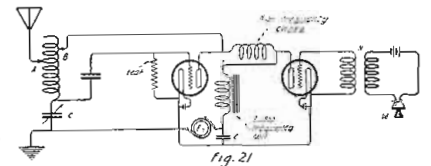

Circuit diagram of the Heising modulation system, the one universally employed in radio broadcast transmitters.

Both oscillator and modulator draw their plate-current from the same machine and through the same iron core choke-coil, shown in Fig. 21 connected directly above the plate circuit generator  $E_h$ . This choke coil prevents the current supplied to the combination of two tubes from varying appreciably; that is, they both together draw constant current from  $E_h$ . The telephone microphone  $M$ , is used to control the potential of the grid of the modulator tube, through a step-up transformer  $N$ . The variation of the potential of this grid will make the plate circuit of the modulator tube take more or less current from the plate circuit of the oscillator tube, as the sum of the two plate circuit currents must be essentially constant. As the amplitude of the high frequency current supplied to the antenna by the oscillator depends directly upon the amount of current supplied to it by the  $B$  machine it is evident that the action of the microphone  $M$  will control the amplitude of the antenna current, making the envelope follow the voice sounds acting at  $M$ .

**"WIRED WIRELESS"**

A new use of the triode in wire telephony makes it possible to send many telephone conversations over the same pair of wires at the same time. The scheme used is the invention of Major-General G. O. Squier and makes it essentially a radio telephone outfit, both sending and receiving, but instead of broadcasting the waves in all directions they are sent along ordinary telephone wires.

The frequency of the currents used are not as high as those used in radio, being generally between 5,000 and 30,000 cycles per second. A transmitter generating, let us say, 20,000 cycles is connected by two telephone wires to a receiving circuit tuned to receive 20,000 cycles, and regular communication is established by the same electrical circuits and actions as though the two stations were using actual radio waves. A detector and amplifier are necessary at the

**Genuine Bakelite!**

The most efficient dials and sockets are made from Bakelite, the world's foremost insulating material. Our experience as one of the country's oldest molders of Bakelite is one of the reasons why BELL Sockets and Dials make good wherever used.

**The BELL DIAL**

Highly polished. Clean, white engraving. Accurate brass bushings that will not wobble on the shaft. Strong mechanically and unaffected by moisture and temperature. Color will not fade. In 2, 3, 3½, and 4 inch sizes. Made also with hole through knob for vernier attachment. Vernier knob to match can be supplied.

**The BELL Square Socket**

One-piece molded Bakelite, for base or panel mounting. Unusual double-wipe spring contact makes firm, sure contact with tube prongs, even after constant use. Use it to get best results.

DEALERS: If your jobber does not have BELL Radio Products, write us for circular on molded sockets and dials.

**BELL MANUFACTURING CO.**  
 11 Elkins Street Boston 27, Mass.

**ELECTRAD LEAD-IN**

Fits right under closed window. Can be bent to fit ledges. Covered with fireproof insulating material, preventing grounding of circuits on wet window sills. Takes place of unsightly porcelain tubes and holes in the window sash. At your dealers', or order direct.

**40¢**

ELECTRAD, Inc. Dept. H  
 428 Broadway New York

**REAL VALUE FREE**

Three circuit book up whether you buy the Amerex Universal Tuner or 109. Amazing results. Litz wire on Bakelite; untuned primary and 180° tickler. Price \$3.75. Similar instruments sell for \$5.50. Full satisfaction or money back within five days.

Senders Write:  
**AMERICAN STANDARD ELEC. CO.**  
 243 West 34th Street New York City



“GOLDEN-LEUTZ”

# “SUPER-PLIODYNE 9”

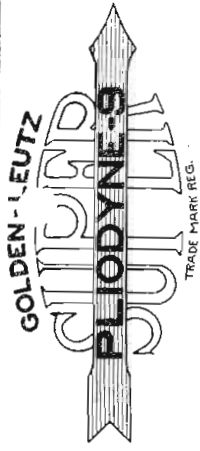

TRADE MARK REG.  
"The Perfect Broadcast Receiver"



Size 40 x 8 x 8

Weight 65 Lbs.

MANUFACTURED UNDER FARRAND LICENSE

A New Broadcast Receiver having 6 Stages of Tuned Neutralized Radio Frequency Amplification, Detector and 2 Stages of Audio Frequency Amplification

*BUILT FOR PEOPLE WHO WANT THE BEST*

Complete Illustrated Catalog and Instruction Book mailed upon receipt of 25c

## GOLDEN-LEUTZ CORPORATION

476 BROADWAY

NEW YORK CITY



# Barkeley Four-Phone Plug

PATENTS PENDING

Connects one to four head sets and all in series to any radio set employing standard telephone jacks.

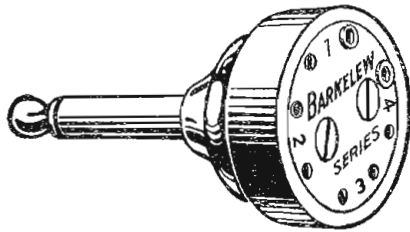

Cat. No. 616  
Price \$1.50

It adds to the appearance of any set. With all phone tips adjusted, the diameter is but 1 1/4 inches. Improvements in the 1924 model make it the most reliable buy on the radio market.

CHICAGO, ILL.  
15 S. CLINTON ST.  
NEW YORK  
50 CHURCH ST.

## BARKELEY

SAN FRANCISCO  
72 FREMONT ST.  
LOS ANGELES  
411 S. MAIN ST.  
MIDDLETOWN, OHIO

ELECTRIC MANUFACTURING CO.

Announcing the New Goldcrest

## CLEARODYNE MODELS

Model 70

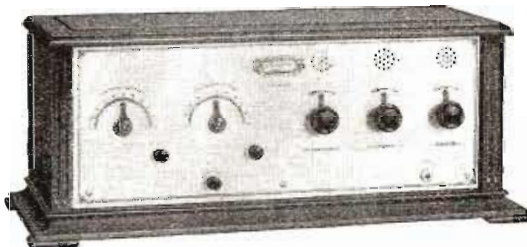

\$75.00

Cleartone engineers have perfected a new circuit, embodying the desirable features of SELECTIVITY, LOG-ABILITY, EXTREMELY SIMPLE TUNING AND PERFECT CONTROL in the new GOLDCREST CLEAR-O-DYNE FOUR TUBE MODELS.

The beautifully etched, gold finished panels and the distinctive solid mahogany cabinets, combine to give you a receiving set which is a valuable addition to any home. Long distance records are being established with these new models, on which testimonials are being received daily. We want you to see and be convinced. Write today for free illustrated circulars, showing all of our beautiful cabinet models.

DEALERS and JOBBERS: Look at the prices below—then at the distinctive design and characteristics above. Write for our interesting proposition—a business builder.

Model 60 .....	\$60.00	Clear-O-Dyne model 70 .....	\$75.00
Model 61 .....	75.00	Clear-O-Dyne model 71 .....	90.00
Model 62 .....	120.00	Clear-O-Dyne model 72 .....	135.00

The Cleartone Radio Company, Cincinnati, Ohio

### R A D I O D Y N E NO LOOPS—NO AERIAL

Ready for operation by grounding to a water pipe or radiator, and throwing a few feet of wire on the floor. Uses any standard tubes—dry cell or storage battery. Extremely selective. Simple to operate—only two controls. Wavelength from 200 to 700 meters. Write for Folder describing this (antennaless) receiver.

WESTERN COIL & E. CO.

314 Fifth Street Racine, Wis.

HEAD SETS LOUD TALKERS  
PHONO ATTACHMENTS

## TRIMM

RADIO MFG. CO., Dept. 66  
24-30 S. Clinton St. Chicago, Ill.

receiving station just as they are in a radio receiving station.

Such "carrier telephony" or "wired wire-less," as it is variously called, will probably never have the vacuum tube apparatus located on the subscriber's premises; it will be installed only in the telephone exchanges, as at present. The carrier current is sent out only between exchanges, that is, over trunk lines. Thus, when subscriber A talks into his microphone, ordinary audio frequency currents are sent to the exchange with which he is connected. Here a carrier frequency oscillator is operating and the voice of subscriber A modulates (varies the amplitude of) this carrier frequency wave, whereupon the modulated wave is sent to the next exchange with which subscriber is connected. In this second exchange are installed a detector and amplifier and the detected current is sent out from the exchange to subscriber B as ordinary audio frequency current, just as though A had been talking directly to B by ordinary telephone currents.

It is feasible, commercially, to send over a trunk telephone line about five carrier frequencies as well as one audio frequency current at the same time without interference. This increases the possible number of calls handled between exchanges by six times as many as would be possible without the scheme, and without installing any more telephone cables.

### RADIO TELEPHONY AND WIRE TELEPHONY COMBINED

It will also be seen by the imaginative reader that he may, while sitting at home, carry on a telephone conversation with a friend in Europe, or anywhere else in the world, by such apparatus as has been described. He may, for example, talk into his microphone in Chicago; the current started in his microphone will be transmitted by wire to a large radio central station. In going the thousand miles from Chicago to the sea coast, where the radio central would be located, however, it would be necessary for the voice current to be amplified several times, by vacuum tubes used as amplifiers at various points in the wire telephone system. These are called "vacuum tube repeaters," or merely "repeaters." Probably four repeaters would be used to take the current from Chicago to New York. At the radio central station the voice current would control the grid potential of a small vacuum tube, this resulting in corresponding changes in the plate current. This would be successively amplified by tubes until it was powerful enough to control the output of a 100-kilowatt tube oscillator. This modulated, powerful, high-frequency wave would be hurled into space for thousands of miles in all directions. It could be picked up by an antenna in Europe, changed from a modulated high frequency current to audio frequency current, put on the ordinary telephone wires and thus transmitted to the friend in question. And even after the tremendous changes which would have been imposed upon the weak current generated in the microphone at Chicago, the received speech in Europe would very likely be clearer than if it had been transmitted over only a few miles of poor telephone line.

It will be noticed that at every step of this miraculous accomplishment, today possible even though expensive, the ubiquitous three-electrode tube, first built by De Forest, then perfected by the workers in research laboratories and finally fitted with the remarkably functioning circuit connections of Armstrong, is quietly playing the all-important parts. Even a Jules Verne, with all his wonderful imagination, would find it difficult to predict all the feats which this device will undoubtedly be carrying out at the end of the next decade.





No. 7111 Eveready "A" Dry Cell  
The best battery for use with dry cell tubes

No. 766 "B" Battery, 22 1/2 volts

## More Power for Summer Radio

WHEN you take radio away with you—take Eveready Radio "A" and "B" Batteries, the batteries whose great power lasts longer. Remember, summer's the time when radio signals are weaker.

Batteries do get used up in time. The ones you've been using, though partly exhausted, may be satisfactory for the strong winter signals, but are probably inadequate for the weaker summer signals.

For instance, use the familiar standard 22 1/2-volt Eveready "B" Battery No. 766. It has variable taps for "soft" detector tubes. Put two, three or four in series to provide sufficient power for amplifiers.

To light the filaments of your dry cell vacuum tubes for the longest time, use Eveready Dry Cell Radio "A" Battery No. 7111. The Eveready "A" will astonish you by its long-sustained vigor. It is advisable to use two Eveready "A's" connected in

multiple for each WD-11 or WD-12 tube—this gives the economical "eighth" ampere drain per cell which insures maximum economy and longer life. For sets employing one to three UV-199 tubes use three Eveready Dry Cell Radio "A" Batteries No. 7111 connected in series.

The greatest electro-chemical laboratory known created these famous dry-cell batteries on which radio largely depends. The experience of thirty years in battery making stands back of them.

Eveready Radio "A" and "B" Batteries—lively, peppy, long-lived producers of power.

For your light-weight sets to take camping or on hikes, Eveready has suitable small batteries.

Manufactured and guaranteed by  
NATIONAL CARBON COMPANY, INC., New York—San Francisco  
Headquarters for Radio Battery Information  
Canadian National Carbon Co., Limited, Toronto, Ontario

Informative and money-saving booklets on radio batteries sent free on request. If you have any questions regarding radio batteries, write to G. C. Furness, Manager, Radio Division, National Carbon Company, Inc., 122 Thompson Avenue, Long Island City, N. Y.

Eveready 6-volt Storage "A" Battery

No. 771 "C" Battery

No. 763 "D" Battery

No. 764 "B" Battery

No. 767 "B" Battery

**EVEREADY**  
**Radio Batteries**  
—they last longer



# Keep Yourself Up to the Minute on RADIO

The one best way is with Lefax Perpetual Radio Handbook. Grows with every new discovery about Radio. Cannot become out-of-date. Gives all known facts and new ones as they are learned by the authors—Dr. J. H. Dellinger, Chief of the Radio Laboratory, U. S. Bureau of Standards and L. E. Whittemore, Department of Commerce, Washington, D. C.

As a purchaser of the Lefax Radio Handbook you receive complete information on new Radio developments every month free for one year. This information comes to you on printed, punched, page form. You add the pages instantly, easily. Includes a complete list of broadcasting stations and full information about every one. No Radio book is or can be like

## LEFAX PERPETUAL RADIO HANDBOOK

Pocket size, loose leaf, flexible imitation Morocco leather—fine looking, long wearing. Type clear, sharp. Illustrations clean, fine, easy to understand. Index tabs of linen—tough, strong—plainly marked.

A practical Radio guide that keeps you up to the minute on Radio and all that goes with it. Lefax Perpetual Radio Handbook grows with Radio. You get new, useful, authentic information, free, every month. It comes to you automatically. Ask your Radio supply man, stationer or bookseller.

**LEFAX, INCORPORATED, Publishers**  
PHILADELPHIA, PA.

### Prolong the life of your tubes with this Filament Voltmeter

By operating tubes at correct filament voltage, the life of tubes is increased at least threefold. This Model 301 Weston Voltmeter costs little more than a tube. With a Weston Voltmeter you can always duplicate instantly any voltage required. For quick tuning and good reception, it is an absolute necessity. Case diameter 3 1/4 in. Every instrument guaranteed. The Weston Electrical Instrument Company has pioneered the development and manufacture of electrical indicating instruments for 35 years in every branch of the electrical industry. The name Weston on an instrument means that there is none better. Get one for your set today.



#### A double range table voltmeter for every radio fan

Tells you actual grid, filament and plate voltages. A great aid in working DX successfully. Ranges 1 1/2 and 150 volts. Weston built, which means stronger. A precision instrument insuring lifetime service and satisfaction. One of seven described in Circular J, which shows instrument connections for both transmitting and receiving sets. Write today for particulars.

**WESTON ELECTRICAL INSTRUMENT CO.**  
173 Weston Avenue, Newark, N. J.  
Branches in All Principal Cities



Electrical Indicating Instrument Authorities Since 1888

# WESTON

STANDARD - The World Over

**\$25 for \$10** BEL-CANTO LOUD SPEAKER  
**PRICE \$10** DELIVERED TO YOUR DOOR  
SOLD ON MONEY BACK GUARANTEE  
BEL-CANTO MFG. CO.  
417-419-421 E. 34th St.  
New York City

**HALLDORSON**  
**\$65** Radio Receivers  
4-Tube Sets Designed and created with deliberate scientific foresight—not a "rush job" for immediate demand. Write today for facts on the most popular set for the home.  
Dealers and Jobbers: Write for Our Attractive Proposition  
**HALLDORSON COMPANY**  
1772 Wilson Ave. Chicago, Ill.

## New Radio Patents

(Continued from page 1770)

loose contact increase with the current and vice-versa, so that the current in the apparatus where it is consumed attains a more constant flow. In order to raise the current to a certain height during that part of the period in which it nears its zero value, according to the invention one or more gas batteries are further connected parallel with the source of the pulsating direct current for which e.g. a battery may be chosen, comprising lead plates submerged in a solution of alum. When in this case the current of the rectifier exceeds a certain value, the battery accumulates energy, which when the current sinks below a certain value is again delivered.

### ANTENNA ARRANGEMENT FOR WIRELESS TELEGRAPHY

(Patent No. 1,483,860. Issued to Otto von Bronk, of Berlin, Germany, Feb. 12, 1924.)  
This invention relates to radio signaling systems and particularly to a method and apparatus for eliminating undesirable effects of the antenna masts.

The great height of the masts used for radio antenna makes it necessary to provide relatively great mechanical firmness. It is, therefore, necessary to make the masts almost entirely of metal. The masts are a troublesome necessity in the alternating field of the antenna, as they produce dis-

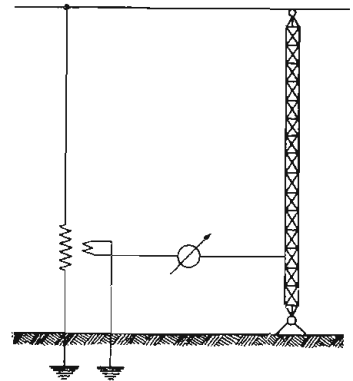

torion in the path of the lines of force between the antenna and its surroundings which unfavorably influence the radiation and produce currents in the masts, which, depending on the resistance present result in losses and diminish the effectiveness of the entire antenna arrangement. To prevent these, the masts are usually separated from the ground by means of insulation, but it is difficult to maintain the insulation permanently good.

The present invention discloses a further means to counteract the effects mentioned. The mast is subjected to an electromotive force by means of an auxiliary source of energy drawn from the high frequency source and having the phase and motive force in the neighboring dielectric. The lines of force from the dielectric entering into the mast are thus reduced to a minimum so that the energy consumed in the mast can only be very small.

### MEANS FOR CONTROLLING ELECTRICAL TRANSMISSION

(Patent No. 1,483,179. Issued to Jacob S. Jammer, of New York, N. Y., Feb. 12, 1924.)

The invention relates to means for controlling the transmission gain or loss in a line transmitting currents of different frequencies, for instance, a telephone line transmitting different frequencies in the voice frequency range, or a carrier line transmitting frequencies, for example, as high as 30,000 cycles per second and as low as 6,000 cycles.

It is customary, in long lines of such character, to insert repeaters giving transmission gains tending to counteract the attenuating effect of the line upon the currents transmitted. Ordinarily a potentiometer is associated with the repeater, in order

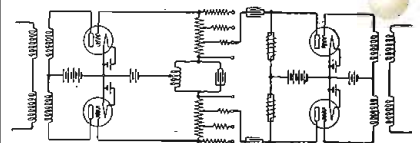

that when the line attenuation increases or decreases the potentiometer setting may be correspondingly adjusted to cause the repeater gain to be increased or decreased by an amount approximately the line attenuation change as nearly as possible. However, the usual changes of line at-



Approved  
by the  
Radio News  
Laboratories

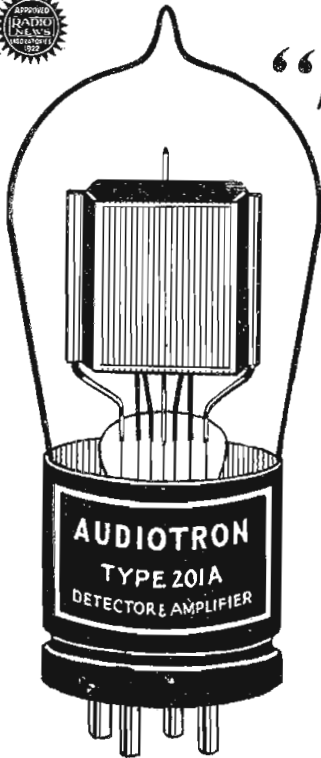

**LIST \$4.00**

## APEX AUDIOTRON GUARANTEE

All Apex Audiotron tubes are guaranteed, and Dealers, as well as the manufacturers, will make replacement on all tubes that prove unsatisfactory in any way. The only requirement is that the tube must not have been burned out.

## APEX AUDIOTRONS

# “Sound Perfection”

Apex Audiotrons have been on the market for a considerable length of time. They have been sold throughout the country and results have been highly gratifying. Apex Audiotrons are now being advertised nationally for the reason that the factory output has become large enough to take care of a great demana.

This is the first time that a manufacturer has sold a tube with a full guarantee. Apex Audiotrons may be relied upon at all times.

ALL TUBES ARE GUARANTEED TO WORK IN RADIO FREQUENCY. ESPECIALLY ADAPTED FOR NEUTRODYNE SETS.

The following tubes are now on sale:

	PRICE
Type 201A—5 volts, .25 amperes . . . . . Amplifier and Detector	<b>\$4.00</b>
Type 199—3-4 volts, .06 amperes . . . . . Amplifier and Detector	<b>\$4.00</b>
Type 12—1½ volts, .25 amperes . . . . . Platinum Filament—Amplifier and Detector	<b>\$4.00</b>
Type 200—5 volts, 1 ampere . . . . . Detector Tube	<b>\$4.00</b>

## “ATTENTION DEALERS”

The following Distributors supply “Apex Audiotron” tubes.

Radio Tube Exchange  
200 Broadway  
New York City  
Radio Equipment Co.  
761 N. Gower St.  
Los Angeles, Calif.  
Radio Specialty Co.  
25 W. Broadway  
New York City  
Standard Automotive Equip. Co.  
1074 Boylston Street  
Boston, Mass.  
Radio Auto Supply Co.,  
920 D St., N.W.,  
Washington, D. C.

Baltimore Hub Wheel & Mfg. Co.,  
Gay Street and Fallsway,  
Baltimore, Md.  
Wm. Spalding & Co., Inc.,  
109-113 W. Jefferson St.,  
Syracuse, N. Y.  
Radio Tube Exchange,  
17 So. Union St.,  
Rochester, N. Y.  
Wellston Radio Co.  
1479 Hodiamont Ave.,  
St. Louis, Mo.  
Ridenour, Seaver & Kendig  
Caxton Bldg.  
Cleveland, Ohio

Globe Electric Co.,  
Chamber of Commerce Bldg.,  
Pittsburgh, Pa.  
W. P. Mussina  
1625 Barnard Ave.  
Waco, Texas  
The Radio Shop, Inc.  
189 Union Ave.,  
Memphis, Tenn.  
Specialty Sales Co.  
535 Main St.  
Springfield, Mass.  
Eisenberg & Schaefer  
137 Market St.  
Philadelphia, Pa.

CANADIAN DISTRIBUTOR: Windsor Radio, Ltd., 26 Ferry St., Windsor, Ont.  
Export Dept.: U. S. Radio Export, 15 Park Row, New York City. Cable Address: Chalbenco.

If your local dealer cannot supply you, order direct.

**RADIO TUBE CORPORATION**  
70 HALSEY STREET NEWARK, N. J.





# CONTINENTAL

*"New York's Leading Radio House"*

## The Sets that Sell

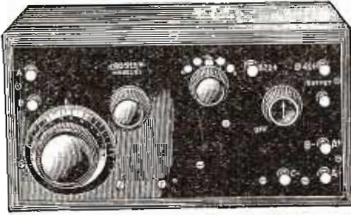

**Crosley Model 51**  
*above*

When your customers want something a little more powerful than the Ace 5 supply them with the Model 51. It is similar to the Ace 5 with the exception of one stage of audio frequency which is included in the cabinet.

Crosley receivers are big sellers. Model 51 has become very popular as a portable set.

**Radiola III**  
*below*

An ideal receiver to sell your customers for portable use in the summer time. It is small, compact, sensitive, and selective, yet powerful enough to operate a loud speaker.

Economy of operation and low cost makes this receiver easy to sell. Don't forget the rush this summer for portable sets.

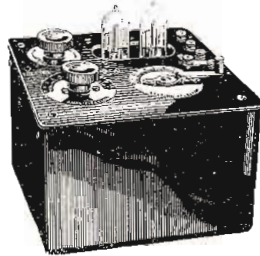

attenuation are greater for the currents of the higher frequencies being transmitted over the line than for the currents of the lower frequencies passing over the line. This is true both as regards cases where currents of the voice frequency range are being transmitted and as regards cases where currents of higher frequencies, for instance, 6,000 cycles and 30,000 cycles are being transmitted. In the former cases the predominating influence in causing change of line attenuation usually is change in the temperature of the line; and in the latter case the predominating influence generally is change of specific inductive capacity of the medium surrounding the line, due to change of dampness. Since the changes of line attenuation vary with frequency, it is clear that merely shifting the potentiometer setting cannot entirely compensate for these changes, inasmuch as changes in the setting of the usual type of simple potentiometer cause repeater gain changes which are equal at all frequencies. The most complete compensation can only be obtained by means of producing transmission gains or losses varying with frequency.

The present invention provides an attenuating device adjustable to give changes in its transmission gain or loss which vary with frequency, and further, to provide such a device wherein movement of a single element may cause the adjustment necessary to effect the varying changes of gain or loss.

**AIRPLANE INTERPHONE SET**  
(Patent No. 1,484,973. Issued to George H. Stevenson, of Rye, New York, Feb. 26, 1924.)

This invention relates to airplane interphone sets and more particularly to intercommunicating sets for wire signaling, one or more of which are also associated with radio signaling apparatus.

An object of the invention is to provide apparatus to permit an occupant of an airplane to keep in constant communication with a distant signaling station on another airplane or on the ground and at the same time to be able to receive communication from other occupants of the airplane.

Another object of the invention is to provide a combined radio and interphone system with common repeating and amplifying elements for both the radio and intercommunicating circuits.

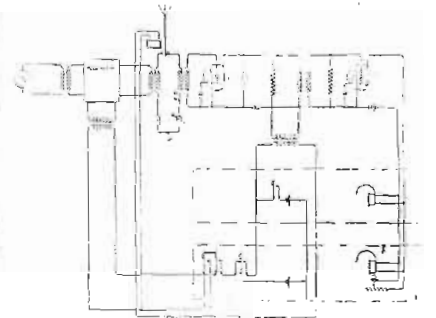

According to this invention, an airplane pilot and the observer are each equipped with headsets interconnected to permit communication during flying. A radio receiving apparatus including an amplifying repeater is also associated with the headsets in such manner that the repeater is common to both the radio receiving circuit and the interphone circuits. A radio transmitting apparatus is placed under the control of the observer. The observer is, therefore, able to carry on a two-way communication with a distant radio station or two-way conversation with his pilot, the same receiving amplifier serving for either conversation. The observer operates a switching arrangement which controls the high frequency radio transmitting circuits and thus connects the antenna either to a radio receiving branch when listening, or to a radio transmitting branch when talking.

### How Radio Relay Linked Six Stations

*(Continued from page 1729)*

program is being broadcast by station WJZ, New York City, WGY in Schenectady, KDKA in Pittsburgh, KFKX in Hastings, Nebraska, and KGO, Oakland, California." most immediately upon the conclusion of Mr. Ralph Howes' opening address, telegrams of congratulation began pouring in to the Waldorf and continued to arrive from increasing distances until the conclusion of the program at 12:15 Eastern Standard time. At 11:22 p. m., E. S. T., the first report of reception, by station 2AC in England, was telephoned from the radio office. At 12:15 a. m., E. S. T., a telegram from Mr. Sadenwater, engineer-in-charge of station KGO in California, stated that the signals had

CONTINENTAL RADIO and ELECTRIC CORPORATION  
FIFTEEN WARREN STREET, NEW YORK, U. S. A.

## Let HOMMEL'S experience guide you



This organization was one of the pioneer wholesale distributors of radio equipment. They have seen hundreds of retailers come and go,—they know from experience "what and when and how" dealers can best sell radio supplies and enjoy a satisfactory margin of profit.

HOMMEL distributes only recognized nationally advertised apparatus that is guaranteed by the manufacturer,—their dealer discounts are very liberal,—their stocks are always ample to take care of any requirement,—they wholesale exclusively and do not compete with dealers by retailing.

HOMMEL'S Dealer Service Department is maintained for your benefit,—their experience and advice will prove helpful to you in many ways, and this service is cheerfully given any time without charge. Get in touch with us to-day, write for the new HOMMEL encyclopedia 246-S—profit by HOMMEL'S experience—it is paying hundreds of other dealers—why not you?

**LUDWIG HOMMEL & CO**  
530-534 FERNANDO ST. ———— PITTSBURGH, PENNA

### DUO SPIRAL HETRO-LOOP

Especially designed for Super-Hetrodyne Receivers. If your dealer hasn't it—write us.  
RADIO UNITS, INC.  
1305 First Ave., Maywood, Ill.

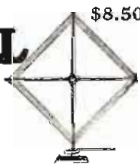

\$8.50

### STEINMETZ

**3 TUBE SET \$37.50**

Has Obtained Many Records for Distance Over Loud Speaker. Get Our Complete Catalog. STEINMETZ WIRELESS MFG. CO.  
5705 Penn Ave. Pittsburgh, Pa.



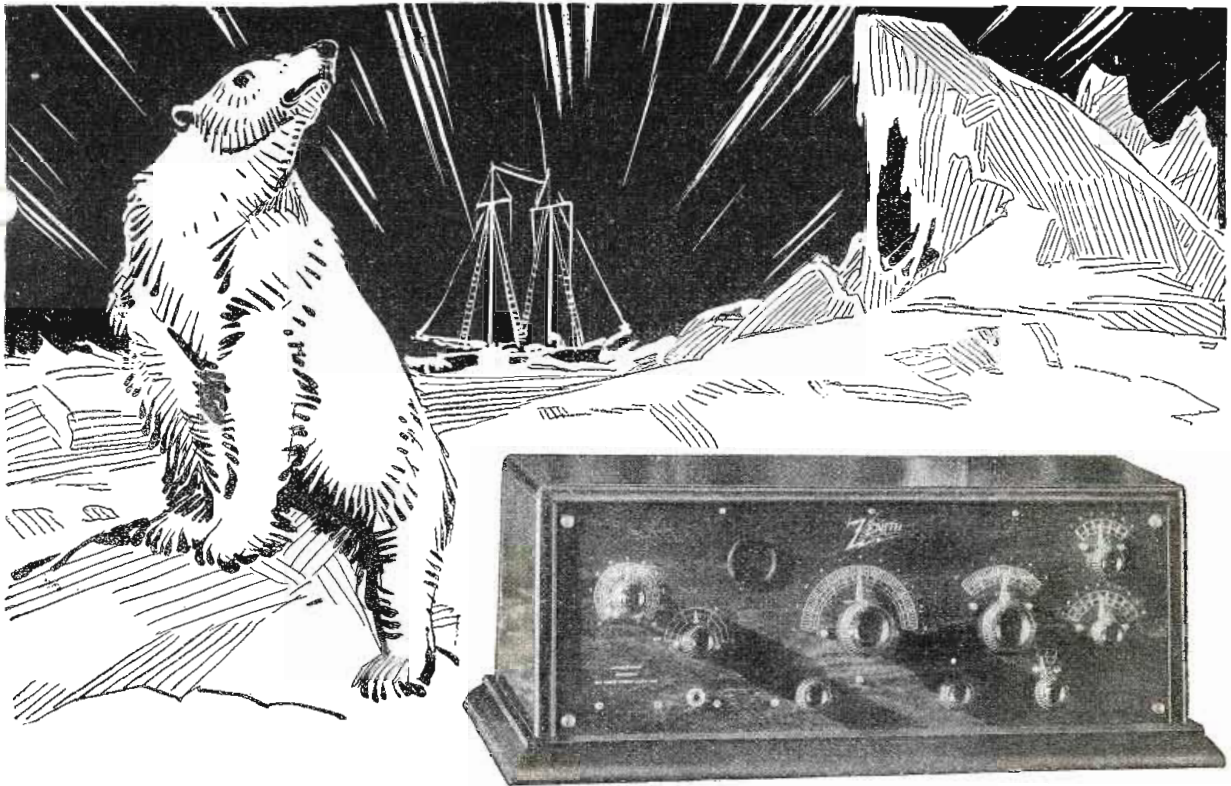

Licensed under Armstrong U.S. Patent No. 1,113,119

## Eleven Degrees from the North Pole

Ice—endless miles of ice, as far as the eye can see. And frozen fast in the ice, amid the deadly stillness and the unearthly lights of the Arctic, a staunch little eighty-nine foot schooner! But Donald B. MacMillan and his band of brave explorers are not alone tonight.

Under their ice-bound hatches they listen eagerly to the news of the outside world, broadcast to them from the Zenith-Edgewater Beach Hotel Broadcasting Station, Chicago—to violins in Newark, Schenectady, Los Angeles—to singers in Atlanta—to a lively orchestra in Honolulu.

Stations in all these cities—and in several hundred others—they have readily tuned in; yet the Bowdoin tonight is only eleven degrees from the North Pole!

Out of all the radio sets on the market, Dr. MacMillan selected the Zenith exclusively—because of its flawless construction, its unusual selectivity, its dependability and its tremendous REACH.

And you can do all that Dr. MacMillan does, and more, with either of the two new models described at the right. Their moderate price brings them easily within your reach. Write today for full particulars.

## Zenith Radio Corporation

McCORMICK BUILDING, CHICAGO



**Model 3R** The new Zenith 3R "Long-Distance" Receiver-Amplifier combines a specially designed distortionless three-stage amplifier with the new and different Zenith three-circuit regenerative tuner.

Fine vernier adjustments—in connection with the unique Zenith aperiodic or non-resonant "selector" primary circuit—make possible extreme selectivity.

**2,000 to 3,000 Miles With Any Loud-Speaker**

The new Zenith 3R has broken all records, even those set by its famous predecessors of the Zenith line. Satisfactory reception over distances of 2,000 to 3,000 miles, and over, is readily accomplished in full volume, using *any ordinary* loud-speaker. No special skill is required.

The Zenith is the only set built which is capable of being used with all present-day tubes as well as with any tubes that may be brought out in the future. The Model 3R is compact, graceful in line, and built in a highly finished mahogany cabinet ..... **\$160**

**Model 4R** The new Zenith 4R "Long-Distance" Receiver-Amplifier comprises a complete three-circuit regenerative receiver of the feed-back type. It employs the new Zenith regenerative circuit in combination with an *audion detector* and *three-stage* audio-frequency amplifier, all in one cabinet.

Because of the unique Zenith "selector," unusual selectivity is accomplished without complication of adjustment.

The Zenith 4R may be connected directly to any loud-speaker *without* the use of other amplification for full phonograph volume, and reception may be satisfactorily accomplished over **\$85** distances of more than 2,000 miles.....

ZENITH RADIO CORPORATION,  
Dept. 1A 328 South Michigan Avenue, Chicago, Illinois

Gentlemen:  
Please send me illustrated literature on Zenith Radio.

Name.....

Address.....



# BULB TYPE The Todd Charger FOR CHARGING STORAGE "B" BATTERIES ONLY.

## A BULB TYPE CHARGER FOR "B" BATTERIES ONLY

Will Put "Pep" Into Your "B" Battery from Your Lamp Socket of 110-120 AC, 60 Cycle Current.

Will charge the Edison element "B" battery also the lead "B" battery of the various makes. Delivers about 90 volts and will charge at the rate of about a little less than a 1/4 of an ampere to about 1/10 of an ampere.

**This Charger Does Away With the Nuisance of the Chemical Rectifier.**

Every Charger is Guaranteed by the Company

**THE TODD ELECTRIC CO., Inc.**  
Sold by all Good Dealers

TYPE C R



PAT. PEND.

**The Charger Has the Following Advantages:**

It is NOISELESS.

**ECONOMICAL:**—a 20-hour charge will cost but 5 cents.

**COMPACT:**—size 3 1/2 x 4 x 9 inches high.

**EFFICIENT:**—will positively charge the battery as current can flow in only one direction.

The Bulb is guaranteed for a period of one year. The charger may be permanently connected to the Radio Set and battery by means of a Double Pole Double Throw switch, thereby eliminating the necessity of disconnecting the Radio Set from the battery and charger.

**PRICE \$9.50**

been received and rebroadcast. These latter messages definitely placed the stamp of success upon the experiment.

One letter in particular indicates the success of the relay, for the writer, a proud possessor of an eight-tube and a 10-tube super-heterodyne set, tuned his eight-tube set to WJZ and left it there, while with his 10-tube set in the next room he brought in WGY, KDKA, KFKX and KGO in succession. "Each station," he said, "was absolutely synchronized in every note and every word with WJZ—there was no appreciable time difference."

Yet the full value of the experiment lies in the fact that the listener-in on a small set in Southern California or Northern Washington, who ordinarily receives little else but KGO—the families in the Southwest to whom KFKX is the clearest station—those in the Mississippi Valley whose sets will not receive east of KDKA, and those in Northern Maine and Canada to whom WGY is the "Distant Station"—could listen in to the program at the Waldorf-Astoria Hotel with as much ease and clearness as did the New Yorkers and New Englanders to whom WJZ is a next-door neighbor. To link up six broadcast stations, to blanket the country so that anybody, anywhere, with an ordinary receiving set could hear the one program, all without the use of wire or other material connections, constitutes the most magnificent example of radio's advance and of its practicability that has yet been shown.

## A Resistance Coupled Amplifier

(Continued from page 1760)

they should be in the neighborhood of 10,000 to 30,000 ohms each. Although best results will be obtained with the use of variable resistances, which may be left fixed after once adjusted, fixed resistances may be successfully employed. They may have one or two taps, so as to allow for a slight amount of adjustment. The following table gives the approximate values of resistances required for the different tubes now on the market, when using an amplifier with a "B" battery of 135 volts. This table was compiled by using a variable resistance, and adjusting it for each type of tube and measuring the value that gave the best results.

Type	Resistance
UV-201	25,000 ohms.
UV-201A	15,000 ohms.
UV-199	20,000 ohms.
WD-12	15,000 ohms.
WE-216A	4,000 ohms.

As a rule, a resistance coupled amplifier requires a higher "B" battery voltage than a transformer coupled one, because the high resistance in series with the tube limits the current flow. Very good results were obtained with a "B" battery of 135 volts, consisting of three 45-volt units connected in series. Although better results may be obtained with higher voltages, this is enough for ordinary requirements. If a good loud speaker is used with such an amplifier, excellent reproduction of every tone of the speech and music will be obtained.



**This Genuine Five Tube**

## Neutrodyne Receiver

The most beautiful and efficient receiver in the world for only \$47.50.

Everybody knows a neutrodyne and here's a chance to buy one. Buy the parts from us for this genuine Neutrodyne Receiver and we will build it for you absolutely free. Coast to coast on your loud speaker.

If after a ten day trial you are not satisfied with the set, we will cheerfully refund your money.

The first one hundred orders received will get 2 large 45 batteries free.

The parts used are as follows:

- |                                   |                              |
|-----------------------------------|------------------------------|
| 2 Sidbenel Jacks                  | 1 Set engraved Binding Post  |
| 3 Genuine Neutrodyne Transformers | 1-.002 Freshman Condenser    |
| 5 Sidbenel Sockets                | 1-.006 Freshman Condenser    |
| 1-6 Ohm Rheostat                  | 1 Set Neutralizing Condenser |
| 1-30 Ohm Rheostat                 | 1 Mahogany Cabinet           |
| 2 Supertran Transformers          | 1 Drilled Black Panel        |
| 20 Ft. Bus Bar                    | 3 Four inch Dials            |
| 1-.0025 Freshman Grid Condenser   | 1 Base Board                 |

Catalogue on request of Storage B Batteries, Parts and Sets.

**SIDBENEL RADIO EQUIPMENT MFG. CO.**  
29 WEST MT. EDEN AVENUE  
NEW YORK CITY

## The Standard Wave-meters of the Bureau of Standards

(Continued from page 1763)

of the inductors are wound with high frequency cable in a single layer upon a skeleton frame of laminated bakelite.

The wavemeter is tuned to a source of radio frequency currents by varying the air condenser and obtaining the maximum



# "BUILD YOUR OWN" WITH "RASCO" PARTS!

Buy from the Oldest and Original Exclusive Radio Parts House in the United States

We pay ALL transportation charges in U. S. ALL GOODS SENT PREPAID IN 24 HOURS

Order direct from this page.

**NOTE NEW PRICES FOR THIS MONTH ONLY**

Money refunded if goods do not satisfy



**Jacks and Plugs**  
Best materials. Silver contacts. Factory making Postal Telegraph jacks, makes these.  
V1000 Jack 4 springs .65  
V1001 Jack 3 springs .75  
V1002 Jack 5 springs .80  
V1003 Plug .55

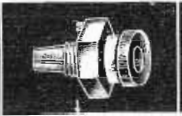

**Cord Tip Jack**  
Takes place of binding posts. Cord tip firmly gripped by jack. Made of brass, nickel plated. Screw to attach lead wire. No soldering necessary.  
V1500 Cord tip jack .15

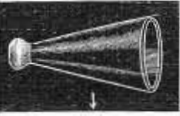

**Phonehorn**  
Base consists of Phone-horn into which fits a fine enameled fibre horn. Size of horn 12"; bell 6 1/2". Slip Phonodaptor end on a single telephone receiver.  
V1321 Phonehorn, prepaid \$1.45



**Radioite Detector**  
Base solid black composition. Automatic crystal holder. Triplo adjustments. Smallest, neatest detector made. Radioite crystal. 200,000 in use.  
V1899 Detector .50  
V1898 Galena detector .50

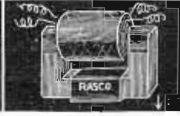

**Audio Frequency Transformer**  
No better Transformer made. Highest class materials. Impregnated coils. Siltcon steel stampings used. Save 50 per cent by assembling it yourself.  
V1100 Ratio 4 1/2-1 \$2.00  
V1150 Ratio 6 1/2-1 \$2.00



**Dup-Coilweb Coil**  
For Reinartz circuit, 200-600 meters. 1 1/2" dia. 4 1/2" diam. 1 1/2" center opening. Coil is firm and will not fall apart.  
V2550 Coilweb Coil \$1.15  
V2660 Coil for panel mounting, 225-600 met. \$1.90



**Melotone Loud Speaker**  
Best popular loud speaker. Flange horn, heavy metal base, five ft. cone. Nickel plated. Greatest tuned (adjustable) talker. Horn length 1 1/2"; bell 6 1/2"; total height 9".  
V255 Melotone Speaker \$4.05



**FREE**  
The big "Rasco" catalogue. Contains all Armstrong circuits. Easy up-to-date vacuum tube hook-ups. Greatest little book printed. Free upon receipt of postal.

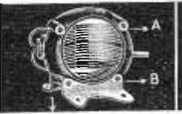

**Molded Variometer**  
Highly substantial instrument. Silk windings. 1/2" shaft. Flange B when placed into A-B direction makes instrument panel mounting. 150 to 650 meters. Money back if this instrument is not all that we claim for it.  
V3550 Variometer \$3.00



**FONEKUSHIONS**  
Made of sponge rubber. Make wearing your receivers a pleasure. Positive-ly exclude all noises and make reception a pleasure. Sponge rubber will last for years. Light as a feather.  
V3550 Fonekushions, set of two \$5.50



**Straight Line Condenser**  
Simplest and most practical type of condenser.  
V4430 "Rico" Condenser 100 mfd. 43 plate capacity . . . \$1.75  
V4230 .0005 mfd. 28 plate capacity . . . \$1.75  
V4110 .0025 mfd. 11 plate capacity . . . \$1.75  
All types no dials \$1.50



**Radio Frequency Transformer**  
Best Radio Frequency Transformer developed so far. Designed by R. E. Lacault, Associate Editor RADIO NEWS. Air core type.  
V2800 Transformer, size 1 1/2"x2 1/2" . . . \$1.50

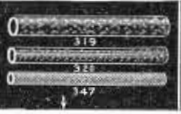

**Spaghetti**  
Varnished flexible cambric tubing. 319 takes No. 22 wire; 320 takes 18 to 20 wire; 31 takes 16 to 18 wire; 344 takes 22 to 28 wire.  
V319-320-321 Perf. \$ .06  
V344 Flexible soft rubber tubing; 10 feet for. \$ .20



**Soldering Iron**  
Smallest and handiest made. Fits any flat iron or percolator plug. Plug then becomes handle. 5" long. Complete but without plug or wire.  
V2200 Soldering Iron . . . \$1.45

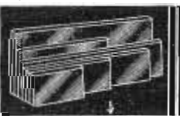

**Formica Panel Clearance Sale**  
As we are discontinuing these particular sizes, this material is now offered at cost. All 3/16" thick.  
V352 6x12" each \$1.75  
V354 6 1/2 x 19 1/2" ea. 1.90  
V356 6x14" each. 1.90  
V357 6x14" each. .65

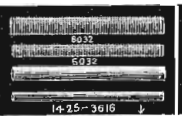

**Brass Rods**  
Sold in 6" lengths only.  
V6032 Rod, 8-32" thread length . . . \$ .09  
V6032 Rod, 6-32" thread length . . . \$ .06  
V1425 Rod, plain 1/4" round, length . . . \$ .10  
V3618 Rod, plain 3-16" round, length . . . \$ .06

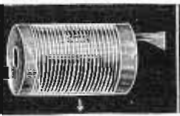

**Litz Wire**  
Prices are per foot. Equals  
V823 E No. 25 B&S .02  
V890 E No. 28 B&S .01  
V891 E No. 21 B&S .04  
V892 E No. 20 B&S .03  
10 per cent discount in 10 foot lots



**Copper Ribbon**  
.005" thick.  
V700 3/4" wide; V701 1/2" wide; V702 3-16" wide. All sizes per foot. . \$ .01  
Copper Foil  
.001" thick. 4" wide.  
V5025 Copper Foil per foot . . . \$ .10  
10-foot length . . . \$ .80



**Tin Foil**  
All our tin foils come 4" wide. Uniform product throughout.  
V2400 Tin foil, 40 amp. hours . . . \$3.90  
V640 Six volt, 40 amp. hours . . . \$ 7.25  
V650 Six volt, 60 amp. hours . . . \$ 9.50  
V851 Tin foil, lb. . . \$ .48



**Switch Knob**  
V199 Knob, 1 1/2" dia. height 5/8"; 8-32" screw.  
V4451 Has 8-32" or 10-32" bushing, no screw.  
V199 Knob . . . \$ .10  
V4451 Knob . . . \$ .06

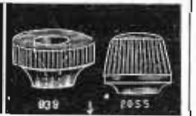

**Marconi Knob**  
Has central hole of 5-32" and seat to hold screw. 1 1/2" dia. height 3/4".  
V658 Knob, each. \$ .12  
Fluted Knob  
With 8-32" bushing. Black composition.  
V2055 Knob 1" high 1 1/4" diam. each . . . \$ .15



**Mounted Crystal-Cup**  
Cup has screw and adjustment nut. Fits all standard mounted crystals. Nickel plated, polished.  
V518 Nickel Cup . . . \$ .20  
Radioite  
Best most sensitive mounted crystal. U. S. Navy using it. Each tested.  
V517 Radioite Cryst. \$ .25



**Rasco Vernier**  
Why use a variable condenser when a vernier attachment will do anything and everything a vernier condenser accomplishes?  
Clerestep vernier made. Can be used with any dial. Soft rubber ring sways dial. Nothing to come apart.  
V1450 Vernier . . . \$ .30



**Angle Bushing**  
Angle piece used to mount panels on board, tubes on panels, etc. 1,000 uses.  
V1475 Angle piece. . . \$ .03  
Adapter Bushing  
Makes 3-16" dial fit 1/4" shaft. 1/4" long.  
V8866 Bushing . . . \$ .04



**Silver Dial**  
Silver surface black enamel lettering. For 1/2" shaft. No set screw required. All 2 1/2" dia.  
V800. Platin variometer; V801 Patm. Con.; V802 Sec. Cond.; V803 Counter; V804 Fil. Riced.; V805 Grid Variometer. Each style . . . \$ .20 each  
Set of six . . . \$1.15



**Storage Batteries**  
Guaranteed for two years. Only NEW material used. Acid proof material. Patent vents.  
V2400 Two volt, 40 amp. hours . . . \$3.90  
V640 Six volt, 40 amp. hours . . . \$ 7.25  
V650 Six volt, 60 amp. hours . . . \$ 9.50  
Shipped express collect.



**Vario-Rotor**  
Made of hard wood, accurately turned. Takes any finish. Large hole 2" diameter. Width 2", diameter 3 1/2". 2 shaft holes.  
V343 Rotor . . . \$ .30  
"Rasco" Universal Bearing. Especially made in this above rotor for panel mounting.  
V3475 Uni. Bearing \$ .25

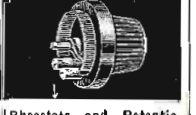

**Rheostats and Potentiometers**  
High heat dielectric base. Come with tapered, knurled knob. 2 1/2" dia. Complete with pointer.  
V4310 6 ohm. . . . \$ .65  
V4311 30 ohm. . . . \$ .45  
V4312 Potentiometer. 200 ohms . . . \$ .85

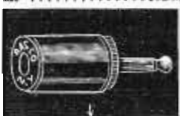

**Phone Plugs**  
Sold from 75c to \$1.00 everywhere. Hard rubber composition shell and patented cord tip holder. Finest workmanship throughout.  
V1030 Rasco Telephone Plug, each . . . \$ .35



**Bakelite Socket**  
Octagon shape. Four nickel binding posts. phosphor bronze contact springs. Best brass bakelite.  
V6510 Bakelite socket \$ .40  
V6500 Tube Socket. Made entirely of composition. Best made. Each. . . \$ .35



**Condensers**  
Best make, non-impregnated condensers. Capacity guaranteed.  
V5050 Phone Condenser, .001 . . . \$ .20  
V5056 Grid Condenser, .0025 . . . \$ .20  
V5059 Grid Leak Condenser. .0025 . . . \$ .30



**Name Plates**  
All name plates brass with silver plating.  
V839 (10-12 or 16) \$ .10  
V809 comes in 35 styles. Any denomination, each style . . . \$ .04  
Panel Scale, 2 1/2" x 9" metal, silver background, black lettering.  
V715 Scale, Each. . . \$ .15



**Binding Post Name Plates**  
Dia. 3/4". These styles: Phones, Ground, Output, "A" Bat., "B" Bat., "C" Bat., "D" Bat., "E" Bat., "F" Bat., "G" Bat., "H" Bat., "I" Bat., "J" Bat., "K" Bat., "L" Bat., "M" Bat., "N" Bat., "O" Bat., "P" Bat., "Q" Bat., "R" Bat., "S" Bat., "T" Bat., "U" Bat., "V" Bat., "W" Bat., "X" Bat., "Y" Bat., "Z" Bat., "1" Bat., "2" Bat., "3" Bat., "4" Bat., "5" Bat., "6" Bat., "7" Bat., "8" Bat., "9" Bat., "0" Bat., "A" Bat., "B" Bat., "C" Bat., "D" Bat., "E" Bat., "F" Bat., "G" Bat., "H" Bat., "I" Bat., "J" Bat., "K" Bat., "L" Bat., "M" Bat., "N" Bat., "O" Bat., "P" Bat., "Q" Bat., "R" Bat., "S" Bat., "T" Bat., "U" Bat., "V" Bat., "W" Bat., "X" Bat., "Y" Bat., "Z" Bat., "1" Bat., "2" Bat., "3" Bat., "4" Bat., "5" Bat., "6" Bat., "7" Bat., "8" Bat., "9" Bat., "0" Bat., "A" Bat., "B" Bat., "C" Bat., "D" Bat., "E" Bat., "F" Bat., "G" Bat., "H" Bat., "I" Bat., "J" Bat., "K" Bat., "L" Bat., "M" Bat., "N" Bat., "O" Bat., "P" Bat., "Q" Bat., "R" Bat., "S" Bat., "T" Bat., "U" Bat., "V" Bat., "W" Bat., "X" Bat., "Y" Bat., "Z" Bat., "1" Bat., "2" Bat., "3" Bat., "4" Bat., "5" Bat., "6" Bat., "7" Bat., "8" Bat., "9" Bat., "0" Bat., "A" Bat., "B" Bat., "C" Bat., "D" Bat., "E" Bat., "F" Bat., "G" Bat., "H" Bat., "I" Bat., "J" Bat., "K" Bat., "L" Bat., "M" Bat., "N" Bat., "O" Bat., "P" Bat., "Q" Bat., "R" Bat., "S" Bat., "T" Bat., "U" Bat., "V" Bat., "W" Bat., "X" Bat., "Y" Bat., "Z" Bat., "1" Bat., "2" Bat., "3" Bat., "4" Bat., "5" Bat., "6" Bat., "7" Bat., "8" Bat., "9" Bat., "0" Bat., "A" Bat., "B" Bat., "C" Bat., "D" Bat., "E" Bat., "F" Bat., "G" Bat., "H" Bat., "I" Bat., "J" Bat., "K" Bat., "L" Bat., "M" Bat., "N" Bat., "O" Bat., "P" Bat., "Q" Bat., "R" Bat., "S" Bat., "T" Bat., "U" Bat., "V" Bat., "W" Bat., "X" Bat., "Y" Bat., "Z" Bat., "1" Bat., "2" Bat., "3" Bat., "4" Bat., "5" Bat., "6" Bat., "7" Bat., "8" Bat., "9" Bat., "0" Bat., "A" Bat., "B" Bat., "C" Bat., "D" Bat., "E" Bat., "F" Bat., "G" Bat., "H" Bat., "I" Bat., "J" Bat., "K" Bat., "L" Bat., "M" Bat., "N" Bat., "O" Bat., "P" Bat., "Q" Bat., "R" Bat., "S" Bat., "T" Bat., "U" Bat., "V" Bat., "W" Bat., "X" Bat., "Y" Bat., "Z" Bat., "1" Bat., "2" Bat., "3" Bat., "4" Bat., "5" Bat., "6" Bat., "7" Bat., "8" Bat., "9" Bat., "0" Bat., "A" Bat., "B" Bat., "C" Bat., "D" Bat., "E" Bat., "F" Bat., "G" Bat., "H" Bat., "I" Bat., "J" Bat., "K" Bat., "L" Bat., "M" Bat., "N" Bat., "O" Bat., "P" Bat., "Q" Bat., "R" Bat., "S" Bat., "T" Bat., "U" Bat., "V" Bat., "W" Bat., "X" Bat., "Y" Bat., "Z" Bat., "1" Bat., "2" Bat., "3" Bat., "4" Bat., "5" Bat., "6" Bat., "7" Bat., "8" Bat., "9" Bat., "0" Bat., "A" Bat., "B" Bat., "C" Bat., "D" Bat., "E" Bat., "F" Bat., "G" Bat., "H" Bat., "I" Bat., "J" Bat., "K" Bat., "L" Bat., "M" Bat., "N" Bat., "O" Bat., "P" Bat., "Q" Bat., "R" Bat., "S" Bat., "T" Bat., "U" Bat., "V" Bat., "W" Bat., "X" Bat., "Y" Bat., "Z" Bat., "1" Bat., "2" Bat., "3" Bat., "4" Bat., "5" Bat., "6" Bat., "7" Bat., "8" Bat., "9" Bat., "0" Bat., "A" Bat., "B" Bat., "C" Bat., "D" Bat., "E" Bat., "F" Bat., "G" Bat., "H" Bat., "I" Bat., "J" Bat., "K" Bat., "L" Bat., "M" Bat., "N" Bat., "O" Bat., "P" Bat., "Q" Bat., "R" Bat., "S" Bat., "T" Bat., "U" Bat., "V" Bat., "W" Bat., "X" Bat., "Y" Bat., "Z" Bat., "1" Bat., "2" Bat., "3" Bat., "4" Bat., "5" Bat., "6" Bat., "7" Bat., "8" Bat., "9" Bat., "0" Bat., "A" Bat., "B" Bat., "C" Bat., "D" Bat., "E" Bat., "F" Bat., "G" Bat., "H" Bat., "I" Bat., "J" Bat., "K" Bat., "L" Bat., "M" Bat., "N" Bat., "O" Bat., "P" Bat., "Q" Bat., "R" Bat., "S" Bat., "T" Bat., "U" Bat., "V" Bat., "W" Bat., "X" Bat., "Y" Bat., "Z" Bat., "1" Bat., "2" Bat., "3" Bat., "4" Bat., "5" Bat., "6" Bat., "7" Bat., "8" Bat., "9" Bat., "0" Bat., "A" Bat., "B" Bat., "C" Bat., "D" Bat., "E" Bat., "F" Bat., "G" Bat., "H" Bat., "I" Bat., "J" Bat., "K" Bat., "L" Bat., "M" Bat., "N" Bat., "O" Bat., "P" Bat., "Q" Bat., "R" Bat., "S" Bat., "T" Bat., "U" Bat., "V" Bat., "W" Bat., "X" Bat., "Y" Bat., "Z" Bat., "1" Bat., "2" Bat., "3" Bat., "4" Bat., "5" Bat., "6" Bat., "7" Bat., "8" Bat., "9" Bat., "0" Bat., "A" Bat., "B" Bat., "C" Bat., "D" Bat., "E" Bat., "F" Bat., "G" Bat., "H" Bat., "I" Bat., "J" Bat., "K" Bat., "L" Bat., "M" Bat., "N" Bat., "O" Bat., "P" Bat., "Q" Bat., "R" Bat., "S" Bat., "T" Bat., "U" Bat., "V" Bat., "W" Bat., "X" Bat., "Y" Bat., "Z" Bat., "1" Bat., "2" Bat., "3" Bat., "4" Bat., "5" Bat., "6" Bat., "7" Bat., "8" Bat., "9" Bat., "0" Bat., "A" Bat., "B" Bat., "C" Bat., "D" Bat., "E" Bat., "F" Bat., "G" Bat., "H" Bat., "I" Bat., "J" Bat., "K" Bat., "L" Bat., "M" Bat., "N" Bat., "O" Bat., "P" Bat., "Q" Bat., "R" Bat., "S" Bat., "T" Bat., "U" Bat., "V" Bat., "W" Bat., "X" Bat., "Y" Bat., "Z" Bat., "1" Bat., "2" Bat., "3" Bat., "4" Bat., "5" Bat., "6" Bat., "7" Bat., "8" Bat., "9" Bat., "0" Bat., "A" Bat., "B" Bat., "C" Bat., "D" Bat., "E" Bat., "F" Bat., "G" Bat., "H" Bat., "I" Bat., "J" Bat., "K" Bat., "L" Bat., "M" Bat., "N" Bat., "O" Bat., "P" Bat., "Q" Bat., "R" Bat., "S" Bat., "T" Bat., "U" Bat., "V" Bat., "W" Bat., "X" Bat., "Y" Bat., "Z" Bat., "1" Bat., "2" Bat., "3" Bat., "4" Bat., "5" Bat., "6" Bat., "7" Bat., "8" Bat., "9" Bat., "0" Bat., "A" Bat., "B" Bat., "C" Bat., "D" Bat., "E" Bat., "F" Bat., "G" Bat., "H" Bat., "I" Bat., "J" Bat., "K" Bat., "L" Bat., "M" Bat., "N" Bat., "O" Bat., "P" Bat., "Q" Bat., "R" Bat., "S" Bat., "T" Bat., "U" Bat., "V" Bat., "W" Bat., "X" Bat., "Y" Bat., "Z" Bat., "1" Bat., "2" Bat., "3" Bat., "4" Bat., "5" Bat., "6" Bat., "7" Bat., "8" Bat., "9" Bat., "0" Bat., "A" Bat., "B" Bat., "C" Bat., "D" Bat., "E" Bat., "F" Bat., "G" Bat., "H" Bat., "I" Bat., "J" Bat., "K" Bat., "L" Bat., "M" Bat., "N" Bat., "O" Bat., "P" Bat., "Q" Bat., "R" Bat., "S" Bat., "T" Bat., "U" Bat., "V" Bat., "W" Bat., "X" Bat., "Y" Bat., "Z" Bat., "1" Bat., "2" Bat., "3" Bat., "4" Bat., "5" Bat., "6" Bat., "7" Bat., "8" Bat., "9" Bat., "0" Bat., "A" Bat., "B" Bat., "C" Bat., "D" Bat., "E" Bat., "F" Bat., "G" Bat., "H" Bat., "I" Bat., "J" Bat., "K" Bat., "L" Bat., "M" Bat., "N" Bat., "O" Bat., "P" Bat., "Q" Bat., "R" Bat., "S" Bat., "T" Bat., "U" Bat., "V" Bat., "W" Bat., "X" Bat., "Y" Bat., "Z" Bat., "1" Bat., "2" Bat., "3" Bat., "4" Bat., "5" Bat., "6" Bat., "7" Bat., "8" Bat., "9" Bat., "0" Bat., "A" Bat., "B" Bat., "C" Bat., "D" Bat., "E" Bat., "F" Bat., "G" Bat., "H" Bat., "I" Bat., "J" Bat., "K" Bat., "L" Bat., "M" Bat., "N" Bat., "O" Bat., "P" Bat., "Q" Bat., "R" Bat., "S" Bat., "T" Bat., "U" Bat., "V" Bat., "W" Bat., "X" Bat., "Y" Bat., "Z" Bat., "1" Bat., "2" Bat., "3" Bat., "4" Bat., "5" Bat., "6" Bat., "7" Bat., "8" Bat., "9" Bat., "0" Bat., "A" Bat., "B" Bat., "C" Bat., "D" Bat., "E" Bat., "F" Bat., "G" Bat., "H" Bat., "I" Bat., "J" Bat., "K" Bat., "L" Bat., "M" Bat., "N" Bat., "O" Bat., "P" Bat., "Q" Bat., "R" Bat., "S" Bat., "T" Bat., "U" Bat., "V" Bat., "W" Bat., "X" Bat., "Y" Bat., "Z" Bat., "1" Bat., "2" Bat., "3" Bat., "4" Bat., "5" Bat., "6" Bat., "7" Bat., "8" Bat., "9" Bat., "0" Bat., "A" Bat., "B" Bat., "C" Bat., "D" Bat., "E" Bat., "F" Bat., "G" Bat., "H" Bat., "I" Bat., "J" Bat., "K" Bat., "L" Bat., "M" Bat., "N" Bat., "O" Bat., "P" Bat., "Q" Bat., "R" Bat., "S" Bat., "T" Bat., "U" Bat., "V" Bat., "W" Bat., "X" Bat., "Y" Bat., "Z" Bat., "1" Bat., "2" Bat., "3" Bat., "4" Bat., "5" Bat., "6" Bat., "7" Bat., "8" Bat., "9" Bat., "0" Bat., "A" Bat., "B" Bat., "C" Bat., "D" Bat., "E" Bat., "F" Bat., "G" Bat., "H" Bat., "I" Bat., "J" Bat., "K" Bat., "L" Bat., "M" Bat., "N" Bat., "O" Bat., "P" Bat., "Q" Bat., "R" Bat., "S" Bat., "T" Bat., "U" Bat., "V" Bat., "W" Bat., "X" Bat., "Y" Bat., "Z" Bat., "1" Bat., "2" Bat., "3" Bat., "4" Bat., "5" Bat., "6" Bat., "7" Bat., "8" Bat., "9" Bat., "0" Bat., "A" Bat., "B" Bat., "C" Bat., "D" Bat., "E" Bat., "F" Bat., "G" Bat., "H" Bat., "I" Bat., "J" Bat., "K" Bat., "L" Bat., "M" Bat., "N" Bat., "O" Bat., "P" Bat., "Q" Bat., "R" Bat., "S" Bat., "T" Bat., "U" Bat., "V" Bat., "W" Bat., "X" Bat., "Y" Bat., "Z" Bat., "1" Bat., "2" Bat., "3" Bat., "4" Bat., "5" Bat., "6" Bat., "7" Bat., "8" Bat., "9" Bat., "0" Bat., "A" Bat., "B" Bat., "C" Bat., "D" Bat., "E" Bat., "F" Bat., "G" Bat., "H" Bat., "I" Bat., "J" Bat., "K" Bat., "L" Bat., "M" Bat., "N" Bat., "O" Bat., "P" Bat., "Q" Bat., "R" Bat., "S" Bat., "T" Bat., "U" Bat., "V" Bat., "W" Bat., "X" Bat., "Y" Bat., "Z" Bat., "1" Bat., "2" Bat., "3" Bat., "4" Bat., "5" Bat., "6" Bat., "7" Bat., "8" Bat., "9" Bat., "0" Bat., "A" Bat., "B" Bat., "C" Bat., "D" Bat., "E" Bat., "F" Bat., "G" Bat., "H" Bat., "I" Bat., "J" Bat., "K" Bat., "L" Bat., "M" Bat., "N" Bat., "O" Bat., "P" Bat., "Q" Bat., "R" Bat., "S" Bat., "T" Bat., "U" Bat., "V" Bat., "W" Bat., "X" Bat., "Y" Bat., "Z" Bat., "1" Bat., "2" Bat., "3" Bat., "4" Bat., "5" Bat., "6" Bat., "7" Bat., "8" Bat., "9" Bat., "0" Bat., "A" Bat., "B" Bat., "C" Bat., "D" Bat., "E" Bat., "F" Bat., "G" Bat., "H" Bat., "I" Bat., "J" Bat., "K" Bat., "L" Bat., "M" Bat., "N" Bat., "O" Bat., "P" Bat., "Q" Bat., "R" Bat., "S" Bat., "T" Bat., "U" Bat., "V" Bat., "W" Bat., "X" Bat., "Y" Bat., "Z" Bat., "1" Bat., "2" Bat., "3" Bat., "4" Bat., "5" Bat., "6" Bat., "7" Bat., "8" Bat., "9" Bat., "0" Bat., "A" Bat., "B" Bat., "C" Bat., "D" Bat., "E" Bat., "F" Bat., "G" Bat., "H" Bat., "I" Bat., "J" Bat., "K" Bat., "L" Bat., "M" Bat., "N" Bat., "O" Bat., "P" Bat., "Q" Bat., "R" Bat., "S" Bat., "T" Bat., "U" Bat., "V" Bat., "W" Bat., "X" Bat., "Y" Bat., "Z" Bat., "1" Bat., "2" Bat., "3" Bat., "4" Bat., "5" Bat., "6" Bat., "7" Bat., "8" Bat., "9" Bat., "0" Bat., "A" Bat., "B" Bat., "C" Bat., "D" Bat., "E" Bat., "F" Bat., "G" Bat., "H" Bat., "I" Bat., "J" Bat., "K" Bat., "L" Bat., "M" Bat., "N" Bat., "O" Bat., "P" Bat., "Q" Bat., "R" Bat., "S" Bat., "T" Bat., "U" Bat., "V" Bat., "W" Bat., "X" Bat., "Y" Bat., "Z" Bat., "1" Bat., "2" Bat., "3" Bat., "4" Bat., "5" Bat., "6" Bat., "7" Bat., "8" Bat., "9" Bat., "0" Bat., "A" Bat., "B" Bat., "C" Bat., "D" Bat., "E" Bat., "F" Bat., "G" Bat., "H" Bat., "I" Bat., "J" Bat., "K" Bat., "L" Bat., "M" Bat., "N" Bat., "O" Bat., "P" Bat., "Q" Bat., "R" Bat., "S" Bat., "T" Bat., "U" Bat., "V" Bat., "W" Bat., "X" Bat., "Y" Bat., "Z" Bat., "1" Bat., "2" Bat., "3" Bat., "4" Bat., "5" Bat., "6" Bat., "7" Bat., "8" Bat., "9" Bat., "0" Bat., "A" Bat., "B" Bat., "C" Bat., "D" Bat., "E" Bat., "F" Bat., "G" Bat., "H" Bat., "I" Bat., "J" Bat., "K" Bat., "L" Bat., "M" Bat., "N" Bat., "O" Bat., "P" Bat., "Q" Bat., "R" Bat., "S" Bat., "T" Bat., "U" Bat., "V" Bat., "W" Bat., "X" Bat., "Y" Bat., "Z" Bat., "1" Bat., "2" Bat., "3" Bat., "4" Bat., "5" Bat., "6" Bat., "7" Bat., "8" Bat., "9" Bat., "0" Bat., "A" Bat., "B" Bat., "C" Bat., "D" Bat., "E" Bat., "F" Bat., "G" Bat., "H" Bat., "I" Bat., "J" Bat., "K" Bat., "L" Bat., "M" Bat., "N" Bat., "O" Bat., "P" Bat., "Q" Bat., "R" Bat., "S" Bat., "T" Bat., "U" Bat., "V" Bat., "W" Bat., "X" Bat., "Y" Bat., "Z" Bat., "1" Bat., "2" Bat., "3" Bat., "4" Bat., "5" Bat., "6" Bat., "7" Bat., "8" Bat., "9" Bat., "0" Bat., "A" Bat., "B" Bat., "C" Bat., "D" Bat., "E" Bat., "F" Bat., "G" Bat., "H" Bat., "I" Bat., "J" Bat., "K" Bat., "L" Bat., "M" Bat., "N" Bat., "O" Bat., "P" Bat., "Q" Bat., "R" Bat., "S" Bat., "T" Bat., "U" Bat., "V" Bat., "W" Bat., "X" Bat., "Y" Bat., "Z" Bat., "1" Bat., "2" Bat., "3" Bat., "4" Bat., "5" Bat., "6" Bat., "7" Bat., "8" Bat., "9" Bat., "0" Bat., "A" Bat., "B" Bat., "C" Bat., "D" Bat., "E" Bat., "F" Bat., "G" Bat., "H" Bat., "I" Bat., "J" Bat., "K" Bat., "L" Bat., "M" Bat., "N" Bat., "O" Bat., "P" Bat., "Q" Bat., "R" Bat., "S" Bat., "T" Bat., "U" Bat., "V" Bat., "W" Bat., "X" Bat., "Y" Bat., "Z" Bat., "1" Bat., "2" Bat., "3" Bat., "4" Bat., "5" Bat., "6" Bat., "7" Bat., "8" Bat., "9" Bat., "0" Bat., "A" Bat., "B" Bat., "C" Bat., "D" Bat., "E" Bat., "F" Bat., "G" Bat., "H" Bat., "I" Bat., "J" Bat., "K" Bat., "L" Bat., "M" Bat., "N" Bat., "O" Bat., "P" Bat., "Q" Bat., "R" Bat., "S" Bat., "T" Bat., "U" Bat., "V" Bat., "W" Bat., "X" Bat., "Y" Bat., "Z" Bat., "1" Bat., "2" Bat., "3" Bat., "4" Bat., "5" Bat., "6" Bat., "7" Bat., "8" Bat., "9" Bat., "0" Bat., "A" Bat., "B" Bat., "C" Bat., "D" Bat., "E" Bat., "F" Bat., "G" Bat., "H" Bat., "I" Bat., "J" Bat., "K" Bat., "L" Bat., "M" Bat., "N" Bat., "O" Bat., "P" Bat., "Q" Bat., "R" Bat., "S" Bat., "T" Bat., "U" Bat., "V" Bat., "W" Bat., "X" Bat., "Y" Bat., "Z" Bat., "1" Bat., "2" Bat., "3" Bat., "4" Bat., "5" Bat., "6" Bat., "7" Bat., "8" Bat., "9" Bat., "0" Bat., "A" Bat., "B" Bat., "C" Bat., "D" Bat., "E" Bat., "F" Bat., "G" Bat., "H" Bat., "I" Bat., "J" Bat., "K" Bat., "L" Bat., "M" Bat., "N" Bat., "O" Bat., "P" Bat., "Q" Bat., "R" Bat., "S" Bat., "T" Bat., "U" Bat., "V" Bat., "W" Bat., "X" Bat., "Y" Bat., "Z" Bat., "1" Bat., "2" Bat., "3" Bat., "4" Bat., "5" Bat., "6" Bat., "7" Bat., "8" Bat., "9" Bat., "0" Bat., "A" Bat., "B" Bat., "C" Bat., "D" Bat., "E" Bat., "F" Bat., "G" Bat., "H" Bat., "I" Bat., "J" Bat., "K" Bat., "L" Bat., "M" Bat., "N" Bat., "O" Bat., "P" Bat., "Q" Bat., "R" Bat., "S" Bat., "T" Bat., "U" Bat., "V" Bat., "W" Bat., "X" Bat., "Y" Bat., "Z" Bat., "1" Bat., "2" Bat., "3" Bat., "4" Bat., "5" Bat., "6" Bat., "7" Bat., "8" Bat., "9" Bat., "0" Bat., "A" Bat., "B" Bat., "C" Bat., "D" Bat., "E" Bat., "F" Bat., "G" Bat., "H" Bat., "I" Bat., "J" Bat., "K" Bat., "L" Bat., "M" Bat., "N" Bat., "O" Bat., "P" Bat., "Q" Bat., "R" Bat., "S" Bat., "T" Bat., "U"



### COCKADAY UNIT

Full Set A, B, C and D Coils

Made strictly in accordance to Mr. Cockaday's Specifications.



Range 150 to 600 Meters

For 1, 3 & 5 Tube Set  
**Price \$5.50**  
Best quality Radion hard rubber tubing 1/2" wall wound with No. 18 double silk covered wire.

Three Large Blue Prints, Illustrated Instructions, and Material Lists for Building the 1, 3 and 5 Tube Cockaday Sets. Price 50c (Free with order for unit)

Guaranteed mechanically and electrically perfect. The outstanding features: Complete set of A, B, C and D Coils with beautifully knurled binding posts, eliminating loose end wires, insuring perfect contact and easier wiring. Made of the best quality material combined with expert workmanship. Distributed capacity or leakage and dielectric losses practically eliminated. Insures selectivity with maximum sensitivity and volume.

Unconditionally Guaranteed to Give Absolute Satisfaction  
At Your Dealer, Otherwise Shipped to You Postpaid  
Dealers and Jobbers Write for Attractive Proposition

**GENERAL RADIO WINDING CO.** Dept. R.6  
214 FULTON ST.  
NEW YORK, N. Y.



deflection of an indicating instrument which is connected to two turns of wire and loosely coupled to the inductor in the wave-meter circuit. Either of two indicating instruments may be used, a thermogalvanometer or a D. C. milliammeter and crystal detector. The D. C. milliammeter and crystal detector are used when more accurate indications are desired than are possible with the thermogalvanometer.

#### STATEMENT

Of the Ownership, Management, Circulation, Etc., Required by the Act of Congress of August 24, 1912, of RADIO NEWS, published monthly at Jamaica, L. I., N. Y., for April 1, 1924.

State of New York }  
County of Queens } ss.

Before me, a notary public in and for the State and county aforesaid, personally appeared Hugo Gernsback, who, having been duly sworn according to law, deposes and says that the following is, to the best of his knowledge and belief, a true statement of the ownership, management (and if a daily paper, the circulation), etc., of the aforesaid publication for the date shown in the above caption, required by the Act of August 24, 1912, embodied in section 443. Postal Laws and Regulations, printed on the reverse of this form, to wit:

1. That the names and addresses of the publisher, editor, managing editor, and business managers are: Publisher, The Experimenter Publishing Co., Inc., 53 Park Place, New York, N. Y.; Editor, Hugo Gernsback, 53 Park Place, New York, N. Y.; Managing Editor, Robert E. Lacault, 53 Park Place, New York, N. Y.; Business Manager, R. W. DeMott, 53 Park Place, New York, N. Y.

2. That the owners are: (Give names and addresses of individual owners, or, if a corporation, give its name and the names and addresses of stockholders owning or holding 1 per cent or more of the total amount of stock.) The Experimenter Publishing Co., Inc., 53 Park Place, New York, N. Y.; Hugo Gernsback, 53 Park Place, New York, N. Y.; Sidney Gernsback, 53 Park Place, New York, N. Y.; R. W. DeMott, 53 Park Place, New York, N. Y.; H. W. Secor, 53 Park Place, New York, N. Y.; Dr. T. O'Connor Sloane, 53 Park Place, New York, N. Y.; Mrs. Catherine Major, 53 Park Place, New York, N. Y.; and M. M. Finnean, 720 Cass St., Chicago, Ill.

3. That the known bondholders, mortgagees, and other security holders owning or holding 1 per cent or more of total amount of bonds, mortgages, or other securities are: (If there are none, so state.) None.

4. That the two paragraphs next above, giving the names of the owners, stockholders, and security holders, if any, contain not only the list of stockholders and security holders as they appear upon the books of the company but also, in cases where the stockholder or security holder appears upon the books of the company as trustee or in any other fiduciary relation, the name of the person or corporation for whom such trustee is acting, is given; also that the said two paragraphs contain statements embracing affiant's full knowledge and belief as to the circumstances and conditions under which stockholders and security holders who do not appear upon the books of the company, as trustees, hold stock and securities in a capacity other than that of a bona fide owner; and this affiant has no reason to believe that any other person, association, or corporation has any interest direct or indirect in the said stock, bonds, or other securities than as so stated by him.

5. That the average number of copies of each issue of this publication sold or distributed, through the mails or otherwise, to paid subscribers during the six months preceding the date shown above is ..... (This information is required from daily publications only.)

H. GERNSBACK, Editor.

Sworn to and subscribed before me this 21st day of March, 1924.

(SEAL) JOSEPH H. KRAUS.

Notary Public, Queens County Register's No. 2951; New York County Register's No. 5291; New York County Clerk's No. 379. (My commission expires March 30, 1925.)

## "Kills Your Reflex Troubles"

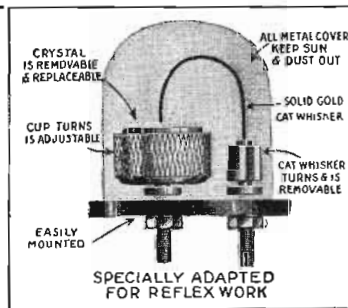

### The "LINCOLN" Enclosed Fixed Adjustable Detector

At last, the ideal detector. This very remarkable device is causing a sensation. Thousands are already in use and radio fans throughout the country are clamoring for it.

Study the illustration—note that the solid gold cat's whisker can easily be turned, adjusted or removed. Observe that the crystal can be turned or replaced at a moment's notice. See that a metal cover—handsome nickel-plated metal—prevents breakage and keeps out light and dust. Every one carefully set and tested when shipped. Guaranteed—any faulty part will be replaced within one year. Defective crystal within six months will be replaced. That's fair—isn't it? This wonderful Enclosed Fixed Adjustable Detector costs only \$2.00. Ask for it at any dealer's.

Manufactured by

**The Lincoln Manufacturing Co.**

LOS ANGELES

Mention this advertisement

Address: Department E-1

## Rub-Mika

The ideal material for Radio Panels. Low absorption, high tensile and dielectric strength. If your dealer cannot supply you write us direct.

**The Cooper Corporation**

Rub-Mika Dept.  
Cincinnati, Ohio

## GUARANTEED "B" BATTERIES

Large 45 volt.....	\$3.60
Large 22½ volt.....	1.80
Medium 45 volt.....	2.75
Medium 22½ volt.....	1.60
Small 22½ volt.....	1.00

All-Variable. Postage Free. Satisfaction Absolutely Guaranteed

**S & H BATTERY SUPPLY CO.**

41 Nevins St., Brooklyn, N. Y.

## Too Much Waves

(Continued from page 1738)

Baltimore to New York because something between those two places interfered?"

"I think I did read something of that sort once; something to the effect that if a radio message were to be sent from Baltimore to New York, or vice-versa, it had to be sent by way of Pittsburgh." I said.





*Noted Musical and Radio Authorities Select three Distinctly New Radio Song and Dance Hits*

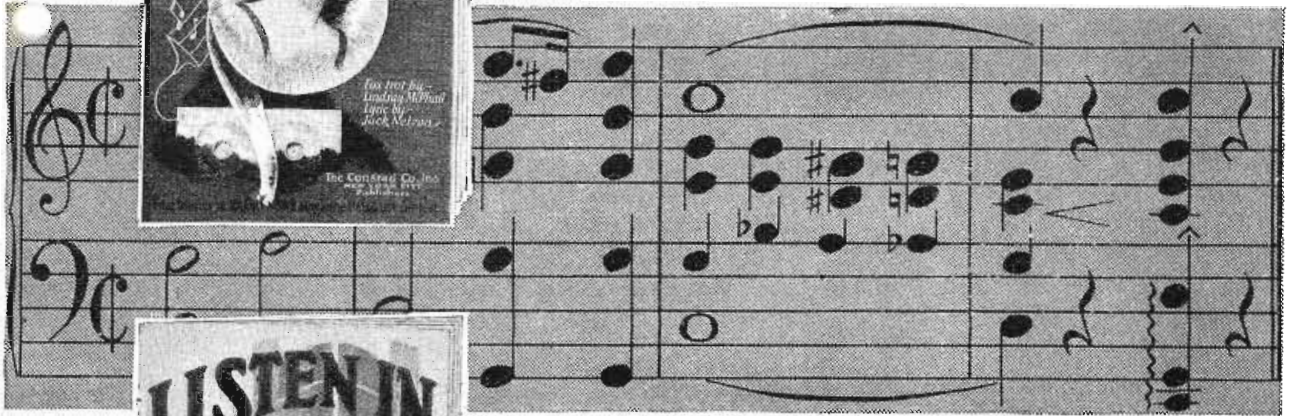

**35c**  
EACH  
Postpaid

## Now We Have *Radio* Song and Dance Hits

In a recent nation-wide Musical Radio Contest three compositions were selected from the hundreds of Manuscripts submitted as prize winners. These numbers have now been published in the conventional form so that Radio Music Lovers and also Music Lovers everywhere can enjoy these distinctly new hits in Popular Music.

These prize Radio Hits will be a sensation in your dance folio. They offer you the opportunity of buying three fine melodies at the same time each better than the other. It were as if you had picked the choice numbers out of hundreds of songs at your dealer.

These Radio Song and Dance hits will be exclusively Radio—To and for the Radio Public. They will be Broadcast from your local Broadcasting station. Listen in for them. Your local Radio Dealer will have copies for you. Look them over the next time you visit him or write us direct for your copies.

*Published and Distributed by*

**THE CONSRAD COMPANY, INC.**  
233 Fulton Street, New York City



### Radio Jazz:

Irresistible foxtrot. One of the prize winners of RADIO NEWS Broadcast contest! Young feet dance—old feet tap time, to the fascinating melody of this real smashing hit.

### Listen In:

Featured in RADIO NEWS Broadcast contest, has caught the fancy of all America! Its rare swing hypnotizes—and its tuneful melody makes it simply irresistible.

### Radio March:

Another Prize Winner of RADIO NEWS Broadcast contest. Here, music lovers, is a wonderful number! Is there anything so appealing as the stirring strains of a military march?



# Advertising Testimony!

## EXHIBIT A

PHONE GRAMERCY 4139

**THE R-C MILLS  
RADIO CORPORATION**  
EXECUTIVE OFFICES  
303 FOURTH AVENUE  
NEW YORK

March 20, 1924

Radio News,  
53 Park Place,  
New York, N.Y.

Gentlemen:

We cannot stand by and refrain from writing you about a matter that is a revelation to us.

We have spent thousands of dollars for advertising, various Radio magazines and in the majority of cases, the results have been very unsatisfactory. Naturally, this is most disheartening.

Last month, we decided to try a one-inch ad in Radio News and up to date, have received a great many inquiries for Leatherson Cabinets from big and reliable concerns.

The results are wonderful and I am going to swear by your good publication henceforth. As soon as possible, we will prepare new copy for the next issue.

*Note* The cost of advertising in RADIO NEWS always seemed high to me but now we realize it is practically nil when one considers the results.

You can refer any prospective advertiser to us if you need such recommendation.

Very truly yours,  
THE R - C MILLS RADIO CORP.  
*Ralph Corn*  
President

*Mr. Crippen  
This should  
interest every  
advertiser  
JMM*

This Is Exhibit A of a Complete Series To Appear Every Month in Radio News Watch for Exhibit B in the July issue

This is only one of the Many Recommendations received by RADIO NEWS from its Advertisers.

### Speed Up Your Production

by sawing bakelite, formica, brass, copper, carbon or wood on a

#### Boice Junior Bench Saw



A precision machine especially adapted to rapid and accurate work. All metal construction. Top 16" x 12" elevates for grooving. Special guide accumulates panels as wide as 24". Saws 1 1/2" stock. Easily driven by 1/4 or 1/2 h.p. motor. Attachments for grinding and sanding. Special saws for bakelite, brass, etc., furnished from stock. Sold on satisfaction guarantee. Thousands in use.

Write today for descriptive circular on this and other BOICE-BUILT Bench Machines and Motors.

W. & J. Boice Dept. 6, 1726 Norwood Ave. Toledo, O.

**FREE VACUUM TUBE RADIO SET**

Can receive 100 miles and more.

RUSH your name to learn how you can get a Vacuum Tube Radio Set **ABSOLUTELY FREE** Don't delay, write today for FREE RADIO PLAN.

HOME SUPPLY CO. Dept. 661 131 Duane St., N.Y.C.

"Have you ever heard of a jury?" he asked.

"Often," I said. "I've heard of quite a few juries. What sort of jury do you mean?"

"A court jury—12 perfectly idiotic jackasses," Billy said bitterly.

"I remember seeing 11 perfectly idiotic jackasses on a jury once," I said. "I was on that same jury and I talked myself deaf and blind but I could not get them to agree with me."

"This jury agreed," Billy said glumly. "It was unanimous. That's why I am here. That's why I am busted."

"Tell me all about it," I urged.

"It's my wife and little children I mind," Pethcod said, getting up and beginning to walk up and down the room nervously. "That \$200,000 would have meant so much to them. And now it is gone! But how was I to know there was a Mount Takalaw? How was I to know there was a Pingak Cave? What did I know of this Orlando P. McFutz, or One-eye Billings, or Peter Duss, or this little shyster lawyer, O'Sinkovitz?"

"Tell me about it, Billy," I begged. "It will do you good to get it off your mind. You went out there to Alacamar, and you bought the paper, and you started your broadcast station—"

"JKJX," he said. "Yes, and it was a dandy. It worked fine, right from the first minute—clear and strong—and I sent out good stuff. I sent out weather reports and tenor solos and jazz band music and bedtime stories and talks on 'The Efficacy of the Prune' and banquets and prize-fights and everything. I got up the prize-fights and the banquets myself, so I could broadcast them. It was a great success. Thousands of people who had never owned radio sets bought sets or built them, and listened in. The circulation of my *Alacamar Times* went up by leaps and bounds. But there was one trouble."

"There is always something," I ventured.

"It was interference," Billy said. "It was interference like that between Baltimore and New York. I could not reach Coboya. My sending outfit was not strong enough. There was something between Alacamar and Coboya I could not get past—it stopped my radio waves. It stopped them almost dead. So, naturally, I decided that I needed a stronger sending outfit—one that would force past that interference, or whatever it was."

"I think I understand," I said. "I don't know much about that sort of thing."

"Neither did I," said Billy wearily. "I know more now. But, anyway, I let it be known—I printed it in the columns of the *Alacamar Times*—that I was going to buy and install a sending outfit 10 times bigger and stronger than the one I owned, so I could roll right over that interference and roll my radio waves right into Coboya."

"Good stuff!" I exclaimed. "That's the spirit! That was the true Billy Pethcod speaking!"

"Yes," he said, sadly, "that's what I thought. And two days later this dried-up little shrimp of a lawyer came into my office and grinned a sort of coyote grin and shoved his card at me. He was this Philander P. O'Sinkovitz, from Coboya. I disliked his looks as soon as I set eyes on him. When I had read his card and looked up he said his three clients were outside. I told him to bring them in, if he wanted to. 'But,' I said, 'if they are going to sue me for libel on account of anything I have printed in my paper they can sue and be blessed. The *Alacamar Times* never backs down.'

"They are not going to sue for libel," he said.

"Then what do they want?" I asked. "They wouldn't have a lawyer if they were not trying to make trouble of some sort."



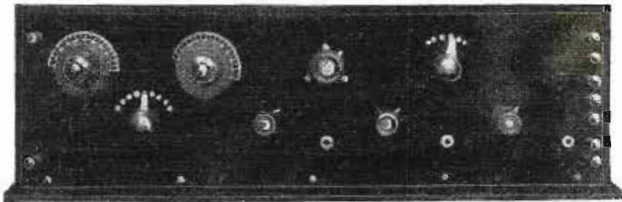
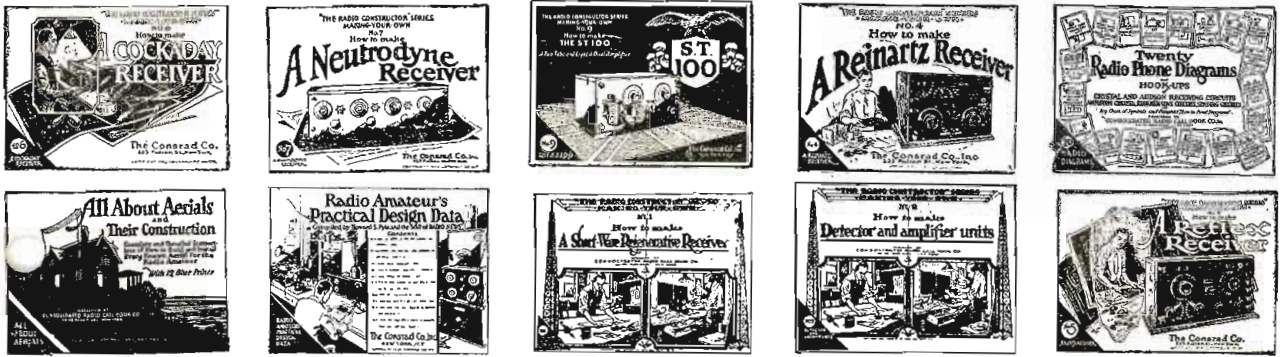

**BUILD YOUR OWN 5-TUBE COCKADAY SET**

This pattern gives the complete assembly, wiring, adjusting and tuning details for the new Cockaday five-tube receiver with Push-Pull amplification. The set as described in our pamphlet of instructions is one of the best receivers for the reception of distant stations due to its remarkable selectivity. It is also noted for great volume, as the power amplifier of the Push-Pull type used in this set is, without question, a big improvement over

other forms of audio frequency amplifiers.

Complete instructions in a four-page pamphlet. Size 8 1/2 x 11 inches. One large blue print Pattern showing a Perspective Wiring Diagram, and Full Size Panel Layout.

Contained in a heavy two-colored envelope, size 9 x 12 inches. Price 50c prepaid

JUST OUT



**HOW TO MAKE THE ULTRADYNE**

This receiver is the last word in improved Super-heterodynes. It employs six tubes and is, without doubt, the most sensitive circuit in existence at the present time. It employs what has been called the "Modulation system" of rectification in place of the usual "frequency change" of the received radio currents as in the standard Super-heterodyne.

Complete instructions given in a Four-Page Pamphlet, one large Blue-Print Pattern showing Perspective Wiring Diagram, Coil Winding Form, Full Size Panel Layout and details for building a cabinet. Contained in a heavy two-color printed envelope. Size 9 x 12 inches. Price 50c

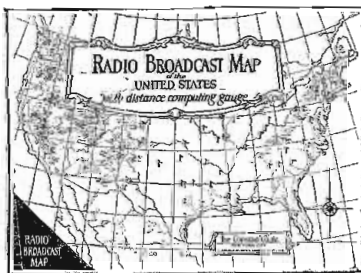

PRICE 50c

**Broadcast Stations Made Easy to Locate**

The Consrad Radio Map is different from all other maps in that it is printed on CLOTH. With proper care will last a lifetime.

The Map measures 17 x 22" and contains a special distance-computing gauge of our own design which enables one to determine the distance in miles between any broadcast station and his receiving set at a glance.

Another special feature of this map is a novel Finder device for locating a broadcast station in quick time.

A complete list of broadcast stations are given on a separate sheet which can be fastened to the map by ordinary paper fasteners.

The map furnished in two colors with the sheet of broadcast stations, enclosed in a two-color heavy manila envelope 9 1/2 x 12 inches.

**THE RADIO READING COURSE**

Here is Your Chance to Learn All You Can About RADIO  
—The \$10.00 "Radio Reading Course"

All the technical details and a thorough explanation of radio reception, written in easily understood, non-technical language by a foremost radio engineer and inventor. The five Lecture Books with over 100 graphic drawings give you the knowledge to intelligently buy, design, build, operate and maintain radio receiving apparatus. This set of five handsome Lecture Books are a complete radio library. New edition completely revised to April 1, 1924.

**SPECIAL AT \$1.25**

AT ALL RELIABLE RADIO DEALERS  
or if desired we will ship it C. O. D.

**"CONSRAD"**

**Make Your Own Patterns**

No.

- 1 How to Make a Short Wave Regenerative Receiver.
- 2 How to Make a Two Stage Amplifier.
- 3 How to Make a Radio-Phone Crystal Set.
- 4 How to Make a Reinartz Receiver.
- 5 How to Make a Reflex Receiver.
- 6 How to Make a One Tube Cockaday Receiver.
- 7 How to Make a Neutrodyne Receiver.
- 9 How to Make the ST 100 Receiver.
- 10 How to Make the Ultradyne Receiver.
- 11 How to Make a Five Tube Cockaday Receiver.

Packet A Radio Broadcast Map of the United States.

Packet B 20 Radiophone Diagrams with Supplements.

Packet D All About Aerials and Their Construction.

Packet E Radio Amateur's Practical Design Data.

**PRICE 50c EACH**

Postpaid

**THE CONSRAD COMPANY**

Publishers and Sales Agents

233 Fulton Street

New York City



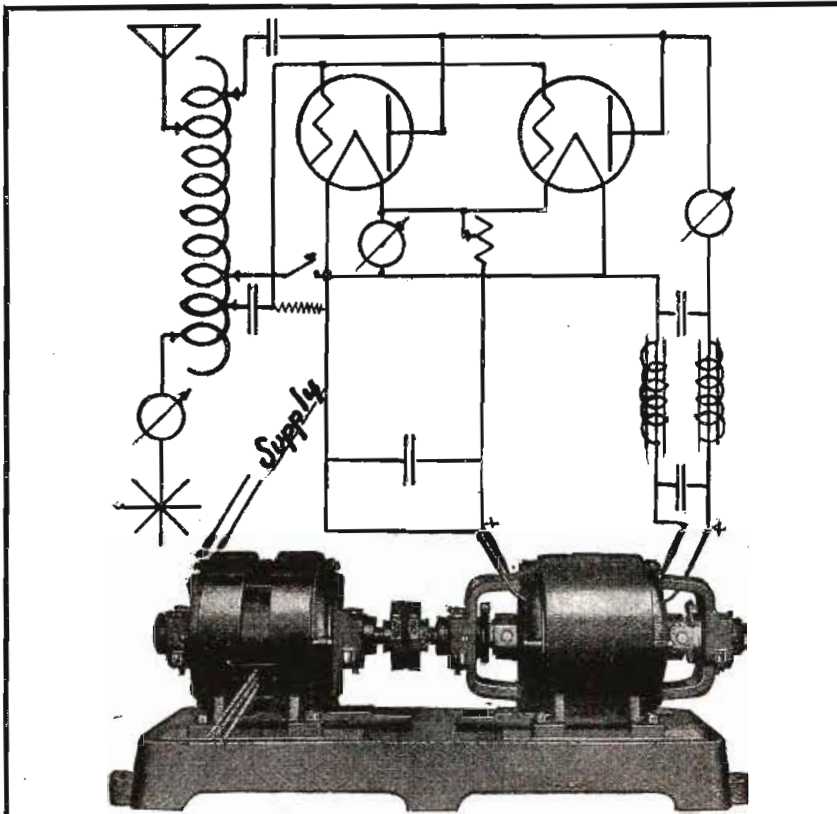

Item 35

A FEW GOOD COMBINATIONS

Item	Description	Recommended for
2	350 V 40 Watt	2-5 watt separate Fil. supply.
7	500 V 100 "	4-5 " with separate Fil. supply.
8	500 V 150 "	5-5 " 2 mod. 1 mast. osc.-2 osc. sep. Fil. supply.
13	1000 V 300 " dbl. comm.	2-50 " with separate Fil. supply.
15	1000 V 500 " " " "	3-50 " or 2-50 watt and 4-5 watt as speech amplifier and mast. osc. Sep. Fil. supply.
16	1000 V 650 " " " "	4-50 " with separate Fil. supply.
20	1500 V 600 " " " "	2 to 3-50 " with separate Fil. supply.
24	2000 V 500 " " " "	1-250 " with separate Fil. supply.
26	2000 V 1000 " " " "	2-250 " with separate Fil. supply.
31	500 V 100 " 10 V 60 Watt same as item 7 but with Fil. supply.	
35	1000 V 300 " 12 V 150 " " " " 13 " " " "	
41	2000 V 500 " 14 V 200 " " " " 24 " " " "	

Many other sets for various combinations of tubes. Special sets made to order.

TRADE "ESCO" MARK

MOTORS — DYNAMOTORS — GENERATORS — MOTOR-GENERATORS

Used by more than 150 universities, Colleges, Research Labs., etc. Many Federal, State, County and Municipal Depts.

Write for Bulletins 237B and 242A Listing over 200 Combinations

ELECTRIC SPECIALTY CO., 211 South St., Stamford, Conn., U.S.A.

Send us your problems—we'll help you solve them.

Pioneers in Developing and Perfecting High Voltage Wireless Apparatus

"They are not trying to make trouble," this O'Sinkovitz fellow said; 'they are merely trying to defend their rights and get justice for the injury you have done them. You can settle with them for \$200,000 and avoid a lawsuit. Or you can be sued.'

"Bring them in," I said.

"So he brought these three fellows into my office. Orlando P. McFutz was a queer specimen; he looked like one of these old-time fake phrenologists; he had long hair and a long greasy black coat and a black beard that hung to his waist. O'Sinkovitz introduced him as the owner of the McFutz Sanatorium—he called him Dr. McFutz. One-eye Billings looked like a murderer—there is no other word. He was an evil-looking pirate, and he had two guns in his belt. O'Sinkovitz said he was a gentleman farmer and land-owner. And Peter Duss looked like—well, he looked like a worm. That's all I can call to mind. He was meek. I never saw such a meek man. Every time anyone looked at him he sniffed and wiped his nose on the back of his hand. O'Sinkovitz said he was a hermit—a holy hermit who had spent all his life in Pingak Cave under Mount Takalaw studying the esoteric aestheticism of the transcendental effluvia of the cosmos. He said Duss had been on the very point of making a tremendous discovery that would have revolutionized the religions of the world and would have made him great and famous and wealthy. He had only one leg."

"Well, what next?" I asked, because Billy Pethcod had stopped to sigh.

"The man they called One-eye Billings spoke first," Billy said. "He sat on the edge of the chair and talked at a cuspidor I had there, and whenever he came to the end of a sentence he spat into the cuspidor. He said he had been the sole owner and proprietor of this Mount Takalaw, half way between Alacamar and Coboya, and farmed it, except for two small parts he rented out. One of these was an 80-acre tract on the Coboya side of the mountain, beyond the peak from Alacamar. He rented this to Doc. McFutz, who had built an open air sanatorium there—tents, mostly. The other part that he rented was a small cave, this Pingak Cave, which was at the base of the mountain on our side—the Alacamar side of the mountain. He rented this cave to this swami, or whatever you call him—Peter Duss—and Duss paid good rent for it to use as his hermit cave, because there were wall-paintings on it, left by some long dead peoples. He said the paintings looked as if they had been done a million years ago but he might be wrong about that—it might have been two million years ago."

"But what had all that to do with you?" I asked.

"Well, it seems it was an iron mountain," Billy said sadly. "It was all loose iron ore—sort of red dirt. Hemite ore, he called it. You could push in your hand anywhere and grab out a handful, it was so soft and easy to dig. And that was the interference my radio waves met on their way to Coboya, you understand. They could not get past that iron-ore mountain. It stood up there with its cliffs and headed off my radio waves, just as the tall steel buildings in New York do, only more so."

"But I don't see how that damaged these three men," I said. "I think it damaged you more—your waves not getting past it."

"Well, you see," Pethcod said, "radio waves are waves; we've got to admit that. They are ether waves. And the first trouble was that this Dr. McFutz—this Orlando McFutz—had established his sanatorium for the cure of the ether habit. Not the morphine habit or the cocaine habit, you understand, but the ether habit. He had discovered, he said, a cure for the ether habit, and he was running his sanatorium to cure women who had got into the habit of sniffing ether, or eating it dropped on a lump of sugar."

# Increase your Range

From 15 to 100 per cent

You can, with your present equipment, by using SPRINGFIELD 16-STRAND BRAIDED ANTENNA.

Most wonderful wire for indoor loops. Its extra large surface—twice that of ordinary wire—enables you to get greater distance and clearness.

125 feet in your attic, in strands 3 feet apart, gives better results than 150 feet of ordinary wire outdoors. Write for free booklet.

At dealers—or send us \$2.50 for 100 feet.

Dealers and Jobbers—write for prices and terms.

SPRINGFIELD WIRE & TINSEL CO.

67A Taylor St., Springfield, Mass.

New York Office: 51 E. 42nd Street

Tel. Vanderbilt 5090

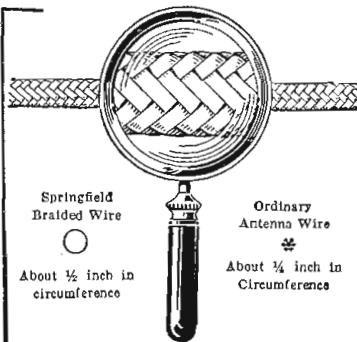

## Springfield 16 Strand Braided Antenna



"And this swami—this Peter Duss—was doing all his thinking and meditating and praying in this small cave with the painted walls. And this farmer and land-owner and proprietor of this mountain of ore, had his home and his farm buildings built on the brow of the mountain facing Alacamar. He figured the value of them at \$100,000, and he said the view was worth that much more, from the top of the thousand foot cliff on the edge of which they stood."

"But what—"  
 "that was \$200,000," Pethcod went on. "And he figured the loss of rent for the cave and Doc McFutz's place at \$50,000. And he put in the extra cost of digging the iron ore at \$800,000, and said that was a low figure. The swami, Peter Duss, figured the loss of the cave and the pre-historic pictures and the loss of his hope of thinking himself into a great prophet's job at \$100,000, in round numbers. And McFutz, the ether-cure man, figured his loss at \$85,654.50. He had it itemized. So, with the fees he had to pay O'Sinkovitz, which came to \$85,000, the total was \$1,320,654.50. But O'Sinkovitz said they were willing to do the fair thing by me and, for prompt cash, settle for \$200,000, money in hand."

"I know where I would have told them to go," I said.

"I did tell them to go there," said Pethcod gloomily, "but they didn't go. They went to the county court of Coboya County and sued me. I hired a good lawyer and he said it was all nonsense and I would win easily, but perhaps he hadn't counted on that jury. The first man called when the case came to trial was Roger Murphy, my broadcast operator. They asked him if there was a broadcast station on top of the Alacamar Times building and he said there was. Then they asked him if I owned it, and he said I did. Then they asked him if a radio broadcast station sent out waves, and he said it did—that was what it was for. Then O'Sinkovitz asked him if we sent waves toward Coboya, and he said we did; he said the waves were plenty strong enough to reach Coboya if it were not for interference somewhere between Alacamar and Coboya. Then they called Doc McFutz."

"The man who had the sanitorium," I said.

"Yes," Pethcod said. "He got into the witness chair and told about having this place—all secret, because ether-users did not want it known that they were ether-users—and how he had over a hundred patients there and how well they were getting along until the ether waves began to splash into the sanitorium."

"Hold on!" I said. "What's that you say?"

"He said the ether waves splashed into the sanitorium," explained Pethcod. "The ether waves, from my sending station, struck against Mount Takalaw on our side of the mountain and the spray dashed over the top of the mountain and fell in the sanitorium. Ether waves of bed-time stories and banquets and things. They came from our station and hit the side of the mountain and splashed up like waves of the sea and the spray fell in his sanitorium. He said his poor helpless patients used to line up along about bed-time story time—all nerve-racked and eager for ether as they were—and suck in the ether spray eagerly. For a while he did not know what was the reason they were slipping back into ether feuds again, or why they got the ether to get their ether jags, and then he discovered that it was the ether spray from our waves. It ruined his business, he said."

"Amazing!" I ejaculated.

"Yes," said Pethcod, "but that was nothing. One-eye Billings, when he was put on the stand, said that for weeks he could not imagine what was the matter with his mountain. Little by little the cliff on which his home and farm buildings were located began to be under-cut, and it was only when

# How I Average \$12 a Day in RADIO WORK

By Howard Houston

"YES, Mr. Crosby, I'll have the set installed tonight . . . yes, all ready to 'listen-in' . . . sure you'll be able to get Washington by 9 o'clock."

Another hour and a half job! And another ten dollar bill in my pocket! It all seems like a dream. But let me tell you the whole story from the very start.

A few months ago, I was driving a bread wagon, selling bread to retail stores. I had a good route though, and if I do say so myself, I had built up a pretty good business. But try as I could thirty-five dollars a week was all I could make that job pay.

I'd be working there now if it hadn't been for Mary. We'd been "keeping company" for about two years, and everything was all set for our getting married as soon as I would be earning more money. But the old job didn't hold out much promise—and I didn't see how I was qualified for any other work that would pay more.

It was Mary who gave me the tip. "You can't earn big money," she said, "unless you're some kind of a specialist. Learn some line of work—become an expert in it." But what business, profession or trade was there that wasn't overcrowded? Where could an ambitious fellow stand a good chance to earn big money and get ahead. Stenographers, accountants, clerks—all down the line—every well established line of work was overcrowded, and the pay was small.

Then Mary said, "Why not find a new field?" That was a good thought. The men who went into the railroad business early "cleaned up." The same was true of the movie game, the automobile business—but what was the coming field? What new development was there that looked like a new promising industry?

We both jumped to our feet.

"RADIO."

Why hadn't we thought of it before? All around us was the evidence of the tremendous development of Radio. The broadcasting stations sprouting up all around—the rapid increase in Radio Stores—new radio manufacturing plants—everybody talking about the latest radio program. Radio had captured America almost overnight—and thousands of men who were on their toes were due to make fortunes out of it.

## Thousands of Men Needed

The very next day after I had finished my route, I went to several radio business firms. "Sure, there was an opening. Oh, they'd pay big money—but did you know Radio?"

That was my cue. Learn Radio. Become a Radio Expert—and I did!

Well, that really is my whole story. I've only started. I've followed the path of least resistance. Sort of built up a business of my own installing, building, and repairing radio sets. Any small job pays me at least \$5—and usually \$10. I can easily make from \$50 to \$100 a week—and more as I get my work systematized.

What Mary and I have got to decide after our honeymoon—oh, yes, we are soon having a very quiet wedding—what we must decide after that—is which end of Radio will be



best. You see, there are dozens of different kinds of work in this field, it's so big. I've already had several offers—one to take charge of a radio department, another with a broadcasting station, another to give radio entertainments, and a good offer as superintendent of construction in a radio plant. What we want to decide on is which will not only pay the most money now but will lead to the most rapid advancement in the future.

## Easy to Learn Radio at Home in Spare Time

Just a word about this Radio business. Some fellows think you've got to have some training before you start to learn Radio. That's bunk. I didn't know the difference between an amplifier and a doorknob before I started. But let me give you a tip. Don't experiment with your radio course. Get the best. The National Radio Institute has been teaching Radio ever since 1914. The government recognizes its course by allowing credits to its graduates when they are trying for a license, so you see you can be confident you're getting the best training possible—and that means a lot.

## Send for Free Book

### "RICH REWARDS IN RADIO"

Incidentally, the National Radio Institute publish a mighty interesting book on Radio. They send it out without cost to anyone who wants to learn about Radio. It is filled with facts, photos, and figures on the Radio Industry, and tells all about its course which quickly prepares you right at home in spare time for one of the big pay positions in Radio.

Take my advice—and Mary's—and send for that, no matter how little you know of Radio, or what your plans are. Just mail the coupon for it now. Address the National Radio Institute, Dept. 13FA, Washington, D. C.

NATIONAL RADIO INSTITUTE  
 Dept. 13FA, Washington, D. C.

Please send me without cost or obligation your Free Book, "Rich Rewards in Radio," which tells all about the opportunities in Radio, and how spare time study at home will qualify me for a big paying radio position. Also full details on your Free Employment service.

Name..... Age.....  
 Address..... Occupation.....  
 City..... State.....



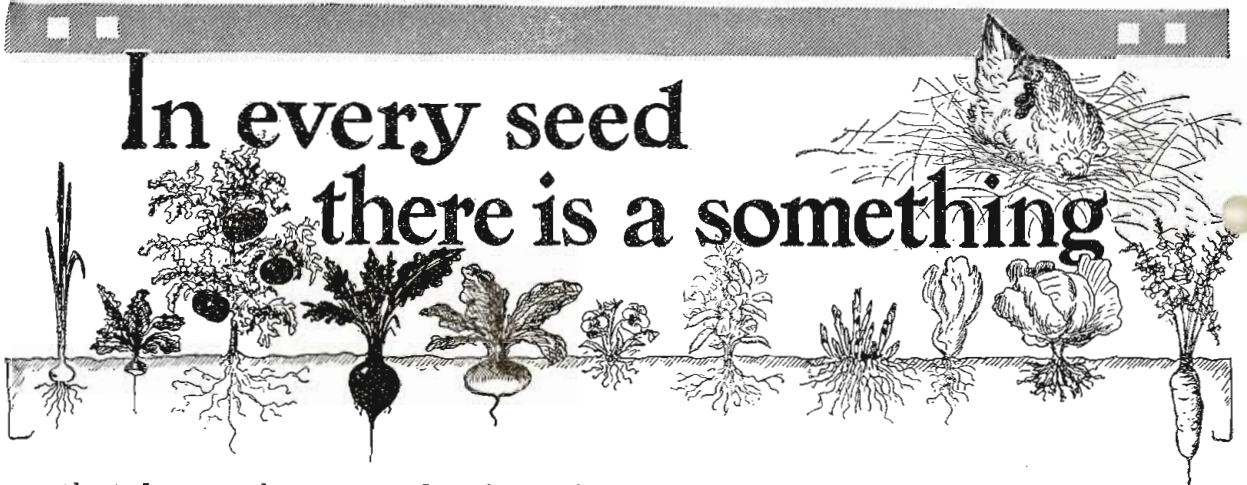

# In every seed there is a something

that knows how to take from its environment the wherewithal to build the body of the organism it animates. From the little seed you place in the ground this **something** sends roots into the earth, blades or branches into the air, and takes **from** the earth and the air that with which it builds.

Within the egg this **something** is wooed to life by the warmth of the brooding mother's breast.

## CHIROPRACTIC

teaches that this **something** knows the secret of converting food into flesh and blood, and carries on all the processes of life, in the human body, by means of impulses sent over the nerves. It teaches that when a nerve is impaired by a vertebra becoming misaligned, these impulses do not flow over the nerves normally, and the result is what we call dis-ease. To get the dis-eased member to function again it is necessary to adjust the vertebra that is pressing on the nerve, to normal alignment, thereby permitting the normal flow of impulses over the nerve.

To adjust the vertebra to normal alignment is the work of a competent chiropractor.

A trial will convince the most skeptical of the correctness of these principles.

### DEFINITION

The practice of Chiropractic consists of the palpation and adjustment, with the hands, of the movable segments of the spinal column to normal position for the purpose of releasing the prisoned impulse.



Write for information  
regarding Chiropractors or Schools  
to the

**Universal Chiropractors' Association**  
Davenport, Iowa, U. S. A.



it was too late that he realized that our ether waves were beating against his mountain like ocean waves against a soft cliff, each wave gnawing into the cliff a little more, until suddenly the whole cliff toppled over, and his home and all his farm buildings and 22,000 head of blooded cattle went hurtling down to the base of the mountain and were utterly destroyed. Luckily, he said, it was an evening when he was in Coboya or he would have been killed and I would have had murder to account for."

"Pethcod," I said, "this is the most remarkable thing I ever heard!"

"Yes," he said, "but I haven't told you the most amazing part. Before the trial I had surveyors go over the ground between Alacamar and Coboya and they could not find a trace of any mountain—not even a hill. But when the swami, Peter Duss, got on the stand, he explained that. He said he first noticed the effect of our ether waves one day when the wall-paintings of the cave began to sort of dissolve before his eyes and melt away. Then the cave began to grow bigger and bigger. The ether waves, he said he supposed, were washing into the cave and wearing its walls away, and washing out the debris as they receded, just as ocean waves would. And presently, on an evening when we were sending an especially strong bit of jazz band music, when the cave had become so large it would have taken weeks to explore it, he heard a rumbling, and he knew the mountain was falling into the cave. He made a rush for the mouth of the cave, and was almost in time, but not quite; as the mountain fell into the cave it caught one of his legs and cut it clean off. Otherwise he was lucky."

"And that," I said, "accounted for there being no mountain?"

"Yes," said Pethcod. "The mountain fell into the cave. And now they will have to mine the ore out of the ground instead of scooping it from the mountain side. So the jury was out ten minutes and awarded them \$1,320,654.50 and costs, and I sold out the *Alacamar Times* and came east. And if every word of that is not the solemn truth, you can call me a soft-boiled door-knob!"

I looked at him for a minute, squarely in the eye. Then I spoke.

"Pethcod," I said, "you are a soft-boiled door-knob!"

"All right, then," he said. "I'll tell you the truth. I never bought the *Alacamar Times*. I bought oil stock, and there wasn't any oil."

### Vacationing With Radio

(Continued from page 1740)

spike into the earth, near where we expected to have the set, and connected a piece of the bell wire to it.

After running the aerial lead-in wire and the ground wire to the respective binding posts on the set, Jim plugged in the headphones and commenced operations. Unlike most accounts of this sort, she perked fine right off the bat and we found that there were numerous broadcast stations that we were going to be able to rely upon for entertainment.

No more radio until evening, for it was our desire to incarnate the little game we had of leaving camp, getting lost and relying on animal instinct—and a compass—to again find ourselves, and camp, in time for chow. As this game has always gone, we found camp at approximately 6:30 p. m., so we started to prepare bacon and coffee, always relished in the great open west where, presumably, men are men. After chow, with that contented feeling following a hearty meal—symbolized by the cow—we lit our pipes, lit the vacuum tube, donned the headphones and let 'er rip.

We centered on broadcast station WHAZ.

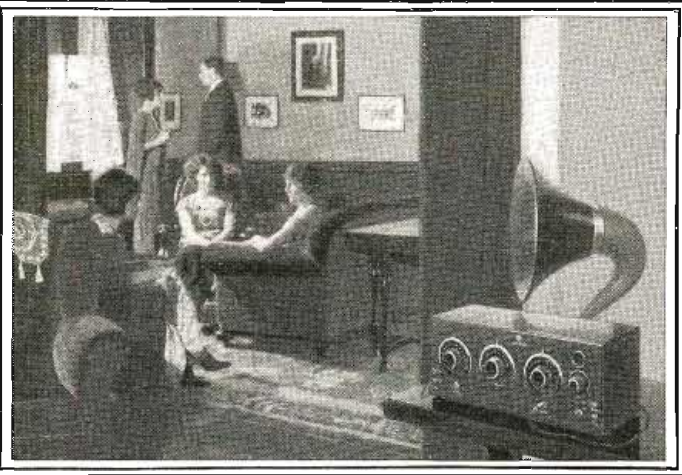

FADA "ONE SIXTY" NEUTRODYNE RADIO RECEIVER

## Clarity

Radio is most enjoyable when the programs of music and other forms of entertainment are coming in sweet and clear; loud enough to be heard perfectly on the loud speaker, yet faithfully reproducing the voice of the singer or the harmonies of the instruments.

Clarity of tone is a feature that has made hosts of friends for the FADA "One Sixty" radio receiver. No matter where the station tuned in may be located—in the East, or in the West, the clarity of tone produced by the "One Sixty" is remarkably lifelike and pure. And so powerful is this wonderful receiver that the majority of broadcasting stations, both local and distant, can be heard clearly and plainly on a loud speaker.

Quality—in design and workmanship—characterizes the FADA "One Sixty" through and through. Combining as it does the famous Neutrodyne principle with skilled FADA craftsmanship, the "One Sixty" represents a great feat of radio engineering.

In selectivity, volume, distance getting, clarity and fine appearance, the FADA "One Sixty" is unsurpassed. To hear it perform is to be convinced. It will be well worth your while to visit your dealer and see this receiver. Price \$120. This does not include tubes, batteries or phones.

F. A. D. ANDREA, INC.

1581 Jerome Avenue

New York City

# FADA

## Radio



ON ALL NEWSSTANDS MAY 15<sup>TH</sup>

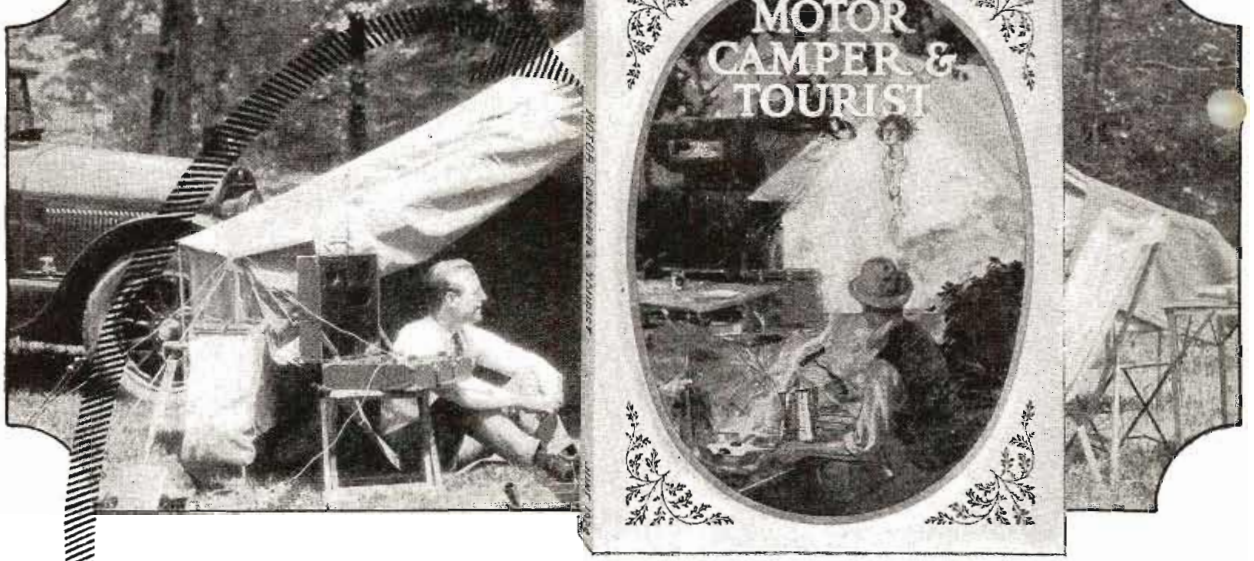

## A NEW MAGAZINE For Every Motor Car Owner

The aim and purpose of this new magazine is to make the motor car worth more to every owner. It will have permanent departments that will describe in detail various trips about the country. The best routes to take, what to see on the trip and how to get the utmost in pleasure from the trip.

To illustrate the great value that this magazine will have for every motor car owner we are listing here the various departments in order of their importance.

THE OPEN ROAD—(ROUTES)  
MOTORCAMPING—HOW TO DO IT  
NEW ROAD AND AUTO LAWS  
NEWS OF THE AUTO CAMPS  
GAS ENGINE POINTERS  
NEW CAMP EQUIPMENT  
MOTOR ELECTRICS  
YOUR TIRES  
FIRST AID

CAMP RADIO  
NEW AND WORTHY AUTO ACCESSORIES  
AROUND THE EVENING CAMPFIRE  
PRIZE CONTESTS  
ROADSIDE REPAIRS  
LATEST AUTO NOTES  
HANDYKINKS  
And the thousand and one other pointers  
on better Motor Travelling.

The JUNE Issue on sale May Fifteenth is the first issue. Every motorist will be surprised at the amount of valuable information that will be contained in it. Those who begin with the first issue will find it indispensable in planning any immediate auto trip long or short.

By filling out the attached coupon you can be assured of receiving this initial issue.

SUBSCRIPTIONS \$2.50 the Year—FOREIGN 50c Extra  
ON ALL NEWSSTANDS—25c THE COPY

SEND FOR  
FREE  
SAMPLE COPY

RN-6

GERMOTT PUBLISHING CO., Inc.  
53 Park Place, N. Y. C.

Enclosed you will find.....dollars for  
my subscription to MOTOR CAMPER & TOURIST.

NAME .....

ADDRESS .....

# MOTOR CAMPER & TOURIST



which was running an excellent musical program. Slowly Jim adjusted the knobs and dials and as he did so the music became louder and louder, shooting little thrills through us as it grew in volume. This, for us, was a new experience. They say of potatoes baked in a camp-fire that they have twice the flavor of those baked in an ordinary oven. Well, the music we were listening to had twice the influence on us it would have had at home. One takes radio in the home as a matter of course, but out in the timber it is utterly different—and beautiful—surrounded by trees, big ones, stretching way up into the sky, and the moon shining down, spreading its glow over everything, and the stillness of nature, the music is so out of the ordinary, so out of place in a way, yet so well expressing the surroundings. Music and voices, such matter-of-fact things when we are in actual contact with them at all times, but how magnificent, how wonderful, when one is far from the masses, resting in the still arms of nature without a vestige of the human element. It is not that one doesn't appreciate it at home, but its influence is much more noticeable when in an environment aside from the usual run of daily life.

Well, we certainly enjoyed ourselves that first night and went to bed feeling somewhat like men in a new world. We had experienced something different.

We were up bright and early the next morning, sensing a new life and a new pleasure in our outing. We weren't in a mood for the game of "lost and found" and came pretty near to remaining in camp and listening in. But there were reports of good fishing in a lake near our camp, a matter of four miles, so we finally left with our rod and tackle.

Back at dusk, we ate a hearty meal of fish, as might be expected, and were again ready to listen in to whatever the outside world would present us with. For a while we browsed about the ether, listening to various stations. All very interesting, all rather marvelous. We, a couple of isolated souls, umpty-ump miles from nowhere listening to the merry-making of the north, the east, the south and the west. The "Thief of Bagdad" never possessed a carpet more full of magic than ours—the little radio set.

Our little campfire burned on merrily, the tops of the monstrous trees waved lazily in the soft breeze above, the moon cast wavering shadows and WGY played "Ava Maria." At the end it seemed as though the whole world stood still, breathless, in expectation of a miracle. But we tuned to WDAP and broke the spell only to run riot in a jazz band trumping out a rhythmic gloom annihilator that awoke a bit of the youth in us. All in all, though, it was rather a laughing matter, as it was so out of harmony with our surroundings, yet it was very, very welcome.

One can imagine the varied programs we picked up, music of every description, talks on this and that, and numerous novelties, but one cannot imagine the wonder of it all, the striking contrasts produced between our surroundings and the voice of the world.

Never again will we go vacationing without a radio set, no matter whether it is to the mountains, the north woods or the seashore. To us it has become an inseparable companion.

If you are going a-vacationing this spring or summer, take a portable set with you. It is an act you will not regret, for the radio will furnish you with pleasant entertainment during what otherwise would be the restless hours of the day. And the cost? It is practically nothing. Dry cell tubes will do the trick and one set of "A" and "B" batteries will last until you return.

For the Buyer Who Discriminates



The Thompson  
**MAGNAPHONE**  
Reg. U.S. Pat. Office

Supreme in  
Tone and Volume

The superiorities of this popular radio reproducer win instant approval from those who appreciate and demand the best, in the radio equipment they buy. Thompson's 14 years of radio experience have given the Thompson MAGNAPHONE electrical, mechanical and acoustic refinements found in no other loud-speaker.

List Price \$35.00

AT DEALERS EVERYWHERE

The Thompson  
**NEUTRODYNE**  
RADIO

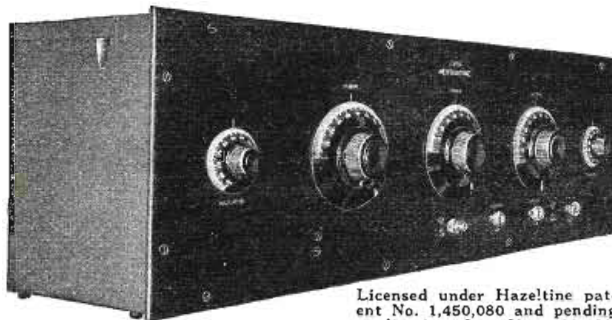

Licensed under Hazeltine patent No. 1,450,080 and pending application Ser. No. 433,729. Other patents pending.

The Neutrodyne is the receiver every radio enthusiast wants, today—and the THOMPSON NEUTRODYNE is one that any dealer can sell with the confidence that it represents the Neutrodyne at its best. Correct in design, refined in every construction detail, carefully balanced, thoroughly tested, the THOMPSON NEUTRODYNE will build customer confidence for any dealer who sells it.

List Price, without tubes or batteries, \$150.00

Write us for the name of the nearest Thompson distributor, who carries the Magnaphone and the Model 5A Neutrodyne ready for immediate delivery

R. E. THOMPSON MANUFACTURING CO.

Sales Office—150 Nassau Street, New York

Factory—Jersey City, New Jersey

# GUNN SECTIONAL RADIO CABINET

**Radio Equipment  
Concealed and  
Free from Dust  
when Compart-  
ments are closed.**

The upper section for Radio Machine is 12¾ in. high inside. The drop lid with framed-in panel provides a convenient table and arm rest when open.

Center book section is 9¼ in. high and Battery section is 11¼ in. high inside.

Outside length 34¼ in., height 48 in.

Inside length 32½ in., depth 10¼ in.



Made in Quartered Oak, Birch Mahogany and Genuine Mahogany.

Dealers Everywhere---If unable to locate the Gunn Dealer in your town, write us.

**THE GUNN FURNITURE COMPANY, - GRAND RAPIDS, MICHIGAN**

BRANCH OFFICES: 11 E. 36th St., New York - 312 W. 10th St., Los Angeles

## Your Phonograph Is a Perfect Loud Speaker

Phonograph engineers spent millions of money and years of time to perfect the acoustic properties of the phonograph. One of the 6 Cross Phonograph Adapters will fit your phonograph, eliminating the unsatisfactory makeshift loose coupling—and giving you a guaranteed satisfactory connection.



If your dealer can't supply you send \$0. for any adapter except for Brunswick \$1.25.

MADE TO FIT THE FOLLOWING POPULAR LOUD SPEAKING UNITS  
Morrison, Western Electric, Holzer-Cabel, Rhamstein, Acousticon, Music Master, "R.C.A.," Duzenbury, Aviator-Kent, Jewett, Dictaphone New Type Baldwin, Aderman, model A & B, Radiocete, model A & B, Firth, model A & B, Muzlock, Burns, Viaphone, Ampiton, Trioly, Peerless, model A & B, "CIC," Melotone

Dealers Note—The Cross 6 fits all, 80% less stock.

### CROSS GEAR & ENGINE WORKS

Address: RADIO DIVISION, JOS. MACK BLDG., DETROIT, MICHIGAN



## AMPERITE The "SELF-ADJUSTING" Rheostat

For a 1 step Amplifier to the—**SUPERHETERODYNE**

—the really perfect filament control.

—eliminates hand rheostats.

—simplifies wiring.  
**RADIALL COMPANY**  
320 W. 42nd Street, New York

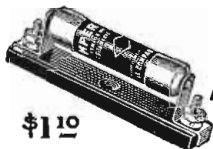

\$1.10

From your dealer

## FRESHMAN VERNIER DIAL

A Bakelite dial with Vernier adjustment. A small rubber tired wheel through the slot in the dial permits you to set the dial to the exact point and obtain the same dial setting every time. Just the thing for Neutrodyne, Polydyne and Super-Heterodyne.

Price, 3 in. \$1.00  
Price, 4 in. \$1.50

At your dealers, otherwise send purchase price and you will be supplied postpaid. Ask your dealer or write direct for free diagrams of Neutrodyne, Polydyne and Super-Heterodyne Circuits.



**Chas. Freshman Co. Inc.**  
Radio Condenser Products

106 Seventh Ave., New York, N. Y.

## Important Events in Radio

(Continued from page 1732)

June 24: Act approved by the United States Government requiring radio equipment and operators on certain passenger-carrying vessels.

1911.—July 1: Radio service organized in Department of Commerce and Labor to enforce the act of June 24, 1910.

1912.—F. A. Kolster, of the Bureau of Standards, invented and developed the Kolster decimeter, which is used to make direct measurements of wave length and logarithmic decimeter. This instrument has been used by the radio service of the Department of Commerce since it was invented.

Early in the year the American Marconi Co. absorbed the United Wireless Co., of the United States.

In February the Marconi Co. procured the patents of Bellini and Tosi, including those for the wireless direction finder.

On February 9 the Australian Commonwealth station was opened.

On April 15 the steamship *Titanic*, on her maiden voyage, struck an iceberg and sank, but, owing to the prompt wireless call for assistance, the lives of more than 700 of her passengers were saved.

The International Radiotelegraphic Conference opened in London on June 4 and approved important regulations to have uniformity of practice in wireless telegraph services. On July 5 the International Radiotelegraphic Convention was signed at London.

July 23: Act approved by the United States Government extending act of June 24, 1910, to cover cargo vessels and requiring auxiliary source of power, efficient communication between the radio room and the bridge, and two or more skilled radio operators in charge of the apparatus on certain passenger-carrying vessels.

August 13: Act approved by the United States Government licensing radio operators and transmitting stations.

1913.—F. A. Kolster submitted to the Government a paper pointing out the advantages of certain applications of radio signaling for use at lighthouses, lightships, and life-saving stations, especially in time of fog.

During this year the Governments of the United States and France experimented between the Eiffel Tower station and Washington by wireless to procure data for comparing the velocity of electromagnetic waves with that of light.

In June a wireless telegraph bill was presented to the Ottawa Parliament and passed under the title "Radiotelegraph act of Canada."

On October 11 the *Voltorno* was burned in mid-Atlantic, and in response to the wireless appeal 10 vessels came to the rescue, 521 lives being saved.

On November 24 the first practical trials with wireless apparatus on trains were made on a train belonging to the Delaware, Lackawanna & Western Railroad.

The station at Macquerie Island is the means of keeping Doctor Maason the Australian explorer, in touch with the outer world. Radio despatches were published in a small journal which was established, called the *Adelle Blizzard*.

November 12: Safety at Sea Conference held in London. At this conference the use of radio received appropriate consideration.

November 24: The first practical trials with wireless apparatus on trains were



made, messages having been received and transmitted on board trains.

1914.—Experiments in wireless telephony were carried out between several vessels lying at anchor five-eighths of a mile apart, ordinary receivers being used with success. The wireless telephone experiments were continued between two warships on the high seas, and the reception was consistently good over a distance of 18½ miles. Successful wireless telephone communications were effected using only very limited energy between vessels on the high seas 44 miles apart. These experiments were repeated where land intervened between the communicating vessels, and in this case again excellent results were obtained. On this day radio telephonic communication was constantly maintained for 12 hours.

On April 15, at Godalming, a memorial was unveiled to the memory of Jack Phillips, chief radio operator of the ill-fated *Titanic*, who died at his post when the vessel foundered in mid-Atlantic on the 15th of April, 1912.

A new departure in the application of radio telegraphy to the safety of life at sea was the equipment of the motor lifeboats of the steamship *Aquitania* with radio apparatus.

High-powered trans-oceanic stations were completed at Carnarvon, Wales, Belmar, Honolulu, and San Francisco during the autumn of 1914. The Honolulu-San Francisco stations were opened to public service September 24. The Tuckerton-Eilvese and Sayville-Nauen stations were in operation about this time.

Most of these stations made use of the latest developments in the art, using undamped and long waves as produced by the Poulsen arc and the radio frequency alternator.

On October 6 E. H. Armstrong was issued a patent covering the regenerative circuit also known as the feed-back and the self-heterodyne circuit.

1915.—During this year F. A. Kolster, of the Bureau of Standards, developed a radio compass said to be more effective than that which was being used.

On February 20 the Panama-Pacific Exhibition at San Francisco was officially opened by President Wilson at Washington, through the medium of wireless telegraphy.

On May 12, in Battery Park, New York City, the mayor unveiled the monument in memory of wireless operators who had lost their lives at the post of duty.

On July 27 wireless communication between the United States and Japan was effected. Two terminal stations were located at San Francisco and Funabashi, near Tokio, and the messages were relayed through Honolulu.

On July 28 the American Telephone & Telegraph Co., working in conjunction with the Western Electric Co., succeeded in telephoning the wireless across the American continent from Arlington to Hawaii, a distance of nearly 5,000 miles.

On October 26 the wireless telephone experiments were continued, communication being effected across the Atlantic from Arlington to Eiffel Tower, Paris.

During this year ship service was greatly improved through the installation of new equipment, embodying features of great practical value, by various operating companies. Efficient emergency radio transmitters came into wider use, owing considerably to the efforts of the radio service of the Department of Commerce and its refusal to pass inefficient equipment. Such installations considered as essential are safeguards to shippers and the seagoing public.

1916.—During the course of a severe blizzard in the United States during Feb-

# ATWATER KENT

Philadelphia

## Exceptional Radio Performance

THE outstanding preference, among families the nation over, for the ATWATER KENT Receiving Set is due to its remarkable performance—to its exceptional selectivity, its wide range—volume of clear reception and ease of operation.

The tonal fidelity of the ATWATER KENT Loud Speaker is the delight of every owner.

ATWATER KENT MFG. CO.  
4943 STENTON AVE., PHILA., PA.



# The Best in Radio

Telmaco Radio Guide Book describes all, 10c.

Our new 64-page Catalog No. TGR contains twenty of the most popular radio circuits printed in blue. These include the Super-Heterodyne, Neutrodyne, Grimes Inverted, Colpitts, Flewelling, Reinartz, Diode Electrad, Super-Regenerative and many others. Each article used in circuits is attractively pictured instead of appearing in straight schematic form. Besides containing blue prints, the best in radio is also illustrated and described. Catalog sent postpaid for Ten Cents. Each circuit worth double. Send for your copy today.



**DEALERS!** Our New Dealers' Catalog and Price List describes nearly all the better Standard Radio Lines. You should have it. Mailed FREE to all bonafide dealers making request on their business stationery.

**TELMACO**  
Quality Radio Exclusively  
Established 1918

Radio Division  
**TELEPHONE MAINTENANCE CO.**  
20 So. Wells St. Dept. B Chicago, Ill.

## New CARTER Plug

The New Carter "ONE-WAY" plug is the latest addition to the famous Carter line of original Radio Products. Simplest, fastest and easiest method of attaching a loud speaker or head set to a plug. No trick trigger or screws. Simply press the cord tip into long phosphor-bronze spring, which tightly makes contact the entire length of the cord tip. Thus a positive and sure contact is made. No fibre insulation is used. Carter originality of design has made possible this quality product at the unusual price of 50c. Any dealer can supply you with the New Carter "ONE-WAY" plug.

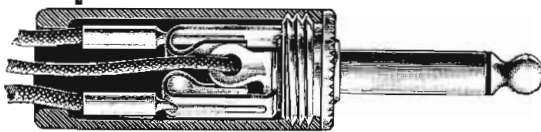

**50c**

Write for catalog of other original Carter products including Jacks, Jack Switches, Inductance Switches, Vernier Rheostats, Automatic Control Rheostats, "TU-WAY" Plugs, and "IMP" Jacks and Plugs.



### PROTECT YOUR RUGS AND FLOORS



The little recesses in the MAY "RUBBER" TRAY collect the Battery Acid thus preventing it from destroying rugs, clothes or scratching floors. Sizes up to 100 amp., 75c—prepaid.

Price for sizes up to 150 amp. .... \$1.00  
If your Dealer cannot supply you, write direct, enclosing Money Order

**MAY RUBBER COMPANY**

27 Warren St. New York City  
Dealers and Jobbers: Write for attractive proposition

### 2LO, LONDON His Goal—At Last!



Using a DE-TEC-TONE Crystal Detector in a 3-tube reflex receiver, 2LO, London, was heard in Hannibal, Mo., in latest tests, verified by A.R.R.L. It is not uncommon to get stations 1,000 miles away on simple crystal sets with

DE-TEC-TONE. Dealers or direct, \$1.50 postpaid.

**DE-TEC-TONE**

Crystal Detector

PYRAMID PRODUCTS CO.  
117 N. DEARBORN STREET, CHICAGO, ILL.

ruary wireless telegraphy was extensively used for train dispatching, as the telegraph wires were down.

The determination of the difference in longitude between Paris and Washington with the aid of radio which had been in progress since October, 1913, was completed during May, the result, expressed in terms of time, being 5 hours, 17 minutes, 35.67 seconds, and has a probable accuracy of the order of 0.01 second.

The initiation of the newly established trans-Pacific wireless service between United States and Japan was celebrated on November 5, by an interchange of messages between the Mikado and President Wilson.

1917.—June 2 marked the "coming of age" of wireless telegraphy in England, that is, that 21 years had elapsed since the registration of patent 12039 in 1896.

1918.—The trend of progress toward continuous-wave communication as distinct from that by damped waves was very marked during this year, a particular impetus being given by the continued development of the electron tube as an efficient receiver and generator of undamped oscillations. Steady improvement was also evident in the arc form of generator which was installed in many new high-power stations.

Wireless telephony also progressed to a marked extent, particularly in the direction of reliability and increase of range, due mainly to the development of valve generator and receivers.

In the equipment of aircraft with wireless great progress was made, both in radio telegraphy and radio telephony.

At the end of the year a high-power station, erected by the United States Government, was opened at Croix d'Hins, near Bordeaux.

In the Argentine the erection of a station destined for direct communication with the North American continent was begun in the vicinity of Buenos Aires.

The extension in the application of wireless telegraphy to merchant vessels continued, and at the close of the year some 2,500 to 3,000 vessels of the British Merchant Marine carried installations.

On July 31 the United States Government took over all wireless land stations in the United States, with the exception of certain high-power stations, which remained under the control of commercial companies.

On September 22 messages transmitted from Carnarvon were received in Sydney, 12,000 miles away. Cable confirmations of these messages were sent forward at the same time but were received some hours later than the corresponding radiograms.

In April a high-power station was opened at Stavanger, Norway, for the use of the Norwegian Government. The station communicates with the United States.

1919.—The successful trans-Atlantic flights of Alcock and Brown, of the American NC4, and of the British dirigible R34, during the summer of the year focused attention upon the application of radio for aviation purposes and its great value for aerial navigation.

On June 30, 1919, there were 2,312 stations of the United States, having increased from 1,478 on June 30, 1918. At this time new ship stations were increasing at the rate of 100 a month. This increase was due to the great number of vessels built during the war period.

The temporary war measures relative to the installation of wireless telegraph apparatus on all merchant vessels of 1,600 tons or over under the British flag was made permanent by a bill passed by the British Parliament.



In February a Spanish decree was issued to the effect that all sailing vessels of 500 tons or over and carrying 50 or more passengers must be equipped with wireless apparatus.

During the year the Radio Corporation took over the radio interests of the American Marconi Co.

The war-time ban on private and experimental wireless stations was removed.

1920.—The steady development of continuous-wave wireless work, was continued during the year and some further progress made in the commercial application of tube apparatus.

On January 14 a law was passed in Greece making the carrying of wireless apparatus obligatory on all Greek merchant ships of 1,600 tons gross and over, or having 50 or more persons aboard, including crew.

On January 25 a new high-power station was opened at Monte Grande, Argentine, call letters LPZ.

Amateur radio work in this and other countries progressed steadily during the year with the gradual removal of war-time restrictions.

Bordeaux, France, high-power station opened.

1921.—Experiments were carried out in France with successful results in the application of Baudot and similar high-speed telegraph apparatus to radio work.

The Nobel Prize for physics was awarded this year to Prof. Edouard Branly for his researches in radio.

The progress made in amateur and experimental wireless is exemplified by the attempts made in February and December of this year to effect communication on short wave lengths between the wireless amateurs of the United States and Great Britain. The first attempt was unsuccessful, but during the second test signals from many American amateur stations were heard both by British radio amateurs and by the representative of the American Radio Relay League who was sent over for the tests. The signals were also heard in Holland.

The American Radio Relay League held its first annual convention in Chicago, August 30-September 3, at which many thousands of amateurs of the United States were present.

The first licenses for broadcast stations were issued in September of this year.

New York radio central station opened on Long Island.

1922.—During this year broadcast stations increased rapidly in keeping with the great interest taken in the art.

On June 7, E. H. Armstrong read a paper before the Institute of Radio Engineers on some recent developments by him of regenerative circuits. Professor Armstrong was granted a patent for the super-regenerative circuit.

Experiments in radio telephoning from ship to shore were conducted during this year. In tests from the steamship *America* it was proved possible to communicate with land telephone stations more than 400 miles distant from the ship.

1923.—On March 2, L. A. Hazeltine, of Stevens Institute of Technology, presented a paper before the Radio Club of America on tuned radio frequency amplification with neutralization of capacity coupling. Professor Hazeltine was granted a patent for the non-radiating neutrodyne receiver.

Great progress was made during the year in the development of vacuum tubes.

Short wave lengths were used to greater advantage than heretofore.

The McMillan expedition to the polar regions had radio for their only means of direct communication. Using low power and short wave lengths their vessel, the *Bowdoin*, communicated with several

# No Matter What Your Vocation



Whether Professional Man  
Business Man or Daily Worker

# A Thorough Training In CHEMISTRY Will Help You To Get Ahead

**T**O be successful today is to know Chemistry! Every line of business, every branch of industry depends upon Chemistry in some form. You may not realize it, but your own proficiency in whatever work you are doing would be increased by a knowledge of Chemistry. In many lines such knowledge is absolutely essential. In others it is a guarantee of promotion and more money.

The keen competition that exists in every commercial activity today requires that a man know all there is to know about his vocation. If you have something to sell—no matter what—Chemistry enters into its makeup. The salesman who knows the chemical composition of his article can talk about it more intelligently than the one who lacks this information, and his sales are proportionately larger. In the building trades Chemistry is of prime importance. The mason, electrician or painter who knows something about Chemistry can do better work and command more money than the one who does not. Through Chemistry a shop-keeper learns how to attract the most trade, and even in clerical positions one can capitalize his chemical skill.

Chemistry should be as much a part of your mental equipment as the ability to calculate or to write correct English. The world is paying a thousandfold more for ideas than for actual labor. The big rewards go to the man who can show how to turn out a little better product at a little lower cost. And Chemistry will give you the ideas that will save money for yourself or your firm in the very fundamentals of your business. There is nothing remarkable about this; it is going on every day. If you have not heard of it before, it is because the general public has been slow to recognize the tremendous value of chemical training. People have been content to leave Chemistry in the hands of a few trained chemists who could not possibly develop the subject to anywhere near its greatest extent.

Now we are on the eve of a great awakening. Our heritage from the World War has been an intense development of the chemical industries in the United States and a tremendous interest in all the applications of Chemistry. People are taking up the subject merely for the good it will do them in their own line of business.

It is no longer necessary to enter college in order to learn this fascinating science. Our Home Study Course trains you just as thoroughly, and with the same assurance of success, as those who took the longer way. And our methods are so simple that we can teach you no matter how little previous education you may have had. Many of our graduates now hold responsible positions or have materially increased their incomes from various enterprises as a result of taking our course. Hundreds of letters from students testifying to the benefits they have derived from our training are here for your inspection.

Remember that you do not need to study Chemistry with the idea of actually practicing as a chemist, although a great many of our students are taking our course with this object in view. If you want to know more about what Chemistry will do for you, if you want to know what our home study course offers, sign and mail the coupon today for FREE BOOK, "Opportunities for Chemists."

## Chemical Institute of New York, Inc.

HOME EXTENSION DIVISION 6  
66-R West Broadway, New York City

**DR. T. O'CONNOR SLOANE**  
Will Teach You Chemistry  
In Your Own Home

The Chemical Institute of New York, of which Dr. T. O'Connor Sloane is Educational Director, was founded to fill the need of ambitious, far-sighted men who realize and recognize the splendid future Chemistry offers them, but who cannot spare either the time or the money to attend college. Dr. Sloane, a foremost authority on Chemistry, will teach you and will give you any individual help you may require. He will personally go over your papers, correct them, point out your faults, explaining you in a practical and interesting way. No special education required other than the ability to read and write English. One student has characterized our lessons as "The course that takes the mystery out of Chemistry."

### Read What One of Our Recent Graduates Reports

"I thought I would let you know of my success. I finished your course about two months ago and now have a fine position as chemist at the DuPont Dye Works. I am getting along fine with my work and like it very much. It was through your course alone that I have been so successful. It is wonderful and I hope you have great success with it."  
(Name and Address on request.)

### Easy Monthly Payments

You do not have to have even the small price of the course to start. You can pay for it in small monthly payments—so small that you won't feel them. The cost is very moderate, and includes everything, even the Laboratory Equipment—there are no extras to buy with our course. Our plan of monthly payments places a chemical education within the reach of everyone.

### Laboratory Equipment Given To Every Student Without Additional Charge

We give to every student without additional charge his chemical equipment, including forty-two pieces of laboratory apparatus and supplies, and seventeen different chemicals and reagents. These comprise the apparatus and chemicals used for the experimental work of the course.

### Special 30-Day Offer

For a short period we are making a special offer that will be worth your while to take advantage of. Write for particulars, using the coupon below or simply a postal card. This will not obligate you in the least. Do not wait until tomorrow. Send the coupon now while you think of it.

### Sign and Mail the Coupon for FREE BOOK

CHEMICAL INSTITUTE OF NEW YORK, Inc.  
Home Extension Division 6,  
66-R West Broadway, New York City

Please send me at once without any obligation on my part, your Free Book "Opportunities for Chemists," and full particulars about the Laboratory Equipment furnished to every student. Also please tell me about your plan of payment and your special 30 day offer.

NAME .....

ADDRESS .....

CITY .....

STATE .....

R. N., 6-24

# JUMBO—the Ideal Battery for WD12 or UV201A Tubes

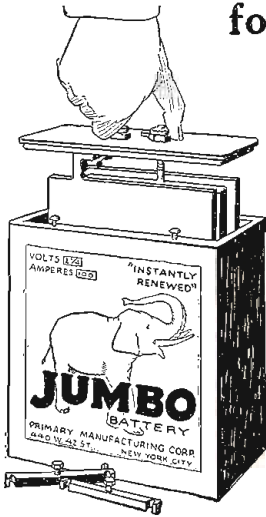

The single Jumbo for WD12 tubes, the double Jumbo for UV201A tubes, will each operate 3 tubes 4 hours daily for 40 days—renewal cost 65c and 95c, respectively, including free home delivery service within Greater New York.

### Instantly Recharged

Outside of New York Jumbo batteries can be recharged at the same rates by any *Jumbo Service Dealer* WHILE YOU WAIT—or in your own home without electrical equipment.

Prices: Single Jumbo . . . . . \$ 5.25  
Double Jumbo . . . . . \$10.00

Capacity: 100 amp. hours

Write for 30-DAY TRIAL  
**PRIMARY MANUFACTURING CO.**  
442 West 42nd Street Telephone  
New York Longacre 1317-6765

stations in the United States while they were frozen in thousands of miles away. Broadcasting concerts from United States were heard during the long dark nights of the arctic zone.

During the year foreign countries became interested in radio telephone broadcasting.

Broadcasting in United States heard in England, and vice versa.

1924.—In January radio was used in the region of the Great Lakes during a blizzard for dispatching trains.

An expedition from the United States, under the leadership of Hamilton Rice, which will explore the Amazon and Orinoco Rivers in Brazil and Venezuela in the interest of geographical science in general, will have radio as their only means of communication.

On February 5 a radio program broadcast in the United States from Pittsburgh station of Westinghouse Electric & Manufacturing Co. was received and rebroadcast in England for the benefit of English stations.

On February 23 a concert broadcast by the same station and relayed from London was heard clearly in Calcutta, India.

Roger Babson, economist, estimates that during this year the American people will spend approximately \$350,000,000 for radio equipment. Sales of radio equipment are running nearly twice as large as all kinds of sporting goods.

A wireless lighthouse has been set up on an island in the Firth of Forth, Scotland. Wireless waves are concentrated by reflectors into a beam which can be sent 100 miles, giving ships their position.—Abstract from the *Radio Service Bulletin*.

## The Engine of Your Radio Set

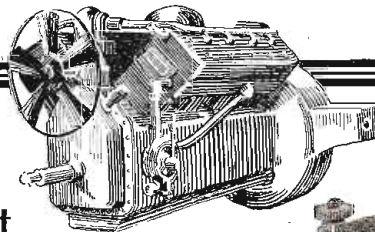

WOULD you select a two-cylinder engine for pleasure driving? Would you use a marine engine to propel a motor truck? Would you use an air-cooled, aeroplane engine in a racing car? When you select audio transformers without considering their qualities you are putting the wrong engine in your radio set.

Supertran high speed smoothness with multi-cylinder reserve power makes it an ideal audio engine to drive your loud speaker. It represents the best engineering because you have no back-fire distortion or poor timing regulation to introduce howling.

**Ford Mica Co.**  
33 East 8th Street  
New York City



WETMORE-SAVAGE CO.,  
New England Distributor  
Boston, Mass.  
Reg. U. S. Pat. Office.

### OPERATION OF RADIO IN GREECE

Some months ago the Revolutionary Government stopped by legal decree the operating of private wireless apparatus in Greece. This measure was taken largely to prevent the Greek public from being reached with propaganda unfavorable to the Revolution.

According to unofficial advices, the Ministers of Finance and Marine of the present government have prepared a law to be submitted to the National Assembly for ratification, by which the operation of private radio sets belonging to Greek individuals will be permitted under certain restrictions and subject to the payment of a license tax.

### Daylight Broadcasting

(Continued from page 1727)

strikes this layer, it is reflected much as a light ray is reflected from a mirror. Thus, a receiving installation located on the earth at a distance of 100 miles from the broadcast station will receive not only the direct wave from the broadcast station, but also the reflected wave emanating from the Heav-  
side layer.

It is well known that the polarity of radio waves differs at any given point in space, and also in time. In other words, a radio wave has its negative and positive side. If now, at the point where the radio receiver is located, the two waves, direct and reflected, arrive at the receiving antenna with the same polarity at any given time, they will aid each other in producing an electrical impulse in the receiver. On the other hand, if their positive and negative sides are together at the antenna, at a definite time, they will tend to neutralize each other and the volume of sound in the radio receiver will be diminished. Moreover, the degree to which the two waves, direct and reflected, aid or neutralize one another, is determined directly by the height of the Heavside layer above the earth. If it is at a higher distance from the earth, the reflected wave will naturally have further to travel, and the result will be that an entirely different part of it will be



## INSULINE ANTI-CAPACITY PANELS Mean the BEST in Radio Panels

Because they come already shielded. Our patented tin foil embedding process eliminates the "Sticky Job." Can be peeled from panel where the shielding is undesirable.

### MANUFACTURERS

We have special facilities for turning out work on short notice, whether it be a rubber or a bakelite (CELORON CONDENSITE) Panel, we can DRILL, BEVEL or ENGRAVE it and guarantee you a high grade job at a moderate price. Write for Anti-Capacity and Plain Panel Samples with Prices. Of course all standard sizes are carried in stock. Other sizes cut to order.

AT YOUR DEALER OR **RADIO PANEL & PARTS CORP.**  
61 Warren St. New York City



brought to the antenna of the receiving installation at the time when the positive side of the direct wave touches the antenna. It has been found by numerous experiments that the height of the layer varies considerably during the night, whereas, during the day it is practically stationary.

The same phenomenon may be caused by ionized clouds near the earth which act in a manner exactly similar to the Heaviside layer.

In many parts of the country, it is a general rule that clouds are more frequent during the night than during the day. Many radio engineers refer the phenomenon of fading during the night time directly to this fact.

**STATIC STATISTICS**

Another advantage offered by daylight broadcasting is the fact that static is practically absent during the morning hours and during the early hours of the afternoon, even in the summer time. In general, it is thought that this fact is due to the infrequency of thunder storms in the morning and to poorer transmission of distant static in daylight.

Radio engineers accept two possibilities in the solution of the problems of daylight broadcasting. In the first place, it is believed that an increase in the power of broadcast stations will provide a sufficient surplus of energy to permit a certain amount of absorption during propagation. Absorption of a radio wave takes place approximately in proportion to the square of the intensity at any given point. This means, naturally, that the station of high output is susceptible to a greater absorption at any given point, than a station of low output. Nevertheless, if a sufficiently great initial impulse is given to the wave, it will counteract these difficulties, and leave a surplus of energy at the receiving installation considerably greater than that produced by a station of low output. The difficulty in the way of this procedure is, of course, the prohibitive cost of erecting broadcast stations sufficiently powerful to cover a relatively large area of the country during the daytime. For this reason, it is also being suggested that receivers might be made super-sensitive; in other words, if the receiver be made 10 times as sensitive, it will be susceptible to impulses which are a tenth as great. This solution is thought inadvisable by many, however, because of the fact that parasitic noises, such as static, disturbances in the receiver and disturbances due to local power lines are increased to such an enormous extent with a super-sensitive receiver, that clearness of reception is entirely destroyed.

For this reason, the trend of broadcasting development today is towards the establishment of four or five great stations located at especially designated points in the country, and capable of furnishing radio entertainment and information to a large area. A few stations of this character could easily provide service for as great an area as at present is provided for by a tremendous number of small broadcast outfits; it is, moreover, suggested that the cost of erecting stations of this kind would be no greater than has been the cost of erecting a large number of small stations. It would also be possible, electrically to connect the four or five powerful stations in such a way that they would be capable of broadcasting simultaneously the same material. And in this direction only, does the radio engineer see the solution of daylight broadcasting problems.

**THE MYSTERY SOLVED!**

An old farmer driving slowly along a country road and seeing an aerial on almost every housetop, exclaimed:

"By heck, now I know what they mean by radio frequency."

*Contributed by F. O'Connell.*

# Atlas

TRADE MARK

## RADIO-REPRODUCTION

## LOUD SPEAKER

*The Musician of the Air*

# Presidential Conventions!

*The Republican Convention, Cleveland, June 10.*

*The Democratic Convention, New York, June 24.*

# A Message to the Public!

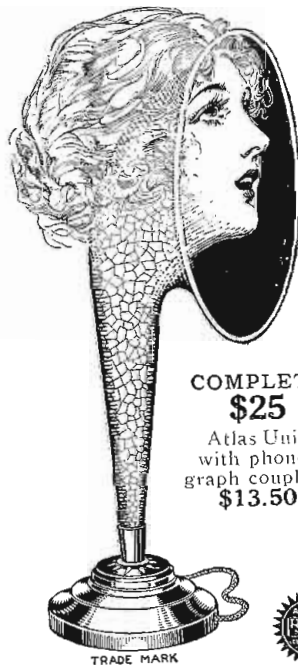

**COMPLETE \$25**  
Atlas Unit with phonograph coupling  
**\$13.50**



**T**HE very next best thing to being actually present at these two events, of national and international importance, is to hear their ATLAS RE-PRODUCTION. Bring these momentous proceedings and orations right into your home in all their original naturalness for the entertainment and instruction of your family and friends. Get all of these speeches, every word clearly inflected; in the full, undistorted tones of the speaker. Just as realistic as though you were actually there. Buy your Atlas NOW!

*Booklet "F" upon request.*

## Multiple Electric Products Co. Inc.

*Makers of Mono—TIME-LAG FUSES—Multiple*

2 ORANGE STREET

NEWARK, N. J.

BOSTON, MASS.	District Offices in	BALTIMORE, MD.
CHICAGO, ILL.	ST. LOUIS, MO.	DETROIT, MICH.
PHILADELPHIA, PA.	PITTSBURGH, PA.	SAN FRANCISCO, CAL.
	DENVER, COLO.	

Sole Canadian Distributors, Marconi Wireless Telegraph Co. of Canada, Ltd., Montreal, Canada.

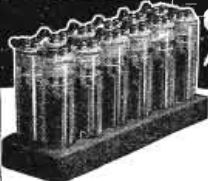

## The RāBAT Junior \$3.96

A Rechargeable Wet 'B' Battery. Capacity 800 Mil-Amps.  
12 CELLS 24 VOLTS

### Your Ultimate "B" Battery

Here are two acid type wet "B" radio batteries that are entirely free from internal current leakage. All elements visible through clear glass cells. RABATS have longer life with higher and more continuous voltage. Noiseless and compactly constructed—The Rabat Junior with a capacity of 800 mil-amps at \$3.96 and the Rabat Senior with a capacity of 2800 mil-amps at \$9.60 represent more actual battery value at a lower cost. More economical to buy—more economical to maintain. Easily recharged from ordinary house current. If your dealer cannot supply you send direct.

*Prices F. O. B. Cleveland, Ohio*

## The Radio Rabat Company

914 Bangor Building  
Cleveland, Ohio



## The RāBAT Senior \$9.60

A Rechargeable Wet 'B' Battery. Capacity 2800 Mil-Amps. 48 VOLTS \$17.88

## BRISTOL SINGLE CONTROL RADIO RECEIVER

USING GRIMES INVERSE DUPLEX SYSTEM  
Patents Pending

MOST SIMPLE TO OPERATE

The set for those who want results with little effort. Anyone in the family can quickly learn to operate it because technicalities and guesswork are eliminated—One Control Dial does it all.

**DOES NOT INTERFERE WITH YOUR NEIGHBOR**  
Other close by reception is not disturbed when you tune in with this non-radiating Receiving Set. It gives you a comfortable sensation of freedom to be able to change from one station to another knowing that you will not interfere with your neighbor's receiving.

**CHOICE OF AERIAL OR LOOP**  
Where conditions make it difficult to install an outside aerial, as in congested sections of cities, good results can usually be had by using inside Loop. In fact, the directional feature of the Loop often brings in stations not possible with a stationary aerial.

Mounted in solid mahogany case with walnut finish, the Bristol Single Control Radio Receiver is handsome in appearance. The price is \$190.00. Bulletin 3013-S describing this set will be mailed on request.



### BRISTOL AUDIOPHONE LOUD SPEAKER

This is known everywhere as the Loud Speaker with the quality tone. Not only is the tone natural and without mechanical distortion, but is sufficiently big in volume to be easily heard in a large room or all through the house. Comes to you ready to use—no auxiliary batteries are required.

Made in three models:  
Audiophone Senior... Price \$30.00  
Audiophone Junior... Price \$25.50  
Baby Audiophone... Price 12.50

**The Bristol Company, Waterbury, Conn.**

## Tufglas Battery Trays

UNDERNEATH RADIO BATTERIES  
SAVE CARPETS AND RUGS



Made of Acid Resisting Glass of great mechanical strength. Sent Parcel Post collect to any part of United States. Add \$1.75 to price if west of Mississippi.

Tufglas Tray Regd. Size: 8 1/2 x 9 3/8" Inside **PRICE \$1.50 EACH**

Dealers and Agents Wanted  
Dept. N

## RUSSELL B. CRESSMAN

GENERAL SALES AGENT  
200 Fifth Ave. N. Y. City

## HYGRADE SPECIALS

Fada Hazeltine Neutrodyne Kit.....	\$21.50
C. D. Tuska Superdyne Kit.....	16.50
Federal or Brandes Head Sets Complete.....	4.75
Nathaniel Baldwin Type C Head Sets.....	7.98
Turney 3000 ohm Head Sets.....	2.98
Ambassador 3000 ohm Head Sets.....	3.25
Dictograph 3000 ohm Head Sets.....	5.98
Acme Transformers Audio or Radio Frequency—All Types.....	3.75
Federal No. 65 Amplifying Transformers.....	3.49
General Radio No. 231A Audio Freq. Trans.....	4.50
American Amplifying Transformers.....	3.75
Globe Audio Freq. Transformers.....	2.75
Acme Variable Air Condensers.....	5.75
Cardwell Variable Cond. 23 Plate \$4.50; 43 Plate \$5.25; Heath's Vernier Cond. 23 Plate \$4.50; 43 Plate.....	3.50
Bradleystats or Bradley Leaks.....	1.59
Ambassador Coils.....	4.75
Nathaniel Baldwin Phonograph Unit.....	8.95
Dictograph Phonograph Unit.....	8.95
Burgess or Eveready 2 1/2 volt B. Batteries.....	1.19
Burgess or Eveready 45 volt B. Batteries.....	3.75

All Orders Must Include Parcel Post Charges

**Hygrade Electrical Novelty Co.**  
41 WEST 125TH STREET, NEW YORK, N. Y.

## Queer Queries and Ready Replies

(Continued from page 1766)

has an ice water range of about two hundred meters in this hook-up.

Q. What is the cause of braying noises in the loud speaker? L. S. Twostage.

A. Braying noises come from the j.

Q. Last night my wave-length was so high I could not hear any of the broadcast stations. I am afraid my antenna capacities are too high. I could hear nothing. My rotary plates were two-thirds exposed. Humiliated.

A. It is no longer fashionable to expose the rotary plates. Your capacities should fall to about 300 meters.

Q. I am a teacher of elementary science. My pupils are interested in radio and I have been giving them some laboratory demonstrations. What attachments are necessary to a horse-shoe to demonstrate lines of force? Prof. T. J. B.

A. The shoe must be attached to a horse. To demonstrate lines of force, stand behind the horse and sting him across the back with 110 volts A.C.

Q. I am using a receiving set on the dashboard of a farm wagon. It is a honeycomb coil set with three jacks. Where is the best place to put the aerial and ground? Farm Hand.

A. Suspend the aerial from the ears of the three jacks, or else attach it to the harness. Leave the ground right where it is, under the wagon.

Q. I am constructing a regenerative single-circuit receiver. Can you show me how to use a tickler? Armstrong.

A. Yes, if you are ticklish.

Q. What is a binding post? Ignorant.

A. A binding post is a five-eighths inch bolt with twisted threads, that is supposed to be forced through a sharp washer with a half-inch opening. It screws into a piece of metal containing a three-eighths inch hole for the five-eighths bolt and two No. 44 holes for No. 12 wire. It is also fitted with a set screw that has no threads and was designed for another style of post. A more exasperating type of binding post has a black knob that gets caught on the bolt before it clamps the wire and pulls the soldered lead off the rear of the bolt. Any good binding post will accomplish the purpose for which it was constructed—namely, to blister the thumb.

Q. I have a very fine receiving set that I got as a Xmas present. During the last week I have been unable to make it work. My aerial is attached to the corn crib. Do you suppose the ears of sweet corn in the crib are getting all the signals? Smarty.

A. It is impossible to state without examining the receiver and eating six or seven ears of the sweet corn.

Q. What hook-up would you suggest for entertaining a dinner party with a loud speaker? I. M. Hungry.

A. Use 45 volts and three forks on the plate and place a napkin across your grid condenser.

Q. Last night with one tube I got Kansas City in Missouri. If I used two stages of amplification would there be any difference? California.

A. No, Kansas City would still be in Missouri.

## JANITOR MUST BE RADIO EXPERT TODAY

If builders throughout the country continue to erect apartment houses and furnish tenants with radio entertainment from a central receiving station, janitors will have to be able to operate receiving sets and handle complaints.

In Washington, several apartment owners object to numerous aerials of many different



types which they claim disfigure the roofs. Other landlords, more thoughtful as to the comfort and happiness of tenants, are installing one aerial with a receiving set in the basement and running wires to plugs in each apartment so that occupants who desire may plug in phones or loud speaker.

This is fine, but can the owners find janitors capable of operating the sets to suit the listeners-in? The Trotts are sure to want jazz from WHIZ, when Kirks desire sacred music, while the minister is calling. Mrs. B.alous insists on an oratorio from WHIZ, at the same time Miss Flapper requests dance music. Willie Whistle calls for a radio talk; Mrs. Dresser, fashions; Mr. Fisti Cuffs, ringside gossip; and Mr. Liter Rary, current topics.

No ordinary janitor could hold the job a day, let alone a night, and one subject to bribes would soon be ready to retire. Only by keeping a request sheet for each hour of the day could he satisfy even a few of the many calls he will receive, with objections outnumbering requests.

No longer will the calls be for "more heat," but "tune out that church and give us some dance music," or vice versa. The life of the future janitor is not one we recommend to self-respecting denizens of the apartment basements. But there may be latent ability capable of developing, which will give them the status of "heating and radio engineers."

### The Reinartz All-Wave Tuner

(Continued from page 1758)

#### FOR ELIMINATING INTERFERENCE

Take two feet of lamp cord and connect one end to the switch point and antenna as shown in the diagram of Fig. 1, leaving the other end open. This may take the form of two pieces of insulated magnet wire rolled up into as small a coil as desired. If selectivity is too great, add to the length of wire used. It must be remembered that the signal strength is reduced if this condenser is made too small.

#### THE TUNING COILS

First we will assume that the required range for tuning is to be 150 to 220 meters, so around the same drinking glass we will wind, with No. 16 double cotton covered wire in jumble fashion five turns, making a three-inch loop for a tap; then we continue with 15 turns, making another loop for a tap; then five more turns and the coil is finished. Slip the coil off the glass and wind a few turns of thread around it and connect the starting end of the coil to binding post No. 1 on the front of the panel; connect the first tap to No. 2, the second to No. 3 and the end of the coil to No. 4. You will notice that there is a 4 to 1 turn ratio of antenna to ground and grid to ground. Maintain this in any other coil you may make. Also notice that the tuning range is approximately 150 to 200 meters and that if you add a cypher to the 15 turns that are shunted with the tuning condenser, you will have 150 and that if you add a cypher to the total number of secondary turns, which is 20, you will have 200, meaning that the approximate range of any coil made with the turn ratio as above, may be determined beforehand. Again, as before, make this coil in any manner desired, but maintain its electrical equivalent.

Another means to lower the wave-length of a tuning coil is to short circuit some of its turns. The natural period of the coil then drops to the first even harmonic of the number of turns not short circuited. This can also be applied to the transmitter described by the author a few months ago,

Fill This In  
 Clip off and Mail-NOW

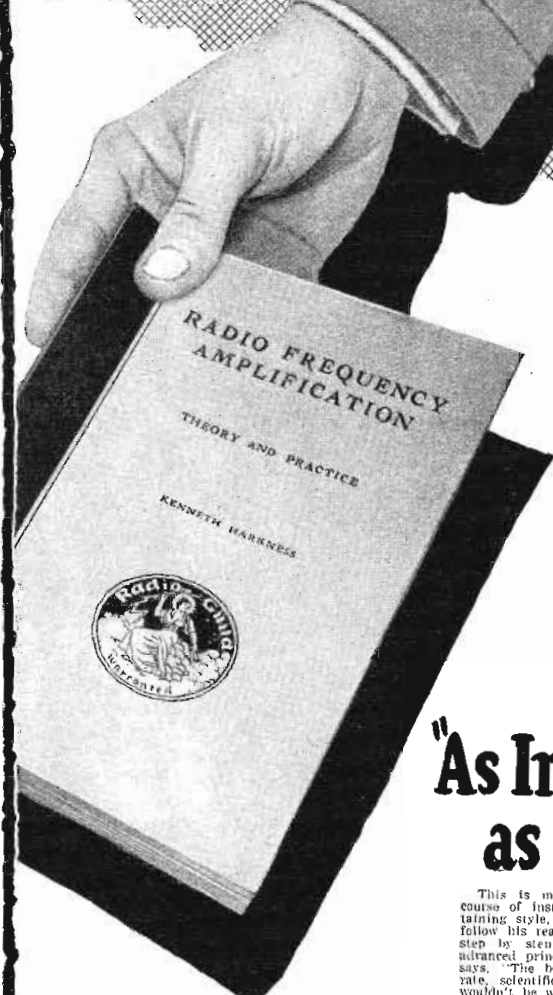

To  
 The Radio Guild, Inc.  
 255 W. Thirty-fourth Street  
 New York, N. Y.

Send for a copy of Kenneth Harkness' famous book, "Radio Frequency Amplification"—the book which contains more real information on one page than a volume of ordinary textbooks!—the book which has brought a clearer understanding of the theory and practice of radio to its thousands of readers.

When the postman brings your copy pay him \$1.25 plus postage. Read the book from beginning to end. See for yourself how it expands your knowledge of radio. Learn how to build the famous Harkness Receivers. Then—if you don't think the book is worth at least double its price, send it back and we will refund every cent of your money.

## "As Interesting as a Novel"

This is more than a textbook—more than a course of instruction. In his easy, lucid, entertaining style, requiring no effort on your part to follow his reasoning, Kenneth Harkness leads you step by step from the elementary laws to the advanced principles of radio science. One reader says: "The book is comprehensive, concise, accurate, scientific, interesting as a novel. I wouldn't be without it for ten times its price."

### Makes Advanced Radio Easy

This book explains to you in easy-to-grasp language the theory of radio reception from A to Z. It tells you everything you want to know about radio—answers all your questions. Kenneth Harkness wrote this book in your language, the language you use every day—the language you understand. His book fills an open gap in radio literature. He explains advanced radio—hitherto understood by mathematicians only—yet he explains it in simple, easily-understood English.

### Tells how to build Sets

Illustrated by 186 drawings, diagrams and photographs, this book explains in detail how to build five different types of radio frequency amplifying receivers. The second edition, just off the press, gives new and complete information on the popular "Harkness Reflex" which operates a loud-speaker with one tube. In a greatly enlarged and profusely illustrated chapter Mr. Harkness shows you how to build his new, improved one- and two-tube receivers, using this "knockout" record-breaking circuit.

Fill in and mail the Coupon-Today!



*Safety demands it*

# The BRACH vacuum radio ARRESTER

*made to protect—not to meet a price*

Approved by the National Board of Fire Underwriters

At All Dealers  
L. S. BRACH MFG. COMPANY  
NEWARK, NEW JERSEY



through which it was possible to tune down to 10 meters for transmission using an antenna having a natural period of 100 meters. Active work along this line is now in progress and after building the tuner described you may tune down to 30 meters and listen to the signals of 1XAM with 500 watts input at that wave. More detailed information regarding this application to both transmitters and receivers will follow.

**TRYING OUT THE TUNER**

With the tuner all finished and antenna disconnected, and with a UV-201A tube as a detector, bring a wave meter into proximity with the tuning coil and only near enough to be effective. Then, with the tube oscillating, set the wave meter at 200, if that is the range of the tuner coil, and listen for the click denoting resonance. Note the reading on the tuning condenser and continue until the entire range has been covered. You will then be in a position to let the amateur know what his QRH is. Connect the antenna and with the detuning coil cut in, set the switch lever controlling these turns until the tuner oscillates readily over the entire tuning range. This may then be left without change for the coil in use. If considerable interference is noted from nearby amateurs, cut out the detuning coil and switch in the series condenser. You will then have the sharpest tuner ever.

NOTE: Any other information desired may be had from the writer if a self-addressed and stamped envelope is enclosed. To date it has been necessary to buy nearly \$25 worth of two-cent stamps, and the writer cannot afford this practice.

## MODERN

### "Push-Pull" Transformers

—were used in the hook-ups illustrated and described on page 1419 of April "RADIO NEWS"; also page 13, March "RADIO IN THE HOME."

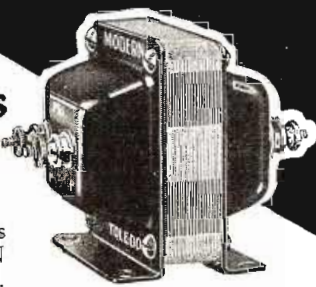

Radio authorities everywhere are unanimous in their endorsement of the MODERN "Push-Pull" method of power amplification.

<p><b>Modern "Push-Pull"</b> Used in addition to one or two stages of audio. Assures clearer and better reception than has heretofore been secured from audio frequency reception.</p>	<p><b>Modern "Reflex"</b> This is the transformer that makes one tube do the work of three in the MonoFlex Circuit. Ask for bulletin on the MonoFlex Circuit.</p>	<p><b>Modern Standard Audio 4 to 1 Ratio</b> Designed especially for use in 2-stage amplifiers. Provides greater audibility than three stages using ordinary transformers.</p>
--	---	--

**Sold by Good Dealers Everywhere**

MODERN Transformers are guaranteed to give satisfaction. Ask your dealer for MODERN Transformers and new bulletin of latest hook-ups. If he can't supply you, write us, giving dealer's name.

**The Modern Electric Mfg. Co.**  
Toledo, Ohio



## Radio Trade Notes

(Continued from page 1769)

ing would have a most beneficial effect on the trade and would be a powerful stimulus to business in the summer months.

The problem of effecting perfect distribution throughout every section of the country is one that is facing the manufacturer of radio apparatus today. With production creeping up to where the immediate shipment orders can be filled, the sales manager is digging out his map and checking over the territory where sales are not as great as they might be. A finer type of merchandising is rapidly coming into the radio industry, and a consequent saving to the public may be expected by the reduction of selling and handling costs incident to the establishment of national distribution.

**THE EXCLUSIVE OUTLET**

The exclusive radio outlet is holding its own, while phonograph and music stores are becoming a greater factor in the sale and distribution of complete sets. The entry of these firms into the field is hardly noted by the regular radio stores, however, as they appeal in a large measure to a new clientele and handle only the sets of one or two makers. A tremendous volume of sales is being built up through these outlets, by several manufacturers, while other set makers in the field find almost no effect on their sales volume because of them.

Many manufacturers are finding themselves forced into the policy of appointing only one or two outlets in a single community or city. This policy, popular in the automobile industry and of considerable popularity in the phonograph field, is just becoming noticeable in radio, and will be largely restricted to manufacturers of sets for some time to come.

**THE EXCLUSIVE JOBBER**

The jobber who has no retailer or manufacturer connections is winning favor in the radio trade much faster than he ever did in the electrical industry, while the music trade is forced to admit that the

JUST THE BOOK YOU WANTED

## "Radio News" Amateur's Handibook

Volume No. 1. (Second Edition)

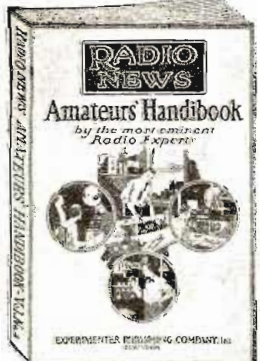

Check full of radio constructive and instructive articles from cover to cover. Written by foremost radio authorities, in plain everyday language which everyone can understand. Sections include articles on Receiving Sets and Sundry Apparatus, Transmitters and Accessories, Radio Theory, Vacuum Tube Data, and Practical Hints for the Amateur. A book which also serves as a ready reference and should find a place in the library of every amateur. It contains 223 pages and over 375 illustrations, diagrams, and photographs, bound in a multi-colored heavy board.

On sale at all leading radio stores. If your dealer cannot supply you, send a dollar bill and the book will be forwarded to you postpaid.

Price \$1.00

**EXPERIMENTER PUBLISHING CO., INC.**  
53 Park Place, New York



exclusive jobber in radio stands higher than he does in their field. The reaction of the retailer is interesting in this connection, and while the exclusive wholesaler seems certain to be the ultimate choice of a majority of the trade, the wholesaler who has a large retail outlet is still an important factor and one who cannot be overlooked in figuring sales plans.

The jobber who handles no competing lines is found in the majority in the radio trade with more and more manufacturers seeking jobbers who will push their lines to the exclusion of all others, and more jobbers refusing to take on competing lines of merchandise. There is considerable difference of opinion on this subject, and arguments pro and con can be started at almost any meeting of the trade. The tendency today, however, is strongly in favor of the "special representative" jobber rather than the house handling any item for which there is a market.

The possibility of manufacturers doing their own jobbing is passing day by day, although in a few cases manufacturers have established jobbers in certain territories where they were unable to find outlets that would function to their satisfaction.

The jobbers' place in the radio trade is firmly fixed, and opinions and records gathered from a number of firms point out that prices to the public are much lower because of the jobber's work, than they would be if sales were made directly to the retailer or user by the manufacturer.

**LOWER PRICES NOT STARTLING**

Prices have been reduced in a number of radio items in the past few months, but apparently the reductions have not been such as to make any purchaser dissatisfied because he did not wait. The bottom on prices is expected about June 15, with a steady price level during the summer months, and until after the holiday season. Naturally this rule will be broken by a few exceptions, by the clearance of lines that are being discontinued and by competitive price cuts that may be made in fights between retailers or manufacturers, but it is felt that present radio list prices are based on quantity production costs, and that there can be no great increases in productions with lowered costs until after the fall season is well under way.

**SUMMER SETS AND SELLING**

Special radio sets for the vacationist, for the summer stay-at-home, for the motorist and for every summer use will be seen in the stores and shops by the time this appears in print. Almost every radio manufacturer in the country has designed a special set of some kind or other for summer selling. The high quality of the broadcast programs this year will mean intensified interest in radio all the year round.

**Courtesy of the Air**

(Continued from page 1737)

tickler reaches the oscillation position. The tickler should be backed slightly below this point.

air search for the distant station should always be made with the tube near to, but always below, the oscillating point, and the tuning can then be done with no inconvenience to anyone. You will recognize the distant station by the sounds of the music or speech, if in operation, or by a slight noise of the transmitter if you chance to hunt it during a quiet period, but with the normal antenna radiations unmodulated, going out.

There is a mistaken popular impression that the single circuit sets are the real of-

# WORKRITE NEUTRODYNE OUTFIT

(Licensed under Hazeltine Patents Nos. 1450080 and 1489228)



All Parts for a Five Tube Neutrodyne Outfit.

Get the experience from building your own Neutrodyne Set. This WorkRite Neutrodyne Outfit contains all the necessary parts and has COMPLETE INSTRUCTIONS. It even contains a drilled panel, baseboard, mounting angle for proper mounting of transformers all packed in a neat box. No shopping around for parts. No uncertainty about getting the proper parts. This WORKRITE OUTFIT is the outfit you want.

- WorkRite Neutrodyne Outfit ..... \$70.00
- With Mahogany Cabinet ..... 80.00

## WORKRITE NEUTRODYNE KIT DELUXE MODEL

Contains

- 3 WorkRite Neutroformers (new style)
- 3 WorkRite E-Z-Tune Dials
- 2 WorkRite Neutrodrons (new design)
- Panel layout, mounting angle and COMPLETE INSTRUCTIONS

**Price \$25.00**

**"WORKRITE RADIO PARTS WORKRITE"**

Send for complete Catalog

### THE WORKRITE MANUFACTURING CO.

1832 E. 30th St., Cleveland, Ohio

(Branch Office, 536 Lake Shore Drive, Chicago)



### GREATER EFFICIENCY

For Radio Followers Who Want the Best

## The Adams Perfected RADIO JACK

Pure silver contacts—phosphor bronze springs—bakelite insulated. Its construction is scientifically correct—its new features make it a decided improvement over the ordinary jack. You'll say so, too!

Write for full information. DEALERS: Get our attractive combination offer.

THE ADAMS RADIO MFG. CO. Chicago



716 West Madison Street

### VARIABLE CONDENSERS

- Prices
- 3-PLATE \$0.65
- 5-PLATE \$0.75
- 13-PLATE \$1.40
- 23-PLATE \$1.75



BUY DIRECT AND SAVE

R. G. ANDERSON CO.

2035 Baxterly Ave. Lakewood, Ohio

Get a Handy Binder for your RADIO NEWS. Holds and preserves six issues, each of which can be inserted or removed at will. Price 65c. Experimenter Pub. Co., Inc., Book Dept., 53 Park Place, New York.

**WEIGHS ONLY 8 OZ.**

**The Scientific**

**A \$200,000.00 COMPANY stands squarely back of the guarantee on every Scientific headset**

**SEND NO MONEY!**

**20,000 TURNS EQUIVALENT TO 3,000 OHMS**

**Order TODAY by Postcard and Pay Postman on arrival**

**\$2.95**

**POST-PAID**

**LOUD SPEAKER UNIT \$1.95**

**THE PHONE IT TOOK A SOLID YEAR TO DESIGN**



**We Guarantee** The Scientific Headset to be the greatest value on the market. Try it for five days. If not satisfactory send it back and your money will be refunded immediately. Circular on request. Dealers wanted.

**THE SCIENTIFIC ELECTRIC WORKS**  
98 Brookline Ave. DEPT. W. BOSTON, MASS.

fenders in this trouble and that sets having two circuits are immune from it. Such is not the case, as repeated tests have shown. A two-circuit receiving set with the tube oscillating in the second circuit when properly adjusted to receive the maximum strength of signals, will act as a radiator of signals to just the same extent as the single circuit set.

That such a condition should be expected, is apparent when we remember that the largest and most powerful transmitting sets are constructed with two circuits.

The advantage of regeneration in the antenna is very great in attaining distance and, if kept below the oscillating point of the tube, causes no disadvantage to others.

The British broadcasting service was started with a strict prohibition of regeneration, but it was soon found that this imposed a hardship that was unnecessary and at present regeneration below the oscillating point is permitted.

The particular point I desire to make, is that the practice of hunting a distant station with the tube oscillating is impolite and that there is no difference in this respect, between a single and a two circuit set.

JUST THE BOOK YOU WANTED

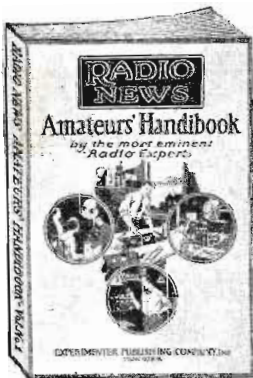

**"Radio News"**  
*Amateur's Handbook*

Volume No. 1. (Second Edition)

Chock full of radio constructive and instructive articles from cover to cover. Written by foremost radio authorities, in plain everyday language which everyone can understand. Sections include articles on Receiving Sets and Sundry Apparatus, Transmitters and Accessories, Radio Theory, Vacuum Tube Data, and Practical Hints for the Amateur. A book which also serves as a ready reference and should find a place in the library of every amateur. It contains 224 pages and over 375 illustrations, diagrams, and photographs, bound in a multi-colored heavy board.

On sale at all leading radio stores. If your dealer cannot supply you, send a dollar bill and the book will be forwarded to you postpaid.

Price \$1.00

**EXPERIMENTER PUBLISHING CO., INC.**

53 Park Place, New York

**Simple C. W. Sets for the Novice**

(Continued from page 1761)

opposite direction to a current traveling up from the ground to the antenna through its coil. Making certain of these polarities is to assure your set going off with the least mental trouble for yourself.

It is well to remember that the circuits of Figs. 2, 3 or 4 can be easily kept from oscillating by wrong polarities of the various tickler coils.

All of these sets can be made to work without the antenna ammeter, but without your knowing if they are adjusted for maximum efficiency or not. To do this, turn on your receiver and having the transmitter supposed to be going, vary the only thing in which ever particular one you happen to be using that is variable and listen for a faint hissing sound which is a duplicate of the sound of your own receiver oscillating, but many times weaker. There is nothing then left to do but adjust in order to get the loudest possible hissing out of that sound of oscillating. Quite often it is strong enough to prevent your receiver from oscillating by blocking the tube which is sufficient to let you know that the thing is really putting some energy into the antenna.

It is understood that these sets are of very low power, using as they do an amplifying tube to produce the power, but just the same you are required to comply with the laws covering transmitters and procure a license for your transmitter, and an operator's license for yourself. Also, you must stay within the amateurs' band of waves of 150 to 200 meters and it is important to see that you do. Also you must respect the silent hours between 8 and 10:30 P. M., standard time. Although these sets described are of low power, you will be surprised with the distances you can cover, for it will be unusual to be in communication over distances of 10 miles and you will no doubt be heard up to 100 now and then.

**NOTICE**

5-XV is broadcasting code on 75 meters for anyone who cares to see how low his receiver will go. The 125-meter wave has been discontinued. A UV-202 with 500 volts D.C. on the plate is being used.

**RADIO "B" BATTERY**

FOR **25c** FOR **25c**



Introductory offer for one month only. Every Battery Guaranteed. The latest in "B" Batteries for VOLUME, DISTANCE and LASTING POWERS.

	Price	Price
	One Battery	Two Batteries
22½ volt, large.....	\$2.50	\$2.75
22½ volt, medium.....	1.90	2.15
22½ volt, small.....	1.50	1.75
45 volt, large.....	5.00	5.25
45 volt, medium.....	3.80	4.05

Only Two to a Customer

Send Money Order to

**BETA BATTERY CO., Inc.**  
15 Whitehall St., N. Y.  
Manufacturers of Radio "B" Batteries Only

**Guaranteed Head-Sets**

"RED-HEADS" are guaranteed radiophones. You run no risk when you buy them. Money back if, after 7 days' trial, you're not satisfied that they're the best receivers on the market at the price. Why not act right now and get a pair? It'll mean getting the maximum from broadcasting from the day you put them into use.

**RED-HEAD RADIO RECEIVERS**

**NOW READY**

The new 1924 Model F Per Pair Complete \$6.50 | The new "Red-Head" Jr. Per Pair Complete \$5.00

"Red-Heads" sent prepaid on receipt of price if you are unable to get them at your dealer's.

The NEWMAN-STERN COMPANY  
Dept. R.N. Newman-Stern Bldg. Cleveland





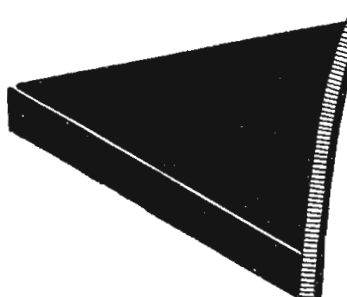

# CELESTO-PANELS



This trademark upon the wrapper identifies the genuine CELESTO Panel. Look for it!

CELESTO Panels are available in the following stock sizes:

7x9	7x30	6x24
7x10	7x40	6x26
7x12	6x9	6x28
7x14	6x10	6x30
7x18	6x12	6x40
7x21	6x14	8x12
7x24	6x18	8x40
7x26	6x21	9x28

(Black and Mahogany Finish)

**H**ARD RUBBER—the finest grade of genuine hard rubber such as is used in CELESTO Panels—knows no superior in the field of radio insulation. Reports from the leading laboratories of the country have proven this time and again.

CELESTO Panels should be your choice if you are building a really sensitive radio outfit. CELESTO Panels prevent the loss of those minute, almost immeasurable electric currents which make all the difference between mediocre and long distance reception.

CELESTO Panels are for sale by the better dealers everywhere. CELESTO Panels are packed in individual wrappers, each bearing the trade-mark. If your dealer cannot supply you please write us.

Manufacturers and Dealers

CELESTO Panels sell easily because they are lower in price and higher in quality.  
Territories still open! Write us at once.

**TRIANGLE RUBBER & SUPPLY CO. 68-74 South St. Boston, Mass.**

# FEDERAL ANNOUNCES

its latest achievement in the field of radio

The "No. 102 Special" Federal Receiving Set will be demonstrated to radio enthusiasts beginning May first.

*If you do not know the name of the Federal Dealer in your locality, write immediately to—*

FEDERAL TELEPHONE AND  
TELEGRAPH CO  
BUFFALO, N. Y.

Boston Chicago  
New York Pittsburgh  
Philadelphia San Francisco  
Bridgeburg, Canada  
London, England



Federal

Standard **RADIO** Products

*Look for this sign*



**NEW STATIONS**  
*Micro-Selective Tuning Did it!*

"Last night," writes Bishop Francis of Chicago, "I put 3 UNIVERSNIERS on my Neutrodyne and got 20 stations I never heard before!"

Do the same! Make your set 100% more selective. Make it Micro-selective! Tune in those elusive DX—those hard-to-get distant stations quickly, easily, clear and loud. Simply replace your dials with UNIVERSNIERS without otherwise altering set.

**Costs No More Than a Good Dial**

Single knob gives continuous direct or 12-to-1 control at will. Rigidly attached pointer assures accurate logging. Does away with vernier condensers! Diameter dial, 3 1/4 inches; knob 2 1/4 inches.

UNIVERSNIER with mahogany knob and gold-plated dial **\$1.50**  
With black knob and silver dial **\$1.25**

At your dealer or postpaid upon receipt of purchase price

Jobbers and Dealers: Write for Discounts  
**The WALBERT MANUFACTURING CO.**  
935 Wrightwood Ave. Chicago, Ill.

**WALBERT**  
**UNIVERSNIER**  
*Micro-selective tuning control.*

**The Transmitter at KFGD**

(Continued from page 1759)

resistance is inserted in the lead to the oscillator and modulator tubes. This resistance is variable in steps of 2,500 ohms. Ordinary grid leaks of the 5-watt size will be suitable. These will easily pass 100 milliamperes and as the modulator-oscillator system does not draw more than this, the resistances do not heat.

Any questions should be sent, accompanied by a stamped and addressed envelope, to Mr. J. M. Baldwin, at Chickasha, Okla., and he will be glad to give pointers.

**Radio Broadcasting in Great Britain**

(Continued from page 1726)

who cannot afford multiple valve apparatus. Another important possible improvement is that of the radio beam in radio telephony. It has been known from the earliest days of electric wave research, and was, in fact, demonstrated by Hertz in his researches that electromagnetic waves could be reflected by parabolic mirrors just as is the case with a search-light. Senatore Marconi used small metal parabolic mirrors for projecting a beam of electric radiation in his early experiments. When, however, we have to use waves of 20 or 30 meters in wave-length, metal mirrors to be effective would have to be of enormous size, and if of solid metal would offer a surface to the wind which would soon result in their destruction. It has been found, however, that, if a number of vertical wires 100 or 200 feet high are arranged around a parabolic ground line so as to form a skeleton parabolic mirror of great size, then a vertical radiating aerial placed in the focal line will radiate a concentrated beam of electric radiation which is but little diffused on either side of the axis of the parabolic mirror. Such skeleton mirrors can be put up even in very windy places. The Marconi Co. has erected one at Poldhu in Cornwall. By its aid, and using very short wave-lengths Senatore Marconi has projected electromagnetic beams for 2,000 miles and found that the electric radiation was practically confined to a small angle of about 30 degrees on either side of the axis line.

There can be no doubt that before long such radio beams will be in use across the Atlantic because in the case of trans-Atlantic radio stations in which the intercommunication is required to be confined to that particular pair of stations, all radiation sent out in other directions is wasted. It is not beyond the bounds of engineering science to erect on either side of the Atlantic skeleton parabolic mirrors with wires 1,000 feet high, which would face one another and project and receive carrier waves of 100 meters wave-lengths sent as a beam across the Atlantic. Such parabolic stations would probably be largely immune from atmospheric disturbances because the receiving aerial would be sheltered on several sides by the mirror.

Radio speech could then be projected across and re-transmitted to various local stations and re-radiated on local wave-lengths. Before long it may be quite a common thing for American listeners-in to hear all British broadcasts, not merely as an occasional feat or in exceptional weather, but as a regular thing.

**TIME SIGNALS**

Another advance of an important character is the broadcasting of Greenwich time by radio telephony. On February 5, there was inaugurated in Great Britain a simul-

**Regal**

Radio Products are built by engineers who actually know Radio. They are mechanically perfect, scientifically accurate and built for unusual durability.

**Perfect Contact Vernier Rheostat**

For fine filament control of tubes and superior tuning, the Regal Vernier stands alone. Nothing just like it on the market. Complete with Knob

6-Ohms ... \$1.25  
30-Ohms ... 1.25



**Fifteen Taps—But Only One Drill Hole Required!**

A 15 Point Switch complete in one unit. No messy soldering. No more drilling of holes. No more clipped panels. Complete with hard rubber Knob and Dial

Type No. 162..... \$1.50

**Broadcast Tested High Quality Audio Transformer**

For clearness of tone, amplification of voice and music from nearby and distant broadcasting stations. Regals are unequaled by any transformers on the market.

3 1/2 to 1 Ratio... \$4.25  
5 to 1 Ratio... 4.50

At all good dealers—otherwise write direct for complete descriptive folder No. 24, sending dealer's name.

**AMERICAN SPECIALTY CO.**  
Bridgeport, Connecticut, U. S. A.



**KESTER SOLDER**  
*Self-Fluxing*

**for Radio Work**

For heavier Radio and general soldering, use Kester Acid-Core Solder—(Underwriters' Laboratories inspected).

For delicate Radio work use Kester Rosin-Core Solder.

For household and general mending, use Kester Metal Mender.

Kester Solder is genuine solder that supplies the necessary flux from tiny pockets within itself as it is consumed. Radio, Electrical, Hardware and Auto Supply dealers can supply you.

**"Requires Only Heat"**



**BRANCH MANAGERS WANTED FOR BLUE SEAL GUARANTEED RADIO**  
If you have \$500 to \$1,000, and have a store or can get suitable space in a store, tell us about it and we will consider appointing you as our representative in your community.  
**BLUE SEAL MANUFACTURING CO.**  
1406-8 South Michigan Ave., Chicago, Ill.

**FAHNESTOCK'S RADIO PRODUCTS**

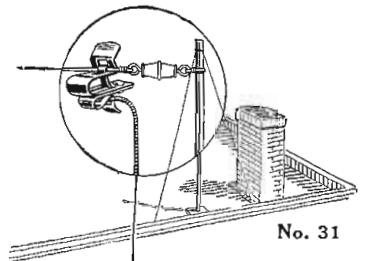

No. 31

**The Antenna Connector**

Snap larger connector over Antenna Wire; insert Lead-in Wire into smaller clip and a perfect connection is the result.

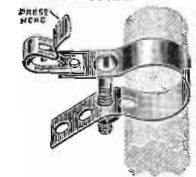

**Improved Ground Clamp**  
Equipped with Fahnestock Patent Wire Connectors Easily Attached.

**No Soldering—For Radio Use Only.**

Our name stamped on all products. None genuine without it.  
At Your Dealers

**FAHNESTOCK ELEC. CO.**  
LONG ISLAND CITY, NEW YORK



Wonderful, new device, guides your hand; corrects your writing in few days. Big improvement in three hours. No failures. Complete outline FREE.  
Write C. J. Ozment, Dept. 32 St. Louis, Mo.



taneous broadcast of Greenwich time transmitted direct from Greenwich Observatory.

The great Mean Time Clock in Greenwich Observatory gives the time for all the world. By means of radio telephony, this clock can now be heard ticking at certain hours of the day in every house in Great Britain which possesses a radio receiver, viz. at 4 p. m., 7 p. m. and 9:30 p. m. The last five seconds of the final minute before those times are heard as clicks. 55th, 56th, 57th, 58th, 59th seconds and the 60th second giving the exact hour is heard as a click a little longer than the others. The importance of this for ships within range is very great, as it gives them G. M. T., and combined with local time obtained by their sextant, enables them to determine longitude exactly.

When the high power British Broadcasting Station is erected, perhaps even American listeners-in may in this way receive Greenwich time. There is one other item with regard to British broadcasting in which the writer has been interested lately, and that is in enabling deaf persons to hear broadcasting.

There are many different kinds of deafness, but one of the most common is of a type called middle ear deafness in which the defect is caused by some disorder of the mechanism of the middle chamber of the ear, but the auditory nerve and center and the apparatus of the inner ear are still normally healthy. This kind of deafness very often originates in neglected "colds" or influenza, or is due to climatic conditions. It is rather prevalent in the damp climate of Great Britain. When so afflicted, the deaf person is greatly hindered in hearing ordinary conversation, speeches or sermons. It is alleviated by the use of portable telephones or electric aids for the deaf. One type of these appliances comprises a small carbon microphone in an ebonite box which can be attached to the coat or dress, a small magneto telephone and a portable battery.

The deaf person may be quite unable to hear with the ordinary head telephones, but if a loud-speaker is employed and if the microphone of the above mentioned portable telephone is placed just at the opening of the horn or trumpet of the loud speaker the whole of the broadcast speaking or singing will generally be heard perfectly. Persons troubled, therefore, with middle ear deafness need not be debarred from the pleasures of broadcast telephony when aided by the above described appliances.

## Are You A Radio Engineer?

(Continued from page 1742)

The vice-president of one of our largest electrical manufacturing companies says, "A Radio Engineer worthy of his title is a graduate Electrical Engineer, who has specialized for at least seven years in the field of radio research." The United States Government recently announced an examination for radio engineers. The requirements as set forth on the Civil Service announcements specified graduation from a recognized institute of learning in Electrical Engineering or Physics, or substitute therefor, it was equivalent to such training, at least, five years experience in a highly specialized or responsible administrative position in radio engineering, where the applicant had sole charge of important radio design or directed the policies of some large manufacturing company engaged in the production of radio apparatus. Where do Tom Smith and Eddie Jones fit in?

There are mighty few actual radio engineers in the world—men worthy of their title. Perhaps the most representative example of an all around radio engineer to-

# Announcing the "GEMPHONE"

## the DOLLAR 1000 ohm ADJUSTABLE PHONE

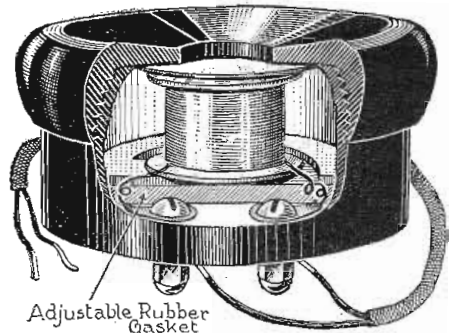

Adjustable Rubber Gasket (Patent Pending)

Don't judge the "GEMPHONE" by its price. It is the cheapest radio phone on the market but its exclusive features place it in a class by itself. Its performance, the clarity and volume of sound reproduction, the faithfulness with which it reproduces radio broadcasting and code, the exquisite quality of tone together with a remarkably loud and clear volume, make it the equal to, and in many cases the superior of, phones at three and four times its price.

The "GEMPHONE" is of standard type and made of the very best grade of materials throughout. It is adjustable—one set screw enables you to adjust the phone to secure perfect reception under any condition.

The case is made of turned wood, an exclusive feature with the "GEMPHONE." This feature is responsible for its exceptionally rich and mellow tone.

The "GEMPHONE" is sold un-assembled. The coil is wound to 1000 ohms—all you need to do is to place the parts into the case, tighten up the adjusting screw and connect the terminals and cord. Our instruction pamphlet shows how to assemble it in two minutes, using only a screw driver.

**\$1 with 3 ft. Cord \$1**  
Shipping Charges Prepaid to any point in the U. S.

## This Complete Radio Receiving Set

Consisting of Radiogem Gemphone and Aerial  
**\$250**



This outfit is absolutely complete. It includes everything you need to hear the Broadcast Programs, market reports, time signals, ship calls or land station messages. Nothing more to buy—no batteries or tubes needed—no upkeep of any kind. The simplest radio outfit made—yet as practical as the most expensive. A crystal receiving set that you can operate and enjoy even though you know absolutely nothing about radio. You receive the RADIOGEM un-assembled, together with a clearly written instruction book, which shows you how to quickly and easily construct the set, using only your hands and a screwdriver. The instruction book explains simply and completely the principles of radio, and its graphic illustrations make the assembling of the RADIOGEM real fun.

Price of Radiogem without phone or aerial, \$1.00

### Order Direct or From the Following Dealers:

- |   |   |   |  |
|---|---|---|--|
| Brooklyn, N. Y.<br>D. S. Qualey<br>Weber Talking Mach. Co.        | Gary, Ind.<br>Tribe of K<br>Grand Rapids, Mich.<br>Specialty Sales Bureau | Mesquite, Texas<br>L. Harbin                              | Pullman, Wash.<br>Elec. Supply Store         |
| Buffalo, N. Y.<br>C. B. Auto Motor Access.<br>Mundie Radio Supply | Hamilton, Ohio<br>W. Hofmeister<br>Hawera, New Zealand                    | New Haven, Conn.<br>Crawford-Plummer, Inc.                | Rever, Pa.<br>R. B. Rupert                   |
| Capetown, South Africa<br>H. J. Williams                          | Jersey City, N. J.<br>Mazie Music & Radio Shop                            | New York City, N. Y.<br>Conrad Co.<br>Radio Specialty Co. | Rockland, Mass.<br>D. & H. Motor Co.         |
| Chicago, Ill.<br>Barawik Co.<br>Home Supply Co.                   | Lake City, Mich.<br>C. E. Barnes  | Standard Distributing Co.<br>Norfolk, Va.                 | Saginaw, W. S., Mich.<br>J. A. Loubert & Co. |
| Cleveland, Ohio<br>Anderson Elec. Co.<br>Service Publishing Co.   | Los Angeles, Cal.<br>Lester's Radio Shoppe                                | North Plainfield, Mass.<br>F. J. Sawyer                   | Santiago, Chile<br>De Castro, Hnos & Cia.    |
| The Market Store  | Lynn, Mass.<br>E. C. Woodman Co.  | Northampton, Mass.<br>L. Z. Weiss Drug Store              | Scranton, Pa.<br>Hollywood Tire Surger       |
| Oallas, Texas<br>Cullum & Boren Co.                               | Media, Pa.<br>Media Elec. Co.   | Omaha, Neb.<br>R. M. Shlaes Co.                           | Seattle, Wash.<br>Frank P. Wilson            |
| Emmitsburg, Md.<br>Maryland State Adv. Serv.                      | Melbourne, Australia<br>Marx & Abraham, Pty. Ltd.                         | Oregon City, Ore.<br>Singer Hill Service                  | Springfield, Ohio<br>Movie Sales Service     |
|   |   |   | Toronto, Ontario<br>Maurice Manus            |
|   |   |   | Washington, D. C.<br>J. T. Smyth             |

## THE RADIOGEM CORP., 66-R-West B'way, N. Y. City

DEALERS--Write for Prices and Circulars.



## DUCK'S

have blazed the way with the best and most dependable radio products.

## FREE

Big 256 pp. Combined Radio Catalog and Text Book—No. 16. Mailed for 25c. in coin or money order. Not sent otherwise. Full of radio information and book-ups. Prices extraordinarily attractive. Ever since 1909 Duck's catalogs have been the best and most dependable radio products.

## THE WILLIAM B. DUCK CO.

711-12 ADAMS STREET Dept. 3 TOLEDO, OHIO

**SILVERTRON TUBES****\$3.75 Prepaid**

Type 201A operates as either Detector or Amplifier on 1/4 amp. filament consumption.

Type WD12 1 1/2 volt.

The Silver Tube with the Golden Voice

A Super  
Vacuum Tube for  
**\$3.75**

Operates as either detector or amplifier on 1 1/2 volts. When ordering specify if detector or amplifying tube is preferred. Fits standard socket. Filament consumption 1/5 of an ampere. Guaranteed to give entire satisfaction or money refunded. Sent parcel post prepaid carefully packed to any address on receipt of \$3.75.

Sole Distributors for U.S.A. and Canada

**New York Radio Company**

71 West Broadway

New York City, N. Y.

The  
**RADI-OWL**

IS  
**FREE**

To the  
**RADIO FAN**



Book includes 14 Latest Hook-ups.  
List of Broadcasting Stations.  
Log for Radio Records and

**Amazing Values in  
Standard Radio Parts**

Every Radio Fan Should Have One  
Write for Your Copy To-day

**GREAT LAKES RADIO CO.**  
RADIO SPECIALISTS  
MARINE BLDG., DEPT. A  
136 W. Lake St., Chicago, Ill.

10 cents will bring one can of ALLEN SPECIAL RADIO SODERING PASTE if you mention this advertisement. A limited number of booklets on "How to Soder Radio Sets" will be given free to early replies.

**L. B. ALLEN CO., Inc.**  
4564 N. Lincoln St.  
CHICAGO, ILLINOIS

day is Mr. John V. L. Hogan of New York City. He is not universally known to the layman, but is well known and highly respected among the fraternity, and in his quiet way, John Hogan is accomplishing things! Surely no fair-minded person will class Tom Smith and Eddie Jones with Mr. Hogan! Yet, they are still "getting away with it" to use a popular expression!

I know and meet numerous operators of broadcast stations each month. It is evidently the custom for the senior operator in a broadcast station to receive the title "Radio Engineer" as part of the job. Many of these boys first heard of radio when they shakingly approached the portals of the Harvard or Great Lakes or other wartime radio schools, just a few short years ago. Some are even post-war graduates of correspondence or resident wireless schools. They appear before the Federal Radio Inspectors for examination—many just get through—display their yellow or white certificate, as the case may be, to some prospective employer, and are immediately placed on the pay-roll of some well meaning broadcast station and become "Radio Engineers." I have examined many of these embryo engineers for licenses and it would appear to me that if their radio knowledge as set forth in their answers to simple questions is an indication of what we may expect from our future Radio Engineers, then it is high time we turned our radio towers into windmills and our vacuum tubes to Christmas tree lights!

### Straightening Out the Radiation Tangle

(Continued from page 1756)

Fig. 3 shows the circuit used. It is to be noted that the tube has a balanced output circuit which completely prevents oscillations in this circuit as follows: Whenever the detector tube is oscillating, the grid coil acts as a primary of a transformer, inducing currents in the winding of the output coil of this stage. Here the current will divide and reach the grid circuit over two paths, but due to the relative directions of the windings of the output coil they are exactly out of phase with each other and so have no effect on the antenna circuit.

Since the panel layout and drilling plans will differ, depending upon the type of condenser and rheostat purchased, no definite instructions will be given. The panel and cabinet should be sufficiently large to hold the condenser, tuning coil and one vacuum tube. A photograph (Fig. 2) shows how the completed instrument looks. This photograph, showing the relative location of each piece of equipment, has various items labeled for simplicity in their description.

#### PARTS REQUIRED

The list of apparatus necessary to be purchased by those who prefer to construct their own unit, is as follows:

1. One panel and cabinet.
2. One tube socket, suitable for tube decided upon.
3. One rheostat, suitable for tube decided upon.
4. One glass enclosed cartridge type, grid leak with clips for mounting.
5. One honeycomb coil 150 turns, unmounted.
6. One 3-inch length of tubing 2-inch outside diameter of insulating material.
7. One variable condenser, maximum capacity .0004 mfd. Should have a high maximum to minimum ratio and very low losses.
8. About 60 feet No. 26 wire with any type of insulation.

### WHY PAY MORE?

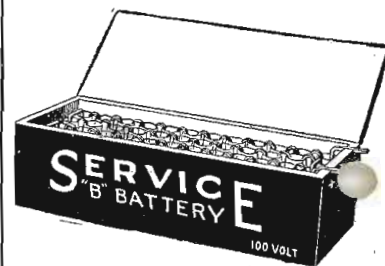

RECHARGEABLE  
50 Volts **\$5.50**  
75 Volts **\$7.75**  
100 Volts **\$10.00**  
125 Volts **\$12.50**

Recharge from any 110 volt A. C. line with small home rectifier. Shipped fully charged and ready for use after adding acid. Will last for years with ordinary care.

#### SERVICE "A" BATTERY



6 Volt **\$14.00**  
80-100 Amps

8 Volt **\$16.00**  
100-120 Amps

2 YEAR GUARANTEE

INDSTRUCTIBLE  
RUBBER CASE

**SERVICE BATTERY CO.**  
704 East 102nd St., Cleveland, Ohio

### The Peak of Radio Perfection



Type LR-170, 3 Stages Radio, Detector  
3 Stage Audio Frequency Amplification

**Uni-Tune**  
TRADE MARK

Receiver and the  
**LOOP TUNER**  
TRADE MARK

Eliminates Aerial and Ground with Clearer Reception. EXTREME SELECTIVITY with easy manipulation. FLEXIBILITY—4 to 7 tubes may be used at will. RANGE—DX stations on the Loud Speaker. SPECIAL WESTON VOLT-METER—Showing A and B Battery voltages. Contains all batteries for dry cell operation. Write for Circular "R."

**NASSAU RADIO CO., Inc.**  
60 COURT ST., BROOKLYN, N. Y., U. S. A.



Reg.  
U. S.  
Pat.  
Off.

**TUSKA RADIO**

#### \$75 BUYS

The new Tuska Popular, Armstrong Regenerative Circuit, 3-inch, low dial tuning. Long range. Steamship office reports hearing U. S. stations 2400 miles away clearly. Others \$35 to \$200. Ask for catalog.

The C. D. Tuska Co., Hartford, Conn.

**MU-RAD**  
**RECEIVERS**

THE ULTIMATE IN RADIO RECEPTION



# Real Radio Essentials!

## 50¢

DIXIE ENGRAVED BINDING POSTS  
8 Moulded Binding Posts ~ Clearly and deeply engraved.

**DIXIE SUPPLY COMPANY**  
91 Seventh Ave.  
New York City

**T**HE well-rounded assortment of screws, nuts, and lugs will greatly simplify the building of your set. The handsomely engraved binding posts will improve its finished appearance.

You need these two radio essentials! At fifty cents per box they are a wonderful buy. **SEND FOR BOTH TODAY!**

DIXIE JUNIOR SCREW ASSORTMENT  
100 Screws, Nuts and Lugs ~ Solid brass, heavily nickel plated.

DEALERS ~ Write about these attractive display cartons

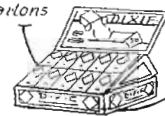

Complete Parts for 1 and 3 Tube **COCKADAY**

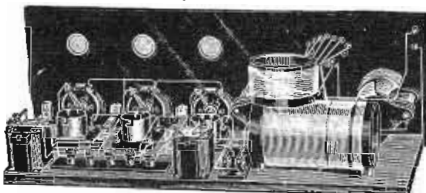

Parts for 3-Tube Set as Follows

	Our Price
7x21x3-16 Drilled Panel and baseboard	\$2.94
1 Cockaday Coil	1.95
2 Comco 26-Plate Ver. Cond. with Dials and Vern. Knobs	6.90
2 A. F. Trans.	8.00
1 Howard Ver. Rho	1.35
2 Howard 25-Ohm Rheos.	2.00
3 Firth Sockets	1.35
1 Switch Lever	.25
7 Points, 2 Stops and 6 Binding Posts	.55
1 Binding Post Strip	.05
2 Patent 2-Circuit Jacks	1.00
1 Patent 1-Circuit Jack	.35
3 Eria Bezels	.45
Grid Leak and Mica Cond.	.65
20 Feet Bus Bar Wire and Miscellaneous Screws, Nuts, Etc.	.25
Schematic Blueprint	.25
<b>1-Tube Set</b>	<b>\$11.95</b>
<b>3-Tube Set</b>	<b>\$27.95</b>

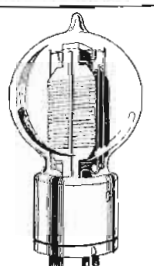

Western Electric VT-2 Tubes \$7.45

## CHICAGO SALVAGE STOCK STORE

509 S. STATE ST.

MAIL ORDERS: Address, Dept. N-6, Chicago, Ill.

### SALVAGE MEANS

Save, Service, Satisfaction

When you buy that radio apparatus from the Chicago Salvage Stock Store, the world's greatest radio store, you can be certain of these three things:

1. You have saved money through the hundreds of radio bargains made possible by our enormous buying power.
2. You have been served intelligently by men who are qualified radio experts.
3. You have bought quality apparatus because we handle nothing but brand-new merchandise GUARANTEED to give complete satisfaction.



Automatic Electric Headset \$3.65

Complete Parts for 3 and 5 Tube **NEUTRODYNE**

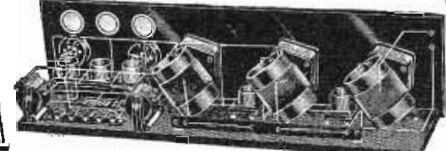

With FREED-EISEMAN OR FADA LICENSED PARTS Parts for 5-Tube Set as follows:

- 7x28x3-16 drilled and engraved panel with baseboard.
- 2 Audio Frequency Trans.
- 3 Eria Bezels.
- 1 .001 Mica Condenser.
- 1 1-Mf. By-Pass Cond.
- 3 Filament Control Jacks.
- 3 4-inch Dials.
- 1 Howard Vernier Rheostat.
- 1 Howard Plain Rheostat.
- 1 Strip of Bakelite.
- 8 Binding Posts.
- Grid Leak and Mica Condenser.
- 2 Firth Sockets.
- 3 Gang Firth Socket with mountings and screws.
- 20 Feet Bus Bar Wire.
- Screws, Nuts and Miscellaneous set.
- Construction Book and Schematic Print.

3-Tube Set \$28.60  
5-Tube Set \$46.25

New Catalog Ready! Send 10c for copy today!



10c

Hookups!

**Panels Drilled FREE.** specially drilled panels are included in each of the sets illustrated and described here. We give this free service only on panels included with complete sets.

Complete Parts for ALL Receivers

1-Tube Eria	20.90
2-Stage Amplifier	12.95
Honeycomb Receiver	17.95
Ultra Audion	8.95
Overland Circuit	8.25
Haynes DX	10.95
Superdyne Receiver	15.95
Long-45 Circuit	16.25
Reinartz	11.45

Complete Parts for a real 8 tube

- 8x40x1/2 Panel Engraved and Drilled.
- 43-Plate Webster Condenser.
- 23-Plate Webster Condenser.
- 8 Kellogg Sockets.
- 1 400-Ohm Frost Potentiometer.

Complete instructions for assembling and blueprints for wiring are included with each outfit. Instructions written so everyone can understand them.

### SUPERHETERODYNE

- 2 6-Ohm Rheostats,
- 5 .00025 Condensers,
- 1 .002 Condenser,
- 1 .006 Condenser,
- 3 1-Meg Leaks,
- 2 4-inch Dials,
- 35 ft. Bus Bar Wire,
- 1 Single Jack,
- 8x39 Base Board,
- 7 Binding Posts,
- 3 Radio Receptor 1716 Transformers,
- 2 Radio Receptor Audio-Transformers,
- 2 1-Mf. Condensers,

- 1 Tuned R. F. Transformer,
- 1 Oscillation Coupler,
- 2 Jewell No. 54 Meters,
- 0-10 D. C. Voltmeter,
- 0-10 D. C. Ammeter,
- 1 C Battery.

OUR PRICE \$92.50



The Improved  
**MIRACO**

—An Amazing  
Value in Long  
Distance Radio Sets

The popularity of MIRACO radio sets is reflected in our tremendous volume and the hundreds of unsolicited testimonials that come to us day after day from our thousands of satisfied users.

The MIRACO is so popular because it is priced at a ridiculously low figure for a real quality set. Just think, only \$29.50 for the model shown in the illustration above and users tell us that they have gotten as many as 122 stations in three consecutive nights and many of them over 2000 miles away. For instance, Mr. E. D. Elliott of Milford, New York, got London, England, Fairbanks, Alaska, La Palma, Panama, San Francisco, Los Angeles, Hood River, Oregon and many others within several evenings. Others have done equally as well.

Everyone can now own  
a Quality Radio Set

These two improved MIRACO models make it possible for every family to own a set—to have a box seat for the opera or symphony or jazz concert right in their own living room.

Workmanship is unexcelled—easy and simple to operate—always dependable. Solid mahogany cabinet—fully guaranteed against any defects in workmanship.

Price for 2-Tube Set..... \$29.50  
4-Tube Set..... 54.50

Write for our new bulletin today.

DEALERS — AGENTS

There's still some territory open.  
Write or wire for proposition.



Midwest Radio Company  
804 Main St., Cincinnati, Ohio

9. Miscellaneous material, binding posts, connection wire, spaghetti, etc., the amount of each depending on the type of apparatus purchased.

10. One vacuum tube, UV-201A, UV-199 are recommended.

11. One ounce of Woods Metal.

CONSTRUCTIONAL DETAILS

Fig. 4 shows the details of the tuning coil, which consists of 100 turns of wire,

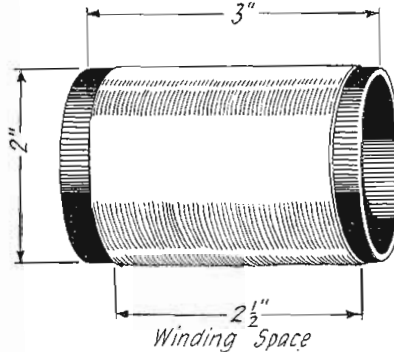

Fig. 4. Constructional details of the aerial tuning inductance of the Clarifier.

tapped at the 15th turn from one end. This coil may be conveniently mounted on the condenser by using small brackets of brass. The shape of these brackets will, of course, depend on what make condenser is selected. The coil should preferably be mounted in a position where there will be least magnetic field encountered from the coils in the receiving set. With a well-designed condenser, a wave-length range of from 215 to 590 meters will be obtained. The stabilizing condenser must next be constructed. This device may easily be made from the grid leak. If the metal ends of the leak are heated slightly they will come off as they are generally fastened with Woods Metal. The grid leak element is then removed and one cap is replaced on an end. A small piece of cardboard is then cut to fit the tube, as shown in Fig. 5.

A small quantity of Woods Metal or other low melting alloy is then melted and poured in the glass tube on one side of the

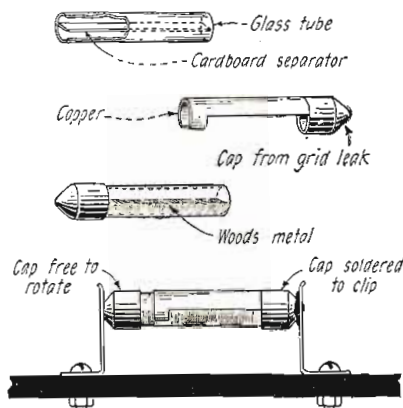

Fig. 5. Details of the cartridge type equalizing condenser.

cardboard strip. This will form a semi-circular rod, firmly soldered to the cap on the lower end and extending nearly the full length of the tube. A small brass trough, semi-circular in cross section, is soldered to the other cap. Fig. 5 gives the details of this device, how it is assembled and how it looks when completed.

This condenser may be readily mounted by means of the grid leak clips.

\$ **1.00**  
**PAL**  
**RADIO**

**Surprised Him!**

**BECAUSE:**

- 1—With no tubes or batteries he gets Local Broadcast loud and clear.
- 2—The PAL was received assembled, tested and ready to use.
- 3—The PAL is GUARANTEED to work or the price is REFUNDED.
- 4—The Price is only \$1.00. With phone and head-band, \$2.00, or complete with aerial wire and all necessities, \$3.00. Phone alone with headband and five-foot cord \$1.00.
- 5—Sold by dealers everywhere or mailed direct on receipt of order with money.

**PAL RADIO CORP.**  
943 Savoye Street, North Bergen, New Jersey

**AMPLEX**  
**GRID-DENSER**  
IMPROVES ANY CIRCUIT

Specified by L. M. Cockaday and other prominent engineers

**1.25**

**Variable Condenser**  
0 to .0005 Mfd.

**ABSOLUTELY ESSENTIAL**

in

COCKADAY and SUPER-HETERODYNE, NEUTRODYNE, ULTRADYNE SUPERDYNE and All Sensitive Circuits for 100% results. Every tube and every circuit requires a permanent fixed capacity. Good or poor results depend upon its exactness. A slight turn of the GRID-DENSER knob finds it for you and permits operation of set at highest point of regeneration, controls and oscillations and maintains perfect stability, giving **GREATER Distance and Louder and Clearer signals.**

**FREE** Booklet with hook-ups showing how to double the efficiency of your set.

At Your Dealers, or send \$1.25 to  
**AMPLEX INSTRUMENT LABORATORIES**  
57 Dey St., Dept. R.N., New York City, N. Y.



One of the caps should be soldered to a clip, as shown in Fig. 5. The other cap on the glass tube is then free to rotate, furnishing a means for varying the capacity of this midge condenser. This condenser should be readily accessible from the top of the cabinet, but need not be on the front of the panel, because when it is once set, the capacity need not be varied unless the type of tube used is changed.

The honeycomb coil must be tapped as near the center as possible. Careful inspection of the sides of the coil should be made and the approximate center turn located. This turn should be pulled out very slightly and a lead soldered on.

The photographs and circuit diagram indicate the best way to assemble these parts and indicate much better the constructional details than can be done in a short description.

The turns on the tuning coil may be wound in either direction and if desired the size and shape of this coil need not be exactly that shown, but the portion connected across the tuning condenser should have an inductance of approximately .250 millihenry if for any reason the shape must be changed.

An extra binding post is furnished connected directly to the grid, to enable the use of a very short antenna if a long one is not available.

As the photographs indicate, the output coil is completely enclosed in a case to prevent damage to the leads, and to prevent the "B" battery from being short-circuited. Since this coil case is somewhat difficult to construct, the builder of this unit should take particular pains to provide suitable connections to this coil which should be protected from breakage. Carefully wrapping the terminals with tape will ordinarily be sufficient. If a spider-web coil having about 80 turns of wire with a tap on the middle turn is more convenient, it may be used instead of the honeycomb coil. A good coil may be made with two wires wound in parallel on a spider-web frame, each winding having 40 turns of wire. The outer end of one winding should connect to the inner end of the other and to the center tap. A flexible two conductor cord should be provided to connect the output coil with the rest of the circuit.

The center tap of the output coil is connected with a flexible cord to the plus terminal of the "B" battery, which should have the voltage recommended for the tube to be provided, for amplifier use. This coil may be laid on top or inside the cabinet of the main receiver, whichever is nearest the grid coil of the detector tube.

It is to be noted that no ground connections are necessary on this unit since the regular ground is to be left on the receiver itself. The antenna is disconnected from the receiver and connected to this circuit. The antenna and ground binding posts on the receiver are to be connected together on single circuit receivers. On double circuit receivers these posts may be connected together also, if it is found by experiment that there is an improvement by so doing.

**HOW TO ADJUST THE CLARIFIER**

It remains to be shown how the balanced output circuit of this tube is adjusted and how the "Clarifier" is to be used in practical cases. After the connections have been made to this device, the tube is turned on to normal brilliancy. The receiving set is adjusted to a low wave-length, such as about 300 meters and a pair of receivers or a loud speaker connected as usual. The balance in the radio frequency tube is obtained by adjusting the small variable condenser. This adjustment can be made in several ways.

Set the receiver dials to receive signals from some broadcast station. When the tuning condenser is swung around it will at some position be in tune also with the incoming signals. If the "Clarifier" tube

# Haynes-Griffin

RADIO SERVICE, Inc. 41 West 43rd St., N. Y. City

## Two Notable Articles on RADIO DESIGN

By A. J. HAYNES



A. J. HAYNES  
Assoc. Inst. Radio Engineers

**"A Simplified Super-Heterodyne"** (January; 1924 "Radio Broadcast.") The set described represents the result of Mr. Haynes's search for perfection after nineteen previous experimental models had been built. Regarding this set the Editor of "Radio Broadcast" said:

The first night this set was tried out in the Radio Broadcast Laboratory, WHAS, in Louisville, Ky., and the three Chicago stations came pounding in, too loud on one stage of audio for comfort. WHB, in Kansas City came in loud enough to be heard one block away. The antenna system was a two-foot loop which cost one dollar.

**"Shooting Trouble in the Super"** (March 1924 "Radio Broadcast.") Here Mr. Haynes gives many practical suggestions for meeting almost every conceivable difficulty which may develop in the super-heterodyne.

### THE DEMAND FOR THESE ARTICLES IS WORLD-WIDE

Never in the history of radio have any articles on radio design attracted more widespread enthusiasm. Thousands of letters from all parts of the world have asked us for copies.

Through the courtesy of "Radio Broadcast" we are able to offer them to interested experimenters at the actual cost of printing and mailing.

Simply send 4c in stamps for each one wanted. Use the handy coupon.

Haynes-Griffin  
145 W. 45 St.  
New York City

Send me articles by Mr. Haynes checked below. I enclose 4c in stamps for each one wanted

- "A Simplified Super-Heterodyne"
- "Shooting Trouble in the Super"

Haynes-Griffin  
Transformer  
**\$4.25**



An efficient intermediate wave radio frequency transformer giving a minimum of audio frequency amplification. Uniformly tuned to a limited wave length range and providing a degree of quietness and stability heretofore unknown in transformers of this type. Haynes-Griffin Input Transformer also \$4.25.

Special  
Oscillator  
Coupler  
**\$3.50**



An indispensable adjunct for those who want the best results from the most advanced circuits.

Parcel Post Prepaid to all points in the U. S. east of the Mississippi River

Haynes-Griffin Radio Service, Inc.

Retail Store: 41 W. 43rd St., N. Y. City  
Mail Order Dept.: 145 W. 45th St., N. Y. City

## Don't Spoil Rugs, Floors, Tables

Sahara Radio "A" Storage Battery—  
It's Dry



Think of its advantage. There is no liquid acid to spill and ruin floors, rugs or creep up posts and ruin clothes—ideal for portable sets. Recharges quickly—easily—and cannot be harmed either by overcharging or drawing down too far. Cuts down noise in car phones and loud speaker. These exclusive features are what you want. We guarantee them. It is not a gelatin battery. It's dry and "chock full" of pep and life. Be the first in your town to have one of these remarkable batteries.

Order Today—Send No Money

We ship C.O.D. subject to your inspection, express prepaid east of the Mississippi River. The price is \$25 if you order at once. Shipments made same day order is received. Remember there is no liquid—It's Dry. Orders are coming in fast. Get yours in today.

**SAHARA DRY BATTERY CO.**

Dept. C PAWTUCKET, R. I.

Dealers: There is a big business for you if you show this battery now. Send for discounts and get exclusive right in your territory.

6 volts  
80 amperes

Solid Rubber  
Box furnished  
either with strap  
or side handles.



## In Touch with the World

Make your set portable with a Ray-O-Vac Dry Cell "A" Battery and take it on your camping trip or tour. Enjoy outdoor life and at the same time keep in touch with things.

Our "Trouble Finder" gives valuable pointers on batteries and other things in the use and care of radio sets. It's yours for the asking.

FRENCH BATTERY & CARBON CO.  
Madison Wisconsin  
Atlanta Dallas Denver Kansas City  
Chicago New York Minneapolis



## RAY-O-VAC Radio's Best Batteries

**CATALOG** L-25-148  
PAGES FREE!

### SUPER-HETERODYNE— NEUTRODYNE I

New Complete Branston Kits including Oscillator Coupler, Antenna Coupler, 3 Inter. J.F. Trans. and Special Transfer Coupler. Complete Kit Lists, \$36.50. Acme 30 Kilo Cycle R.F. Trans., \$5.00. All American 2,000 to 10,000 Meter Trans., \$6.00. Hilco Antenna Coupler, \$8.00—Oscillator Coupler, \$7.00. Gen. Pads Neut. Part, 5 tube, \$65.60; 4 tube, \$64.00; Kit, \$25.00.

**AMERICAN RADIO MFG. CO.**  
WHOLESALE DISTRIBUTORS  
Dept. A 6 West 14th St. KANSAS CITY, Mo.

Learn **Electricity** by actual work in Great School of Coyne, on massive apparatus. Complete in 3-6 months. Enter anytime. R. R. Fare Free. Special limited offer. Send for Big Free Catalog. Coyne Electrical School Dept. A-594 1300-1310 W. Harrison St., Chicago, Ill.

is oscillating, the pitch of the notes received will change as its tuning condenser is swung in and out of tune. If this tube is not oscillating, the intensity of the signal will change but not the pitch. Since it is desired to stop all oscillations in this tube the small stabilizing condenser is adjusted until the intensity only is changed, when the tuning condenser is varied.

Another method consists of utilizing the feature that all oscillations in a tube are stopped by touching the grid terminal of the circuit with the finger. The stabilizing condenser is adjusted so that no plucking noise or click is heard when the grid terminal is touched with the finger. When the stabilizing condenser is once adjusted (and this adjustment is not difficult to obtain since the setting is not a critical one if the device is properly constructed), it ordinarily need never be touched again.

### CLARIFIER CAN BE CALIBRATED

In order that tuning be made easy, the "Clarifier" tuning dial may be calibrated against the receiving set and then later both it and the receiver may be calibrated for various wave-lengths by jotting down the positions where each station is found. It may be calibrated against the receiving set by coupling the output coil near the grid tuning condenser in the "Clarifier;" one or two clicks will be heard in the receivers when the two circuits are in tune with each other. If the construction has been properly carried out it will be found that the adjustment required for a particular wave-length is constant from day to day.

It will be found that the signal intensity is greatly improved since the device seems to be a particularly efficient radio frequency amplifier.

Although one tuning dial has been added, it will be found that tuning is much easier than before. This is due to the fact that the adjustments of a single circuit receiver often change from time to time depending on the position of the tickler coil or plate variometer and changes in antenna constants. In this new plan the resistance in the grid circuit of the detector tube is much lower since the antenna resistance is no longer included, therefore, regeneration is more easily controlled and is not as critical as before. The lower resistance in the grid circuit of the detector tube increases selectivity remarkably. Tests have shown it very much superior to double circuit regenerative receivers in this matter. A wave trap or filter is not needed since this radio frequency unit will do the work instead.

There should be no necessity for receiving any signals on the zero beat method so the quality of the received signals is also improved and there need be no squeals in the receivers or loud speaker. All these items are conducive to greater distance reception, so the device seems well worth while, even if the receiver radiation item were not considered.

## Detecting Music With A Nitrogen Tube

(Continued from page 1744)

or vapor before reaching the plate. The so-called hard tubes are ones from which the gases and vapors have been so thoroughly evacuated, say to one hundred millionth of a millimeter of mercury pressure, that practically no collisions of electrons and gas atoms occur; soft tubes are ones in which so great a condition of evacuation has not been reached. With the best vacuum at present obtainable (that is in the hardest tubes) there will always be a great many atoms left—say from one hundred million to one thousand million atoms per cubic centimeter



**"The Loud Speaker"**  
**FREE**  
**To Radio Dealers**

We believe that this latest issue of the "LOUD SPEAKER" is the most useful and complete book of its kind ever published for dealers.

It not only contains big values in the fastest selling standard parts for radio, but also has detailed diagrams of the very latest and most practical hook-ups. The prices shown are list prices which enables you to sell your customers direct from the book. A confidential dealers' discount sheet is enclosed. Send for a copy at once, you will be highly pleased with it.

**DEALERS USE YOUR LETTERHEADS**  
We have only a limited edition of these "LOUD SPEAKERS"

WRITE FOR YOUR COPY AT ONCE

**WESTERN RADIO MFG. CO.**  
*Manufacturers and Distributors*  
138 W. LAKE ST., CHICAGO, ILLINOIS

**World's Greatest**  
**BATTERY BARGAIN**

**FREE** Written 2-Year Guarantee  
Your Proof of Performance  
**SAVE 50%**

and Get a 45V "B" Battery and Hydrometer Free  
Thousands of Radio News readers will do just that through this amazing World Battery offer. They will buy the famous 2-year guaranteed World battery at the lowest price ever quoted and with it they will get free a hydrometer and a 45V "B" battery.

**COMPARE THESE PRICES**

Special 2 Volt Storage Battery . . . . . \$5.00	For U.V.199 Tubes
For W. D. 11 and W. D. 12 Tubes. Will run 200 hours on one charge. Rechargeable.	6 Volt, 60 Amps. \$8.50
Special 4 Volt Storage Battery . . . . . \$8.00	6 Volt, 80 Amps. 10.00
	6 Volt, 100 Amps. 12.50
	6 Volt, 120 Amps. 14.50
	6 Volt, 140 Amps. 16.00

**SEND NO MONEY**

You need not send a penny. Just send your name and address and mention this advertisement. The battery you specify will be shipped to you the day your order is received. When the battery arrives, inspect it—read our 2-year guarantee before paying C.O.D. charges. Confine yourself you are protected from every angle—that the World Battery saves you 50 per cent. Get the 45V "B" Battery and hydrometer FREE. Send your order today.

**World Battery Co.**  
1219 So. Wabash Ave.  
Dept. 10 R.N.  
CHICAGO, ILL.

45V "B" Battery and Hydrometer 5 per cent discount for cash in full with order.

**"K. & C."**  
**RADIO PARTS AND SETS**

Known throughout the world. For 10 years used by ships, shore stations, U. S. Navy, amateurs and professionals. Write for price lists.

**KILBOURNE & CLARK MFG. CO.**  
Head Office :: :: Seattle, Wash.  
Branches:  
Chicago, San Francisco, Los Angeles, Portland,  
New York, representatives, Steelman, Inc., 24 Murray St.

**BECOME A PROFESSIONAL PHOTOGRAPHER**  
**EARNING \$35 TO \$125 A WEEK**

Three to six months' course Motion Picture, Commercial, Portraiture. Practical instruction. Day or Evening Classes. Ask for Catalog No. 56.

**N. Y. INSTITUTE OF PHOTOGRAPHY**  
NEW YORK CHICAGO BROOKLYN  
141 W. 36th St. 630 S. Wabash Ave. 503 State St.



# 1500 MILES and MORE on ONE TUBE

Thousands of Fans Are Doing Better—A Guaranteed DX Getter

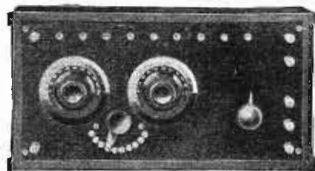

FRONT VIEW

## "SHEPCO" "ALL PURPOSE" RECEIVER

Trade Marked—Patents Granted and Pending

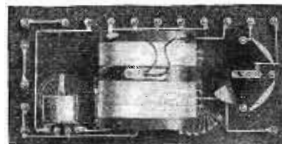

REAR OF PANEL

### "SHEPCO" "All Wave" Jr. Non-Radiating DX Coupler

Patents Granted and Pending  
Combination flat and bank  
wound. Eliminates use of  
all variometers, vario coup-  
lers and loading coils.  
Guaranteed to bring in dis-  
tant stations loud and clear  
on one tube.

Guaranteed Wave Length  
150 to 1000 Meters  
in single circuit  
150 to 700 Meters

in triple circuit  
At all dealers or  
sent prepaid on  
receipt of price.

**\$6**

With 6  
Hook-ups

A complete one tube set mounted on genuine Bakelite panel in finely finished genuine mahogany cabinet. Equivalent to one step of audio frequency for volume. Equal to much more expensive many-tubed sets for distance and selectivity.

### ALL PARTS GENUINE

Contains only best units — guaranteed genuine "SHEPCO" "All Wave" Jr. DX Coupler and genuine U. S. Tool Condenser.

### INTERCHANGEABLE CIRCUITS

May be used as complete single, double or triple circuit, single tube reflex, part of plate variometer set, plate and grid variometer set and as tuner in many other circuits. Exclusive arrangement of terminals at top of panel permits changing hook-ups quickly, without tools.

### NO OTHER SET LIKE IT Good as a Course in Radio

Prices, Without  
Accessories

**\$21**

Absolute Money  
Back Guarantee

At your dealers or sent pre-  
paid on receipt of order and  
remittance.

**SHEPARD-POTTER CO., Inc.**

Plattsburgh, N. Y.

Set of six efficient hook-ups with every set or sent on receipt of ten cents in stamps to cover cost of mailing.

Two Stage Audio Amplifying unit for use with "SHEPCO" "All Purpose" or any other set.

**\$21**

# ONE TUBE OR FIVE!!



**\$25.00**

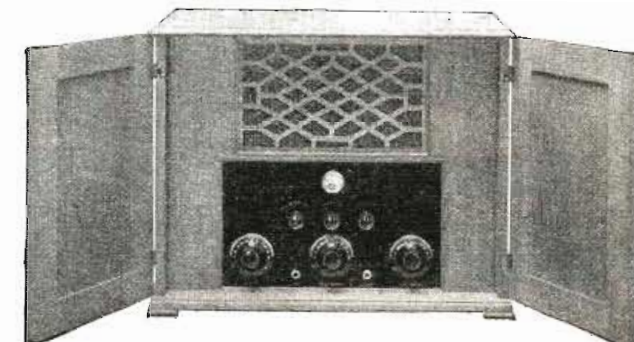

**\$225.00**

or

## RADAK

quality is the same; the highest from every angle.

We are selling you not a mere mechanical assembly, although the materials are the best the market affords, but a pleasure box which contains music you can enjoy, speech you can understand, with simplicity you can master and all the distance you have a right to expect. You need not experiment with untried products unless you want to. RADAK is backed by seventeen years' exclusive radio manufacture—the oldest in America.

Licensed under Armstrong U. S. Patent 1113149. Bulletin on request.

INSIST UPON RADAK. Your Dealer will secure one for you.

**CLAPP-EASTHAM COMPANY**  
107 MAIN STREET, CAMBRIDGE, MASS.

395 Broadway  
New York, N. Y.

Caxton Bldg., Cleveland, Ohio

709 Mission Street  
San Francisco, Cal.

## Two Radio Parts That Should be Parts of Your Set

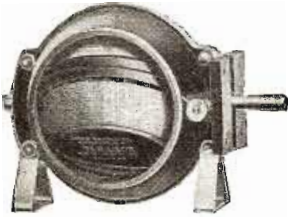

### Paragon Variometer No. 60

Reduces dielectric losses to the minimum. Possesses the ideal advantages of coils surrounded by air and at the same time essential mechanical strength. Meets the rigid electrical requirements of Paragon Parts. Gives better results. Price \$5.00.



### Paragon Variocoupler No. 65

Strongly made with coils of double black Condensite tubes with highly polished finish. Single turn taps and switch are unnecessary. Makes possible a very fine control. Simple to operate. Price \$3.50.

Write for illustrated catalog

ADAMS-MORGAN COMPANY  
6 Alvin Ave., Upper Montclair, N. J.

## PARAGON

Reg. U. S. Pat. Off.

RADIO PRODUCTS

## RADIO TUBE EXCHANGE

We Repair All Standard Makes of Tubes  
Including

W.D.-11 or 12  
U.V.-199 or C.-299  
C.-11 or 12  
U.V.-201A or C301-A  
D.V.-1 or D.V.-2  
U.V.-200 or 201  
C.-300 or 301

\$2.50



All tubes guaranteed to do the work.  
RADIO TUBE EXCHANGE  
200 BROADWAY NEW YORK CITY, N. Y.  
All Mail Orders Given Prompt Attention  
Orders sent Parcel Post C. O. D.

### SIGNAL ELECTRIC MFG. CO.

Menominee, Mich.  
Manufacturers of Radio Apparatus, Receiving and  
Sending. Dealers send for discounts and catalog.

—yet the electrons move so fast that one will travel, on the average, 10 kilometers (about six and a quarter miles) without hitting an atom. Since the filament plate distance is generally about one centimeter, the actual number of collisions will be negligibly small. If, however, there is gas in the tube, either put there purposely or developed from the plate due to overheating it, and the gas pressure is from one one-thousandth to one-tenth of a millimeter or more, a sufficiently great number of collisions will take place to alter the characteristics of the tube in a marked way. The first thing that the user is likely to notice in a tube which is soft or has gone soft to this extent is a "blue glow." Now this blue glow, both as to its mode of production and its possible significance, is interesting to the physicist.

Let us suppose that the gas in the tube is nitrogen. The atom of nitrogen is known to have a central nucleus containing a net charge of seven units of positive electricity and two exterior shells of electrons, the inner shell with two electrons in it, the outer with five in it. The atom as a whole is therefore, electrically neutral containing seven positive units and seven negative units.

Fig. 1A represents this structure in a diagrammatic way, but the most likely arrangement of the electrons in the atom is shown in Fig. 1B. The electrons are thought to move in the paths there represented, but these paths themselves shift about in space so that the real atom is in three dimensions—not in two, as shown in the figure. These atoms do not generally exist separately in the tube, but stick together in pairs forming molecules, each of which has two nuclei of seven positive charges each and a total of 14 electrons arranged around them in some way at present unknown. This molecular system is normally in a state of equilibrium under the action of the forces between its parts, but it can be made to vibrate or oscillate from this normal state to certain other unusual states and back again if it is struck with sufficient force. Consequently when an electron comes along on its way from the filament to the plate and strikes the molecular system it will, if it strikes it hard enough, make that system vibrate. The result of these vibrations will be that the molecule will give out electro-magnetic waves just like those from a wireless sending station, but much shorter (about one ten-millionth as long as average broadcasting waves) which are waves of light capable of effecting the retina of the eye. When we look at a tube in which many millions of atoms are oscillating, due to continual impacts of electrons, we therefore see light coming from it—the "blue glow" above referred to. Now the wave-length of the light must depend on how the parts of the molecule are arranged and on the forces between the parts in a certain sense just as the wave-length of a sending set depends upon its components, and their arrangement. We may hope, then, from a study of these wave-lengths to find out something about the construction of the molecule. To make this study we photograph the spectrum of the blue glow through a spectroscope, and thus learn what wave-lengths are present and how the energy of vibration of the molecule is distributed among these wave-lengths. Although such researches have not, up to the present time, enabled us to specify the exact structure of the nitrogen molecule or of any other molecule, the outlook is nevertheless hopeful.

Fig. 2 is a photograph of apparatus in use in the Research Section of the Randal Morgan Laboratory of Physics, University of Pennsylvania, to investigate such a problem. The experimental tube is shown at A. It is made of pyrex glass and contains a tungsten filament supported in a removable stopper at a distance of about one-eighth inch from a copper box the lid of which

## This may be the trouble with YOUR set—

You can probably change  
your grid leak for higher

**Detecting Efficiency**  
The highest efficiency can  
only be obtained by changing  
both resistor and condenser.

### Can You Do This?

RESISTOR



THE DAVEN COMBINED RESISTOR-  
CONDENSER MOUNTING DOES BOTH

If your dealer cannot supply you  
write

**Daven Radio Company**

Resistor Specialists

10 Campbell Street Newark, N. J.

## SALESMEN

Largest radio publish-  
ing organization in the  
world wants salesmen,  
either whole or side line,  
to sell an assortment of 20  
books to the trade.

Liberal commission to  
hustlers

Box 233, Radio News,  
New York City



### Charge Your Battery For A Nickel

The Gold Seal Homecharger  
Charges Radio and Auto Batteries  
at home overnight for a  
nickel. Your dealer has it.  
Write for FREE booklet and  
list of broadcasting stations.

The Automatic Electrical  
Devices Co.

118 W. 3rd St., Cincinnati, O.

### Add to Summer Joys by Keeping Radio Records

"Where I Go By Radio," the Handy Little  
Record Book, has easy system and space for many  
records. Lists Radio Stations and other features.  
\$1.00 gets two Popular or one Holiday Edition.  
At all newsstands or dealers, or direct from

RADIO DEPT., R., PROGRESS PR.  
Union, South Carolina, U. S. A.

## Factory to Rider

Saves \$10 to \$25 on the Ranger Bi-  
cycle you select from 44 Styles, colors  
and sizes. Delivered free on approval  
express prepaid for 30 Days' Free Trial.

\$5 a Month if desired. Possession and  
Monthly payment plan. Bicycles \$21.50 and up.  
Use at once on our liberal  
terms, wheels, equipment at half  
Tires at special prices. Write for marvelous new  
prices, wonderful 30 day trial offer and terms.

**Mead CYCLE COMPANY**  
DEPT. G 116 CHICAGO



Write us  
today for  
free catalog



is a grid. The box, acting like a plate, is charged by a "B" battery to a known potential, and the electrons from the filament are drawn over to it. In the presence of enough nitrogen, a blue glow is thus produced inside the box. In the side of the box is an opening out of which the light comes, entering the spectroscope and camera at C. Various accessories are necessary, such as the vacuum pumps and vacuum gauge at D and E, the reservoir of pure nitrogen at F and the heating bath and liquid air trap at G and H for controlling the amount of vapor in the tube.

Since it is important to know the exact amount of energy possessed by the electrons which are striking the atoms and making them give off light, electrical connections are necessary for controlling the potential of the box. These connections are shown in Fig. 3.

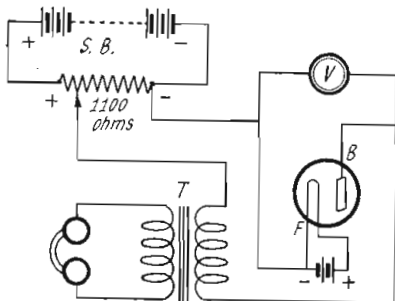

Fig. 3

The circuit used with the nitrogen tube.

This arrangement, which is self-explanatory, enables us to put any desired positive potential up to 150 volts on the box and to read off the difference of potential between the box and the filament on the voltmeter V.

The voltages used being low (from 12 to 16 volts), the glow was faint—almost if not quite invisible—and long exposures of the photographic plate were necessary. Since other experiments had led to the suspicion that an arrangement like this might oscillate and thus produce false voltages within itself, a telephone transformer with phones was introduced at T during the long exposures. An oscillation would thus be evidenced in certain cases by a musical sound in the phones. In this particular case there was no musical hum, but the full program of music, songs and speech from

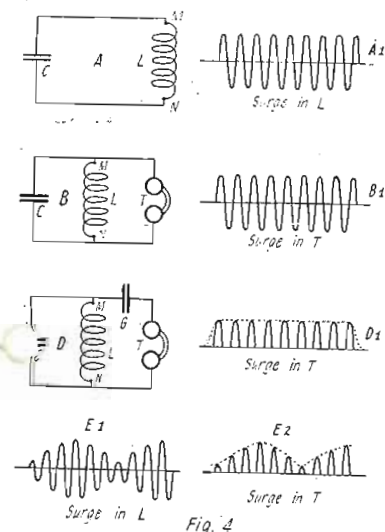

Fig. 4

This diagram shows how incoming signals are rectified and made audible in the telephones.

**W. M. WILKES**  
Nashville, Ind.  
Feb. 19, 1924.  
Phenix Radio Corp.,  
5 Beekman St., N. Y.

Gentlemen:  
I congratulate you on the Ultradyne circuit. It has sidetracked my big Super-heterodyne. Have just tuned out Cincinnati coming heavy on 309 meters and got KGO at Oakland, California good and strong at 312 meters on the loud speaker with one stage of audio amplification. It's the best circuit of them all!

Yours very truly,  
W. M. Wilkes.

**BAY VIEW HOTEL**  
Mattapoisett, Mass.  
March 24, 1924.  
Phenix Radio Corp.,  
5 Beekman St., N. Y.

Gentlemen:  
I have put the set in operation and regularly get Cuba, Miami, Florida, Chicago and Hastings, Nebraska, with fine volume on the loud speaker. With earphones have heard Tacoma, Washington, Calgary, Alberta and a station in Saskatchewan, using a small loop.

Very truly yours,  
F. V. Andrews.

"The Standard of Comparison"

# ULTRADYNE

The Improved  
SUPER-HETERODYNE

Send for the 32-page illustrated book giving latest authentic information on drilling, wiring, assembling and tuning 6 and 8 tube Ultradyne receivers.

**50c**

Employs "Modulation System," an entirely new principle of radio reception just developed and perfected by R. E. Lacault, A.M.I.R.E. technical editor of Radio News and formerly Radio Research Engineer with the French Signal Corps Research Laboratories.

This principle is of such a basic character that the sensitiveness is increased over that of any known receiver. Weakest signals are made to operate the loud speaker. Results secured by the Ultradyne exceed by far those obtained with Reflex, Super-Regenerative Neutrodyne and even with the well-known Super-Heterodyne. This is true in regard to selectivity, range, signal audibility, simplicity and general efficiency.

The "Modulation System" is employed exclusively in the Ultradyne, the improved and simplified Super-Heterodyne.

Write for descriptive circular.

**PHENIX RADIO CORP.**  
3-7 Beekman St. New York City

**Stop Worrying About Dry Cells**

Rechargeable "A" Battery  
PRICE \$7  
POSTPAID

The PRECISION STORAGE A Battery ends your worries about dry cells—It is rechargeable. Saves its cost in a few months. Operates from 4 to 6 WD12 or WD11 tubes. Gives constant voltage that assures good reception. Shipped to you fully charged—dry.

**PRECISION ELECTRIC CO.**  
147 West 24th Street N. Y. City

## LEARN RADIO

Here's your opportunity. Radio needs you. Win success in this fascinating field. Trained men in demand at highest salaries. Learn at home, in your spare time.

### Be a Radio Expert

I will train you, quickly and easily, to design, construct, install, operate, repair, maintain, and sell all forms of Radio apparatus. My new methods are the most successful in existence. Learn to earn

**\$1,800 to \$10,000 a Year**

**FREE** Wonderful, home-construction, tube receiving set, of latest design. Write for "Radio Facts" free. Engineer Mohaupt.

RADIO ASSOCIATION OF AMERICA  
Dept. 156, 4513 Ravenswood Ave., Chicago

**WANTED**—Back numbers of Radio News, Dec., 1921, Jan. and Feb., March and April-May, 1922. Experimenter Publishing Co., 53 Park Place, New York City.



A very popular style of Radio Table. Designed especially for receiving. Plenty of leg room. Battery cabinet is on right instead of left as shown in cut.

**Specifications**

Hardwood, rubbed mahogany or golden oak finish.  
Height, 31 inches; top, 20x34 inches.  
Drawer with lock, size 4x10x13 inches.  
Battery cabinet, size 17x14x16 inches.

**PRICE**

No. 30-R Radio Table

Freight prepaid to east of Mississippi River .....\$18.00  
To Rocky Mt. States, freight prepaid.. 20.00

This Table is a very handsome piece of furniture weighing, crated, 85 lbs. We make these in our own factory in large quantities and sell direct to you at a small factory profit.

**RADIO CABINETS**

Our cabinets are high-grade in every respect and are not to be classed with the cheaply made stained cabinets with which the market is flooded.

Hardwood, hinged tops, tops splined to prevent warping, rubbed dark red mahogany finish.

**SIZES AND PRICES**

7x14x10 deep	.....\$3.00
7x18x10 "	..... 3.25
7x21x10 "	..... 3.50
7x24x10 "	..... 3.75
7x26x10 "	..... 4.50

Postage prepaid to east of Mississippi River. To Rocky Mt. States add 25 cents each.

Cash Must Accompany All Orders.

Send for Free Catalogue

**THE SOUTHERN TOY CO., Inc.**  
HICKORY, NORTH CAROLINA

**New York's Finest Radio Shop**



Finding an unprecedented demand for real mail order service we have created a well organized Mail Order Department which will promptly fill the demands of our many out-of-town patrons.

We will gladly mail our Suggestion Booklet upon receipt of 4c to cover cost of postage. Address Dept. R.

**Harold Herbert, Inc.**  
160 West 46th Street  
Just East of Broadway  
NEW YORK CITY

**AMPLION**  
The World's Standard  
Loud Speaker

nearby broadcast stations was received. Although at first sight this seems very remarkable, nevertheless a little consideration will enable us to give an easy explanation in full accord with well known elementary principles.

Reception in radio telephony depends essentially on the use of a rectifying device. Let us suppose that we have a loop circuit like A in Fig. 4. This, being made up of metallic conductors, contains a column of electrons passing through the inductance L and terminating on the plates of the condenser C, which is a reservoir of electrons. This column is normally at rest, but it has a natural period of oscillation depending on the magnitude of L and C and, just as a tuning fork is readily set into oscillation by a sound wave of the same pitch as that of the fork, so this column of electrons is easily set into surging back and forth by an electromagnetic wave of the period natural to the circuit if such a wave passes over it. Now when the column of electrons surges down through L it is choked by the inductance of L, and the concentration of electrons at M becomes greater than at N—that is, M rises to a higher negative potential than N. Similarly, when the surge reverses and passes up through L, N will be at a higher negative potential than M. Therefore, if we connect M and N by a wire with a telephone in it, as shown at B in Fig. 4, an alternating current will flow through the phones just like the current surging in A. However, from an ordinary broadcasting wave, the alternations will be at the rate of about one million in each second, which is so rapid that the telephone diaphragm cannot respond to it, and, consequently, nothing at all is heard in the phones. Suppose, now, that we introduce a rectifying gap at G, either a crystal or a two-electrode tube. Since the gap can only transmit current when the plate of this gap is positive, as explained earlier, current will now flow through the phones in one direction only. The phone current will be as shown at D1. The successive bumps shown above the line are too close together in time to be recorded by the diaphragm separately so all that is heard is a click at the beginning of the wave chain when the diaphragm is first drawn down and a click at the end when the diaphragm is released. This effect, indicated by the dotted line in D1, is produced when an unmodulated carrier wave passes over the loop. If the wave is modulated as at E1 it will be received in the telephones as at E2 and the diaphragm will give out a sound corresponding to the dotted envelope of the bumps, which is exactly similar to the sound wave used in the first place to modulate the carrier wave.

This is the usual simple theory of reception with a rectifying detector. Comparison of Fig. 4D with Fig. 3 shows at once that however dissimilar the apparatus of Fig. 2 may seem to be from an ordinary wireless receiver, it is nevertheless from the electrical viewpoint identical.

The storage battery furnishes the capacity of the loop; the high resistance of 1,100 ohms furnishes the inductance while the sides of the loop are made up of the connecting wires which were in this particular case some 40 feet long, running in ceiling conduits beneath the ground level and passing through two switchboards and other complications. The nitrogen filled tube served as a rectifying detector; nothing further was necessary. A loop made up in this way would have a broad resonance so that close tuning would be unnecessary. A definite tuning effect can be exercised as usual through control of the filament temperature and through small variations of the potential on the box obtained by moving the slider.

For certain simple and well known reasons intimately connected with the foregoing discussion, but into which we do not here have space to enter, an arrangement of

**Your Loud Speaker Unit**

The Camco Loud Speaker Unit may be attached to any Horn or Phonograph. Space does not permit telling you about its tone and other fine qualities. You must see and hear it to fully appreciate its merits. Price \$8.00.

**Camco Headsets**  
Cannon Ball, \$3.50;  
Superb, \$4.50; Grand,  
\$5; De Luxe, \$7.50.  
At your dealers or write

**GANNON & MILLER SALES CORP.**  
47 W. HURON ST. BUFFALO, N.Y.

*The New and Perfect Variable Grid Leak*

**65¢**

**THE BRADY LEAK**

Although it is cartridge type it is different in principle from any Variable Grid Leak you have ever used before.

**A.C. BRADY CO.**

COMPLETE WITH MICA CONDENSER AND PERFECT LEAK MOUNTING **\$1.00**

At your dealer—or post paid on receipt of purchase price.

**A.C. BRADY CO.**  
Improved Radio Apparatus  
108-SEVENTH AVE. NEW YORK CITY

**"R" EVERLAST "C"**

Radio "B" Batteries are best by test. Made for Radio use only. Owners of large sets should try "EVERLAST" for endurance.

The R. C. Mills Radio Corporation  
Mfrs., 303 4th Ave., New York City

**Grewol Detector**

The Reflex crystal detector, adjusted permanently at the factory.

**NEW LIST \$1.50**

**PRICE**

**Grewol Mfg. Co.**  
Newark, N. J.



this particular kind will be more sensitive as a detector than the three-electrode tube set up in the usual way with a grid leak and condenser. Such a device offers further advantages for use as a detector in that it can be kept free from radiation. With the development of suitable arrangements for controlling the gas pressure we may look for the rather extensive use of tubes of this type for reception in the near future.

The experiment here described, having as at first laid out, no immediate connection with radio art, serves as an example of the numerous investigations of no obvious practical application continually being carried out in the physical laboratories of the universities. Such work has frequently served in the past as the basis for commercial developments of great importance of which that of the radio is only a single example. It is not intimated that the particular experiment here described will be or can be given a useful commercial application in radio because, as has been made plain, no new radio principles are involved in it. When, however, the problem which the apparatus was designed to study—that of the exact structure of the nitrogen molecule—is carried through to completion, far-reaching practical applications might possibly result in future years. The solution of such a deep problem will, of course, require the collaboration of many physicists and the use of many other experiments very different from the one here described.

**Will the Future Broadcast Station Be Buried?**

(Continued from page 1733)

space above the earth such as passing clouds and to the ionization of the atmosphere. However, when the antenna employed for transmission purposes is buried or submerged

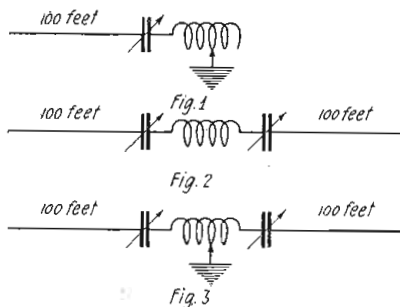

The three arrangements employed by Dr. Rogers in his latest experiments with underground antennae.

under the surface of the earth, the electromagnetic waves thus propagated are not subject to the fluctuating conditions prevalent in the ether—or, at least, they do not exist to such a marked degree."

**Correspondence from Readers**

(Continued from page 1767)

not pay the receiver tax, but every transmitter, ham or broadcaster, is fully licensed and tuned dead on his allotted wave, which is more than can be said of yours. As one who has frequently heard your stations, from WJZ downwards, I can truthfully tell you that on much less power. (1 K.W. input, not 7 K.W. in the aerial) we have a better service with better and more high-class pro-

**BAKELITE**

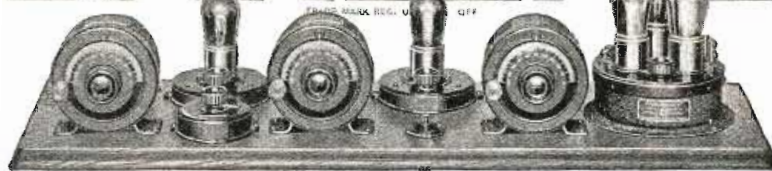

**Atwater-Kent and Bakelite**

The enthusiastic commendation accorded Atwater-Kent Radio Broadcast Receivers is due, not alone to the fine workmanship which they exemplify, but to their performance in the hands of inexperienced operators.

The simplified design, made possible through the use of molded Bakelite, is largely responsible for the ease of operation.

Bakelite possesses a combination of properties not found in any other material and which makes it peculiarly suited for this service. Its excellent electric properties provide complete insulation which

remains unimpaired under all atmospheric or climatic conditions.

Its great mechanical strength, permanent beauty of finish and color enhance the value of any Radio Equipment in which it is used.

The permanence of all the properties of Bakelite have caused leading Radio Manufacturers to adopt "The Material of a Thousand Uses" as standard insulation for the manufacture of parts and complete units.

Write for a copy of our Radio Booklet B.

**BAKELITE CONDENSITE REDMANOL**

are the registered Trade Marks for the Phenol Resin Products manufactured under patents owned by **BAKELITE CORPORATION**

**Send for our Radio Map**

Enclose 10c. and let us send you the Bakelite radio map. It lists the call letters, wave length and location of every broadcasting station in the world. Address Map Department.

**BAKELITE CORPORATION**

247 Park Avenue, New York, N. Y.  
Chicago Office: 636 West 22d Street

**THE MATERIAL OF A THOUSAND USES**



**The Saturn**  
Perfect Jack and Automatic Plug  
Write for Literature  
Your order filled by mail promptly.  
Every article absolutely guaranteed.

**The SATURN Mfg. & Sales Co., Inc.**

48 Beekman St.  
New York, N. Y.

**HEATH RADIANT CONDENSERS**

A definite guarantee of lasting accuracy—PERMANENTLY FLAT Plates. The Heath process of stamping to absolute flatness and their tempering to steel hardness protects you from warping, buckling plates. The difference is worth the effort of insisting on Heath Condensers.

**Micrometer Geared Vernier**  
Reducing gear gives hair-line adjustment, so essential in the finely tuned circuits. Separate tension adjustment.

Write for Literature!  
Canadian Distributor: Marconi Wireless Telegraph Co., Montreal, Canada  
Jobbers and Dealers Write for Proposition  
**HEATH RADIO & ELECTRIC MFG. COMPANY**  
206 FIRST ST., NEWARK, N. J.

Insure your copy reaching you each month. Subscribe to Radio News—\$2.50 a year. Experimenter Publishing Co., 53 Park Place, N. Y. C.



### Chart the air with SHAMROCKS

“... some broadcast listeners grope in the dark not knowing what is coming. Others have their entertainment thrust upon them. But I can get Cuba, Montreal and other outlying stations—from my chart which I have made with my Shamrock set.”

Anybody can build this distance getting set with the Shamrock Kit. The Kit contains two Shamrock balancing condensers—and three Shamrock air core transformers, mounted and properly balanced on U. S. Tool condensers, made expressly for Shamrock.

Inspect this kit at your dealer's today. If he hasn't it in stock, send us the coupon below.

Kit, List Price \$20  
SHAMROCK MANUFACTURING CO.  
Dept. 60, Market St., Newark, N. J.



SHAMROCK MFG. CO.,  
Dept. 60, Market St., Newark, N. J.  
Gentlemen: Send me detailed information on the Shamrock Kit.

Name .....  
Address .....  
Dealer's Name .....



**ERLA**  
DISTRIBUTORS  
Dealers—Send your orders to the largest exclusive Radio Jobbers in the west. It means better service.

**HUDSON-ROSS**  
123 W. Madison St. Chicago

grams than any station in the U. S. A. Come right over here and see for yourself what we are doing. You won't be troubled with the squeals of forty-thousand regenerative ten-cent receivers and two programs at once. As for DX, the records of reception here of your stations will convince you what we can do. For short range DX, it is quite easy to pick up Aberdeen in London with one valve on a straight non-super circuit, and Aberdeen has only 1 K.W. input, not 5 K.W. in the aerial. If we had the high power that you waste we should expect to get anything going on a hairpin and a lump of coal.

Coming down to the stuff in your periodical: Can't you find something new? The Autoplex, Albright, etc., circuits are all very nice. I suppose you don't know that the Autoplex was used in the British Air Force in 1917 as a short-wave receiver and it is not a derivative of the Armstrong either. The Albright modification of the Colpitts, and the Colpitts itself, were used in the Navy here in 1918. The Flewelling has been exhaustively tried out here by one of the periodicals and has been found to give no better results than a well used single circuit regenerative receiver. As for the Armstrong, the German Telefunken people made some D.F. sets with loop aerials for the Austrian Army in 1918. I believe, which only employ one double grid valve and they can give the Armstrong flivver a start and then win. You can hear real speech on them.

When are you going to pick Europe up and rebroadcast our stuff as the B.B.C. here has done with yours? Not until we get umpteen kilowatts in the aerial I suppose. Why don't you get some of your folk besides the real DX stars like Mr. Schnell, to build some radio receivers?

Sir, if you want a holiday, and I fear you do, why not come over here yourself and have a look around and a listen-in. Call and see the British Broadcasting Co., Marconi's and a few of the more high-class firms. Get them to show you what we can do in the way of good class apparatus. Go through the shops and see what we can do in the way of cheaper stuff. Good variometers and variocouplers that will work, at \$1 to \$2.50. Tubes at \$2, and not bootleg at that. Phones at \$3, N. & K., that sell with you at \$8.50, can be bought here for \$4. You would then see that you tuned on the wrong wave-length as far as knowing what "Radio in England" is like.

I am sorry for you, I really am. Come over and then go back and tell them the truth.

Excuse my typing. I prefer to hammer the other sort of key.

A. F. C. BAYES,  
British 5XZ,  
48 Lavender Gardens,  
London, S. W., England.

[Thanks for the compliments 5XZ—BUT we DID get our information from an American observer recently returned from England. Stories about bootleg stations (those that pay no government tax) can be read by anyone in many British radio journals.—Editor]

### DOPE ON THE SINGLE CIRCUIT RECEIVER

Editor, RADIO NEWS:  
Will have to issue a call for help. The letter regarding single circuit receivers which you printed for me in your January issue on page 946 has caused a flood of letters and it is a physical impossibility for me to answer them. I have now found out that you have quite a circulation, as letters have come from all over the world. Please print the accompanying circuit and letter so they may all receive the information they have requested:  
Aerial—One cable composed of 16 strands of enamel insulated No. 26 copper braided

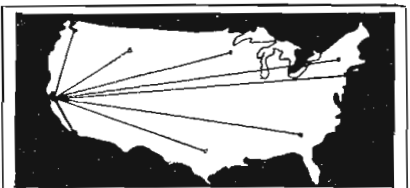

### ON ONE TUBE

Broadcasting from Atlantic Coast, Canada, Mexico, Cuba and Hawaii heard in California by users of the CROSS COUNTRY CIRCUIT Range due to simplicity. One tuning control. ANY NOVICE can build easily and cheaply. Dry cell tubes used. No soldering. Complete instructions, Blue print panel layout. Assembly Photo, etc., postpaid 25 cents. Stamps accepted.

#### WHAT USERS SAY

EAST—Am more than pleased with the parts ordered from you. The first night I hooked it up and received Omaha. Since then Minneapolis and Los Angeles. It works better without amplification than most sets with two stages.  
—Donalds, S. C.

WEST—I am sending you a list of some of the stations heard on one tube: WSB, WGY, KDKA every night. PWX, WWJ, WTAM, WLW every night. CFAC, CHCB. Not long ago I purchased another set of parts from you and first night got WGR, Buffalo, and KDKA.  
—Lone, Calif.

NORTH—Received coils OK today. If I have same results with these that I had with last will be wanting more. I am 1,500 miles from nearest station and have picked 56 to date. Chicago, Havana, Mobile, New Orleans and TWO IN ENGLAND.  
—Lunenburg, Canada.

Send stamp for further information.

Vesco Radio Co. BOX RN-117  
OAKLAND, CALIF.

SEND FOR YOUR FREE COPY

### TESTED HOOK-UPS SUBMITTED BY USERS OF OUR



WONDERFUL TRANSMITTER  
BUTTON FOR LOUD SPEAKERS

Price \$1.00  
POSTPAID  
with instructions

AMPLIFICATION AND EXPERIMENTS

### K. ELECTRIC CO.

15 PARK ROW NEW YORK

Genuine Gilfillan Radio Parts can always be identified by this trade-mark—look for it



### GILFILLAN BROS. Inc.

Kansas City Mo. Los Angeles Cal. New York N. Y.

### ELGIN SUPER-REINARTZ

The Set Which Copied  
2LO LONDON, ENGLAND

ON ONE TUBE  
Send Stamp for Descriptive Circular

ELGIN RADIO SUPPLY CO.

207 E. Chicago Street, Elgin, Ill.

\$2.00 12th Edition \$2.00

### WIRELESS COURSE IN 20 LESSONS

By S. Gernsback, A. Loscarboura and H. W. Secor  
The Standard Radio Text Book  
Size 6x9 inches. 264 pages. 500 illustrations. Binding de Luxe. Semi-flexible Leatherette Cover. Genuine Gold Stamped, Round Corners, Red Edges.  
EXPERIMENTER PUBLISHING CO.  
53 Park Place New York, N. Y.



wire 40 feet high at open end, 35 feet high at lead-in end, 130 feet from open end to set and from set to ground.

Variable condenser—22-plate, built in vernier type, with end support plates of good insulating material, pigtail connection from rotary plates and extension shaft made of bakelite.

Coupler—Primary 4-inch tube wound with 70 turns Litzendraht 20-strand enameled No. 38 copper double silk covered, tapped at 1/4 inch and each 10 turns thereafter. Rotor 60 turns same size Litz, untapped and wound on a rotor to fit a 3 1/2-inch tube, extra space taken up by bakelite washers.

Grid Condenser—The two phosphor bronze plates removed from a .00025 mfd. grid condenser spaced and backed with thin sheets of mica and clamped between bakelite strips. Leak is pencil mark across the bakelite between the lugs.

Fixed condenser (c) in the ground lead bridging the phones and plate battery is a mica insulated .0005 mfd. fixed condenser.

Tube—UV-200.

Rheostat—Carbon pile type.

Filament battery—90-ampere hour storage battery.

Plate ("B") battery—22 1/2-volt.

Tube socket—Highly glazed porcelain.

The above set was constructed for experimental purposes and for comparison tests with a number of receivers and from the standpoint of selectivity and distance, exceeded all expectations and in one week of exhaustive tests proves its superiority over any receiver tested by bringing in 136 broadcast stations in a period of one week, and on

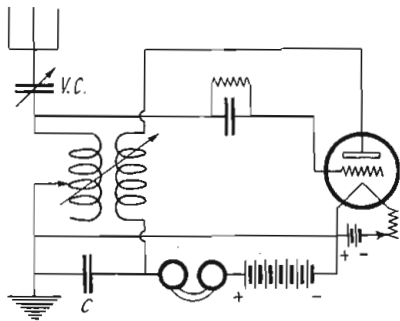

The conventional single circuit tickler feedback circuit will prove exceptionally sensitive and stable if correctly designed.

one night bringing in on the 400-meter band 11 phone stations including Los Angeles Times, Shepard Store, Boston and PWX. Havana, with the vernier plate only, not even a change of tickler adjustment. These tests were made last winter before the wave separation. It is a physical impossibility to tune this set without a vernier condenser. I am not giving a drawing of the amplifier, as I think every experimenter and radio fan understands its hook-up, however, I might give a few hints. In the first place ALWAYS use a separate plate battery for the detector tube, and if you use three stages of audio frequency, use a separate plate battery for each amplifier tube using 45 volts on the first, 67 1/2 volts on the second and 90 volts on the third. Bridge the primary of each transformer with an audio frequency choke coil (the primary of a Wayne Bell transformer is ideal) and place a 1 or 2 mfd. condenser in series with the primary of the transformer and the plate. The choke should be connected on the battery side of the transformer and run to the plate of the tube. The condenser should be in series with the transformer primary and the plate of the tube. If you must have amplifiers, why not use transformers that are made as nearly perfect for the particular type of tube you are using as it is commercially possible to construct? I constructed my own and they

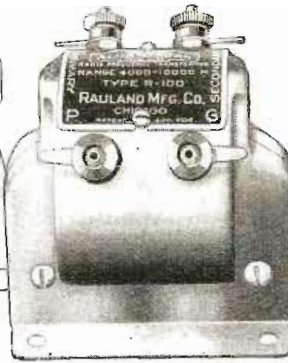
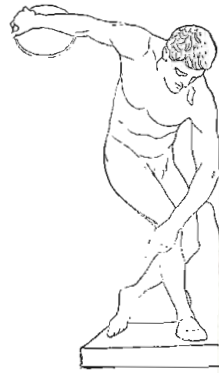

The New All-American Long Wave Radio Frequency Transformer.

# The MASTERPIECE OF AMPLIFICATION

Again All-American steps to the fore, this time with a long wave radio frequency transformer that has already taken two continents by storm.

Placed on the market only after every conceivable test had been given in an endeavor to find even a single flaw, it has proved itself "the masterpiece" of all transformers suitable for Super-Heterodyne, Ultradyne and all straight radio frequency and reflex circuits.

It is for wave lengths 4,000 to 10,000 meters (75 to 30 K.C.). Among its advantages are windings of extremely low capacitance, properly treated and impregnated. A handsome nickel-plated shell of the same shape and size as All-American Audio Frequency

Transformers insures ease of assembly and neatness. And it is shielded to prevent inter-stage coupling or re-action.

Yet the price—in conformity with the All-American policy of building only the best but building in great quantity to moderate the cost—is but \$6.

A notable addition to the All-American family of audio and radio frequency and power amplifying transformers—the most popular, most widely used transformers in the world!

### Special Offer!

Diagram-circular on power amplification and All-American Book of 22 Tested Hook-ups sent for 4c in stamps.

All the better dealers sell the All-American.

RAULAND MFG. CO.,

2650 Coyne St., CHICAGO



# ALL-AMERICAN

AMPLIFYING TRANSFORMERS

Largest Selling Transformers in the World

## SENSATIONAL OFFER FADA NEUTRODYNE

FADA Complete parts for \$69.60  
FADA 5-tube Neutrodyne set

FREE: We will make up (this remarkable set absolutely FREE for you and guarantee the best results. A genuine MAHOGANY CABINET will also be given FREE.

Our guarantee is unconditional. If the set does not work to your satisfaction, return within two weeks and money will be refunded.

FADA KIT \$54.60  
Sealed and Original

PERFECTION RADIO CORP.  
119 W. 23rd St. 59 Cortlandt St.  
118 Nassau St. 78 Cortlandt St.  
NEW YORK CITY

## Now you can get a Photo-Electric Cell



Here's a real commercial photo-electric cell of the gas ionic type that can be used for modulation in wireless transmission. Also in telephotography, television, stellar photography, spectrum analysis, for burglar alarms, light buoy operation, etc.

Remarkably stable to voltage changes, while responding in direct proportion to variations in light intensity of normal wave lengths.

Type B-1 Photo-Electric Cell with single contact Edison base \$17.50  
Edison Receptacle \$1.00  
Descriptive circular on request.

General Research Laboratories  
326 River Street Chicago

\$17.50

Get a Handy Binder for your RADIO NEWS. Holds and preserves six issues, each of which can be inserted or removed at will. Price 65c. Experimenter Pub. Co., Inc., Book Dept., 53 Park Place, New York.

Use it!



Price, \$1

At Your Dealer

**WALNART VARIABLE GRID RESISTANCE**

To Bring in Distant Stations Clear and Loud Stops Tube Noises

The **Walnart** Grid Resistance

Varies Zero to Six Meg.

Walnart Fixed Condenser 25c extra

Ask to see **WALNART QUALITY RADIO PRODUCTS** SEND FOR FOLDER Jobbers, Dealers, Manufacturers Write for Discounts

Continental Bakelite Dilecto XX is used as a base for this instrument to insure positive dielectric insulation.

**WALNART ELECTRIC MFG. CO.**

Dept. 610, 1249 W. Van Buren St., Chicago, Ill.

**100% EFFICIENCY** guaranteed in using the **EASTERN COUPLER** for the **Superdyne Circuit**

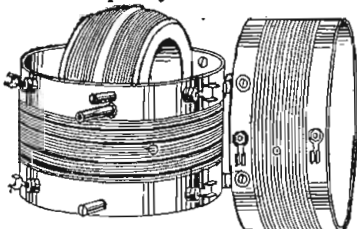

Most improved design and finest workmanship. Wound with double silk wire on Genuine Bakelite Tubing. Picture hook-up and material list free with each coupler.

PRICE, \$6.00

Mail orders filled. Dealers communicate. **EASTERN RADIO MFG. CO.** 22 Warren St., Dept. R.N., New York, N. Y.

are built for the particular tubes used but if you don't do that why not do the next best thing and use transformers made by the tube makers?

One other caution regarding the tuner and I will quit.—My grid condenser is mounted on the stationary plate side of the tuning condenser and has a lead of 1/2 inch to the tube socket binding post. Make it shorter than that if you can and please don't use hard rubber or fibre for insulating this set. Use bakelite or formica. No shields were used to prevent losses and they are not necessary with a grid variable condenser. Buzz out every strand of the Litz at each tap, get them all in the circuit. Use no cement or varnish on the windings. You may make a few narrow streaks across the rotor windings at right angles to the winding to prevent the winding coming off. None are needed on primary; it won't come off. The grid leak is very important and should be adjusted for the tube used individually. Try this. Connect set to aerial and ground. Disconnect fixed condenser around phones and battery, tap switch on 40 turn tap, tuning condenser on zero, tickler at maximum. Adjust leak until sharp high pitch squeal is heard, reconnect condenser around battery and phones and you will never need to use over 10 or 20 degrees on the tickler; it will break sharp and not mush for you. To all my radio friends at home and abroad I wish to say I am sincerely sorry that it is a physical impossibility to answer your letters and thank you for your communications. 73 to all of you.

W. C. ABELE.

**TRY THIS ON YOUR BARNYARD**

Editor, RADIO NEWS:

WBAP recently entertained radio fans from 1 p. m. to 1:30 p. m. with a Barnyard orchestra, the same being about 3,000 chickens in the Poultry Dept. of the Ft. Worth Fat Stock Show. Sure could hear the roosters crowing and the hens cackling. I put my loud speaker in the window and all the roosters in the neighborhood started crowing and one of my "games" walked up to the window and cocked his head to one side and kept looking at the speaker, as much as to say: "You don't look like a rooster, but I will try you for a round or two!"

J. E. BRADLEY, Justine, Texas.

**WIRE INFORMATION WANTED**

Editor, RADIO NEWS:

I wish to suggest that advertisers of radio parts and sets should start now and state reasonably full information concerning goods offered.

Reasons for this are: The experimenter, and home-set builder, are at a loss to know whether certain advertised coils, condensers, etc., have the proper values of inductance, capacity and range required for the circuits they may be trying to develop. Dealers, generally, are not in a position to give specific information, and many amateurs have to buy through mail order houses, especially those amateurs residing in small towns.

Set advertisers should state prices, type of circuits used, whether use of dry or storage battery is optional, also whether more than one type of antenna may be used successfully, etc.

Radio prospects are becoming more educated daily through numerous articles in newspapers and magazines as to the desirable features of a semi-technical nature, that parts and sets should possess. And considering that a very limited variety of parts and sets are stocked (outside of the large cities) this published information would no doubt save correspondence. Personally, it seems to me that published letters as to performance of sets in hands of users is a good feature, enabling a prospect to average up the

*The Complete Efficient and Economical Aerial*  
**ANTENNELLA**

No Aerial or Antenna Needed



\$1.25

Why pay \$10.00 or more to have an aerial spoil the appearance of your home? Antennella eliminates all unsightly wiring, lightning arresters, etc., and precludes the possibility of dangerous grounding on a power line. It also stops "canary bird" re-radiation from nearby oscillating sets interfering.

**ANTENNELLA**

is not only a real distance getter but also successfully overcomes static annoyances.

At your dealer, otherwise send purchase price and you will be supplied postpaid.

**Chas. Freshman Co. Inc.** Radio Condenser Products

106 Seventh Ave. New York

**BUY the New \$1.50**

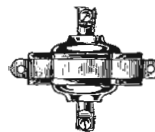

**KEYSTONE RADIO LIGHTNING ARRESTERS**

The new Keystone, made of genuine Bakelite, approved by Underwriters. Absolutely weather, dust, damp proof and has no vacuum to lose.

At Your Dealers

**Electric Service Supplies Co.**

Mfrs. of Lightning Arresters for over 31 years.



17th & Cambria Sts., PHILADELPHIA, PA. Monadnock Bldg., CHICAGO, ILL., 50 Church St., NEW YORK, N. Y.

**Let This Amazing RADIO Book Answer Your Questions**

106 Pages—260 Radio Questions and Answers—92 Illustrations—Radio Terms, Laws, Regulations, Symbols and Equations—List of Latest Broadcasting Stations—Explanations of All Types Receiving and Transmitting Sets. Over 10,000 sold—NOW ONLY \$1.00. Send Money Order, Check or Cash. (Guaranteed to satisfy or money refunded.) None sent C. O. D.



Now Only \$1.00

National Radio Institute, Dept. 13FQ, Washington, D. C.



range of a particular set for his own desires. Wishing a certain type of receiver as regards circuit design, loop operation, and price, I wrote to 10 manufacturers for information that could have been easily incorporated in their advertising, and found that only one receiver filled requirements.

No doubt a great deal of present radio correspondence is unprofitable to the advertiser, as proof of which note the ads beginning to appear, stating that full information and hook-ups are inclosed with the

ARCHIE KLINGBELL,  
258 Prospect St.,  
Ashtabula, Ohio.

**THE RADIAUTOFLEX**

Editor, RADIO NEWS:

I submit the following diagram and description of a single tube, single circuit, regenerative set which I have built and used with great success. The diagram is self-explanatory and with this set I have been able to pick up all stations east of the Mississippi, as well as a great number west. My latest achievement has been to listen in to Station KGO in Oakland, Cal., every night for the past week.

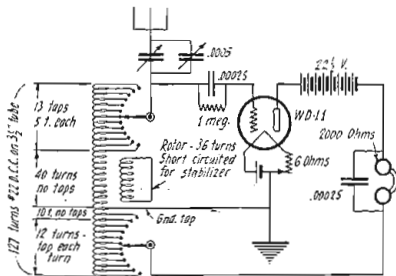

Here is a new one to try out. An absorption circuit is employed to insure stability.

Trusting that this is of interest, and as the circuit is of my own design and is reflexed (?) by the use of an auto transformer, I have called the circuit the "Radiautoflex."

FRED W. CLOUGH,  
32 Forest St.,  
Whitinsville, Mass.

**RE- RESULTS WITH THE ST-100**

Editor, RADIO NEWS:

Referring to the publication of my letter in a recent issue of RADIO NEWS, headed "Results with the ST-100," I am in receipt of many communications requesting further information and reporting results.

I regret to state that, shortly after the publication of the letter referred to, I suffered the loss of my house and all equipment, by fire, and am at present at a loss in dealing with correspondence. I must apologize to all who wrote me for my seeming neglect.

All letters will be replied to at the earliest possible moment. I trust you will extend to me your usual courtesy by publishing this letter in your "Correspondence from Readers" columns.

J. A. YOUNG,  
Carruthers, Sask., Can.

**NEUTRODYNE EXPERIENCE**

Editor, RADIO NEWS:

I don't know when I have read a more amusing story than the one by Lester D. Cushman in the March, 1924, issue of RADIO NEWS. Anyone who has attempted to build a neutrodyne cannot help but get a good laugh out of that story of his experiences. I had a similar one and perhaps it would be interesting to some others.

I ought to state in the beginning that I am familiar with all other electrical principles, and when I bought the three neutroformers and mongrel parts I had a right to the confidence that I could build a five-tube

**Type RF-2**

Price \$110.00  
(Without Tubes and Batteries)

**Pride of Possession—**

Ownership of the new Eisemann Broadcast Receiver imparts a sense of keen satisfaction.

Little is left to be desired—not simply because of distinctive appearance, but by reason of the remarkable performance of the RF-2.

New distance records have been reported almost daily since the introduction of this latest receiver.

A transformer-coupled tuned radio frequency circuit is employed, with two stages of audio frequency amplification.

ASK YOUR DEALER  
Descriptive Literature on Request

EISEMANN MAGNETO CORPORATION  
William N. Shaw, President  
50 Thirty-Third Street Brooklyn, N. Y.

**EISEMANN**

**BROWNIE CRYSTAL**

Guaranteed the Best \$1.00

"REFLEX SPECIAL" QUICK CONTACT RECTIFIER

Withstands Heavy Plate Voltage  
The Acme Apparatus Co. says "prevent distortion and howling by using a BROWNIE CRYSTAL in REFLEX SETS."

Order From Your Dealer or Direct

**ROLAND BROWNIE & CO.**  
22 Saunders Street Medford, Mass.

**Jones Multi-Plug & Cable**

Put this type on your new set; it is small and may be mounted anywhere. With cord and plug, \$4.00 Type T. M.

Put this type on seven binding posts of your present set. With cord and plug, \$5.00 Type B. T.

Put your Batteries on shelf in basement and run this 3-ft. cable through floor to set.

5 A and B, battery wires in cable. Antenna and ground are separate leads from cap. Guaranteed net to insure efficiency of set. For sale by all Jobbers and Dealers. Fully covered by patents applied for. Manufactured by

612 S. Canal St. HOWARD B. JONES Chicago

**WANTED—**Back numbers of Radio News, Dec., 1921, Jan. and Feb., March and April-May, 1922. Experimenter Publishing Co., 53 Park Place, New York City.

# BRANSTON KIT

No. R-99



Contains: 1 Oscillator Coupler, complete with mounting brackets, bank wound inductance and adjustable coupling coil with locking device; 3 Intermediate Radio Frequency Transformers, very sharply tuned and completely shielded; 1 Special Transfer Coupler for first or last stage of Intermediate Frequency; and 1 specially designed Coupler for using Antenna

**\$36.50**

## Branston-Guaranteed

This apparatus is of standard Branston. Quality, rigorously tested and proved better than anything heretofore obtainable. Its efficiency and superior performance will delight you.

### Our Book

## "SUPER HETERODYNE CONSTRUCTION"

(Price \$1.00). The amateur can easily make complete and efficient Super-Heterodyne Receiver that will be extremely selective, give remarkably fine quality of tone and be noticeably free from interference.



Add miles and smiles with Branston Standard Radio Parts.

See your dealer at once, or write us today for all information.

Chas. A. Branston, Inc.  
817 Main St., Buffalo, N. Y.  
Manufacturers of the famous Branston Violet Ray High Frequency Generators.

In Canada—Chas. A. Branston, Ltd., Toronto, Ont.

# SOLOX

(SOL-OX)  
**THE IDEAL  
SOLDERING FLUX  
FOR RADIO AND  
FINE SOLDERING**

A scientific SOLVENT of OXIDES of all Metals except Aluminum. It does NOT contain Water, Grease, Oil, Fat, Wax, Resin, Acid, or any corrosive chemical substance.

Radio Soldering troubles disappear like magic and the surplus flux evaporates under heat of soldering, leaving a clean, sound joint that will stay put forever.

Of your dealer, or send 50c to the makers

**D. X. RADIO RESEARCH  
LABORATORIES**  
Crugers-on-Hudson, N. Y.

Insure your copy reaching you each month. Subscribe to Radio News—\$2.50 a year. Experimenter Publishing Co., 53 Park Place, N. Y. C.

set, 18 inches long, 7½ inches high, and 10 inches deep in strict violation of the inventor's instructions. My first step was to mount the neutroformers on a temporary panel, lay the parts on a table and proceed to wire them up in a haphazard manner with covered wire. I got it done, without any soldered joints, and let me tell you it was a perfect performer. It looked more or less like a bunch of withered eel-grass, but I had done what the inventor said not to, so I was satisfied and enjoyed it for a few days before tearing it down to do the job right. There is where I made my mistake; what I should have done was to measure its acreage and built a box to surround it, but no. I built a nice cabinet of the size mentioned and proceeded to wire up the outfit to match. It took me about three days to get ready for another test and I had a whole lot of stuff neatly stowed away in a very small space. With all my original assurance I called the family together to watch me "hook 'er up and tune in." I went over the range of the dials three or four times and not a "perk," and it wasn't because I didn't hold my mouth right, I did. I held it in every way imaginable. It seemed that the "performance" had floated away with the eel-grass. I tried to explain that there was so much ether in the air, perhaps we were unconscious and couldn't hear the music, but when I said that, the cat got up and walked out, thereby disproving my theory. I was finally convinced that all my labor had been in vain. I checked and re-checked, but all to no avail. It eventually got on my nerves and my wife said I ought to get a new panel and follow instructions, or go to see a doctor. That made me a little mad and I decided that, not by a cannibal's shoe-horn would I surrender, even if I had to give up my job and settle down for life to make that thing perform again.

Well, after resting a few days from the nervous strain I had been under, I tore it all down again and laid it on the table as of old, eel-grass and all. From then on I began to learn something about radio. You have told it all before so I won't go into that. I have wired and rewired the outfit about 12 times (my wife says it is 1,200 times, but that can't be, because I have been working on it only four months), and today I have it all complete and working perfectly. It is in the original cabinet, a well proportioned set that doesn't look like a snake's coffin, and I get California on the loud-speaker. I am not proud of the wiring job, as I let looks go for efficiency. I have done one or two radical things that may be of interest. I haven't a fixed condenser in the layout, nor a grid leak. I wired the second neutrotron direct from the second grid to the ground; I couldn't get rid of the beat note otherwise. I am heartily in favor of neutralized outfits and do believe something should be done to abolish the squeals in other sets.

My advice to anyone building a neutrodyne is, take plenty of space.

GROVER C. RICHARDS,  
419 Cumberland Ave.,  
Portland, Me.

### FROM AN ENGLISH READER

Editor, RADIO NEWS:  
On reading the March issue of RADIO NEWS, I find on page 1225 an interesting article by Mr. George E. Oliver, A.M.I.R.E., headed "The Trans-Atlantic Broadcast Tests," and I should like to say a word about some remarks mentioned therein.  
Under the chapter of "2LO Breaks Through," I should like to correct the following: "We then set our loop in the direction of 2LO (370 meters) and listened on his wave." "a voice broke through in English dialect repeating several times 'LO' (which we interpreted to mean 2LO)." The two above errors should be as follows: "(365 meters)" and "LO"

## "Madera"

die-cast  
WOOD

is neutral to  
static vibrations



The acoustics of a die-cast wood are superior for radio reproduction under all conditions, but especially in times of troublesome static discord.

For Madera—an artificial wood, cast in steel dies under great pressure and heat—tends to absorb and neutralize these vibrations instead of magnifying them as metal does.

**MADERA CLEAR SPEAKERS**  
reproduce radio signals with great purity and fidelity. No. 806 here illustrated is one of five numbers. It is 23 in. high, has a 10¼-in. bell and retails at \$17.50.

It exceeds loudspeakers sold at double this price. Ask your dealer to demonstrate it. If he does not have Madera Clearspeakers, write us, giving his name and address.

**AMERICAN ART MACHE CO.**  
343 W. Austin Ave. Chicago

## S. HAMMER RADIO CO.

307 Atkins Ave., Brooklyn, N. Y.

**NEW COCKADAY  
DISTORTIONLESS AMPLIFIER**

Complete parts exactly as specified by Mr. Cockaday.

4 Na-Aid Sockets... \$2.60	1 Pr. Como Dup.	\$10.00
2 Marco Jacks... 1.50	1 American 5 to 1	5.60
2 Amco 20 Ohm	1 Dubiller .00025	400
Rheostats ... 2.00	6 Dubiller Coil	
1 Bradleym No. 25	1 805 Cond.	3.30
1 Bradleyleak ... 1.70	10 10by Binding Post	1.50
1 Panel 7x12	1 Panel 7x12	1.95
List Price, \$40.00		<b>\$32.00</b>

OUR PRICE for above complete parts...  
The above parts can be bought separately

\$150 FREED-EISEMANN NEUTRODYNE, Model N. B.-5. Wired in Freed-Eisemann's own factory. None shipped C.O.D. Special...	<b>\$122.50</b>
\$80.00 GENUINE FREED-EISEMANN, Knockdown parts for 5 tube neutrodyne set. Model K.D.-50	<b>\$61.00</b>
\$120 FADA NEUTRODYNE SET No. 60. Wired in Fada's own factory. None shipped C. O. D. Special.	<b>\$88.00</b>
\$65.00 FADA KNOCKDOWN PARTS. No. 167-A. Sealed in Fada's factory.	<b>\$49.00</b>
COCKADAY 4 CIRCUIT TUNER. Complete parts exactly as specified by Mr. Cockaday for the IMPROVED 4 circuit tuner.	<b>\$51.00</b>
N & K PHONES IMPORTED. 4000 ohms. Model D. List price, \$8.50. Our price.	<b>\$5.95</b>
DR. SEIBT PHONES. 6000 ohms. List price, \$12.00.	<b>\$5.75</b>
\$12.00 BALDWIN. Type C, Double	<b>\$7.95</b>

Orders over \$5.00 cannot be prepaid  
Money Orders or C. O. D.—Write for Price List  
Not Insured Unless Insurance Charges Included



## Better Tone for Your Radio!

Greater distance, volume and selectivity guaranteed with this aerial, or money refunded. Not a "strip of flat copper" but a Laboratory product in which capacity, resistance and strength have been calculated. Try it without risk!

Demand the genuine by name **TRANSCONTINENTAL RIBBON**. If your dealer cannot supply you order 50 Ft. \$1.50 direct from the manufacturer, post-75 Ft. 2.25 age paid. Thousands now in use for broadcasting and receiving. Endorsed by world's greatest Radio Engineers as the aerial for better results, better tone.

At all good stores

**Acorn Radio Mfg. Co.** 307 W. Lake St. Dept. 405 CHICAGO

# TRANSCONTINENTAL RIBBON AERIAL

**DEALERS! Write for Special Offer!**



should have been "Halloo." It is the custom of all British broadcast stations to call, "Halloo, Halloo (then call sign and name of station) of the British Broadcasting Company testing."

Capt. Eckersley was announcing that morning, and I do not think a man of his position would say "ello" instead of "Halloo." I trust you have no objection to my bringing this to your notice.

I see American radio enthusiasts are very much interested in the circuit discovered by Mr. John Scott-Taggart, which is named after him, the 100 being the amount of different circuits he has "discovered", I believe. Over here that circuit was very popular six months ago, but the craze has worn off, and there is a great interest taken in the circuit known as "P.W." combination (reflex) and which is named after a weekly paper the "Popular Wireless." I have made six of these receivers and can report as follows:

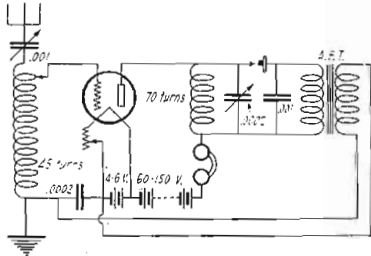

The P.W. circuit, a one-tube reflex, quite popular in Great Britain at the present time. According to Mr. Gibbs' statements it is well worth trying.

Will work loud speaker 20 miles from transmitting station with 1½ K.W. or over. Receiving range: U. S. stations have been received *direct* by amateurs here.

The only drawback with this circuit appears to be lack of selective tuning, but this can be overcome by making anode coil react on antenna tuning inductance; nearby stations are then completely eliminated.

I trust the above will prove of use to your readers.

A. M. GIBBS,  
London, England.

**QUITE RIGHT**

Editor, RADIO NEWS:

In March RADIO NEWS, a correspondent displayed an extremely selfish attitude in declaring that "regenerative sets should be tabooed." It is, perhaps, human nature to be selfish regarding the use of one's possessions, but it certainly is not a complimentary quality. It is true, to a certain degree, that improperly constructed, improperly operated, regenerative sets cause interference, yet we radio fans must unselfishly put up with these slight inconveniences for the good of the pastime. This gentleman states that one can get equally good results by employing a non-regenerative hook-up using two tubes. This extra tube is where the hitch comes. Radio, when introduced, was heralded as a poor man's pastime, and naturally the poor man cannot afford to use an eight-tube super-heterodyne, and since the regenerative sets give the best results for the smallest amount of time and money expended, it is used extensively by the poor man. As to influencing legislation to rule against the desire of the majority, this statement is absurd. The only way out of the matter, as I see it, is for our friend to supply the poor man with eight-tube super-heterodynes.

LAURENCE G. LARKE,  
450 Green Street,  
Cambridge, Mass.



**"MINUTE MAN"**  
*Radio Receiving Set*  
Incorporating Pathe Type "P" Plusiformers

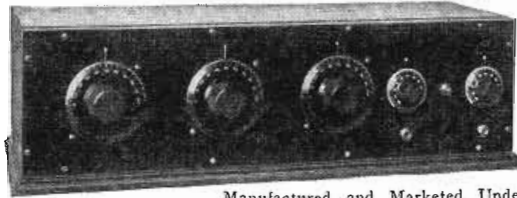

Manufactured and Marketed Under  
Licensed Agreement. Patent Pending

**Price \$125.00**

(Tubes, Batteries extra)

**T**HE new five-tube "Minute Man" was specially constructed to meet the demand for a receiving set embodying these features:

**NO SQUEALS.**

Tune in either with a loud speaker or head phones without any squeals or rasping. At any setting of the dials there is none of this unpleasantness so prominent in many other sets.

**PURE TONE.**

The reproduction of broadcasting by the "Minute Man" is remarkable for its clarity and sweetness of tone, increasing your enjoyment a hundredfold.

**SIMPLICITY**

The "Minute Man" is simplicity itself to operate. The dials can be adjusted by a child—and the set is "Fool-proof." The dial settings are constant. A station once located can always be brought in without preliminary searching.

Genuine mahogany cabinet and panels.  
Gold engraved dials.

**FREE BOOKLET**

Booklet, "How to Build a 5-Tube Receiver, Using Three Plusiformers," sent free on request. Address Dept. A21.

Dealers and Jobbers—Write Dept. A21 for catalogs and prices of Pathe Line.

**PATHE PHONOGRAPH AND RADIO CORP.**

20 GRAND AVENUE, BROOKLYN, N. Y.

**Save 1/2 Cost of New Tube**

**GUARANTEED VACUUM TUBE REPAIRS AT POPULAR PRICES.**

We try to maintain 24-hour service.  
All repairs guaranteed.  
Tubes satisfactory or money refunded.  
Special discounts to dealers.  
Send broken and burned out tubes parcel post.  
Repaired tubes returned parcel post, C. O. D.

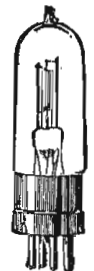
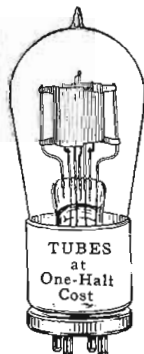

**HARVARD RADIO LABORATORIES**  
200 OLD COLONY AVE. SO. BOSTON, MASS.

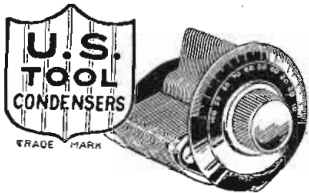

## Up to the Progress of Radio

Material and workmanship equal to the most exacting requirements of the latest circuits.

### FOR Superheterodyne, Superdyne, Inverse Duplex Four Circuit Tuner

#### USE

Vernier Cap. .00057 Mfd. (24 Plate)  
or  
Plain Cap. .00055 Mfd. (23 Plate)  
Condensers of recommended capacity for all known circuits are also carried in stock by leading radio retailers.

#### End Plates of CELERON

Be Sure of Quality—Buy U. S. Tool Condensers

### 100% Guaranteed!

Write for Booklet

**U. S. TOOL CO., Inc.**  
118 Mechanic St., Newark, N. J.

## "I would not use any other battery after KIC-O"

says Frank W. Harris, a Radio Fan of Ottawa, Canada. KIC-O Storage "B" Batteries will improve any Radio set. Try one on yours. Our guarantee protects you. The life is unlimited. Recharge from any 110 volt A.C. line with small home rectifier.

#### GUARANTEE

Your money back on any KIC-O Battery if not satisfied within 30 days' trial. Write for full information on "A" and "B" Batteries.

**KIC-O** Storage "B" Batteries. Long Service. Low Cost.

Volts	Price Plain	With Panels
22	\$5.50	\$11.75
32	7.25	14.00
48	9.50	17.00
68	12.50	22.50
100	17.50	28.50
145	23.50	

Unmounted Rectifier ..... \$1.00  
Mounted Rectifier ..... 2.50

**KIMLEY ELECTRIC COMPANY, Inc.**  
2665 Main Street Buffalo, N. Y.



## DEALERS

Send for new bulletin of parts & knocked down outfits.  
**RADIO PARTS MANUFACTURING CO.**  
1249 Marlboro Avenue Detroit, Mich.

## Hearings on the Radio Bill

(Continued from page 1736)

exercise "discretionary power" in accordance with the public interest in licensing stations. While in sympathy with the provisions of the bill to prevent monopoly, Mr. Hoover said that in his opinion the determination of whether or not a concern was attempting monopoly illegally was not an administrative one, but a judicial one.

The Commerce head also referred to radio monopolies and told the committee that it was inconceivable that the American people would allow this new-born system of communication to fall exclusively into the hands of any individual, group or combination. In discussing the matter of payment for broadcasting, he said that he did not favor the placing of a license or tax on receiving sets.

Calling attention to the inadequacy of his facilities, he said that one of the great difficulties in the effective efforts of the department has been the lack of funds, and that the attempt to police 20,000 stations with a total field force of 29 supervisors was obviously an absurdity.

#### TERM OF LICENSE

Mr. Hoover was followed by Commander D. C. Bingham, of the Naval Communication Service, who said that the bill in general was satisfactory, but he voiced the same criticisms, opposing the licensing of any operators and the charging of fees for such licenses. He asked that station licenses be made for 50 years instead of 10, which appeared to be in opposition to the sentiment of the committee. He further explained that he was opposed to the advisory committee provided for in the White Bill.

In reply to the suggestion of the 50-year license, Secretary Hoover said he was absolutely opposed to more than 10-year periods, as 50-year terms would tend to create monopolies in the air.

Charles Caldwell, of New York City, who appeared on behalf of the Radio Broadcasters Society of America, was very emphatic in his reference to the "radio monopoly." He said that in general his society favored the White Bill. He took up the matter of patent rights which he said was a vital matter in the entire radio situation of today. He said that he favored the schedules of fees as provided for in the bill, but thought a fee of \$100 should be provided for entertainment stations. Mr. Caldwell believed that the decisions of the Secretary of Commerce, as provided for in the bill, should be reviewable by the courts.

C. B. Cooper, representing the Radio Trade Association, endorsed what Mr. Caldwell said, saying that his association wants to support the bill with the changes suggested.

One of the interesting witnesses was A. R. Belmont, vice-chairman of the Radio Committee of the American Railway Association, who suggested some radio possibilities for the railroads. He particularly desired the insertion of a clause which would allow the construction of radio equipment on "mobile railroad equipment."

Raymond Asserson, Broadcasting Supervisor for New York City, testified on the efforts of the City of New York to purchase a radio broadcasting set from the American Telephone & Telegraph Co. He said that the City of New York has wanted a sending station for the past three years, but that it has been balked by the telephone company.

Joseph A. Devery, Assistant Corporation Counsel of New York City, suggested that



**FROM "FACTORY TO USER" PRICES**  
High grade Radio Cabinets, sturdy built, and fine looking. Built up from selected genuine black walnut or birch. Elegantly finished. The black walnut cabinets are finished in rich natural walnut. The birch cabinets are finished in Adam brown mahogany. All dull gloss. Tops on all cabinets hinged. The black walnut cabinets have continuous piano hinges. The birch cabinets have regular hinges. The fronts of the cabinets are rabbeted to take the panel. Panels not included. Money back if not satisfied.

No.	For Panel	7" depth	Br. Mahog.	Walnut
87	6x7	"	\$1.75	\$3.10
610 1/2	6x10 1/2	"	2.25	3.85
614	6x14	"	2.75	4.85
621	6x21	"	3.25	5.70
710	7x10	"	2.40	4.20
712	7x12	"	2.80	4.90
714	7x14	"	3.00	5.25
718	7x18	"	3.25	5.70
721	7x21	"	3.60	6.30
724	7x24	"	4.10	7.20
726	7x26	"	4.75	8.30
727	7x27	"	5.00	8.75
728	7x28	"	5.25	9.20
914	9x14	10"	3.35	5.80
1214	12x14	10"	3.85	6.75
1221	12x21	10"	4.75	8.25

F.O.B. Milwaukee, Wis.  
**UTILITY SUPPLY COMPANY**  
435-439 27th Street Milwaukee, Wis.

## TO THE RADIO DEALER

Let us explain how you can make the sale of our publications a worth while, well paying part of your business. Every one that enters your store is a prospective buyer of **RADIO NEWS**. **RADIO NEWS** will sell with little effort on your part.

You may sell our publications on a single copy basis with a fine margin of profit or on a subscription basis with a generous commission allowance.

Write now for further details.

**EXPERIMENTER PUBLISHING CO.,**

53 Park Place, New York

## VIA POST 15% OFF OR EXPRESS RADIO

Personal attention given all orders. No matter what you want we will ship it to you. No catalog or expensive literature. Simply state what you want, giving full description to avoid errors. Return list price.

Less 15% and your order will be promptly filled.

Add Shipping Charges

**NORDEN, HAUCK & CO.**

"Purchasing Agents DeLuxe"

25 S. Ashmead Place Germantown Phila., Pa.

### 21 Jewels

Nothing less than 21 Ruby and Sapphire jewels in good enough for Burlington masterpiece.

#### Quality and Style

Adjusted to the second temperature—  
isochromism—positions, 25 year Gold Strata Case, in 100 designs, \$1 down. Balance in small monthly payments. Send for free book.

**Burlington Watch Company**  
19th Street and Marshall Blvd.  
Dept. A.594 Chicago, Illinois

## RADIO CABINETS

"Ebcos Specials" and Standards. Solid Mahogany. Packed in Test Cartons. Prompt delivery. Write for prices.

**ELECTROTYPE BLOCKING CO.**  
410 West 27th St., New York City  
Phone Chickering 9843



the authority to grant licenses, etc., should be lodged in some kind of a board or commission instead of with the Secretary of Commerce. At this point Representative Davis of the Committee said that a Communications Board might be organized for the regulation of radio, similar to the Interstate Commerce Commission for the railways, which would set rates and have other regulatory powers.

Another witness, Paul B. Kleugh, executive chairman of the National Association of Broadcasters, told the committee that his organization represented 78 of the leading broadcasters of the country. This organization approves the bill "in spirit," he said. He favored the appointment of the Advisory Committee as provided in the bill, but recommended the appointment of a board or commission, rather than leaving the whole affair in the hands of the Secretary of Commerce. The personnel of the Advisory Committee, he thought, should include amateurs, manufacturers and the broadcasters. Speaking of monopolies, he referred to the American Society of Composers, Publishers and Authors as an "iniquitous monopoly."

A. T. AND T. SPEAKS

E. S. Wilson, Vice-President of the American Telephone and Telegraph Co., appearing before the committee at the second day's hearing, said that his company had "No intention nor desire to monopolize the air," as had been charged. He said that in general his company was in favor of the White Bill, but made a few suggestions, indicating that an appeal should be allowed from the decision of the Secretary of Commerce in the matter of granting licenses to broadcast stations. In the event the Secretary of Commerce is about to revoke a license for any reason, he believes that the offender should be allowed to remedy any violation of the law before the license is revoked. No objection was made to the monopoly provisions in the bill. When Mr. Wilson's attention was called to these provisions, he stated that his company was thoroughly in sympathy with them. Answering questions of members of the committee, Mr. Wilson stated that the telephone company had licenses for a number of stations for broadcasting, and that the Western Electric Co. had sold 49 broadcasting units.

William E. Harkness, who followed him on the stand, stating that he was broadcasting manager to the American Telephone and Telegraph Co., said that while no definite advertising policy had yet been adopted by the company, a rate was then being charged of \$100 for 10 minutes or \$400 per hour. In connection with the broadcasting of advertising, Mr. Harkness explained that it had to meet with the approval of "listeners-in." He said that the company was desirous of presenting both sides of a controversy during the same evening, if possible. The company does not favor any political party or any particular propaganda in its broadcasting, he declared, and made no effort to conceal advertising.

When Judge Davis, a member of the committee, asked Mr. Harkness if he did not favor the appointment of a board or commission to have jurisdiction over radio communication rather than the Department of Commerce, he replied that he had no preference in the matter. Judge Davis, however, said that in his opinion the Government would have to do something of the kind. Broadcasting from Station WEAJ, Mr. Harkness advised, cost approximately \$250,000 last year, while the company did not receive half that amount through advertising. He told the committee that broadcast stations were spending anywhere from \$10,000 to \$100,000 a year. The Telephone Company has no plans for charging for receiving amusement programs and does not contemplate such a step in the future.

RADIO FREQUENCY AMPLIFICATION with the BALLANTINE VARIOTRANSFORMER

# The final "punch" for the "Knock-Out" Series of Reflex Sets

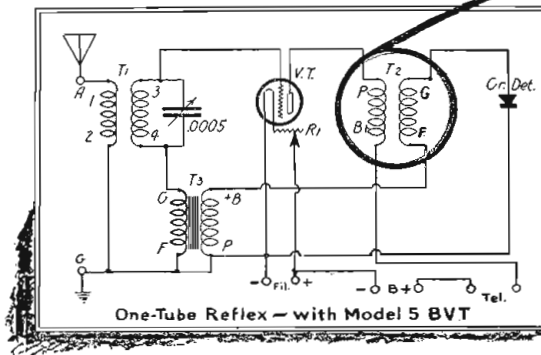

\* If unstable, reverse P and B+



Model 5 BALLANTINE VARIOTRANSFORMER  
With bakelite base or split metal collar for panel mount. Complete, ready to use, price \$9.60



## This instrument simplifies construction and operation

SINCE its first appearance in RADIO BROADCAST for November, the One-Tube Reflex Circuit has fully lived up to its promise in distance, volume and quality. And the fans, in their letters, heartily endorse the term "Knock-Out" as applied to the results obtained.

**Fewer parts—greater results**  
The above diagram is a refinement of the original in that the condenser-and-coils of the radio frequency element are replaced with the tunable BALLANTINE

VARIOTRANSFORMER. This makes tuning easier and prevents oscillation due to changing the crystal detector. Furthermore, on weak signals especially there is a marked increase in volume.

**The words of unbiased experts**  
In the January "R-B Lab." Section, the sponsors of the original circuit say of the BALLANTINE improvement: "Reception generally superior to that achieved by the set described in November."

### Send for instruction sheet

For those interested in finer reception we have prepared an instruction sheet on the One-Tube Reflex. Your copy is free on request.

**BOONTON RUBBER MFG. CO.**  
Pioneers in Bakelite Moulding

624 Fanny Road, Boonton, N. J.

RADIO FREQUENCY AMPLIFICATION with the BALLANTINE VARIOTRANSFORMER

BUILT TO ORDER SETS ARE SUPERIOR TO FACTORY MADE. WE SPECIALIZE IN

5 Tube Neutrodyne	\$70.00
5 Tube Plusform	75.00
4 Tube Superdyne	60.00

The above sets are built in Solid Mahogany, Piano finished and Piano hinged Cabinets. Workmanship, parts and satisfaction guaranteed.

U. S. L. CONDENSERS

\$4.60 17 Pl. Vernier	\$3.15
5.00 23 Pl. Vernier	3.40
5.60 43 Pl. Vernier	3.75
3.00 Acme Radio and Audio Transformers	3.95
3.00 Eria Audio and Radio Transformers	4.20
12.50 pr. Como Push and Pull Transformers	10.50
18.50 Homcharger Gold Seal A. C.	14.95
6.50 Silk Covered Collapsible Loop	4.50
7.00 Westinghouse Storage B Batteries	6.39
21.00 6-80 amp. Storage Batteries	11.75
2.00 Filkstats	1.85

REMITTANCES MUST INCLUDE POSTAGE

**MARVEL RADIO SPECIALTY CO.**  
132 Nassau St., New York City

### 800 Miles with Roll-O Crystal on a Common Crystal Set



Every ROLL-O CRYSTAL is tested for loud and clear reception on stations from 300 to 800 miles away. Work perfectly on any ordinary set. No batteries or tubes needed. Sensitive throughout. S & T I S F A C T I O N GUARANTEE. Mail \$1.00 (stamps or coin) for Three ROLL-O CRYSTALS. Sent postpaid.

**ROLL-O CRYSTAL CO.**  
Desk 142, Mt. Washington, Cincinnati, Ohio

Insure your copy reaching you each month. Subscribe to Radio News—\$2.50 a year. Experimenter Publishing Co., 53 Park Place, N. Y. C.



**For sending or receiving—**

*Bakelite-Dilecto Panels are FAULTLESS*

Panels of this excellent material are giving perfect service in many of the greatest broadcasting stations. And in thousands of homes it is making possible the highest achievement in radio reception, through its many valuable, radio-advantageous qualities.

**bakelite dilecto**

*(A Laminated Phenolic Condensation Material)*

The U. S. Navy and Signal Corps have used Bakelite-Dilecto for nearly ten years. To knowing radio men, that is plenty of proof of the product's merit. Panel your radio set with Bakelite-Dilecto. Your dealer can get it cut and drilled for you.

THE CONTINENTAL FIBRE CO.  
Factory: Newark, Delaware

Service on Bakelite-Dilecto (also Continental-Bakelite, Conite, Concox and Vulcanized Fibre) from:

- NEW YORK—Woolworth Building
- PITTSBURGH—301 Fifth Avenue
- LOS ANGELES—307 S. Hill Street
- CHICAGO—Wrigley Building
- SAN FRANCISCO—75 Fremont Street
- SEATTLE—1041 Sixth Avenue, So.

Offices and Agents Throughout the World

**IT IS A PORTABLE**

No aerial, ground or loop required for Local Stations. You can take it with you when visiting. Use it in your Hotel room—On your vacation—Anywhere, Anytime.

**LONG RANGE**  
—east to coast—

Reception Loud and Clear. Wide range on loud speaker.

Single Tube "SUPERFLEX" in Leatherette Case, Very Neat.

Order NOW—Will be sent C. O. D. parcel post anywhere on receipt of \$1.00 with order, to cover postage.

PRICE..... \$65.00 COMPLETE

Ready to operate. Dealers write

**BENSON ENGINEERING COMPANY**  
2125 N. Halsted Street. Chicago, Illinois

Get a Handy Binder for your RADIO NEWS. Holds and preserves six issues, each of which can be inserted or removed at will. Price 65c. Experimenter Pub. Co., Inc., Book Dept., 53 Park Place, N. Y.

K. B. Warner, Secretary of the American Radio Relay League, said that from the standpoint of his association the present law was satisfactory, and to that extent, it is opposed to the new White Bill. He asked that a provision be inserted referring specifically to amateur radio operators, explaining that they would need protection for the future. The League, he said, is anxious to secure definite recognition for amateurs. Taking issue with Commander Bingham of the Navy, Mr. Warner said that he favored licenses for operators, since they make for efficiency. He also favored fees for these licenses, as this would allow more frequent inspection by the government and better enforcement of the law.

L. L. Lee, chief of the Radio Division of the Emergency Fleet Corporation, and John Nicholson of the Legislative Committee of the U. S. Shipping Board, appeared before the committee, opposing both the issuance of licenses to operators and the collection of fees for them.

Mr. Lee told the committee that if the White Bill were enacted into a law, it would prevent the use of radio by Shipping Board vessels, except at an additional expense of about \$200,000 a year. He pointed out that radio is a very great help in the saving of life at sea and should be kept free from as much additional expense as possible. He told the committee that, as far as he had been able to learn, no foreign country charged fees for its vessels' radio equipments, adding that the fees provided for in the White Bill for vessels were most "unusual."

Major J. O. Mauborgne, of the Army Signal Corps, read a letter to the committee from the Secretary of War protesting against several features of the bill as being "prejudicial to the national defense of the country." He pointed out the need for leaving the regulation of wave-lengths for the army in the hands of the Secretary of War instead of the Secretary of Commerce, and asked for special recognition of the Army in the bill.

During the course of his testimony, he said that the Department of Commerce stands on the policy that it represents the commercial radio interests of the country as against the interests of the government departments. With the exceptions noted in his testimony, Major Mauborgne said that the War Department is in sympathy with the White Bill.

**FOR THE RADIO CORPORATION**

The appearance of David Sarnoff, Vice-President of the Radio Corporation of America, was heralded with considerable interest. Advocating the need for legislation, Mr. Sarnoff pointed out that a "common sense compromise" between the benefits of private initiative and the evils of destructive competition must be found. He believes in the freedom of radio and the freedom of speech in broadcasting, he explained. It is his conviction that broadcasting can be made commercially practicable without collecting from the receiving end; its value lies in its universality and its ability to reach all, and he objects to selling it to a few, which he said would become "narrowcasting."

"The R. C. A.'s ambition," he indicated, "is to put radio within the reach of everybody and the Corporation will support efforts of Congress to enact legislation in the public interest and will not hamper further radio development."

Likening broadcasting to a bar, at which causes may be pleaded before public opinion, he pointed out that if there had been broadcasting in 1858 there might have been no Civil War; the Lincoln-Douglas debates might have been broadcast to the whole nation, and Lincoln might have achieved his peaceful program.



**DISTANCE! The Only Authorized Cockaday Coil**

Gets distant stations easily and clearly. Hundreds have substituted this quality coil for those of inferior make, and are amazed at the improved reception, selectivity and general D-X results.

Y. M. C. A. Secretary, Wilmerding, Pa., says: "We've been getting KHJ in Los Angeles on three tubes (WD-11) but since installing your coils we now get KHJ on the detector alone, a distance of 2300 miles, and much clearer." The Authorized Cockaday Coil is made in strict accordance with specifications of Laurence M. Cockaday, inventor of the famous Cockaday Four Circuit Tuner. Wound on hard rubber tubing, 1/2" wall, with No. 18 D.S.C. copper wire which insures selectivity, greater volume, sharp tuning and maximum sensitivity. Guaranteed.

At your dealers, otherwise send purchase price and you will be supplied postpaid.

**\$5.50**

Approved by

*L. M. Cockaday*

**PRECISION COIL CO., Inc.**  
209-D Centre Street  
New York

**NAZELEY'S PORTENA**

**Folding Loop**  
Patent Pending

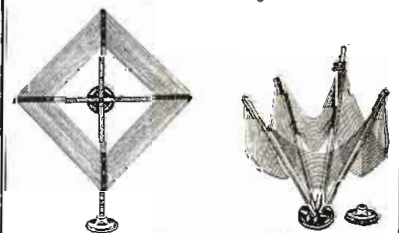

Folds up like an umbrella—  
Works like a charm  
Spread 28 inches

Genuine Bakelite Facing; 85-foot Green covered wire; Rich mahogany finish. In an individual morocco covered Tube. **List \$7 each**

one dozen to a case  
**J. NAZELEY CO.**  
571 HUDSON STREET  
NEW YORK CITY



Those appearing on the last day's hearings included: Judge S. B. Davis, Solicitor of the Department of Commerce; J. Harry Covington, representing the Tropical Radio Telegraph Company, and C. Francis Jenkins, inventor, of Washington, D. C.

Judge Davis, on behalf of Secretary Hoover, stated that in accordance with suggestions made by various witnesses before the committee, the Department wants a review of decisions rendered by the Secretary of Commerce in connection with licenses of all kinds. He asked, however, that this review be in the court and not by any governmental tribunal, adding that such a review should be provided for in the bill.

He also represented the Secretary as opposed to those provisions of the bill which would make him determine what is and what is not a monopoly.

Mr. Jenkins appeared before the committee asking certain provisions in the bill for the sending by radio of photographs and moving pictures. He pointed out especially that the bill is limited to "radio communication," in word and intent, saying it was his belief that any radio broadcast station set up for any other purpose would not be subject to regulation by the Secretary of Commerce.

It is believed that a favorable report will be brought out by the committee in a short time and that it will deal in detail with radio monopoly.

### I Want to Know

(Continued from page 1772)

A. 3. The cord key is: White, ground; black, —"A"; red, + "A"; green, —"B"; yellow, + "B"; brown, + "B." Yellow is for the detector plate battery and the brown is for the amplifier plate battery.

#### EFFECT OF CLOSE COUPLING

(943) Mr. C. Y. Halsey, Calameda, Calif., asks: Q. 1. Why is it that with less wire, with the primary wound in the grooves of the secondary form, the wave-length range is greater than when the primary and secondary are wound in separate coils? Enameled wire was used.

A. 1. The natural wave-length of both the primary and secondary circuits is considerably increased by the close coupling, and better results will be had if a greater number of turns are used with a coupling of about 1/4 inch. The condenser effect of two coils so closely related is very undesirable.

#### BOOTLEG TUBES

(944) Mr. Robert G. Denmead, West Liberty, Ohio, requests:

Q. 1. What is a method of distinguishing genuine tubes from the bootleg variety?

A. 1. This fact can only be determined by laboratory inspection of each tube, either as a complete tube or in its component parts. The only practical method of obtaining a standard tube is to purchase it from a reputable dealer who will make adjustments if it is found defective.

Q. 2. Can a three-tube neutrodyne receiver be used with the Aeriola Sr.?

A. 2. We cannot advise using a delicately balanced radio frequency amplifier, such as the neutrodyne, with a regenerative receiver. Better results will be had by using the standard circuit, which has appeared in our columns.

#### NEUTRALIZING THE NEUTRODYNE

(945) Mr. C. N. Watson, Smith's Mill, Minn., asks:

Q. 1. How are the neutrodyne neutralizing condensers adjusted?

A. 1. The simplest way is to tune in a very strong signal of a low wave-length. The tube, in which the capacity is to be neutralized, is removed from the socket and the tube filament prongs insulated in such a way as to prevent its lighting, and then replaced in the socket. The neutralizing condenser is now adjusted until the signal becomes inaudible. Should it be found impossible to neutralize the tube to any extent, it may be necessary to reverse the primary windings of the neutroformers. If the capacity of one neutrodon is found to be insufficient, two may be used, connected in parallel. If the minimum capacity of the neutrodon is found to be too great for the particular tube used, the circuit can be balanced by connecting a neutrodon from the grid to the plate of the tube in the circuit that is being neutralized. By an adjustment of these two neutrodons it should be possible to balance the circuits very easily. After the circuits have been adjusted for short wave-

# Establishing The MOZART Baby GRAND



IT was only to be expected that our name would help toward establishing our new reproducer in the enviable position it is so rapidly gaining.

Whatever the reason, probably no similar product ever met with more instantaneous success. May we quote from another entirely unsolicited appreciation, which accompanied one of our most recent repeat orders.

"All who have heard it have told me to keep it in the background, as I still have.....to get rid of. For clearness, it is the best I have heard and I feel I cannot stock too many. Ship C.O.D., etc.

(Signed) C. KRESLOG, Wabash, Indiana."

#### PRICES: F.O.B. Factory.

Reproducer complete with (gold plated) unit and polarity-indicating cord .....	<b>\$12.00</b>
Unit only with polarity-indicating cord, gold plated.....	<b>5.00</b>
Unit only with polarity-indicating cord, nickel plated.....	<b>4.00</b>

Shipping weight of reproducer, 7 lbs. (approx.).  
Dimensions—Diameter of bell, 12". Length and height overall, 12 1/2".  
Orders sent direct should be accompanied with a local dealer's name when possible.

RADIO DIVISION

## THE MOZART GRAND CO.

Manufacturers of Fine Instruments  
NEWARK, N. J., U. S. A.

## We repair the following RADIO TUBES and Guarantee Them



WD-11 .....	\$3.00	DV-6 .....	\$3.00	UV-201A .....	\$3.00
WD-12 .....	3.00	DV-1 .....	3.00	C-301A .....	3.00
UV-200 .....	2.75	DV-2 .....	3.00	Marconi .....	3.00
UV-201 .....	3.00	DV-6A .....	3.00	Moorhead .....	3.00
C-300 .....	2.75	UV-199 .....	3.00	6 v. Plain Detector .....	2.75
C-301 .....	3.00	C-299 .....	3.00	6 v. Plain Amplifier .....	3.00

Mail Orders solicited and promptly attended to  
Dealers and Agents write for Special Discount

### H. & H. RADIO CO.

P. O. BOX 22-H

CLINTON HILL STA.

NEWARK, N. J.

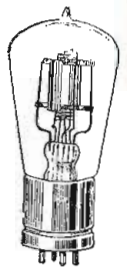

Insure your copy reaching you each month. Subscribe to Radio News—\$2.50 a year.  
Experimenter Publishing Co., 53 Park Place, N. Y. C.

# Every Question ANSWERED for only \$1

At last you have under one cover a Complete Radio Handbook

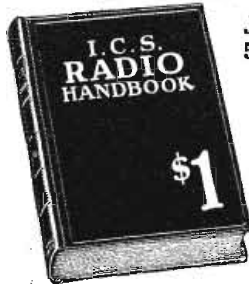

**JUST OUT 514 PAGES**

Compiled by **HARRY F. DART, E.E.**

Formerly with the Western Electric Co., and U. S. Army Instructor of Radio. Technically edited by F. H. Doane.

40,000 ALREADY SOLD

NO more need you turn from book to book, hoping to find what you want. It is all here, in 514 pages crammed full of every possible radio detail. Written in plain language, by engineers for laymen. Clears up the mysteries, tells you what you want to know. A complete index puts everything within your reach in a few seconds.

**IT EXPLAINS:** Electrical terms and circuits, antennas, batteries, generators and motors, electron (vacuum) tubes, every receiving hook-up, radio and audio frequency amplification, broadcast and commercial transmitters and receivers, super-regeneration, codes, license rules. Many other features.

**Under one cover.** Yes, it is all in one volume of 514 pages of clear type with hundreds of diagrams and illustrations. Takes the place of eleven or more specialized texts, each costing from two to ten times the dollar you pay for this single book. Belongs in every radio-equipped home, on every amateur's table.

Send \$1 to-day and get this 514-page I.C.S. Radio Handbook—the biggest value in radio to-day. Money back if not satisfied.

TEAR OUT HERE

INTERNATIONAL CORRESPONDENCE SCHOOLS  
Box 8284-B, Scranton, Penna.

I enclose One Dollar. Please send me—post-paid—the 514-page I. C. S. Radio Handbook. It is understood that if I am not entirely satisfied I may return this book within five days and you will refund my money.

Name.....  
Address.....

## GHEGAN RADIO RELAY

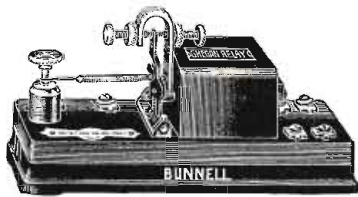

Taps permit tubes of various impedances to be used. With Bunnell Register this Relay will copy telegraphic signals at a speed of 60 to 90 words per minute. With Siphon Recorder speeds up to 200 words per minute have been obtained. Normal operating current is 1/2 in 2 Milli-Amperes. Send stamp for catalogue No. 45-B.  
Ghegan Radio Relay.....\$40.00  
Special Price to Dealers

J. H. BUNNELL & CO., 32 Park Pl., New York City

Insure your copy reaching you each month. Subscribe to Radio News—\$2.50 a year. Experimenter Publishing Co., 53 Park Place, New York City.

lengths, the test should be repeated for the maximum wave-lengths obtainable on the set. With this latter adjustment it may be necessary to change the neutralizing condensers a little bit to prevent oscillation at the longer wave-lengths.

Q. 2. What causes the great difference in the balance of a neutrodyne set when the tubes are changed?

A. 2. This unbalancing you have noticed is due to the difference in the internal capacity of the tube.

Q. 3. What is the effect of increasing the capacity of the neutralizing condenser after the balancing-out point has been reached?

A. 3. The increased capacity acts as a short circuit of the tube and results in reduced signal strength. Occasionally, increasing the capacity may cause oscillation in the tube circuit.

### CORRECT "B" BATTERY VOLTAGE

(946) Mr. Paul W. Hair, Mt. Gillead, Ohio, requests:

Q. 1. With a standard regenerative set, the signals suddenly stop, but can be brought back by touching the grid post on the socket, or by turning the tube rheostat off and then turning it on again. Grid leaks do not seem to make much difference. The plate voltage was varied between 16 and 25 volts. What is the remedy for this?

A. 1. You are using an exceptionally soft tube which will require a "B" battery potential of less than 16 volts. Some tubes, particularly the ones first developed, would very often operate perfectly with a plate potential of not more than 3 or 4 volts.

### FILTER FOR SUPER-HETERODYNES

(947) Mr. John Hancock, N. Plainfield, N. J., wants to know:

Q. 1. Is there any way of reducing the loud rushing sound and other tube noises, when two stages of A.F. amplification are used, in sets of the super-heterodyne type?

A. 1. A simple way of reducing tube noises in the super-heterodyne is to connect a resistance of 5,000 ohms to 200,000 ohms across the secondary winding of the first A.F. transformer. The exact value for this must be determined by experiment. A condenser is usually required across the primary winding of this transformer. The capacity will vary between .001 mfd. and .006 mfd. We are showing in these columns the connection for a filter which may be tried. It may be advisable to vary the constants somewhat, depending upon the particular set. The primary or secondary of an audio frequency transformer could be tried as the iron core choke; the unused winding being left unconnected.

### "B" BATTERY CURRENT CONSUMPTION

(948) Mr. H. S. Griffith, West Brighton, Staten Island, N. Y., writes:

Q. 1. What is the approximate "B" battery current consumption of the Ultradyne? (8 tubes.)

A. 1. 30 to 35 milliamperes are required, at 90 volts potential, for good operation of the Ultradyne.

Q. 2. How long will "B" batteries last?

A. 2. It is impossible to say just how long "B" batteries would last, as it depends upon many conditions, such as location of batteries (whether hot or cold, damp or dry), materials used to make the battery, the length of time they have been out of the factory and the number of hours the set is in use.

### RADIO MATHEMATICS BOOKS

(949) Mr. H. Cameron, London, Ont., Can., asks:

Q. 1. Would it be advantageous to neutralize the radio frequency amplifier in the Ultradyne receiver?

A. 1. Very satisfactory results are had in the use of a potentiometer. It is often best to be able to adjust the intermediate R.F. stages to the highest efficiency and this could not easily be done, if the regular system of neutralization was used.

Q. 2. What books deal with the higher mathematics of radio?

A. 2. Radio mathematics are well covered by "Principles of Radio Communication," by Morecroft; "Elementary Mathematics of Radio," by Willis; "Wireless Telegraphists Pocketbook," by Fleming; Bureau of Standards' "Circular No. 74." These may be had by writing to the Wireless Press, 326 Broadway, New York City. An exception is "Circular No. 74," which may be obtained from the Government Printing Office, Washington, D. C.

### LONG DISTANCE RECEIVER

(950) Mr. Walter Bornmummsan, New Orleans, La., requests:

Q. 1. Please publish information about a four- or five-tube set which will receive signals 2,000 to 3,000 miles distant, consistently?

A. 1. There are no sets that will receive signals from such a distance, consistently. The nearest approach is the super-heterodyne. The most advanced models are known as the "Ultradyne" and the "Armstrong second harmonic, reflexed Super-Heterodyne."

### GLASS DRILLING

(951) Mr. William C. Prucha, Browerville, Minn., asks:

Q. 1. How can small and large holes be drilled in a glass panel?

## PATENTS

**To the Man with an Idea**

I offer a comprehensive, experienced, efficient service for his prompt, legal protection and the development of his proposition. Send sketch, or model and description, for advice as to cost, search through prior United States patents, etc. Preliminary advice gladly furnished without charge. My experience and familiarity with various arts frequently enable me to accurately advise clients as to probable patentability before they go to any expense. *Booklet of valuable information and form for properly disclosing your idea free on request. Write today.*

**RICHARD B. OWEN**  
PATENT LAWYER  
2 Owen Building, Washington, D. C.  
2276A Woolworth Bldg., N. Y. City

**PATENTS** WRITE for our Three Guide Books and "REC-ORD OF INVENTION" before disclosing inventions. Send model or sketch and description of your invention for Examination and Instructions. Electrical cases a specialty. Highest references, reasonable terms, prompt attention.

No charge for the above information.

**VICTOR J. EVANS & CO.**  
919 NINTH ST., WASHINGTON, D. C.

## PATENTS

If you have an invention and desire to secure a patent, send for our Free Guide Book, HOW TO GET YOUR PATENT. Tells our Terms, Methods, etc. Send model or sketch and description for our opinion of its patentable nature.

**RANDOLPH & CO.**  
Dept. 459 Washington, D. C.

## PATENTS

**C. L. PARKER**  
Formerly Member  
Examining Corps,  
U. S. Patent Office.  
PATENT - LAWYER  
McGill Bldg., Wash., D. C.

**Patents, Trade Marks, Copyrights, Patent Litigation**  
Handbook for Inventors, "Protecting, Exploiting and Selling Inventions," sent upon request.

## PATENTS

**ON RADIO IMPORTANT PROTECT**

**Mason, Fenwick & Lawrence**  
Patent & Trade Mark Lawyers  
Washington, D. C. New York Chicago  
Established over 60 years

## PATENTS

Trade-Marks, Copyrights and Patent Litigation  
Write for advice and instructions how to proceed, costs, etc. Hand Book with illustrations of 100 Mechanical Movements sent free on request.

**ALBERT E. DIETERICH**  
Patent Lawyer and Solicitor  
Successor to Fred G. Dieterich & Co.  
690A Ouray Bldg., Washington, D. C.

## 199 NECESSITIES

WIMCO 199 SOCKET .....	.75
WIMCO 199 C SOCKET .....	1.00
WIMCO 199 ADAPTER .....	.75

Send for free literature.  
Jobbers' Inquiries solicited.

**THE WIRELESS MFG. CO., Canton, Ohio**  
MANUFACTURERS—DISTRIBUTORS



A. 1. Small holes may be drilled in glass panels by using either a high speed drill or a triangular file. It is necessary to use a drill guide to keep the drill in position. A high speed need only be used with the drill. The file speed must be determined by experiment. Use a heavy solution of camphor in oil of turpentine while drilling. For holes larger than one-fourth inch, use a copper tube. Emery and water are used with this type of drill. To increase the feed of the grinding mixture slots may be cut in the tube.

Q. 2. Should radio instruments be insulated from the glass panel?

A. 2. Radio instruments should be insulated from the glass panel. Bakelite or hard rubber may be used for this purpose. These non-hygroscopic materials must be used because glass is hygroscopic and, therefore, is a good insulator only when perfectly dry.

LOOP AERIALS AND THE NEUTRODYNE

(952) Mr. Alex Weber, Detroit, Mich., requests:

Q. 1. How can radio frequency amplification be added to the Autoplex?

A. 1. Radio frequency cannot be successfully added to the Autoplex.

Q. 2. Is there more than one way to connect a loop to the Neutrodyne?

A. 2. We are showing several methods of connecting loop aerials to the Neutrodyne. If a ground is used, the directional effect of the loop will be eliminated or, at least, greatly reduced.

EXCEPTIONAL TONE QUALITY

(953) Mr. R. G. J. Desme, Boston, Mass., asks:

Q. 1. Please publish a diagram of a receiving set having exceptionally good tone quality.

A. 1. The diagram of the Superdyne, having this characteristic, will be found in the "I Want to Know" department of the May, 1923, issue of Radio News.

Q. 2. How is it possible to tell the direction from which the signals are being received when using a loop aerial?

A. 2. The most satisfactory way to calibrate the directional effect of a loop is to receive given stations and mark the setting of the loop resulting in maximum signal strength.

TUBE TRANSMITTER

(954) Mr. R. Walsh, Fair Oaks, Calif., wants to know:

Q. 1. May I use one or more 5-watt tubes wired in parallel in place of a UV-201A, in the circuit printed on page 245 of the March, 1924, issue of Radio News?

A. 1. Yes. Use one 5-watt tube to replace each 201A.

Q. 2. Regardless of the number of 5-watt tubes used will the tone be sharp and clear?

A. 2. The quality of transmitted signal will depend upon the quality of the apparatus used and the efficiency of the wiring.

Q. 3. How is a telegraph key inserted in this circuit for code transmission?

A. 3. A telegraph key may be inserted in the grid return lead of the tube. It is not necessary to remove the microphone circuit.

ADDING HEADPHONES

(955) Mr. Harold F. Ludwig, Gilman, Mont., asks:

Q. 1. Please explain the reason for the fact that two or more pairs of headphones cannot be connected to my set (a standard three circuit regenerative receiver which works very well with one pair of receivers), using either the series or the parallel connection, without making the set inoperative.

A. 1. Providing the headphones are all right, the trouble may be remedied by increasing the "B" battery voltage. It may be necessary slightly to change the value of the grid leak. Reversing the connection of one or both pairs of receivers may help.

CURRENT SUPPLY UNIT

(956) Mr. Henry Smith, N. Plainfield, N. J., requests:

Q. 1. What is the wiring diagram of the Western Electric No. 2-A Current Supply Unit and how is it connected to the Western Electric Amplifier?

A. 1. The circuit and diagram of connections are shown in these columns.

Q. 2. How is the No. 2-A current supply unit made?

Exact constants have not been made public and the average experimenter is not advised to attempt the building of one of these instruments as it is a very easy matter to burn out the two tubes if a wrong connection is accidentally made.

Q. 3. What is meant by the mark "G" on the Western Electric Power Amplifier?

A. 3. This marks the ground connection. It is sometimes better to leave the ground unconnected.

RADIATION PROBLEM

(957) Mr. Junius M. Martin, Salem, Iowa, writes:

Q. 1. It seems that there must be some way to prevent radiation from existing radio sets, either by legislation or use of special apparatus, and there must be some sets on the market which do not

Tested and listed as standard by Underwriters' Laboratories



The FANSTEEL Balkite battery charger

PATENTS APPLIED FOR

has no vibrators, bulbs or moving parts and is entirely noiseless

The Fansteel Balkite Battery Charger for Radio "A" Batteries [6 volt] is an entirely new type of rectifier, based on the use of Fansteel Balkite, a new and rare metal developed for this purpose. It is entirely noiseless. It cannot deteriorate through use or disuse. It has nothing to replace, adjust, or get out of order. It cannot discharge or short circuit the battery, and requires no attention other than an occasional filling with distilled water. It will not overcharge, and cannot fail to operate when connected to the battery and line current. It is unaffected by temperature or fluctuations in line current. It is simple, efficient, and indestructible except through abuse. The charger may be used while the radio set is in operation. Without added attachments it may also be used to charge "B" storage batteries.

FANSTEEL BALKITE

is a new metal developed for this charger. It acts as a valve, allowing current to flow into the battery but not out of it. It is the most efficient charger valve made, is practically indestructible, and does away with noisy, delicate vibrators and fragile bulbs.

The Gould Storage Battery Company is also marketing, under the Fansteel Balkite Patents, a complete battery and recharging unit known as the Gould Unipower, into which this charger, under the name, "The Fansteel Balkite Rectifier," has been incorporated.

The Fansteel Balkite Battery Charger will charge the ordinary 6 volt radio "A" or automobile storage battery at 3 amperes, from 110-120 AC, 60 cycle current. It comes complete and ready for use. Get it from your dealer, or use the coupon below.

Price, \$19.50 [West of the Rockies]

FANSTEEL PRODUCTS CO., Inc., Dept. 6-A, North Chicago, Ill.

FANSTEEL PRODUCTS CO., Inc., Dept. 6-A North Chicago, Illinois

Enclosed please find \$19.50 (\$20.00 west of the Rockies). Send me the Fansteel Balkite Battery Charger for Radio 6 volt "A" Batteries. If I am not entirely satisfied I will return it and you will refund my money.

Name ..... Street ..... City ..... State .....

EARN MONEY AT HOME

YOU can make \$15 to \$60 weekly in your spare time writing show cards. No canvassing or soliciting. We instruct you by our new simple Directograph System, supply you with work and pay you cash each week. Write today for full particulars and free booklet. WEST-ANGUS SHOW CARD SERVICE LIMITED Authorized Capital \$1,250,000.00 154 Colborne Building, Toronto, Can.

SUNSET REFLEX CRYSTALS

Accepted for reflex sets by De Forest Radio Tel. & Tel. Co.; Erlman Laboratories in the Reflex Detector; Yellowlip Detector, and others of Equal Prominence. 50c Granular Galena in Bulk Mrs., Dealers, Jobbers; Write for Proposition U. S. MFG. & DIST. CO. 45 CLINTON ST., NEWARK, N. J.

"VANGARD" The Best Transformer Money Can Buy Correspondence Invited Frank A. Ryder 19 South La Salle Street, Chicago

Thank Your Favorite Stations-Request Your Favorite Selections YOUR OWN Name and Address Printed FREE On Every Card "Thank You" cards are all the rage. Stations appreciate them. A pleasure to use. Be hospitable. Low introductory price. 100-5 for \$50-\$2.00; 500-\$3.50 POSTPAID. Order today. MONEY REFUNDED if Not Satisfied Good quality cards—High grade printing. You will be DELIGHTED. Send order with check or money order today—NOW. RADIO PRINTERS, Dept. 26 Mendota, Illinois



## The Leading Jack PACENT

And in order to keep it always in the lead, improvements are made from time to time to increase its already well known durability and neat appearance.

Some of the recent improvements are listed below together with the now famous "Pacent Jack specifications."

- 1—A new design of tapered springs greatly improves its neat appearance and contour.
- 2—Heavier nipple construction, avoids any possibility of stripping threads or breaking.
- 3—A lock washer in addition to flat washer under the head of assembly screw, increases sturdiness and prevents wear of insulation.
- 4—Finer Micarta insulation.
- 5—Entire frame satin nickel finished.

### Pacent Jack Specifications in addition to those listed above:

Coin silver contacts (riveted to springs).  
Genuine German silver springs.  
Nickel plated brass frames (not iron).  
Extra booster springs.  
Lugs fantailed for convenient soldering.  
Provided with three washers.  
Fits any panel  $\frac{1}{4}$ " to  $\frac{3}{8}$ ".  
All details precisely accurate.  
Rugged construction throughout.  
There are 10 types of Pacent Jacks—a jack for every circuit.  
Strict adherence to these specifications in making Pacent Jacks has won for them the distinction of being used as standard equipment by many of the leading set manufacturers.

Write for catalog N-6

Pacent Electric Co., Inc.  
22 Park Place New York

# Pacent

## RADIO ESSENTIALS

### AUTOMOBILE MAKES 27 MILES ON AIR

An automobile goes 27 miles on air by using an automatic device which was installed in less than 5 minutes. The automobile was only making 30 miles on a gallon of gasoline but after this remarkable invention was installed, it made better than 57. The inventor, Mr. J. A. Stransky, 770 Eleventh Street, Pukwana, South Dakota, wants agents and is willing to send a sample at his own risk. Write him today.—Adv.



"Built first to Last"  
RADIO PRODUCTS  
Coto-Coil Co.  
Providence, R. I.

radiate. What information is available on this subject?

A. 1. The matter of radiation from receiving sets is daily becoming a matter of concern to all broadcast listeners. The matter of legislation has been abandoned due to the difficulties of enforcing any laws that might be enacted. Most of the sets causing interference are the low priced ones of the highly radiating type of regenerative receiver. While the sets could be rewired for a different circuit they would not be as efficient as before and would require additional tubes to restore their former efficiency.

The need of all this can be eliminated by education of the public to certain rules for tuning, which are: No. 1. Reduce the detector tube filament current as much as possible, consistent with good reception. No. 2. Reduce the tickler coupling as much as possible. Observation of these two points will result in a "Golden Rule" set. A simple test to determine whether a set is oscillating is to turn the wave-length dial slightly; if a whistle is heard on both sides of the adjustment for the program, the set is oscillating, radiating a wave that is interfering with other receiving sets. The remedy is to immediately reduce the coupling or reduce the filament current. This will result in better reception of the program.

One can be sure of having a non-radiating set by purchasing a receiver such as the Neutrodyne, Teledyne, Ultradyne or Super-Heterodyne. Laboratory experiments indicate that the Sodian Tube, a new type of detector incapable of oscillation or regeneration, will shortly take its place among radio apparatus as an instrument of great sensitivity, and rival of the three element tube when used as a detector. A description is given in this issue of an instrument which may be added to radiating sets to prevent radiation. This seems to be a very successful solution of the problem, and we may expect further advances along the line of equipment which may be used with existing sets, enabling broadcast listeners to enjoy a complete program without hearing the *Canary Islands* broadcasting.

## Directed Radio Rays

(Continued from page 1743)

published in last month's *RADIO NEWS*. The energy radiated was about 140 watts for the ordinary transmitter and reached 500 watts in the transmitter functioning on an harmonic. In order to obtain the same results at the receiving stations, an especially designed receiver was employed by the amateurs listening in to the signals. The details for its construction were published in all the French radio publications before the tests were started. The system consisted of an horizontal antenna, one and one quarter wave-lengths long, Fig. 3, erected five meters above the ground and coupled tightly to a square loop shunted by a variable condenser. The reception could be accomplished

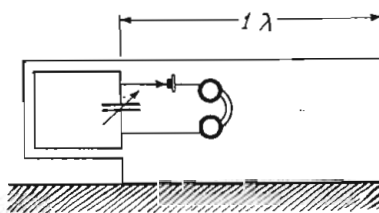

Fig. 3

The combination antenna-loop used to receive the short wave signals.

either with a tube or a crystal detector followed by audio frequency amplification. The beat note was produced by a separate heterodyne, the construction of which was also described in the radio publications.

### RESULTS

The system suggested was found best for steady results, although the amateurs were, of course, free to use any system which would give dependable reception. One of the best and simplest was that designed by M. Deloy. It consisted of an aperiodic antenna with a single detector tube and tickler feed-back, no audio frequency amplification was found necessary to receive the short signals at a distance of 475 miles.



## EXPERIMENT At Our Expense

Install it inside your cabinet, under the table, in every position and location, on every hookup, and under all conditions. For 10 days give it every possible test. Wonderfully compact and damage-proof—all enclosed in polished Bakelite shields and flat as this magazine. If it measures up, keep it. Your money immediately refunded, should you return it. Send C.O.D. order NOW!

Type A-737 (300-700 meters) 6 inches square—non-directional	.....\$10
Type A-7236 (175-1000 meters) 6 inches square—non-directional	.....\$12
Type B-2537 (300-700 meters) 18 inches square—directional	.....\$20
Type BL-2520 (200-18,000 meters) with honey-comb coil mounting, 18 inches square—directional	.....\$25

Send for Bulletin T. 102.

V-DE-CO RADIO MFG. CO.  
Dept. N, Asbury Park, N. J.

Good soldering means good reception



Patent applied for

## "JIFFY" BLOW TORCH and SOLDERING OUTFIT

A complete soldering outfit consisting of self-blowing torch, copper iron, holder and bottle of non-corrosive flux. Torch is safe, rapid, and will not explode. An ideal set for soldering radio parts and general repair work.

Complete outfit delivered postpaid for \$2.50  
Jiffy Torch \$1.25 postpaid  
Send stamps, cash or money order or sent C.O.D.

HANDYCAP MFG. CORP.  
Dept. N.N. Riverdale, Ill.



## RADIO HORN

Let the whole family listen to the music. Add to the appearance and value of your set. Mail a dollar bill for horn like picture, knocked down, prepaid. Easily assembled by anyone.

\$1.00

FOX MFG. COMPANY, DEPT. N  
247 So. Broadway, Los Angeles, Cal.

## TUBES REPAIRED

Only Middle West Tube Service Station  
8 Hour Service. No Extra Charge for Broken Glass.  
WD-11, WD-12, C-11, C-12 .....\$3.00 Ea.  
UV-201, C-301 ..... 3.00 Ea.  
UV-201-A, C-301-A, UV-199, C-299 ..... 3.00 Ea.  
UV-200, C-300 ..... 2.75 Ea.  
We Buy Burnt out Tubes.

All Tubes GUARANTEED and Returned P.P. C.O.D.  
DEY'S RADIO SERVICE  
Dept. L, 5413 Race Avenue Chicago, Ill.



The real tests were started in February, 1923, and up to the middle of May there were only four experimenters who were able to follow the tests. Their number increased to 10 during the month of August. Unfortunately none of them were able to listen during each transmission since their time was limited. This produced a little more than 150 observations from which we had to draw our conclusions. From the results, it seems that at Lille, 125 miles from Paris, the transmission in fundamental wave was louder than the one in harmonic. At Marseilles, 250 miles, the difference was very little, while at Nice, 475 miles, the harmonic transmission was much louder than the fundamental one. These results were the same during the day as during the night. Reception was very good in the southern direction since all the experimenters located in this direction reported loud signals practically all the time. This fact is all the more remarkable since it was found that at about one-half the distance between Paris and the southern coast at Lyon the reception was poor. Also, the country is practically flat between Paris and Lyon, while several chains of mountains are directly across the path from Paris to the southern coast.

The first results may be explained by the theory of the reflection toward the ground of the inclined wave beam radiated from the antenna vibrating on an harmonic—this reflection being caused either by the Heavyside layer, or other agencies.

However, it should be noted that the phenomenon of reflection is observed during the day, as well as during the night, being much more intense at night. One is tempted to deduce from the above result some other conclusions. The transmission on the fundamental wave-length is very well received at 475 miles, sometimes with very great audibility. The waves reaching up to this distance seem, therefore, to have been radiated at a small angle, otherwise, as indicated by the radiation curve, Fig. 1, their intensity would have been small. This checks the theory of a reflecting layer, the distance of which does not exceed 62 miles, as otherwise the effective reflection at a distance of 475 miles from the transmitter would only affect waves radiated under a small angle.

The fact that the reception of the signals transmitted on an harmonic seems reinforced at such great distances, while the most dense beam is radiated at a great angle leads to the conclusion that the reflection phenomenon is notably different from geometrical reflection. It would be better explained by progressive action on the inclination of the beam similar to that found in the phenomenon of a mirage in which the ordinary reflection takes place at a high altitude after the rays have already gone through ionized layers of air which themselves produce important deflections.

If the reflecting layer really exists, all these phenomena may easily be explained and one may furthermore deduce an important practical fact from the results obtained. The inclination given to the wave beam by the transmission on the harmonic is not, apparently, the best suited for a distance of 475 miles. It might be possible, therefore, to obtain, with a suitable arrangement of antenna, more remarkable results.

It may be well to note two facts which have been observed by some amateurs (and which may be explained by the results previously obtained). The first was noted by an amateur who listened only twice during the tests. At 156 miles from Paris he noticed that the harmonic was very much louder than the fundamental. He was probably located at a point where the reinforcing effect of the transmission on harmonics, due to the reflecting layer, was strong. This reception was at night. The second fact is more typical: while at Marseilles (South) at night, between 9 and 9:30 p. m., the funda-

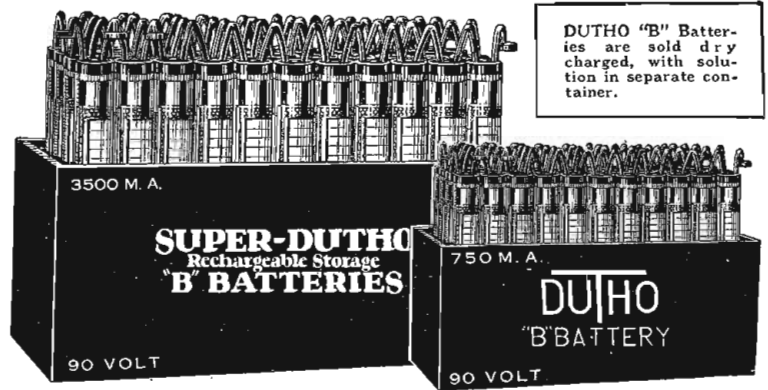

# The NEW SUPER-DUTHO Rechargeable Storage "B" BATTERIES

Here's what they cost you

- 24 V. Super-Dutho \$9
- 45 V. Super-Dutho \$17
- 90 V. Super-Dutho \$32
- 24 V. "S" type Dutho \$5
- 45 V. "S" type Dutho \$9
- 90 V. "S" type Dutho \$17

have 3500 M. A. Hours capacity and are designed especially for larger sets which demand a steady plate current, for loud, clear, undistorted reception. Note the low prices.

You can still get the 750 M. A. Hour Dutho "B" Batteries for portable and all other sets

### Important Technical Features

The new exclusive Dutho-Seal eliminates leakage and electrical loss: prevents external discharge. Ample water space eliminates necessity of frequent filling. Arrangement of cells allows complete visibility. To separate plates Dutho employs rubber to insulate as well as separate: wood for its hygroscopic qualities. Any size Dutho "B" Battery can be charged at one time with the new Duthoid Rectifier, from any light socket for but a few cents. Special Hydrometer is furnished with every Super-Dutho "B" Battery. It accurately tells you when your battery needs charging—when charge is completed. There is no guesswork.

If your dealer can't supply you, we'll send Dutho "B" Batteries, transportation charges prepaid anywhere in Canada and U. S. A., when money order or certified check accompanies the order.

"L" Type Battery 3500 M. A. Hours				Duthoid Chemical Rectifier	"S" Type Battery 750 M. A. Hours			
Volts	Length	Width	Height		Volts	Length	Width	Height
24	6 3/8 in.	2 1/2 in.	8 1/4 in.	<b>\$1.80</b>	24	4 1/2 in.	2 in.	6 1/2 in.
45	11 1/4 in.	2 1/2 in.	8 1/4 in.		45	8 1/2 in.	2 in.	6 1/2 in.
90	11 1/4 in.	4 3/4 in.	8 1/4 in.		90	8 1/2 in.	3 3/4 in.	6 1/2 in.

Send for our Booklet on Storage "B" Batteries

**DURKEE-THOMAS PRODUCTS COMPANY**

1228 FOLSOM STREET :: SAN FRANCISCO

702

DEALERS: Dutho "B" Batteries sell on sight. Write for our dealer proposition

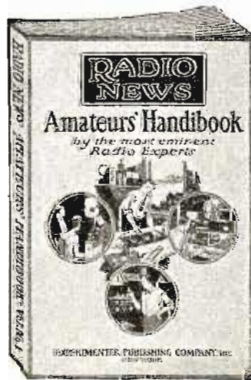

Price \$1.00

Just the Book You Wanted

**"RADIO NEWS"**  
Amateur's Handibook

Volume No. 1. (Second Edition)

Check full of radio constructive and instructive articles from cover to cover. Written by foremost radio authorities, in plain everyday language which everyone can understand. Sections include articles on Receiving Sets and Sundry Apparatus, Transmitters and Accessories, Radio Theory, Vacuum Tube Data, and Practical Hints for the Amateur. A book which also serves as a ready reference and should find a place in the library of every amateur. It contains 224 pages and over 375 illustrations, diagrams, and photographs, bound in a multi-colored heavy board.

On sale at all leading radio stores. If your dealer cannot supply you, send a dollar bill and the book will be forwarded to you postpaid.

EXPERIMENTER PUBLISHING CO., INC. 53 Park Place, N.Y.



### Can this be a Loud Speaker?

YOUR surprise is natural! For this shows what a transformation is possible with a

### THOR REPRODUCER

Yesterday a loud speaker, in the form of an ugly horn! Today, a charming torchiere, floor or table lamp that brings a tone of luxury to your living room and harmonizes with your decorative scheme.

THOR REPRODUCER is a non-directional loud speaker, which distributes its mellow tone in all directions with equal clarity and volume. Its remarkable acoustic properties win it instant approval.

Immediate delivery guaranteed. Dealer and Jobber connections are still open.

For full information and catalog address the

**Thor Radio Company**  
Claus Spreckels Bldg., San Francisco

(102)

mental signal was very strong, but the harmonic transmission could not be heard; an amateur in Strassburg (east) listening at the same time could not receive the fundamental signals, but could hear the harmonic transmission very loudly. These results are all the more remarkable since they were obtained by two very good operators who can be relied upon for the accuracy of these observations. It seems that on that particular night the conditions were exceptional, since transmission on the harmonic is generally received on the south coast of France with very good audibility. This may have been caused by variation in the distance of the reflecting key or from the ground, or by a change in its angle in regard to certain directions. It might also have been that the ionization of the atmosphere changed, due to some effect of the sun. This particular case seems to be typical of the phenomenon of fading, of which we know so little, as yet.

#### FADING

During these tests—and thanks to the number of experimenters listening in at the same time in the various directions—a good opportunity was afforded for checking the fading effects. Fading seems to be more frequent on the fundamental wave than on the harmonic. Even without disappearing entirely, the fundamental wave is generally noted as irregular, contrasting with the stability of the reception on the harmonic. These facts are very interesting, as one would have forecast the contrary the wave-length being shorter. The reception of the different transmission at a distance of 475 miles was made by several experienced operators, who sent in very interesting reports, showing that the fading is practically nil. At this distance, the signals are generally loud and stable, and permit the use of such wave-lengths for regular commercial radio traffic. Such a service could be established with the same safety as one employing long wave-lengths and high power. The power is only a fraction of that which must be used with the long-wave stations at short wave-lengths. Another advantage of these higher frequencies is that communication may be established without any trouble from static, or atmospherics. Reception is possible on the short wave-lengths when it is absolutely impossible to receive on the long waves due to static. Atmospheric interference becomes tremendous when an electrical storm occurs between the stations, or in the neighborhood of the receiving antenna. One of the amateurs read complete messages, while a thunder storm was raging nearby.

All the observations taken seem to prove the existence of a reflecting action occurring at high altitudes. This action, which seems to be more intense at night, is also noticeable during the day time, and the efficiency of the reflecting action might be increased by properly choosing a type of transmitting antenna adapted to this particular work. However, these tests are not conclusive enough to positively prove the existence of the reflecting layer. They are being carried on further in order to increase the number of observations taken, and new methods are now being designed to check the phenomenon observed by amateurs listening in on the special transmissions made at various hours of the day and night. From a practical standpoint, it seems that by properly choosing the transmitting antenna and the wave-lengths for communications at a given distance, it would be possible to insure great consistency in the audibility and steadiness of the signals with comparatively little energy. When using such systems the antenna and apparatus necessary are very small, and communications are not effected by static, which is one of the most important reasons why short wave transmissions will become more and more used.

## Sterling

### POCKET METERS

"Right Resistance"

Reliable

Always Correct

A type for every need

A need for every type

Operating your radio set with out a reliable pocket meter is like an engineer running a train without a watch. Sterling Pocket Meters are guaranteed correct. They have the "right resistance" so as to give a true indication of the battery's condition under test and do not needlessly drain the battery.

Voltmeters  
Voltammeters  
Ammeters



"Has the bulge on all of 'em"

The Sterling Manufacturing Company  
2850 Prospect Ave. Cleveland, Ohio

### WATCH YOUR BATTERIES

Get a **PERFECTION HYDROMETER** today and test your storage batteries regularly if you want perfect reception. Beware of imitations. Insist on the genuine "Perfection."

\$1.00

At all good radio stores.



Perfection Hydrometers are nationally known and used. The only Hydrometer with the 3-point test accurate float. Approved by the Radio News Laboratories.

Manufactured by Bemco Mfg. Co., New York City  
Eastern Distributors Radio Panel & Parts Corp., 61 Warren Street New York

## Perfection HYDROMETER

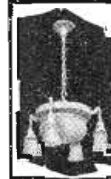

### "Lighting Fixtures"

READY TO HANG (Direct from Manufacturer) Completely wired including glassware. Send for Catalogue No. 26. (Just off the Press) Special Proposition to Dealers **ERIE FIXTURE SUPPLY CO.** STATION R ERIE, PA.

**\$3 DOWN** Brings you a Genuine **UNDERWOOD TYPEWRITER**

**10 DAYS FREE TRIAL** Your \$3.00 unconditionally returned if at end of 10 days you are not satisfied with this latest model UNDERWOOD typewriter rebuilt by the famous Shipman Ward process.

**GREAT PRICE SAVING** Direct to you from the largest typewriter factory in the world by our money saving methods.

**EASY MONTHLY PAYMENTS** So small that you will not notice it while you enjoy the use of this wonderful machine.

**FREE BOOK OF FACTS** Explaining Shipman Ward's wonderful system of rebuilding typewriters and also valuable information about the typewriter industry both instructive and entertaining.

Act Today! Mail Coupon **5 Year Guarantee**

Shipman Ward Mfg. Company  
105 Shipman Building  
Montrose & Ravenswood Aves., Chicago

Please send me a copy of your free book of facts, explaining bargain offer.

Name.....  
St. and No.....  
City..... State.....

You can be quickly cured, if you

## STAMMER

Send 10 cents for 288-page book on Stammering and Sluttering. "Its Cause and Cure." It tells how I cured myself after stammering 20 yrs. B. N. Beque, 899 Beque Bldg., 1147 N. 111 St., Indianapolis



## The Antenna System

(Continued from page 1747)

former, a board as long as the width of the window and about four inches wide is required. This is placed between the sash and the sill, as shown. Holes can then be drilled and ordinary porcelain tubes such as can be found in any electrical shop, inserted. Thus both the aerial and ground wires can be brought into the house without marring the wood work. Strips of thin copper with a binding post at each end make good lead-ins. The copper is first covered with insulation. Such strips can be bought at any radio store or you can make one by covering a thin strip of copper with rubber friction tape as shown in Fig. 3.

Let us now consider the problem of those of us who cannot have an outside aerial. Most of us who live in apartments must put up with makeshifts, so some of the best methods will be discussed and illustrated.

Looking around the room, the first possibility that our eye finds for the suspension of an aerial where it will be out of the way, is the picture moulding. This may indeed be used very effectively. Of course, there is not much moisture indoors, so the moulding itself is a fairly good insulator and if desired, for reasons of economy, insulators may be done away with and the aerial wire fastened directly to the wooden moulding. However, if we can afford to invest in five insulators, results will undoubtedly be much better. To keep up the efficiency and lower the cost we can substitute porcelain insulators for the Electrose ones. Ordinary porcelain cleats such as electricians use are very satisfactory; these cost only a few cents each. The illustrations, Fig. 4, show the appearance of such an aerial and also a top view. Note that the ends of the wire composing the aerial are not connected together. In order to preserve the form of the aerial so that it will present a neat appearance, it may be found necessary to run a waxed cord from insulator A to B. Any kind of wire may be used for an aerial of this type, either bare or insulated. Since the wire does not have to stand any of the strains to which an outdoor aerial is subjected, the size of the wire is not important. Bell or annunciator wire does very well, although slightly greater efficiency will be found if a larger size is used.

Considering the aerial problem as a whole, we find that practically any metallic body will act as an aerial, providing there is no connection between it and the ground, or that none of the received electricity can leak off and find its way to the earth. This puts us on the track of many other collectors of radio waves, which will answer our purpose. Many persons living near broadcast stations have obtained good results by employing the method illustrated in Fig. 5. Here a wire is soldered, or otherwise fastened, to the metal spring of a bed and then connected to the receiving set. A regulation ground such as described before is used with this and all other aeriels described herewith. The writer has heard good reports from novices who have used fire-escapes and tin roofs which were not grounded, for aeriels. A little experimenting along this line will often give rise to surprising results. However, for best results, make sure that the metal object which you contemplate using is not grounded.

For short wave reception, an aerial such as that illustrated in Fig. 6 is very good. By short waves, we mean those wave-lengths on which amateur transmitting sets are allowed to operate. Some interesting radio-phone conversation can often be picked up around 150 to 200 meters. The aerial illustrated is known as the cage type. It consists of four or more strands of wire strung

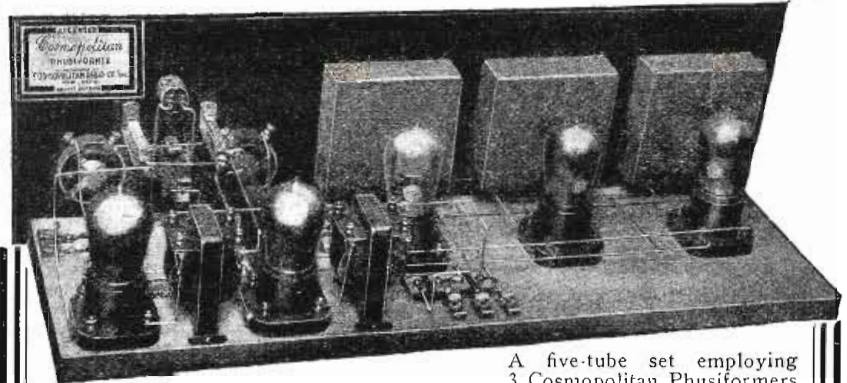

A five-tube set employing 3 Cosmopolitan Phusiformers

## Listen In— To the Missing Link of Radio

### Station COSMOPOLITAN PHUSIFORMER BROADCASTING:



Price \$9.50

"I am a tuned radio frequency transformer—I am a complete unit that can be used in any set—I eliminate all coils and variable condensers—I absolutely guarantee no oscillation—no radiation—no interference—no body capacity. To any set in which I am used I also guarantee greater distance and volume than any other set using the same number of tubes. I am ready to have you make me prove my claims. Ask your dealer for an actual demonstration. Compare a Cosmopolitan Phusiformer set with any set made."

Ask for diagrams giving full details as to the construction of Cosmopolitan Phusiformer sets. Price 25 cents.

COSMOPOLITAN PHUSIFORMER CORPORATION

Licensed Manufacturers

15-17 West 18th Street

New York City

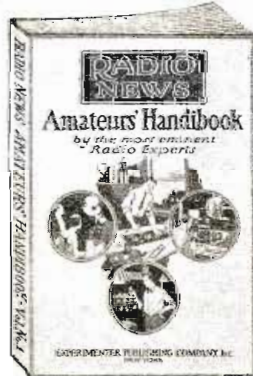

Price \$1.00

JUST THE BOOK YOU WANTED

## "Radio News" Amateur's Handbook

Volume No. 1. (Second Edition)

Check full of radio constructive and instructive articles from cover to cover. Written by foremost radio authorities, in plain everyday language which everyone can understand. Sections include articles on Receiving Sets and Sundry Apparatus, Transmitters and Accessories, Radio Theory, Vacuum Tube Data, and Practical Hints for the Amateur. A book which also serves as a ready reference and should find a place in the library of every amateur. It contains 224 pages and over 375 illustrations, diagrams, and photographs, bound in a multi-colored heavy board.

On sale at all leading radio stores. If your dealer cannot supply you, send a dollar bill and the book will be forwarded to you postpaid.

EXPERIMENTER PUBLISHING CO., Inc.  
53 Park Place, New York

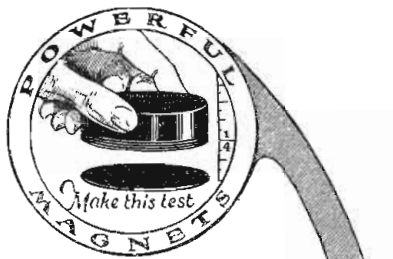

You may have a good receiving set, but if your head set is not scientifically constructed it takes all the joy out of reception. You are sure of good results with a

### Stromberg-Carlson

#### Radio Head Set

because the coils are layer wound and layer insulated and the magnets very powerful.

Powerful magnets give sensitivity necessary to long distance reception. Layer wound and layer insulated coils ensure standing up under high plate voltages.

Ask Your Dealer  
STROMBERG-CARLSON  
TELEPHONE MFG. CO.  
1060 University Ave.  
Rochester, N. Y.



between two circular spreaders. These may be of either wood or metal. A connection is made to each wire for the lead to the set. These wires are then all brought together to a common point and led to the set. This type is very efficient, but should be at least 30 feet long. It can just as well be placed in the attic and an insulated wire run to the set.

Those so-called "railroad apartments" of three or four rooms in a line are ideal for the location of a good long aerial. Two suggestions for this work are given in Fig. 7. Fairly heavy wire should be selected for the aerial in a case of this kind; No. 14 bare or insulated wire should be used. If it is possible to do so, the aerial may be put well out of the way by boring holes in the walls, as shown in dotted lines in Fig. 7. Porcelain or other insulating tubes are then

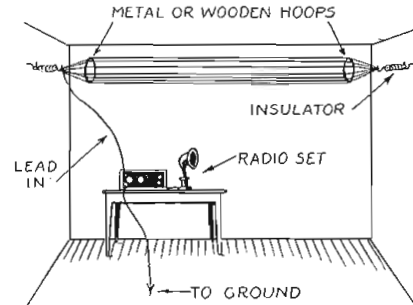

FIG. 6

Another form of aerial that can be employed to advantage where there is but little space.

put in the holes and the wire run through, as shown. For best results and greatest efficiency, place an insulator at each end of the wire. The lead-in should be soldered to the aerial at a point as close to one end of the wire as possible. This gives what is known as an "inverted L" type of aerial. There will be a loss if the lead-in is connected to the center, as in this case, the wave-lengths to which the aerial will respond, will be decreased. In other words, the effective or working length of your aerial will be cut in half, which is a very undesirable feature when dealing with short indoor aerials. If you cannot bore holes in the walls as suggested, the wire may be run through the doorways, shown by the solid lines in Fig. 7. In this case, a very small notch may be cut in each door so as to allow it to close without bending the wire sharply. Insulated wire would probably be the best in this case, as otherwise minute electrical currents might leak off to the ground and not go through your set. This would be particularly so in damp or wet weather when wood collects quite a little moisture and becomes a fairly good conductor.

The writer believes that from the above descriptions of various indoor aerials the reader can glean sufficient information to enable him to get good results. There is, however, one other type of aerial which we must investigate before leaving this most important subject, namely, the one wherein the electric light circuit is made to act as a collector of radio waves. Two methods of doing this are illustrated in Figs. 8 and 9. In the first, a standard type of "aerial plug," such as can be bought in any radio store, is shown. These are known under various names and consist of one or more condensers in a small case, on the outside of which will be found one or more connections. This device, the theory of which we will not attempt to explain here, is screwed into a standard socket which is already connected to a source of current. The electric lighting circuit may be supplied with either alternating or direct current,

### A Pleasant Surprise Awaits the User of the A. C. H. SHARP TUNER DIALS

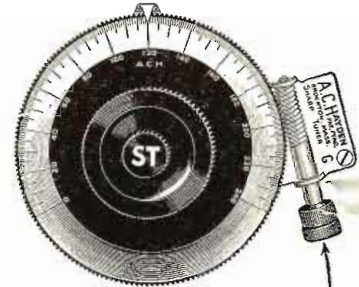

#### Why the A.C.H. is different

- 3 in. DIAL (156-TO-1)
- 4 in. DIAL (215-TO-1)

Will improve any receiving set, making difficult tuning easy  
Money Back Guarantee

Price 3" size...\$2.50 Price 4" size...\$5.00  
Regular fitting 5/16 shaft 3/4 and 3/16. 3c each extra  
Extra Advantage of the A.C.H.  
1. Can be attached or removed from any instrument.  
2. Rough tuning same as any dial.  
3. Movement so fine that the eye cannot detect but the ear can.  
4. Automatically locks instrument so no jar can disturb it.  
5. Dial grounded reducing the body capacity to a minimum.  
6. Special dial 2 graduations where ordinarily one.  
MAIL ORDERS SENT PREPAID IN U. S. A.  
A. C. HAYDEN RADIO & RESEARCH CO.  
BROCKTON, MASS., U. S. A.



### FAR BETTER NEUTRALIZING

with the  
Reliable  
Neutralizing Condenser

If after using this little condenser on your set you do not find it has enabled you to "neutralize" more readily you'll be the first radio fan who didn't better conditions with the Reliable condenser. Try it. Costs \$1.00. It's worth ten.

THE  
RELIABLE PARTS MFG. CO.  
7306 Madison Ave., Cleveland, Ohio

### A Well Paying Field RADIO

Last year was a \$175,000,000 radio year, and Radio has just commenced to grow! Get in on the ground floor. Train for a position as Radio Operator or Radio Installation and Service man. New Radio Sales and Service course. Radio Operator's Course by Correspondence.

Send Today for Illustrated Booklet  
Y. M. C. A. Radio Institute  
158 East 86th St., New York

WHOLESALE ONLY  
We Specialize in Equipping  
NEW DEALERS  
with Complete Radio Stocks  
MANHATTAN RADIO CO.  
112-114 Trinity Place  
NEW YORK CITY

### MAGNAVOX R3

Latest nationally advertised loud speaker with electrical modulator. List \$35. Introductory \$25. Our large quantity purchases saves you \$10. Order now before it is too late.  
Radio Central, Dept. RG, Abilene, Kans.

**SAVES YOU 50%**

Genuine **AHLBELL NEVERLEAK** Solid Rubber Case  
2-Year Unconditional Guarantee

**SILVER-S BATTERY**  
For AUTO and RADIO

Tremendous saving for you on this non-leakable, Guaranteed Superior Quality Storage Battery. One-piece indestructible case, can't leak, spill, or injure rugs or clothing. No more breakage of jars or acid eaten boxes. 2-year written unconditional guarantee covers leakage as well as performance and fully protects you. Silver-S quantity production and Big Buying Power makes possible this unheard-of value.

**50% - SEE WHAT YOU SAVE - 50%**  
5 per cent Discount for cash in full with order.

AUTO PRICES		RADIO PRICES	
6-V, 11 Plate - \$13.00	6-V, 100 Amps. \$13.50	6-V, 120 Amps. 15.50	6-V, 140 Amps. 17.00
6-V, 13 Plate - 15.00			
12-V, 7 Plate - 18.00			

Add 6 per cent Government tax  
Government tax exempt

Inspect this Wonder Battery. Read our 2-year Guarantee before you pay one cent. Satisfy yourself you are getting the best battery made - at 50 per cent saving. Shipment made by Express C. O. D. subject to examination. No delay. Send name and address and style wanted TODAY!

**SILVER-S BATTERY COMPANY**  
201 E. Ontario St., Dept. 50, Chicago, Ill.

SEND NO MONEY

**VULCANIZED FIBRE**

Be sure and specify  
"WILMINGTON FIBRE"

Sheets, Rods, Tubes, Washers, Etc., Specialties  
Wilmington Fibre Specialty Co. Wilmington, Del.  
Branch Offices "Everywhere"



these terms being applied to differentiate between a continuous current flowing in only one direction (direct), and a current which flows in one and then the other direction (alternating). The lead to the aerial post of the radio set is connected to one of the connections on the case and changed to the others until the best results are obtained in the receiving set. It is then left that way.

Where one of these "aerial plugs" is not available, a very satisfactory substitute may be made, as shown in Fig. 9. Here a drop-light is used and around the connecting wires, but not making any connection thereto, are wrapped four or five feet of flexible wire. The only connection made to the latter is where it is fastened to the aerial binding post on the receiving set. If no drop-light is available with a long length of exposed wire, fasten about five feet of double lamp-cord to a standard connection plug. Do this just as if you were going

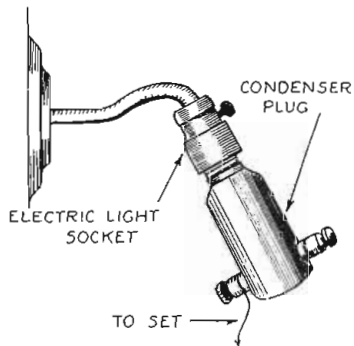

FIG. 8

By screwing a condenser plug into the light socket the electric light wires can be used as an aerial.

to use the wire as extension cord. Do not, however, connect anything to the free ends of the wire; in fact, do not even scrape the insulation from the wire at this point. Now take a long single-strand piece of flexible wire and wrap it around the extension cord, but do not make any metallic connections to the same. Then connect the free end of the single wire to the radio set. With either of these two "electric light line aerials," fairly good results may be expected on nearby stations. One advantage of the type shown in Fig. 9 is that an electric light bulb may be placed in the socket and used

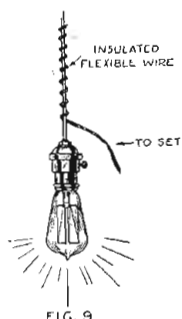

FIG. 9

Another way of accomplishing the same thing is by winding or interlacing some insulated flexible wire with the wires of an electric drop lamp, as shown.

at the same time as the aerial is being used to receive radio messages. In the case of the plug, the switch in the socket should be turned on. The same applies to the other makeshift described. No current, however, will be consumed in either case, and none will pass through the set.

Future articles written in the same clear, simple and understandable manner as the above will appear in this department every month. They will deal with various problems that confront the beginner and with various types of sets. If you have made any experiments, or have had any experiences that you think would interest the readers of this department, send them to the writer.

# Enhance Your Set With "PIONEER"

## Get the Best

*they are cheapest in the end!*

Pioneer Variometers and Variocouplers are the most popular with set builders all over the world. Their advanced construction have demonstrated that "Pioneer" leads — genuine moulded Bakelite produced in our own factory — highest grade hardware — with positive contacts. Latest design in winding and coupling all make for greater efficiency and better reception. Pioneer instruments are not the cheapest on the market—but for results have no equals.

To get results you must have the best. Ask your dealer for "Pioneer," if he cannot supply, write us.

**PIONEER RADIO CORPORATION**  
101 Pioneer Ave., GALESBURG, ILL.  
Sales Agents in All Large Cities

**\$650**

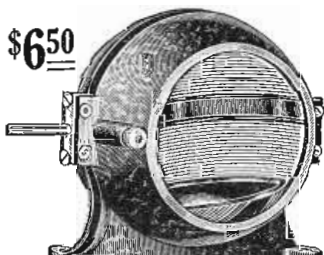

"Pioneer" Variometer

**\$700**

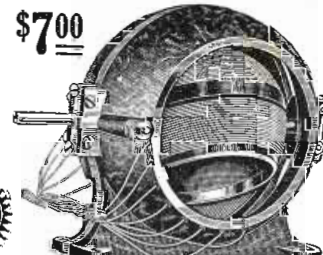

"Pioneer" Variocoupler



SEND NO MONEY

5 DAYS FREE TRIAL

REMINGTON

"INVINCIBLE" Rebuilt GUARANTEED STANDARD No. 10 Self Starter Model

A real bargain. All late improvements—84 characters, standard type, back spacer, etc. As near new in appearance and operation as modern methods and expert mechanics can produce. Many other standard makes. Time payments if desired. Shipments from nearest of our 29 stores. Order now or write for circular. Resident salesmen wanted.

American Writing Machine Co.  
Est. 1880

Factory 468-R Central Ave., Newark, N. J.

## 8 TUBE

### SUPER-HETERODYNE

We are distributors for the popular Radio Receptor Kit for the 8-Tube Radio Receptor Superheterodyne Circuit which is making the remarkable trans-oceanic records. The kit including special transformers, by-pass condensers, and coils, with a simple blue print chart for easy building. Special beautifully engraved Bakelite panel for the Super-Het, with sockets, loop, variable and fixed condensers, rheostats, potentiometer, grid leaks and all additional parts necessary for building the circuit. Complete Radio Receptor Kit and Accessories ..... \$110

\$55

\$55

FRIEDLANDER-KOPPLE  
RADIO SERVICE

149 Church Street, New York  
Telephone: Barclay 4919

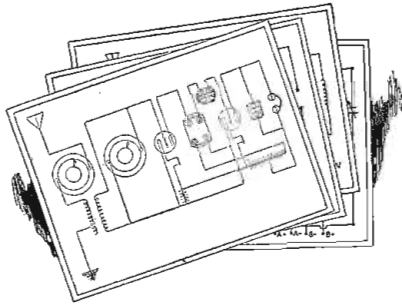

## Free Blueprints Show How to Increase Your Range

### Free Blueprints of Radio-Frequency Hook-ups

Ask your dealer for free blueprints of Duratran radio frequency hook-ups. If he has none, write to us for them and give us his name. They show how a Dubilier Duratran will convert your one-tube set into a sensitive radio-frequency receiver.

Don't throw your one-tube regenerative set away because you can't get the distant stations.

Simply add a stage of Duratran radio-frequency amplification. And you will save the ten or fifteen dollars you would spend in building a new radio-frequency set.

The Duratran will enable you to bring in the distant stations because it amplifies on all broadcasting wave lengths twenty times. All the stations come in with equal clarity because of this unrivalled uniform amplification.

Your dealer sells Dubilier Duratrans. Price \$4.00.

Dubilier Condenser & Radio Corporation  
40-46 West Fourth Street  
NEW YORK



# RADIO

SEND FOR OUR COMPLETE MONEY SAVING CATALOG  
**TIMES SQ. AUTO SUPPLY CO. INC.**  
**MAIL ORDER DEPT.**  
1743 BROADWAY at 56th STREET  
NEW YORK, N.Y.

**YOU DON'T NEED TUBES** to hear programs from stations 400 to 1000 Miles Away. I can show you how to get them on YOUR CRYSTAL SET. Changes often cost Less Than One Dollar. Send self-addressed envelope for picture of my set.  
**LEON LAMBERT**  
So. Volusia, Wichita, Kansas

## List of British Amateur Stations

(Continued from page 1757)

- 5KI Alex T. Wallace, Breettenham, Hedge Lane, Palmers Green, N. 13.
- 5KW Rene Hodges, Holly Mount, Westdale Lane, Mapperley, Nottingham.
- 5KX W. Ward, Agent for 5KW portable.
- 5KY E. E. G. Allsopp, Ingie Nook, Wigginton Road, Tainworth.
- 5LA L. H. Sundry, 60, Bellevue Road, Ealing.
- 5LB H. C. Foster, Hornby Castle, Lancaster.
- 5LF Secretan & Mallett, Ltd., 149, Lawther Parade, Barnes, S.W. 13.
- 5LG J. F. Johnston, 48, Borough Road, Altrincham, Cheshire.
- 5LJ E. Jackson, 37, Manley Road, Whalley Range, Manchester.
- 5LK Radio Electric Co., Craig-y-don, Penn., Wolverhampton.
- 5LO J. W. Clough, 142, Revidge Road, Blackburn.
- 5LP J. H. A. Whitehouse, Brighton, Cheshire.
- 5LV N. Willson, "Clairmont," Tenbury Road, King's Heath, Birmingham.
- 5LZ A. G. S. Quinn, 61, Carnarvon Road, Stratford, E. 15.
- 5MA R. Munday, 17, Malden Road, New Malden, Surrey.
- 5MC W. Woodhams, 24, Marlborough Place, Brighton.
- 5MD R. W. Hardistz, 5, Ethelbert Road, Canterbury.
- 5ML O. R. Healey, 11, Glebe Road, Wallasey, Cheshire.
- 5MO W. G. Dixon, "Dipwood," Rowlands Gill, near Newcastle-on-Tyne.
- 5MP Colin Bain, 51, Grainger Street, Newcastle-on-Tyne.
- 5MR N. P. Soate, 15, Winterstroke Gardens, Mill Hill, N.W. 7.
- 5MU C. W. Tiberington, Dorset Motor and Coach Works, Dorchester, Dorset.
- 5MY W. G. Wyatt-Ingram, 41, Lambert Road, Brixton Hill, London, S.W. 2.
- 5ND J. H. Taylor, Macaulay Street, Huddersfield.
- 5NF R. W. Galpin, Bank House, Herne Bay.
- 5NH A. C. Hulme, 59, Poplar Avenue, Edgbaston, Birmingham.
- 5NN J. H. D. Ridley.
- 5NO B. B. C. Starion, Newcastle.
- 5NP Eric P. Burgess, 2, Queen's Road, Manningham, Bradford.
- 5NT C. H. Frisharz, 23, Tenynson Street, Lincoln.
- 5NU H. L. Thomson, 100, Old Fallow Road, Cannock, Stafford.
- 5NV E. J. Allen, 8, Westfield Place, Dundee.
- 5OC Col. C. E. Jennings.
- 5OD R. Bates, "Holmside," St. Catherines, Lincoln.
- 5OL J. F. Cullen, 68, Queen's Drive, West Derby, Liverpool.
- 5OW H. Green, Norman House, Swinton, Manchester.
- 5OY Belvedere and District Radio Society, Hagis, Robin Road, Belvedere, Kent.
- 5PH C. F. Metcalfe, Flacten Works, Halifax.
- 5PS J. E. Catt, "Melrose," Alexandra Road, Farnborough, Hants.
- 5PU T. Allison, 33, Wilton Grove, Merton Park, S.W.
- 5PW F. H. de Veuille, Meriden House, Trinity Road, Handsworth, Birmingham.
- 5QB A. G. Bainton, "The Hollies," Palace Road, S.W. 2.
- 5QD G. H. Wray, 19b, Church Gate, Loughborough, Leicestershire.
- 5QE D. G. Bird, 8, Oshourne Terrace, South Shields.
- 5QM V. R. Mills, 122, Hughendon Road, Hastings.
- 5QV F. L. Stubbery, "Fairmead," Vista Road, Clacton-on-Sea.
- 5QZ Newport and District Radio Association, H. Q. (Memorial Institute), Queen's Hill, N.
- 5RB A. R. V. Garnett, "Bonair," Southwell Park Road, Camberley.
- 5RC W. Briertley, 59, Gayner Park, Filton, Bristol.
- 5RF L. P. Heaster, 18, Tansfield Road, Sydenham, S.E. 26.
- 5RP H. I. Hughes, Hughes & Watts, Ltd., Woodchurch Road, Oxtou, Birkenhead.
- 5RQ G. W. Tonkin, 164, Coldharbour Road, Westbury Park, Bristol.
- 5RZ A. G. Wood, 93, Upper Tulse Hill, S.W. 2.
- 5SC B. B. C. Glasgow Station.
- 5SF J. K. Wilkie, "Avondale," Knowsley Road, Cressington Park, Liverpool.
- 5SI C. L. Naylor, 43, Hill Crescent, Longden Road, Shrewsbury.
- 5SL John S. Yeomans, 11, Hill View Terrace, Chapel Alterton, Leeds.
- 5SP E. Warner, "Dilnot," Horeham Road, Sussex.
- 5SQ A. P. MacGrory, 16, Main Street, Campbelltown.
- 5ST R. R. Morrison, Spring Grove, Kilbarchan, Renfrewshire.
- 5SU Captain Ian Fraser, St. John's Lodge, Inner Circle, Regent's Park, N.W. 1.

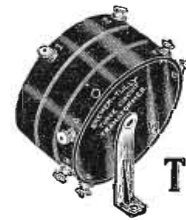

## B-T 3-Circuit Transformer

Heart of the B-T Prize R. F. Circuit.

Write for circular showing step by step plan of construction which insures success.

## B-T OSCILLATOR COUPLER



\$4.00

(Transformers for Super-Heterodyne ready July 1st.)

**BREMER TULLY MFG. CO.**

Cahal and Harrison Sts.  
CHICAGO

## VACUUM TUBES REPAIRED

WD-11, WD-12, UV-201A, UV-199 and others for **\$2.50**

Quick service. All tubes repaired by us guaranteed to work as good as new. Send your dead tubes. All you pay is \$2.50 plus postage to postman.

**THOMAS BROWN CO.**

511-519 ORANGE ST. NEWARK, N. J.

## DON'T

expect good results from Neutrodyne, Acmodyne or Reflex receivers if questionable materials used. Our knocked down outfits contain high grade instruments of proven merit at reasonable cost. Send card now and see for yourself. Costs little and saves much.

**RADIO PARTS MANG. CO.**  
1249 Marlborough, Detroit, Mich.

**MAN WANTED** by largest concern of its kind. Part or full time. **EXPERIENCE UNNECESSARY - OUR MEN GETTING UP TO \$200.00 WEEKLY.** Lowest Prices.  
**RED SEAL COAL COMPANY**  
276 Coal Exchange Building, Chicago, Illinois

## To the Radio Dealer

Let us explain how you can make the sale of our publications a worth while, well paying part of your business. Every one that enters your store is a prospective buyer of Radio News. Radio News will sell with little effort on your part.

You may sell our publications on a single copy basis with a fine margin of profit or on a subscription basis with a generous commission allowance.

Write now for further details.

**EXPERIMENTER PUBLISHING CO.**  
53 Park Place New York



- 5SW C. Bedford, Turton Hall, Gildersome, near Leeds.
- 5SZ J. W. Riddiough, "Lawnside," Baildon, Yorks.
- 5TA V. I. N. Williams "Mersk," Lees Road, Bramhall, Cheshire.
- 5TF P. A. Gooding, 16, Cambridge Road, Hammersmith, W.
- 5TH S. H. Suthers, Jilmore, Petersfield, Hants.
- 5TI J. Bonnett, 159a, Turner's Hill, Chestnut.
- 5TL E. D'Eresby Moss, 4, St. George's Terrace, Regent's Park, N.W. 1.
- 5TO H. Rayner, 32, Grange Road, Cleckheaton.
- 5TR J. H. J. Cooper, 8, Cowley Road, Ilford, Essex.
- 5TU J. Leitch Rodger, "Woodside," Western Terrace, Falmouth.
- 5TV V. H. Lloyd, 27, Coptihall Gardens, Twickenham.
- 5TW R. S. Baugh, "Longfield," Wake Green Road, Moseley, Birmingham.
- 5TX R. S. Baugh, Portable.
- 5TZ W. G. Skerratt, 11, Bath Road, Cowes, I.O.W.
- 5UA A. Barber, 15, Hartington Terrace, Lidget, Green, Bradford.
- 5UC J. Gardener, Lewis Road, Sutton, Surrey.
- 5UL L. Coverney, 12, Wallwood Road, Leytonstone, E. 11.
- 5UM H. Allchin, 78, Chester Road, Forest Gate, E. 7.
- 5UO R. L. Simmonds, 61, Brightfield Road, Lee, S.E. 12.
- 5US J. Croysdale, 5, Elm Grove, Burley-in-Warfedale, Leeds.
- 5UV L. A. Jeffrey, 90, Harringay Road, Green Lanes, N. 15.
- 5UY D. B. Fry, "The Laurels," Mayfield, Sussex.
- 5UZ H. Stephenson, "The Bottoms," Gildersome, near Leeds.
- 5VC J. Gardener, Lewis Road, Sutton, Surrey.
- 5VD P. J. Wakefield, 31, Station Road, Church End, Finchley, N. 3.
- 5VK B. Caldwell, "Coverswall," Lower Walton, near Warrington.
- 5VL R. W. Leader, 93, Pinner Road, Harrow.
- 5VP G. F. Kitchen, 10, Beech Road, Green Lanes, N. 15.
- 5VT G. C. Webb, 10, Osborne Road, Stroud Green, N. 4.
- 5VU S. W. Buiters, 51, Clarendon Road, West Croydon.
- 5VW W. V. Harrington, 51, First Avenue, Hoe Street, Walthamstow.
- 5VX J. H. Ives, 49, Acme Road, Watford, Herts.
- 5WA B. B. C., Cardiff Station.
- 5WD K. Ullyett, 25, Harrington Road, Leytonstone, E. 11.
- 5WM J. B. Renshaw, "Wireless House," Old Chapel Street, Blackburn.
- 5WR C. C. Morriss, Southernay, Heron Hill, Belvedere, Kent.
- 5WZ E. W. Hettich, 1, King Street, Jersey.
- 5XM F. Eustance, 92, Briardale Road, Moseley Hill, Liverpool.
- 5NS F. B. Thomas, 7, Mornington Villas, Wanstead, E. 11.
- 5XT Philip B. Thompson, 1, Chase Side Place, Enfield.
- 5XU T. N. Lord, 6, Trafalgar Terrace, W. Park Street, Dewsbury.
- 5XX H. C. Styles (Correspondence), Watford.
- 5XZ A. F. C. Boyes, 48, Lavender Gardens, London.
- 5YB G. Thompson, East Rigton, East Keswick, near Leeds.
- 5YD E. Bridgwater, Premier Picture House, Widnes.
- 5YI A. L. Goodliffe, 17, Malvern Road Nottingham.
- 5YM E. H. Robinson, Langmead, Pirbright, Surrey.
- 5YQ J. Gallocher, 4, Havelock Terrace, Paisley.
- 5ZH Cromwell Eng. Co., 127, Fulham Road, S. W.
- 5ZO W. F. Mills, 11, Stoney Hey Road, New Brighton, Cheshire.
- 5ZR F. Austen, 52, Church Street, St. Peter's, Broadstairs.
- 5ZT E. S. T. Edwards, 18, Ripon Street, Moss Side, Manchester.
- 5ZV W. Herring, 221, Newark Road, Lincoln.
- 5ZX T. L. Rawson, Maulsley House, Victoria Road, Thornton, Preston.
- 5ZY L. Headlam, Stakesby Road, Whitby, Yorkshire.
- 6AA Durham and Northumberland Colliers' Fire and Rescue Brigade, The Rescue Station, 854, Scotswood Road, Newcastle-on-Tyne.
- 6AB Durham and Northumberland Colliers' Fire and Rescue Brigade (Portable), The Rescue Station, 854, Scotswood Road, Newcastle-on-Tyne.
- 6AC Robert H. Rice, 70, Seaside, Birmingham.
- 6AD W. H. Fortington, 237, Dudley Road, Rotton Park, Birmingham.
- 6AH R. H. P. Callings, 4, Dean Place, Liskeard, Cornwall.
- 6AJ G. Ensoll, 25, Victoria Road, Dukinfield, Cheshire.
- 6AL James Parker Morter, 49, Westow Hill, Upper Norwood.
- 6AO A. V. Ruddlesden, 24, Wakefield Road, Dewsbury, Yorkshire.
- 6AP J. A. Hobson, Hill Close, Berkswell, near Coventry.
- 6AQ A. H. Bird, 35, Bellwood Road, London, S. E. 15.

# MICHIGAN

## Midget \$27

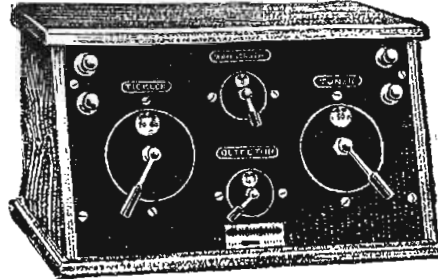

M. R. C. 10 Michigan One-Tube Receiving set. Has no equal for range, clearness, selectivity or volume. The same stations always come in at the same dial numbers

**J**UST a twist of the finger and you bring in station after station with a Michigan Midget.

Seated in your own home you can enjoy that wonderful Southern music from Atlanta or that invigorating dance orchestra from Chicago, or that enchanting Classic from St. Louis and all at cost within the reach of everybody's pocket book.

This surely is one of Radio's greatest achievements—that Michigan engineers have accomplished. Quality at a price that everybody can afford.

For those who desire to use a loud speaker—we suggest the additional purchase of the Michigan Amplifying Unit M. R. C. 11—\$30.

Your dealer will be glad to demonstrate the Michigan Midget. Go and see him today.

*Licensed under  
Armstrong U. S.  
patent 1,113,149 and  
pending letters of  
patent 807,388.*

Watch for our  
Remarkable  
Announcement  
Which Will  
Appear in  
July Radio News

### MICHIGAN RADIO CORPORATION

33 Ottawa Street

GRAND RAPIDS, MICHIGAN

Bakelite Jack

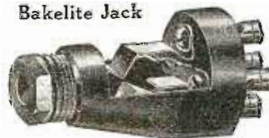

- No. 30—Single circuit open \$ .80
- No. 31—Single circuit closed .85
- No. 32—Double Circuit . . . . 90
- No. 33—"A" Battery Switch .90

Every CICO PRODUCT is packed in a distinctive GREEN BOX and unqualifiedly guaranteed against all defects.



#### ADVANTAGES

CICO JACKS—moulded completely from Bakelite. Neat binding posts. More compact than other jacks. Phosphor bronze springs. Direct connections to springs. Sterling silver contact points.

CICO 2-WAY PLUGS—constructed so that loud speaker and headphones can be connected simultaneously or individually as you wish (note two slots in each terminal). Fit all standard jacks. Take all types of tips.

Consolidated Instrument Co. of America, Inc.  
41 East 42nd Street, New York

2-Way Plug



Price 60c

SEND FOR  
FREE  
SAMPLE COPY

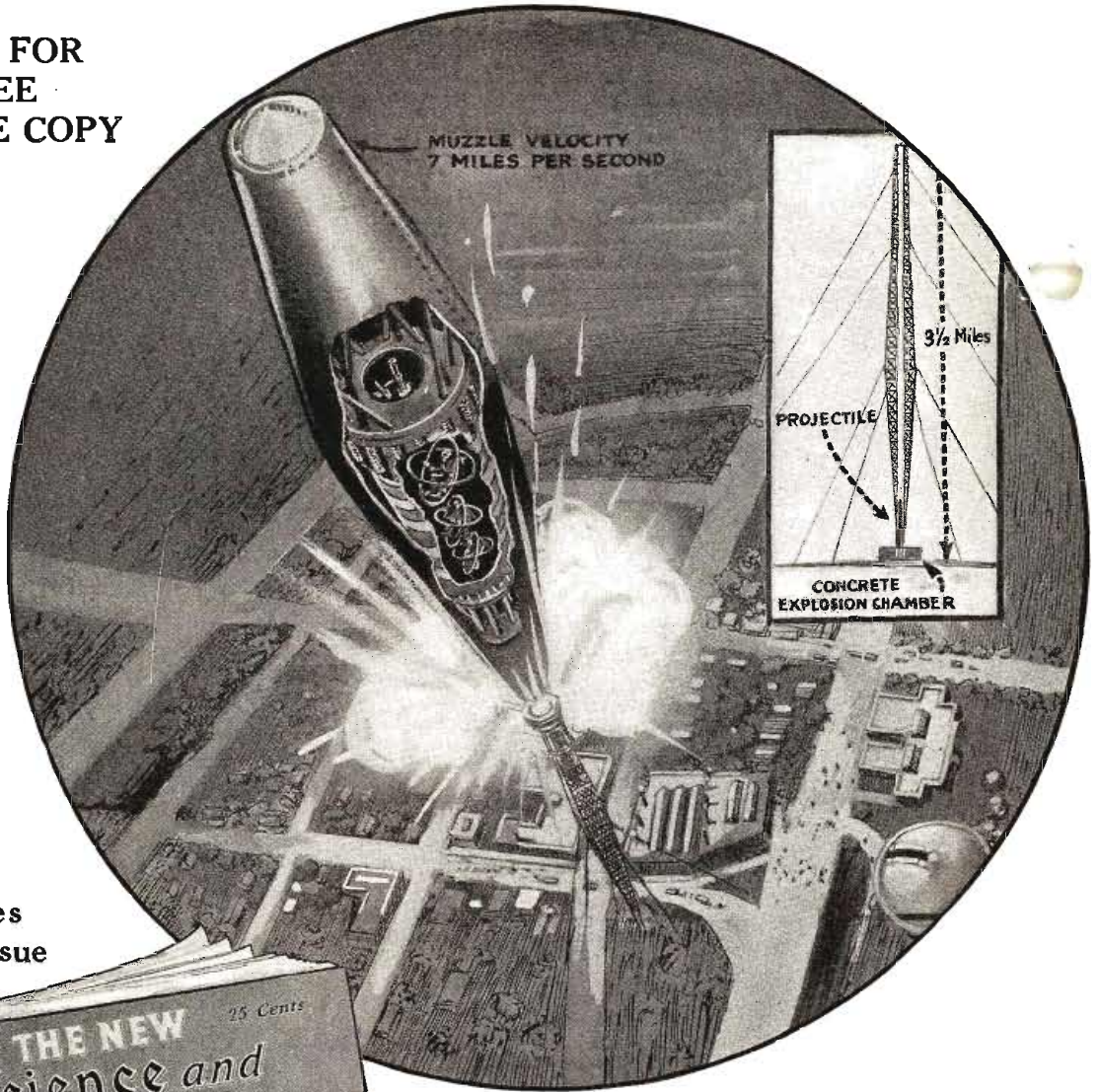

25  
RADIO  
Features  
Every Issue



## The Wonders of Science Told in Pictures

SCIENCE and INVENTION is the only magazine that tells all of the up-to-the-minute Scientific marvels in PICTURES. It makes hard subjects easy to understand.

SCIENCE and INVENTION costs 25c the copy at Your Newsdealers or \$2.50 per year by subscription. Use the coupon below when subscribing.

**EXPERIMENTER PUB. CO., INC.**  
53 Park Place, N. Y. City

Experimenter Publishing Co., Inc. R. 24  
 53 Park Place, New York  
 Enclosed find.....dollars for which please enter  
 my subscription to SCIENCE and INVENTION for.....years.  
 Name .....  
 Address .....



- 6AW Edward James Jarvis, "Naseby Cottage," High Street, Waltham Cross.
- 6BB John Bolt, Crouchly, Lynn, Cheshire.
- 6BC W. Douglas Clague, White House, High Heworth, Gateshead-on-Tyne.
- 6BD B.B.C., Aberdeen Station.
- 6BJ C. Solomon (Portable), 10, Cavendish Road, Brondesbury, N.W. 6.
- 6BM B. B. C. Station, Bushy Road, Bourne-mouth.
- 6BN G. E. Minwalla, "Dorothy," 25, Weighton Road, Anerley, S.E. 20.
- 6BQ J. L. Cannon (Portable), 14, Woodcroft Avenue, Broomhill, Glasgow, W.
- 6BR G. H. Ramsden, Overdale, Ilkley.
- 6BT C. A. Jamblin, 82, York Road, Bury St. Edmunds.
- V. F. M. Oliver, Whitmore Lodge, Sunnys-hill, Berks.
- 6BW J. C. Mason, 8, Westmorland Road, New Briton.
- 6CF W. C. Lingard, Bridgeholme Green, Chapel-en-le-Frith, Derbyshire.
- 6CG A. W. Eagle, 42, Park Lane, Tottenham, N. 17.
- 6CI C. E. Tilley, 10, Guthlaxton Road, Leicester.
- 6CW D. Burne-Jones, "Gwalior," Rustic Avenue, Streatham, S.W. 16.
- 6DC G. Young, 37, Burnard Road, Mount Estate, Gorton, Manchester.
- 6DJ A. C. Copey, 27, Sutherland Road, Tottenham, N. 17.
- 6DM C. Knight-Coutts, 16, Vine Street, Evesham.
- 6DP Norman Crowther, 219, Roundhay Road, Leeds.
- 6DU E. J. Newton, 1, Jerningham Road, New Cross, S.E. 14.
- 6DW Douglas H. Johnson, 131, Clapton Common, London.
- 6DZ Capt. L. A. K. Halcomb, South Leuc, 106, Millhouses Lane, Sheffield.
- 6FB W. Grocott, Church Road, Oxley, near Wolverhampton.
- 6FH G. W. Livesley, 3, Spring Bank, Market Drayton.
- 6FJ C. V. Jarvis, 21, Baltic Road, Tonbridge.
- 6FK Worcester Cadet Sig. Co., R. C. of Sigs., Junior Tech. Sch., Sansome Walk, Worcester.
- 6FL E. R. Kirkby, 36, B. K. Rhodes, Halifax.
- 6FQ A. B. Richardson, 9, Quarry Road, Hastings.
- 6FV W. H. Taylor, 37, Bridge Street, Warrington.
- 6GM E. A. Wilson, "Roxburgh," 42, Heber Road, N. W. 2.
- 6GO L. A. Sayce, 5, Toward Terrace, Sunderland.
- 6GT G. Turton, 3, Lydford Road, Maida Hill, W. 9.
- 6GW Percy Brian, 79, Lakey Lane, Hall Green, Birmingham.
- 6GY T. McL. Galloway, Wyntersted, Dollar, N.B.
- 6GZ R. C. Neale, Farnborough Road, Farnborough.
- 6HD National Wireless and Electric, Ltd., Church Road, Acton, W. 3.
- 6HK J. W. F. Cardell, Trethessas, Newquay, Cornwall.
- 6HO National Wireless and Electric Co., Ltd., Church Road, Acton, W. 3.
- 6HR W. O. Keiller, 51, Highworth Road, New Southgate, N. 11.
- 6HS H. Saville, Delainere Works, Longford Road, Stratford, near Manchester.
- 6HV W. J. Butler, 15, Algernon Road, Edgbaston, Birmingham.
- 6HX C. H. Nokes, Misidia, High Street, Ripley, Surrey.
- 6HY F. Dyer, 59, Antill Road, Tottenham, N. 15.
- 6IC Arnold Jewett, 310, Hopwood Lane, Halifax.
- 6IG Edward Brady, 6, Coltsgate Hill, Ripon, Yorks.
- 6IL J. H. Roscoe, 183, Chester Street, Dirkenhead.
- 6IM L. G. Kamm, 88, Hornsey Lane, Highgate, N.
- 6IR G. Hornsby, 14, Baring Street, South Shields.
- 6IX W. G. Fudger, "Brora," Priviliswood Road, Godalming.
- 6JB Wimbledon Radio Society, Red Cross Hall, 59, Church Road, Wimbledon.
- 6JS Percy R. Selden, 76, Albert Road, Alexandra Park, N. 22.
- 6JV Capt. H. J. B. Hampson, 477, Earlharn Rise, Norwich.
- 6JN R. J. W. Lankster, Wanderings Farm, Kingston Road, Kingston-on-Thames.
- Vyvyan A. G. Brown, Fawley Lodge, Coley Avenue, Reading.
- 6KC Radio Specialty Co., 41, Limbrick, Blackburn.
- 6KK J. Cookson, 66, Albert Road, Blackpool.
- 6KU H. G. Clacy, 114, Bradshaw Road, Watford, Herts.
- 6LB L. J. Fuller, Glenburn, Seagry Road, Waustead, E. 11.
- 6LJ S. K. Lewer, London, N.W.
- 6LW R. C. Davies, Sunny Side, 22, Grainger's Lane, Cradley Heath, Staffs.
- 6MD R. J. Brown, "Greba," Gledbow Lane, Roundhay, Leeds.
- 6MG B. W. D. Lacey, 33, Woodbridge Road, Moseley, Birmingham.



The "Unidyne" is a super four-tube instrument employing one stage of radio-frequency amplification, detector and two stages of audio amplification. All Unidyne panels bear this pledge of dependability. They may be had in either vertical or horizontal mountings in cabinets to suit your fancy.

## When a Set Bears This Mark--You Can Be Sure of Dependable Performance

**F**OR selectivity, range and volume, the Unidyne Radio Set enjoys an enviable reputation.

Typical of the thousands of records that owners have made is the log of the short test recorded below.

Harvey, Illinois, Saturday Evening, March 22, 1924.  
(Using 30-foot Indoor Aerial)

11:42 P.M.	K.G.O. Oakland Calif.	309 Meters—1900 Miles  Whistling Solo—"Spring Song"
11:44 P.M.	W.S.A.I. Cincinnati	312 Meters—300 Miles Piano Solo—"Adoration Waltz" Played by Ruth Eddy
11:50 P.M.	K.G.O.	Baritone Solo—"Till I awake"
11:57 P.M.	K.G.O.	St. Francis Hotel Orchestra
11:59 P.M.	W.S.A.I.	Frarkers Rag Muffins "Somebody Loves You After All."

During this time three Chicago Stations were broadcasting among which was W.D.A.P. (360 meters), W.T.A.S. (Elgin 275 meters) was also broadcasting.

**F**OR simplicity the Unidyne panel offers distinct advantages. There are only two controls to tune with and a neater, more compact unit cannot be found.

Once you determine the dial setting for a station, that station when broadcasting will "come in" at its own setting any time, regardless of the antenna used. Ask any of the better dealers for facts about the Unidyne set or write.

**UNITED MFG. & DIST. CO.**  
9705 Cottage Grove Ave., Chicago, Ill.

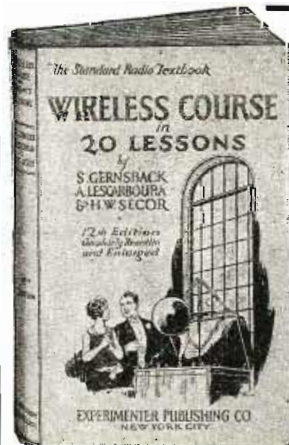

**\$2.00**      12th Edition      **\$2.00**

## WIRELESS COURSE IN 20 LESSONS

By S. GERNSBACK, A. LESCARBOURA  
and H. W. SECOR

### The Standard Radio Text Book

Size 6 x 9 inches. 264 pages. 500 Illustrations. Binding de Luxe. Semi-flexible Leatherette Cover. Genuine Gold Stamped, Round Corners, Red Edges.

**Experimenter Publishing Co.**

53 Park Place

New York, N. Y.

# Everyday Practical Electrics For Everybody

**P**RACTICAL ELECTRICS is probably the most novel magazine of its kind ever conceived. It is personally edited by H. Gernsback, editor of SCIENCE & INVENTION, MOTOR CAMPER & TOURIST and RADIO NEWS. Mr. Gernsback, who founded the old "Modern Electrics" as well as the "Electrical Experimenter," knows thoroughly what his readers want and have wanted for many years. PRACTICAL ELECTRICS, the 100% electrical magazine, eclipses the best that was in "Modern Electrics" and "Electrical Experimenter."

Electricity covers such a tremendous field that the man who does not keep abreast with it does himself a great injustice. PRACTICAL ELECTRICS covers that field from every angle. It is written in plain every-day language that all can understand. It portrays the entire electrical development of the month faithfully in non-technical language. It caters to everyone interested in electricity, be he a layman, an experimenter, an electrician or an engineer—each will find in this magazine a department for himself and plenty more.

The APRIL ISSUE of  
**PRACTICAL ELECTRICS**  
Contains Over 50 Big Features  
among which are—

- HIGH TENSION ARMOR
- DETECTION OF ICEBERGS
- INFRA RED LIGHT TELEPHONY
- DEMOUNTABLE STORAGE BATTERY
- HOT WIRE AMMETER
- ELECTRIC PIANO, ETC.

## PRIZES

This magazine offers a number of prizes, as follows:  
\$100 Old Telephone Receiver Contest.  
Our \$50.00 Prize Contest for Junior Electricians and Electrical Experimenters includes as its elements simplicity, as great a degree of novelty as possible, and practicability.  
Also a new prize contest giving four prizes amounting to \$37.50 for the best account of an odd electrical experience.  
\$3.00 for the best article on Elec-Tricks, the new department.  
\$3.00 for the best "short-circuit," the semi-humorous department.  
In addition to this, the magazine pays high prizes for all electrical experiments, electrical articles, etc. See current issue for full details.

For Sale At All Newsstands. 25c. the Copy. \$2.50 a Year.  
Canada and Foreign—\$3.00 a Year

**GERMOTT PUBLISHING CO., Inc.**  
Successors to PRACTICAL ELECTRICS CO.  
53 PARK PLACE NEW YORK CITY

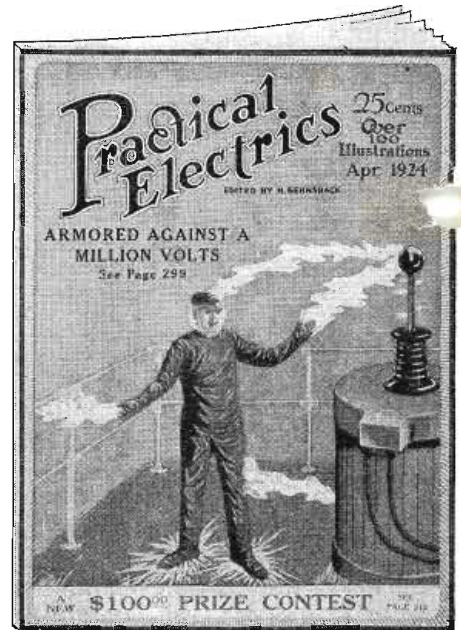

Send For  
**FREE**  
Sample Copy

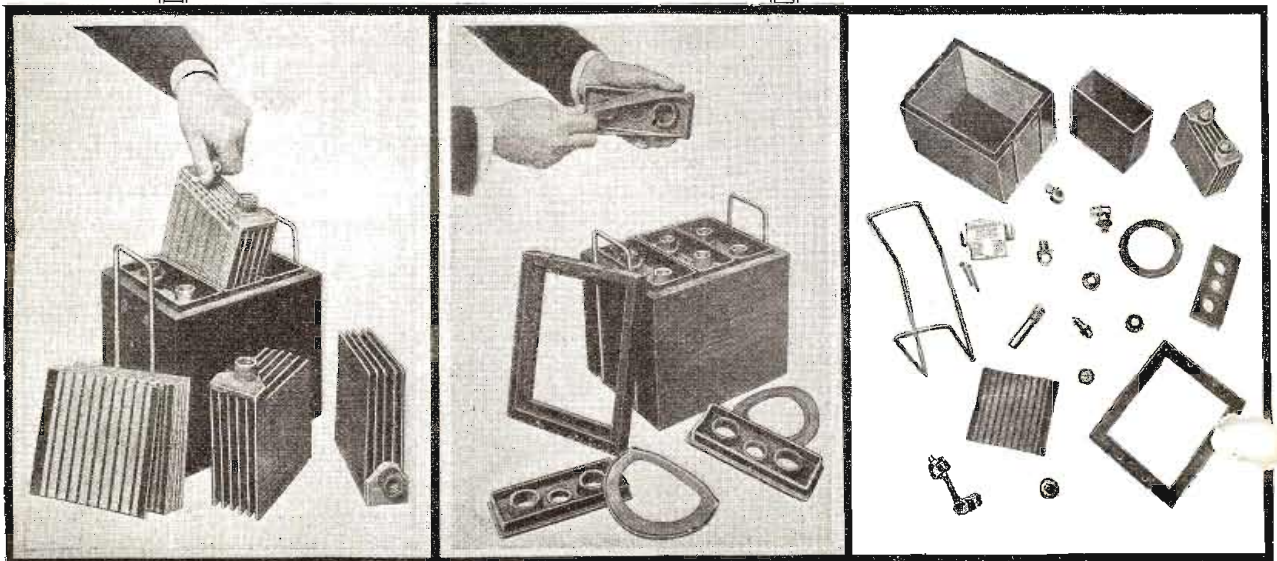

**Demountable Storage Battery**  
A Novel Article appearing in the April Issue



- 6MQ G. C. Patching, 84, Allcroft Road, Ken-  
tish Town, N.W. 5
- 6MU Edgar J. White, Lausdowne Villa, 83,  
Rochdale Road, Blackly, Manchester.
- 6NF A. D. Gay, 49, Thorulaw Road, W. Nor-  
wood, S.E. 27.
- 6NG J. W. C. Cropper, 10, Manor Street, Hoo-  
ley Hill, near Manchester.
- 6NH J. W. Davies, Dodington, Caterham Val-  
ley, Surrey.
- 6NJ C. W. Watson, Butts Mills, Barnolds-  
wick, Yorks.
- 6NL British Radio Mfg. Co., 9, South Castle  
Street, Liverpool.
- 6NP W. Gill, 7, Church View, Heckmondwike.
- 6NS J. Frater, Felling-on-Tyne.
- 6O F. W. Woodward, 5, Portland Gardens,  
Harringay, N. 4.
- 6OI W. H. Felton, 47, Sompting Road, Worth-  
ing, Sussex.
- 6OX B. Quentin, Lislet Lodge, St. Sampson,  
Guernsey.
- 6OZ H. Thompson, 1, Rye Street, C-on-M.,  
Manchester.
- 6PD A. J. Dixon, White House, Hertford  
Road, Enfield Wash, Middlesex.
- 6PG C. H. Targett, 21, High Street, Dartford,  
Kent.
- 6PJ F. Ison, 47, Oxford Road, Walthamstow,  
E. 17.
- 6PK Universal Radio Co., 129, New Bridge  
Street, Newcastle-on-Tyne.
- 6PT Leonard Lott, "Gants Muir," Berrow  
Road, Burham-on-Sea.
- 6QC Grammar School, Loughborough.
- 6QV J. Alan Godfrey, 160, Bethune Road, Lon-  
don, N. 16.
- 6RK R. Gregson, 3, Bank Road, Blackpool,  
Lancs.
- 6RO Arthur Taylor, 146, King's Road, Cardiff.
- 6RY H. Leslie Bowen, 13, Daniel Street, Bath.
- 6SB R. Heather, 102, Lyndhurst Road, Peck-  
ham, S.E. 15.
- 6SK A. E. Vollmer, 57, Lyttelton Road, Ley-  
ton, E. 10.
- 6SQ Chas. Rogers, 3, Alders Avenue, Chinley.
- 6TD K. L. Palmer, Vyrnwy House, Llan-  
saintffraid, Montgomeryshire.
- 6TN E. H. Wright, 13, Boices Street, Brighton.
- 6UC A. C. Chatwin, 162, Hagley Road, Egbas-  
ton, Birmingham.
- 6VL R. W. Leader, 93, Pinner Road, Harrow  
(Portable).
- 6ZY L. Gordon, 133, Old Street, Ashton-  
under-Lyne.
- 2ADF A. M. Robinson, The Lychgate House,  
Combe Road, Croydon.

**Calls Heard**

(Continued from page 1755)

- 9CKM, 9DAV, 9DBZ, 9DEL, 9FE, 9DHL,  
9DHR, 9DIA, 9DIL, 9DKH, 9DOE, 9DOJ,  
9DPX, 9DQH, 9DR0, 9DRC, 9DSL, 9DXR,  
9DTH, 9DWS, 9EAK, 9EAR, 9EDZ, 9EIS,  
9ELL, 9EP, 9EQ, 9ER, 9KY, 9SM, 9VY.  
Spark—5UD, 9DHZ, 9VV, ICW—SCHV, 3BG.

- RENE BURLET, F8CS, 4 RUE TARBE,  
REIMS MARNE, FRANCE  
C.W.—1ACA, 1ALZ, 1AJP, 1AIP, 1AWW,  
1AIA, 1AJW, 1ARY, 1ALL, 1AXN, 1APC,  
1BWF, 1BLN, 1BDU, 1BWD, 1BGC, 1BGF,  
1BAC, 1CCG, 1CDU, 1CMX, 1CWP, 1CVS,  
1CFN, 1CMA, 1CMP, 1CDV, 1ER, 1FD, 1FM,  
1KC, 1OL, 1OW, 1PA, 1PT, 1RW, 1UH, 1XU,  
1YK, 1YB.

- On 100 Meters—1ALJ, 1ABF, 1AJA, 1AJP,  
1BSD, 1BDI, 1CAK, 1DMA, 1XJ, 1XW, 1XAH,  
1XAK, 1XAM, 1XAR.

- C.W.—2AFP, 2ANA, 2ARN, 2AAY, 2AOL,  
2AUR, 2AGB, 2BRB, 2BN, 2BQH, 2BY, 2BTW,  
2BUC, 2BYC, 2BSC, 2BQD, 2BUM, 2CZO,  
2CHV, 2CBL, 2CPD, 2CQZ, 2CEI, 2CNL, 2CEE,  
2CLA, 2CZA, 2DD, 2DY, 2DR, 2GK, 2IC, 2II,  
2JV, 2KF, 2IU, 2PZ, 2TS. Spark—2CCX, 2RS,  
2RK. C.W.—3APT, 3ABA, 3AB, 3AFA, 3AJD,  
3AFS. 100 meters—(3OT), 3QV, 3MB. C.W.—  
4BY, 4HN, 4JO, 4OA, 4ZA. 100 meters—4BZ,  
4OE, 4XC, 4XE.

- C.W.—5FV, 5LR, 5NI, 8AMM, 8AMB, 8ASV,  
8AOB, 8ALF, 8AVT, 8BDT, 8BDA, 8BNH, 8BCI,  
8CJ, 8CIG, 8CKO, 8COM, 8DAA, 8GZ, 8KH,  
8MZ, 8SZ, 8UF, 8XAL, 8XAN, 8VV, 8ZO. 100  
meters—8XAP, 8XBH.

- C.W.—9ARZ, 9AIM, 9BAK, 9BRK, 9BP,  
9DAX, 9EKY, 9DQU, 9MC, 9VM, 9ZN, 9ZT,  
9ZG. 100 meters—9XW.

- Canadian. C.W.—2AM, 2BG, 2CG. (on 100  
meters—2BE, 2BN, 3BG, 1BQ, 9BL), 2MV, 3AP,  
3CO.

3L crd on request.

- 6C P. O. BOX 51, BURLINGAME, CALIF.  
C.W.—5AJJ, 7HR, (7NO), 7NT, (7VM), 7WP,  
7ZD, 3ABU, 3ADB, 5AAW, 5ANC, 5TJ, 5BUC,  
8ALM, 8CRU, 8CTP, 9AMI, 9AVN, 9CEV,  
9CPZ, 9DRW, 9ER, 9VM, 3LG, 4CS, (5ADB),  
5AJJ, 5EH, 5FT, 5RG, 5TJ, 8ABM, 8AOK,  
8ATC, 8ASV, 8CKM, 9ACI, 9ATK, 9BMX,  
9BRK, 9CCM, 9CEE, 9CHC, 9CMK, 9CZM,  
9DBF, 9DRK, 9DXN, 9DR, 9NU, 9XBE.  
Complete log hr. crd on request.

- 9BEZ, WICHITA, KANSAS  
(1AAC), 1ACB, 1AGH, 1AIG, 1APC, (1AUR),  
1AWW, 1BES, 1BCU, 1BHN, 1BYB, 1BWJ,  
1CAO, (1CCX), 1CI, 1CLB, 1CMP, (1CMX),

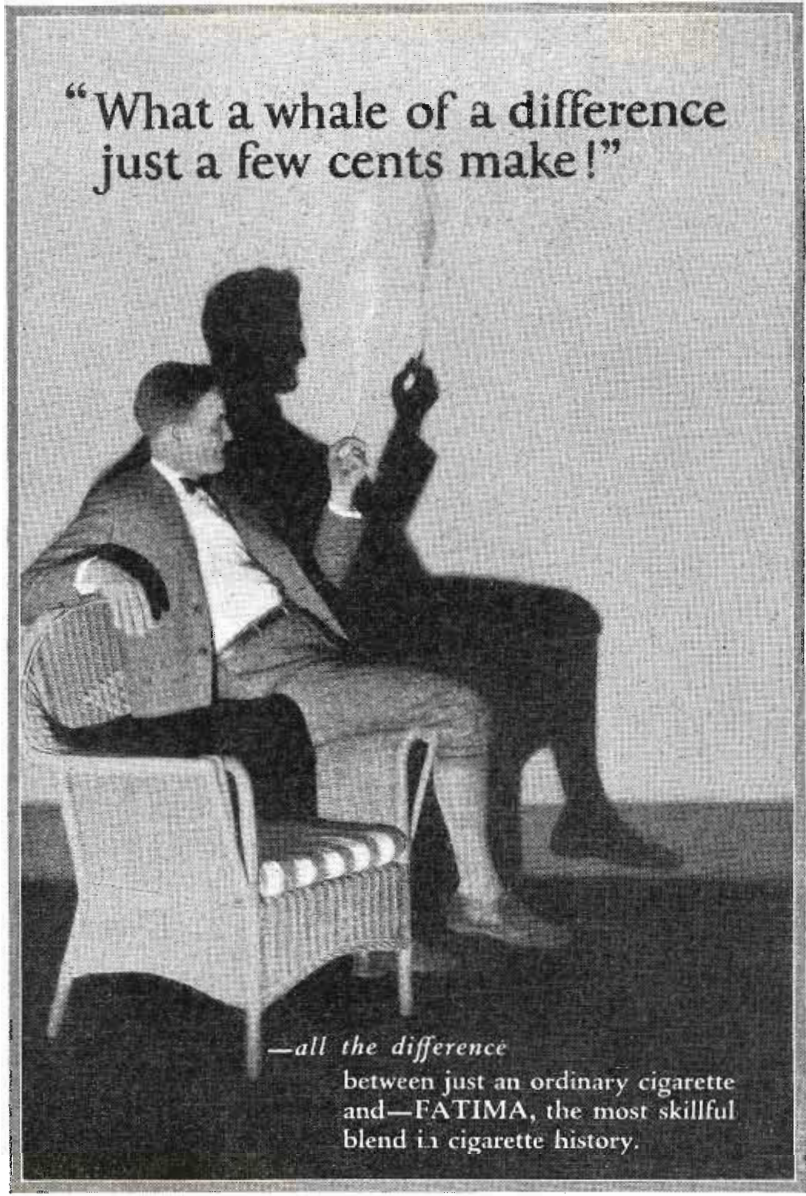

—all the difference  
between just an ordinary cigarette  
and—FATIMA, the most skillful  
blend in cigarette history.

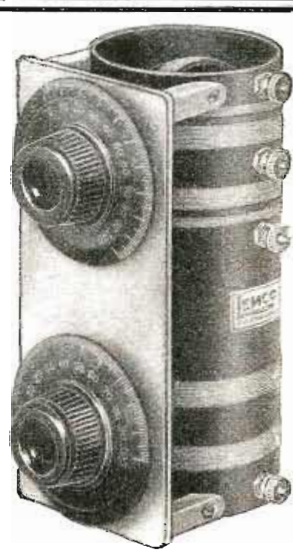

**SIMPLIFY YOUR SET!**  
Increase Your Range—Improve Your  
Control—Hook Up a



**TRIPLE DUTY TUNER**

Insist on Lemco Pro-  
ducts from your supply  
dealer; if he hasn't  
them we'll forward  
prepaid on receipt of  
purchase price.  
No. 100. Broadcast  
Tuner list (less  
dials) ..... \$7.50  
With Bakelite dials  
(as illustrated), \$8.70  
No. 340. Crystal Set  
(as illustrated) \$7.50  
Circulars with dia-  
grams for simple re-  
generative, Filwelling,  
radio frequency and  
other circuits sent on  
request.



DEALERS and JOBBERS **LEE ELECTRIC & MFG. CO.**  
Write for Attractive Proposition 220 Eighth St. San Francisco, Cal.

# TIPS!

## FOR THE Radio Amateur Constructor

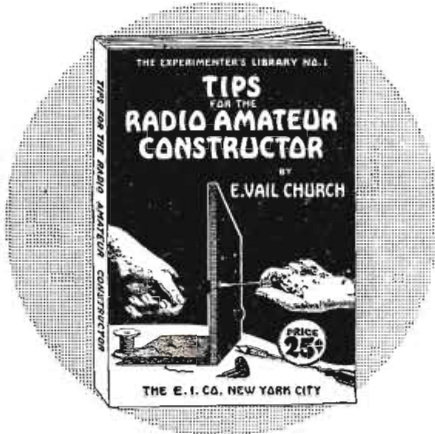

The Latest Book of the Experimenters' Library: It gives everyone the inside tricks on constructing his own Radio Set. It combines the experience of an Expert Set Builder. It is of value to everybody. One chapter is devoted exclusively to the fine points of drilling the Radio Panel and Cabinet. Another to the Mounting of the Instruments and so on till every detail of Radio Set Construction is covered. This Book is now in Circulation. Ask your dealer for a copy.

**PRICE 25c**

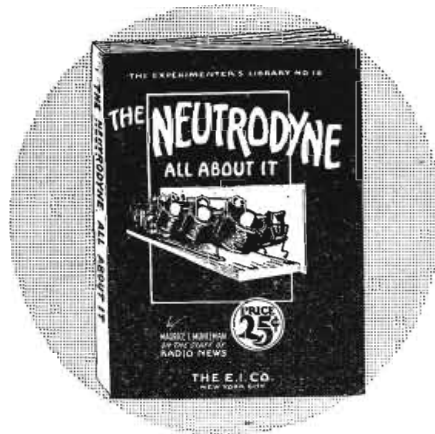

## THE NEUTRODYNE ALL ABOUT IT

Twenty-one Chapters on the Neutrodyne are covered in this neat, handy book. Anyone interested in the Neutrodyne Set and how it works should have a copy. It is complete to the smallest detail—such as "Locating Trouble," "Adding Regeneration," "Drilling the Panel" etc. The book covers only the up-to-the-minute data. It is an advance in Radio Literature. Get a copy now.

**PRICE 25c**

Other Books in the  
EXPERIMENTERS LIBRARY

→  
PRICE 25 CENTS EACH



**AT ALL RELIABLE DEALERS**

**THE E. I. COMPANY**  
233 FULTON STREET

*(The Consrud Company, Selling Agents)*  
NEW YORK CITY



1CPI, 1ER, 1EZ, (1FS), (1II), 1ML, (1VC), 1XB, 1XN, 1YB, 2AL, 2AMI, (2ATE), 2AZY, 2BEE, 2BRB, 2BSC, 2CEE, (2CGJ), 2CIN, 2CNK, 2CPD, 2CUB, (2CYW), 2GK, (2KU), (2WR), 2XAY, 3ABW, 3ACY, (3ATB), 3AVA, 3BDO, 3BJ, 3BUY, 3BVH, (3CHH), 3CHP, 3CJN, 3CKJ, (3HH), 3KQ, 3LR, 3VW, 3WX, 3XN, 4AB, 4AI, 4BA, (4FS), (4FT), 4JE, (4KU), (4NA), (4QW), 6AAO, 6AAQ, (6ABK), 6ACM, 6ACU, 6ADT, 6AGE, (6AO), 6APE, 6AQO, (6AWE), 6BBC, 6BBW, 6BTI, 6BHI, 6BNI, (6BQR), 6BUY, 6BVG, 6CBB, 6CBE, 6CDG, 6CGS, 6CIX, 6CKP, 6CKR, 6CMS, 6CNC, 6GL, (6KW), (6NB), 6OL, 6QJ, (6XAD), 6ZBS, 6ZBJ

Canadian—2BE, 2CE, 2EI, 3AEC, 3HI, 3MO, (3), 3PZ, (3TF), (3YH), (4AD), (4CO), (4), 4FN.

Can you hear my 20 watt C. W. PSE QSL.

5ANF, ENID, OKLA. (DET. ONLY)

1AJN, 1ART, 1AWE, 1BCR, 1ER, 1SW, 2BRB, 2BSC, 2CPO, 2COZ, 2TT, 3ALX, 3BGJ, 3BJ, 2BUV, 3CCX, 3HH, (3HS), 3QV, 3RG, 3TF, 3YO, 4CO, 4CS, 4DV, 4ER, 4IO, 4JE, 4JR, 4MY, 4OG, (4PK), 4RR, 5AAQ, 5AAW, 5ABD, 5ACH, 5ACI, 5AHR, 5AGN, 5AGS, (5AIC), 5AJB, (5AJI), 5AJT, 5AKN, 5ALL, (5ALV), 5AMU, 5AMV, (5AZ), (5BE), (5CE), 5CV, (5DM), 5EK, (5GB), (5GI), 5GM, 5JB, (5JC), (5KA), 5MB, (5MN), 5NW, 5NY, 5OR, 5PH, (5OD), (5QJ), 5OL, (5OW), 5OY, 5RG, 5RO, (5TS), 5UA, (5UK), (5VA), 5VM, 5VT, 5XAU, 5XD, 5ZAI, 6AAO, 6ABK, 6AHP, 6AJB, 6ARB, 6BBC, 6BBW, 6BDI, 6BH, 6BOU, 6BJF, 6BO, 6BUI, 6CBF, 6CEJ, 6CEK, 6CGW, 6CIB, 6CKA, 6GT, 6NB, 6NBI, 7ADM, 7FD, 7FO, 8ADA, 8AES, 8ALM, 8ATP, 8AZG, 8AZM, 8BCE, 8BCF, 8BCP, 8BOE, 8BOI, 8BWC, 8BZT, (8CCJ), 8CGU, 8CN, 8CPK, 8CPY, 8CRY, 8CVM, 8CXI, 8CZY, 8DCY, (8DDC), (8DGP), 8EB, 8KH, 8NE, 8PL, 8RV, 8ZC, 9AAI, 9AAQ, 9AAU, 9ABF, 9AC, 9ACX, 9ADR, 9AEM, (9AFR), (9AGL), (9AGO), (9AHJ), 9AHS, 9AHZ, 9AIM, (9AIT), 9AJD, 9AK, 9AKA, 9ALG, 9AMF, (9AMI), (9APD), 9APE, 9APS, (9AQK), (9ARI), (9ASW), 9ATO, 9ATR, (9AVG), (9AVM), 9AVN, 9AXX, 9AYX, (9AZA), 9AZF, 9AZG, 9BAB, 9BAF, 9BAL, 9BCF, 9BCX, (9BDF), 9BDH, (9BDZ), 9BEU, (9BEZ), (9BGX), 9BHI, 9BHK, 9BIE, 9BIE, 9BIF, (9BIO), 9BIS, (9BIL), (9BLB), (9BLG), 9BLW, 9BLY, 9BMR, 9BMX, (9BNU), 9BOZ, 9BP, (9BPS), (9BQJ), 9BQO, 9BQQ, (9BRK), (9BSI), 9BTL, 9BUN, (9BVV), 9BX, 9BXV, 9CAM, (9CCM), (9CCN), 9CCO, 9CCS, 9CCW, (9CEA), 9CEE, 9CFL, 9CFH, 9CFX, 9CGS, 9CHK, 9CIX, (9CJC), 9CKA, (9CKD), 9CMK, (9COL), 9COM, (9CRN), 9CSX, 9CTG, 9CTR, 9CUC, 9CUD, 9CVV, 9CXO, 9CXP, 9CYW, 9CZM, 9CZW, 9DAG, 9DAP, 9DBF, 9DBH, 9DCH, (9DCP), 9DCW, 9DDS, 9DEQ, 9DMJ, 9DKQ, 9DOZ, 9DPP, 9DR, (9DRO), 9DWA, 9DWE, 9DXV, 9DYI, (9DYR), 9DYZ, 9EA, 9ESN, 9FM, 9EDO, 9EEA, 9EFH, 9EFQ, 9EFZ, (9EGU), 9EIB, 9EID, 9EIC, 9EIJ, (9EKY), 9ELB, 9ELD, 9EQ, 9ER, (9HW), 9JU, 9LE, 9LF, (9LZ), 9MC, 9MM, 9NU, 9OK, 9RV, 9RY, 9SS, (9TH), 9TS, 9TW, 9UX, 9VM, (9WI), (9XBE), 9YB, 9YY.

U. S. A.—CCA, CTK, (CYI).

Canadians—3BO.

Will appreciate QSL's on my 10-watt R. A. C. C. W. All cards answered.

9CKA, ELK POINT, S. DAK.

1CAB, 1XAZ, 1CAZ, 1ON, 1KP, 1CMP, 1AUL, 1FH, 1BSZ, 1FM, 1AIT, 1AFE, 1KC, 1YB, 1BKQ, 1AAC, 1AAP, 1A00, 1AYT, 2KU, 2BQH, 2BM, 2GD, 2BRF, 2BBN, 2BNZ, 2ADO, 2ZY, 2ALY, 2BGI, 2BQU, 2AL, 2GK, 3ADB, 3VP, 3BUV, 3BG, 3CDU, (3OE), 3CAN, 3ADE, 3BLF, 3CCX, 3HS, 3AEK, 3CKG, 3AJX, 3JE, 3YO, 4GZ, 4ANA, 4MI, (4BZ), 4PK, 4CO, 4IZ, 4AF, 4SG, 4SF, 4BK, 4WV, 4FG, 4SPK, (4FT), 4AI, 4SI, 4DV, 4FS, 4LL, (5ANC), 5PV, 5OY, 5JG, 5SZ, 5SG, 5ALV, 5ATU, 5UY, 5HY, 5ZM, 5NZ, 5QI, 5QW, (5BX), 5WS, 5EH, 5MB, (5CV), 5AU, 5RG, 5NA, 5TO, 5AGS, 5AGH, 5AK, 5KA, 5NK, 5IA, 5AJQ, 5NW, 5NT, 5ALR, 5AJB, (5HE), 5QL, 5VM, 5OD, 5DM, 5TS, 5XAU, 5AJJ, 5ABF, (5CV), 6BUY, 6CBG, 6AAU, 6AID, 6XAD, 6BUR, 6APC, 6CAY, 6BJB, 6ZT, 6ADH, 6BUI, 6BIK, 6LV, 6AAO, 6ADT, 6BLW, 6EU, 6NX, 6GT, 6BBW, (6CKR), 6CBC, 6CDJ, 6ACM, 6NB, 6AKW, 6PC, 7AHC, 7FO, (7CO), 7OD, 7BJ, 7VM, 7FA, 7AIM, 7OB, (7NR), 7AKK, 7WP, 7IG, 7JY, 7FD, 7ES, 8CF, 8AWJ, 8DCB, 8BKD, 8CCT, 8ACY, 8BEK, 8ADK, 8KC, 8CTP, 8ABS, 8BHG, 8DO, 8BOG, 8CHV, 8VY, 8BSF, 8VN, 8CZZ, 8CUS, 8DII, 8OAK, 8CVM, 8AIG, 8DIG, 8BKN, 8DGO, 8AK, 8BWB, 8TX, 8BED, (8CWP), (8CPK), 8ADD, 8ADA, 8DKB, 8RT, 8BY, 8WP, 8BBP, 8DDP, 8RM, 8ARO, 8NX, 8DGR, 8DDT, 8AWJ, 8AA, (8CZY), 8BYD, 8DDC, 8APT, 8BDV, 8OE, 8CZ, (8EB), 8BPC, 8DAK, 8ALW, 8DZ, 8RJ, 8AAJ, 8AZM, 8CLF, 8CMY, (8BVV), (8ALM), 8ACV, 8ACN, 8UP, 8DCZ, 8XE, 8AZO, 8ATP, 8BPA, 8SPK, 8RV, 8BCE, 8DAE, (8YX), 8BYN, 8DBM.

Canadian—3ZT, 3NI, 5GO, (4HH), (4CO), 3XI, 9BJ, 9BP, 3AD, 3JE.

Will QSL crds. QRK my 50-watt C.W.? Always glad to QSR.

Correction. 9CKY—L. B. Eiche, Jackson and Van Dorn Streets, Lincoln, Neb. (Quoted in April issue as 9CKG.)

*"You have solved the Reflex problem!"*

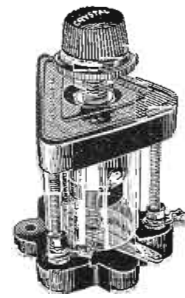

— SAID EDITOR OF  
**N.Y. EVE. WORLD'S RADIO MAGAZINE**

—World's Most  
**Efficient Crystal**

"The new Freshman 'double adjustable' crystal detector 'stayed put' even when the set was deliberately shaken, stood up to 130 volts on the plate circuit without noise or distortion.

"This detector meets every requirement of the reflex circuit.

"It is enclosed and provided with two adjustments, one varying the position of the crystal, and the other regulating the brush contact adjustment.

"The crystal is a pure natural ore and is imbedded in an insulated housing, thus eliminating short circuits and consequent loud noises resulting from the cat whisker touching the metal housing.

"The Freshman detector can be panel mounted with only a small knob showing. All around it is the best crystal detector unit found for reflex work."

—Statement of Editor of N. Y. Eve. World's Radio Magazine (March 29th, 1924).

Every experimenter can feel confident that when the radio authority of one of the greatest newspapers in America says the Freshman is the best detector—it must be true!

Note the exclusive Freshman features:

- Loop-end contact!
- Non-metallic housing!
- Double-adjustable!
- Mounts neatly on Panel!
- Stays set when adjusted!
- Withstands high voltages!

**FRESHMAN**  
Double Adjustable **\$ 1.50**  
Crystal Detector

For Panel or Base Use, complete with crystal

Merely turn the knob as you would a dial—No more searching for the sensitive spot!

Freshman Special Crystal with Non-Metallic Housing \$ .50

At your dealers, otherwise send purchase price and you will be supplied postpaid.

**Chas. Freshman Co. Inc.**  
*Radio Condenser Products*

106 Seventh Avenue, New York City

Write for free diagrams of Neutrodyne, Polydyne, Tri-Flex, Super-Heterodyne and other popular circuits.

**LEARN THE CODE AT HOME**

"Just Listen—The Omnigraph will do the teaching"

with the

**OMNIGRAPH**

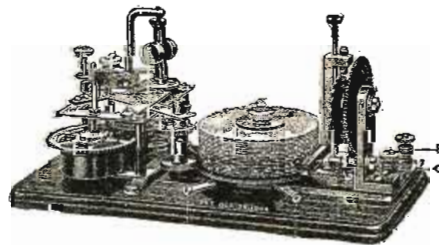

THE OMNIGRAPH Automatic Transmitter will teach you both the Wireless and Morse Codes—right in your own home—quickly, easily and inexpensively. Connected with Buzzer, Buzzer and Phone or to Sounder, it will send you unlimited messages, at any speed, from 5 to 50 words a minute.

THE OMNIGRAPH is not an experiment. For more than 15 years, it has been sold all over the world with a money back guarantee. The OMNIGRAPH is used by several Depts. of the U. S. Govt.

—in fact, the Dept. of Commerce uses the OMNIGRAPH to test all applicants applying for a Radio license. The OMNIGRAPH has been successfully adopted by the leading Universities, Colleges and Radio Schools.

Send for FREE Catalog describing three models.

DO IT TODAY.

**The Omnigraph Mfg. Co., 20 Hudson St., New York City**

If you own a Radio Phone set and don't know the code—you are missing most of the fun

Get a Handy Binder for your RADIO NEWS. Holds and preserves six issues, each of which can be inserted or removed at will. Price 65c. Experimenter Pub. Co., Inc., Book Dept., 53 Park Place, N.Y.



# OPPORTUNITY AD-LETS

Follow these advertisements every month. Reliable advertisers from all over the country offer their most attractive specials in these columns.

Classified advertising rate eighteen cents a word for each insertion. Ten per cent. discount for 6 issues, 20 per cent discount for 12 issues. Name and address must be included at the above rate. Cash should accompany all classified advertisements unless placed by an accredited advertising agency. No advertisement for less than 10 words accepted.

Objectionable or misleading advertisements not accepted. Advertisements for the August issue must not reach us later than June 1st.

## CIRCULATION LARGER THAN THAT OF ANY OTHER RADIO PUBLICATION

EXPERIMENTER PUBLISHING CO., INC., 53 Park Place, New York, N. Y.

### Agents Wanted

**Agents Wanted** in every city and town to sell standard radio apparatus. Attractive discounts given. If interested write us at once stating age and radio experience. **Wilmington Electrical Specialty Co., Inc.**, 405 Delaware Ave., Wilmington, Delaware.

**General Agents—Service Men!** Genuine Gold Letters for store windows easily applied. 20 per cent cash commission on all orders from local agents appointed by you anywhere. 50 per cent discount on your own orders. Free samples. **Metallic Letter Co.**, 422 N. Clark St., Chicago.

**Big Money and fast sales.** Every owner buys gold initials for his auto. You charge \$1.50; make \$1.35. Ten orders daily easy. Write for particulars and samples. **American Monogram Co.**, Dept. 133, East Orange, N. J.

**We want Salesmen and Agents,** either whole or side line, to sell our low priced radio books to the trade. Excellent proposition for live wires. **The E. I. Company, Publishers**, 233 Fulton St., New York City.

**You can make \$75.00 to \$100.00 a week** selling our big line of 156 articles, used constantly in every home. Write us, we will send you our handsome \$15.00 Sample Case Outfit, on trust. **Federal Pup Food Co.**, Dept. T, Chicago.

**Use our handsome Catalog!** get orders from every home for Dr. Blair's famous home products. Liberal pay. **Dr. Blair Laboratories**, Dept. 541, Lynchburg, Va.

**Attention—Agents!** Big Money-Making proposition. Mozart Felt Rug, guaranteed made of entirely new felt. Rapid seller. 100% profit. Sample prepaid \$1.75. Write today for full particulars. **Mastler-Fayne Mfg. Co.**, 20-N Sudbury St., Boston, Mass.

**A Business of Your Own.** Make Sparkling Glass Name and Number Plates, Medallions, Checkboards, Signs. Big illustrated book free. **E. Palmer**, 515, Wooster, O.

**Sell your spare time—\$2.50 per hour—Your Pay Daily—Pleasant, profitable, easy work** near home, writing orders for Mac-O-Chee New Style Guaranteed Hosiery. No capital required—No experience necessary—We teach you how to succeed—Special premiums to purchaser makes sales easy—Harvey Smith made \$18.20 first day. **Mrs. F. Brown**, \$13.50. You should do as well—Send for new sales plan and Proof of Profits—Free. **Mac-O-Chee Hosiery Company**, Room 4746, Cincinnati, Ohio.

**Big Money and Fast Sales.** Every owner buys gold initials for his auto. You charge \$1.50, make \$1.44. 10 orders daily easy. Samples and Information free. **World Monogram Co.**, Dept. 27, Newark, N. J.

### American Made Toys

**Manufacturers on Large Scale,** also homeworkers, wanted to manufacture Metal Toys and Novelties. Millions needed of Barking Dogs, Wag Tail Pups, Wild Animals, Automobiles, Indians, Cowboys, Baseball Players, Cannons, Toy Soldiers, Crowing Roosters, Statues of Liberty, Miniature castings of Captains, Bathing Girl Souvenirs and others. Unlimited possibilities. Guaranteed Casting forms furnished manufacturers at cost price from \$5.00 up, with complete outfit. No experience or tools necessary. Thousands made complete per hour. We buy goods all year and pay high prices for finished goods. Cash on delivery. Contract orders placed with manufacturers. Catalog and information free. Correspondence invited only if you mean business. **Metal Cast Products Co.**, 1896 Boston Road, New York.

### Art

**Art Objects, Books, Pictures.** Particulars free. Send no money. **O. W. Miller**, 27NX Warren St., New York.

### Automobiles

**Build a Real Automobile—Weight 150 pounds.** Handy men or boys build at small cost. Complete book, Easy-To-Follow-Plans, 25c.; also eold complete. Famous 2 1/2 H. P. Shaw motor supplies power. Stamp brings descriptive circular. **Shaw Manufacturing Company**, Dept. R, N. 2, Gatesburg, Kansas.

### Business Opportunities

**Wanted radio line.** Send distributor proposition. **N. Christensen & Sons**, Beaufort, S. C.

**Common Sense and \$100 or more** will establish cash business. Dept. X, **Paul Kaye**, 149 Broadway, N. Y.

**\$1.50 for 5 minutes work** applying gold initials to automobiles by simple transfer method. Experience unnecessary. Sample free. **Ralco**, 323-A Harrison Ave., Boston, Mass.

**Make \$100 Weekly in Spare Time.** Sell what the public wants—long distance radio receiving sets. Two sales weekly pays \$100 profit. No big investment, no canvassing. **Sharpe of Colorado** made \$955 in one month. Representatives wanted at once. This plan is sweeping the country—write today before your county is gone. **Ozarka**, 513 Washington Blvd., Chicago.

**Start Mail Order Business—Practical information** concerning its wonderful opportunities obtainable through The Mail Order News, America's leading mail trade publication. Yearly subscription \$3.00. Sample 25c. Booklet free. **Mail Order News**, 1638 Bristol Bldg., N. Y.

### Chemistry

**Learn Chemistry at Home—Dr. T. O'Connor** Sincere, noted educator and scientific authority, will teach you. Our home study correspondence course fits you to take a position as chemist. See our ad on page 1819 of this issue. **Chemical Institute of New York**, 66 West Broadway, New York City.

### Exchange

**For Sale—10 watt set** for key or broadcasting. For particulars write **A. E. Schilling**, 108 Elm St., Kalamazoo, Mich. Will send photo on request. **Station WLAQ**.

**For Sale—Murad No. M. A. 13** with bulbs and B Battery. **P. O. Box**, 122 Kimball, S. Dak. Make cash offer.

**For Sale—Grebe CR-5, \$85; RORX, \$45;** both, cash \$100. Baldwin type 2 phones, \$10. First class condition guaranteed. **Kenneth Baker**, Clarkston, Wash.

### For Investors

**Investors' Educator:** 900 mechanical Movements, 50 Perpetual Motions. How to procure and sell patents. Mechanical Movements greatly assist Investors, suggest new ideas. Explains how to select an attorney and avoid Patent Sharks. Price \$3. Postage Free. **Albert E. Dieterich**, 696 Omaha Building, Washington, D. C.

### For Sale

**Lattice steel flag pole,** 90 feet high. Would make an admirable aerial mast. May be seen on the grounds in Hillside School, Orange Road, Montclair. Interested parties may inspect, and make offer to the Secretary, **Board of Education**, Valley Road, Montclair.

### Health

**Free—Stop using tobacco.** We will give you information how to conquer habit easily and permanently. Results guaranteed. **Anti-Tobacco League**, Box M, Omaha, Neb.

### Help Wanted

**We want Salesmen and Agents,** either whole or side line, to sell our low priced radio books to the trade. Excellent proposition for live wires. **The E. I. Company, Publishers**, 233 Fulton St., New York City.

**Earn \$25 Weekly, spare time,** writing for newspapers, magazines. Experience unnecessary; details free. **Press Syndicate**, 973, St. Louis, Mo.

**All Men, Women, Boys, Girls,** 17 to 65 willing to accept Government Positions \$117-\$250 traveling or stationary. Write **Mr. Ozment**, 251, St. Louis, Mo., immediately.

**Detectives Needed Everywhere.** Travel. Experience unnecessary. Write **George Wagner**, former Government Detective, 1968 Broadway, N. Y.

**Clerks for Government postal and other good positions.** \$1,400-\$2,300 yearly. Experience unnecessary. Full particulars free by writing **G. W. Robbins**, Civil Service Expert, 305 Burchell Bldg., Washington, D. C.

### Improved Made Toys

**Wanted—Manufacturers and Houseworkers** to manufacture Metal Toys and Novelties. Wonderful opportunity. Millions needed. In Whistling Birds, Wild Animals, Wag Tail Pups, Crowing Roosters, Automobiles, Baseball Players, Statues of Liberty, Indians, Toy Soldiers, Barking Dogs and 50 others. No experience or tools necessary. Guaranteed casting forms with complete outfit, at cost, from \$3.50 up. We buy goods all year. Cash on delivery. Higher price for finished goods. Contract orders placed. Send for catalog and information free. **The Improved Metal Casting Co.**, 242 E. 150th St., New York.

### Instruction

**Learn Chemistry at Home—Dr. T. O'Connor** Sincere, noted educator and scientific authority, will teach you. Our home study correspondence course fits you to take a position as chemist. See our ad on page 1819 of this issue. **Chemical Institute of New York**, 66 West Broadway, New York City.

**Used Correspondence Courses** bought and sold. Bargain catalogue, 1,000 courses free. **Students' Exchange**, Dept. 5, 47 West 42 St., New York.

### Miscellaneous

**Remanufacture Fords—Most profitable business** on earth or established. Delicious confectionery. Easy to make. **Formula \$1.00**. **Arthur A. Lutz**, York, Penna.

**Be an aviator!** Thirty-day course. Ten hours air time \$150. Good standard aeroplane \$800. **Miller Aviation School**, Benton, Ill.

**Make Money! Sell Pop Corn.** Make into balls, cakes or crystallized. Delicious confectionery. Easy to make. **Formula \$1.00**. **Arthur A. Lutz**, York, Penna.

**Gasoline Lamps, lanterns and heaters.** Catalog free. **Little Wonder Mfg. Co.** Terre Haute, Ind.

### Motorcycles—Bicycles

**Don't Buy a Bicycle Motor Attachment until you see** our catalog and prices. **Shaw Mfg. Co.**, Dept. 6, Gatesburg, Kansas.

### News Correspondents

**Earn \$25 Weekly Spare Time** writing for newspapers, magazines. Experience unnecessary; details free. **Press Syndicate**, 973 St. Louis, Mo.

### Patent Attorneys

**Patents.** Send drawing or model for examination and report as to patentability, advice and booklet free. Highest references. Best results. Prominence assured. **Watson E. Coleman**, Patent Lawyer, 644 G Street, Washington, D. C.

**Patents.**—Inventors should write for **Free Guide Books and Record of Invention Blank** before disclosing inventions. Send model or sketch of your invention for our free opinion of its patentable nature. **Radio, Electrical, Chemical, Mechanical and Trade-Mark experts.** **Victor J. Evans & Co.**, 922 Ninth, Washington, D. C.

**Lacey Patent-Sense.** See page 1780.

**Patents—Send for form "Evidence of Conception"** to be signed and witnessed. **Form, fee schedule, information free.** **Lancaster and Allwine**, 269 Ouray Blvd., Washington, D. C.

### Patents

**Inventions Commercialized.** Patented or unpatented. Write **Adam Fisher Mfg. Co.**, 278 St. Louis, Mo.

### Personal

**Lonely Hearts—Exchange letters;** make interesting new friends in our jolly club. **Eva Moore**, Box 308, Jacksonville, Florida. Enclose stamp.

**Correspondence Club—Many wealthy members** everywhere. Fascinating particulars free. **Smith**, Box 1107Y, Denver, Colo.

**Exchange Cheery Letters** with new friends. Write **Bealy Lee, Inc.**, 4254 Broadway, New York City. Stamp appreciated.

**Loneliness—Join our club—make acquaintances** everywhere. Big illustrated book with descriptions and photos, sent in plain wrapper for ten cents. **Bonadde Co.**, Dept. 58, Kansas City, Mo.

### Photo Finishing

**Films Developed \$5.—Prints 3c each.** The new **Davis Finish**. **Davis Photo Shop**, Dept. R, Cincinnati, Ohio.

### Printing

**Quality Printing—1,000 letterheads, envelopes, cards or statements, \$2.00.** Your name on 200 nice sheets and 100 envelopes \$1.00. Samples free. **Howlett's**, Paris, Ill.

### Radio

**Boys! Don't Overlook This.** The "Rasco" Baby Detector. Greatest detector ever brought out with molded base. Fully adjustable. See former advertisements in this publication, or our catalog. Detector with Galena Crystal, complete \$6c, the same detector with Radiotele Crystal, 75c prepaid. Send for yours today. **Radio Specialty Company**, 96-98 Park Place, New York City.

**Attention—50 Vacuum tube look-ups.** The greatest collection of vacuum tube circuits ever brought under two covers at such insignificant cost. These diagrams will be found in the great "Rasco" catalog which contains raw materials and parts in a greater profusion bringing the catalog to you in stamps, or coin, will bring the catalog to you. **Radio Specialty Co.**, 96-98 Park Place, New York City.

**Build Your Own.** The best look-up I ever tried. Yours for a dollar. Any complaint your money back. **E. F. Waits**, Corinth, Miss.

**Radio Panel-White "Pyralin Ivory"** makes the most beautiful set of all. Guaranteed satisfactory. Any size 3-16" thick, 3c per square inch. Sample sent. **E. P. Hailom**, 614 Main St., Fort Worth, Texas.

**Munzig Circuit—Two tubes do five operations.** 500 miles on loop. Write for circuit and circulars. **Ray-Dee-Aircraft Instrument Co.** Redlands, Calif.

**W. R. C. Radio Crystal Receiver.** Best value for the money. Motor refunded if not satisfied. **Postpaid \$2.75.** **Wagner Radio Co.**, 2821 South Fourth St., St. Louis, Mo.

**Radio applause cards.** Latest out six original designs, 75c. per 100. Samples 10c. **Weatherby Company**, Medina, Ohio.

**Parts galore.** 300 Amp. Batteries, quitting \$1.00. **O'Brien**, Pierceton, Ind.

**Radio Troubles—Detonation eventually causes** coil, scratchy, unpleasant reception. The "Radio Trouble Shooter" with its unique and simple test systems, effectively remedies receiving difficulties, restoring original sensitivity. Book postpaid by return mail 50c. **Original Information Service**, Box 278-B, Galveston, Texas.

**Magnavox R3 or M4—Latest nationally advertised** reproducers. List \$35. Introductory \$25. The factory seal is your guarantee. **Radio Central**, Dept. R, Adlene, Kansas.

**Make Your Own Crystals—Easy, cheap, sensitive.** Guaranteed instructions \$1. **Lock** Box 935, Wichita, Kansas.

**Panel Taut for cutting** peep or meter holes in radio panels. Cuts smooth hole one to five inches in diameter, with little effort. Only \$2.50 postpaid. **Homer Malcomb**, Whitewater, Wis.





**BATTERY CONDUIT**

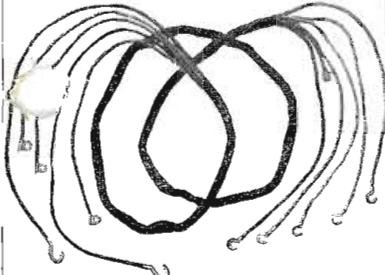

**A GREAT CONVENIENCE**  
Cat. No. 106...\$1.20

Contains 5 separate cables. Each cable is made of flexible copper wire, 16 gauge, rubber and braided cotton covering, and the five are covered with braided cotton insulation. Each wire is coded, 2 for "A" bat., 3 for "B" bat.

**R. MITCHELL CO.**  
255 Atlantic Ave. Boston, Mass.

It's a



**Radio Plate Battery**

Longer Service  
Less Frequent  
Buying

**DIAMOND "B" BATTERIES**

Reduce the Upkeep  
of Your Set

At All Good Dealers  
Diamond Electric  
Specialties Corp.  
103 So. Orange Ave.  
NEWARK N. J.

Dealers and Jobbers: Write  
for Proposition.

**TUBE INSURANCE**

91 1/2% of all tubes are needlessly destroyed

**RADECO SAFETY FUSES**

offer complete protection  
Price 50c each

**RADIO EQUIPMENT COMPANY**  
Street Boston, Mass.



**Wholesale Radio Equipment**

East Pittsburgh, Pa. Next door to KDKA

**Same Day Shipments**

**Radio—(Continued)**

**You Don't Need a Tube Set**—Surprise your friends, Build the surprisingly efficient distance-volume crystal set. Parts any 5 and 10. Cost less than a dollar. Plans and instructions, 25c. coin. New Idea Radio, 373 82nd Street, Brooklyn, N. Y.

**If your Neutrodyne won't "Neut"** o.k., send 10c. for details of Kladaq Coast to Coast circuit, bill of materials, etc., to change over your Neut into a set that will bring them all in from Mexico City to Tunucu, Cuba, on a loud speaker. Or send \$5.00 for all extra parts, blue print, etc., you need to do this. Stamps accepted. Radio list for stamp. Super Heterodyne specifications, 10c. Kladaq Radio Laboratories, Kent, Ohio.

**Atwater Kent Receivers get results.** Latest models \$70.00 No. 9 \$56.00; \$100.00 No. 10 \$83.00. Order today. Phillipson Radio Co., Battle Creek, Michigan, 33 Meadham Avenue.

**Wholesale Prices on Standard Receivers, 30% discount.** Thomas Radio Co., Muncie, Indiana.

**Call Cards**—Two colors; \$5.25 per 500. Government postals \$9.00. Lyons Publishing Co., Lyons, Kansas.

**Eliminate Body Capacity** with our anti-capacity insulated shaft extension bushings, 2 1/2 inches long, for 3/16 inch and 1/4 inch shafts. Excellent results when used on variometers, variocouplers and condensers. 25 cents each, postage paid. Jester-Cooper Company, P. O. Box 924, Houston, Texas.

**A-1 Crystals are ideal for distance.** Received KGO—1,525 miles and sixty other stations. You can buy A-1 crystals guaranteed tested on distant station broadcasting. Fifty cents each, postpaid. California Radio Minerals, Harry Grant Jr., 501 Oak Grove Ave., Burlingame, California.

**Will Sacrifice My Grebe CR-12** in original packing box, for first \$124.00. W. Egerton, 438 Main Ave., San Antonio, Texas.

**Must Sell My \$123.00 Federal No. 58 Set,** only used a few nites, for first \$65.00. G. Atchison, 3712 Roosevelt Ave., San Antonio, Texas.

**Radio Batteries**

Super Radio A and B Circuit Batteries, which bring in long distance reception. Sold for cash or on payment plan. Write for prices and details. Radio Battery Corporation, 591-B Industrial Bank Bldg., Flint, Mich.

**Salesmen Wanted**

A Salesman wanted in every town or city within 25 miles of a broadcasting station to sell Radiogem, the complete radio receiving set that retails for \$2.50. With Radiogem there is nothing else to buy—the outfit includes the Radiogem receiving apparatus, 1,000 ohm phone, and aerial outfit. The cheapest radio outfit on the market—yet as practical as the most expensive. Big money to the right men. Send \$1.35 for sample outfit. The Radiogem Corp., 66-R West Broadway, New York City.

**Lightning Strange Battery Compound.** Charges discharged batteries instantly. Eliminates old method entirely. Sold free to agents. Lightning Co., St. Paul, Minn.

**Shoes**—Become our local salesman selling high grade shoes direct to wearer. Quick seller and good commission. Experience not required. Tamers Shoe Mfg. Co., 616 C St., Boston, Mass.

**Sell Coal in Carload Lots.** Side or main line. Experience unnecessary. Earn week's pay in an hour. Liberal drawing account arrangement. Washington Coal Company, 767 Coal Exchange Building, Chicago.

**Scenery to Rent**

Settings for Opera, Plays, Minstrels. Plush Drops. Address Amelia Grain, Philadelphia.

**Song Poems Wanted**

Poems Wanted—Sell your song-verses for cash. Submit Mss. at once, or write New Era Music Co., 152 St. Louis, Mo.

**Stammering**

St-Stu-t-t-tering and Stammering cured at home. Instructive booklet free. Walter McDonnell, 121 Exchange Bank Bldg., Washington, D. C.

**Stamps and Coins**

California gold. Quarter size 27c; half-dollar size 55c; Half-dime and Catalog 10c. Norman Schultz, Colorado Springs, Colo.

**Stamps Free**—Variety Packet foreign stamps with envelope—2c postage. Gray Stamp Company, Station E4, Toronto, Canada.

**Stamps**—50 varieties, Brazil, Peru, Cuba, etc. 10c; 50 different U. S., 2c; 1,000 hinges, 10c. 1,000 mixed, 25c. List Free. C. Stephenson, 5956 Cote Brillante, St. Louis, Missouri.

**Telegraphy**

Telegraphy—Both Morse and Wireless taught thoroughly and quickly. Tremendous demand. Big salaries. Wonderful opportunities. Expenses low; chance to earn part. School established fifty years. Catalog free. Duke's Institute, Cour St., Indianapolis, Ind.

**Ventriloquism**

Ventriloquism taught almost anyone at home. Small cost. Send 2c stamp today for particulars and program. W. Smith, Room M-368, 125 N. Jefferson Ave., Peoria, Ill.

**Wanted to Buy**

Full Value Paid for Old Gold, Jewelry, Watches, Diamonds, crowns, bridges, dental gold, silver, platinum. Packages returned if our offer is not satisfactory. United States Smelting Works (The Old Reliable), 120 So. State St., Dept. 18, Chicago, Ill.

Cash for old jewelry, teeth, gold, silver. Highest prices. Prompt payment. Mail to Baltic Mercantile Co., 10119 Baltic Rd., Cleveland, Ohio.

# Easy to Do Business

With "Liberty M. O."

No red tape—no bother

## Everything You Need In Radio

Biggest stock in New York. Dependable, well-known, advertised goods—and satisfaction guaranteed or money back. Reference, Corn Exchange Bank, Terminal Branch.

### SEND NO MONEY

for goods—just pay postman on delivery. Postage free.

## Order from this Ad.

TRANSFORMERS, All-American, 3-1, 5-1, 10-1; 500,000 in use. List \$1.75	<b>\$3.45</b>
TUBES, O-T 2, Siltertone; 4-volt; dry cell; equal to any. Save 34%. List \$6.00	<b>3.95</b>
TUBES, RCA WD-11 or WD-12, 1 1/2-volt; dry cell. List \$5.00. Save 16%	<b>4.20</b>
HEAD PHONES, Little Tautler; always satisfactory. List \$4.00	<b>2.95</b>
HEAD PHONES, Baldwin "C"; double; none better. Save 30%. List \$12.00	<b>8.45</b>
COUPLERS, Genuine Capitol All-Wave, 150-3,000 meters. List \$7.00	<b>5.45</b>
VARIOMETERS, Libbey, mounted; 150-600 meters; high grade. List \$7.00	<b>2.95</b>
LOUD SPEAKERS, Perfec-tone, adjustable; excellent. List \$15.00	<b>11.45</b>
LOUD SPEAKER UNITS, Blue Stream; single; use with any horn. Very satisfactory. List \$3.45	<b>2.45</b>
NEUTRODYNE KITS, Work-Rite, Hazeltine patents. List \$17.50	<b>14.25</b>

**FREE** With your first order we will send you free a 28 x 38 in. radio station map of the U. S. and a set of 31 Decalcomania name transfers for your panel. Send order today.

**CUT-PRICE CATALOG 10c**

Amount refunded on your first order. Book crammed full of money-saving offers of sets, parts, accessories and diagrams. You need it.

WRITE FOR IT TODAY!

# LIBERTY MAIL ORDER HOUSE

Dept. 6796  
106 Liberty St., N. Y. C.

Capacity 1,000



# The Breakers

Atlantic City, N. J.

ON THE OCEAN FRONT

Fireproof

American and European Plans

Orchestra Dancing  
Golf Privileges Cabinet Baths

Garage

JOEL HILLMAN, President

## LEICH ELECTRIC CO.

Leich Headphones, Non Tune Rectifiers  
L-Radio Jacks and Plugs  
Write for complete Radio Bulletin 101-C  
GENOA, ILLINOIS

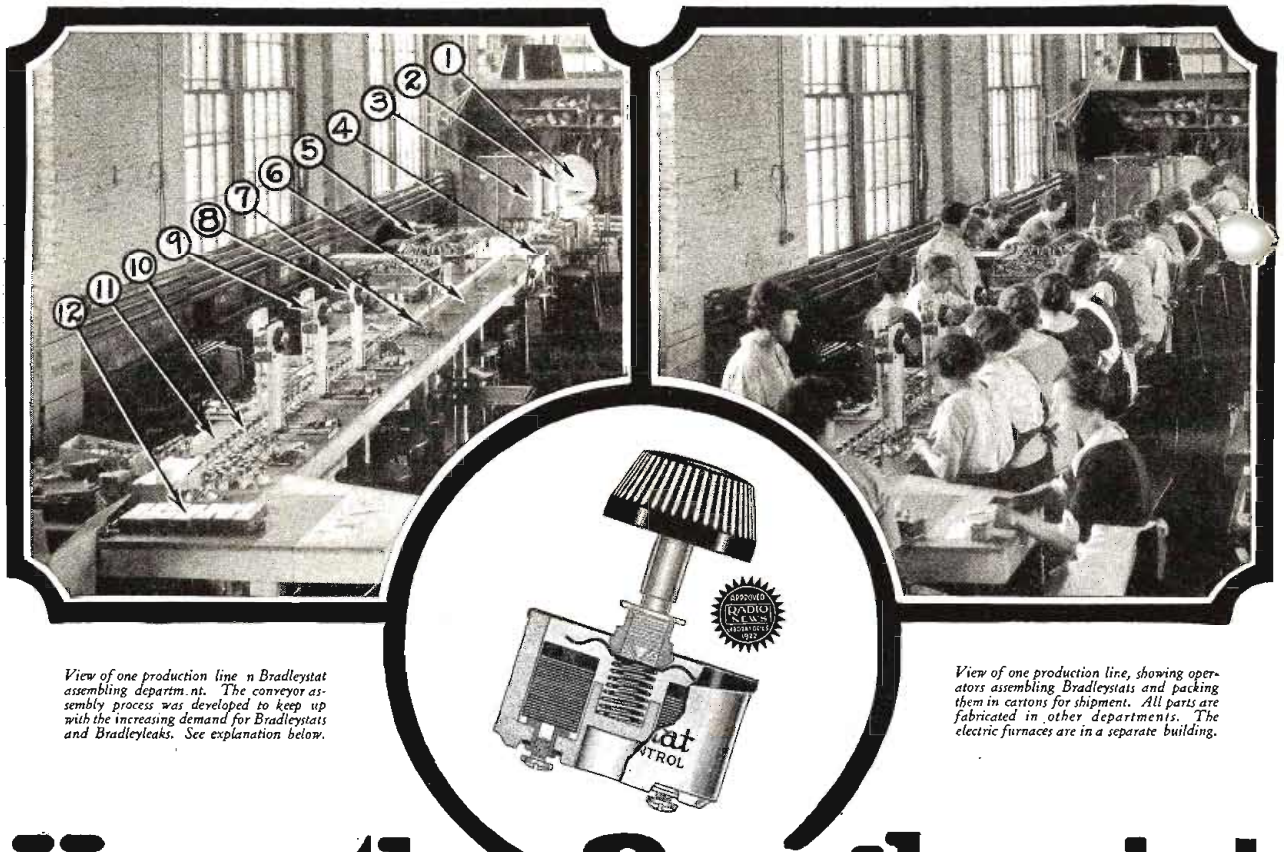

View of one production line in Bradleystat assembling department. The conveyor assembly process was developed to keep up with the increasing demand for Bradleystats and Bradleyleaks. See explanation below.

View of one production line, showing operators assembling Bradleystats and packing them in cartons for shipment. All parts are fabricated in other departments. The electric furnaces are in a separate building.

# How the Bradleystat is made

FOR over twenty years the Allen-Bradley Co. has made graphite disc rheostats for battery chargers and motor starters. The experience gained during these twenty years is embodied in the most perfect filament rheostat used in radio, the Bradleystat.

Today, the Universal Bradleystat, with its two columns of graphite discs under adjustable pressure, provides unequalled control for radio tubes. Its control is absolutely noiseless, stepless and of exceedingly wide range.

Bradleystats are assembled by the most modern methods and tested rigidly before they are shipped.

The illustration above depicts the assembly process that guarantees a uniform product for the radio fan.

- |                              |                             |
|------------------------------|-----------------------------|
| 1—Cleaning porcelains        | 7—Installing cover plates   |
| 2—Riveting terminals         | 8—Inserting adjusting knobs |
| 3—Threading terminals        | 9—Six testing machines      |
| 4—Inserting terminal screws  | 10—Conveying Bradleystats   |
| 5—Disc-filling machine       | 11—Inspecting Bradleystats  |
| 6—Inserting pressure springs | 12—Packing Bradleystats     |

Bradleyleaks follow the same process, except for the use of different discs and the installation of condensers.

Install Bradleystats in your radio set, if you want the finest filament control obtainable. Try one, and experience new delights in radio reception.

**Allen-Bradley Co.**  
Electric Controlling Apparatus

287 Greenfield Avenue



MILWAUKEE, Wisconsin

For Sale at All Dealers  
BRADLEYSTAT . . . . \$1.85  
BRADLEYLEAK . . . . 1.85  
CONDENSER (.00025 mf.) . . . . .35

THE ALLEN-BRADLEY CO. HAS BUILT GRAPHITE DISC RHEOSTATS FOR OVER TWENTY YEARS



# Triple Range



0.1ohm

Low  
Loss

## The True Measure of Efficiency

0.1 ohm is the resistance of the  
**CONNECTICUT**  
D-10

### Triple Range Variable Condenser

at a capacity of 330 micro-microfarads on a wave length of 215 meters.

This is a statement that means something

Those who know that the losses of a condenser are in direct proportion to its resistance—

Those who have learned that measurements taken at radio frequency are much more valuable than those taken at audio frequency—

Those who can see the importance of judging the efficiency of a condenser for amateur and broadcast work on results obtained at a frequency in the immediate vicinity of that at which it is to be used—

Will see in the above the real reason why this condenser should be used by all who wish to obtain the greatest degree of signal strength and sensitivity from their receiving equipment

### Three Condensers in One

These three ranges of capacity enable it to take the place of the ordinary eleven, twenty-three and forty-three plate instruments

The chart tells the story—

The range indicated by Curve B—from .000075 to .000275 mfd.—approximately that of an eleven plate condenser is secured by wiring into the circuit from posts G and B

The range indicated by Curve A—from .0001 to .0006 mfd.—approximately that of a twenty-three plate condenser, is secured by wiring into the circuit from posts G and A

The range indicated by Curve AB—from .00015 to .00085—approximately that of a forty-three plate condenser is secured by bussing A and B and wiring into the circuit from G and B

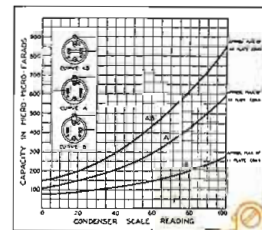

**FEATURES: Vernier Scale—Complete Shielding—Compact Size**  
And all the convenience that goes with One-hole Mounting

**PRICE \$4.50**

Complete with dial, index stud, spacing washers and buss bar.

Send for Bulletin A-104 describing this unique instrument, with information and diagrams illustrating its special applications.

**CONNECTICUT TELEPHONE & ELECTRIC COMPANY**  
MERIDEN RADIO DIVISION CONNECTICUT



J-125 Head Phone  
\$7.00



D-5 Wave Filter  
\$6.50



J-121 A. F. Transformer  
\$5.00



J-136 Sodion Adapter  
75 cents



J-128 Sodion Socket  
75 cents

# \$35 for a two tube Radiola

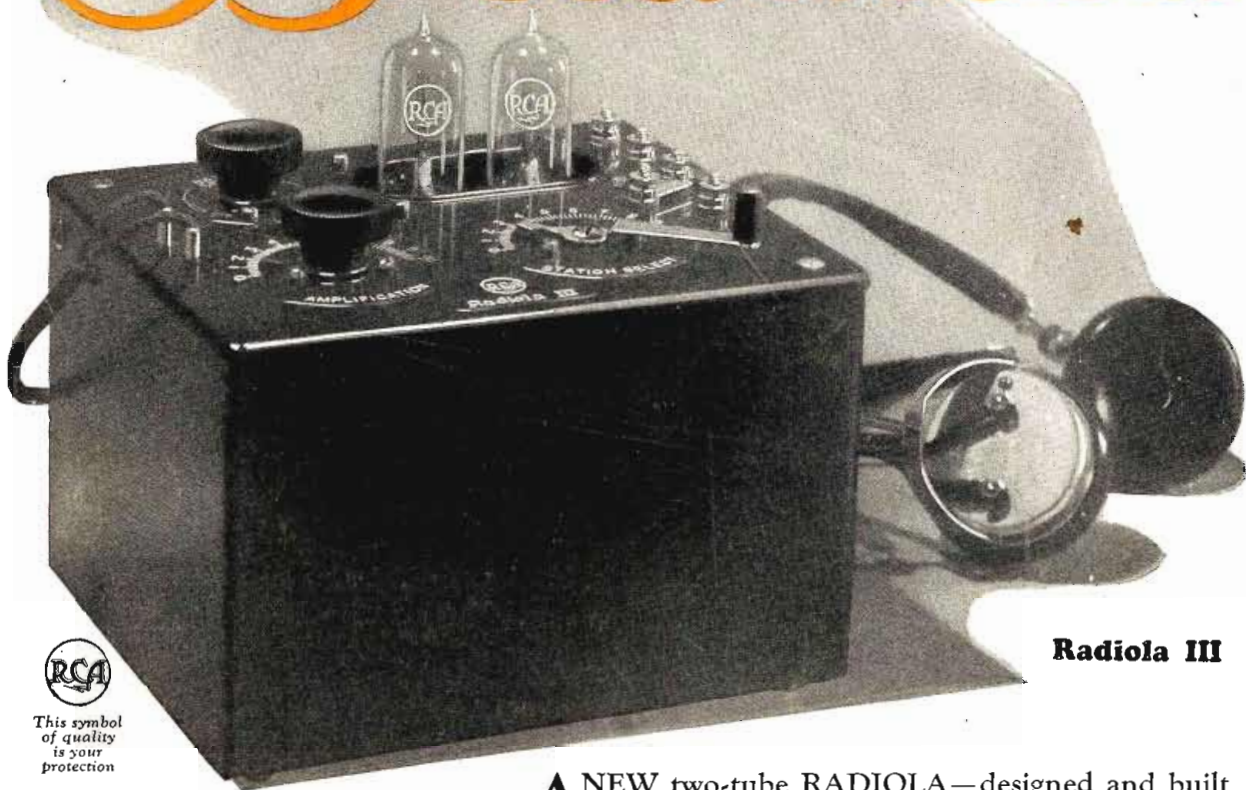

**Radiola III**

  
 This symbol of quality is your protection

**At \$35**  
 Radiola III. Two Radiotrons WD-11. Head telephones. In brief, everything except the dry batteries and the antenna.

**You Can Add**  
 Radiola Loudspeaker, \$36.50  
 Radiola Balanced Amplifier (push-pull) to get long distances with a loudspeaker. Including two Radiotrons WD-11 \$30

**Or Buy Complete**  
 RADIOLA III-A, the amplifier combined with Radiola III in one cabinet; with four Radiotrons WD-11, head telephones and Radiola Loudspeaker . . . . . \$100

*Operates on Dry Batteries*

*There are many Radiolas at many prices. Send for the free booklet that describes them all.*

A NEW two-tube RADIOLA—designed and built by world-famed engineers in the great RCA laboratories—priced at less than you could build it for at home! A real RADIOLA—including the tubes and the headphones. A new model. Improved in sensitivity and selectivity. Getting distance on the headphones, and near stations on a loudspeaker. Receiving clearly—reproducing truthfully. Its thirty-five dollar price means at last that every home everywhere can tune in on the fun with a small receiver built for big performance.

*“There’s a Radiola for every purse”*

Radio Corporation of America

Sales Offices:  
 233 Broadway, New York 10 So. La Salle St., Chicago, Ill. 433 California St., San Francisco, Cal.

RADIO CORPORATION OF AMERICA	
Dept. 26 (Address office nearest you.)	
Please send me your free Radio Booklet.	
Name	_____
Street Address	_____
City	R.F.D. _____
State	_____

# Radiola

REG. U. S. PAT. OFF.