

RADIO NEWS

REG. U.S. PAT. OFF.

Edited by HUGO GERNSBACK

JUNE
25 Cents

Over 200
Illustrations



TELEVISION
ON
PHONOGRAPH
RECORD
SEE PAGE 1422

EXPERIMENTER PUBLISHING COMPANY, NEW YORK, PUBLISHERS OF
SCIENCE & INVENTION - RADIO LISTENERS' GUIDE - AMAZING STORIES - MONEY MAKING - RADIO INTERNACIONAL

Cunningham

RADIO TUBES

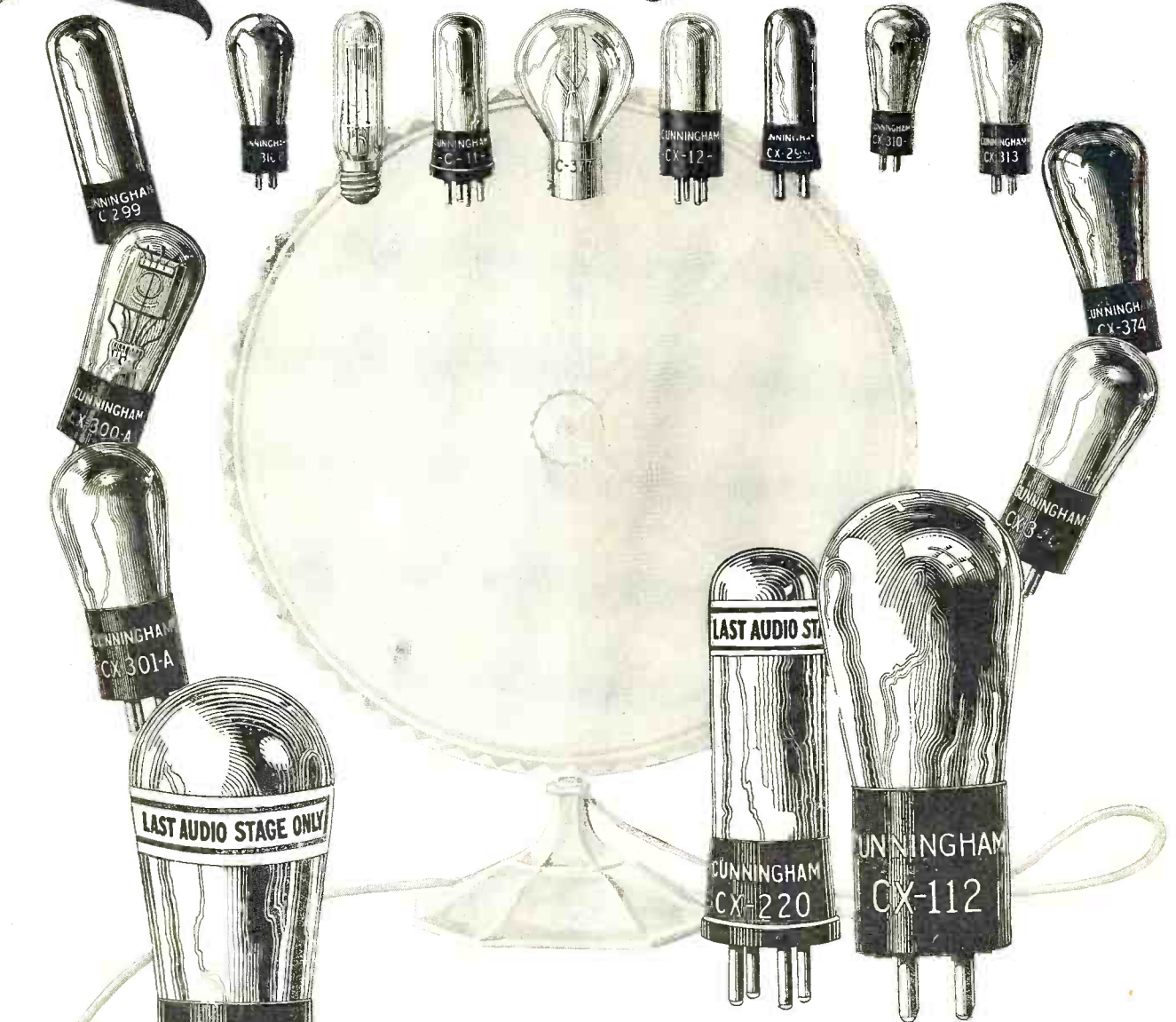

At the Reproducer

At the reproducer—where quality counts most—Cunningham Power Tubes prove their indispensability to finished, well-rounded tone. Just as CX-371, CX-112 and CX-220 are leaders in the crusade for more natural reproduction, so other Cunningham types are leaders in their various fields.

Consult your dealer. He knows the right combination of radio tubes for your receiver.

Sixteen Types all in the Orange and Blue Carton

E. T. CUNNINGHAM, INC.

New York

Chicago

San Francisco

Manufactured and sold under rights, patents and inventions owned and/or controlled by Radio Corporation of America.

Since 1915
Standard
for all
Sets.

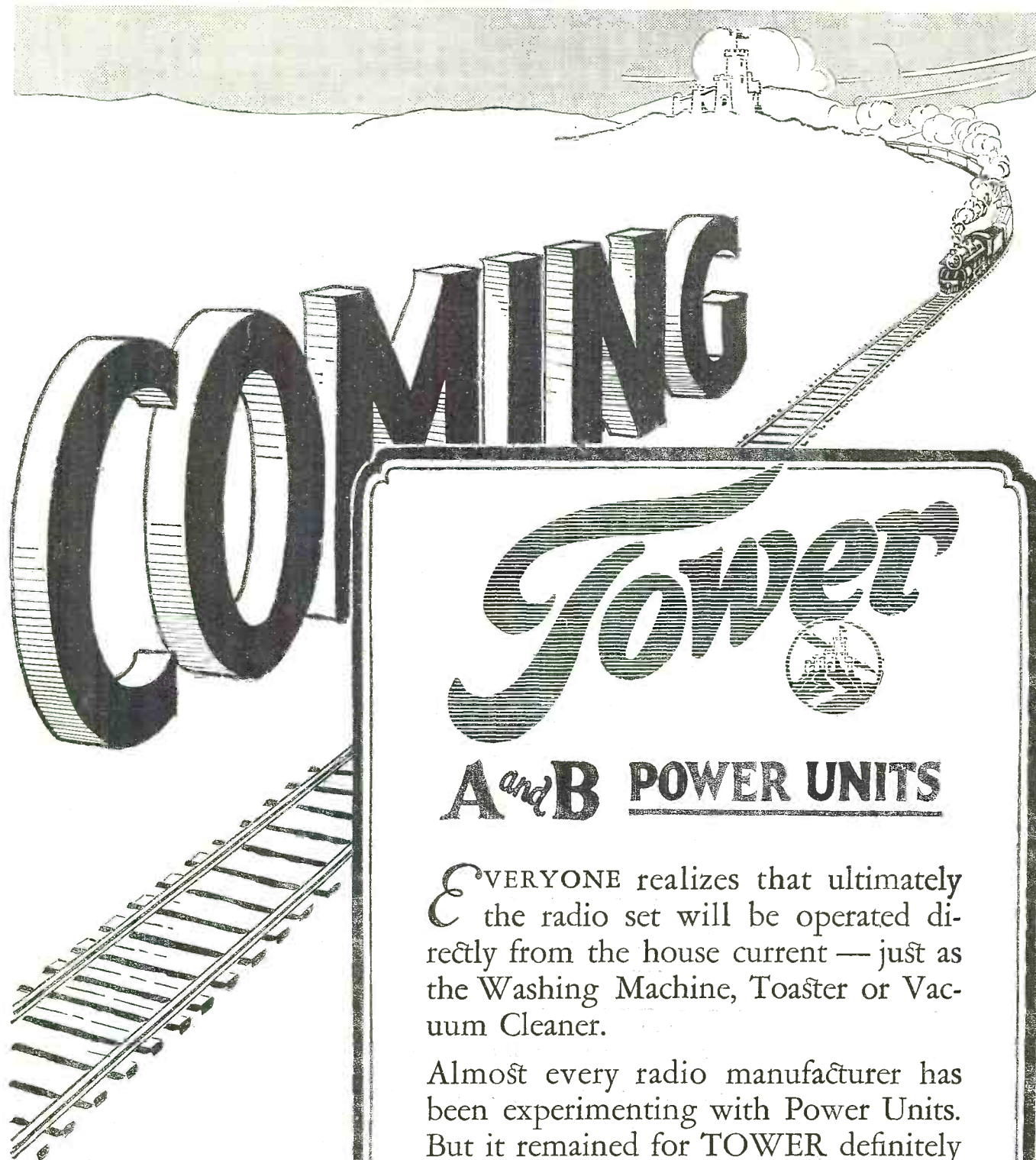

A^{and}B POWER UNITS

EVERYONE realizes that ultimately the radio set will be operated directly from the house current — just as the Washing Machine, Toaster or Vacuum Cleaner.

Almost every radio manufacturer has been experimenting with Power Units. But it remained for TOWER definitely to establish a new standard in electric light socket operation — at lowest prices consistent with maximum quality.

Coming, in next month's issue, full particulars regarding TOWER Power Units.

TOWER MFG. CORP. Boston, Mass.

RADIO NEWS

Published by EXPERIMENTER PUBLISHING COMPANY, Inc., Publishers of "Radio News," "Science and Invention," "Radio Program Weekly," "Radio Listeners' Guide," "Spare-Time Money Making" and "Amazing Stories."

H. GERNSBACK, President. S. GERNSBACK, Treasurer. R. W. DEMOTT, Secretary.

Member: Audit Bureau of Circulations Radio Magazine Publishers Association

Editorial and General Offices: - - 230 Fifth Avenue, New York City

VOLUME 8

JUNE, 1927

NUMBER 12

Contents of This Issue:

Television to the Front, By Hugo Gernsback 1419	The Transoceanic Radiotelephone Interflex, By Mark Hinder 1446
Guiding the Battle Fleet, By Lieut. H. F. Breckel 1420	Aerial Electricity and the Solar Cycle 1449
Television Sees in Darkness and Records Its Impressions, By A. Dinsdale 1422	The New Raytheon "A-B-C" Power Unit, By Arthur H. Lynch and James Millen 1450
Radio Vision Demonstrated in America, By H. Winfield Secor 1424	The El-Fonic Adapter Unit, By F. A. Jewell 1453
Uncle Sam's Smallest Broadcast Station, By S. R. Winters 1427	The DeLuxe System of Broadcast Reception, By Arthur H. Lynch 1456
Radio News of the Month, 1428	Progress in Radio 1459
Radio News of the Month Illustrated, By George Wall 1429	New Power Pack and Power Amplifier, By McMurdo Silver 1460
The Face That Vamped a Thousand Guys, By Robert Francis Smith 1430	Easy Construction for the "Ham," By John L. Reinartz 1462
English-Australian Radio Beam System 1432	Letters from Home Set Constructors 1464
New York's Welcome Ship 1433	Radio Wrinkles 1466
List of Broadcast Stations in U. S. 1434	Radiotics 1467
Giant New Transmitting Tube, By Joseph Riley 1435	RADIO NEWS LABORATORIES 1468
What Tuning Really Does Electrically, By E. H. Rietzke and S. K. MacDonald, Jr. 1436	I Want to Know, By Joseph Goldstein 1470
What's New in Radio 1438	"Televisionary" 1484
The Interbalanced Regenerative Receiver, By Andrew Barbieri 1442	"Choose Your Sound," By Roy Coleman 1485
	Radio Jingles 1486
	Book Review, By Robert Hertzberg 1501
	Current Radio Articles 1502

In Forthcoming Issues:

A DESCRIPTION OF THE STRO-BODYNE CIRCUIT

The first practical combination of the regenerative and superheterodyne principles by a French engineer.

A STUDY OF THE INTENSITY OF BROADCAST STATION RADIATIONS, BY S. R. WINTERS

Explaining the importance of knowing a station's working range.

A TRAVELER'S SET

A description of a small and really portable receiver, which can be built into a standard card-filing case.

RADIO NEWS is published on the 10th of each preceding month. There are 12 numbers per year. Subscription price is \$2.50 a year in U. S. and possessions. Canada and foreign countries, \$3.00 per year. U. S. Coin as well as U. S. Stamps accepted (no foreign coins or stamps). Single copies, 25 cents each. Checks and money orders should be drawn to order of EXPERIMENTER PUBLISHING CO. INC.

All communications and contributions to this journal should be addressed to Editor, RADIO NEWS, 230 Fifth Ave., New York, N. Y. Unaccepted contributions cannot be returned unless full postage has been included. All accepted contributions are paid for on publication. A special rate is paid for novel experiments; good photographs accompanying them are highly desirable.

RADIO NEWS, Monthly. Entered as second class matter, July 12, 1924, at the Post Office at New York, N. Y., under the Act of March 3, 1879. Additional entry at Long Island City, N. Y., and San Francisco, Calif. Title registered U. S. Patent Office. Copyright, 1927, by The Experimenter Publishing Co., Inc., 230 Fifth Ave., New York. The contents of this magazine are copyrighted and must not be reproduced in the United States without giving full credit to the publication. Translation into foreign languages must not be made unless permission is obtained from the publishers. Copyright in Germany. Reproduction of articles in Germany is reserved for Radio, Berlin 42.

RADIO NEWS is for sale at all newsstands in the United States and Canada, and at Brentano's, Ave. de l'Opera, Paris, France. European agents: S. J. Wise Et Cie, 40 Place Verte, Antwerp, Belgium.

HOW TO SUBSCRIBE FOR RADIO NEWS. Send your name, address and remittance to Experimenter Publishing Co., 230 Fifth Ave., New York. Mention the name of the magazine you are ordering. We also publish SCIENCE AND INVENTION, RADIO PROGRAM WEEKLY, RADIO LISTENERS' GUIDE, SPARE TIME MONEY MAKING and AMAZING STORIES. Write clearly.

RATES AND TERMS. The subscription rate for RADIO NEWS is \$2.50 per year (12 numbers). When remittances do so by check, money order, or registered letter if cash is enclosed. Avoid sending cash through the mail if possible. Subscriptions for less than one year are not accepted. Subscription may be made in combination with SCIENCE & INVENTION, RADIO PROGRAM WEEKLY, RADIO LISTENERS' GUIDE, SPARE TIME MONEY MAKING and AMAZING STORIES.

POSTAGE. We prepay postage in all parts of the United States, Mexico and island possessions. For foreign or Canadian subscriptions we require 50 cents in addition to the subscription price for additional postage charge.

CHANGE OF ADDRESS. Notify us as far in advance as possible. It requires several weeks to make an address change on our records. Always write clearly.

General Advertising Dept., 230 Fifth Avenue, New York City

ADVERTISING REPRESENTATIVES

L. F. McCLURE, 720 Cass Street, Chicago, Ill.
DAVIES, DILLON & KELLY, 15 West 10th St., Kansas City, Mo.
T. F. MAGRANE, Park Square Bldg., Boston, Mass.

HARRY E. HYDE, 548 Drexel Building, Philadelphia, Pa.
A. J. NORRIS HILL CO., 5 Third St., San Francisco, Calif.
412 West 6th St., Los Angeles, Calif.

Snap a switch

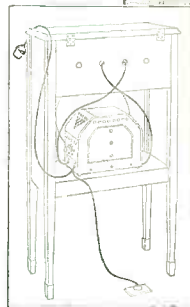
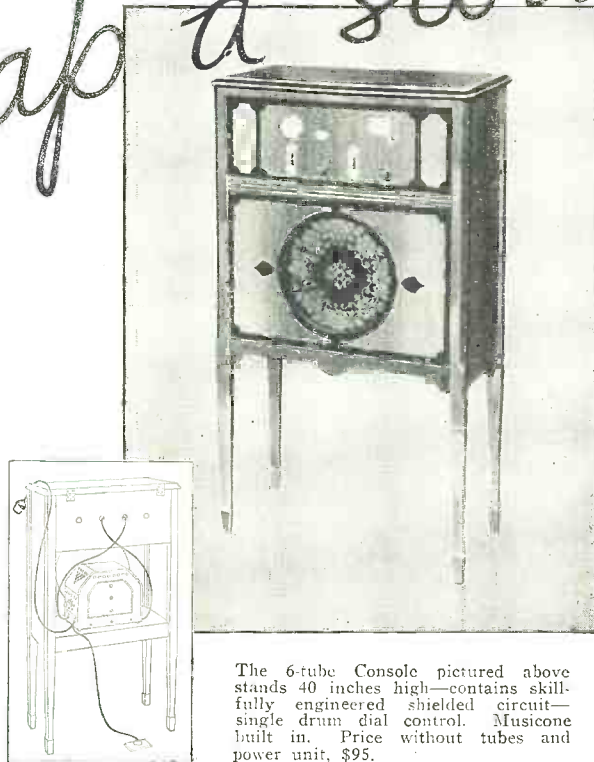

- No more batteries.
- No battery charger to watch.
- No batteries to water.
- No failure of the power plant just as you sit down to a fine program.
- No upsetting the house to have the radio serviced.
- No apologies to make to callers that the batteries have just run down.
- No batteries to recharge.
- No batteries to renew.

The 6-tube Console pictured above stands 40 inches high—contains skillfully engineered shielded circuit—single drum dial control. Musicone built in. Price without tubes and power unit, \$95.

A B and C power from light socket for the latest model Crosley A C Radios

This power unit weighs 13 pounds, stands 9 inches high and is 4 inches wide and requires no more attention than a vacuum cleaner or an electric iron. It transforms mechanically ordinary 110-volt 60-cycle house current into smooth quiet radio energy. *No interfering hum!*

Price \$50

Crosley radios especially designed to use this battery eliminator are the 6-tube AC-7, a neat table model of the famous Crosley single drum control receiver selling at \$70 and the 6-tube console model AC-7-C, pictured above at \$95.

Prices slightly higher west of the Rocky Mountains.

Crosley Musicone \$9.75 and \$14.75

Write Dept. 22 for descriptive literature.

THE CROSLEY RADIO CORPORATION

Cincinnati, Ohio

Powel Crosley, Jr.



TO SET

Crosley sets are licensed under Armstrong U. S. Patent, No. 1,113,149 or under patent applications of Radio Frequency Laboratories, Inc., and other patents issued and pending.



INDEX TO ADVERTISERS

INDEX TO ADVERTISERS

A	Page	D	Page	J	Page	R	Page
Acme Apparatus Co.....	1479	DeForest Radio Co.....	1471	Jefferson Electric Mfg.		Radiall Company	1474
Acme Electric & Mfg.		Deutschmann Co., Tobe..	1480	Co.	1495	Radio Association of	
Co., The	1482	Dexter & Sons, Inc.,		Jewell Electrical		America	1493
Adams-Sibley Develop-		C. H.	1496	Instrument Co.....	1493	Radio Corp. of America	
ment Corp.	1487	Dongan Electric Mfg. Co.	1478	Jewell Labs.....	1487	Back Cover	
Aero Products, Inc.....	1486	Donle-Bristol Corp., The	1495			Radio Institute of	
Aero-Systems, Inc.....	1490			K		America	1490
Aerovox Wireless Corp...	1476	E		Karas Electric Co.	1484	Radio Specialty Co.	1481
Alden Mfg. Co., The....	1488	Electrad, Inc.	1486	Kellogg Switchboard &		Raytheon Mfg. Co.	1477
All Radio Co.....	1488	Electric Specialty Co., ...	1497	Supply Co.	1476	S	
Allen-Bradley Co.	1474	Emerson-Radval Corp....	1484	Klosner Radio Corp.	1498	Sheridan Plaza Hotel ..	1498
American Chime Clock		Engineers' Service Co....	1498	Kodel Radio Corp., The..	1500	Shure Radio Co.	1480
Co.	1500	Erie Fixture Supply Co..	1484	Kokomo Electric Co.	1491	Silver-Marshall, Inc.	1482
American Hard Rubber				L		Smith, B. Hawley	1474
Co.	1492	F		Lacault Radio Labs., R. E.	1494	Southern Toy Co.	1496
American Mechanical		Fansteel Products Co....	1488	Lacey & Lacey	1490	Starrett Mfg. Co.	1496
Labs.	1478	Fast & Co., John E.....	1478	Langbein-Kaufman Radio		Steinite Labs.	1497
Amplion Corp. of America	1498	Ferbend Electric Co.....	1472	Co.	1482	Sterling Mfg. Co., The ..	1474
Amrad Corp., The.....	1476	Ferguson, Inc., J. B.....	1486	Leutz, Inc., C. R.	1492	Sterling Stop Watch Co..	
		Ferranti, Inc.	1492	Lynch, Inc., Arthur		The	1500
		Formica Insulation Co..		H.	1478, 1482	Stewart Battery Co.	1496
		The	1489	M		Straus & Schram	1474
		Freshman Co., Inc., Chas.	1498	M & H Sporting Goods		T	
		Frost, Inc., Herbert H... 1484		Co.	1480	Thordarson Electric Mfg.	
		Furness Bermuda Line... 1490		Martin-Copeland Co.	1491	Co.	1482
B				Metro Electric Co.	1489	Tower Mfg. Corp.....	1413
Bathgate Co., Inc.,		G		Midwest Radio Corp.	1490	Townsend Laboratories ..	1484
Walter	1496	Gearhart-Schleuter Radio		N		V	
Bogue, B. N.....	1500	Corp.	1500	Nassau Hotel, The	1491	Valley Electric Co.	1492
Boudette Mfg. Co.....	1496	General Radio Co.....	1490	National Carbon Co., Inc.,	1490	W	
Brady, John B.....	1486	Goodrich Rubber Co.,		National Company, Inc... 1480		Walker Co., Geo. W.	1496
		The B. F.....	1476	National Radio Institute.. 1417		Weber, Henry	1490
		Gray & Danielson Mfg.		Norden-Hauck, Inc.	1485	Webster Co., The	1480
		Co.	1500	North American Bretwood		Western Radio Mfg. Co.	1490
		Grigsby-Grunow-Hinds		Co., The	1475	Windsor Furniture Co....	1482
		Co.	1473	O		Wirt Company	1496
		H		Omnigraph Mfg. Co., The	1497	World Battery Co. ..	1492, 1500
		Hammarlund Mfg. Co.... 1493		P		X-Y	
		High Frequency Labs.... 1488		Parker, C. L.	1498	X-L Radio Sales Co.....	1490
C		I		Penn Radio Sales Co.... 1482		X-L Radio Labs.	1484
C. E. Mfg. Co., Inc.....	1474	International Resistance		Press Guild, Inc., The	1486	Yahr-Lange, Inc.....	1494
Carborundum Co., The... 1491		Co.	1498			Yaxley Mfg. Co.	1498
Carter Radio Co....	1478, 1500						
Central Radio Labs.....	1480						
Chemical Institute of							
N. Y., Inc.....	1483						
Chicago Radio Apparatus							
Co.	1489						
Chicago Salvage Stock							
Store	1492						
Cloverleaf Mfg. Co..							
Inside Back Cover							
Columbia Radio Corp....	1492						
Conrad Co., Inc., The							
1501, 1504, 1505,							
1506, 1507, 1508							
Cooper Corp., The.....	1496						
Copper & Brass Research							
Ass'n.	1418						
Cornish Wire Co.....	1492						
Coyne Electrical School..	1488						
Cresradio Corp.....	1500						
Crosley Radio Corp., The	1415						
Cunningham, Inc., E. T.,							
Inside Front Cover							

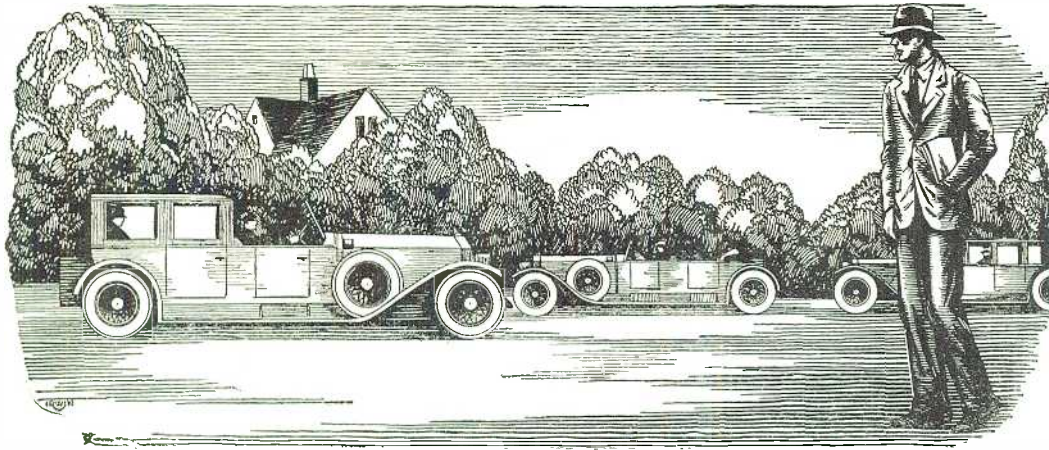

Many times in the old days, while I trudged home after work to save carfare, I used to gaze curiously at the shining cars gliding by me, the prosperous men and women within. Little did I think that inside of a year, I, too, should have my own car, a decent bank account, the good things of life that make it worth living.

I Thought Success Was For Others

*Believe It Or Not, Just Twelve Months Ago
I Was Next Thing To "Down-and-Out"*

TODAY I'm sole owner of the fastest-growing Radio store in town. And I'm on good terms with my banker, too—not like the old days only a year ago, when often I didn't have one dollar to knock against another in my pocket. My wife and I live in the snuggest little home you ever saw, right in one of the best neighborhoods. And to think that a year ago I used to dodge the landlady when she came to collect the rent for the little bedroom I called "home"!

It all seems like a dream now, as I look back over the past twelve short months, and think how discouraged I was then, at the "end of a blind alley." I thought I never had had a good chance in my life, and I thought I never would have one. But it was waking up that I needed, and here's the story of how I got it.

I was a clerk, working at the usual miserable salary such jobs pay. Somehow I'd never found any way to get into a line where I could make good money.

Other fellows seemed to find opportunities. But—much as I wanted the good things that go with success and a decent income—all the really well-paid vacancies I ever heard of seemed to be out of my line, to call for some kind of knowledge I didn't have.

And I wanted to get married. A fine situation, wasn't it? Mary would have agreed to try it—but it wouldn't have been fair to her.

Mary had told me, "You can't get ahead where you are. Why don't you get into another line of work, somewhere that you can advance?"

"That's fine, Mary," I replied, "but what line? I've always got my eyes open for a better job, but I never seem to hear of a really good job that I can handle." Mary didn't seem to be satisfied with the answer but I didn't know what else to tell her.

It was on the way home that night that I stopped off in the neighborhood drug store, where I overheard a scrap of conversation about myself. A few burning words that were the cause of the turning point in my life!

With a hot flush of shame I turned and left the store, and walked rapidly home. So that was what my neighbors—the people who knew me best—really thought of me!

"Bargain counter sheik—look how that suit fits," one fellow had said in a low voice. "Bet he hasn't got a dollar in those pockets." "Oh, it's just 'Useless' Anderson," said another. "He's got a wish-bone where his back-bone ought to be."

As I thought over the words in deep humiliation, a sudden thought made me catch my breath. Why had Mary been so dissatisfied with my answer that "I hadn't had a chance?" *Did Mary secretly think that too?* And after all, wasn't it true that I had a "wish-bone" where my back-bone ought to be? Wasn't that why I never had a "chance" to get ahead? It was true, only too true—and it had taken this cruel blow to my self-esteem to make me see it.

With a new determination I thumbed the pages of a magazine on the table, searching for an advertisement that I'd seen many times but passed up without thinking, an advertisement telling of big opportunities for trained men to succeed in the great new Radio field. With the advertisement was a coupon offering a big free book full of information. I sent the coupon in, and in a few days received a handsome 64-page book, printed in two colors, telling all about the opportunities in the radio field and how a man can prepare quickly and easily at home to take advantage of these opportunities. I read the book carefully, and when I finished it I made my decision.

WHAT'S happened in the twelve months since that day, as I've already told you, seems almost like a dream to me now. For ten of those twelve months, *I've had a Radio business of my own!* At first, of course, I started it as a little proposition on the side, under the guidance of the National Radio Institute, the outfit that gave me my Radio training. It wasn't long before I was getting so much to do in the Radio line that I quit my measly little clerical job, and devoted my full time to my Radio business.

Since that time I've gone right on up, always under the watchful guidance of my friends at the National Radio Institute. They would have given me just as much help, too, if I had wanted to follow some other line of Radio besides building my own retail business—such as broadcasting, manufacturing, experimenting, sea operating, or any one of the score of lines they prepare you for. And to

think that until that day I sent for their eye-opening book, I'd been wailing "I never had a chance!"

NOW I'm making real money. I drive a good-looking car of my own. Mary and I don't own the house in full yet, but I've made a substantial down payment, and I'm not straining myself any to meet the installments.

Here's a real tip. You may not be as bad off as I was. But, think it over—are you satisfied? Are you making enough money, at work that you like? Would you sign a contract to stay where you are now for the next ten years, making the same money? If not, you'd better be doing something about it instead of drifting.

This new Radio game is a live-wire field of golden rewards. The work, in any of the 20 different lines of Radio, is fascinating, absorbing, well-paid. The National Radio Institute—oldest and largest Radio home-study school in the world—will train you inexpensively in your own home to know Radio from A to Z and to increase your earnings in the Radio field.

Take another tip—No matter what your plans are, no matter how much or how little you know about Radio—clip the coupon below and look their free book over. It is filled with interesting facts, figures, and photos, and the information it will give you is worth a few minutes of anybody's time. You will place yourself under no obligation—the book is free, and is gladly sent to anyone who wants to know about Radio. Just address J. E. Smith, President, National Radio Institute, Dept. F B-9, Washington, D. C.

J. E. SMITH, President,
National Radio Institute,
Dept. FB-9, Washington, D. C.

Dear Mr. Smith:

Please send me your 64-page free book, printed in two colors, giving all information about the opportunities in Radio and how I can learn quickly and easily at home to take advantage of them. I understand this request places me under no obligation, and that no salesmen will call on me.

Name

Address

Town State

For better reception —
Copper Shielding

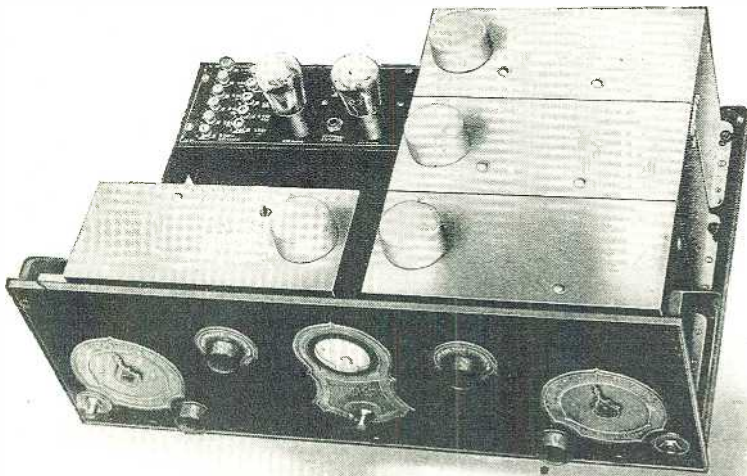

This Stromberg-Carlson six-tube Neutrodyne set, No. 601, is completely shielded with sheet Copper

*Write for our new book on
Copper Shielding. There is
no cost or obligation.*

Copper shielding gives
closer selectivity and
finer tone quality.

Sheet Copper combines
higher conductivity
with easy working
qualities.

COPPER & BRASS
RESEARCH ASSOCIATION
25 Broadway — New York



RADIO NEWS

HUGO GERNSBACK,
Editor and Publisher

Editorial and General Offices, 230 Fifth Avenue, New York

Vol. 8

JUNE, 1927

No. 12

TELEVISION TO THE FRONT

By HUGO GERNSBACK

WITH the official recognition of Television by the Radio Commission, as well as the actual successful demonstration early in April by the American Telegraph and Telephone Co., it may be said that television has finally arrived. The Commission, in setting apart the waveband of 150 to 200 meters for television, and particularly television for experimental purposes, recognized that one of the greatest, long-awaited and predicted inventions of modern times has at last come to the front.

It is interesting to note, in passing, that RADIO NEWS' sister magazine, SCIENCE AND INVENTION (then called *The Electrical Experimenter*), was the first to use the term "Television," in many articles on this subject which it has been publishing for some fifteen years.

To the layman who does not as yet know what television is, I may say that the term describes an electrical process, whereby it is possible to see at a distance and to view distant events as they are taking place. In this way television does for the eye what the telephone does for the ear. Your friend, using the telephone, talks to you from his office, while you are sitting in yours; while the television process is comparable in that you will see your friend as he is talking to you, and, *vice versa*, he will see you.

I have said, many times before, that there exists some confusion in the public mind because there has appeared in the press the unfortunate term of "radio movies," which is a totally different thing from television. The "radio movie" is to television what the phonograph record is to the telephone. The telephone transmits and receives a conversation while it is being held; the phonograph records the conversation or the music, and it is then laid aside until it can be reproduced at a later date. Radio movies are in this class, in that an event is filmed or otherwise recorded and then transmitted at a distance by wire or by radio. I hold the opinion, however, that most likely radio movies will not be very popular in the future when once we have television—which indeed we already have.

When the term "television" is used nowadays, it means television coupled with radio, although there is, of course, no necessity for such a view; because if you have television by radio you can have television by wire, and *vice versa*. If television apparatus is perfected to such a degree that it becomes a commercially practical instrument, the telephone companies will not hesitate to make an attachment that can be used on your desk or home telephone. In that case you will be able to converse with your friend and see him at the same time, if this is desirable.

But, if, for instance, you are not dressed or otherwise do not make a presentable appearance, a button located in the telephone stand which starts transmission may be left unpressed; in which case you will be able to see your friend, but he may not see you.

Television, as far as radio is concerned, will extend the present benefits of radio tremendously. It is recognized by every one that, inasmuch as radio is "blind," an entirely new world will be opened to the radio listener if he can see as well as hear. It will then be possible not only to hear the President of the United States, when he speaks, but to see him as well. And the same thing will be true of Lopez and his orchestra, as well as of all the performers when grand opera is broadcast direct from the stage.

The race for television has been on for over twenty-five years, but it may be said that television became practical only during the past few years, since the invention of a light-sensitive photo-

electric tube. Heretofore it was necessary to use selenium as a light-sensitive instrumentality, which translated the light impulses into electrical ones. It was found, however, soon, that selenium is too slow, because of its inertia, and television apparatus constructed with selenium cells gave no practical results. The photoelectric cells, of which there are now a number of excellent types, have no inertia or lag, and work practically with the same speed as the variations of light. At the sending end of a television apparatus we have at the present time the mechanism of a rotating disc with lenses (or just plain holes), which cuts up the picture successively into points, the impressions of which are then transmitted either by wire or by radio.

At the receiving end a similar apparatus is used, in which the incoming impulses react on an electric-light bulb, which, being usually of the gaseous type, responds with the speed of light to the variations that come into the receiver. Here again, we have a revolving disc with lenses, whereon the light of the aforementioned lamp impinges, and through which the picture is reconstructed on a screen. I have used the word "picture," but it

should be understood that the "picture" may be the face of your friend, while he speaks, or of a baseball player while he plays. Of course this is only the roughest popular outline of a television apparatus, and there are many minor steps which are quite important, but which have not as yet been solved to the satisfaction of our engineers.

For one thing, we require a motor at the transmitter to rotate the disc with its lenses, while a duplicate motor is needed at the receiver to drive its disc and lenses. The ticklish part of the problem has always been, so far, to keep the two motors running in exact step; because the smallest variation in the speed of the motors (that is, when the two motors run out of phase), will cause a blur at the receiver, and the received television picture on the screen will be distorted and a total loss. It is believed that in time the rotating disc will be done away with entirely and that some vibrating medium, perhaps, will be used instead; whereby it should be possible to have perfect synchronization of both transmitter and receiver.

There is one thing that is certain, and that is that the race for television is at the present at its maximum of effort. All the big technical research organizations, the world over, are frantically working on the problem, and it may be said that the organization or inventor who solves the problem in the most practical way will have an invention that will far outrank radio as we know it today. Even as late as five years ago it was thought that a television attachment would probably be a most cumbersome apparatus. We no longer think so today, and I am quite certain, for one, that the final television apparatus on your radio set will take up no more room than your present cone speaker.

And, while I am delighted with the decision of the Radio Commission to set aside a special band for television experiments, actual television as applied to radio will not need an extra waveband. The reason for this is very simple, in that the television impulses can be sent out by the present broadcast transmitters without any trouble. They will be sent out on exactly the same wave at a frequency (of modulating vibrations) so high that the human ear can no longer hear the result. The process will be then reversed at the receiver, where the inaudible signals will be fed through a system of intermediate and step-down transformers, where they will be used for the regular television reception methods.

Wherein the Editor rejoices over the official recognition and practical demonstrations that Television has arrived—and dips back into the days when it was in the field of prophecy—pausing to explain what Television is—how it gives us the history of the present moment—while the "radio movie" tells that of yesterday—how Television may be by radio or an attachment to your wired telephone—and how it may be made an integral part of broadcasting without encroaching farther into other wavebands—yesterday's "impossibility" is tomorrow's necessity.

Mr. Hugo Gernsback speaks every Monday night at 9 P. M. from station WRNY on various radio and scientific subjects.

Guiding the Battle Fleet

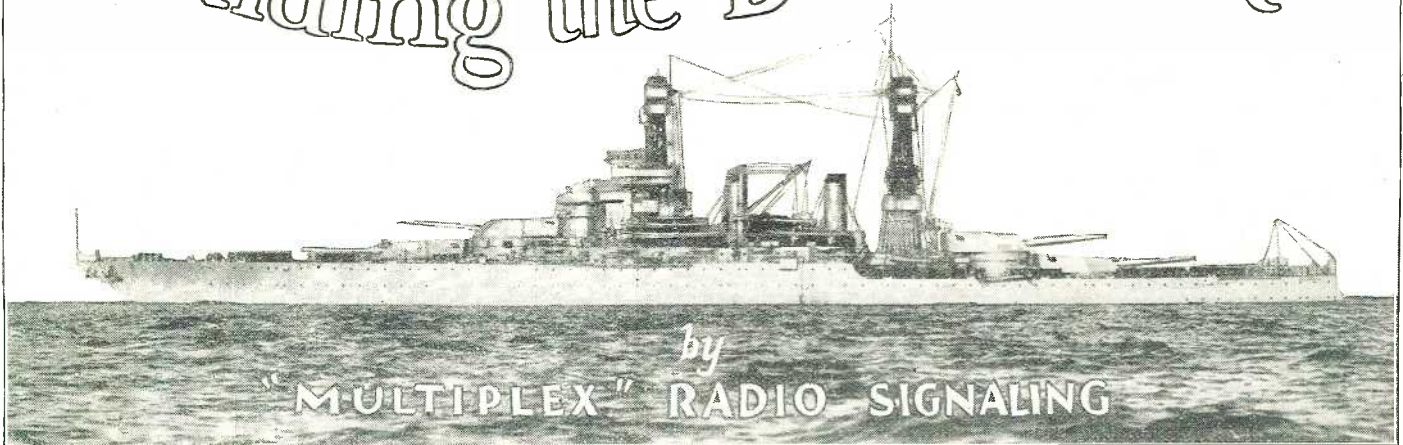

(Above: U.S.S. "Colorado," showing a number of the cage-type aerials with which she is equipped.)

By Lieut. H. F. BRECKEL, U.S.N.R.F.

EVER observant of the importance of radio communication in its application to the strategy of modern naval warfare, the United States Navy has always been insistent in the matter of developing its radio system to the highest possible standard attainable. It is not boasting to point out that, considering the apparatus installed, the ship and shore stations of the navy throughout the world occupy a very superior position; while in the matter of personnel its technical and operating staffs are the equal of any.

The navy's demands for advanced designs and developments have been largely responsible for the rapid progress of American radio systems. Through its modern research laboratory at Bellevue, D. C., the navy has contributed in no small way to the radio art; and the development and perfection of the "multiplex radio system" by this laboratory under the direction of Dr.

A. H. Taylor is but one example of the results obtained.

HIGHLY SELECTIVE CIRCUITS

This, which is also known technically as "the coupling-tube system," can be best described in its functioning as follows (quoting from the patent issued): "The invention relates particularly to the reception of a multiplicity of high-frequency electrical signals, employing the same collector or antenna. The particular object is the multiple reception between the several receivers connected to the one collector. The improvement is of particular value on shipboard, where it may be desirable to receive a large number of signals simultaneously, and where the facilities for rigging a number of antennae are limited."

While the values or constants of the component parts of this system are not available for use, it can be stated that the apparatus comprises a "combination of a collector or antenna circuit having a high resistance in series therewith, and a plurality of radio receivers connected thereto, each through the following elements: a coupling thermionic vacuum tube having its input circuit connected between two points in the high resistance, and the output circuit having in series therewith a tunable circuit variable in nature and in parallel relation; a tunable rejector circuit in series relation with the foregoing tunable circuit, and a further tuned circuit in parallel relation with the tuned rejector circuit."

USE ON BATTLESHIPS

It is through the use of this development as applied practically, that the success of

what can be truly termed "multiplex radio communication," by ships of the navy, is made possible. As applied to the communication system of a battleship, in connection with a special antenna arrangement for transmission, this so-called "Multiplex" system makes it possible to carry on both transmission and reception simultaneously on a number of different frequencies, using either high or low power as the occasion may demand.

The material for this system having been installed on one of our most powerful dreadnaughts, the U. S. S. *Colorado*, a description of it, along with its possible accomplishments, will prove most interesting; for it achieves that which, during the period several years back, was frequently deemed impossible of practical accomplishment without undue interference.

This battleship is equipped with five radio transmission systems; termed, respectively, the main transmitter; a secondary transmitter (tone-modulated type); another secondary transmitter (continuous-wave telegraph and telephone type); fourth, what is known as the auxiliary transmitter, this being of the vacuum-tube type, adaptable to either tone-modulated or continuous frequency transmission; and a "stand-by" spark system. Four antennae are available for use in connection with the transmitters, which have ranges varying from 50 to 3000 miles, as conditions permit, and are designed to permit of transmission over a comparatively wide range of frequencies.

The four modern-tube-transmitters can be used simultaneously; it is possible to send at the same instant, without interference, four separate messages to four different points; as, for example, one to a distant battle squadron, one to the cruiser force, one to the supply ship or destroyer flotillas, and one to aircraft forces.

FROM 4000 TO 100 METERS

The variable-frequency control system applied to the transmitters is such as to provide for transmission over a range of from 75 to 3000 kilocycles; thus giving the *Colorado* a choice of any one of a possible 195 practical communication channels contained in this band of frequencies if the continuous-wave method of telegraphy is used;

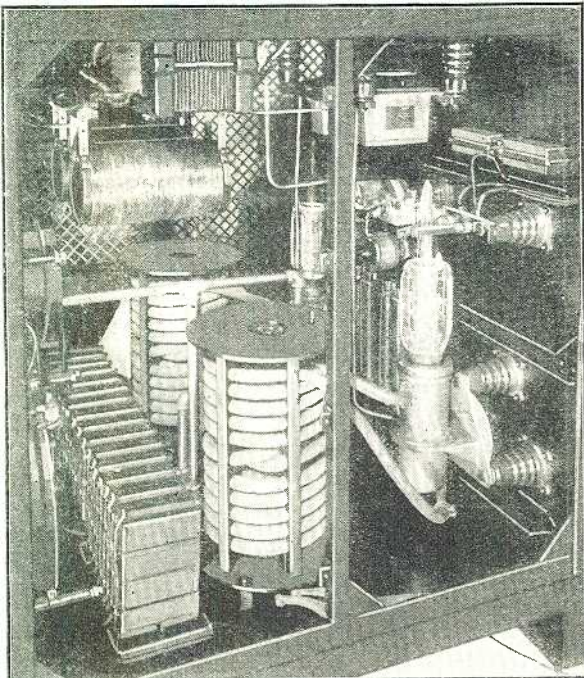

At left, a modern high-power naval transmitter, such as used on the "Colorado"; note the elaborate water-circulation system for cooling the vacuum tubes.

more than 500 channels if the tone-modulation system is used; while, if the radiophone only were used, there would be available but 50-odd channels, owing to the great concentration of apparatus and possible heterodyning of emitted waves.

The receiving equipment of the great fighting machine is no less elaborate, comprising some eight complete receptors, in addition to a late adaptation of the radio compass. These all function in connection with the multiple-reception device previously described, through which all can be operated simultaneously on a single antenna without the slightest interference between them. However, in spite of this possibility, three extra antennae are provided for use, in an emergency or under conditions which may require them.

These receivers are grouped to provide for the many requirements of naval strategy and communications, which include reception of signals from shore stations; the reception of tactical orders; the reception of fire-control observation signals; the interception of enemy communications, and the reception of general orders and routine messages.

The receivers are so calibrated as to permit of reception over a range of frequencies from 10 to 3000 kilocycles, and are the last word in development. They provide for positive reception over maximum distances.

RADIO COMPASS AS A SCOUT

The radio compass takes bearings of transmitters, operating over a range from 10 to 2000 kilocycles, with a good degree of accuracy. This, it is well known, is coming every day into greater use by vessels, in determining their relative position or bearing in fog or darkness, etc. In the case of a battleship, its strategical importance in "fixing" the position of a hostile fleet is of primary value in warfare of the sea. With the speed of the modern fighting ship, enabling it to cover wide distances, it is necessarily made harder to track down a roving enemy force.

In this connection may be recalled the fact that it required more than a hundred British war vessels to track down and put a stop to the depredations on commerce by two fast German cruisers during the early part of the world war. Under certain conditions the use of a radio compass would have enabled a pursuing force to locate the enemy, and also, if merchant vessels were so equipped, would have permitted their evading the cruisers. This statement is, of course, based on the assumption that the enemy makes use of his transmitting equipment, which might or might not be the case.

In the main, however, modern naval strategy calls for complete silence of radio transmitters except when circumstances imperatively make it necessary to use them; which, it may be stated, is not infrequent in spite of the desirability of silence.

Therefore, the so-called "multiplex system" installed aboard the *Colorado* is of

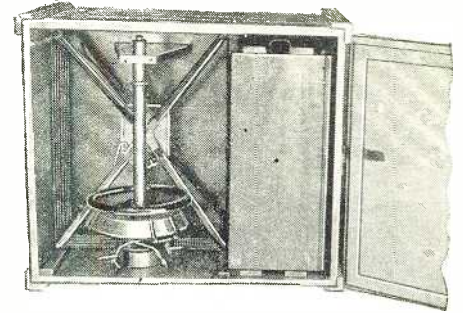

A naval portable radio compass, packed in its case for transportation.

Summing up the "multiplex system" of radio, this enables the *Colorado* to accomplish at the same instant the following: transmit four radio messages; receive seven radio signals from the fleet of battleships or other forces; receive one message from a naval shore station; and take radio compass bearings on other frequencies not being used by the transmitters and receptors at the time.

This is a wonderful achievement, especially to one familiar with the difficulties incidental to operating numerous transmitters and receivers simultaneously in the necessarily close confines of space encountered aboard a battleship. Incidentally, it might be mentioned that there is employed a special system of remote control, which readily permits of the operation of any three transmitters and receptors from three distant points of the ship, known technically as the conning tower (the battle station of the commanding officer and others), the navigating bridge, and the flag bridge.

Thus we see that the navy has continued, without pause, its development of this vital branch of the service which constitutes the nation's first line of defense. We need have no doubt that its vessels are equipped with the latest radio devices, upon which the strategies of modern naval warfare are placing ever-increasing responsibility.

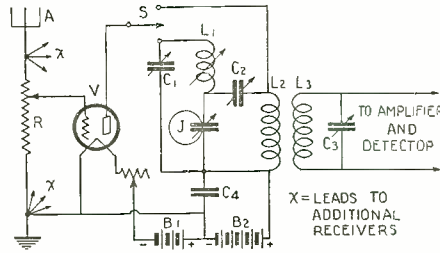

The fundamental circuit of Dr. Taylor's receiver. R is a high resistance, making the antenna "aperiodic," and at different values of which several such circuits may be connected. J is the rejector device, the condenser being shunted by an element whose inductance and resistance are very low. The coupling tube V prevents feed-back from the receiver into the antenna. The circuit values employed by the navy are not available.

great advantage under the varied requirements for the use of radio in the carrying out of modern naval warfare; especially so in actual battle or other actions, upon the commencement of which the element of secrecy is no longer paramount.

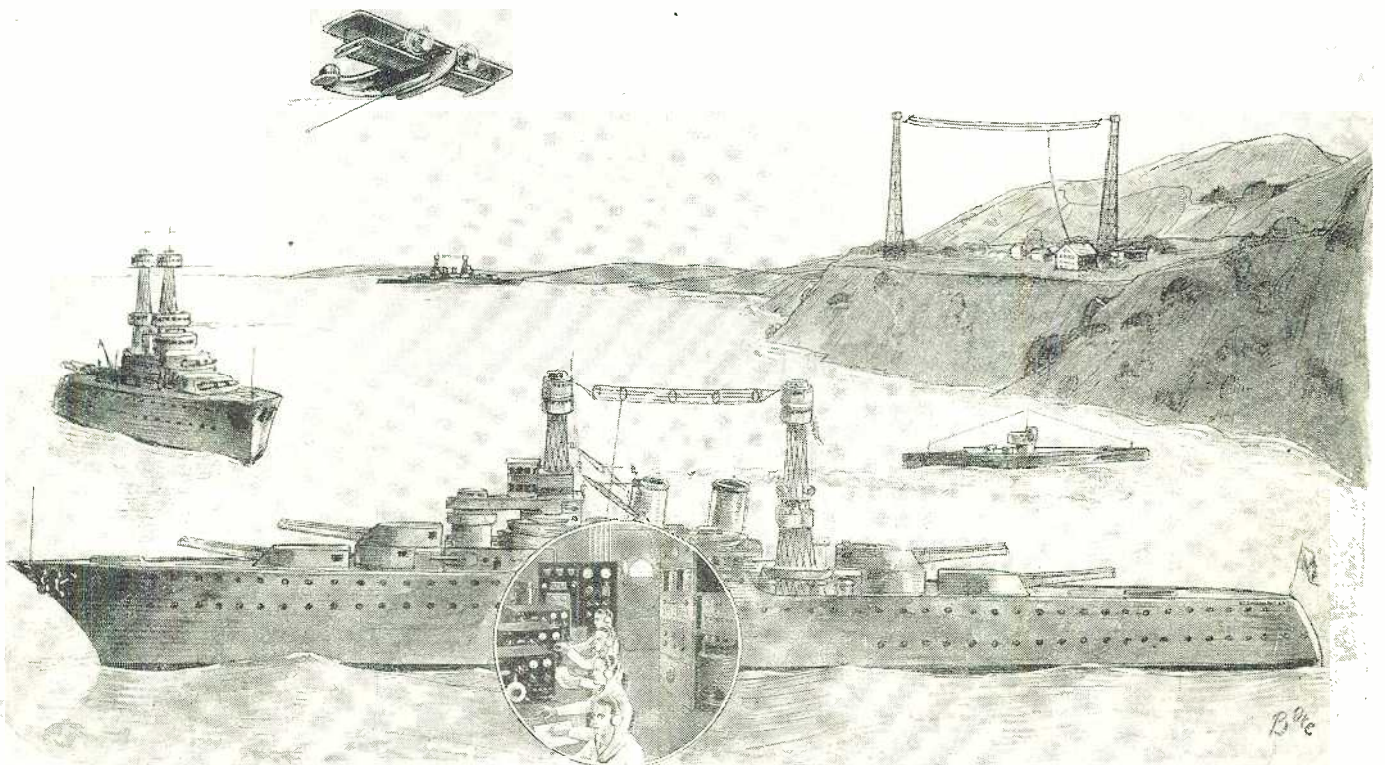

In the depths of the battleship, the operators are transmitting simultaneous signals and receiving from the other battleship, the cruiser, the submarine, the airplane and the land station, all main aerial should be destroyed or damaged. Other transmitters and receivers are provided at the posts of the admiral and other important officers.

Television Sees in Darkness and Records Its Impressions

An Account of John L. Baird's Latest Achievements
Transmission of Moving Images by Radio

By A. DINSDALE

Mr. Baird demonstrating his Phonoscope, a machine for preserving radio pictures by means of phonograph records.

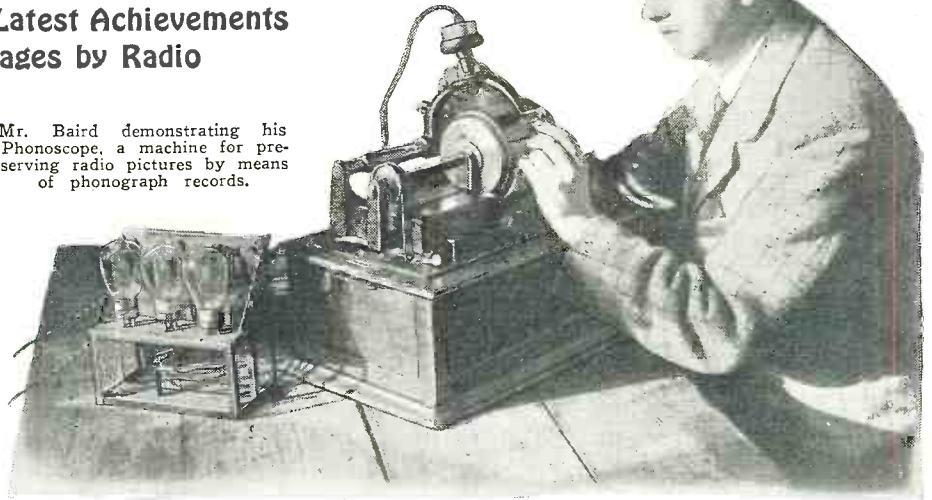

SINCE developing his apparatus till a crude image was reproduced, as described in RADIO NEWS for September, 1926, Mr. Baird has greatly improved the quality of his results by the use of rays invisible to the human eye. He has also utilized a phonograph to record the transmissions in permanent form for future repetition. It has been lately announced that experiments in transatlantic transmission are being initiated to demonstrate Mr. Baird's system in America.

—EDITOR.

IT was, I think, Sam Weller who explained to the Judge that he was unable to follow the accused's movements, "not being provided with million-magnifying double-barrelled opera glasses to see through a brick wall and a flight of stone stairs."

It is now over a year ago since I first had the opportunity of looking through just such a magic pair of opera glasses and saw what was going on through not one but several

brick walls, and also, by a rather curious coincidence, a flight of stone stairs. I sat in a large room and saw on a little screen the face of a friend who was in a different part of the building, separated from me by two flights of stone stairs and many brick walls.

His voice came to me from a loud speaker: "Can you see me?" he asked, and see him I did, at least a small sepia-tinted replica of him about six inches square. I saw him

turn his head, open his mouth, wink his eye. I even saw the curling wreaths of smoke from his cigarette. It was indeed Sam Weller's opera glasses come to reality.

The magic opera glass is called a Televisor, and is the result of years of patient research into the problem of Television by the Scottish inventor, John L. Baird, whose apparatus has been described in this journal. (See RADIO NEWS for September, 1926). The Televisor far transcends in power anything imagined by the witty Sam, for brick walls and flights of stone stairs are mere trifles to it. Its range is only limited by the distance over which we can converse by telephony, either wire or radio.

It gives to the eye what broadcasting has already given to the ear, and enables us to see by radio.

At that demonstration a year ago (one of Baird's first after overcoming at last the difficulties which have baffled the leading scientists of the world for so long) tremendously powerful lights were necessary to illuminate the sitter whose image was to be transmitted to distant points. So powerful were these lights, in fact, that the "victim" was well-nigh blinded and burned by their intensity.

Obviously, the first necessity was to increase the sensitivity of the light-sensitive cell, in order that the intensity of the light required might be decreased. Within a few months this was successfully accomplished so that the lighting required was no more brilliant than that used in a photographic studio.

CONCERNING THE SPECTRUM

Not entirely satisfied with these results, however, Baird began experimenting to see if he could not make use of invisible rays, and these experiments led to most important results. In order to understand clearly exactly what has been done, let us consider briefly the spectrum.

Beneath the range of the shortest wireless waves are other wavelengths extending in length down to infinitesimally small fractions of an inch. The frequency of these waves is enormously high, and the entire range of known frequencies, from the lowest to the highest, is known as the spectrum.

An illustration of these appears at the left, showing the wavelengths to which we assign colors, and the range of normal sight.

The composition of the spectrum may be outlined as follows: Starting at the highest known frequencies, the spectrum is divided up into sections in which fall first the gamma rays given off by radium, X-rays,

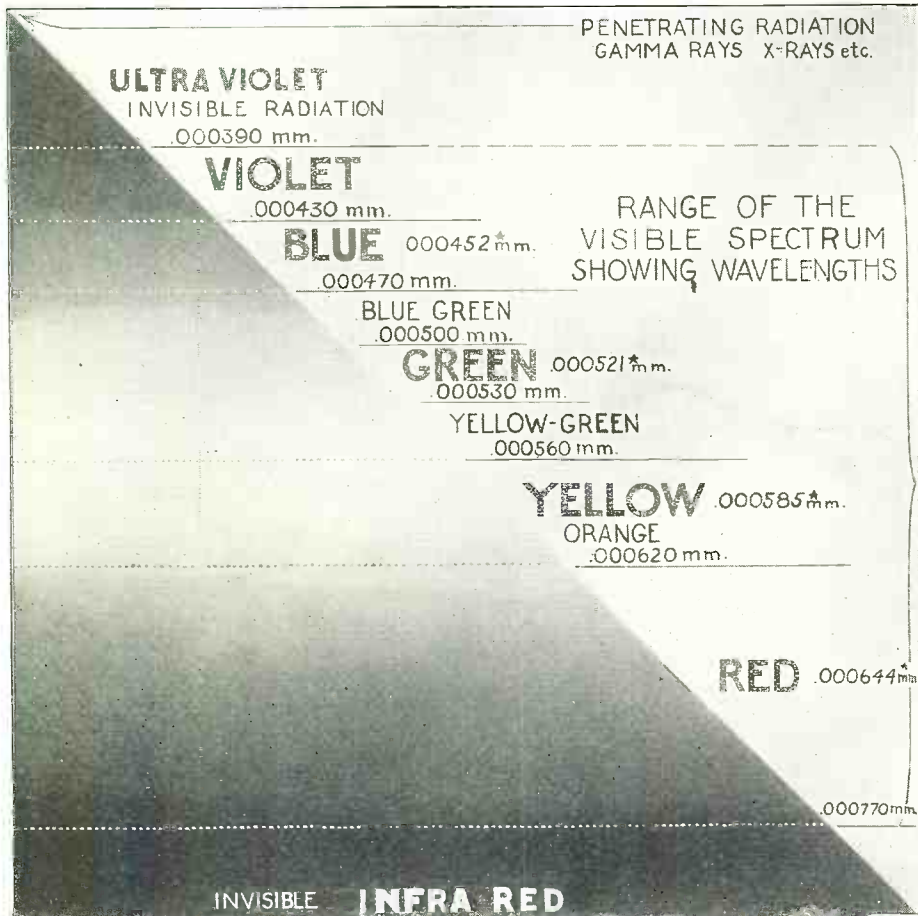

The electromagnetic rays of the "visible spectrum," one billionth as long as those used in broadcasting, produce on the eye the effect of color (the stars indicate the wavelengths of the primary colors). Beyond its limits, at either end, no sensation of sight is caused. However, photoelectric cells register the impact of both ultra-violet and infra-red rays. The latter are used for "lighting" at the receiver of the Baird Televisor; and at the transmitter are reproduced as visible light, giving a normal effect.

ultra-violet rays, the visible spectrum (light), infra-red rays, and finally, radio waves. (A description of its exploration will be found on page 218 of the September issue of RADIO NEWS, previously mentioned.)

The most familiar of these sections is the visible spectrum, which contains the colors extending from violet to red. It is more familiar to us because it is the only band of frequencies within the entire spectrum to which the unaided human senses are capable of responding. To detect the other frequencies special instruments are necessary; such as, for example, a radio receiver, when it is desired to detect radio waves.

Light-sensitive cells, such as are used in a television transmitter, are capable of responding to not only visible light, but also a narrow range of frequencies beyond the upper and lower limits of the visible spectrum; and it is this fact which has made possible one of the latest developments in television.

In his first attempt to make use of invisible rays, Baird used ultra-violet rays; but these proved to be far too dangerous, for they had a bad effect upon the eyes of sitters.

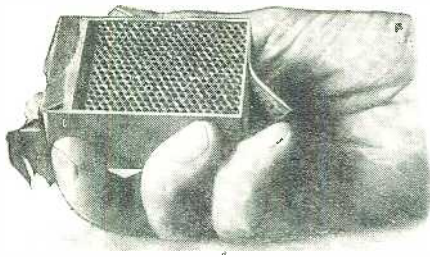

The cellular structure of the image-projection tubes used in Baird's television apparatus.

Turning to the other end of the visible spectrum, Baird next tried infra-red rays, and immediately discovered that his light-sensitive cell was capable of responding equally well to these rays, which are invisible to the human eye.

SEEING IN TOTAL DARKNESS!

Within a short space of time the inventor was able to dispense entirely with visible light, with the very startling result that it was possible to see in total darkness!

This is, perhaps, the most spectacular development of all in connection with television, and it has an uncanny and impressive effect upon visitors to a demonstration; as I discovered for myself recently when I was privileged to witness a demonstration of "seeing by dark light."

First of all, I was shown into the transmitting studio, the windows and doors of which were heavily draped to exclude all daylight. The place was in complete darkness. Even after having become accustomed to the stygian gloom it was literally impossible to see my hand in front of my face; and yet those watching the receiving screen were able to see me put my hand up in an effort to see it!

Leaving a friend of mine there I wended my way down stairs to the receiving theatre, where I conversed with my friend over the telephone and simultaneously watched his face on the television screen. He assured me that he was still in total darkness, and yet there was his image on the screen before me, an image which, incidentally, showed considerable improvement over that which I first saw over a year ago!

Thus have the Powers of Darkness been dispelled—those mythical powers which, right down through the ages of Man's history, have struck terror into the hearts of the ignorant and the superstitious.

It is difficult to estimate the full extent of the importance of this achievement in warfare, for it renders it possible to follow the

FIG. 1.
The infra-red rays are reflected from the object, through the tubes, and the revolving slotted discs C and D, where they are broken up, as explained in the text. They are then transformed into electrical energy by the cell, and are fed to the transmitter. At the receiving station they may be recorded on a phonograph, and reproduced at any future time.

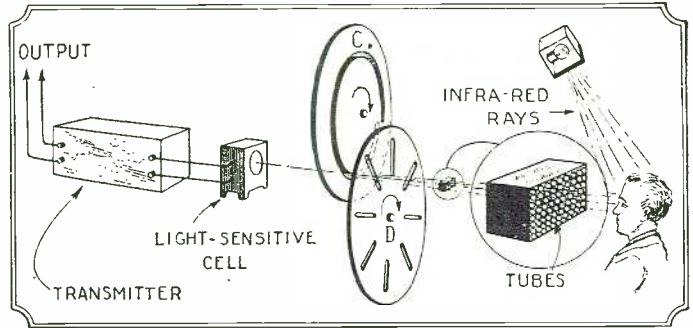

movements of the enemy when he believes himself to be under cover of darkness.

Attacking aircraft, approaching under cover of the night, will be disclosed to the defending headquarters by the electric eye of a television apparatus. They will be followed by searchlights emitting not visible light but infra-red rays, and as these rays will be invisible to them they will continue to approach until, without warning, they are brought down by the guns of the defense.

Darkness, the great cloak for military operations, will no longer give security. The attacking party, creeping forward for a surprise attack on a pitch-black night, will be swept by an invisible searchlight and watched on the television receiving screen of the defenders. They will be permitted to come well within range and then find themselves, in spite of the apparent protection of darkness and the absence of visible searchlights, overwhelmed and decimated by well-directed gunfire.

It is to be hoped, however, that other uses may be found in peace time for this latest development of television. The fact that infra-red rays possess great fog-penetrating powers opens up possibilities in connection with the navigation of ships during foggy weather.

SEEING THROUGH FOG

To understand the possibilities in this direction it is only necessary to consider the behavior of ordinary visible light during foggy weather. The most intense white lights, it will be noticed, show through fog as a dull red color. The thicker the fog the duller the red which shines through.

This phenomenon is not due to any change in the characteristics of the original source of light. The fact is that any given light-source emits not one single color of light, but several, which combine to give the effect of a single color. By means of filters which will allow only certain component colors to pass, all other colors can be eliminated. Fog acts as a filter which will pass only red light.

The penetrating power of light varies as the fourth power of the wavelength; so that red light penetrates some 16 times more effectively than blue light, and infra-red light 200 to 300 times.

Red light has already come widely into use in aerodromes and for other purposes where fog-penetrating properties are of importance. This new application of television renders possible the use of infra-red rays with their still greater penetrative powers.

Mr. Baird seated before his television transmitter. The three black-faced boxes are the sources of the infra-red rays.

They will not, of course, be visible to the naked eye, even through fog. It will be necessary at the receiving end (e.g., a ship at sea) to make use of a television apparatus in order actually to see through fog.

In order to generate infra-red rays any form of lamp may be used which will provide the necessary intensity of illumination, although certain types of lamps are richer in infra-red rays than others. Having selected a suitable light-source all that is required to obtain infra-red rays from it is a filter which will cut off all the frequencies but those belonging to the invisible rays. Several substances may be used as filters, such as, for example, hard rubber.

Thus, in order to transform an ordinary searchlight (which is already very rich in infra-red rays) into an infra-red ray searchlight, it is necessary only to cover the front of it with a suitable filter substance.

The infra-red rays are used by Baird in exactly the same way as ordinary visible light. That is to say, the rays are directed upon the sitter, and the "dark light" reflected from his face is passed on to the television transmitter.

IMPROVEMENTS IN IMAGE-EXPLORING MECHANISM

Since his apparatus was last described in these pages, Baird has made some improvements in his image-exploring mechanism. He has discarded his rotating disc of lenses, retaining only the two rotating slotted discs. To understand his reasons for doing this.

(Continued on page 1490)

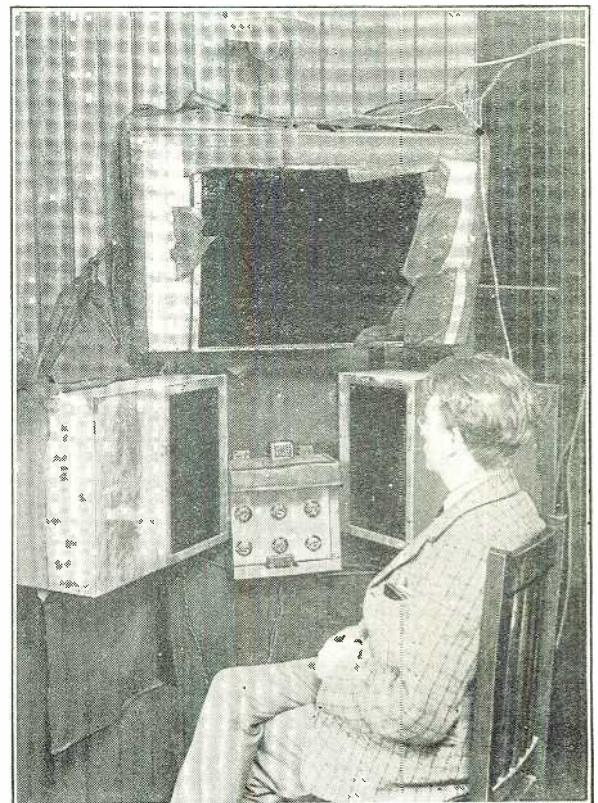

Radio Vision Demonstrated in America

By H. WINFIELD SECOR

FOR the past several years RADIO NEWS has been describing various television systems, all more or less in an incomplete state. That described by Mr. Secor, however, is a real development, by means of which clear and recognizable images are received. We are sure all our readers will be interested in reading the details of its operation.—EDITOR.

APRIL 7, 1927, will always be a memorable day in the annals of science, for on that day, before a group of invited guests, the experts of the Bell Telephone Laboratories demonstrated in New York the first, practically perfect reproductions of the living image of Mr. Herbert Hoover and other speakers at the Washington end of a telephone circuit; and secondly, similar images transmitted by radio from Whippany, N. J., thirty miles away.

To make the subject more interesting, it is well to state at the outset that at the transmitting end of the circuit the image of the moving object was reproduced in two forms. In the smaller receiving instrument the size of the image is about $2\frac{1}{2} \times 2$ inches, and here the likeness was very perfect; Mr. Hoover's face appearing in a photographic reproduction against a rose-pink background. This color is due to the use of neon gas in the glow-tube, which is placed behind a revolving disk in the small machine. The larger reproduction apparatus, used to show the built-up image before the assembled guests, had a screen approximately 24 inches wide by 36 high. Here also the general color of the background was pink, due to a grid of evacuated glass tubing containing neon gas, which formed a surface on which the picture was built up by means of 45,000

light-flashes sweeping over the screen every second.

HOW IMAGE IS TRANSMITTED

Referring to the diagram (Fig. 1, A, B and C), we shall first consider how a concentrated light-beam from an arc lamp is caused to sweep across the object, a human face for example, in a series of small spots and at the rate of 900 light-flashes per second. The light from the arc is concentrated through a condensing lens upon the back of the rotating perforated disk shown in the figure. There are 50 small holes drilled through this disk, these being laid out in a spiral; it rotates eighteen times per second, or 1080 revolutions per minute. As the three stages of the process, (Figs. 1A, B and C), demonstrate, and thanks to the slit or diaphragm placed behind the disk, one hole only

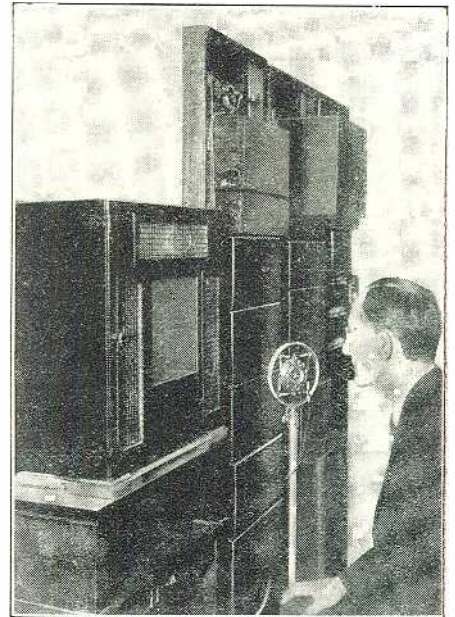

Close-up of microphone and the three large photo-electric cells behind grille doors. The light rays coming through the square opening between the latters. The apparatus in the background comprises amplifiers and other devices used in the transmission.

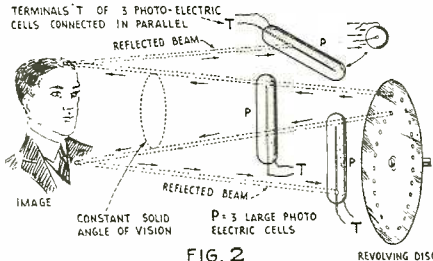

FIG. 2

How the extreme positions of the succeeding pencils of light exploring the object at the transmitter are enabled to pick up the whole image. The solid angle of vision is made up of rapidly moving beams of light.

is permitted to pass a light beam at a time. Look at Fig. 1A; then note that at B the second hole in the spiral has reached the vertical position and a small beam of light passes

through and sweeps across the image in the second lower position. Look at Fig. 1C, and it becomes evident that No. 3 hole has reached the vertical position, and the third pencil of the beam sweeps across the image in the third position from the top of the face or other object at the transmitter.

This action is repeated, as becomes clear, so that when the 50th or innermost hole of the spiral on the disk comes into position before the diaphragm, a pencil of light passes through, sweeping the bottom of the image. This is clear on inspection of Fig. 2.

It is well known that the motion picture of today is possible only because of the retention of vision by the human eye. That is, sixteen slightly-different pictures are jerked, one after another, in front of the lens and flashed on the theatre screen every second. Due to the "lag" of the human eye, the individual pictures overlap and give the illusion of a perfect moving image. The same thing occurs in this television system; but instead of flashing each light across the face sixteen times per second, the engineers who developed this system of television in the Bell Telephone Laboratories cause the light-beams to travel across the image at a speed of eighteen times per second. As there are fifty light-beams, due to the fifty perforations in the rotating disk at the transmitter, there are 18 times 50, or 900 light-targets traveling across the image every second!

It might be thought that such a strong concentrated pencil of light, when it traveled across the eyes, for instance, would prove unbearable; but such is not the case. The effect when looking toward the opening in the transmitting machine is like looking into a camera lens with a fairly strong light behind it. The light beams change place so fast that the final result is a slightly flickering bluish light which seems to bathe the face or other object at the transmitter.

The next very important point to note is that, as the light-beam (at Fig. 1A for instance), moves across the top of the man's face, a ray of light with a constantly-changing angle of incidence is reflected from the face and impinges on some part of the three large photo-electric cells used in this perfected system of television.

Looking at Fig. 2 we see how the three large photoelectric cells of new design are arranged in front of the image. In the pictures you will note that these three photo-electric cells, each of which measures about

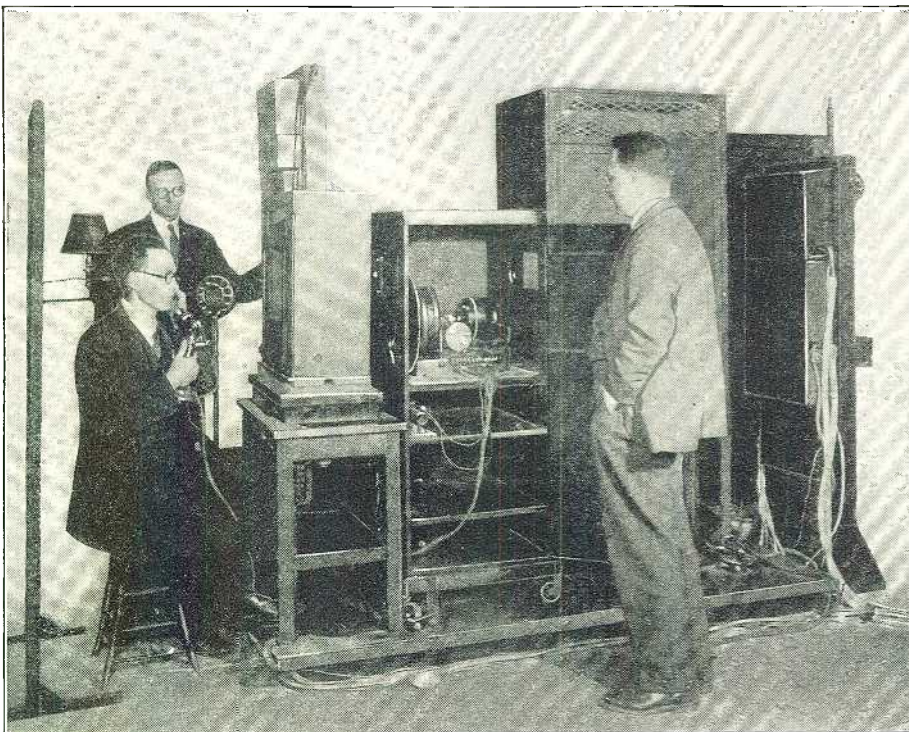

A subject sitting before the transmitting mechanism. In the center cabinet are the 60-cycle and 2,000 cycle A.C. motors which drive the perforated disk. The light from an arc in the cabinet at the rear passes through the holes in the revolving perforated disk and falls on the face of the subject.

Photos courtesy of Bell Telephone Laboratories.

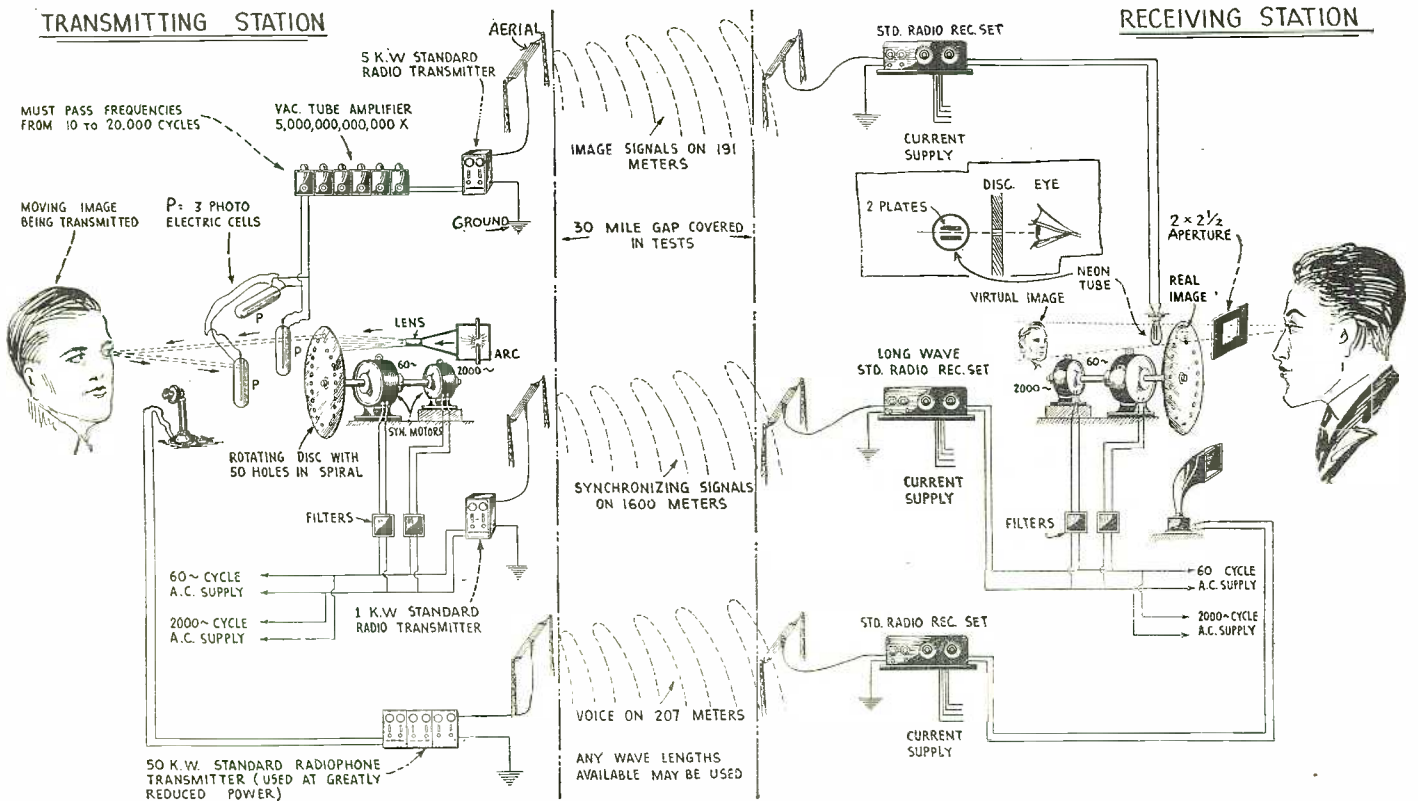

Fig. 3. A comprehensive diagram of the entire radio television apparatus; the subject, an image of whose face is being transmitted by radio, appears at the left, while the person observing the transmitted and reproduced image appears at the right. The perforated disk causes rapidly moving targets of light to sweep across the face; the reflections fall on photo-electric cells, P. The light fluctuations are thus transformed into minute electric currents, and these are amplified 5,000,000,000,000 times. The radio image signals are picked up by a standard receiving set, and after amplification, the image signals pass into a neon glow-tube placed behind a second revolving disk, driven in exact synchronism with that at the transmitter. The observer looking through the small aperture sees the image built up on a plane behind the whirling disk. The voice is transmitted and received in usual manner; while a third radio wave transmits synchronizing signals for the motors.

14 inches long and 4 inches in diameter, are placed inside three metal boxes provided with wire-grille doors to protect them from breakage. The doors are kept shut, even when the machine is in operation. These photoelectric cells, which were devised under the direction of Dr. Herbert E. Ives of

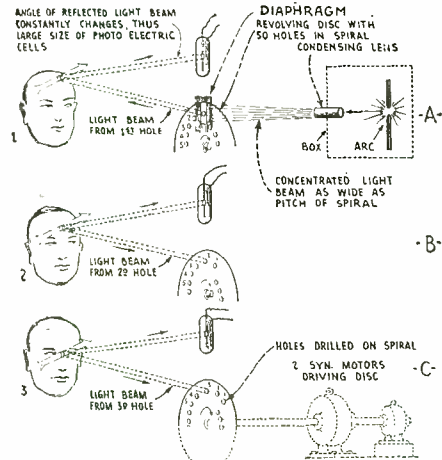

FIG. 1

Successive light beams issuing from the holes in the whirling disk at the transmitter sweep over the object; their movement is exaggerated here.

the Bell Telephone Laboratory staff, comprise a central electrode running the length of the tube, while the rear inside half of the tube all the way up is coated with a metallic deposit. The tubes are then exhausted and the proper gas introduced. These photoelectric cells have practically no lag whatever, and their action is therefore instantaneous.

As Fig. 2 shows, there is a constant solid angle of vision, filled with a constantly-moving series of light-beams. As becomes evident, the angles of the reflected beams will be constantly changing as the in-

itial beams shoot forth from the apertures in the rotating disk. This is one of the main reasons why such large photoelectric cells are required. These are undoubtedly the largest ever used. The terminals of the cells are connected in parallel, so that their action is all concentrated in one circuit, as becomes clear from an inspection of the diagram, Fig. 3.

RADIO TRANSMISSION OF IMAGE

Instead of using three telephone circuits, in the radio transmission three different wavelengths were utilized, as indicated in Fig. 3. Looking at this we see how a concentrated light beam from the arc shoots through one of the holes in the revolving disk, which is driven by two synchronous motors; thence to the face, from which the light beams are reflected progressively upon one of the three large photo-electric cells, every gradation of tone or color upon the face or other image encountered by the spot of light as it sweeps across the face is transmitted to the receiver. For this reason the spots of light, as they build up

the image at the receiving instrument, give a very faithful reproduction of the image at the transmitter.

A special vacuum-tube amplifier of several stages serves to magnify the very minute fluctuating currents coming from the photoelectric cells five thousand, thousand, million (5,000,000,000,000) times. It is interesting to note that this vacuum-tube amplifier had to be designed to amplify all frequencies from ten up to twenty thousand cycles. The image-currents then enter a

The glass screen and front of the loud-speaker horn used. The large image reproduced appeared on the screen at the top. Vacuum-tube amplifier at right.

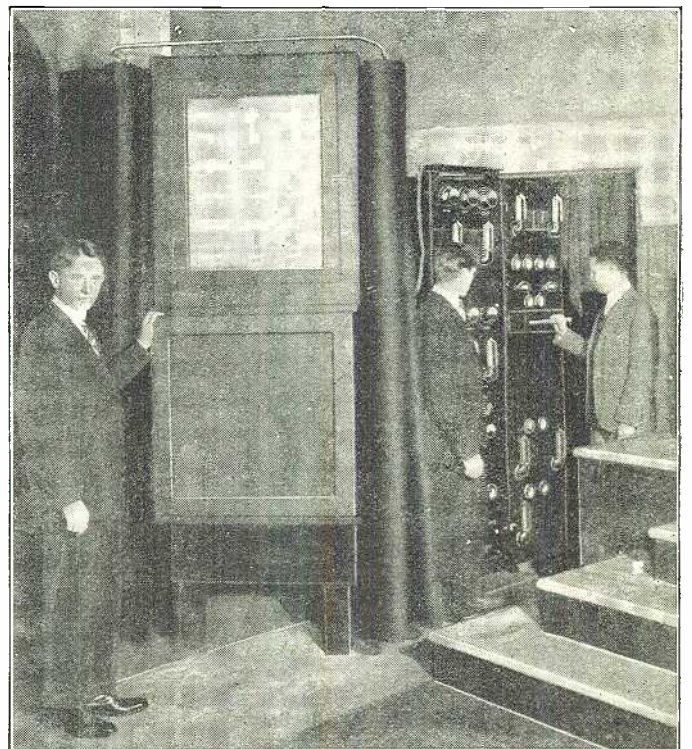

5-kilowatt standard radio transmitter of the vacuum-tube type, and leap across the thirty-mile gap between Whippany and New York City on a wavelength of 191 meters.

In New York a standard receiving set picks up the 191-meter image-signal, and after amplifying it sufficiently, passes it into a neon tube, placed directly behind a second revolving disk having the same speed and number of perforations as the disk at the transmitter station. The person at the receiver simply looks through a small aperture at the swiftly-moving pulses of light as they become visible through the whirling holes in the spinning disk. He sees the real image build up apparently at the position of the disk, while the virtual image is of course considerably behind the disk, as the drawing shows.

mitter and receiver, this motor being designed for a frequency of 2,000 cycles per second. As will be seen, a slight variation at this frequency is much less noticeable than it would be at 60 cycles; and so, between the two motors, the synchronous speed is maintained practically uniform at all times.

Note particularly how the 2,000-cycle alternating current supply is connected in

ceiving set, and then passed into a loud speaker placed alongside of the picture-reproduction mechanism.

REPRODUCTION OF IMAGE

Sufficient has been said to give an insight as to how the image is reconstructed or built up by light pulses, rapidly following one another at the receiving instrument.

TRANSMITTER

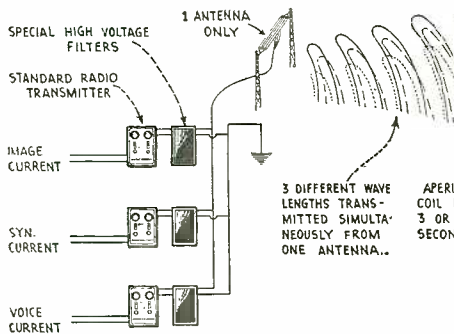

At the right: The large exhibition screen, built up of a continuous length of glass tubing, along the rear walls of which are cemented 2,500 tin-foil segments. The tube is filled with neon gas; light spots appear opposite each segment when electrically energized.

RECEIVER

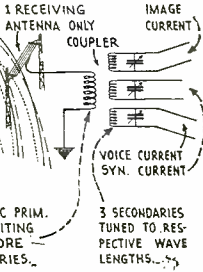

FIG. 4

Left: Simplified system, whereby three transmitters, tuned to different wavelengths, are joined to a common antenna through suitable filters.

HOW SYNCHRONISM IS ESTABLISHED

It required much special research work and clever designing of the synchronizing circuit and motors used for this perfected television scheme; and to Mr. H. M. Stoller is due the credit for the special synchronizing means finally adopted.

This very important part of the system of television has several new aspects. Due to the high speed of the light-image transmission and reception, quite necessary to produce a practically perfect image at the receiving end of the line, it was soon found that ordinary 60-cycle synchronous motors would not do. Synchronous motors, as is well known, have the habit of hunting; that is, they will swing a little below or a little above their true normal speed at times. To reduce the degree of this variation resulting from hunting, a second synchronous A.C. motor was placed on the same shaft that drives the rotating disk, at both the trans-

parallel to the 60-cycle A.C. supply circuit. Suitable filters made up of inductances, resistances and condensers are placed in each pair of leads running to the synchronous motors, as Fig. 3 shows. Where television takes place over three telephone circuits, the action is quite simple; while with radio transmission, the insertion of a standard transmitter of the vacuum-tube type is necessary to transmit the synchronizing signals to the receiving instrument.

In the demonstration recently conducted, these synchronizing signals were transmitted to the receiving station by a one-kilowatt transmitter, on a wavelength of 1,600 meters. It should be noted at this point that no such high power is necessary, and all of the units were operated at considerably less than normal capacity. The reason that these particular transmitters were used is the fact that they happened to be available and handy at the experimental station.

In radio transmission of the television image, the synchronizing signals were picked up on a standard receiving set fitted with suitable inductances and condensers for tuning at 1,600 meters; and the amplified synchronizing signals were then fed into the circuit supplying the 60-cycle and 2,000-cycle A.C. to the two synchronous motors driving the revolving disk in the receiving instrument.

HOW VOICE WAS TRANSMITTED

Referring to Fig. 3, we see that the voice of the subject before the television transmitter at the receiving station was picked up by a standard microphone, fed into a standard radiophone transmitter (a 50-kv. set was here used at greatly reduced power), from whence it leaped across the 30-mile gap to New York on a wavelength of 207 meters.

The wavelengths used were purely arbitrary and chosen because of their freedom from interference at this time. Any wavelengths available can be used, so long as the three are sufficiently separated to be tuned in clearly and without any overlapping at the receiving station.

The radio waves carrying the voice were picked up on a third and independent antenna amplified by means of a standard re-

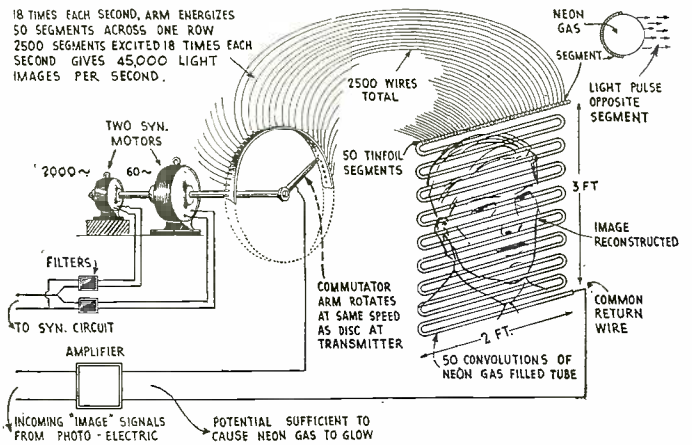

FIG. 5

Referring to Fig. 3 once more, we note that the neon glow-tube, placed behind the revolving perforated disk, is about the size of a 75-watt electric light bulb; it contains two flat metal plates a short distance apart. The detail sketch in the upper right-hand corner of Fig. 3 shows the relative position of the eye, the perforated disk and the neon glow-tube when viewed from the top. Usually a curtain is drawn around the person looking through the aperture. The remarkable thing is that no screen of any kind is here used, and we might say the person at the receiving instrument sees the likeness

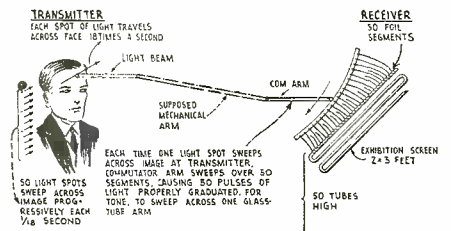

FIG. 6 How the image on the large receiving screen is built up. 45,000 light pulses flash across it every second.

of the person at the transmitter actually reconstructed in the air.

The image at the receiving instrument is built up by reproducing the same number of light pulses per second, as those flashed across the face or other object at the transmitter. That is, the eyes of the person gazing through the aperture at the receiver witness 900 flashes of light per second, each of which carries the proper tone of some part of the image. The revolving perforated disk at the receiver rotates at the same speed as that at the transmitter, and like it has also fifty perforations. One of the wonderful things accomplished at this juncture is the perfection of the synchronization between the two revolving disks. Another very important contribution to the science of television is of course the special photoelectric cells used at the transmitting instrument.

SIMPLIFIED RADIO TRANSMISSION

Where the picture is transmitted and received over telephone circuits, four circuits would ordinarily be required; but, thanks to the ingenuity of the scientists who worked on this problem in the Bell Telephone Laboratories, this has been reduced to three circuits by combining the 60-cycle and 2,000-

(Continued on page 1480)

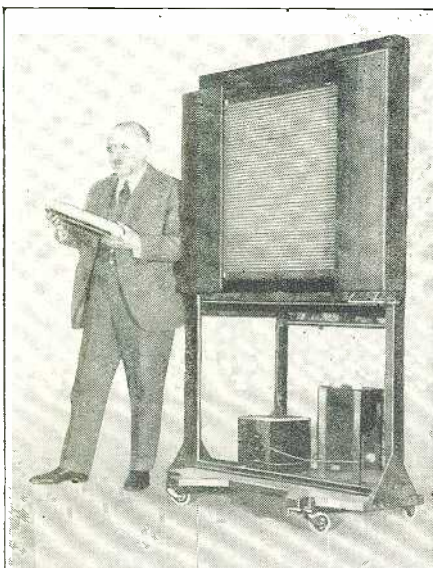

Dr. Herbert E. Ives is shown holding one of the giant photo-electric tubes. At his left, the screen on which the large television image was reproduced.

Uncle Sam's Smallest Broadcast Station

Bureau of Standards Studies Conditions on Miniature Scale

By S. R. WINTERS

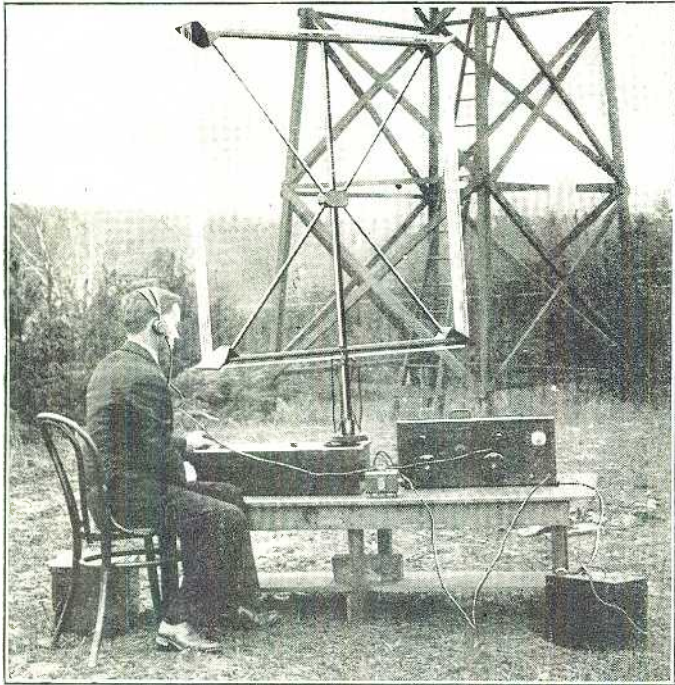

thickly clustered forest trees. Its pretentious antenna system, and its elaborate equipment for intercepting radio signals are among the qualifying aspects which would identify this station as a radio fan's paradise.

To T. Parkinson, S. S. Kirby, Morris Strock, and other members of the laboratory staff, this radio "shack" is merely a workshop or experimental laboratory where they can explore into the mysteries of radio waves. Ultimately by the work of this field

S. S. Kirby at the Kensington open-air station, receiving signals from the 50-watt loop transmitter, a third of a mile away.

Photo © Harris & Ewing.

At a point one mile south of Kensington, Maryland, two representatives of the Radio Laboratory of the Bureau of Standards have established a miniature broadcast station and an open-air receiving station. Only one-third of a mile intervenes between the 50-watt transmitter and the receiving equipment; the waves radiated from a loop antenna are picked up in a similar manner.

Unpretentious as this apparatus may seem, the objective of these experiments has a far-reaching implication. The feeble energy emitted from this 50-watt broadcasting station (feeble compared with the new 100,000-watt power tube being used experimentally at station WGY, Schenectady) is adequate to the needs of standardizing instruments and in formulating a basis for measuring the signal strength of different broadcast stations.

In fact, it is probable that the very field intensity measurement apparatus used for intercepting signals from this 50-watt station may be employed in determining the strength of signals from the powerful 100,000-watt experimental broadcasting station of the General Electric Company. Moreover, with more than 700 broadcasting stations in operation and more than 300 additional stations clamoring for admission, this equipment for studying the field intensity of signals and for defining "complete-service areas" in radio reception will become increasingly serviceable in the art of broadcasting. The Federal Radio Commission may need to consult the findings of these instruments in the re-allocation of wavelengths, and in other problems of straightening the tangled skein of broadcasting.

DODGING LOCAL "STRAYS"

Far removed from the disturbing influences that beset radio reception in congested areas, the radio receiving station has a beautiful setting with a background of

ing sets; semi-automatic recorders for noting the fading characteristics or fluctuations of radio waves; and field-intensity-measurement units for determining the strength of signals from different broadcast stations.

The antenna system consists of a single wire strung over a distance of 100 feet and supported by two towers 60 feet high. The lead-in wire is placed exactly in the center of the 100-foot antenna wire, 50 feet from each of the towers of wooden latticework, not including the insulators. Each tower is equipped with two platforms, one 20 feet and the other 40 feet from the ground. This antenna system includes also a three-wire counterpoise, stretched six feet above the ground.

WORK OF THE STATION

The field laboratory is engaged in three main lines of investigation at present. T. Parkinson and S. S. Kirby are continuing their researches into the problem of the fading of radio signals and making measurements of the signal strength of transmitting stations. Morris S. Strock is measuring the frequencies of standard-frequency broadcasting stations. The subject of field intensity measurements takes into consideration the use of relatively high-power broadcasting stations and its effect upon radio reception.

Freedom from interference — electrical disturbances, for example—is insured by the location of this field station. Power, telephone, and telegraph lines were systematically avoided in selecting the site for this experimental laboratory. Nor, since its establishment, has the entrance of any communication or power lines been permitted. Messages between this field station and the

experimental station 25,000,000 broadcast listeners should be better informed as to the causes of the waxing and waning of radio signals, the existence of "dead spots," the "zones of silence" or skip-distance effects of radio waves, and the reasons for the occasional rough quality of received sounds.

The radio receiving equipment at this field laboratory consists of standard receive-

(Continued on page 1472)



Morris S. Strock making measurements of frequency of the wave of a broadcast station. A large number of wavemeter coils are kept by the Bureau for this special work of checking standard-frequency signals.

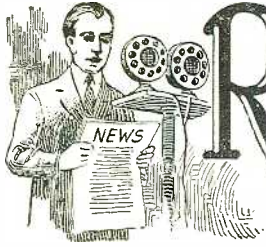

Radio News of the Month

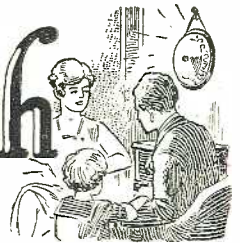

CLEARING THE ETHER

THE first announced decision of the Radio Commission with respect to wavelength reassignment is a definite statement of policy to permit only frequencies expressed in even tens of kilocycles; and to prevent further operation of stations in the United States on the six channels (291.1, 312.3, 329.5, 356.9, 410.7, and 434.5 meters) which have been allotted for exclusive Canadian use. The thirteen U. S. stations now operating on these, as well as all others less than ten kilocycles removed, must seek new assignments; and the commission announces that these will probably be in the "limbo" below 220.4 meters. No reassignments are available as our list of stations goes to press, but it is intimated that every present broadcaster will be relicensed on some wavelength, except for voluntary withdrawals.

"ON THE AIR"

THIS phrase does not suit the purists in radio parlance; but it is more appropriate in the case of one mid-western station (WIBU, Poynette, Wis.) which derives its power, at least, out of the air. It is equipped with two windmills, which, through generators coupled to them, charge the storage batteries of the station. This is economical as well as novel.—Clarence Thompson.

NO ROYALTIES IN RUSSIA

THE Soviet authorities have carried out their principles in radio administration. It has been officially decided that musicians, authors and artists will receive no additional compensation for broadcasting, nor royalties for the performance of their works. It is argued that if a microphone is placed on the stage, the musician makes no extra effort; and, instead of expecting compensation, the composer should be grateful for the advertising given his works.—L. Reid.

FRANCE NATIONALIZES RADIO

AFIVE-YEAR period has been set by the French government for the conclusion of private broadcasting. After that, all stations will be taken over and none but government broadcasting will be permitted. Considerable dismay is expressed by many in Europe, in the belief that broadcasting will sink more and more to the level of administrative propaganda, as its private ownership is being eliminated rapidly.

BRITISH WAVE CHANGES

ADDITIONAL readjustment of the wavelengths of the B. B. C. stations, from that given in February RADIO NEWS, has proved necessary. Those which have been altered are Bradford, now 252.-meters; Sheffield, 272.7; Nottingham, 275.2; Leeds, 277.8; Swansea, Stoke, Dundee and Hull, 294.1; Liverpool, 297 (The above are the relay stations, which it had been planned to operate on 288.5); Belfast, 306.1; Birmingham, 326.1; Plymouth, 400.

—Edward Brown, Jr.

SUPER-SENSITIVE RELAY

A VACUUM tube of higher sensitivity than heretofore known was demonstrated a few days ago. The tube, which is termed a "grid-glow" relay, being filled with neon, is said to cause a modification in the plate current 100,000,000 times as great as that on the grid; or, in other words, it will respond with a 25-milliampere current to the most infinitesimal change in its adjustment. A description will appear in **SCIENCE AND INVENTION** for July.

CALL BOARD FOR AIRPLANES

AN addition to the ingenious system of a radio airplane control devised by the army laboratory at Dayton has been announced by the war department. Capt. Paul B. Edwards, who produced the airplane beacon, has worked out a device by which orders are transmitted and reproduced on a panel similar to a telephone indicating board. It is operated by signals from a transmitter on which is a dial with numbers from 0 to 99; dialing one of these actuates relays and causes the corresponding number to flash in the plane.

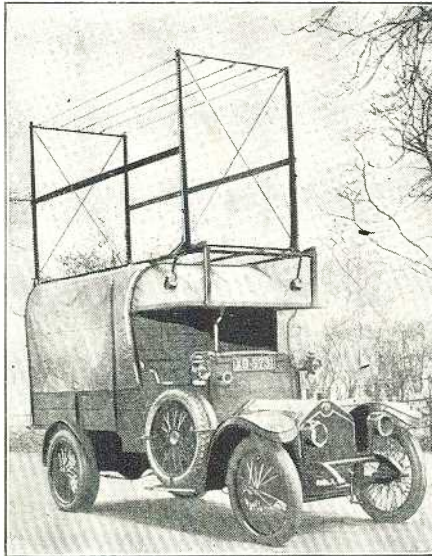

A "wave of crime" has induced the Metropolitan Police Department of London to equip with radio apparatus a car for patrolling the outlying districts. It is shown with its folding aerial raised for use.

© Herbert Photos, Inc.

BELGIAN PROGRAM AMBITIOUS

THE new radio station at Ruysselede, Belgium, which received its tests last month, is to link that country with the Congo and the Americas; the receiving station of the system is at Liedekerke. Belgium has laid, and is laying, underground cables for long-distance wires providing several hundred trunk lines to its frontiers; and is understood to be seeking to attract the central European radio organization, now located at Geneva under the auspices of the League of Nations, on the representations that central broadcasting, as well as aviation, can be much more effectively carried on from the plains of the Low Countries, rather than among the Alps.—L. Reid.

TELEVISION'S FIELD

OFFICIAL recognition of television's place in the broadcast band was given by the Radio Commission with the announcement that the band between 1,500 and 2,000 kilocycles (150 and 200 meters) now practically abandoned by the amateurs, would be utilized for broadcasting and further experimentation with "radio sight" instead of hearing. This band, with more than half as many channels as the whole broadcast range, indicates the importance assigned by the commission to the new developments, elsewhere described at length in this issue of RADIO NEWS. Another dictum of some interest was an official interview stating that the commission will recognize the right of local authorities to regulate stations, prescribe hours, prohibit excessive power in congested districts, etc.

"SOUNDING" THE UPPER AIR

LIKE a scientific romance is the plan actually to be carried out by French scientists in testing the action of radio waves in the upper air. Light balloons, carrying automatic transmitters, are to be sent up to a height of ten miles or more, where human beings cannot venture, and reception therefrom carefully recorded and studied.

AN ODD RULING

THAT personification of red tape, Mr. Bumble, laid down the dictum that the secret of administration is to give people exactly what they don't want. Acting, apparently, on this principle, the British postmaster-general has withdrawn the wavelength of 440 meters, used experimentally by the Manchester Scientific Radio Society; not on the grounds of interference, but because a musical program was transmitted instead of "matter of no general interest to the public, or musical scales."

RELIEVING THE DEFICIENCY

THE Federal Radio Commission started its work quite "broke," because of the lack of an appropriation. Receipts of 10 cents have been reported, one fan who believes in governmental paternalism having sent in that sum with the request for verification of a station he had heard. Another sent in an ardent letter demanding the immediate abolition of static.

(Continued on page 1474)

EUROPEAN MIX-UP

LISTENERS in Europe seem, from all reports, to have too little difficulty in getting Spanish stations, to which the international conference at Geneva allocated wavelengths they are unwilling to adopt; and the British press reports further that they do not even adhere to the wavelengths reported by them. The consequence is interference all over the lower portion of the broadcast scale. A new 2-kw. Spanish station, Radio Iberica, Madrid, is in operation, with a reported wave of 272.7 meters.

Radio News of the Month Illustrated

By GEORGE WALL

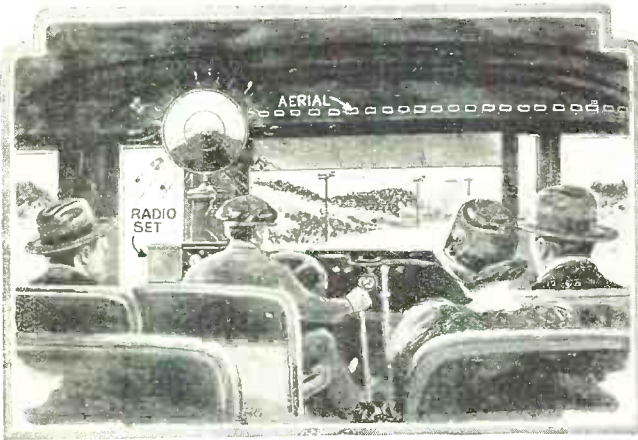

The increasing popularity of the bus as a means of inter-urban transportation has been one of the striking developments of the past few years. Luxurious fittings, comfortable seats; and now the radio is an attraction offered on its entire fleet by a Birmingham-Montgomery (Alabama) line. News, sports, quotations and forecasts are available, as well as music, to the travelers.

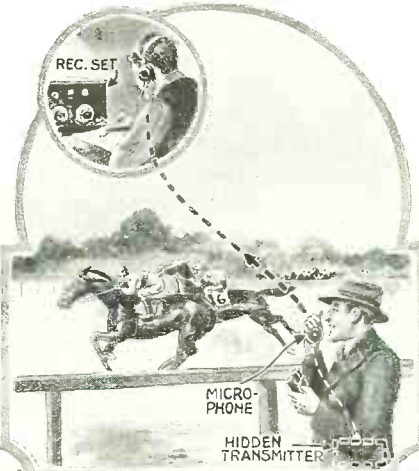

It is hard to bottle up news nowadays, when radio laughs at barriers. Officials of the Jefferson Park race track, near New Orleans, awarded to a news agency the exclusive right to report results; and its competitor sent in a reporter with a portable radio set under his coat. (The apparatus is reported to have been a recent German product, though details are not given.) At any rate, the ingenious reporter was arrested by the track authorities on a charge of disturbing the peace, pending an investigation of his right to transmit matter of this nature.

Below is pictured an occurrence when too many rescuers endangered the success of a life-saving errand. The calls of the sea were so numerous that order had to be officially restored by naval intervention.

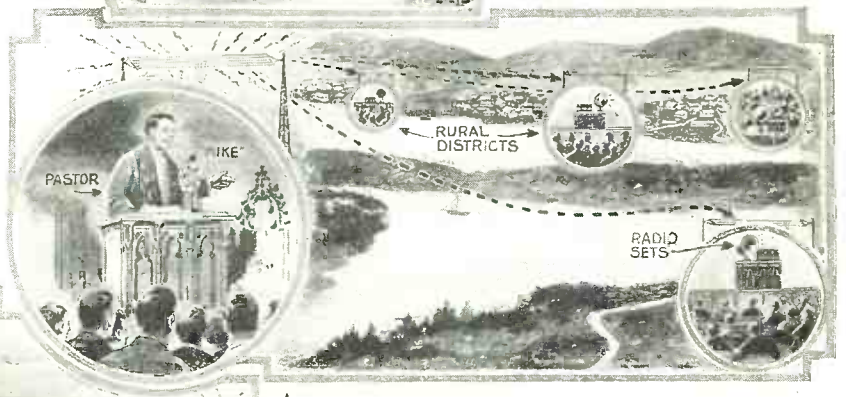

The problem of the deserted country churches has been troubling religious bodies; radio is now being sought as a substitute for a resident pastor and choir. While the individual worshipper in his home may now tune in a city service, this lacks the social effect of a congregation gathered in their own edifice. A recent test was made by the Baptist Temple, of Rochester, N. Y., of a "remote-control" service, though in its own edifice, both minister and choir being outside. The subject of the sermon was "Radio Religion."

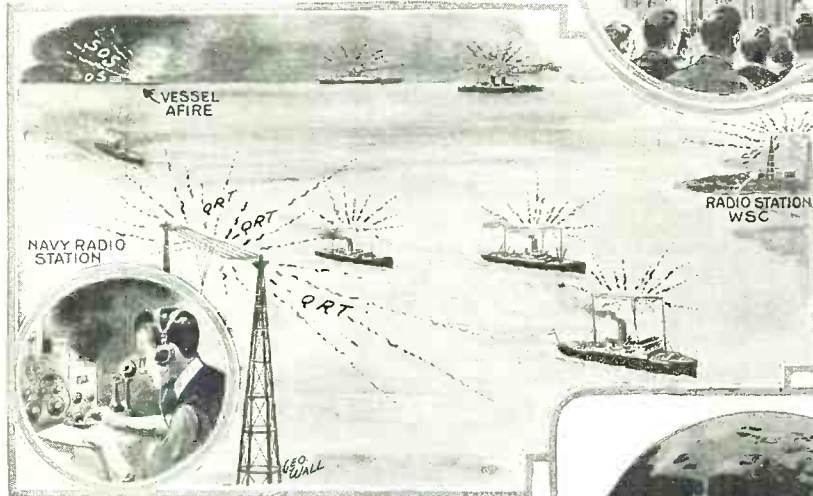

The Spanish freighter, Cabo Hatteras, caught fire and sent out a feeble SOS. Scores of ships along the coast replied with inquiries for her position, "jamming" the ether with a radio clamor. The Brooklyn Navy Yard sent out QRT (stop transmitting) until quiet was restored and the Japanese ship, Washington Maru, was able to locate the Cabo Hatteras and announce through WSC at Tuckerton, N. J., that she was rescuing the imperiled crew.

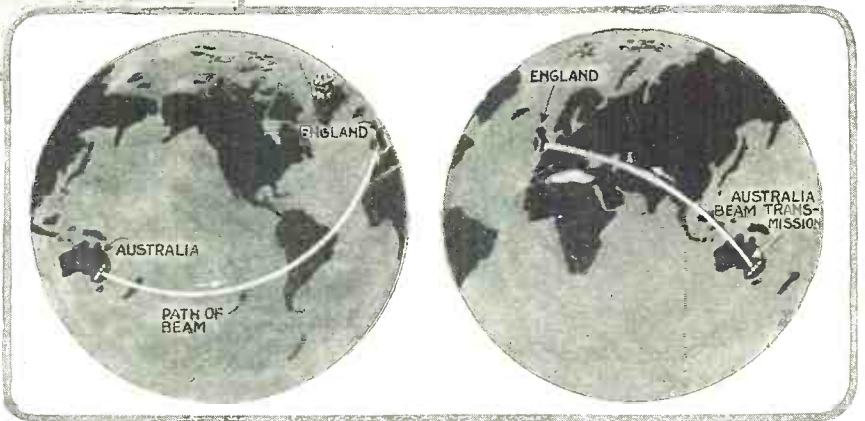

Australia and England are now connected by beam-transmission radio stations; tests have proved the system successful over a distance equal to half the circumference of the earth. To take advantage of the greater strength of signals transmitted over a dark hemisphere, the direction of the beam is reversible. When it is early morning in England, the transmission is most effective across the Pacific Ocean and South America; when it is evening in England, it is the next morning in Australia, and the beam is directed across Asia and Russia. Illustrations of the apparatus used will be found on another page.

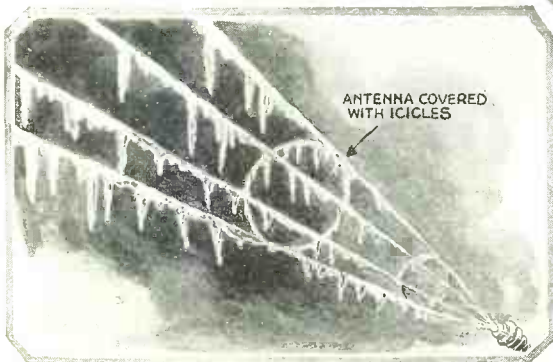

Winter may even freeze a radio station off its wavelength. Station WOR found one night that its frequency was changing fast, and investigation showed that icicles were the cause. Every time one fell, the capacity of the antenna was altered.

The Face that Vamped a Thousand Guys

By ROBERT FRANCIS SMITH

IN case we ain't been lost on the desert together, I'm Joe Hammerstein, dancer extraordinaire—my billing—and the sex appeal is Doris, specialist in the Black Bottom and kindred maneuvers. Also, may I add, she is Mrs. Hammerstein out at Brightmere-on-the-Deep, Long Island, which is just one of my troubles. Simply a couple nice folks anking along in the *Inanities* of 1927 on the Great Tight Way.

The show's a hit, going on record as being the first Broadway production in four years to carry an entire trunkful of costumes. The critics has been kind, and the speculators avid, and we gets our salaries once a week like regular people. We're a happy gang, and mix like alcohol and ginger ale, since several of the bunch are radio nuts like ourselves. Conversation back-stage is half "my act," and half "with only *two* tubes I got London, clear as a bell—" with occasionally somebody making a sane remark for the sake of variety.

Everything's smooth, except that we takes on a new chorus girl who don't know a grid-leak from a piccolo. Of course she's gotta be broken in—nobody in the *Inanities* is allowed to get by without at least a crabbing knowledge of radio—and I takes it upon myself to teach her the rudiments. At the outset I sees where they'll have to be very rude.

"This," I says, pointing for clarity's sake, "is a radio."

The front-row torment gasps. "You're not fooling me?"

"Can the bow-stealing," I commands: "This is my entrance cue."

"Do you have to have cues for radio, like billiards?" she inquires, all dimples.

I sets down in front of the outfit. "This," I explains, "is a dial. It has numbers on it, and you turn the dial until the cats have quit arguing on the back fence and you get the resonant tones of the County Marine Band of Wahoo, Wyoming. And if you don't like the County Marine Band of Wahoo, Wyoming, you keep on turning the dial and in comes the sturdy tenor of Master

John Wojciecowski, adolescent nasal artist at the Methodist Church in Springfalls, Indiana. It's all very enlightening."

"Isn't it!" chortles Betty. "Just like the automat—you put a nickel in a slot and maybe you get ice cream and maybe you get hash."

I takes out my watch. "You'll have to bear up a couple of hours," I states. "Besides, I'm a married man."

Betty grins. "Oh, I'm not hungry," she says. "I was only—"

I am revived with salts and a shot of pre-war shellac.

At the close of the performance Betty, who'd been chinning with the stagedoor man in an effort to extract a loan, rushes in with an extra decked out with headlines like a twenty-four sheet poster.

"They've arrested Mildred LeRoye!" she gasps, swallowing her gum.

Consternation reigns—also thunders.

"Arrested Mildred!"

"For cryin' out loud, wha'for?"

"It must be some mistake!"

But it ain't. Mildred is very uncomfortably lodged in the hoosegow. As soon as the final curtain dusts the boards the bunch beats it down to the free tenements. And Mildred's there, her face damp and streaked with powder and paint. She's been crying, copious.

The facts, laid before us by the police, tally as follows: The night previous Mr. Willard Montagu, second husband of Mildred LeRoye's, had been murdered in his home up the Hudson—not Sing Sing. Head crushed by a blow. The evidence against Mildred is complete. In the first place, Montagu had been handling a few of her investments, which proved to have been unfortunate. Also, Montagu is a radio hound, and has a small ten-watt broadcasting station on his estate in Westchester. He often gave small programs, many times entirely unaided. Montagu was an accomplished musician, playing a dozen instruments, also having a good voice. The night in question he had been alone, with no guests, it being

the servants' night off. Listeners testified they heard Mildred sing several numbers over Montagu's station. Upon discovering the murder, they also discovered Mildred's handkerchief initialed, two letters addressed to her, but most important, her fingerprints on the dials of Montagu's radio equipment!

There were no witnesses. So the evidence is highly circumstantial, save for one thing. Mildred positively refuses to talk—will not offer an alibi, or disclose her whereabouts the evening previous.

We pleads, argues and fumes, but not one syllable will Mid peep.

Police opinion has it that Mid was spending the evening in a quiet *tete-a-tete* with her former meal ticket and then an altercation caused the demise. That's all we can get, and it's enough.

On the way home that night Doris blubbers all over my coat. "P—poor Mid!" she sobs. "She d—didn't do it, did she, J—Joe?"

I'm supposed to be an oracle, so I admits she's innocent. "Then why's she in the jug?" demands Doris. That's the feminine of it.

"She has a lawyer," I puts in, hoping for the best.

"Lawyer!" snorts Doris. "What she needs is a shot of anti-lockjaw serum!"

Then it occurs to me so sudden I hits a rock and almost loosens my bridgework. "The Master!" I yelps.

"Jerry—oh, of course!"

About the only thing the small-change bandit and I agrees upon is the invincibility of Jerry Lawson. Jerry—The Master, according to the flunkey at the front door—is a scientist. Young, dark-haired, slim, twenty-four and endowed with several bonded millions and no sense of humor, he's our neighbor and fellow conspirator down at Brightmere. The Master's ideas ain't always effective, but they're well-intended, and invariably interesting, if you can stand the strain. The moment we runs the bus into the garage I goals a touchdown over the hill to Jerry's.

Sure enough, he's in his laboratory—a

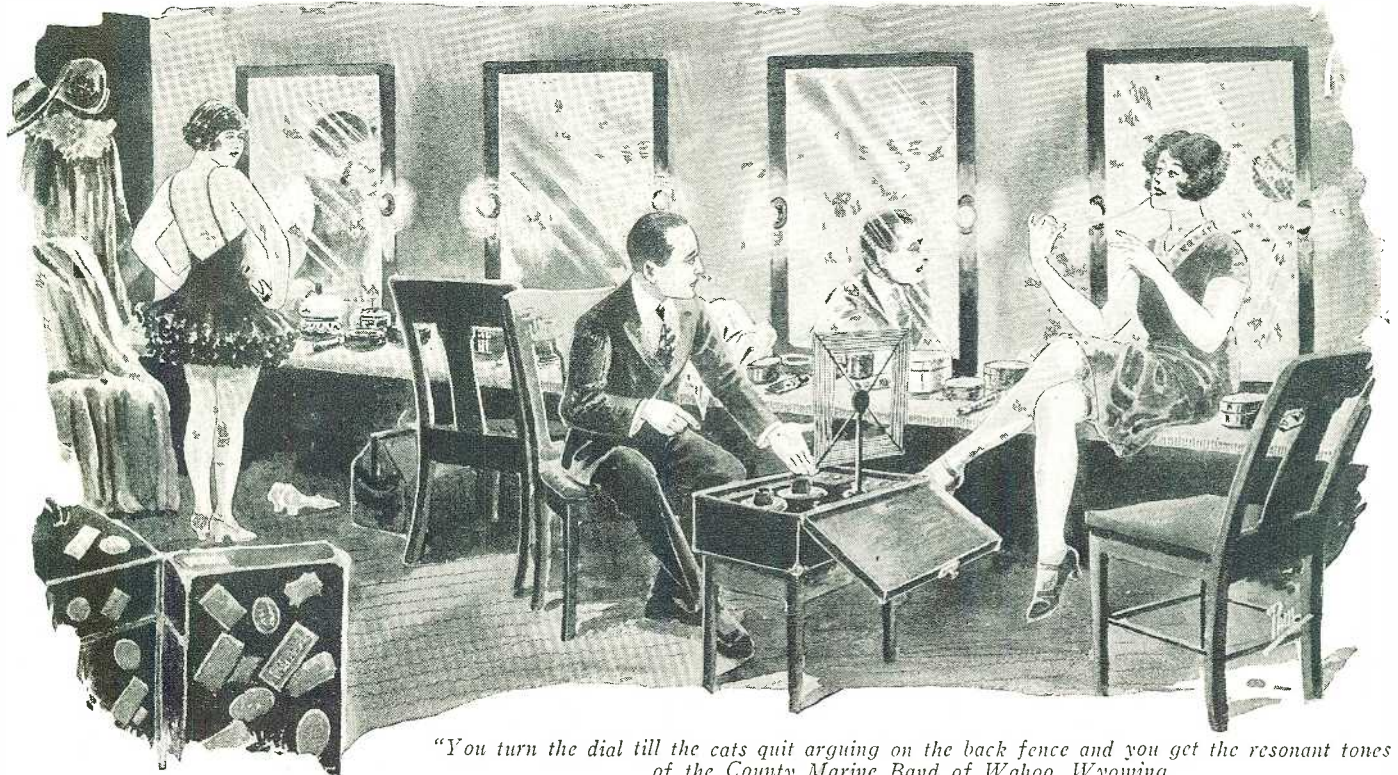

"You turn the dial till the cats quit arguing on the back fence and you get the resonant tones of the County Marine Band of Wahoo, Wyoming."

nice new building of eight rooms and one thousand push-buttons—and sitting in his old morris chair. I'm primed to speak but he beats me to it.

"Yes, I've heard," he says, as I starts to gab. He points to the evening paper before him.

The Master's been backstage often and knows the gang, and I don't have to ask aid—he's right there with the assisting palm.

"Why, it's an outrage," he exclaims. "I didn't hear of it in time to get down to the jail, but I'll do so tomorrow. She won't talk, eh?"

"Not even for a third degree, much less a two-and-a-half," I declares.

"Her fingerprints were on the dials?"

"They were—and identical."

Jerry pauses. "They could have been forged—it's possible—though not likely. We're forced to assume that Mildred was there."

I grunts. "We thought she'd lined up a simple-life booking of the back-to-nature circuit," I says. "Seems sorta funny she didn't tell us the whole truth about things."

"Did any woman?" asked The Master, and I admits none ever did until it strikes me that Jerry's unwittingly made a wise crack. But The Master is ultra-serious.

"Tell me, Joc," he requests, "had Mildred been having any communication with her husband of late?"

"Her ex-husband," I corrects. "Why, they were friends, of course. Mid's ex-hubbies never stop loving her."

"Ex-husbands?" accents The Master. "She'd been wed before?"

I grins. "It's a game with Mid," I explains. "Montagu was her second attempt. She's just got rid of her fourth."

This gives Jerry a bit of thought. "Are all the others living?"

"As far as I know, they are."

Silence a moment. "Who were they?"

"Number one was Harry Fay, the comedian. That lasted three whole months. Montagu was second, running time six months three weeks. Third was the Earl of Southshire, which made Mid a countess until she found she'd have to leave America. A technicality saved her citizenship. Last was young Pete Lowry, whom she divorced last spring."

"What types were they?"

I parks on a bench. "Well, Fay was a comedian, a female impersonator. I guess Mid grew tired of the gorgeous creations Harry used to buy for his act. Harry was a nice chap, though. The two just couldn't agree."

"Female impersonator?" repeats The Master. "Go on."

I coughs. "The Earl looked like a shifty bird to me. He never even got Mildred out of the country. They only lasted twenty-two days."

"Montagu?"

"A child of fortune, clubman, older than Mid, and highbrow. No business man, though he tried to assist friends in invest-

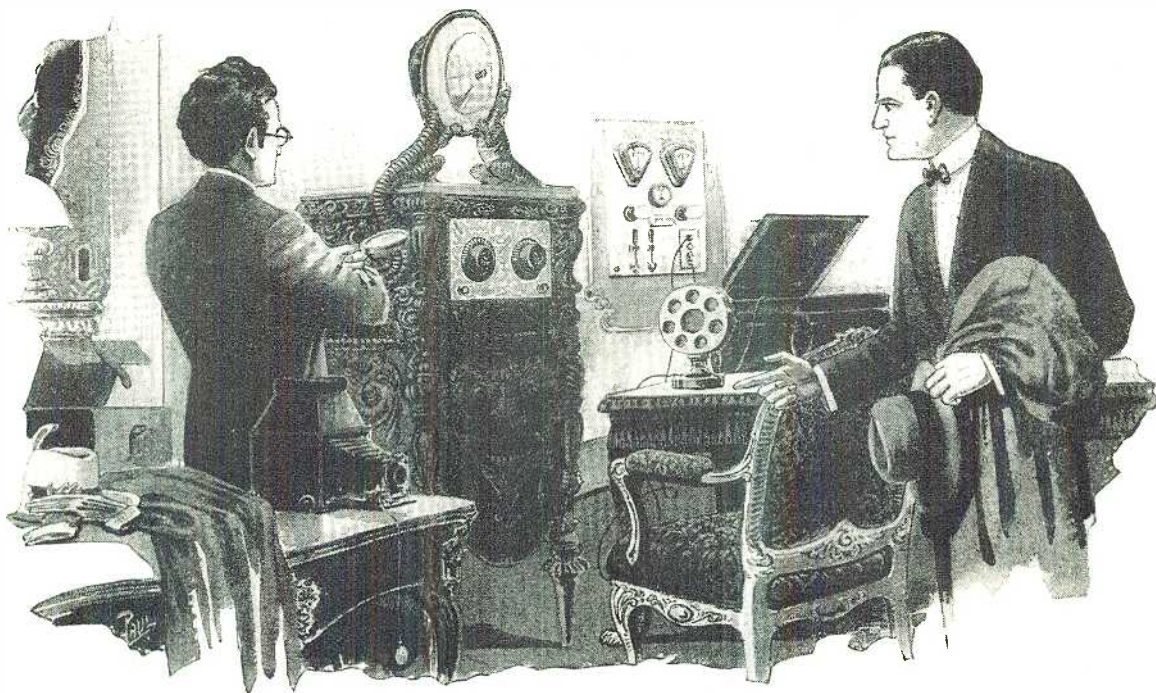

"The dials with the fingerprints are on the receiving set. That will be Point Number One."

ments. Mid lost a bit through him, I happen to know. Good scout personally."

"I met Montagu once," says The Master. "Pleasant fellow."

"Lowry is the kid son of Wall Street himself. College junior at the time. Interested in science, and rather clever, too. His old man kicked him off the family roll of honor and Mid paid his laundry bill for a time until he wouldn't stand for it and they separated. A high-spirited cuckoo, Lowry."

The Master muses a moment. "Any prospects for a fifth?"

That brings a grin. "Well, it's back-stage small-talk, and not to go any further, but Tap Jones—you know Tap—is much smitten over Mid. They were lovers years ago, before her first marriage. It wouldn't thrill me if he still thinks she's the all-in-all."

The Master smiles his faint smile. "That brings the list of suspects down to five, as far as matrimonial connections go. No other relatives? No sisters, brothers, cousins, or such?"

"Mid's an orphan," I replies. "I never knew she had any natural family. And I've known her for many seasons."

"Any enemies you could name?"

I pauses. "Everybody has enemies," I says, slow. "I can't recall any in particular, though many were envious of her."

Jerry gets up. "That closes the list, I believe," he states. "Tomorrow we'll see the police and go up to the scene of the murder."

We does that, arriving at the estate about eleven. The Master's police card admits us, and we goes upstairs to the broadcasting room. Nothing has been altered. Jerry examines the set.

"The transmitter is orthodox enough," he states, "but the receiving set is startlingly original. Have you ever seen one like it?"

It's a bizarre affair, very gaudily done, with elaborate carved woodwork in what looks like Chinese style. It seems to be vaguely familiar, but I can't place having seen one like it.

"The dials with the fingerprints are on the receiving set," states The Master. "That will be Point Number One—Mildred must have been tuning."

"Quite possible."

"Evidently, then, Mildred was here. Last

night I labored over the idea that someone might have tampered with the transmitter with malice aforethought, but it is in correct operating order."

"Yes?"

Jerry continues. "Assuming that Mildred was here and listening in, the dials must be resting at a position for some station."

I grins. "Naturally, but can you prove it?"

The Master points to a small circular card surrounding the dial. "His set was so accurate that instead of inscribing the dial numbers in a ledger, he simply wrote the call letters on the card. It's a two-dial affair, and was set for a station in Chicago. See?"

It's true. The call letters are set.

"As I happen to know, that station was not on the air that night," says Jerry. "Which, however, proves little; Mildred might have been tuning for it just the same, or it might have been some other night. But it's a point to be kept in mind."

He examines the receiver minutely, but can't find the name of the maker. He's brought his flashlight, and taken a few photos of things. Later we interviews several nearby residents who heard the program. We ain't done much, but there's little we can do. So we returns to Brightmere, empty-handed.

Due time is two weeks later, after the Grand Jury has brought a charge of first-degree murder onto Mildred. Me, I'm busy trying to straighten out some comedy bits in the show, and The Master goes it alone, except for Tap Jones, who's taken my place.

I ain't heard any more facts, nor has the police, although The Master has been working hard. Mildred, of course, is still out of the cast, and tearfully refuses to talk. We consoles her as we can, which ain't a lot. The trial opens on a Monday morning.

It takes two days to impanel a jury. The evidence points straight at Mildred, and the press hasn't been any too lenient. The only thing that puzzles me during those two days is that The Master and Tap Jones are not present.

Wednesday morning wears away, with the two salvation hunters still away from court. Witnesses for the State are called, consisting of those who heard the program, police officers, and a few sundry neighbors, *et al.* It's one o'clock when they calls Mildred to the

(Continued on page 1495)

English-Australian Radio Beam System

The latest links in the chain uniting that empire upon which the sun never sets are the short-wave beam transmission radio stations by which England, Australia and India are brought in direct touch. The views below are scenes at the newly-completed English stations at Grimsby and Skegness.

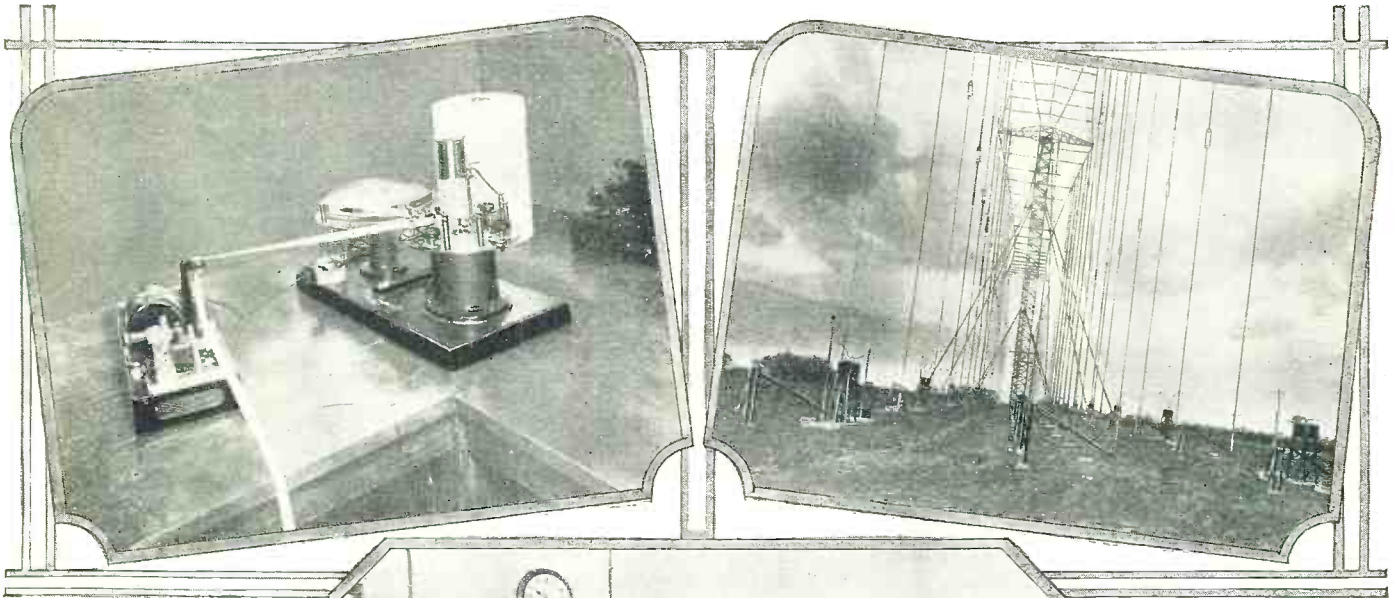

Above is shown one of the automatic "siphon" recorders of the Skegness receiving station. This device, similar to those used to record cable signals, registers the message in a wavy ink-line upon the paper tape. At the right is an interior view in this station, in which recorders like those above may be seen. On either side are telegraph instruments, connecting with the transmitting station and the central radio office of the British postal system.

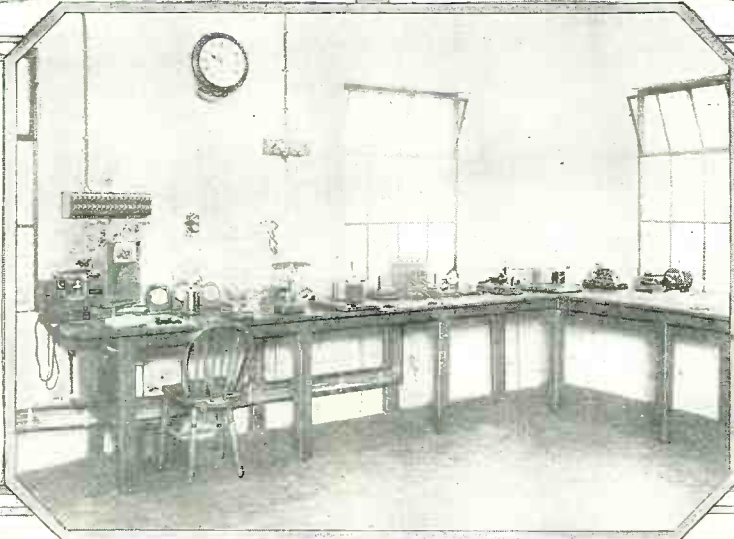

Above, a view of the aerial system of the transmitting station at Grimsby, with two lines of aerial on either side of the central reflectors. The message may thus be focused toward Australia in either an easterly or a westerly direction, as mapped on page 1429. The wires are held vertical by heavy weights; the elevated black boxes contain feeders for pairs of the aerial wires. A comparatively small power is required, because of the directional characteristics of the system, to span nearly 15,000 miles.

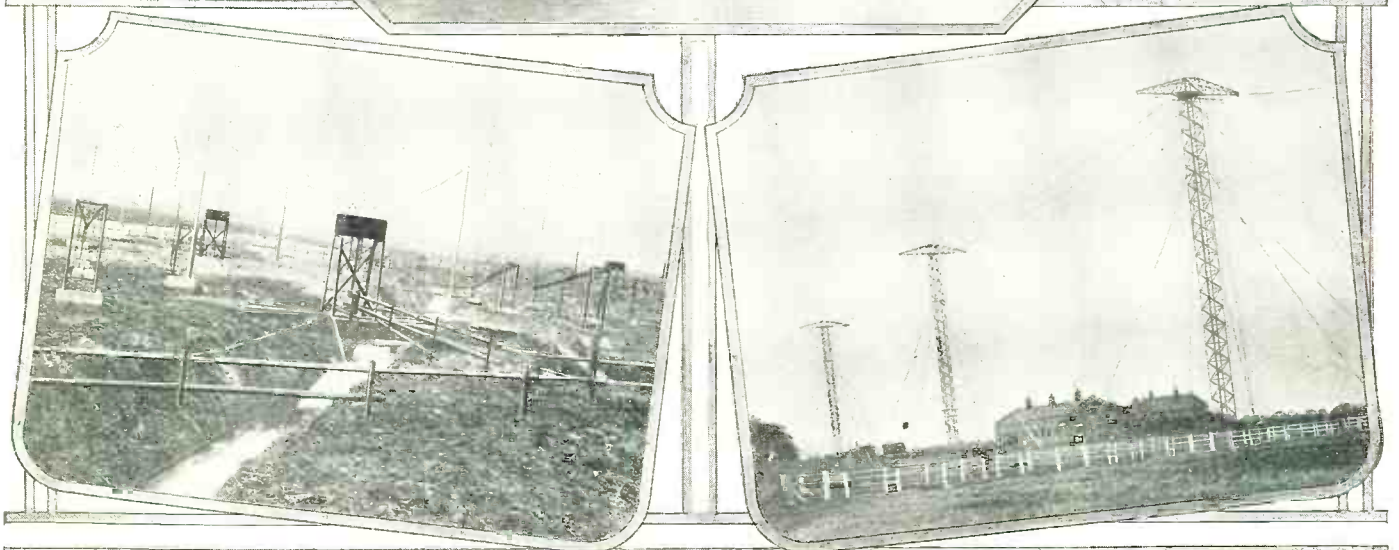

Above at the right is another view of the station at Grimsby, with the double-aerial and reflector system in the foreground. The machinery building is at the left of this view, and the transmission hall at its right. The separate antenna used for Indian messages is not shown here. At the left, above, is a view of the receiving aerial at Skegness, showing how the difficulties of the marshy soil were overcome. The coupling boxes are prominent in this picture.

Photos © Herbert Photos, Inc.

Radio on New York's "Welcome Ship"

At the gateway of the Western World, the City of New York has constituted herself the hostess of America's distinguished guests. One of the ships of her fleet, the "Macom," has as an important duty conveying the bearers of the city's first greetings. With the radio apparatus shown here, liaison is maintained directly with Atlantic liners as they near the port, so that the ceremonies may be timed exactly.



Above is Chief Radio Operator Orth at the "Macom's" receiver. At his left is a 5-tube superheterodyne with a power amplifier; at his right hand a navy type receiver, which has a range of 250 to 3,000 meters for receiving ship and land messages. In the picture in the upper right corner of the page, Mr. Orth is shown at the transmitting panel of the "Macom's" equipment. This is a 500-watt quenched-spark transmitter, and operates on 600 and 730 meters.

At the center right is the good ship "Macom" herself, gaily decked out to welcome an American champion home from Europe.
Photos © Herbert Photos, Inc.

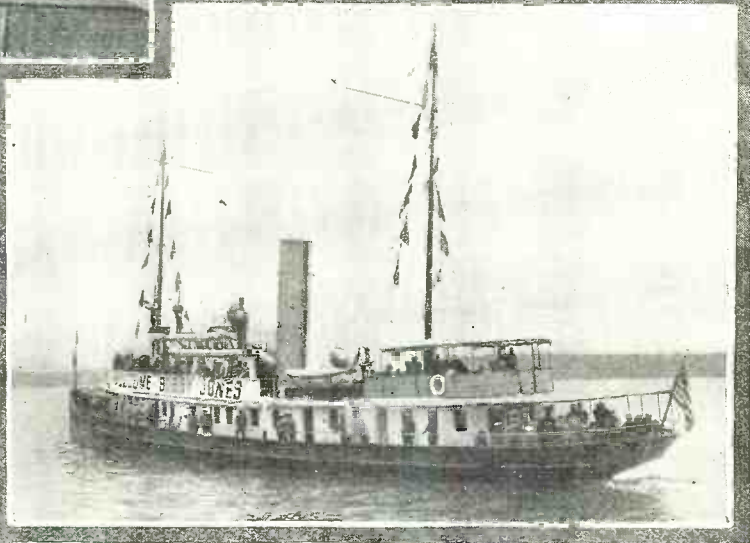

Familiar as the waters of New York Bay are to Capt. William G. Hamilton, the heavy fogs which drift over them make it often necessary to resort to the "Macom's" radio compass, as shown below.



The odd structure above serves, not only as a lighthouse, but also as a community radio loud speaker. It is located at Dartmouth, Mass., where the Round Hills Radio Corporation maintains station WMAF. Around this battery of huge speakers the whole population of the town may gather on pleasant evenings to hear programs reproduced with a volume that fills all outdoors.

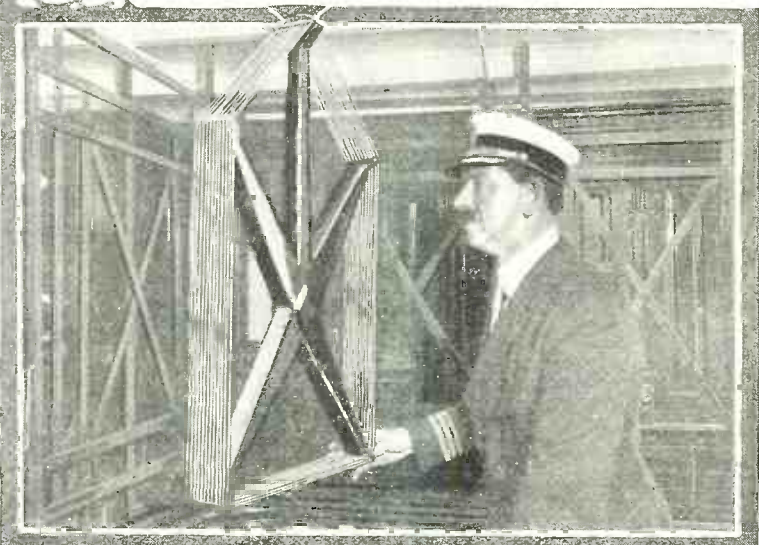

List of Broadcast Stations in the United States

Radio Call Letter	BROADCAST STA. Location	Wave (Meters)	Power (Watts)	Radio Call Letter	BROADCAST STA. Location	Wave (Meters)	Power (Watts)	Radio Call Letter	BROADCAST STA. Location	Wave (Meters)	Power (Watts)	Radio Call Letter	BROADCAST STA. Location	Wave (Meters)	Power (Watts)	
KDKA	East Pittsburgh, Pa.	*309.1	Var.	KGDJ	Cresco, Iowa	202.6	10	KWKG	Stockton, Calif.	248	50	WDAD	Nashville, Tenn.	225.4	1000	
KDKB	East Pittsburgh, Pa.	*65.6	Var.	KGDM	Stockton, Calif.	217.3	5	KWKC	Kansas City, Mo.	236	100	WDAE	Tampa, Fla.	273	1000	
(Various short-wave transmissions)																
KDLR	Devil's Lake, N. Dak.	236.9	10	KGDW	Dallas, Tex.	285	100	KWLC	Decorah, Iowa	431	50	WDKF	Kansas City, Mo.	365.6	1000	
KDYL	Salt Lake City, Utah	236.8	250	KGDP	Pueblo, Colo.	260.7	10	KWTC	Pullman, Wash.	318.6	500	WDAH	Amarillo, Texas	263	250	
KELW	Burbank, Calif.	253	250	KGDR	San Antonio, Tex.	240	15	KWUC	Le Mars, Iowa	263	5	WDHJ	El Paso, Texas	267.7	100	
KEX	Portland, Ore.	147	1000	KGDV	Humboldt, Neb.	241.8	100	KWWG	Brownsville, Texas	278	1500	WDBE	Fargo, N.D.	261	500	
KFAB	Lincoln, Neb.	*340.7	5000	KGDY	Shreveport, La.	291.1	500	KXXL	Portland, Ore.	400	50	WDBJ	Roanoke, Va.	270	100	
KFAD	Phoenix, Ariz.	272.6	50	KGEF	Oldham, S. D.	210	15	KYA	San Francisco, Calif.	399.8	1000	WDBK	Cleveland, Ohio	237	500	
KFAU	San Jose, Calif.	217.3	50	KGEH	Los Angeles, Calif.	516.9	1000	KYW	Chicago, Ill.	535.4	5000	WDBO	Winter Park, Fla.	240	500	
KFBH	Havre, Mont.	275	50	KGEI	Eugene, Ore.	236.1	10	KZIB	Manila, P. I.	249.9	20	WDBZ	Kingston, N. Y.	232.4	10	
KFBC	San Diego, Calif.	380	100	KGEL	Yuma, Colo.	252	10	KZKZ	Manila, P. I.	240	100	WDEL	Wilmington, Del.	266	100	
KFBL	Sacramento, Calif.	335	100	KGEJ	Jamesstown, N.D.	325	50	KZM	Oakland, Calif.	240	100	WDFL	Minneapolis, Minn.	293	500	
KFBM	Everett, Wash.	235	100	KGEO	El Centro, Calif.	251	15	KZRO	Manila, P. I.	400	500	WDDO	Chattanooga, Tenn.	256	500	
KFBT	Trinidad, Colo.	258	15	KGEP	Grand Island, Neb.	371	15	NAA	Arlington, Va.	*454.5	1000	WDRG	New Haven, Conn.	268	100	
KFBV	Laurens, Wyo.	275	500	KGEQ	Minneapolis, Minn.	330	50	WAAD	Cincinnati, Ohio	258	25	WDWF	Edgewood, R.I.	440.9	500	
KFCB	Phoenix, Ariz.	238	125	KGER	Long Beach, Calif.	325.9	100	WAAG	Chicago, Ill.	278	50	WDWM	Newark, N. J.	380.2	500	
KFCR	Santa Barbara, Calif.	113	15	KGES	Central City, Neb.	295.4	10	WAAM	Newark, N. J.	293	50	WDZ	Tuscola, Ill.	286.9	250	
KFDD	Boise, Idaho	275.1	50	KGEU	Lower Lake, Calif.	222	50	WAAT	Jersey City, N. J.	225	500	WEAF	New York, N. Y.	*491.5	5000	
KFDM	Broomfield, Tex.	315.6	500	KGEV	Denver, Colo.	204	15	WAAW	Omaha, Neb.	384.4 & 278	500	WEAI	Ithaca, N. Y.	254	500	
KFDY	Brookings, S. Dak.	217.8	1000	KGEW	Kalispell, Mont.	352	100	WABB	Harrisburg, Pa.	291	10	WEAM	North Plainfield, N. J.	261	250	
KFDZ	Minneapolis, Minn.	231	10	KGEY	Alva, Okla.	205.1	25	WABW	Richmond Hill, N. Y.	315.6	5000	WEAN	Providence, R. I.	367	500	
KFEC	Portland, Ore.	252	150	KGF	Oklahoma City, Ok.	354	50	WABY	Kingston, Pa.	410.7	100	WEAR	Cleveland, Ohio	578	750	
KFEL	Denver, Colo.	251	250	KGFH	Creoseta, Calif.	118.8	100	WABI	Bangor, Me.	277	100	WEAU	Sioux City, Iowa	275	150	
KFEM	St. Joseph, Mo.	267.7	2000	KGFI	Fort Stockton, Tex.	220.4	15	WABR	Toledo, Ohio	263	50	WEBC	Superior, Wis.	242	500	
KFEN	Kellogg, Colo.	232	50	KGFJ	Los Angeles, Calif.	218	100	WABW	Wooster, Ohio	206.8	10	WEBE	Cambridge, O.	234	10	
KFFP	Moberly, Mo.	242	10	KGFK	Hallock, Minn.	225	100	WABX	Mount Clemens, Mich.	246	500	WECH	Chicago, Ill.	370.2	2000	
KFGG	Iowa City, Ia.	224	10	KGFL	Trinidad, Colo.	222	50	WABZ	New Orleans, La.	275	50	WECL	Boston, Mass.	348.6	500	
KFGH	Wichita, Kansas	*267.7	500	KGFM	Yuba City, Calif.	450	15	WABC	Akron, Ohio	258	500	WENR	Chicago, Ill.	*265.3	1000	
KFHA	Gunnison, Colo.	235	50	KGFN	Aneta, N. Dak.	222.1	15	WADF	Detroit, Mich.	312.3	500	WEPS	Gloicester, Mass.	295	100	
KFHL	Oskaloosa, Iowa	236	10	KGFJ	Mitchell, S. Dak.	293	15	WAGM	Royal Oak, Mich.	223.5	50	WEW	St. Louis, Mo.	360	1000	
KFI	Los Angeles, Calif.	467	5000	KGK	Oakland, Calif.	*361.2	5000	WAGS	Somerville, Mass.	350	50	WFAA	Dallas, Texas	475.9	500	
KFIF	Portland, Ore.	217.8	150	KGKR	San Antonio, Tex.	315	50	WAIU	Columbus, Ohio	293.9	5000	WFAV	Lincoln, Neb.	275	500	
KFIO	Spokane, Wash.	272.6	250	KGKS	Amarillo, Tex.	234.2	100	WALK	Bethayres, Pa. (Port.)	233	50	WFBC	Knoxville, Tenn.	250	50	
KFIP	Yakima, Wash.	256	50	KGKT	San Francisco, Calif.	206.8	50	WALM	Minneapolis, Minn.	244	5000	WFBE	Cincinnati, O.	232.4	500	
KFIS	Juneau, Alaska	246	10	KGU	Honolulu, Hawaii	270	50	WAMQ	Azusa Park, N. Y.	217.8	100	WFB	Altoona, Pa.	*277.6	100	
KFIZ	Fond du Lac, Wis.	273	100	KGV	Portland, Ore.	278.5	100	WAPI	Opurn, Ala.	311.3	1000	WFBJ	Altoona, Pa.	*277.6	100	
KFJB	Marshalltown, Iowa	248	10	KHJ	Los Angeles, Calif.	405.2	500						WFBK	Altoona, Pa.	*277.6	100
KFJJ	Oklahoma City, Okla.	260.7	1000	KHX	Los Angeles, Calif. (port.)	119.9	500						WFBM	Indianapolis, Indiana	268	250
KFJJ	Astoria, Ore.	246	10										WFBP	Baltimore, Md.	251	100
KFJM	Grand Forks, N. Dak.	278	100										WFBZ	Galesburg, Ill.	254	20
KFJN	Portland, Ore.	129	100										WFFD	Flint, Mich.	243	100
KFJY	Fort Dodge, Iowa	246	100										WFHH	Clearwater, Fla.	355.4	500
KFJZ	Fort Worth, Tex.	254	50										WFI	Philadelphia, Pa.	394.5	500
KFKA	Greeley, Colo.	*272.6	50										WFIK	Hopkinsville, Ky.	356.9	1000
KFKB	Millard, Kas.	434.5	500										WFKB	Chicago, Ill.	217.3	1000
KFKC	Lawrence, Kans.	275	500										WFLA	Boca Raton, Fla.	440	1000
KFKD	Hastings, Neb.	232	100										WFLB	Brooklyn, N. Y.	205.4	500
KFKS	Kirkville, Mo.	232.4	75										WFLC	Lancaster, Pa.	248	10
KFLR	Albuquerque, N. Mex.	254	100										WGBB	Freeport, N. Y.	244	100
KFLU	San Benito, Tex.	236	20										WGBD	Memphis, Tenn.	277.6	15
KFLV	Rockford, Ill.	229	100										WGBF	Evansville, Ind.	236	500
KFLW	Galveston, Tex.	240	250										WGBH	Syracuse, N. Y.	292	500
KFMR	Sicklerville, Ky.	238	100										WGBS	Astoria, N. Y.	214	100
KFMY	Northfield, Minn.	336.9	500										WGBU	Pulford, Fla.	384.4	500
KFNF	Shenandoah, Iowa	461.3	1000										WGBX	Orono, Me.	234.2	500
KFOA	Seattle, Wash.	351.3	1000										WGPC	Newark, N. J.	252	500
KFOB	Burlingame, Calif.	226	50										WGES	Oak Park, Ill.	315.8	500
KFOD	Long Beach, Calif.	233	750										WGR	Buffalo, N. Y.	370	1500
KFOR	Davenport, Iowa	231	50										WGL	New York, N. Y.	422.3	1000
KFOU	Wichita, Kans.	231	50										WGM	Jeannette, Pa.	269	150
KFOX	Omaha, Neb.	248	100										WGMU	Richmond Hill, N.Y. (port.)	236	100
KFOY	St. Paul, Minn.	252	250										WGN	Buffalo, N. Y.	302	100
KFPL	Dublin, Texas	252	20										WGT	Atlanta, Ga.	319	750
KFPM	Greenville, S.C.	242	10										WGW	Milwaukee, Wis.	381.4	400
KFPR	Los Angeles, Calif.	350	500										WGY	Schenectady, N. Y.	*379.5	5000
KFPV	Cartersville, Mo.	260.7	100										WHA	Madison, Wis.	535.4	1000
KFPY	Spokane, Washington	272.6	500										WHAD	Milwaukee, Wis.	275	500
KFQA	St. Louis, Mo.	258.5	50										WHAP	Rochester, N. Y.	278	100
KFQB	Fort Worth, Texas	508.8	2500										WHAR	Atlantic City, N. J.	275	500
KFQD	Anchorage, Alaska	227.1	100										WHAS	Louisville, Ky.	399.8	500
KFQE	St. Louis, Mo. (City) Calif.	229	250										WHAZ	Troy, N. Y.	379.5	500
KFQW	Seattle, Wash.	215.7	50										WHB	Kansas City, Mo.	366.6	500
KFQX	Seattle, Wash.	210	15										WHBC	Ottawa, Kan.	250	10
KFQZ	Hollywood, Calif.	225.4	500										WHBD	Bellefontaine, Ohio	242	100
KFRB	Beverly, Tex.	248	250										WHBF	Rock Island, Ill.	222	100
KFRD	San Francisco, Calif.	267.7	50										WHBL	Chicago, Ill. (port.)	215.7	100
KFRF	Colorado Springs, Colo.	239.9	100										WHBM	Chicago, Ill. (port.)	215.7	20
KFRG	Colorado Springs, Colo.	239.9	100										WHBN	St. Petersburg, Fla.	238	10
KFRH	St. Louis, Mo.	345.1	500										WHBO	Johnstown, Pa.	250	100
KFRJ	Denver, Colo.	321	50										WHBQ	Minneapolis, Minn.	293	500
KFRK	Ogden, Utah	224	50										WHBR	Cincinnati, O.	215.7	300
KFRS	Oakland, Calif.	256	50										WHBU	Anderson, Ind.	218.8	10
KFRU	Salt Lake City, Utah	263	100										WHBV	Philadelphia, Pa.	215.7	100
KFRV	Venice, Calif.	208	500										WHBW	West De Pere, Wis.	350	50
KFRW	St. Louis, Mo.	308	100										WHDI	Minneapolis, Minn.	278	500
KFRX	Independence, Kas.	236.1	50										WHEH	Rochester, N. Y.	253	500
KFVJ	Houston, Texas	239.9	50													

Giant New Transmitting Tube

Ten Horsepower Needed to Heat Filament of 100-kw. Transmitter

By JOSEPH RILEY

ONLY three years ago, when a broadcast station announced that it was going to transmit with 1000 watts power, people gaped and wonderingly said, "Heavens, what a station!" Then came the "super-power" stations with 5,000 watts, and fans became doubtful if they could hear any other when the powerful one was operating. The results were gratifying, however, for these stations did not create as much interference as expected; so now, when a transmitting tube rated at 100,000 watts (100 kilowatts) is announced, only admiring interest is shown—nothing more.

This giant transmitter, developed in the research laboratories of the General Electric Co. at Schenectady, was recently used at 2XAG, the super-power transmitter of station WGY. This tube takes the place of eight 20-kw. tubes in the transmitter, and as yet engineers are still experimenting with it. With a tube of this size available, it is possible to operate with higher power than has heretofore been utilized. Up to the present time 50 kilowatts in the antenna has been considered super-power; but this output will seem small when it is considered that 500 kw. can be made available.

At present the 100-kw. tube has been used as a radio-frequency amplifier in the transmitter, fulfilling there a use comparable with that of the radio-frequency amplifiers in an ordinary broadcast receiver. In a receiver the radio-frequency amplifier magnifies the current picked up by the antenna; in the transmitter the output of a 20-kw. tube is amplified by the newest addition to the tube family and put into the antenna.

NOVELTIES IN CONSTRUCTION

Naturally, with a tube of this size, new methods of construction were necessary to provide strength and durability. Exclusive of its water jacket, the tube is five feet high, two-thirds of this height consisting of a copper envelope four inches in diameter. This copper serves a dual purpose, offering protection to the tube elements and acting as the plate or anode of the tube. The leads to the filament and the grid pass through a glass tube which is about twenty inches long. Effecting an airtight copper-to-glass seal was one of the many problems that had to be solved before these great tubes could be successfully used. However, now this seal has been made mechanically strong and will hold the vacuum.

Current is supplied to the filament, which consists of six tungsten wires, each about sixteen inches long, through copper leads capable of carrying several hundred amperes; these leads being approximately the diameter of a lead pencil. The power needed to light such a filament is equivalent to that necessary for lighting 170 50-watt lamps; the filament is held in tension by a spiral spring. The grid is nearly three and a half feet long and is an ingenious structure of tungsten and molybdenum. To get the maximum strength with a minimum of metal, bracing is employed such as is used in bridges. It is necessary that this element of the tube stay exactly in its assigned position, for any sagging or swaying due to expansion from the heat would cause a disastrous short circuit. The grid connection is introduced through a glass arm about midway down in the glass tube.

THE "SAFETY VALVE"

One of the most important factors in the operation of an electron tube is the degree of vacuum. The effects of relatively high increases of pressure are as disastrous in a tube of this size as lack of lubrication in the bearings of an engine. To guard against increases of pressure an "ionization" gauge is used on this 100-kw. tube, in the form of a three-element vacuum tube sealed to the glass envelope. Connections to its filament, grid and plate are made from the

(Continued on page 1489)

The young lady is supporting in her right hand one of the new 100-kw. transmitting tubes and in her left a 20-kw. tube. The "pressure gauge" tube is seen at the extreme left.

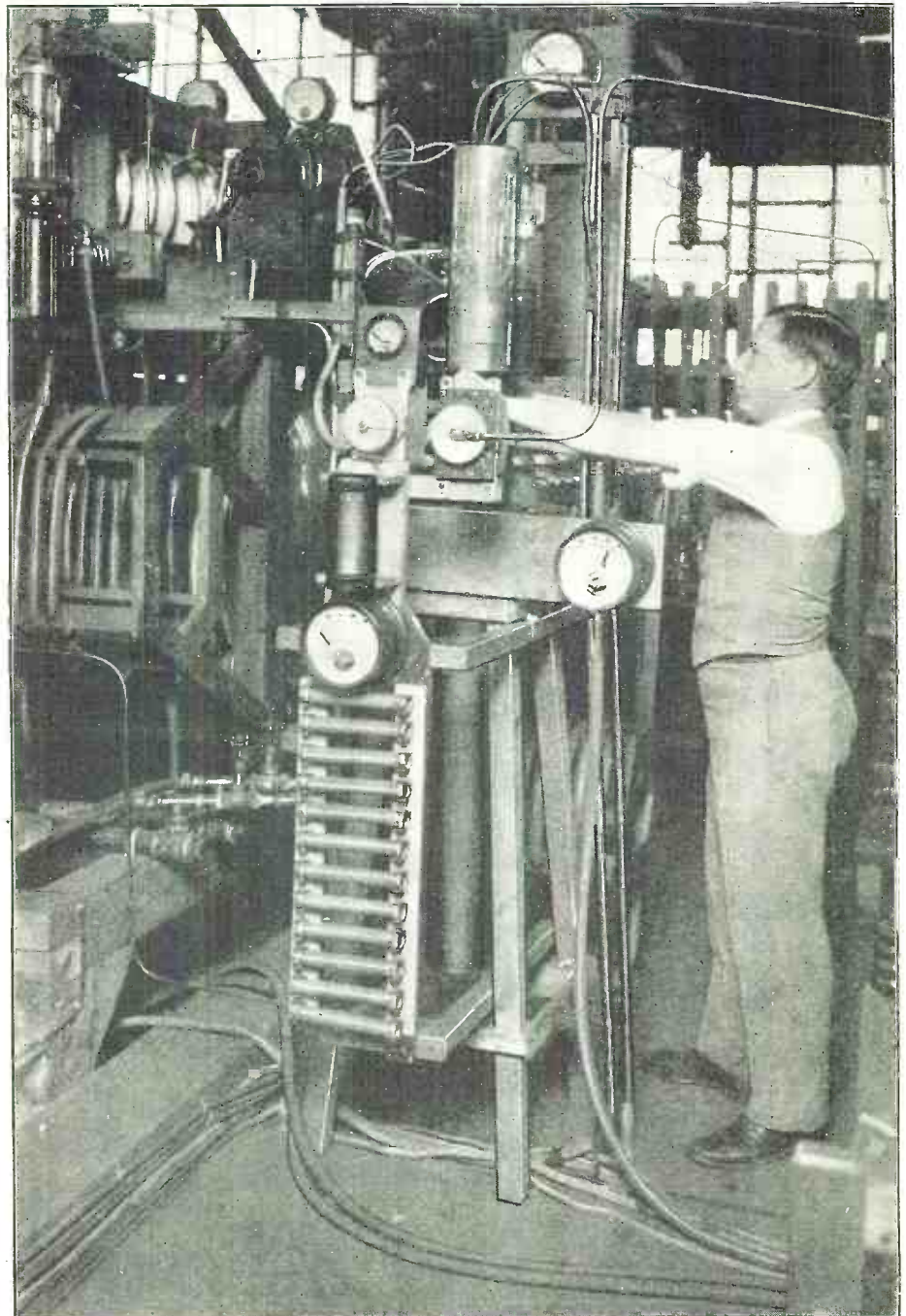
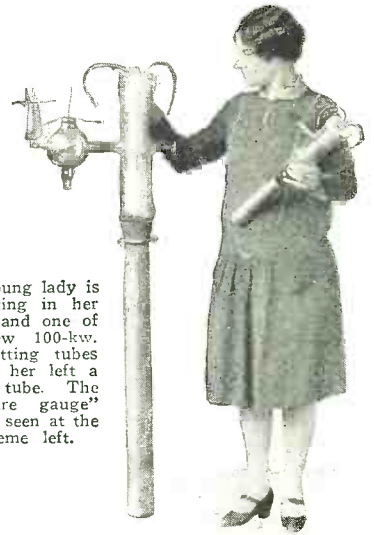

The 100-kilowatt tube, used as a radio amplifier in the development transmitter of WGY. Observe its height above the operator's hand.

Photos by courtesy of General Electric Co.



What Tuning Really Does Electrically

An Explanation of What Happens in the Circuit You Tune

By E. H. RIETZKE and S. K. MacDONALD, Jr.

FROM the earliest days of radiotelegraphy, then commonly called "wireless telegraphy," right up to the present time, people have been tuning radio receivers and transmitters with very little idea of what they were actually doing. For many years the average commercial radiotelegraph operator or the amateur "varied" condensers and coils, judging only by results accomplished, knowing nothing more than that he increased his wavelength when he added capacity or inductance, and vice versa. After broadcasting was made practical in 1920 the broadcast listener paid out his money and received a receiving set with many knobs and dials; and he then learned by experience that, by turning certain dials in a certain direction, he could eliminate one station and pick up another.

Some owners of receiving sets are still content to do this; but the great majority of broadcast listeners and experimenters, especially those who are building their own receivers, are beginning to want to know what it's all about.

Why must stations be separated by ten kilocycles? What is a kilocycle? Why does one set "tune sharper" than another? Why is the maximum selectivity not always desirable? Just what is low loss, and why?

All these questions, and many others, are questions that can only be answered by first explaining the electrical action of the circuit.

ELEMENTS OF A RADIO-FREQUENCY CIRCUIT

Let us first consider any "radio-frequency" circuit, in any receiver. We find that it consists of an inductance coil, either fixed or variable by steps, a condenser, usually continuously variable, and resistance. By the last, we do not mean an inserted resistance, such as a rheostat, but simply the resistance of the wires, the resistance of the soldered connections, the losses in the condenser, etc. These various resistances and losses are very important and with their effects will be taken up in detail later.

We have our circuit including this capacity, inductance, and resistance. We know that by adjusting this circuit we can tune one station in or another out. This is accomplished by changing the electrical length of the circuit; so that it requires a longer or a shorter time for an electrical impulse to travel the complete length of the circuit.

ELECTRICITY TAKES TIME TO FLOW

Many people have the idea that all electrical action is instantaneous. If we think in ordinary units of time this is, practically, correct. But when dealing with currents and voltages at radio frequencies, we are thinking of time by units in which a millionth of a second is large. From this viewpoint electrical actions are not instantaneous. A current in a circuit may rise from zero to some maximum value, fall to zero, reverse in direction, and repeat the whole process in less than one millionth of a second; and every one of those changes will have some effect on the circuit and the tube to which this circuit is connected. We must therefore revise our ordinary conception of time and remember that much may happen in the circuit in one millionth of a second.

Now, going back to the electrical length of the circuit, it is conceivable that, since electrical changes in the circuit are not instantaneous, a voltage increase across one part of a circuit may take place at a later time than this same increase in some other part of the circuit. This would indicate that this impulse was traveling along the circuit; and since a certain length of time was taken in getting from one part of the circuit to the other, the circuit must have a certain "electrical length."

This electrical length is due to the inductance and the capacity in the circuit. The properties of inductance are such as to oppose any change in the current flowing in the circuit. The current in a radio-frequency circuit is continually changing; rising, falling and changing in direction. (Fig. 1. The height of the curve above the line 0-0 indicates the amount of current in one direction; its depth below the line the current in the opposite direction.) Therefore, since the inductance in the circuit always opposes these changes, the greater the value of the inductance, the greater is the opposition to the change, and the greater is the time interval required for the same change in the circuit.

In the same way, a certain condenser requires a certain interval of time (depending on its capacity) to charge to a given voltage and, when once charged, it will also require a certain time to discharge through the circuit.

INDUCTANCE OPPOSING CAPACITY

It can be seen then that, if any part of the

circuit is "cut" by a magnetic field in such a way as to induce a voltage across it (for example, when the wave from the transmitter cuts the receiving antenna), the condenser will start to charge; but in order to do this, a current must rise in the circuit to charge the condenser. This rise of current is opposed by the inductance, thus slowing down the charge of the condenser. The larger the capacity of the condenser, the greater the current flow must be to charge it to a given voltage. The larger the value of the inductance, the greater the opposition it offers to the change of current; therefore the longer will be the time interval required for one complete charge.

The same principle applies to the discharge of the condenser; the larger the condenser and the larger the inductance, the longer the time interval required for a complete discharge. We can see then that, the greater the values of inductance and capacity, the greater the required time interval will be for any cycle of charge and discharge, and therefore the longer the "electrical length" of the circuit.

WHAT IS FREQUENCY?

In any alternating-current circuit composed of inductance and capacity, a complete cycle consists of a complete charge of the condenser, its discharge through the inductance, the charge of the condenser in the opposite direction and the second discharge through the inductance. All of this requires time and, since an electrical impulse travels through space at the normal rate of 300,000,000 meters per second, the wavelength is taken as the distance the impulse would travel through space in this given time. The natural frequency of the circuit is computed from the time of one cycle of events and is expressed as the number of these cycles that would take place per second. Since this runs up into very large values the unit of frequency, at radio frequencies, is usually taken as the kilocycle. One kilocycle equals one thousand cycles. (Per second is always understood.)

If we induce an initial charge, or voltage difference between the plates of our condenser, we can assume that this condenser will discharge through the inductance, building up a magnetic field around it; this field will collapse, returning the energy back into the circuit and charging the condenser in the opposite direction. The condenser will then discharge again, etc.; the energy first being in the form of an electric field within the condenser, and then in the form of a magnetic field around the coil. All this is taking place in a regular cycle of events; the time interval of each cycle depending on the amount of inductance and capacity in the circuit. These cycles would continue, each action being a little weaker than the previous one, until all the original energy was expended in heat in the resistance of the circuit. Theoretically, if we could have a no-loss, no-resistance circuit, these charges and discharges would continue forever, from the initial charge, with no loss of energy. Since this condition of no loss is impossible to attain, practically our energy is expended after a few cycles.

But if, instead of supplying our circuit with a single kick of energy and then leaving it free to oscillate, we were to provide a continuous source of energy that would aid in charging the condenser at exactly the instant it had finished discharging and was due to begin the next charge, it can be seen that our circuit would continually receive energy at just the right time to keep it always at a maximum value. If, however, we were to

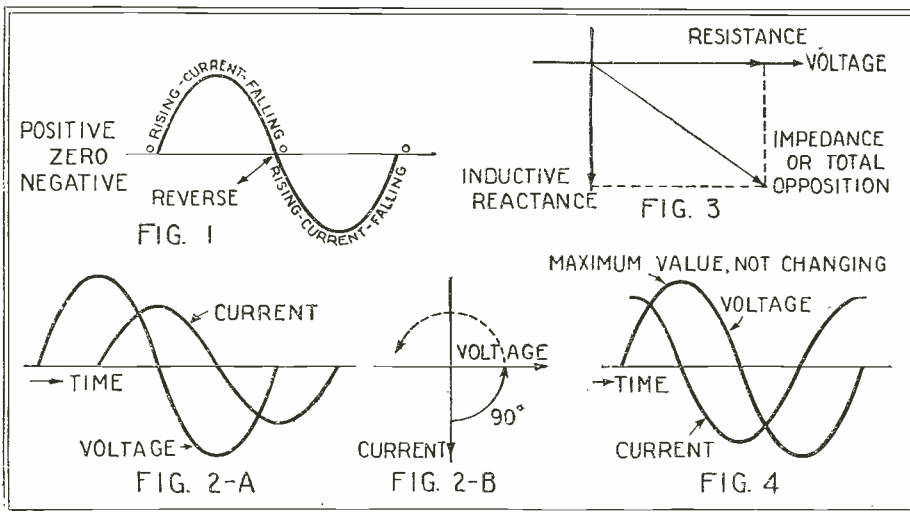

Fig. 1. A complete cycle of alternating-current. Figs. 2-A. Illustrating the "lag" and "lead" of the current and voltage, or "phase angle" as in Fig. 2-B. Fig. 3. Vector diagram showing the relations of resistance and inductive reactance to impedance. Fig. 4. Illustrating voltage "leading" the current; the two are out of phase with each other.

apply this second source of power at such a time that it would oppose, or "buck" the energy already in the circuit, the two would tend to cancel and the result would be very little energy in the circuit.

Going still further into the electrical action of this circuit, we will consider the effects of the three circuit values (of resistance, inductance and capacity) on the relation between the current and voltage of the circuit.

EFFECTS OF IMPEDANCE

First let us take the effect of resistance. The total energy expended in the circuit is expended in the resistance. Resistance neither opposes nor aids the change of current in the circuit. It tends to keep the current and voltage in phase; that is to make them rise and fall together. If it neither aids nor opposes the change in current we may, for practical purposes, say that it has a negligible effect on the electrical length or natural frequency of the circuit. Its effect on the value of current in the circuit is very important and will be discussed later.

Next, let us consider the effects of a pure inductance on the current and voltage relations in the circuit. Since an inductance offers opposition to the change of current, there will be a tendency for the current to rise to its maximum value at a certain interval after the voltage has reached maximum. Also, the current will drop off to zero at a certain time after the voltage has reached zero. Inductance, then, introduces a current lag in the circuit. If the circuit contained a pure inductance, this lag would be ninety electrical degrees, or the time of one-quarter of a cycle. This may be seen in Figs. 2A and 2B.

It will be seen that, by the time the current reaches its maximum value, the voltage will have risen to maximum and have fallen back to zero.

Since the addition of inductance to a circuit opposes the changes in the current, the current will not be able to rise to such a high value as it otherwise would. Therefore, inductance must offer opposition to the current and, since increasing the inductance increases the opposition to the change, it would also increase the opposition to current flow. This opposition would also increase with an increase in the rate of change, that is, of the frequency. This opposition is measured in ohms and is called inductive reactance.

We now have two oppositions to current flow in the circuit, that of the resistance and that of the inductive reactance. Since resistance tends to keep the current and voltage in phase, and inductance tends to make the current lag ninety degrees behind the voltage, their combined effects will be at right angles and the total effect will be as shown in Fig. 3. This represents in diagram form the resultant of two forces, equal to the diagonal of the parallelogram which they form when plotted on paper with lengths proportioned to their values. It will be seen that the total impedance is greater than either the resistance or the reactance. Therefore the current in the circuit will be decreased if either of these is increased.

EFFECTS OF CAPACITY CHANGES

Studying the effects of capacity in the circuit, we find that the capacity tends to make the current rise rapidly when the voltage rises; and it tends to keep the current flowing when the voltage is falling off. When the condenser is completely discharged there is no pressure across it, and the opposition to the charge is zero. Therefore when our voltage rises rapidly a large current will flow. But when the voltage has reached its maximum value, just before it begins to fall off, it is (for the instant) not changing, therefore there is no flow of current in or out of the condenser.

This must cause the current to reach maximum and fall off to zero while the voltage

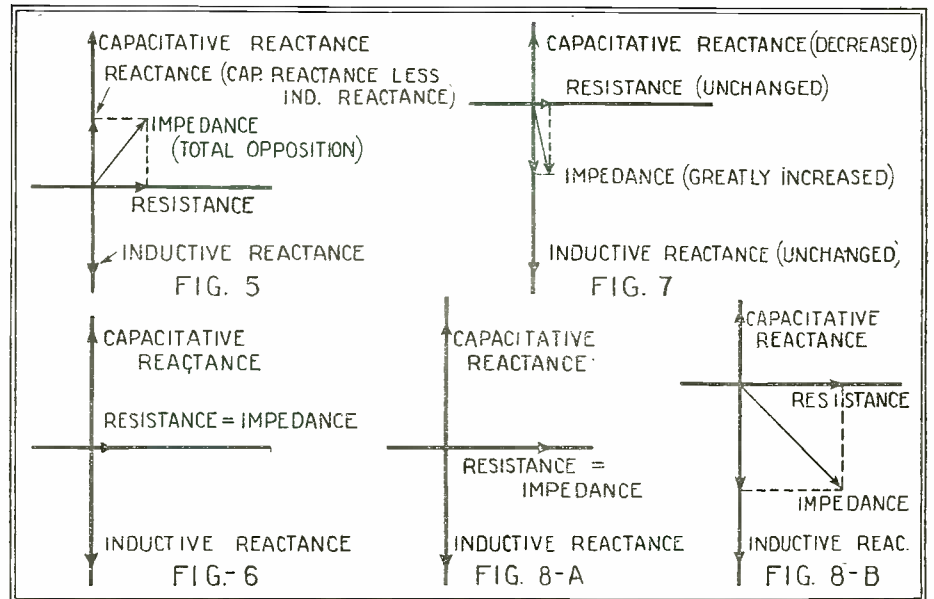

A group of vector diagrams illustrating the effects of resistance, impedance, inductive and capacitive reactance on tuned circuits, and their relation to each other, as explained below.

is rising only from zero to maximum; thus we get a leading current, the lead in a pure capacity circuit being ninety degrees. Since a large capacity will require a greater current to charge it to a given voltage in the same length of time than a smaller condenser, the opposition to current flow in the capacity circuit decreases with an increase of capacity. Also, since the current flow in the circuit to charge a given condenser to a given voltage must be greater if we decrease the time of the charge, we can see that the opposition to current flow in the capacity circuit must decrease with an increase of frequency.

This opposition offered by capacity is called capacity reactance and its effect is also ninety degrees different from that of resistance; but it is one hundred and eighty degrees different from, or exactly opposite to, that of inductive reactance. This will be seen in Fig. 5.

It will be noticed that, as the effect of the inductance is exactly opposite to that of the capacity, one therefore counteracts an equivalent amount of the effects of the other. If we had a circuit containing inductance, capacity and resistance and were supplying energy to it at a frequency at which the capacitive reactance equalled the inductive reactance, the only opposition to the current flow would be the direct-current, or "ohmic" resistance of the circuit. This is shown in Fig. 6. This condition is called a condition of resonance; and the resonant frequency of the circuit is the frequency at which the inductive reactance equals the capacitive reactance.

RESONANCE AND LOW LOSSES

At this frequency the opposition to current flow is the least and, for a given voltage, the greatest current will flow in the circuit at this frequency. It should be noted, particularly, that at the condition of resonance, the only limit to the amount of current flow we can obtain is the lowest value to which we can reduce the resistance. Therefore, if two receivers are tested together, the sets being identical except for the resistance of the connections, the one having good connections will get a much greater signal strength on the same station than the one having poor connections. This applies to all the losses in the circuit, from wire of too small a size, high-loss condensers, etc.

TUNING A RECEIVER

Now, assuming that we have a good low-loss circuit in resonance with the transmit-

ting frequency of some certain station, we will get a condition as in Fig. 6. We wish to cut this station out; suppose we increase the capacity in our circuit. An increase of capacity decreases the capacitive reactance; therefore, our inductive reactance remaining unchanged, we get a condition shown in Fig. 7. Since our impedance, or total opposition, has been greatly increased the current in the circuit has been greatly decreased; therefore the received signal strength has been greatly decreased. Since the average receiver has two or more tuned circuits, when both or all circuits are thus detuned the received signal goes out very sharply, if the circuit has little other resistance.

Let us consider a circuit having the same values of inductance and capacity, but a larger value of resistance. This is shown in Figs. 8A and 8B.

As shown in Fig. 8A, the total opposition at resonance (pure resistance only) is considerably larger than that indicated in Fig. 6. The received signal would therefore be several times weaker. In the detuned condition, shown in Fig. 8B, the total impedance is not very much larger than in the resonant condition. Therefore, if the signal were heard at all, the same amount of detuning would not cut it out; especially if the signal happened to be a strong local signal. This receiver would be said to tune broadly; stations separated in frequency only a few kilocycles from the local station would be heard weakly, if at all, and a large amount of interference from the local station would be experienced.

CHANGE OF RESONANT FREQUENCY

When we increased our capacity, in the above example, we decreased the capacitive reactance at that particular frequency but left our inductive reactance unchanged. Referring back to the effects of a variation of frequency on the inductive reactance we see that, if we decreased the frequency, the inductive reactance was decreased and the capacitive reactance increased. Therefore (while increasing the capacity in the previous case left the inductive reactance the same and decreased the capacitive reactance) if we now decrease the frequency it will be seen that the capacitive reactance would be increased and the inductive reactance decreased; and this frequency could be decreased until the capacitive reactance again equalled the inductive reactance. We would again have our circuit at a resonant frequency; but this frequency would be lower

(Continued on page 1493)

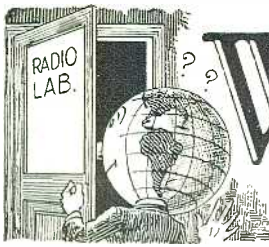

What's New in Radio



MANY GOOD POINTS IN SET FOR HOME ASSEMBLY

RADIO constructors who are seeking parts for a five-tube receiver which is sensitive, selective, loud, clear and, at the same time, inexpensive, will find this unusual combination of virtues in a recently-announced kit of parts. The circuit for which it is designed comprises one stage of tuned R.F. amplification, a non-regenerative detector, and three stages of A.F. amplification using the "Truphonic" audio couplers. The two variable condensers which tune the R.F. and detector grid circuits are separate instruments mounted on a common frame and adjusted manually by means of two dials of the edgewise-drum type protruding through the front surface of the set panel.

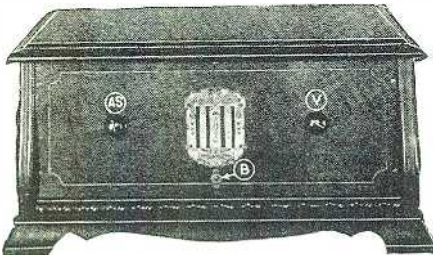

Front view of the five-tube receiver. The tuning is accomplished by means of the center dials.

As can be seen from the accompanying wiring diagram, the antenna circuit is inductively coupled to the grid circuit of the R.F. amplifier tube through the coupler AC. The primary of the latter is tapped in four places, the taps being led to a small switch (AS) on the left side of the front panel. This switch allows the owner of the receiver to adjust the primary inductance to suit the length of his own aerial and, in general, to change the selectivity of the set. The least number of primary turns will give the greatest selectivity.

The grid circuit of the R.F. tube is tuned by the secondary of the antenna coupler and by the variable condenser C. Its plate is coupled to the grid of the detector tube by a variable inductor, or "variometer" (VP), the stator of which is directly against the grid end of the fixed inductor (RF) in the grid circuit of the detector. When the rotor is turned by the knob V on the front panel, the inductance in the plate circuit and the mutual inductance between

the latter and the grid circuit of the detector are varied. This adjustment gives complete control of the interstage coupling over the entire wavelength range of the receiver (200-550 meters), and permits peak sensitivity at all times.

The advantageous characteristics of the

edge of the sub-panel, the four remaining tubes. A battery switch (B) is mounted on the front panel directly beneath the decorative dial escutcheon.

Three ready-wound tuning coils are available for those constructors who do not care to make them. For experienced fans the

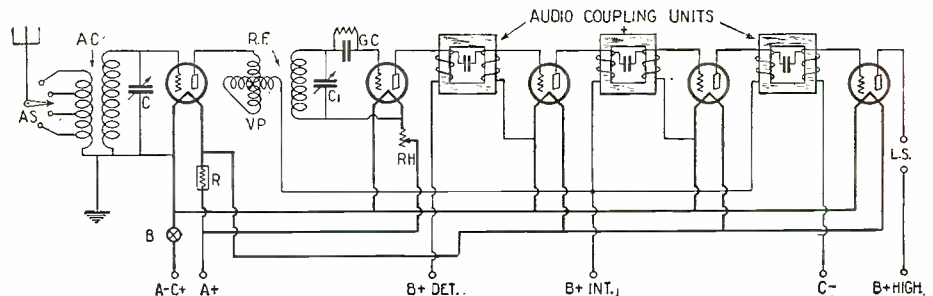

Schematic wiring diagram of the receiver. Note particularly the position of the variable inductor or "variometer" in the plate circuit of the R.F. tube.

coupling units in the audio and of the circuit are well known to experimenters who have followed developments in amplifier systems. The three stages included in this set furnish amplification more than enough for the home, and reproduce broadcast voice and music with lifelike clarity.

One rheostat and one fixed resistor regu-

following dimensions, which will enable them to make their own coils, are given:

Antenna coupler AC, bakelite tubing, 3-inch outside diameter, 2½ inches long. Primary, 16 turns of No. 24 D.S.C. copper wire, tapped at the 8th, 12th, 14th and 16th turns. Secondary, immediately next to the primary, 53 turns of the same wire. The ends of the

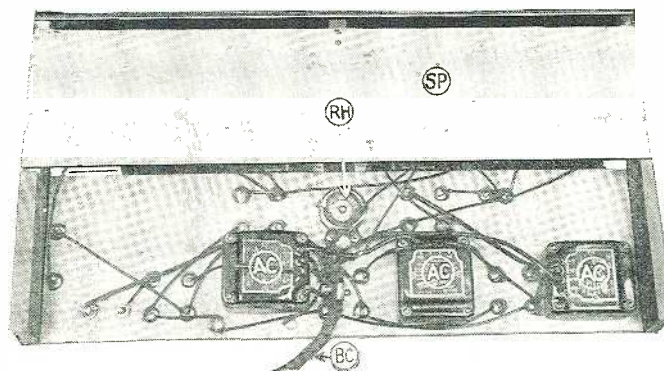

Under view of the sub-panel, SP, showing the rheostat, RH, and the audio units, AC. The battery cable, the ends of which are marked in the schematic diagram, is indicated by the letters BC.

late the current to the filaments of the five tubes. The rheostat (RH), mounted on the sub-panel of the receiver directly behind the tuning condensers and between the R.F. and detector-tube sockets, controls the detector tube alone; the resistor R, along the back

primary and secondary which face each other are the ground and grid terminals respectively. Variometer coils, VP; stator, 9 turns of No. 24 D.S.C. wire on a 3-inch tube 1½ inches long. Rotor, 9½ turns No. 30 D.S.C. wire on a 2¾-inch tube, ½-inch long. The rotor turns inside the stator on brass shafting. Secondary coil, RF: 61 turns No. 24 D.S.C. on a 3-inch tube, 2½ inches long.

The antenna coupler is mounted with its primary end facing the back of the panel; the variometer-secondary coil assembly mounts parallel to the latter. The rest of the mechanical construction is obvious from the illustrations. The wooden front panel 18 by 7 by ¼ inches, holds the condenser unit, the two coils, (with the antenna switch and the variometer knob on the front side) and the battery switch. Along its sides, near the bottom, are two horizontal wooden members, which extend to the rear and hold a sub-panel. On the upper side of the latter are found the five tube sockets, the knob of the rheostat, grid condenser and leak, filament resistor, aerial

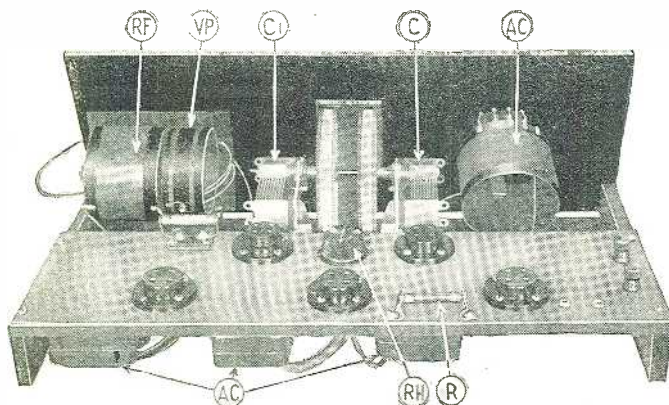

Rear view of the assembled receiver, showing the positions of the various parts. VP is the variometer primary of the R.F. transformer. Illustrations courtesy Donle-Bristol Co.

and ground binding posts and tip jacks for the loud speaker; on its bottom are the audio couplers and the rheostat. The outfit, in the cabinet, measures 9½ by 10¼ by 18 inches.

The illustrations show a set assembled from the available parts. It was tested in the RADIO NEWS Laboratories, and operated in a most creditable fashion. Its fine quality of reproduction was especially remarked by those who heard it.

NEW TONE ARM COMBINES PHONOGRAPH AND RADIO

ANY standard mechanical phonograph playing a disc record may be converted into an electrical reproducing machine of high quality, by means of a new attachment which operates in conjunction with a radio receiver. Increased volume, elimination of the annoying needle scratch and a more complete reproduction of the entire musical range of frequencies without distortion are the features claimed for the system by the manufacturers of the device.

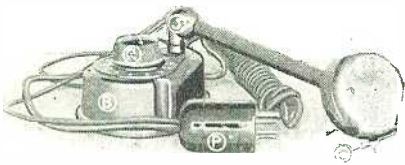

The substitute tone-arm. The phonograph needle fits in the chuck C.
Photographs courtesy Crosley Radio Corporation

Briefly, the attachment can be described as a substitute tone arm for the talking machine. It is connected by means of a flexible cord and a plug to the detector socket of the radio set, and translates the sound impressions on the phonograph record into electrical impulses. These pass through the audio-amplifier section of the set, are amplified by it just as detected radio signals are, and are then reproduced as sound by the usual radio loud speaker. The advantages of such an arrangement for the owner of a good radio set can be appreciated, when one considers how markedly superior present-day radio cone speakers are to the small horns used in thousands of old-model phonographs, many of which are totally incapable of reproducing low notes.

The substitute tone arm consists of two elements, a heavy pear-shaped base B, and the tone arm proper, which is connected by a universal joint J to the small end of the base. The latter is hollow and contains a rheostat R, which is connected directly across the bobbin winding of the actual reproducer unit (B in the close-up view). A small chuck C holds the regular phonograph needle.

The plug P is exactly like a tube base.

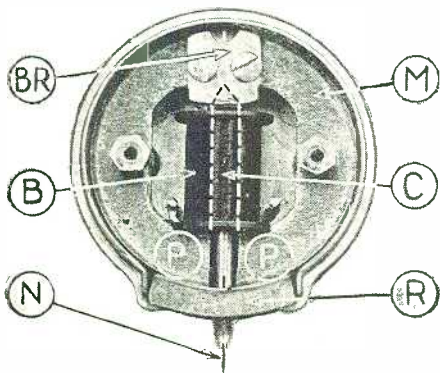

A close-up of the reproducer unit proper. The white dotted lines indicate the core over which the bobbin B is wound.

and fits in the detector socket of the radio receiver. Only two of the pins (plate and one filament) are used. An extra cord fitted with a clip is provided so that the proper connections to the set may be made.

The interior construction of the reproducer unit proper is shown in the accompanying close-up view. The letter C indicates a hollow soft-iron core or armature, over which is wound a bobbin of fine wire, B. The back end of this armature is clamped in place against the permanent magnet, M, by means of the bracket, BR, in such a manner that its other end (the lower one in the photograph) lies between

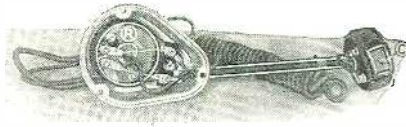

The bottom of the tone-arm base has been removed here to show the rheostat inside. C is the needle chuck.

but does not touch the magnet poles, P. This end, after passing through a piece of soft rubber, R, which acts as a damping device, terminates in the small chuck which holds the needle, N. The armature assembly is free to vibrate.

In accordance with a fundamental principle of electricity, every movement of the armature in the magnetic field of the permanent magnet will cause a current to flow in the bobbin. Thus, when the needle is rested on a phonograph record and the turn table is started, the "wiggles" or waves in the record grooves make the needle vibrate in exact accordance to their shape, and therefore electric currents of corresponding wave-form are generated in the armature winding. It is merely necessary to amplify these current fluctuations in the audio-amplifier stages of the radio set and to deliver the output from the latter to the loud speaker to obtain electrical phonographic reproduction of the finest quality. The rheostat R acts as the volume control.

The installation of this new attachment is a simple matter, involving no changes in the radio set itself. The detector tube is removed, the plug P inserted in its place, and the extra lead wire connected to the detector "B" plus. The switch from radio to phonograph music, or vice versa, can be made in a few seconds.

AMPLIFICATION FACTOR OF 30 IN NEW TUBE

BECAUSE of the widespread interest of amateur set builders in audio-frequency amplifiers of the so-called "resistance-coupled" type, a high-mu tube designed to provide the highest practical voltage amplification essential in these amplifiers, and suitable for use as a detector as well, has been brought out by a prominent manufacturer. Its amplification factor is 30, as compared to the 6 or 7 of standard tubes. The advantage of this high value is evident when one considers that the resistance amplifier depends entirely on the tube for its step-up, while in the transformer amplifier the step-up effect is brought about by the transformer ratio as well as by the tube.

The overall amplification afforded by one stage of "resistance" coupling employing the new triode is substantially equivalent to that of the average stage of transformer coupling employing a standard tube. Thus it will be possible for set constructors to reduce their favorite resistance amplifiers from three to two stages, and still obtain satisfactory volume for loud-speaker operation. However, existing three-stage units can be left un-

changed and the new tubes inserted in them with subsequent increases in the overall output.

Following are the complete characteristics of the high-mu tube, which will undoubtedly be of interest to all radio experimenters:

As an amplifier: filament, 5.0 volts, 0.25 ampere; amplification constant ("mu") 30; plate resistance (at 135 or 180 volts, under operating conditions; not at zero grid bias) 150,000 ohms; blocking condenser, .005- to .05-mf.; amplifier grid leaks, 1 to 2 megohms; plate current at rated voltages, 0.2-milliamperes; plate coupling resistor, 0.25-megohm (250,000 ohms).

As detector: (with grid condenser and leak) grid condenser, 0.00025 mf.; grid leak, 2 to 5 megohms. For detection by grid-bias method, see following table. (Suggested for use where sensitivity is of less interest than tone quality; not recommended for code reception alone.)

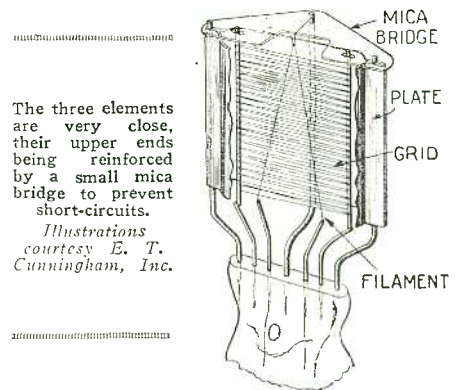

The three elements are very close, their upper ends being reinforced by a small mica bridge to prevent short-circuits.

Illustrations courtesy E. T. Cunningham, Inc.

PLATE AND GRID VOLTAGE VALUES

Amplifier		
"B" Voltage	Grid Bias-Volts	Plate Resistor (ohms)
135	1.0 to 1.5	0.25 megohm
180	3.0	0.25 megohm
above 180	3.0 to 4.5	0.5 to 1.0 meg.

Detector

Condenser and leak:		
"B" Voltage	Grid Leak	Plate Resistor
135	2.0 to 5.0 megohms	0.25 megohm
180	2.0 to 5.0 megohms	0.25 megohm

Grid bias:

"B" Voltage	Grid Volts	Plate Resistor
135	3.0	0.25 megohm
180	4.5	0.25 megohm

MIDGET CONE SPEAKER IS ONLY FIVE INCHES HIGH

AN interesting radio novelty, in the form of a midget loud speaker of the cone type, has appeared on the market. The entire instrument is but five inches high, weighs only a few ounces and can be held in the palm of the hand—but it is a real loud speaker. When connected to a standard six-tube receiver it reproduced voice and music with a high degree of volume and clarity

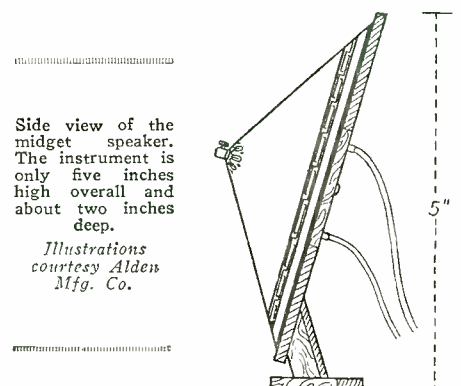

Side view of the midget speaker. The instrument is only five inches high overall and about two inches deep.

Illustrations courtesy Alden Mfg. Co.

that surprised the staff of the RADIO NEWS Laboratories.

The base and the baffle board, on which the edge of the cone rests, are made of thin wood. The speaker driving-unit is mounted on one side of the baffle board, being hidden by the paper cone. The cone and baffle board assembly is inclined obliquely to the base, in order to balance the speaker and to prevent it from falling over.

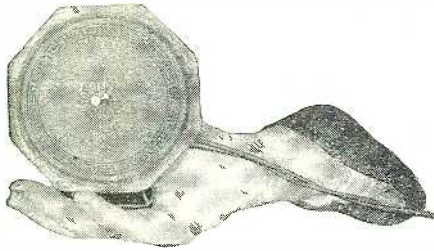

The small size of the midget cone speaker is evident in this photograph.

This cone speaker has many possibilities as a means of amusement. Being so tiny, it can be hidden in closets, drawers, under tables and chairs, in lamp shades and inverted bowls and even in large dishes, and can thus be made to produce some rather startling "talking" effects. An ingenious experimenter will undoubtedly be able to spend many interesting hours playing with the instrument and placing it in odd positions around the house.

TRANSFORMER COMPENSATES SPEAKER DEFICIENCIES

A NEW output transformer, which connects between the radio set and the loud speaker, is intended to compensate in a large degree the deficiencies of some speakers. In explaining this unusual feature, the manufacturer says:

"It is a well-known fact, that has been demonstrated in many established laboratories too many times to be doubted, that loud speakers will not operate below 100 cycles, and the majority produce very little sound in proportion to the strength of the received signal at frequencies below 200 or 250 cycles (middle 'C' on the piano). We have recognized this fact and have constructed the transformer to compensate for the defect. This has been done by designing the instrument to supply maximum energy at 30 cycles, with a gradual fall-off in energy delivered to the loud speaker as the frequency increases. The net result is much more realistic response than is obtained by other methods of loud-speaker coupling."

The impedance value of the secondary of the output transformer is approximately 1,500 ohms at 30 cycles, which is about the

impedance of the average loud speaker at this frequency. This matching of values results in the maximum delivery of energy to the loud speaker. The primary impedance is such that the maximum undistorted power is obtained from a 171-type power tube; although at the same time it is satisfactory for the 112, 210 and 201A types.

The complete "conductive separation" of the loud speaker from the plate circuit of the last amplifier tube protects the delicate windings of the former from the heavy current and high voltage of the latter, and obviates the possibility of burning out the speaker. The actual connections of the transformer diagram, which shows that the primary is connected between the plate of the last amplifier tube and the "B+," and that the speaker is bridged simply across the secondary. The device is equipped with four tip jacks and a length of telephone cord

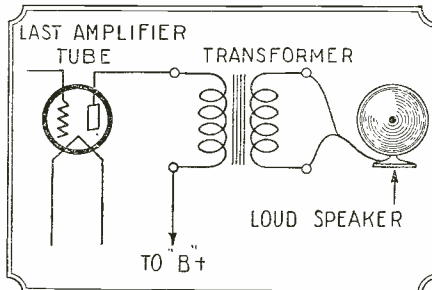

How the output transformer is connected to the last amplifier tube in a set and to the loud speaker.

fitted with cord tips at both ends. Thus it can be connected in a few seconds, the flexible cord leading to the output posts on the radio receiver and the secondary tip jacks accommodating the speaker cord proper.

The new output transformer is housed in an attractive one-piece, black-enamelled, drawn-steel case, 4 inches high, 3 1/4 inches wide and 2 1/2 inches deep. It may be located near the receiver or screwed down, by means of its mounting lugs, inside the receiver cabinet or console.

NEW VARIABLE RESISTOR CARRIES 40 WATTS

TO meet the increasing demand for heavy-duty variable resistors for service in high-power socket-supply devices and super-power amplifiers, a Brooklyn manufacturer has brought out a new resistor of the compression type with a carrying capacity of forty watts. It is obtainable in various resistance-ranges for different purposes.

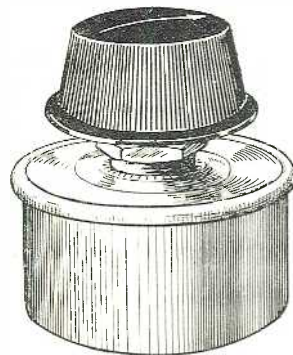

The connection lugs of the variable resistor, not visible in this view, are at the bottom of the case. It is of the single-hole mounting type.

The instrument is two inches in diameter and 2 1/4 inches high overall. As can be seen in the cross-sectional view, it consists of a heavy brass shell, which contains a mixture of resistive material (RM) confined between the bottom of the shell and an adjustable plunger. The latter is made of a disc of

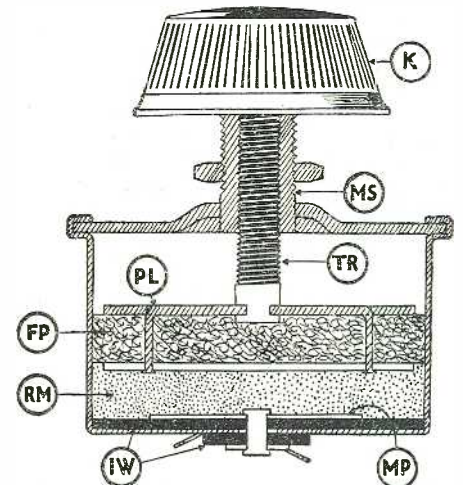

Cross-section view of the heavy-duty variable resistor.

Illustrations courtesy American Mechanical Laboratories.

felt-like material (FP), held between two metal plates (PL). These plates are a fraction of an inch smaller in diameter than the felt wad, which fits snugly against the inner surface of the shell, thus preventing the resistive mixture from leaking out above it. The position of the plunger is adjusted by means of the knob K, which turns the threaded rod TR. The resistor is mounted on a panel with the aid of the mounting stud and nut MS.

The resistive element is a mixture of highly-pulverized graphite and pulverized mica. The graphite furnishes the conductivity, which varies in accordance with the pressure applied to it, while the interspersed mica particles, being resilient, act as tiny springs between those of graphite. When the pressure on the mixture is increased by the advance of the plunger, the resistance between the brass shell (acting as one electrode) and the metal plate MP (insulated from the shell by the washers IW) decreases. When the pressure is relieved the mica particles expand and cause the entire mixture to fill out the space between the plunger and the bottom of the shell. This action of the mica prevents the mixture from "packing," a trouble that would be fatal as far as the usefulness of the resistor is concerned.

Micrometer adjustment of the resistance can be obtained by this variable-pressure arrangement. The action is fully reversible, the same minimum, maximum and intermediate values being obtainable repeatedly, no matter how many times the knob is turned in and out.

SWITCHING RELAY CONTROLS "A" AND "B" CIRCUITS

THE power-switching relay illustrated therewith is one of the sturdiest and best constructed instruments of its kind submitted to RADIO NEWS. In general, it is a device for automatically switching A.C. house-lighting circuit connections for the "A" and "B" socket-power units and for an external power

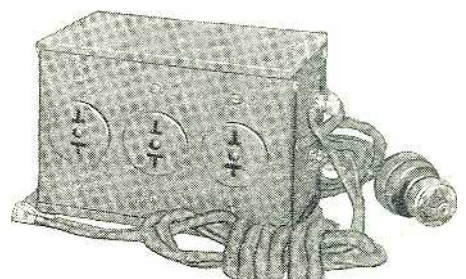

General view of the switching relay.

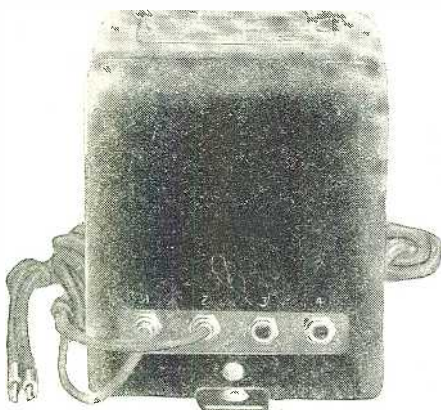

View of the output transformer, showing the connecting cord and tip jacks.

Illustrations courtesy Silver-Marshall, Inc.

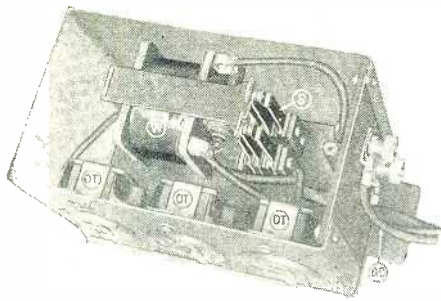

Inside view of the switching relay.
Illustrations courtesy Stromberg-Carlson Telephone Mfg. Co.

amplifier (if used) when the lever of the filament battery switch on the front panel of the receiver is operated. It makes the use of separate switches on the power units unnecessary, and converts the set switch into a master control.

The relay consists essentially of an electromagnetically-operated double-pole, double-throw switch, contained in a decorative iron case. On one long side of the latter are mounted three standard outlets, which take the ordinary two-prong plugs attached to the connector cords of socket-power units. At one end is a small insulated panel holding two binding posts, to which is connected a length of flexible wire to reach the radio receiver. Another cord runs to the lamp socket.

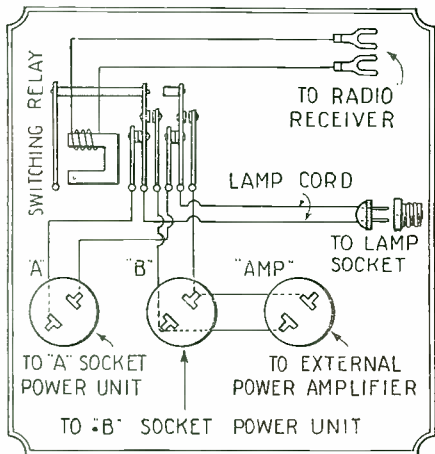

Diagram of the switching relay connections.

This relay is of the shunt type; that is, the electromagnet which actuate the switch springs is connected directly across the "A" circuit in the receiver on the set side of the battery switch, instead of being connected in series with the battery proper. It consumes a very small amount of current, but does not cause a drop in the voltage across the "A" terminals. The trickle charger for the "A" battery is plugged into the outlet on the left, while the "B" supply and amplifier units are plugged into the other two.

The operation of the system is simple, and will be understood from a study of the diagram of connections. When the switch on the receiver is in the "off" position, no current flows through the relay winding, and the two main contact springs (the second and fifth from the left) rest against their respective contacts at the left. The alternating current from the lamp socket thus energizes the trickle charger, which in turn feeds a slight current to the "A" battery. When the set switch is snapped on, the relay winding is energized and the contact springs are moved over to the right. This movement causes the alternating current from the "B" unit and the external am-

In the illustration of the inside of the relay, the A.C. outlets are marked OT, the winding of the electromagnet W, the switch springs S, and the cord to the set BC.

DUAL POTENTIOMETER GIVES THREE BIASING VOLTAGES

A NEW device, for which constructors of socket-power units will undoubtedly find extensive use, in a double-arm voltage-divider, or "potentiometer." This, when wired in the obvious manner in the negative lead of the "B" circuit, provides one fixed and two variable grid-biasing voltages. It is a wire-wound instrument having a resistance of 2,000 ohms and a current-carrying capacity sufficiently high to adapt it to practically all forms of "B" supply devices.

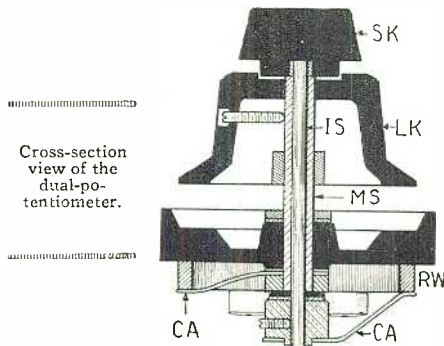

Cross-section view of the dual-potentiometer.

The construction of this dual potentiometer is rather interesting, as can be seen from the view and the sectional line drawing shown herewith. The frame of the instrument is that of a standard rheostat or potentiometer, the resistor element (RW) being set in the usual position near the outer edge. The two arms (CA) traveling over the wire are operated by superimposed knobs working through concentric shafts, the inner of which, IS, is made of insulating material. The small knob SK on the top actuates one of the arms through the insulated shaft IS, while the lower knob, LK, turns the other by means of the outer metal shaft MS. The contact-arm assembly, attached to the lower end of the insulated shaft, is separated from the end of the outer shaft by an insulating washer.

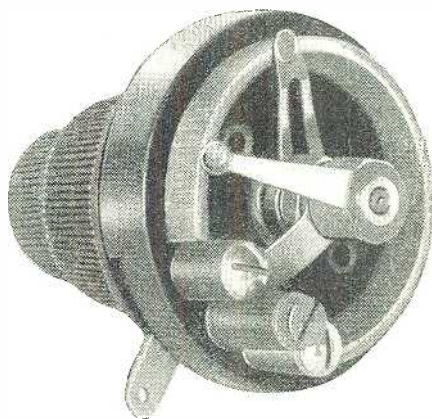

The dual potentiometer.
Illustrations courtesy Ansco Products, Inc.

The potentiometer is furnished with three binding posts and an additional connector lug. It can be mounted on an instrument panel in no more space than is required for an ordinary single-arm control, or it can be fastened to the baseboard of a socket-supply device by means of a simple L-shaped bracket.

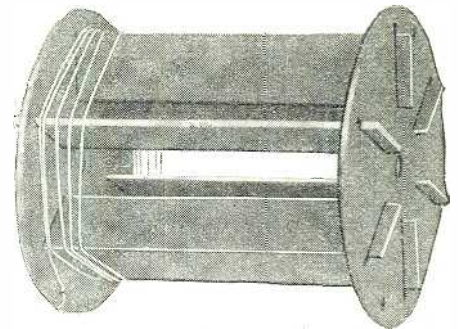

The coil-form assembled and with a few turns of wire in place.
Illustrations courtesy Thorp Roderick, Ltd.

LOW-LOSS INDUCTORS MADE WITH COIL-FORM

FOR the benefit of radio constructors who have occasion to wind their own coils for special circuits and sets of their own design, a British firm has brought out an inexpensive collapsible coil-form which can be assembled in a few seconds and which is very easy to handle. It consists simply of two round end-pieces, of thick impregnated cardboard, with six radial slots cut in the face of each. Into these slots fit six stiff strips of similar cardboard, notched at their ends to lock against the faces of the end discs.

The exact dimensions of these parts are given in the accompanying drawing. The half-tone illustration shows the form completely assembled, and with a few turns of

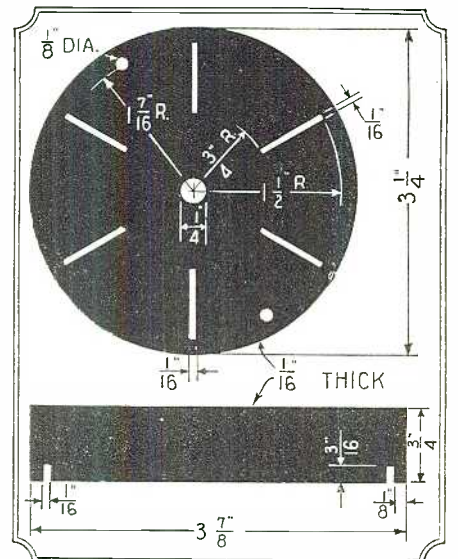

The dimensions of the coil-form and pieces and heads are shown above. Two discs and six strips are used.

wire started in place. The wire is merely wound over the edges of the strips, the ends being tied in small holes in the discs. Coils made on this form can readily be experimented with, the open construction permitting easy tapping of the turns and the addition or removal of wire.

A convenient feature of the form is that the flat strips can be slotted near their ends to accommodate a piled primary winding if the form is wound as a tuned R.F. transformer. Similarly, a tickler winding can be placed at the other end if the coil is connected before the detector tube in a combination R.F.-regenerative set.

An inductor made on this form can truly be said to be of the "low-loss" kind, as there is comparatively little solid dielectric and the wire touches only the thin edges of the flat strips. This skeleton type of winding is used by the Bureau of Standards for its standards of inductance.

The Interbalanced Regenerative Receiver*

Single Control Adjusts R.F. Coupling and Detector Regeneration

By ANDREW BARBIERI

IN many receivers employing one or two stages of R.F. amplification ahead of a regenerative detector, means are provided for independent adjustments of the primary-secondary coupling of the R.F. transformers and of the regenerative action of the detector. However, we do not believe that the idea of making one control serve both purposes has been presented before; therefore, we take pleasure in putting before our readers the Interbalanced Regenerative Receiver, in which this feat is successfully accomplished. The system was devised by Mr. Barbieri, the author of this article, in the RADIO NEWS Laboratories.

—EDITOR.

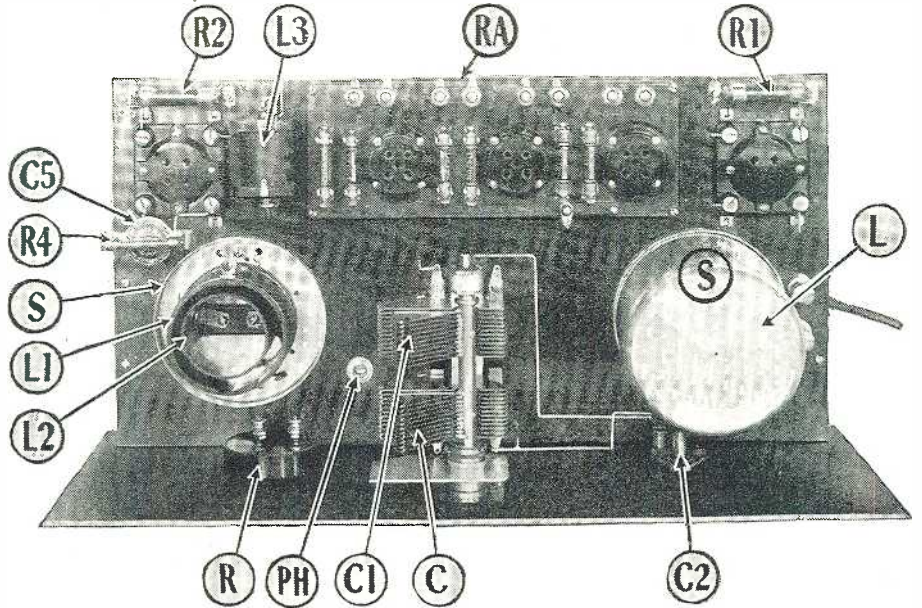

A top view of the completed receiver. The parts are: L, aerial coupler; L1—L2, R.F. transformer with tickler; L3, R.F. choke; C—C-1, tuning condensers; C2, balancing condenser; C5, grid condenser; R, regeneration control; R1—R2, filament ballaste; R4, grid leak; PH, Phasatrol; RA, three-stage resistance amplifier, and S, coil shields.

THE "Interbalanced Regenerative Receiver" is a five-tube set whose circuit comprises one stage of tuned-radio-frequency amplification, a regenerative detector, and three audio amplifier stages of the resistance-capacity-coupled variety. It derives its name from its main features: *i.e.*, the simultaneous adjustment, by one control, of both the coupling between the R.F. and detector tubes and the regenerative action of the latter. This control takes the form of a variable resistor of 10,000 ohms maximum, connected in such fashion that it provides the closest coupling and the strongest regeneration when its resistance is highest. This action is assisted by the phase-shifting device known as the "Phasatrol," which is connected in the plate circuit of the R.F. tube, between the plate and the primary of the R.F. transformer.

SERIES TICKLER-PRIMARY

The operation of the system can be under-

stood from a brief study of the schematic circuit shown herewith. The diagram shows an antenna coupler L (consisting of the usual untuned primary and the secondary tuned by the large condenser, C, and the "vernier," C2), wired to the grid of the first (the R.F.) tube. The plate is coupled to the detector by a similar transformer, L1, which is fitted in addition with a fixed tickler coil, L2. The tickler is connected to the plate of the detector through the fixed condenser C6, completing its circuit back through the primary of the R.F. transformer. It should be noted particularly that the tickler is actually in series with the primary; *both coils, therefore, act upon the secondary of the transformer as*

feed-back mediums. The variable resistor is connected across the outer ends of the respective coils, and thus acts as a throttle (in a way, as a variable short-circuit) on them. The fixed condenser and resistor enclosed in the dotted circle represent the elements of the Phasatrol.

The latter device prevents oscillation in the R.F. stage by shifting the phase relationship of the feed-back current (through the grid-plate capacity of the tube) to the original signal impulse, as explained in past numbers of RADIO NEWS. Its presence also accounts for another phase shift in the feed-back current flowing through the tickler coil L2 (and also through the primary, L1) from the plate of the detector, this shift taking place in such a manner that the inductive effects of both the legitimate tickler and the erstwhile primary on the secondary coil are *additive*; in other words, the primary, in addition to acting as such, acts also as a tickler coil.

As previously mentioned, the variable resistor R regulates the dual effects of the primary and of the tickler. It is adjusted for maximum response while the set is being tuned to various wavelengths.

The R.F. choke L3 is very important in that it prevents leakage of the R.F. currents through the "B" circuit.

SIMPLE CONTROL METHODS

The advantages of the Interbalanced Regenerative Receiver are obvious. The manual operation of the receiver is simplified, for what ordinarily are two fairly critical adjustments are reduced in number to one. Also, the system of control reduces the detuning effect of the tickler on the secondary coil of the R.F. transformer, and allows the use of a double variable condenser for the tuning of the R.F. and detector circuits. A midget condenser (C2), for supplementary adjustment of the R.F. condenser (C), is provided, but in actual use it is set once and left alone. The tuning of the receiver solves itself into the mere movement of the condenser dial and the

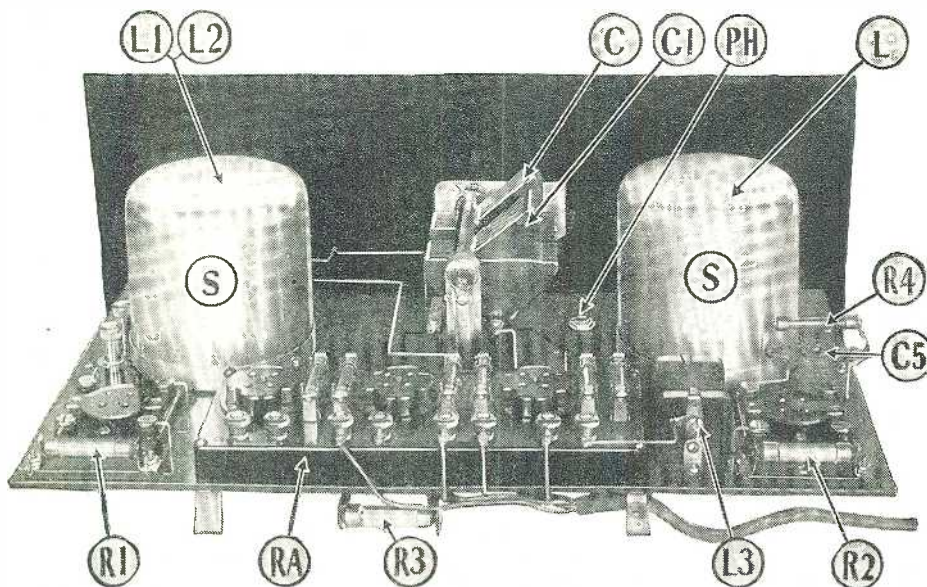

A rear view of the interbalanced receiver. R3 is the filament ballast for the tubes in the resistance-coupled amplifier unit, RA. Both coil shields are shown in place.

*RADIO NEWS Blueprint Article No. 21.

sheet
insfers
urger to the
fner, if one is

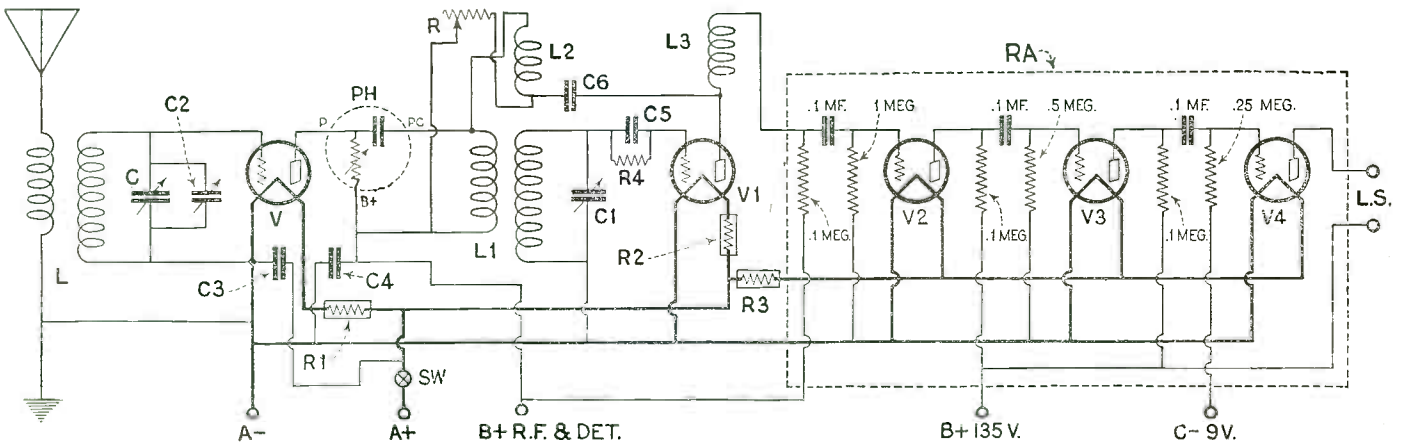

Schematic diagram of the interbalanced regenerative receiver. Its novel feature is the control of regeneration through the variable resistor, R, between the primary and tickler, L1 and L2.

An Interbalanced receiver was constructed in the RADIO NEWS Laboratories, and works very successfully. It is selective and highly sensitive, the dual regeneration control permitting the circuit to be adjusted to maxi-

imum effectiveness. The quality of reproduction, as might be expected from the use of a straight resistance-capacity coupled audio amplifier, is well-nigh perfect.

Any radio constructor of average ability

and mechanical facilities can duplicate this excellent outfit at little trouble and expense. The accompanying illustrations give complete data.

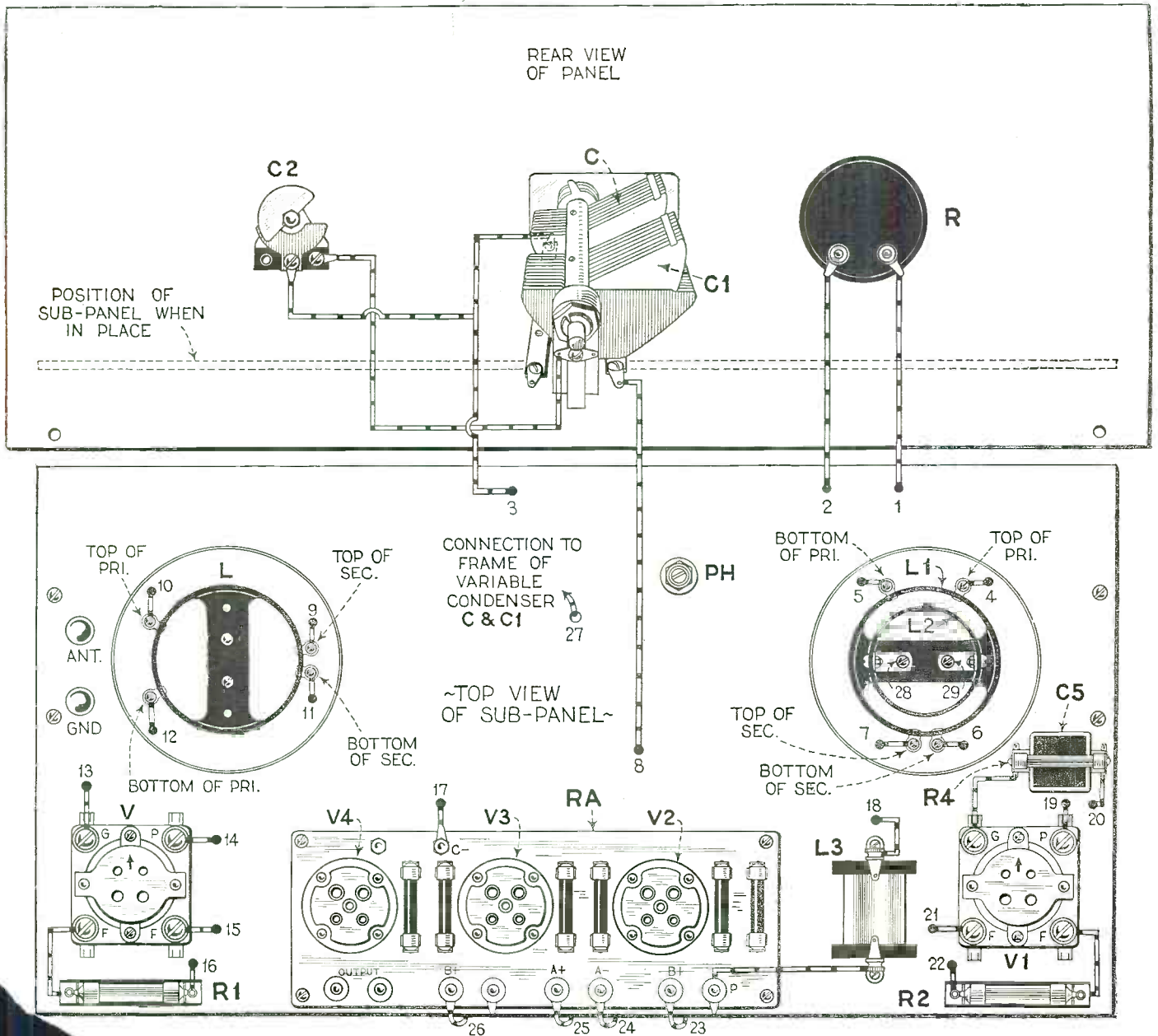
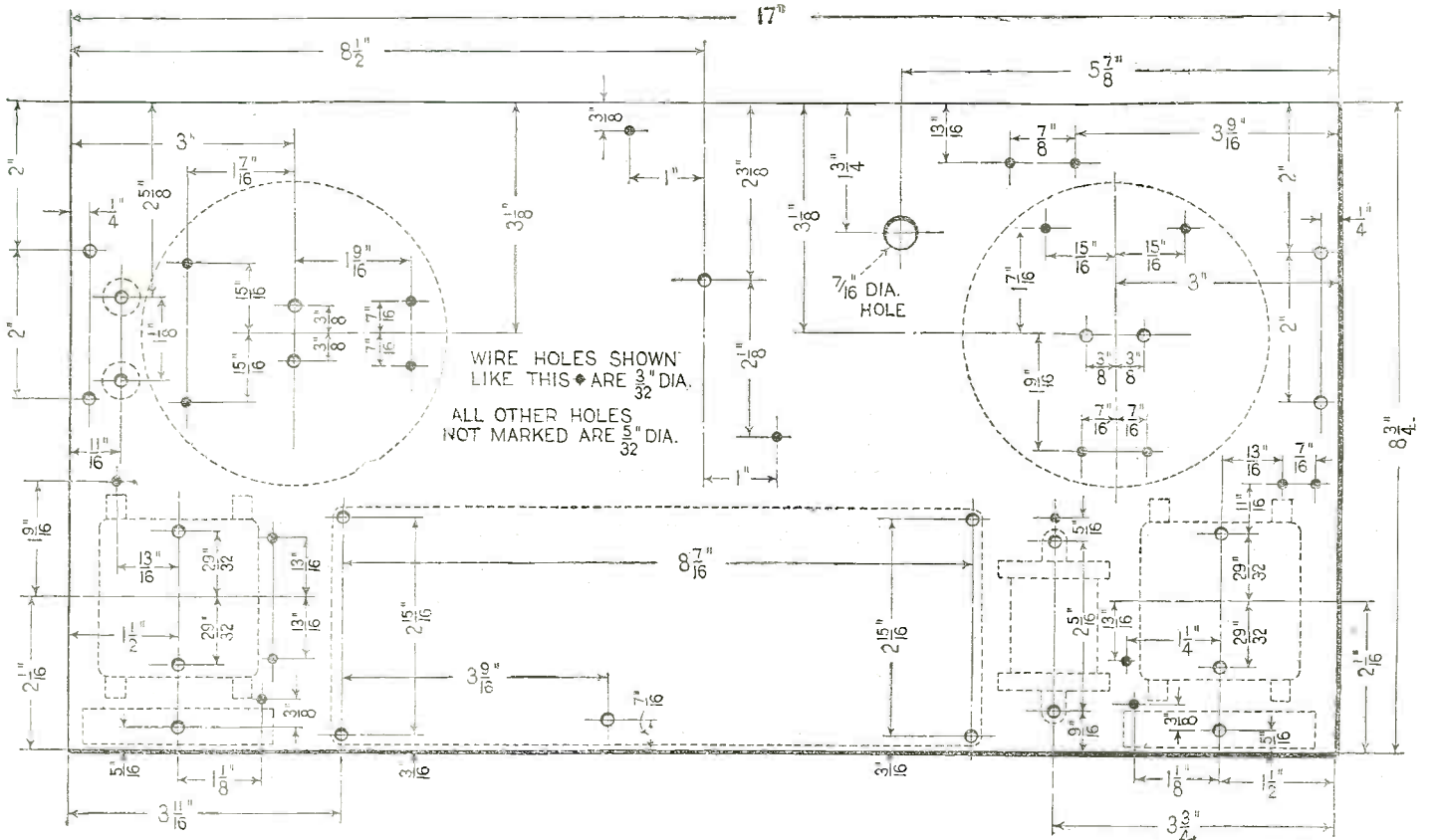

Diagram of the front panel and the top of the sub-panel. See next page for the wiring on the bottom of the sub-panel. The balancing condenser, C2, has a maximum capacity of 50-mmf.



Drilling layout for the sub-panel. The instruments are indicated in their proper positions by dotted outlines.

ASSEMBLY

The set consists of two essential units, a vertical front panel, a rear horizontal one

(sub-panel), fastened to the former by a double condenser C-C1 in its center, the vari-pair of sub-panel brackets and with the ad-able resistor R, at the left, the midget conditional aid of the frame of the double vari-condenser C2 at the right, and the battery switch able condenser. The front panel holds the SW directly below the dial. The sub-panel

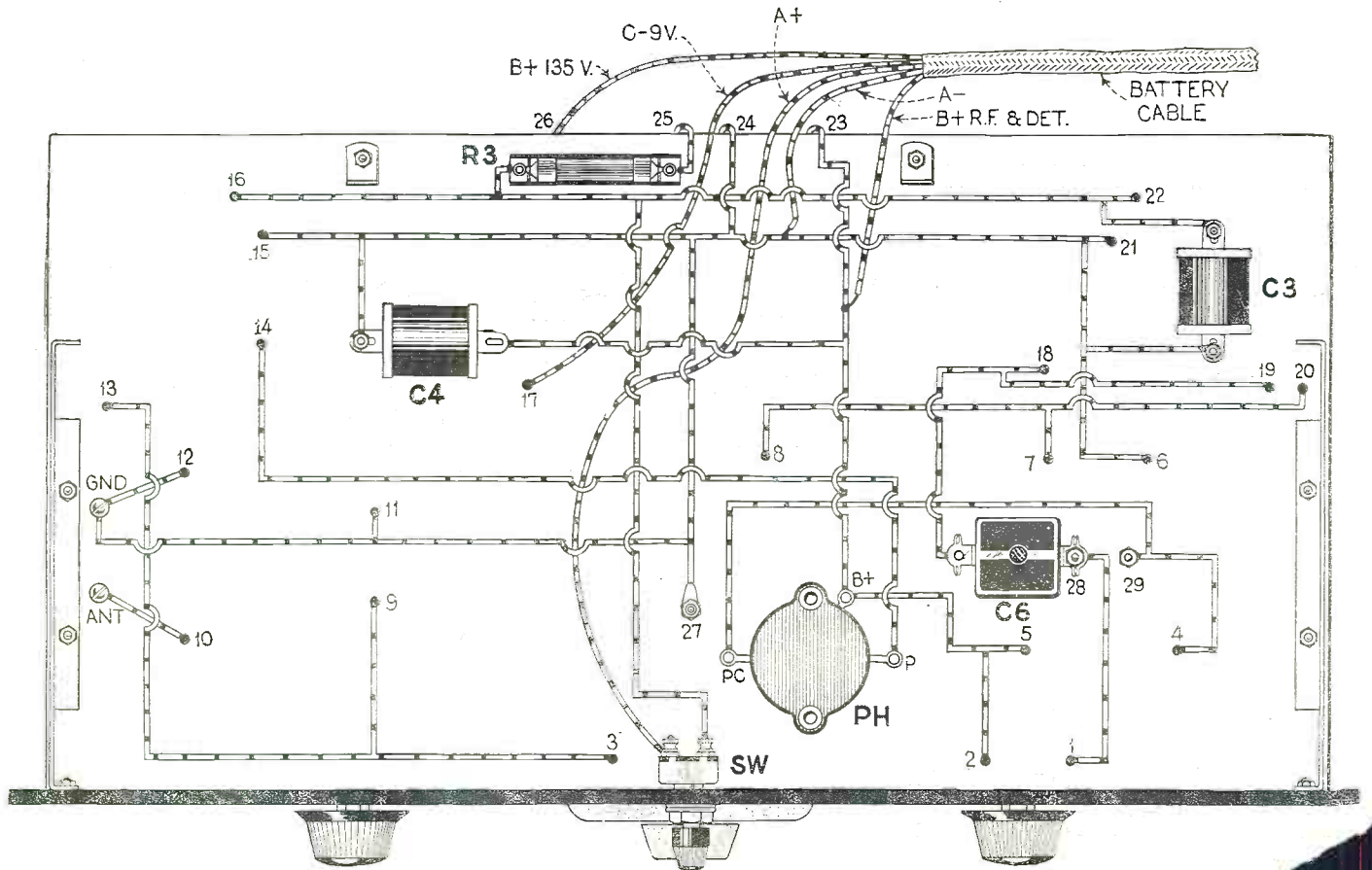

The wiring diagram of the under side of the sub-panel. C3 and C4 are by-pass condensers of large capacity. C6 is the small by-pass condenser leading from the plate circuit of the detector tube.

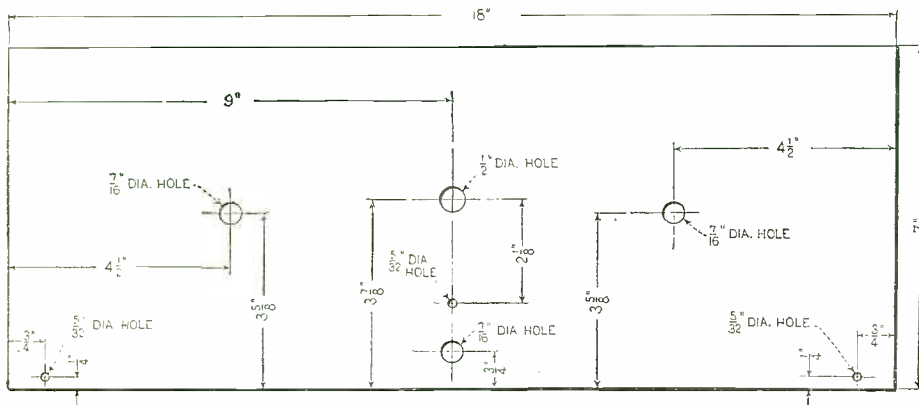

holds the rest of the parts, including the two shielded inductors L, L1-L2 in the shields S, two separate tube sockets V and V1, the R.F. choke L3, the grid condenser and leak C5-R4, the filament ballasts R1 and R2, and the complete three-stage resistance amplifier unit RA. The Phasatrol PH is mounted on the sub-panel in a position between the double condenser and the right-hand coil L1-L2. The under side of the sub-panel holds the fixed condensers C3, C4 and C6, and also the filament ballast R3. The filament switch, which is on the front panel, is below the level of the sub-panel.

Two binding posts are provided for the aerial and ground connections, but a five-wire flexible cable leads the "A," "B," and "C" voltages to the outfit.

WIRING

In making the Interbalanced Regenerative Receiver, the constructor should first mark

Above: Details of the front panel. All the necessary dimensions are given. Right: Front panel view of the set. R is the regeneration control, SW the filament switch, C.C1 the gang-tuning condenser and C2 the 50-mmf balancing condenser.

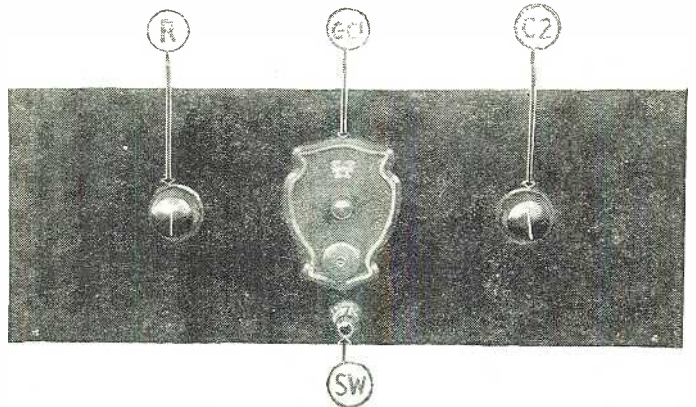

and drill the front and sub-panels in accordance with the fully-dimensioned drawings shown herewith. The fit of each instrument in its proper holes should be tested before it is mounted in place permanently; it is much easier to enlarge holes or to drill new ones when the panel is flat and empty of parts than it is when the set is half wired and some error in placement is discovered.

The front and sub-panel assemblies should be completed first as separate jobs, and the two sections then joined together by means of the brackets. The constructor should not fail to insert a machine screw through the hole marked 27 in the picture wiring diagrams, to hold the bottom of the condenser

frame against the sub-panel. This screw acts also as a connector between the condenser frame and several wires beneath the sub-panel.

The dimensions of the two R.F. coils L and L1-L2 are given in the accompanying drawing. The antenna coupler is a straight solenoid of the dimensions indicated, with the ten-turn primary wound over one end of the secondary. The inter-stage coupler L1-L2 is identical with L1 as far as the primary and

SYMBOL	Quantity	NAME OF PART	REMARKS	MANUFACTURER *
L	1	Ant. coupler		1 2
L1	1	R. F. transformer		1 2
L2	1	Tickler coil	Special (See drawing)	
L3	1	R. F. choke	85 millihenries	2 10,17
C, C1	1	Gang condenser	.0005 mf.	3 4,10,16,17,18
C2	1	Balancing condenser		4 1,3,10
C3,C4	2	Fixed condensers	0.5 mf. By-pass	5 8,19,20,21,22,23,24,25
C5	1	Grid condenser	.00025 mf. With grid leak clips	5 21,22,23,24,25
C6	1	Fixed condenser	.002 mf. By-pass	5 8,19,20,21,23,23,24,25
R	1	Var. resistor	0 to 10,000 ohms. Regeneration control	6 5,8,26,27
R1, R2	2	Fil. ballast res.	5 v. 1/4 amp. For R. F. & Det. tubes	7 28,29,30
R3	1	Fil. ballast res.	5 v. 1 amp. For A. F. tubes	7 28,29,30
R4	1	Grid leak	2 megohms	8 7,9,19,21,24,27,28,31,32,33
PH	1	Phasatrol	Stabilizing device	8
RA	1	Res. amplifier	Complete three-stage unit	9 27,31,34
S	2	Coil shields	Aluminum	10
SW	1	Fil. switch		5 8,10,26,27,34
	2	Sockets	UX type	11 1,10,17,35,36,49
	2	Binding posts	("Ant." & "Gnd.")	12 1,11
	1	Dial	Vernier type	13 2,10,11,17,37
	2	Brackets		10 36,38
	1	Panel	7 X 18 X 3/16"	14 38,39,40,41
	1	Sub-base	8 3/4 X 17 X 3/16"	14 38,40,41
	roll	Hookup wire		15 42,43
	1	Battery cable	5 wire	15 42,43
V, V1	2	Tubes	5 v. 1/4 amp. Standard type	44 45,46,47
V2, V3	2	Tubes	5 v. 1/4 amp. High-Mu	44 45,46
V4	1	Tube	5 v. 1/2 amp. Semi-power	44 45,46,47

NUMBERS IN LAST COLUMN REFER TO CODE NUMBERS BELOW.

1 General Radio Co.	2 Samson Electric Co.	3 Hammerlund Mfg. Co.
4 Allen D. Cardwell Mfg. Co.	5 Carter Radio Co.	6 Central Radio Labs. (Centralelab)
7 Langbein & Kaufman Co. (Flkey)	8 Electrad, Inc.	9 De Jur Products Co.
10 Silver-Marshall, Inc.	11 H. H. Fby Mfg. Co.	12 X-L Radio Labs.
13 Cornell Electric Mfg. Co.	14 The Celoron Co.	15 Bolden Mfg. Co.
16 Kerns Electric Co.	17 Pacent Electric Co.	18 General Instrument Co.
19 Tobe Deutschmann Co.	20 Sprague Specialty Co.	21 Dubilier Condenser Corp.
22 Ritter Mfg. Co.	23 Wireless Spec. App. Co. (Paradon)	24 Aerovox Wireless Corp.
25 Sengano Electric Co.	26 Herbert H. Frost, Inc.	27 Allen Bradley Co.
28 Arthur H. Lynch, Inc.	29 The Radiall Co. (Anparite)	30 L. S. Brach Co.
31 Davan Radio Corp.	32 Int. Resistance Co. (Durham)	33 The Carborundum Co.
34 Leslie F. Muter, Inc.	35 Ameco Products Co.	36 Benjamin Electric Co.
37 Martin-Coyland Co. (Marco)	38 Amer. Hard Rubber Co. (Radion)	39 The Lignole Corp.
40 Vicarta Fabricators, Inc.	41 Insulating Co. of Amer. (Insuline)	42 Acme Fire Co.
43 Cornish Wire Co.	44 Radio Corp. of America	43 E. T. Cunningham, Inc.
46 C. F. Mfg. Co. (Ceco)	47 The Ken-Red Corp.	48 The Van Horne Co.
49 Alden Mfg. Co.	50	51
52	53	54

* THE FIGURES IN THE FIRST COLUMN OF MANUFACTURERS INDICATE THE MAKERS OF THE PARTS USED IN THE ORIGINAL EQUIPMENT DESCRIBED HERE.

parts instead of those listed in the first column of manufacturers, be careful to allow for any possible difference in size from those originally used in laying out and drilling the panel and sub-base.

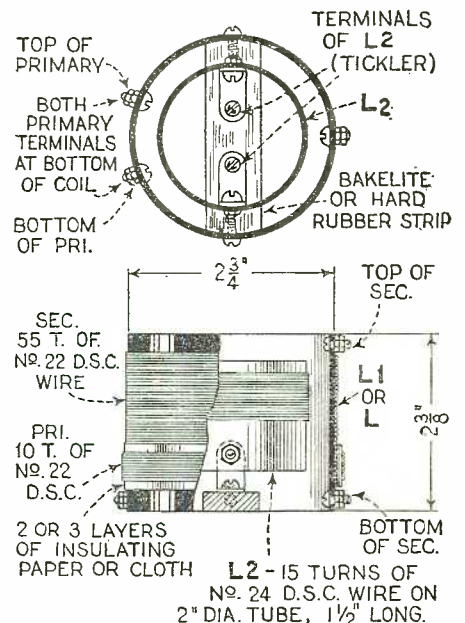

Details of construction of the radio-frequency coils, L, L1, and the tickler coil, L2.

secondary are concerned; differing only in that it holds a fixed tickler (L2). This is placed inside the secondary tubing.

Both coils are mounted upright inside round aluminum shields four inches in diameter and four inches high. These cans comprise very shallow bottoms, over which the

(Continued on page 1488)

The Transoceanic Radiotelephone Interflex*

A New and Simplified Receiver Which Will Bring In Transatlantic Conversation

By MARK HINDER

IN the April issue of RADIO NEWS was described a transatlantic telephone receiver capable of picking up the radiotelephone conversations between this country and England. The same receiver can be used for regular broadcast reception by changing the size of the coils. Since the publication of this set a new one has been developed which is far simpler in construction and considerably more sensitive; it is described in the accompanying article. With a good-sized outdoor aerial no difficulty is found in receiving the conversation on both sides of the ocean. Like the former receiver, it can be used for reception on the regular broadcast wavelengths by merely changing the coils.

Again it should be mentioned that any overheard radio message, either in code or speech, must go no further than the listener, as the United States Statutes provide (Sec. 27, Radio Act of 1927): "No person not being authorized by the sender shall intercept any message and divulge or publish the contents, substance, effect, purport or meaning . . . or use the same or any information therein contained for his own benefit, or for the benefit of another not entitled thereto." This does not apply, of course, to regular broadcasts.

—EDITOR.

POSSIBLY there have not been enough recent novelties in regular broadcasting to keep the radio fan content; but, at any rate, with the announcing of radiotelephone service between this country and England, the whole world seemed to sit up and take notice. The romance of it was enough to set the imagination afire and it became the desire of

almost every radio fan to "take a listen-in" on the buzz of commerce and the interesting conversations.

The Editors of RADIO NEWS took it upon themselves to provide radio fans with a set by which they could listen in on the otherwise private talk. Due to the fact that "single-sideband transmission" is used, a special receiver is required; the regular type

for, whereas in the former set two vacuum tubes were required, one for producing the necessary missing sideband-frequency and the other for detection, only one tube is required here for both functions. This tube (V) is set into oscillation at the same frequency as the single-sideband transmission. This is accomplished by the tickler coil L2. The crystal detector D handles the rectifica-

Front-panel view of the completed transoceanic radiotelephone interflex. L, L1, and L2, respectively, are the primary secondary and tickler coils. C and C1 are the tuning condensers, R and R1 the filament rheostats and J is the loud-speaker jack.

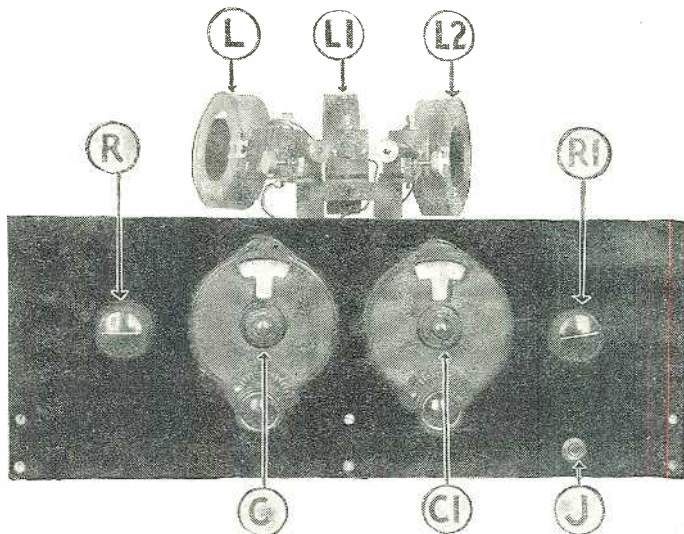

broadcast receiver cannot pick up the conversations.

The first set, devised for this purpose, which we described two months ago, is of an excellent type and perfectly suited to the purpose, but it lacks the necessary sensitivity to insure consistent reception from both sides of the ocean. The set described in this article is far more simple than the former and is based somewhat on the principle of the original Interflex circuit, devised by Mr. Hugo Gernsback.

EFFECT OF THE CRYSTAL

The use of the Interflex principle immediately simplifies the whole arrangement;

tion but, like all rectifiers, does not make a complete job of it. Further rectification takes place in the tube V which is actually oscillating.

If a grid leak and condenser are substituted for the crystal detector the set will not function properly; the crystal is *absolutely necessary* for the correct operation of the set.

The first tube, which is a detector, oscillator and amplifier combined, is controlled by the filament rheostat R1, and it will be found that the adjustment of this is important in bringing in the conversation at its best. The adjustment however, is not at all critical.

THE AUDIO AMPLIFIER

The audio amplifier is of the transformer-coupled type, there being two stages. The two A.F. tubes V1 and V2 are both controlled by the same filament rheostat R. Constant readjustment of this is not necessary; it can be set for the best response and left in that position. This, of course, is true of the rheostat for the first tube too: because the receiver is always operating on the same wavelength and receiving from the same transmitters, both in use simultaneously.

Since it is desirable to receive the conversations undistorted, so that all of the overtones which go to make up the character of the human voice are amplified, the best type of A.F. transformers, with large cores and high-impedance primaries, is recommended.

The two A.F. tubes are of the 201A type and unsuited to power amplification, but great volume is hardly desirable in this instance. Also, high "B" voltages are necessary, and it will be noted from the circuit diagram that no more than is employed. If it is desirable to

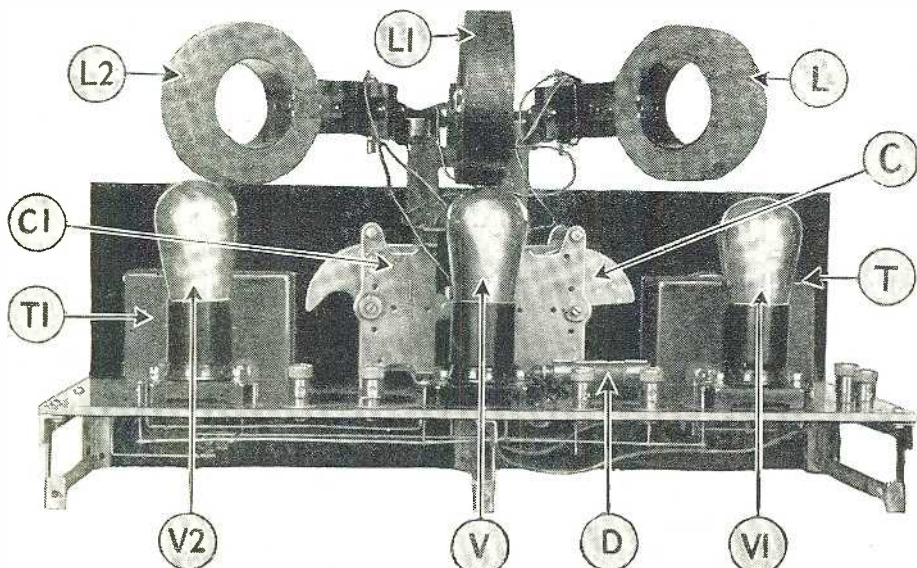

A rear view of the transoceanic interflex receiver. D is the fixed crystal detector, T and T1 the A.F. transformers; V, the detector-oscillator tube and V1 and V2 the A.F. amplifiers.

*RADIO NEWS Blueprint Article No. 22.

volume the "B" voltage should be increased to 135, and a tube of the 112 type used in the tube socket marked "2nd AF" (V2) in the illustrations.

Either phones or a loud speaker can be used on this set, and a jack (J) is provided for this purpose. When the plug is inserted in this jack the set is automatically turned on. When the plug is removed the tubes go out. This is a very nice arrangement for, after the set is once adjusted for the reception, it need not be touched again. Then, all one has to do to hear the telephone conversations is to plug in the phones or loud speaker.

THE CONSTRUCTION

The construction of the Oceanic Radio-telephone Interflex is comparatively simple, as there is not a great amount of apparatus to complicate the layout.

It is best (it always is) to drill both the panel and the sub-base according to the sketches and then mount the parts on each before attaching them together. The panel layout includes the two rheostats, the two variable condensers, the filament-control jack and the three-coil mounting. It will

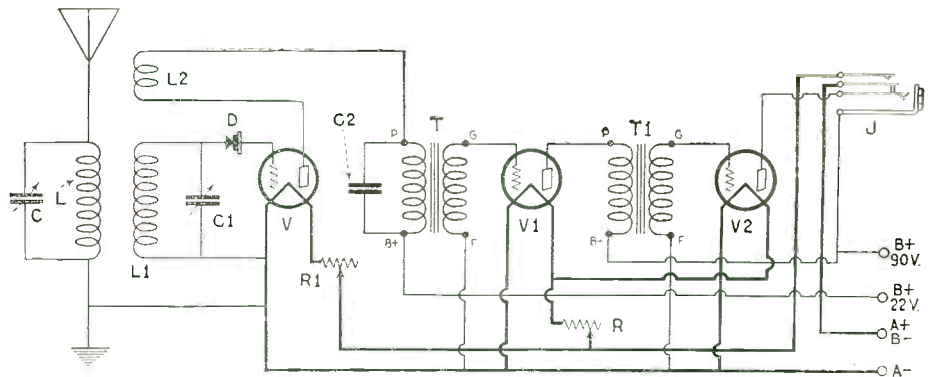

The schematic circuit diagram of the transoceanic interflex.

be noticed that the coil mounting is supported by the variable condensers. This simplifies matters considerably.

The sub-base layout includes the tube sockets, the two A.F. transformers, the fixed crystal detector (D) and the binding posts on the top and the brackets and fixed by-pass condenser (C2) on the bottom.

After all the parts are mounted, go ahead

with as much of the wiring on both the panel and sub-base as can be completed before the two are attached. After this is done, attach the panel to the sub-base by means of the brackets and complete the wiring between the two.

Note that a great deal of the wiring is under the sub-base. This is not absolutely necessary; but it makes a very neat job

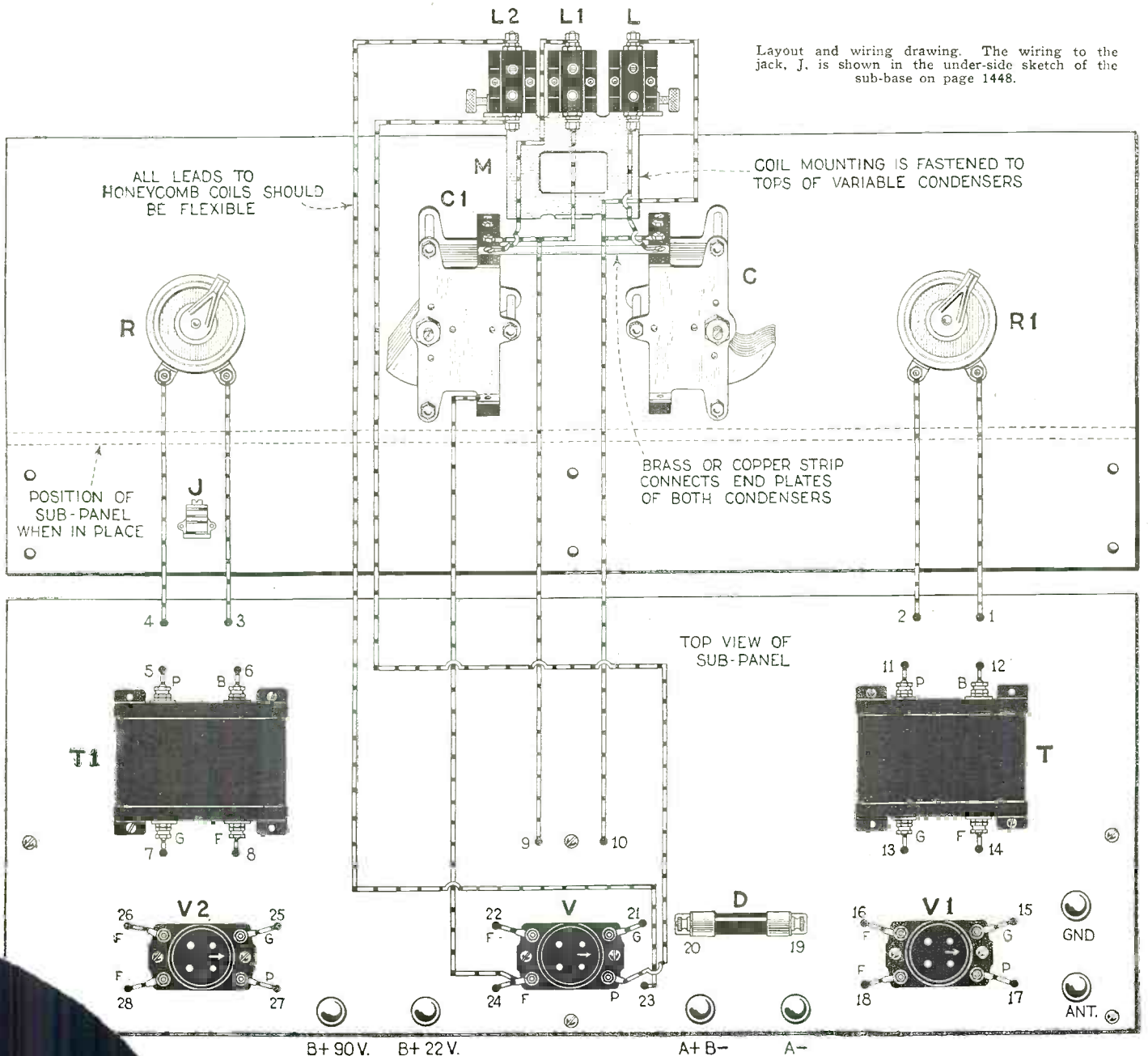

Layout and wiring drawing. The wiring to the jack, J, is shown in the under-side sketch of the sub-base on page 1448.

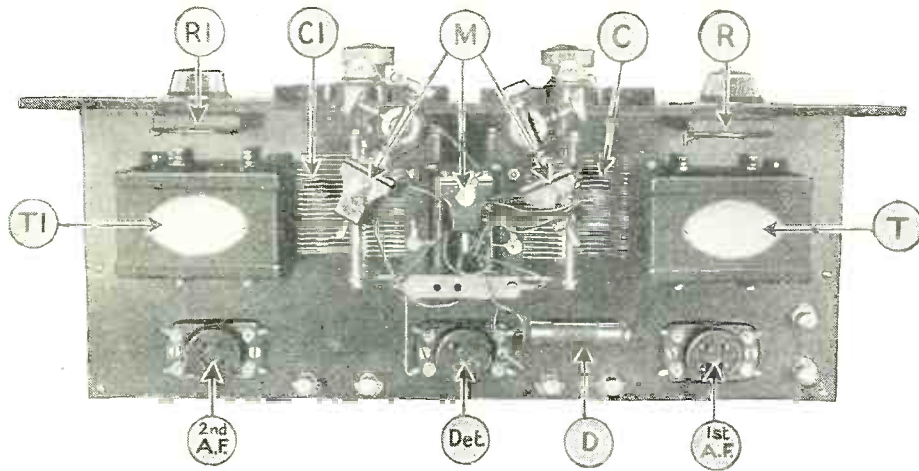

Top view of the receiver. This shows the coil mountings very well and it will be noticed that there are knurled adjusting screws, which make it possible to "lock" the coils in position after this has been correctly determined. The center coil-mounting is stationary.

and in the long run is probably more satisfactory than any other arrangement.

All of the wiring can be easily followed from the two large wiring sketches shown. Wherever a wire passes through a hole to the under side of the sub-base it is numbered alike on both sides, in the diagrams, so that it can be traced out to its termination.

INSTALLATION

There isn't a great deal that can be said about the installation, as all of the post markings are shown in the accompanying sketches. One thing of importance, however, is the aerial and ground installation. It has been pointed out before that, if the best results are desired, a large aerial should be used. It should be at least 100 feet in length, well insulated and as high above the ground as it is possible to get it. The ground connection should be made to the water pipe and be sure that a good contact is made. Remember, that, if the English conversation is to be picked up well, the resistance of the antenna system must be low. This can be accomplished only by making good, clean connections.

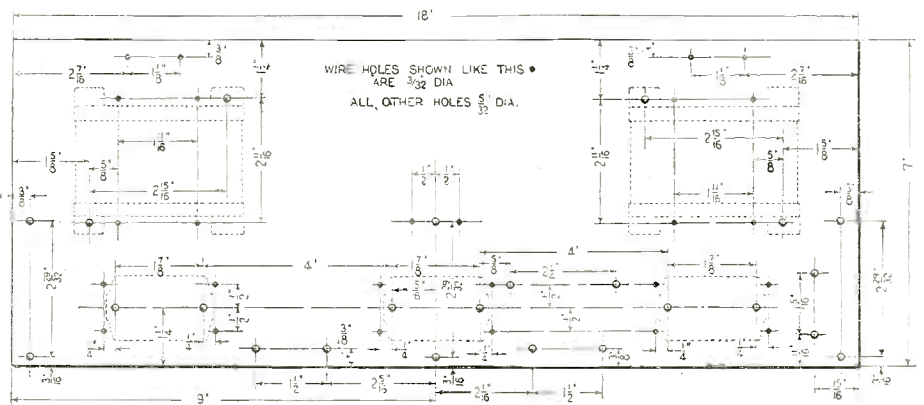

Drilling and dimensional details of the sub-base. The instruments are shown in dotted lines and will be readily recognized.

OPERATION

As previously mentioned, after the receiver is once adjusted for the best reception of the transatlantic telephone conversations, it need not be touched again. Of

It will be found that the adjustment of the condenser C is not critical, but that the adjustment of C1 is. Now, the job at hand is making the set sensitive enough to bring in the talk from the other side of the

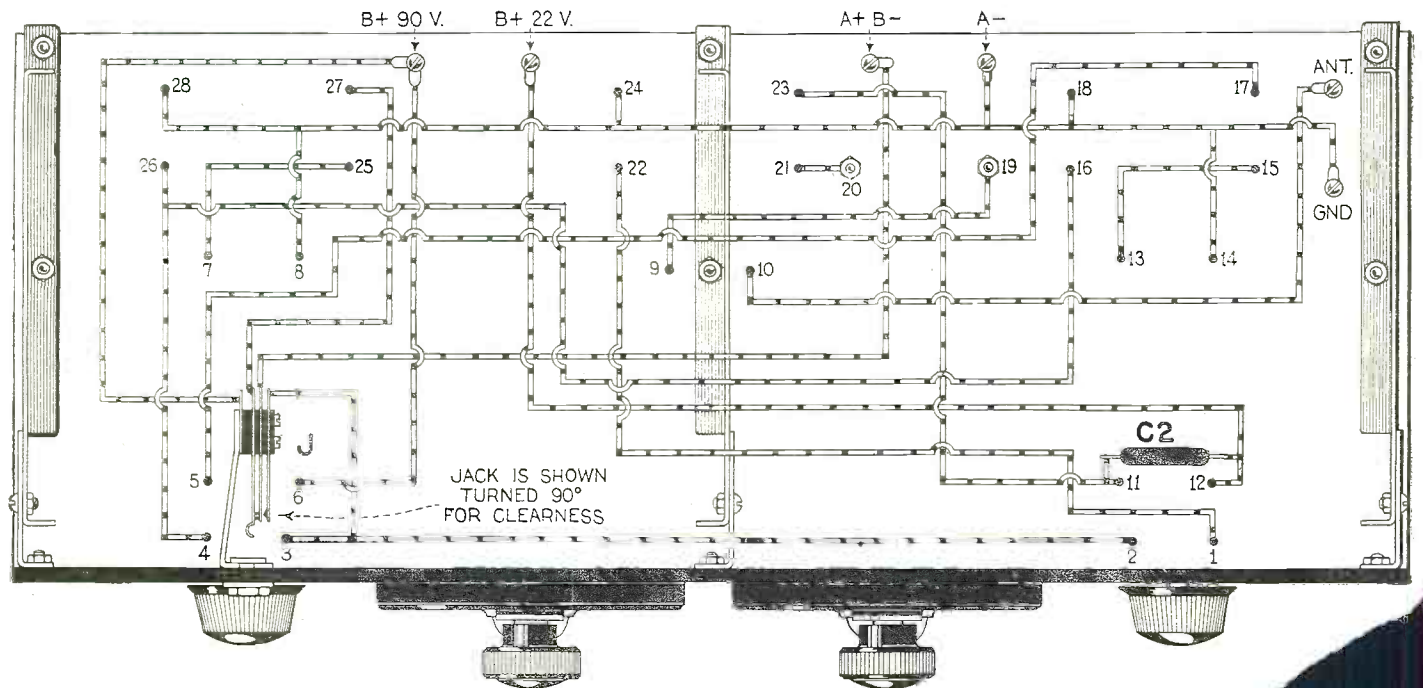

The wiring of the transoceanic interflex under the sub-base. C2 is the fixed .001-mf. by-pass condenser which connects across the primary of the first A.F. transformer T.

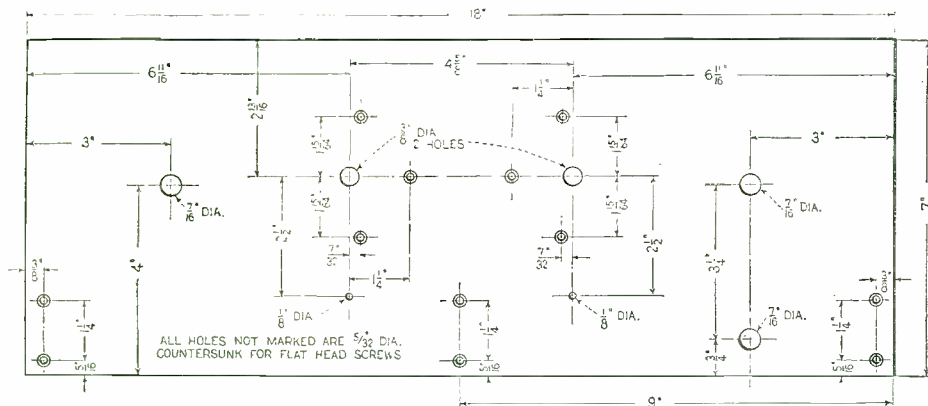

The drilling and dimensional details of the front panel.

Atlantic, as well as from this side. This will take a bit of time and patience and will require careful adjustment of the variable condenser C1, the tickler coil L2 and the rheostat R1. They should be set for maximum volume and clarity. Distortion of voice will disappear only when the settings of these three devices are correct.

After these adjustments have been made, it should be possible to plug in a loud speaker and hear the talk anywhere in a room. When you wish to turn the set off just pull the plug out of the jack. Thereafter, the telephone conversations will be heard at any time phones or a speaker are plugged into the jack, providing the American and English transmitters are operating.

AN ALL-WAVE RECEIVER

It is not at all difficult to adapt this receiver to reception on any wavelength from approximately 200 to 8,000 meters. All that is really necessary is to change the size of the coils L, L1 and L2 to correspond to the band of wavelengths you wish to cover. These coils are sold in all sizes and it is easy to determine from the tables just what size of coils should be used with .001-mf. variable condensers to cover the different wavebands. Since the variable condensers in this receiver are of such high maximum capacity, it will be found that a very wide band of wavelengths can be covered with a single set of coils.

It is understood, of course, that the tube V should be oscillating only when the receiver is used for the reception of transatlantic telephony. At all other times the coil L2, which is the tickler, should be so adjusted that the tube V does not oscillate but is, nevertheless, near to the point of oscillation. The nearer the tube is to this point, the more sensitive the receiver will be. Regeneration or oscillation is easily controlled by the tickler coil L2.

The advantage of this arrangement is that you can have on hand a complete set of coils to cover all the important wavebands and whenever you want to shift from, say a

extremely high capacity of the two variable condensers C and C1. It is necessary to use these, however, in order to reach the high wavelengths employed by the transatlantic telephone transmitters.

Though the tables usually available are fairly correct on the upper limits of the wavebands which may be covered with a given coil and size of condenser, many assign too high a figure for the minimum wavelength; possibly through allowing too large a minimum capacity for the circuit. For instance, some would indicate that the coils used in this set do not tune down to 5,000 meters—as they do. The transatlantic radiophone signals on 5260 meters come in with the dial of condenser C reading about 10, as we have said; though some tables indicate that this should be between 7,000 and 8,000 meters. A very slight change in frequency corres-

SYMBOL	Quantity	NAME OF PART	REMARKS	MANUFACTURER *
L	1	Duo-lateral coil	1000 turns	1
L1	1	Duo-lateral coil	1250 turns	1
L2	1	Duo-lateral coil	1000 turns	1
C, C1	2	Var. condenser	.001 mf.	2 11,23,27
C2	1	Fixed condenser	.001 mf. By-pass	3 6,14,15,16,17,18,19,20
R	1	Rheostat	10 ohms. For detector tube	4 1,6,14,21,22,23,27,39,40,41
R1	1	Rheostat	5 ohms. For audio tubes	4 1,6,14,21,22,23,27,39,40,41
D	1	Fixed detector	Crystal detector with mount	5
M	1	3 coil mount	For L, L1 and L2	1
J	1	Jack	Double circuit fil. control	6 1,21,22
T, T1	2	A. P. transformers		7 1,24,25,26,27,28,29,30,31
	3	Sockets	UX type	1 10,25,27,28,32,33,34
	6	Binding posts		8 27,32
	1	Panel	7 X 18 X 3/16"	9 35,36,37,38
	1	Sub-base	7 X 18 X 3/16"	9 35,36,37,38
	3	Brackets		10 9,28
	2	Dials	Vernier type	11 1,25,28,31,32,39,40,41,42
V, V1, V2	3	Tubes	5 v. 1/4 amp. Standard type	12 43,44
		roll	Hookup wire	13 45,46,47,48

NUMBERS IN LAST COLUMN REFER TO CODE NUMBERS BELOW.

1 Patent Electric Co.	2 Allen D. Cardwell Mfg. Corp.	3 Micamold Radio Corp.
4 Central Radio Labs. (Centralab)	5 The Carborundum Co.	6 Carter Radio Co.
7 Jefferson Elec. Mfg. Co.	8 X-L Radio Labs.	9 Amer. Hard Rubber Co. (Radion)
10 Benjamin Electric Co.	11 The National Co.	12 Belden Mfg. Co.
13 Radio Corp. of America	14 Electrad, Inc.	15 Tobe Deutschmann Co.
16 Aerovox Wireless Corp.	17 Sprague Specialties Co.	18 Dubilier Condenser Corp.
19 Potter Mfg. Co.	20 Wireless Spec. App. Co. (Paradon)	21 Yaxley Mfg. Co.
22 Herbert H. Frost, Inc.	23 Allen Bradley Co.	24 All-American Radio Corp.
25 Bremer-Tully Mfg. Co.	26 Ferranti, Inc.	27 General Radio Co.
28 Silver-Marshall, Inc.	29 Keras Electric Co.	30 Thordarson Elec. Mfg. Co.
31 Sanson Electric Co.	32 H. H. Fby Mfg. Co.	33 Gray & Danielson (Romler)
34 Alden Mfg. Co.	35 Formica Insulation Co.	36 The E. F. Goodrich Rubber Co.
37 The Lignole Corp.	38 Micarta Fabricators, Inc.	39 Martin-Copeland Co. (Marco)
40 Wireless Radio Corp.	41 Pilot Elec. Mfg. Co., Inc.	42 Brooklyn Metal Stamping Co.
43 Acme Wire Co.	44 Cornish Wire Co.	45 E. T. Cunningham, Inc.
46 C. E. Mfg. Co. (Deco)	47 The Magnavox Co.	48 The Van-Horne Co.

* THE FIGURES IN THE FIRST COLUMN OF MANUFACTURERS INDICATE THE MAKERS OF THE PARTS USED IN THE ORIGINAL EQUIPMENT DESCRIBED HERE.

If you use alternate parts instead of those listed in the first column of manufacturers, be careful to allow for any possible difference in size from those originally used in laying out and drilling the panel and sub-base.

200- to 550-meter band, up to around 3,000 meters or so, all you have to do is to take out the three smaller coils and replace them with those suitable for the 3,000-meter band. The coils are easily plugged in and out.

This receiver is really not adaptable to wavelengths below 200 meters because of the

ponds here to a very large difference in wavelength, making long-wave receivers seem apparently very broad in tuning. For the broadcast band, 50-turn coils are most suitable. 75-turn coils being large and 35-turn coils somewhat too small, even with these large condensers.

AERIAL ELECTRICITY AND THE SOLAR CYCLE

RECENT studies of the electrical charge of the atmosphere, made by Dr. Bauer of the Carnegie Institution, have shown that the increase with elevation of the normal voltage of the earth's atmosphere (as compared with the negatively-charged earth) varies with the time of year—being greatest when the earth is nearer the sun, as from October to March, rather than from April to September, when the earth is in the more elongated portion of its orbit. This is independent of the seasons, which are reversed in the two hemispheres. At the present time researches are being made into the problem of the solar cycle—that is to say, the eleven-year period during which the number of sunspots waxes and wanes. It is believed that several years will be required to determine the cycle satisfactorily; and then

the problem will assume the larger phase of a secular one, which part of a century may be needed to work out.

While these considerations do not bear directly upon radio, it is certain that their solution will add data of importance to the understanding of many things connected with radio transmission and reception. While it is well known that the transmission of the magnetic waves of radio is affected by light, it has become certain that the "potential gradient of atmospheric electricity passes everywhere through extreme values during twenty-four hours at about the same universal times, irrespective of whether the observing station be enveloped by sunshine or darkness." This potential gradient has an average value of about 130 volts per meter of vertical height, being

maintained by the great resistivity of the air. It may be doubled, and almost disappear again during each daily cycle, particularly in inland regions; but whether this electrical charge on atmospheric particles is renewed by solar, or more distant, radiation had been a matter of discussion.

The charging from the atmosphere of an insulated conductor or aerial is a phenomenon observed as early as 1752, long before the production of artificial electromagnetic waves. The fundamental explanation of the source and distribution of the earth's atmospheric charge, which may bear a relation to the asymmetrical position of its permanent magnetic field, may throw much-needed light on the question of the propagation and fading of radio waves.

The New Raytheon "A-B-C" Power Unit

A True "A, B and C" Current Supply Which Operates from 110-Volt A.C. Mains

By ARTHUR H. LYNCH and JAMES MILLEN

RADIO NEWS has the pleasure of presenting to its readers the first true "batteryless" "A, B and C" socket-power unit. The heart of this unit is a new 350-milliamper rectifier tube, which is capable of passing sufficient rectified current for all purposes. The only necessary change in the receiving set is the re-wiring of the filament circuits, from a parallel to a series connection, which is a simple matter. We feel sure that this complete "A, B and C" socket power unit will receive a hearty welcome.

—EDITOR



The completed "A-B-C" socket-power unit. The parts are: T, power transformer; T1-T2, filter chokes; C-C1, filter condenser blocks; R2, R3, R4, voltage regulators; R5, "A" power resistance-bank; MA, milliammeter. The binding-post connections are designated in the illustration.

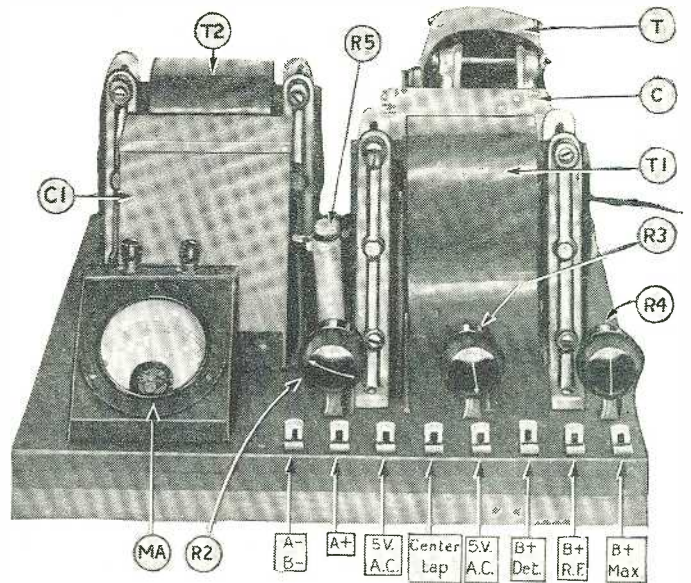

EVER since the inception of radio broadcasting, many manufacturers of complete sets have realized the necessity for powerizing their receivers if they were long to remain in business. The public demand for completely lamp-socket-operated radio is ever increasing. Almost all far-sighted set manufacturers have been concentrating their research efforts toward the development of such receivers—receivers that could be plugged into any lamp socket just the same as a vacuum cleaner or electric toaster.

The result of such research was first apparent in the perfection of the "B" power units; still the public was not satisfied. Then along came "A" supply units in such various forms as combination storage batteries and trickle chargers; and outfits in the form of overgrown "B" units in which large chokes, transformers and tungar rectifier tubes were employed.

Then engineers began to realize the tremendous advantages of a *series*, rather than a *parallel* connection of the receiving tube filaments when lamp-socket power was to be used. When so connected, the filament voltage, instead of being 3, or 5, is equal to the number of tubes in the set multiplied by 3 or 5. At the same time, instead of the filament current being equal to the *sum of the currents* drawn by each tube, it is equal to

but the current normally drawn by a single tube.

PROBLEMS OF CURRENT INCREASE

The real significance of this fact is apparent when one stops to consider the tremendous increase in the difficulty of rectifying and filtering alternating current, as the direct-current load is increased and the voltage held down. First, when the choke coils are used in such heavy-current circuits they must, to be effective, be constructed of such enormous physical dimensions as to be economically impractical. Then again, the power losses in any circuit increase as the square of the current, making operating costs far from economical.

Even the filter condensers are improved in effectiveness by an unbelievable amount when used in a series-filament, rather than a parallel-filament, power unit. In fact, a filter condenser is just about 400 times more effective at 200 volts than at 10 volts, which means that the low-voltage condenser for equal electrical effectiveness must have

many times the capacity of a condenser in a high voltage filter. This will be seen from the fact that the energy stored in an electrostatic capacity increases with the *square* of the voltage.

USE OF QUARTER-AMPERE TUBES

When these points had been duly considered, some manufacturers and engineers found that, by designing a set using 199-type tubes with the filaments in series rather than in parallel, and using a power-supply device composed of the parts of a heavy-duty "B" unit, a complete electrically-operated set was obtained. This was truly satisfactory except for one point—and that rather vital—the 199-type tubes. These small tubes are not very rugged and must be carefully handled if the best results and reasonable life are to be secured.

The problem at hand was to develop a rectifier tube capable of passing enough current to operate the 201A-type tubes. This has been accomplished in the new 350-milliamper rectifier tube which forms the new "A-B-C" unit.

The circuit employed in the "A-B-C" Power Unit is essentially the same as that used in all the plate supply units. (See Fig. 1.) The only real difference is that the physical size of the various components has been increased to give the same high degree of performance at 300 milliamperes as their little brothers do at 60 milliamperes.

THE NEW TUBE

The heart of the circuit is the new 350-milliamper "BA" rectifier tube, shown in Fig. 2. To the eye, the electrodes contained in the tube differ but slightly from those of the small "BH" tubes. In fact, the main difference in appearance between these two rectifiers is only the size of the external glass bulb; that of the "BA" tube being of about the same size as an old-type 75-watt lamp.

A most unusual electrical characteristic of the tube is the manner in which its impedance changes with the load current, so that it delivers practically a constant average over the usual load-current range encountered in practical applications of the tube.

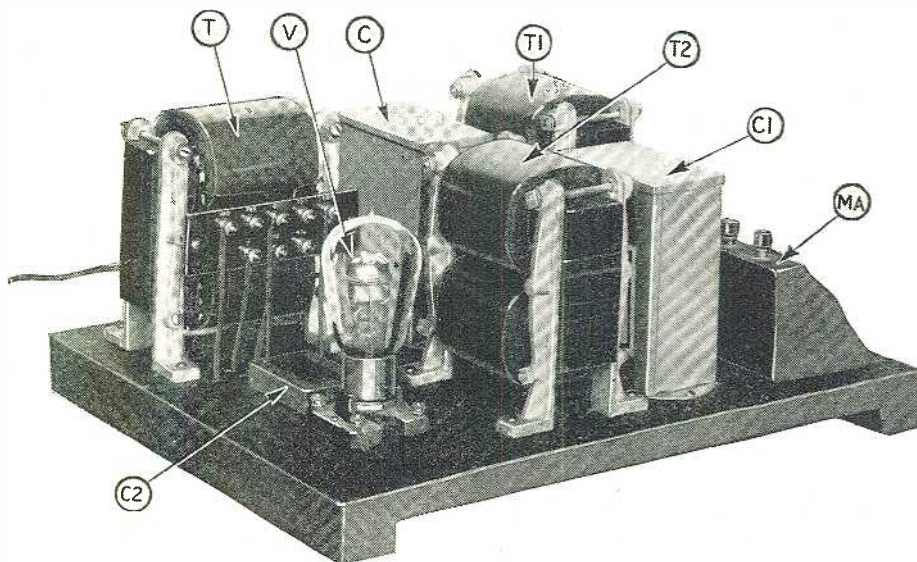

Another view of the completed unit. C2 is the buffer condenser block and V the new 350-milliamper rectifier tube.

mate
revalen
umber of
er this ques

Thus, when the "A" current has been adjusted to the proper 250 milliamperes, subsequent variation of the various "B" and "C" voltage controls will not disturb the initial "A" adjustment. This feature is illustrated by the regulation curve shown in Fig. 3.

The current range within which the tube may be used lies between 200 and 350 milliamperes, as shown in the curve of Fig. 3. For currents over 350 milliamperes, the life of the tube rapidly decreases; while for currents much under 200 milliamperes its efficiency rapidly falls off. The total current drawn from an "A-B-C" unit of the type herein described is approximately 285 milliamperes, with the great majority of sets. Thus the tube is worked at just about the center of its range of maximum efficiency.

TRANSFORMER AND BALLASTS

The transformer has, in addition to the usual 110-volt primary, a double high-voltage secondary with a voltage of 330 across each side, and a low-voltage winding with center tap, which supplies 5 volts for the power-tube filament in the audio amplifier. It has been found that a resistance of between 10 and 15 ohms placed in the primary circuit of the transformer is essential for the best operation of the complete unit. This ballast resistor prevents the transformer from drawing an excessive current from the 110-volt line when starting, and also acts as a protective device to prevent damage to the transformer tubes and filter chokes in case of a short circuit or momentary flash-over in the rectifier tube. It has been found that a 10-ohm power rheostat connected in the 110-volt line in shunt with a 20-ohm fixed resistor, makes an excellent method of adjusting the filament current for the receiver tubes to the exact 250 milliamperes required. This permits the use of fixed wire-wound resistors, with their permanent resistance values, instead of variable high-resistance units in the D.C. circuit.

With such an arrangement, fixed resistors of the proper value to give approximately the correct current value are used and then the current is adjusted to exactly 250 milliamperes by means of the 110-volt line rheostat.

Alternating current is used on the filament of the power audio tube in the receiver for two reasons. One is, that the power tubes require 1/2-ampere, rather than 1/4-ampere, filament current. The other, and more important reason is that, by using A.C. on the filament of the last tube, superior performance is obtained. This is due to the fact that the potential difference between the filament circuit of the power

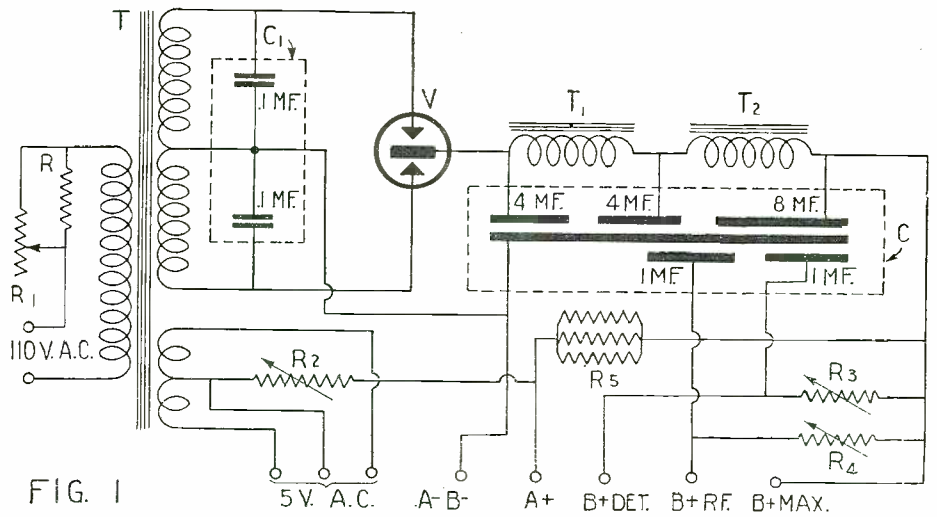

FIG. 1 Complete schematic diagram of the "A-B-C" socket-power unit. The fixed resistor bank, R5, may be replaced with a suitable variable resistor, such as listed on the specification sheet, for controlling the "A" current.

tube and the filament circuits of the remaining tubes can be made equal to the grid bias required for the last tube (40 volts or so)

drop were to be obtained by passing the return plate current of all the tubes through a common resistor.

THE FILTER CIRCUIT

The filter circuit is of the conventional π-section type, now almost universally used.

The only difference between a conventional "B" power-unit filter and that employed in this unit is in the physical size of the choke coils, which are constructed with larger air gaps, larger iron cores and heavy wire. The choke coils have an inductance of at least 10 henries at 300 milliamperes D.C., and a D.C. resistance of 160 ohms each or 332 ohms for the pair. This latter point is extremely important; for, if chokes with lower D.C. resistance were employed, the rectifier tube would pass an exceedingly high current in case of a short circuit, and thus damage the tube, and possibly the transformer. By using a pair of chokes, with a combined D.C. resistance of at least 330 ohms, this danger is averted.

The condensers employed in the unit illustrated are put up in two convenient containers, designed especially for this type of power unit.

The importance of using good resistors in the construction of a power unit of this type cannot be over-stressed. The units for the "A" supply in particular are perhaps most important and should be wire-wound,



Fig. 2. The new 350 - milliampere rectifier tube of the gaseous-conduction type which is used in the "A-B-C" socket-power unit. Photo courtesy of Raytheon Mfg. Co.

and thus, as shown in the circuit diagram, the grid voltage is obtained without the introduction of undesirable interstage coupling, which would result if this voltage

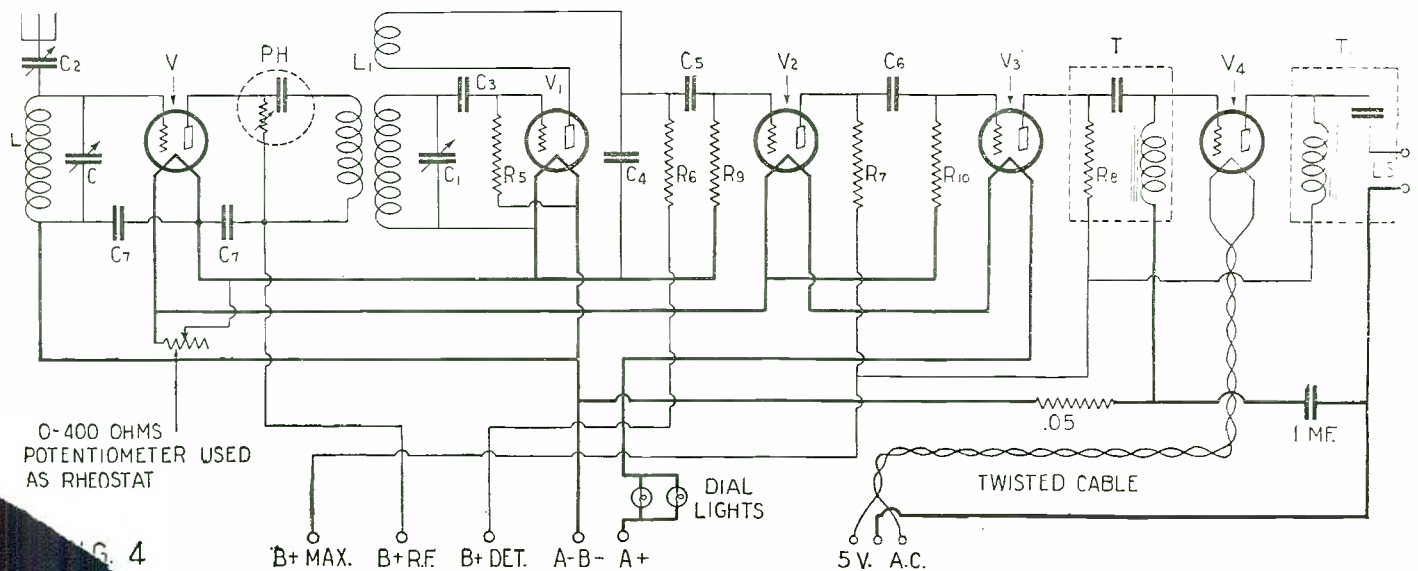

FIG. 4 Circuit diagram of the Modernized Browning-Drake receiver (as described in the May issue of RADIO NEWS) revised to accommodate it to the "A-B-C" socket-power unit. The changes in the circuit are indicated by the heavy lines.

on porcelain or other material capable of withstanding considerable heat. Wire-wound resistors are silent, permanent in value and have a very low temperature coefficient, and that positive.

The value of the "A" or filament resistance will depend upon the number of tubes used. For instance, in the case of the 5-tube Browning-Drake Receiver described by Arthur H. Lynch in the May issue of RADIO NEWS it is 670 ohms or thereabouts.

Variable resistors are employed as a simple means of regulating the detector and R.F. plate voltage. The full high voltage is applied to the plate circuits of all the audio tubes. The grid-bias voltage is controlled by means of a third variable resistor; although it will be found that a fixed 2,000-ohm wire-wound resistor will also prove satisfactory for such use.

CONSTRUCTING THE POWER UNIT

The power unit shown in the several illustrations is mounted on a base of 1/2-inch wood 14x18 inches. The base is reinforced with cross strips at the two ends. These strips serve also to raise the base and thus permit much of the wiring to be run underneath, which enhances the final appearance of the unit.

The arrangement of the parts is rather unique, the transformer and two chokes all being so located with respect to each other that they provide for a minimum of undesirable electromagnetic coupling.

In this connection it will first be noticed that the axis of the transformer coil is at right angles to those of each of the choke coils, while the two choke coils are placed according to the neutrodyne angle of minimum coupling.

When properly placed, as shown, the various units should be bolted in place by means of 8/32 round-head steel machine screws and washers. Wood screws will not do if a substantial job is desired, because of the weight and high centers of gravity, relative to the mounting screws, in the transformer and chokes.

Use well-insulated rubber-covered flexible tinned copper wire, No. 18 or its equivalent, for making all the connections.

In soldering to the socket terminals, use no more flux than necessary, and then remove all traces of even that with alcohol. Flux between the two "F" socket contacts may so lower the insulation resistance (across which is close to 700 volts A.C.) as to cause an arc when the line voltage is turned on.

NECESSARY RECEIVER CHANGES

By carefully studying Fig. 4 and comparing it with Fig. 2 on page 1344 of Mr. Lynch's article in the May issue (on the construction of the Browning-Drake receiver for battery operation) the changes necessary in the circuit of any receiver for conversion to "A-B-C" power-unit operation should be readily understood. Briefly summarized, they are:

(1.) The rewiring of the filaments so that all are *in series*, instead of in

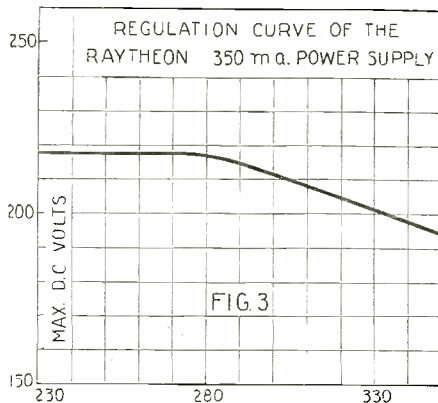

Showing the voltage-current characteristics of the 350-MA. tube.

The Greatest Circuit of the Year
Coming—The Stroboddyne Receiver, Embodying a New Principle

THE "Stroboddyne" circuit is probably the greatest advancement ever made over the original superheterodyne. It is the work of a French engineer and embodies the first practical adaption of super-regeneration and the superheterodyne in the same circuit. There is no true first detector or frequency-changer; the beat-frequency is obtained in a most ingenious manner, and the amplification provided by the first tube far exceeds that of any other known arrangement. The result is remarkable sensitivity.

The receiver itself employs eight tubes and includes a stage of tuned-radio-frequency amplification and a stage of power audio-frequency amplification. The power tube can be operated either from the regular batteries or from a standard socket-power unit with a filament winding on the power transformer. There are only two tuning controls, which makes the set as easy to operate as any standard receiver.

RADIO NEWS holds the sole publication rights for this revolutionary circuit in the United States. Starting with the July issue, we will offer our readers a series of three articles on the Stroboddyne Receiver. These will cover the theory of the circuit, the construction of the receiver, and instructions in its operation and adaptation to socket-power units.

—EDITOR.

parallel. In this connection, starting with the "A—" binding post on the set, go to one side of the detector tube

socket, then from the other filament terminal on the detector tube socket to one on the R.F. tube socket, and so on from the R.F. tube to the first A.F. tube, the second A.F. tube, and back to the "A+" binding post. Omit all rheostats and filament ballasts.

(2.) Change the grid-return connections as shown in Fig. 4 of this article; no "C" batteries will then be required.

(3.) Run a pair of twisted leads from the filament terminals of the last, or power, audio tube (which should be a 171 type) to two binding posts marked "5V-A.C."

(4.) Connect the grid return of the power tube, through a 50,000-ohm (.05-megohm) resistor to the "A—" binding post on the set. Also add the 1-mf. condenser, which is connected from the

"C—" side of the power tube grid impedance (leak) to a binding post marked "Center-Tap" on the power-tube-filament winding.

(5.) For a volume control, connect, in rheostat fashion, a large-size 400-ohm potentiometer across the filament terminals of the R.F. tube socket. Cutting out resistance by-passes some of the filament current around the R.F. tube filament and thus cuts out, gradually, the R.F. amplification.

(6.) Generally dial lights have 6-volt, 120-milliamper filament. In such a case, connect the two lights in parallel, and then insert the pair in the filament lead as shown in Fig. 4.

SYMBOL	Quantity	NAME OF PART	REMARKS	MANUFACTURER *
T	1	Power trans.	150 watts	1 25, 31
T1, T2	2	Filter chokes	10 henries, D.C. resistance 156 ohms	1 25, 31
C, C1	2	Cond. blocks	4-4.8-1-1 mf. (Single block obtainable)	2 28, 29, 30, 32, 34, 35
C2	1	Cond. block	(Two 1 mf. buffer condensers)	2 28, 29, 30, 32, 34, 35
R	1	Fixed res.	20 ohms. Heavy duty	3 11, 23
R1	1	Var. res.	10 ohms. Fil. power type	4 12, 18, 27, 33, 35
R2, R3, R4	3	Var. res.	Universal "B" type	4 3, 27, 37, 38, 39
R5	3	Fixed res.	2000 ohms. (or variable system)	5 4, 18, 27, 33, 37
MA	1	Milliammeter	0-500 milliamperes range	6 13, 14
V	1	Rectifier tube	350-milliamperes rating	7
	1	Socket	UX type	8 12, 15, 16, 17, 18, 19, 20, 21, 28
	8	Binding posts		9 4, 12, 15, 16, 18
	1	Cord and plug	Standard	26
	1	Rosette	Porcelain. One piece	26
	1	Baseboard	14 X 18 X 1/2" (wood)	
	roll	Hookup wire	No. 18 insulated	10 23, 24

NUMBERS IN LAST COLUMN REFER TO CODE NUMBERS BELOW.

- | | | |
|------------------------------------|------------------------------|------------------------------------|
| 1 Acme Apparatus Co. | 2 Tube Deutschemann Co. | 3 Carter Radio Co. |
| 4 American Mech. Labs. (Clarostat) | 5 Arthur H. Lynch, Inc. | 6 Weston Elec. Instrument Corp. |
| 7 Raytheon Mfg. Co. | 8 Airgap Products Co. | 9 Fahnestock Elec. Co. |
| 10 Belden Mfg. Co. | 11 Taxley Mfg. Co. | 12 General Radio Co. |
| 13 Jewell Elec. Instrument Co. | 14 Hoyt Elec. Instrument Co. | 15 Silver-Marshall, Inc. |
| 16 H. H. Eby Mfg. Co. | 17 Benjamin Electric Co. | 18 Ameco Products, Inc. |
| 19 Facent Electric Co. | 20 Alden Mfg. Co. | 21 Gray & Basile Inc. (Reslar) |
| 22 L. L. Radio Labs. | 23 Acme Wire Co. | 24 Cornish Fire Co. |
| 25 Dongan Electric Co. | 26 Bryant Electric Mfg. Co. | 27 Central Radio Labs. (Centralab) |
| 28 John E. Fast Co. | 29 Dubilier Condenser Corp. | 30 Inrad Condenser & Mfg. Co. |
| 31 Ford Radio & Mica Corp. | 32 Concourse Electric Co. | 33 Ward Leonard Elec. Co. |
| 34 Polymet Mfg. Corp. | 35 Sangamo Electric Co. | 36 Herbert H. Frost, Inc. |
| 37 Allen Bradley Co. | 38 Pilot Elec. Mfg. Co. | 39 ElectroRad, Inc. |

* THE FIGURES IN THE FIRST COLUMN OF MANUFACTURERS INDICATE THE MAKERS OF THE PARTS LISTED IN THE ORIGINAL EQUIPMENT DESCRIBED HERE.

If you use alternate parts instead of those listed in the first column of manufacturers, be careful to allow for any possible difference in size originally used in laying out and drilling the panel and sub-base.

The

The El-Fonic Adapter Unit*

Combining the Phonograph With Any Radio Receiver

By F. A. JEWELL†

IN the first article of this series, which appeared in the April issue of RADIO NEWS, Mr. Jewell described the El-Fonic capacity pick-up device, together with the dual-impedance-coupled audio-frequency amplifier, both of which he has developed. In the second, he described a combination receiver, the Phono-Radio, which can be used for receiving broadcast programs or for reproducing phonograph music as desired. In the following article it is shown how, with this unit, music from the phonograph can be reproduced through any radio receiver employing vacuum tubes.

Briefly, this unit consists of an oscillating circuit, the output of which is modulated by the capacity pick-up and becomes the input of a radio receiver. Music from phonograph records can, therefore, be played through your receiver and the quality of reproduction of this music depends entirely on the receiver employed. We recommend it to our readers who desire phonograph music that is "just a little better."—EDITOR.

MANY people who have heard phonographs of the new types that have lately appeared on the market have said to themselves, "I would like to have one of those." Then, when they inquire what the cost is and what they can get for their old phonograph, they find that it involves a considerable outlay of money.

YOUR OWN BROADCASTER

In the April issue of RADIO NEWS was described a method whereby a phonograph's reproduction can be vastly improved by the use of the El-Fonic capacity pick-up in connection with the Jewell dual-impedance

Here the Adapter is shown connected to the capacity pick-up on the phonograph. The output of the adapter is connected to the antenna and ground binding posts of the tuned-R.F. receiving set, the music issuing from the loud speaker.

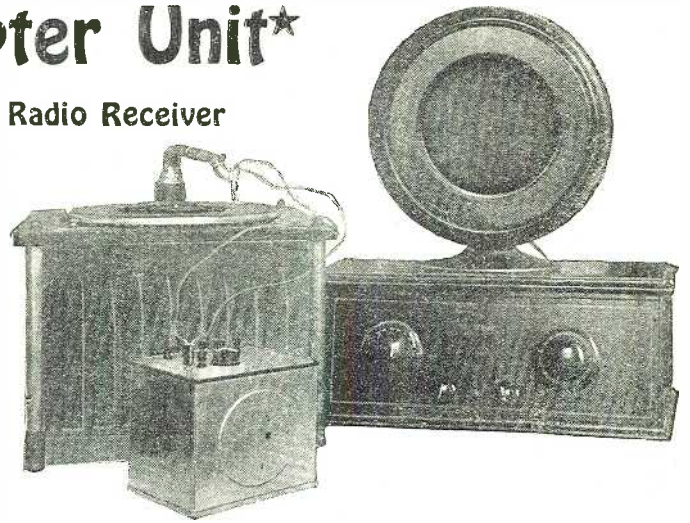

audio-frequency amplifier, which is designed especially to give reproduction of all the harmonics and overtones inscribed on the record. There are, however, many who do not care to build an outfit of this nature, desiring something more simple and easier of construction.

With this idea in mind, the little device described in this article was developed. As may be seen from the circuit shown in Fig. 1, it is simply an oscillator coupler and a

tenna and ground binding posts. Within the set this current is treated in the same manner as a similar current received over the air from a broadcast station. As a matter of fact, this adapter is nothing more than a miniature station, by means of which you can have whatever type of entertainment you desire—limited only by the records in your phonograph album.

THE PICK-UP'S FUNCTION

Let us consider for a moment just how this pick-up operates. It is a well-known fact that there are on the market at the present time several types of pick-ups for phonographs, among the best known being the magnetic and the carbon types. Both of these types have grave disadvantages, which need not be gone into here; but these disadvantages are overcome in the pick-up developed by the writer. In the matter of "needle-scratch," for example, by no other type of pick-up is this annoying feature of the phonograph reduced to a minimum as it is in the El-Fonic.

This pick-up device consists of a small condenser of two plates, one being of brass and the other, the movable one, of aluminum. To this latter is attached an ordinary needle holder. As the whole device weighs only a few ounces, the needle practically floats in the groove of the record; the needle, thereby, being free to transmit all the tones and harmonics, inscribed on the sides of the groove, to the movable plate of the condenser. Now, as the scratching

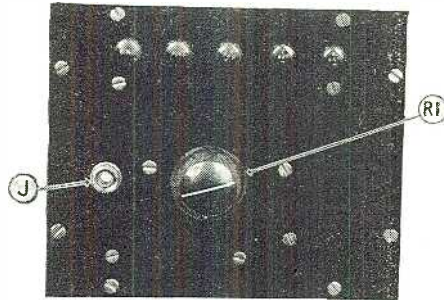

The top-panel view of the Adapter; R1 being the variable resistor and J, the jack.

vacuum tube which generates a constant radio-frequency current. The amplitude of this constant frequency is varied by the small condenser in the pick-up, and the radio-frequency current thus modulated is fed into the receiving set through the an-

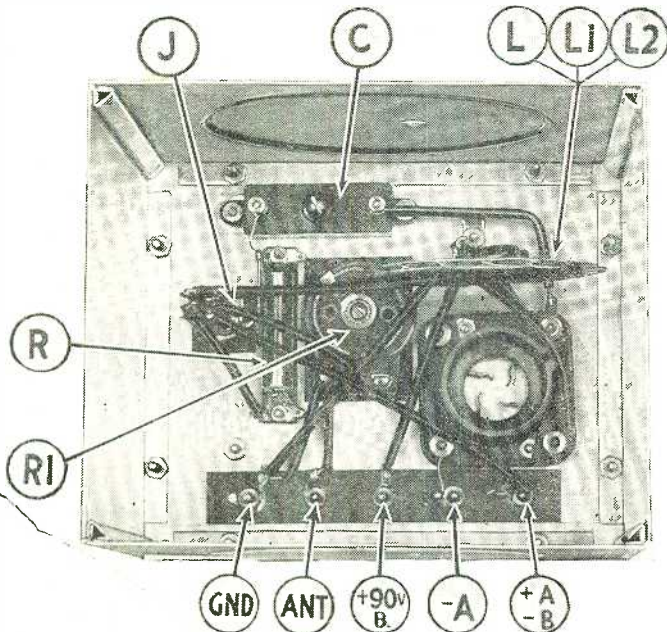

The interior view of the Adapter is shown at the left. At the right, front and rear views of the capacity pick-up. This is fitted with a rubber washer, so that it can be fitted to any phonograph.

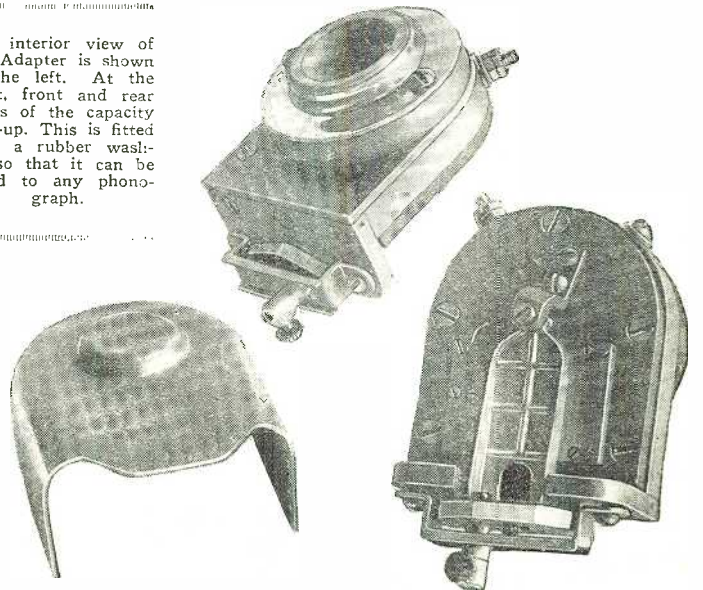

*Radio News Blueprint Article No. 23.

† Consulting Engineer, Adams-Sibley Development Corp.

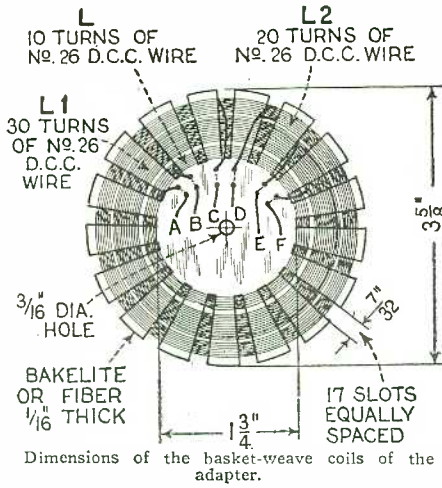

volume to such an extent that it will not overload the radio-frequency amplifier tubes. The pick-up is designed to be used feeding directly into a detector tube and, if there is any amplification before the detector, there must be inserted some device like the resistor, R1, to reduce the output. If this is not done the music reproduced in the loud speaker will be mushy and distorted, clearly a case of overloading.

The operation of the set is far from difficult. The antenna and ground binding posts of the adapter are connected to the antenna and ground posts of the radio receiver, the plug is inserted in the jack, thus lighting

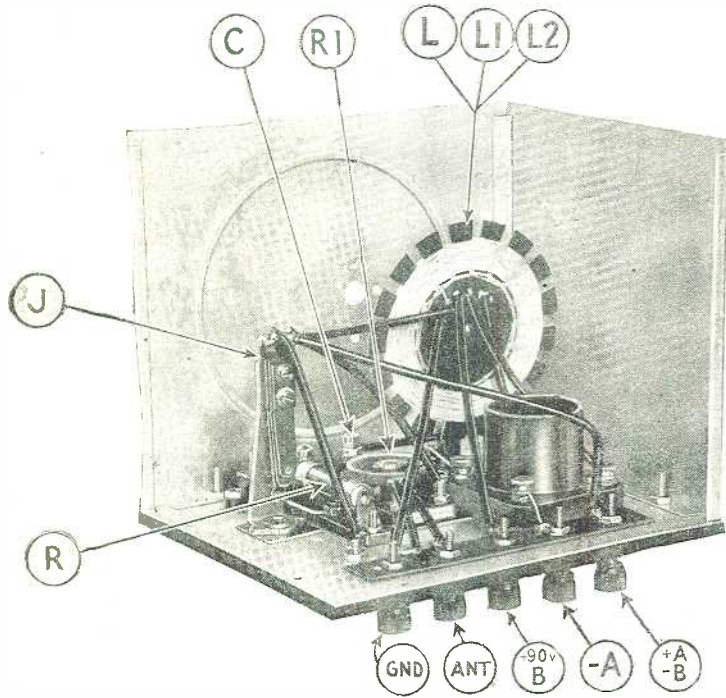
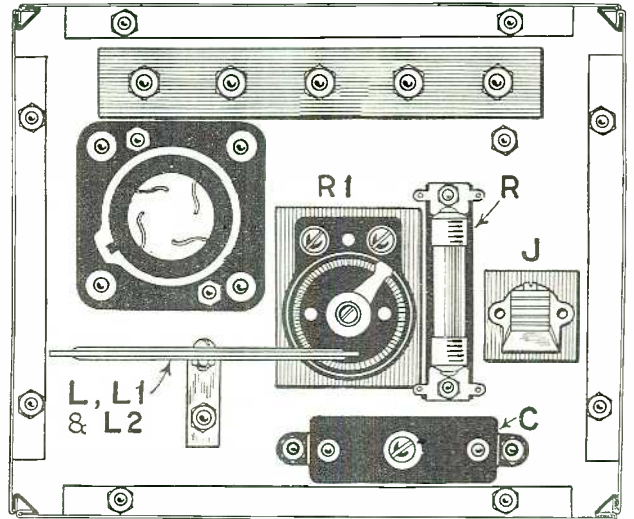

In the upper left-hand corner are the necessary details for winding the oscillator inductor, L, L1 and L2. In the upper right-hand corner is illustrated the manner in which the apparatus is placed on the panel. At the left is the interior of the adapter, showing the different parts. J is the jack; R, the filament-ballast resistor; C, the adjustable condenser; R1, the 5,000-ohm variable resistor; L, L1 and L2, the oscillator coils. These symbols apply to all the illustrations.

the filament of the tube, and the pick-up is placed on the revolving record of the phonograph. If there is a whistle superimposed on the music the condenser, C, should be varied until this disappears. If the music is distorted try varying the variable resistor, R1. If this does not clear it up entirely the fault is not in the adapter, but somewhere in the radio receiver, more than likely in the audio-frequency amplifier.

With the average five-tube, tuned-radio-frequency receiver, the results obtained with the El-Fonic adapter should be far superior to the average phonograph; the volume should be greater and both the high and low notes should come through with a snap and brilliancy not found ordinarily. This adapter lends itself admirably to portable outfits also. Many portable radio receivers on the market today will give loud-speaker volume and, when this adapter is used with one of these and a portable phonograph, the results are excellent. An outfit of this kind will be found to be just the thing for summer dancing when the ordinary small portable phonograph does not deliver enough volume for a good-sized dance floor.

For the highest quality of reproduction from this combination, however, a loud speaker of real merit is necessary.

may be adjusted so that it will not be on the wavelength of any broadcast station in the vicinity and heterodyne with it, which would cause a whistle when the phonograph is being operated. Once this condenser is adjusted it need not be touched again.

The form on which the coils are wound is held in place by a bracket bent in an "L" shape, which is slightly bowed so that the metal will not come in contact with the wire of the coils. One end of this bracket is screwed into the metal of the shield, and the other to the center of the coil form.

The jack, J, and the variable resistor, R1, have a thin sheet of fiber to insulate them from the metal shield. Every other piece of apparatus, with the exception of the binding posts, is mounted directly on the shield. The shield is used also as an electrical connection for the negative side of the filament circuit, thus saving quite a bit of wiring.

The terminals of the pick-up device are connected to the terminals of a plug. When this plug is inserted in the jack, J, the pick-up is thereby connected in the circuit of the pick-up coil, L, and at the same time the filament of the vacuum tube is lighted. The filament is controlled by a filament-ballast resistor, one side of which is connected to the metal shield.

The variable resistor, which has a value of 5,000 ohms, is placed in the output circuit in order to cut down the

SYMBOL	Quantity	NAME OF PART	REMARKS	MANUFACTURER *
L, L1, L2	1	Coupler	Special (See drawing)	1
C	1	Adj. condenser	.0001 to .0005 mf.	2, 12, 13
R	1	Var. ballast	5 volts, 1/4 amp.	3, 14, 15, 16, 23, 27, 28
R1	1	Var. resistance	5,000 ohms	4, 5, 17
J	1	Jack	Single circuit fil. control	5, 18, 19, 20, 25
S	1	Shield	Aluminum	6
	1	Socket		7, 8, 13, 20, 21, 22, 23, 24, 25, 26, 40
	5	Binding posts		8, 2, 21, 22, 28
	1	Ins. panel	5 7/8" X 6 15/16" X 3/16"	9, 10, 27, 28, 29
	9	Insulating strips	(See sketch)	10, 9, 27, 28, 29
	1	Tube	5 v., 1/4 amp. 201-A type	11, 30, 31, 32, 33, 34, 41, 42
	roll	Hookup wire	Insulated	35, 36, 39

NUMBERS IN LAST COLUMN REFER TO CODE NUMBERS BELOW.

1 Adams-Sibley Dev. Corp.	2 X. L. Radio Labs.	3 The Radiall Co. (Amperite)
4 Electrad, Inc.	5 Carter Radio Co.	6 Hamerlund Mfg. Co.
7 All-American Radio Corp.	8 H. H. Eby Mfg. Co.	9 Amer. Hard Rubber Co. (Radion)
10 Micaarta Fabricators, Inc.	11 Radio Corp. of America	12 Leslie F. Miter Co.
13 Dremor-Pully Mfg. Co.	14 Leckshins-Gaulman Co. (Elkey)	15 Arthur H. Lynch, Inc.
16 L. S. Beach Mfg. Co.	17 Allen-Bradley Co.	18 Yaxley Mfg. Co.
19 Herbert H. Profs., Inc.	20 Pacent Electric Co.	21 Silver-Marefall, Inc.
22 General Radio Co.	23 Amco Products, Inc.	24 Benjamin Electric Co.
25 Pilot Electric Co.	26 Gray & Darrelson (Replér)	27 Insulating Co. of America
28 Formica Insulation Co.	29 The Celoron Co.	30 E. T. Cunningham, Inc.
31 C. F. Mfg. Co. (Ceco)	32 The Van-Horne Co.	33 The Magnavox Co.
34 Ken-Rad Corp.	35 Acme Wire Co.	36 Belden Mfg. Co.
37 Daven Radio Corp.	38 Tobe Deutschmann Co.	39 Cornish Wire Co.
40 Alden Mfg. Co.	41 Zetka Laboratories	42 Cam Tube Co.

* THE FIGURES IN THE FIRST COLUMN OF MANUFACTURERS INDICATE THE MAKERS OF THE PARTS USED IN THE ORIGINAL EQUIPMENT DESCRIBED HERE.

If you use alternate parts instead of those listed in the first column of manufacturers, be careful to allow for any possible difference in size from those originally used in laying out and drilling the panel and sub-base.

FORM COPYRIGHT, 1927, E. P. Pub. Co.

The De Luxe System of Radio Broadcast Reception

Dealing with the Construction of a Socket-Operated Receiver

By ARTHUR H. LYNCH

SEPARATE UNITS

THIS article, the last of a series of three on the Modernized Browning-Drake circuit, covers principally the "electrification" of the set described in the May issue of RADIO NEWS, that is, adapting it to lamp-socket operation.

The receiver itself is the same except that it contains no audio amplifier, this being combined with the socket-power unit.

The combined power amplifier and socket-power unit is of a new type and gives excellent reproduction and all the volume desired. The same unit supplies the necessary "B" voltage for the receiver.

The "A" power unit is a combination low-capacity storage battery and trickle charger controlled by an automatic relay switch. It requires practically no attention.

If you are after one of the finest receivers and power amplifiers, both operating direct from the lamp socket, we would suggest that you build this one designed by Mr. Lynch.

—EDITOR.

PERHAPS that old saying about history repeating itself wasn't quite so far wrong after all. At least from some recent observations, it seems to have some slight confirmation in the radio industry. Remember the old "pre-war" two-filament Audiotrons? Just this season a new tube manufacturer placed a double-filament 201A-type tube on the market.

And then how about the old tuner "boxes" and amplifier "boxes"? Complete receivers with tuners and audio amplifiers in one cabinet were almost unheard-of contraptions in the early days of radio.

Then came broadcasting and the so-called "broadcast receivers," which for a time tried to include even the speaker and antenna as well as the batteries in the same unit as the set proper. Surely the reader hasn't already forgotten the D-10 De Forest set of only a few years ago.

But now, with well-nigh perfect audio reproduction obtained by means of the new lamp-socket-powered three-stage amplifiers, the separation of the radio and the audio amplification channels of broadcast receiving sets into at least two distinct units is apparent in some of the newer designs, such as the author's De Luxe system.

The De Luxe system consists of an exceedingly efficient, selective, sensitive, easily-tuned, and reliable two-tube receiver, the output of which is fed through a new combination high-quality audio channel and lamp-socket power-supply device.

The amplifier-power unit supplies all necessary power to both the receiver and the amplifier, with the exception of the "A" power for the two tubes in the set and the first two tubes in the amplifier. "A" power for these tubes may be obtained either directly or indirectly from the lamp socket, as will be explained later in this article. The entire outfit is automatically controlled by the volume-control knob on the receiver. As this knob is turned from right to left, the volume gradually decreases from a full, life-like intensity to a mere whisper and then the entire outfit is automatically shut off. Turning the volume control to the right

Drilling and dimensional details of the panel and sub-panel.

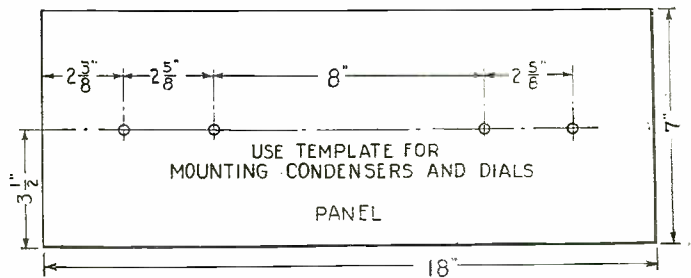
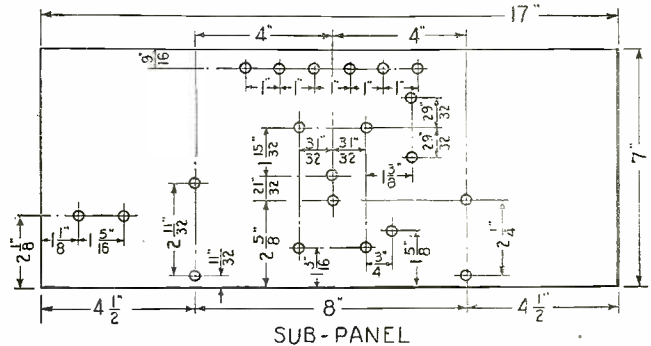

FIG. 4

first turns on all the power and then gradually increases the volume.

RADIO NO LONGER A CURIOSITY

Aside from volume, ease of control, and reliability of operation, perhaps the most desirable, and at the same time the most neglected, virtue of a modern broadcast re-

ceiver is fidelity of tone. When radio was new, it was classed as a novelty, and even a few squeaks and squawks ever so faintly resembling music were greeted with great enthusiasm. The novelty stage has now passed and perfection of performance is the paramount requisite of receiver design.

Listening to the receivers of past years may be rather accurately compared to a person's watching a ball game through a crack in the fence. There is, at first, a

thrill attached to the process which tends to compensate for the inconvenience and limited vision. Soon, however, the novelty wears off and only a grandstand seat with full and undistorted vision will suffice to hold one's interest. The full, clear and undistorted tone quality, obtainable from the new-day radio receiver capable of such performance as the De Luxe system is even better than the grandstand seat. It brings the performance, the crowd, the excitement, in fact, everything, right to the listener's living room, without the inconvenience and expense of his going in person to the performance.

THE AMPLIFIER

As will be seen from Fig. 1, the heart of the De Luxe System is the power amplifier and "B" supply.

This unit comprises one stage of impedance-coupled and two stages of resistance-coupled audio-frequency amplification. The first two stages are used as voltage amplifiers and employ high- μ tubes; while the last stage is used as a power amplifier and employs the 171 type of tube. The remaining tube is a type "BH" Raytheon filamentless rectifier, which is used in the "B" and "C" voltage supply. A view of the unit itself is obtained from the illustration of Fig. 2.

The entire amplifier, together with its associated power supply equipment, is mounted on a sturdy cast-iron base and finished in block-crystal lacquer. Many of the essential parts, such as the

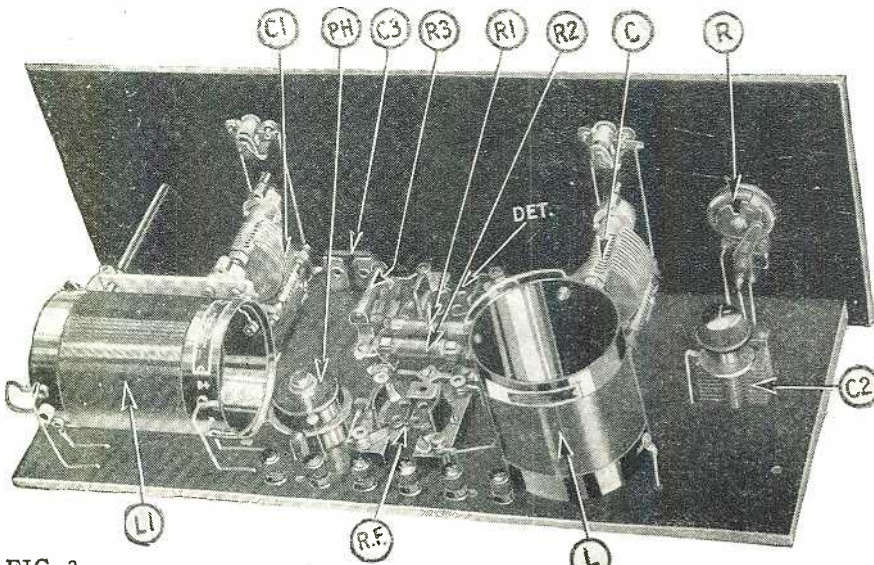

FIG. 3

A rear view of the special Browning-Drake receiver designed to operate with a separate audio amplifier and socket-power unit. The lettered parts are described in specification sheet on page 1458.

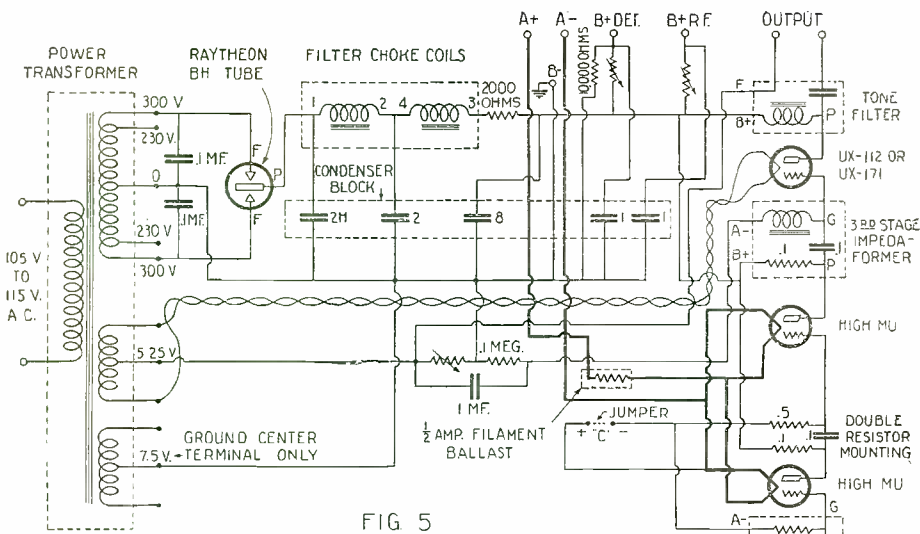

FIG 5

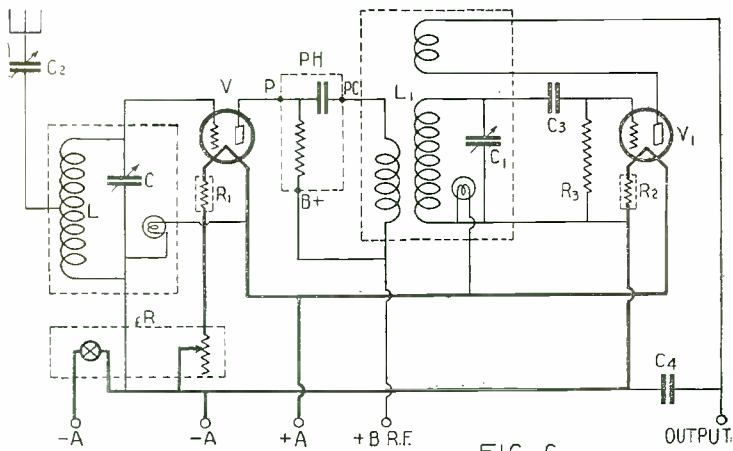

FIG. 6

Above: The complete schematic diagram of the impedance-resistance power amplifier and socket-power unit shown in the illustration at the bottom of the page. Left: Circuit diagram of the special Browning-Drake receiver.

resistors, buffer condensers, grid condensers, resistors and, of course, the wiring, are concealed within this base.

The power transformer, designed by Philip Eyrick of Cambridge, Mass., supplies, in addition to the high voltage for the Raytheon rectifier, a low voltage for use on the filament of the power tube. A noteworthy feature of the transformer is the special electrostatic shield between primary and secondaries to eliminate noise in the receiver due to line disturbances.

As a result of the use of unusually large air gaps and a generous iron core in the filter chokes, their inductance values remain unusually constant, even with heavy loads.

As the result of such design the amplifier may be used, when so desired, with super-heterodyne and other multi-tube sets drawing heavy "B" current with the same excellent results as with a small two-tube set. Lower voltages, down to practically zero, are readily obtainable by means of the voltage-control knobs provided for the purpose.

The grid-bias voltage for the power tube is also variable and the control is mounted on the sloping front panel of the amplifier base, along with the two "B" voltage controls. By having this control variable either the 112 type or the 210 type tubes may be used in place of the 171, when so desired. Either the 210 or the 112 may be used, but the 171 type is the ideal tube. The volume obtainable from the amplifier when the 171 is used is greater than will ever be required in the majority of cases.

The amplifier channel itself has several unique features, of which perhaps the following are the most outstanding:

(1.) Incorporation of a radio-frequency choke in the input circuit, to keep the radio-frequency energy present in the plate cir-

cuit of the detector tube from getting into the amplifier and thus impairing the tone quality.

(2.) Use of an input impedance, rather than resistance, in order to make possible the use of the new special detector tubes with their high plate current.

(3.) The use of metallized filament, grid and plate resistors to insure permanent and noise-free results.

(4.) The use of the Millen system of amplifier stabilization and "motor-boating" prevention; a phase-shifting inductance in the power-tube grid circuit.

(5.) The use of a tone-filter in the output to prevent damage to the loud speaker and distortion due to the passing of the heavy plate current of the last or power tube through the loud-speaker windings.

(6.) The use of high voltage on all the amplifier tubes, made possible by the incorporation of the amplifier and power supply into a single unit. High "B" and "C" voltages are essential for the best tone quality.

THE TWO-TUBE SET

The radio section of the De Luxe system is identical in every way except physical layout with the radio end of the five-tube Modernized Browning-Drake receiver described by the writer in RADIO NEWS for May, 1927. In this instance, as only two tubes are incorporated in the receiver, a much smaller front panel is used. As no tubes need be placed along the back edge of the sub-panel, the standard tuning units with coils mounted directly on the backs of the variable condensers may be used without making the set more than seven inches deep. This arrangement simplifies construction to a considerable extent, as mounting the condensers automatically mounts the coils. The set is illustrated in Fig. 3. Incidentally, the variable condensers are designed to serve as mounting-brackets for carrying the sub-panel.

The coils themselves are unusually efficient, being wound with enameled wire on three-inch bakelite tubes in such a manner that each turn is spaced from the next by half the diameter of the wire. Such construction reduces electrical losses to a minimum. Another feature is the use of the new Phasatrol system of stabilization which has already been described.

As previously mentioned, a combination switch and rheostat serves as a volume control. The rheostat is employed in addition to a filament ballast resistor in the filament circuit of the R.F. tube. Such a combination prevents damage to the tube when the rheostat is turned all the way on. Another separate filament ballast is used to control the detector tube filament. The use of these insures the operation of tubes at the proper

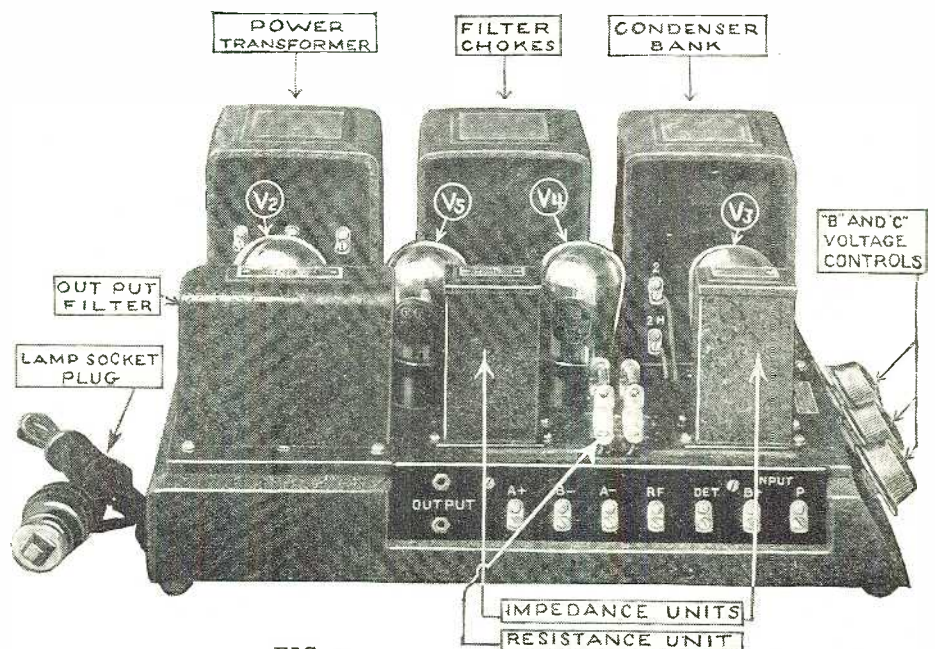

FIG. 2

The completely assembled and wired power amplifier and socket-power unit. This supplies the "B" and "C" voltages for the amplifier and the "B" voltages for the receiver.

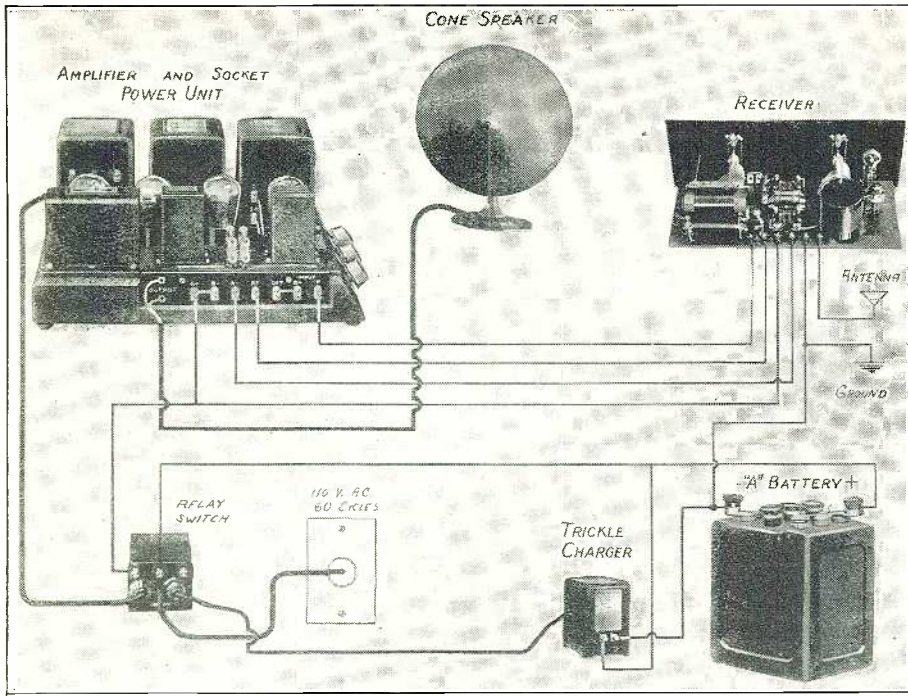

Fig. 1

A picture wiring diagram of the complete De Luxe system. The relay switch takes care of the "A" power unit, composed of the storage battery and trickle charger.

voltages without unnecessary controls and the use of an expensive voltmeter.

MOUNTING THE PARTS

In constructing the set, first prepare the front and sub-panels according to Fig. 4. The sub-panel is made half an inch shorter at each end than the front panel, so that the set will fit a standard 7x18-inch cabinet.

When the panels have been prepared, mount the tuning units in place, by means of screws through the sub-panel into the tapped holes in the bottom of the condenser frames. Then mount the two sockets, the filament ballast resistors, the grid-leak mounting, the antenna series condenser, the binding posts, and finally the Phasatrol. The "chassis" which results may then be almost completely wired before adding the front panel, which is fastened to the condensers. With the front panel in place, the dial lights and rheostat-switch may be wired, completing the set.

It is recommended that semi-flexible triple-insulated wire be used rather than bus bar. All connections must be carefully soldered, particularly those to the tuning units. The grid condenser should be mounted just as close to the grid terminal of the detector tube socket as possible.

The special "A—" filament connection is used so that the switch on the panel of the set may control the filament of the first two (the high-mu) tubes in the amplifier and, by means of a relay, the lamp-socket power, as well as the two tubes in the set.

"A" POWER FOR THE SYSTEM

There are two general forms of lamp-socket "A" power. One consists of a combination of trickle charger and small "A" battery, so arranged that the battery is automatically placed on charge whenever the set is not in operation. Such a system is economical, reliable, and exceedingly satisfactory from an engineering point of view.

The other, or true "eliminator" method, is, in its present state of development, rather expensive and more difficult to adjust.

For economy, silent performance and reliability with a minimum of care, the system illustrated in Fig. 1 is recommended. The trickle charger may be of either the bulb or chemical types; or, if preferred, one of the combination outfits, in which the bat-

tery and trickle charger are enclosed within a single case, may be employed.

OPERATING THE SYSTEM

The first step to be taken in putting the De Luxe into operation after the various units have been connected together, as shown in Fig. 1, is to insert the various tubes in their proper sockets.

Although we have a set with but one stage of radio-frequency amplification, due to the use of special R.F. and detector tubes, of a regenerative detector circuit and of extremely low-loss coils and condensers, the receiver is exceedingly sensitive to weak signals from distant stations.

Thus, through the use of only a single stage of R.F., the cost of the set is reduced, the construction and operation simplified and, most important of all, the audio quality is not jeopardized by the cutting of sidebands, which takes place in many multi-stage radio-frequency amplifiers.

In the amplifier the tubes used are two high-mu, a 171, and a Raytheon "BH." as indicated in the illustration. Tubes of the 201A type should not be used, under any condition, in the amplifiers; as the grid-biasing voltage provided for the first two tubes is correct only for high-mu tubes.

With the tubes in place, loosen all three variable voltage controls on the amplifier, insert the cord from the relay switch into a base outlet or lamp socket and turn up the volume control on the panel of the set.

Next turn in the grid-bias control on the panel of the amplifier almost as far as it will go. Do not, however, turn it all the way. Then turn in the other two controls very slightly. A local broadcast station

(Continued on page 1472)

SYMBOL	Quantity	NAME OF PART	REMARKS	MANUFACTURER ★
RECEIVER				
L	1	Antenna Coil		1
L1	1	R. F. Transformer	With variable tickler coil	1
C	1	Var. condenser	0.0005 mf. Attached to coil L	1
C1	1	Var. condenser	0.00025 mf. Attached to coil L1	1
C2	1	Var. condenser	10 to 150 mmf. Midget type	2 17
C3	1	Grid condenser	0.00025 mf.	3 4, 5, 7, 18, 19, 20, 21, 22
C4	1	Fixed condenser	0.001 mf. By-pass	4 3, 5, 7, 18, 19, 20, 21, 22
R	1	Rheostat	10 ohms. Combined with fil. switch	5 23, 24
R1, R2	2	Fl. ballast Res.	5 v. 1/4 amp. With mountings	5 25, 27, 28
R3	1	Grid leak	5 megohms. With mounting	6 3, 4, 7, 18, 27, 28, 29
PH	1	Phasatrol	Stabilizing device	7
	2	Sockets	UX type	8 9, 25, 30, 31, 32
	6	Binding posts		9 17, 31
	1	Panel	7" X 18" X 3/16"	10 33, 34, 35, 36
	1	Sub-base	7" X 17" X 3/16"	10 33, 34, 35, 36
	2	Dials	Vernier, illuminated	1 37
		Hookup wire		11 38, 39
V	1	Tube	5 v. 1/4 amp. R.F. amplifier	12 40, 41, 42, 43
V1	1	Tube	5 v. 1/4 amp. Special detector	12 40, 41
AMPLIFIER and POWER UNIT				
	1	Power amplifier	Including socket-power unit	1
	1	Relay switch		13 23, 44
	1	Trickle Charger		14 15, 45, 46, 47, 48, 49
	1	Storage Battery	6 v., 40-60 ampere hours	15 14, 50
V2	1	Rectifier tube	Filamentless type	16
V3, V4	2	Tubes	5 v., 1/4 amp. High-mu	12 40, 41
V5	1	Tube	5 v., 1/4 amp. Power amplifier	12 40, 41, 42, 43
	roll	Connection wire		11 38, 39

NUMBERS IN LAST COLUMN REFER TO CODE NUMBERS BELOW.

1 The National Co.	2 Precise Mfg. Co.	3 Dubilier Condenser Corp.
4 Tobe-Deutschmann Co.	5 Carter Radio Co.	6 Arthur H. Lynch, Inc.
7 Electrad, Inc.	8 Airdgep Products Co.	9 H. H. Fby Mfg. Co.
10 Hicarte Fabricators, Inc.	11 Belden Mfg. Co.	12 C. F. Mfg. Co. (Gaco)
13 L. S. Braeh, Inc.	14 Testinhouse Elec. & Mfg. Co.	15 Electric Storage Battery Co.
16 Raytheon Mfg. Co.	17 K-L Radio Labs.	18 Aerovox Wireless Corp.
19 Wireless Specialty App. Co.	20 Potter Mfg. Co.	21 Sprague Specialty Co.
22 Sengano Elec. Co.	23 Yaxley Mfg. Co.	24 Central Radio Labs. (Centralab)
25 The Rediall Co. (Amperite)	26 Aiden Mfg. Co.	27 Daven Radio Corp.
28 Langbein & Kaufman Co. (Elkay)	29 International Pkg. Co. (Darham)	30 Silver-Marshall, Inc.
31 General Radio Co.	32 Benjamin Elec. Co.	33 Amer. Hard Rubber Co. (Radion)
34 Insulating Co. of Amer. (Inquiline)	35 Diamond State Fibre Co.	36 Formica Insulation Co.
37 Martin-Copeland Co. (Marco)	38 Acme Wire Co.	39 Cornish Wire Co.
40 Radio Corp. of Amer.	41 E. T. Cunningham, Inc.	42 The Van Hornes Co.
43 The Magnavox Co.	44 Jewell Elec. Inst. Co.	45 Pansteel Products Co.
46 Konite Corp.	47 Kodak Radio Corp.	48 General Elec. Co.
49 Valley Elec. Co.	50 Gould Storage Battery Co.	

★ THE FIGURES IN THE FIRST COLUMN OF MANUFACTURERS INDICATE THE MAKERS OF THE PARTS LISTED IN THE ORIGINAL EQUIPMENT DESCRIBED HERE.

If you use alternate parts instead of those listed in the first column of manufacturers, be careful to allow for any possible difference in size from those originally used in laying out and drilling the panel and sub-base.

generally takes the form known as "tagging" or "tail effect," in which the reproduced notes are not clear and clean-cut, but lag into each other or seem to have "tails."

The method of overcoming this condition is simple. It lies in the use of a power supply with better voltage-regulation characteristics, which, in turn, means greater power output. The obvious step in this direction is to the use of two of the tubes of the 316B type in a full-wave rectifier circuit, instead of the conventional half-wave circuit. An examination of the voltage-regulation characteristics of two of these tubes so connected indicates that the no-load output voltage will be about 750; falling, in proportion to the current drawn, to approximately 575 volts at 70 milliamperes, or a fall of 275 volts as compared to that of 550 volts over the same current range for the single tube. Considering such a power supply, the operating conditions with a 210-type amplifier tube would probably be a plate current of approximately 25 milliamperes, while a current of approximately 60 milliamperes would be drawn by the voltage-regulator tap and associated resistances supplying "B" potential to a receiver. Under this condition, the anticipated plate voltage upon the power tube would be approximately 420 to 440, with a 25- to 35-volt negative grid bias, although these conditions will vary slightly under particular operating conditions. Such a power pack, if the audio and output transformers be of good design, will give the quality of reproduction normally expected from a 210-type tube, but not obtainable where only a half-wave power-supply arrangement is used with one 316B-type tube.

PACK EASY TO BUILD

The power pack itself is illustrated in the half-tones, and the circuit is shown in Fig. 1. To the right is the power amplifier, comprising two transformers, one input (amplifying) and one output, designed to provide uniform amplification at all frequencies from 30 to approximately 5,000 cycles when operated in conjunction with the average receiver. Above the 5,000 cycles the audio amplifier cuts off rapidly, with resultant practical elimination of heterodyne

An under view of the power amplifier and socket-power unit. The parts are: C, C1, C2, low-voltage by-pass condensers; C3, C4, C5, high-voltage filter condensers; R1, filament resistor; R3, R4, fixed-resistance units; and R, "C"-voltage rheostat.

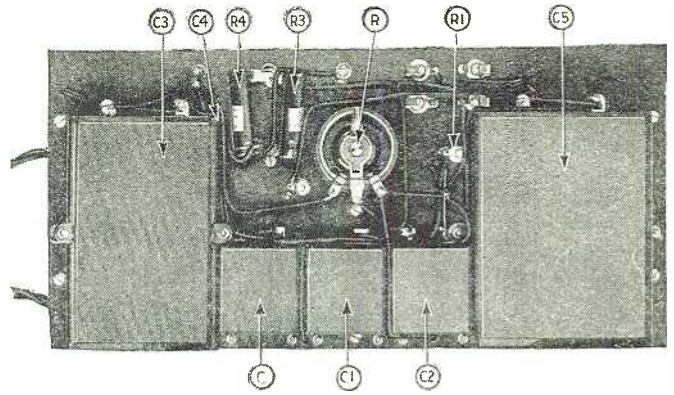

squeals, hissing, and a large portion of atmospheric noises heard in normal reception.

To the left of the output transformer, T4, will be seen the power tube, V3, in front of which are located the input and output tipjacks for the amplifier stage. At the rear of this tube is the voltage-regulator tube, V2. To the left of the unit are the two power transformers, T and T1, each provided with a 7.5-volt filament winding and a 600-volt secondary. Each 600-volt secondary supplies one of the rectifier tubes (V and V1) at the right of these power transformers; while one of the filament windings is used to light both tubes and the remaining filament winding lights the amplifier tube.

At the rear center of the assembly is the filter choke, T2, which incorporates a special selective feature designed to eliminate the 120-cycle fundamental hum to a greater extent than is possible with the usual two-choke, brute-force filters. In front of this choke is the 4,000-ohm resistor, R2, serving to reduce the maximum output of the eliminator to 90 volts, which is applied to the glow tube for receiver operation. The small knob adjusts the "C" bias of the amplifier tube and, indirectly, may be used to control the tone quality by accentuating either low or high notes when the amplifier is in operation. The three binding posts are for connection to a radio receiver to supply 45 and 90 volts.

EASY TO CONSTRUCT

The construction of this power pack is quite simple and well within the ability of the average fan, for only standard parts are used. The assembly itself is remarkably simple, for all parts are fastened to a single insulating panel.

To construct the pack, the parts should be placed upon the panel as shown in the illustrations, and the necessary mounting holes drilled; after which all parts may be fastened to the panel, using 1/2-inch 6/32 machine screws and nuts. In the case of the two condensers, C3 and C4, they must be held in place by 1-inch 6/32 machine screws beneath the power transformers; they are held together by means of the mounting screws running through their pierced lugs. Under the right-hand end of the sub-base, the 4-mf. condenser, C5, is placed, while at the rear are the three 1-mf. condensers, C, C1 and C2. Beneath the socket for the power tube, the 200-ohm resistor, R1, is mounted.

The wiring of the power pack is very simple. It should be done with insulated hook-up wire, which is extremely simple to manipulate, and, being tinned, facilitates soldering.

BALANCING RESISTOR CENTER-TAPPED

The 200-ohm resistor, R1, will be found to have no center tap and, in order to provide one, a wire should be soldered to the winding at the approximate physical center, the exact position, be it a few turns either way, having little effect on the operation of the receiver.

The 4,000-ohm resistor, R2, is mounted upright upon the base and can be seen just in front and at the left of the filter choke. It is held to the base by means of a long brass rod, both ends of which are threaded to take mounting nuts. This resistor should be placed so that air may circulate on all sides of it, for it becomes so hot in operation as to cause slight burns if touched.

OPERATION REMARKABLY SIMPLE

In connecting the power pack for operation, there is only one point in which caution should be observed. This has to do with correct polarity of the primaries of the power transformers, so that the operation of the power-supply device will be as a full-wave rectifier rather than as a half-wave rectifier. This can most easily be accomplished by connecting the whole unit up, inserting the glow tube, and putting the two plugs, attached to the cords of the transformer, in home-lighting sockets. If these plugs are reversed, it will be noticed that the glow tube will glow more brilliantly with one arrangement than with the other, and care should be taken to see that the two cords are joined together to provide the connection which gives the greatest brilliancy for the glow tube. If a milliammeter, 0-50 scale, is handy, it may be connected between the plate of the power am-

(Continued on page 1487)

SYMBOL	Quantity	NAME OF PART	REMARKS	MANUFACTURER *
T, T1	2	Power transformers	7.5 v. fil. winding 700 v. sec.	1
T2	1	Filter choke	For filter circuit	1
T3	1	A.F. trans.	3 to 1 ratio	1 8,9,10,11,12,13,14,15
T4	1	Output transformer	1 to 1 ratio	1 9,11,14
C, C1, C2	3	Fixed condensers	1 mf. 400 v. D.C. rating	2 16,17,18,19,20,21,22,36
C3	1	Fixed condenser	1 mf. 1000 v. D.C. rating	2 16,17,18,19,20,21,22,36
C4	1	Fixed condenser	2 mf. 1000 v. D.C. rating	2 16,17,18,19,20,21,22,36
C5	1	Fixed condenser	4 mf. 1000 v. D.C. rating	2 16,17,18,19,20,21,22,36
R	1	Rheostat	1000 ohms	3 37
R1	1	Fixed res.	200 ohms. Wire wound	3 23,24
R2	1	Fixed res.	4000 ohms. Wire wound	4
R3	1	Fixed res.	3500 ohms. Wire wound	4
R4	1	Fixed res.	5000 ohms. Wire wound	4
	4	Tip jacks		3 23
	4	Sockets	UX type	1 5,10,11,13,14,25,26,27,28,29
	3	Binding posts		5 1,11,25,30
	1	Panel	7 X 14 X 3/16"	6 31,32,33,34
V, V1	2	Rectifier tubes	Emission type	7 35
V2	1	Glow tube	Voltage regulator type	7 35
V3	1	Tube	Power amplifier 7.5 v. fil.	7 35

NUMBERS IN LAST COLUMN REFER TO CODE NUMBERS BELOW.

1 Silver-Marshall, Inc.	2 Sangamo Electric Co.	3 Taxley Mfg. Co.
4 Ward Leonard Elec. Co.	5 H. H. Fby Mfg. Co.	6 Insulating Co. of Amer. (Insuline)
7 E. S. Cunningham, Inc.	8 Amer. Trans. Co. (Amertran)	9 Sencor Electric Co.
10 Brown-Rully Mfg. Co.	11 General Radio Co.	12 Thorndson Elec. Mfg. Co.
13 All-American Radio Corp.	14 Patent Electric Co.	15 Ferranti, Inc.
16 Tobe-Dutschmann Co.	17 Dubilier Condenser Co.	18 Wireless Spec. App. Co. (Paradon)
19 Aerovox Wireless Corp.	20 Potter Mfg. Co.	21 Polymet Mfg. Co.
22 Electrode, Inc.	23 Carter Radio Co.	24 Leslie F. Muter Co.
25 Amco Products, Inc.	26 Benjamin Electric Co.	27 Alden Mfg. Co.
28 Gray & Danielson (Resler)	29 Airgrip Products Co.	30 X-L Radio Labs.
31 Amer. Hard Rubber Co. (Radion)	32 The Caloron Co.	33 Micarta Fabricators, Inc.
34 Formica Insulation Co.	35 Radio Corp. of America	36 Micomold Radio Corp.
37 Allen-Bradley Company		

* THE FIGURES IN THE FIRST COLUMN OF MANUFACTURERS INDICATE THE MAKERS OF THE PARTS USED IN THE ORIGINAL EQUIPMENT DESCRIBED HERE.

If you use alternate parts instead of those listed in the first column of manufacturers, be careful to allow for any possible difference in size from those originally used in laying out and drilling the panel and sub-base.

Easy Construction for the "Ham"

Constructional Details and Operating "Dope" for An Inexpensive Transmitting Outfit

By JOHN L. REINARTZ



JOHN L. REINARTZ

THIS is the first of a series of five articles by Mr. Reinartz, who needs no introduction to radio amateurs. In the May issue of RADIO NEWS appeared an interview with Mr. Reinartz, in which he gave some valuable hints for hams and outlined what this series is to cover.

The transmitter which is here described is a duplicate of the one which Mr. Reinartz used when he went to Greenland with the MacMillan Expedition in 1925. While at Etah, Greenland, communication was established with amateurs throughout the United States and Europe; so that, if this transmitter is constructed according to directions, it has almost unlimited possibilities. In the July issue of RADIO NEWS will be described the Reinartz short-wave receiver, with full constructional details.

—EDITOR.

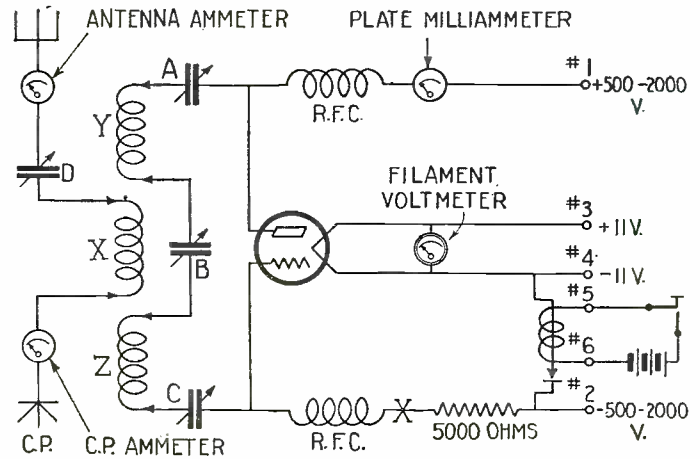

FIG. 1. The complete schematic diagram of Mr. Reinartz's transmitter. This circuit is adaptable to any size of tube, from 5 watts up, and requires no alteration in any case.

MUCH has been written and said about the many different varieties of thrills that one can get in this day and age. Some folks get theirs by going to a ball game; others find the most enjoyment in attending the theatre; but one of the greatest kicks possible is to be had by sitting down at a table in your room, pressing a key and knowing that the energy you are releasing will be caught and interpreted by someone thousands of miles distant.

Many fellows have said that the "thrill that comes once in a lifetime" to them was on the night when they, for the first time, had worked a fellow-ham across the ocean. And they are quite right. It should give them the greatest possible satisfaction to know that the transmitter they have worked, prayed—and perhaps sworn—over is working and working right.

A transmitter which is capable of giving such satisfaction is the one described in this article. First of all, the circuit which is employed is simple and at the same time efficient; the construction as may be seen from the illustrations, is far from difficult or expensive; and it is a transmitter that has smashed records.

MECHANICAL CONSTRUCTION

Let us first consider the construction of the wooden frame of the transmitter. Two pieces of wood, 24 inches long and 1 1/4 inches square, form the side supports upon which are fastened the cross pieces that carry the condensers, meters, inductances, etc. Three of these cross-pieces are required, their dimensions being 16x4x1/4 inches. Two wooden feet of 1 1/4-inch wood are prepared and shaped as shown in Fig. 2. The shelf indicated in Fig. 3 (for use for 5- or 50-watt tubes) is 13 1/2x3 3/4x1/4 inches. If a 250-watt tube is to be used then it will be necessary to have the two wooden blocks on which are placed the clamps for the tube. Two 1/4-inch wooden dowel pins, 3 3/4 inches long, are needed for the radio-frequency chokes.

First the three cross-pieces are fastened in position on the two 1 1/4-inch uprights, which are then fitted to the two feet. The four clamps, on which rest glass towel rods for supporting the coils, X, Y and Z, are screwed on just above the middle cross-piece. In the lower cross-piece between the two meters are mounted the six binding posts; the four condensers and the four meters are then mounted as shown.

The resistor, in the grid circuit of the tube, and the relay are not attached to the

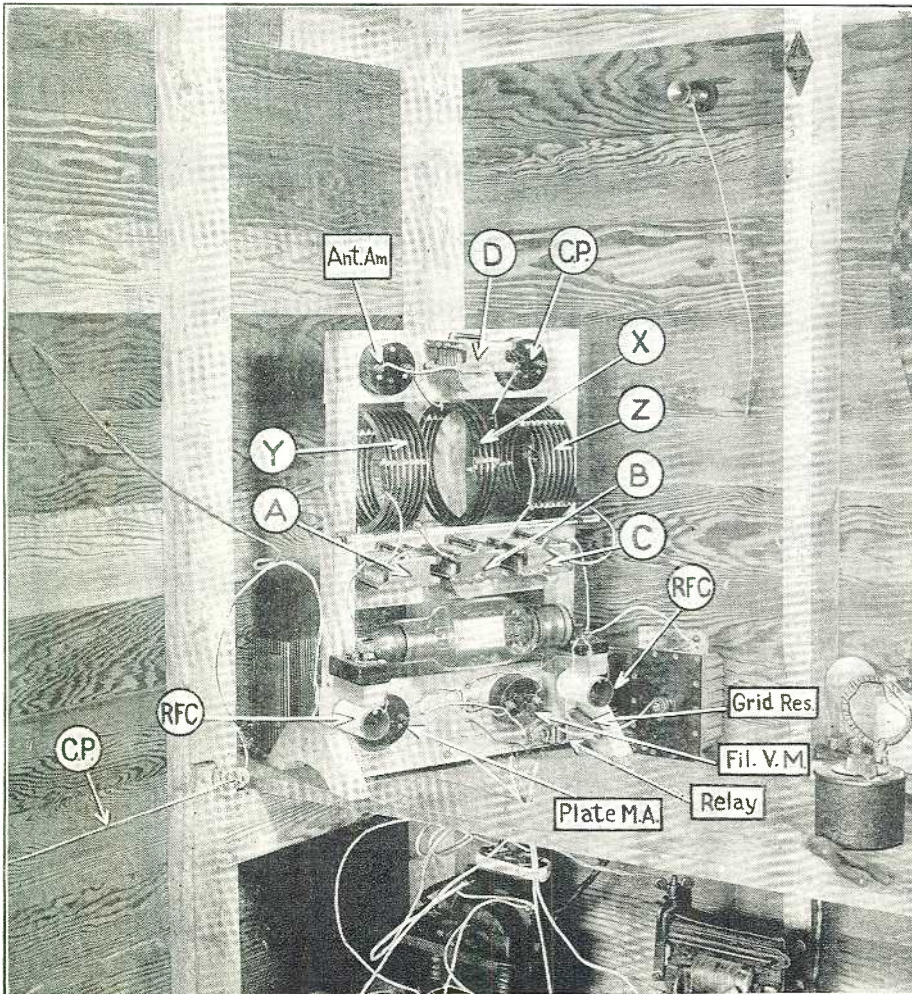

A rear view of Mr. Reinartz's transmitter. RFC are the radio-frequency chokes; A is the plate variable condenser; B, the primary tuning condenser; C, the grid variable condenser; D, the secondary tuning condenser; X, secondary inductance; Y, plate inductance; Z, grid inductance and C.P. (above) the counterpoise ammeter.

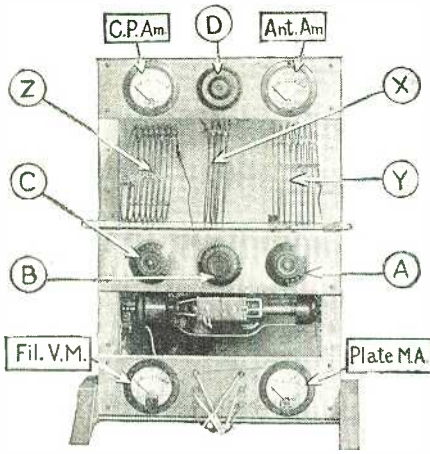

A front view of the transmitter panel. The parts are lettered just as in the other illustrations.

wooden frame but supported by the connecting wires. The radio-frequency chokes, RFC, are wound of No. 24 D.C.C. wire on an insulating tube 2 inches in diameter and 3½ inches long. These tubes are wound to within ⅛ of an inch of the ends, making about 70 turns.

The inductance coils, X, Y and Z, are of ⅜-inch copper ribbon 7 inches in diameter and wound edgewise. The turns are spaced ¼-inch and held in position by means of glass beads tied between them. The number of turns depends, of course, upon the wavelength on which it is desired to operate. If all the turns on the coils are not used there are dead-end capacity effects, which should be eliminated in order to get the lowest tuning in the primary circuit. It should be decided on what wavelength it is desired to operate and suitable coils should be obtained according to the following table:

Wavelength Meters	Coil X Turns	Coil Y Turns	Coil Z Turns
20	4	4	4
40	4	8	8
80	8	16	16

The same variable condensers, having a capacity of 250-mmf., are used in each case.

As may be seen from the illustrations, the three coils are mounted on the glass towel racks, which are supported by the clamps on the two 1¼-inch uprights. This distance between them is ample to keep them in position. Connections are made to these coils by means of clips—indicated by arrows in the schematic diagram—so that the coils can be easily changed in case another wavelength is to be used.

The tube to be employed depends entirely on the constructor and his pocketbook. Needless to say, when the higher power tubes are used it is more costly; and it is far better to have a low-power outfit and have good apparatus than to try to make cheap things perform in a manner of which they are incapable. If the constructor will follow the directions given by the manufacturer, in regards to the voltages, currents and grid leak to be employed with the type of tube he buys, he should get good results.

OPERATION

It is extremely important, for the best results, that the antenna-meter side of the antenna coil, X, be placed next to the inductance, Y, in the plate circuit. By connecting the antenna in this manner harmonics are eliminated and sharp tuning results. The secondary tuning condenser, D, must be between the antenna meter and the point at which the antenna is connected to the set. The output meters should be carefully connected in the same relative positions in the circuit, i.e., the antenna meter should be between the antenna and the condenser, not between the condenser and the coil X.

The circuit will oscillate with minimum plate input current when no secondary circuit exists. The grid condenser, C, should then be adjusted for lowest plate input, the plate condenser, A, not being so critical. The primary tuning condenser, B, serves only as a frequency changer and its range is greater than any one of the amateur wavelength bands, i.e., 20, 40 and 80 meters.

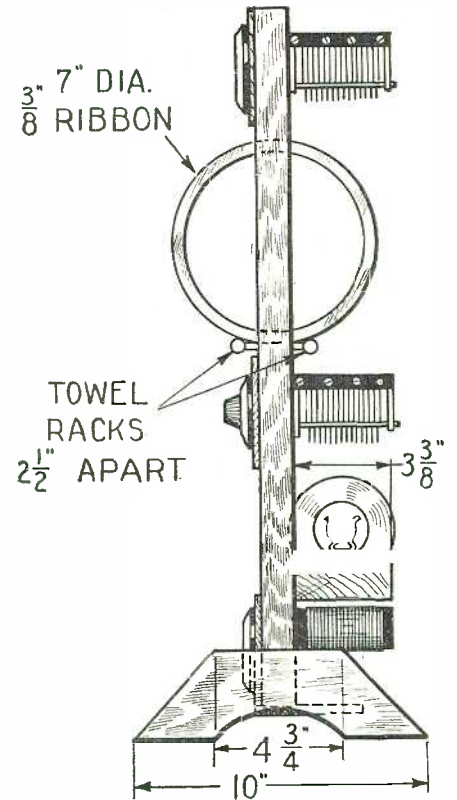

Fig. 2. Side elevation of the transmitter panel.

When the output circuit is connected, tuning for resonance is accomplished by means of the antenna condenser, D, if the primary, or oscillating circuit frequency has already been determined. Otherwise the "happen-chance" frequency is changed to suit the operator.

In order to obtain balanced output readings in the two radio-frequency meters,

(Continued on page 1497)

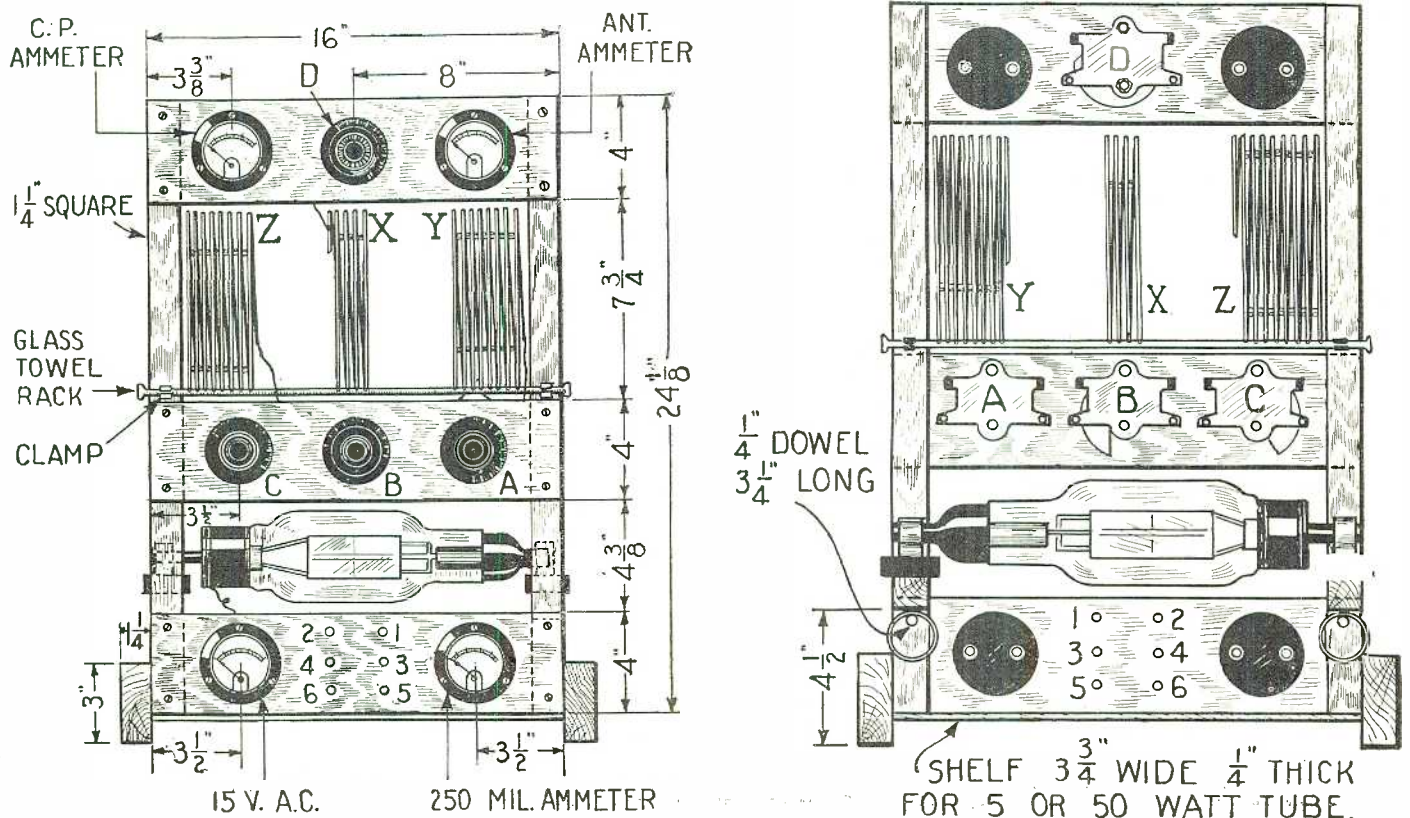

Fig. 3. Layout and constructional details of the complete transmitter as shown in the illustrations; front view at the left and rear view at the right. The entire framework is made of wood. The inductances X, Y and Z are mounted on heavy glass rods.



Letters from Home Set Constructors



OUT OF THE WORK BOX

Editor, RADIO NEWS:

As a regular reader of RADIO NEWS, I congratulate you on having the magazine which certainly has the widest usefulness for the fan, as well as for the non-technical reader. I desire to offer a suggestion which I believe will make your magazine still more popular, and won't really hurt your advertisers, though at first glance some of them might get that idea.

Here's the notion: All the circuits you offer now don't help much in utilizing apparatus we may already have; and if you invited your readers to give you lists of what they have, then select the most promising ones and help us to combine them with later apparatus into efficient sets, you'd make a ten-strike, and help sell new units that otherwise would not be bought.

To build a complete new set every year or so is beyond the means of many of your readers, I fancy, especially those of us who have learned never to buy anything but the best—so that while we learn much from your new blue-print sets, my suggestion as a side-line would fill a real need.

I might say that, after trying every method of wiring, I have found that insulated soft-copper bell-wire at one cent a foot, retail, with as few soldered joints as possible, using partial sub-panel wiring, gives far superior results to any other method or material I have tried. Lacking copper, I have used tea-chest tinfoil, pasted on wood or cardboard, for shielding.

I adopted your wrinkle of using a tube socket and base for battery connections but went it one better and used two bases, putting the two "A" leads in a cable in one base, three "B" in the other, using two sockets for receptacles. It is a neat and convenient disposal of the five leads, and so convenient I'd hate to be without it.

JOHN L. NEATE,
2949 Albina Street, Victoria, B. C.

(Our correspondent's suggestion is interesting, but hardly practical; as the contents of the work boxes of our readers differ too widely for us to prepare individual diagrams with "proper placements, wiring and shielding" in each case. In the new RADIO NEWS blueprint articles, lists of alternates are given, as extensively as possible, which will add to the convenience of the constructor who has material already on hand; but, in view of the fact that RADIO NEWS has a third of a million purchasers, it is impossible to provide for the utilization of each individual stock of parts. Substitution by the builder is apt to require personal experimentation by him. Our "I Want to Know" department is, however, often able to prescribe for individual cases; it is necessary, by reason of the diversity of problems submitted, to make a nominal service charge for this work.—EDITOR.)

WISHES OPTIONAL R.F. STAGES

Editor, RADIO NEWS:

I am an old radio fan; I think I can say so, as I still have the first issue of RADIO NEWS, and in fact, many volumes of the *Electrical Experimenter*. As I read and re-read every issue of the former, I wish to compliment you on the recent change in policy, which I think is one of the greatest improvements seen in a long time.

I would like to pass along an idea: when using the regulation set for nearby stations, because you are fond of the good old box of parts, or else the average 5- or 6-tube set better fits the pocketbook, it sometimes will not reach those far-off stations you see scheduled. Hence the desire for a compact R.F. unit—the one I have in mind is pictured by Fig. 2 on page 641 of RADIO NEWS for December, but of course modified to some extent—which is not used on locals or the powerful stations. It would have only one control; when pointer reads "local" the output of the tuned-R.F. amplifier goes into the detector. Then for distance we turn our pointer to "DX," which throws switch and causes output of tuned-R.F. tubes to go through our distance unit, giving several stages of additional R.F. amplification. All four tubes in this unit could be connected in series (WD- or WX-12), or four 199 tubes connected in series parallel would use very little current and additional space, while a 6-volt battery could be used without rheostat.

Without much change we could thus add to our present set a unit which gives us more power and does not add complicated tuning controls. If such a unit were on the market, I would buy a little deeper cabinet or one with battery compartments at the side, in which I could place this unit. I have no "lab." but do have occasional ideas. Perhaps someone else may be interested in this; for I enjoy the ideas of others as they appear in RADIO NEWS.

A. W. SHEWMAN, M. D.
Philadelphia General Hospital, Philadelphia, Pa.

APPRECIATES LAYOUT DATA

Editor, RADIO NEWS:

I am enclosing another year's subscription, and I thought it might interest you to know that I think your plan of giving the names of the manufacturers of parts, the distances that the parts should be spaced, and the specifications of coil construction, is very helpful. One building a set and not know-

ing the proper placement sometimes puts the parts too close together or makes the leads too long; and of course you know the result. At least, that was my experience when I first began set building; and though I started several years ago, a few simple facts that are published in RADIO NEWS help me yet. I also think it is a good plan for the editor to give the results of any new circuit that is published; I always like to know whether it will pay to change to a new circuit, and when you give your experience, one can almost tell whether he is using as good a circuit or not.

A. L. TRUEBLOOD,
Inwood, Illinois

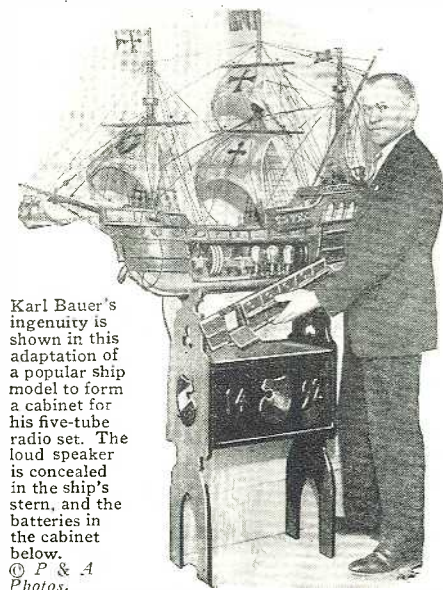

Karl Bauer's ingenuity is shown in this adaptation of a popular ship model to form a cabinet for his five-tube radio set. The loud speaker is concealed in the ship's stern, and the batteries in the cabinet below. © P & A Photos.

AN UNUSUAL COMBINATION

Editor, RADIO NEWS:

If it will help any, I will contribute my method of "sharpening" the tuning of a regenerative three-circuit tuner of my own design—in which I am now using your interflex idea, substituting a crystal in place of a grid-leak, with midget variable seven-plate condenser for balancing. I am using an antenna somewhere between 300 and 400 feet—almost the length of the block I live in—but this is, primarily, to get loud-speaker volume on my "pure and simple" crystal set. Most of the time I listen to the locals on this crystal set which brings them in about as loud as an ordinary two-tube combination with one stage of audio amplification.

You will notice that I show the sliding tickler (instead of feeding back direct into the first, [top] secondary, as is the usual way), feeding into the second secondary first, then—as I presume)—both being only 3/4 inch from first secondary, there may be a feed-back of increased audio-frequency energy from the coupled tickler and second secondary back to the first secondary, for I get increased volume on DX as well as on locals with this stunt.

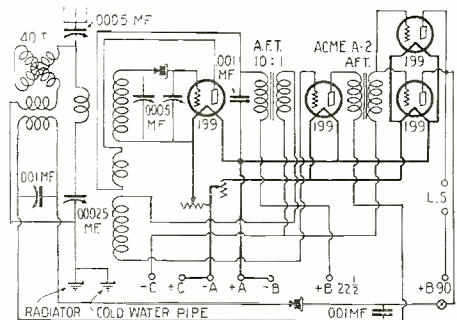

This seemingly-complex combination is really two sets; a simple crystal receiver and a four tube combination based on the Interflex principle. The maker calls it "a freak, junk set, with no soldered connections."

Although the second secondary is hooked up in the manner of a reflexing radio-frequency stage, there may not be any such thing as reflex about it—I use the term reflex only because it is hooked up after that manner. Possibly this will make it more clear. I have eliminated the

second secondary with feed-back to first secondary, and made it the usual three-circuit regenerator hook-up; and have come back to this arrangement as more satisfactory. The tuned primary is used only because I have so long an aerial to make the crystal circuit work independently on my loud speaker for locals.

As shown here, the tube set may be switched off, leaving the crystal set to work alone, or the tube set may be switched on and crystal set switched off, or they may both be used together, but to no advantage. I have two secondaries wound on one piece of tubing, same size, an inch apart, primary and tickler on separate larger tubing to let them slide up or down outside of both secondaries. I seem to get some advantage from reflexing second tube via lower secondary and first audio to "C" battery.

GIBBS MASON,
97A Newbury St., Boston, Mass.

(Mr. Mason's hypothesis that A.F. energy is fed back through the R.F. transformer seems difficult to accept; yet his experience is that this connection seems to improve reception. The experimenter who is not afraid to try something different often obtains excellent results.—EDITOR.)

UNIVERSAL ALL-CIRCUIT SET

Editor, RADIO NEWS:

I believe you will be interested in knowing the results obtained from a 5-tube T. R. F. set built from data obtained from the article in December RADIO NEWS, by Joseph Riley. I have made up this set using Pilot parts contained in the Pilot Universal kit, except that I have used Kelford rheostats, Patent jacks, and one Volutrone transformer 5:1 and one Kelford transformer 3:1. I also used 3/4-inch birch veneer panels with two coats of Pratt & Lambert's No. 61 black lacquer instead of rubber panels. All parts were purchased at Kresge's or Grant's dollar stores here, except three Cunningham tubes used as R.F. and detector; the audio tubes were purchased at Kresge's at 89 cents each.

In building this set, instead of one single and one two-gang condensers, I used three single 17-plate condensers, as I had these on hand. This set was completed on New Year's day. After correcting trouble due to contact in the sockets, the stations came rolling in in dandy shape. There is some interference between stations, which is also present in expensive factory-built sets; otherwise this set is a complete success.

Stations received to date are as follows: KDKA, KFAB, KFKB, KFNF, KFRU, KLDS, KMA, KMMJ, KMOX, KOA, KOIL, KPRC, KSD, KSO, KTHS, KVOO, KYW, PHX, WAAW, WBBM, WCCO, WDAF, WDAF, WDDO, WDEO, WBEH, WENR, WFAA, WGH, WGN, WGY, WHBB, WHO, WHT, WJAZ, WJAX, WJJD, WKRC, WLLB, WLW, WOAI, WOC, WOK, WOQ, WORS, WRR, WSAI, WSB, WSBC, WSM, WSMB, and last but not least, the new G. E. station at Mexico City, CYJ. This looks like a transcript of my log book, but there are many blank spaces I expect to fill yet. I will say further that I am using 199 tubes. Thanks for the assistance received from your article.

P. G. MATHIS,
3402 Remick St., St. Joseph, Mo.

ONE-TUBE LOOP RECEIVER

Editor, RADIO NEWS:

Dear Sir—I am writing to tell you of the remarkable results I have been getting with a one-tube loop set that I built from the diagram of a combined receiver and transmitter, for use with a loop. I found this in the "Standard Hook-Ups" section of your magazine in the July, 1926, issue.

I have received the following stations: KOA, WBBM, WLW, WOC, KMOX, WGN, WOAV, WOI, WHO, WORD, KFAB, WSM, KSO, and many others. Using UV-199 tubes, with about 12-15 "B" voltage, and a four-foot loop.

I want to congratulate you on your magazine. It is the best in the country. I would like to see you print the diagram of another good one-tube loop set.

MERRILL SMITH,
Tallman Building, Ames, Iowa

A VICTOREEN ENTHUSIAST

Editor, RADIO NEWS:

I must say that I beg to differ with Mr. E. A. Schnell, whose letter appears on page 992 of your February issue. I will agree with him that the Tropadyne is the best set that can be procured, tube for tube, because I built one myself when they first came out, and used it one year before making a change.

But the best radio set, bar none—whether it cost \$200 or \$2,000—is a nine-tube superheterodyne using the Victoreen essential kit and three stages of Melloformer A.F. amplification. Use two jacks on the panel, one double-circuit and one filament-control single-circuit. Put in a Cutler-Hammer Variophon (200,000) on the panel and shunt it across the secondary of your last audio transformer. Use a 200A tube for your first detector and a 201A for your second, with a 4 1/2-volt grid bias instead of the usual grid leak and condenser. Don't use the

Victoreen master-control unit, but use two separate, high-grade variable condensers.

Anyone who follows these directions will have a radio set that is absolutely the best in regard to selectivity, tone, quality, DX and volume. A power tube, of course, is absolutely necessary in the last stage; use 135 volts on the plate. Hook the set to a 50-foot aerial and plug in a Windsor cone speaker.

The selectivity of this set is the best I have seen or heard tell of. WGY is on 379.5 meters, KJR is 384.4, WTAM 389.4 and KIIQ 394.5. I can separate these stations and bring any one of them in with volume if weather conditions permit or there is not a loud heterodyne. An ordinary heterodyne howl can be kept in the background. It is necessary to use vernier dials; I use Pilot and find the stations mentioned tune in and out on half a degree dial reading.

I consider a real DX test one that is made at noon, or early in the afternoon. I have received KDKA with fair volume, WMC, WJIO, KYW, WDAF, WGY and all stations within that radius of West Frankfort with good volume between noon and 3:00 p. m.

Anyone who wants a set that is really a performer will please hook up the one described—and if you don't get the results I did, I'll build one for you that will.

DAN KENNEDY, West Frankfort, Illinois

When I had made the connections shown in Fig. 1, the detector was adjusted until a rushing noise like static was heard in the phones. Just then I

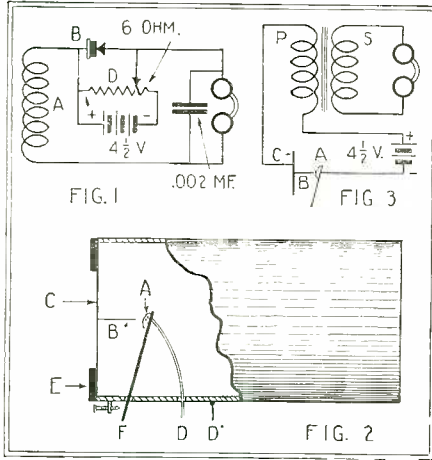

"Singing Crystal" hook-ups; Fig. 1, as microphone; Fig. 3, as reproducer. The adjustments are very critical. Fig. 2 is a section of the apparatus; A, galena crystal; B, needle; C, tin diaphragm; D, lead to crystal; D', lead to metal can; F, hard-rubber support.

dropped a screwdriver and a ringing sound was heard. I saw that the crystal was acting as a microphone and thought I would see if it were possible to make it reproduce speech. I constructed a rule "mike" out of tin cans, with a circular piece of tin for a diaphragm, as shown in Fig. 2. This was connected in series with the ground connection of my three-tube receiver, which was then tuned till a rushing sound was heard. I spoke into the microphone and my voice and that of people talking twenty feet away came out of the speaker with great volume.

The next step was to connect it to the output of the receiver and adjust the pressure on the needle again. To my surprise, I could tune in stations and hear the speech very clearly. The lighter the pressure, the greater the volume.

After trial of several sizes, I find a three-inch diaphragm gives the best results. It is made from the bottom of a tin can, with an ordinary sewing needle soldered to it, and is held firmly to the metal frame by a metal ring. The crystal was of ordinary galena; several of the same type have been tried with the same results.

It was connected as shown in the circuit diagram (Fig. 3) and after many adjustments began producing a low singing hum. I thought at first this came from the phones, but found it to be coming from the diaphragm. The adjustment was very critical and sometimes it was impossible to find the sensitive spot. I have, however, been able to keep it singing five minutes at a time.

I hope this line of investigation may turn out of practical value. Perhaps some one is working on it to this end.

D. HERBERT RAKES, RFD 4, Bentonville, Arkansas.

CRYSTAL EXPERIMENTS

Editor, RADIO NEWS:

After reading the article, "The Singing Crystal," in RADIO NEWS for January, I decided to do some experimenting; but not having zincite, used crystals of the galena type which I had on hand.

LIST OF BROADCAST STATIONS IN THE UNITED STATES

(Continued from page 1434)

Table listing broadcast stations in the United States with columns for Radio Call Letter, Broadcast STA. Location, Wave (Meters), Power (Watts), and Wave (Meters), Power (Watts).

*Standard or constant frequency. †Location of transmitter only.

LIST OF CANADIAN BROADCAST STATION CALLS

Table listing Canadian broadcast station calls with columns for Call Letter, Location, Wave (Meters), Power (Watts), and Call Letter, Location, Wave (Meters), Power (Watts).



STOP-PINS FOR DIALS

Many of the older makes of variable condensers did not have stops built into them; so that they may be turned so far that the blank edge of the dial comes opposite the indicating mark on the panel, and the dial setting cannot be read without retuning the condenser. By cutting away the blank edge of the dial to a depth of about 3/8 inch, and leaving only the engraved edge (as shown in the illustration) a stop-pin can be used, which will prevent the dial from getting turned too far. The

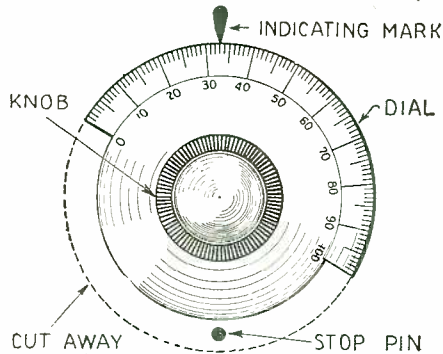

The dial thus cut down prevents turning the condenser plates too far.

stop-pin should be driven into the panel on exactly the opposite side of the dial from the indicating mark on the panel. This stunt works particularly well with the old type of Remler dials, because they are of bakelite and cut very easily.

A stop-pin can be made out of a brass escutcheon pin with the head cut off. A hole which will just fit the pin snugly can be drilled into the panel opposite the indicating mark, and the escutcheon pin coated with glue and forced into the hole. It should be allowed to project about 3/8 inch, and the top should be rounded.

Contributed by Charles F. Felstead, 6CU.

AN ANTENNA-CHANGING SWITCH

It is quite common to insert a fixed condenser in series with the antenna, to reduce spread over the dial of nearby broadcast stations and enable tuning-in other stations

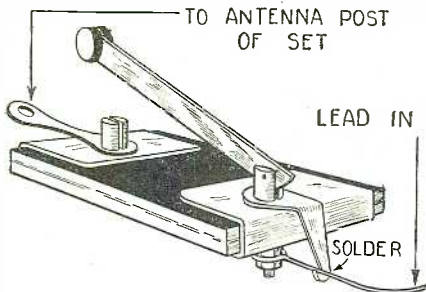

This wrinkle will be found an inexpensive and handy one for changing the electrical length of the aerial.

on that portion of the dial. In some instances this causes reduction of volume, but is absolutely necessary if other stations are to be properly heard. Then there are times when the interfering station is not broadcasting, or it is desired to listen to stations on

other portions of the dial where there is no interference, and a direct antenna connection is wanted to secure maximum volume. This wrinkle enables the set operator to throw in direct connection or utilize the condenser by simply throwing the switch shut or open. It is constructed from the working parts of a miniature single-throw switch (costing 15 cents) which are mounted on the condenser proper, discarding the base of the switch.

Contributed by Edw. C. Delsing.

REMOTELY-CONTROLLED RECEIVER

For various reasons—some of which are well known to experimenters who have younger brothers and sisters—it has been the custom of many fans to keep the radio equipment in an up-stairs room where no harm can come to it. Then there is always inconvenience to the rest of the family because they have to go up-stairs to listen to the music.

This problem was easily overcome by using the plan suggested in the accompanying illustration. The receiver is tuned to a program and the switch SW is placed in the "off" position. As long as the down-stairs speaker is plugged-in the set on the floor above remains in operation. However, if the plug is removed from the jack, this automatically turns off the set.

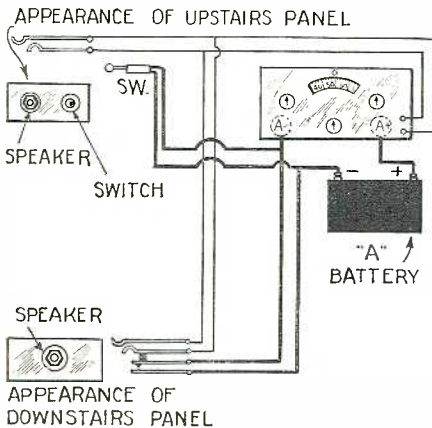

Connecting the set to speakers up and down stairs thus will be a great convenience for the family.

If the loud speaker up-stairs is wanted, and the one below is not in use, then SW must be in the "on" position. Even if both speakers are in use the switch has no effect on the functioning.

The materials needed are: two small bakelite panels, about 3x5 inches, one single-circuit jack, one single-circuit filament-control jack, and one filament switch.

Contributed by Nathan H. Silverman.

AN INEXPENSIVE CABLE PLUG

All that is needed to make this "plug" is a piece of wire. There comes a time in every fan's life when he wants to disconnect his set from the batteries. If he does not have a cable plug—and the majority of sets are not so equipped—he must first disconnect the cable from the batteries and then from the set. If the wires are removed from the set first, they may touch each other and cause a short-circuit.

To disconnect the set quickly, the lugs on the cable must be attached in some way, so that all may be removed at the same time and yet not come in contact with one another. This can be done with a piece of bell-wire.

While the lugs are yet connected to the binding posts, twist the wire two or three times around a lug, then stretch the wire to the next lug and again twist two or three

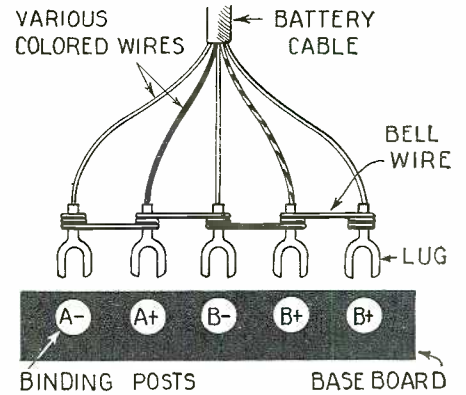

This "cable plug" is quickly made. The wire used must be fairly stiff and well insulated.

times and so on till all the lugs are connected to each other. The bell-wire will keep the lugs apart and all lugs can be taken off at the same time by simply loosening or tightening the binding posts. The only precautions to be observed are to see that the wire is stretched tightly and that it is thoroughly insulated.

Contributed by Edwin Boeger.

QUIETING NOISY TUBES

Coating radio vacuum tubes with paraffin is an easy method of silencing microphonic noises and other disturbances to which some are subject. To shield tubes by this method it is necessary only to heat a little paraffin, bringing it to a liquid state. Pour it immediately into a small jelly glass, filling the glass to a depth of about two inches. Hold the tube to be coated by the base and insert

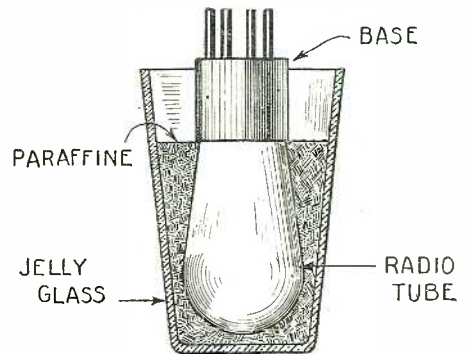

A simple remedy for making noisy tubes less responsive to vibration.

it upside down into the glass. The displacement will cause the paraffin to rise, thoroughly coating the surface of the glass. Care should be taken not to allow the paraffin to rise beyond the top of the base. Withdraw the tube and allow any drops to

(Continued on page 1497)



CHEAP AT DOUBLE THE PRICE

Big-hearted gesture mentioned in the St. Louis Dispatch of Feb. 20: "See our line of Grebe Radios, offered in both table and console models, priced from \$000 to \$000." Will all you gents who would like a new set kindly form in line on the right, and don't crowd? They're certainly cheap enough.

Contributed by M. G. Moseley.

THEY CRY FOR IT

Ultra-smooth advertisement in the Kansas City Star of Feb. 27: "In our 32 page booklet the CHOKE OIL-condenser coupling and many other uses of fixed condensers are fully explained." Believe us when we tell you that we sent for one of those books. We want to know all the uses for choke oil.

Contributed by Lawrence Davis.



A SHOCKING ELIMINATOR



From the Jan. 30 issue of the Lincoln, Nebraska, State Journal we glean this advertisement: "Serbend B eliminators, 90 volts HAN-DLES, 5 tubes or less, \$12.50." Not for us, folks. We sure want to steer clear of anything like that around the house. Every time you pick up the thing we suppose that you get 90 volts up your arms. No thanks!

Contributed by A. L. Henriksen.

FOR THE GREAT OPEN SPACES



On Feb. 18, in the Nashville Banner, appeared an advertisement telling about antenna equipment. "Antenna outfits complete with 100-FOOT AERIAL INSULATORS..." That's what we call husky insulators. Of course you would need a 100-acre lot to string up such an antenna, but a little thing like that isn't important.

Contributed by J. M. Whitus.

HOW COME?

Strange occurrence reported in the San Francisco Chronicle of Feb. 27: "CELLO" injured by Battery Overcharge." Now this is what comes of trying to tune a musical instrument with a battery charger. If it had been a mandolin, which has steel strings, we wouldn't think much of it; but a cello. We give up!



Contributed by E. H. Blanchard, 6BZZ.

LATEST SURGICAL ACHIEVEMENT

In Radio News magazine for March, a step forward in medical circles was announced. "The incomparable radio tube that OPERATES ON LOUD SPEAKER." Of course this spells disaster for the surgeons, but remember this is an age of science. Have the adenoids removed from your faithful speaker by this clever tube.

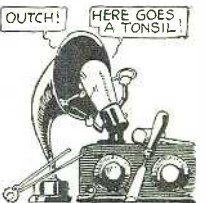

Contributed by R. F. Duncan.

A CATFISH, PERHAPS

Feline touch given to an advertisement in the Detroit Sunday News of Jan. 16: "Karas Condensers, Transformers and Aquematic KATS, 40% off." Of course, we don't know if this is a case for the S.P. C.A. as the pussies are mentioned as being abbreviated 40%. By the way, just what is an aquematic cat?

Contributed by W. G. Mortimer.



IF you happen to see any humorous misprints in the press we shall be glad to have you clip them out and send to us. No RADIOTIC will be accepted unless the printed original giving the name of the newspaper or magazine is submitted with date and page on which it appeared. We will pay \$1.00 for each RADIOTIC accepted and printed here. A few humorous lines from each correspondent should accompany each RADIOTIC. The most humorous ones will be printed. Address all RADIOTICS to

Editor RADIOTIC DEPARTMENT, c/o Radio News.

SAY IT WITH FLOWERS

The florist has entered the radio field, as seen in the Chicago Evening American of Mar. 11: "Regeneration is obtained by means of a feed-back SOIL with TUNING condenser." This feed-back soil is great stuff, but what we want to know is what kind of dirt is this? Details will be appreciated.

Contributed by W. H. Peterson.



SOMETHING MUST BE MISSING

From the Mar. 6 issue of the St. Louis Post-Dispatch: "The inclusion of station WMAQ as part of the CHIN in which KSD is a link, is announced." We suppose that heretofore there was a missing link, or maybe this is a double chin? Anyhow, we've found out that stations do have chins and that's something.

Contributed by M. C. Tietjens.



FUNNY BUSINESS

New accessory for batteries announced in the New York Sun of Mar. 21: "sets which use the house lighting socket as a source of current to supply batteries fitted with a TICKLE CHARGER." We suppose that the function of this instrument is to tickle the electrons in the battery and make them charge through the circuit.

Contributed by Walter G. Voss.

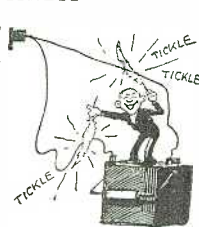

IS THIS RED TAPE IN THE R. F.?

Progress of radio technique in Germany reviewed in the New York Herald-Tribune of Mar. 27: "The development of resistance amplifiers consisted mainly in the fact that they could be used only for very limited frequency TAPE." Here's hoping that they succeed in cutting some of these bands that are hampering the radio art in the Fatherland.

Contributed by Wood Gaylor.



ALSO GIVEN THE GATE?

Departure item noted in the Tulsa Daily World of Feb. 27: "She is a noted American soprano and HAS TAKEN THE AIR SEVERAL TIMES RECENTLY." To tell the truth we cannot see why she was thrown out just for being a soprano, but we'll whisper you a secret; we think that some of 'em should be given a lot of air.

Contributed by Earl White.



FOR THE BUSY HOUSEWIFE

Radio is now aiding the overworked lady of the house, as evidenced in the Philadelphia Public Ledger of Feb. 27. In the list of parts for the "Ireland" receiver there is listed, "One 'Ireland' antenna INDUSTRIANCE." We assume that this gadget is energized by the radio waves and goes over the house doing the daily dusting.

Contributed by K. Brown.



RADIO IN THE KITCHEN

Culinary triumph recorded editorially by the Citizens' Radio Call Book for March: "The call COOK is proud of the type of editorial content." To radio music and radio reading we have now added radio cooking. We did read of shipwrecked sailors cooking their food over the captain's radio set, but this sounds more like a regular diet.

Contributed by Frank Kinney.



THE POOR ANTENNA!

Cruelty to antennae revealed in the Mar. 11 issue of the Chicago Evening American: "Station WRNY will shortly go on the air with a BRUISED antenna." Mike of the Investigation Dept. was sent over the station at once to ascertain if the engineers had been treating the antennae were glad to be unfounded.

Contributed by E. L. Eastline.

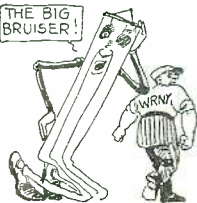

FOR THE SUMMER VACATION

Hint for the traveler who enjoys his radio, in the St. Paul Pioneer Press of Feb. 27: "RADIO-5-tube complete. Magnavox speaker LEAVING CITY." When you leave town for your vacation, just tell your speaker where you are going and send him off. He'll be there when you arrive.

Contributed by R. R. McBrady.



OH, THE OLD GRAY MARE--

From the Detroit Free Press of Jan. 27 we have this gem: "Most of the MARE operated by a single control." This is the latest in control by radio. We have had aeroplanes and automobiles guided by the ether waves, but science does progress. However, this horse control is not perfected, only part of the animal being under the driver's influence.

Contributed by W. G. Mortimer.

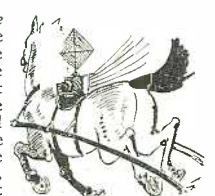

to the certain been ing, but we turn the repo

APPROVED RADIO NEWS LABORATORIES 1922

RADIO NEWS LABORATORIES



RADIO manufacturers are invited to send to RADIO NEWS LABORATORIES, samples of their products for test. It does not matter whether or not they advertise in RADIO NEWS, the RADIO NEWS LABORATORIES being an independent organization, with the improvement of radio apparatus as its aim. If, after being tested, the instruments submitted prove to be built according to modern radio engineering practice, they will each be awarded a certificate of merit, and a "write-up" such as those given below will appear in this department of RADIO NEWS. If the apparatus does not pass the Laboratory tests, it will be returned to the manufacturer with suggestions for improvements. No "write-ups" sent by manufacturers are published on these pages, and only apparatus which has been tested by the Laboratories and found to be of good mechanical and electrical construction is described. Inasmuch as the service of the RADIO NEWS LABORATORIES is free to all manufacturers whether they are advertisers or not, it is necessary that all goods to be tested be forwarded prepaid, otherwise they cannot be accepted by the Laboratories. Apparatus ready for the market or already on the market will be tested for manufacturers, as heretofore, free of charge. Apparatus in process of development will be tested at a charge of \$2.00 per hour required to do the work. Address all communications and all parcels to RADIO NEWS LABORATORIES, 230 Fifth Avenue, New York City.

LOUD SPEAKER KIT

The speaker shown was built in the Radio News Laboratories from a kit submitted by the Engineers' Service Company, 25 Church Street, New York City. The cone is three feet in diameter and of the

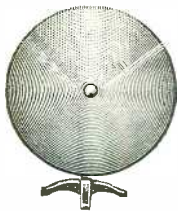

free-edge type. Although very simple in construction, the speaker has very high tone qualities, and is capable of delivering enormous volume with faithful reproduction of speech and music.

AWARDED THE RADIO NEWS LABORATORIES CERTIFICATE OF MERIT NO. 1905.

COIL WINDER

The coil winder shown, submitted by Charles F. Young, 3954 Ludlow St., Philadelphia, Pa., is designed for the automatic winding of coils of the basket-weave type. This ma-

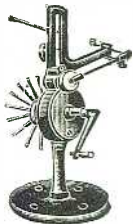

chine will be very useful to the radio experimenter and a handy addition to the radio work-shop. The coils obtained from the machine are very neat.

AWARDED THE RADIO NEWS LABORATORIES CERTIFICATE OF MERIT NO. 1916.

BATTERY CHARGERS

The "Banner (Dynamik)" trickle charger, (Model 600), submitted by S. R. Fraick & Company, 15 South Clinton Street, Chicago, Ill., is designed to be used in connection with



either a 4- or 6-volt storage ("A") battery. It has a charging rate of 0.6 amperes and is noiseless in operation. It operates on 110, 120, or 220 volts A.C., 50-60 cycle.

AWARDED THE RADIO NEWS LABORATORIES CERTIFICATE OF MERIT NO. 1926.

Model 750 is of the open type and designed for charging a 6-volt ("A") battery at the rate of 2½ amperes. It operates on the same

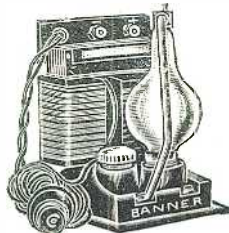

range of voltages as Model 600 above. The apparatus is compact, well built and satisfactory in its operation.

Model 1200 operates on the same range of voltages and uses a Tungar-type bulb as rectifier. The apparatus is well built and is enclosed in a

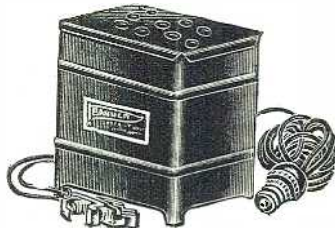

neat metallic housing. It operates silently and charges a 6-volt storage ("A") battery at the rate of 2½ amperes.

Model 650 operates on a similar range of voltages and can be used for charging either a 6-volt or a 12-volt "A" battery, or 96-volt storage

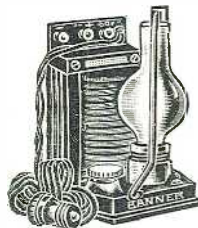

("B") batteries. The charging rate for a 6-volt battery is 2½ amperes; for a 12-volt battery, 1½ amperes. The apparatus is silent and satisfactory in operation.

AWARDED THE RADIO NEWS LABORATORIES CERTIFICATE OF MERIT, NO. 1927, 1928, 1943.

BATTERY CABLE AND SOCKET

This "Multiplug Type MB" submitted for test by Howard B. Jones, 614-618 S. Canal St., Chicago, Ill., permits quickly and simultaneously the connection and disconnection of all batteries and ground and antenna leads. The 8-foot, rubber-covered battery wires are bound together in a covered cable, while the antenna and ground leads are separate. The corresponding socket is of the bracket type, and permits baseboard mounting.

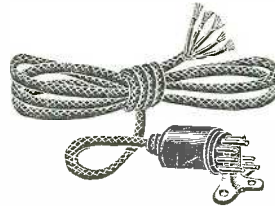

AWARDED RADIO NEWS LABORATORIES CERTIFICATE OF MERIT NO. 1944.

CORRECTION

In the description of the "Jewell 'A-B' Relay," Certificate No. 1953, in this department in the May issue of Radio News, a typographical error caused the statement that the Model 593 operates on 3 amperes. This should have read 0.3 (three-tenths) ampere.

ELECTROLYTIC CONDENSER

The "Mershon" condenser (Model D-15-30 shown), submitted by the Amrad Corp., Medford Hillside, Mass., embodies two capacity units of 15-mf. each. The folded aluminum sheets are the anodes while the central strip immersed in the electrolytic is the common cathode. This condenser has many uses, especially in connection with the construction of "A" and "B" power units.



AWARDED THE RADIO NEWS LABORATORIES CERTIFICATE OF MERIT NO. 1961.

R.F. TRANSFORMER

The "Holmes" radio-frequency transformer shown, submitted by the Holmes Electric Manufacturing Co., 3229 Sheffield Ave., Chicago, Ill., is of the air-core type and is shielded in a metal housing. It can be very successfully used as a transformer in an untuned radio-frequency amplification stage, and is especially adapted for portable receivers on account of its small size.

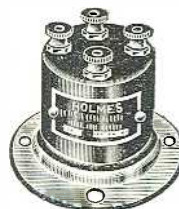

AWARDED THE RADIO NEWS LABORATORIES CERTIFICATE OF MERIT NO. 1963.

SOCKET-POWER UNIT

The "Crosley" A.C. supply unit shown, submitted by the Crosley Radio Corp., Cincinnati, Ohio, is designed to operate in connection with the Crosley radio receiver, type AC-7, and supplies its filament, plate and grid-biasing voltages. A Raytheon "BH" tube is used as a rectifier. Its operation is quiet and very satisfactory; the unit is compact and very neatly built.



AWARDED THE RADIO NEWS LABORATORIES CERTIFICATE OF MERIT NO. 1964.

BATTERY

The "Telecell" battery shown, submitted by the Waterbury Battery Corp., Waterbury, Conn., is a wet primary battery of the copper-oxide, zinc and caustic soda type. The voltage of the battery during the discharge is between 0.7 and 0.5 volts. The capacity of the battery is 75 ampere hours. With a continuous discharge of one ampere the battery will deliver 50 ampere hours. The "Telecell" can be used very conveniently in connection with radio receivers using low-voltage tubes.



AWARDED THE RADIO NEWS LABORATORIES CERTIFICATE OF MERIT NO. 1966.

SOCKET POWER UNIT

The "Webster Little Giant" "B-C" power unit shown, submitted by the Webster Co., 1005 Tribune Building, New York, N. Y., operates on 110-volt 50-60 cycle A.C.

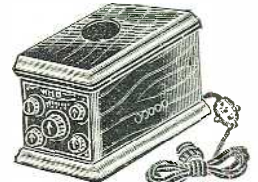

and supplies three plate voltages (detector, amplifier and power) and two biasing ("C") voltages. The variable resistances permit variation of each of the voltages. A full-wave Raytheon tube is used as rectifier. The unit supplies current

Use all power
 Use voltages
 The elimination
 to 180 volts and

is very quiet in operation. No hum was heard during the test.

AWARDED THE RADIO NEWS LABORATORIES CERTIFICATE OF MERIT NO. 1970.

CRYSTAL RECEIVER

The "Multiphone" radio receiver shown, submitted by the Multiphone Company, 1540 San Pablo Ave., Oakland, Calif., uses a D-coil variometer as an antenna tuner and has its terminals so arranged that sev-



eral head phones can be connected simultaneously. It covers a great part of the broadcast range and gives very good reception on locals. Two types are available: one black and one transparent in finish.

AWARDED THE RADIO NEWS LABORATORIES CERTIFICATE OF MERIT NO. 1971.

SOCKET-POWER UNIT

The "Erla" "B" power unit, (B-205 shown), submitted by the Erla Electrical Research Laboratories, 2500 Cottage Grove Ave., Chicago, Ill., operates on any lamp socket on 105-125 volt 60-cycle A.C. and



uses a full-wave Raytheon "BH" tube as rectifier. The voltage on the detector can be regulated from zero to 50 and that on the amplifying tubes to 125 volts. The apparatus is very compact and neatly built. It operates silently without causing any hum.

AWARDED THE RADIO NEWS LABORATORIES CERTIFICATE OF MERIT NO. 1972.

AUTOMATIC SWITCHES

The "Full Automatic" switch (Model 602 shown), submitted by the Liberty Bell Manufacturing Co., Inc., Minerva, Ohio, operates from the receiver. One of the leads of the line is permanently connected to the trickle charger and "B" supply, while the other lead is connected either to the "B" power



unit or to the trickle charger, as the set is "on" or "off." This instrument is equipped with a fuse, and operates satisfactorily with any receiver having three or more tubes of the 201A type.

AWARDED THE RADIO NEWS LABORATORIES CERTIFICATE OF MERIT NO. 1973.



Model 301-S is similar in appearance and construction to the Model 602 described above, except that it is somewhat smaller in size and has no fuse.

AWARDED THE RADIO NEWS LABORATORIES CERTIFICATE OF MERIT NO. 1974.

RESISTOR STRIP

The "Vitrohm" resistor strip (No. 507-9 shown), submitted by the Ward Leonard Manufacturing Company, 54 Willow Street, Springfield, Mass., is designed to be used in "B" power units having an output up to 250 volts. This strip has a total resistance of 12,000 ohms, and



is tapped in such a way that six of the plate voltages most commonly required can be obtained. The unit is rated to dissipate 100 watts continuously without damage to the resistance wire. The strip is supplied with mounting brackets.

AWARDED THE RADIO NEWS LABORATORIES CERTIFICATE OF MERIT NO. 1977.

RHEOSTAT

The "Peerless Junior" rheostat shown, submitted by the Bedford Electrical and Radio Co., 22 Campbell Road, Bedford, England, is of the one-hole-mounting air-cooled

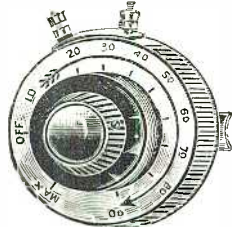

type. It is provided with an "off" position and equipped with a nickeled dial. Three different sizes (6, 15 and 30 ohms) are available.

AWARDED THE RADIO NEWS LABORATORIES CERTIFICATE OF MERIT NO. 1981.

CONDENSER

The fixed condenser shown, submitted by the Graham-Farish Manufacturing Co., 17, Mason's Hill, Bromley, Kent, England, uses mica as its dielectric and has its capacity unit hermetically covered with sealing wax in a molded bakelite hous-



ing. The measured capacity is, within reasonable limits, close to the rated value. The conductor is provided with slotted lugs to allow easy connection with the grid leaks and high-resistance units made by the same company.

AWARDED THE RADIO NEWS LABORATORIES CERTIFICATE OF MERIT NO. 1984.

CONDENSER

The variable condenser shown, submitted by the Ormond Engineering Co., Ltd., 199-205 Pentonville Road, King's Cross, London, N.1, England, is of the low-loss

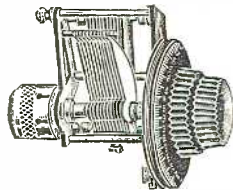

straight-line-frequency type. This condenser is provided with a very fine vernier arrangement and is well designed electrically and mechanically.

AWARDED THE RADIO NEWS LABORATORIES CERTIFICATE OF MERIT NO. 1985.

RESISTOR

The "Rigid Pigtail" resistor shown, submitted by Arthur H. Lynch, Inc., Fisk Building, 57th Street and Broadway, New York City, N. Y., has its resistance element made of a metallized glass rod and is equipped with two short ends of bus bar, approximately 1/4



inches long, soldered to the cups of the unit. This allows easy soldering and protection from excessive heat of the readily fusible alloy used to connect the resistance element to the cups.

AWARDED THE RADIO NEWS LABORATORIES CERTIFICATE OF MERIT NO. 1986.

CONDENSER

The variable condenser shown, submitted by Pival, 53 Rue Orfila, Paris XX, France, is of the low-loss straight-line-frequency type. The plates of the stator and rotor

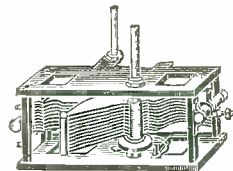

are silver-plated, and fused quartz is used as insulator. The built-in vernier allows very fine adjustment of the capacity. As a whole this instrument is very neatly and efficiently constructed.

AWARDED THE RADIO NEWS LABORATORIES CERTIFICATE OF MERIT NO. 1987.

INTERCHANGEABLE COILS

The short-wave coil shown, submitted by the Aero Products, Inc., 1772 Wilson Ave., Chicago, Ill., is of the interchangeable type and in-

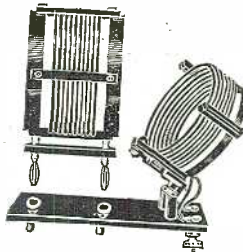

tended for amateur and experimental use in short-wave transmitters. The interchangeability of the coils allows the amateur to shift his operating wavelength to a more desirable one.

AWARDED THE RADIO NEWS LABORATORIES CERTIFICATE OF MERIT NO. 1988.

Nos. 4 and 5 shown, submitted by the same company, are designed to allow the amateur having a short-



wave receiver of 15-135 meters, using Aero coils, to extend its receiving range up to 550 meters.

AWARDED THE RADIO NEWS LABORATORIES CERTIFICATE OF MERIT NO. 1989.

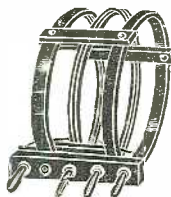

The short-wave tuner coil shown, submitted by the above concern, is of the interchangeable type and intended for use in amateur and experimental short-wave receiving work.

AWARDED THE RADIO NEWS LABORATORIES CERTIFICATE OF MERIT NO. 1990.

SOCKET-POWER UNIT

The "Warren" "B" power unit shown, submitted by the Warren Electric Co., Peoria, Ill., operates on 110-120-volt 50-60-cycle A.C.; it



employs a chemical rectifier. Four different voltages, three of which are variable, can be obtained. The power supply is sufficient for most radio receivers, and the operation of the apparatus has been found to be satisfactory.

AWARDED THE RADIO NEWS LABORATORIES CERTIFICATE OF MERIT NO. 1991.

RHEOSTAT

The "Peerless Dual" rheostat shown, submitted by the Bedford Electrical and Radio Co., 22 Campbell Road, Bedford, England, is of the one-hole-mounting type. The resistance unit has two windings in



series, one of 6 ohms, and a continuation on the same strip up to 30 ohms, and is completely exposed to insure perfect cooling. The contact arm is smooth in operation and provides a perfect contact.

AWARDED THE RADIO NEWS LABORATORIES CERTIFICATE OF MERIT NO. 1992.

SOCKET-POWER UNIT

The "A-B-C" Radio Power Unit shown, submitted by the Acme Electric and Manufacturing Co.,

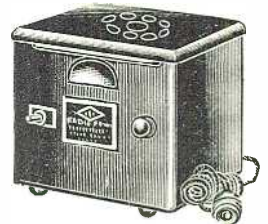

1444 Hamilton Ave., Cleveland, Ohio, is designed to operate on 110-volt, 50-60-cycle A.C. It embodies in one container a 6-volt storage "A" battery, a charger, a "B" power supply and an automatic control relay. A 2-ampere half-wave rectifier bulb, of the Tungar type, is used in the charger, which has two charging rates: 1 1/2 amperes and 3/4 ampere. The "B" power uses a tube of UX-213 type and is capable of delivering 30 milliamperes at 135 volts. The automatic relay disconnects the line from the charger and connects it to the "B" power when the set is on. The operation of the unit has been found very satisfactory.

AWARDED THE RADIO NEWS LABORATORIES CERTIFICATE OF MERIT NO. 1993.



I Want to Know

Conducted by Joseph Goldstein

THIS Department is conducted for the benefit of our Radio Experimenters. We shall be glad to answer here questions for the benefit of all, but we can publish only such matter as is of sufficient interest to all.

1. This Department cannot answer more than three questions for each correspondent. Please make these questions brief.
2. Only one side of the sheet should be written upon; all matter should be typewritten or else written in ink. No attention paid to penciled matter.
3. Sketches, diagrams, etc., must be on separate sheets. This Department does not answer questions by mail free of charge.
4. Our Editors will be glad to answer any letter, at the rate of 25c. for each question. If, however, questions entail considerable research work, intricate calculations, patent research, etc., a special charge will be made. Before we answer such questions, correspondents will be informed as to the price charge.

INCREASING RANGE OF THREE-CIRCUIT TUNER

(Q. 2216) Mr. S. Snyder, Hackensack, N. J., asks:

Q. 1. I have a 3-circuit receiver of the Ambassador type employing a detector and two stages of A.F. amplification. I have read that the Radio Commission considers the possibility of reducing the broadcast wave band to include the wavelengths from 200 down to 150. Would you please inform me of the changes necessary to enable me to receive these wavelengths?

A. 1. From the accompanying diagram, it will be seen that only a few minor changes would be necessary to adapt a receiver of this type to the lower wavelengths.

A S.P.D.T. switch, S, is connected as indicated. A tap taken on the secondary of the 3-circuit tuner, at a point 15 turns from the grid end, is connected to one tap of the switch. The end of the secondary which usually goes to the grid condenser is connected to the other tap of the switch. The lead from the grid condenser and tuning condensers is brought to the movable arm of the switch. It is now a very simple matter to tune to either the high wavelengths or the lower ones by simply using the correct switch tap. It may be necessary to reduce the detector voltage when tuning to the shorter wavelengths, since the tickler coil may be too large and excessive oscillation may occur.

For those desirous of constructing this receiver the following is the list of parts:

- 1 three-circuit tuner, T;
 - 1 variable condenser, .0005-mf., C1;
 - 1 grid condenser, .00025-mf., C2;
 - 1 grid leak, 2-megohm, R1;
 - 1 fixed condenser, .002-mf., C3;
 - 1 switch, S;
 - 1 rheostat, 20 ohm, R2;
 - 1 rheostat, 15 ohm, R3;
 - 2 audio frequency transformers, ratio 3:1, T1, T2;
 - 1 single circuit jack, J.
- Structural material, sockets, etc.

It is extremely unlikely that the broadcast wavelength band will be extended beyond its present limits (200-550 meters), the Radio Commission having decided that millions of dollars worth of receivers would be made obsolete by the change. A comparatively simple set of the 3-circuit type can be adapted to lower waves without much trouble, but other receivers are not so flexible.

A HIGH-VOLTAGE RECTIFIER

(Q. 2217) Mr. C. L. Maynard, Chicago, Ill., asks:

Q. 1. Having just obtained my amateur transmitting license, I am desirous of going on the air. I have a 50-watt tube hooked up in a Hartley cir-

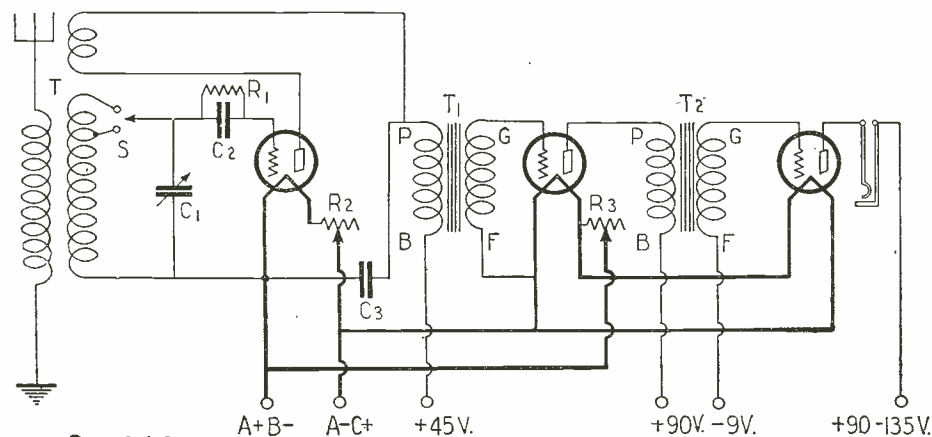

Q. 2216

A dual-range three-circuit receiver. By means of an S.P.D.T. switch it may be changed over instantly to the 150-200 meter band. This will be interesting to many experimenters.

cuit, but am puzzled as to what I shall use for plate supply. Can you give me any suggestions for obtaining a high-voltage supply of about 1,000 volts D.C.?

A. 1. There are several means of obtaining the high-voltage D.C. necessary for the plates of transmitting tubes. The motor generator is about the most convenient way of obtaining this D.C. supply, but unfortunately the cost of a machine of this type is rather prohibitive and since most "hams" usually are possessed of vacant pockets, we will have to look to some other source of plate supply.

The next best method is that of using a step-up transformer with some type of rectifier. There are four means of rectification usually employed for obtaining D.C. from an A.C. source; namely, vacuum tubes, a synchronous motor driving a revolving disc, the mercury arc, and the electrolytic rectifier. Of these the last is the simplest and cheapest, although it requires regular maintenance in order to keep it operating properly. However, if constructed with care, this type of rectifier, with a good filter system, will give a pure D.C. supply that compares favorably with that obtained from a motor generator.

Of the different metals used as elements in the chemical cell, aluminum and lead have proven cheapest and best. It is absolutely necessary that the aluminum be of the highest grade obtainable, because any impurities will hinder the rectifying process and tend to cause rapid disintegration of this electrode. The lead need not be of high quality, any available form of this element being satisfactory.

For the average amateur transmitter using a 50-watt tube, the size of the elements should be about 1x4 1/4 inches, with 3 inches immersed in the solution and the remaining inch bent at right angles to serve as a connecting lug. (The size of these elements depends upon the current to be passed. It has been found that a square inch of aluminum will efficiently handle a current of 80 milliamperes. It will be seen, therefore, that the dimensions given above are such that the elements will safely pass 240 milliamperes. The plate current of a 50-watt tube seldom exceeds 150 milliamperes, so that there is a safety margin of 60 per cent.)

Half-pint glass Mason jars make excellent containers for the solution and the electrodes, or even ordinary drinking glasses will be satisfactory. There is no necessity for using larger jars, as some "hams" do, as the efficiency of each cell depends on the size of the plates and not on the amount of solution used. The number of cells used in the rectifier depends directly on the applied A.C. voltage. Each cell will safely withstand a potential of 50 volts, so that it is necessary only to divide the total A.C. voltage obtained from the plate transformer by 50 in order to arrive at the number of jars required. This number, however, is only one-half of the total

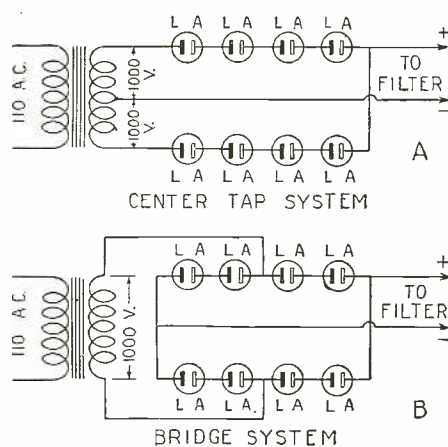

Q. 2217

Two very effective methods of connecting a high voltage rectifier. The number of jars is computed as explained in the text.

number required, since we are going to employ full-wave rectification.

When the step-up transformer is supplied with a center tap, the cells are connected as shown in Fig. Q. 2217 A. Of course, it is understood that the total desired output voltage must be obtained on either side of the center tap. In the case of a transformer having no center tap, the bridge method shown in Fig. Q. 2217 B is employed. Both of these methods operate with equally efficient results.

There are several chemicals that can be used for the rectifying solution. Ordinary borax has been known to give excellent results, but of late has been supplanted by sodium phosphate and ammonium phosphate; at any rate use the one that you can obtain. Make a saturated solution of the chemical in water, using enough to supply the particular number of jars you are using. There is no noticeable improvement to be had by using distilled water. After the solution has been stirred until no more of the chemical will dissolve, it should be allowed to stand overnight, to allow any excess to sink to the bottom. The plates are now bolted together, lead to aluminum, etc., and the clear solution is poured into the jars to within a quarter of an inch of the top.

The next step is known as "forming." A 100-watt lamp is placed in series with the primary of the transformer and the current turned on. The bulb will light up, because the current is being partly shorted through the unformed cells. After running for about half an hour, it will be noticed that the bulb has ceased to glow, showing that the plates are beginning to form. At this point a lower resistance, such as an ordinary electric iron, should be substituted for the bulb, and the current allowed to run for another period of time until the input has dropped to practically zero. The iron should then be removed and the full 110 volts connected directly to the primary. During the process of formation the transformer may heat somewhat, but after the plates have been thoroughly formed the load drawn from the line should not exceed 25 watts. A good grade of oil should then be added to the top of each cell, to prevent evaporation of the water.

Best results will be obtained from the rectifier after it has been in operation four or five days, and it should continue to give a continuous supply of high voltage over an extended period of time.

Correspondents asking questions about the construction or operation of home-sets will prevent delay by enclosing schematic diagram, with value of components used; as such circuits are always standard.

FUTURE PERFECTION OF RADIO RECEPTION DEMANDS RADIO TUBES DESIGNED FOR EACH RADIO FUNCTION.

deForest



Like the Benvenuto Cellini cup from the Altman collection of the Metropolitan Museum in New York, the De Forest Audions are fine examples of craftsmanship and painstaking skill.

DE FOREST engineers have recognized certain characteristics in the functioning of tubes in all radio units. Our laboratories have labored long to advance these characteristics that so improve radio reception, and now, these highly desirable elements have been developed in De Forest Audions for specific operations in the various radio reception departments.

Fans who are keen to bring their radios up to the highest degree of efficiency will eagerly adopt these Specialist Audions, the idea of which has long been appreciated in England.

These new De Forest Specialist Audions are now available for detector work, radio frequency amplification and use in all audio stages in types taking up to 500 volts on the plate.

To demonstrate the advantages of this idea and the improvement possible in your radio's performance, tune in a weak and distant station

or turn down the volume of a local until you can just barely hear it in the loud speaker. Substitute De Forest DL-4 Specialist radio frequency Audions in place of the RF. amplifiers you have been using. Note the remarkable increase in volume—how much louder the distant station and how the music of a local is raised to room filling proportion.

Radio amateurs will appreciate the characteristics of these efficient tubes. We must remember that regardless of RF circuits, tubes for best results must be uniform. The rigid limits, both electrical and mechanical, to which De Forest Audions are held assure a high standard of uniformity. With a very constant grid-plate capacity and high mutual conductance the volume these Audions obtain from distant reception is both amazing and satisfying.

These DL-4's are recommended for trial before you change *all* the tubes in your set.

De Forest Audions have been standard since 1906. The same genius who has made the broadcasting of voice and music possible is still hard at work for greater perfection and greater achievement in radio reception.

Of course, De Forest has designed a general purpose Audion. It is a good one and where price is a consideration the D-O1A Audion is an unequalled value at \$1.65. This tube is built to the same high standards of quality that mark all De Forest Audions.

De Forest dealers are pretty much everywhere. Look for displays of the brilliant black and orange Audion containers in shop windows. (Metal boxes in which De Forest Specialist Audions are packed insure their safety and dependability.)

If dealer is not available write for booklet which describes characteristics of each Audion and for chart indicating proper replacements for all standard makes of radio.

WRITE DEPT. 12 FOR DESCRIPTIVE LITERATURE
DE FOREST RADIO COMPANY

Powel Crosley, Jr.



President

JERSEY CITY, N. J.



**Lowest Priced
QUALITY
"B" Eliminator**

Outstanding quality confirmed by lasting good performance on over 50,000 sets. The following interesting endorsement—though but one out of thousands—verifies our claim of "singular value" in the good Ferbend "B" Eliminator.

THE UNIVERSITY CLUB
Pittsburgh, Pa.

I received your High Voltage Eliminator and am so well satisfied that I want to tell you about it. I have the latest model single Dial Atwater Kent and I now know what "Atwater Kent" means since operating it with your "B" Eliminator and a Radiotron Power Tube. Reception is powerful and so perfect that no one is able to distinguish the Radio reproduction from the original broadcast from the Studio.

If all Radio lovers knew how wonderfully and economically the Ferbend Eliminator works, you could not build enough to supply everyone. Our Radio is used from 40 to 50 hours a week, but our electric bills have not increased at all.

Yours very truly,
J. Scheuer.

Original cost less than half of any equipment of similar quality; lowest maintenance cost.
\$12.50
Model III, for all sets using 90 Volts.
Model IV, for extremely large sets and sets using power tubes; delivers up to 180 Volts, 50-60 Cycle, A. C.—\$17.50.

MONEY BACK GUARANTEE

not only in operation, but in workmanship, quality, durability and appearance. Sooner or later you will change to "B" Socket Power. Why pay more?

Approved and passed by the rigid laboratory tests of Radio News and Popular Radio.

See your Dealer—or Send Direct
Shipment made direct on receipt of price, or C. O. D. if preferred. Use for 10 days to convince yourself—if unsatisfactory write us within that time and purchase price will be refunded. Send Coupon TODAY.

FERBEND ELECTRIC COMPANY
425 W. Superior Street Chicago, Illinois

**FERBEND
"B" ELIMINATOR**

FERBEND ELECTRIC CO.
425 W. Superior St., Chicago, Ill.

- () Send \$12.50 model.
- () Send \$17.50 model.
- () Send at once. Payment enclosed.
- () Send C. O. D. () Send Literature.

Name.....

Address.....

City.....State.....

The DeLuxe System of Radio Broadcast Reception

(Continued from page 1458)

should next be tuned in, and the three knobs readjusted for best results.

During this process the adjustment on the Phasatrol should be set halfway between the two extreme positions. With the am-

plifier adjusted, the Phasatrol should be re-adjusted, by means of a long stick sharpened at one end to resemble the point of a screw-driver.

The proper adjustment of the Phasatrol is such that both dials may be tuned to resonance without the set's oscillating. During this process the tickler coil should be turned at right angles to the large coil L1, to which it is attached.

A variation of the detector-voltage control on the amplifier will enable an adjustment to be secured such that the detector tube will go into oscillation smoothly as the tickler coil is rotated.

The antenna series condenser should be so adjusted that the two tuning dials read very nearly alike when tuned to any one station.

The call letters may be recorded directly on the dials, to facilitate the reception of the same stations at a later date.

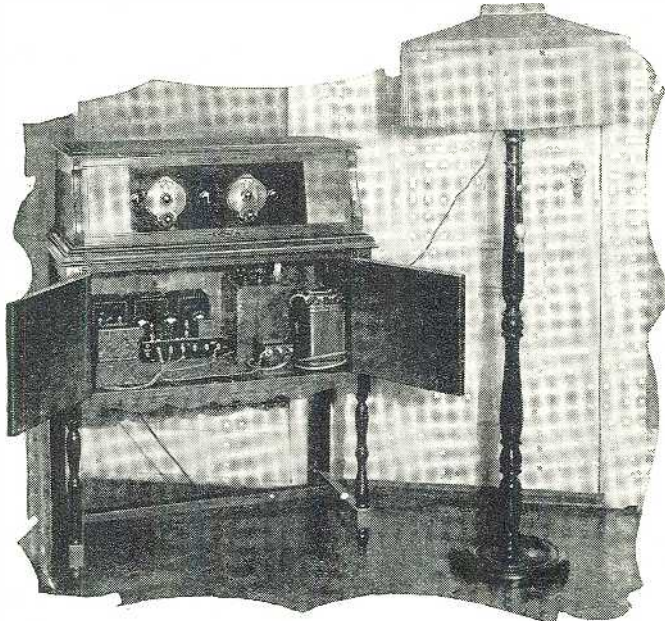

The De Luxe system mounted in a handsome console, the amplifier unit and power supply beneath. The adjustable panel is adapted to the short chassis. The remote speaker is not shown.

**Uncle Sam's Smallest
Broadcast Station**

(Continued from page 1427)

Bureau of Standards or elsewhere are sent and received exclusively by radio. Many of the experiments necessarily must be conducted at night; but storage batteries furnish the energy for the needed artificial lighting, thus again avoiding the installation of an electric-power system, with its possible interference with radio reception.

This field laboratory is situated one and one-half miles from Chevy Chase Lake, and five miles from the Bureau of Standards. The use of the land was tendered by Colonel M. K. Barroll, a retired officer of the Coast Artillery Corps. Eventually, most of the problems of the vagaries of electric waves will be studied at this field station, except such parts of the Bureau's work as must be done by means of mobile radio stations.

LARGEST PER CAPITA

"Austria, having issued 250,000 licenses, is, considering the size of its population, the second country in broadcasting in Europe." Monaco is organizing a Day of National Teeth-gnashing about this, thirteen of its citizens having allowed their licenses to lapse.—*Popular Wireless*, London.

TUNING IN OLD SOL

Owner: "I understand now, that 'static' is nothing more or less than the sun trying to communicate with us."

Visitor: "So that is why your set has dials?"

—Anna M. Anderson.

A PAWKY MAGISTRATE

WHEN he imposed fines of £2 (\$10) each on two Aberdeenshire radio "pirates" (owners of sets for which the license is unpaid) the sheriff was told by the prosecutor that fines of £10 had been imposed in recent English cases. The sheriff replied that heavier fines might be required to bring Englishmen to their senses, but he hoped the Scotsman, with his appreciation of the value of money, would come to his senses through the imposition of a much smaller fine.—*Amateur Wireless*, London.

THE BLOOPER

When Jenkins hunts for KGO,
For miles around the listeners know
Who twists and twirls his radio—
"That's Jenkins."

With whoops and howls the heavens abound,
The local stations fade from sound,
And fiercest static goes to ground
For Jenkins.

But Jenkins with his one-tube set
Has never logged that station yet,
No KGO can Jenkins get—
Not Jenkins.

Yet always have I yearned to know
If, in their Oakland studio,
Our Yankee friends of KGO—
Get Jenkins?

—*Wireless Weekly*, Sydney, Australia.

NOT FOND OF IT

Characterizing jazz as an industry rather than an art, Ernest Newman, the music critic, puts down jazz composers as "musical illiterates."

"My set is all right, but....."

my "B" Batteries are just about gone?" How often have you had to embarrass yourself by explaining that run-down "B" Batteries and not your radio set were the cause of all those reception "noises"—or worse, no reception at all?

Put an end to such "embarrassing moments." Do away with the annoyance and expense of constantly replacing wasteful "B" Batteries. Go to your nearest dealer and ask for a Majestic "B" Current Supply Unit to try on your set. Then, your "B" power troubles are over. You will have permanent, "full strength" "B" current direct from your light socket every time you turn on your set.

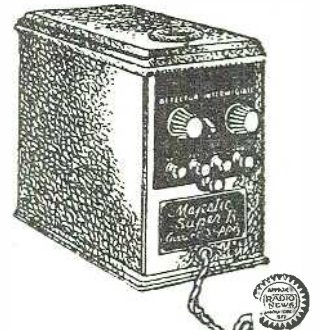

Majestic "B" Current Supply

The best "B"-Unit regardless of price

Majestic Standard - B
Capacity Nine 201-A tubes or equivalent. 45 milliamperes at 135 volts.

\$26.50

West of Rocky Mts., \$29.00
Raytheon Tube \$6.00 extra

Majestic Super - B
Capacity 1 to 12 tubes, including the use of power tubes. 45 mils. at 150 volts.

\$29.00

(as illustrated)

West of Rocky Mts. \$31.50
Raytheon Tube \$6.00 extra

Majestic Master - B
Positive control of all output voltage taps. For sets having high current draw or heavy biasing batteries. 60 mils. at 150 volts.

\$31.50

West of Rocky Mts. \$34.00
Raytheon Tube \$6.00 extra

[CAN BE PURCHASED ON DEFERRED PAYMENTS]

No acids or liquids. No hum. Uses Raytheon tube. No filament to burn out. G.-G.-H. double sealed moisture proof condensers positively prevent breakdown, the cause of 95% of B-eliminator troubles.

GRIGSBY - GRUNOW - HINDS - CO.
4572 ARMITAGE AVE, CHICAGO-ILL.

Majestic "B" is best

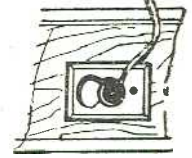

Bradleystat

PERFECT FILAMENT CONTROL

For noiseless, smooth filament control and maximum range, ask your dealer for the Bradleystat. This well-known



graphite disc rheostat can be used for ALL TUBES, without change of connections. The bakelite knob is removable, if desired.

The one-hole mounting makes the Bradleystat easy to install.

Bradleyleak

THE PERFECT GRID LEAK

With a range from 1/4 to 10 megohms, the Bradleyleak offers a variation of adjustment that adapts it to any tube or any circuit. A small grid-

condenser can be attached direct to its terminals. One-hole mounting.



Bradley-Amplifier

Resistance-Coupled

PERFECT AUDIO AMPLIFIER

For perfect tone quality, use resistance coupling, and for convenience and reliability, ask your dealer for a Bradley-Amplifier. Ready to install in your radio set.



Mail this coupon to

ALLEN-BRADLEY CO.
287 Greenfield Ave., Milwaukee, Wis.

Please send me your folders on Allen-Bradley radio devices, including the Bradley-Amplifier.

Name

Address

Radio News of the Month

(Continued from page 1428)

DENMARK REACHES OUT

THE government of Denmark has undertaken a series of programs for the special benefit of Danes living abroad and others who may be interested, under the title of "Hjemlandstransmissioner." They will commence about midnight (6 P. M. EST) two or three times a month. However, Copenhagen on 337.5 meters (1-kw.) is the only Danish station which American broadcast sets could receive. The others are Odense, 810 meters, and Soroe, 1154. The latter station is to be replaced by an 8-kw. transmitter, on the same wavelength, at Soroe, which will have several relays.—S. A. Blangsted.

WEATHER MAPS FOR AIRSHIP

A RADIO map receiver of the Jenkins type, similar to that pictured in January RADIO NEWS for ship purposes, has been placed on the dirigible Los Angeles. It should be sufficient to give ample warning of the approach of such a storm as came upon her ill-fated sister, the Shenandoah.

RADIO FIRES FOG SIGNALS

"GUNS" which are loaded with acetylene gas, similar, except in size, to a well-known toy, are now used as fog signals on the Firth of Clyde in Scotland; they are discharged by radio. Whenever fog is observed, the transmitter at Rosneath Beacon, a mile and a quarter away, is set in operation. A pendulum dipping into a mercury cup at each oscillation makes and breaks a circuit; this creates signals which are received by a two-tube set at the gun-house. Each signal affects a relay, and after a predetermined number of swings of the pendulum, the gas gun is discharged by an electric spark, and automatically reloads itself with an explosive mixture of gas and air. A shot can be fired every ten seconds. Relays are provided also for opening and closing the gas valves of the guns, which need attendance only once in three months, to replace tubes and supply new batteries and carbide.

MEDICAL RADIO CODE

SO common has become the practice at sea of asking by radio for medical instructions, that a codebook is to be compiled for this purpose. It should be useful, also, in many inland communities whose medical facilities are limited.

SOUTH AFRICAN RADIO

THE Johannesburg station, JB, which has been in touch with America through its rebroadcasts, closed Feb. 1; a financial failure because of the number of "pirates," as the radio listeners who dodge payment of their license fees are called in the Transvaal. In the interests of radio, however, the amateurs of the Transvaal Radio Society, however, will endeavor to maintain it temporarily, in the hope that the work will be taken up again.

A RADIO TRAFFIC COP

A SYSTEM of radio traffic control is suggested by H. D. Hubbard, of the bureau of standards, Washington, to replace the lighting systems now in use. Under this plan, each car would have a buzzer in connection with a circuit tuned to a fixed frequency. The traffic officer would use a short-wave transmitter which would send out "Stop" and "Go" signals at the street intersection. "Officer, my circuit must have got detuned—" "Tell it to the judge!"

90 Volt Power Unit :: \$12.75

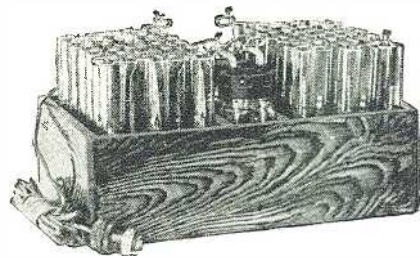

Hums, line noises, etc., positively impossible with this new advanced unit. Plug in and forget Non-acid and noiseless. All detector and intermediate voltages plainly marked. Simpler to hook up than dry cells. Operates any type set 1 to 12 tubes.

Greater volume and clearness guaranteed. If not thoroughly satisfied return after using 30 days for complete refund. Guaranteed further 2 years. For 110-120 volts A.C. 25 to 60 cycle current. 90 volts, \$12.75; 112½, \$15.25; 135, \$17.50; 157½, \$19.50; 180, \$24.00; 202½, \$26.00.

Also built for D.C. current 110 and 32 volts at only \$3.00 additional, any size above. Ample stocks—same day shipments. Simply say—ship C.O.D. or write for my interesting literature, testimonials, etc.

B. HAWLEY SMITH

334 Washington Ave., Danbury, Conn., U.S.A.



NO set is better than its tubes, no tubes than their filament control. Amperite alone controls filament current automatically, perfectly. Order by name. Accept nothing else. Simplifies wiring. Eliminates hand rheostats. **FREE—Send for Radial Book.** Explains Amperite operation. Gives season's popular Hook-Ups and Construction Data. Address Dept. R.N.G. **Radial Co., 50 Franklin St., New York**



Price \$1.10 mounted (U.S.A.) Sold Everywhere

AMPERITE
REG. U.S. PAT. OFF.
The "SELF-ADJUSTING" Rheostat



FREE this **Sterling** 32 page RADIO BOOK

Your most valuable ally in selecting your necessary accessories and home servicing equipment. Tells what testing meters are needed for every purpose, explains the correct use of "B" Eliminators, shows seven types of battery chargers, gives the "how and why" of checking set operation and of renewing the life of tubes at home. Write today for booklet "M"—no obligation.

The Sterling Mfg. Co., 2831 Prospect Ave., Cleveland, O.

Make any Good Receiver **BETTER**



HOME FURNISHINGS FREE ON CREDIT - Catalog

Over 1400 bargains in living room, dining room and bedroom furniture, rugs, dishes, etc. A year to pay. 30 days trial. Write today for free catalog. **STRAUS & SCHRAM** Dept. A392, Chicago, Illinois

WHICH Shall It Be?



Panel or Baseboard Mounting?

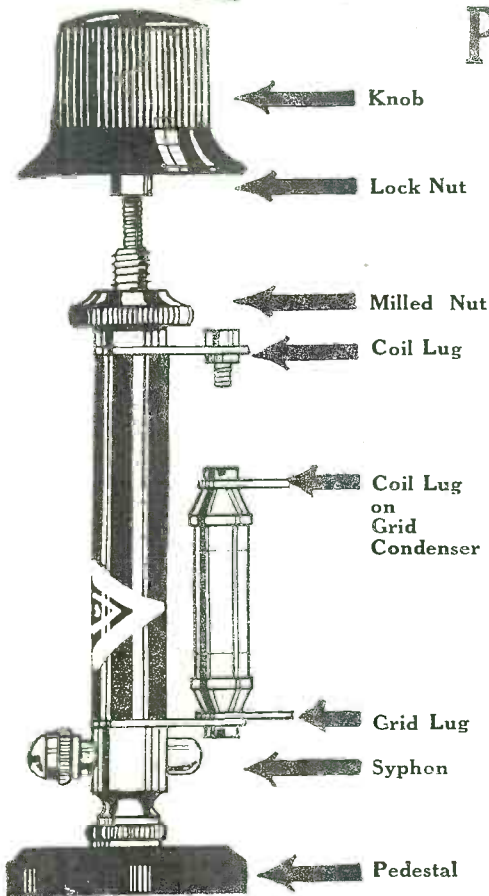

Best sensitivity is obtained from a detector tube when a variable grid leak is used, because the leak may be adjusted to give the correct biasing effect and afford adjustment of leakage from grid.

If the leak is to be used in a regenerative receiver it may be mounted on the baseboard, adjusted once, for greatest volume on a distant station, and left thus. In non-regenerative receivers, for utmost distance reception, mount the leak on the front panel, so it may be conveniently adjusted from time to time.

The new DE LUXE MODEL BRETWOOD VARIABLE GRID LEAK may be mounted on baseboard, by passing two screws through the pedestal. Proper screws are supplied with each leak. The Bretwood may be panel-mounted by drilling a 1/4-inch hole, removing the knob and milled nut, passing the shaft through the back to the front panel, tightening the milled nut against the panel and then the knob against the hex. lock nut.

Note: Proper connections are: Coil lugs joined by soldered wire and connected to outside end of secondary, grid lug to grid post of detector tube.

TO DEALERS: If your wholesaler cannot fill your orders we will supply you direct.

The De Luxe Model Bretwood Variable Grid Leak is specified by Herman Bernard for Radio World's four-tube Universal receiver.



Bottom View of Pedestal

North American Bretwood Co., 141 West 45th St., N. Y. City.

Gentlemen: Enclosed find \$1.75. Send me at once one De Luxe Model Bretwood Variable Grid Leak on 5-day money-back guarantee. (Or \$2.25 for leak with grid condenser attached.)

Name

Address

City State

Inquiries Solicited from the Trade

Power Tubes MUST Have Power

There's trouble ahead for the dealer who equips a set with a 171 Power Tube and then fails to make sure that the "B" supply actually does deliver the required 180 volts. Ordinary "Eliminators" will not hold up to 180 volts on high current consuming sets. A special "B" supply is vital. The Kellogg "B" Power Unit is made to fill this want.

Kellogg



"B"
Power
Unit

180 VOLTS Guaranteed

With 40 Milli-ampere Draw
(and 110 volt A.C. supply)

Here's the "B" supply that will make your high current consuming set perform 100%. How it will cut down your service expense! How it will solve those mysterious complaints that arise when you trust to rated voltages and fail to check up the "B" supply with a high resistance volt meter, when in actual use on the set.

Dealers! Jobbers! Investigate!

This matter of equipping your sets with adequate "B" voltage is vital to your business. Look into it at once. Mail the coupon for full details.

KELLOGG
Switchboard & Supply
Company
CHICAGO, ILLINOIS

Kellogg Switchboard & Supply Co.
Dept. A-100, Chicago, Illinois.
Please send me full details concerning your "B" Power Unit, designed especially for supplying adequate voltage for high current consuming sets equipped with 171 Power Tubes.

Name
Address

RADIO PRACTICAL JOKES

A YEAR or more ago, Britons were alarmed by the broadcasting of the sounds of a "revolution"; and those who missed the announcement felt that the levity was improper. Less serious was the announcement, a few days ago, that Germany and New York had been connected by the transatlantic radiophone; later traced to a hoax played by a London operator on one in Frankfort-am-Main, which led to a press dispatch followed by an official investigation on the part of the British postal authorities.

REWARDS OF MERIT

PRISONERS in Austria are to be allowed radio sets, it is announced, with the distinction that those whose conduct merits it will be allowed the additional liberty of tube sets instead of crystal receivers.

WHEN EXPERTS FAILED

AT the farewell dinner of the B.B.C. recently, radio duffers listened with unholy glee to a distressing attempt to accompany the meal with music broadcast from the Albert Hall. Wagner is not the most suitable accompaniment to a banquet at any time, but the failure of all the talent represented in the room, from Senatore Marconi himself to Capt. Eckersley, to make the loud speakers behave themselves was soothing to the self-esteem of humbler folk who sometimes struggle ineffectively to secure decent reception.—*News of the World*, London.

FROM STAGE TO ORCHESTRA

BERLIN theater orchestra conductor, Marc Roland, has solved in a novel way the problem of keeping in contact with singers on the stage despite the din of the orchestra about him. He had a microphone installed on the stage and connected with earphones which he wears clamped over his head. This enables him to hear the singers better and thus follow them with greater precision than is ordinarily possible from the orchestra pit.

BRITISH FANS ENTERTAINED

IN spite of much "grousing" by our British cousins over the quality of programs retailed to them (at \$2.45 per annum) by the British Broadcasting Co., a "small-sized boom" in radio apparatus is reported following the innovation early this year of broadcasting sporting events. By March the authorities had worked up to a bridge game as an attraction for listeners, as well as boat and horse races.

FAKE RADIO INSPECTORS

CANADIAN set owners were recently the victims of a larceny, when three men, representing themselves as officers of the radio service, seized sets in the possession of Toronto householders, and made their escape.

PRISON RADIO CONCERT

CONVICTS of the Pennsylvania Eastern penitentiary, their identity hidden by their numbers, broadcast a radio program a few days ago through two eastern stations. The outstanding song hit was a Chinese solo by the only oriental in the prison, which was announced as "I wish I was in Pekin Peekin' In, Instead of In Here Peekin' Out." Another interesting number was "Eli, Eli," in Hebrew.—*P. B. DeYonge*.

SHORT-WAVE PROGRAMS

IT is reported that the 3-kw. station, POY, at Konigswusterhausen, Germany, has been working very successfully with Japan on short-wave broadcast transmissions on 54 meters. Australians are looking forward to hearing these; and possibly Americans provided with short-wave receivers or appliances mature in on them.

demand
AEROVOX

**FILTER CONDENSER
BLOCKS**

For Working Voltages of 200, 300,
400, 600 and 1000 Volts D. C.

Flexible leads for connections eliminate all possibilities of damage from soldering.

AEROVOX WIRELESS CORPORATION
60-72 Washington Street
Brooklyn, N. Y.

Goodrich

Radio Panels

Black, Mahogany and Walnut.
Standard thickness 3-16" and 1/4".
High softening point prevents warping.
Low free sulphur content prevents discoloration.
Machine easier and are better electrically than any other material in common use.
Your radio dealer has them or will get them for you—if not, write to us and we will see that you are supplied.

Also hard rubber for coils, spaghetti tubing and miscellaneous rubber items for Radio Manufacturers.

Radio Sales Division

The B.F. Goodrich Rubber Company
Established 1870 • Akron, Ohio

AMRAD

Raytheon Leads



Raytheon BA
350 m. a.
(½ size)

Raytheon's leadership in the rectifier field is demonstrated again by the announcement of these sensational new rectifiers, worthy to take their places beside Raytheon Type B and BH



Raytheon A
2½ Amps.
(actual size)

LIGHT SOCKET A-B-C POWER with one rectifier

By this amazing rectifier, Raytheon BA-350 m. a., the final great step in the development of radio power is accomplished. Compact, built-in A-B-C power, without accessories, becomes a fact.

Soon a specially selected group of leading radio manufacturers will announce their newest receivers, using Raytheon BA-350 m. a. Standard 201A tubes are used, and all batteries, chargers, accessories, and outside power equipment are eliminated.

Raytheon BA-350 m. a., the crowning accomplishment of the Raytheon Research Laboratories, has at last given the radio world a practical, proven solution to the problem of simple light socket receiver operation.

A REVOLUTIONARY SCIENTIFIC ACHIEVEMENT in high current, low voltage rectification

Raytheon A-2½ amps. is revolutionary in principle, in construction, in performance. It is an unbreakable metal cartridge, compact and simple, without liquids or filaments.

Above all, it is The Efficient Rectifier. Its operating cost over the period of a year, compared with that of other types of rectifiers designed for similar uses, will show a cash saving of many dollars.

Raytheon A-2½ amps. was invented by Monsieur André of La Radiotechnique in Paris, and developed by the Raytheon Research Laboratories with his co-operation.

Battery chargers and "A" power units using this remarkable rectifier will bear the same seal of approval that distinguishes all Raytheon-equipped power devices.



Only manufacturers whose units have been tested and approved by Raytheon may use this seal on their products.

RAYTHEON MANUFACTURING COMPANY

Cambridge, Massachusetts

New Prices

Type B	\$4.50
Type BH	6.00
Type BA	7.50
Type A	4.50



The Heart of Reliable Radio Power

The "A-B-C" Power Unit

QUALITY DONGAN PRODUCTS

For the Raytheon BA 350 MA Tube to eliminate all batteries

SUCCESSFUL elimination of all batteries by the use of the new Raytheon BA 350 MA Tube is now a fact. Dongan Transformer No. 3591 and Double Choke No. 3584, used with Raytheon's new tube, offer the highest efficiency in performance. For manufacturers, these parts are now available unmounted. Our engineers are at your service.

Fans—Send money order for immediate delivery. Enclosed in handsome, durable metal case.

Dongan Electric Mfg. Co.
2987-3003 Franklin St., Detroit.



No. 3591 Transformer, \$15 List.



No. 3584 Double Choke \$15 List

TRANSFORMERS of MERIT for FIFTEEN YEARS

SAY IT WITH AUTOMOBILES

WHILE Swiss listeners pay \$3.00 apiece a year for the privilege of listening, they evidently feel that they have received more than their money's worth. The director of the Berne station was invited at Christmas to pick himself out a motor car, and did so, without taking it seriously. On New Year's day, to his great surprise, it was delivered to him with the compliments of the audience of "Radio Bern." This station last year transmitted for 2100 hours, half the time being given to concerts, and one-fifth to talks.—S. A. Blangsted.

A QUESTION SETTLED (?)

"BRITISH manufacturers have led the world in the development of the radio tube ('wireless valve')—itself a British invention, and intend to continue to do so."—British Radio Valve Manufacturers' Association, in *Wireless World*, London.

A HOPELESS ROMANCE

THE first "radio suicide" is reported from Vienna, where a middle-aged domestic fell in love with a musician whose broadcasts she heard over her radio. She bought his photograph and treasured it; but her impassioned love letters remained unanswered by even a verification of reception, and finally the heartsick spinster turned on the gas.

RADIO AND THE WEATHER

THAT, when temperature is low, radio signals are strong; while when the temperature is high, signals are weak, is fairly well known to the listener; but the Bureau of Standards at Washington has been analyzing the problem more deeply.

A study of the variation in strength of signals from the transatlantic radio stations at Tuckerton and New Brunswick, N. J., conducted by Dr. L. W. Austin and Miss I. J. Wymore of the Bureau over more than two years, appears to prove that there is some kind of inverse relationship between signal strength and local temperature.

The commonly accepted ideas regarding the earth's atmosphere indicate that there should be no connection between the weather near the ground and conditions at heights of 62 miles or more, where the main variations in radio signal intensity are supposed to be produced. However, the Bureau's investigations show that the variations in signal strength are actually produced in the upper atmosphere and not in the portion of the wave traveling along the ground, because in the region involved there is no definite change in intensity as a result of long continued rains or droughts or because of the presence or absence of snow, at least for wavelengths over 1,000 meters. In addition, it is hardly conceivable that the rapid intensity changes observed during cold waves can be due to the penetration of frost into the ground, because this is of necessity a gradual process.

A RADIOPTIMIST



THE PRODIGI WHO HAS MEMORIZED THE WIRELESS CODE IN FIVE MINUTES TRIES HIS HAND AT COPYING A NAVY-YARD DISPATCH!

CARTER

New Resistors

Code No. F-15—(15 ohm)90
Code No. P-10,000, 25 (10,000 ohm) 1.75

Chosen as usual for

RAYTHEON A. B. C. Power Supplier

Because:

- they are permanent
- they stand up
- they are fairly priced

See them at your dealer's.
In Canada: Carter Radio Co., Ltd.
CARTER RADIO CO.
Chicago

CLAROSTAT

the greatest universal range variable resistor and Heavy Duty model play a stellar role in the marvelous RAYTHEON A, B, C UNIT.

CLAROSTAT'S ability to cover the entire resistance range (from practically zero to 5,000,000 ohms) and its current-carrying capacity of 20 watts and the unique electrical principle that enables it to dissipate heat generated by resistance to current flow, make it invaluable for all socket power construction.

Caution! CLAROSTAT is being imitated! Insist on seeing the name which is stamped on every genuine unit.

"The GATEWAY TO BETTER RADIO," 32 pages covering everything in radio; sent upon receipt of 25c. Send stamps or coin to Dept. RN.

American Mechanical Labs.
285 N. 6th St., Brooklyn, N. Y.

LYNCH METALLIZED

WARRANTED FIXED RESISTORS HEAVY-DUTY-TYPE

The new Lynch wire-wound heavy duty resistors for eliminator and power work are now ready. These units are ideal for use in Raytheon and all other power circuits.

EQUALIZORS

For perfect filament control use the Lynch Equalizers. There is a type for every type of tube and for any combination of tubes. A Lynch Equalizer will take the place of your filament rheostats. Complete, with mounting, \$1.00.

Lynch Suppressors and Low-loss mountings mean better radio.

At All Good Dealers

ARTHUR H. LYNCH, INC. 250 W. 57th St. New York, N. Y.

For Raytheon A-B-C Power Supply

Genuine FAST Condenser Unit

Fast Condensers are standard equipment in over a million radio sets and eliminators. Tried and tested.

Send for special bulletin and prices.

John E. Fast & Co.
3980 Barry Ave., Chicago, U. S. A.



The "A-B-C" Power Unit

RESCUE FOR THE HOME

Within a few years, it is now the sober relief of scientists and engineers, radio will broadcast motion pictures into the home. Then will come television, and again reference is to the home. A person may sit in his armchair, possibly by an ornamental furnace stoked by radioed heat-waves, lift a telephone receiver and see the person speaking. One may see as well as hear the President of the United States deliver his inaugural and see as well as hear the crowds around him.

Is odor translatable into waves and susceptible of being transmitted by radio? In that case the people of the future may not only hear and see the bells of Moulmein pagoda, but catch the scents borne by the wind through the palm trees—without leaving home.

This evaluation of the new triumphs of mechanics in terms of the home is probably an old habit of thought we have not outgrown, but it suggests possibilities. Science has badly shaken the home, science may yet come to its rescue. What the steam engine took away the radio cycle and radio beam may in part restore.

Having acquired the habit of going outside the home for gainful occupation, the industrialized world naturally fell into the habit of going outside the home for its recreations. Radio is now beginning to reverse the process. It brings recreation back into the family circle. Dance music and opera have arrived. Baseball and football and prizefights have partially come back, via the radio announcer. Broadcast movies and television will almost complete the process.

In the rural districts it is said that the movie has operated to slacken the drift to the cities. In the cities radio may operate to slacken the drift to the theatre, the opera house, the dance hall, the night club. There will always remain the gap between the audible, visible crowd on the screen and the crowd itself in the stadium, between the theatre audience on the screen and the flesh-and-blood tingle of a first night in the theatre. But the reproduction within four walls will be lifelike enough to hold many at home who now venture out—especially in bad weather.

Within ten years we are promised television. The engineers had better hurry, if the rescue of the home is a conscious purpose with them. In ten years there may be very little home to salvage. Already we are down to a couple of rooms and a bath.—*New York Times.*

A CHOKE COIL



How to operate your set from the Lamp Socket . . .

3 good methods—ACME can help you in any one

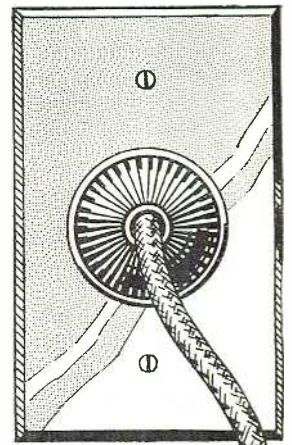

NOW dependable lamp socket operation is here—what you have long wanted. By making your radio set up-to-date, you get more fun out of it. Lamp socket operation is convenient and dependable—insures high quality reproduction.

No matter what set you have, it can be made to operate from the lamp socket. Acme has spent years and made countless experiments on all the different methods to obtain best results.

There are three good methods now available for A and B supply.

Method 1.—An Acme E-4 "B" supply unit and an Acme Charger, A6 or A7, with Filters now available, (for sets using 201A tubes with parallel filaments).

Method 2.—The Raytheon BA 350 milliamper tubes with Acme Transformer BA 1 \$15.00; Acme Choke Coils BA 2 \$15.00 each (two needed); and Condensers, (for sets using 201 A tubes with series filaments).

Method 3.—An Acme E-4 "B" Supply and Acme AC 1, (\$5.00), transformer for lighting the filaments of AC vacuum tubes.

Send 10 cents for "Power Supply for Radio Sets"

This 32-page book gives complete instructions and diagrams of each of the three methods of operating your set from the lamp socket. Send us the coupon below and 10 cents, today, and we will forward a copy of this book to you by return mail.

If you cannot buy any of the parts mentioned of your local dealer, order direct of us, checking proper place in coupon and enclosing check or money order. Acme Apparatus Company, Dept. K-24, Cambridge, Mass.

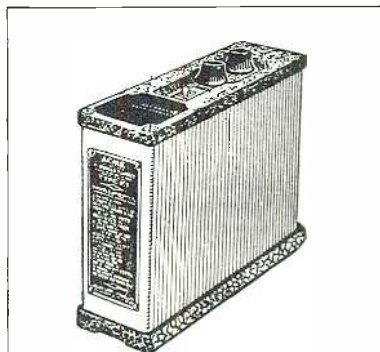

Acme E-4 "B" Power Supply \$35.00

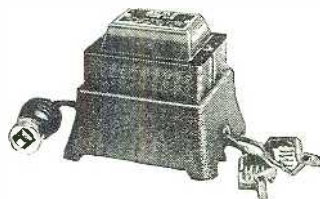

Acme A6, 2½ Ampere Charger \$12.50
Acme A7, 5 Ampere Charger \$18.00

ACME
~ for amplification

ACME APPARATUS CO., Dept. K-24, Cambridge, Mass.
Gentlemen:—I enclose 10 cents. Please send me a copy of your new 32-page book, "Power Supply for Radio Sets."

Name
Street
City State

NOTE: If ordering parts direct of us, please place check mark preceding name of part wanted and enclose check or money order for same.
 BA1 Transformer \$15.00; BA2 Choke Coils \$15.00 each; E-4 "B" Supply \$35.00;
 A6, 2½ Ampere Chargers \$12.50; A7, 5 Ampere Charger \$18.00; AC1 \$5.00.

The "A-B-C" Power Unit

Radio Vision Demonstrated in America

(Continued from page 1426)

cycle alternating current circuits feeding the synchronous motors. Where regular wire circuits are to be used, there can be a still further reduction to one full-metallic circuit of two wires; as it is perfectly feasible now to transmit the three distinct currents for the image, for synchronism, and for the voice, by utilizing three carrier-frequencies. These must have a value above an audible frequency, in order not to interfere with the voice transmission. With voice transmission over special telephone circuits, the engineers have for several years been able to transmit six telephone currents over one circuit simultaneously, by using carrier-currents of different frequencies; in the case of multiplex telegraphy they are now transmitting ten different signals over a two-wire circuit simultaneously by the use of suitably graduated carrier-currents.

Looking at Fig. 4 we see how it is possible to simplify the radio transmission of picture images by this or any other system, and where three different wavelengths have to be transmitted simultaneously for the image, synchronism and voice transmission. As pointed out in an interview of the writer with one of the scientists of the Bell Telephone Laboratories, who is familiar with this remarkable achievement by their engineers, it is possible, if occasion required it, to connect the three standard radio transmitters shown in Fig. 3 to a single antenna as shown in Fig. 4. This can be accomplished by connecting special, high-voltage filters comprising suitable inductances, condensers and resistances, in series with the respective radio transmitters and the common aerial and ground. In the recent demonstration and tests leading to it, it was found much cheaper and more convenient to use three separate transmission antennas and also three separate and independent receiving antennas. These special filters required where three radio transmitters are to be connected to one antenna, are quite expensive, and ordinarily it does not pay to use them.

There are several ways in which the three wavelengths being transmitted simultaneously can be picked up and passed into the three independent circuits, for the image, synchronism and voice circuits. One of the simplest ways of picking up and sharply tuning the three desired wavelengths is shown in diagram at Fig. 4. Here an aperiodic primary winding on a special coupler transfers the aerial energy to three or more independently tuned secondary windings. All the operator has to do is to tune the respective secondary circuits to the desired wavelengths. This is the system used for reception of transatlantic radio telegraph messages. The more elaborate system of Dr. A. Hoyt Taylor of the Navy (see page 1421) can be used; as well as numerous others which have been patented and described in the technical press.

DETAILS OF LARGE-IMAGE SCREEN

These details have probably made fairly comprehensible how at last it has become possible for a person at one end of a telephone or radio circuit, to actually see the moving image of the person at the other end, but the mind fairly staggers at the results obtained in reproducing a larger television image on a screen measuring two by three feet, such as that demonstrated before the audience which attended the introduction of this system of television.

Imagine for a moment what a problem the engineers had to solve, when it became

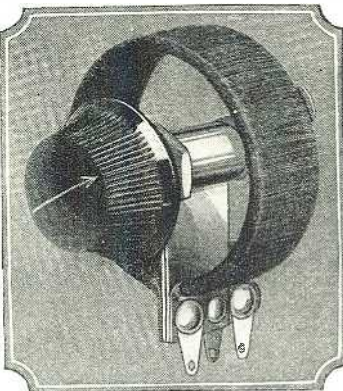

Centralab

50 Watt Rheostats and Potentiometers

for new Raytheon A-B-C Power Supply

DESIGNED especially for this circuit and wire wound. These new Centralab controls have a tremendous overload capacity that insures infallible service. Easy to mount, diameter only 2 inches. No burn outs or warpings, as all material is practically heat proof.

- 50 ohm Centralab 50 watt Rheostat for circuit resistance R-5.....\$1.75
- 150 ohm Centralab 50 watt Potentiometer for circuit resistance R-1.....\$1.75

At your dealers, or mailed direct

CENTRAL RADIO LABORATORIES
19 Keefe Avenue Milwaukee, Wisconsin

WEBSTER

B and C Socket Power Raytheon Equipped

Your Super Hct. 11, Victoreen, 9-In-Line, Madison-Moore, Norden Hauck-10, Infradyne, or other super power sets equipped with Webster socket power give amazing tone, distance and volume; gets stations never logged before. Equip your set with Webster unit before you miss important programs from run down batteries. Write us for free booklet.



"Improving Your Radio."
THE WEBSTER CO.
866 Blackhawk St., Chicago

SO GOOD!

Not just So-So. The RADIO you build with the genuine

NATIONAL

RADIO PRODUCTS
National Co., Inc., Cambridge, Mass.

Featured--First in RADIO NEWS

Just as in the case of the new A-B-C Power Unit, the newest developments of Radio invariably featured—first—in RADIO NEWS.

M&H

Radio's largest kit supply house

ESTABLISHED 30 YEARS

A-B-C

Socket Power Unit

It's here!—the new Full Kit Raytheon Pack that eliminates all Batteries. **\$120**

EL-FONIC Capacity Pick-up

A Miniature Broadcast Station in your home. Kit of Parts

See description in **\$24.50** Radio Magazines.

We have complete Kits for all Constructional Articles appearing in this magazine

The De-Luxe Browning-Drake

Arthur Lynch has made the Browning-Drake a masterpiece—more complete than ever before. **KIT PRICE \$35.10**

TRANSOCEANIC

Kit as assembled by the designer. **\$36.95** As its name implies, a super-power receiver of exceptional design and quality.

Our Circular

IS NOW READY It Will Pay Set Builders to Send for This

M & H SPORTING GOODS CO.
512 Market Street, Philadelphia, Pa.

RAYTHEON A-B-C POWER SUPPLY

Trans-Oceanic Telephone Interflex (Orders shipped same day received)

FREE | New 1927 Catalog | FREE

Wholesale Headquarters

Shows photographs and hook-ups of all latest kits, complete line of cabinets and consoles, accessories and parts. We are headquarters for all nationally advertised lines. Dealers and professional set builders write on your letterhead today for your copy of this big FREE CATALOG.

SHURE RADIO CO., 333B-35 W. Madison St., Chicago.



CONDENSERS and VERITAS RESISTORS

Stand up on their Jobs

To-be Deutschmann Co., Cambridge, Mass.

The "A-B-C" Power Unit

SM Do You Hear'em?



When you listen to your set do you really hear the sibilant "SSS" and "th" sounds, or does your imagination have to supply them? Do you actually feel the low notes of the 'cello or is your imagination again supplying the notes your set loses?



Simply because S-M audio and output transformers installed in any set eliminate the necessity for "imagining" good reproduction—because they actually give it—you'll find them in almost all of the better circuits.

That's why Sargent and Rayment specified them for the Infradyne—because they knew of no better guarantee of perfect tone quality.

You can have it too—just get a pair of 220 audios and a 221 output transformer from your dealer on a satisfaction or money-back guarantee and prove it!

S-N 220 audio and 221 output transformers are \$8.00 and \$7.50 each, respectively.

652 Reservoir B

The S-M 652 B supply kit is the guaranteed answer to your B eliminator or B battery troubles. It won't run down, its output voltages are constant to a few per cent, and it won't "motor-boat" or "putt."

Its power output is sufficient for the largest set—up to 45 milliamperes at 90 volts 10 milliamperes at 45 volts and plenty of current for a 171 power tube on the 180-volt tap. And, all adjustments are automatic!

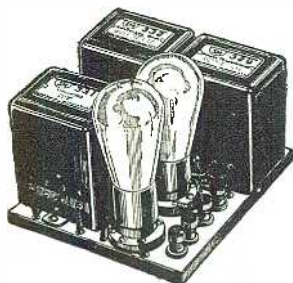

You can put it together in a few hours on the living room table, hook it to your set and enjoy reception with B troubles at an end, for the 652 is a veritable reservoir of ample, constant, reserve power.

All parts ready to assemble, less CX-313 and CX-374 tubes, price \$34.50.

SILVER-MARSHALL, Inc.
848 W. Jackson Blvd.
Chicago, U. S. A.

evident that to properly build up the image of a face for example, on a screen as large as two by three feet, that not less than 45,000 light images or pulses per second, must occur! This meant, for one thing, that the synchronism between the two rotating elements at the transmitter and receiver must not be out of step by more than one ninety-thousandth of a second. As one of the scientists connected with this work pointed out to the writer, if either one of the revolving elements slipped out of synchronism by one-half a cycle, it would result in a *negative* image being received instead of a *positive*. In other words, you would see a white man with a black face and white hair. This problem, therefore, was one of the hardest ever placed before electrical engineers.

Other phases of the research problem were encountered in the development, by Dr. F. Gray, of the large neon tube used for the production of an image large enough to be viewed by a considerable audience. The development and use of such a tube, with its present total of 2,500 external electrodes, required the construction of a current-distributor from which 2,500 wires, like a gigantic optic nerve, extended to the tube. When the front of this tube is observed, its whole area appears to glow at once; so rapidly does the instantaneous spot travel from one electrode to another that the eye does not appreciate its successive positions.

Referring to Fig. 5 we see that, instead of the revolving disk previously used for reproducing the image, we here use the two synchronous motors on a common shaft to rotate a commutator arm, and this arm passes over no less than 2,500 compactly-arranged metal segments, cemented along the rear walls of the 50 convolutions of the neon tube. These are correctly and progressively energized. Note that the incoming image signals, instead of passing into a single glow-tube, as in the simple apparatus for the small image, are now amplified to a sufficiently high potential to cause the neon gas in the large grid-tube to glow at the spot corresponding to any one of the 2,500 tinfoil electrodes.

The man who built the commutator needed lots of patience, a good hot soldering iron, and also plenty of time. He had to connect the 2,500 insulated wires running from as many tinfoil segments, cemented on the back of the neon tube, in exact order to their respective segments around the stationary commutator frame. When he had connected 50 wires from the 50 segments along the top glass arm for example, he then repeated this with the 50 wires coming from the 50 tinfoil segments along the second leg of the neon tube, etc. The action taking place in the magnified image on this large exhibition screen is made a little clearer perhaps by looking at the mechanically analogous diagram in Fig. 6.

Referring to Fig. 6 for the moment, let us note that as one of the fifty pencils of light at the transmitter sweeps across the face for example, it, by analogy, causes a mechanical arm, corresponding to the commutator brush, to sweep across the fifty metal segments, and has therefore caused fifty spots of light of varying intensity or tone to sweep across this top leg of the glass neon tube. As the commutator has 2,500 segments, it will be seen that, while the fifty light beams passing through the transmitter disk cause 900 spots of light to traverse the face or other object each second, the number of light pulses, all properly graduated reproduced on the large glass tube screen will be 45,000. In other words, 2500 light pulses appear 18 times every second on the 2 x 3-foot exhibition screen; this is sufficient to give a satisfactory image, owing to the retention of vision by the human eye, as described in the first part of this article.



Sure Satisfaction
"A & B"
SOCKET POWER UNIT

One switch controls everything. Connects with your house current and gives you a constant, dependable flow of "A & B" power.

Gives matchless service.
Compact.
May be used with any set.



Comes ready to operate at

Only \$67⁵⁰

East of the Rockies

Ask your dealer or jobber or write us for information on our entire line.

THE ACME ELECTRIC & MFG. CO.
1412 Hamilton Ave., Cleveland, O.

To get the utmost from those new High-Mu tubes

DESIGNED to official specifications for use with the new Radiotron and Cunningham Resistance-coupled High-Mu tubes, the new Lynch Metallized Resistance Coupled Amplifier Kit will give you perfect tone with full volume. May be used with any receiver. At all good dealers, or by mail, prepaid \$9. Write for literature.

ARTHUR H. LYNCH, INC.
Member RMA
250 West 57th St., New York, N. Y.

How To Build A Giant 3 ft. Cone Speaker for only \$14.15



Send for This Today

Read this interesting pamphlet and learn how you can easily build a giant 3-foot Cone Speaker, equal to factory made, that reproduces all frequencies, works with any set that will operate a loud speaker.

Build Your Own 3-ft. Cone Speaker

PENN C. S. Unit and PENN Parts recommended by leading radio authorities. From your dealer; if he cannot supply you, order direct, f.o.b. N. Y. C. Complete parts. DOUBLE 3-ft. Cone Speaker, only \$14.15. Pamphlets sent for 10c., coin or stamps.

PENN RADIO SALES CO.
104 Fifth Ave., Suite 2401, New York City.

Radio Transformers

For All Purposes

Thordarson Electric Mfg. Co.
500 W. Huron Street
Chicago, Ill. (3511)

ELKAY EQUALIZERS



specified as "ballast" for the Inter-Balanced Regenerative Receiver are made by The Langbein-Kaufman Radio Co. (Dept. N), 62 Franklin St., New Haven, Conn. Write for prices and tables of values.

WINDSOR HORN and CONE Loudspeakers and Loudspeaker Consoles

WINDSOR FURNITURE COMPANY
1410 Carroll Avenue, Chicago, Illinois
Los Angeles Branch, 917 Maple Ave.

Chemistry paves the road to Success!

Some people measure success in terms of money and others in degree of knowledge and culture. Chemistry is the one uncrowded profession today that offers both. America, always a land of amazing opportunities, is especially so now in the field of applied Chemistry. Industries have developed within eight years more rapidly than the output of trained men to conduct them. Every big industry needs chemists and there is a real demand for them immediately.

Earn a Bigger Salary from now on—

Good Chemists Command High Salaries; you can make yourself independent for life by unearthing one of Chemistry's Undiscovered Secrets!

Do you remember how the tales of pirate gold used to fire your imagination and make you want to sail the uncharted seas in search of treasure and adventure? And then you would regret that such things were no longer done. But that is a mistake. They are done—today and everyday—not on desert islands, but in the chemical laboratories throughout your own country. Quietly, systematically, the chemist works. His work is difficult, but more adventurous than the blood-curdling deeds of the Spanish Main. Instead of meeting an early and violent death on some forgotten shore, he gathers wealth and honor through his invaluable contributions to humanity. Alfred Nobel, the Swedish chemist who invented dynamite, made so many millions that the income alone from his bequests provides five \$40,000 prizes every year for the advancement of science and peace. Herman Frasch, who showed how to extract sulphur built up a huge fortune. C. M. Hall, the chemist who discovered how to manufacture aluminum made millions through this discovery. F. G. Cottrell, who devised a valuable process for recovering the waste from flue gases, James Gayley, who showed how to save enormous losses in steel manufacture, L. H. Baekeland, who invented Bakelite—these are only a few of the men to whom fortunes have come through their chemical achievements.

NOW IS THE TIME TO STUDY CHEMISTRY

Not only are there boundless opportunities for amassing wealth in Chemistry, but the profession affords congenial employment at good salaries to hundreds of thousands who merely follow out its present applications. These applications are innumerable, touching intimately every business and every product in the world. The work of the chemist can hardly be called work at all. It is the keenest and most enjoyable kind of pleasure. The days in a chemical laboratory are filled with thrilling and delightful experimentation, with the alluring prospect of a discovery that may spell Fortune always at hand to spur your enthusiasm.

YOU CAN LEARN AT HOME

To qualify for this remarkable calling requires elaborate specialized training. Formerly it was necessary to attend a university for several years to acquire that training, but thanks to our highly perfected and thorough system of instruction, you can now stay at home, keep your position, and let us educate you in Chemistry during your spare time. Even with only common schooling you can take our course and equip yourself for immediate practical work in a chemical laboratory.

EASY MONTHLY PAYMENTS

You don't have to have even the small price of the course to start. You can pay for it in small monthly amounts—so small that you won't feel them. The cost of our course is very low, and includes everything, even the chemistry outfit—there are no extras to buy with our course. Our plan of monthly payments places a chemical education within the reach of everyone.

SPECIAL 30 DAY OFFER

Besides furnishing the student with his Experimental Equipment, we are making an additional special offer for a short while only. You owe it to yourself to find out about it. Write today for full information and free book "Opportunities for Chemists." Send the coupon right now while it is fresh in your mind. Or just write your name and address on a postal and mail it to us. But whatever you do, act today before this offer is withdrawn.

DON'T WAIT—MAIL COUPON NOW!

CHEMICAL INSTITUTE OF NEW YORK, Inc.

Home Extension Division 6

36-R West Broadway

New York City

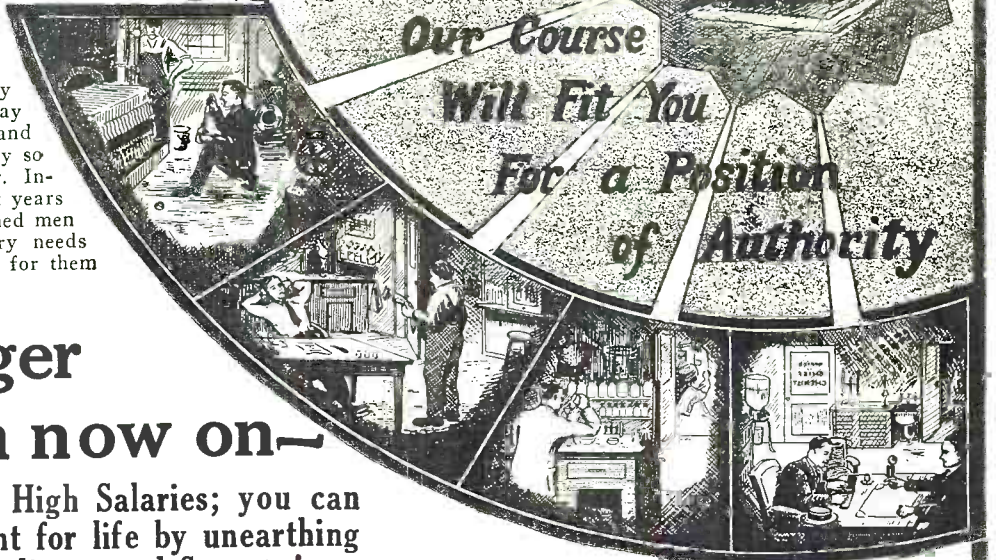

LETTERS From Students Who Have Taken This Course

You will probably be pleased to learn one of the lessons gave me an idea to turn my chemical knowledge to profitable account. I am now making a varnish and paint which undersells the other type products by \$2.60 a gallon, in some cases more. Have been receiving gallon orders from painters during past week which has netted me a profit of \$12.50 for my "spare-time chemical industry." Many thanks for your training thus far.

J. J. KELLY.

I am but half way through your course and am certain that I have saved my Company many times the cost of the course and raised myself in the Share Holders estimation. The knowledge obtained has its immediate practical application and I do not hesitate in saying your course and the personal attention you give is invaluable to the practical man in any business where chemistry plays a part. You may use this letter and my name and address to the furtherance of your good work.

JOHN WALTER.

I have not written since I received the big set. I can still say that it far exceeded my anticipations. Since I have been studying with your school I have been appointed chemist for the Seranton Coal Co., testing all the coal ash by proximate analysis. The lessons are helping me wonderfully, and the interesting way in which they are written makes me wait patiently for each lesson.

MORLAIS COUZENS.



T. O'CONOR SLOANE, A.B., A.M., LL.D., Ph.D.

Noted Instructor, Lecturer and Author. Formerly Treasurer American Chemical Society and a practical chemist with many well known achievements to his credit. Not only has Dr. Sloane taught chemistry for years but he was for many years engaged in commercial chemistry work.

EXPERIMENTAL EQUIPMENT FURNISHED TO EVERY STUDENT

We give to every student without additional charge this chemical equipment, including forty-nine pieces of laboratory apparatus and supplies, and forty different chemicals and reagents. These comprise the apparatus and chemicals used for the experimental work of the course. The fitted heavy wooden box serves not only as a case for the outfit but also as a useful laboratory accessory for performing countless experiments.

CHEMICAL INSTITUTE OF NEW YORK

Home Extension Division 6

66-R West Broadway, New York City

Please send me at once, without any obligation on my part, your free Book "Opportunities for Chemists," and full particulars about the Experimental Equipment given to every student. Also please tell me about your plan of payment and your special 30 day offer.

NAME

ADDRESS

CITY STATE

R.N. June, 1927

HERE IT IS!

Marvelous Townsend
BELIMINATOR \$4.95
 (Complete) *only*
Size Down Balance Cop.

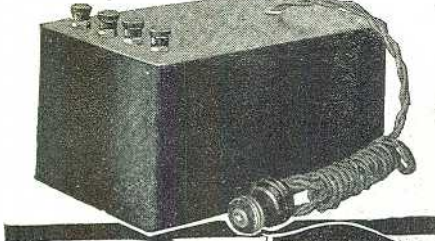

Direct from Factory
 at lowest price on record

10 Days FREE TRIAL
 You are the Judge!

Here is great news! For half the price of a set of "B" batteries you can now enjoy greatly improved reception and be done forever with the nuisance of recharging and renewing unreliable "B" batteries. We make every part that goes in the Townsend "B" Eliminator in our own factory. That's the reason we can give it to you at such a low price—give you a high quality instrument backed by a real guarantee. Users report splendid results. A fine "B" Eliminator at the lowest price on record. Our 10 days Free Trial proves it.

MONEY BACK

if not amazed and delighted

You alone are the judge. We could not afford to make this guarantee if we were not sure of the Townsend "B" Eliminator's splendid performance. Just plug into your electric light socket and in a moment you will realize what good reception means. Delivers up to 100 volts on any set, on direct or alternating current—any cycle. Gives full wave rectification. Full tone, clarity and volume—uninterrupted by screeches of fading batteries.

REPORTS SATISFACTION

Alexandria, Ind.
 Enclosed find check for which please send me two Townsend "B" Eliminators. I am using one of your Eliminators on a reflex set that a well known "B" Eliminator costing \$27.50 would not operate.
 H. FRED CAREY.

The Townsend "B" Eliminator is completely enclosed in a heavy steel case with beautiful lacquer finish. Handsome in appearance—satisfactory in operation.

Rush Order Today!

Simply fill out the coupon and slip it into an envelope with only \$1.00. Get it into the mail at once. Your "B" Eliminator will be sent you promptly by return mail. Deposit only \$3.95, plus postage with the postman. Try out the Eliminator for 10 days—then if not astonished and thrilled by improvement in operation, return it to us and purchase price will be refunded in full. You don't need to put up with battery nuisance another day when it is possible to own a "B" Eliminator at this startlingly low price. Send for it today.

TOWNSEND LABORATORIES
 713 Townsend St. Dept. 25 Chicago, Ill.

Attach Only \$1.00 to this Coupon

TOWNSEND LABORATORIES
 713 Townsend St., Dept. 25, Chicago, Ill.

Gentlemen: Attached find \$1.00. Kindly send at once Townsend "B" Eliminator, C. O. D., for \$3.95, plus postage, on guaranteed 10-day free trial.

Name _____

Address _____

City _____ State _____

"Televisionary"

"WE have found it necessary to coin a new word here," said C. Francis Jenkins, the inventor, to newspaper representatives, in speaking of the television demonstrations by radio and trunk telephone wires. "We speak of television as sight transmitted over wires, and of *radiovision* when the transmitting medium is the air."

"May I bespeak the adoption of *radioscape* to designate the image projected in television?" said Henry Woodhouse, president of the Aerial League of America, in a recent letter to the *New York Times*. "The expression was first used in reporting the findings of the committee, of which I was chairman in 1923, which studied the prospects of television. In the early days of aviation I proposed the adoption of *airscape*, and no better term has been found so far to designate views photographed from the air. *Radioscape* would readily be understood to mean an image transmitted by radio."

While the radio view of a landscape may be expected as a later development, at present radiovision is limited to interior scenes under proper illumination, and the "teleoppper" or "radioppper" suggested by an English writer seems to be etymologically more appropriate. The words which will finally be adopted are those which will strike the public fancy as most easily pronounced and understood.

A TO-BE NEEDED NEW WORD

The classical mind does not like to see a new word built up from two different languages, especially when those two languages happen to be Greek and Latin. It prefers to see words made up from one language only, as for example, the familiar word telephone, which is derived from the Greek word *tele*, meaning *far off*, and a second Greek word, *phono*, meaning *I speak*.

One of the alternatives suggested instead of the word television is the word *teleopsis*, a word wholly Greek in origin since it is derived from the Greek words *tele* and *opsis*, the latter meaning a *view*.

Now I rather like the word *teleopsis*, and I'll tell you why. With the word television we find the word *televisor* used to denote a television receiver, but if the word *teleopsis* came into use, I think that we should all agree that the best word for a teleopsis receiver would be *teleoppper*.

I think *teleoppper* a vast improvement on *televisor*, don't you?—*Wireless Magazine*, London.

SOME DO!

"I have a particular aversion to sopranos on the radio, and whenever one starts to sing I tune off immediately," says a contributor to the column, "My Most Embarrassing Moment," in the *New York News*: "My daughter, June, 4, and myself attended an entertainment recently where a soprano was scheduled to sing. Just as a beautiful clear voice was heard, my little one chirped up very clearly: "Mother, shall I turn her off?"

HAVE YOU HEARD THESE?

This week's Explorer: The tired man who said he was looking for a portable storage battery.

This week's Inventor: The man who is trying to devise a means of preventing tube filaments from heating up, and a silencer for loud speakers.

This week's Cheerful Ass: The man who asked whether, if he gave up the phonograph in favor of radio, his 12-inch records would fit a 3-tube set.—*Popular Wireless*, London.

XL Products

Model "N" Vario-denser
 Pepup Your Set!

Quick, easy tuning—more volume, clearness, stability, with an X-L VARIO DENSER in your circuit.

Specified and endorsed by foremost Radio designers in all latest and best hook-ups.

Model "N" tube oscillation on all tuned radio frequency circuits. Neutrodyne, Roberts two tube Browning-Drake, McMurdo Silver's Knockout, etc. capacity range 1.8 to 20 micro-microfarads. Price \$1.00.

Model "G" with grid clips obtains the proper grid capacity on Cockaday circuits, filter and intermediate frequency tuning in heterodyne and positive grid bias in all sets. Capacity range: Model G-1, .00002 to .0001 MFD. Model G-5, .0001 to .0005 MFD. Model G-10, .0003 to .001 MFD. Price \$1.50.

X-L PUSH POST Push it down with your thumb—insert wire, remove pressure and wire is firmly held—vibrations will not loosen—releases instantly. Price 15c.

Strip of 7 on panel. Price \$1.50

Build the new L O F T I N-WHITE constant coupled radio frequency circuit. FREE wiring diagram showing use of this and other popular circuits sent on request.



X-L RADIO LABORATORIES
 2426 Lincoln Street, Chicago, Ill.

FROST-RADIO

BAKELITE and METAL FRAME RHEOSTATS

Made in a wide variety of resistances to suit every requirement. Your dealer can supply you. Get in touch with him today.



Bakelite Type, 2 1/2 to 75 ohms, 75c.
 Bakelite Potentiometer, 200 and 400 ohms, \$1.00.
 Metal Frame Rheostats, 2 1/2 to 75 ohms, 50c.
 Metal Frame Potentiometers, 200 and 400 ohms, 75c.

HERBERT H. FROST, Inc.,
 Main Office and Factory
 Elkhart, Ind.

Chicago Pittsburgh New Orleans
 New York Philadelphia St. Paul
 Boston Washington, D. C. Los Angeles
 Buenos Aires, Argentina

M-EMERSON-MULTIVALVE

Seven-element tube with 201A filament, three plates and three grids. Uses any battery. Operates on 5 volts. Draws only 1/4 ampere. Fits any standard socket. Can be used with many circuits. Write for information.

List Price \$6.50
 Exclusive Licensees and Manufacturers
Emerson Radval Corp.
 25 West 43rd St. N.Y.C.

KARAS EQUAMATIC MANUAL 10c

MAIL 10c today for complete Manual of Karas Equamatic 5-Tube Sensation. Contains simple instructions and complete wiring diagrams for building this great receiver—the most powerful and most selective 5-tube radio frequency receiver ever designed. Address

KARAS ELECTRIC CO.,
 1124 Association Bldg. Chicago

LIGHTING FIXTURES

Ready to Hang

Direct from the manufacturer. Completely wired, including glassware. Send for new catalogue No. 28. Just Reduced Prices.



Special Proposition To Dealers
 Erie Fixture Supply Co., Inc.,
 Station R. Erie, Pa.

“Choose Your Sound”

“The roar of Niagara has now been successfully broadcast and other strange sounds are expected to follow.”—*News Item.*

The latest fad in radio,

Is not around the world to go—

Imaginary visits here and there.

It's to sit with eyes that glisten,

In a hypnotized condition.

While funny sounds are wafted through
the air.

You'll surely get a thrill or two
(There's really much in store for you),

By tuning in on N-O-I-S-E.

Hear Niagara's mighty rumble,

A man in Guatemala stumble,

The heart-beat of an Asiatic flea.

Hear the ice in Iceland cracking,

Or the terrifying smacking,

As two lovers kiss in sandy Zanzibar.

Get the Geisha girls tea-sipping,

Or a Zulu chieftain clipping

The end of his American cigar.

Hear the maidens sigh in Guadalupe;

A Hindoo lapping gumbo soup.

In Oriental, mystic Hindustan.

List to a hungry spider crawl,

Along the base of China's wall;

The mist arising on the Isle of Man.

Hark to a gentle April rain;

A Porto Rico hurricane;

The drop of stocks in Wall Street's
gloomy chasm.

If other sounds you've never heard;

Just ask for them—the more absurd,

The surer is it that your station has 'em.

—Roy Coleman.

A HINT TO HOTEL BUILDERS

AN incentive to equipment with radio connections, multiple aerials, etc., of hotels soon to be constructed, should be found in this article from the chatty pages of *Variety*, the theatrical weekly. There are many others beside the members of the histrionic profession who are radio fans.

“It is an old gag for theatrical people to pass up the first rate hotels and go to third-rate ones so they can take their dogs—or cats—with them. But John Snecenberger, manager for Al Jolson, goes to the little old-fashioned hotels for another reason—he gets a better reception there. We mean radio reception. For it seems that the new big hotels are built on a steel framework, which to radio is what a bull would be to a Christmas gift shop.

“Mr. Snecenberger contends that radio is a cure for every vice—unless you consider radio, itself, a vice. Does he take a pretty little lady out to dinner after the show, does he hunt up poker games, does he scurry about after bootleggers' addresses? He does not. Immediately the curtain goes down he streaks for his radio, about which he knows more than Mr. Marconi. And it is a dull night that he doesn't get 78 stations.

“But it keeps him on the move, for he won't stay in a room where he can't tune in perfectly. And in Atlantic City he established his record. In his week at the Knickerbocker hotel there he moved five times before he could find a room good enough for his pampered radio.”

NORTH BRITISH THRIFT

IT was an Aberdeen listener, of course, who called at the post office and blandly inquired if his license could be supplied at half the usual fee, as he had become deaf in one ear!—*News of the World*, London.

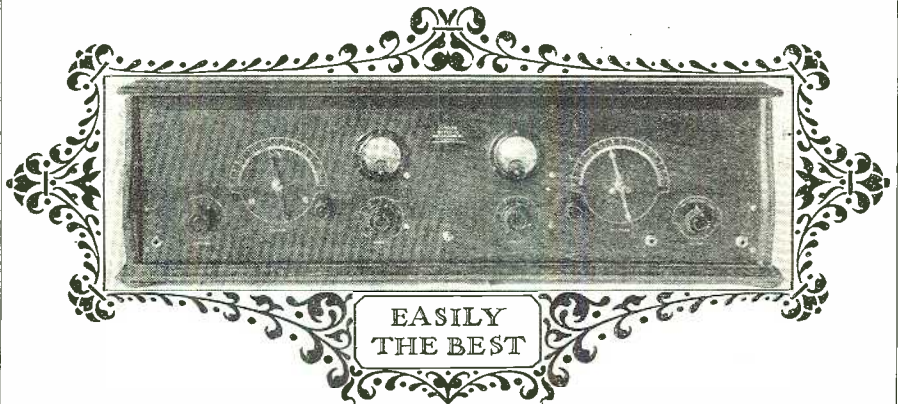

The New Custom-Built 10 Tube Model SUPER-10 SPECIAL

This is the greatest receiving set ever built by Norden-Hauck Engineers. Nothing equals it for sheer performance, quality and distinction. Absolutely nothing has been omitted to provide supreme radio reception—a new standard previously unknown.

The SUPER-10 SPECIAL is the response to your demand for radio perfection, expressed in an individual hand built Receiving Set. Every detail bespeaks the master craftsman. Thus those who would add the final touch of luxury and distinction, may gratify their desire in the Special Super-10. It is for those who want and can afford the best.

EXTRA POWER—Guaranteed Selectivity—absolutely faithful reproduction at any desired volume—and marvelously easy to operate.

Of course the SUPER-10 SPECIAL may be operated either from house current or batteries. The Norden-Hauck Model 500 HI DUTY Power Unit has been designed particularly for the SUPER-10 SPECIAL or any other receiver requiring large current capacity, numerous voltage taps and controls up to 525 volts for the new 210 Power Tube. Upon request attractive illustrated literature which has been prepared on the SUPER-10 SPECIAL and Power Unit will be gladly mailed to you without cost or obligation.

The Standard Super-10 has not been discontinued or superseded by this Special model.

Complete structural Blue Prints and parts are obtainable for the SUPER-10 SPECIAL, STANDARD SUPER-10 and the MODEL 500 POWER UNIT.

NORDEN-HAUCK, INC.

Marine Building

ENGINEERS

Philadelphia, Pa.

For Your Convenience Use the Attached Coupon.

NORDEN-HAUCK, INC.
Marine Building, Philadelphia, Pa.

I enclose \$..... for which send me, postpaid, items checked below:

- | | |
|--|---|
| <input type="checkbox"/> Complete structural Blue Prints for the SUPER-10 SPECIAL @ \$2.00. | <input type="checkbox"/> Complete structural Blue Prints for the MODEL 500 POWER UNIT @ \$1.00. |
| <input type="checkbox"/> Complete structural Blue Prints for the SUPER-10 STANDARD @ \$2.00. | <input type="checkbox"/> Illustrated literature on the SUPER-10 SPECIAL. STANDARD. |

Name.....Address.....

Thousands Use These Ingenious TRANSMITTER UNITS

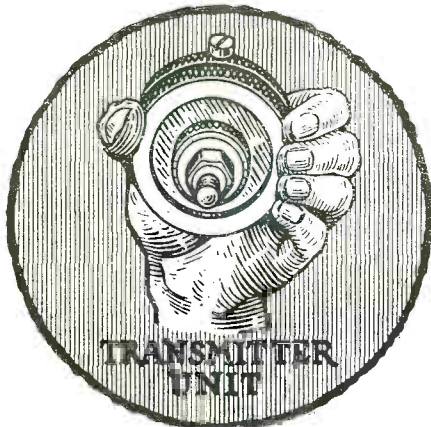

Here's a marvel of Engineering design—a practical miniature transmitter, used by thousands of radio fans and experimenters for amplification purposes. It is a most novel unit, having hundreds of uses. Every amateur should have two or three of these amplifiers in his laboratory.

A FEW USES FOR THESE UNITS

 -LOUD SPEAKER RETRANSMISSION-	 -PHONOGRAPH MUSIC AT A DISTANCE-
 -GRID LEAK-	 -AMPLIFIER-
 -ONE STAGE AMPLIFICATION-	 -RADIO AMPLIFIER-
 -TALKING LIGHT-	 -DETECTOR-
 -CODE PRACTICING DEVICE-	 -BALDWIN PHONE AMPLIFIER-

With each unit is mailed an eight-page instruction pamphlet containing suggestions for innumerable uses. Our supply is limited; avoid disappointment by ordering today. The coupon below is for your special convenience.

SPECIALLY PRICED
While they last— **95c**
(or Two for \$1.75) per unit

THE PRESS GUILD,
66-R West Broadway, New York, N. Y.
Enclosed find 95c/\$1.75 for which send me postpaid one/two amplifier units as advertised.

Name

Address

City, State

RADIO JINGLES

LESSENERD INDUCTANCE

*A tough Bowery boy named O'Boyles
Had a date with one of the "goils";
She'd had her hair bobbed,
And he cussed till she sobbed,
For he liked her much better in*
—Paul E. Sommer.

FROM AN ENGLISH "AM"

*A regular glutton was Peter,
To whom no notion was sweeter
Than to guzzle and eat;
He thought bacon a treat,
But was also a noted*
—Arthur Wolfendale,
Wigan, Lancashire.

HETERODYNED!

*A girl stopped to giggle and titter—
Just then a big Cadillac hit her;
Soon she "turned up her toes,"
As the old saying goes—
To the graveyard they then did*
—Frank D. Lockwood.

FROM A RADIANT AMATEUR

*times a day I
Keyed up, glowing as I greet her;
I'll have to put her in a*

To keep the from Rae Zinnelle.
—R. A. Rounsavelle.

SPARKS' CHANTEY

*Sailor boy, be jolly,
For sure as you are born,
Radio "sigs," by golly*
Reach the from Cape
—Nils Radhe.

UNDERGROUND RESEARCHES

*A popular star, they've found,
Made a full of money at Brown;
But the banks he won't trust,
For fear they'll go bust,
So he buries his in the*
—Carl F. Haubrich.

STUMBLING OVER A WAVE TRAP

*"Oh, what's that noise? Hark!
Go get a cop, please—"
"Shut up, you big cheese,
That's dad coming home in the d*
—Robert Jaffe.

ANOTHER CRIME WAVE

*There was an archdeacon of Bristol,
Who murdered his niece with a pistol,
"For," said he, "I can't bear
Your absurdly-cropped hair,
And your listening in with a*
—"Punch," London.

LOCAL RECEPTION

*My sister bought a radio set,
To tune in stations far;
The only one that she can get
Is WFBR.*
—Marguerite Poos, Baltimore, Md.
(A suggestion for the jinglers. See if you can do better with your log.—Jingle Editor.)

Licensed by Rider Radio Corporation.
Pat'd 5-2-'16
Pat'd 7-27-'26
Other Patents Pending

Eliminate Oscillations in your set

Phasatros

DON'T be satisfied with mediocre results in that set you've been building—eliminate oscillations—get distance clear—by installing Phasatros.

"A True Balancing Device for Radio Frequency Amplifiers"

Phasatros are very simple to install and adjust. Check interference, improve reception as well as banish oscillation squeals. Your dealer or service man will gladly install Phasatros. Price \$2.75. Write for free hook-up circular and descriptive matter.

"Quality Parts for Quality Reception"

Dept. 27, 175 Varick St., New York, N.Y.

ELECTRAD

THESE COILS IMPROVE ANY RADIO RECEIVER!

T.R.F. KIT List \$12.00

This set of supersensitive Aero Tuned Radio Frequency Coils has never failed to improve the performance of any radio receiver. Tremendously increased power, extreme selectivity, and improved tone quality are sure to result from their use. This kit of Aero Coils has a much lower high frequency resistance than other types of inductances. You should use them in any circuit, if you want the best possible results.

FREE Big 8-page 4-colored layout system (actual size blue prints) and complete instructions for building the 5-tube Aero-Dyne Receiver free with each kit. Also insert showing how to wire for a power tube if desired. Extra copies, 75c each.

Get these Aero coils from your dealer. If he is out of stock, order direct from the factory.

AERO PRODUCTS, INC.
Dept. 105, 1772 Wilson Ave. Chicago, Ill.

Special Library of Information on

RADIO PATENTS and TRADE MARKS

JOHN B. BRADY
Patent Lawyer
Ouray Building Washington, D. C.

Cable address: RADIOPAT Telephone: Main 4806

For Absolute Tone Fidelity hear a FERGUSON RECEIVER. Ask the nearest Authorized Ferguson Dealer or write us. J. B. FERGUSON, Inc., 225 West 57th St., New York, N. Y.

New Power Pack and Power Amplifier

(Continued from page 1461)

plifier tube and terminal No. 2 of the output transformer. Then, when the power transformers are properly poled, maximum reading will be observed upon the milliammeter.

In operation, care should be exercised in handling the power pack, for, delivering as it does well over 400 volts in operation, a dangerous shock might be obtained. This same condition holds should either the amplifier tube or the voltage-regulator tube be removed from its socket, in either of which cases the output voltage will mount to a higher value. If desired, a connection in the base of the glow tube (formed by the contacts "P" and unused "F") may be used as a switch to break the primary circuits of the power transformers by connecting them in one side of the cord of each power transformer. This provides an automatic switch in case the glow tube is removed.

From zero to 10 milliamperes may be drawn from the 45-volt tap of the power pack; and from zero to 45 milliamperes from the 90-volt tap, with the assurance that the voltages will remain far more constant than in the case of ordinary socket-power units, because of the use of the glow-tube regulator. One precaution to be observed in operation is that, should the power pack be used with one stage of amplification in a radio receiver, difficulty may be experienced from howling. This may be overcome by reversing the cords leading to the two tipjacks marked "SFT" and connecting to the primary of the audio transformer.

If the builder will construct the power amplifier and receiver "B" supply described above carefully, with attention to proper selection and assembly of parts, he will be surprised at the remarkable quality of reproduction obtainable from it, as compared to other power packs employing but a single rectifier tube. He will be impressed as well by the tremendous volume provided by the power tube.

HISTORY REPEATS ITSELF

An Atchison man looks upon radio as something flying in the face of Providence. That was the way his grandfather looked on the bathtub.—*Atchison Globe*.

MY RADIO

The evenings were so dull and slow
Until I got my radio,
But now the flying minutes go
Careering straight ahead.

I catch the prophets weathering,
I get Chicago on the string
And just when someone starts to sing,
It's time to go to bed.

That radio has taught me how
To nurse a child or milk a cow,
The proper way to make a bow,
And how to cure the croup.

I've learned the very latest wheeze
How to banish baggy knees;
I wish they'd teach me how to sneeze
When my mouth is full of soup.

—C. W. Newcomb.

EL-FONIC PRODUCTS

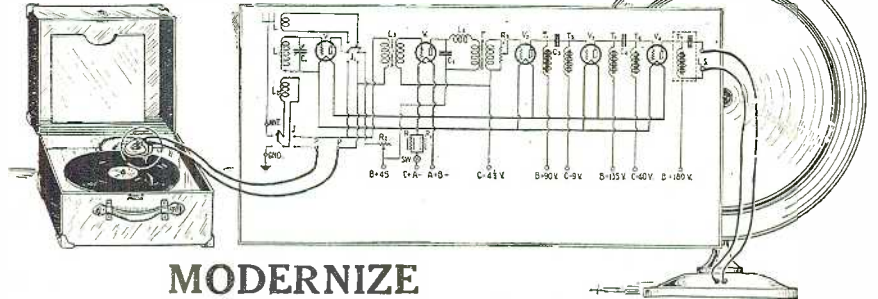

MODERNIZE

YOUR VICTROLA OR PHONOGRAPH INCLUDING PORTABLE MODELS

You can play all those good old Records and new ones with the

EL-FONIC capacity pick up

—and bring them all back to life right out of your Radio Loud Speaker.

No static, no fading, no interference, no needle scratch, perfect fidelity of tone over the entire audible band of frequency less any trace of distortion.

EL-FONIC CHOKE

2,000 HENRIES GRID IMPEDANCE LEAK

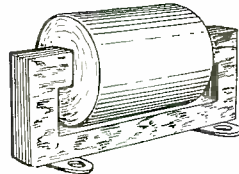

\$6.00

PREVENTS MOTOR BOATING

ADAMS-SIBLEY DEVELOPMENT CORPORATION
119 West 63rd St., New York, N. Y.

PRICE
\$14.50

Established below list during a limited period for the experimenter only

FREE

With every El-Fonic Pick-Up a complete set of blueprints and instructions of how to build the Jewell Audio Amplifier.

And the El-Fonic Phono-Radio Receiver.

Forwarded by Parcel Post, prepaid, upon receipt of remittance.

JEWELL EL-FONIC ADAPTER

FOR USE IN CONJUNCTION WITH THE EL-FONIC PICK-UP

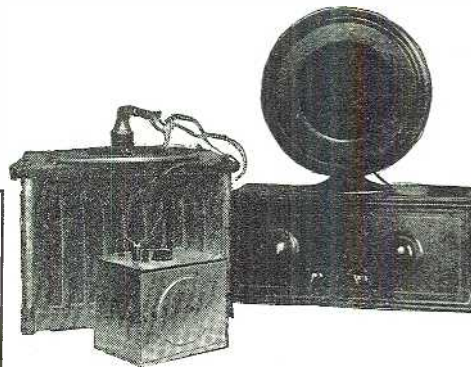

\$12.50

Jewell Dual Impedance Audio Amplifier Kit \$35.00

- 1 Oscillator coil
- 2 2,000 Henries Grid Chokes.
- 3 200 Henries Plate Chokes.

1 200-600 Meter Radio Frequency Transformer.

1 Audio Transformer.

1 Radio Frequency Choke.

Free — with Every Kit a Complete Set of Blueprints and Instructions.

This adapter when placed between the EL-FONIC capacity pick-up and YOUR RADIO RECEIVER will ELECTRIFY YOUR VICTROLA OR PHONOGRAPH. In other words, it is a miniature Broadcasting Station that is modulated by your Phonograph and played through your Radio Receiver and Loud Speaker.

Parcel Post prepaid on receipt of remittance.

Jewell Laboratories

119 West 63rd St., New York, N. Y.

El-Fonic Oscillator Coil
\$2.50

Jewell Grid Chokes 2,000 Henries
\$6.00

Jewell Plate Chokes, 200 Henries
\$5.00

El-Fonic Pick-Up
\$14.50

Jewell Radio Frequency Transformer, 200-600 meters
\$4.00

Jewell Audio Frequency Transformer
\$5.00

Jewell Radio Frequency Choke
\$2.00

IF YOU LIVE WITHIN 75 MILES OF NEW YORK Read

NEW YORK



The new, complete Listeners' Guide to Radio Programs FOR THE FIRST TIME

A really complete radio program for New York and its environs is available. Not only are all the features of the programs listed by their full name but the program is printed in such a way, that the title to be rendered, be it vocal or instrumental, will be printed so that if you wish to listen in to a certain station, you will know in advance just what its program will be in detail.

RADIO PROGRAM WEEKLY is also a weekly magazine in which you will find reflected everything that happens or will happen in broadcasting that is of interest to you. You who listen constantly to radio programs must often feel curious as to what goes on behind the scenes, and what the process of broadcasting entails. You can not help but be interested in the artists, the radio directors, and announcers. All of this and more is represented each week in RADIO PROGRAM WEEKLY in a non-technical interesting manner. The magazine has been built in such a way that it is of interest to every one of the family.

ALTOGETHER, RADIO PROGRAM WEEKLY

Can be summed up as follows:

- 1st—A non-technical radio magazine, published and edited for the radio listener;
- 2nd—Brings to all radio listeners correct and exhaustive radio programs;
- 3rd—Keeps listener informed of each and every phase of radio broadcasting of interest to him;
- 4th—Serves as an effective link between the listener and the broadcaster;
- 5th—Helps uphold the listener's rights; and,
- 6th—Is fair to broadcasters and artists.

0¢ THE COPY

OUT EVERY THURSDAY ON ALL NEWSSTANDS

Published by the Publishers of RADIO NEWS

DESCRIBED
IN APRIL
ISSUE
OF
RADIO
NEWS



BUY H F L
TRANS-
FORMERS
AT ANY
RELIABLE
DEALER



NA-ALD

UX POWER TUBES installed in any set without rewiring by, Na-Ald Adapters and Connectoralids. For full information write Aiden Manufacturing Co., Dept. K-29, Springfield, Mass.

ELECTRICITY—EASY AT LAST!
Learn By Doing in 90 Days
NO BOOKS—NO LESSONS. Big tabs waiting to pay \$50 to \$200 a Week. Come to COYNE for 90 days then get one. Learn by doing. COYNE gives you training and experience. Write for big FREE book and PRIZE R. R. Fare offer. COYNE ELECTRICAL SCHOOL, 1306 W. Harrison St., Dept. A7-77 Chicago, Ill.

Balkite
Radio Power Units
FANSTEEL PRODUCTS CO., INC.
North Chicago, Illinois

EVERYTHING IN RADIO
AT ATTRACTIVE PRICES. SETS OR PARTS.
Orders shipped exactly as ordered. Prompt Service.
Write for Prices. Mail Order Only. Send Your Address.
ALL RADIO COMPANY, 417 North Clark St., Chicago

Insure your copy reaching you each month. Subscribe to RADIO NEWS—\$2.50 a year. Experimenter Publishing Co., 230 Fifth Ave., N. Y. C.

The Interbalanced Regenerative Receiver

(Continued from page 1445)

cans proper are fitted after the set has been completely assembled and wired.

The wiring of the set can be done quite easily with the aid of the schematic and picture diagrams. The filament end should be tackled first, completed and tested before anything further is attempted. It will be seen that the filament ballast R1 is connected to the R.F. amplifier tube alone, R2 to the detector alone, and R3 to the three audio-amplifier tubes. The filament switch is in the positive leg of the circuit. After all the wires have been fastened in place and the "A" ends of the battery cable soldered, five tubes should be inserted in the sockets, the cable connected to the "A" battery and the switch snapped on. If all the tubes light up, remove them, disconnect the battery and proceed with the rest of the set. If one or more remain dark, go over the wiring. It is very easy to forget a short section at some vital point and thus to leave the circuit open.

The use of a complete audio-amplifier unit saves much labor in both the assembly and wiring operations. The principle of the unit employed has been fully described in RADIO NEWS for June and October, 1926.

POWER SUPPLY

The "A," "B" and "C" power requirements are standard. A six-volt storage battery, two small "C" batteries, and 135 volts of "B" battery will provide the receiver with its power. The success of a "B" socket-power unit with a straight resistance-capacity amplifier is problematical, as any radio experimenter knows. Some units work beautifully, without producing the slightest trace of a hum; others generate a terrific "motor boating" noise. In general, the use of additional filter and by-pass condensers will cure the trouble; sometimes the substitution of a high-inductance grid choke for the grid leak of the last A.F.-tube is very effective.

THE BEST RADIO LANGUAGE

MANY European amateurs have been conducting a series of experiments between England and the Continent to find out what are the best languages for broadcast purposes. They have come to some definite conclusions. French, they say, is not a good language for radio purposes; its sounds are too soft and similar, the enunciation not clear enough, the accents not deliberate. Spanish and Italian are likewise placed in the same category. Russian and German are much better for broadcast purposes, as their sounds are guttural, deliberate and definite. The sounds find a ready response in the microphone. English is somewhere between German and French: it is a fairly good language for the radio fans but not the best. Of all the languages Welsh is claimed to be the best, for its euphonisms and alliterative sentences are not only pleasing to the ear but very easily received by the microphone. Welsh people have claimed many times that their language is that of Heaven. —E. B. Rard.

(The News Editor, having Welsh ancestry, is somewhat gratified by this refutation of a popular slander, which alleges that the Welsh language originated at the building of the Tower of Babel, through a singular incident. Two masons were engaged in an altercation, so the story runs; and at the moment of the "confusion of tongues," one slapped the other across the face with a trowel of mortar. The folk tale quoted, now definitely disproved by the findings above, relates that the man with the mouthful of mortar immediately continued conversing in Welsh.—NEWS EDITOR.)

Giant New Transmitting Tube

(Continued from page 1435)

pressure-indicating device on the operating panel. This gauge indicates the ratio of ionization by collision with electrons due to pressure or amount of the gas present, thus showing if the gas content is becoming too high in the big tube.

It was necessary to design a new water-cooling jacket to carry off the heat generated in this tube; in a jacket of the customary type there is contained an inner flexible jacket for directing the water over the plate.

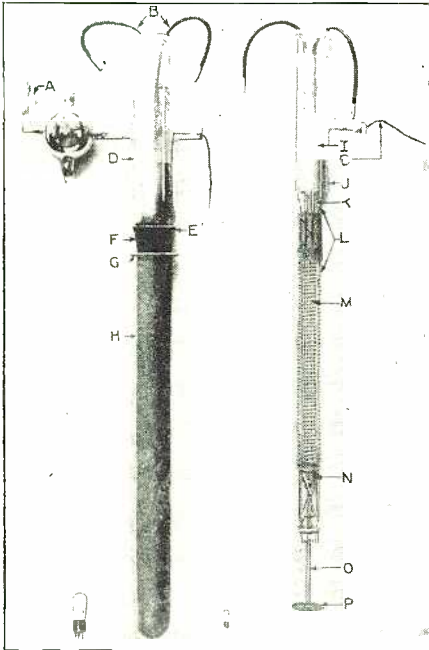

In contrast to the 100-kw. tube are shown at the bottom the proportions of a 201A-type and a "peanut" tube. The parts of the large tube are designated by letters as follows: a, ionization gauge; b, filament lead wires; c, grid lead; d, high tension bushing; e, glass junction to copper anode; f, anode seal; g, securing flange; h, copper anode; i, filament pinch seal; j, grid supporting clamp; k, molybdenum inner filament leads; l, tungsten grid structure; m, parallel filaments; n, filament spring support; o, quartz support and insulator; p, spacer disk.

As may be seen from the illustrations, the tube when mounted for use is about seven and a half feet high. It weighs in the neighborhood of one hundred pounds. An interesting sidelight is that the high-frequency output of this tube, if used to supply power for 40-watt lamps, would light 2,500 of them. What the future holds in the development of vacuum tubes is hard to say; but if the present trend continues at the rate of the last few years, we will soon have super-power stations using only about five tubes altogether.

AN OSCILLATING WAVEMETER

Fate Father: "So coming to listen to the new radio was only a blind. Here I find my daughter in your arms with her head on your shoulder!"

Confused Suitor: "Er, no, sir, you see I was simply getting her wavelength" and he fondly caressed her new permanent.

—Anna M. Anderson.

FACILITATING DX WORK

Listeners who have not got a radio license, declares an authority, have not got the right spirit. But we understand that the B.C.I. crystal user who got America the other night had the right spirit, even if it was a wet one.

—Popular Radio Weekly, London.

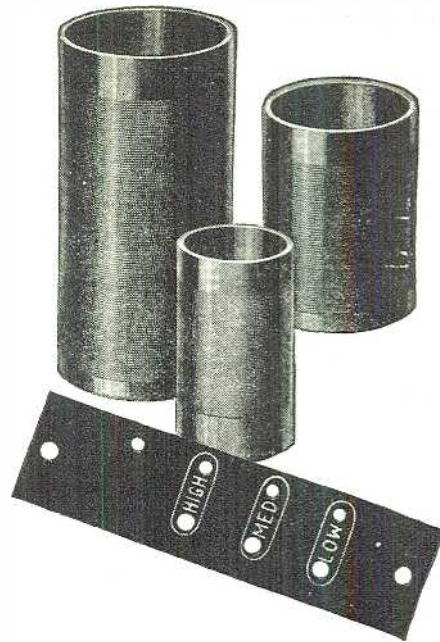

Formica Services For Manufacturers

Formica threaded tubing, with threads ground in is a very smooth, good-looking job. Formica supplies all kinds of punched sub panels, strips and parts and marks the identification of terminals by two processes.

KIT PANELS

Formica kit panels supplied to amateur set builders through the leading jobbers and dealers include: Karas Equamatic, Bremer-Tully Power Six, H. F. L. Nine-in-Line with sub panel, Victoreen Single Dial or two dial, Infradyne 7"x28" and 7"x30", Aerodyne, St. James 8 Tube, Bremer-Tully Counterphase, Browning-Drake National, Madison Moore Superheterodyne and others.

Special panels cut to size and Formica tubing are also available for amateurs.



THE FORMICA INSULATION CO.
4618 Spring Grove Avenue, Cincinnati, Ohio

Hear the FORMICA
Orchestra Tuesday
9 to 10
over WLW



Formica has a
Complete Service on
Insulating Material for
Radio Manufacturers

30 DAYS FREE TRIAL 7 Tube-Single Dial RADIO SET



Write for this Wonderful offer direct from factory World's greatest radio. Perfect working, single dial control. 7-tube receiver, shipped to your home for 30 days free trial. Test it for distance, volume and tonal quality—and if you are not convinced that it is the best single dial set you ever heard return it to factory.

Retail Price
\$75
Completely Assembled

METRODYNE SUPER-SEVEN

Only one dial tunes in all stations. Get 1,000 to 3,000 miles on loud speaker. Easiest set to operate. Highest grade parts used. Magnificent Two-tone Walnut Cabinet.

Big Profits to Agents and Dealers selling Metrodyne radios. All or part time. Great money making opportunity. Demonstrating set on 30 days free trial. WRITE FOR OUR OFFER.

METRO ELECTRIC CO.
2161 N. California Ave., Dept. 106, Chicago, Ill.

Dealers! Set Builders!

Save Money—Write for

CHI-RAD'S FREE RADIO CATALOG

Madison-Moore—Victoreen
Browning-Drake—Nine-In-Line
Transmitting Apparatus

Be Sure to Use Business Letterhead
When Answering

CHICAGO RADIO APPARATUS CO.,
415 S. Dearborn St., Dept. RN., Chicago

Opportunity abounds in Radio

Advancement in salary and rank is rapid in this fascinating work. Trained men are always in high demand—as ship operators sailing to foreign lands, and as mechanics, assemblers, salesmen and installers on shore.

Study at home

Radio Institute of America offers the finest instruction obtainable. The low cost of the course makes it a real investment that pays dividends in higher wages. Study at home! Write now for full information.

SEND THIS IN

Radio Institute of America F
324 Broadway, New York City

Please send me full information about both your Home Study Courses of radio instruction—with code and without.

Name.....
Address.....

RADIO INSTITUTE OF AMERICA
(Formerly Marconi Institute)
Established in 1909
324 Broadway New York City

Learn in 10 WEEKS at Home

Become a RADIO EXPERT

Earn Big Money In this Gigantic, Fascinating Field!

WE GUARANTEE TO REFUND TUITION IF YOU ARE NOT SATISFIED WHEN YOU COMPLETE THE COURSE

Everyone should have radio knowledge today. Now you can get a simplified complete home study course that will qualify you to hold a big-pay Radio job. Even if you do not plan to become a professional. You shouldn't pass up this chance to learn all about Radio at a price hitherto unheard of. Money-back guarantee. Ask for particulars.

AERO-SYSTEMS, Inc., Dept. 206, 19 South Wells Street, Chicago, Ill.

MAIL COUPON NOW

AERO-SYSTEMS, Inc., Dept. 206
19 South Wells Street, Chicago, Illinois.

Please send me full particulars of your amazing low-priced complete Radio Course.

Name.....
Address.....

Turn Dial-get programs everywhere: 30 Days FREE!



MIRACO
Tune 5

28 in. long

Uses super Miraco Radios set Coast to Coast, Canada to Mexico, loud and clear on speaker; outperform \$100 to \$200 sets. Some hear Europe. Marvellous bargain! Don't buy unless 30 Days Trial proves it. Most Selective, Clearest and Most Powerful Distance-Getter among big, fine 5-tube radios. Solid walnut cabinet. Write for **Factory Prices—SAVE UP TO 1/2**. Every set completely assembled, rigidly tested, fully guaranteed. Ultra-5, \$49.75 list. Speakers, batteries, tubes, etc. at big savings.

Free literature, users' testimony and **BIG SPECIAL OFFER!**

MIDWEST RADIO CORPORATION
Pioneer Builders of Sets

404 -E Miraco Bldg., Cincinnati, O.

USER-AGENTS WANTED
Write for discounts

INVENTORS who derive largest profits know a good deal certain simple but vital facts before applying for Patents. Our book Patent-Sense gives those facts; sent free. Write LACEY & LACEY, 631 F St., Washington, D. C. Established 1869.

Television In Darkness

(Continued from page 1423)

let us consider briefly the rotating lens disc and its function in the apparatus.

The lens-disc, it may be remembered, consisted of a large disc upon which were mounted 16 lenses, in two groups of 8, each lens in each group being set a little nearer the center of the disc, or staggered. As the disc revolved each lens took a small portion, or narrow strip of the image and swept it across the light-sensitive cell, so that the entire image was so swept across once for every revolution.

The image was thus divided into 16 vertical strips. They were further sub-divided into minute horizontal portions, or flashes, by the two other rotating discs, and each flash was, in turn, thrown upon the light-sensitive cell and signalled to the distant receiver.

From the foregoing it will be obvious that the fineness of the "grain" of the image as seen on the television screen was limited to sixteen vertical strips, or lines. This is all right for a small reproduced image; but when it is desired to enlarge the size of the television screen it becomes necessary to retain the fineness of grain during the magnification process. Sixteen image strips are scarcely discernible as such, on a screen only about six inches square; but on a screen six feet square the effect can well be imagined.

The obvious solution to the problem seems to lie in an increase in the number of lenses mounted upon the rotating lens-disc, but when an attempt was made to do this, mechanical difficulties were immediately encountered. In the first place, in order to accommodate the desired number of lenses, the diameter of the disc had to be increased to such an extent that it became unwieldy. Secondly, the weight of the lenses increased the centrifugal force of the rotating disc to such a great extent that it burst.

Baird therefore cast about for some other means of projecting an image in small sections across his light-sensitive cell. Besides lenses, prisms and vibrating mirrors can be,

A HOWLING RECEIVER



Ideal Summer Vacations

BERMUDA

Only 2 Days from New York

A "different" vacation with the charm of a trip to Europe

8 day tours—\$97
and up, including every expense for steamer, hotel and side trips. Longer tours in proportion. Rates effective June 1.

Two sailings weekly on the transatlantic liners.

**FORT VICTORIA
FORT ST. GEORGE**

to this quaint little foreign land. A happy sea voyage and a real vacation with all sports.

The St. George Hotel, in historic old St. Georges, with its beautiful location, excellent service, and large tiled swimming pool, offers the last word in modern hotel luxury. \$6.50 per day and up, for room and meals.

Note: Bermuda is free from hay fever.

For illustrative booklet and reservations write

FURNESS

BERMUDA LINE
34 Whitehall St., New York
or any authorized agent

RADIO CATALOG

DEALERS
Send for our new 1927 catalog.

COMPLETE PARTS
Improved Nine-In-Line Super;
Melo-Head; Selective Nine;
Camfield Super Selective Nine;
Citizens Super Eight; Victrola Super; and many other popular circuits.

Use your letterhead.

Western Radio Co.
134-136 W. Lake St. Chicago, Ill.

FIRST CLASS

TRICKLE CHARGER \$250

Post Paid IN U.S.A.

When Cash Accompanies Order. Complete parts 6 ft. extension cord—nothing else to buy. Simple instructions, screwdriver, pliers and 30 min. work. Guaranteed to work on any A.C. socket.

X-L RADIO SALES, Dept. RN
2424 Lincoln Ave., Chicago, Ill.

RADIO Salvage SHEET

SET BUILDERS — DEALERS
Get this Bargain Sheet

It enables you to buy high grade, nationally advertised kits, transformers, condensers, and parts at less than factory cost. Most prices are equal to 60% and 75% discounts. We sell you C. O. D. direct by mail ONLY—no references required.

HENRY WEBER
6742 N. Maplewood Ave., Chicago, Ill.

GENERAL RADIO

Parts and Accessories. Write for Catalog No. 926-N.

General Radio Co. Cambridge, Mass.

EVEREADY
Radio Batteries

—they last longer

COVERAGE OF THE NEW YORK MARKET

is now available through
"RADIO PROGRAM WEEKLY"

Write for Rates
230 Fifth Ave. New York, N. Y.

and have been used for this purpose; but they have their own peculiar disadvantages. Finally the idea of the pin-hole camera occurred to Baird one day, and he devised an apparatus based on this principle.

PROJECTION TUBES A SOLUTION

This apparatus is illustrated in Fig. 1. It consists of a block, or cellular structure, of tubes of tiny diameter which is arranged between the sitter and the two rotating slotted discs. The cellular structure can be seen in the illustration of this block.

Each tube in the block casts an image of a small part of the scene before it, so that the total effect of the block is to split up the entire image into scores of tiny round sections, or dots, and it only remains to impress the light values represented by each individual dot upon the light-sensitive cell in proper sequence.

Baird does this by retaining two revolving discs of his original system. One of these discs has a long spiral slot in it, while the other has a series of radial slots. These discs revolve immediately behind the cellular structure, as shown in Fig. 1, in such a manner that the discs overlap, the overlapping portions moving past each other in opposite directions as the discs revolve.

The spirally-slotted disc, C, revolving comparatively slowly, exposes layer after layer of the tubes to the light-sensitive cell, shifting in a vertical direction. The slots in disc D, which revolves at a high rate of speed, are so arranged, however, that the light ray of only one tube at a time is exposed to the light-sensitive cell.

Thus, while, say, the lower layer of tubes is open to the cell through the spiral slot, the slots in the disc D swing rapidly along the line and flash the light of each tube in turn upon the cell. Then the next row of tubes is dealt with, and so on, until the entire image has been flashed over the cell.

At the receiving end, apparatus exactly similar is installed, except that the light-sensitive cell is replaced by a source of light which is varied by the incoming electrical impulses, which are strong for high-lights medium for halftones, and zero for dark parts of the picture. Immediately in front of the cellular structure, at the end remote from the spinning discs, there is a ground-glass screen, upon which the picture appears, a faithful reproduction of the original, complete with even gradations of light and shade, and showing the movements of the sitter exactly as would a movie film.

THE NEXT STEP

Whereas the older method used by Baird, employing a spinning disc of lenses to project the image upon the light-sensitive cell, tended to produce at the receiver end a picture made up of closely-fitting narrow strips, the new method gives a picture made up of tiny dots, like a newspaper reproduction.

The grain can be made very much finer by this new method, and the picture enlarged considerably; but, even so, the ultimate degree of fineness obtainable, when enlarging the screen, is limited by mechanical imperfections. Obviously there is a limit to the number and thinness of the tubes which can be employed, as also there is a limit to the speed at which discs can be revolved.

Recognizing this, Baird continued his research until he has now developed what he calls an "Optical Lever" to replace all his present image-exploring mechanism. I am not yet at liberty to describe this latest development, owing to the patent situation, but it can be stated that by means of it any degree of fineness of grain can be optically obtained, and there is no mechanical limit to the speed of operation.

PERMANENT RECORDS OF SCENES

An interesting phenomenon in connection with television is that, if the output currents of the light-sensitive cell are listened to in a telephone receiver, they can be heard as



For Good Reception!

Guaranteed to remove the battery nuisance and deliver clearer tone and increased volume. Provides three different voltages at the same time. Each tap adjustable over a wide range, making possible any desired voltage from 5 to 150, absolutely harmonizing "B" current supply to your set. Raytheon tube used as rectifier. No noise or vibration. Contains no acid or solution and will not get out of order. Operating cost negligible.

At Your Dealer's

Price, Complete with Raytheon Tube - - \$35.00
Kokomo Electric Company
 Kokomo, Indiana

Kingston "B" Battery Eliminator

Mar-Co Dials

IMPROVE ANY SET
 CARBORUNDUM STABILIZING DETECTOR UNIT.
 CARBORUNDUM GRID LEAKS AND RESISTORS
 SEND FOR FREE BOOK.
 THE CARBORUNDUM COMPANY, Niagara Falls, N. Y.

WORLD Radio Units Save You 50%

"A" Current From Your Light Socket World "A" POWER UNIT

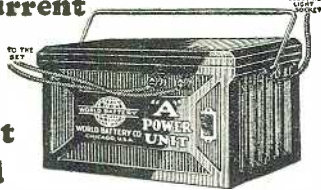

Automatically provides even, unvarying "A" current from the moment you throw on your set switch. A marvelous improvement—at less than half the cost of any similar equipment. Finer reception, uninterrupted by "fadeouts" and "screches." Absolutely noiseless. Assures full tone quality from your set and wider D X range. Shipped complete, subject to inspection, on receipt of price—or C. O. D. if you wish.

\$12.75 Complete

25 Amp. Unit for sets of 4 tubes or less —\$12.75
60 Amp. Unit for sets of 5 tubes or more—\$13.75



"B" Batteries 12 Cell 24 Volt

Sturdy construction. Solid Rubber Case protection. Recharged for almost nothing. Endorsed and listed as standard by Radio News Lab., Pop. Radio Lab., Pop. Sci. Inst. Standards, Lefax, Inc. and other famous Radio Authorities.

Send No Money Just state number wanted, and we will ship same day order is received by Express, C. O. D., subject to examination. 5% discount for cash with order.

Extra Offer: 4 Batteries in series (96 volts) \$10.50.

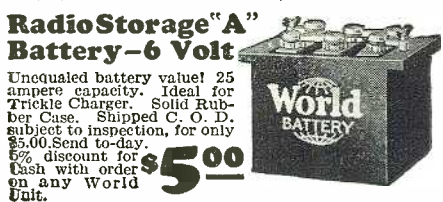

Radio Storage "A" Battery—6 Volt

Unequaled battery value! 25 ampere capacity. Ideal for Trickle Charger. Solid Rubber Case. Shipped C. O. D., subject to inspection, for only \$5.00. Send to-day. 5% discount for cash with order on any World Unit.

WORLD BATTERY COMPANY
1219 So. Wabash Avenue
Dept. 75 Chicago, Illinois

Set your radio dials at 258.3 meters for the World Storage Battery Station W S B C. Variety—New Talent—Always Interesting.

CORWICO

AERIAL KITS

Corwico complete aerial kits include everything necessary for aerial, ground and hook-up requirements. They simplify the buying of antenna equipment and assure a good aerial and connections for best reception. Prices from \$1.75 to \$4.50. Higher priced kits include Brach Storm King Lightning Arresters.

Dealers and Jobbers—Write for proposition.

CORNISH WIRE COMPANY
30 Church Street New York City

RADIO DEALERS' CATALOG—FREE!

A most complete catalog of everything in Radio. All the latest hook-ups, Sets, Parts and Kits of every description. Live Dealers need this book. Write on your business stationery.

COLUMBIA RADIO CORP.,
711 W. Lake St., Dept. 241, Chicago, Ill.

sounds, and every object or scene has its own peculiar characteristic sound.

For example, the fingers of a hand held in front of the transmitter will give rise to a sound similar to the grating of a very coarse file, while the human face will cause a high-pitched whistle which will vary in pitch as the head is turned or even when the features are moved.

For experimental purposes Mr. Baird had some phonograph records made of the sounds made by different persons' faces, and by listening carefully to the reproductions of these records it is possible to distinguish between one face and another by the sounds they make! With practice, faces may even be recognized by the sounds produced.

A further interesting point of far-reaching importance is that these records can be turned back into images. This is done by replacing the ordinary sound box by an electrical reproducer and causing the output currents from it to vary the intensity of the light source of a televisior. Thus, we can now store a living scene in the form of a phonograph record as well as in the form of a cinematograph film! Baird calls this invention a "Phonoscope."

There is room here for the imaginative to indulge in speculation on the scope for future development along these lines.

There would appear to be no limit to the remarkable inventive genius of John L. Baird, and the enormous possibilities of television stir the imagination, conjuring up visions of marvelous inventions before which even Sam Weller's magic opera glasses pale into insignificance.

STANDARD-FREQUENCY TRANSMISSIONS

THE Bureau of Standards, in announcing its schedule for this summer's standard-frequency signals from its station (WWV, Washington), calls attention to the fact that there are some differences in the frequencies from those previously given.

All signals are C.W., with a slight high-pitch modulation to aid in their identification. At the beginning of each 8-minute period, a general call is given, which continues for about two minutes; it is followed by the signal itself, a series of very long dashes with the call letters intervening, which lasts for four minutes. The announcements of the next frequency are then given,

AMAZING STORIES

IN THE JUNE ISSUE

THREE PRIZE WINNING STORIES: "The Visitation," by Cyril G. Wates; "The Electronic Wall," by Geo. R. Fox; "The Fate of the Poseidonia," by Clare Winger Harris; each an ingenious and original narrative, distinctly individual, written around the cover illustration of the December, 1926, issue of AMAZING STORIES.

THE MOON POOL, by A. Merritt. (Part II).

THE STORY OF THE LATE MR. ELVE-SHAM, by H. G. Wells; an unusual story with an extraordinary plot, which puts you in mind of "Station X."

THE LOST COMET, by Ronald M. Sherin.

THE FOUR-DIMENSIONAL ROLLER-PRESS, by Bob Olsen, a very clever story, telling in layman's language, what the fourth-dimension really is. It is well-told, plausible, and makes excellent reading.

SOLANDER'S RADIO TOMB, by Ellis Parker Butler. In his inimitable style, the famous author of "Pigs is Pigs" gives us the humorous angle of the radio-fan and radio.

You will find that

ACE

Hard Rubber PANELS

have superior insulating values and easy working qualities — yet they cost no more than ordinary panels. Ask to see the new ACE Crackle Surface and Walnite Surface Panels.

Order from your dealer or write to

AMERICAN HARD RUBBER CO.
11 Mercer Street
New York, N. Y.

SET BUILDERS

Before you build get our special prices on the parts you are planning to use. We'll save you money. Largest and most complete stock in U. S. A.

Chicago Salvage Stock Store
Dept. RN. 509 S. State St., Chicago, Ill.

For Perfect Amplification—

FERRANTI

Audio Frequency Transformers Amplify faithfully every note in the scale—each transformer tested ten times—your set needs one for perfect reproduction. Model A.F. 3—\$12.00. Model A.F. 4—\$8.50.

FERRANTI, INC.
120 West 42nd St., New York, N. Y.

Valley Chargers

Manufactured by
VALLEY ELECTRIC CO.,
ST. LOUIS, MO.

C. R. LEUTZ, Inc.
6th and Washington Aves.,
Long Island City, New York

and there is a 4-minute interval for readjustment.

All this, of course, is in telegraphic code. Amateurs and experimenters desiring information on how to receive and utilize these signals for purposes of calibration of apparatus can obtain this from Letter Circular 171, which is sent by the Bureau on request.

SCHEDULE OF SIGNALS

(Upper P. M. figures, kilocycles)	May 20	June 20	lower figures, meters.)	July 20	Aug. 22
10:00	1500	3000	125	250	
	200	100	2400	1199	
10:12	1650	3300	140	283.3	
	182	91	2142	1058	
10:24	1825	3600	160	320	
	164	83	1874	937	
10:36	2025	4000	180	363.7	
	148	75	1666	825	
10:48	2225	4400	206.3	410	
	135	68	1454	731	
11:00	2450	4900	233.3	466.7	
	122	61	1285	643	
11:12	2700	5400	266.7	525	
	111	56	1123	571	
11:24	3000	6000	300	600	
	100	50	999	500	

(*Times given are beginning of transmission, EST. Each period lasts 8 minutes, as explained above.)

\$75.00 A WEEK BUILDING RADIO SETS

—in your spare time

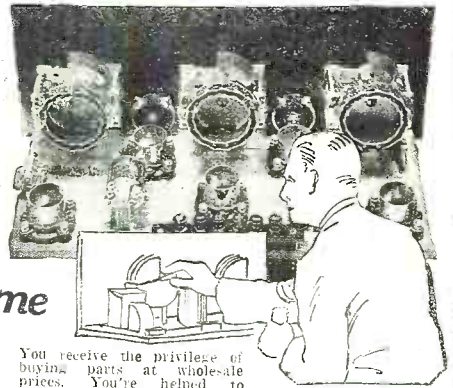

Join the Radio Association of America. Learn how to build and repair radio sets. The Association will train you—start you out in business if you wish. Be the radio "doctor" of your community. \$3 an hour upwards easily made. Radio offers you a big money-making opportunity right now.

You receive the privilege of buying parts at wholesale prices. You're helped to make money.

JOIN THE ASSOCIATION NOW

If you're interested in Radio for either pleasure or profit, join the Association without delay, because we have a plan whereby your membership may not need not cost you a cent. Only a limited number of these memberships are acceptable. Write now for details. Write before it's too late.

This Association has prepared a beautiful book that gives bare-facts regarding the profit possibilities of the Radio Industry, the purpose of the Association, and the details of the Special Membership Plan.

MAIL THIS COUPON

RADIO ASSOCIATION OF AMERICA
 Dept. RN-6—4513 Ravenswood Ave., Chicago.

Send me your book and details of your Special Membership Plan.

Name

Address

City State

EARN \$500 IN SPARE HOURS

"I have at last found myself," writes Lyle Follick, Lansing, Michigan. "I have already made over \$500 building radio sets after working hours." Werner Biehler, Rochester, N. Y., writes, "I have made over \$50 a week in my spare time."

Our members are starting radio stores, increasing their salaries, securing better positions, earning big money for the most enjoyable kind of spare-time work.

WHAT A MEMBERSHIP MEANS

A membership in the radio Association of America enables you to get into Radio and make money from the start.

You're taught how to build and repair all kinds of sets.

A described in a British Patents Corporation and W. Dubilier, an arrangement being shown in the illustration on page 1459. Incoming voltages are applied between the grid G and the filament F of a tube V1, the plate circuit of which contains an inductance L1, comprising the primary winding of a radio-frequency transformer, the usual "B" battery being omitted for the sake of clearness. The secondary winding comprises an inductance L2, having a very much larger number of turns than the primary winding L1, and is connected between the grid G2 of a second tube and the common filament lead F, or a "C" battery if desired. Coupled to L1 and L2 is another inductance L3, tuned by a condenser C1, the tuned circuit L3 C1 being tuned to the same frequency as the incoming signals. The specification states that this arrangement gives amplification which is sometimes 50 per cent. greater than that obtained with the more usual form of R.F. transformer.—*Wireless World*.

What Tuning Really Does

(Continued from page 1437)

than in the previous case and the wavelength would be longer. Thus, in increasing our capacity, we bring our circuit into resonance with a lower frequency; and if a station within range is transmitting on this frequency we will hear it, but we will not hear the first station.

It will be seen from the above that, to tune to a certain station's frequency, we merely vary the capacity or the inductance, or both, until the opposition offered by the inductance equals the opposition offered by



Listed by Underwriters

Lightning has no respect for people or their radio sets. When it strikes it takes the shortest path to ground. If your set is not protected by a reliable lightning arrester the charge has but one path to follow, and that is through your set.

The Jewell Lightning Arrester is listed and regularly checked by Underwriters Laboratories, thus insuring a uniform product with maximum protection to costly radio equipment.

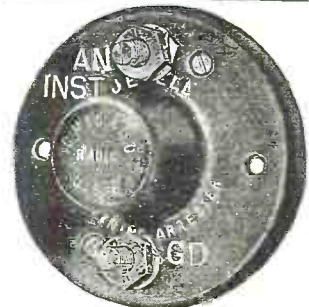

Jewell Lightning Arrester

The above illustration shows the arrester at about one-half size. The case is glazed brown porcelain and encloses an accurately calibrated air gap which is assembled and sealed to exclude moisture. The arrester is suitable for either indoor or outdoor installations.

Write us for descriptive circular No. 1019.

Jewell Electrical Instrument Co.
 1650 Walnut Street, Chicago, Ill.
 "27 Years Making Good Instruments"

28 Leading Radio Engineers Specify Hammarlund Products In Their Newest Receivers

HAMMARLUND MANUFACTURING COMPANY
 424-438 W. 33rd Street, New York



Ask us for a list of the latest models of receivers for which Hammarlund Products are officially specified.



Write for illustrated literature describing Hammarlund Precision Products for all of the popular circuits.



Insure your copy reaching you each month. Subscribe to Science & Invention—\$2.50 a year. Experimenter Publishing Co., 230 Fifth Avenue, N. Y. C.

"Inquiries - - - -
greatly exceeded anything that we had hoped for."

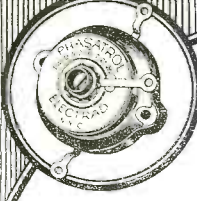

ELECTRAD
INC.
MAIN OFFICE
NEW YORK

173-175 VARICK STREET, NEW YORK
TELEPHONE WALKER 4585

March 26, 1927

CABLE ADDRESS
DICEP:NEW YORK

CODES
A. B. C. FIFTH EDITION
WESTERN UNION
LIBRARY

Mr. Hugo Gernsback
Radio News
730 Fifth Ave.
New York, N. Y.

Dear Mr. Gernsback:

I thought you might be interested in receiving the writer's comments as to the pulling power of Radio News.

In announcing our new device, Phasatrol, to the market we used a number of publications. A few articles - one in the March issue by John Rider and another article by Arthur H. Lynch, in News, incorporated this new product of ours.

The results, frankly, were astonishing and really more than could be expected. The number of inquiries that came in greatly exceeded anything that we had hoped for.

The article by Arthur Lynch has drawn better than any magazine incorporating an Electrad product.

You may rest assured that it will be unnecessary to ever sell Electrad on the merits of Radio News as a consumer demand creator.

Cordially yours,
ELECTRAD, INC.

PER *Arthur Moss*
TREASURER

the capacity. In this case the total impedance is the resistance of the circuit; and the strength of signal received, as well as the sharpness of tuning, depends directly on how small the value of the resistance is made.

SELECTIVITY MAY BE TOO GREAT

It is possible, if extreme care is taken to keep the losses down and if a number of these circuits are used successively, to obtain almost any desired selectivity or sharpness of tuning. Selectivity, however, beyond a certain degree is not always desirable. For instance, the signal from a station broadcasting music covers a frequency band of at least ten thousand cycles, five thousand

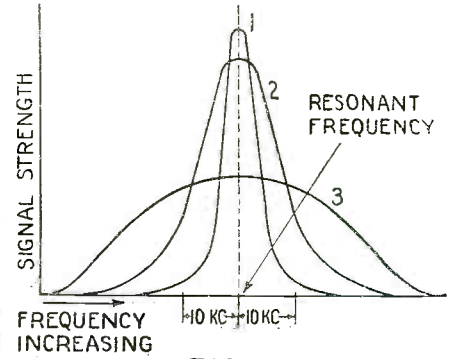

FIG. 9

MR. MOSS has no corner on the advertising pages of Radio News. They are always open to receive advertising of any reputable product. The chances of duplication of splendid showing by Electrad are all in favor of the manufacturer. New rates for fixed space to be used for a period of one year are now in effect. Communicate with our nearest branch office or your advertising agent.

EXPERIMENTER PUBLISHING CO., Inc.,
230 Fifth Ave., New York, N. Y.

ADVERTISING REPRESENTATIVES

- L. F. McClure, 720 Cass St., Chicago, Ill.; Davies, Harry E. Hyde, 548 Drexel Bldg., Philadelphia, Pa.
- Dillon and Kelly, 15 West 10th St., Kansas City, Mo.; A. J. Norris Hill Co., 5 Third St., San Francisco
- T. F. Magrane, Park Square Bldg., Boston, Mass.; Calif.; 412 West 6th St., Los Angeles, Calif.

over the entire range of receiver. These circuits must therefore tune broadly enough to eliminate the possibility of a complete cut-off at any position of the dial. This broad tuning is effected by introducing a certain amount of losses in each circuit, and then using more stages of amplification to make up the signal strength that was lost in the broadening process. This method is used by several receivers now on the market.

WHEN THE TELEVISION IS PERFECTED
"Lady Singleton is asking for you on the television, sir."

"Dear me, I shall have to call her back—I'm not dressed.—Frank Godwin in *New York Evening Post*.

SEND FOR THIS BOOK

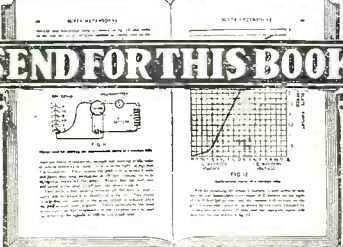

"SUPER-HETERODYNE CONSTRUCTION & OPERATION"
By R. E. Lacault, E. E.
ORIGINATOR OF THE ULTRADYNE

This is a book full of practical information and many illustrations for the owners and builders of Super Heterodyne receivers. Written in plain, non-technical language so that everyone can understand it. It explains the how and why of each part, how to improve your present set, how to locate and remedy troubles, how to build a power amplifier, and completely describes the latest design of the New L.R.4 by R. E. Lacault, clothbound—Price.....\$1.97

Complete set of correct and accurate full size drawings for the construction of the L.R.4—the latest R. E. L. design. Price.....\$1.00

OUR SERVICE DEPARTMENT
Can improve your receiver. Sets wired for power tubes. Sets shielded and rebuilt.

WRITE FOR ESTIMATE

Build your own "A" and "B" battery eliminator at small cost. We furnish parts required and show you how.

R. E. Lacault Radio Laboratories Book Dept., 1931 Broadway, New York.

KNOWN AND USED THE WORLD OVER



EASY TO INSTALL
Efficient on all circuits—non-directional—more stations logged.

LASTS A LIFE TIME
No sagging wires—no corrosion—always in service.

"Super Ball" Antenna

Under all conditions, the durability and absolute reliability of the Super Ball Antenna have been proved. It has achieved an international reputation—has given complete satisfaction in the service of users.

30 Day Unqualified Guarantee By The Manufacturer

See your dealer today. An army of satisfied users in America and Europe.

YAHN-LANGE

MILWAUKEE, WIS. INCORPORATED DETROIT, MICH.

Station
WRNY
NEW YORK

373.8 Meters - 802 kilocycles
is owned and operated by the
publishers of this magazine
Our Editors will talk to you
several times every week—
See your Newspaper
for details

TUNE IN ON
WRNY

The Face That Vamped a Thousand Guys

(Continued from page 1431)

chair. She refuses point blank to answer any questions as to her whereabouts, repeating, again and again, "I didn't kill him! I didn't kill him!"

Several of us gets into the chair in behalf of Mildred's character, which runs proceedings up to three o'clock. Then we're set. Mildred's lawyer is helpless. The jury is just about to leave, when there's a commotion at the back of the hall. The judge raps for order, and a disheveled object comes up the aisle. I gives a gasp. It's our normally immaculate Jerry, much the worse for wear but brimming with talk. He doesn't look like his usual self, but a word with the lawyer lets him through the gate. He approaches His Honor.

"Your Honor," he pants, "may I present the person who has just confessed to the killing of Willard Montagu?"

The courtroom is dead silent for a moment. Then Jerry turns and beckons to the door. In comes Tap Jones, also bedraggled, with two cops assisting in the fray.

"My God!" I mutters. "Not Tap—" But the three separates, disclosing a fourth in their midst. This object is also ripped up and black-eyed, but I recognizes him. So does several others in the court, including Mildred. She rises from her chair, wide-eyed with astonishment.

"Harry Fay!" she screams, and faints—into the quickly-provided arms of Tap Jones.

The Judge bends over, startled. "Do you confess to this murder?" he asks, taken aback at the sudden change in affairs.

Fay grumbles through his swollen lips. "Yes, you've got me," he mutters, his eyes lowered. "I killed him."

The Master intercedes. "May I explain for him?"

The Judge nods, wiping his brow. "After I heard of the murder I visited the home of Montagu, accompanied by Mr. Hammerstein," begins Jerry. "I was drawn, in particular, to the peculiar radio receiving set, frankly a masterpiece in cabinet work. I was unable to ascertain the name of the maker, or where Mr. Montagu had secured the set, until one day when I interviewed Miss LeRoye. To my surprise, I found that she had a set identical to that owned by the deceased!

40 Non-Technical Radio Articles

every month for the beginner, the layman and those who like radio from the non-technical side.

SCIENCE & INVENTION, which can be bought at any newsstand, contains the largest and most interesting section of radio articles of any non-radio magazine in existence.

Plenty of "How To Make It" radio articles and plenty of simplified hook-ups for the layman and experimenter. The radio section of SCIENCE & INVENTION is so good that many RADIO NEWS readers buy it solely for this feature.

Radio Articles Appearing in June Science & Invention

- Radio Direction Finder for Airplanes
- The National Radio School
- Radio Direction of Traffic
- Silver-Marshall Short-Wave Receiver
- A Secret System of Radio Transmission
- A Radio Cabinet
- And Many Others

~ a Musica Masterpiece!

Specified for the
TRANS-OCEANIC
TELEPHONE-INTERFLEX
In Radio News

ALL of the orchestra, all of the voices—amplified with realism and life! Nothing missing or distorted—fine programs heard as actually given. With its musically balanced audio curve (as pictured), the big Jefferson Concertone faithfully recreates all radio performances. Fully shielded. Sealed against deterioration by dampness. And only \$6. at dealer's. Interesting literature sent those who write.

JEFFERSON ELECTRIC MFG. CO.
Largest manufacturers of small transformers

541 So. Green St.,
Chicago, Ill.



Jefferson Concertone Transformers



A simple, efficient circuit designed around a supersensitive detector tube, a novel means for properly regulating the energy transfer to this detector, and the TRUPHONIC three stage audio system to make the most of the pure output of the detector and insure the greatest beauty of tone;—that's the DONLE-BRISTOL B-6 TUBE CIRCUIT.

- Kit No. 1 (Coils only) \$7.50
- Kit No. 2 including Coils, special Condensers and 3 TRUPHONIC audio units \$30.50
- Each kit with full directions
- B-6 Supersensitive Detector...\$5.00

Write for literature

THE
DONLE-BRISTOL CORP.,
54 Cambridge Street
Meriden, Conn.



RADIO NEWS

JUNE BLUEPRINTS

- You can obtain a complete set of Blueprints for these receivers direct from RADIO NEWS
- THE INTERBALANCED REGENERATIVE RECEIVER
Radio News Blueprint Article No. 21..... \$1.25
 - THE TRANSOCEANIC RADIOTELEPHONE INTERFLEX
Radio News Blueprint Article No. 22..... \$1.25
 - THE EL-FONIC ADAPTER UNIT
Radio News Blueprint Article No. 23..... \$1.00

Order Direct from RADIO NEWS

230 FIFTH AVENUE, NEW YORK, N. Y.

MENTION NAME OF RECEIVER AND ARTICLE NUMBER



The next storm may do it. Provide the protection the National Board of Fire Underwriters demand. It takes but a few minutes to attach a

WIRT LIGHTNING ARRESTER

It is the approved air-gap type, heavily insulated with Bakelite to withstand high voltage. A Bakelite "petticoat" provides added protection by draining off water and keeping out dust. Metal parts are brass. Nothing to rust or wear away. Will last a lifetime.

Terminals are extra heavy, and designed for connecting to aerial without cutting wire.

At all dealers for \$1.25 each. Get one today, for tomorrow—well—you never can tell.

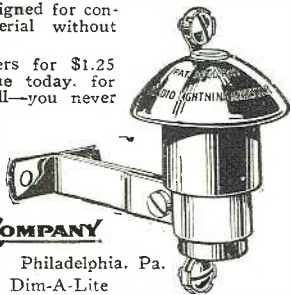

WIRT COMPANY

5241 Greene St. Philadelphia, Pa.
Makers of Dim-A-Lite



Condenser Tissues

? IS your Radio set giving trouble? Do the condensers have to be replaced frequently? Are you aware that this annoyance can usually be traced to the use of imperfect condenser tissue paper?

Condensers built with DEXSTAR Condenser Tissue, will give longest service and highest efficiency. ASK your dealer to ask the manufacturers, to use DEXSTAR Tissues only, as insurance against condenser break downs.

C. H. DEXTER & SONS, Inc.,
Specialists on High-Grade Condenser Tissues
Windsor Locks, Conn.

RADIO PANELS OF GENUINE BAKELITE

Cut, drilled and engraved to order. Send rough sketch for estimate. Our Complete Catalog on Panels, Tubes and Rods—all of genuine Bakelite—mailed on request.

STARRETT MFG. CO.
520 S. GREEN ST. CHICAGO

Cooper "A" Eliminator
Not a Power Unit
Employs No Trickle Charger
Operates direct from the
Light Socket. See Your Dealer

"Miss LeRoye told me that the set had been built for her by her former husband, Peter Lowry, an electrical engineering student at college and a natural craftsman, and presented to her as a Christmas gift. I looked up Mr. Lowry, and he told me that he had built both sets, and given one to Miss LeRoye and the other to Montagu, who was a very good friend, despite matrimonial complications.

"I then re-examined Montagu's set, and found that the dials did not quite match, in coloring, with the panel, nor did those of Miss LeRoye's set match with her panel. Microscopic examination proved that the dials had *recently been exchanged!* Some fiend had taken the dials from Miss LeRoye's set, which naturally held her fingerprints, and placed them on Montagu's set, bringing back to Miss LeRoye's set the dials taken from Montagu's, to avoid suspicion. Gentlemen, those dials were a deliberate substitution!"

There's an audible stir in the courtroom, but Jerry continues:

"That, of course, nullified the evidence of the letter and handkerchief, which could easily have been dropped, but did not throw out the fact that Miss LeRoye had sung over Montagu's station. This puzzled me for a few days until, in further examining Montagu's effects, I found a complete library of Miss LeRoye's phonograph records, containing all of the numbers she had supposedly sung the night in question. It was so absurdly simple that no one had thought of it."

More applause.

"While I had established Miss LeRoye's innocence in a fair way, I had not found the guilty person. In looking through Montagu's business records, I discovered instances of financial transactions with Harry Fay, Miss LeRoye's first husband. They had all, or practically all, been heavy losses to Fay, although it was patent that Montagu had lost on them as well. They established a possible motive for Montagu's murder on the part of Fay, but no incentive for throwing the blame on Miss LeRoye. Further rummaging about the radio room brought to light a greasy screwdriver, with a wooden handle, plainly fingerprinted. These prints proved to be neither those of Montagu, Miss LeRoye, or any person so far connected with the case. I took a long chance and secured Fay's fingerprints. They tallied."

The Judge beams, but The Master keeps right on, not waiting for applause.

"In confessing, Fay declared that he hated Montagu, not only because of his losses, but because he considered Montagu, Miss LeRoye's second husband, had alienated her affections from him. Though outwardly professing friendship for Miss LeRoye, Fay hated her, because he felt that she had broken up his happiness. On the evening under discussion, Fay knew that Montagu was alone, and also knew where Miss LeRoye was, and that she was in no position to talk in the matter. So, during a piano number which Montagu was giving, Fay sneaked in through a rear window and killed him with an iron from the fireplace, just as he completed his selection over the radio. Then Fay continued the program, simulating Montagu's voice—Fay is a mimic of no small calibre—and played several of Miss LeRoye's records. Then he altered the dials, dropped his evidence, and left. Only he forgot all about his own fingerprints when he dropped the screwdriver. Why he didn't use gloves then, as he must have done while handling the dials, I cannot see, but he plainly did."

"Had to take off my gloves to pick up a set-screw," supplies Fay, in a weary, end-it-all tone. "Forgot about the screwdriver."

"Very careless of you," reprimands The Master.

"Yes, wasn't it?" agrees Fay.

That about settles it, and Mid is freed with emphasis. Tap Jones takes her away,

Only \$4.25
for this beautiful Cabinet!!

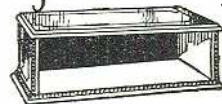

The Blue Ridge

Dimensions and prices

7"x18"x10"....	\$4.25
7"x21"x10"....	4.50
7"x24"x10"....	4.75
7"x26"x10"....	5.50
7"x28"x10"....	6.25
7"x30"x10"....	6.75

f.o.b. Hickory, cash with order.

c.o.d. half-price with order.

A real bargain in cabinets. This piece is beautifully finished in walnut or mahogany, with nicked lid support and full-length piano hinge. Rubber anti-vibration feet and free base-board, 1/2" non-warping.

12 hour service
factory to you!

Southern Toy Co. Inc.
MANUFACTURERS HICKORY N.C.

POSITIVE ELIMINATION OF INTERFERENCE "WEB" WAVE TRAP

PRICE

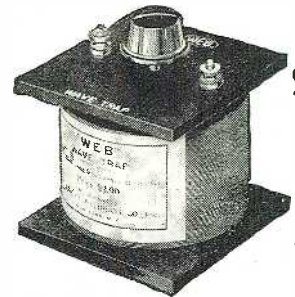

\$2.00

Positively eliminates interference. Increases Distance. Increases Volume. Increases Selectivity. Reduces Static. Works on all sets, including loop sets. Tested and Approved by RADIO NEWS Laboratories ON SALE AT YOUR DEALERS, or will be sent upon receipt of check, money order or cash by the manufacturer, under money back guarantee.

Manufactured by
WALTER E. BATHGATE CO., Inc.
65 West Broadway, N. Y.

SOCKET POWER UNITS

Ask your dealer, or write us for complete information on our complete line of socket power units, chargers, Radio "A" and auto storage batteries. STEWART BATTERY COMPANY
119 N. Peoria St. Chicago, Ill.

The SONOCHORDE CONE \$25.
Brings the Studio Home

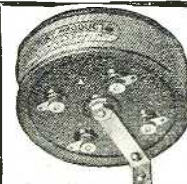

Build a Victoreen Universal using
VICTOREEN Super Coils
Send for Folder
Geo. W. Walker Co.
6528 Carnegie Ave.
Dept. H Cleveland, O.

and that night the *Inanities* celebrates Mid's fifth—and last, according to Tap. But later, in our dressing room, Doris approaches Mid with scandal aforesought.

"Dear, just between ourselves, where were you that night? Why didn't you defend yourself?"

It's a question we've been waiting to hear, and Mid makes Doris and me promise to go easy on the reputation.

"I'll admit I lied to you—a little," she says, "about that rest in the country." Then she explains.

Later on, at Brightmere, The Master pops the same crack. He also promises to lay off the press about it.

"Well, you see," I begins, grave, "Mid's been on the stage for a long time, her laurels resting not only on her voice but her face. That face of Mid's is known around the world—everything from personal appearances to testimonials for pipe tobacco. She thought, of late, that her map was looking a bit old and out of date, with wrinkles here and there, and the thing worried her until she took the fatal step."

"Yes, yes?" urged The Master.

"Those two weeks she was gone she spent in a beauty hospital, under an assumed name, having her face lifted! Fay knew this, and realized that he had her cornered. For if, in order to save her life, she had admitted having had the operation, she would have disclosed her age, and been the laughing stock of Broadway. That spelled ruin. If she valued her reputation more than her life, the chair was handy. From her viewpoint, she had small choice in the matter. Fay was clever, and I hand him the palm."

Jerry is standing up, amazed. "Why, the little fool!" he yelps. "Didn't she realize what would happen if she were found guilty?"

I grins. "Heaven will protect the working girl," I quotes, "but that depends on whom she works."

Copyright, 1926, by Robert Francis Smith.

Radio Wrinkles

(Continued from page 1466)

fall back into the glass. This coating will quickly harden, after which the tube should be dipped again. Should any of the paraffin get on the base, it may be scraped off with a knife.

Do not let the paraffin get too hot. It should be poured from the pan into the glass as soon as it reaches a liquid state, and allowed to stand in the glass a minute or so before dipping.

Contributed by Howard R. Potter.

Easy Construction for the "Ham"

(Continued from page 1463)

secondary tuning condenser, D, and the counterpoise are both varied until there is a like reading on each of these two meters. Resonance is always indicated by the plate milliammeter and is evidenced by the highest reading. Never go by the antenna or the counterpoise meters for the highest output. If it is desired to include a grid meter in the circuit, it may be inserted at the point marked X in Fig. 1 between the grid leak and the radio-frequency choke. This meter should read approximately ten per cent. of the plate-meter reading.

ANTENNA INSTALLATION

The matter of protection is very important and the rules of the underwriters should be

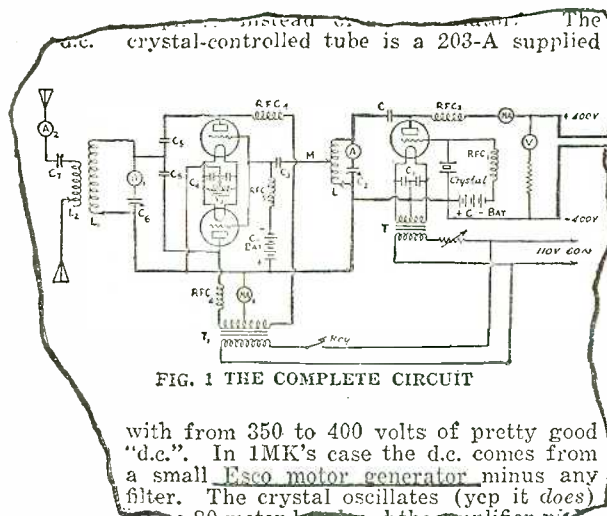
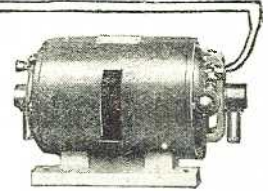

FIG. 1 THE COMPLETE CIRCUIT

The crystal-controlled tube is a 203-A supplied with from 350 to 400 volts of pretty good "d.c.". In 1MK's case the d.c. comes from a small Esco motor generator minus any filter. The crystal oscillates (yep it does)

Clipped from March 1927 Q. S. T.

This is item 4--It is a very good set for crystal control.



Bulletin 237E List over 500 combinations of generators, motor generators and dynamotors for Radio. If you have not a copy write for one.

P.S.—Have you a copy of Filter Facts?

ELECTRIC SPECIALTY COMPANY

Mark "ESCO" Trade

211 South Street

Stamford, Conn., U. S. A.

Manufacturers of Motors, Generators, Motor-Generators

Dynamotors and Rotary Converters, for Radio and Other Purposes



FRED W. STEIN
Designer of Famous
Steinite Circuit.

Steinite

LIGHT SOCKET NO-BATTERY RADIO

Don't confuse the Steinite with Power Units that operate independently and merely attach to light socket to eliminate batteries. Steinite uses no batteries—is one complete synchronized unit. Think of regular battery expense before you buy a radio.

1c An Hour To Operate THE HIGHBOY

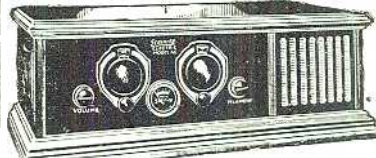

With Built-in Speaker
Faithfully reproduces all voices and every musical instrument with fidelity of tone. Not merely designed to eliminate battery annoyance and expense—these Steinite Models are built to use power that batteries can not supply. Hear the Tone Test and you will be convinced. Their clear reception will surprise you. Any Steinite Dealer will gladly answer every question asked about these new Steinite Models.

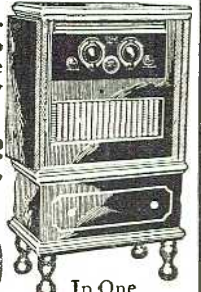

In One Complete Synchronized Unit

\$125 Built-in Speaker

Highly selective; coast to coast reception. All cabinets solid Philippine Mahogany, beautifully finished in dark brown shaded lacquer. Attach to any lighting circuit (60 cycle a.c. 95 to 125 v.) Use new Q.R.S. Rectifier Tube. Guaranteed against all electrical or mechanical defects. 2-dial control. Prices do not include tubes.

STEINITE LABORATORIES
Factory at Atchison, Kans.
Largest Exclusive Radio Factory in the West.

Jobbers!
Write for Terms and Territory on these popular Steinite Models
Dealers
Write your Jobbers

Gen'l Sales Office:
506 SO. WABASH
CHICAGO, ILL.

\$100 TABLE MODEL
Use any Speaker.

LEARN THE CODE AT HOME

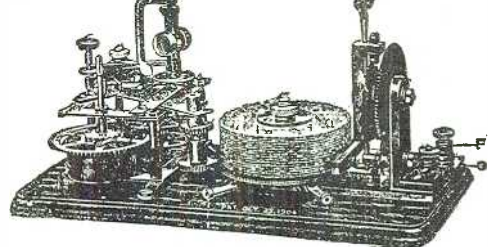

WITH THE OMNIGRAPH

THE OMNIGRAPH Automatic Transmitter will teach you both the Wireless and Morse Codes—right in your own home—quickly, easily and inexpensively. Connected with Buzzer, Buzzer and Phone or to Sounders, it will send you unlimited messages at any speed, from 5 to 50 words a minute.

THE OMNIGRAPH is not an experiment. For more than 15 years, it has been sold all over the world with a money back guarantee. The OMNIGRAPH is used by several Depts. of the U.S. Govt.—in fact, the Dept. of Commerce uses the OMNIGRAPH to test all applicants applying for a Radio license. The OMNIGRAPH has been successfully adopted by the leading Universities, Colleges and Radio Schools.

Send 6c for Catalog THE OMNIGRAPH MFG. CO., 15 HUDSON STREET, NEW YORK CITY
If you own a Radio Phone set and don't know the code—you are missing most of the fun

Insure your copy reaching you each month. Subscribe to Radio News—\$2.50 a year. Experimenter Publishing Co., 230 Fifth Ave., N. Y. C.

For Convenience Sake —

Control your "B" eliminator and trickle charger automatically with the

Yaxley Automatic Power Control

Turn on your set and the Power Control cuts in your "B" eliminator, cutting out the trickle charger. Turn off your set and the Control cuts out the "B" eliminator and in with the trickle charger. Its automatic operation is sure and reliable.

No. 444—Automatic Power Control—Series Type for use with sets having tubes with a current draw equal to or greater than 6 U.V.-199 type of tubes \$5.00
 No. 445—Automatic Power Control—Multiple Type—for any tube set \$6.00

At your dealer's. If he cannot supply you, send his name with your order to

YAXLEY MFG. CO.
 Dept. N
 9 S. Clinton St., Chicago, Ill.



Three Foot Cone OR Roll Type Speaker

MAKE YOUR OWN AND SAVE EIGHTY PER CENT OF COST WITH THE FAMOUS ENSCO KIT. ONLY \$10.00.

MAKE YOUR OWN THREE FOOT CONE OR ROLL SPEAKER IN LESS THAN AN HOUR. Complete parts furnished in kit form. We guarantee this speaker the equal of any manufactured cone speaker at any price.

With this THREE FOOT CONE SPEAKER you hear all the tones. It brings out the true depth and beauty of orchestral and instrumental music. Can be operated softly for Living Room Music or Full Volume for dancing, and without trace of distortion.

Kit includes famous "ENSCO" cone unit, the only direct-drive, distortionless unit for large cones; Allambra Phonotex for big cone, with brass apex, two Sepia Prints showing cabinet or simple stand construction. All necessary instructions.

Buy this wonderful speaker under our absolute guarantee. Your money back if you are not convinced that it is the finest reproducing medium obtainable at any price. It works on any set, with ordinary Tubes or with Power Output.

SEND NO MONEY!

ENGINEERS' SERVICE CO.,
 25 Church St., (Desk N) New York City

Write your name plainly as indicated below, then mail and complete kit will be forwarded to you. Just pay postman \$10.00 upon delivery.

NAME
 ADDRESS

C. L. PARKER

Ex-Examiner U. S. Patent Office

Attorney-at-Law and Solicitor of Patents
 McGill Building, Washington, D. C.

Patent, Trade Mark and Copyright Law

carefully followed. For convenience the regulations pertaining to transmitters are given at the end of this article.

A very efficient lightning protector can be easily made by the constructor by following the idea illustrated in Fig. 4. On a hard-rubber base, 4x4x1/2 inches, are mounted three 1/4-inch brass rods which are pointed. These points are brought to within about 1/4-inch of each other, and connected to the antenna, the counterpoise and the ground as

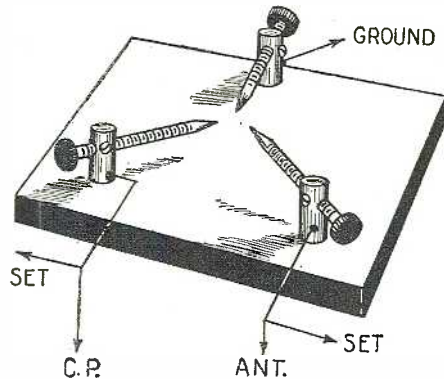

Fig. 4. Details of an inexpensive and efficient lightning protector.

shown. This type of protector has been passed by the underwriters for use with transmitters and will be found one of the best types that can be made or purchased.

The keying relay is a reconstructed Ford-generator relay with the series coil removed. The shunt coil is connected in the key line to the battery, as indicated in Fig. 5.

The antenna need be only a vertical wire forty feet in length. The construction of this will depend, of course, upon the individual location. For instance, the writer's antenna is suspended from the top of a 32-foot mast erected on the roof of a garage which is about fifteen feet high.

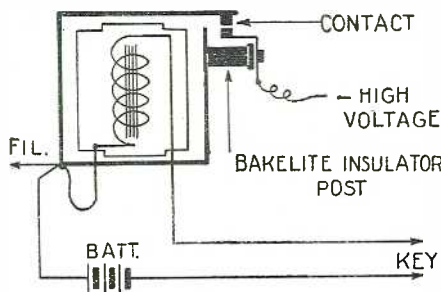

Fig. 5. Details of the heavy-duty keying relay, which is operated by a hand key in a low-voltage circuit.

When the counterpoise can be located approximately two feet above the ground it should be about twenty feet long (which is half of the antenna height), but it should be so arranged that its length can be varied. The reason for this is that, by varying the length, the current reading in the antenna and counterpoise meters can be made equal.

An easy method of varying the counterpoise length is by running through two pulleys, spaced horizontally about 20 feet apart, the counterpoise tied to the end of an equal length of rope. One of these pulleys is connected to the counterpoise inductance and when the rope is pulled it varies the effective length of the counterpoise.

UNDERWRITERS' RULES

a. Antenna and counterpoise outside buildings shall be kept well away from all electric light or power wires of any circuit of more than 600 volts, and from railway trolley or feeder wires, so as to avoid the possibility of contact between the antenna or counterpoise and such wires under accidental conditions.

b. Antenna and counterpoise where placed in proximity to electric light or power wires of less than 600 volts, or signal wires, shall be constructed

Hotel SHERIDAN-PLAZA

CHICAGO

Sheridan Road at Wilson Ave.

At this beautiful hotel, in Uptown Chicago, you'll find choicest accommodations at prices lower than those of downtown.

Excellent restaurant and Narcissus Grill Cafeteria. 18 minutes to downtown. Elevated, surface lines, fast motor coaches.

Rooms with private bath, \$2.50 a day and up. 250-car garage directly opposite.

H. A. BIRNBAUM,
 Manager



Eliminates Interference! without extra tuning THE NEW KLOSNER STATION-SEPARATOR

The New Klosner Station Separator is unconditionally guaranteed to work to your satisfaction.

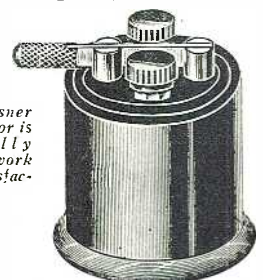

Positively overcomes crowding and "cross talk" between stations, especially on lower wave lengths. No skill necessary to attach or operate it with your set. Just connect in series between your aerial and set.

\$1.00 at your dealers or direct from us.

KLOSNER RADIO CORP.,
 1022 East 178 Street New York



Six tubes - One Control FRESHMAN MASTERPIECE

Sold by Authorized Freshman Dealers Only



OPPORTUNITY AD-LETS

Follow these advertisements every month. Reliable advertisers from all over the country offer their most attractive specials in these columns.

Classified advertising rate twenty-two cents a word for each insertion. Ten per cent discount for 6 issues, 20 per cent discount for 12 issues. Name and address must be included at the above rate. Cash should accompany all classified advertisements unless placed by an accredited advertising agency. No advertisement for less than 10 words accepted.

Objectional or misleading advertisements not accepted. Advertisements for the August issue must reach us not later than June 1st.

CIRCULATION LARGER THAN THAT OF ANY OTHER RADIO PUBLICATION

EXPERIMENTER PUBLISHING CO., INC., 230 Fifth Avenue, New York, N. Y.

Agents Wanted

Big Money and fast sales. Every owner buys gold initials for his auto. You charge \$1.50; make \$1.35. Ten orders daily easy. Write for particulars and free samples. American Monogram Co., Dept. 133, East Orange, N. J.

Guaranteed Genuine Gold Leaf Letters anyone can put on store windows. Large profits, enormous demand. Free samples. Metallic Letter Co., 429 N. Clark, Chicago.

Auto Gas Saver Free. To introduce. Amazing car performance. Doubles mileage. CRITCHLOW, inventor, D-88, Wheaton, Ill.

Sell absolute necessities. Cost 2c. sells 25c. Prices lowest. Seven different samples free. Catalog FREE. Mills Sales Co., 15 East 16th St., New York.

15c puts your name on mailing list year. Receive offers, magazines. Kentucky Agency, Covington, Kentucky.

Art

Genuine French Art Pictures—ten for \$1.00. R. Wentworth, care Coney Island Post Office, New York.

Business Opportunities

Free Book, Start Little Mail Order Business. Pier Company, 724P Cortland Street, N. Y.

Stocks, Bonds, Domestic, Foreign, bought, sold. Dealers in all marketable securities. Frank Y. Everett & Co., 20 Broad St., New York.

Co-operative membership in EIA RADIO is establishing one honest, industrious man of each locality in his own successful radio industry. Young married men preferred. Write, naming your county. Equitable Industries Association, Radio Division, 350-R Broadway, New York.

Advertise in 275 Country Newspapers, 28 words, \$10.00. Keator, Hartford Bldg., Chicago.

Earn \$120 to \$250 Monthly; expenses paid as railway traffic inspector; we secure position for you after completion of 3 months' home study course or money refunded. Excellent opportunities. Write for free booklet. G-20, Standard Business Training Inst., Buffalo, N. Y.

Monogram Automobiles \$1.35 Profit, ten minutes work. Every owner wants them, millions without, particulars free. Motorists Accessories Co., Mansfield, Ohio.

Chemistry

Learn Chemistry at Home. Dr. T. O'Connor Sloane, noted educator and scientific authority, will teach you. Our home study correspondence course fits you to take a position as chemist. See our full page ad on page 1483 of this issue. Chemical Institute of New York, 66R-W Broadway, New York City.

Correspondence Courses

Used correspondence school courses sold on repurchase basis. Also rented and exchanged. Money-back guarantee. Catalog free. (Courses bought). Lee Mountain, Pisgah, Alabama.

For Inventors

I am in touch with hundreds of moneyed men and manufacturers who wish to buy good inventions. Hartley, 33 Court St., Bangor, Maine.

Help Wanted

Earn \$25 weekly, spare time, writing for newspapers, magazines. Experience unnecessary. Details FREE. Press Syndicate, 973, St. Louis, Mo.

Set Builders! We furnish jobs for you. (No Fee.) Competent men needed today in every community to build 10-27, Hammarlund-Roberts, Ultraayne, Loftin-White and Browning-Drake Sets. Big money for you if you can qualify. Register Now, giving particulars, experience, references. Allen-Rogers, Inc., 118 E. 28th St., New York City.

Detectives Needed Everywhere. Travel. Experience unnecessary. Particulars free. Write, American Detective System, 2190 Broadway, N. Y.

Instruction

We teach you to build your own radio free. Write for particulars. Bastrop Radio Shop, Bastrop, Texas.

Build Your Own Broadcasting Set. Very simple and inexpensive. Instructions for \$1.00. Walter Schultz, Kenesaw, Neb.

Miscellaneous

Inventors: Use our special service for presenting your invention or patent to manufacturers. Adam Fisher Mfg. Co., 278-A Enright, St. Louis, Mo.

Forms to Cast Lead Soldiers, Indians, Marines, Trappers, Animals, 151 kinds. Send 10c for illustrated catalogue. H. C. Schlerke, 1034 72nd St., Brooklyn, N. Y.

Wanted: 200 men who have built 2 or more successful receivers. \$7-\$10, spare time evenings. Not a selling proposition. E. W. Parker, Lynn St., Peabody, Mass.

Motorcycles, Bicycles

Don't Buy a Bicycle Motor Attachment until you get our catalog and prices. Shaw Mfg. Co., Dept. 6, Galesburg, Kansas.

Old Money Wanted

\$2 to \$500 each paid for hundreds of Old or Odd Coins. Keep all old money, it may be very valuable. Send 10c for New Illustrated Coin Value Book, 4x6. Guaranteed prices. Get posted. We pay Cash. Clarke Coin Company, 14 Street, LeRoy, N. Y.

Patent Attorneys

Patents—Send for form "Evidence of Conception" to be signed and witnessed. Form, fee schedule, information free. Lancaster and Allwine, Registered Patent Attorneys in United States and Canada, 269 Ouray Bldg., Washington, D. C.

Patents. Send drawing or model of your invention for examination and instructions. Advice and booklet free. Highest references. Best results. Promptness assured. Watson E. Colman, Patent Lawyer, 721 9th Street, N.W., Washington, D. C.

Inventors—Should write for our Guide Book, "How to Obtain a Patent" and Record of Invention Blank, sent free. Send model or sketch of inventions for our Inspection and Instructions Free. Radio, Electrical, Chemical, Mechanical and Trademark Experts. Terms Reasonable. Victor J. Evans & Co., 922 Ninth, Washington, D. C.

Patents

Inventions Commercialized. Patented or unpatented. Write Adam Fisher Mfg. Co., 278 Enright, St. Louis, Mo.

Patent Sense—Valuable book free. See Lacey's ad page 1484—Lacey & Lacey, 631 P. St., N.W., Washington, D.C. Established 1869.

Patents for Sale

1,596,931. Won interference in Patent Office over Jifo Support shown page 636, Nov. 1925 Radio News. B. P. Joyce, 1014 Pershing, Davenport, Iowa.

Postage Stamps

Stamp Collectors—Phillips Monthly Bulletin (Illustrated) offers over 2000 special bargains, sets, packets, single stamps, etc., each issue. Free Phillips, Box 1012, Hartford, Conn.

Printing Outfits and Supplies

Print your own cards, stationery, circulars, paper, etc. Complete outfits \$8.85; Job Presses \$11, \$29; Rotary \$19. Print for others, big profit. All easy, rules sent. Write for catalog presses, type paper, etc. Kelsey Company, P-13, Meriden, Conn.

Multigraph typewritten letters sell anything. Two dollars thousand. Miscellaneous printing. Mayer Rey Corporation, Monmouth, Illinois.

Radio

Boys! Don't Overlook This. The "Rasco" Baby Detector. Greatest detector ever brought out with moulded base. Fully adjustable. See former advertisements in this publication, or our catalog. Detector with Galena Crystal, complete 50c, the same detector with Radiocite Crystal, 75c prepaid. Send for yours today. Radio Specialty Company, 96-98 Park Place, New York City.

Attention!—50 vacuum tube hook-ups. The greatest collection of vacuum tube circuits ever brought under two covers at such insignificant cost. These diagrams will be found in the great "Rasco" catalog, which contains raw materials and parts in a greater profusion than any other catalog. Send for free catalog. Radio Specialty Co., 96-98 Park Place, New York.

Free Sample Ivory Radio Panel, the new radio panel now in great demand. Its handsome grained and polished surface, insulating qualities, workability, and permanent finish, will make the most beautiful and efficient set of all. Also Ivory dials and knobs. IvoryLite Radio Panel Co., 3230 Avenue G, Fort Worth, Texas.

Send 25c for catalog. Amount to be deducted in first order. Dombrowski, 4341 S. Campbell Ave., Chicago, Ill.
Y. M. C. A. Radio Institute, 151 East 86th Street, New York. Hundreds of successful graduates. Home Study and School courses. Radio operating or Mechanics. Send for Free Booklet.

Build the latest non-directional hexagonal aerial for better reception, tone and quality. Full instructions with blueprint, \$1.00. R. F. Williams, North Powder, Oregon.

Let us quote price on your requirements for that outfit you're building. Radio Parts Sales Co., Orange, N. J.

Transmitting Sets. All Powers for every Wavelength—within every purse. Also Wavemeters and Short Wave Tuners, S & S Radio Co., 31 N. Warren St., Trenton, N. J.

Repairing Specialist on Loud Speakers, Headphones and Transformers. Guaranteed Work with Lowest Prices. S. & S. Radio Co., 31 N. Warren St., Trenton, N. J.

Salesmen Wanted

Salesmen—Amazing New Drugless health product in big demand. \$6.50 profit on every sale. The \$2,500,000.00 spent yearly for health assures you a tremendous market with no dull seasons. Exclusive territory. Write for special offer. Radiumized Applicator Co., 1303-C Fillmore, Buffalo, N. Y.

Scenery for Rent

World's Most Beautiful Settings for operas, plays, minstrels. Amelia Grain, Philadelphia.

Song Poems

Song Poem Writers—Address Ray Hibbeier, D7X, 2101 No. Keystone Ave., Chicago.

Song Writers

Song-poem writers. Monarch, 1172 Broadway, Dept. 122, New York.

Stammering

St-t-t-tering and stammering cured at home. Instructional booklet free. Walter McDowell, 121 Arcade, 1126 Granville Avenue, Chicago, Ill.

Telegraphy

Telegraphy—Both Morse and Wireless taught thoroughly. Big salaries. Wonderful opportunities. Expenses low, chance to earn part. School established fifty years. Catalog free. Dodge's Institute, Cour St., Valparaiso, Ind.

Wanted to Buy

Full Value Paid for Old Gold, Jewelry, Watches, Diamonds, crowns, bridges, dental gold, silver, platinum, gold or silver ore; magneto points, old false teeth. Packages returned if our offer is not satisfactory. United States Smelting Works (The Old Reliable) 59 So. State St., Dept. 10, Chicago, Ill.

150 RADIO HOOK-UPS

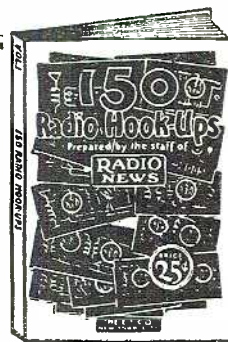

68 Pages of Radio's Most Popular Circuits

This 68-page book of the Conrad Company is the latest compilation of Hook-ups in Radio. The Hook-ups are those that have been tried, tested and perfected by time and by thousands of Radio Listeners.

This priceless book contains: 18 Crystal Detector circuits, 39 Regenerative, 21 Reflex, 23 Radio Frequency, 10 Super Regenerative, 10 Amplifier and Oscillator, 5 Super-Heterodyne and other valuable Hook-ups.

All circuits are shown by simplified drawings and each is explained in detail.

The book is 6x9 inches in size, illustrated, and is contained in a special attractive 2 color cover.

25c ON ALL NEWSSTANDS

**The Conrad Co., Inc.
230 Fifth Ave., New York**

Now you can build the kind of a radio you have always wanted



This BOOK TELLS HOW

No matter whether you want to improve a set you now have or build a new one - get this book first. Tells how to build the latest one, two and three dial receivers - 5 to 7 tubes.

10¢ PREPAID
GEARHART-SCHLUETER, Fresno, Cal.

CARTER

New Resistors



Half Size

All standard sizes 1/4 to 1000 ohms. Used in filament circuits and as grid resistors.

Special resistors made to order.

Write for Illustrated Folder.

In Canada: Carter Radio Co., Ltd., Toronto

CARTER RADIO CO.
 CHICAGO

The Kodel Radio Corp.

The World's Largest Manufacturers of Battery Chargers and Eliminators

Cincinnati, Ohio

Watch for our 1927-28 Announcement

STOP WATCHES

Needed for Accurate Laboratory Timing. The "Pastor" is a guaranteed fifth-second time-piece. Unbreakable crystal. Price only \$7.50. Start, stop, flyback hand. Or a fifth-second Timer only, 30 minute register, 6 jewel. Price only \$11.25

Write today to
 Sterling Stop-Watch Co., M'frs.
 15 East 26th St. New York, N. Y.

and installed in a strong and durable manner, and shall be so located and provided with suitable clearances as to prevent accidental contact with such wires by sagging or swinging.

c. Splices and joints in the antenna and counterpoise shall be soldered unless made with approved splicing devices.

d. Lead-in conductors shall be of copper, bronze, approved copper-clad steel or other metal which will not corrode excessively and in no case shall be smaller than No. 14.

e. Antenna and counterpoise conductors and wires leading therefrom to ground switch, where attached to buildings, shall be firmly mounted 5 inches clear of the surface of the building, on non-absorptive insulating supports such as treated pins or brackets, equipped with insulators having not less than 5 inches creepage and air-gap distance to inflammable or conducting material, except that the creepage and air-gap distance for continuous wave sets of 1000 watts and less input to the transmitter, shall be not less than 3 inches.

f. In passing the antenna or counterpoise lead-in into the building a tube or bushing of non-absorptive, insulating material, slanting upward toward the inside, shall be used and shall be so insulated as to have a creepage and air-gap distance of at least 5 inches to any extraneous body, except that the creepage and air-gap distance for continuous wave sets of 1000 watts and less input to the transmitter, shall be not less than 3 inches. If porcelain or other fragile material is used it shall be protected where exposed to mechanical injury. A drilled window pane may be used in place of a bushing provided creepage and air-gap distance as specified above is maintained.

g. A double-throw knife switch having a break distance of at least 4 inches and a blade not less than 1/8 inch by 1/2 inch shall be used to join the antenna and counterpoise lead-in to the grounding conductor. The switch may be located inside or outside the building. The base of the switch shall be of non-absorptive insulating material. This switch shall be so mounted that its current-carrying parts will be at least 5 inches clear of the building wall or other conductors, except that for continuous wave sets of 1000 watts and less input to the transmitter, the clearance shall not be less than 3 inches. The conductor from grounding switch to ground shall be securely supported. (It is recommended that the switch be located in the most direct line between the lead-in conductors and the point where grounding connection is made.)

h. Antenna and counterpoise conductors shall be effectively and permanently grounded at all times when station is not in actual operation and unattended, by a conductor at least as large as the lead-in and in no case smaller than No. 14 copper, bronze, or approved copper-clad steel. This protective grounding conductor need not have an insulated covering or be mounted on insulating supports. The protective grounding conductor shall be run in as straight a line as possible to a good permanent ground. Preference shall be given to water piping. Other permissible protective grounds are the grounded steel frames of buildings and other grounded metal work in buildings and artificial grounding devices such as driven pipes, rods, plates, cones, etc. The protective grounding conductor shall be protected where exposed to mechanical injury. A suitable approved ground clamp shall be used where the protective grounding conductor is connected to pipes or piping. Gas piping shall not be used for the ground. (It is recommended that the protective grounding conductor be run outside the building.)

i. The operating grounding conductor shall be of copper strip not less than 3/8 inch wide by 1/32 inch thick, or of copper, bronze, or approved copper-clad steel having a periphery, or girth, of at least 3/4 inch, such as a No. 2 wire, and shall be firmly secured in place throughout its length.

j. The operating grounding conductor shall be connected to a good permanent ground. Preference shall be given to water piping. Other permissible grounds are grounded steel frames of buildings or other grounded metal work in the building, and artificial ground devices such as driven pipes, rods, plates, cones, etc. Gas piping shall not be used for the ground.

k. Where the current supply is obtained directly from lighting or power circuits, the conductors whether or not lead covered shall be installed in approved metal conduit, armored cable or metal raceways.

1. When necessary to protect the supply system from high-potential surges and kick-backs there shall be installed in the supply line as near as possible to each radio-transformer, rotary spark gap, motor and generator in motor generator sets and other auxiliary apparatus one of the following:

1. Two condensers (each of not less than 1/10 microfarad capacity and capable of withstanding 600-volt test) in series across the line with mid-point between condensers grounded; across (in parallel with) each of these condensers shall be connected a shunting fixed spark-gap capable of not more than 1/32 inch separation.

2. Two vacuum tube type protectors in series across the line with the mid-point grounded.

3. Resistors having practically zero inductance connected across the line with mid-point grounded. (It is recommended that this third method be not employed where there is a circulation of power current between the mid-point of the resistors and the protective ground of the power circuit.)

4. Lightning arresters such as the aluminum cell type.

Guaranteed Performance

at a **50% Saving!**

World Storage "A" Battery

2-Year Guarantee Bond in Writing



New Prices

SOLID RUBBER CASE RADIO BATTERIES

6-Volt, 100-Amperes \$10.00

6-Volt, 120-Amperes \$12.00

6-Volt, 140-Amperes \$13.00

SOLID RUBBER CASE AUTO BATTERIES

5-Volt, 11-Plate \$10.00

6-Volt, 13-Plate \$12.00

12-Volt, 7-Plate \$14.50

WORLD BATTERY CO., 1219 So. Wabash Ave. Chicago, Ill.

Set your radio dials at 283.3 meters for World Storage Battery Station W5BC. Variety—new talent—always interesting.

BUILD YOUR OWN GRANDFATHER'S CLOCK



—and then build them for your friends and neighbors — Everyone wants one—fine profits, no competition. We furnish blue prints and finishing material, works, dial, pendulum, weights, etc.

Plain works as low as \$5.00, others with chimes at a range of prices to suit every customer.

Ask for Attractive Free Offer

AMERICAN CHIME CLOCK COMPANY

1681 Ruffner St., Philadelphia, Pa.

Cresradio Corporation

Formerly CRESCENT RADIO SUPPLY CO.

Announce their removal to 166-32 Jamaica Ave., Jamaica, N. Y.

Your patronage has required us to double our floor space twice in three years.

Laboratory Product



CRESCENT LAVITE RESISTANCES

Dual resistances for DeForest "11" tube or one or two fifty watters, \$3.50

Special Grid Leaks for any tube to order. Let us solve your voltage drop problems. Use all tubes in a crystal controlled transmitter on main generator. Our resistances will take care of the different voltage requirements.

Improve reception in any circuit!

REMLER RADIO PARTS

Write for New 1927 Catalog

Remler Division of
 Gray-Danielson Mfg. Co.
 260 First Street - San Francisco

You can be quickly cured if you

STAMMER

Send 10 cents for 288-page book on Stammering and Stuttering "Its Cause and Cure." It tells how I cured myself after stammering 20 yrs. **B. W. BOGUE, 6968. Bogue Bldg., 1147 N. Ill. St., Indianapolis.**

Insure your copy reaching you each month. Subscribe to **RADIO NEWS**—\$2.50 a year. Experiment Publishing Co., 230 Fifth Ave., N. Y. C.

BOOK REVIEW



The first and only complete manufacturers directory of all Standard Radio Receivers.

We all want to know what kind of a set is best to buy. Here is a book that describes all standard manufactured sets from authentic descriptions furnished by the *manufacturers themselves*.

It gives you all the information you need to make your choice, saves you from "blind" buying, and vain regrets.

GIVES PRICES, TECHNICAL DESCRIPTIONS—ILLUSTRATIONS

Receivers are illustrated, prices are given, manufacturers' names and addresses supplied. General characteristics of sets are described, number of tubes, "Electrified" Receivers, etc., etc. All you need know—Just like a permanent "Show."

The only book of its kind—absolutely unprejudiced. 52 pages—size 6 x 9 inches profusely illustrated.

DON'T BUY IN THE DARK—AVOID MAKING THE WRONG CHOICE.

USE "The directory of Standard Radio Sets."

ONLY 25c
Sold Everywhere

If your dealer cannot supply you
Write direct

The Conrad Company, Inc.
230 Fifth Ave. New York, N. Y.

By ROBERT HERTZBERG

HOW TO USE RESISTANCE IN RADIO, published by the Ward Leonard Electric Company, Mount Vernon, N. Y. 5½x6½ inches, 32 pages, paper covers, illustrated. Price, \$0.15.

DESIGN AND MANUFACTURE OF RESISTANCE UNITS, and RESISTORS FOR RADIO CIRCUITS, published by the International Resistance Company, Philadelphia, Pa. Four-page folders, cost free.

While all three of these pamphlets must be classed essentially as advertising matter, they contain much useful information that the radio experimenter will find interesting and profitable. The first is something of a symposium of socket-power-unit hook-ups, and contains data on the assembly of a number of typical devices of this kind. A particularly valuable chapter deals with Ohm's Law and how to use it in solving the common resistance problems encountered in radio work.

The last-named pamphlet is devoted mostly to the use of high-value resistors (of the small tubular variety) in receiving circuits. It gives some excellent advice on the selection of various sizes of resistors for different purposes in radio sets.

OUR RADIO PROGRAMS—WHAT IS WRONG AND WHY, by Corbett-Smith.

Published by John Bale, Sons and Danielsson, Ltd., London, England. 5½x8 inches, 40 pages, paper covers. Price, one shilling. We have been hearing for some time that broadcasting in Great Britain is in a very bad state. It has been stated that the programs are banal, the management of the stations amateurish, and that the recent acquisition of the British Broadcasting Company by the government has only aggravated what was already an exasperating situation. However, we had no idea that the general public dissatisfaction could be great enough to produce a bill of complaint so full of biting ridicule and invective as this serious work of a popular British writer. If only half of what he says about the B.B.C. and its methods of operation is true, British broadcasting must indeed be in a very sorry condition.

"Like a hundred other now great British concerns, the B.B.C. was the result of private enterprise," Mr. Corbett-Smith writes. "Half a dozen men sitting round a table, and a small office on loan to start with. Those men were all men of note in commerce and industry, engaged in the manufacture or sale of radio apparatus. Their interests were wholly industrial or commercial. They began the creation of a great machine. They created that machine—and a machine it remains a machine without a soul.

"And that is 'what is wrong with the B. B. C.?' he summarizes neatly.

The men appointed to the task of formulating programs had, it is asserted, absolutely no knowledge of the entertainment business, and the programs they presented showed this ignorance from the start.

"And yet this was an artistic enterprise, the greatest in the country," comments the writer. "At the present time, and to the best of my knowledge, there are only two men out of a staff that must run into hundreds, who can justly be said to possess the birthgift and so anything of the knowledge, experience and inclination demanded for the art as a whole."

Even the business administration of the great B. B. C. monopoly was faulty. In discussing this aspect of the general disorder, Mr. Corbett-Smith says:

"I remember once, some two odd years ago, trying to put through a perfectly straightforward business deal with the Company. Naturally I expected from them the attitude and disposition of an ordinary business corporation. But after lengthy and courteous discussions in which the rudiments of business were denied, I left in a state of complete bewilderment to sleep over it. Next morning, puzzling over it in bed with my first cigarette, I tried to recall where before I had met that quaint behavior. Suddenly I leaped out of bed. I had got it. It was exactly how my little son of two and a half had behaved when denied a biscuit or checked for some tiny fault. He would hide in a corner and talk it over with himself in queer little comments.

"I went back to the B. B. C. and humored the official exactly as we humored the youngster at home. It worked to perfection. That officer came out of his corner at once, and within a few minutes

WHEN ~ ~
stations crowd the air
& spoil your programs

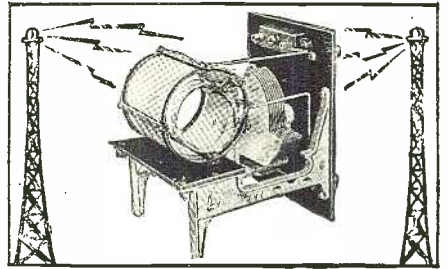

use a
Wave trap!

Brand New Conrad Pattern
Enables You to Build One at
Home

NO matter how large or small, how expensive or inexpensive a Radio Set may be, it can be decidedly improved with a good WAVE TRAP.

The Receivers of today are not built incorrectly—They are as efficient as Radio Engineering skill can make them.

The fault lies in the fact that there are so many stations on the air that receivers cannot separate them properly.

The simple WAVE TRAP solves this problem—It brings order out of chaos. It helps separate the Wave-lengths.

THE NEW CONRAD
WAVE TRAP PATTERN

This new pattern contains a gigantic blueprint, size 27¼ inches by 20½ inches, containing simplified Panel layout, Front View, Top View, Side View and Picture Wiring diagram. All measurements are shown actual size. Also a complete Illustrated Pamphlet is enclosed that shows you exactly how to proceed throughout the entire construction; these are enclosed in a heavy folder envelope size 9¼ x 9½ inches.

Note: This Wave Trap can be installed in a few seconds. It does not have to be put inside your set.

ORDER YOUR PATTERN NOW

Only 25c
Sold Everywhere

If your dealer cannot supply you write direct.

THE CONRAD CO., Inc.
230 Fifth Ave., New York, N. Y.

RADIO

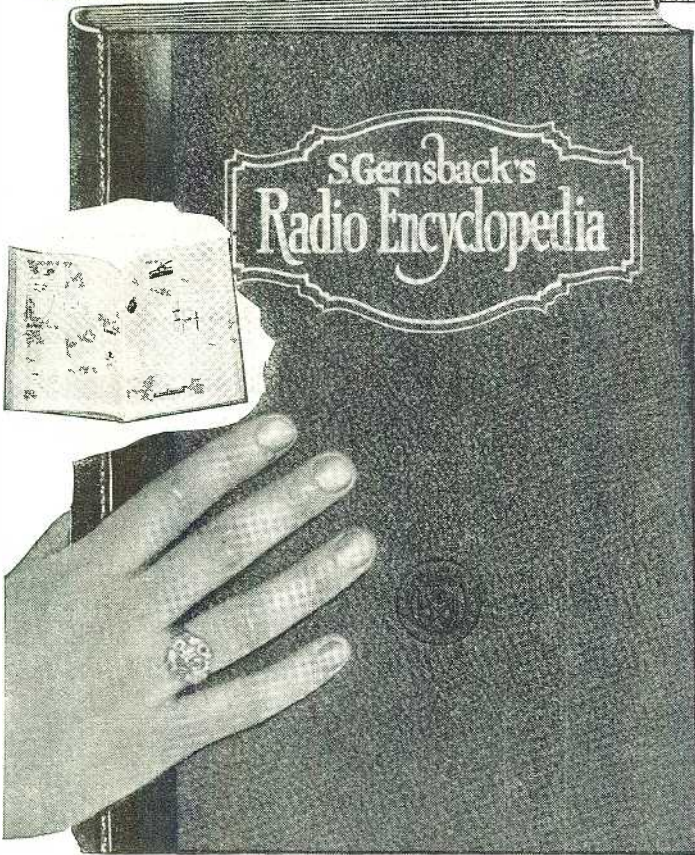

NOT A DICTIONARY—A REAL ENCYCLOPEDIA OF RADIO

ONE THOUSAND BOOKS—IN ONE

The First Classification and Explanation of the
Countless Words Used in the Specialized
Science of Radio

Edited by **SIDNEY GERNSBACK**

Editor of *Radio Listeners' Guide* and *Spare Time Money Making*. Author of *Wireless Course* in 20 Lessons, *Practical Electricity Course*, etc.

S. GERNSBACK'S RADIO ENCYCLOPEDIA is the only standard work ever published in America attempting to classify alphabetically the countless words used in the highly specialized science of RADIO. The ENCYCLOPEDIA is written in plain English so that everybody can understand the definition and descriptions. No expense has been spared covering over two years in compilation, to make it worthy a place in your library. It is published in one volume—168 pages—size 9x12 inches, nearly an inch thick and nicely accommodates the beautiful illustrations and the large, easy to read type. Every page is replete with illustrations—to make the text easily understandable. **REMEMBER THIS IS A REAL ENCYCLOPEDIA—NOT A DICTIONARY—** and very few of the things described and illustrated in this volume can be found in any dictionary, or any other encyclopedia.

The book contains as a supplement a classified cross-index designed to bring together radio references under one heading having relations in common. All circuits new and old are described by word and picture and every part and apparatus used in Radio is explained and made understandable by means of photographs and drawings. The work contains 1,930 definitions, 549 photographs, drawings and diagrams. The volume is printed upon fine paper—bound in full black Karatol, marbled paper fly leaves and end sheets, with the title stamped in gold. This volume should find a place in every library, and will be a veritable boon to you who are interested in Radio, from any angle. The advance sale was so tremendous that a very large edition has been printed, effecting a very considerable saving in printing, etc. This saving is being passed on to present purchasers, and you may obtain the encyclopedia for the present at only \$2.00.

Price \$2.00 POSTAGE PAID

If Your Dealer Cannot Supply You
SEND ALL ORDERS DIRECT TO
SIDNEY GERNSBACK
230 5th Ave., New York, N. Y.
Money Refunded If Not Absolutely Satisfactory.

MR. S. GERNSBACK,
230 Fifth Avenue,
New York, N. Y.

Dear Sir: I enclose \$2.00. Kindly send me "postpaid" one copy of your Encyclopedia!

Name

Address

City..... State.....

From A

Here Are Only a Few of the Countless Subjects In This Book:

- A. Aerials
Alternating Current
Alternators
Amplification
Amplifiers
Antennas
Arcs
- B. Batteries
Biographies
- C. Capacity
Circuits
Coherers
Condensers
Coils
Coupling
Crystals
Current
- D. Detectors
Dielectric
Discharge
- E. Electrolytic
Electromagnetic
Electromotive Force
Electrons
Electrostatic
- F. Feed Back
Field
Filaments
Flux
Frequency
- G. Galvanometers
Grids
Grounds
- H. Heterodyne
High Frequency
- I. Impedance
Inductances
Inductance Coils
Induction
Inductive
Insulating Materials
- K. Keys
- M. Magnets
Magnetic
- O. Oscillations
Oscillators
- P. Plates
- R. Radiations
Radio
Radio Frequency
Reactances
Rectifiers
Resistances
Resonance
- S. Switches
- T. Theory of Current Flow
Transformers
Transmission
Tuning
- U. Units
- V. Vacuum Tubes
- W. Wave
Wires
Etc., etc.

I had left him happily playing with his bricks on the hearthrug."
This is a comparatively tame sample of Mr. Corbett-Smith's denunciation, which he tempers to some degree with a few suggestions for improvement.

THE RADIO AMATEURS' HANDBOOK, by Francis Edward Handy. Published by the American Radio Relay League, Hartford, Conn. 6½x9½ inches, 177 pages, paper covers, illustrated. Price \$1.00.

This manual of short-wave radiotelegraphic communication is the amateur's Bible. It was prepared by the communications manager of the American Radio Relay League, the national (and to some extent international) organization of transmitting "hams," and embodies the extensive experience of the thousands of members of that body. It should be read by every radio experimenter who has grown slightly weary of building mere receiving sets and who is just beginning to contract the transmitting fever.

The book is profusely illustrated and contains many useful hook-ups, charts and other data. It is divided into eight chapters, whose headings are self-explanatory. They are: What Is An Amateur?; Getting Started; Fundamentals; How Radio Signals Are Sent and Received; Building a Station; The A.R.R.L. Communications Department; Operating a Station; The Experimenter.

In the chapter on Building a Station, Mr. Handy covers the subject with a completeness that covers every question the embryo "ham" is likely to ask. He begins by telling what tools are necessary for the building operations, and then describes a simple receiver, a wavemeter, and a number of transmitters of different sizes to suit different pocketbooks. He also discusses the peculiar aerial problem which the use of short waves creates, and offers many little suggestions about the design and erection of the proper systems.

Current Radio Articles

POPULAR RADIO, March, 1927.

With the March number *Popular Radio* begins a new feature in the form of an expanded list of broadcast events of the month. It has done this, according to an editorial announcement, to supply listeners with the program details which the daily newspapers had been in the habit of eliminating in most senseless fashion. Note we say "had been," for during the very time the magazine was in the process of preparation the New York papers suddenly reversed their policies and began printing programs in recognizable form.

The feature articles include: "The Three Blankets Around the Earth," by E. E. Free; "How to Build the New Standard Browning-Drake Receiver," by Glenn H. Browning and F. H. Drake; "Resistance Coupled Amplifiers—How to Make Them Work With Power Packs," by William T. Taber; "How to Build the New SC-11 Receiver," by McMurdo Silver and Lawrence Cockaday; "Your Laboratory Tools," by Lowell Madden, Jr., and "Uncle Sam's Wavemeter," by Andrew R. Boone.

The new Silver-Cockaday set uses two stages of R.F., a battery-biased detector, and two straight stages of transformer-coupled audio. The components of the second R.F. and detector tubes are shielded, the entire outfit being mounted on a stamped metal chassis.

RADIO BROADCAST, April, 1927.

An interesting account of Commander Donald B. MacMillan's 1926 exploration into the Arctic regions is given in this number of *Radio Broadcast* by Austin C. Cooley, who acted as radio operator (also as assistant engineer, camera man, night watchman, etc.) on board the *Sachem*, the vessel that accompanied the explorer's famous *Bowdoin*. From the radio standpoint, the expedition was a triumph for short waves, the 36.8-meter transmitter proving entirely successful in keeping the party in touch with the United States.

Mr. Cooley's article is especially recommended as diverting reading because it contains much human interest material and is not overburdened with technical details. The adventures he recounts are the kind that give radio amateurs the itch to travel and to see the world.

In "Further Comments on the R.B. 'Lab' Receiver," the *Radio Broadcast* Laboratory Staff offers some suggestions on the substitution of dry-cell tubes for the storage-battery type, discusses A.C. heating of the power tube's filament, gives coil data and some trouble-shooting hints, and remarks on the advantages of shielding.

In other articles Kingsley Wells gives four methods of improving the quality of the old-model Freshman receivers; Keith Henney describes the construction of a short-wave transmitter for the 20-, 40- and 80-meter bands; Edgar H. Felix tells what radio fans should know about the vacuum tubes they buy; James Millen gives constructional data on a D.C. amplifier-power supply device; John B. Brennan offers some improvements on the "Hi-Q" receiver, and John F. Nielsen presents a

to Z

ADVANCE announcements

from

**JUNE
 ISSUE**

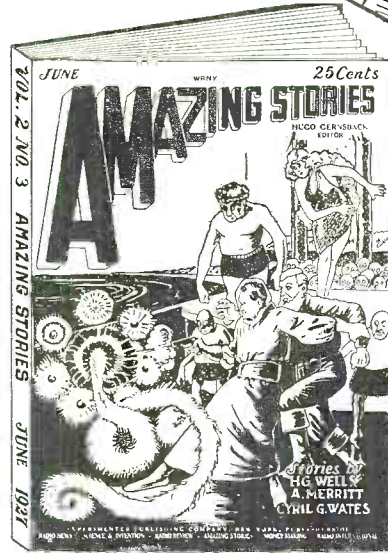
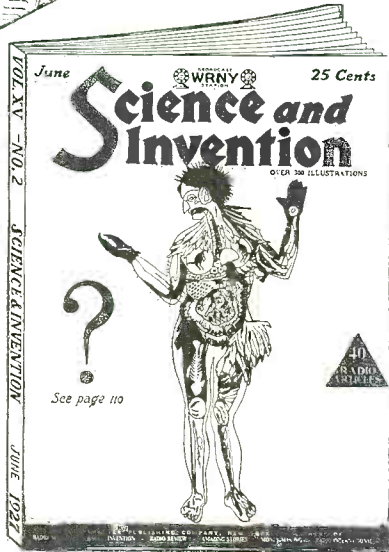

from

**JUNE
 ISSUE**

Can We Fly to the Moon?

Here's a brand new development—a combination rocket and aeroplane that brings a trip to the moon far closer to actual possibility. This machine is pictured and described in June SCIENCE and INVENTION. Don't miss it.

Is Man Compounded from Animals?

A noted German biologist propounds a very unusual and remarkable hypothesis that man was compounded from the animals. His reasoning is remarkably convincing and tremendously interesting—See SCIENCE and INVENTION for more details.

How Steel Auto Bodies are Made

Do you know that complete automobile bodies are fabricated from sheet steel in 45 minutes. It's a fact! How this is achieved will be found in the June SCIENCE and INVENTION.

Receiving Broadcast on Short Waves.

Get a new thrill from Radio—build a short wave set—you will be astounded at the powerful reception, lack of "fading," sharper signals and less static. Short Wave reception can't be beat. See June SCIENCE and INVENTION.

These and a hundred or more other scientific subjects are presented in the one big 100-page, illustrated JUNE issue of SCIENCE and INVENTION.

25c—On All Newsstands

Subscriptions
 \$2.50 the Year

USE THIS COUPON

This is the first prize story of our cover contest. Mr. Wates, the author, not only knows how to write interestingly and convincingly, but he also keeps your interest from beginning to end. Nor does he allow you to guess what it is all about until the end. The story not only is good fiction, but contains excellent science.

"The Visitation"

By Cyril G. Wates

We present our readers with a real mystery story, and perhaps one of the strangest you have ever read. It is another of those marvelous, amazing stories, that only the master, H. G. Wells, can write.

"The Story of the Late Mr. Elvesham"

By H. G. Wells

The second prize-winning story, selected chiefly because of the excellent science contained in it and the plausible manner in which the entire story is developed. The plot in this story is excellent and has an unparalleled method of unfolding the high spots that keep you on edge from beginning to end.

"The Electronic Wall"

By Geo. R. Fox

Most of us have heard about comets, but very few of us have ever seen one. As is well known, there has been a great deal of superstition about comets in the past, and the most dire things have been predicted, when one of them approached the earth sufficiently near to become visible to the naked eye. The present story by our new author is excellent for any one who wants to brush up his knowledge of comets in general with a quantum of good fiction thrown in for good measure.

"The Lost Comet"

By Ronald Sherin

Also many other stories of the semi-scientific, fiction type. The most amazing stories in the world.

25c—EVERYWHERE

Subscriptions
 \$2.50 the Year

USE THIS COUPON

EXPERIMENTER PUBLISHING CO., Inc.,
 230 Fifth Avenue, New York, N. Y.

Gentlemen: I enclose \$.....for one year's
 subscription to

Name

Address

City..... State.....

AMAZING

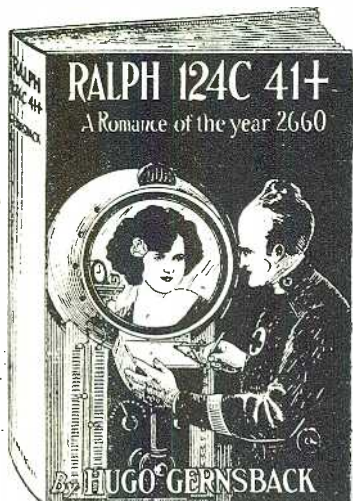

WORLD SCIENCE and ROMANCE IN THE "YEAR 2660"

from the pen of the renowned editor and Scientific Experimenter **HUGO GERNSBACK**

Against an amazing background of mechanical, electrical and chemically altered life of mankind there is set a brilliant and colorful romance in the life of the greatest living scientist of that age.

Ralph's love for the beautiful stranger, his conquest of his rival and the winning of the great saturnine Martian, culminating in a running fight in space with treachery and terror conquered by almost unbelievable and incredible weapons, make one of the most interesting and gripping stories ever told.

\$2.15 POSTPAID

Experimenter Publishing Co.,
230 FIFTH AVENUE
NEW YORK, N. Y.

AMATEURS! EXPERIMENTERS! BEGINNERS!

ALL USE

Hugo Gernsback's

"RADIO FOR ALL"

A permanent, comprehensive Reference Book on Radio. A Thousand Textbooks and pamphlets combined in one. For everyone interested in the art of Radio.

Price \$2.00 Postpaid

EXPERIMENTER PUB. CO., INC.,
230 FIFTH AVE., NEW YORK, N. Y.

16 pages of MODERN MAGIC by Dunninger

116 PAGE BOOK ON MAGIC "POPULAR MAGIC"

Thousands of Parlor and Stage Tricks used by America's foremost magician. Big second edition fresh from press. Illustrated. Size 8x12 inches.

50c

NOVELTIES! FUN! MYSTERY!
SOLD ON ALL NEWSSTANDS
EXPERIMENTER PUBLISHING CO.,
230 Fifth Avenue New York City

fundamental analysis of loud speakers. The regular monthly departments, "As the Broadcaster Sees It," conducted by Carl Dreher, and "The Listeners' Point of View," by John Wallace, are, as usual, interesting and to some degree instructive.

QST, April, 1927.

A wealth of technical information for the advanced radio experimenter and transmitting amateur is contained in QST, which is the official organ of the American Radio Relay League. Short resumes of the leading articles follow:

"Radio Translated for the Experimenter," by C. William Rados, the similarities between radio laws and the laws of heat, light, mechanics and wave motion are pointed out; "A 15-Meter Commercial Station, 2XS," a description of a powerful short-wave station at Radio Central, Rocky Point, L. I.; "Which is the Detector Tube?," by L. W. Hatry, a discussion of the fine points of detector action in vacuum tubes and of the tendency of some amplifier tubes to act as detectors. "The Institute of Radio Engineers," by John M. Clayton, all about the I.R.E., who belong to it, and how to become a member; "A Traffic Tuner," by Harold P. Westman, a short-wave receiver using a two-plate tuning condenser that spreads the tuning readings all over the dial instead of confining them to a small portion of it; "Radiotron CX-340—UX-240," by Robert S. Kruse, the complete characteristics of this new high- μ tube; "A Sensitive Thermo-Couple," by Benjamin J. Chromy, how to make at little expense and trouble a device rarely tackled by radio experimenters; "The Purpose of the Army-Amateur Affiliation," by Capt. A. C. Standford; "Developments in Dry Electrolytic Rectifiers," by Robert S. Kruse, deals specifically with the new Elkon 2-ampere charger and Elkon "A" substitute; "How Far Is It?," by C. C. Knight, some really important "dope" on figuring distances on the surface of the earth—should be read by every DX fan; "The Most Useful Meter," by R. F. Shea, how to use a vacuum-tube voltmeter for a surprising variety of purposes; "Electrolytic Filter Condensers," by Louis F. Lenck, how to make good filter condensers for transmitting sets out of ordinary aluminum pie plates.

THE WIRELESS WORLD AND RADIO REVIEW, March 16, 1927. London, England.

The first seven pages of this lively weekly magazine are devoted to a description of a device called "The Complete Eliminator, a Heavy-Duty Battery Substitute." The "B" portion is of familiar design, containing two full-wave rectifier tubes in a flexible circuit that allows the use of several voltages. The "A" section actually uses a small storage battery, but it is kept floating across the output side of a full-wave rectifier, and according to the article, acts as a filter and not as a battery.

The second article is a report of a demonstration of quality reception staged by the British Broadcasting Company recently at a home exhibition at Olympia. The sets on display used two, three and five tubes, the detectors being regenerative in all outfits. The simplest receiver comprised a single-circuit regenerator (that will squeal most heartily in neighboring sets) and one stage of transformer-coupled audio amplification. The others use a single stage of R.F. amplification and audio amplifiers of the resistance-capacity-coupled type.

WIRELESS MAGAZINE, March, 1927. London, England.

British broadcasting may be in a terrible mess, but the British radio magazines certainly are not. They are well-edited, profusely-illustrated and easily-read publications, containing a wealth of interesting matter. In this number of *Wireless Magazine*, for instance, are articles on a variety of up-to-date radio topics. A few of the titles follow: "A Loud Speaker Tone Control and Filter Unit," with which a full size blueprint is furnished free; "The Paradyne Four," a set using a variable-coupling arrangement exactly like that in the well-known American Karas "Equamatic" receiver; "Do We Want Broadcast Novels?," the pros and cons of a question agitating the British listening public; "The New B.B.C. Double-Decker Studio," "An H.T.-from-D.C. Mains Unit," or (translated into American) a "B" socket-power unit for direct current; "The One-Knob Three," a single variometer for tuning, non-regenerative detector, and two stages of resistance-capacity-coupled A.F. amplification.

The magazine also publishes a number of general-comment departments that strongly contradict the erroneous and widely-prevalent impression that the British are humorless, or at least slow to appreciate a joke. Their humor is deliciously subtle, and not at all so extravagant as ours; even the radio magazines show this.

MODERN WIRELESS, March, 1927. London, England.

This is another topnotch publication. Among the numerous articles are: "The Skyscraper Amplifier," one-stage resistance-capacity, and one-stage transformer-coupled; "An Hour with H.F. Transformers" (the abbreviation "H.F." in case you have no English-American dictionary on hand,



Party Manners!

RADIO Receivers know no rules of etiquette—they cannot be taught to act on best behavior when company and friends are judging them—but they can be made to act properly if the operator understands the few simple factors that effect tuning or the proper adjustment of the Receiver's controls.

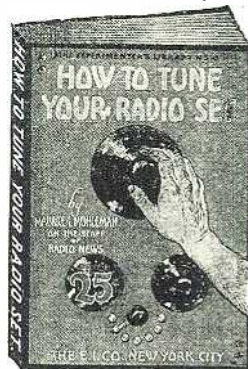

The 64 page, illustrated book on How to Tune Your Radio Set (Consrad-25c) is a carefully prepared, yet simplified, instruction book on tuning alone.

Receivers, of different types, individual characteristics are handled separately. All there is to know, All that must be known before one can really say to understand the tuning of a set—is given in this book.

25c Everywhere

If your dealer cannot supply you write direct.
The CONSRAD CO., Inc.
230 Fifth Ave. New York, N. Y.

SUMMER



fun with this powerful portable set!

MAKE THIS A RADIO SUMMER

Touring, camping, or at home, a portable Radio Receiver is a real summer enjoyment. It's convenient to carry, in your car, with your baggage, or if at home from room to room or out on the lawn.

You can build your own "portable" at a small cost—from a "Consrad" pattern which gives all instructions and parts needed, together with full size blueprints of panel and wiring diagram.

The Consrad method is the simplest ever devised—you do not have to be a Radio Expert to use it.

THIS CONSRAD PATTERN

50c—EVERYWHERE

Or send direct on receipt of 50c.

THE CONSRAD CO., Inc.

230 Fifth Ave., New York, N. Y.

Accept this Book FREE!

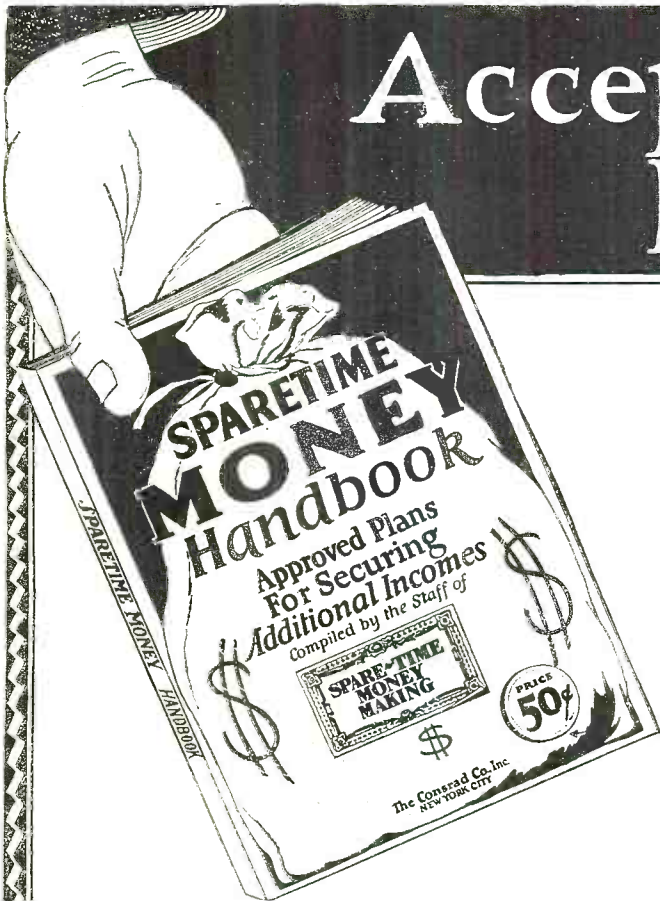

SIXTY-SEVEN plans—completely outlined with a procedure for establishing yourself in those most successful and most lucrative Spare Time businesses in the United States.

Each plan consists: First—of a definite workable item that can be retailed by people of limited means and have only a few spare minutes a day to utilize. Second—the best method of production is outlined carefully with suggestions as to what to avoid. Third—Avenues of distribution or selling are given—such methods of selling by mail as are applicable and all similar details are discussed, and Fourth—information of importance in carrying on to reap large, generous profits is discussed.

Altogether you have before you complete, accurate Spare Time businesses that have returned hundreds of dollars to others.

Sparetime Money Handbook contains 100 Pages of the large magazine, 9 x 12 inches—with handsome colored covers, over 100 illustrations.

Here is a complete list of the plans in this great book:

A Spot Remover That "Does the Work."
Two Glove Specialties.
Fishing Flies to Tempt the Angler's Dollars.
A Luscious Candy Bar, and a Novel Selling Plan.
Low-Cost Printing "Cuts" Coupled with an "Ad-Service."
Supplying Economical Cedar-Oil Moth Protection.
A "Self-Locking" Cure for the Troublesome Garage Door.
A Wiper That "Shoo's" Rain from Windshields.
A Mail-Order Service in Mail-Order Lists.
A Mailing Service for Mail-Order and Other Merchants.
Another Cost-Cutting Service for Circularizers.
Individualized Stationery in a Bargain Mail Offer.
"Your Favorite Song for Ten Cents!"
Setting Up a "Collection-By-Mail" Agency.
A Service Which Delivers "Anything That's Printed."
How to Become a "Business Opportunity" Broker.
Making the Merchant's "Rebate Offer" Work for You.
Profits from Magazine Subscriptions.
Manufacturing a Simple and Economical Duplicating Device.
Furniture "Restoration" Is Becoming a Golden Field.
"What Shall I Get Him to Play With?"
Cashing in on Potato Chips.
Building Up a Stenographic Bureau by Part-Time Independent Service.
A Tried Market for Used Cars.
A Business in Used Boxes.
A Woman's Plan: A Noon-Time Box Lunch Service.
A "Homes To Rent" Bureau Performs a Valuable Service.
"Sandwich Snacks" Find a Universal Sale.
Athletic Trunks and School Pennants as a Home Industry.
Pies and Cakes "Fresh from the Home Oven."
Home-Made Desserts "Per Cut" for the Small Family.
A Circulating Library Provides a Pleasant Home Vocation.
A Service to Give the Baby's Parents "An Evening Out."

"Professional Shopping" Developed as a Standard Service.
Marketing Home-Made Preserves.
Home-Made Gift Novelties and Toys Find a Preferred Market.
Dressing Dolls as Little Girls Like Them.
Making Needlework Pay Through Christmas Bazaars.
Writing as a Money-Producing Trade.
Vending Machines as Steady Income Producers.
Making a Business of Special Florists' Orders.
A "Local Interest" Publication with a Double Profit Plan.
Working Into the "Sales Promotion" Field.
A Spare-Time Money-Making Field in Radio.
A "Garden Crop" Money-Making Plan for Boys.
A Christmas-Money Enterprise for Boys.
Paying Your Way Through College.
Campus Photographs Aid the Student Worker's Income.
A City Agency for Fresh Eggs.
Money in Mushrooms.
Raising Pedigreed Pets as a Side-Line.
Every Community Needs a "Nurses' Directory."
Spare-Hour Flower Selling—A New Idea.
An Old Auto Generator Can Be Made to Earn Money.
An "Endless Chain" Agency.
There May Be Money in the Nearest Woods—"Nut Meats."
"One Dish a Day"—An Apartment Dweller's Scheme.
She Loves Children—And Makes Money Playing with Them.
Turning Cheese Cloth Into Money.
An Idea for Making Rubber "Bumpers" for Faucets.
Pin Money from Old Dishes.
Making Cushions for Profit.
A Boy's Plan—Make and Sell Rubber Bands.
Making Ornamental Flowers from Sea Shells.
Turning "Deviled Eggs" Into Dollars.
A Boy's Plan to Help the Housewife on "Wash Day."

Don't let this opportunity go by---clip and mail this coupon NOW!

The Consrad Co.
INCORPORATED
230 Fifth Avenue
New York, N. Y.

The CONSRAD CO., Inc.—230 Fifth Ave., New York, N. Y.

Gentlemen: On your absolute guarantee that your big SPARETIME MONEY HANDBOOK is just as described by you, you may send me same FREE. All charges prepaid. You are to send me this book at once, and enter my name for a full year's subscription to the SPARETIME MONEY MAKING, 12 numbers, for which I enclose \$1.50, the price of the SPARETIME MONEY MAKING alone.

My name is

My address is

D. X. ON A LOOP WITH THE TROPADYNE

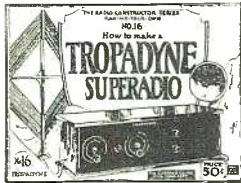

SUPER-HETERODYNE

THE World famous Tropadyne has never been surpassed.

It gets volume, clarity and marvelous D.X. reception, all on a loop antenna—No outdoor cumbersome aerial necessary.

It's a powerful Super-Heterodyne simplified, which makes it possible for anyone to construct it.

Conrad Pattern No. 16 shows you how to build this Receiver at home. New system blueprints of Wiring and Panel layout take the mystery out of blueprints. A child could understand them.

Blueprints are 19 x 44 inches.

There is also a 14-page instruction booklet, illustrated, that gives in full, all steps in the construction.

20,000 have used this Pattern

ORDER THIS PATTERN TODAY
PRICE 50c

THE CONSRAD COMPANY
230 Fifth Ave. New York City

\$35--builds this set
in your spare-time!

The World Famous "NEUTRODYNE"

There are reasons why the "Neutrodyne" has been the leading Circuit for years. It gives quiet operation, no-oscillating and good power.

It's easy to tune—and easy to build. You can save many dollars by building your own Neutrodyne, using the famous Conrad Pattern.



Use This
Conrad
Pattern
50c

This Pattern gives 2 full sized blueprints 16x30 inches of the Panel layout and Wiring diagram, also a 4-page, illustrated, instruction Booklet. The Conrad method of building is the simplest ever devised. Anyone can build from it.

THE CONSRAD CO., Inc.
230 Fifth Ave., New York City
Enclosed send 50c for one copy of your "Neutrodyne Pattern."

Name
Address
City State

means high frequency or radio frequency); "Red Tape and Broadcasting," further complaint about the stodginess of British radio programs; "A Reinartz Three Valver," "Are Filament Rheostats Obsolete?"; "Short Waves and Amateur Transmissions"; "Zero Beat Reception," "An Experimental Crystal Set," "Getting the Best From a Cone."

QST FRANCAIS, March, 1927. Paris, France.

Wading every month through the bewildering mathematics in this premier French radio magazine is like taking a dose of castor oil. Skip the formulae and you obtain nothing from the articles; refuse castor oil and retain your stomach ache. When we find in this otherwise excellent publication an explanation that demands nothing more advanced than a knowledge of square root, we shall herald the fact with shouts of joy.

Included among the articles are these: "Radio-Phone Propagation Phenomena," "Radio-Frequency Amplification," "The Electrolytic Rectifier," "A Study of Multi-Element Tubes," "Short Waves and Underground Radio," "Oscillographs," and "Wavemeters."

DER DEUTSCHE RUNDFUNK, March 13, 1927. Berlin, Germany.

The appeal of this magazine is largely to the non-technical listener interested in reading about the performers he hears and the programs they deliver. In the technical section are a number of short articles covering the following subjects: the construction and use of a capacity bridge; the construction of intermediate-frequency transformers for service in a superheterodyne; hints on emptying storage-battery cells by means of a siphon; the protection of loud-speaker windings by choke coils and blocking condensers.

FUNK, March 4, 1927. Berlin, Germany.

This weekly is very much like *Der Deutsche Rundfunk* in that it features the program activities of the European broadcast stations. The technical section is more extensive, and includes a seven-page article, illustrated with detailed drawings and photographs, dealing with the assembly of a four-tube receiver. This set uses a simple circuit comprising one stage of radio-frequency amplification, detector, and two stages of transformer-coupled audio amplification, with tuning inductances of the plug-in type. Its appearance is rather imposing, the front panel containing no less than four large dials, seven small knobs and a dozen or so incidental binding posts, jacks, etc.

This Book and Magazine section will appear in each issue of RADIO NEWS, and contain reviews of the new publications of interest to radio students, from the beginner to the most advanced. It will be found a useful guide to intelligent purchasing. For the benefit of our readers, contemporary periodical offerings, both American and foreign, will also be briefly listed.

STATEMENT OF THE OWNERSHIP, MANAGEMENT, ETC., REQUIRED BY THE ACT OF CONGRESS OF AUGUST 24, 1912.

Of Radio News, published monthly at New York, N. Y., for April 1, 1927.

State of New York, County of New York, ss.
Before me, a notary public in and for the State and county aforesaid, personally appeared Hugo Gernsback who, having been duly sworn according to law, deposes and says that he is the Editor of Radio News, and that the following is, to the best of his knowledge and belief, a true statement of the ownership, management, etc., of the aforesaid publication for the date shown in the above caption, required by the Act of August 24, 1912, to wit:

1. That the names and addresses of the publisher, editor, managing editor, and business managers are:

Publisher, The Experimenter Publishing Co., Inc., 230 Fifth Avenue, New York, N. Y.;
Editor, Hugo Gernsback, 230 Fifth Avenue, New York, N. Y.

Business Manager, R. W. DeMott, 230 Fifth Avenue, New York, N. Y.

2. That the owners are:

The Experimenter Publishing Co., Inc., 230 Fifth Ave., N. Y.; Hugo Gernsback 230 Fifth Avenue, New York, N. Y.; Sidney Gernsback, 230 Fifth Avenue, New York, N. Y.; R. W. DeMott, 230 Fifth Avenue, New York; H. W. Secor, 230 Fifth Avenue, New York, N. Y.; Dr. T. O'Connor Sloane, 230 Fifth Avenue, New York, N. Y.; Mrs. Catherine Major, 230 Fifth Avenue, New York, N. Y.; M. M. Finucan, 720 Cass Street, Chicago, Ill.

3. That the known bondholders, mortgagees, and other security holders owning or holding 1 per cent. or more of total amount of bonds, mortgages, or other securities are: None.

4. That the two paragraphs next above, giving the names of the owners, stockholders, and security holders, if any, contain not only the list of stockholders and security holders as they appear on the books of the company but also, in cases where the stockholder or security holder appears upon the books of the company as trustee or in any other fiduciary relation of the person or corporation for whom such trustee is acting, is given; also that the said two paragraphs contain statements embracing affiant's full knowledge and belief as to the circumstances and conditions under which stockholders and security holders who do not appear upon the books of the company as trustee, hold stock and securities in a capacity other than that of a bona fide owner; and this affiant has no reason to believe that any other person, association, or corporation has any interest direct or indirect in the said stock, bonds, or other securities than as so stated by him.

HUGO GERNSBACK.
Sworn to and subscribed before me this 25th day of March, 1927.

JOSEPH H. KRAUS, Notary Public.
(My commission expires March 30, 1929)

(SEAL)

~ ~ only 35. to build this five tube COCKADAY

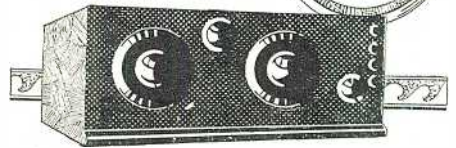

Invest 50c in the Popular CONSRAD PATTERN and Save 1/2 on Your Set

Radio's most popular "Home Built" circuit, Powerful and easily built. Used by the thousands everywhere. Parts cost only \$35 if you use the Conrad Pattern. Two full sized blueprints given, with fully illustrated instruction booklet. All measurements full size.

Panel layout and Wiring diagram simplified so that anyone can understand them. Save NOW on your Radio—Buy one of these patterns.



Price 50c

Conrad Co., Inc.,
230 Fifth Ave., New York City, N. Y.

Enclosed 50c for one copy of your pattern, "How to build the 5-tube 'COCKADAY'."

Name
Address
City State

\$MONEY\$

Real Money

May be earned during your spare time taking subscriptions to—

**RADIO NEWS
SCIENCE & INVENTION
AMAZING STORIES
SPARE-TIME MONEY
MAKING**

For full details write
AGENCY DIVISION
Experimenter Publishing Company
230 Fifth Ave. New York, N. Y.

POWERFUL SPEAKER OPERATION

with only 2 TUBES

HARKNESS RECEIVER

A marvelous Reflex circuit with tuned Radio Frequency using no potentiometer or neutralizing Condensers to prevent oscillation. Simple in operation, easy to build and inexpensive.

Build this set with a Conrad Pattern. Contains full size blueprints on panel and circuits. Also 4-page illustrated instruction sheet. Simplest patterns ever made.

50c—THE COPY

THE CONSRAD CO., INC.,
230 Fifth Avenue New York, N. Y.

Order this book!

To PUZZLEDOM

—Sam Loyd's

TRICKS and PUZZLES

THERE are one thousand hours of fun and frolic—in Sam Loyd's "Tricks and Puzzles." There is only one Sam Loyd, the Puzzle King, the incomparable, a true master mind, and he has crowded in this new volume, "Tricks and Puzzles," the best work of his lifetime.

In this book are thousands of puzzles, games, tricks, conundrums. Hun-

dreds of illustrations. Scores of puzzle stories, dozens of humorous anecdotes.

With this inexhaustible gold mine of entertainment at hand you need never be at loss for an evening party program or a rainy day's delight.

It's a book for young and old folks alike—Riddles for the youngsters—Brain teasers for the grown-ups.

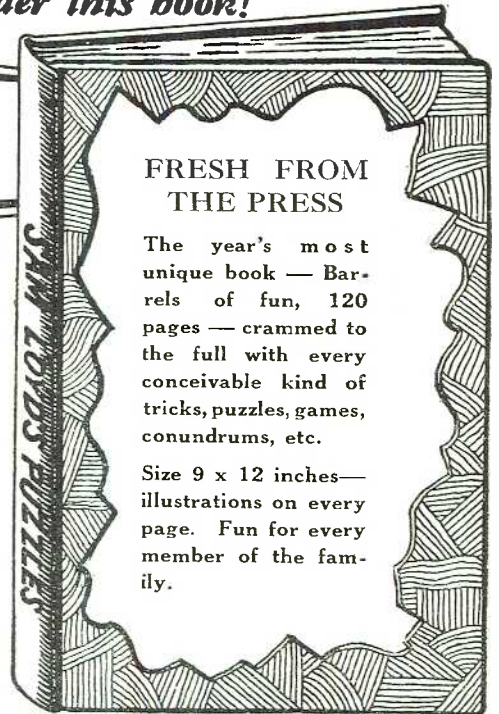

FRESH FROM THE PRESS

The year's most unique book — Barrels of fun, 120 pages — crammed to the full with every conceivable kind of tricks, puzzles, games, conundrums, etc.

Size 9 x 12 inches—illustrations on every page. Fun for every member of the family.

PRICE 50c THE COPY
SOLD ON ALL NEWSSTANDS

If your dealer cannot supply you, use this coupon

EXPERIMENTER PUB. CO., Inc.
230 FIFTH AVENUE NEW YORK CITY, N. Y.

EXPERIMENTER PUB. CO., Inc.
230 Fifth Ave., New York, N. Y.
Gentlemen—I enclose 50c for one copy of Sam Loyd's Tricks and Puzzles.

Name
Address
City..... State.....



read **PALMISTRY EXPLAINED!**

Secrets of your hands

Learn the Secrets, in your palm, your friend's palm. The most amazing Science in the world.

Palmistry is within everyone's grasp. Everyone's palm is like an open book, their character, habits, life lines and fortune are indelibly imprinted there.

Learn how the professionals read your palm and then go out and mystify your friends—you can expose their innermost secrets at their expense.

This brand new 116 page, illustrated book is as up-to-date as the art has progressed. It's more thorough than any on the market.

Palm reading is simplified. With this book you can become proficient in a few days.

Buy your copy today—you're in for a big surprise and plenty of fun.

100 PAGE BOOK
FRESH FROM
THE PRESS

50c

On All Newsstands

If your dealer cannot supply you write direct

Experimenter Pub. Co., Inc.
230 Fifth Ave., New York, N. Y.

Experimenter Pub. Co., Inc.
230 Fifth Ave., New York, N. Y.

Gentlemen—I enclose 50c for one copy of "SECRETS OF YOUR HANDS" (PALMISTRY EXPLAINED).

Name
Address
City, State

Issued every month in leading magazines

CONSRAD NEWS

ADVERTISEMENT

World's largest Radio Book publishers

Radio Waves— What Are They?

Waves we cannot feel, see or hear, yet they are everywhere.

Waves in a body of water are clearly visible, but Radio Waves can neither be seen, heard nor felt. Yet these same Radio Waves have length, frequency, velocity, height and form.

Radio Waves travel with a velocity of about 186,000 miles a second. The distance to which a Radio Wave will travel before dying out depends to a certain extent on its frequency.

The sound waves at the broadcast station are impressed upon a Radio Wave and this carried to a receiving set which in turn transforms them back to sound waves.

How this remarkable transposition is made and all about Radio Reception is thoroughly and simply explained in the Consrad Book, No. 11, "HOW RADIO IS RECEIVED."

The book can be bought at your Radio Dealers or you can buy a copy direct, the price is 25c—use the coupon below for ordering.

The Fun of Building a Radio Set—and the Thrill of Saving.

A good, carefully built Radio Receiver can equal, even surpass, in some cases, the finest factory made sets.

There is no special difficulty in constructing a good set if one starts with a good circuit and the proper instructions.

To help home set builders in achieving the best results, the Consrad Book No. 2 "HOW TO BUILD PRACTICAL RADIO SETS" is published.

The 64-page book contains many circuits of the most practical and efficient types—complete circuits are shown in all cases. The price of this book is only 25c—you can buy it at most Radio Stores or order direct by the coupon below.

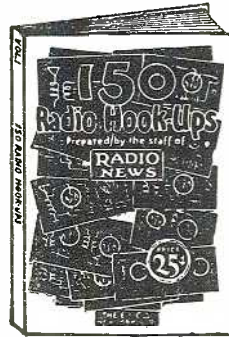

Latest, finest collection of hook-ups obtainable—64-page book, illustrated. Price 25c.—Order Below



67 DEFINITE and WORKABLE PLANS TO MAKE MONEY

SIXTY-SEVEN plans—completely outlined with a procedure for establishing yourself in those most successful and lucrative Spare Time businesses in the United States.

Each plan consists of a definite workable item that can be retailed by people of limited means and have only a few spare minutes a day to utilize.

Altogether you have before you complete, accurate Spare Time businesses that have returned hundreds of dollars to others.

Sparetime Money Handbook contains 100 Pages, of the large magazine size, 9 x 12 inches—with handsome colored covers, over 100 illustrations.

ORDER BY COUPON ON THIS PAGE

THE CONSRAD RADIO LIBRARY

- Book 1—Tips for the Radio Amateur Constructor.
- Book 2—How to Make Practical Radio Receiving Sets.
- Book 3—Radio Questions Answered.
- Book 4—Radio Frequency Amplification.
- Book 5—Loud Talkers and How to Build Them.
- Book 6—How to Tune Your Radio Set.
- Book 7—One Hundred Radio Hook-ups.
- Book 8—One Hundred and Fifty Radio Hook-ups.
- Book 9—All About Radio Parts.
- Book 10—History and Operation of the Vacuum Tube.
- Book 11—The Neutrodyne, All About It.
- Book 12—How Radio Is Received.
- Book 13—The Radio Trouble Finder.
- Book 14—Reflex Radio Receivers.
- Book 15—The Super-Heterodyne, Theory and Construction.

These books are sold by all Radio Dealers—or you can use coupon here.

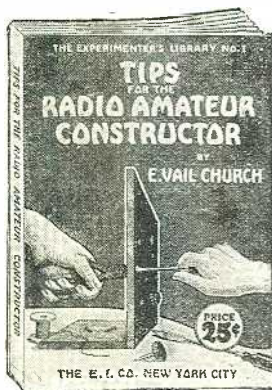

"A Chain is only as strong as its weakest link--!"

A Radio Set as strong as its weakest part.

Each and every part of a Radio Set must function properly, if you will get good reception.

There are many hints used by Radio Experts that make for perfect set building and perfect operation of all parts. These hints are combined into a 64-page illustrated book of great value to every set builder.

"Tips for the Radio Constructor Book No. 1."

64 Pages, 5x8—illustrated. Price 25c. Order Now!

THE CONSRAD CO., INC.
230 Fifth Avenue, New York, N. Y.

Gentlemen—I enclose \$..... for 1 copy of Books Number.....
..... Sparetime Money Handbook

Name
Address
City State

Astounding results acclaim SUBANTENNA the one, great, new Radio Improvement

Get Distance Loud and Clear All Summer.

Amazing New UNDERGROUND ANTENNA System Works Like a Sieve

Think of the broadcast music as fine sand and the static, arc-light sputters and other unwanted noises as large pebbles. SUBANTENNA acts like a sieve. The screen holds back the large static pebbles, but lets the music, or the sand, sift through. In reality, SUBANTENNA is a scientifically designed high frequency wave filter, so constructed and of such material, as will retard the passage of such impulses as comprise static, and at the same time offer an easy path to impulses having the characteristics of the broadcast wave. So absolutely astounding are the results obtained from SUBANTENNA, that until you have spent an evening with a set connected to one, you positively have no idea how truly clear and wonderful distant reception can be.



Yes, it is now possible. Loud, clean, clear, crisp distant reception right through raging summer static! Imagine listening to beautiful music, thinking it is from a local station, then hearing the announcer clearly speak the call letters of a station a thousand miles away. Imagine the pleasure of bringing in amazingly pure DX with tremendous volume on the same set which with an old type aerial, gets mostly rasping noise! No wonder SUBANTENNA is acclaimed one of the greatest new things in Radio! No wonder we can make a daring offer to let you test SUBANTENNA for 10 days and nights, entirely at our risk!



SUBANTENNA

Read PROOF of the Startling Performance of SUBANTENNA

"No Static"
"I have received the Subantenna. My grandson installed it. **STATIC IS NO MORE.** Am well satisfied. I can tune in stations I never could coax out of the air even though I had a long aerial."—A. E. F., Kans.

Much Clearer
"We are all very much pleased with the way this underground aerial works. We find that the stations come in much clearer, and there is practically no static. It has been a great novelty in our neighborhood."—A. T. S., Chicago.

"Better Selectivity, Static Gone"
"It has always been impossible for me to eliminate the Drake Hotel. I was told that Subantenna would enable me to do this. Although skeptical, in view of many similar claims made by other manufacturers of radio accessories, I had one of the Subantennas installed. The results have been most satisfactory, in that I have not only been able to get every station in Chicago or any consequence, when the Drake was on the air, but out-of-town stations as well. In addition I am able to report that static which was a source of much annoyance before, has been entirely eliminated so far as I am able to observe."—L. J. P., Chicago.

Michigan Gets California
"I have had KFI, California, several times and go all over the U. S. A. to Portland, Maine. You have the goods. It is far better for volume and tone on loud speaker than outside aerial."—C. J. S., Mich.

Filters Out So Much STATIC and Noise You Never Know They Exist

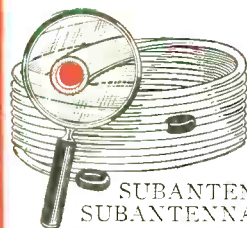

SUBANTENNA is a proved success. Fans in all parts of the country write glowing letters in praise of it. Read in the adjoining left column what several users say about SUBANTENNA. Others write that SUBANTENNA has completely rid them of interference nuisances that had always spoiled even their local reception. Not only static, but arc-light sputters, leaky power line crackles and a host of other disturbing noises. So much sweeter—so much better—does SUBANTENNA make local as well as distant reception; such a tremendous improvement does it make in both the winter and summer performance of any radio set, that no one, once he has used SUBANTENNA, would ever go back to the old style aerial again.

TRIAL OFFER

MAKE THIS CONVINCING TEST

Install SUBANTENNA. Leave your old aerial up. Select a bad night when DX is almost impossible with the ordinary aerial. Make a comparison station for station, connecting first your aerial, then SUBANTENNA. If from stations that are just a mess of jumbled noise with the old aerial, you don't get reception that rivals local in sweetness and clarity the instant you switch to SUBANTENNA, this test won't cost you even a single penny. Send Coupon at once for scientific explanation of SUBANTENNA and for particulars of GUARANTEE and FREE TRIAL OFFER. Send COUPON NOW!

CLOVERLEAF MFG. CO.
2715-E Canal St., Chicago, Ill.

CLIP AND MAIL AT ONCE

Cloverleaf Mfg. Co.,
2715-E Canal St., Chicago.
Tell me all about SUBANTENNA, your unqualified, unconditional guarantee and your FREE TRIAL OFFER.

Name

Address

HEAR
ELECTRONS
JUMP!

Do electrons jump? We talk about quadrillions of them per second leaping across from the filament of the plate of a Radiotron, when you are listening to a lecture. But these particles are so tiny that no microscope could make them visible—not even a thousand of them clustered together!

They cannot be seen. But in one of the Radiotron laboratories there is an interesting device with which they can be heard. A delicate amplifying system and a loudspeaker do for the ear what the microscope cannot do for the eye—they reveal the actual existence of the electron. You hear it hit the chamber.

This device is but one of many fascinating machines built in the laboratories of "pure science" where research carries forward our knowledge of the vacuum tube and its action. When you buy an RCA Radiotron, you have the benefit of this research, in the fine performance of the tube in your set.

There is a Radiotron for every purpose. Look for the RCA mark to be sure it is genuine.



RADIO CORPORATION
OF AMERICA
New York Chicago
San Francisco



The new radio
is clearer
try this improvement
on your old set

Most people want radio music loud enough to fill a room. But on many sets this volume of tone cannot get through the last audio stage without getting badly distorted. But you don't hear this blurred music so much today.

Since RCA developed the power Radiotrons, they've been adapted into new sets. Make the same change in your old set. Let the big volume through clear and true-toned—without distortion. Put in one power Radiotron in the last stage, and clear up the tone!

Bring your storage battery set up-to-date with
a power RADIOTRON UX-171 or UX-112
a detector RADIOTRON UX-200-A

and RADIOTRONS UX-201-A for all-round quality

Bring your dry battery set up-to-date with
a power RADIOTRON UX-120

and RADIOTRONS UX-199 for all-round quality.

RCA  Radiotron

MADE BY THE MAKERS OF THE RADIOLA