

# How Far Will the Crystalloi Detector Operate?

Here is the recent experience of an amateur. His letter, dated at a town in Central New York, came into our office just a few days ago. We copy it exactly as received.

Connecticut Tel. & Elec. Co.  
Meriden, Conn.  
Gentlemen:

Please send me at least three names and addresses of recent purchasers of your Crystalloi Detector. I have one of your type AA detectors and have done some very good work with same. On the night of Jan. 5, 1920, NAA was readable, 5 ft. from phones and audible at 15 ft. Among some of the other stations heard with receivers away from ears are: NAD, NAE, NBA, NAJ, NAW, NCQ, NAR, and dozens of others.

Please let me hear from you at once. I wish to know what others are doing.

(Name on request.)

Stations named above are:

NAD—Boston, Gloucester, Deer Island, Fourth Cliff  
(Direction finder stations)  
NAE—Cape Cod, Mass.  
NBA—Balboa, Darien, Canal Zone  
NAJ—Great Lakes, Illinois  
NAW—Guantanamo Bay, Cuba  
NCQ—Seatia, Ship  
NAR—Key West, Florida

Would you like to do as well? You can, with a Crystalloi. Our booklet tells you all about it. Ask for a copy.

**CONNECTICUT TELEPHONE & ELECTRIC COMPANY**  
Meriden Connecticut

# RADIO AMATEUR NEWS

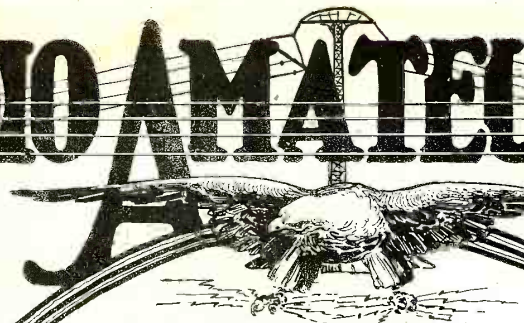

## CONTENTS

### FOR MARCH

PAGE	PAGE
About Radio Clubs By H. Gernsback, Editor 463	The Construction of a Honeycomb Coil Winding Machine....By M. Walter, Jr. 479
New Radio Station at Lyon, France By Henri de Gallaix 464	The Ideal Radio Cabinet By E. Shalkhauser, A.B. 480
The Vacuum Tube in France By W. Tock 466	Amateur Navy Type Short Wave Regen- erative Set.....By J. S. Brown 481
New Radio Apparatus..... 467	The Planchette Tuning Board By S. K. Culbertson 482
Efficient 200 Watts Emergency Trans- mitter.....By E. T. Jones 468	Ideas—Fourth Spasm—By T. W. Benson 483
The Armstrong Super-Autodyne Ampli- fier.....By H. W. Houck 469	The Tree Antenna..... 484
The Design of a 1 kw. Arc Converter By J. B. Down, Ensign, U. S. N. 472	Radio Patents ..... 485
A New Way to Get Your Fundamental By "Yose" 475	Radio Digest ..... 487
The Differential Circuit—By L. Hanson 476	With the Amateurs..... 488
Radiophone Experiments By F. R. Kingman 477	The Autobiography of a Girl Amateur.. 490
Radio Constructor..... 478	When the Lights Grew Dim By R. W. Allen 491
	Club Gossip..... 492
	Junior Radio Section..... 493
	I Want to Know..... 497

RADIO AMATEUR NEWS is published on the 25th of each month at 233 Fulton Street, New York. There are 12 numbers per year. Subscription price is \$2.00 a year in U. S. and possessions. Canada and foreign countries, \$2.50 a year. U. S. coin as well as U. S. stamps accepted (no foreign coins or stamps). Single copies, 15 cents each. A sample copy will be sent gratis on request. Checks and money orders should be drawn to order of EXPERIMENTER PUBLISHING CO., INC. If you should change your address notify us promptly. In order that copies be not miscarried or lost. No copies sent after expiration.

All communications and contributions to this journal should be addressed to: Editor, RADIO AMATEUR NEWS, 233 Fulton Street, New York. Unaccepted contributions cannot be returned unless full postage has been

included. ALL accepted contributions are paid for on publication. A special rate is paid for novel experiments; good photographs accompanying them are highly desirable.

RADIO AMATEUR NEWS. Monthly. Entered as second-class matter June 6th, 1916, at the Post Office at New York, N. Y., under the Act of March 3, 1897. Title registered U. S. Patent Office. Copyright, 1920, by E. P. Co., Inc., New York. The Experimenter Publishing Co., 233 Fulton Street, N. Y., N. Y. The Contents of this magazine are copyrighted and must not be reproduced without giving full credit to the publication.

RADIO AMATEUR NEWS is for sale at all newsstands in the United States and Canada; also at Brentano's, 37 Avenue de l'Opera, Paris. For Great Britain: Geoffrey Parker & Gregg, 63 & 84, The Mall, Ealing, London.

Published by EXPERIMENTER PUBLISHING CO., INC. 233 Fulton Street, New York City  
 H. GERNSBACK, President S. GERNSBACK, Treasurer R. W. DE MOTT, Secretary

# TRIODE

(TRADE MARK)

## Audio Transformer Type P

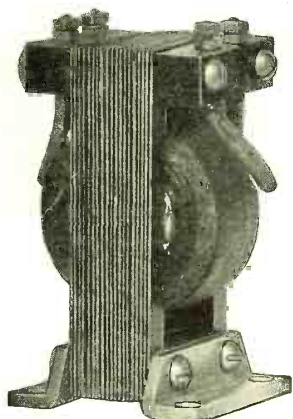

PRICE \$7.00  
Postpaid  
**IMMEDIATE  
DELIVERY**

Standard Vacuum  
Tubes \$7.00 each.

Due to its operation on the principle of voltage amplification through resonance this transformer provides a maximum of low frequency amplification and is superior to all others. Permits reliable daylight reception from European stations. Establishes new amateur long distance records. Renders remarkable amplification of all signals. May be used with the Marconi and all standard tubes.

# TRIODE

(TRADE MARK)

## Vacuum Tube Socket Type F



Price \$1.25 Postpaid

The base of this socket is bakelite dielecto and will not crack and break like the moulded material of the usual socket. Contact springs are stamped with identifying letters. Base is provided with three rubber feet and four countersunk holes for panel mounting.

We also manufacture:

- Eaton Oscillators
- Grid Leaks
- FARADON MICA TRANSMITTING CONDENSERS
- Standard and Special Radio Equipment of Every Description
- Two Step Amplifiers
- Damped and Undamped Receivers

**Wireless Specialty Apparatus Co.,** ENGINEERS, DESIGNERS, MANUFACTURERS  
BOSTON, MASS., U. S. A.



TWO STAGE AMPLIFIER

# AMPLIFICATION

Somewhat

# BEYOND THE USUAL

is

Secured with our type Q. O. coil, designed on a somewhat different principle. Its somewhat higher price is trifling, results considered.

- Two Stage Amplifier, complete.....\$50.00
- Type Q. O. Coil, mounted..... \$7.50
- Type Q. O. Coil, unmounted..... \$5.00

Immediate deliveries—From most good dealers. Bulletins F and Z sent for 4-cent stamps list our complete line of high grade, moderately priced, apparatus for the Radio Laboratory.

## THE CAMBRIDGE RECTIFIER

illustrated here will charge your storage batteries at home from any alternating current lamp socket cheaply and simply. It is fully described in Bulletin R.

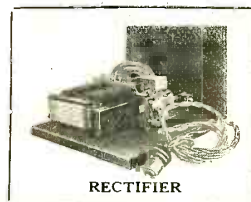

RECTIFIER

**CLAPP-EASTHAM CO.**

120 MAIN STREET

CAMBRIDGE, MASS.

*You benefit by mentioning the "Radio Amateur News" when writing to advertisers.*

NAME .....  
 ADDRESS .....  
 STATE .....

ELECTRO IMPORTING COMPANY,  
 231A Fulton St., New York City.

I enclose herewith 6 cents in stamps or coin for which please send me your latest Cyclopeda Catalog No. 21 containing 176 pages, 263 illustrations and diagrams, including Treatise on Wireless Telegraphy, and 20 coupons for your 160 page Free Wireless Course in 20 lessons.

R. A. N. (3-20)

**FILL IN THIS COUPON FOR YOUR COPY OF**  
**Our New 176 Page Cyclopeda No. 21**  
**IT IS WAITING FOR YOU**

Full size fac-simile of our catalog just as it looks when you get it  
**1-2 INCH THICK** **WEIGHT ALMOST 1-2 POUND**  
**263 Illustrations**

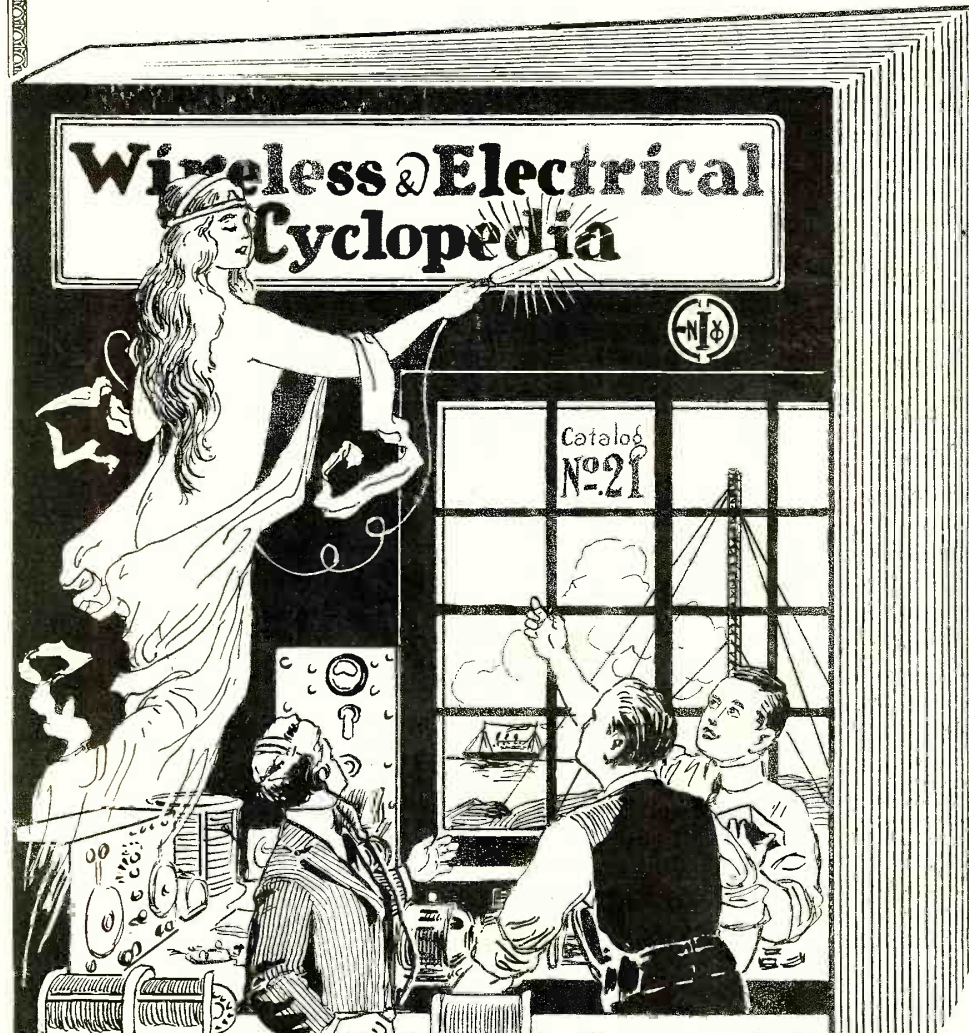

**Wireless & Electrical Cyclopedia**

**The Electro Importing Co.**  
 231 FULTON STREET NEW YORK  
**"EVERYTHING FOR THE EXPERIMENTER"**

**A Few Interesting Things from Catalog No. 21**

- Treatise on Wireless Telegraphy by H. Gernsback, Editor Electrical Experimenter and Radio Amateur News—13 big pages, 3 illustrations.
- The Wireless Law of 1912—all about it, what you can do and what you can't.
- How to receive and send Radio messages.
- How far you can send messages.
- Table of wave lengths of principal U. S. & foreign Radio high power stations.
- How to receive time signals by Radio.
- How to construct an amateur aerial.
- How to use the test buzzer.
- How to join the "Radio League of America" FREE, including application blank.
- How telephone receivers are wound and built, tested and magnetized. 3 pages, 2 illustrations.
- Experiments with a pony telephone receiver, with 6 illustrations.
- Wireless Codes: Morse, Continental, Navy.
- Experiments with spark coils, 3 pages.
- How to photograph electrical discharges (sparks).
- All about storage batteries, how to test them, recharging, etc.
- Tesla experiments, 2 pages.
- How to make Selenium Cells (illustrated).
- FREE** with this wonderful cyclopedia—20 coupons for our 160 page Wireless Course in 20 lessons, 250 illustrations, 50 tables. Catalog explains how you can get this Course absolutely free.

**"THE LIVEST CATALOG IN AMERICA"**

**I**N this cyclopedia you will find 116 pages all about radio. One of the greatest catalogs of its kind in print.

You will find in it dozens of wireless instruments of the famous E. I. Co. make. Remember always that this company was the **FIRST** to make and sell wireless instruments, the first wireless outfit having been placed upon the market by them in 1904. The E. I. Co. *knows how*, because it has the experience. Others imitate but cannot equal

E. I. Co. for quality and workmanship.

Other things you will find listed in this catalog: Electrolytic Interrupters, Bulldog Spark Coils, Chemical Outfits, Omni-graphs, Code Practice Sets, Telegraph Instruments, Primary Batteries, Storage Batteries, Solenoids, Hydrometers, Volt and Ammeters, Batterymeters, Electrolytic Rectifiers, Rheostats, Tesla Coils, Nickel Plating Outfits, Lighting Plants, Dynamos and Motors, Microphones, Detectiphones, Loud

Talkers, High Frequency Apparatus and supplies, Heating Pads, Electro-magnets, X-ray tubes, Telephones, Magnetos, Low Tension Transformers, Books, etc., etc.

**IN A WORD THE MOST COMPLETE CATALOG IN PRINT**

**ELECTRO IMPORTING CO.**  
 231-A FULTON STREET NEW YORK, N. Y.  
**"Everything for the Experimenter"**

# LEARN WIRING

## Earn \$50.00 to \$75.00 a Week

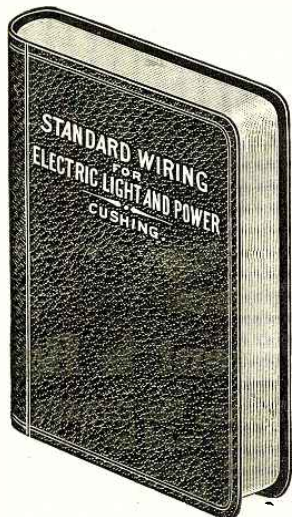

POCKET SIZE  
LEATHER COVER  
GILT EDGES

THE NEW EDITION **1920** COMPLETELY REVISED

## “STANDARD WIRING”

*Will Make You An Expert Wireman*

**GENERATORS**—How to install them, care for them and operate them; all their troubles and how to prevent and cure them; all diagrams showing connections for compound, series and shunt wound machines. How to operate them in parallel or in series. How to protect them and wire them in accordance with the underwriters' requirements.

**MOTORS**—How to install them, how to protect and operate them. The required amperes, volts or horse power when any two factors are known. How to take care of hot boxes, sparking commutators and other troubles. How to change the direction of rotation when desired. How to start and stop any kind of motor in any class of service. All diagrams of motor wiring. How to find the proper size of wire for any motor for direct current or for A. C. single, two or three-phase.

**OUTSIDE WIRING**—Pole line construction, line wires, service wires, roof structures, poles and their dimensions and weights, and how to erect and protect them and wires they carry. Insulators, guard arms, guy anchors. Tree wiring, splicing, service and entrance wiring. How to install Lightning arresters. Transformers with diagrams and instructions.

**INSIDE WIRING**—When and where to use rubber covered, slow burning and weatherproof wire. How to find the proper size of wire to use for lamps, motors or heating devices for any current, voltage and drop, either by formula or by the many tables that are given in this section of the book. How to wire for two-wire or three-wire systems. Direct current, two-phase and three-phase with formulae and tables, with examples worked out for each system and in a simple manner that anyone can understand and use. How to run wires on walls, ceilings, floors, through partitions and walls and in concealed places, damp places and where dangerous surroundings exist. When and where to install Switches, Cut-outs and Circuit Breakers and just how to do it. How to wire for high and low voltage systems and the precautions to be taken. The proper way to install Knife and Snap Switches, Cabinets and Cut-out Boxes, Outlet, Junction and Switch Boxes, Panel Boards, Wooden and Metal Raceways. How to install complete interior conduit jobs either for rigid metal, flexible metal or flexible non-metallic conduit. Concealed knob and tube work or armored cable. How and where to install and wire electric and combination lighting fixtures. How and where to use flexible cord and where not to use it. How to install arc lamps and gas filled lamps and the fixtures and rules required.

**LIGHT AND ILLUMINATION**—What is meant by proper and efficient illumination, the latest data on

Mazda and gas filled lamps of every candle power and wattage. Direct, indirect and semi-indirect illumination and where each should be used. Illumination required for various classes of service from show window lighting to public halls and from factories to small residences.

**SPECIAL SECTIONS**—House and residence wiring with diagrams; how to wire garages; how to wire theatres and moving picture houses; electric organs; marine wiring for ships and vessels; how to install and care for watt-hour meters; electric ranges, etc.

**STORAGE BATTERIES**—Both lead and Edison types and how to install, charge, discharge and care for them to get the best results.

**250 ELECTRICAL AND MECHANICAL TERMS AND UNITS**—Giving their definition, values and what they mean in your work together with the complete metric system of weights and measures.

**TABLES**—Fifty-two tables giving every dimension, carrying capacity, resistance, weight and strength of every size of wire and cable of copper, steel and iron. All the necessary dimensions, capacities, weights, and other data on conduits, fuses, insulators, lamps sockets, motor efficiencies, current per horse power of motors. Proper size of wire for all classes of power, light and heating installations. The proper symbols to use to indicate on plans just what is wanted from a motor to a small snap switch with all necessary diagrams.

**APPARATUS AND SUPPLIES**—A classified list of the leading manufacturers of officially approved wires and wiring devices. Engines, generators, motors, appliances, fixtures and all supplies necessary for any complete installation from a Central Station to a small cottage.

*The only complete and accurate Book on Wiring and Construction published.  
Over twice the useful information ever contained in any previous edition.*

**440 PAGES - LEATHER COVER - GILT EDGES - POCKET SIZE, \$3.00**

*Sent Postpaid to Any Address on Receipt of Price by*

**H. C. CUSHING, Jr., 14 West 40th Street, New York**

*Every Electrical Inspector in the United States will approve your work if done in accordance with the simple rules given in “Standard Wiring”*



Fleming Pat. No. 803684  
De Forest Pat. Nos. 841387-879532

# A WARNING

to Manufacturers  
Importers  
Dealers  
Jobbers  
Agents  
Amateurs  
Purchasers  
Users of

## Vacuum Tubes

### The Marconi V. T. Patent is Basic

United States Letters Patent to Fleming, No. 803,684, November 7, 1905, has been held to be valid by Judge Mayer of the United States District Court for the Southern District of New York, and by the United States Circuit Court of Appeals for the Second Circuit.

It is a basic patent and controls broadly all vacuum tubes used as detectors, amplifiers or oscillators in radio work.

No one is authorized to make, sell, import or use such tubes for radio purposes, other than the owners of the patent and licensees thereunder. Any others making, selling, importing or using them alone or in combination with other devices, infringe upon the Fleming patent and are liable to a suit for injunction, damages and profits. And they will be prosecuted.

### THE AUDIOTRON AND THE LIBERTY VALVE ARE NOT LICENSED UNDER THE FLEMING PATENT

The price of the genuine Marconi V. T. delivered is \$7.00 each. The standardized socket is \$1.50 additional. The standard resistance, complete, costs \$1.00 and is made in the following sizes:  $\frac{1}{2}$  megohm, 1 megohm, 2 megohms, 4 megohms, 6 megohms.

Do not take chances by making, importing, selling, purchasing or using vacuum tubes for radio purposes not licensed under the Fleming patent. By selling, purchasing or using licensed tubes for radio purposes you secure protection under the Fleming patent and avoid the risk of litigation for infringement thereof.

This warning is given so that the trade and public may know the facts and be governed accordingly.

*Send all remittances with order to* **COMMERCIAL DEPARTMENT**

**MARCONI WIRELESS TELEGRAPH CO. OF AMERICA**  
**RADIO CORPORATION OF AMERICA**  
225 Broadway      Woolworth Building      New York

*Sole Distributors for De Forest Radio Telephone & Telegraph Co.*

Retail Office and Exhibition Rooms, 25 Elm St., New York

Schofield Bldg., Cleveland, Ohio  
American Bldg., Baltimore, Md.

Insurance Exch. Bldg., San Francisco, Cal.  
136 Federal St., Boston, Mass.

301 Commercial Bank Annex, New Orleans, La.  
109 South 2nd St., Philadelphia, Pa.



# RADIO AMATEUR NEWS

H. GERNSBACK — EDITOR



Vol. 1.

MARCH, 1920

No. 9

## About Radio Clubs

THE writer receives many requests, almost daily, from ambitious amateurs desiring to start radio clubs, and who do not know how to go about it. The simplest way and the one that has proven uniformly successful is as follows:

No matter how small the town or city is in which you live, you will always be able to locate two or three amateurs, who with very little talk can be induced to form themselves into a radio club. Of course, you cannot have a club with only three or four members, but the idea is to get a few charter members to start the ball rolling.

The next thing to do, is to hold a meeting at one of the member's home, decide upon the club's name, formulate its rules, select a meeting place and decide upon all other important points in connection with the new club, and which are never the same for two clubs.

The next move and the most important by far is to enlist the good-will of the press, and this as we know from experience has never failed. If the secretary of the club will write out a neatly typewritten statement of the club's purposes, by-laws, etc., and will see the editor of his local paper, nine times out of ten a nice reading notice will be published free of charge.

It should be noted that this reading notice should always be worded in such a manner that *reference is made to the fact that new members would be heartily welcome.*

Then if other amateurs in town or in the vicinity see this notice in the newspaper, they will not be slow in writing to the secretary to secure all the particulars of the club, and soon many members will be enrolled.

The secretary of the club should be urged to keep in touch with his local newspapers *at all times*, because they will be of inestimable value to the club in the future. The secretary should have a picture taken of all the members; another picture may be taken of the members as they group around the club's radio set; such pictures are always welcomed and gladly printed by the newspapers which greatly enhance the standing of the club. In exchange for this publicity, every radio club can furnish the newspaper offices with free radio news, such as weather reports or anything else of importance that comes thru the air. Most of the smaller newspaper offices in the country do not have quick wireless news service, and not one newspaper in a hundred has its own radio outfit with which to receive the news. Consequently, there will soon arise an intimate co-operation between the newspaper offices and the radio club, one helping and boosting the other.

You will be surprised to know that even in a small Ohio locality of 2500 people, intelligent co-operation with the local papers has resulted in the club's enrollment of seventy or eighty members, with new members being enrolled every day.

The point the writer wishes to make here is that radio is still in its infancy, and the more new enthusiasts we can bring to the cause, the better for the entire radio fraternity.

In the case mentioned before, there were only about ten actual radio amateurs in this particular small Ohio town at the time the club was started, but as soon as regular newspaper notices began to appear other boys became interested in wireless, and today this locality has one of the most progressive clubs in the country for its size. A club such as this one becomes an important force by itself. Should adverse legislation threaten us again, this club will do its duty and *because it is linked with the newspaper office, it will make itself heard very much quicker in Washington than otherwise.* Always bear this in mind.

Just to show what progressive amateurs can accomplish with newspaper publicity we wish to cite the following. Take for instance the *Pittsburgh Gazette-Times* and the *Seattle (Wash.) Post-Intelligencer*. Every Sunday these two papers have signed articles in a regular conducted department. The former has a big, well written department called "*The Radio Amateur*." One of the members of the local club furnishes the articles, which are usually more or less technical, but are being read just the same by those technically inclined of the community. The *Post-Intelligencer* conducts a department called "*Radio Waves*." This department is interesting because it publishes radio questions and answers as well as the necessary diagrams.

You would do well to write to these two papers for a copy of their Sunday edition, and see for yourself how the trick is done.

This radio feature is regularly conducted every Sunday and forms a standing department of these big newspapers.

Once a club has been started, or rather organized, it will be an easy matter to get it on its feet. The writer recommends that every club, in order to hold it together, should exact weekly or monthly fees, and these fees should not be too low. Personally, the writer knows that from 50c to \$1.00 a month for each member is about right because no club can live without having sufficient funds in its treasury to keep it going.

Apparatus, headquarters, printed matter, etc., all cost money, and no club will command respect unless it has these. If the local amateurs are at all interested, they will gladly pay such a small amount per month in order to benefit in all the advantages that are afforded by such a club.

There should be lectures at least once a week by a member well versed in radio matters. After the lecture, there should be a debate on the subject of the lecture, all of which keeps the interest of the members alive. A progressive club also would wish to give prizes for the best of such papers, and very often such papers of sufficient interest should be submitted to the radio magazines in this country for publication.

The writer shall be glad to answer any questions about the formation of clubs as well as any other matter pertaining to clubs or radio organizations.

H. GERNSBACK.

# New Radio Station at Lyon, France

By HENRY de GALLAIX

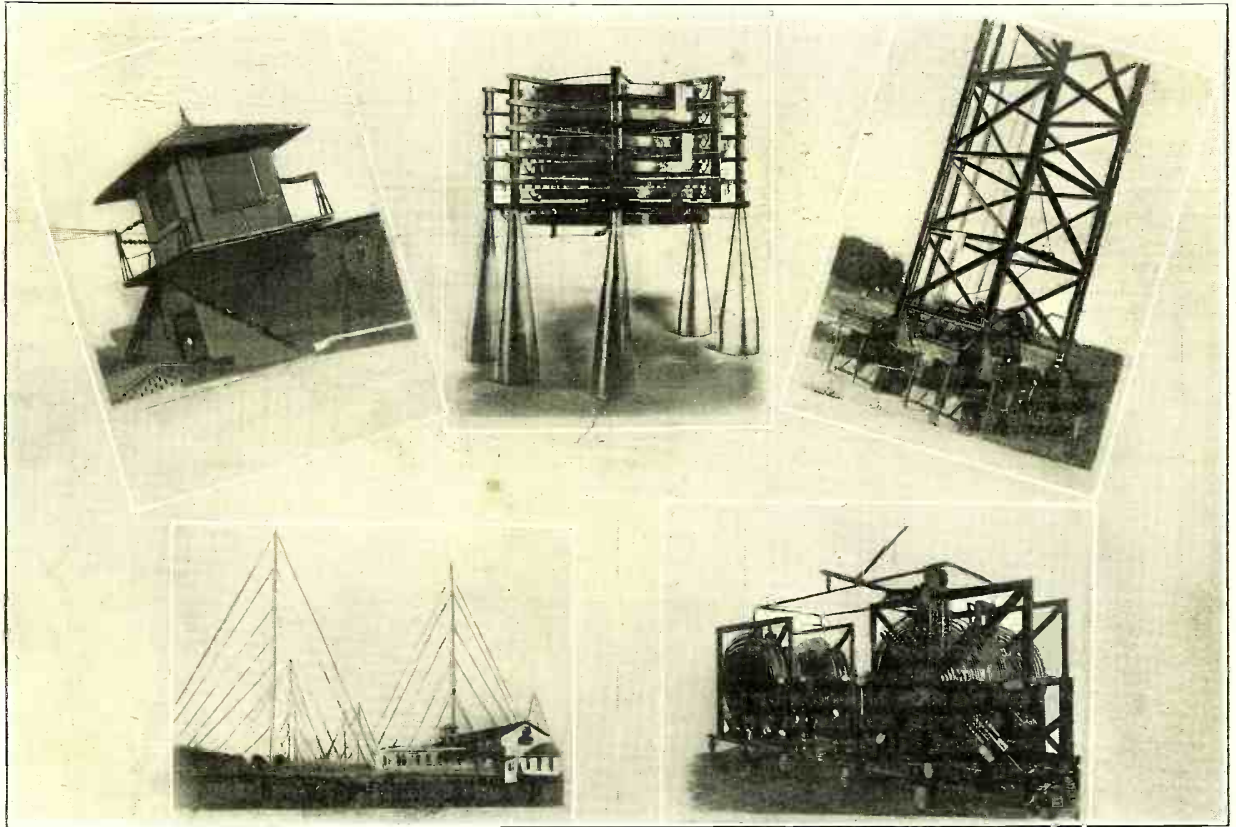

Here Are Five Views of This High Power French Station. The Upper Three Photographs Show Respectively: Roof of Station and Lead-in, Gigantic Loading Inductance, Base of One of the Huge Steel Towers; While the Lower Two Photographs Show the Station Buildings and a General View of the Tuning Inductances.

**F**RENCH radiotelegraphic construction has made considerable progress recently by establishing at the powerful wireless station at Lyon, France, a new high power transmitter. It is founded upon rather new principles and may rightly be considered one of the most efficient actually in use among the great radio telegraphic stations of the world.

This new transmitting group is composed of three machines. To be true, one of them, an alternator with a frequency of 1,000 cycles per second, has been installed, operating on a musical spark. This transmitter has been in operation for some time and therefore will not be considered in our description.

The new transmitting group performs its work with but two machines, namely:

A direct current motor.

A high frequency alternator.

Both stand on the same base and are coupled by a shaft. This "motor-alternator" may work at three different speeds, that is:

- 3,000 revolutions per minute
- 2,500 revolutions per minute
- 2,000 revolutions per minute

which gives three different frequencies:  
 A frequency of 20,000 periods per second  
 A frequency of 17,000 periods per second  
 A frequency of 13,500 periods per second  
 and realizes three wavelengths, approximately as follows:

- 22,000 meters
- 18,000 meters
- 15,000 meters

These three speeds of rotation are obtained by a gear box which controls a special and very sensitive regulator, acting directly on the electrical motor which sets the alternator in motion.

This method of regulation is very effective and allows, during the transmission, an absolutely perfect reception by the interference method.

The direct current motor of the group has four principal poles, four auxiliary poles, a compensation winding, and is of the type common to the turbo-motors, but entirely closed and cooled by a powerful air blast which has previously past thru an air filter. This motor works at a potential of 500 volts, consumes a normal current of 750 amperes and thus absorbs a

total power of 375 kilowatts. Its field excitation is separate and operates at 110 volts. This motor has a constant maximum speed of rotation of 3,000 revolutions per minute, which gives to its rotor a peripheral speed of 90 meters per second.

The alternator is of the inductor type and consists of two field inductances. The external excitation of the alternator works also at 110 volts. Each field is divided into two independent sections and the center of each section is connected to the ground by means of protective lamps. The alternator is constructed for a maximum speed of 3,000 turns per minute, which gives to its rotor an approximate speed of 150 meters per second. The insulation of the field windings may bear 2,000 volts, however, the highest tension in charge at the terminals seldom exceeds 1,000 volts.

The rotor of the alternator is cooled by means of circulating oil. The oil reaches the rotor thru one of the free ends of the central shaft of the group, and after having gone through a considerable number of small feed pipes is brought back to the center of the shaft where it is finally forced out and cooled in a reservoir of the water circulation type. This circulation of oil thru the rotor and the stator of the alternator is accomplished by means of a special pump set in motion by a motor and is made under a pressure varying from two to three kilograms. The force of this pressure is shown by a gauge. Specially constructed thermometers give the temperature of the oil circulating thru the rotor

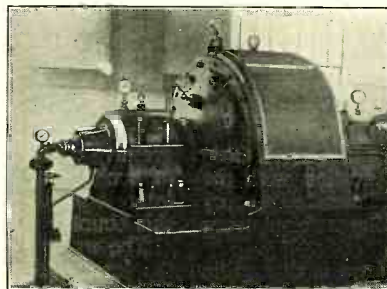

This Photograph Is That of the High Power Alternator Mentioned in This Article.



and stator of the alternator and a special clock-work reveals at once any abnormal heating of the oil.

The lubrication of the bearings of the alternator and of the direct current motor is effected at a pressure of about two kilograms and is mechanically controlled by the rotation of the group (motor-generator).

In order to reduce more or less serious losses caused by the strenuous ventilation necessary for the proper performance of any high frequency alternator, this particular machine is hermetically sealed and the rotor of the alternator runs in a vacuum kept at 700 millimeters by a small pump; this in turn is controlled by an asynchronic motor. This unique and interesting arrangement gives a saving in power of 20 kilowatts.

Many ingenious safety devices have been installed for this new installation—some of which may be briefly described as follows:

A—To prevent the starting of the group should the pumps not be properly working.

B—To stop the group automatically in case something goes wrong with the lubrication or in case of an excessive heating of the lubricant.

C—To make it impossible to exceed the speeds above a safe limit.

D—To put it briefly several other contrivances forcing the group to work in its limits of security required for the normal operating service.

The initial starting of the group is obtained by progressive excitation of the direct current motor at 500 volts. After having established the oil cooling system in circulation, the complete starting of the set requires about three minutes. The stopping is effected more quickly.

This completes the description of the

motor-alternator group and we will now explain how the high frequency circuits are utilized.

The four sections of the alternator deliver their output directly into the primary windings of four transformers. The sec-

ondary principle applies to the secondary circuits but with the added capacity of the antenna. The antenna tuning inductance is composed of eight elementary self-inductances made of a spiral of red copper band. These eight spirals are connected in series and placed one on top of the other, and on an equal axis. By means of movable connections the total inductance of the antenna may be altered. This antenna coil will bear a current of 350 amperes and its insulation to the ground will stand an applied maximum potential of 100,000 volts. Transmission is accomplished by short-circuiting the sections of the alternator by means of four independent Morse-Key relays. These Morse-Keys are of a very simple type and electrically controlled.

The antenna of the radio station at

Lyon is of the horizontal or flat top and is supported by eight metallic square masts propped by a number of guys. The two front masts are 200 meters high, the six others are 180 meters high.

The station in normal service is able to charge the antenna with an energy exceeding the required 200 kilowatts. But up to the present time, and on account of insufficient insulation of the antenna, no regular transmission at that power has been possible; in fact, transmission at not more than half that power or about 100 or 120 kilowatts in the antenna has been made. Even at this reduced power this permits a very efficient reception in the U. S. and the service is infinitely better and more regular than is required by the many political and commercial dispatches exchanged between the two friendly nations, France and the U. S. A.

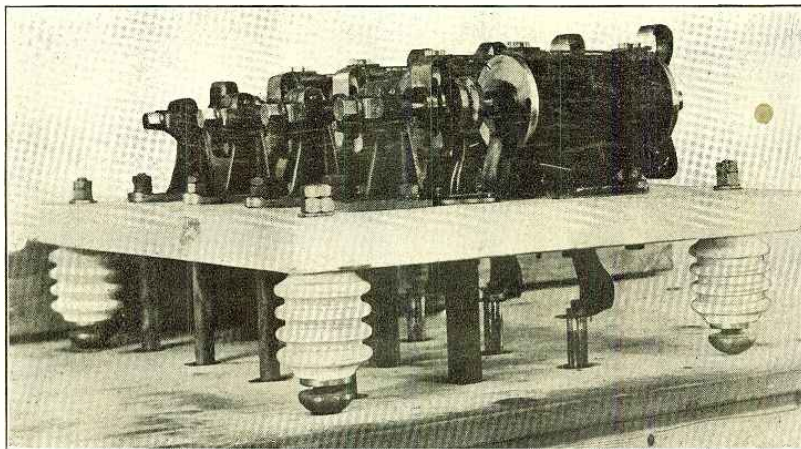

A Close-Up of the Four Magnetic Circuit Breakers or Relays Controlled by Morse Key and by Which Transmission Is Accomplished.

ondary windings of these transformers are connected in series parallel and thence in the antenna-ground circuit. These open air core transformers are of the well-known Tesla type. Their coupling is made changeable in order to equalize the charge of the various sections of the alternator.

An antenna loading inductance allows regulation of the resonance of the antenna according to the individual frequency given by the alternator.

The completion of the regulation is effected by a hand gear acting on a special speed regulator of the group (motor-alternator). This regulator makes it possible at the three standard speeds of the group (3,000, 2,500 and 2,000 revolutions per minute) to increase or reduce the speed by 3 per cent.

The antenna coil is made of spirals of red copper bands and placed in superimposed rows. Thus the capacity of the primary circuit is reduced to a minimum. The

## Forecasting Weather From Static

### The Scientific Observation and Study of Static as a Weather Forecaster

It is well known how useful to maritime and agricultural circles have become the official weather reports sent out by the government radio stations each day. These reports involve carefully gathered data and observations taken in all parts of the country, and from which are deduced impending weather conditions. Altho in this instance radio is the medium by which the reports are broadcasted, the radio receiver may also be employed as a direct means of forecasting. This is made possible by the study of meteorological phenomena of the atmosphere, a phenomenon which is always accompanied by electrical disturbances affecting a radio receiver and usually referred to as "static" or "strays."

According to the most recent researches of French scientists the intensity and the frequency of these strays may determine to a certain extent the atmospheric changes constantly taking place and thus the weather may easily be forecasted.

Amateurs residing in rural districts may establish a name and a good reputation for themselves by giving this subject careful study, so that they may render valuable information and warnings to farmers as to impending rain and snow storms, cold or warm spells, etc., thereby allowing ample

time for the safety or preservation of crops, cattle, etc.

There are six specific conditions to be observed in the study of static, as the following descriptions will show:

(1) Violent intermittent rumblings of statics heard in the telephone receivers of a radio receiver indicate an approaching shower. If the rumbling sounds seem to be rapidly increasing in frequency it is a sign that the shower is traveling toward the general direction of the receiving station; if the frequency seems to be slowly decreasing, it is evident that the shower is traveling in an opposite direction.

(2) A heavy hail storm in the vicinity of the receiver will make its approach known to the listening operator by a form of static resembling a low whistling noise, caused by rapid succession of discharges between each globule of hail when they happen to meet on their downward path.

(3) Brief cracklings, well spaced and rather weak in intensity, usually precede a rise in temperature such as a spring thaw.

(4) If the wind is about to shift its direction, the static disturbances, will be more evident on low wave lengths, each discharge will be regular in intensity and

the time interval separating them rather even, as compared to class 1 strays.

(5) Numerous rumblings frequently accompanied by bursts of grinding discharges of heavy intensity often burning out or fusing detector points, indicate great barometric depressions and are the forerunners of tempests and storms.

(6) The approach of rain, snow or fog, by increasing the conductivity of the air as well as the earth, is favorable to radio communication. Zero weather or dry spells, on the other hand, are said to have an opposite effect.

In general, it may be said that by the proper use of the receiver; by carefully recording the hours and the characteristics of the various forms of static intercepted—that is, whether loud, feeble, short, long, intermittent, isolated, grouped, etc., noting their various wave lengths, and by combining these observations with the official reports as well as with the local atmospheric conditions, a new basis of observation will be secured, which, properly regulated by experience, will prove very valuable and practical to persons having need for a dependable means of weather forecast. Surely, agriculture would benefit a great deal by such an advantage.

# The Vacuum Tube In France

By W. TOCK

IT is safe to say that a very few people know of the important rôle played by the three electrode valve in the war, but those who were fortunate, or unfortunate, enough to be able to watch the supply grow from one or two gas-operated round valves to cases and cases of the French type, of varying degrees of hardness and efficiency, they will really appreciate what an important item they became on the great list of war material.

Out of all the apparatus using the valve the first to appear was the now well known low frequency amplifier, used for the interception of enemy conversations and buzzer messages on their telephone lines. It is only fair to give the credit for the first use of this device to the Germans, as their army staff had foreseen the advantages to be gained, and, in conjunction with their other preparedness measures, were able to place completely equipped listening posts along various parts of the front very early in the war—how early is not definitely known, but it is certain that these sets were put in operation as soon as the armies settled down to definite trench warfare, and a great deal of the information the Boche obtained, and which was attributed to spies within the Allied lines, was in reality gathered from the telephone conversations of officers and men who never imagined that every word they said was being faithfully copied by an English-speaking German stenographer who, a few short months before, had probably been a clerk in some London business house.

It is difficult to say just when the Allies discovered how the information was being obtained by the enemy, but in the fall of 1915 the French began experimenting with valve amplifiers for intelligence work and the British followed suit, with the result that the first listening post on the British front was placed in operation in April, 1916.

Much could be said on the design and

efficiency of the different types of amplifiers that followed one after another as new ideas were tried out and old ones discarded, but undoubtedly the French led

instrument designed for both high and low frequency amplification, a three pole change-over switch being placed on the front panel to make this change. When used for low frequency work the two terminals L1 and L3 are employed and the switch placed in the down position; this connects the primary of the first, or earth to valve, transformer in series with the line so that the voltage fluctuations may be induced into the secondary and so vary the grid potential of the first valve.

When it is desired to use the device for high frequency work, such as directly connected to an aerial and earth, the terminals L2 and L3 are used and the switch thrown to the top. In this position, as will be seen from the diagram, Fig. 5, the first transformer is cut out of the circuit and terminal L2 leads to the filament and L3 thru a condenser and lead to the grid of the first valve, which then functions as a detector, the remaining two tubes applying the recti-

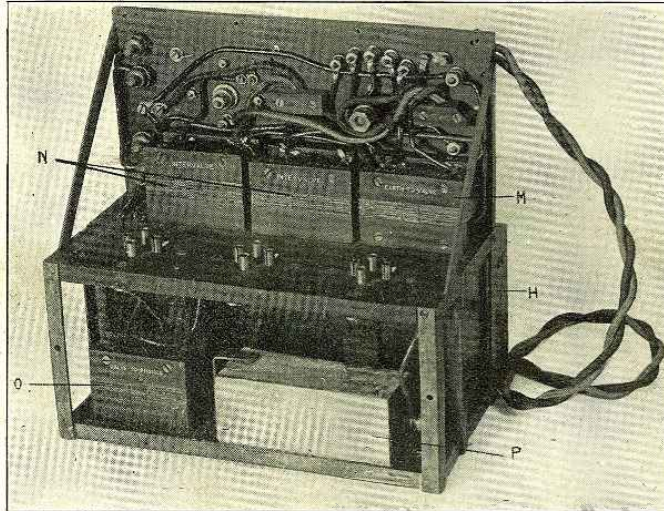

Fig. 3—Amplifying Transformers for the Three Valves Are Clearly Shown Here at N as Well as the Telephone Transformer at O.

the way for sensitiveness and ruggedness in these instruments. A British design, known as the "C Mark III," appeared at the end of 1917, which was of an entirely new pattern, gave excellent service, and was highly efficient for low frequency amplification, either when used for earth currents or the usual wireless receiving work.

This instrument, shown in the accompanying photographs, is mounted in a weatherproof case  $9\frac{1}{2}$ " x  $9\frac{1}{2}$ " x  $6\frac{3}{4}$ " in size and contains all the necessary apparatus including a 60-volt battery supplying the plate circuits of the three valves which are coupled by the usual transformers—shown clearly in Fig. 3. Figs. 1 and 2 are other views of the set, the interesting points of which are shown by the lettering.

A, line terminals, B, telephone plug sockets, connected to telephone transformer for use with low resistance phone (60 ohms each); C, flexible leads to high voltage plate battery; D, plug connection to filament battery (4 volts); E, five point line switch for primary of "earth to valve" transformer; F, filament resistance control; G, screws for renewal of plate battery; H, plate battery, 60 volts in 15-volt taps; J, countersunk rubber gasket for doors of case; K, lever clasps for weatherproof doors; L, inspection windows for valves; M, earth to valve transformer; N, intervalve transformers; O, telephone transformer; P, A. 4 volt dry cell; Q, strut for holding up lid.

The most unusual feature of this unit is the small dry cell so placed in the circuit, Fig. 4, that it produces a negative potential of 1.4 volts on the grids of the valves, the result of which is the practical elimination of current in the grid filament circuits and a decrease in the average current taken from the plate battery; in this case 2.6 milliamperes for the three tubes. The cell will last for a considerable period and can run down appreciably without loss of efficiency.

Among the numerous types of amplifiers built by the French, perhaps the most used and best known is the 3 valve "Modèle 3 ter," a highly satisfactory and sensitive

fied signal.

The only unusual point in this instrument is the method of connecting the cores of the three transformers to ground in an effort to eliminate "howling" noises from the telephone circuit.

It will be noticed that, contrary to British practise, high resistance telephones are connected directly in the plate circuit which in this instrument is supplied with the necessary potential by an 80-volt battery. The filament circuit requires from 4 to 6 volts and is controlled by a rheostat, the adjustment of which is the only operation needed to secure good results with this amplifier.

To the French again goes the credit for the initial use of earth currents as a means of communication which is especially useful in the very forward areas where it is difficult and at times of heavy shelling impossible to keep up telephone lines.

"Télégraphie par Sol" or telegraphy thru  
(Continued on page 500)

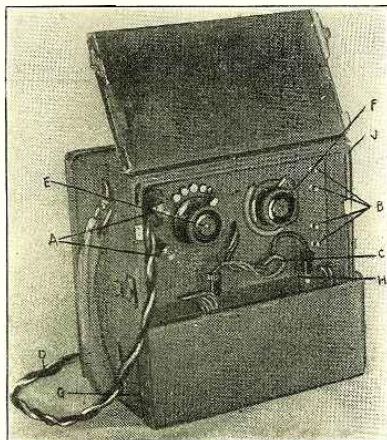

Fig. 1—The Instrument Is Mounted Within a Weather Proof Case and Is Fitted With Portable Straps.

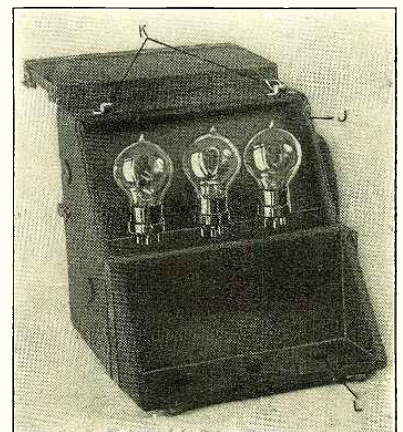

Fig. 2—This Amplifier Is a Complete Unit in Itself and Contains Both A and B Batteries.

# New Radio Apparatus

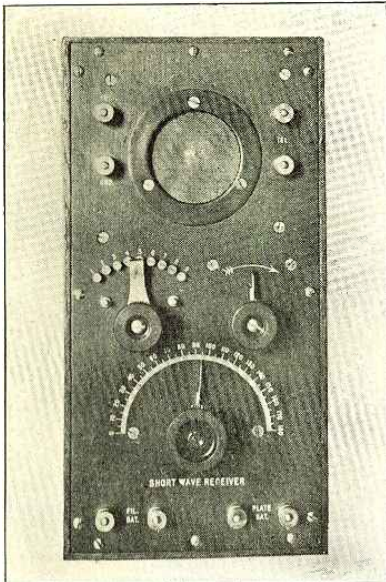

Fig. 1—New Type of Short Wave Receiver Which May Also Be Used as a Radiophone Transmitter.

There is a large demand at the present day for compact radio set for short wave receiving. In fact, the demand exceeds the supply. Altho there are several types of short wave receivers on the market, there are not many radio concerns attempting to put out a first class short wave set. Those that have been placed before the public are practically all of the horizontal cabinet type.

A well-known radio concern has brought out a new type of short wave receiver which has many new advantages. To begin with, as seen from the illustration, it is compact, neat in appearance, and has proved exceedingly efficient. The wavelength range of this set is from 180 to 1,150 meters when used with an antenna capacity .00034 F.

The photograph in Fig. 2 shows the interior construction of the set. The single

circuit control is used. Nine taps are taken on the primary which is wound with silk Litzendraht wire. For undamped work local oscillations are controlled by the same variable condenser which is used for the wavelength control. Oscillations are produced thruout the entire wavelength range. The set is complete in itself and in addition to the inductance contains a balancing tuning condenser, vacuum tube socket, a grid condenser and leak and variable filament rheostat. Bakelite is used for the panel. A novel feature of this set is that it may be used as a sustained wave transmitter for radio telegraphy and telephony. A telegraph key or telephone transmitter may be placed in series with the ground lead. With 250 volts in the plate circuit using a standard vacuum tube, a transmitting range of eight miles was covered on a wavelength of 250 meters.

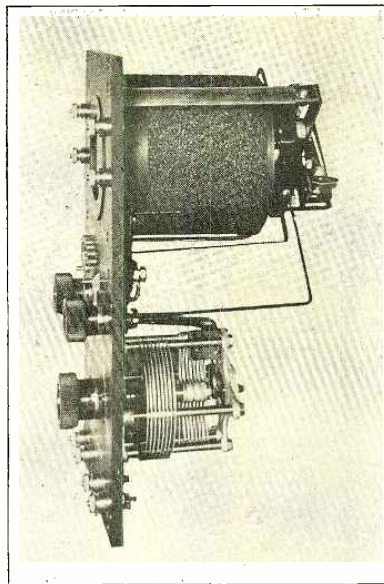

Showing the Interior Construction of the Short Wave Receiver.

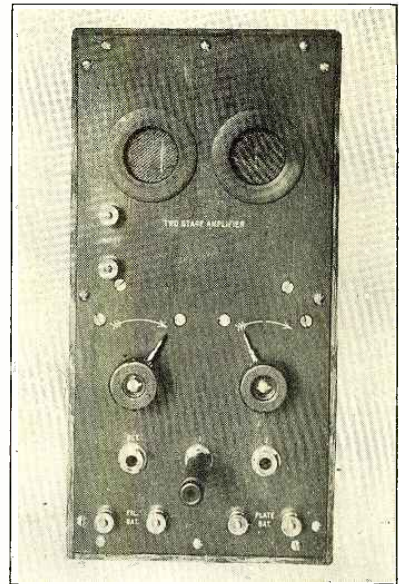

A Type of Amplifier Which Will Not Disturb Telephone Currents.

## TWO-STAGE AMPLIFIER.

Another popular instrument manufactured by this same concern is a two-stage audio frequency amplifier as shown in Fig. 3. In the construction of this amplifier two close core audio frequency transformers are used. Separate filament controls are provided for each vacuum tube. The connections for telephones to the various stages of amplification are made by plugs and jacks. The vacuum tubes are mounted vertically and are removable from an opening in the top of the cabinet. The principal advantages claimed for this set are: it does not squeal or whistle on short wavelengths and the amplifier will not distort telephonic currents.

This apparatus should prove very popular to amateurs who are desirous of obtaining efficient amplification of weak signals.

## New Panel Rheostat

A type of rheostat which embodies new and important features has been recently placed in the market.

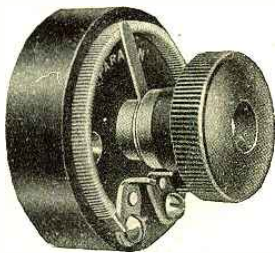

A Small, Neat and Compact Type of Rheostat Which May Be Back-Mounted or Assembled As Shown For Front Mounting.

In the first place, as will be seen in the illustrations, this rheostat is small, compact and presents a neat appearance. An added feature is the provision made for mounting it either on the front of the panel or on the rear of the panel with the control knob on the front. Two shafts are provided, one which is approximately one inch in length, and the other about two inches. The short shaft may be used for mounting the entire rheostat on the front of the panel, the knob and arm being attached to the shaft by small set-screws. If the amateur decides to mount the rheostat in the rear of the panel, the long shaft is used in place of the short one.

The resistance wire is embedded in a circular piece of bakelite and, with all the wire cut in, the resistance is 10 ohms.

Figure 2 shows the rheostat as it appears when mounted on the rear of the panel.

For those who are desirous of constructing a small and compact receiving set, this type should meet with exceptional favor.

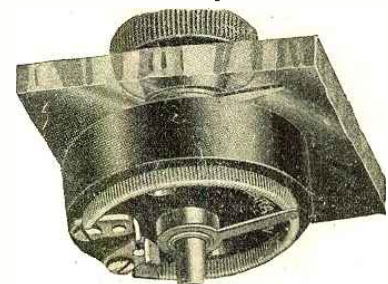

Here the Rheostat is Shown Back-Mounted. This is Accomplished by Using a Longer Shaft Which is Furnished With the Instrument.

# Efficient 200-Watt Emergency Transmitter

By EDWARD T. JONES, I. R. E.

WHEN a vessel at sea is disabled or in a sinking condition it is very probable that her power equipment will soon discontinue the generation of current as the steam from the ship's main plant begins to fail. Water creeping slowly up and putting out its fires will cause this, as well as numerous other causes which have been present in accidents of this nature.

This would mean that, even tho a vessel was still afloat but the power supply failing, transmission would not be carried on for any length of time necessary to the safety of all concerned. For this very reason, the United States radio law requires an emergency transmitter with a range of at least 100 miles. This set, described, fills these requisites to the "T," so to speak.

This emergency transmitter was designed as an auxiliary to the main transmitter, for operation in cases where the 110 volt source is put out of commission thru various causes, such as collision at sea, or the bursting of the steam line. It also provides for transmission in cases where the vessel is tied up at the dock, and the boiler fires drawn for cleaning or repairs. The range of this set is approximately 200 miles. This set is so efficient in operation that it is likewise suitable as a main set for equipment on small vessels and pleasure yachts.

The self-contained type of construction is used. Since emergency equipment must be operated from a storage battery, switches and rheostats for charging and discharging storage batteries are built into the set. For maximum safety, it is also desirable to provide an additional small single wire antenna. With this consideration in view, as well as the demand for maximum flexibility, the set is designed so that it will operate on either a main or auxiliary antenna without requiring re-tuning when changing over from one to the other. This set is suitable for operation on auxiliary antenna, where capacities range from .0002 to .0006 mf. capacity and on main antenna whose capacities range from .001 to .0013 mf.

A switch is likewise arranged so that the prime mover may be run from over the ship's main or the storage batteries. The transmitter is built upon a bakelite-dilecto panel, supported from an angle iron frame. The instrument's control and spark gap are mounted on the front of the panel. The radio frequency circuits are mounted on the upper rear portion of the panel, and fastened to it by rugged bakelite dilecto mounting. The low tension units are mounted on the lower rear of the panel, and rigidly fastened to the supporting metal frames.

## MOTOR GENERATOR.

The motor generator is a two-bearing

Holtzer-Cabot machine. The motor is a DC 120 volt shunt and interpole machine, with a speed of 3000 RPM, which drives a 200 watt 500 cycle inductor type genera-

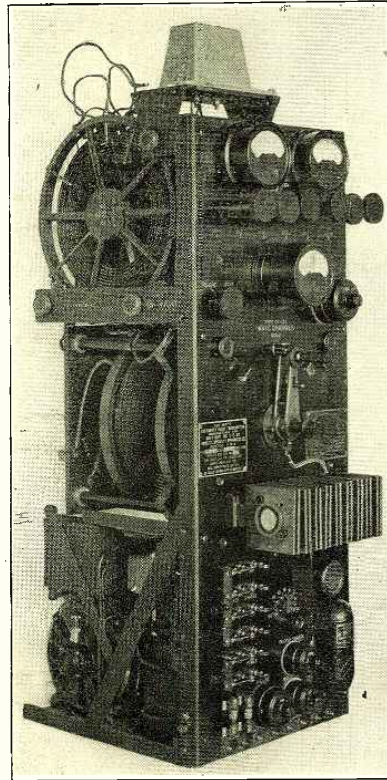

This Ideal Little Transmitter Would Be Just Right for the Pleasure Yacht of Mr. Rich Amateur.

tor. The motor is started by a two-step automatic starter, mounted on the lower right hand side of the panel. Field control for the motor and generator is provided for. Snap switches are used for the DC and 500 cycle line. A watt meter and volt meter are mounted on the upper portion of the panel. A snap switch permits the reading of either the DC line or the 500 cycle voltage. The 500 cycle generator contains a protective device to prevent radio frequency surges from damaging the windings.

## TRANSFORMER AND REACTANCE.

The output of the generator is fed into a combined reactance and minimum leakage transformer whose efficiency is 89%.

## HIGH TENSION RADIO APPARATUS.

The transformer charges a (Faradon) .004 mf mica condenser. The spark gap consists of nine units of the self-cooled type. The primary and secondary are located at the rear center of the panel. Continuous variation of coupling is provided by a control located at the center of the panel. Concentric with the coupling control is the wave changer switch. Three standard wavelengths are provided, namely, 300, 600 and 952 meters. The wavechanger switch simultaneously varies the period of the primary, the coupling between the primary and antenna and the loading inductance in series with the antenna.

An antenna inductance consisting of six variometers is located directly above the primary and coupling coils. Three of the antenna variometers are used for the main antenna, and the remaining three for the auxiliary antenna. Continuous variation of tuning of any wavelength on either antenna, without the adjustment of any of the remaining five tunes is thereby provided. A clutch located on the wavechanger switch handle, connects the wave changer to either ground or auxiliary antenna. A series antenna condenser is fastened on brackets above the antenna coils, for shortening the main antenna, to obtain a 300 meter wave. An antenna ammeter is mounted on the upper portion of the panel. A send-receiver switch is located above the wave changer on the left of the panel. On the receiver position the switch breaks the AC line and the ground connection to the transmitter and connects the antenna to the receiver. On the transmitter position it completes the circuits without transmission and disconnects the antenna from receiver.

## BATTERY CONTROL.

The battery charging equipment consist of a charge-discharge switch, a battery rheostat and a trickle charge switch. A double throw switch for feeding the prime mover from either the ship line or the storage battery is located directly under the charge-discharge switch.

## GENERAL.

All connections to the set are made at binding posts, located at the base of the panel. All low tension wiring on the set is lead covered and cleated to the panel. The lead sheeting is grounded. The key is of the flare proof type and is provided with flexible leads for connecting to the transmitter. Special attention has evidently been paid to the provision of a large safety factor in view of the emergency character of this equipment and its small space factor. The workmanship and finish are of unexcelled quality.

—Photo-Courtesy Wireless Specialty Apparatus Co.

## Particulars of Transmissions from the Eiffel Tower and Lyon Wireless Stations\*

*Eiffel Tower.* Call letters F. L. The Eiffel Tower has three different types of transmission.

A. Musical transmission S. F. R. on 150 kilowatts, which is used for time signals, weather reports, and some news.

B. Trembling note transmission on 70 kilowatts, used for sending clock ticks for the precise determination of time by the method of coincidence. This method is well known and needs no explanation. We wish to observe, however, that 300 ticks are sent instead of 180, as was the custom before the war. (With suspension of the

\*Courtesy of Mr. L. McMichael. Translation from the French by Mr. R. H. Klein.

60th, 120th, 180th, 240th.)

C. Continuous wave transmission of 150 kilowatts with Poulsen arcs, which is used for working with various correspondence.

Working Hours (G.M.T.):

Time.

0.15 to 1.00 F. L. Arc 8,000 metres with S.A.R. (Sarajevo, Serbia) arc 4,000 m.

1.00 to 2.00 F. L. Arc 8,000 metres with S. E. W. (Nicolatjeff-South Russia) Marconi 3,500 m.

2.00 to 3.30 F. L. Arc 8,000 metres with H.B. (Budapest) Telefunken 3,700 m.

3.30 to 4.30 F. L. Arc 8,000 metres with W.A.R. (Warsaw, Poland) Telefunken 2,000 m.

4.30 to 5.30 F. L. Arc 8,000 metres with M.S.K. (Moscow, Russia) Marconi 5,000 m.

5.30 to 6.30 F. L. Arc 6,000 metres with P.R.G. (Prague, Czecho-Slovakia) Telefunken 3,000 m.

6.30 to 8.00 F. L. Arc 8,000 metres P.S.O. (Posen, New Poland) Telefunken 1,750 m.

8.00 to 9.45 F. L. Arc 8,000 metres with F.W.D. (Salonika, Greece) arc 7,000 m.

(Continued on page 504)

# The Armstrong Super-Autodyne Amplifier

## Part II

By H. W. HOUCK

**I**N Part I of this article, the advantages and difficulties of high frequency amplification were taken up and the principle of the Armstrong Super-Autodyne Amplifier set forth. A complete circuit of an Armstrong resistance coupled amplifier with constants was also shown, enabling experimenters to build such a receiver for reception of signals at wavelengths of below 150 meters to above 200 meters.

This second article will take up in more detail the building up of the various parts of the receiver, the combining of the various instruments, testing, and operating. The location of troubles and their remedies will also be treated. Finally the building, testing and adjustment of the more critical, but highly efficient, inductive coupled amplifier will be given.

### Construction of the Resistance Coupled Amplifier.

Those experimenters who have been building Armstrong amplifiers for their own use will realize within a few weeks that such a receiver cannot be built up in a cabinet, hooked up, and be expected to work the first time. In fact, it is doubtful whether an expert on multi-stage amplifiers could be expected to do this every time, nor would he attempt it. Men who are most familiar with such apparatus as multi-stage amplifiers usually build each part of the circuit separately, *not in a box*, but spread out on a table, or several tables when necessary, so that changes and adjustments may be easily made, faults corrected, and operating features improved, without interaction or coupling back of parts. The advantages to be gained by this method for an experimenter who is familiarizing himself with his amplifier are apparent. If success is to be obtained, he must so familiarize himself with the operating characteristics of each part of his receiver and then to the total receiver that he can locate troubles in his *open set-up*. To do this properly may take several weeks, but is well worth the time spent. In the long run it is the shortest way to obtain satisfactory results. It will be found that when the multi-stage amplifier is compressed into a small space, in combination with an oscillator, that a new set of troubles will appear, which the builder of the apparatus did not encounter in his open set-up. The only way to learn the action of amplifiers is to build them, and although each experimenter may find different difficulties, the present article will take up the more common causes of troubles and endeavor to minimize them by pointing out the best methods of procedure.

The building of the fixed-frequency resistance coupled amplifier is the first step.

In the drawing five stages of amplification are shown. It is not advisable to use less than four stages or more than six in such an amplifier. Connections and circuit constants may be obtained from Fig. 5 and Fig. 9. The amplifier coupling coils,  $L_4$ ,  $L_5$ , should be of approximately 12 millihenrys

ing about 4 amperes if five Marconi V.T.'s are used. The ordinary white porcelain ten-ohm type of rheostat is capable of carrying no more than two amperes satisfactorily, but two of these may be used in parallel and mounted on the same shaft. While not essential, it is often desirable to use a separate rheostat to each tube. The coupling resistances  $R_4$  should have negligible distributed capacity. Otherwise the radio frequency energy will choose the capacity path of low impedance from plate to filament and thus lower the efficiency of the amplifier. High voltage "B" batteries, 140 volts, are necessary, due to the high resistances of the circuit. In no case should the high voltage batteries be connected anywhere in the circuit except near the filaments. If separate batteries were used, for instance, between the plates and coupling resistances, the capacities of the batteries to ground act as a by-path, giving much the same results as distributed capacity in the resistance coils.

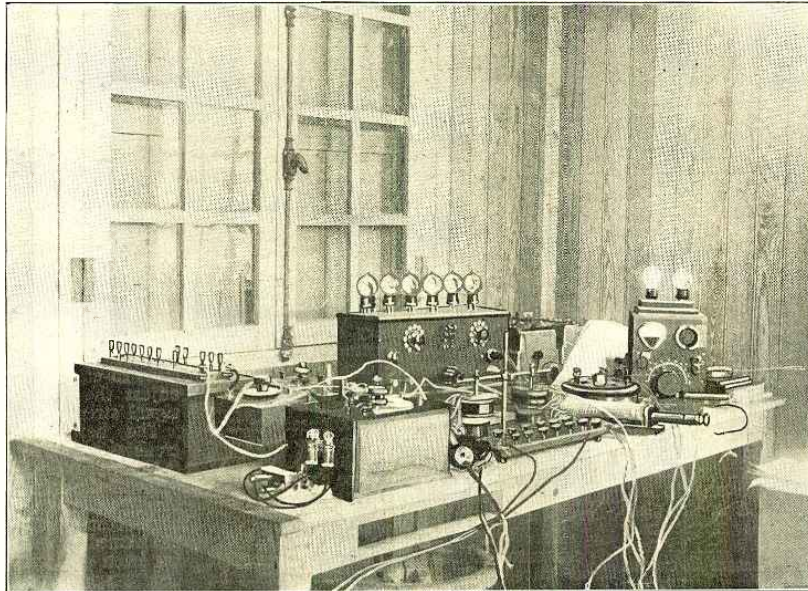

Fig. 16—This Photograph Shows a Laboratory Set Containing All the Essential Apparatus Necessary for the Armstrong Super-Autodyne Amplifier.

each, when bridged by variable condensers of the range indicated. In any event circuits  $C_4$ ,  $L_4$  and  $C_5$ ,  $L_5$  should have natural frequencies of 75,000 cycles (4,000 meters). The tube sockets should be screwed to a table or board, in line at distances of about 12 inches, and wired up. It is important that *all connections be soldered*. The filament rheostat  $R_1$  must be capable of carry-

ing about 4 amperes if five Marconi V.T.'s are used. The ordinary white porcelain ten-ohm type of rheostat is capable of carrying no more than two amperes satisfactorily, but two of these may be used in parallel and mounted on the same shaft. While not essential, it is often desirable to use a separate rheostat to each tube. The coupling resistances  $R_4$  should have negligible distributed capacity. Otherwise the radio frequency energy will choose the capacity path of low impedance from plate to filament and thus lower the efficiency of the amplifier. High voltage "B" batteries, 140 volts, are necessary, due to the high resistances of the circuit. In no case should the high voltage batteries be connected anywhere in the circuit except near the filaments. If separate batteries were used, for instance, between the plates and coupling resistances, the capacities of the batteries to ground act as a by-path, giving much the same results as distributed capacity in the resistance coils.

After having connected up the amplifier, and tried the filaments, the circuit is ready for testing. The usual method of testing consists in loosely coupling a wavemeter, adjusted in this instance to 4,000 meters, to coil  $L_4$  (Fig. 9). Circuit  $C_4$ ,  $L_4$  should be used as the driver, and should be placed at a distance from  $L_5$  of several feet. A high frequency buzzer in series with a battery, connected across  $C_4$  will serve as the driver. With the telephones on the wavemeter, and the wavemeter set at 4,000 meters, adjust  $C_4$  for loudest response. Note the setting and lock the condenser if possible. Next put telephones on the amplifier and adjust circuit  $C_5$ ,  $L_5$  by carrying  $C_5$  for loudest response and note the scale reading. Lock the condenser if possible. If a wavemeter is not available, set condenser at  $C_4$  at about  $180^\circ$  and tune circuit  $C_5$ ,  $L_5$  as before.

Each tube should now be checked for amplification. A very satisfactory method consists in disconnecting the lead from the grid of the first tube, tightening the couplings between  $L_4$  and  $L_5$ , and connecting the grid lead successively to the grid condensers of each tube, beginning with the last detector tube. A definite increase in strength of sound should be heard as the number of tubes included in the circuit is increased. In case of trouble, this test localizes the cause of poor amplification to one certain stage.

A similar method consists in tapping successive tubes with the finger. A definite increase (or decrease) in sound should be heard as progressive stages are tapped. Another very good method of ascertaining the condition of different parts of the amplifier and of finding trouble consists in utilizing a voltmeter to check the voltages

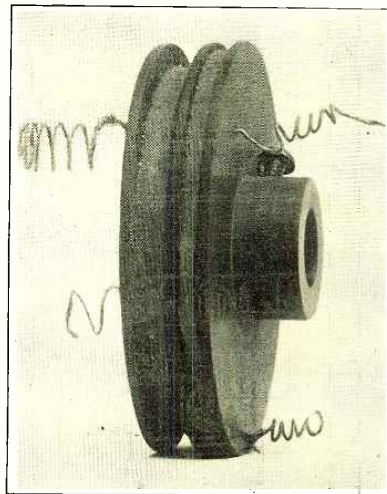

Fig. 12—A Compact and Efficient Transformer. Primary is Wound On Right and Secondary On Left.

of various parts of the circuit. For instance, a definite voltage should be obtainable between, say, the negative filament and the plate of each tube. The high voltage battery should be checked before applying this test. The above methods of testing may be applied to the amplifier after being

however, the wavelength of oscillation may be checked by adjusting  $C_2$  to the minimum and maximum values at which the circuit oscillates and making corresponding resonant wavelength readings on the wavemeter.

After the amplifier and oscillator circuits

set-up will give an exceptionally businesslike appearance. A hard rubber or bakelite switchboard for switches, terminals, etc., may be mounted vertically on each of these units by means of angles, if desired. If the set is built into a cabinet or set of cabinets later each part should be built separately and tested separately before combining, as explained above. In no case should this be attempted until familiarity with the action of the actual circuit and apparatus has been obtained.

After having completed the set it may be calibrated in the following manner: Connect the complete receiver to the antenna and ground with which it is to be worked. Loosely couple a wavemeter used as a driver to a turn in the antenna or ground lead. Vary the secondary condenser, heterodyne condenser and coupling for best results and note the wavelength. A record should be made of the settings of primary and secondary of tuner, condenser and coupling of the oscillator for the various wavelengths within range of the receiver and tabulated. Such a tabulation is extremely useful. Figure 15 shows such a calibration. In this case the receiver was calibrated on a loop. Consequently there is only one column for the tuning. In instances where the set is calibrated on a different antenna from that to which it will be connected later a chart giving settings of all but the antenna circuit may be made. This part of the calibrations is good on any antenna. To receive a signal on a given wavelength it is then necessary to adjust the various circuits to constants shown on the chart and adjust the antenna circuit for maximum signal strength.

The best procedure in hunting for troubles after the set has been constructed is to localize the trouble to one of the three parts of the receiver, that is, tuning system, oscillator and amplifier. After this has been accomplished the trouble may be found and remedied without difficulty. If the tests for each component part of the set have been gone through with, the experimenter will have gained such familiarity with the operation of the receiver that he will be able to devise means of "trouble shooting" and localizing of trouble without any difficulty.

Internal noises in the amplifier constitute one of the greatest troubles that will be encountered. These troubles apply to all multi-stage radio frequency amplifiers, as well as to the types of amplifiers described in this article. These noises may be roughly classified into two general types—howling or whistling noises and boiling or frying sounds.

Causes of howling were partially covered in Part I of this article. Howling in radio frequency amplifiers may be caused by the telephone cord or other parts of the plate circuit of the detector coupling back into the amplifier circuit. This can be illustrated by holding the telephone receivers near the input of almost any high or low frequency amplifier. The only remedy for this is to find the cause of coupling back in

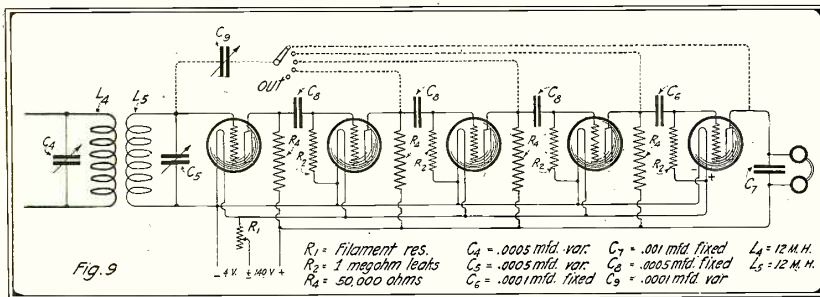

This Circuit Diagram Shows Method of Connecting the Resistance Coupled Amplifier and "Feed Back" as Well as Various Constants.

placed in the cabinet as well as before.

It will be noted that no filter is shown in the leads to the telephone receiver. It is found that while it is an advantage in some cases to have it, no detrimental effects will occur if care is taken to see that coupling back from the plate circuit of the detector tube does not occur. The telephone cords should be kept away from the amplifier tubes. If they are covered with copper braid or "shielding," which is grounded, this effect will not be evident.

The oscillator should now be connected up. The circuit shown in Fig. 5, lower left-hand corner, is that of the ordinary "three top coil" variety, and is quite easy to manipulate. Coil  $L_2$  is included in the plate circuit of the tube and is magnetically coupled to the grid coil  $L_1$ , which in turn is tuned by the variable condenser  $C_2$  circuit.  $C_2$   $L_2$  determines the oscillation frequency, and is coupled to the secondary circuit  $C_1$ ,  $L_1$  of the receiving transformer. As very little oscillatory energy is required in the secondary, the oscillator need not be particularly efficient. Hence some of the extra condensers and other refinements used with power oscillators are dispensed with. The filament and plate batteries of the amplifier may be used for the source of potential for the oscillator.

With certain tubes it is quite possible that oscillation will not take place over the required wavelength with the exact coupling and number of turns shown in Fig. 5. In this case it is best to wind on a few more turns on each end and top off several turns on each coil and adjust until the circuit oscillates over the range of the receiver. Another way of accomplishing the same result consists in winding  $L_2$  on a slightly smaller tube, thereby giving adjustable coupling. With ordinary vacuum tubes, it is not thought that any great difficulty will be had on this score.

A test for oscillation is as follows: Couple a wavemeter with telephones and crystal detector connected unilaterally to oscillator coil  $L_2$ . Make sure that the detector is adjusted by the use of a buzzer or other means. Even though the circuit may be oscillating and energy transferred to the wavemeter circuit, no audible indication will be heard, due to the high frequency of the undamped oscillations. But if telephone circuit be stopped by disconnecting one telephone terminal and tapping it on the binding post, a sharp click will be heard if the oscillator energy is present. If a wavemeter is not obtainable, an inductance shunted by a variable condenser, tuned to circuit  $C_2$   $L_2$  and a crystal detector shunted by a pair of telephones, one side of which is connected to one terminal of the condenser, will serve the purpose. By use of the wavemeter,

are functioning properly they may be combined with the receiving transformer and first detector, as shown in Fig. 5.

The most convenient method of testing the circuit is to couple a wavemeter, or other high frequency buzzer circuit used as a driver to the secondary  $L_1$  of the loose coupler. Set the wavemeter at 200 meters and adjust secondary condenser  $C_1$  and oscillator condenser  $C_2$  until the wavemeter buzzer is heard. The note will be heard at two different values of condenser settings of  $C_2$  in much the same manner as in the reception of undamped signals by ordinary heterodyne methods, with the exception that the buzzer note will not be mushy, but will retain its characteristic tone.

After having proceeded thus far, the experimenter should check the antenna circuit for wavelength range. This may easily be done by connecting a high frequency buzzer in series with a battery across a turn or two of wire or across a one mfd. condenser inserted in the ground lead, and coupling a wavemeter circuit to the primary of the receiving transformer. The primary should be adjusted from maximum to minimum wavelength, at all times preserving enough turns in the primary of the receiver transformer to transfer the signals to the secondary winding. Take corresponding wavelength readings to check the range of the receiver.

In this article the construction of cabinets for the set and details of mechanical design have not been taken up. It is thought that the experimenter can best do this utilizing the materials and tools available in his particular case. Undoubtedly many will prefer to use an "open" set. If care is taken in the placing of the apparatus, alignment, wiring, etc., of each part, such as the tuning system, heterodyne and amplifier mounted on a properly finished base the ordinary

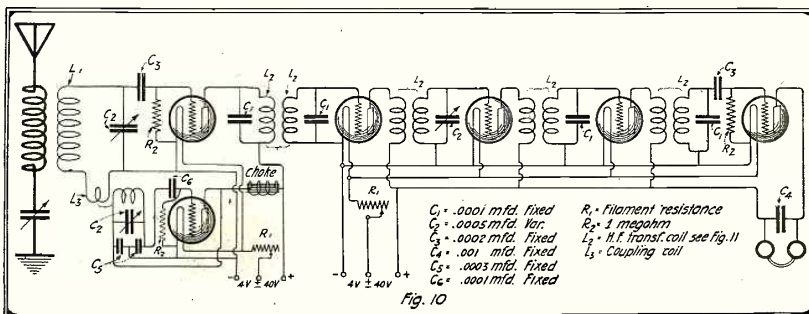

This Shows the Circuits of the Inductive Coupled Amplifier with Capacity Coupled Oscillator and the Necessary Constants.

the detector circuit (including plate batteries) or any part of the low frequency amplifier (if one is used).

Howling is sometimes caused by unequal voltages which may be set up in such metal parts as transformer cores, tube socket supports, brackets, etc. This trouble may often be entirely eliminated by grounding all the metal parts or by connecting them to the plate battery.

Other causes of howling are loose connections, high resistance connections or broken at any point in such plifiers the coupling back effect is always present to a greater or lesser degree, but due to the load on each tube, that is, the coupling transformers with their associated circuit, the energy fed back does not equal the losses in the circuit and oscillation does not take place. But if a lead is broken at any point in such an amplifier so as to take off this load, the energy fed back may well equal the circuit losses so that audio frequency oscillations will occur, hence the necessity of making low resistance connections and soldering all joints, etc.

Boiling or frying noise may be due to what is known as battery noise. This is especially noticeable when old or worn-out dry cells are used for plate batteries and is due to local action, etc., in the battery. It may be detected by connecting the telephone receivers across each section of the battery and listening for noises. Other causes of similar amplifier noises are poor grid leaks, loose or dirty tube contacts and faulty grid condensers. A faulty grid condenser or poor grid leak may cause what is known as "blocking."

In working with multi-stage amplifiers it will be found that some tubes work best in certain parts of the circuit. For this reason it is best to try each tube in a different stage of the circuit until best results are obtained. It will also be found that some tubes that are poor oscillators are good detector or amplifying tubes and vice versa.

A very useful device for use with the resistance coupled amplifier is a telephone transformer. This consists of a primary wound on an iron core made up of core wire or laminations. The primary winding should have an impedance equal to the output impedance of the tube to which it is to be connected in place of the telephones. The secondary winding should be thoroughly insulated from the primary winding and so designed that its impedance at audible frequencies is equal to that of the telephones to which it is to be connected.

In view of the fact that a plate potential of 140 volts is used in this amplifier, the telephone transformer prevents the phone windings from burning out and protects the operator from shock.

An extremely valuable connection which may be put in the resistance coupled amplifier is shown by dotted lines in Fig. 9. This arrangement constitutes a capacity coupled regenerative or feed-back circuit by means of which signals may be amplified to a much higher voltage without the use of additional tubes. This arrangement

consists merely of a small variable condenser of .0001 mfd. maximum capacity connected between the grid of the first amplifier tube through a switch to the plates of any one of the following tubes. Hence the energy in the plate circuit of the last tube, for instance, may be fed back to the

oscillation will usually occur even when odd numbers of tubes are connected.

The above feed-back connection is embodied in a standard type of multi-stage radio frequency resistance coupled amplifier in use by the French Army. The same connection may be employed utilizing resistance or magnetic coupling as well as capacitive coupling, but the latter is deemed more practical for ordinary use.

By use of two double pole double throw knife switches or the equivalent, it is possible to utilize the resistance coupled amplifier for the reception of long wave signals. Such a circuit is shown in Fig. 14. One switch is used to change the amplifier from the super-autodyne frequency changer to the secondary of the long wave receiving transformer while the second switch transfers the antenna from the short wave loose coupler primary to the long wave primary. In most cases it is preferable to use two separate antennae—one for short wave reception and one for long wave work. If this is done, one switch is eliminated. This connection is good only if used with a resistance coupled amplifier. Other types of high frequency

amplifiers are efficient only over a comparatively narrow band of wavelengths. Fig. 13 gives data for the construction of a capacity coupled oscillator for use as a heterodyne having a wavelength range up to 1,000 meters, at which point the resistance amplifier begins to be efficient without the frequency changer system. Further details of this oscillator are given with the inductive coupled amplifier.

The combination of a super-autodyne receiver utilizing resistance coupling with the capacity feed-back feature on a loop or small antenna for short waves, together with a switching system with a large loop or antenna for long wave work, constitutes an ideal receiving system capable of receiving damp, undamp and telephone signals at long or short wave lengths over great distances.

**Construction of an Inductive Coupled Radio Frequency Amplifier.**

While the resistance coupled amplifier is ideal in many respects, it is not a very efficient type of amplifier. Hence the general construction of an inductive coupled high frequency amplifier will be taken up. It may be connected in the circuit of Fig. 5, in place of the resistance coupled amplifier, thereby utilizing the same oscillator and tuning system, but the circuit given in Fig. 10 shows a very good form of capacity coupled oscillator which may be used. Any oscillator that is operative over the required range of wavelengths is suitable for this work; an easy matter to remember.

The chief advantage of the inductive coupled amplifier over the resistance coupled type is the greater efficiency. In fact, it is quite possible to obtain almost as much amplification with four stages of the inductive type as with six steps of the resistance type. Moreover, due to the low resistance of the coupling (Cont'd no p. 508)

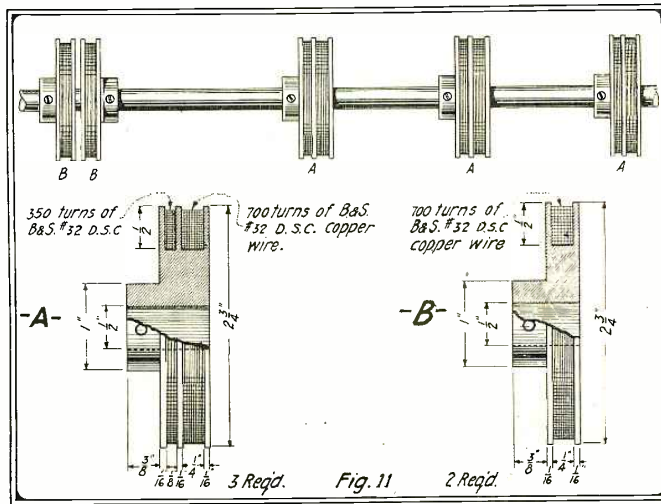

This Drawing Shows Construction Data On High Frequency Transformers and Method of Mounting.

grid of the first tube and further amplified. If too much capacity is used at  $C_0$  oscillation will occur. This condenser should be adjusted for operation just below the oscillating point for maximum amplification of spark and telephone signals. But for the reception of undamp waves  $C_0$  may be ad-

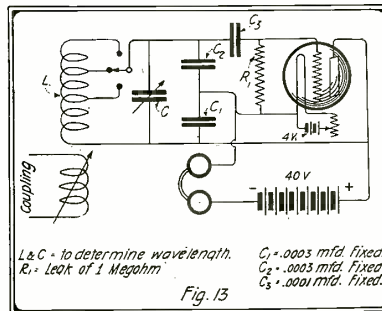

Capacity Coupled Oscillator for Long Wavelengths and the Necessary Constants.

justed for oscillation. Theoretically, due to phase relations of succeeding tubes with respect to the first tube, amplifying regenerative action should occur only when the grid circuit of the first tube is coupled to the plate circuits of following even numbers of tubes, that is, the second, fourth, sixth, etc. However, due to stray fields,

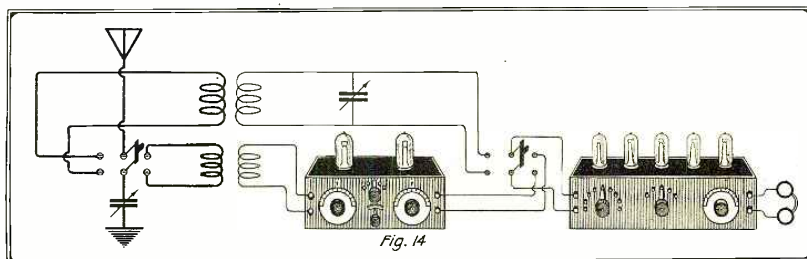

Method of Connecting Switch So as to Insert the Resistance Coupled Amplifier Direct On the Antenna for Long Waves.

# The Design of a One Kilowatt Arc Converter

By JENNINGS B. DOW, Ensign U. S. N.

SOME time ago, in the course of experimental work connected with controlling devices for radio-frequency currents, the writer found it necessary to design a small arc converter.

Accordingly, one was designed and constructed. By good fortune the resulting apparatus proved to be most admirably suited to perform the work for which it was designed. For this reason and because the amount of published information on the details of this class of arcs has been almost negligible, the writer has decided to present it in this form.

There were three conditions which affected the design of this converter, viz:

1. The output in radio-frequency energy had to be in the order of a kilowatt (power input, one to three kilowatts).

2. It had to be capable of operation more or less continuously.

3. The oscillations produced had to have steady characteristics in order to be suitable for radio-telephone work.

The first of these conditions was quite easily taken care of, for its fulfillment meant merely the satisfying of certain electrical requirements, such as the selection of proper electrode sizes, insulation and magnetic field characteristics, together of course with such controlling devices as are necessary.

The second of these conditions was not so easily fulfilled. Any heat developed in operation must be dissipated to prevent undue lowering of arc resistance resulting from increased vapor at the higher temperatures.

And it must be kept within the maximum allowable temperature rise for which the insulation of the converter is designed. Most of the heat generated, at least that portion of which it might effect a serious disintegration of the electrodes, may be carried away by *water cooling* both electrodes. In the apparatus herein described the positive electrode is cooled by forcing a stream of water against the copper tip. This abundance of water, one-eighth inch from the arc itself, keeps the temperature very low as might be expected. The negative (carbon) electrode is cooled by housing the carbon holder within a water jacket. The length of carbon projecting out of the

holder was made as short as possible so that the path of heat conduction thru carbon to the comparatively cool electrode holder would be a minimum. This is necessary owing to the rather low *thermal*

supply of gas of high thermal conductivity to the chamber. Hydrogen is best suited for this purpose, but unfortunately is not ordinarily obtainable in an uncombined state.

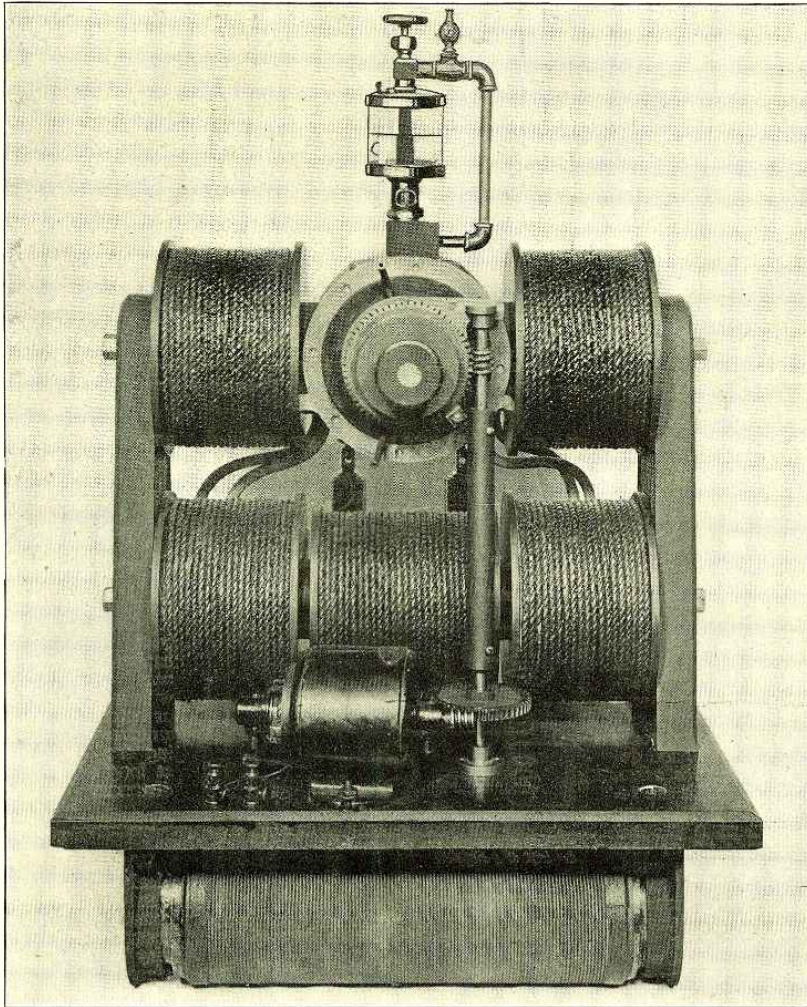

Actual Photograph of the Arc Converter Designed and Constructed by the Author. You, too, Mr. Amateur, Can Build One Like It.

conductivity of carbon. A considerable portion of the heat generated serves to raise the temperature of the medium surrounding the arc, and this was taken care of in the following manner:

A set of eight copper radiating flanges was made to fit snugly over the part of the positive electrode projecting into the arc chamber, and these were kept cool by the water circulating thru that electrode. The water jacket for the negative electrode was made in such a way as to present a considerable portion of its surface to the medium within the chamber, which also resulted in lowering the temperature of this medium. The most important part of the cooling arrangement, and that part upon which successful operation of the arc as the oscillator is dependent, is the

Alcohol vapor is the next best practical material. This may be used by vaporizing it outside of the arc chamber in a vial of some sort and conducting it into the arc chamber thru tubing heated to prevent condensation; by administering it, drop by drop into the arc, relying upon vaporization there (this method is very efficient, but has a tendency to produce irregularities in low power arcs), or by dropping it in small quantities upon a small porous tube surrounding the arc and heated by it (this works excellently and avoids the production of irregularities). Ordinary illuminating gas, artificial or natural, is excellent also. It is easily obtainable, its flow is easily regulated, but its composition is uncertain. This latter characteristic must be given consideration here, as certain compositions produce bad results. Small arcs often fail to operate, owing to this fact alone. One argument favoring such a hydrocarbon as illuminating gas is that most forms of it build up the negative electrode. This was particularly the case at Annapolis, Md., where if gas alone is used the carbon electrode must be cut down every hour or so of operation to prevent

natural *shortening* of the arc by *carbon deposit*. In this particular case it was found that by combining alcohol and gas in certain proportions a mixture was made which added practically as much carbon to the electrode as was burned away. This rendered very constant operation possible.

Another factor to be considered in using gas is the provision for clearing the arc chamber of soot, where considerable amounts collect. This is an important consideration, too, as this material, in *blanketing* the insulating parts, renders them useless as insulators. This is especially true if voltages in excess of 400 are used. Moreover, the soot, in depositing upon the metal parts—cooling flanges, water jacket and inside of arc chamber proper—



prevents a rapid conduction of heat to these parts. It will be observed from the drawings that the first of these difficulties was eliminated by making the insulating pieces large, thereby making the path of current thru such soot as deposits upon them as long as possible. The second difficulty was remedied by making all parts of the chamber where soot deposits readily accessible and removable for such cleaning as may from time to time be necessary.

The last condition that had to be fulfilled was that of steady operation. It was decided to use a magnetic field to make the efficiency of the device as high as possible, but it was not known to what limit this could be used, as irregular operation increases with the strength of this field above a certain critical point. For radio telegraph work, it is obvious that this need not be given such careful consideration as is necessary here.

A mean flux density of 4,000 gauss was assumed to be about the required strength, so the "blowout" coils were designed for this figure. This was found later in practise to be an excellent choice, for many experiments were made with magnetic fields to determine to just what limit this flux density could be pushed, and the original value was permanently decided upon. It is to be regretted that the results of some of these experiments cannot be described here. As a matter of information, field strengths up to 10,000 gauss were used with no less than twelve electrode and pole tips combinations.

An interesting figure is that connected with transverse and longitudinal magnetic

fields. It was found that a flux density of 4,000 gauss in a transverse field produced the same irregularities in the arc as one of 10,000 gauss in a longitudinal field.

to a negligible quantity which would involve large separation between turns and layers and result in great bulk so characteristic of many arc converters. In view of the construction adopted, suitable choke coils must be placed between the electrodes and the solenoids.

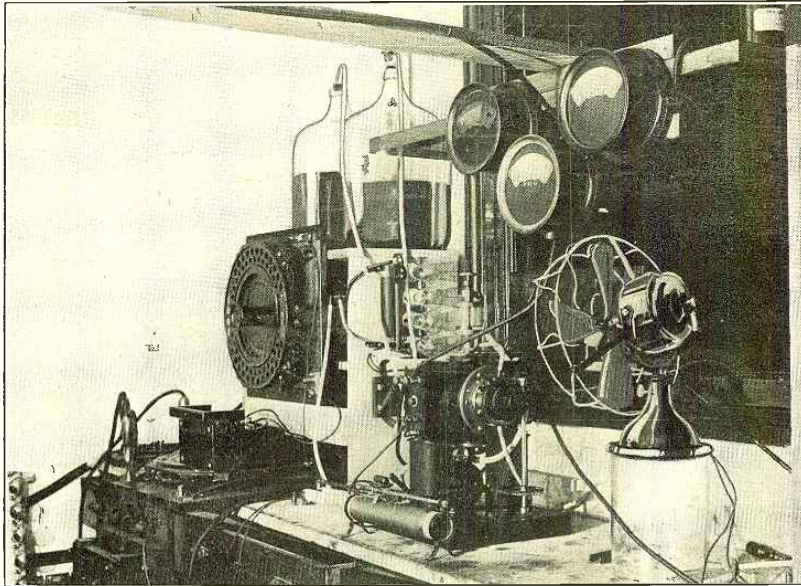

Another Photograph of the Arc and a Corner of the Laboratory Where It Operated Successfully. Note the Fan for the Purpose of Cooling the Apparatus.

The efficiency of the latter was found to be 10 per cent greater than the former. A mechanical difficulty did not warrant the use of the longitudinal field permanently, however, in this particular arc converter.

**SOLENOID DESIGN.**

By referring to the drawings it will be seen that the total air-gap in the magnetic circuit is 1 3/4 inches (3.2 centimeters) and since the reluctance of this gap is so great in comparison to that of the iron circuit, the former only needs be considered in the magnetic circuit calculations. Assuming that the converter is to be operated at 3 K.W. input, which at 500 volts would require a current flow of 6 amperes, and neglecting the reluctance of the iron path for the reason stated above, the number of turns required to produce the desired flux density of 4,000 gauss may be very easily determined.

$$\text{M.M.F. (in ampere-turns)} = \frac{0.8 B l}{\mu} =$$

10230 where,  
 B = flux density in gauss,  
 l = length of air-gap in centimeters,  
 μ = permeability of flux path (for air, μ = 1),

$$\frac{NI}{l} = 1705 \text{ turns, or } 1700 \text{ approximately.}$$

A winding space 5/8 by 1/32 inches is available, and into this it will be found possible to wind the required 850 turns per coil in 13 layers of 66 turns per layer with No. 13 D.C.C. magnet wire. Approximately sixteen pounds of this wire will be required for each coil. The resistance per coil will be approximately 2 ohms and at a current flow of 6 amperes this would result in a loss of 76 joules per second in the form of heat. The radiating surface of each coil is about 150 square inches, hence the radiation factor is 0.48 watt which may be considered entirely safe for coils of this type.

These coils are not designed for use and choke coils as this would necessitate the reducing of the capacity between layers

**CONSTRUCTION NOTES.**

No allowance is made in the drawings for clearance between moving parts. It is assumed that the builder will machine the various parts to the dimensions given, then remove with a very fine cut sufficient stock to make the required fit, which must be close in the case of those which offer passages for air into the arc chamber. Lubrication is depended upon for the necessary seal. In the original apparatus herein described, parts were machined all over, and all metal parts except those of the magnetic circuit are made of brass.

Where materials other than brass are used a note to that effect is made.

Fig. 1. Arc Chamber—The drawing shows the details of the arc chamber and the fibre washers for both electrodes.

Fig. 2. Water Jacket—The inner cylinder or bearing tube is preferably made of rolled brass as it is desired to make this as thin as possible consistent with good wearing qualities and water tightness.

Fig. 3. Journal—This piece fits the bearing tube of the water jacket with a running fit. The worm gear is shown as a separate piece; the reason for this is obvious since in most cases it will be more economical to cut a stock gear down than to hob out a gear on the flange. Two pins, 180 degrees apart (not shown in the drawing), hold the gear in place.

Fig. 4. Striking Bushing—This fits into

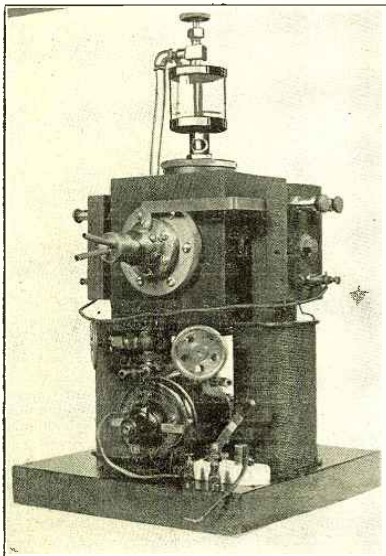

This View of the Arc Shows the Copper Anode Side. Note the Two Water Circulating Pipes.

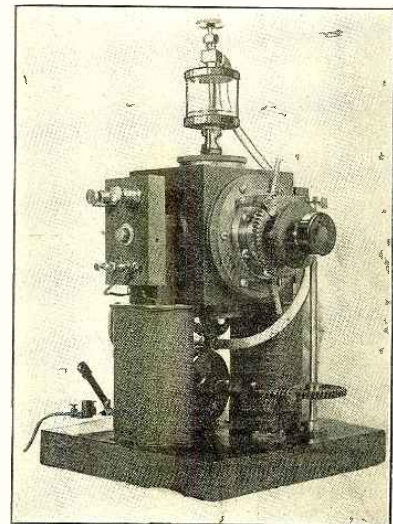

While This View Is That of the Carbon Cathode Side. Note the Rotating Device.

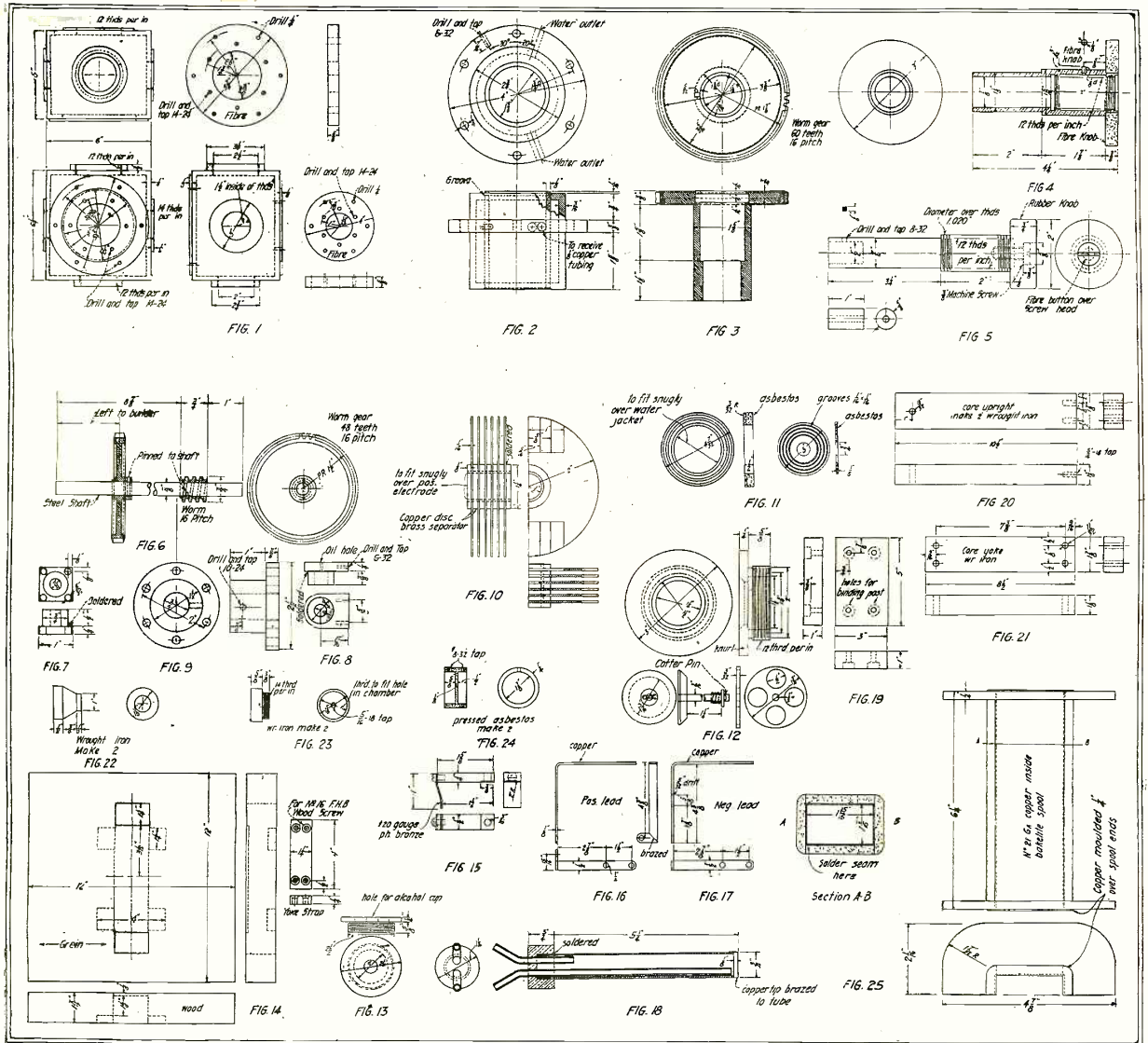

Complete Construction Details for This Arc Converter. This Information Should Prove of Real Value to the Experimenter Desiring to Construct a Small But Efficient Arc Suitable for Radio Work.

the inner surface of the journal with a sliding fit. The pin restrains its lateral motion to  $\frac{1}{8}$  inch which is ample for this arc. A steel spring consisting of  $4\frac{1}{2}$  turns of No. 16 B. & S. gage piano wire around the part of the bushing  $1\frac{1}{8}$  inches in diameter bearing against the shoulder on the bushing and the one inside of the journal returns the bushing to battery after the arc is struck.

Fig. 5. Electrode Holder—This screws into the striking bushing and makes possible the regulation of arc length. The  $\frac{3}{8}$ -inch hole in the end is for holding the carbon tips. When carbons under  $\frac{3}{8}$ -inch in diameter are used, an adapter such as the one shown in the drawing must be used to fit them into this  $\frac{3}{8}$ -inch hole.

Fig. 6. Vertical Driving Shaft—This transmits motion from the driving motor to the journal and thence to the electrode. The top and bottom bearings for this shaft are shown in Figs. 7 and 8, the former being secured to the arc base and the latter to the copper lead from the terminal block to the water jacket. The driving motor should be of approximately 1/10 H.P. and have some means of speed control. It is connected to the vertical shaft by a fiber extension to its own shaft and

a worm which meshes with the worm gear on the vertical shaft. The details of this part of the construction are left to the builder as they will depend to a greater or lesser extent upon the various dimensions of the motor. As may be seen by referring to the drawings the train of gears gives a reduction of 2,880 to 1; and since the speed of rotation of the electrode should be about  $\frac{3}{4}$  R.P.M., a motor whose nominal speed is 2,200 R.P.M. will be right.

Fig. 9. Positive Electrode Holder—This piece is secured to the smaller of the fiber washers shown in Fig. 1.

Fig. 10. Radiator—This fits over the portion of the positive electrode within the chamber and serves to conduct such heat as it receives from the medium surrounding the arc to the water-cooled electrode.

Fig. 11. Asbestos Soot Discs—The thinner one is held in place between the arc chamber and the radiator, and the thicker one fits snugly over the portion of the water jacket inside the chamber. Both prevent soot from depositing around the insulation where the electrodes enter the chamber by closing up the pockets there. It will be observed that there are several grooves in the faces of these discs. These are intended to make the path for current

over such soot as deposits upon them as long as possible.

Fig. 12. Poppet Valve—This is simply a spring loaded conical seated valve which serves to relieve the chamber of excessive pressures caused by gas explosions. It screws into the bottom of the chamber.

Fig. 13. Cap—This screws into the top of the chamber and provides a means of inspecting the interior. A threaded hole is made in the center for holding the alcohol feed cup.

Fig. 14. Base—The drawing is self explanatory. It might be added, however, that unless the electrode driving motor is of somewhat the same dimensions as the one shown in the photograph, a modification in the dimensions of the base must necessarily be made.

Fig. 15. Journal Clamp—This serves a twofold purpose; it prevents ordinary lateral movement of the journal, and in combination with it acts as a safety valve for the chamber in that it allows the journal to blow out in case of unusually large explosions. It is secured to the flange of the water jacket with an 8-32 machine screw and the spring clip bears upon the outer face of the journal flange.

(Continued on page 511)

# A New Way to Get Your Fundamental

By "YOSE"

IT is often asked by experimenters, as well as by constructing engineers, why it is not possible to get the exact natural period of an antenna.

There are several means for getting the approximate period and the results are

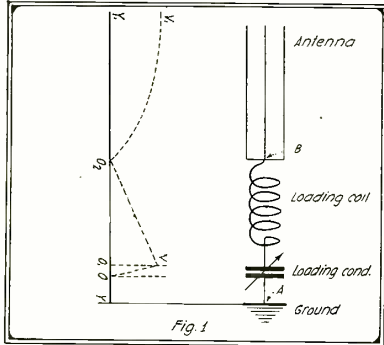

Graphic Explanation of How Fundamental Is Obtained.

accurate to the necessary degree of closeness for all practical purposes. However, human nature is not satisfied with this. It is a stubborn thing, whence the writer offers the following exact method used under many conditions in response to repeated inquiries from experimenter-amateurs for an exact method *without* the use of any single extra loops of wire, extra condensers, etc.

Fig. 1 shows the principle of the method. An antenna is loaded with a series loading coil and condenser. If such a coil and condenser is tuned to the exact natural frequency of the antenna it may be taken away and the point A at the base of the antenna connected to ground without changing the natural period of the antenna.

This is a well known fact, but does not seem to have been applied in this particular way. In other words, an artificial or "dummy" antenna in series with its twin or "image," so to speak, has no effect on the natural period of the latter.

The reason for this becomes clear if we examine the arrangement shown in Fig. 1, so as to determine its voltage at any point from the point A along the loading elements up to the point B. As we pass up thru the condenser the potential difference rises until we reach the beginning of the coil and then goes down again as we approach the base of the antenna at B.

If we are exciting the arrangement by shock or impact, such as a spark to the ground side of the condenser, we may take an electrostatic voltmeter and measure

the voltage between A and various points between A and B. We will find a minimum value when the exploring point reaches B. It should be zero, theoretically, but the resistances present make this impossible. These voltages are indicated by the lines drawn from YY to the voltage line OVO. In the condenser the voltages uses from zero at the point O to OV (say 100 volts) the point O, and decreases to zero again at the point O. Above O it rises as shown by the curve OV to the end of the antenna.

Since the points A and B have no voltage difference when the antenna is oscillating at its natural frequency, it therefore doesn't matter whether the apparatus joining them is removed or not. This leads us to Fig. 2, showing the actual hook-up used in the measurement, as of the exact fundamental of an antenna.

Let us take a calibrated excited X and couple it inductively to the coil, L<sub>1</sub>, of a second calibrated circuit, Y, of about the same range and characteristics as X: in other words, let Y have a variable condenser of about the same value as that in X and suppose both X and Y to be direct reading.

Now we may consider Fig. 2 as representing a driving circuit which at the fundamental of the antenna A will drive a "dummy" antenna Y, composed of coil L and condenser C, in series with the "equivalent" antenna A.

This equivalent antenna is made up of an equivalent capacitance and inductance C and L, which change with the frequency. This fact need not bother us, as we are

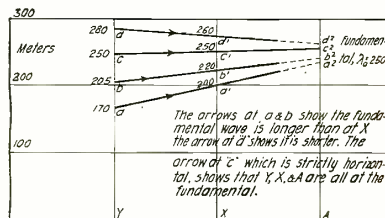

In This Diagram X May Be Considered as a Sort of Tuning Station.

not interested in these values at present. All we need know is that Ca and La considered as an equivalent to A will not be influenced by the presence of Y. We know quite well it will not be influenced at the fundamental of A. Hence by coupling A to X thru Y we have not changed the behavior of A<sub>0</sub> at the fundamental of A.

**METHOD OF TEST.**

Let Y have a detector and telephones

shunted across L, as in the usual receiving circuit. Start X to oscillating at about 200 meters. If X is an oscillion an audio frequency should be impressed on it. If this is not convenient, use a "ticker" in Y or still better use another calibrated oscil-

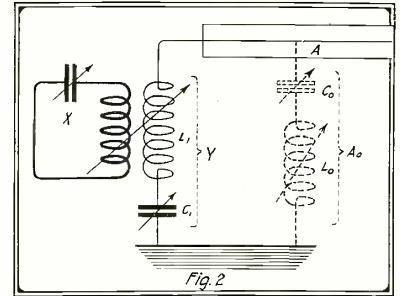

Driver or Buzzer Circuit Employed to Excite Antenna.

lion in place of Y. The actual method is the same in all cases, no matter whether X gives damp or undamp oscillations.

**PROCEDURE.**

To get the fundamental of a tune Y to X and note reading of Y. If Y tunes to say 170 meters where X is sending out 200 meters, then X is tuned to give a smaller wavelength than the fundamental of A, which may be 250 meters. This is what would usually happen to the average experimenter.

If we try again by tuning X nearer to A at (say) 220 meters, we will find that Y will tune at about 205, that is X and Y are both approaching the fundamental of A or 250 meters.

If we get careless and unknowingly tune X to say 260 meters, we shall find that Y tunes at say about 280 meters. Hence we see we have now overshoot the mark and have past in the oscillations in X thru the fundamental frequency of A.

When Y is exactly in tune with X at exactly the same scale readings, then X, Y and A are all in tune at the scale reading giving the fundamental of A.

In the above case it may be found in practise that in working up to the fundamental wavelength starting with X at say 200 meters, we cannot get a closer balance than 245 meters for Y and 248 for X. On the other hand, when we come down starting with say 300 meters in X we cannot get closer than 252 meters for Y. In this case it is best to average the two values of X, 248 and 252 meters, giving the exact fundamental as 250 meters. This method

(Continued on page 520)

## A French Radio School

The accompanying photograph was received from one of our French correspondents and shows a section of the code instruction room of the Radio Electricque School at 11 Rue Cambronne, Paris. This institution trains young men to become expert radio telegraphers for the French Merchant Marine which, by the way, has grown to considerable proportion during the War. In addition to this France has made great strides in radio development, and particularly in vacuum tubes; in fact, some of the amplifiers used in the trenches proved of exceptional value in eavesdropping upon German telephone communica-

tion, as well as various systems of ground telegraphy. It was then that the French authorities realized the necessity of com-

petent men well versed in the art of radio communication.

The French have no doubt been taught a lesson by the American foresight for realizing the value of the radio amateur during the War. As a comparison, the French operators were men of advanced years who had obtained technical training in the military posts, while the American military operators were young men who had developed their knowledge of radio as amateurs.

Other foreign countries are also beginning to see this necessity and are adopting similar methods in educating the young men in radio telegraphy.



# The Differential Circuit

By LEONARD HANSON, 7th Service Co., S. C.

(Ed. Note: If the amateur has the necessary apparatus, it is suggested that this circuit be tried, even tho it is not a radically unique one. Future radio development depends greatly upon static elimination, and for that reason theories of this nature should be put to practice by all truly interested in the radio art.)

## ONE METHOD OF STATIC ELIMINATION.

THE differential circuit is designed to eliminate static interference as encountered during the reception of radio signals. It is so designed that it will not decrease the strength of signals desired to receive and yet completely prevent all static discharges, regardless of their intensity, from entering or being heard in the phones.

The circuit makes use of two aerials, as shown in diagram number one; they are of the inverted "L" type and are located at right angles to each other. A receiving set is connected in circuit of each of the aerials and the phone terminals of each of the receivers are connected to the two primaries of the differential transformer, as shown in diagram number two. Amplifiers are connected to the secondary of the transformer.

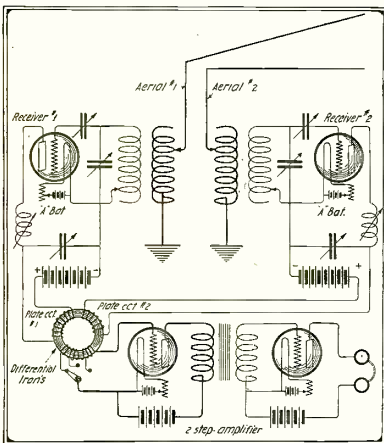

Fig. 1—Two Aerials at Right Angles Form the Basis of This Circuit.

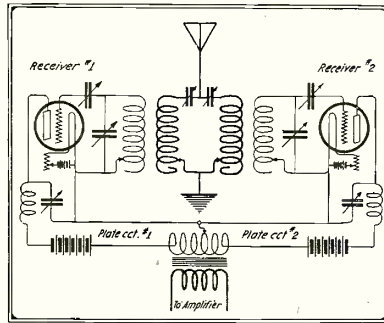

Fig. 3—In This Instance the Author Makes Use of But One Aerial.

The differential transformer consists of a thoroly laminated iron core, two primary coils and one secondary coil. The number of turns in the two primary windings are equal and are connected so as to cause the current through them to flow around the core in opposite directions. The two primary windings are parallel windings and are not the tandum differential, as shown in diagram number two. The secondary winding is made variable by taps.

The two primary windings are connected into the two-plate circuits, and since the current in the two-plate circuits are to be equal and also the number of turns in each of the primary windings, it is obvious that the two magnetizing influences will be exactly equal and opposite and no magnetic effect will be produced. But if the current is varied in one of the plate circuits the iron core will immediately become magnetized and will induce a current into the secondary winding of the differential transformer. Now if the current is simultaneously varied with the same intensity in the two-plate circuits, no magnetic effect will be detected nor will a current be set up in the secondary of the transformer.

It is important that the two-plate circuits be electrically balanced; that is, their respective capacity, inductance and resistance should be equal, and in order to facilitate this, variable resistance, inductive

and capacity may be placed in the circuit.

It will be seen that any interference or current that is induced simultaneously into each of the aerials will not pass the differential transformer. Static discharges will produce highly damped oscillations and will simultaneously set the two aerials into vibration at whatever frequency they happen to be tuned to. These discharges are rectified by the "tube" and are converted into a pulsating current in the plate circuit; the two-plate circuits will, therefore, pulsate simultaneously with an equal degree of freedom, and as this will not vary the field of the differential transformer, static therefore cannot be heard in the phones.

If a nearby station is working on say 3000 meters and receiver number one is tuned for 3000 meters and the other receiver is tuned for say 2500 meters, signals from the 3000 meter station will be readily received and static will be nil in the phones even tho an electric storm be nearby. This will be understood by the fact that receiver number one will be effected by the 3000 meters station and static discharges, while the receiver number two will be effected only by the static discharges. Thus the plate circuit of receiver number one will pulsate with a period equal to the frequency of the wave train of the sending station and with an interposed frequency

(Continued on page 519)

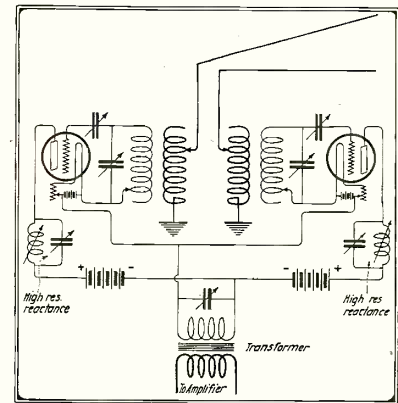

Fig. 2—In This Circuit the Transformer Has But One Section in Its Primary.

## Australian Notes

At a recent lecture on Radio Communication before the industrial section of the Royal Society Mr. E. T. Fisk spoke of the rapid development of wireless telegraphy.

A remarkable demonstration of wireless telephony was given with the aid of apparatus designed and manufactured in Sydney by a local wireless company. A gramophone was played into a wireless telephone transmitter at the works in Clarence street and the music was received on a few wires strung along the wall in the lecture room in Elizabeth street. The music was clearly audible in all parts of the hall, and the lecture was suitably closed with the audience standing while the national anthem was played by wireless telephony.

### NATIONALIZATION OF RADIO IN AUSTRALIA.

Consideration is being given by the Australian Navy Board in conference with certain wireless institutes and companies to

the question of issuing licenses for the private use of wireless plants.

The acting minister for the navy, Mr. Poynton, said that he would take no steps to remove the restrictions on the use of private wireless stations. Wireless was an agency over which the Federal Government should have full control. Very serious consideration should be given before private enterprise was permitted to have a share in the control. This does not affect amateur licenses, which are under consideration also at the present time.

In connection with the granting of experimental licenses to amateurs, it must be shown that the proposed experiments will have a definite object in view and are likely to advance the art of radio telegraphy and radio telephony.

This means that the number of licenses to be issued will be limited, with the object of more efficient control.

Contributed by RAYMOND EVANS.

### ADDITIONAL NOTES.

"Bugdom" is the scene of great rejoicing, for after a period of inactivity extending over five years the amateur is now allowed to erect an aerial and receive signals. Transmitting permits will probably be issued in the near future.

Restrictions here are far more severe than in the U. S. A. Receiving stations must be licensed, and for a transmitting license the operator must be capable of receiving and sending at a speed of twelve words per minute (five letters being counted as one word). Wavelength 200 meters and power input not to exceed 100 watts with 200 watts in special cases.

The wireless societies of Queensland, New South Wales and Victoria have amalgamated, and it is expected that the societies in the other states will follow suit, the body being known as "The Wireless Institute of Australasia."

(Continued on page 520)

# Radiophone Experiments

Practical Experiments by an Amateur

By FORREST R. KINGMAN

IT is a well known fact that the difficulties of transmitting speech with and without wires are greater than the sending of mere signals, since in the former currents of the same amplitude, phase

A closed core transformer was used, the cross section area of which was 1.5 C.M. sq. or 2.25 sq. C.M. The total length of the core was 10 C.M. and the total width was 9 C.M.

mouth piece in the center was placed over the large end of the megaphone.

The reason for this was to keep out other interfering sounds. The transmitter

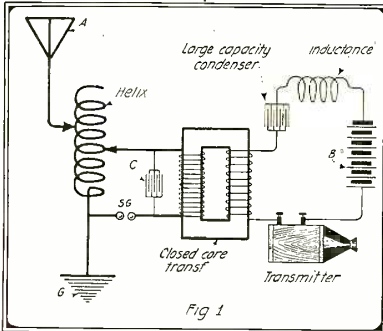

First Attempt of the Author Employing Ten Ordinary Telephone Transmitters.

and frequency with the local vibrations must be retained; while in the latter any kind of electric impulses will serve. In Radio Telegraphy where a spark gap and a crystal detector are used, the energy is transmitted in trains of waves having a decaying amplitude as shown, and otherwise known as damped waves.

This method cannot meet the requirements of a sine wave for the propagation of speech, which in the latter case must have a constant amplitude and which are known as undamped or continuous waves.

My first attempt in constructing a Radiophone outfit was to place ten carbon-grain transmitters in one end of a square box. Fig. 1 shows the circuit of this experiment. A megaphone was placed at the other end. The transmitters were placed so that they formed a circle, seven outside and three in the middle, having their mouthpieces facing the megaphone. These transmitters were connected up in parallel to a set of dry cells, and a closed core transformer was used for increasing the potential of the resultant sine waves.

Now, when articulate speech was impressed upon the megaphone, the sound waves acted on the ten transmitters at the same time, and thus each one sent out wave currents corresponding to the waves or vibrations of the voice and the combined currents of all transmitters when in parallel produced a very strong wave suitable for transmission of speech.

The condenser used in series with the circuit of the transformer was of extremely large capacity. The inductance was variable.

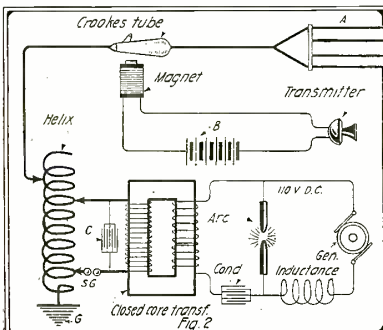

In This Circuit We Have a Crookes Tube as Well as a Regular Arc. Modulation Is Accomplish Thru Cathode Rays.

The primary was wound with No. 20 S.S.C. wire B and S gauge. The secondary was wound with No. 38 enameled wire. The spark gap shown in Fig. 1 was so small that the two electrodes almost touched each other. A condenser was placed across the secondaries. A common helix was used for tuning inductance. The aerial was about 75 feet above the earth and 125 feet long. The four-wire system was used. According to my experience, I believe this system of radiophone is one of the best that I know of for short ranges. When I conceived this system, I thought I had something entirely new. However, I soon learned that another nearby amateur had also used the same principle of placing a number of transmitters in a box.

My next attempt in constructing another wireless telephone was based upon an entirely different principle.

I used the well known arc system of producing high frequency currents, but instead of placing a transmitter in the ground circuit of the antenna circuit, I connected a Crookes Tube in series with the main antenna circuit. See Fig. 2 for method of connection.

I based this theory of this experiment on the fact that Cathode rays from a Crookes Tube are deflected by a magnet, so I placed a 500 ohm electro magnet in series with a set of dry cells and a carbon-grain transmitter.

The magnet was placed so that it acted directly on the Cathode rays. Now the wave currents from the transmitter varied the strength of the magnetic flux and thus produced fluctuating Cathode rays corresponding to the modulated waves produced by the voice. This system of radiophone should be very favorable for high power stations.

A few days after I had tried out this system of radiophone with not very much of a success. I came to the conclusion that the microphone principle of the radiophone was the best to work upon, so I constructed another system similar to my first experience, shown in Fig. 1, but instead of using a number of carbon grain transmitters connected in parallel, I constructed a transmitter similar to the old Blake transmitter, but instead of using a platinum point and a polished silver button I used two polished silver buttons, one button being soldered to the center of the diaphragm, the latter being made of a thin sheet of phosphor bronze. The other button was soldered to the end of a phosphor bronze strip. The strip was fixed (shown in Fig. 3) so that the buttons almost touched each other. A thumb screw was used to adjust the proper distance between the two buttons.

I learned by experimenting that an ordinary mouth piece was not suitable for this type of radiophone transmitter, as the sound waves were not powerful enough to make the diaphragm vibrate so that the button contact points responded to each vibration of the voice; however, I overcame this difficulty by placing the diaphragm in the small end of a megaphone so that the sound waves were concentrated upon the diaphragm and which caused it to vibrate with greater force than would otherwise obtain. A wooden disc with a

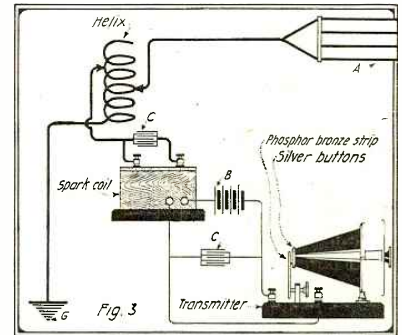

A Specially Constructed Blake Type Transmitter Is Employed in This Experiment.

was connected in series with a set of dry cells, and a condenser was connected across the contact points to eliminate sparking.

A 1" spark coil was used as a transformer for raising the potential of the wave currents. I found that this system of radiophone worked better for short ranges than I had anticipated. My last experiment with the radiophone was by using the principle of induction. I made a transmitter as shown in Fig. 4. The transmitter was constructed upon the principle of a miniature induction coil, and the diaphragm acted as the vibrator. Thirty turns of No. 28 S. S. C. B and S. wire was formed in a round coil about 3/8" in diameter. This coil was fastened at the end of the diaphragm and the leads were fastened to posts at the base of the transmitter.

I next made a small iron core out of a bundle of small iron wires. The length of the core was 1" and the diameter was 1/4". I wound a secondary winding of No. 40 enamel wire on this core, which almost covered the entire length of it.

Now I mounted the apparatus so that it formed a complete transmitter, having mouth piece diaphragm primary and secondary coils, core and base. The apparatus was so arranged that the end of the core projected inside the fixed coil on the diaphragm, but not enough to touch the diaphragm. As was said before, the coil or the diaphragm was called the primary coil and the one on the core was called the secondary coil. I placed ten of these in a box similar to the box I used in Fig. 1, their individual mouth pieces all facing

(Continued on page 521)

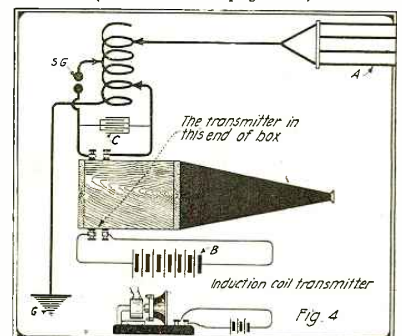

Fourth Experiment of the Writer Making Use of a One-Inch Spark Coil.

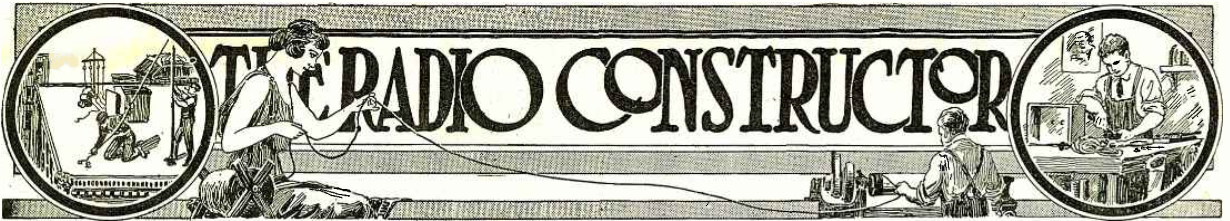

# New Type Multi-Layer Coil

By RAY T. FOSTER

**T**HE small circular coils being so popular at this time for use with wireless instruments, the writer devised a method of winding one type of circular coil which should be met with approval, as considerable trouble is experienced by many in the construction of coils that are home made.

To begin with, be sure you have all the necessary materials close at hand. Those needed are as follows: Some good insulated wire say about No. 30 B. & S., and also some No. 26 for the primary, one square foot of heavy cardboard, two square feet of thin cardboard, a length of cardboard tubing. This should be about 1 3/4" in diameter and should have a thickness of 3/16 of an inch for best results. About one half pound of beeswax, and two binding posts, the smallest size you can get. These articles at hand together with a small mandrel to hold the coil while winding, and a contrivance for melting the beeswax, and you are ready to begin.

First take the cardboard tubing and cut it into 3/4" lengths. Place these into the hot beeswax and let them boil for awhile until they are impregnated with the wax. Then take them out and let them cool and harden. While they are drying, take the thin cardboard and cut it into strips one-half an inch wide; cut each of these strips into small 3/4" lengths. This done you are now ready to begin winding. Take one of the small lengths of tubing and punch a small hole thru it about one-quarter of an inch from the outer edge; grasping one end of the smaller size wire, place it thru

the hole and bring it out and around the tube edge, going thru the hole again. This is done to prevent the wire from slipping

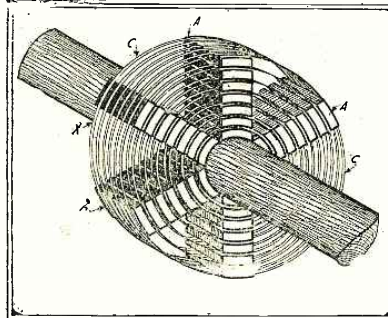

Fig. 1—This is a Side View of the Core and Method of Winding.

at the start. Now comes the part that the writer found rather tedious owing to the fact that the wire was used to hold down the small squares of cardboard and therefore quite a bit of trouble was experienced in keeping these pieces in place. If you have a pair of tweezers handy use them to hold the cardboard strips and dip these strips or squares of cardboard into the hot beeswax and take them out immediately, placing them at even distances around the small cardboard tube until there are six of them in place. It will be understood that the beeswax will dry quickly and cause the

cardboard pieces to adhere to the tube thus preventing slipping. After you have placed the first layer of strips begin winding, spacing the wire so that you get five or six turns in the length of the strips. This done lay another layer of the cardboard strips and repeat the operation being careful to get the same number of turns to each layer. When you are thru, it is an easy matter to find out how many turns you have wound by merely counting the layers and multiplying it by the number of turns per layer.

The primary is wound in the same way as the secondary only the larger wire is used and it is not necessary to make it as large as the secondary.

A very good substitute for Litz wire can be made by twisting three or four strands of No. 34 or No. 36 wire together and soldering both ends so that the four wires at each end are joined together. Use this for the primary.

In the illustration it will be observed that the coil ends are removed. It is not necessary to put these ends on until after the coil is wound. A shows the layers of cardboard strips and C shows the windings. X-X are the two leads taken from the coil.

The coil ends may be made from the heavy cardboard or if you like, of wood. The ends should be large enough so that at least one-half inch will exist between the diameter of the coil proper and the outer diameter of the ends. In one of the ends drill two small holes. These are for the two binding posts.

## Simple Amateur Variometer

**A**N efficient and easily constructed variometer which costs little and occupies small space may be constructed along the lines here given, tho the measurements may be altered to suit individual requirements.

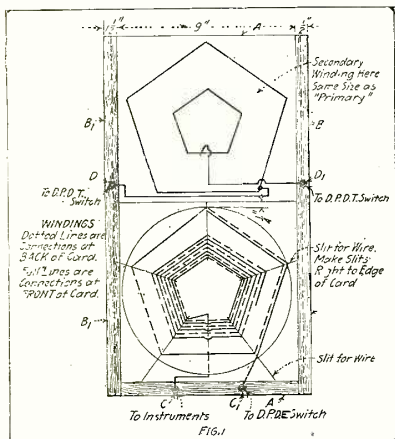

The Variometer Is Wound as Shown. The Secondary Passes Over the Primary.

Base A may be made of good hardwood 9" by 1' 4". Two grooved pieces, B and B<sub>1</sub>, of match boarding are fastened one on each side. See Fig. 2.

Two pieces of strong pasteboard or cardboard, each 8" by 8 1/4", are required, one on which to wind the primary and the other for the secondary. The latter should slide freely along the grooves.

From the exact center of each card strike two circles, one 3" diameter, the other 7 1/2" diameter.

Divide the outer circle into five segments and cut a slit about 1/16" wide down as far as the inner circle from each point in the five point star formed.

Wind each card from the 3" circle to the outside circle with No. 24 D. C. C. wire, so that in each complete turn there are two-fifths of the wire on the front of the card and three-fifths on the back and vice versa in consecutive turns as in Fig. 1.

The two cards should be identical when finished. The primary may be fastened to the base between the sliders and the ends of the coil brought out to terminals C and C<sub>1</sub>.

The ends of the "secondary" coil may be connected to terminals D and D<sub>1</sub> by flexible wire long enough to allow of the secondary being moved along in the grooves.

By connecting the coils to a double pole, double throw switch (as shown in Fig. 3) the inductances may be connected so as to work either in conjunction with or in opposition to each other. These coils may be used as tickler or transformer.

Contributed by C. ROBERTS PILL, Hyde Park, England.

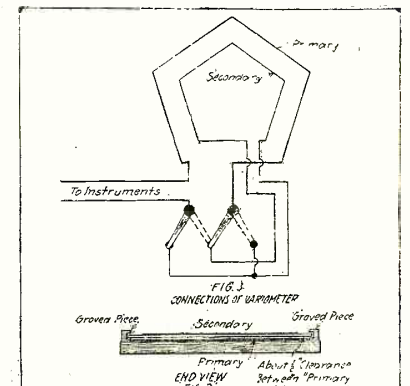

Method of Connecting Up the Variometer.

# The Construction of a Honeycomb-Coil-Winding Machine

By MARTIN WALTER, Jr.

AS the hand process for winding honeycomb coils is rather tedious, and since not especially good results are obtained, I think this winding machine will meet with the approval of most "hams" who construct their own apparatus.

The construction is not difficult and the materials may be obtained from an old wooden box, but hard wood such as oak or ash is preferable as the bearings will not wear out so soon and a better all around appearance is obtained.

A complete list of parts is as follows; capital letters referring to parts are lettered in the diagram:

One board for base 6" x 9" x 1"; two uprights, 6" high, 4" at base, tapering to 1" at top— $\frac{1}{2}$ " wood, K & K'; two sides,  $2\frac{3}{4}$ " x  $2\frac{7}{8}$ " x  $\frac{1}{2}$ ", J & J'; one block, 2" x 1" x 1", F; one guide stick, 6" long,  $\frac{3}{4}$ " at base, tapering to  $\frac{1}{4}$ " at top, A; one wooden cylinder 2" long by 2" outside diameter, E; one arm for handle,  $2\frac{3}{4}$ " x 1" tapering to  $\frac{1}{4}$ ",  $\frac{1}{2}$ " thick, H; one connecting arm  $4\frac{1}{2}$ " x  $\frac{1}{4}$ " x  $\frac{3}{8}$ ", B;  $1\frac{1}{4}$ " dowel  $8\frac{1}{4}$ " long;  $1\frac{1}{4}$ " dowel  $5\frac{1}{4}$ " long; one spool, 1" outside diameter, for handle, G; one spool  $\frac{1}{2}$ " outside diameter, D; one spool,  $1\frac{1}{2}$ " outside diameter, for crankshaft, C; one small screw-eye; one sheet, No. 1 or No. 2 sandpaper; some strong string; a large rubber band.

When all the parts have been made, they should be assembled as per sketch. Five-sixteenth inch holes must be bored for the dowel bearings, but if the reader has no bit that size a  $\frac{1}{4}$ " drill will do as well, provided the dowels are scraped down with a scraper or chisel to fit loosely in the hole. The sandpaper is put on U and D so the string belt will not slip. This is essential, because if A's movement is irregular the finish coil will not have a true honeycomb-like appearance. First cut sandpaper to size, then spread glue evenly on it and place on spool or dowel, wrapping string tightly around it to hold in place. After the glue is dry the string may be removed. After the sandpaper is on the spool (D in diagram) it should be fastened to the dowel with good glue. Likewise C, G and H are also fastened with glue. In the photograph, I is a porcelain handle from an old gas stove, but a piece of dowel cut to size, will do just as well. The belt, which for clearance is not shown in the drawing, is a long piece of heavy twine wound from U around D, up and around U, repeating until six or seven turns have been taken, when the ends should be tied together in a secure knot. A strong rubber band should now be cut in half and tied over the string belt as a further pre-

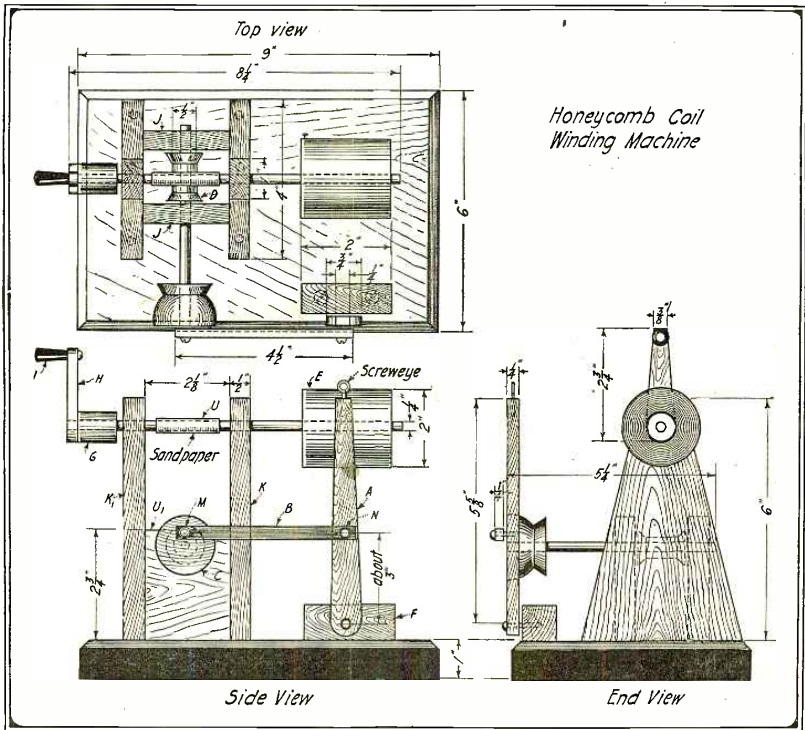

Here Are the Construction Details of the Machine Which Winds the Most Talked of Coil of Today.

caution against slipping. The bearing, M should be from  $\frac{1}{4}$ " to  $\frac{3}{8}$ " away from C, and N should be from 3" to  $3\frac{1}{2}$ " up from O, but, if when in use the machine winds coils less than an inch in width, N should be moved away from O until the desired result is obtained. If, on the other hand, the coils are too wide N should be moved down. A small screw should be placed on E to hold the wire when starting a coil.

The tube on which the coils are wound may be made from thin cardboard cut in strips  $1\frac{1}{2}$ " wide and 7" long. A little glue is applied to one end of the strip when it is placed around E and held with a string as in the case of the sandpaper. After the tube is made thread the wire (No. 24 S. C. C. or S. S. C. for small coils and No. 26 or 28 for large ones) through the screw-eye on A, and thence to the screw on E. The wire must be under some

tension or the coils will be wound too loosely. I find that placing several heavy books on it between the spool and the machines does very nicely.

When winding, do not go very fast or the coil will be uneven. Also never let go of the handle, because if you do the whole coil will unwind. If the coils are painted with a very thin layer of shellac after each layer of wire, they will hold their shape better and will not come unwound so easily. After the coil is finished remove it from the cylinder, cut off the surplus paper and tie a string around it to keep it from unwinding. The coils may be mounted to suit the reader's particular requirements and may be used as loading coils, or two together may be used as a loose coupler, etc. Of course, a variable condenser must either be put in shunt or series with the coil or the capacity cannot be varied.

## Crystal-Audion Hook-up

Owing to the high cost of vacuum tubes, not so much the tubes themselves as the batteries, has led many to include in their sets a good stable mineral detector, not only for emergencies but also for signals

With This Circuit and by the Use of a Single Point Battery Switch Quick Change Is Made from Audion to Crystal.

sufficiently loud to be received on it. The practice is to receive on the tube first, and when a loud signal is received the tube circuit is changed to the mineral. Usually this requires a double or triple-pole double-

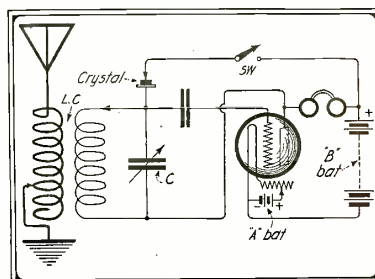

throw switch and somewhat complicated wiring. To offset these disadvantages, the following simple circuit using a single point switch was evolved to change from a DeForest ultra-audion to a crystal hook-up. Being a constant reader of R. A. N., and not having seen such a hook-up before, I thought some of the other readers might be interested in it. When the switch is open and filament lit, the audion is in use. When closed, the mineral set may be operated, provided, however, that the filament is not lit.

Contributed by E. HOWARD.

# An Ideal Radio Cabinet

By E. G. SHALKHAUSER, A. B.

THE general trend of radio panel construction to-day points toward neatness, compactness, flexibility and efficiency of operation; in short maximum range with minimum space and energy loss. Apparatus and methods of construction of only five years ago are now considered old and out of date, especially that phase of amateur construction dealing with apparatus arrangement and mounting. Not even the most farsighted radio men dream of developments in the radio art which have become a reality to us of the present day. Moreover, few amateurs, except possibly beginners, think of a sliding tuner and galena as permanent appliances in a radio set. The amateur of to-day will not think of having an exceptional radio set until he has mounted all his instruments in a cabinet and at least won local comment for efficient work. When he contemplates purchasing instruments his first thought is of the panel on which to mount them. He cannot compete with his fellow amateurs if his apparatus is scattered haphazardly over the table or room. He must arrange everything in neat, compact and systematic form.

The manufacturer of radio apparatus aims above all else to satisfy the buyer and caters to his wishes. Just to convince the sceptical as to what is considered up-to-date equipment it is only necessary to call his attention to the advertising pages of a good radio magazine of to-day. This will settle all questions as to what the amateur wants and is looking for. Radio sets not mounted on panels or in cabinets are not demanded, and for this simple reason the post-war market has brought out none for sale.

Since the panel type of radio set is seemingly the most practical and efficient one, the author has conceived a method of mounting this panel, whereby the amateur can add something decidedly advantageous to his set not only in appearance but also in convenience of operation and protection of his apparatus.

The cabinet, herewith illustrated and described, should prove of value to all amateurs, especially to those who find their radio quarters limited in space. In a great number of wireless amateur establishments space is at a premium, and to be able to do away with one or two tables or boxes upon which an ordinary cabinet is mounted would be decidedly advantageous, besides lending an air of attractiveness to the "den." Even the parlor will not be disgraced to find a cabinet of this type located in some remote corner.

Everything entering into the construction of this cabinet is of simple design and no amateur, however small his tool shop or pocketbook, need hesitate about building one for himself.

The various parts may be procured, sawed to proper lengths, from the lumber-dealer. The writer recommends this procedure as the best, since any small altera-

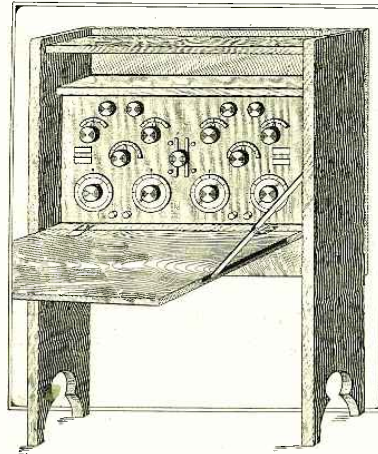

This Cabinet Set May Well Be Given a Conspicuous Place in the Parlor.

tions to be made thereafter can be made by the constructor, and the cost thus kept down to a minimum. The dimensions for the piece parts are clearly indicated on the detailed drawing, the stocklist also including the number of piece parts required. The two end upright details will require more time to construct than any of the other parts. The grooves which fit the horizontal boards can be readily cut into the wood by means of a hammer and chisel. Care should be taken not to fit parts loosely as the liability of non-rigidity is greater if the joints do not fit perfectly tight and close. A good method is to cut the grooves in the form of a V similar to a dovetail joint and to slip the top and bottom pieces in from the side. This is

a more difficult method of construction, but will repay the maker in the end, as it adds to the rigidity of the cabinet. If the grooves are cut rectangular as is shown on the drawing, triangular pieces of wood glued into the corners from the inside will give additional firmness and stability to the cabinet.

After the wood has been cut and the corners removed it should be finish off with sandpaper and given the desired stain and finish. The choice of finish, whether mahogany, oak, or walnut, is left entirely to the builder. He will naturally choose the color which matches with the other woodwork in the room. To obtain the best results in wood finishing it is advisable to consult a book on cabinet construction, which will describe in detail the various methods of wood treating and finishing. It is needless to mention that only those parts, facing to the outside, require a good polish appearance. The other parts, as designated in the stocklist under material, can receive a single coat of stain or filler.

It is highly desirable that in a well constructed cabinet of this type the use of nails or screws be eliminated as much as possible. They may be used when fastening parts together from the inside. But in addition all joints and grooves should receive a coat of good cabinet glue. This will be found to eliminate many future troubles and avoid the use of cross pieces to brace the cabinet.

The shelf located in the upper part has not been divided into smaller pigeon holes on the drawing. In most cases it will not be found necessary to have more than one compartment, but the amateur can choose here as he desires. Probably a double compartment would satisfy the majority, as one could be used exclusively for message blanks and files and the other for the station log and miscellaneous material.

The front cover may be used as a writing board when in the down position and as a protection for the panel instruments when raised and locked. It can be attached with end pins and hinged in the manner shown on the drawing.

Both methods are practical and simple to apply. To withstand the downward pressure when writing or copying messages a brace is attached at each end of the board. The size and kind used will determine the method of attaching them. The ones shown are the best to use and can be obtained in any hardware store. If possible the groove cut into the end of the writing board to fasten and hold the brace should not show from the front when the desk is in the closed position. This is merely for the sake of good appearance.

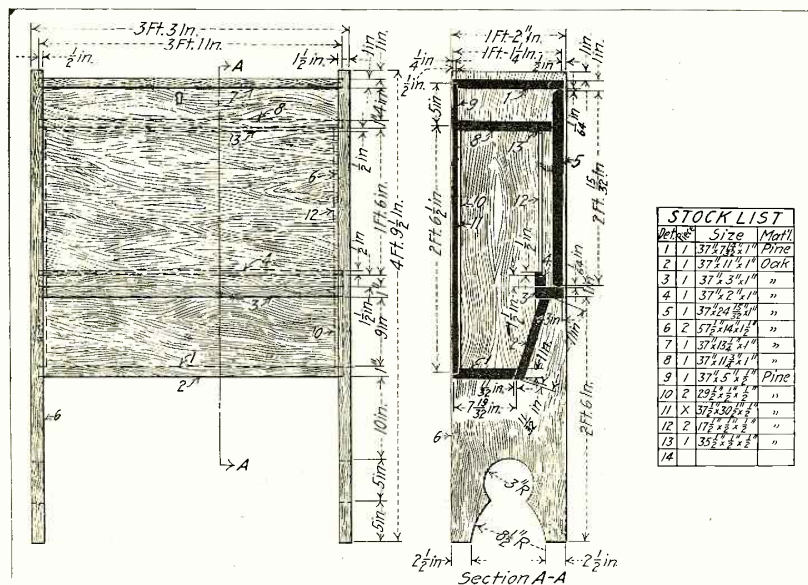

Follow These Directions Carefully and You Will Be Well Pleased With the Results of Your Handiwork.

(Continued on page 522)



# Amateur Navy Type Short Wave Regenerative Set

By J. STANLEY BROWN

**P**LEASE admit it, Mr. Amateur, one of the chief reasons that you have for not constructing a short wave regenerative set is that you do not care to construct a couple of variometers. Well, that is only natural, and you are not to be blamed, as it is doubtful if they are worth the trouble unless you wish them for some purpose other than that just mentioned. Perhaps many of us are aware that it is very seldom that a set will be found in the army or navy in which variometers are employed for tuning. We know that Uncle Sam has some very fine radio engineers and it is more than likely that they know their business.

The concensus of opinion among them is that the variometer gives altogether too critical an adjustment, in fact one that is not in the least stable, as many of us have learned to our sorrow. It is true that the variometer tuned, short wave regenerative set will give slightly louder noises (get the distinction between these and signals) than sets using any other method of tuning.

The navy standard circuit is the "tickler circuit," by which we understand that a tickler coil, in inductive relation to the grid or secondary circuit, is used to cause regeneration of plate currents. This circuit is simple of adjustment, will function properly if loaded to higher wave lengths, is stable and is very efficient.

With the above as motive the writer will endeavor to make plain the electrical and mechanical details of what to his mind is an ideal amateur receptor. He will endeavor not to go too deeply into details, however, as the REAL AMATEUR always ignores them in favor of his own, or to use that "old spool of wire on the top shelf."

The first attempt is shown in the photograph, and it worked perfectly. The photograph was not retouched. The prospective builder will notice that it does not correspond with the assembly drawing. This is due to the fact that the original did not lend itself well to production in quantities for evident reasons. The new design is smaller and more pleasing to the eye.

For the panel a piece of 3/4" black sheet "Formica" 5 1/2" x 14 1/2" is used. It is given a dull grain finish with sandcloth

white sheet celluloid and is 3 1/2" in diameter. If the surface is gone over with very fine sandpaper, it will be found possible to

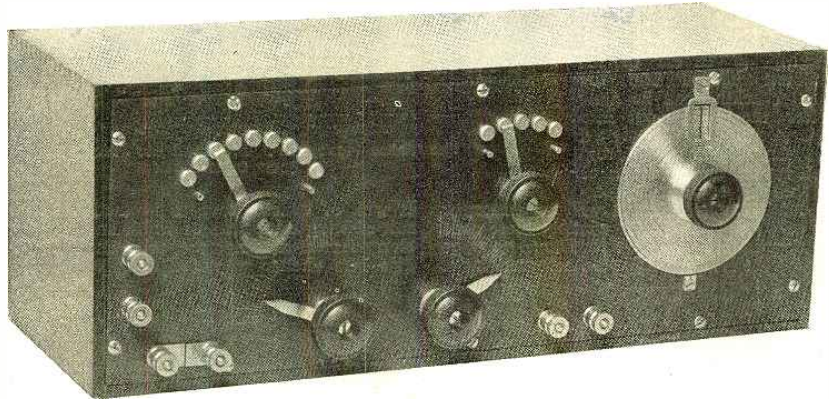

This is a Photograph of the Author's First Attempt Described Here. Note the Neat Appearance and Simplicity of Construction.

and oil. The first part of the work may be done on a felt wheel faced with No. 180 dust. As to the method of engraving you are referred to the author's article on page 228 of the November issue of RADIO AMATEUR NEWS. The general layout of this panel may be seen in Fig. 1.

Before sawing out the panel it might be well for the constructor to remember that an additional 5" of length will provide ample room for the mounting of a standard vacuum tube and its controls.

A section thru the condenser control is shown in Fig. 2. It will be noticed that there are but five rotary and six stationary plates. The capacity should be very nearly .0002 mfd. at full scale. This value may seem low but it will be found in practise that low capacities and correspondingly high inductance values will permit much louder signals when dealing with short wavelengths. If the amateur does not care to make his plates, he may procure them and their separators from a radio supply house.\* The dial, item 20, is made of 1/16"

\* Name of supply house furnished on request.

mark on the scales with India ink. The method of fastening the dial in place needs no explanation except that it might be well to run a set-screw thru item 27 in such a way as to keep the dial from turning on the shaft. The writer has never found this procedure necessary, however.

Item 29 is a spring washer, item 23 a hexagonal nut, items 18 are lock pins and item 21 is a collar driven on the shaft to keep the plates in position.

In regard to the stationary part of the condenser, item 3 is a bearing plate made of 3/16" black sheet "FORMICA." Care should be taken to see that the holes in it line up with those in the panel. It is best to "spot" it after the panel is drilled.

The tie rods, item 49, are threaded into the panel and locked in place by the round nuts, item 48. The No. 8-32 hexagonal nuts, items 50, are used to adjust the height of the stationary stack of plates before the bearing plate, item 3, is screwed in place. Notice that the rotating part of the condenser is connected to the terminal pin on the bearing plate by a soldered stranded pigtail. This prevents any annoying and scratching sounds when tuning.

The two switches shown are standard units that have just been put upon the market. Their construction is shown in Fig. 4. The shaft should be .249" in diameter to permit a nice running fit to a 1/4" reamed hole. Knobs are 1/8" in diameter.

The contacts should be about 5/16" in diameter. After setting in place it is customary to face them off with a sandpaper block or on a disc wheel.

Use any neat appearing standard binding posts and hold the two electrodes of a safety gap under the base of the primary posts, T.

The indicators, items 42 and 56, are made of transparent celluloid and are held up on small brass spacers. They are engraved in the rear and the marks are filled with scale white.

Coupling is accomplished in a very simple manner as can be noted from the cross-section of it in Fig. 3 and from the assembly drawing as well. The coupling arms are strips of half hard sheet brass, No. 14 B. & S. gage. Make them 1/2" wide and 5" long. Bend in opposite directions as shown in the assembly. Notice that the coils

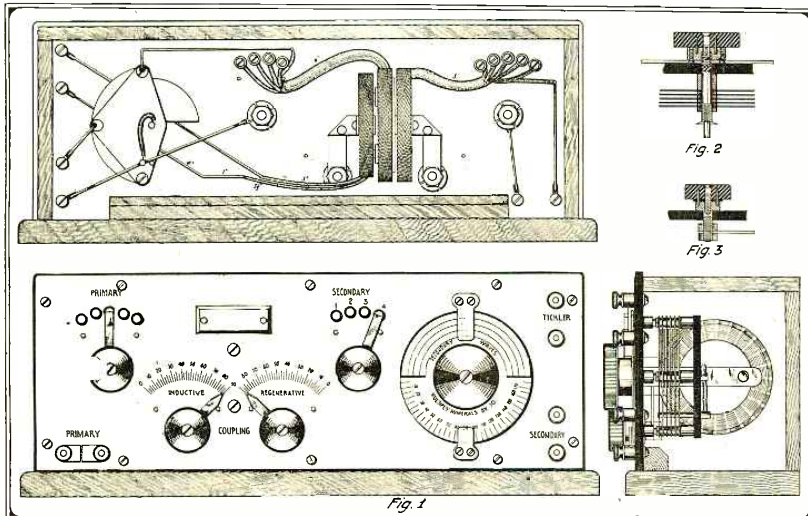

Five Views of Various Parts Which Go Toward the Make-up of This Efficient Little Set. You Will Admit There Is Nothing Very Intricate About Its Internal Wiring

are offset from their centers to facilitate proper coupling control on the panel front. Make the pointers out of the same brass sheet as the indicators. The stop pins are simply short lengths of  $\frac{1}{8}$ " brass rod threaded into the panel.

The three coils are of the universally wound type commonly known as the "honeycomb" coil. All data for their construction will be found in Figs. 5, 6, and 7. The number of turns is slightly in excess of the amount needed and the final checking can be done after the set is put into operation. The desired wavelength range is from 150 to 650 meters so as to permit the copying of commercial ship stations as well as amateurs. A very good method of winding these coils is described by Mr. C. R. Dunn on page 285 of the December RADIO AMATEUR NEWS.

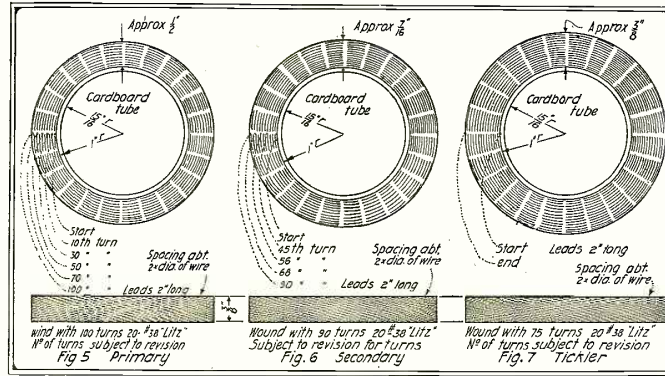

The Three Honeycomb Coils and the Necessary Data for Their Construction.

It will, of course, have to be modified to suit existing conditions of width and diameter. After winding, the coils should be dipped into shellac to make them moisture

proof as well as to bind them. Flexible leads of the lengths indicated in the assembly drawing should be attached to the coils and taped together as shown. Small wooden cleats are made in accord with Fig. 8 to serve in mounting the coils. Three of them are required. The central coil, the secondary, is held rigidly to the panel by means of brass brackets and No. 8-32 flat head machine screws. The brackets are shown in Fig. 9. Make flexible connections to the length indicated and make them fast to the terminal pins which are driven into the panel but not thru it. All the rest of the connections are of No. 14 B. & S. solid copper wire, hard drawn. Solder all connections with nothing but resin-core solder. The case is best made of birch and given

(Continued on page 518)

## The Planchette Tuning Board

By S. K. CULBERTSON

THE "Planchette" tuning board speaks for itself and is a unique departure from the every-day cylindrical coil type. Its advantages or disadvantages may best be determined by actual experiment and operation, for it is a well known fact that rarely are any two radio men capable of manipulating the wireless apparatus of any single set of instruments to the same degree of efficiency, skill or "grace."

The design of the "Planchette" tuning board as originally constructed was for time signals reception only, but its tuning qualities were found to be so well defined that it could be inducted into service as a tuning board for any and all wave lengths within its limited range. The schematic diagram illustrates the mechanical features involved. Devoid of all blue-print hieroglyphics, which tend to confuse rather than clarify the detailed construction, is left to the ingenuity of the experimenter, and only a guiding outline becomes necessary.

The circular disc, 12" in diameter and  $\frac{3}{4}$ " thick, is cut from a smooth well seasoned board. The edges are beveled or rounded. A circular piece 4" in diameter is cut from the center of this wooden disc.

No. 20 magnet wire is now wound closely and tightly around this flat rim, as shown in diagram, the ends terminating at the two lower binding posts. Slightly trim the circular piece cut from the center and force it back into position.

Two contact brushes are attached to the flat rotating knob which differ slightly in diameter, and are in turn concentrically attached to the center of the tuning board. These brushes of spring brass strips are connected to the two upper binding posts—Fig. 1—allowing sufficient slack for rotation. The insulation is carefully removed from the wire around the circumference of rotation to allow the brushes to make contact.

The tuning board may lie flat upon the table, or for convenience mounted in an upright position as shown. Any number of hook-ups are possible and loose-couple effect is easily obtained.

The energetic experimenter might build three such instruments, providing each with a single contact brush. No. 1 could be mounted stationary and used as a primary inductance, while 2 and 3 placed on either side of No. 1, respectively, act as movable secondaries, thereby affording a means of adjusting their mutual inductive relation. Since the coupling at all times would remain comparatively loose, the flat contact knob of No. 1 could be easily reached.

Altho Figure 2 shows an elementary circuit for this type of tuner, hundreds of combinations are possible. We might call this one a Series-Accumulative hook-up, since the secondaries are in series, and, when properly attuned, absorb energy from both sides of the primary. Or by reversing the hook-up—using No. 1 as the simple secondary, 2 and 3, connected in multiple, as a double primary—we have an "interference preventer" of considerable merit.

Then again, let No. 2 remain the primary, No. 1 the secondary and No. 3 the tertiary; the last two units are movable,

while the primary is fixed. With this arrangement the three "dough-nuts" will tend to weed out local disturbances, forced oscillations and other undesirable interference, especially if strong signals are being received. With these suggestions and what has previously been said, the average experimenter may easily work out his own salvation.

The variable condensers, which represent an outlay of considerable capital, are not absolutely essential, but aid considerably towards efficiency and ease of operation. They also enhance the outward appearance of the complete apparatus as a whole, blending simplicity into that complex and mysterious environ, so effective when the uninitiated visitor is present.

*Ed. Note: These coils will add a business-like appearance to the average amateur's station in addition to their efficient operation.*

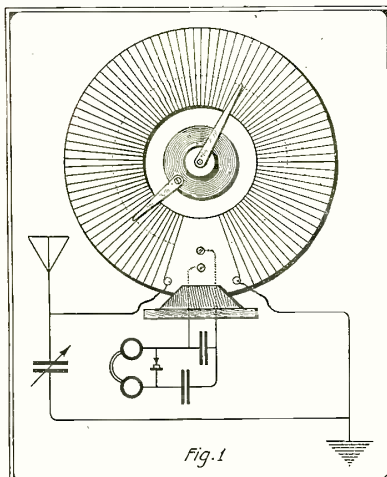

In This Instance a Single Coil Is Being Used as a Straight Tuning Coil.

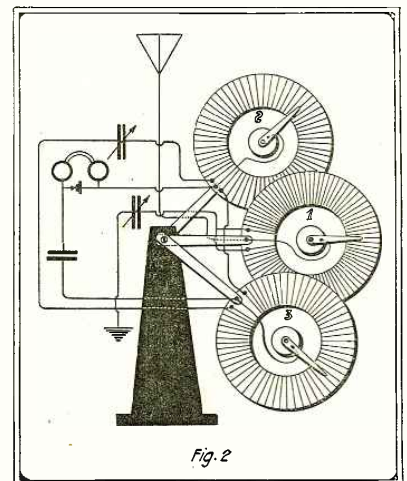

In This Combination the Three Coils Are Used As a Series—Accumulative Hook-up.

# "Ideas"—Fourth Spasm

By THOS. W. BENSON

**L**ISTEN, Bugs, I just got in communication with a fellow on Mars and he handed me some dope on the Dynamic Amplifier they use up there to copy all the stuff from the earth. Nope, didn't have a bit of trouble reading his stuff; y'see they get all our messages with this amplifier, and of course they have doped out our line of gab, *compree?* His English, tho; was pretty punk; talked like one of these here "intellectuals" in fact. But, shucks, y'can't expect the poor boob to be perfect. Howsomever, I'm here to chin about amplifiers, so there ain't no use stalling'.

Y'know you ain't in it without about three stages of amplification and tubes, and such are expensive. In addition, the generation of electricity by batteries is old, old stuff. I thank Mars for being able to reveal to you the secret of this wonderful new amplifier, of which there is practically no limit to the amplification obtainable and only a detector tube is required.

The disadvantages of tube amplifiers are well known, or perhaps they ain't, depends whether you have one or not. First thing, tubes vary, hence the transformers must be built special. Tube burns out new transformer, usually.

Then the high voltage batteries shooting juice thru a vacuum works fine, but it's blamed hard to get much juice thru, so you add another stage, and so on.

Of course, we admit there is no inertia in a stream of electrons and mechanical resistance does not have to be overcome—

true, but let me show you how the Martians use magnetic lines of force to build their amplifiers and mechanical energy instead of batteries for their juice.

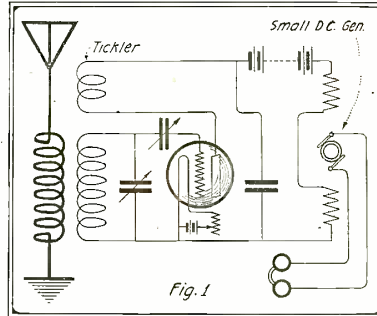

This Is a Great Idea and Certainly Ought to Work—Try it.

First of all, consider a little D.C. generator. If we have this spinning and connect a battery to the fields for an instant, current will be generated in the armature for an instant. Well now, if we connect the field of the machine into the plate circuit and the armature of the generator to a set of low resistance phones we have the same effect only reversed. That is, the reception of a signal weakens the field, blimp goes the armature current. Lovely, isn't it?

Now we put another machine on the same shaft, feed its field from the armature of the first machine. We are getting some *stuff* out of the second machine because the mechanical energy used to drive both machines is converted into electrical energy in step with the incoming signals. Eureka!

That's the important part of the idea, each stage controls the generation of current in the next, so there is no limit. Put a 150 K.W. machine on the end of say fifteen stages and send the message back

to the sender by sound—he can readily check his mistakes, what!

No fooling now, it is good, but after the third stage let us put a relay in, so that when the plate current slumps the circuit is closed thru a 100 V. auto-horn.

These machines don't have to be big by any means, a row of tiny D.C. motors connected together, acting as generators, driven by a motor from the power lines, ought to do the trick nicely. They should be high speed machines, running about 4000 r. p. m., so the rotor will get a chance to pass a couple of poles during each spark at the transmitter.

I think the Martian chap stated that they used an audibility standard called "Helluvanoyes," a spark coil QRM'd things just as he was shooting it. The detector tubes they use are also novel. It resembles ours a lot, but instead of a filament to generate the electric stream, they have—

"Yes? Confound it, won't some other night do? Oh very well, dear, just as you say. Excuse me for the evening, folks, the wiff wants to go to the movies."

*14th Asst. Editor's Note: It's a good thing this bird's better-half insisted, otherwise his decrement might have increased to a dangerous point and Heaven only knows where he would have wound up at.*

*We will write him and suggest frequent trips to the movies as part of the treatment to cure him of these spasms.*

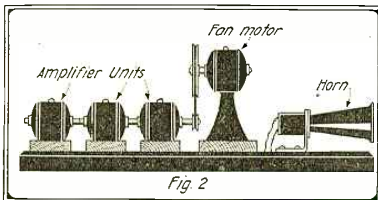

This Looks Like the Nearest Thing to Perpetual Motion.

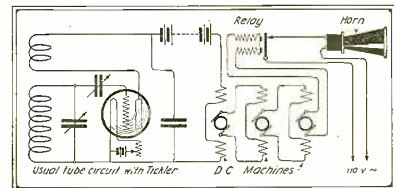

We Think it Must Be the Auto Horn That Does the Trick.

## "Stranded Antenna Wire On Tap"

Here is a rough and ready rig that will convert a spool of small wire into stranded aerial in "jig time." The materials for its building will include a head from a butter firkin and a number of spools corresponding to the number of strands desired in the conductor. The balance of the construction is obvious, and to quote a modern saw, "A word to the wise isn't necessary." With the machine rigged as shown on the edge of a bench it is only necessary to spin the disc on its pivot and turn the take-up reel. The closeness of the twists is regulated by the rate of speed given the disc in relation to the speed of the take-up.

It is possible to make an absolutely uniform twist by belting both movers to a common shaft. Here the finished wire should take a turn or two around the take-up reel and pass on under sufficient pull to prevent its slipping on the reel.

If a smaller model is attempted for the conversion of spark coil secondaries into "Litzendraht," the builder should provide small weights to set onto each spool that does not exhibit enough friction in turning. The best strands result when all

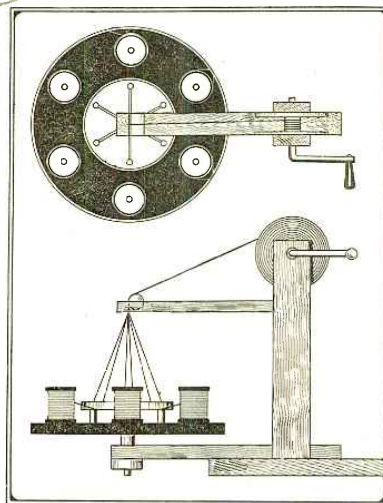

spools turn with the same amount of resistance.

The guide hole should present a hard, smooth, rounded surface to the finer wires, and the writer has employed for this purpose the larger sized glass beads, being careful to avoid any barbs of glass around the hole.

With this style of rig, three pounds of No. 24 salvaged from an old generator

Here is the Little Machine Which is Certain to Attract Amateur Interest. It is Quite a Unique Feature to Be Able to Manufacture Your Own Stranded Wire.

field has been the wherewithal for two first rate amateur aeriels and the surplus is doing duty in the ground lead.

While this machine will prove itself very useful for the making of stranded aerial wire, it may also be employed to make stranded antenna leads, as well as adjustable leads leading to and from various sections of the transmitting and receiving instruments. Contributed by C. H. BIRON.

# The Tree Antenna

By S. E. MORE

EVER since the first army buzzer transmitter was connected up and put in operation at the commencement of the war, the tree, ordinarily one of the most peaceful objects on the landscape, has been the center of a storm of radio articles accusing it of possessing the properties of an antenna to a greater or lesser degree. First came the newspapers, where in the middle of the sixth page between an ad for pork and beans and an announcement of a bargain corset sale, we read in large type of how some amateur out in Hoskins Corners had connected a wire to a tree and unaided had copied signals from the government station nearly fifty miles away. Then a few weeks later, in the Sunday magazine section, we read of the doleful vision of the newspaper scientist with a Ph.D. and a C.Q. after his name, who pictured the big towers of Annapolis, Belmar, and San Diego covered with cobwebs while the operator in his undress blues sat in the shade of the old apple tree handling all the navy's business without even knocking the apples off.

Then the opposition got started. Mr. What's-His-Name, out in Nebraska, president of the local radio club, and an authority on matters pertaining to radio, said positively that it couldn't be done. Anybody with any brains could see it, too, because wasn't the tree grounded? And then Mr. Hoosis from Texas wrote a long article explaining everything and showing that because of a peculiar twist of fate, Ohms law wouldn't apply to a tree, and therefore it couldn't possibly work.

But just as things seemed about to settle down again into their normal course and we were getting ready to acclaim Mr. Hoosis from the housetops, Bill Simpkins up in Wisconsin broke into print and said he didn't give a hang what Mr. Hoosis said, or Mr. What's-His-Name either, and that the theory never worked out in practice anyway, because he drove a nail in his tree and twisted a wire around it and heard signals all the way from NAJ. And so they went, back and forth, until to this day we have still to find an article that attacks the problem from an engineering point of view, and gives all sides a fair show. The writer has tried to do this in what follows.

An antenna by definition may be said to be any conductor so arranged as to be capable of radiating and absorbing electromagnetic waves. Such a conductor always possesses three electrical characteristics in a greater or lesser degree. These three are, resistance (R), inductance, either concentrated or distributed (L), and distributed capacity (C). An electrical representation of any capacitive antenna, such as the familiar flat top aerial, is shown in Fig. 1. Here the dotted condensers represent the antenna capacity and the dotted coils the antenna inductance. R is a lumped or concentrated resistance which is equivalent to the total amount of resistance in the aerial.

Now a familiar property of every good antenna is that it has a certain well-defined frequency at which it oscillates best. This is perhaps better known as the fundamental or natural wavelength of the antenna. The better the antenna, the more well defined this frequency will be, and the stronger it will oscillate at this frequency. The frequency of the oscillations depends upon many factors, and for clearness an oscillating antenna may well be compared to a swinging pendulum.

When a pendulum is started swinging and left alone to die down, the length of time required for one complete swing de-

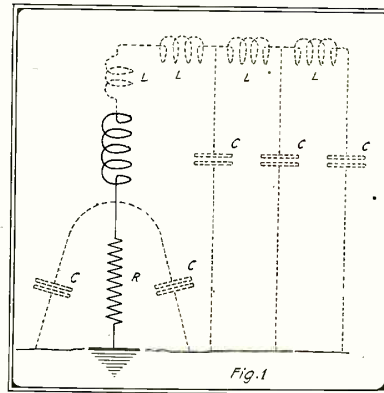

Electrical Representation of Any Capacitive Antenna.

pends upon the length of the pendulum, and the time required becomes longer as the length of the pendulum is increased. The length of time required for it to come to a standstill depends upon the amount of friction it encounters during its swing. When swinging in air, a given pendulum may go back and forth twenty times before coming to rest. When immersed in water it will not swing twenty times, probably not more than two or three, and when it is put in a heavy oil and given a start it will slowly fall back to its original position without a single oscillation. In the last case the pendulum did not possess a free period of oscillation, and the only way it could be made to oscillate was by forcing it first in one direction and then into the other.

Returning again to the antenna, the time required for it to oscillate depends upon its electrical length, which is determined by the amount of inductance and capacity it possesses, and the time required for it to stop oscillating, once it has started, depends upon its resistance. As was the case with the pendulum, if sufficient resistance is added in the circuit, a point will be reached at which the antenna will no longer be able to oscillate freely. After this point it can only be made to oscillate by keeping the induced voltage applied continuously, thus forcing it to follow its direction. This critical point at which the antenna loses its free period is mathematically expressed where L is measured in henries, and C in farads. If R is greater than this value free oscillations will not occur in the circuit.

Now to go back to the tree, which has been somewhat neglected in the discussion so far. A tree possesses the three electrical characteristics that all antennas do, namely, R, L and C. The values for these can be

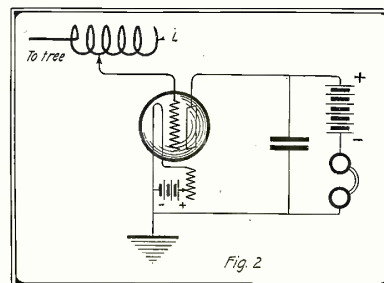

A Possible Means of Connection Direct to Tree Antenna.

approximated with sufficient accuracy to substitute them in the equation and determine the action of the tree as an antenna, if it has any such action. The average sized tree has a capacity to ground that is probably in the neighborhood of .002 microfarads and a distributed inductance of about 25 microhenries. These values of course have not been measured, but the writer has had sufficient experience with different antennae to be able to approximate the values as above. Substituting these in the equation, we find that R must be less than

$$2 \sqrt{\frac{25 \times 10^{-8}}{.002 \times 10^{-6}}}, \text{ or } 2\sqrt{12,500}, \text{ which equals}$$

equals 224 ohms. In other words, in order to be capable of free oscillations, the whole tree must have a resistance less than this value. In order to get an approximation for the resistance of a tree, the writer drove two nails a foot apart into some new bark near the roots of an elm tree. With a 22-volt battery and a milliammeter, a deflection was observed so small as to be almost negligible when the circuit was closed. As near as it could be calculated from this experiment, the resistance figured to be about 500,000 ohms per foot. This is about the same resistance that a wet board of the same length would have, and this perhaps furnishes a good illustration of its actual conductivity. Of course, this extreme value of resistance eliminates all possibility of free oscillations occurring. There is, however, one other possibility that must be considered before the tree antenna can be tossed into the discard.

When electromagnetic waves are passing the tree, a certain current, however small, will be induced into it. While this current is flowing, a difference of potential will be set up between different points along the trunk. Assume a transmitting station 50 miles away having an antenna 20 meters high and radiating 10 amperes, and assume also that the tree is 20 meters high, and that the "lead in" is taken off 15 meters above the ground. The current induced in the tree would then be about  $1.67 \times 10^{-9}$  amperes, a value too small to be measured with the most sensitive galvanometer. The difference of potential, E, between the point where the lead in comes off, and the earth, is equal to the product of the current and the resistance between the two points in question. This product is  $1.67 \times 10^{-9} \times 5 \times 10^8 \times 45$  (assuming 3 feet equal one meter), and this equals .0375 volts. This value of voltage, properly used, could be made to produce a readable signal. But it must be borne in mind that this is a strictly "no load" voltage, and that as soon as any load is put on it, the drop of potential will be enormous, and what is left will not be capable of affecting a detector. This then eliminates the possibility of connecting a coil, or a coil and series condenser in the lead in, and putting the signal thru a loose coupler in the usual manner. Fig. 2 shows a possible connection, in which the voltage could be used without putting a "load" on it. As connected here, the grid of the vacuum tube would assume a negative potential with respect to the filament, hence there would be no grid current and the only energy taken from the tree would be that necessary to charge the capacity between the grid and filament, and thus affect the plate current. Some tuning might be accomplished by varying the coil L, altho it is hardly likely that much selectivity would be obtained.

(Continued on page 519)



**Apparatus for Receiving and Strengthening Oscillations**  
(No. 1,165,454, issued to Josef Schiessler.)

This invention relates to receiving and strengthening apparatus for electrical undulations and has for its object to provide an arrangement, whereby very weak electrical oscillations or undulations such as those occurring in electric telegraphy or telephony with or without wire may be detected and strengthened, so as to cause powerful undulations in the current of the receiving instrument. According to this invention an electrode suspended in a pendulum-like manner and easily movable, which is provided with a suitably shaped soft iron core is arranged so as to be fixed in the direction of its axis by an adjustable magnetic field damping its free and forced oscillations. The other electrodes, hereinafter termed contacts, which may be made wholly or in part of a radioactive substance or of an alloy containing the same are adjustably mounted on two oscillatory electrodes which in their turn may be fixed by an adjustable magnetic field.

The resistance formed by the transition of the current between said electrodes, which will hereinafter be referred to as the transitional resistance and which may, for instance, be an arc, is acted upon by influencing the pendulum electrode by adjustable electro-magnets of a suitable magnetic system, which

The currents to be measured are those which flow in the circuit of the main binding posts M, M<sup>1</sup>

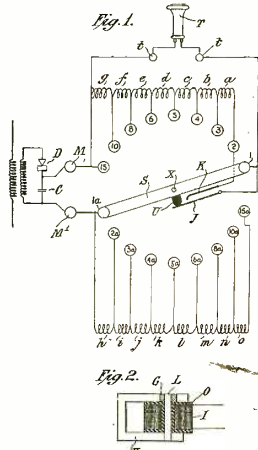

(Fig. 1) of the measuring apparatus or meter. These currents are assumed to come from the circuits at the left. They are those which would be used for the normal receiving operation of telephone T (such as the ordinary electromagnetic instrument) in said main circuit M, M<sup>1</sup>, when the meter is not connected thereto. The telephone T shown as connected to the meter is usually the same telephone receiver which is normally used for receiving, independently of the meter, with the circuit at the left of M, M<sup>1</sup>, Fig. 1. When this telephone is connected to the meter binding posts *b, b*, as shown, it is then the instrument appertaining to the meter. In shunt to said telephone T are impedance coils *a-g*, which are controlled by a switch S, operating over switch-points 1-15. When switch S contacts with point 1, no impedance coils are in circuit, and telephone T will operate as in its normal receiving use; therefore, if desired, the meter may be left in circuit permanently, with the telephone connected for normal use in the receiving circuit, provided the switch S be on point 1, so that the telephone may be used as normally, and so that at any desired moment the meter may be used by merely operating switch S.

**Receiver of Electrical Oscillations.**  
(No. 1,313,654, issued to R. A. Weagant.)

The invention relates to receivers for electrical oscillations, and is applicable to the reception, detection and amplification of various kinds of oscillations such as continuous oscillations and damped oscillations.

In the drawing annexed hereto and forming part of this specification is shown a form the invention may take, although it is capable of considerable variation.

Referring to the drawing is shown an aerial at 1, which includes an aerial tuning inductance 2 and the primary of a transformer 3. The aerial is earthed or connected to a suitable capacity as usual at 4. Coupled to the aerial either directly or inductively is a secondary circuit which includes an inductance 5 having in series with it a variable condenser 6, which is connected to one element 7 of a detector. This detector preferably consists of a sealed vessel enclosing a plurality of elements separated by a conductive gaseous medium, although other forms might be used.

Another element 8 of the detector, preferably a cold element, is connected to a local circuit which includes an indicating device such as a telephone 10 shunted around which is a variable condenser 13. In series with telephone 10 is placed a relatively large resistance 16 shunted by a condenser 17 in series with an inductance 18. Resistance 16 is connected in series with a battery 19 preferably of relatively high voltage, which is connected to one of the elements of the detector, preferably the negative side of the hot element 11. The hot element may be in the form of a filament kept at incandescence by means of a battery 12 in the usual manner and may be connected to the earth as at 14, altho this earth connection is not essential. Connected across the local circuit and connecting elements 8 and 11 is a condenser 20 in series with an inductance 21. These are both preferably adjustable, so that they may be varied to secure the best effects. Inductance 21 is used when receiving continuous oscillations, and is not essential for receiving damped oscillations, except when they are very weak.

Condenser 17 and inductance 18 permit of the tuning of a circuit, including the telephone, to the group frequency, so that in the event of the apparatus being used to receive damped oscillations the effects produced by the groups of oscillations are very much magnified.

In using the apparatus to receive continuous oscillations, the inductance 18 may be dispensed with.

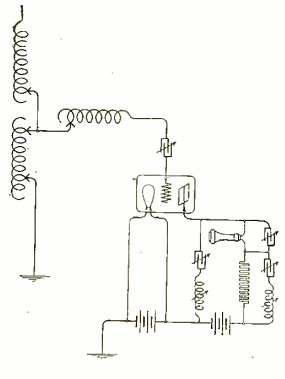

**Radiophone System.**  
(No. 1,313,112, issued to John H. Payne, Jr.)

It has been well known for some time that an electron discharge device comprising a cathode, capable of emitting electrons, a co-operating anode and a discharge controlling member or grid, all inclosed in an evacuated receptacle, can be utilized to produce high frequency alternating currents. Such a result is obtained by suitable coupling of an external circuit which includes the cathode and anode with a second circuit which includes the cathode and grid. By varying the potential of the grid the current between cathode and anode is caused to pulsate and this pulsating current will give rise to an alternating current in another circuit suitably coupled thereto.

The object of this invention is to overcome present modulating difficulties and provide an efficient system for modulating the high frequency current in which the desired range of control may be secured by means of a single device of the general type referred to.

In carrying the invention into ef-

fect a device is utilized comprising the usual cathode, anode and grid, and a second grid which may be operated entirely independent of the first grid. The high frequency current is produced by coupling the

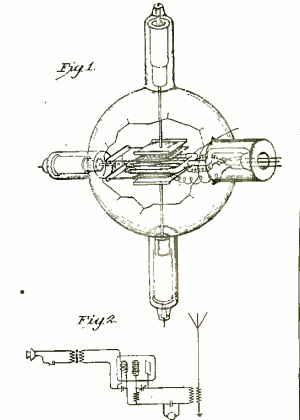

circuit which includes one of these grids with the plate circuit and the modulation of the current is secured by applying the potentials obtained from the telephone currents to the second grid.

The invention will best be understood by reference to the accompanying drawing, in which Fig. 1 shows a device which may be utilized for carrying the invention into effect, and Fig. 2 shows diagrammatically the circuit connections which may be employed.

**Wireless System.**  
(No. 1,476,000, issued to L. F. Fuller.)

The invention relates to improvements in wireless telegraphy and

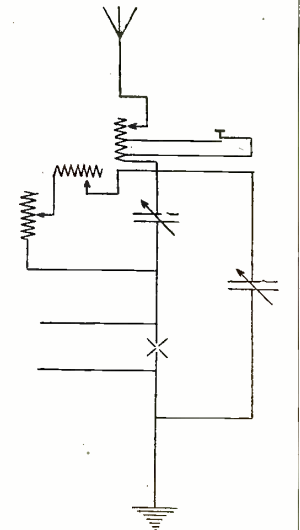

especially to improvements in the transmitting circuit.

The object of the invention is to obtain a higher antenna current with a given input than has been heretofore obtained.

By the use of my invention IR losses are greatly reduced and the resistance of the antenna circuit is reduced, with the result that a much higher antenna current is obtained.

may slide lengthwise with respect to the said electrode in order to obtain a varying sensitivity of the arrangement.

The electro-magnets, which may be connected either in series or in parallel, are acted upon by the oscillations or undulations to be detected and strengthened.

**Telephone Current Meter.**

**Telephone Current Meter**  
(No. 1,324,465, issued to G. W. Pickard.)

The object of the invention is to provide a meter by which accuracy of measurement can be obtained under all circumstances and conditions of use.

Of the drawings Figure 1 is a diagrammatic illustration of the invention; Fig. 2 is a sectional elevation showing the construction of the impedance coils employed therein.

# \$100 RADIOPHONE PRIZE CONTEST

ONE of the most disappointing features of Radio Amateur Progress at present is the seeming lack of interest in the Radiophone.

The Editor of this publication has always taken the stand that the ultimate goal for all radio enthusiasts lies, without a shade of doubt, in radio telephony.

The reasons are so obvious and so convincing; while not one single argument can be found against it. Radio telephony is the one and only solution out of all the many Radio amateur's troubles, to wit:

With Radio Telephony, interference with Government and Commercial stations is practically done away with at one stroke. Consequently and logically, the radio amateur will at once be placed in a safe and dignified position. He will not be bothered as in the past and present with anti-amateur legislation. *But American radio amateurism will surely perish if its future rests upon radio telegraphy.*

With Radio Telephony, no codes need be mastered. You talk, that's all. With Radio Telephony, the length of time required to send a message is from 1/10 to 1/20 shorter. Consequently more traffic can go on for a given time than now.

With Radio Telephony, the turning is infinitely sharper and better, consequently less interference. With Radio Telephony, radio amateurism will become truly great—of a national scope. Where there is one radio amateur telegrapher today, one hundred will grow in his stead the moment practical radio telephony is here. Everyone will use the radiophone! The farmer, the business man, country folks, motorboats, autos, etc., etc.

Now the curious and surprising thing is that the radiophone has been with us for some years past. There is nothing new about it, no secrets, no patents that need bother any amateur. Then why don't we use this wonderful invention to the very limit? It will surely boom Radio Amateurism more than any one thing in this world ever can or will. We have all the tools, so where is the hitch?

Now, the Publishers believe in the truly wonderful future of the Radio Telephone. They will stake their reputation—nay, if necessary, their all—on their conviction. They will spare no expense, leave no stone unturned, to make American Radio Amateurism one of the world's greatest institutions. And Radio Amateur Telephony will be the keystone to this edifice.

With this in mind the Publishers wish to bring out the best from the ranks of our amateurs, the best being of course radio telephone transmitting instruments. Any modern radio receiver is capable of receiving either radio telegraph or radio phone messages. We are concerned here, only with the instruments that *send* the messages.

## PRIZES OF \$100 IN GOLD

First Prize.....	\$50.00
Second Prize.....	25.00
Third Prize.....	15.00
Fourth Prize.....	10.00

The Publishers therefore offer prizes of \$100 in gold for the best articles on a practical radio telephone outfit. America's foremost radio experts will act as judges of this contest. As every one of the judges will pass upon the manuscripts submitted there can be little doubt that all contestants will be treated fair and impartial. Furthermore, we feel certain that this contest will not only bring out the very best there is in the American amateur, but that it will lift the new art to an unknown and undreamt of level.

Here are the men who will act as the judges of the contest. A distinguished array of the best radio talent in America:  
**Dr. Lee de Forest, Ph.D.,** Inventor of the Audion.  
**Dr. Greenleaf W. Packard,** Inventor of the Crystal Detector.  
**Dr. Louis Cohen, Ph.D.,** Radio Expert and Inventor.  
**Fritz Lowenstein,** Radio Expert.

H. W. Secor, Assoc. I. R. E., Associate Editor, Electrical Experimenter.  
 H. Gernsback, Editor, Electrical Experimenter and Radio Amateur News.

## RULES OF THE PRIZE CONTEST.

The set to be described may be of the vacuum tube type, the arc type, the quenched or other spark type. Or it may have embodied in it new features not known at present. The important part is that the set must have been actually built, that it either is in use now or has been in use. "Ideas" or patent descriptions are strictly excluded from this contest. It is also obvious that, insofar as this contest is conducted chiefly to bring out NEW ideas, commercial radio telephone outfits, as now sold by several makers, are excluded from the contest.

It is necessary to state what instruments are used, and if certain instruments have been bought, the make must be stated. The transmitting distance of the radio-phone should be given, i. e. the record distance covered with the set. A complete diagram of connections, neatly executed in ink, is to be furnished. A good photograph (not smaller than 3 x 7") giving at least two views of the set is necessary. A photograph of the builder is required.

The sizes and the kind of wire used in the construction must be given, as well as the dimensions of the principal parts. More than one outfit may be entered by a contestant. The contest is open to every one (radio clubs included), except manufacturers of wireless apparatus. The manuscript should not be longer than 1,500 words. 1,000 words are preferred. All prizes will be paid upon publication.

The contest closes in New York April 12th, and the first prize-winning article will appear in May, 1920.

Address all manuscripts, photos, etc., to "Editor Radiophone Prize Contest," care of this publication.

## Wireless Telephone Experiments by German Postal Department

By Our Berlin Correspondent

THE German postal authorities are at present considering the starting of a wireless telephone service. Experiments recently made on the Tempelhof Field near Berlin have given excellent results, a perfect communication being obtained over 30 to 40 kms. distance. These tests are now being extended to communication between Berlin and Hamburg; that is, to distance about ten times longer.

The transmitter is contained in a box and mainly comprises one or more evacuated glass tubes where electric waves are produced. The current vibrations produced by talking into the microphone superimpose themselves on these undamped waves, thus imparting to them a deformation corresponding to the microphone transmitter currents. The waves, which thus constitute a true picture of the words pronounced are sent out into space, being made audible at some distant place within the range of the apparatus by a receiver comprising similar glow lamp bulbs or vacuum tubes, the above process being repeated in an inverse order, the waves impressing themselves

on the tubes and causing a telephone receiver, inserted in the receiver circuit, to perform sound vibrations entirely in accordance with the words spoken in the microphone.

An obvious advantage of radio-telephony as compared with ordinary telephony, of

course, is the absence of any lines and complicated switching apparatus. Radio-telephony therefore is especially suitable for unexplored countries—for instance, the recent explorations in the interior of South America, North Pole journeys, trips thru deserts and jungles—as well as for tele-

phone communication on sea, between traveling railway trains, aircraft, etc., and the ground, as well as for the simultaneous transmission of the same piece of news to a number of persons.

In the accompanying picture the German experimenters are making use of a collapsible steel mast by means of which they may lower or increase the height of the portable aerial and thus secure accurate tests of distances possible with the radiophone system in use. An efficient ground connection was obtained by sinking a steel pipe in the earth near the operating table shown in the photograph. German radio engineers place a great deal of confidence in the future possibilities of their vacuum tubes; many types having been developed during the war.



German Radio Engineers Conducting Radiophone Experiments Near Berlin.

# RADIO DIGEST

## APPLICATIONS OF THE CATHODE RAY TUBE IN RADIO WORK.

By L. E. WHITMORE AND L. M. HULL.

Two general types of cathode ray tubes have been used for investigating the oscillations in radio frequency circuits at the Bureau of Standards, Washington, those having the usual plain cathode and those having a hot filament cathode. The former require exciting voltages of from 8,000 to 20,000 volts and are suitable for the investigation of oscillating currents of the order of magnitude of one ampere. The high-tension voltage is obtained by double-valve rectifiers from an A.C. supply, using condensers and choke coils to smooth out the rectified wave. With the second type using a Wehnelt cathode, from 500 to 1,000 volts is required and the tube is suitable for the investigation of oscillating currents of the order of 0.05 amp. On account of the relatively low exciting voltage this type of tube is much more sensitive to electrostatic and electromagnetic deflections. These oscillographs are being used in an investigation of the harmonics in aerial circuits excited by vacuum tube generators.—*Abstracted from September Physical Review.*

## VACUUM TUBE AMPLIFIERS.

By W. SCHOTTKY.

The author claims to have been one of the first Germans to take up the study of vacuum-tube amplifiers from an engineering standpoint, and in this paper he gives an outline of the results of his studies. In the first part of the article the functions of the input transformer are discussed and analytical expressions are derived which define the conditions of optimum amplification when adapting a given tube to a certain amplifier problem. The second part deals with the predetermination of the tube constants from certain constructional data of the tube. The problem is reduced to a unit-dimensional one by introducing the so-called "effective potential in the grid plane" as a single variable. Expressed in terms of the plate potential and the potential values on the control elements, this "effective potential" is a linear function whose coefficients depend only upon the design of the tube and the electrodes. It is shown that the optimal amplification of a cylindrical tube with one grid is proportional to the square root of the plate battery voltage and to the square root of the length of filament and grid, and inversely proportional to the square root of the distance from filament to grid. The theory is checked by measurements on a Siemens-Halske tube of given design.—*Abstracted from Archiv für Elektrotechnik, May 5, 1919.*

## A NOTE ON THE COMPARISON OF INDUCTANCE, OR OF AN INDUCTANCE AND A CAPACITY, BY AN ELECTROMETER METHOD

This method makes use of an electrometer whose quadrants are connected across a condenser in series with the inductance to be measured and whose needle is joined to the centre point of a high non-inductive resistance shunting the condenser and inductance. It is shown that the deflection of the electrometer is proportional to the inductance, to the square of the current and inversely proportional to the capacity. Experimental verification of these relations is given. The method is most sensitive when working near the resonant frequency of the capacity-inductance circuit, but the results are independent of the

frequency and wave form of the A.C. supply. The results were found to be in agreement with measurements on an A.C. bridge.—*Abstracted from October Physical Review.*

## MULTIPLEX RADIO TELEPHONY.

Two radio telephone conversations were carried on over a distance of five miles, using a single antenna, by F. M. Ryan, J. R. Tolmie and Roy O. Bach. As many as five telegraphic messages were sent or received simultaneously with a single antenna and as many telephone conversations could have been carried on had there been sufficient apparatus at hand. The method used was that of a number of radio frequencies with a series antenna circuit.—*Proceedings, February 9, Radio Institute, N. Y. City.*

## RADIATION FROM COMPOUND ANTENNÆ.

By M. ABRAHAM.

Assuming that two antennæ radiating synchronously and having their capacity to earth mainly concentrated in the horizontal portions are erected in close proximity, each will induce currents in the other and the energy required to maintain them in oscillation is greater than the sum of the amounts required to maintain each of them individually in oscillation. There is an increased radiation from the antennæ resulting from the superposition of their fields. This increase vanishes when the oscillations of the antennæ are displaced in phase by a quarter of a period. A general expression is worked out for the sum of the radiations for any phase displacement between the oscillations of the component antennæ, both for the radiations along the earth's surface and also for the total radiation. The case is also considered of two antennæ one of which is excited by the transmitter while the other one is entirely separate but tuned to the same frequency. This shows that if the secondary antenna has a certain resistance and is at a given distance from the primary antennæ a complete shadow is thrown by the auxiliary antenna, while radiation from the main antenna is increased in the opposite direction by a species of mirror action. Such a secondary antenna may also be used at a receiving station to screen the main aerial from undesired radiations. The conditions for such screening to be effective are worked out. Two secondary antennæ closely coupled together by their fields and situated at such a distance from a single primary antenna as not to react upon it appreciably, produce the same effect as a single secondary antenna of twice the radiation resistance.—*Abstracted from October Technical Review.*

## EFFECT OF WIRELESS WAVES UPON PLANTS.

By J. C. BOSE

I resumed my investigations on the effect of wireless waves upon plants at the beginning of this year. I wish to find out whether plants in general perceived and responded to long ether-waves reaching them from a distance. The perception of the wireless stimulation was to be tested, not merely by the responsive movement of sensitive plants, but also by diverse modes of response given by all kinds of plants.

For sending wireless signals I had to improvise the following arrangement, more powerful means not being available. The secondary terminals of a moderate sized

Ruhmkorff's coil were connected with two cylinders of brass, each 20 cm. in length; the sparking took place between two small spheres of steel attached to the cylinders. One of the two cylinders was earthed and the other connected with the aerial 10 meters in height. The receiving aerial was also 10 meters in height and its lower terminal led to the laboratory and connected by means of a thin wire with the experimental plant growing in a pot; this latter was put in electric connection with the earth. The distance between the transmitting and receiving aerial was about 200 meters, the maximum length permitted by the grounds of the institute.

I may state here that with the arrangement described I obtained very definite mechanical and electric response to wireless impulse. For the former I employed the plant *Mimosa*; the latter effect was detected in all plants, sensitive and ordinary.—*Abstracted from February Scientific American.*

## THE WAVELENGTHS RADIATED FROM OSCILLATING VALVE CIRCUITS.

By S. R. HUMBY AND B. F. J. SCHONLAND.

When two oscillation circuits are coupled together and oscillations are set up in them there are usually two oscillation frequencies, establish. This paper investigates this case when the oscillations are maintained by a valve, the two coupled circuits being included in the grid and plate circuits respectively of the valve.

It is shown that when the coupling is in the normal direction for the maintenance of oscillations, there is only one wavelength radiated (with its harmonics) of length equal to the longer of the two "coupling" waves. With the reaction coupling reversed the wavelength radiated (when the valve oscillates) is the shorter one only of the two coupling waves. It is stated that the authors have been led to the conclusion that the phase difference between the oscillatory currents in the grid and plate circuits can be either 0° or 180°, but cannot have values differing sensibly from these.

A mechanical analogy of the valve operation is given, and also some further measurements on the wavelengths radiated when the aerial circuit is directly coupled to the plate circuit, by tapings from the plate-circuit inductance—referred to as the "anode tap" connection.—*Abstracted from October Electrician.*

## TELEPHONE TRANSFORMER.

By A. D. KENT.

Basing his article on the fact that there are many amateurs who cannot afford headphones having high resistances, such as 3,000 to 4,000 ohms, the writer describes and gives the details of an open-core telephone transformer which obviates the use of high resistance receivers.

The core is constructed of number 24 laminated soft iron wire cut up into three-inch lengths. Six ounces of number 30 single silk covered copper wire are used in the secondary, which is wound directly upon the core. The primary, which is wound over the secondary, consists of three ounces of number 44 single silk covered copper wire. The usual insulating materials are suggested.

The resistance of the primary is 4,500 ohms while the secondary resistance is 60 ohms. The transformer is used as follows: The primary is connected in the crystal circuit of the receiver or if an audion is used the primary is connected in the plate circuit.—*Abstracted from March Wireless World.*

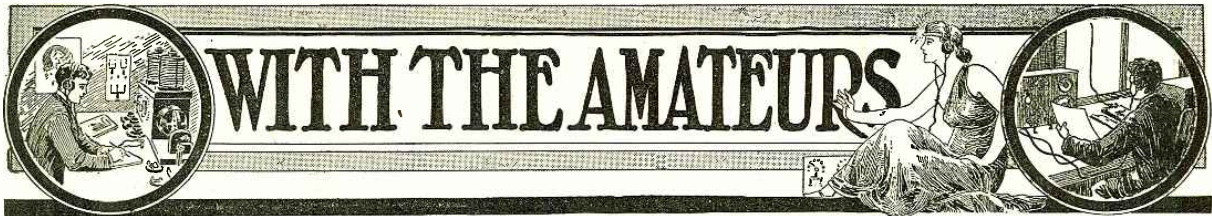

**T**HIS Department is open to all readers. It matters not whether subscribers or not. All photos are judged for best arrangement and efficiency of the apparatus, neatness of connections and general appearance. In order to increase the interest in this department, we make it a rule not to publish photographs of stations unaccompanied by a picture of the owner. We prefer dark photos to light ones. The prize winning pictures must be on prints not smaller than 5 x 7". We cannot reproduce pictures smaller than 3 1/2 x 3 1/2". All pictures must bear name and address written in ink on the back. A letter of not less than 100 words giving full description of the station, aerial equipment, etc., must accompany the pictures.

**PRIZES:** One first monthly prize of \$5.00. All other pictures published will be paid for at the rate of \$2.00.

## White Station at Ennis, Tex.

Station 5AP is owned and operated by Raymond L. White, of Ennis, Texas. This station is located three miles from the city of Ennis at the Lake Side Country Club. The station is a one-room boxed building and is something similar to the radio cabin found on boat deck of the average ocean-going liner. The station is situated at the end of one of the sixty-foot masts and a six-wire inverted T antenna is used. The location of this station is ideal as there are no buildings or obstructions near, and when the station is fully completed some very efficient work will be handled. In location it is something similar to 9ZN of Chicago, Ill.

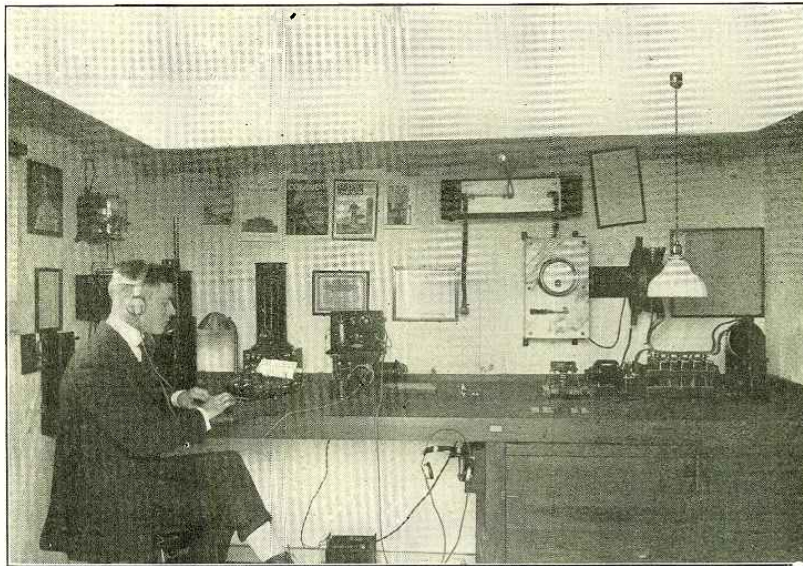

Here is Mr. White and His Trusty "Mill." Lots of Elbow Room in the Effective Layout of This Station.

The transmitter consists of a 1 K.W. Thordarson transformer having a secondary voltage of 24,000. Twelve Murdock molded condensers (capacity .0017 M.F.

each) are employed, connected in series parallel (seven condensers missing in photo). A Murdock non-synchronous rotary gap. The oscillatory transformer is made of 1" x 1/16" brass ribbon; and

a short wave regenerative receiver will be completed by about March 1st, at which time no doubt much more efficient work will be done on wavelength between 200 and 600 meters.

## Charles L. Sear's Station

At the right of the set is shown the rotary gap which is enclosed in a heavy aluminum casting. The zinc-aluminum compound rotor revolves at a speed of 1800 R.P.M. The fixt electrode is of the copper knife-edge type. The clearance is about five-thousandths of an inch. Fourteen points are used. In the construction of the oscillation transformer 1 in. x 1/32 in. brass ribbon was used in the secondary and 1/4 in. x 1/32 in. in the primary.

The large meter shown at the left of the transmitter case was originally a Weston Voltmeter, but by a considerable amount of labor it has been converted into a calibrated hot wire meter with a maximum reading of 8 amps. The flexible leads are of braided copper wire. The transformer used is a one K.W. closed core type. The condenser used was

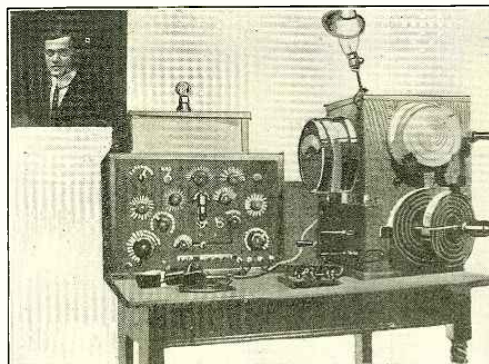

Not So Much Room Here But Nevertheless a Well Planned Station.

made from 8 in. x 10 in. photograph plates with sheet copper electrodes. The whole being sealed in a metal tank with paraffine. The transformer and condenser together with the spark gap motor are mounted inside the cabinet thus allowing the use of short secondary leads.

The receiving set is mounted on a buffed and lacquered fiber panel and is of the regenerative type using a tickler coil. Both types of audions are used, the Marconi V. T. and the DeForest tubular; the latter is shown mounted in the center of the panel.

One radical change may be noted in the contacts which were made of square brass. The slot cut in the panel is for the purpose of varying the secondary and tickler coil coupling.

CHAS. L. SEARS.  
St. Louis, Mo.



**VANNEMAN STATION.**

Here is a photograph of my receiving station—the transmitting set being in process of construction. It is made up of the following apparatus: Navy Type Loose Coupler, Paragon RA-6 Short Wave Regenerative Receiver, Three Long Wave Inductances, Holtzer-Cabot and Murdock phones, Blitzen and Murdock Variable Condensers, Two Audiotron Cabinets and a Murdock Antenna Switch.

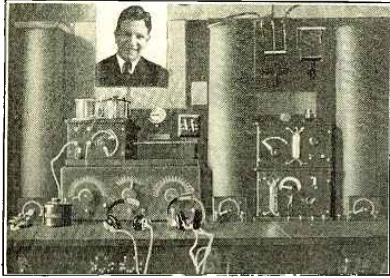

Very Well-Planned Receiving Apparatus, We Would Say.

The aerial is 52 feet long and about 175 feet high. My elevation is higher than any other amateur in the city, since I have the advantage of living in a high apartment house with a lenient landlord!

The Transmitting Set consists of a 1/2 k. w. Blitzen Transformer, Cambridge Semi-quenched Rotary Spark Discharger, Dubilier Mica Condenser (.01 mfd.), Commercial Type Oscillation Transformer, Murdock Kick-back Preventer and heavy duty key. These transmitting instruments are being mounted in a cabinet 28"x18"x10", with switches and Hot Wire Ammeter, mounted on the front panel. I hope to be able to send in a photograph of this complete set very soon, as it is almost completed.

I have no difficulty in hearing all the stations in the east and amateurs as far west as Chicago.

DONALD K. VANNEMAN, "3AD."  
Baltimore, Md.

**DAVIS RADIOPHONE STATION.**

Here is a photograph of my radiophone station which was constructed by following the designs and explanations of a recent article in RADIO AMATEUR NEWS. With this outfit I am able to transmit speech very effectively up to a distance of about five miles. The vacuum tube I am employing is a very good one and operates along the same lines as the Marconi tubes. My high potential plate voltage is secured by using fifty or sixty small dry cells. A similar outfit can be constructed by any amateur, who will find the necessary details in any up-to-date publication or any current numbers of radio magazines.

For the past nine years I have been a commercial operator, having taken out my

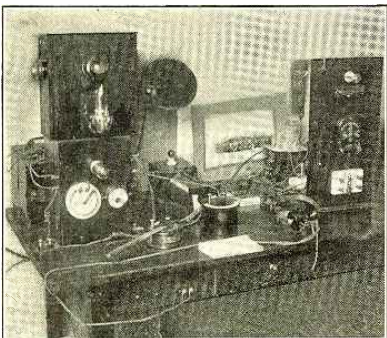

Mr. Davis Is an Old-Timer at the Game and Has Recently Built a Radiophone.

first ship on February 1, 1911. I find radio work very interesting, and particularly the radiophone.

The very near future will see many amateurs employing this new device as a means of communication, finding it more effective and sometimes more satisfactory than radio telegraphy, particularly those who are not well versed in the Continental Code.

WILLIAM H. DAVIS,  
Baltimore, Md.

**WILKES DEARING'S STATION.**

This is a photo of my radio set, and if it is published I will congratulate myself and think that I'm not so "wee" an amateur, after all! You will note that it is all home-made, the raw material being bought, assembled and wired in a cabinet. I will now tell about it from the aerial to the ground.

The aerial is composed of two wires, each 285 feet long, 40 feet high and has a lead-in length of 75 feet. It is of the inverted "L" type, well insulated and every joint carefully soldered. It works well on long distance, receiving from large government stations, but it is hard to get the commercial ones on account of its size.

The receiving set is composed of loading coil, loose coupler, variable and fixed condensers, audion detector with its usual controls and accessories and a Murdock No. 55, 2,000 ohm head set. The audion detector is made of De Forest units, which is ideal as it is a boon to the experimenter contemplating the building of a set. I have learned the code on the omnigraph, but have not as yet got speedy enough to copy all the stations I hear. Like other



This Amateur Makes Use of the De Forest Units, Which He Calls Ideal.

amateurs, I delight in listening to N. A. A. Of course I hear numerous other stations besides Arlington.

I also have a spark coil sending set of five miles radius that I use to communicate with other amateurs nearby. However, I have not operated it since the opening of amateur wireless in April, 1919.

I have another set under construction, which is to employ crystal detector, audion detector for arc and spark waves and a one-step amplifier. I agree with Mr. Gernsback in that, if the amateur wishes to live, he will have to turn his attention to radio telegraph apparatus that is non-interfering, or else the radiophone, the latter being the more preferable.

WILKES DEARING, Covington, Tenn.

**BUCHOLZ STATION.**

The above is a photo of 9AY. The transmitter, which is on the left, is mounted in a hardwood case. Inside is an Acme 1/4 K.W. transformer, oil condenser and non-synchronous discharger. The condenser consists of twelve 3/16 glass plates each 8 x 10 inches and twenty-four pieces of 1/64 sheet copper 6 x 8 inches with lugs. This condenser is variable but the leads are not brought out on the cabinet for the sake of saving leads and to cut down the wave in the closed circuit. The rotary is of the spinning dish type with a speed of from

1,200 to 5,000 r.p.m. On the front may be seen the Murdock oscillation and the rotary power and aerial switches. Two aeriels are employed. The lead from the 75-foot "T" sending aerial may be seen where it connects with the oscillation transformer. The other, a 2-wire 300-foot one, comes in at the upper left-hand corner of the panel above the H. W. ammeter. All connections are made with 2-inch copper ribbon and heavy "Litz" on the open circuit. This set is very satisfactory, giving two amperes on high power and 1 1/2 am-

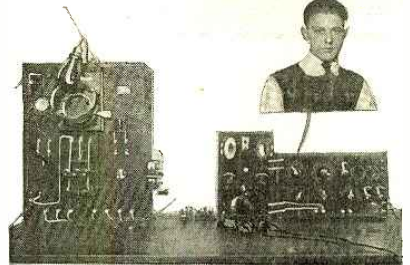

Mr. Bucholz Has Properly Arranged and Separated His Transmitter and Receiver.

peres on low which is not bad for a 1/4 K.W.

The receiving set is mounted in two cabinets, one a tuning panel, the other a detector panel with a one step amplifier. The tuning panel has a set of 4,000 to 21,000 meters. De Forest honeycomb coils and a vario-coupler wound on bakelite with "Litz." An 8-pole rotary switch in the center of the panel changes all connections. The tickler and secondary connections are carried to the detecting panel by straps. The tuning panel easily explains itself. Two bulbs, two rheostats, three variables (forty-three plates) and necessary switch for high voltage and tickler shunt are seen. The binding posts in the upper right-hand corner are for a Paragon receiver. Holtzer Cabot 3,000 ohm phones are employed. Also a pair of Brandes navy receivers. All panels are dark, finish with engraved scales on bakelite fronts. The filament switches are on the table front and are not shown in the picture; they are of the flush wall type. With this set I can copy POZ, IDO, NPM, NPN, MPD, NFF, etc., on the undamp. On 600 meters I hear practically all of the boats both east, south and west of here as well as NAT, NAH, NAO and NAR. As for 200 meter stations I hear plenty of them and from many districts. A variable is employed in series for amateur reception. D. C. BUCHOLZ, "9AY."

6206 University Ave., Chicago, Ill.

**WATKINS STATION.**

The following is a description of my amateur radio installation:

The transmitting set consists of a 1 K.W. closed core transformer, oil immersed, glass plate condenser, non-synchronous  
(Continued on page 522)

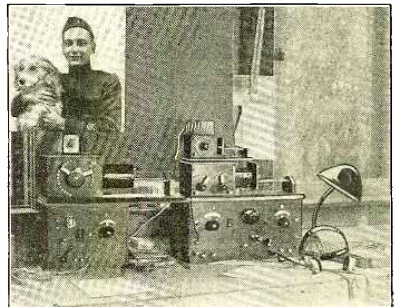

This California Man Secures Very Good Results with This Set.

# The Autobiography of a Girl Amateur

Being a True Account of the Trials and Tribulations of a Lady Member of that Honorable Body of "Hams."

I WAS taught in school to avoid starting a letter or manuscript with the personal pronoun "I," but in this case I do not see how I can get around it otherwise, so, boys, overlook it this once, won't you? I started by career in the telegraphic and radiographic fields at the tender age of 18 as a copy-girl in one of the main telegraph offices of a large company, and in a city noted for its many subways and tall buildings. When I was not busy keeping "bonus" operators well supplied with stacks of messages, I was worming my way into the good graces of the wire chief, who let me practise on a "slow" local wire, where eventually I learned to send and receive the American Morse code at a fair rate of speed. Two years later I was actually given a regular wire to handle, and the fascinating dots and dashes kept me busy and content until Miss A. G. Packer came along to interrupt my peace of mind.

Perhaps some of you do not know or recall Miss Packer, so I will refresh your memories. She was the bona-fide and undisputed first sea-going woman radio operator of the Atlantic Coast, and probably of the world, for that matter. Some of you old-timers may throw down your aerial switch on me and sputter out that Mrs. Eckles of the Pacific Coast was the first, but if you do I refuse to enter into a controversy with you. You will have to fight it out with Mr. Duffy of radio fame, who knows all about the records of every radio operator, male or female, from Bobalune, Argentine, to Niki, Greenland. To get back to Miss Packer, she sailed the seas as a genuine radio operator from November, 1910, to April, 1911 on the Clyde steamer *Mohawk*. Many of the newspapers ran feature articles about it, showing the lady operator at her post, etc., and the future began to look dark indeed for a great number of professional radio men, who saw visions of dazzling blondes and brunettes smiling prettily at old sea-dog captains.

The result of all this was that I immediately decided I wanted to become another lady operator, and, if possible, a sea-going one. Accordingly, I visited the offices of the old United Wireless Telegraph Co. and asked as to the prospects. An anaemic young man, who boastfully remarked that he had traveled to all important ports of the world as a radio operator, informed me that altho I could probably pass a telegraph test I would have to qualify as a radio operator, which meant that I should have to learn all about motor-generators, transformers, helices, detectors, three-slide tuners, etc. I left the place rather discouraged. Had I been a boy I could easily have visited nearby amateurs and thus learned at first hand just what there was to the "game," but you will admit it would not have been quite the proper thing for me to call on strange young men and ask to see their sets. I therefore, had to learn some other way. I asked my brother's help to install a small outfit, but he laughed at my earnestness and put it down as a new whim of mine. I refused to "let it go at that," as he suggested, and one day, while looking over the wares of the newsstand at the corner I noticed a unique magazine called

*Modern Electrics*, which seemed to specialize on radio subjects. In one copy I read where a boy fourteen years old had received messages 500 miles distant on a home-made amateur outfit employing an electrolytic detector, a tuning coil, two pairs of seventy-five ohm receivers and a seventy-five foot aerial. If a boy of fourteen could accomplish such a "feat," I reasoned, so could I,

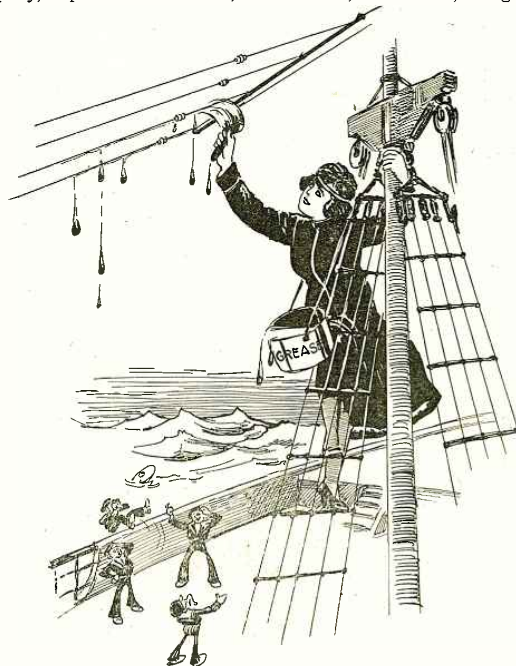

"I Was Informed That Greasing The Aerial Wires Was Part Of The Game."

and I at once began work on a similar set. I showed the magazine to my brother, who refused to become enthusiastic, but nevertheless I "forced" him to assist me in erecting a small antenna on the roof and in due time I had secured the necessary instruments and could hear the old "NY" (New York) station calling "DU" (Wilmington, Del.). In those early days of radio the American Morse code was used exclusively in the radio work of this country, so I had very little difficulty in learning to read the "buzzes" as compared to the "clicks" of the telegraph sounder. Shortly after this, I purchased a two-inch spark coil, increased the length of my antenna and soon had a first-class transmitting outfit with which I earned quite a "rep" talking back and forth with New York City and other surrounding amateurs, among whom were such pioneers as "DR," "VN," "C," "CH," "PK," "YN," "PX," "GE," etc. Of course, I had a call of my own, but I cannot give it to you, as otherwise that would give me away. I do not know whether you boys will agree with me or not, but I never considered it wise to give my address to other amateurs, so that even to-day many probably wonder who I was and what became of me and my two-inch squeaky spark. Of course, in those days there was no such thing as tuning, or station licenses, or assignment of calls, or government supervision—it was just one grand "etheric medley," as it were, and for that reason there was no need of

my identity being known to anyone.

At last I thought I knew enough about the game to try my luck as a professional. I therefore secured an interview with the superintendent of the radio company previously mentioned. When I told him I was prepared to take an operator's test, this gentleman smiled indulgently, then changing his expression to one of studied seriousness and importance, asked me if I was prepared to perform the duties of a radio man in every detail, which included, among other things, the climbing of a ship's rigging every morning at daybreak in order to grease the aerial wires, so that messages could "shove off" more easily. I had never heard of this "stunt" before, but I thought that if Miss Packer could do it, I certainly could also. So I answered that I was fully prepared. He laughed uproariously at this—so much so in fact that it finally dawned on me that he was jesting at my expense. I did not hesitate to tell him so either. He finally told me that he would "take my name and bear me in mind" and inform me of the next lady-operator vacancy.

I went away and waited one month without a word from the radio company. I accordingly wrote the superintendent about his promise. His answer was to the effect that a recent government decision had decreed that it was unlawful for a woman to perform the duties of a radio operator on board a vessel. I thought this a polite way of "turning me down," so I wrote to the Department of Commerce, which was then beginning to issue the so-called "Certificate of Skill." I finally secured the certificate, but not the job. At the same time I was informed, to my dismay, that my friend, the radio superintendent was quite right. Lady radio operators were no longer fashionable.

I was heart-broken. My dreams of wearing a snappy blue uniform, as the pictures of Miss Packer had shown, with sparks on my sleeves and a regular cap, were thus at an end. I forthwith decided to go to some South American or European country, where I believed the novelty of a lady radio operator would appeal to marine officials, but the great war came along and curtailed my plans. Meanwhile, I was still telegraphing and of evenings digging into the mysteries of radio. I learned to recognize and understand the difference in meaning between the words "decrement" and "oscillation," as well as what constituted the characteristic of a broad and a sharp wave. I had previously secured station operating licenses under my brother's name and had been assigned the call letters of "2??" so when the war came along and I was forced to "close down" my station, I hoped the government would be so short of radio operators that it would draft all women operators as well and send them to sea.

This, unfortunately, never came to pass, so I had to content myself by enrolling in the naval reserve force as a first-class "yeomanette." My knowledge of radio came in good stead at last, but not exactly as I would have liked it. For the space of almost a year I did nothing more exciting than to check the daily "logs" of naval radio listening-in stations, which proved to

(Continued on page 513)

# "When The Lights Grew Dim"

By ROBERT W. ALLEN

IT was after the hour of midnight. A lull had occurred just before "press" was to be transmitted by the powerful San Francisco wireless station. Then the silence of the ether was broken by the signals of a Japanese steamer some thousand miles or so from the city.

It was always the Japanese operators who began interfering when all stations were waiting patiently for press. Some amateurs listening at this early hour of the morning made remarks that cannot be repeated here. Sufficient to say the Japanese still continued to call the San Francisco station. Again and again the government operator in the city tried in vain to "break" the persistent Japanese operator. As usual, the interferer heeded not the signal to stop sending.

Press news was continually being delayed by some such malicious interfering. The navy man at San Francisco did not like to begin transmitting until all was quiet. American steamships on the Pacific would find it impossible to receive the desired signals if some other steamer close by was sending with full power. Press would necessarily be delayed until it was found possible to silence the operator so wilfully hindering the news of the day.

To say that the operators, both commercial and amateur, were angry would be putting it mildly. After staying up all night and then to be delayed in this manner was extremely vexing. With a disconcerted sigh more than one amateur turned off his filament current and decided to go to bed. Others still impatiently waited, determined that they were not going to be cheated out of "Px." They were not sorry they had done so, for the Japanese operator had become tired of pressing his key and in a moment the San Francisco station would begin transmitting.

The navy station, however, did not immediately commence. What was the delay, thought many an operator? There was no more interference and press was already a half hour late. The answer to this question soon came, as ship stations hundreds of miles from shore heard what seemed to them a voice. It was very faint and the words could not be distinguished. A few minutes passed and then the voice became louder and louder until operators marveled at the rapid advancement of radio telephony.

Until now the words spoken were meaningless and sounded like a foreign language. As the voice became more audible the language appeared to be English and startled many that night at the first spoken words.

Amateurs listening in on the Pacific coast jumped from their chairs in intense excitement. Their receivers remained clamped to their ears, altho the voice was very loud. And the powerful speech was decidedly masculine.

But such a voice! Altho it was clear and distinct, yet it had an uncanny hollow tone, as if the unseen speaker was not quite human. It was a voice that would cause any man to turn pale, as was then the case with many wireless men. If they did not speak aloud, then certainly they were too awed

to talk. Possibly the amateurs gave vent to their thoughts more freely than the commercial operators who in most cases removed the vibrating phones from their ears.

"I am talking from Mars," said the voice. "I am talking from Mars. Can you all hear me?" The voice paused here as if expecting an answer. Operators of powerful stations decided it was impossible for their signals to be heard on Mars. Still it was possible that the remarkable man on the planet possessed a receiver capable of picking up these signals. Therefore the power-

der that anyone received him, but somehow everyone copied the message. The operator told Mars that the man at his side was a secret service man. He was sorry as soon as he said it, but what harm could it possibly do? Was not Mars millions of miles away?

The voice could once more be heard. "Secret service man, you say?" There was a loud laugh as the distant voice derisively said this.

"Secret service man," he repeated; "hope you don't set him on my trail." Here there was another loud laugh and many an amateur laughed with him. It certainly would be comical to have a secret service man searching for someone on Mars.

"You ask why I volunteer no valuable information," spoke the voice. "Well, I shall tell you. I wish to be rewarded for any information I may impart. What is more, I demand to be paid whether I tell you the desired information or not. Yes, I have you in my power. For at any moment I am able to make wireless communication impossible. This is just a sample—"

The voice suddenly ceased and in its stead was heard the most deafening static that was ever received by any station. It certainly would be impossible to transmit or receive radiograms under such conditions. When the voice could again be heard the man seemed exultant.

"You see," he said, "I may do as I wish. Not only can I create extreme atmospheric conditions, but I am competent of destroying any wireless station I please." This was followed by laughter.

"To-morrow," said the Martian static-maker, "I shall make my demand of the United States Government. At 1 o'clock I will again call you." The parting sentence from the dweller of Mars was spoken in harsh tones,

as if the unseen man on that planet held decided enmity toward America. When the last word was spoken, what sounded like the rotation of a dynamo was heard. It became weaker and weaker until it could no longer be heard.

The newspapers thruout the land had the story in huge headlines, and they had much more. The people on Mars were described in full, altho the voice had not told of conditions or of the people on the planet. The improved means of transportation installed on Mars; the vast range of their wireless instruments, and many other things covered page after page of the morning papers. Extras were forthcoming thruout the day. Something new would always come up which the reporters had not heard of before.

Amateur stations were bombarded with news-seeking reporters. Those who had impatiently gone to bed before press was to be transmitted were indeed chagrined. Altho some listened-in all day, not a voice greeted them. Amateur signals were continually being flash back and forth thru the ether. Practically all messages were pertaining to the startling wireless telephone on Mars.

The day and part of the night slowly passed and the scheduled time was drawing near. Every amateur who possessed a set was listening-in, and there were many sets

(Continued on page 515)



"Nothing Can You Or Anyone Else Do That I Do Not Know."

ful station at San Francisco answered the call in the International Morse code.

"M-a-r-s, M-a-r-s," transmitted the operator, and there followed a series of questions which for many years men tried to answer.

"San Francisco, San Francisco," came back the voice. "I received you o.k., but your signals are very weak. The various questions you may wish to ask I will not answer. No! The answers would convey to you a vast amount of information. So you wish to know how I look, do you? Ha! ha! What a decidedly humorous question. Perhaps I look something like you." Here the man laughed again and went on.

"Who is that man sitting beside you? He seems excited and he will have reason to be so before I am finish. Why does he go to the telephone, my man? Ha! You wonder how I know? Nothing can you or anyone else do that I do not know. At this very moment you are calling out to someone in the room. Ah! You turn pale. My good man, do not be so frightened. How is it possible for me to harm you when I am such a distance away? Come, my man, answer my questions."

San Francisco again called Mars, but the operator's hand refused to act normal and consequently his sending was nothing like that of the man who formerly sent press without making a "break." It was a won-

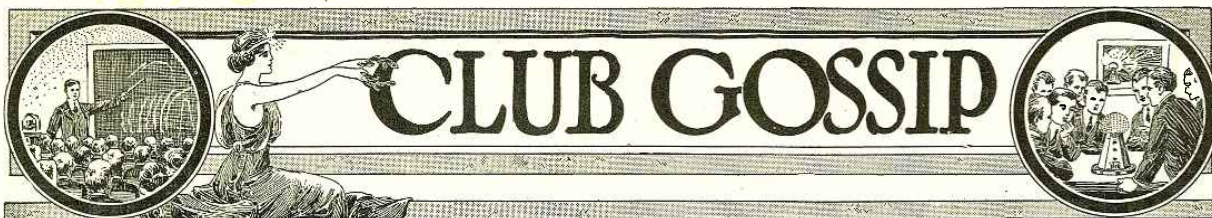

### RADIO INTELLIGENCE POST.

The Radio Intelligence Post of the American Legion wishes to hear from former service men who were attached to the Radio Intelligence Division of the General Staff.

Membership in this Post should be interesting to these men for the opportunities it gives for exchange of experiences and social activity, as well as keeping abreast of radio developments.

The secretary is A. L. Bernhard, 1679 42nd Street, Brooklyn, N. Y. Write today.

### THE STUDENT'S RADIO CLUB.

The Student's Radio Club of the Okmulgee Vocational High School at Okmulgee, Oklahoma, has been organized for the purpose of studying wireless telegraphy and telephony. Nine students from the vocational electricity department belong to the club. The club is open to any member of the high school. The initiation fee is \$1.00 and dues are 50 cents per month.

The officers of the club are: President, Ted Stoner; vice-president, Lisle Wheeler; secretary, Dwight Becker; treasurer, Vance Cummins.

The members have built most of the apparatus, which consists of: A navy type coupler, audion cabinet, variometer, loading coil, Galena detector, fixed condensers, test buzzers, etc. They are now building a 2 K. W. step-up transformer for sending and demonstrational purposes.

The meeting nights are Tuesdays and Thursdays of each week from 7 to 9 p. m. On Tuesday night code practice is given and on Thursday night lectures on wireless telegraphy and telephony are given.

All club activities are under the supervision of Mr. R. R. Ritchie and Mr. R. R. Stewart, instructors in the electrical department. The club would like to hear from other clubs and amateur organizations in their district.

### DANBURY HIGH SCHOOL RADIO CLUB.

The Danbury High School Radio Club was organized early in December. The following officers were elected: Prof. Harrison Moore, instructor; Frank H. Griffin, president; Stuart A. Northrop, vice-president; Abraham M. Dick, secretary and treasurer.

Twenty members were enrolled, all of whom are members of the High School. Several honorary members who recently served in the army as wireless operators were admitted, and these men have offered many valuable suggestions to the club.

The club was organized to give instruction to students interested in wireless. At some of the meetings held several lectures were given by members pertaining to the science. A large aerial has been set up and the set is now in operation. Address all correspondence to A. M. Dick, secretary and treasurer, Danbury High School, Danbury, Conn.

### COLORADO SPRINGS WIRELESS ASSOCIATION.

The Colorado Springs High School Amateur Wireless Association was organized in 1916, under the name of the Electro Radio Club by a number of enthusiastic amateurs of the school, among whom were: Richard Roby, Barton Hoag and Aloson Kurth, while the head of the physics department acted as supervisor. The membership at that time was about twenty active members.

When the stations were closed for the period of the war, the organization disbanded. Now that the stations are open again, the club has reorganized with the founders of the pre-war club as heads, with a membership double the original one.

We have a one-kilowatt sending set (Thordarson equipment), and a DeForest two-step amplifier for receiving equipment and are hearing everyone that is sending.

The club has an experienced speaker who lectures to us on the theory, operation, etc., of wireless instruments so that the members will soon have licenses.

Time and press reports are received on the set and as soon as it can be arranged the club will post bulletins in the school.

The club is open to anybody in the country that is interested in wireless. The dues are one dollar to associate members. Meetings are held every Monday night at the school. The club is having some photos of the apparatus taken and one will appear in this magazine soon. Most all the members have stations at their homes so there is plenty of around-town communication.

The officers of the club are: Richard Roby, director; H. Wells, director; A. Kurth, president; C. Daily, vice-president; T. Gray, secretary and treasurer.

It goes without saying that RADIO AMATEUR NEWS is a necessary part of the club.

### HOLLYWOOD ELECTRICAL AND RADIO CLUB.

The Hollywood Electrical and Radio Club is a new organization composed of Hollywood's most wide awake boys. Meetings are held at their headquarters, 4402 Sunset Blvd. Boys are admitted to this club after passing an examination of receiving five words a minute.

Instruction is given to new members. Papers and magazines of interest are read at meetings every week. And on a number of occasions lectures have been delivered by E. R. Brockway, instructor, University California Southern Branch. This club has been in existence only three months and is already the proud possessor of the following instruments: Four loose couplers (1,200, 2,000, 3,500 and 4,000 meters), two loading coils 1,800 meters each, three crystal detectors and an audiotron detector, operated by a 6V-80 A. H. storage battery, four pairs Brandes 2,000 ohm phones, one voltmeter reading 600 V., with several other scales, one partly constructed audiotron panel, one battery charging set and an omnigraph.

Our antenna is composed of two No. 14 copper wires spaced six feet apart, 200 feet long, 80 feet high, at one end and 63 feet high at the other, with a 53-foot lead-in. We expect to have a sending set in the near future.

Following is a copy of the minutes of the last

### Radio Articles in March Issue Electrical Experimenter

*Gaseous Telephone Transmitters—*  
by Richard A. Engler.

*Radio Frequency Current on  
Wires—*by Col. J. A. Mauborgne.

*\$25.00 For a Radio Poem.*

*Vacuum Tube Amplification—*by P.  
H. Boucheron.

*Construction of Honeycomb Induc-  
tances—*by Hilbert R. Moore.

*An Experiment With Wave Motion*  
—by L. A. Bartholomew.

*Radio "Lab" Prize Contest.*

meeting: Friday evening, 7.30 p. m., meeting was called to order by Joe Franz, president. The following new officers were installed: Don Brockway, president; Joe Franz, vice-president; Stanley Lohman, secretary; Bill Brockway, treasurer.

Two new members were initiated into the club. F. R. Brockway gave a lecture on storage batteries and magnetic lines of force. Several interesting and instructive experiments were performed.

Address all communications to secretary, S. W. Lohman, Los Angeles, Cal.

### NORTHWESTERN RADIO ASSOCIATION.

The members of the Northwestern Radio Association, the organization of amateur radio students and operators of Portland, Oregon, have reorganized under the name of the "Northwestern Radio Association," and the following officers elected for the year 1920:

Charles L. Austin, president; John Hertz, first vice-president; Geo. W. Cameron, second vice-president; Ralph T. Galyean, secretary; Geo. W. Cameron, treasurer; Lester White, sergt.-at-arms; Chas. L. Austin, chief inspector.

Meetings are held every Friday evening and are largely attended, as any person holding a radio license or who is interested in radio communication is eligible to membership. As several new members are being added at each meeting, a larger room has been arranged for in the Journal building. A program consisting of a talk by at least two members, on some subject of a part of the radio set, is held at each meeting. Several members of the association have very efficient stations and communication with stations in Idaho, Nevada, California and Washington is held nightly.

Any club or person desiring to communicate

with the association may do so thru the secretary, R. T. Galyean, 460 Miller Ave., Portland, Oregon.

### THE ENGLEWOOD H. S. RADIO CLUB.

The Radio Club of Englewood High School, N. J., was organized for the purpose of bringing all those together who are seriously interested in radio. The club has a constitution consisting of eleven rules and regulations governing the procedure at the regular meetings held once a week. The meetings are held in the lecture room or in the physics laboratory of the school, usually under the supervision of Mr. LeValley, the instructor in physics, or one of the club's officers. There are nine members in the club so far, and applications are coming in fast. We expect to have lectures or talks on radio by some expert operators of our acquaintance.

The club has already bought apparatus and wire and will soon erect an aerial over the school building. A code class has been established, which meets every week. By means of a buzzer, arrangement we learn to receive almost as well as with an omnigraph. A maximum of ten words a minute has been reached by some of our members. In order to join this club a candidate must possess an up-to-date receiving outfit. Two of our members expect to obtain amateur licenses soon. All communications should be addressed to N. Edgars, secretary.

### SACRAMENTO RADIO CLUB.

The Sacramento Radio Club of Sacramento, California, was organized in December, 1915, for the purpose of bringing together those interested in radio, in Sacramento and vicinity. The club was very successful for some time and enjoyed a membership which at one time reached over eighty paid-up members.

When the war began, practically every member of military age went into some branch of the service and in the early part of 1918 the club was disbanded for the duration of the war. We again organized in July, 1919, and now have a membership of thirty or more, which is constantly increasing.

Any person over the age of 16 years who is interested in radio work of any kind is eligible for membership and a fee of 5 cents per month is charged to defray the expenses of keeping up our club room, etc.

The club has purchased a hot-wire meter and wave meter for tuning up transmitting sets, and a mimeograph for printing circular letters and bulletins. A one-half K. W. transmitting set is now under construction, which will be installed in the club room for the use of the members. Address all communications to William H. Yeav, president, Sacramento Radio Club, Sacramento, Calif.

### POMONA RADIO ASSOCIATION.

The Pomona Radio Association is a club which, tho it is a very good one, is not well known outside of California. At present we have 15 members and more coming up. We meet every Wednesday night at the different members' houses and will soon meet in our club house, which is undergoing repairs.

The order of our meetings is as follows: First there is a short business session, then a lecture on a radio topic by some member, then an open discussion of radio in general. Last, but not least, comes the "cats," which tend to stimulate attendance and everybody stays until the meeting is over.

At our last meeting we were given a lecture by Edward Marti, of the French Aviation Service, on the subject of Wireless Telephony in the Army. He explained all about it and showed some blue prints of the diagrams used. The open discussion that followed lasted two hours and it was decided to erect a central radiophone station from where the president could call special meetings and also tell news of interest to the club members. The officers at present are: Horlan Cannon, president; Howard E. Wright, secretary; Russel Hillen, treasurer; Otto Tyler, chief operator and radio inspector. Our dues are 25 cents a month. We would like to hear from other clubs and will gladly correspond with them.

Howard E. Wright, secretary, Pomona Radio Association, Pomona, Cal.

### THE WORCESTER COUNTY RADIO ASSOCIATION.

The Worcester County Radio Association was formed last fall but had scarcely been fully organized before its club rooms were totally destroyed by fire. Its members, far from being discouraged, continued meeting regularly, meanwhile keeping a look-out for new quarters, which were

(Continued on page 523)



## Junior Radio Course

### The Reason For The Use of Various Wavelengths

**A**LTHO the meaning of the word *wavelength* was explained to you in lesson four of the December issue, we must go back to this subject once more in order to clearly understand all points connected with it. Later on, when you learn more about radio you will realize the importance of wavelength and the big part it plays; in fact, you must not hope to build a sending set and operate it unless you know just what you are going to do so as to tune it to the amateur wavelength of 200 meters.

Some of you boys who are beginners may quite naturally ask why are not all radio wavelengths tuned at one general wavelength, such as 600 meters, so as to make it easier for everybody to remember. This cannot be done for the following reasons: In the first place, all radio stations in the world are using the same "line," so to speak; that is, they all send their message thru the same ether, as it is called. It is not like the telegraph or the telephone lines, where each line is separated from the others and only two persons can use the wire at one time; that is, at one end there is a person talking or sending and at the other end of the wire there is a person listening or receiving.

In radio thousands of stations are constantly sending and receiving messages at the same time, and it is all being done thru the same and only one ether. If it was not for wavelengths and tuning there would be quite a mixup in the ether

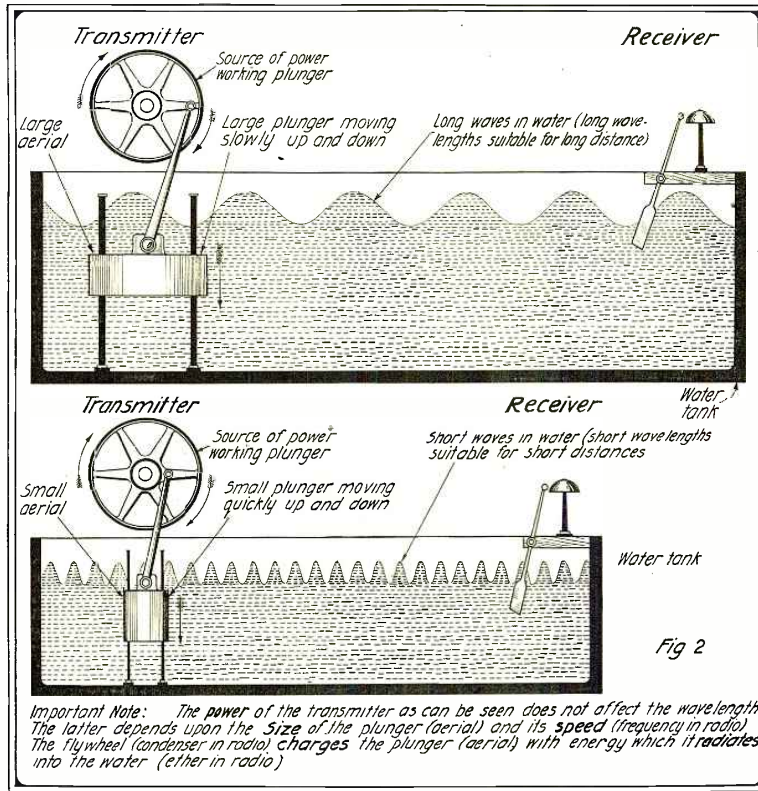

Carefully Study These Sketches and the Analogy Used. One is That of a Long Wavelength Used for Long Distances and the Other is That of a Short Wave Used for Short Distances.

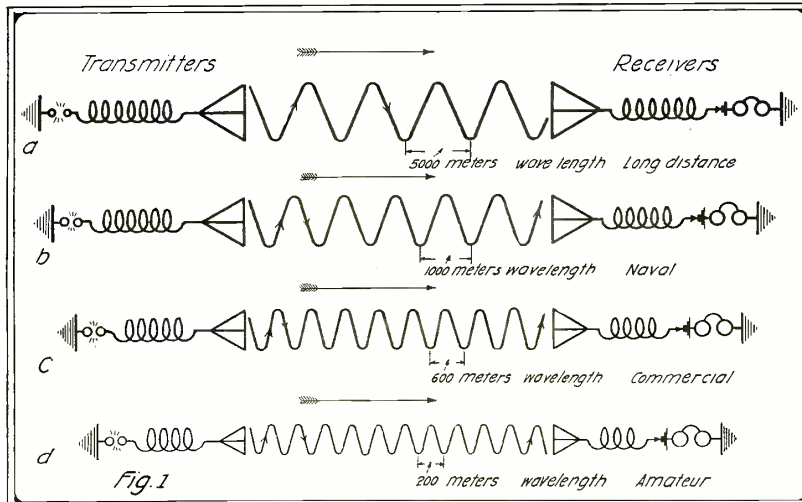

This Represents Some of the Most Important Wavelengths Employed in Modern Radio Work. These May Range from 200 to 5,000 Meters.

with every station sending at the same time. It would be like a lot of people in one large room or hall, all of them shouting at the top of their voice to each other and expecting to be heard and understood. In this case they are all using the same air, so that the combined sound waves produced by the voices unite into one grand roar and no one is understood.

In radio, however, wavelengths come to the rescue and even tho all stations in the world are using the self-same ether they are able to "weed out" stations not wanted and listen to any particular one they may choose.

Wavelengths used in radio work vary from 100 to almost 20,000 meters, so you see there is quite a variety to choose from. Low power, short distance sending sets use wavelengths of 100, 200, 300, 450, 600 meters, as they wish, while high-power long-distance sending sets use wavelengths above 1,000 meters. By doing this they do not interfere with each other very seriously because if a transmitter is tuned to a sending wavelength of 200 meters, its waves will not affect any nearby receiver unless that receiver is actually adjusted or tuned for 200 meters.

Now, boys, from what has been explained so far, don't think that every radio station has its transmitter tuned to a separate and distinct wavelength, so that all a receiving station has to do is to tune its receiver to any station it wants. This is not possible, as there are too many ship and

shore stations in the world to give them all a separate wavelength. Radio stations and their wavelengths are divided into groups or classes, depending upon what use is to be made of them; for instance, long distance stations of high power which send messages from the U. S. to Europe are given sending wave lengths of 5,000 meters or more; naval radio stations communicate with battleships on about 1,000 meters; commercial shore stations and merchant ships employ a wavelength of 600 meters, and *American amateurs are forbidden to go above 200 meters for sending.*

Figure 1 shows the general grouping of these wavelengths and their uses. Of course, these are not the only wavelengths employed. There are many others used as well, but they are all sufficiently separated and spaced so as not to interfere with each other. Remember one thing, however, which is that the power of a sending set does not affect the wavelength. By that

we mean that whether you increase or decrease the power of a transmitter, the wavelength remains the same. All that power does is to decide *how far* the waves will travel. In other words, a two-inch spark coil will push a wave along space farther than a one-inch coil will. Long wavelengths, such as 5,000 meters or more, are better able to travel long distance on account of their greater size, *while short wavelengths of 300 meters or less are more suited for travelling short distances.* A picture explaining just how this is done is shown in Fig. 2. In this illustration water waves are used instead of radio waves, so that you may better understand the principle we have explained.

As you have been told before, the wavelength of a transmitter or sending set depends upon several things—first upon the aerial, that is, the *longer* the aerial the greater the wavelength; second upon the tuning coil of the transmitter, that is, the

more turns of wire it contains the more it will help to increase the total wavelengths; third upon the size and capacity of the sending condenser, that is the greater the capacity of the condenser to hold electric charges, the greater will be the wavelength.

In our next lesson we shall dwell upon the natural decaying of damp waves, otherwise known as *decrement* and the part it plays on wavelength.

#### QUESTIONS FOR THIS LESSON

1. Why is it necessary to employ various wavelengths in radio telegraphy?
2. What wavelengths are used in radio work?
3. What kind of stations use long wavelengths and what kind use short ones?
4. What conditions determine the length of a wave?
5. Does more or less power increase or decrease the wavelength?

## Dictionary of Technical Terms Used in Radio Telegraphy

**Abscissa**—The horizontal measure of a curve plotted on squared paper. See ordinate, co-ordinate and locus.

**A. C.**—See alternating current.

**Acceleration**—Rate of change of velocity. See units.

**Accumulator**—See storage battery.

**Acetylene**—In flammable gas (C<sub>2</sub>H<sub>2</sub>). Formed by action of water on calcium carbide (CaC<sub>2</sub>).

**Aclinic Lines**—Lines representing the magnetic equator.

**Actinic Rays**—See ultra violet rays.

**Active Spark**—One produced solely from energy contained in the condenser. Produces active oscillations. Compare arc, spark.

**Admittance**—The mho. A circuit of impedance 1 ohm has an admittance of 1 mho.

**Aerial**—A system of wires insulated from and suspended at advantageous height above ground, generally being connected through suitable apparatus to earth. Used to radiate energy in form of ether waves from oscillations flowing along it, and to receive energy in form of oscillations from ether waves crossing it. When used for reception the correct name is antenna, tho both terms are used for either either receiving or radiating.

**Aerial Circuit**—Consists of aerial and earth, including all coils and condensers which may be between these and forming a direct path to earth and aerial.

**Aerial Tuning Condenser**—Variable condenser in aerial circuit. Used to vary oscillation constant.

**Aerial Wire**—Wire forming the aerial.

**Ag.**—Argentum. See silver.

**Agonic Lines**—Lines passing through certain parts of the earth where magnetic and geographic meridians coincide. There is no declination on these lines, of which there are two.

**Al.**—See aluminum.

**Alloy**—A compound of two or more metals.

**Alternator**—Dynamo arranged to produce alternating currents by employing collecting slip rings instead of a commutator. See high frequency alternator.

**Alternating Current**—One having its direction of flow constantly changed and incidentally its magnitude. That is, one which periodically changes its direction of flow.

**Aluminium**—Al. White, light, sonorous, ductile, malleable metallic elements. Specific gravity, 2.6; melting point, 1157° F.

**Amalgam**—Alloy formed with mercury.

**Ambrotin**—Trade name of an insulator made from fossil copal mixt with certain silicates.

**Ammeter**—Instrument for measuring cur-

rent in amperes in a circuit. Is connected in series with the circuit. Exists in a variety of forms, the most common of which depends upon fact that the force a magnet exerts depends upon the number of ampere turns. Therefore the greater the number of amperes sent through its coils the greater will be its attraction of a balanced armature. See also hot-wire ammeter and moving coil ammeter.

**Alkali**—Series of compounds called bases, including soda, potash and ammonia, which neutralize strong acids.

**Ammoniac**—See Sal A.

**Alexanderson Alternator**—A type of high frequency alternator which produces continuous oscillations.

**Amorphous**—Uncrystallised, that is having no definite form.

**Amp.**—See ampere.

**Ampere**—Unit of current. Is that current which, when past through a certain solution of silver nitrate in water, deposits .001118 gramme of silver per second. Flow of one coulomb per second. One ampere flows thru one ohm when an E.M.F. of one volt is applied.

**Ampere-Hour**—Commercial unit of quantity. Is that quantity which flows in one hour thru a circuit carrying a current of one ampere. Is equal to 3,600 coulombs.

**Ampere Turns**—Express by the product of number of turns of, and the number of amps. flowing thru the coils of an electro-magnet. Thus, one ampere-turn would be one amp. flowing thru one turn.

**Amplifier**—Device used to increase the volume or intensity of a received impulse or signal. See magnetic amplifier, microphonic amplifier, vacuum tube amplifier.

**Amplitude**—The greatest vertical distance attained above or below zero during a cycle by a wave or oscillation curve. Of an A.C. is the maximum voltage or current.

**Analogy**—A likeness in certain respects between things which are otherwise entirely different. Explanation of radio between things which are otherwise hydraulic analogies.

**Anastase**—See oxide of titanium.

**Anchor Gap**—Small spark gap in aerial circuit used to automatically disconnect detector when transmitter is being used. The powerful transmission spark jumps the gap instead of passing thru the instruments.

**Angle of Declination**—The angle which a compass needle makes from the geographical North Pole.

**Angle of Dip**—The angle at which a magnetized needle dips when free to swing in a vertical plane. At the true magnetic North Pole of the earth the needle will be pointing straight down.

Is also called angle of inclination. **Angle of Inclination**—See angle of dip.

**Angular Force**—See torque.

**Anglesite**—See lead sulphate.

**Anhydrous**—Without water.

**Anion**—See electrolysis.

**Annealed**—Softened by a process of heating and cooling.

**Anode**—See electrolysis.

**Anode of a Cell**—The negative pole of that cell.

**Antenna**—Aerial when used for receiving. Actually a "feeler". See aerial.

**Anti-Logarithm**—Tables for converting mantissæ to logs.

**Antimony**—Stibium. Sb. Metallic elem. S.G. 6.71. M.P. 810° F.

**Antinodes**—Points of greatest amplitude in a train of waves or oscillations. Also called loops and loops of potential.

**Anti-Spark Discs**—Ebonite discs fixt at intervals along Bradfield tube to assist in preventing sparking in wet weather.

**Aperiodic**—Untuned.

**Apparatus**—A group of instruments necessary for the carrying out of any experiment or for the carrying on of any process.

**Apparent Solar Day**—Time between zenith of sun on one day to zenith of sun on following day.

**Arc**—When two carbon rods in contact and having an electric current passing thru them, are separated, a conducting arc of carbon vapor is formed between them, producing an intense white light. See arc generator.

**Arc Generator**—A system involving the use of the arc for the production of continuous or undamp oscillations. See transmitter-arc.

**Attenuation**—The fractional reduction in intensity of a periodic disturbance as the distance from the source is increased.

**Arc Lamp**—A mechanism for automatically "striking" an arc, i. e., bringing the two carbons together and then automatically separating them to the correct distance. Mechanism also provided to "feed" the carbons as they are burnt away. The negative carbon is pointed, whilst the positive has a hollow crater tip. In England arc lamps are usually connected in parallel series, but in America the series connection is used.

**Arc of a Circle**—Any given portion of its circumference.

**Arc Spark**—One in which there is a slight arcing, due to some current from the transformer leaking across gap which is too small. Gives very poor production of active sparks.

**Armor**—The protective steel or iron wire in which are the currents given out by the machine. In case of motor the coils

(Continued on page 514)

# Junior Constructor

## Radio Instruments Made With a Detector Standard

By JAMES MILLER

THE detector standard shown in Fig. 1 may prove very useful to the junior radio experimenter who makes his own apparatus. It can be bought for 20c or may be made by the builder himself. Fig. 2 gives the dimensions. The base illustrated in Fig. 3 is made to fit this standard and is sold by several radio supply houses. It is made of molded black electrose and sells for about 30c. Following is a description of a few of the instruments which can be easily made from the above-mentioned articles:

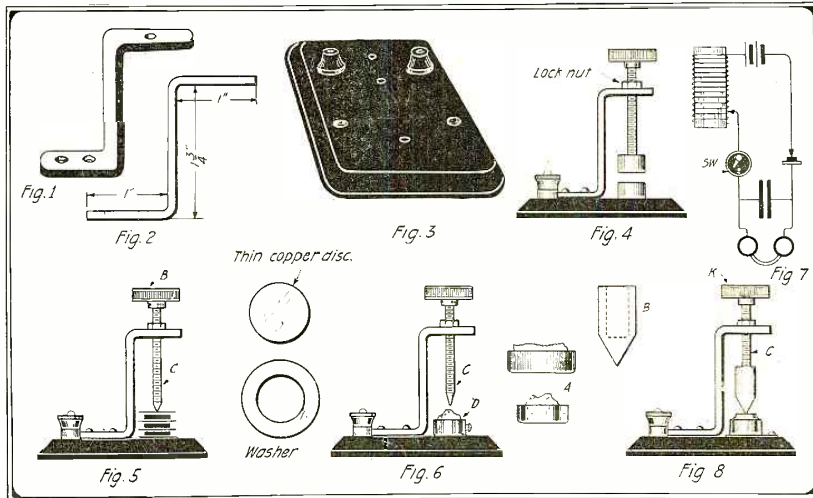

Follow These Simple Directions And You Will be Able To Make This Universal Little Standard Perform The Work Of Four Different Instruments.

### 1. A SMALL SPARK GAP.

With two short 8-32 machine screws and nuts, fasten the standard to the base. Insert the binding posts on the base and correct the standard to one of them. Next, make two zinc electrodes by cutting from a round battery zinc two pieces  $\frac{1}{2}$ " long. Drill and tap with an 8-32 thread. Mount these as shown in Fig. 4 and connect the lower one to the other binding post. This gap is very satisfactory when used on small spark coil sets. A lock-nut should be added as shown.

### 2. SMALL QUENCHED GAP.

A very satisfactory quenched gap for small spark coil sets may be made by removing the two zinc electrodes from the spark gap described above and piling up beneath the threaded rod (C in Fig. 5) several small brass discs, which should be separated by thin mica washers. The pressure is regulated by knob B in Fig. 5. Connection is made from the bottom plate to one binding post and the standard to the other. This gap is regulated by the number of plates and the pressure.

the carborundum detector described above. The mineral should then be ground off flat as in A, figure 8. Instead of fastening the cup to the base it should rest on a small sheet of copper or brass. This sheet is fastened down and connected to a binding post. From a piece of  $\frac{3}{8}$ " brass rod cut off a piece 1" long. With a No. 19 drill make a hole  $\frac{3}{4}$ " deep in one end and point the other, as in B, figure 8. Insert a spring in the hole and slip the cap over the end of rod C in figure 8. A sensitive spot is located by moving mineral around.

### 3. CARBORUNDUM DETECTOR.

By making a blunt point on rod C (Fig. 6) and the addition of the mineral cup D, a first-class carborundum detector is obtained. For good results it is necessary to use a battery of about  $\frac{3}{4}$  volt. It is not necessary to adjust the battery, except to reverse the polarity of the current on some crystals. Figure 7 is a simple hook-up for use with this detector.

### 4. A SILICON DETECTOR.

A good silicon detector can be made by mounting a piece of tested silicon with Wood's metal (soft lead) in the cup of

### NOVEL SWITCH.

This design is for a double throw double pole switch. Having two sets and but one pair of phones it was necessary to have a switch which could be changed in a short time. The drawing explains itself. A push of the handle to the right places the phones on the set connected to M posts while the left places it on N. By using more points any number of sets can be used. Also by increasing the number of blades any number of poles can be obtained. This switch can be mounted in a cabinet with the handle outside and some indicating dial arrangement used. A switch of this type can be used in many places on a wireless and to an amateur of limited means forms an excellent substitute for an anti-capacity switch.

Contributed by DAVID R. HULL.

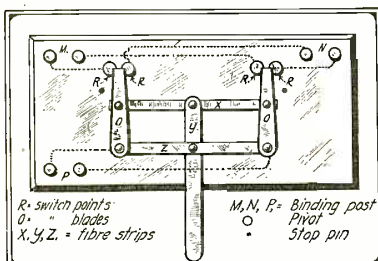

An Effective Little Switch And Not Very Complicated Either.

### A MAKESHIFT KEY-SPRING.

If you ever misplace the tension spring of your sending key, here is one way to replace it:

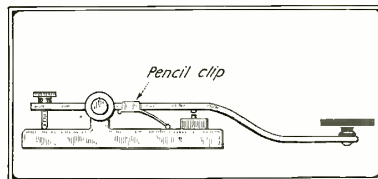

Surely You Will Have An Old Pencil Clip Laying Around To Replace A Missing Spring.

An ordinary pencil clip is used. The part that fits around the pencil is bent flat, as shown, so as to take hold of the key lever. The long part is bent down so that it bears on the base of the key. The tension is adjusted by sliding the clip back and forth. If the clip is of springy metal, such as phosphor bronze, this makes quite a good key-spring.

Contributed by THEODORE D. PECK, JR.

### VARIABLE FROM PHONOGRAPH RECORD.

A simple and yet effective variable condenser of the rotary type suitable for grid circuits of vacuum tubes may be con-

structed cheaply by employing an old phonograph disc record and by following this explanation and diagram.

A sheet of tinfoil is shellacked on both blank sides of the record after it has been sawed in half and the edges carefully rounded off. Three blocks of wood shown at A, B, and C on figure 1 are used to support the lower half of the record and are firmly glued to the base. The brass rod D is three-sixteenth inch in diameter and is used to control the upper half of the condenser plate. Bakelite may be used as a suitable top for the instrument to add to its appearance, upon which a scale may be drawn showing various degrees of capacity. Contacts must, of course, be made to D as well as to E.

Contributed by EDWARD DANNENBERG.

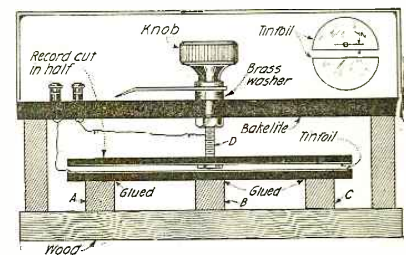

Dig Out An Old Phonograph Record And Make It Earn Its Living In This Manner.



# The RADIO LEAGUE of AMERICA

HONORARY MEMBERS  
ADMIRAL W.H.G. BULLARD, U.S.N. NIKOLA TESLA  
PROF. REGINALD FESSENDEN DR. LEE DE FOREST  
Manager, H. Gernsbach



## Radio Clubs and the League

By H. GERNSBACH

**W**E are in receipt of many letters from time to time addressed to us by secretaries of Radio Clubs and Associations, who wish to know how the club can become affiliated with the RADIO LEAGUE OF AMERICA.

### MONTHLY PRIZES

- A First Prize of \$10.00
- A Second " " 5.00
- A Third " " 3.00

will be paid hereafter every month for the best three letters published on this page, by members of the R. L. O. A.

The subject of the letters is "WHAT THE R. L. O. A. HAS DONE FOR ME"

Directly due to the League thousands of amateur members enlisted in either Army or Navy. Every member must have some good story to tell us. We want that story for the benefit of other members. If you did not enlist, but wish to write on another topic AS LONG AS IT HAS A CONNECTION WITH THE R. L. O. A. YOU MAY DO SO. Such a letter may win the 1st prize as well.

If only one letter is printed, that letter will be paid for at the rate of \$10. Address all letters:

PRIZE CONTEST,  
RADIO LEAGUE OF AMERICA  
231 Fulton St. New York City

There is certainly no doubt about this, and the way it is accomplished is simply to have the secretary of the club fill out the application blank in the name of his club, and the membership certificate will then be made out to the club itself. In this way the club becomes directly affiliated with the RADIO LEAGUE OF AMERICA and the certificate can then be displayed in the club's headquarters.

In order to encourage clubs to enlist members to the RADIO LEAGUE OF AMERICA, we will pursue the following procedure hereafter: On this page we will list the names of the clubs under the following classifications:

If all the members of the club are also members of the RADIO LEAGUE OF AMERICA, or 100 per cent., the club will be listed with two stars preceding its name. If only fifty per cent. or less of the club's members are members of the RADIO LEAGUE OF AMERICA, one star will be displayed in front of the club's name. In the next issue we will start a directory of clubs which we will run as a feature hereafter, and we urge the secretaries of all clubs to send us at once a statement, giving the total amount of members enrolled up to the time of writing, and also inform us how many of these members are also members of the RADIO LEAGUE OF AMERICA.

We desire to make this club directory the most comprehensive one in the United States, and we will print such information as is of value alongside the club's name, such as the number of its members, when the club started, and other useful information that will help to bring more new members to the club.



Fac-simile of Button.

Due to the fact that RADIO AMATEUR NEWS, with a circulation close to 40,000 copies monthly, reaches practically every amateur in America, the clubs listed in these pages will be in a position to obtain thousands of new members, directly due to such monthly propaganda.

In connection with this, we would ask the secretary of the club to fill out the blank listed on this page and return it at once to us so we will have it in good time before going to press with the next issue. Particular attention is called to this month's editorial, and every club member should read the information contained therein carefully.

We shall be glad to send to the secretary of every club a supply of literature and booklets concerning the purposes of the RADIO LEAGUE, as well as application blanks, etc., if the secretary of the club will advise us how many of these he can use to good advantage. Requests for such literature should be addressed to the business manager of the RADIO LEAGUE, who will promptly take care of same.

It may not be amiss to speak here of the LEAGUE's handsome pin or button which was specially designed for members of the RADIO LEAGUE OF AMERICA pursuing an incessant demand for an insignia to identify the LEAGUE's members. An illustration is shown here of the pin which is made in our national colors.

The rim is laid in hard red enamel, the background behind the lettering is white, while the field behind the aerial is in blue. All lettering and the aerial are in gold. The button is gold plated and measures half an inch in diameter. It is, however, only sold to members at the cost price of 25 cents each. Non-members cannot buy it at any price. A solid gold button made in exactly the same manner except that the metal is entirely gold is supplied at \$3.00 to members. This button is worn in the lapel of the coat or vest, or displayed otherwise as the wearer may see best fit. The button itself is distinctive and forms a ready means for members to get in touch with

each other. We have seen it happen time and again, and we have many letters on file where two members in the same city who did not know each other, became acquainted by means of the RADIO LEAGUE button, and have since become staunch friends. In the

### Information for Radio Club Directory

- Name of Club.....
- City and address.....
- When organized?.....
- How many members has Club?.....
- How many of these members are members of R. L. O. A.?.....
- Name of President.....
- Name of Treasurer.....
- Name of Secretary.....
- When does the Club meet?.....
- Weekly dues.....
- Monthly dues.....
- Yearly dues.....
- Has Club its own regular rooms?.....
- What sort of Radio Equipment has club?.....
- What is the value of the Equipment?.....
- What is Club's call letter?.....
- What is the average age of members?.....
- How many application blanks for R. L. O. A. do you require?.....
- Other information.....

Address this blank to

RADIO LEAGUE OF AMERICA,  
231 Fulton Street, N. Y. C.

next issue, we will publish some letters showing how former members of the RADIO LEAGUE OF AMERICA who enlisted in the service made many invaluable friends in France simply by displaying the button, which was recognized by other members of the LEAGUE.

In pursuance to many requests from foreign correspondents we desire to state here that the charter rules of the RADIO LEAGUE OF AMERICA permit only Americans to become members of the LEAGUE. Any American, no matter where his residence is, is eligible as a member. This ruling is obvious for the reason that over ninety-five per cent. of the members pledged their station and services to the United States Government.

### Application for Membership in the Radio League of America

**I**, THE UNDERSIGNED, a Radio Amateur, am the owner of a Wireless Station described in full on a separate sheet attached hereto. My station has been in use since....., and I herewith desire to apply for membership in the RADIO LEAGUE OF AMERICA. I have read all the rules of the LEAGUE, and I hereby pledge my word to abide by all the rules, and I particularly pledge my station to the United States Government in the event of war, if such occasion should arise.

I understand that this blank with my signature will be sent to the United States Government officials at Washington, who will make a record of my station.

Witnesses to signature:.....

Name.....

City.....

State.....

Date..... 192

In the event of national peril, will you volunteer your services as a radio operator in the interest of the U. S. Government?.....

**This last question need not be answered unless you so desire it.**  
**NOTE:—The rules of the League are printed on the Membership Certificate published in the February issue of the R. A. N.**

Send this blank to Radio League of America, 231 Fulton St., N. Y. C.





**T**HIS Department is conducted for the benefit of our Radio Experimenter. We shall be glad to answer here questions for the benefit of all, but we can only publish such matter of sufficient interest to all.

1. This Department cannot answer more than three questions for each correspondent.
  2. Only one side of the sheet should be written upon; all matter should be typewritten or else written in ink. No attention paid to penciled matter.
  3. Sketches, diagrams, etc., must be on separate sheets. This Department does not answer questions by mail free of charge.
  4. Our Editors will be glad to answer any letter at the rate of 25c for each question. If, however, questions entail considerable research work, intricate calculations, patent research, etc., a special charge will be made. Before we answer such questions, correspondents will be informed as to the price charge.
- You will do the Editors a personal favor if you make your letter as brief as possible.

**AUDION-CRYSTAL AMPLIFIER.**

(130) Raymond Leydig, Eldorado, Kansas, wishes to be advised on the following:

Q. 1. Please give me a diagram so that I may use an audion and a mineral as detector and amplifier respectively, using the tuning coil and instruments as follows: 1

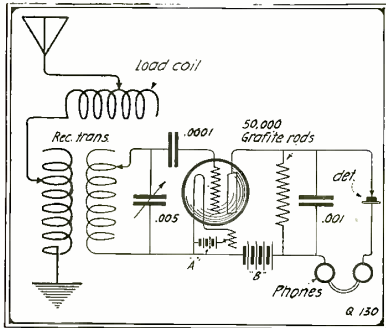

This Hook-Up Is Suitable for an Audion-Crystal Amplifier.

receiving transformer, of 3,500 meters range; 1 fifteen thousand meter loading coil; 1 pair of 3,200 ohm receivers, 2 variable condensers and one fixed condenser, .0005, .001, .003, M.F.D. respectively.

- A. 1. Diagram is shown herewith.
- Q. 2. Will I need additional apparatus?
- A. 2. You will need a graphite rod resistance of approximately 50,000 ohms, as well as suitable A. and B. batteries.
- Q. 3. How far may I receive with this set?
- A. 3. 500 miles and probably more under favorable conditions.

**RECEIVING EUROPEAN STATIONS.**

(131) W. H. Gillard, Hamilton, Ontario, asks:

Q. 1. Is it possible for me to hear European stations using a 6,500 meter variable coupler and an audion panel similar to the Mignon undampmt wave system, suitable condensers, a 3,000 ohm head set and an

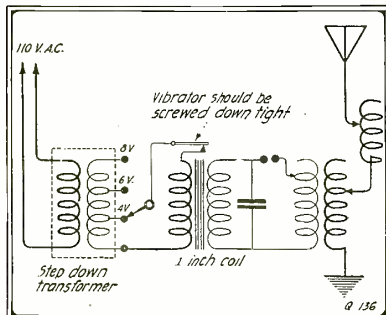

Spark Coil Transmitter Using Step-Down Transformer.

aerial 100 feet long, 60 feet high, of 4 wires?

A. 1. Yes, providing you make careful adjustments and conditions are favorable you should hear some of the undampmt stations which operate at about 5,000 meters. We suggest, however, that you install a longer aerial and add additional inductances of your system so that you may be able to hear stations operating at 15,000 meters or more.

Q. 2. What is the receiving distance of a set comprising one 4,000 meters loose coupler, one Crystal detector, one 43 plate variable condenser, one Murdock 3,000 ohm set, one small fix condenser and the 100 foot aerial described in question one?

- A. 2. Approximately 600 miles, possibly more.
- Q. 3. What is the total wavelength of the receiving set described in question 1.
- A. 3. Approximately 4,400 meters.

**AMATEUR SENDING DISTANCE.**

(132) Thos. G. Pillsbury, Enid, Oklahoma, wishes to know:

Q. 1. What is the approximate transmitting range for general amateur stations?

A. 1. There is no specific distance limit

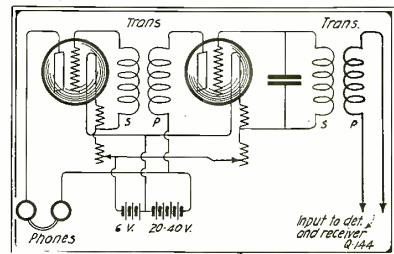

Diagram of Connections of a Navy Type Two-Stage Amplifier.

for amateur transmission. There is, however, a limit to the power input which must not exceed 1 k.w. for general amateurs and 1/2 k.w. for restricted amateurs when they are within five miles of a government station.

**USING MIRRORS FOR CONDENSER PLATES.**

(133) A. Painchaud, Montreal, Canada, would like to know:

Q. 1. I have forty mirrors 8 by 10 inches. Is it possible to make use of them for transmitting condensers making use of the quicksilver on the back of the glass instead of tinfoil?

A. 1. Yes, but you will have to scrape off the quicksilver for the space of one inch from all edges, and it will also be necessary for you to use tinfoil on the reverse side of the mirror. Due to the very thin coating of the quicksilver, however, this will not make a very good condenser.

Q. 2. What is the wavelength of a four wire aerial, 30 feet high and 45 feet in length?

A. 2. Its natural period is approximately 120 meters.

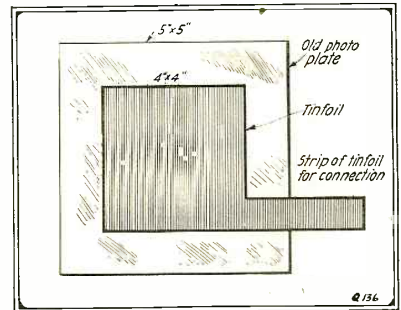

Typical Condenser Plate for Small Transmitter.

**WAVE LENGTH OF HONEYCOMB COILS.**

(134) J. Kenneth Brown, Greeneville, Tennessee, wishes the following information:

Q. 1. What is the formula used to calculate the wavelength of honeycomb coils?

A. 1. The Bureau of Standards, Washington, D. C., is at present engaged in research work on these coils. Results of the tests will be published later.

Q. 2. How may one construct audio frequency transformers?

A. 2. We refer you to the pamphlet "Design and Construction of Audion Amplifying Transformers," by E. T. Jones, a copy of which will be sent you upon receipt of 25 cents.

**EMPLOYING RECTIFIER FOR AUDION.**

(135) Milton Herbert, Chicago, Ill.,

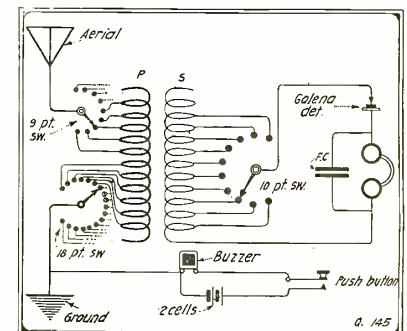

Diagram of Pocket-Size Receiver Circuit.

asks:

Q. 1. Will a rectifier, which changes 110 A.C. to 6 volts D.C., be suitable for a filament of an audion?

A. 1. Yes, but we do not recommend its use.

Q. 2. Is a "B" battery of 24 volts of sufficient potential to use on an Audiotron bulb?

A. 2. Yes, but not for all conditions. We suggest a variable "B" battery potential from 20 to 80 volts.

#### USING A.C. ON SPARK COIL.

(136) Wayne Copeland, Warsaw, New York, wishes to know the following:

Q. 1. Is it possible to use 110 volt A.C. on a one inch spark coil directly, and without an interrupter?

A. 1. A.C. being an interrupted alternating current does not need an interrupting device. You will have to step down the voltage so as to be suitable for your one inch spark coil. Then block the vibrator tightly.

Q. 2. If not what instrument must be used in the circuit?

A. 2. We suggest a small step-down transformer and employ about six volts.

Q. 3. Please give a diagram for the above circuit. It should be noted that this will not give you as good a spark as if you used D.C. or a 6 volt battery.

A. 3. Diagram is shown herewith

Q. 4. Can you suggest a suitable condenser for the above coil?

A. 4. Remove the gelatine from four discarded 5" x 5" photo plates and face them on each side with 4" x 4" sheets of tinfoil using shellac for this purpose. See illustration accompanying this question.

#### AMATEUR WAVE LENGTH.

(137) Frank O. Pratt, Woodhaven, L. I., wishes the following information:

Q. 1. What is the best method to keep within a 200 meter wavelength while employing a 1/2 k.w. transformer, oscillation transformer, Electro high tension condenser and rotary spark gap?

A. 1. This can readily be determined by the proper use of a wave meter. It depends a great deal on the fundamental wavelength of your aerial.

Q. 2. My antenna is a four wire, 75 foot one, 30 feet high; what is its wavelength?

A. 2. The natural period of your antenna is approximately 180 meters. You should have no trouble in keeping close to 200 meters.

Q. 3. Will you show a hook-up using one bulb as an amplifier and a crystal as a detector.

A. 3. A suitable diagram for this purpose is shown in question 130.

#### SOUND AMPLIFICATION.

(138) Ernest W. Wilson, Alexandria, Va., requests the following information:

Q. 1. Can a speaker in an auditorium be heard by an audience in another room of the same building. If so is there such a machine on the market.

A. 1. The Magnavox apparatus should be able to do this.

#### USE OF THE GRID LEAK.

(139) A. Cunningham, New York City, asks:

Q. 1. What is the "grid leak" resistance used for and is it necessary for the operation of an audion detector?

A. 1. The "grid leak" is shunted across the grid condenser and is for the purpose of providing a quicker discharge path for the negative charges of the grid. It is almost indispensable with modern vacuum tubes circuits.

Q. 2. Is a rotary gap absolutely necessary for amateur transmission?

A. 2. Not necessarily, but much better results are secured by its use.

#### FORMULA FOR INDUCTANCE OF COILS.

(140) H. A. Gross, Brooklyn, New York, wishes to know:

Q. 1. What is the formula for computing the wavelength of coils?

A. 1. We refer you to the Nagaoko formula which is:

$$L = 4\pi^2 \frac{a^2 n^2}{b} K,$$

Where L = inductance in centimeters,  
a = mean radius of coil in centimeters,

n = total number of turns,

b = Length of coil in centimeters,

K = a constant varying as the ratio  $\frac{2a}{b}$

#### LICENSES FOR AMATEURS.

(141) Orion G. Albert, Philadelphia, Pa., asks:

Q. 1. Can an amateur transmitting station be operated without an operator's license?

A. 1. Both station and operator's licenses are necessary.

Q. 2. How may a transmitter slightly

Of this issue, the ninth one since "Radio Amateur News" started, 35,000 copies have been printed and circulated. We have added eight more pages, too, this month, to take care of the many new features, as well as advertising.

With your help and support we promise to double the size of the magazine within the next few months.

Boost R. A. N.

over 200 meters be reduced?

A. 2. By reducing the L.C. value of your oscillating circuit, in other words, its inductance and capacity, or by reducing the length of the antenna.

Q. 3. What is the wavelength of a three wire aerial 100 feet long and 40 feet high at one end, and 10 feet high at the other?

A. 3. Approximately 275 meters.

#### SPEED OF HERTZIAN AND SOUND WAVES.

(142) Chas. Croatman, Woodhaven, Long Island, asks:

Q. 1. What would be the range of a loose coupler having a primary 6 inches long, 4 inches in diameter, wound with No. 24 enameled wire and a secondary 6 inches long, 3.7 inches in diameter, wound with No. 32 wire?

A. 1. Approximately 2,000 meters.

Q. 2. What is the speed of light waves, Hertzian waves, and sound waves.

A. 2. Light waves and Hertzian waves travel at the rate of 186,000 miles (300,000,000 meters) per second, while sound waves travel at the rate of 1,090 feet per second.

#### INSULATION OF INDOOR LOOPS.

(143) Lloyd Hinton, Toronto, Canada, wishes to know:

Q. 1. To what extent should an indoor loop aerial be insulated and what should be the size of the wire?

A. 1. No great amount of insulation is necessary for an indoor aerial except by small ball insulators at points of support. Any regular antenna wire No. 14 or 16 can be used.

Q. 2. What types of batteries and voltages are necessary with one Marconi vacuum tube?

A. 2. The filament or "A" battery should be a 40 to 60 ampere hour, 4 to 6 volts storage battery, and the "B" or plate battery which should consist of 30 to 40 dry cells of the flashlight type.

#### NAVY TWO-STEP AMPLIFIER.

(144) James H. Murrow, Philadelphia, Pa., asks:

Q. 1. Can you give me a diagram of a Navy type two-stage amplifier?

A. 1. Diagram is shown herewith.

Q. 2. Does the presence of nearby trees affect receiving or transmitting range; if so how?

A. 2. If the aerial is not quite clear and remote from the vicinity of trees both the transmitting and receiving ranges may be slightly affected, owing to the fact that the trees will absorb some of the radiated energy.

#### POCKET-SIZE RECEIVER.

(145) William S. McKay, Baltimore, Md., would like to know the following:

Q. 1. Will you kindly let me have a wiring diagram of the "Pocket Size Receiver" described in the September issue of R.A.N.

A. 1. The diagram requested is shown herewith.

#### VARIABLE HONEYCOMB COILS.

(146) Donald Ramsdell, York Village, Me., asks:

Q. 1. Would two specially made honeycomb coils with taps taken off be as efficient as a large loose coupler?

A. 1. Yes, in fact, honeycomb coils with taps permitting variable amounts of inductances to be used at will are generally considered more effective and compact than others forms of coils, and besides are inexpensive.

Q. 2. What wavelengths for primary and secondary of these coils should be used to get all damp stations?

A. 2. Both should preferably have a variable inductance of from 150 to 4,000 meters. If you wish to intercept all spark stations, which is rather a broad field, and covers from the amateur wavelength of 200 meters to Washington time signals on 2,500 meters, we suggest the use of several sets of coils, such as one set to cover 150 to 350 meters, another 450 to 1,050 meters, and another 1,760 to 4,000 meters.

Q. 3. How many taps should be taken off the primary and secondary?

A. 3. Six taps from the primary and four taps from the secondary are sufficient.

#### VARIOUS NAMES FOR VACUUM TUBES.

(147) Lawrence Schmitt of Chicago, Ill., wants to know:

Q. 1. What is the difference between an audion, a vacuum valve, an electron relay, and an audiotron?

A. 1. There is no difference; they all refer to the now generally accepted term vacuum tube, usually abbreviated to V.T. Individual manufacturers of vacuum tubes often give trade names to their products similar to the ones you mention.

Q. 2. What is a tungar rectifier and what is it used for?

A. 2. A tungar rectifier is in reality a modified form of Fleming valve, having a filament and a plate. It is generally employed to rectify 110 volts A.C. to low-voltage D.C. suitable for the charging of automobile or vacuum tube storage batteries.

Q. 3. What should the voltage of a "B" battery be?

A. 3. This depends upon the make of the bulb used and the purpose it is put to. Generally 20 to 30 volts as a detector, and 30 to 80 volts as an amplifier. This must be determined by experiment.

**MURDOCK  
No. 55**

IN APPEARANCE  
THESE 'PHONES  
SATISFY THE RE-  
QUIREMENTS OF  
THE MOST CRIT-  
ICAL.

2000  
OHM  
COMPLETE  
DOUBLE SET  
**\$4.50**

IN DURABILITY,  
THESE 'PHONES  
WILL SERVE AS  
LONG OR LONGER  
THAN ANY.

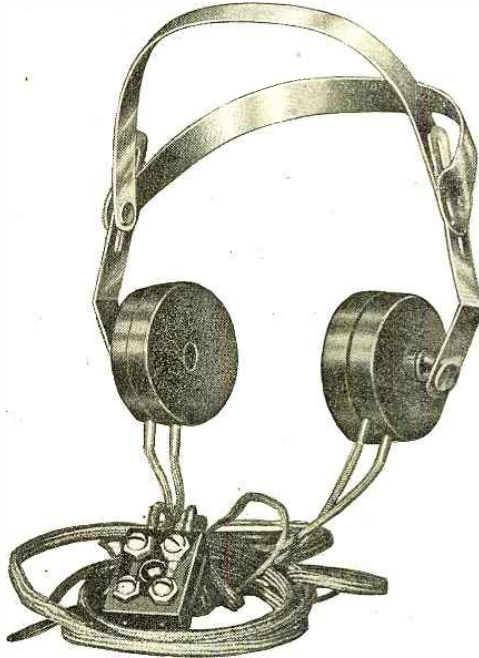

IN OPERATION  
THESE 'PHONES  
SURPASS IN SENSI-  
TIVENESS THE EX-  
PECTATIONS OF  
THE MOST OPTI-  
MISTIC.

3000  
OHM  
COMPLETE  
DOUBLE SET  
**\$5.50**

IN RELIABILITY,  
THESE 'PHONES  
YIELD TO NONE,  
THEIR CONSTRU-  
CTION INSURING  
"ALL - THE - TIME"  
SERVICE.

**RIGHT IN PRICE AND IN PERFORMANCE**

The substantial success earned by these receivers can be attributed to the instant recognition and acknowledgment of their remarkable value, by thousands of users. If, by chance, **you** are not acquainted with their merits, or are dubious regarding the possibility of securing really good 'phones at such prices, we suggest a trial, with the customary assurance of "satisfaction or money back."

Our Bulletin No. 19B Illustrates and describes the Complete Line of Reasonably Priced MURDOCK APPARATUS. A Copy Will Be Sent at Your Request.

**WM. J. MURDOCK CO.**

50 CARTER ST.

CHELSEA (BOSTON 50) MASS.

509 MISSION STREET,

SAN FRANCISCO, CAL.

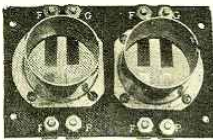

**When you buy a  
RADIO  
SERVICE  
V.T.  
RECEPTACLE**

you obtain the same material and workmanship as specified by the U. S. Navy for this class of apparatus.

A grade XX Bakelite Delecto base, the best insulating material known; flat phosphor bronze contact springs and an aluminum socket, not cast, but spun from hard sheet aluminum. The complete unit so assembled as to always make perfect contact with your bulb.

These Receptacles were not designed to meet price competition, but constructed to give you the best obtainable no matter what price you pay.

- Type S1—Single Tube (for inside mounting)..... \$1.20
- Type S2—Single Tube (for bench and experimental use)..... 1.75
- Type S3—Double Tube (for amplifier use)..... 2.75
- Type S4—Triple Tube (for detector and two-stage amplifier in three-stage amplifier use).... 3.75

The above receptacles are all made in two styles, for either receiving or transmitting tubes. This should be specified when ordering.

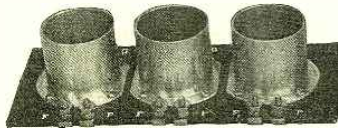

TYPE S4

**RADIO SERVICE & MFG. CO.**  
LYNBROOK, L. I. NEW YORK

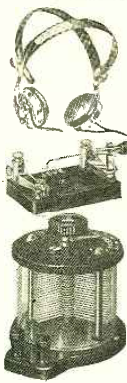

**WE** are giving away hundreds of expensive wireless instruments, electrical apparatus, supplies, etc., for selling a household article that goes like wild-fire because it is a genuine necessity and because it sells so cheap. All of our premiums are guaranteed new and perfect. We give you no junk.

Plans to receive high grade wireless apparatus without costing you a cent should surely interest you. An opportunity such as this one may never again be placed before you so take our Advice and grab it.

A very fortunate purchase permits us to sell a household article at the astonishingly low price of twenty-five cents a set, at which price they are irresistible. Their splendid value and attractiveness, their usefulness and their quick selling qualities will make them go like hot cakes. This article is a genuine necessity in each and every home.

Remember, you get these goods as a premium for selling the articles and sending us the money after they are sold. You don't have to pay a cent for them.

Send us four cents to cover postage and expense and we send you our catalogue, select your premium from, and complete information about our offer.

By continuing the sale of our goods you can receive some magnificent apparatus. Drop us a postal and leave the rest to us.

**BECK NOVELTY HOUSE**  
1298 Carroll Street, Brooklyn, N. Y.

**RADIO MEN  
WIRELESS AMATEURS**

We carry a complete line of Grebe, De Forest, Marconi, Murdock, Clapp-Eastham, and all other leading makes of Radio Apparatus from Contact points to complete sets.

AGENTS FOR

**RADISCO APPARATUS**

including Coils, "B" Batteries, Indicating Dials and other parts distributed by them. Mail Orders given prompt attention.

Open Evenings until 9.30 p.m.

**KELLY & PHILLIPS**  
312 Flatbush Ave., Brooklyn, N. Y.  
Telephone Sterling 2380.

**POPULARITY FOLLOWS THE  
UKULELE**

If you play quaint, dreamy Hawaiian music or latest songs on the ukulele you will be wanted everywhere. We teach by mail 20 simple lessons; give you free a genuine Hawaiian Ukulele, music, everything—no extras. Ask us to send the story of Hawaiian music. You will love it. No obligation—absolutely free.

**The Hawaiian Institute of Music**  
1400 Broadway, Dept. 12C, New York



**The Vacuum Tube in France**

(Continued from page 466)

the earth is accomplished by means of a transmitter, very similar in construction to an ordinary spark coil, working to an amplifier of the type described above. The sending unit consists of a high-power buzzer, the primary of which is joined thru a key to a 10-volt battery, the secondary

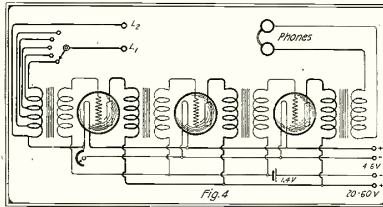

An Unusual Feature of This British Amplifier Is the Small Negative Potential Dry Cell of 1.4 Volts.

being connected (Fig. 6) to a line of well insulated wire whose ends are grounded by means of earth pins placed at distances from 150 to 200 yards apart, the line between the two grounds being known as the base. In the French power-buzzer, "Modele 2 bis," the vibrator is fitted with a sliding brass weight, the movement of which varies the frequency of interruption of the primary circuit from 300 to 750 per second, thereby enabling each set to have a distinctive note.

In operation alternating currents of audio frequency are induced in the secondary winding of the buzzer and flow thru the line wires to the earth pins where

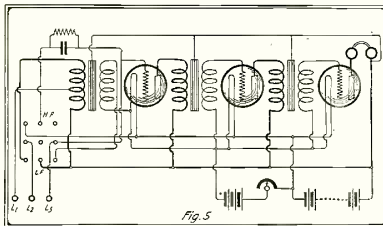

This Shows the Circuit Diagram of the French Amplifier Known as "Modele 3 Ter."

they spread out thru the conducting soil and are picked up by a similarly grounded line at the receiving amplifier. The base at the receiver, for efficient working, should be parallel with the transmitter base, and in practise is laid out with the aid of a compass on some pre-arranged bearing. Reliable communication can be established in this manner in at distances up to 2,000 yards.

Altho designed by the French originally, the British developed the power-buzzer amplifier to some extent and at the beginning of 1918 produced a combination set having a "Mark III" amplifier (shown in the photographs) and a power-buzzer, similar to the "Type 2 bis," mounted in a single case and having several interesting

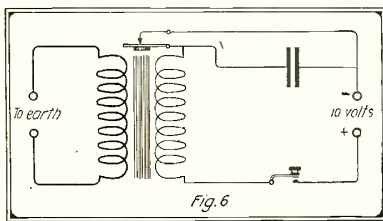

Schematic Diagram of the French High-Power Buzzer Sending Unit.

features, one of which was a hot-wire ammeter in one of the buzzer secondary leads enabling the operator to see at once if his set was working efficiently. This combination set gave good results and was used to some advantage in numerous "hot spots" on various parts of the front.

The Germans, however, made most use of the T. P. S. system as a standard means of communication having specially trained power-buzzer sections; it is quite probable tho that they were forced to use this measure thru the shell-fire of the Allies which no doubt left much to be desired in the life of the German linemen.

**NEW WIRELESS DEVICE.**

*Ships in Distress Can Ring Alarm Bells on Other Ships*

A novel wireless emergency calling device by which ships in distress can ring alarm bells on other ships within wireless range is reported by the American Chamber of Commerce in London.

The present wireless system of communication requires that an operator to hear a call must be on duty, wearing the usual telephone headpiece. The new device is said to enable any station or ship equipped with a special automatic transmitter key to call up any station or ship within range, fitted with a corresponding selective receiver relay, even if the operator is absent. The calling up, according to the American Chamber, is effected by a bell which starts ringing on the ships called.

It is claimed that one of the most important uses of the devices will be to ensure immediate and general attention to S. O. S. calls.

**WIRELESS EXPLOSIONS.**

Italian scientists were said, before the war, to have succeeded in discharging explosives several miles away by means of wireless waves, tho the public was never altogether convinced. Any doubt of the possibility of such an achievement is dispelled by recent public experiments in England. A device at the Marconi headquarters in Cambridge set off a mine of gunpowder at Chelmsford, thirty-five miles away, by the mere pressing of a button. The same device is said to ring alarm bells on vessels 300 miles distant; and the experts say there will be no difficulty in firing guns at that distance.

Improvements of the mechanism are expected soon to multiply the range of operation. If another war breaks out, it is expected that an operator sitting at a desk in Paris can set off explosives in Berlin, or vice versa. Wireless waves from Berlin or London might blow up fortification or business districts in New York. All that would be necessary would be a mine properly placed, connected with a wireless receiver, and a powerful sender, adjusted to the proper wave length, at the other end. Airplanes flying over a city, ship or fort could explode mines likewise, and observe the result of the explosion.

This is just one of the little innovations we may expect in the next war, and another excellent argument for doing our level best to see that there shall not be any next war. There are plenty of peaceful purposes for the wireless.

**AMERICAN LEGION COUPLES  
DANCE TO MUSIC  
BY RADIO.**

National history in music transportation was made at the grand ball of Oakland, Cal., post, American Legion, in celebration of Lincoln's birthday at the Civic auditorium recently, when hundreds of couples tript the fox-trot to music conveyed by "wireless" from the Fairmont Hotel orchestra in San Francisco. The strains of the orchestra carried clear across the bay furnished a jazz melody which could be heard all over the big auditorium dance floor.

# AMATEURS ATTENTION! Send over 25 Miles on D.C.

Here at last is real "commercial type" radio apparatus designed for low power direct current. New transmitting records are in store for you. Take advantage of this special introductory offer and save \$7.50.

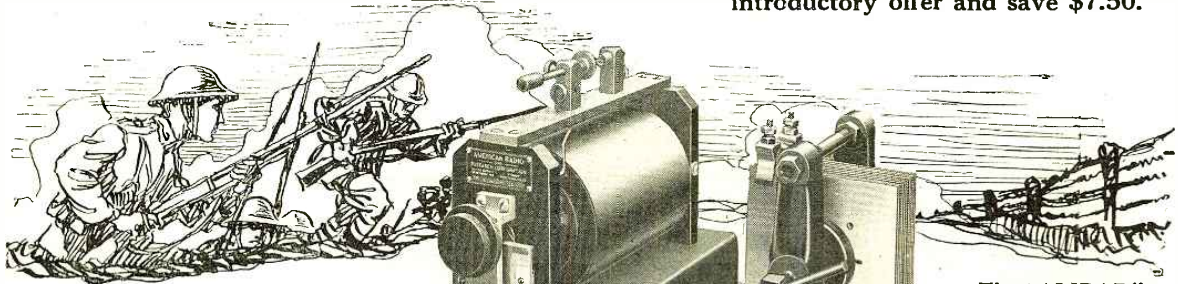

### THE "AMRAD" INDUCTION COIL

6 Volt or 32 Volt

is almost an exact duplicate of the U. S. Signal Corps coil used in trench service during the war. It has bakelite insulation throughout. Its secondary, wound in 29 sections, produces 50,000 volts. Rated at 100 watts this coil has an output about 100 per cent. greater than the average 2 inch coil. The vibrator is rugged, steady and non-sticking and designed to give a spark frequency equivalent to 100 cycles which means maximum transmitting range on short wave lengths. The 32 volt coil is intended especially for use on farm lighting circuits. When ordered separately this type is \$1 extra. To get maximum results with the 6 volt coil a heavy 6 volt storage battery is the best and most economical source of current.

Price, 6-volt type..... \$28.50

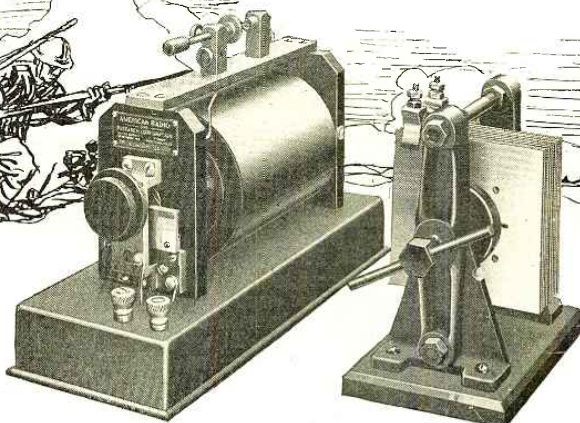

### The "AMRAD" QUENCHED GAP Special Induction Coil Type

All your power on one sharp wave and a clear, bell-like note at every tap of the key will make other amateurs in your state sit up and take notice. The Amrad Quenched Gap, carefully

operated, yields the secret of long range transmitting on low power. This special gap is identical in design to the heavy 1/2 k.w. and 1 k.w. Amrad Quenched Gaps now being installed in long distance amateur stations. Not only will this special quenched gap make your transmitter as efficient, for its power, as the more costly equipment but you will be able to send more messages without interfering with other stations. For the first time in the history of amateur radio every induction coil transmitter can now be tuned to comply with Government decrement regulations. The Amrad Quenched Gap is the secret.

Price, Induction Coil Type..... \$12.50

### Special Introductory Offer

If you have had limited power at your disposal and inefficient apparatus or if you are waiting to be introduced to the fascination of sending radio messages over into the next county or state here is your chance to get the two most important pieces of transmitting apparatus at an actual saving of \$7.50.

"Amrad" Induction Coil, regular price . . . . \$28.50  
"Amrad" Quenched Gap, " " " " . . . . 12.50  
\$41.00

### Special Price for the Double Buy, \$33.50

Either 6-volt or 32-volt coil may be chosen

**How to Order** Show this advertisement to your dealer and ask him to order one of these combinations for you. If you have no radio dealer in your vicinity send us check or money order for \$5 and we will ship direct to you by parcel post C. O. D., the balance plus postage. Act promptly, as the standard Signal Corps parts which we secured from the Government were only sufficient to make up a limited number of sets. If you are not ready to buy and want further information send for free Bulletin P which contains complete description and operating directions.

**Dealers' Opportunity** Write at once for short-term trade discount on this combination. No better opportunity to introduce apparatus of such high quality at such low prices will ever be had again. The offer is made especially to introduce our rapidly growing line of "commercial type" radio apparatus.

Address all communications to New York office

**AMERICAN RADIO AND RESEARCH CORPORATION**  
25 Park Row                      Factory at Medford Hillside, Mass.                      New York

## Memorize Continental Code Almost Instantly

My Method is the Short Cut  
to Success.

Complete Chart and Full  
Instruction, TWO DIMES.

C. K. DODGE

Mamaroneck, N. Y.

Sample of WHAT THEY SAY ABOUT IT

"Am using your chart for my  
Wireless Class and it is the best  
yet. All my pupils make fine head-  
way with it."

M. W. POWELL,  
Warren, Ariz.

Local address on request.

## GET THEM — RIGHT NOW

In order to introduce the quality of  
"Meraco" Apparatus and Accessories  
to future patronizers we are offering  
for a period of ONE (1) MONTH  
ONLY Our

### PERFECT "B" BATTERY

at \$1.00 each postpaid  
to any part of the U. S. or Canada.  
This offer closes at 12 o'clock noon  
APRIL 26th, 1920

Order a bunch today—orders filled  
according to rotation

Mercury Radio Appliance Co.  
672 Broadway, Brooklyn, New York

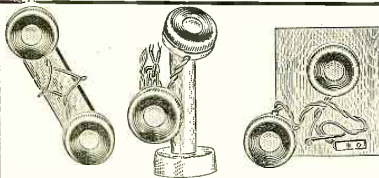

## MAKE YOUR OWN TELEPHONE

2 receivers, 2 transmitters connect-  
ing cords and diagrams.

Guaranteed to talk 100 ft. or  
farther on two batteries.

\$1.00 Complete. Canada \$1.25.

Inland Specialty Co.

1562 N. Robey St. Chicago, Ill.

## OMISSION IN THE OCTOBER ISSUE

In the article entitled "Short Wave Re-  
ceiving Transformer of Novel Design," by  
Raymond Evans, in the October issue of  
RADIO AMATEUR NEWS, part of the detailed  
description was omitted in transferring  
from page 173 to 200. The omitted portion  
should read as follows:

"tapt to suit. The switchgear requires  
a little lathework, as will be seen by the  
drawings, but will certainly tend to give  
the instrument a much more professional  
appearance. The switchblade is laminated  
and should have a spacing piece placed full  
length before bending to the drawing. It  
is secured to the knob by two small brass  
pins. The pointer for the coupling adjust-  
ment knob is secured in the same manner.  
The brass spindle H should be a tight fit  
in the secondary drum and rest in the bear-  
ing piece E and thru a hole drilled thru  
the switch post.

"The primary form is held in position by  
being screwed to a small hard rubber block  
D, to which is also screwed the brass bear-  
ing piece C.

"Wind the primary with fifty turns of  
No. 28 SCC wire, looping tappings out at  
the 6th, 10th, 16th, 24th, 35th and 50th turn,  
respectively, and the secondary with eighty  
turns of No. 36 SSC wire with tappings  
at the 15th, 30th, 50th and 80th turn.

"These secondary tappings must be fas-  
tened under the small screws on the drum  
and led off to the back of plug-sockets in  
the correct order with a very light gage  
flex wire. Shellac windings well. Secure  
small copper lugs F and G under the nuts  
at the back of all contact buds and plug-  
sockets, also under the terminal posts. The  
connections will be made to these after  
assembling is complete."

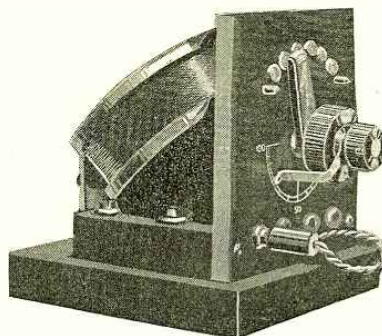

This is the Instrument Which Was Con-  
structed by Following the Author's Direc-  
tions.

The author of this article in advising us  
of the omission, sent us at the same time a  
photograph of the instrument which a

friend of his constructed by following the  
instructions given in the article. We will  
admit that it is a neat looking instrument  
and should prove very efficient.

## RADIO WORKS BEST AT NIGHT.

Under normal conditions the wireless  
station at Meudon, Paris, is unable to re-  
ceive daylight signals from Ascension  
Island, but can do so during the hours of  
darkness. During the eclipse, which was  
not visible in France and only partially  
visible in Ascension, special tests were  
made between the two stations, and it was  
found that while the moon's shadow passt  
between them, Ascension was quite audi-  
ble at Meudon, the signals failing as the  
shadow passt away.

## Radio Intelligence Bureau Earn \$125 to \$150 per Month Complete Course and \$15 Pre- Practice Buzzer Set

Course prepared by a leading authority on the  
subject. All questions answered free after pur-  
chase of course. The entire faculty is at your  
command to solve your problems.

**We Design** Wireless Receiving sets; Wire-  
less Transmitting sets; Wireless  
Telephone sets; Underground "Rogers" installations,  
complete or individual instruments, at nominal cost.  
Build your own apparatus at one-tenth the cost. We  
furnish dimensions, drawings, and diagrams complete.  
Special Questions answered by our Query Department  
at 25c each. If questions involve considerable research  
work, etc., a special charge, not to exceed \$5.00, is  
made.

RADIO INTELLIGENCE BUREAU  
864 Roosevelt Pl., Dept. A, New Orleans, La.

## Audiotron Adapter

### SOMETHING ENTIRELY NEW

The TeCo Specialists  
products Fits any four  
point standard socket.  
Note the price, don't  
be without one.

Pat. appl'd for. Price \$1.75

The TeCo Radio Co.  
P. O. Box 3362 Boston, Mass.

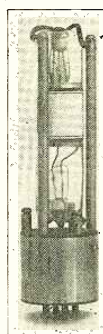

## Build Your Own Wireless Receiving Set

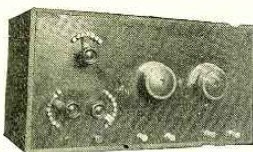

Think of the pleasure and practical experience you will  
gain in making your own set. You can save at least  
\$25.00 by buying the parts and assembling it yourself.  
This is not a toy, but a regular, large sized set (16"x  
8"x6") capable of receiving messages ranging in wave  
length from 170 to 2,500 meters. We will furnish you  
with large, full sized blue-print and full information con-  
cerning winding of coils, mounting of instruments on  
panel, "hook up"—in fact complete detailed instructions  
written in plain, easy to understand language.

### Our Offer is This:

Send \$1.00 and we will send you the blue-print and instruction sheets—also prices of all  
parts. When you order at one time \$5.00 or more worth of parts, you may deduct this  
\$1.00 from the total. Since the blue-print and instructions alone are worth \$1.00, and  
since we can save you money on wireless material, you cannot possibly lose. So send \$1.00  
to-day before this slips your mind and start making your set as soon as possible.

K. & G. Wireless Supply Co.

Dept. 16B—152 Chambers Street

New York City

## INDUC- W. SIEGERT WOOD TANCE WIND- PAT. IND TERN

1250 West 97th Pl.  
CHICAGO, ILL.

Special Radio and Electrical  
apparatus built to order

Electrical Experimental Work

Write for Estimates — I Will Save You Money

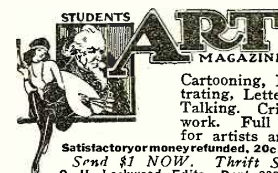

Publishes  
cash art as-  
signments,  
lessons and  
articles on

Cartooning, Designing, Illustrating,  
Lettering and Chalk-Talking. Criticises amateurs'  
work. Full of information  
for artists and art students.

Satisfactory or money refunded. 20c copy, \$1 for 6 issues.  
Send \$1 NOW. Thrift Store, Chicago.  
G. H. Lockwood, Editor, Dept. 600, Kalamazoo, Mich.

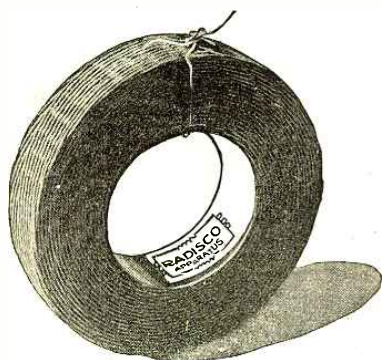

## Two Famous RADISCO SPECIALTIES

### RADISCO COILS

conceded by several well known Radio Men to be far superior to any similar type of Inductances. Made in seventeen sizes, tapped and plain. Wave length range from 200 to 20,000 meters, priced from 60c to \$4.85. Plentiful supply in stock at all Radisco Agencies.

### RADISCO BETTER "B" BATTERY

is made according to Government specifications in two (2) sizes— $3\frac{3}{4}$ " x 2 x  $2\frac{1}{2}$ " and  $6\frac{1}{2}$ " x 4 x 3". A first-class 15 cell, 5 group battery, VARIABLE VOLTAGE (Pat. applied for) is a special feature of this battery which enables you to provide critical voltage regulation for your vacuum tube by means of a switch connection with cells, taps of which have been taken off. Very economical and convenient. If one cell goes bad just test each group of 3 cells and short circuit the bad one. Price, small size, \$1.40. Large size, \$2.40, at any agency, or if ordered by mail include postage for 2 pounds on small size and 5 pounds on large size.

RADISCO AGENTS carry only apparatus of proven merit. Look for the Radisco trade mark on all parts you buy and be sure of getting efficient apparatus.

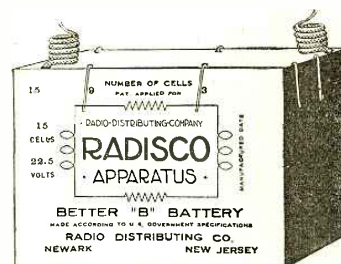

Below are listed a few of the reliable firms who carry the RADISCO COILS, Better "B" Batteries and are our Agents for all other standard apparatus of merit.

### COMMUNICATE YOUR WANTS TO THEM

#### ALBANY, N. Y.

E. L. Long,  
21 Magnolia Terrace  
ATLANTIC CITY, N. J.  
Independent Radio Supply Co.  
118 So. New Jersey Ave.

BEINVILLE, QUEBEC, CAN.  
Canadian Radio Mfg. Co.

BOSTON, MASS.  
Atlantic Radio Co.,  
34 Batterymarch St.

BROOKLYN, N. Y.  
Kelly & Phillips Electric Co.,  
312 Flatbush Ave.

BRONX, NEW YORK CITY.  
Amateur Wireless Equipment  
Co.,  
1390 Prospect Ave.

CHICAGO, ILL.  
Chicago Radio Laboratories,  
1316 Carmen Ave.

EUREKA, ILL.  
Klaus Radio Apparatus

HAMPTON, N. H.  
DeLancey Felch & Co.

LOS ANGELES, CALIF.  
The Wireless Shop,  
511 W. Washington St.

McKEESPORT, PA.  
K. & L. Electric Co.,  
427 Olive Street.

NEW ORLEANS, LA.  
L. A. Rose,  
4323 Magnolia Street.

NEWARK, N. J.  
A. H. Corwin & Co.,  
4 West Park Street.

NEWCASTLE, PA.  
Pennsylvania Wireless Mfg. Co.,  
507 Florence Ave.  
"8HA"

PHILADELPHIA, PA.  
Philadelphia School of Wire-  
less Telegraphy,  
Broad and Cherry Streets.

PROVIDENCE, R. I.  
Rhode Island Elec. Equip. Co.,  
45 Washington Street.

PITTSBURG, PA.  
Radio Electric Co.,  
4521 Forbes St.

SCRANTON, PA.  
Shotton Radio Mfg. Co.,  
P. O. Box 3  
Branch 8 Kingsbury St.,  
Jamestown, N. Y.

SPRINGFIELD, MASS.  
Electric Service Co.,  
585 Armory Street.

TORONTO, ONT., CAN.  
The Vimy Supply Co.,  
585 College Street.

WASHINGTON, D. C.  
National Radio Supply Co.,  
1405 U Street, N. W.

WICHITA, KAN.  
The Cosradio Co.,  
1725 Fairmount Ave.

*If none of the above agencies are in your vicinity, communicate with*

**RADIO DISTRIBUTING COMPANY : : Newark, New Jersey**

**AMATEURS**

RECEIVING OUTFITS AND INSTRUMENTS

Complete Tuning Coil Receiving Set \$4.50

Send stamp for descriptive literature

**MAYMIN RADIO MFG. CO.**

1845 E. Twelfth Street Brooklyn, N. Y.

**ACROMATIC TELESCOPE**

Made upon new scientific principles, nicely brass bound with powerful lenses, scientifically ground. Travelers, hunters, farmers, boy scouts and everyone needs a telescope. Have you ever enjoyed the marvels of a telescope? Each telescope guaranteed just as represented, or money promptly refunded. Send 99 cents to-day. EASTERN NOVELTY CO., Dep. 69 17 E, 93 St., New York

**Copper Aerial Wire**  
*Two Feet for One Cent*

WE are still offering No. 14 gauge copper aerial wire at 50¢ for 100 feet. We can also supply No. 12 gauge at 80¢ per 100 feet. All orders must be accompanied by postage and insurance charges—otherwise we will ship your order by express collect. We accept no C. O. D. orders. Price of above wire subject to change without notice.

We list a few of our other items below. Carbon grain transmitters—We have in stock a number of common and local battery transmitters which cannot be duplicated for the price which we are selling them for. These transmitters are highly efficient when used for plain telephone work or wireless telephony. The local battery type operates on 2 dry cells while the common battery type requires 16 volts to 24 volts. The current consumption is very low on either type. Shipping weight 2 lbs. Price \$1.00  
Large horseshoe magnets, very powerful, shipping weight 2 lbs. Price 30¢  
Condensers, ½, 7/10, 1, 1½ and 2 M. F., shipping weight 2 lbs. Price 50¢  
4500 ohm resistance coils, wound with German silver resistance wire, shipping weight 4 ozs. Price 40¢  
Variable resistance lamps, provided with brass mounting, shipping weight 1 lb. Price 25¢  
Watchcase receivers, bi-polar 75 ohm wire cord, while they last, shipping weight 1 lb. Price 65¢

Send 5¢ for our illustrated catalogue. **ELECTRICAL SPECIALTY CO.**  
Dept. R, 48-50 So. Front St., Columbus, Ohio

**WANTED**  
**BY THE EDITOR**

of this publication who desires as an assistant a young man well versed in radio matters. The applicant must be of good appearance and should have some literary and correspondent experience. Only a hustler, one who can accomplish things in a minimum amount of time wanted.

The position is just as big as the candidate wants to make it—there is an unlimited future for him.

Apply by letter only, in own handwriting, give all previous experience, employment and earning capacity.

Address

H. GERNSBACK,  
233 Fulton St., N. Y. C.

**THE GRID LEAK.**

There is nothing complicated about this very necessary audion appliance. All you need do is to draw a lead pencil line on a piece of heavy cardboard and insert the line across the grid condenser.

**NEW ORLEANS**  
WIRELESS SUPPLIES AND  
MINERALS OF ALL DESCRIPTIONS

L. A. ROSE

4323 MAGNOLIA STREET  
NEW ORLEANS, LA.  
Send 6 cents for Catalogue

**The Radio Engineering Company**  
MANUFACTURERS OF

'RADIO APPARATUS'

Beg to announce their reorganization and the opening of a show room and distribution center FOR THE SOUTH, of all standard radio apparatus.

The famous

**"RECO" KEY**

reduced for a short time to \$6.50. Six cents in stamps will bring our new and revised catalog now on the press.

Note New Address:

827 Madison Ave., Baltimore, Md.  
CALL 3 EM

**Particulars of Transmissions**  
**From the Eiffel Tower and**  
**Lyon Wireless Station***(Continued from page 468)*

- 8.30 to 8.35 F. L. Arc 8,000 metres with P.O.Z. (Nauen, Germany) alternator high frequency 12,600 m.
- 9.45 F. L. Musical 2,600 metres, weather report; key to this will follow shortly.
- 9.55 to 10.00 F. L. Musical 2,600 metres, international time signals.
- 10.02 to 10.05 F. L. Musical 2,600 metres, sidereal time signals.
- 10.44 to 10.50 F. L. Musical 2,600 metres, French time signals.
- 11.00 to 12.00 F. L. Arc 6,500 metres, with S.A.R. as before.
- 12.00 to 12.30 F. L. (Y.A.) Arc 3,200 m. Reseau de securité (safety system).
- 12.30 to 15.00 F. L. Arc 8,000 metres with H.B. as before.
- 15.00 to 15.30 F. L. Musical 3,200 metres Press (about 400 words).
- 16.00 to 16.15 F. L. Musical 2,600 metres weather report.
- 16.30 to 17.00 F. L. Arc 8,000 metres, with P.R.G. as before.
- 17.00 to 18.00 F. L. Arc 8,000 metres, with I.D.O. (Sao Paolo near Rome), arc 11,000 m.
- 18.00 to 19.00 F. L. Arc 8,000 metres, with P.S.O. as before.
- 19.00 to 20.00 F. L. Arc 8,000 metres, with W.A.R. as before.
- 20.00 to 21.00 F. L. Arc 8,000 metres, with S.E.W. as before.
- 21.00 to 22.00 F. L. Arc 8,000 metres, with H.B. as before.
- 22.00 to 23.30 F. L. Arc 8,000 metres, with P.S.O. as before.
- 23.28 F. L. Trembling note 2,100 metres, clock ticks.
- 23.35 F. L. Musical 2,600 metres, weather report.
- 23.44 to 23.50 F. L. Musical 2,600 metres, time signals and time of clock ticks.

Note 1.—In case of failure of the Arc system, the work is done on Musical note, 2,600 metres.

Note 2.—On the 1st and 15th of every month Eiffel Tower sends a continuous wave transmission for calibrating wave metres. At 18.00 and during one minute a series "A's," then a sustained dash of the three minutes on 5,000 m. wave. At 18.10 and during one minute a series of "B's," then a sustained dash of three minutes on 7,000 m. wave. (See paragraph following for further information on these transmissions.)

No. 2. Lyon Station (Poste de la Doua), call letters Y.N. Lyon transmits in two days.

A. Continuous wave with Poulsen arcs of 150 kilowatts and 250 kilowatts, which is constantly in use.

B. Continuous wave by the Bethenod high frequency alternator system, about 350 kilowatts. This transmission, which is quite new, will take the place of the arcs as soon as the apparatus is entirely completed. From time to time trial transmissions are made. This transmission can easily be recognized by the purity and stability of the note. Lyon will be one of the most powerful stations in the world. The time signals from Lyon are daily taken at Shanghai (China).

C. Working hours (G.M.T.).

Time.

0.00 to 3.30 Y.N. Arc alternator 15,500 m. duplex with N.S.S. (Annapolis, Maryland, U. S. A.), arc Poulsen 16,800 and 18,000 m. and with N.F.F. (New Bruns-

**Stromberg-Carlson**  
**Radio Head Set**

A Set that combines your ideal of extreme sensitiveness with a strong, durable construction that stands the gaff of continuous service ashore or aboard ship.

All operating parts housed in dust-proof and moisture-proof aluminum cases. The diaphragm is mounted metal-to-metal in such a way that temperature variation will not disturb the air-gap adjustments. Non-conducting spool heads and slotted pole tips eliminate 90 per cent. of the eddy current losses that are found in other head sets.

Each set is wound to a resistance of 2,000 ohms with pure copper wire and furnished complete with 6-foot moisture-proof cord attached. Tested for matched diaphragm tuning and operating qualities in actual service before shipment.

Send \$12.00 for sample set for trial in your own station — satisfaction guaranteed or your money refunded upon return of set. Write for Bulletin 1206 giving full description.

**Stromberg-Carlson Telephone Mfg. Co.**

ROCHESTER, N. Y.

Chicago, Ill.

Kansas City, Mo.

Toronto, Ont.



# LEARN WIRELESS AT HOME

## The Demand for Wireless Operators Far Exceeds the Supply

The New York Wireless Institute will make you an operator—AT HOME—in your spare time—quickly, easily and thoroughly. No previous training or experience required. Our Home Study Course has been prepared by Radio Experts. Experts able to impart their practical and technical knowledge to YOU in an *easy to understand* way. The graded lessons mailed you will prove so fascinating that you will be eager for the next one. The instruments furnished *free*, will make it as easy to learn the Code as it was to learn to talk. *All you will have to do*, is to listen.

### Big Salaries

Wireless operators receive excellent salaries ranging from \$125 to \$200 a month and it is only a stepping stone to better positions. There is practically no limit to you, earning power. Men who but yesterday were Wireless Operators are now holding positions as Radio Engineers, Radio Inspectors, Radio Salesmen at salaries up to \$5000 a year.

### Travel the World Over

A Wireless Operator can visit all parts of the world and receive fine pay and maintenance at the same time. Do you prefer a steady position without travel? There are many opportunities at the numerous land stations or with the Commercial Wireless or with the Steamship Companies.

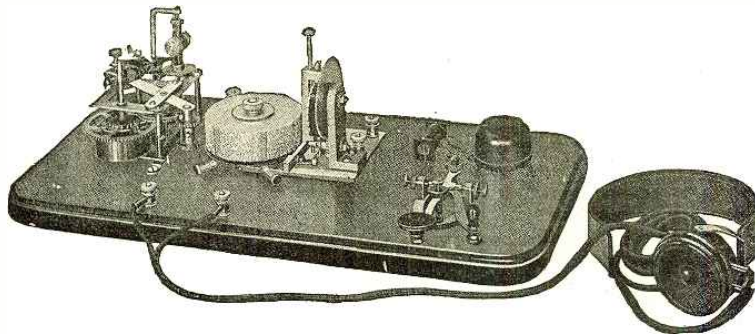

This wonderful Set for learning the Code furnished free with our Course

### FREE Instruments and Text Books

We furnish free to all students, during the course, the *wonderful receiving and sending set exactly as produced in the illustration*. This set is not loaned, but given to all students completing the Course.

The Transmitter shown is the celebrated *Omnigraph* used by several Departments of the U. S. Government and by the leading Universities, Colleges, Technical and Telegraph Schools throughout the U. S. and Canada. Start the *Omnigraph*, place the phone to your ear and this remarkable invention will send you Wireless Messages, the same as though you were receiving them, through the air, from a Wireless Station hundreds of miles away. When you apply for your license, the U. S. Government will test you with the *Omnigraph*—the same model *Omnigraph* as we furnish to our students. Ask any U. S. Radio Inspector to verify this.

### Easy Payments

A small payment down will enroll you. We will make the payments, so easy that anyone ambitious to enter the fastest growing profession—Wireless—may do so.

### Send for FREE Booklet

Without obligating you in any way, send for our booklet "How to Become an Expert Wireless Operator"—it is free. Mail the coupon below, or postal or letter—but do it today.

### NEW YORK WIRELESS INSTITUTE

Dept. 22, 258 Broadway, New York City

New York Wireless Institute  
Dept. 22, 258 B'way, N. Y. City

Send me free of charge, your booklet "How to Become an Expert Wireless Operator," containing full particulars of your Course, including your *Free Instrument Offer*.

Name .....

Address .....

City or Town.....State.....

### FREE Post-Graduate Course

A one month's Post-Graduate Course, if you so desire, at one of the largest Wireless Schools in N. Y. City. New York—the Wonder City—the largest port in the World and the Headquarters of every leading Wireless and Steamship Company.

# WIRELESS MEN and AMATEURS

## The Second Edition of the Consolidated Radio Call Book

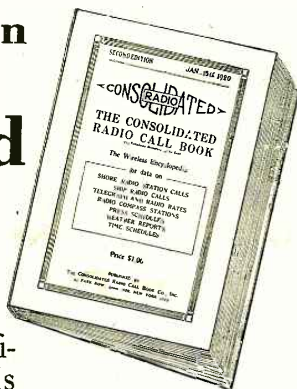

The only book in print officially listing all the radio calls as issued by the Bureau of Commerce.

Every vessel and land station in the world is represented and listed alphabetically, according to names of vessels or land stations, and according to call letters; Revision of American coastal stations under U. S. Naval control, and their new calls.

## All Amateur Calls Also Listed

### IMPORTANT NEW Given Free with Each Copy

A Wireless Map of the World in colors is given absolutely free with each copy. This map shows the locations of all the high powered RADIO stations in the world, including the time signal stations. In addition it tells at a glance how far away any of these stations are. Of greater interest are the time zones, which enable the amateur to compute instantly the correct time for the zone in which he is located from any time signal station.

## Price \$1.00 Prepaid

Either Direct from us or for sale by  
the following responsible Dealers:

American Electro Technical Appliance Co.  
235 Fulton St., New York, N. Y.  
Atlantic Radio Co.  
34 Batterymarch St., Boston, Mass.  
L. Bamberger & Co.  
Newark, N. J.  
Cutting & Washington Co.  
6 West 48th St., New York City.  
L. W. Cleveland Co.  
441 Congress St., Portland, Me.  
J. H. Bunnell & Co.  
32 Park Place, New York City  
Doubleday Hill Electric Co.  
719 Liberty Ave., Pittsburg, Pa.  
Lester J. Jenkins  
923 Purchase St., New Bedford, Mass.  
A. T. Hovey  
61 Belvidere St., Boston, Mass.  
Klaus Radio Apparatus  
Eureka, Ill.  
Manhattan Electrical Supply Co.  
17 Park Place, New York City  
114 S. Wells St., Chicago, Ill.  
McCarthy Bros. & Ford  
75 W. Mohawk St., Buffalo, N. Y.  
E. P. Noll & Co.  
21 N. 7th St., Philadelphia, Pa.

Nola Radio Co.  
134 Chartres St., New Orleans, La.  
Newman-Stern Co.  
1874 E. 6th St., Cleveland, Ohio  
National Radio Supply Co.  
1405 U. S. N. W., Washington, D. C.  
Pioneer Electric Co.  
137 E. 5th St., St. Paul, Minn.  
James W. Poole, Inc.  
16 Columbia St., Boston, Mass.  
F. D. Pitts Co.  
12 Park Square, Boston, Mass.  
Precision Equipment Co.  
2437 Gilbert Ave., Cincinnati, Ohio  
Radio Distributing Co.  
4 West Park St., Newark, N. J.  
Reuter Electric Co.  
34 E. 8th St., Cincinnati, Ohio  
Radio Equipment Co.  
630 Washington St., Boston, Mass.  
Southern Electrical Co.  
3d and E. Sts., San Diego, Cal.  
H. E. Williamson Electric Co.  
316 Union St., Seattle, Wash.  
Jos. M. Zamoiski Co.  
Baltimore, Md.

Published by

## Consolidated Radio Call Book Co., Inc. 41 Park Row, New York City

This book also contains the advertisements of practically every leading company in the radio field.

wick), Alexanderson alternator 13,600 m.  
3.30 to 4.30 Y.N. Arc 8,000 m. Press.  
5.30 to 6.30 Y.N. Arc 8,000 m. Press.  
8.45 to 8.58 Y.N. Arc or alternating 15,500 m. Aldebaran time signals.  
1st minute 0" to 50" letter V  
2nd minute 0" letter E  
10" letter K  
20" letter E  
30" letter X  
40" letter E  
50" letters BT  
3rd minute 0" letter E  
10" letter Q  
20" letter E  
30" letters ZT  
40" letter E  
4th minute 0" to 10" long dash  
10" to 20" silence  
20" to 30" long dash  
30" to 40" silence  
40" to 50" long dash  
5th minute 0" to 10" long dash  
10" to 20" silence  
20" to 30" long dash  
30" to 40" silence  
40" to 50" long dash  
6th minute 0" to 10" long dash  
and so on until the end of the seventh minute,  
8.58 to 9.05 Y.N. Arc 15,500 m. time signals, with the following preamble: "Lyons signaux horaires Greenwich = debut des tops a 09.00 = 09.02 = 09.04 as."

And after this preamble a series of letter T's.

At 9.00 a dot.

From 9.01 to 9.01, 55", a series of letter D's.

At 9.02 a dot.

From 9.03 to 9.03, 55", a series of figure 6's.

At 9.04 a dot.

From 9.10 to 21.00 Y.N. Arc 15,500 m., eventually duplex working with America without fixed times.

From 21.00 to 22.00 Y.N. Arc 8,000 m. Press for Holland (in French).

Remarks: On the 1st and 15th of each month Y.N. sends calibration waves in the same way as F.L. does.

At 18.20 and during a minute a series of "C's," then a sustained dash of three minutes 10,000 m. wave.

At 18.30 and during a minute a series of "D's," then a sustained dash of three minutes.

At 18.45 or at 19.00, according to the time necessary to making measurements Y.N. transmits the rectified values of F.L. and Y.N. and does this on a 15,000 m. wave.

Examples: "A" 5,070 m.

"B" 7,080 m.

"C" 10,025 m.

"D" 14,990 m.

Repeated three times.

### NEW FRENCH CALL LETTERS.

The following, forwarded to us by our French correspondent, gives the call letters of new French radio stations, as well as changes which have occurred up to date. As will be noted, the Bordeaux station is included. This station, according to advance information, promises to be the largest station in the world and will be known as a 1000 K.W. plant. Copy these calls in your call book and on your "Radio Map of the World," as you will probably hear some of them some of these cold, crisp static-less nights:

FFA Algiers.  
FFC Bonifacio.  
FFH Le Havre.  
FFM Marseilles.  
FFN Nice.  
FFU Ushant.  
FFX Bordeaux.  
FUC Cherbourg—Rouges—Terres.  
FUD Dunkirk—Casteinau.

# Vacuum Tubes Repaired

We repair the filaments and other elements in all types of vacuum tubes and guarantee them to operate equally as well as a new tube. In most cases they operate better. We produce wonderful oscillators, detectors, and amplifiers.

MARCONI VT DE FOREST VT  
MOORHEAD TUBES WESTERN ELECTRIC

**Repaired at Four Dollars and Fifty Cents each**

ELECTRON RELAYS  
OSCILLAUDIONS

**Repaired at Four Dollars each**

All Foreign-made receiving tubes repaired at Six Fifty and power tubes depending upon size.

We have purchased a large quantity of burned out Marconi Vts. and electron relays which we offer for sale at five dollars.

Remember these tubes are guaranteed good as new.

Dealers write us

**VACUUM TUBE REPAIR CO.**

511 Perry Building

Oakland, Cal.

## LICENSED BY DE FOREST AUDIOTRON

### *The Original Tubular Vacuum Amplifier*

The AudioTron Vacuum Tube is now manufactured and sold as a genuine audion licensed under DeForest Patents Nos. 841387 and 879532 to be used only for amplification in radio communication and only for experimental and amateur purposes and only in audio frequency circuits.

The\* AudioTron has a double filament of special thorium tungsten and the operating life is over 2,000 hours. No special socket is required. The electrical and mechanical dimensions result in a heavy plate current and corresponding signal strength. Plate voltage under 40. Our guarantee insures satisfaction.

**PRICE \$6.00 EACH**

If your local dealer cannot supply you we will ship postpaid when cash accompanies order.

*The AudioTron Exclusive Guaranty:* Each and every AudioTron is guaranteed to arrive in good condition and to prove fully satisfactory. Replacement of unsatisfactory tubes will be made free of charge.

**AudioTron Audio-Frequency Transformer \$7.00**

*Laminated closed core, two coil type.*

*DEALERS:—Write for our attractive trade Proposition.*

**AUDIOTRON SALES CO.**

Lick Bldg.

**SAN FRANCISCO, CALIF.**

# Up -- Down -- or Sideways

# ACE

Q matter how you want to look at "Ace" instruments, they are ideal for an up-to-date radio installation.

Doctor "ACE" has tonic for weak signals that give them some kick and on transmitting apparatus he sure has the dope. Better get acquainted with "Doc".

You may pay more, but you can't buy better.

## The Precision Equipment Co. (Inc.)

MANUFACTURING ENGINEERS

2437 Gilbert Ave., (Dept. A) Cincinnati, Ohio

## RADIO EXPERIMENTERS ATTENTION

Announcing the entrance into the radio field of the  
MUTUAL PURCHASERS ASSOCIATION

Amateurs and other purchasers of radio, electrical and experimental equipment and raw materials should write immediately for details of our co-operative purchasing plan. You can purchase through the association at a saving, almost any article advertised in this magazine. Your individual purchase receives the price benefits of our co-operative wholesale buying. A large percentage of the profit on your order will be returned to you in credit checks.

Recent purchasers obtained the following credits:

- \$2.00 in credit returned on TELEPHONE RECEIVERS listed at \$15.00.
- \$3.00 in credit returned on QUENCHED GAPS listed at \$18.00.
- \$8.50 in credit returned on 500 V 100 WATT MOTOR GENERATOR listed at \$85.00.
- 25c in credit returned on MICROPHONE TRANSMITTER BUTTONS listed at \$1.00.
- \$4.00 in credit returned on 6 V 40 AMP STORAGE BATTERIES listed at \$16.00.
- \$1.00 in credit returned on AUDIO FREQUENCY TRANSFORMERS listed at \$7.00.
- 10% in credit returned on HONEYCOMB WOUND COILS.

The above are but a few examples of profit sharing returns and are listed to indicate the savings obtained on apparatus of STANDARD MAKE.

This is solely a purchasing organization which has no goods to sell either of its own manufacture or any one particular make. Orders are filled immediately. Credit checks are forwarded when orders are shipped.

MANUFACTURERS: What have you to offer in quantity purchases in the radio line? We represent a growing buying power. Send catalogues and quantity discount lists. We can move your stock rapidly.

### SPECIAL OFFER

to members only, Marko 4 V. 60 Amp. Storage Batteries for \$7.00 Net.  
Supply of these batteries limited.

## MUTUAL PURCHASERS ASSOCIATION

Department AN-F

2-4 Stone Street, New York

- FUE Mengam.
- FUI Ajaccio—Aspretto.
- FUK Aran Aim el Turck.
- FUN Lorient—Pen—Mané.
- FUQ Porquerolles.
- FUR Rochefort-sur-Mer.
- FUX Toulon—Croix des Signaux.

## The Armstrong Super-Autodyne Amplifier

(Continued from page 471)

coils 40 volts is sufficient plate potential for the inductive amplifier, whereas 140 volts is necessary in the resistance coupled amplifier. The cheapness and ease of construction of the former type is another great advantage. However, in all fairness to the resistance coupled type of amplifier, it should be made clear that the inductive amplifier is much more difficult to adjust, although after once it is adjusted it needs very little attention. Its chief disadvantage is that it is efficient over a comparatively narrow band of wavelengths, which makes such a connection shown in Fig. 14 prohibitive in use with the inductive coupled amplifier.

A schematic diagram of connections of the inductive coupled amplifier used in connection with a capacity coupled oscillator is shown in Fig. 10. The choke coil may consist of a pair of telephone receivers. They prevent the condenser  $C_2$  from being short-circuited by the plate batteries. The phones in this position also serve other purposes. They may be worn to test for oscillation by listening for a double click when the grid is tapped with the finger. If it is desired to calibrate the oscillator, it is only necessary to bring the wavemeter near the oscillator inductance and adjust until a click is heard in the telephones. If two clicks are heard the mean condenser setting should be taken as that of the oscillator wavelength. By loosening the coupling until one click is heard in the telephones the exact wave may be found very accurately. Coupling coil  $L_2$  consists of about five turns of wire and may hinge or rotate in the end of the oscillator inductance.

A compact and very efficient method of construction and mounting of the transformer coupling to the fixed frequency amplifier and of the amplifier transformers coils is shown in the drawings of Fig. 11. This construction has given very satisfactory results in operation. A photograph of one of the transformer coils, "A," Fig. 11, is shown in Fig. 12.

The coupling coils to the fixed frequency amplifier, as well as the transformer coils, must be wound in the same direction. The inside leads of the primaries and secondaries must connect to plate batteries and filaments, respectively, for best results. Using electrical and winding data given in Figs. 10 and 11, the amplifier will be resonant at a wavelength of about 3,000 meters, but the exact wavelengths is immaterial as long as the frequency is not too high. After winding the bobbins, they should be placed on a shaft of hard rubber, bakelite or wood about fifteen inches long.

After the complete amplifier is assembled and connected, as in Fig. 10, it must be adjusted. The adjustment consists mainly in tuning each grid circuit to the wavelengths of the grid circuit of the preceding tube. The plate circuits are aperiodic. First adjust all  $L_2C_2$  circuits to resonance. Each of these circuits consists of a bobbin of 700 turns shunted by a fixed condenser of .0001 mfd. capacity. If the amplifier transformer coils are adjusted separately to the same wavelength with a wavemeter, the primaries of 350 turns, should be wound afterwards, as they will effect the adjustment. In most instances the wavelength adjustment may be effected by varying the amount of active material in the

## SPECIAL SALE!

We have on hand 2,000 Carbon Grain Transmitters as per photograph. They are first-class instruments and may be used for all kind of experiments, especially for wireless telephone sets, where a heavy current is to be passed through. Slightly used, but in perfect working order. Money refunded if not satisfied. A real bargain. Order one or more today.

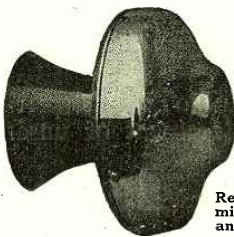

Reduced Photograph of Transmitter showing nickel plated case and Hard Rubber Mouthpiece

**\$1.00 ONLY**

Postage extra.

Ship. Weight, 2 lbs.

Diameter, 3 1/4 ins.

**THE ELECTRO IMPORTING CO., 231 Fulton St., NEW YORK**

condensers, loosening or tightening the screws slightly in some types of condensers, and in instances where sealed-in condensers are used, by varying the number of turns on the bobbins. In one amplifier of this type it was found that if the condensers were first measured and selected for uniform capacity, and the bobbin turns carefully counted so that all bobbins were identical, practically as good results were obtained as when each condenser was adjusted with its particular coil to conform to a certain wavelength.

Another quick and simple method of tuning the amplifier circuits consists in shunting a radio frequency buzzer in series with a battery across the condenser of  $L_2C_1$  of the primary of the coupling transformer between the frequency changer detector and the amplifier. Each grid circuits should be tuned until loudest signals are heard in the telephone. During this operation less trouble will be experienced if very loose coupling to the driver circuit is used and small plate potentials used on the amplifier tubes.

In Fig. 10 the condenser  $C_2$  in the grid circuit of the second tube is a variable of .0005 mfd. maximum capacity. This condenser is used to control the regenerative or feed-back action and, due to the small capacity needed here, it acts opposite in results to the feed-back condenser used in the resistance coupled amplifier circuit of Fig. 9. That is, the amplifier will appear more stable with the condenser at maximum and as its capacity is reduced greater amplification will be obtained until the point is reached where the amplifier oscillates. For best results the amplifier should be used just under the oscillating state unless undamp signals are to be received.

In Fig. 10 the grid leak of the detector tube is shown connected to the negative side of the filament battery. After building the amplifier this connection should be taken off and tried on the positive end of the filament. With certain combinations of tubes, grid leaks and plate potentials best results are obtained when the grid of the detector tube is run slightly positive. While adjusting the circuit of the inductive coupled amplifier some difficulty will be experienced due to the feeding back effect of the various coils upon each other. At first sight it would appear that with air coils in such a multi-stage amplifier at close range the coupling back effect would be impossible to eliminate. It has been found, however, that if the feed back condenser  $C_2$  is set near its maximum value and the transformer coils "A" pushed together and pulled apart, some combination will be found that will stop the oscillations. The capacity of  $C_2$  may then be further reduced and the adjustment continued until the coils are brought much closer together. In this manner it is quite possible in most instances to reduce the length of the shaft to nine inches, but unless space is a very important factor it is not advisable to cut the length of the shaft to less than 15 inches as the amplifier will be more stable in operation at the greater distance. After the amplifier has once been adjusted it will stay in adjustment almost indefinitely as long as it is properly taken care of and batteries kept in proper condition.

After building and adjusting the inductive coupled amplifier it may be combined with either the tuning system and inductive coupled heterodyne oscillator of Fig. 5 or the tuner and capacity coupled heterodyne oscillator of Fig. 10. The various troubles, their cause and remedies as well as testing of the complete receiver was covered as well as space permitted under the resistance coupled receiver. The receiver should also be calibrated and a calibration chart made as explained above.

Those who have but little experience with high frequency amplifiers should not be discouraged if they have trouble in getting

# THE BEST PRICE GIVES EFFICIENT EQUIPMENT FOR ALL

The Best Radio Supply Organization in the Central East



Doing the Largest Radio Supply Business in the Central East

## THE LIST ALL POSTPAID

### SPECIAL OFFERS

Postpaid when marked P.P.

Order by Number	Instrument	Regular Price	P.P.	Our Price
1.	Genuine AUDI-TRON BULB.....	\$6.00	PP	\$5.50
2.	SIGNAL CORPS "B" BATTERY—22.5 volt, 3/4x2x2 1/4.....	1.50	10c	1.25
3.	SIGNAL CORPS "B" BATTERY—22.5 volt, 6/2x4x3.....	2.50	35c	2.10
4.	SPECIAL NAVY & ARMY "B" BATTERY—22.5 volt, 14x8x6.....	6.00	70c	5.50
5.	STANDARD variable condenser, assembled, 48 plates, .001 mfd.....	4.00	PP	3.50
6.	Knock-down variable condenser, 47 plates.....	2.50	PP	2.25
7.	TRESCO variable condenser, 43 plates, knock-down, .001 mfd.....	2.75	PP	2.35
8.	Crystal detector, De FOREST. (Glass case, dust proof).....	2.60	PP	2.25
9.	Variable air condenser, no case, assembled, .0005.....	5.25	PP	4.90
10.	De FOREST HONEY COMB COILS—Type L-25, 130-375 meters.....	1.40	PP	1.30
11.	De FOREST HONEY COMB COILS—Type L-35, 180-515 meters.....	1.45	PP	1.34
12.	De FOREST HONEY COMB COILS—Type L-50, 240-730 meters.....	1.52	PP	1.40
13.	De FOREST HONEY COMB COILS—Type L-75, 330-1030 meters.....	1.60	PP	1.45
14.	De FOREST HONEY COMB COILS—Type L-100, 450-1460 meters.....	1.70	PP	1.54
15.	De FOREST HONEY COMB COILS—Type L-150, 600-2200 meters.....	1.80	PP	1.62
16.	De FOREST HONEY COMB COILS—Type L-200, 830-2850 meters.....	1.90	PP	1.70
17.	De FOREST HONEY COMB COILS—Type L-250, 1300-4000 meters.....	2.00	PP	1.88
18.	De FOREST HONEY COMB COILS—Type L-300, 1550-4800 meters.....	2.10	PP	1.87
19.	De FOREST HONEY COMB COILS—Type L-400, 2050-6300 meters.....	2.25	PP	2.00
20.	De FOREST HONEY COMB COILS—Type L-500, 3000-8500 meters.....	2.40	PP	2.14
21.	De FOREST HONEY COMB COILS—Type L-600, 4000-12000 meters.....	2.65	PP	2.37
22.	De FOREST HONEY COMB COILS—Type L-750, 5000-15000 meters.....	2.80	PP	2.50
23.	De FOREST HONEY COMB COILS—Type L-1000, 6200-19000 meters.....	3.30	PP	2.69
24.	De FOREST HONEY COMB COILS—Type L-1250, 7000-21000 meters.....	3.35	PP	3.00
25.	De FOREST HONEY COMB COILS—Type L-1500, 8200-25000 meters.....	3.60	PP	3.25
(All above coils have plug mount).				
26.	Direct reading wavemeter, 130-230 meters.....	6.50	30c	6.00
27.	High Frequency Buzzer, 500 cycle note (Improved type).....	2.25	PP	2.00
28.	High Frequency Buzzer, 500 cycle note (Original type).....	2.00	PP	1.85
29.	Graphite Potentiometer, 5000 ohms, complete.....	3.00	PP	2.75
30.	Wall Insulator (Special) 5 9/16" long (Electro type).....	1.40	PP	1.10
31.	Marconi VT base.....	1.50	PP	1.40
32.	De Forest Grid Leak.....	.75	PP	.70
33.	De Forest 11 ohm rheostat, porcelain base, complete.....	1.00	PP	.90
34.	Rheostat, back panel mount type, 5 ohms, complete.....	1.75	PP	1.60
35.	Panel type rheostat.....	1.00	PP	.95
36.	Volt meter. Reading to 8 volts.....	1.25	20c	1.15
37.	Volt meter. Reading to 80 volts, with resistance ready to mount.....	2.00	20c	1.75
38.	Ammeter reading 0 to 3.5.....	1.75	20c	1.60
39.	Barr Mercury-Cup Detector.....	4.00	15c	3.75
40.	Hard rubber V.T. bases.....	1.00	PP	.94

### SPECIAL NOTE:

We supply radio instruments to the radio amateur at a very reasonable price. All instruments are new, nothing second-hand; our SERVICE is for the radio amateur. This is a special offer for thirty days only. Consult us before buying; we can save you money. Drop us a line.

## The Best Costs You Less When You Buy From Us

Our 200 to 2500 meter loose coupler costs \$18.00. You cannot buy a better instrument if you pay more.

Mention Radio Amateur News

THE RADIO APPARATUS  
**SERVICE**  
 711—THIRTEENTH STREET, WASHINGTON, D.C.  
 "A SUPPLY COMPANY FOR THE RADIO AMATEUR"

Dept. 1-A

# RADIO APPARATUS

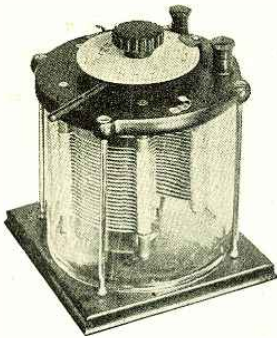

Distributors of Quality experimental and laboratory radio apparatus for high schools, colleges and individuals.

De Forest Type CV Vernier Variable Condenser in glass case.

"Ideal for wavemeter work and for a good laboratory standard."

Cat. No.	Cap. Mf.	Mounting.	Price.
CV-1000	.001	Unmounted without vernier.....	12.40
CV-1003	.001	Unmounted with vernier.....	14.25
CV-1010	.001	In standard glass case without vernier.....	17.50
CV-1013	.001	In standard glass case with vernier.....	19.50
CV-1500	.0015	Unmounted without vernier.....	14.00
CV-1503	.0015	Unmounted with vernier.....	15.60
CV-1510	.0015	In standard glass case without vernier.....	19.00
CV-1513	.0015	In standard glass case with vernier.....	20.60

Remember—We carry this material right in stock and can make immediate delivery postpaid to any part of the U. S. upon receipt of order. Give our service a trial!

Send 6 cents for new catalog just Out!

**F. D. PITTS CO. Dept. C,** 12 Park Square, Boston, Mass.

satisfactory results at first. Even the most experienced sometimes have some difficulty in finding some source of noise or other trouble. If each part of the amplifier is built carefully, with due consideration with respect to the placing of the various parts, connections adjustments, batteries, etc., and each part tested separately as units are added on to the circuit, the completed instrument will repay the builder in the results possible to obtain with its use.

With an amplifier similar to one of those described here ordinary amateur stations 1500 miles and more distant have been copied in New York City with only a three-foot loop antenna.

Such feats will be duplicated by the score in several months. These results are not to be classed as freaks but may be expected to take place regularly under normal conditions.

The photograph of Fig. 16 shows a laboratory set-up containing all essential apparatus for an Armstrong-Super Autodyne amplifier with additional auxiliary equipment.

While the above article has merely touched upon the elementary principles of setting up radio frequency amplifiers enough data has been given to enable an experimenter with a fair knowledge of electricity and radio telegraphy to construct, and intelligently operate, an Armstrong Super-Autodyne Amplifier.

Fig. 15

Wave-length	Tuner	Heterodyne	Oscillator Coupling
365	90	100-	1.
350	85	92-	1.25
300	67	71-89	2.
250	45	47-60	2.5
200	29	31-38	2.5
150	13	15-17	2.75
135	8	9-11	2.

Fig. 15—An Example of a Calibration Chart for an Armstrong Super-Autodyne Amplifier.

# ATTENTION AMATEURS

The only practical adapter

Price \$1.50

## RADISCO AGENCY

We make up sets to specifications

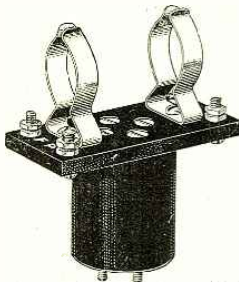

Made by the  
**AMATEUR WIRELESS EQUIPMENT CO.**  
1390 Prospect Ave., Bronx, N. Y.

SOLD BY

- J. H. Bunnell & Co., 32 Park Place, N. Y. C.
- International Electric Co., 224 Fulton St., N. Y. C.
- Manhattan Elect. Supply Co., 17 Park Place, N. Y. C.
- Wireless Equipment Co., 19 Park Place, N. Y. C.

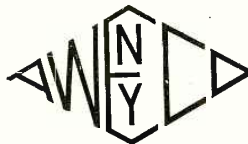

Dealers write for proposition

### CORRECTION.

In Mr. Houck's previous article of February, 1920, Fig. 5 on page 405 should bear the following correction: The B Battery of the resistance coupled amplifier should read 140 volts instead of 40 volts, as shown.

### TO ENLIST RADIO AMATEURS.

The first attempt to gather news by wireless from all parts of the United States was put into operation during the Cleveland Electrical Show, March 10 to 20. A wireless station capable of receiving messages from across the ocean, brought here by the United States Marines from Philadelphia, has been set up.

Amateurs everywhere are asked to send fifty-word news bulletins to the station between 9 o'clock in the morning and midnight. The amateurs are requested to get their stories from newspaper offices of their localities.

In many cases the newspapers have promised to give them in regular news style the best local news of the day.

### ANOTHER USE FOR RADIO-PHONE.

The first wireless telephone system in Kansas will be installed by a lumbermen's supply company, connecting its Topeka and Wichita offices, it was announced recently by W. E. Bullis, vice-president of the company.

### ERRATA.

The paper, Static Elimination of Directional Reception, by Greenleaf W. Pickard, which appeared in the January issue of the RADIO AMATEUR NEWS, should have been credited to the Institution of Radio Engineers, New York City. This paper was presented at a meeting of the Institute on November 5, 1919.

# WIRELESS AMATEUR

Send a 2c stamp for full description of the most efficient detector in the wireless field today. Tested by Marconi Wireless Telegraph Co. and U. S. Government. Instantly adjustable at a constant pressure.

L. STEWART BARR, Inventor, Vice-President of The Service Radio School  
THE BARR MERCURY-CUP DETECTOR Dept. B, The Wyoming, Washington, D. C.

**MONEY for YOU** Add to your Salary—Make extra Pin Money Start a lucrative business of your own. Spend an hour each day taking subscriptions for the "Radio Amateur News." We'll pay you well and you'll enjoy the work. Write for full particulars. Circulation Dept., RADIO AMATEUR NEWS, 233 Fulton St., N. Y. City.

You benefit by mentioning the "Radio Amateur News" when writing to advertisers.

**The Design of a I. K. W. Arc Converter**

(Continued from page 474)

Figs. 16 and 17. Electrode Leads—These connect the positive and negative electrodes with the two upper binding posts on each terminal block. The small holes in the negative lead are for securing the top bearing of the vertical shaft in place.

Fig. 18. Positive Electrode—This drawing is self explanatory.

Fig. 19. Terminal Block—The Steel cap screws which hold the core uprights against the iron plugs in the sides of the chamber also serve to hold the terminal blocks in place. The dimensions of the holes for securing the binding posts are left to the builder.

Figs. 20, 21, 22, 23 and 24. Core Details—The two uprights and the yoke form the main body of the magnetic circuit. These lead the flux thru the iron plugs shown in Fig. 23 to the pole tips shown in Fig. 22. The pole tips are insulated from the plugs and are held in place by the insulating pieces of Fig. 24. These insulating pieces prevent the passage of any high voltage leak to the arc chamber and other parts which may result from the arc's blowing out to the side in starting.

The material used in constructing the above insulator is the same as that used in constructing the soot discs heretofore mentioned.

Fig. 25. Solenoids—The spools for these are made of 1/4-inch Bakelite sheet, the parts being held together preparatory to winding by the sheet brass or copper sleeve inside, the ends of which are molded around the end pieces of the spool. To assemble a spool, a wood core must be used, and during the process of winding a wood block secured to this core at each end of the spool should be used to prevent the wire from pushing the spool ends out of place. During the process of winding each layer should be given a good coat of insulating varnish (not shellac, under any circumstances) and a sheet of fiber paper interposed between every other layer. After the winding is completed, the coils should be baked to thoroly dry the varnish—the length of time and temperature required will, of course, depend upon the nature of the varnish used. Cotton insulation should not be subjected to temperatures in excess of 200° F. Most insulating varnishes bake best at 150° to 175° F. for 24 to 72 hours.

Additional Fittings—The gas connections are 1/8-inch globe valves fitted to the bottom of the chamber. One valve has a single hose connection and the other (the inlet valve) has a double hose connection consisting of a "T" with two extensions. One of these extensions leads thru a hose connection to the alcohol feed cup.

The top binding posts on each terminal block should be of sufficient size to take a number ten stranded conductor, and as these will more than likely be purchased from stock, no other specifications need be given.

The bottom binding posts for the solenoid terminals will be used in the supply circuit where stranded wire is unnecessary; hence, they may be made much smaller than those referred to above.

Any good air-tight sight feed oil cup having a connection to the space above the liquid so that the chamber pressure may be applied there will serve as an alcohol feed cup. It should have a capacity of about three fluid ounces.

**OPERATION NOTES.**

1. Insert choke coils between the electrodes and solenoids (blow-out coils).



**DUCK'S** New Big-264 Page No. 13 Wireless and Electrical Catalog

Will be mailed for 12c in stamps or coin which may be deducted on first order of \$1.00. Catalog not sent otherwise.

We regard this catalog as our greatest effort. It embraces everything in wireless worth while. 172 pages with no waste space devoted exclusively to wireless instruments. Your amateur friend will tell you that there never has been any wireless catalog to take the place of catalog of this company and above all that you can absolutely depend on our goods. There is no need for any other catalog when you have this big catalog.

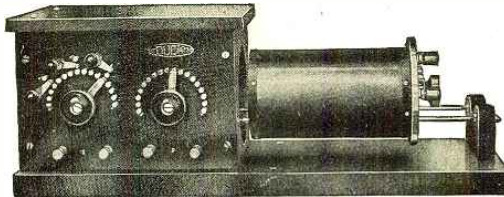

NEW MODEL SBB, NAVY TYPE RECEIVING TRANSFORMER

A big improvement over our former model. Primary divided into four sections, with three dead end switches, greatly improving selectivity.

Secondary divided into three sections, with two dead end switches, eliminating harmonics. The change in the construction of the guide rod support makes it possible to obtain a looser coupling. It is a wonderful improvement over our old model both in performance and appearance. Only \$23.50.

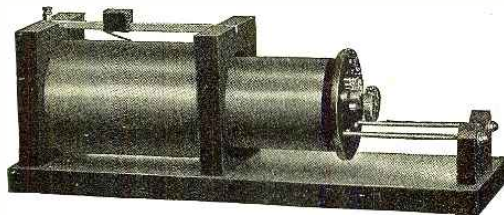

OUR IMPROVED ARLINGTON RECEIVING TRANSFORMER

The secondary on our new type Arlington is divided into three sections with two dead end switches eliminating dead end effect and harmonics and giving greater selectivity. The end support is similar to that on our Navy type permitting a looser coupling. It is a beautifully finished instrument.

Price only \$10.50.

THE WILLIAM B. DUCK CO., 230-232 Superior St., Toledo, Ohio

**"Old Town Canoes"**

OLD TOWN CANOE CO.  
953 Fourth St.  
Old Town, Maine, U. S. A.

**Every Stroke Counts**



Laze along in the alder shadows or shoot through swift water, an "Old Town Canoe" will obey every move of your paddle. Light as a bubble, graceful as a swan, but staunch as a scow. The "Sponson Model" is the safest canoe made—safer than most row boats. Write for catalog. 3000 canoes in stock. \$67 up. At dealer's or factory.

**LEARN WIRELESS**

TEL. BACK BAY 5964

**EASTERN RADIO INSTITUTE**

899 Boylston St. Boston, Mass.

Our prospectus for the asking

Splendid opportunities now in the Merchant Marine. Big salaries. All graduates GUARANTEED good positions by one of the largest Wireless Telegraph Companies operating hundreds of ships to all parts of the world. REMEMBER: We are the OLDEST, LARGEST and BEST EQUIPPED school of its kind in New England, and have THOUSANDS of satisfied graduates to our credit. THIS SPEAKS FOR ITSELF. Day and Evening classes. Advanced classes in Radio Theory and code. Start any Monday.

**UNIVERSAL SYSTEM RADIO APPARATUS**

Efficient Equipment for all purposes  
Damped and Continuous Waves  
Send stamp for catalogue  
UNIVERSAL RADIO MANUFACTURING CORP.,  
Dept. W., Elmira, N. Y.

**Arnold**

**Loose Couplers**

Combination Loose Coupler Parts and accessories.  
Send 3c stamp for literature which is sure to interest you.  
J. F. ARNOLD  
2082 Lexington Av. N.Y.  
Established 1910

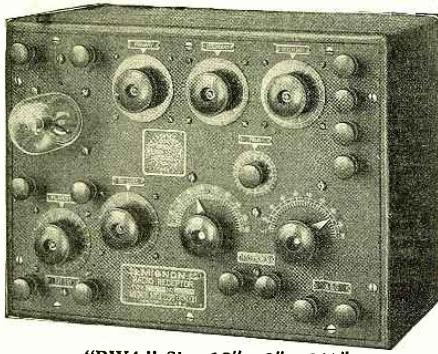

"RW4," Size 12" x 9" x 6 1/2"

## MIGNON "RW4" UNDAMPED WAVE RECEPTORS

**NO** Loose Couplers  
Loading Coils  
Variometers  
Amplifiers

Strongest, Most Distinct Signals

### IMPORTANT—NOTICE

Ernest C. Mignon, inventor of the famous disc-core undamped wave receptor, is no longer connected with the Mignon Wireless Corporation, of Elmira, N. Y., or their successors—the Universal Radio Mfg. Corp. Address all communications for Mignon apparatus to

**MIGNON MANUFACTURING CORPORATION, Newark, N. J.**

### DAMPED AND UNDAMPED WAVE APPARATUS FOR ALL PURPOSES

Endorsed by Radio Department of D., L. & W.  
R. R. Co.

Write for Literature.

**MIGNON MFG. CORP.**  
NEWARK, N. J.

Dept. R.

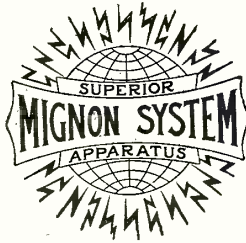

## WIRELESS APPARATUS

We manufacture the celebrated OMNIGRAPH Automatic Transmitter for teaching the Wireless and Morse Codes. We have had a long and successful experience in the Wireless field and have been at this same address for more than 12 years.

When in need of Wireless Material of any kind—from a binding post to the most expensive Receiving Set—avail yourself of our long Radio experience and take advantage of our expert Technical advice

## FREE of Charge

Send us your order for ANYTHING you desire, at the SAME price as listed or advertised in any catalog or magazine. We will purchase it and forward to you PROMPTLY. If it cannot be secured PROMPTLY, we will so inform you and return your money.

We will give you SERVICE and will charge you nothing for it. Our standing and credit with the leading Manufacturers is unquestioned. Let us have your orders—large or small—you are assured of real service at no extra cost to you.

**THE OMNIGRAPH MFG. CO.**  
39 Cortlandt Street New York

Arthur Batcheller

R. F. Trop

Guy R. Entwistle

### MASSACHUSETTS RADIO and TELEGRAPH SCHOOL

Conceded by the Radio Fraternity to be the best equipped  
Radio School in New England. Write for literature.

18 BOYLSTON ST.

Tel. Beach 7168

BOSTON—11—MASS.

Ordinarily, choke coils are used in a circuit to smooth out a current which is more or less pulsating, or subject to irregularities of that nature. As used in connection with arc converters, their purpose is fundamentally to prevent high-frequency surges from entering the supply circuit and causing damage to unprotected windings in that circuit. Almost any form of inductance, if it be great enough, will smooth out a current flowing thru it; but, in order to act as a barrier to high-frequency currents, the capacity between component parts must be negligible. Ordinary multi-layer coils are therefore not desirable. Contrary to much misleading information that has circulated about, iron cored inductances may be used. Such inductances should, however, consist of but one layer of wire and this should be separated from the core by at least 3/8 inch of air space. The writer has found that for such a converter as this a 3-foot length of 4-inch wrought iron pipe wound with one layer of number 14 D. C. magnet wire, separated from the pipe as stated above, inserted in each leg of the circuit, serves the purpose admirably.

2. The blow-out coils may be excited from a source of power other than that used for the arc, but, as these coils aid the choke coils materially in smoothing out the irregularities such as "commutation," they should preferably be left in the supply circuit. The polarity of the magnetic field should be such that the arc is deflected upward.

3. In starting the arc after it has cooled off, and when little or no gas remains in the chamber, it is a good plan to short-circuit the blow-out coils, thereby eliminating their effect upon the arc. The arc may then be struck and the chamber will warm up very rapidly, volatilizing any alcohol remaining in it, or administered into it, thereby bringing the chamber to its operating condition before any oscillations are started. This will eliminate bubbling of the arc in starting, which produces very disagreeable effects upon neighboring receiving installations. An alcohol supply of about ten drops per minute should be sufficient to maintain a filled chamber of gas, and if more than this is necessary, it is almost certain to be due to chamber leaks.

4. Wave-lengths in excess of 3000 meters should be used for best results. In order to facilitate operation at the higher frequencies, it will be necessary to increase the transverse field strength very materially.

5. When using full power, be sure that the energy in the oscillating circuit is being transferred to some absorbing or radiating system; otherwise practically all the input energy will be dissipated in the form of heat in the arc, and dangerously high temperatures may result.

6. The correct arc length will depend upon the voltage applied, the field strength, the constants of the oscillating circuit and the nature of the electrodes used, which should be of the hard uncured variety of carbon in the case of the negative electrode and rolled copper for the positive one. Ordinarily the arc length will be about 3-32 inch.

7. Do not allow the arc to become short-circuited by the circulating water system. A 10-gallon bottle fitted up to discharge by gravity thru each electrode cooling system is a suggested solution to the problem of avoiding this kind of short-circuit. Many experimenters have attempted to use a great length of rubber hose in lieu of an isolated system like the one suggested. It is obvious that such a substitute can be made, but it must be remembered that the resistance of this water path must be great because of the high voltage used. It should be remembered that the high-frequency resistance of a water conductor is relatively



low, owing to the uniform current distribution in such a conductor.

Screws Required				Used for Securing
Size	Length	Material	Quantity	
1/8"-10	3"	Steel cap screw	2	Uprights to pole pieces (with washers)
1/8"-10	1/2"	do	4	Yoke to uprights (with washers)
1/4"-20	3/8"	R.H.B. mach.	24	Water jacket and pos. electrode holder to fibre washers, and washers to chamber.
1/4"-24	1/2"	do	1	Pos. electrode in holder
0-32	1/2"	do	2	Journal clamp
0-32	1/2"	do	4	Pole tips to insulating pieces
0-32	1/2"	Steel no head	1	Carbon tips, or adapters to elec. holder
6-32	1/2"	R.H.B. mach.	2	Vertical shaft bearing to elec. lead.
x	1/8"	do	8	Binding Posts
1" x 16	R.H.B. wood	do	8	Yoke straps to base
3/4" x 6	R.H.B. wood	do	4	Vertical shaft bearing to base

Complete List of Screws Required for the Construction of This Arc.

8. It has been possible to put nine amperes into an antenna having a resistance of 15 ohms with this converter operating at 3 K.W. input. Owing to the fact that this converter was designed principally for laboratory work, and to the fact that little opportunity was offered for actual transmission tests because of the proximity of the Naval Academy Laboratory where the work was carried out, to so many government radio stations where interference might have been caused, little work, other than that for which it was designed, was done. Work with it, however, covered a period of eleven months and embraced all phases of its operation.

### Autobiography of a Girl Amateur

(Continued from page 490)

be the reading of strenuous and war-like phrases, such as "loud 500 cycle note jamming," "43K calling 96E," "testing going on," "time signals from NAA," etc.

Now that the fuss is all over, I have hooked up my set once more, which has grown to considerable proportions and includes vacuum tube and honeycomb coil reception. I have been assigned a temporary permit and call letters under my brother's name, who, by the way, has become a real "ham," and you boys may now hear me working my set most any evening; that is, when I am not copying "POZ" or "LCM" on my three-step amplifier. Many a naughty "ham" has been seriously "bawled out" by me, never knowing that a mere girl was doing the "b.o." at the other end of the ether space.

In conclusion, I want to tell you boys that I have always been a deep-dyed-in-the-wool amateur, the same as you have, and probably always will be, even after I am married—my husband simply will have to stand for it. I shall see, however, that my experimenting does not interfere with the regularity of his meals. As a matter of fact I would rather buy a new storage battery for my vacuum tubes than buy a new spring hat—that is how I feel about it.

Let us hear a little more from other girl amateurs. I feel certain there must be quite a number of them in the United States. Who knows, perhaps some future day will see radio being employed as a medium of communication for the proper and conventional exchange of *billets doux*, as they say in France, and possibly a few Cupid's arrows will be radioed back and forth.

P. S.—Do not bother the editor by writing him and asking him for my name and address, as he has given me his word that he positively will not disclose my identity.

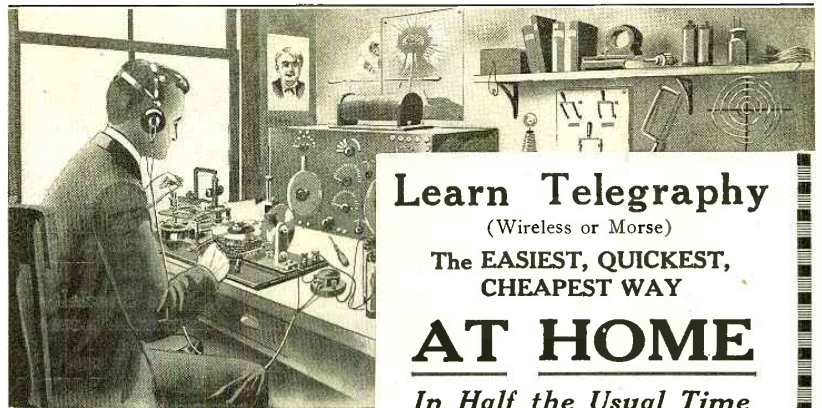

## Learn Telegraphy

(Wireless or Morse)

The EASIEST, QUICKEST, CHEAPEST WAY

## AT HOME

In Half the Usual Time

# WITH THE OMNIGRAPH

"Just Listen—The Omnigraph will do the teaching"

The Omnigraph is an *Automatic* Transmitter that teaches you both the Wireless and Morse Codes, at home, without any expense except the cost of the machine itself. Merely connect to battery and your Buzzer, or Buzzer and Head Phones, and the Omnigraph will send unlimited messages by the hour, at any speed you desire.

USED BY THE U. S. GOVERNMENT

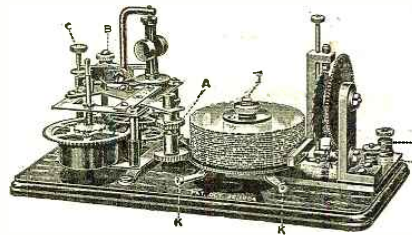

The Omnigraph is used by the Government in testing all applicants applying for a Radio License. It is also used extensively by the large Universities, Colleges and Telegraph Schools throughout the Country for teaching Wireless and Morse. Hundreds of the Army's skilled operators who served during the war learned with the Omnigraph.

## Let The OMNIGRAPH Teach You Wireless

For a few dollars you can have a complete outfit that will make you an experienced operator in the shortest possible time. No hard, laborious work—just learn by listening. The Omnigraph is adjustable so you can start receiving messages slowly, gradually increasing the speed as you become proficient.

You'll be surprised how quickly you will attain speed. Even if you are already an operator the Omnigraph will help you. It will make you more proficient, more accurate and more confident. Thousands of Omnigraphs are in use to-day and thousands of operators owe their success to them.

### Write for Free Catalog

Send for a catalog to-day, showing the 3 different models, \$12.00 to \$28.00. Every Omnigraph is sold with the absolute guarantee that you must be satisfied or your money back for the asking. Mail the coupon to-day—the catalog will come to you by return mail.

The Omnigraph Mfg. Co.,  
39 F Cortlandt St.,  
New York City.

Gentlemen:—

As per your ad in Radio Amateur News please mail me your free catalog of Omnigraphs.

Name .....

Address .....

City..... State.....

## WILCOX PANEL SWITCHES

TYPE 101

A beautiful and efficient standardized switch for general use. Furnished in two sizes.  
1" Radius, Brass finish...40c Nickel finish...50c  
1 1/2" Radius, Brass finish...50c Nickel finish...60c

TYPE 102 (Illustrated)  
A compound switch especially suitable for the primary of loose couplers. 1 1/2" outside radius.  
Brass finish.....\$1.10 Nickel finish.....\$1.25  
ALL POSTPAID

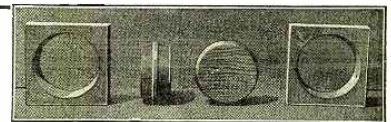
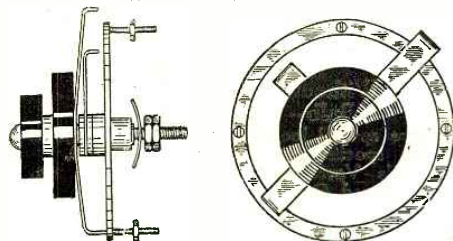

## VARIOMETER PARTS

Turned from hardwood. Set as shown consisting of stator (two parts), rotor and form for winding coils. Postpaid \$2.50  
Size of stator 5 1/2" sq.

Other sizes made to order.  
SET NO. TWO contains all parts for the variometer including the above and knob, scale, pointer, shaft, binding posts, wire and instructions for assembly. Postpaid \$5.00

### BUILD YOUR OWN APPARATUS

Our standardized parts and materials make it easy to build efficient apparatus that is beautiful and uniform in appearance.  
NEW LOOSE LEAF CATALOG READY  
Sent for five cents in stamps.

The Wilcox Laboratories  
Lansing Dept. G Michigan

# GALENA

UNMOUNTED Navy Regulation Size GUARANTEED  
**25c EACH POSTPAID 5 FOR \$1.00**

My vast practice in all DETECTOR MINERALS enables the Amateur to come in direct contact with REAL GALENA. This material is personally selected at the mines, every piece cut to the proper size and TESTED ON ARLINGTON SIGNALS.

Former mineral cutter and selector for the Wireless Specialty Apparatus Co., who supplied the NAVY and commercial companies.

## FUSIBLE METAL

SUFFICIENT QUANTITY FOR MOUNTING POSTPAID 25c

**R. BROWNLIE**

27 OAKLAND AVE.

EVERETT, MASS.

## AT LAST

### A Two Stage Audio Frequency Amplifier

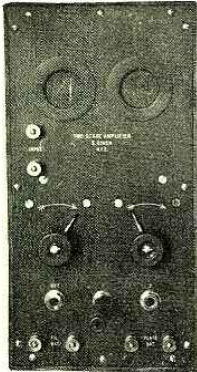

which does not squeal, howl or whistle is being offered to the Amateur. This being the "Saco" Amplifier, which amplifies radio telegraph and telephone signals with maximum intensity and with no distortion of the incoming wave. Plug and jack system being used for connecting the receivers to either detector, first or second stage amplifier.

The very best engineering skill has been applied in designing the amplifier and the highest grade material and workmanship used in the construction of this unit.

**PRICE "Saco" type A-2 Audio Frequency Two Stage Amplifier \$50.00**

**HUDSON RADIO CO.**

182 Pulaski St., Brooklyn, N. Y.

Sole Distributor of S. Cohen products in U. S. and Canada.  
 Dealers and Agents write for proposition.

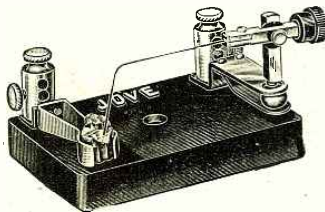

(GHEGAN PATENT)

**Bunnell** INSTRUMENTS  
 Always Reliable

### JOVE DETECTOR

Handiest, Handsomest, Best.  
 Sample by Mail, \$1.80  
 Tested Galena Crystal, 25c

High Grade, Inexpensive Keys, Transformers, Condensers, Spark Gaps, Receivers, etc.  
 Send stamp for new edition 42RN Catalog.

**J. H. BUNNELL & CO., 32 Park Place, New York**



**American Electro Technical Appliance Co.**  
 235 Fulton Street New York City

A wonderful Audion Panel, used as a detector, oscillator, or one-step amplifier; especially designed for commercial and laboratory use where a variety of circuits for different tests is desired, as illustrated.

Without Bulb—\$67.50.

Bulb—\$7.00 extra.

We have special loose coupler parts, complete with specifications, slider type—\$4.00.  
 DeForest's Variable Condensers—\$5.25 up.  
 Amrad Quenched Gap—\$17.50.  
 Catalog soon ready—send 10 cents for it.

## Dictionary of Technical Terms Used in Radio

(Continued from page 494)

to which the driving current is applied. wound round an insulated cable.

*Armstrong Circuit*—See regenerative circuit.

*Artificial Magnet*—One produced by magnetizing a previously unmagnetized piece of iron or steel.

*Asbestos*—An incombustible mineral having a fibrous texture. A poor conductor of heat, or a good insulator for heat.

*Astatic Galvanometer*—One having an astatic pair of swinging needles.

*Astatic Pair*—Two magnetic needles of equal length and strength fixed parallel with unlike poles adjacent and with magnetic axis in same vertical plane.

*Asynchronous*—A motor which does not run in synchronism with the driving alternating current.

*Atmosphere*—A complex mixture of gases, principally oxygen and nitrogen in a proportion of 21 to 78, surrounding the earth with a thickness or depth of about 100 miles, beyond which is presumed to be a nearly perfect vacuum. Pressure at earth's surface is about 14.75 lbs. per sq. in. Density about .08 lb. per cubic foot. Commonly referred to as air. Unit of pressure is atmosphere which is equal to a column of mercury 30 inches high at 0° C.

*Atmospherics*—See Xs, strays, static.

*Atom*—The smallest portion of an element that can take part in a chemical action.

*Atomic Weight*—A.W. Weight of an atom of an element compared to one of hydrogen, which is generally taken as unity.

*Au.*—Aurum. See gold.

*Audion*—A De Forest type of valve detector. Its distinctive feature is the third electrode. De Forest's own definition is, "A relay operated by electrostatic control of currents flowing across a gaseous medium." It consists of three electrodes in an evacuated bulb, one of these being a heated filament, the second a gridlike electrode, and the third a metal plate. See valve, amplifier, rectifier, tube.

*Aurora Borealis*—Luminous atmospheric and electrical phenomenon radiating from earth's northern magnetic pole. Believed to cause certain static disturbances.

*Audibility Meter*—An instrument used to measure approximately the comparative strength of incoming signals.

*Automatic Transmitter*—Instrument for high speed transmission operated by a specially perforated paper tape running between small brass wheels. See perforator.

*Auto-Transformer*—A direct coupled transformer.

*Axis of Magnet*—Shorted line joining the two true poles.

**THE AMERICAN AMATEUR HAS COME INTO HIS OWN.**

Mr. Marconi recently acknowledged that the United States headed the list of nations foremost in wireless inventions, and in general development of the possibilities of radio electric waves. Probably one of the factors contributing mostly to this may be directly ascribed to the American radio amateur.

Remember this: British and French periodicals are constantly pounding away on their respective governments for a general amateur radio operating liberty similar to ours. They advance a good argument in their favor, the fact that we Americans who enjoy amateur privileges have done more for the advancement of the art than any other countries. However, these amateur privileges will only be tolerated providing every radio man minds his p's and q's and does not violate the confidence placed in him by the American government.

**"When the Lights Grew Dim"**  
(Continued from page 491)

hastily constructed in one day. The apparatus ranged from crude mineral sets to delicate receivers with many steps of amplification. Those who sold wireless apparatus certainly did an excellent business. Everyone was now in readiness and waiting to hear the demands of the unknown individual, millions of miles distant.

No station was transmitting and the ether was undisturbed from wireless waves. The interfering Japanese were quiet for once in their lives. Not a sound except a little static broke the profound stillness. All detectors were adjusted to their highest degree of sensitiveness. Those possessing powerful receiving apparatus had many visitors that evening. It lacked but a few minutes of one, and everything was laid aside and phones clapt tightly to many hundreds of ears. Men who had been nervously smoking blew their final cloud toward the ceiling and threw away the tobacco. All talking ceased.

The station of Ralph Hamilton, one of the most powerful receiving stations among amateurs, was one of those who had received the strange wireless telephone the night before. No one was at Hamilton's station but himself. Many were the requests that Hamilton received that day to have visitors in the evening, but none did he grant. When the fellows stopt calling him "Ham"—a sobriquet derived from his name—he would give them some attention. Because of the fact that Hamilton used a small spark coil for transmitting while the other amateurs possessed powerful transformers, was no reason why he could not receive long distances.

European stations were easily readable in the day time at Hamilton's station, as well as other far-away signals. No one had yet seen his station and all they knew was that he had a spark coil. Such a degenerating piece of apparatus! When he told the fellows that these long-distance words were heard they simply could not believe it and called him "ham," and thus the name stayed.

It has been said before that Hamilton possess a sensitive receiving set. He was not interested in transmitting; thus only the spark coil. To-night Ralph Hamilton was one of the most excited young men in the city. The night previous he had received the voice from Mars so loudly that he had used a mineral detector instead of his audion and amplifiers. With a poor piece of mineral the signals had been loud enough to have been heard many feet from the phones.

This perplexed Hamilton. Certainly the other fellows had not received the voice as he had. Over the air he had heard amateurs say that with their audion detectors the signals were as loud as those transmitted by the San Francisco station. Hamilton, however, was taking no chance of missing the powerful voice from Mars, and consequently five little filaments burned brilliantly in his station. The hour of one was approaching and in a few minutes the voice would make its demands. Would it fail to speak?

His watch was set correctly with the government "time" signals. As the minute hand rested on twelve and the hour hand on one, every bulb on Hamilton's set seemed to "lock" from the loudness of the incoming signals. Quickly changing over to the mineral detector, the signals were again loud and clear.

"I see," said the voice, "I have a large audience. Ha! It affords me extreme pleasure to gaze upon your interesting faces.

**"SHRAMCO"**

**Reliable Wireless Apparatus  
Standardized Parts  
Raw Materials**

"SHRAMCO" switch points and knobs have long been standard. Our 24 page Catalog H contains complete line. Do you need KD Variables, Instrument Switches, Plugs, Jacks, Coils, "B" Batteries, Indicating Dials, Etc.? If so SEND 5c IN STAMPS FOR COPY TODAY AND WE WILL PLACE YOUR NAME ON LIST FOR FUTURE BULLETINS WITHOUT CHARGE.

**SHOTTON RADIO MANUFACTURING CO.**  
P. O. Box 3 SCRANTON, PENNA.  
Branch—8 Kingsbury St., JAMESTOWN, N. Y.

**NEW MOTORS**  
FACTORY GUARANTEED - ALL SIZES - IN ORIGINAL BOXES  
**Your Opportunity** To Buy New Guaranteed Electrical Apparatus of Standard Manufacture.

Single Phase Motors	Charging Generators	Polyphase Motors	Battery Charging Outfits
110 220 volts, A. C., 60 cycle, 1800 R. P. M. with pulley	Suitable for all lighting Battery Charging and Power Requirements.	2 and 3 phase, A. C., 220 v, 60 c. 1750 R.P.M., complete with base and pulley.	To operate on A. C., 60 cycle, single phase voltage as specified.
1/4 H. P., 110 volts, induction, full load start. \$24.50	8 volts, 10 amp. \$16.50	1/2 H. P. \$42.50	110 volts, A. C., 100 watt, 24 volts, without switchboard \$40.00
1/2 H. P., 110-220 volts, induction, full load start. \$38.50	15 volts, 10 amp. \$21.00	1 H. P. \$59.50	110 volts, A. C., 150 watt, 24 volts, with switchboard \$68.50
1/2 H. P., 110-220 volts, repulsion, for compressor \$46.50	40 volts, 6 amp. \$24.50	2 H. P. \$72.50	110-220 volts, A. C., 250 watts, 24 volts, without switchboard \$75.00
1 H. P., 110-220 volts, repulsion, with sliding base \$67.50	110 v, 2 1/2 amp. \$24.50	3 H. P. \$84.50	220 volts, A. C., 200 watts, 30 volts, without switchboard \$85.00
2 H. P., 110-220 volts, repulsion, sliding base \$108.50	40 volts, 12 amp. \$38.50	5 H. P. \$102.50	110 volts, A. C., 375 watt, 36 volts, without switchboard \$85.00
3 H. P., 110-220 volts, repulsion, sliding base \$124.50	110 volts, 5 amp. \$38.50	1 H. P., high speed, 3600 R.P.M., 228 v. \$36.50	220 volts, A. C., 500 watts, 48 volts, with switchboard \$110.00
5 H. P., 110-220 volts, repulsion, sliding base \$164.50	40 volts, 25 amp. \$58.50	110 volts, 18 amp. \$58.50	72 volts, A. C., 750 watts, 72 volts, without switchboard \$125.00
	Moving Picture Arc Generator \$85.00		

WRITE FOR CATALOG. BARGAINS IN MOTORS AND GENERATORS

**1/4 SPECIAL** 110 volts, A. C., 50 c. S.P., 1750 RPM. Complete, cord, plug & pulley. MONEY BACK. **\$19.75 EACH**

**WASHING MACHINE MOTORS** Suitable for operating Small Coin Presses, Coffee Grinders, Bottle Washers, Etc. Reg. Value \$22.50. **\$19.75 EACH**

GUARANTEE: 25% deposit required on all orders. Balance C. O. D. by Express. Shipping Terms: Sight draft with Bill of Lading attached by freight.

MANUFACTURERS' DISTRIBUTER  
**CHAS. H. JOHNSTON, Box 16, West End, Pittsburgh, Pa.**

**Wireless Amateurs, Dealers and Manufacturers!**  
Have You Seen the  
**"DEPENDABLE"**  
Line of Radio Instruments and Complete Sets?  
We manufacture a large line of **DEPENDABLE** apparatus—not the cheap mail order variety, yet our prices are low. Tuners, Couplers, Detectors, Fixed and Variable Condensers, Loading Coils, etc., also Binding Posts, Switch Points, Switch Levers, etc., etc.  
Send for New Catalog No. 9  
**DORON BROS. ELECTRICAL CO. Hamilton, Ohio**

**ARE YOU SELF-CONSCIOUS?**  
Embarrassed in company, lacking in self-control? Let us tell you how you can overcome these troubles.  
**THE VERITAS SCIENCE INSTITUTE**  
1400 Broadway DESK 24 New York

**STAMMER**  
If you stammer attend no stammering school till you get my big new FREE book and special rate. Largest and most successful school in the world curing all forms of defective speech by advanced natural method. Write today. North-Western School for Stammerers, Inc., 2366 Grand Ave., Milwaukee, Wis.

## Mesco Radio Buzzer

With Shunt Resistance—  
U. S. Navy and U. S. Army  
Standard.

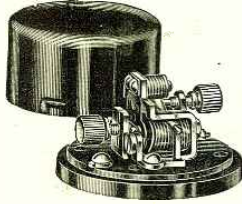

The Radio Officers of the NC planes, after testing all other buzzers, decided to use the "Mesco" on their radio equipment. The R-34 was equipped with two of them.

Why? Because of its reliability and constancy in operation; greater output efficiency; ease of adjustment; unaffected by extreme variations in weather conditions; exposed wire eliminated.

Sparking is almost entirely eliminated, so that the energy lost in light and heat in the operation of other buzzers is here conserved and radiated in the form of oscillating energy.

This buzzer maintains a constant note and is recommended as an exciter for checking wave-meters where pure note and ample energy are required.

List No. 55. Mesco Radio Buzzer. Price...\$2.05

We carry a very large and complete line of standard wireless apparatus and solicit your inquiries. Wireless experts in all of our stores.

### M-10 Wireless **MESCO** Manual M-10

About March 15th we will have ready for distribution a new Manual and Catalog of standard radio material illustrating and describing in detail the various instruments used in connection with the transmission and reception of wireless messages. No expense has been spared to make this Wireless Manual complete and up-to-date in every way so as to be of assistance not only to the amateur, but also to the professional user and experimenter in the most fascinating of all modern arts.

The size of the Manual will be 5 1/2" x 9" and will contain approximately 180 pages.

If interested send in your name and address and a copy will be sent to you as soon as issued.

**Manhattan Electrical Supply Co., Inc**  
New York: 114 So. Wells St. St. Louis: 1106 Pine St.  
Chicago: 604 Mission St. San Francisco: 604 Mission St.

**Special** While they last, regular \$10.00 radiation meters; range 0-2 and 0-2 1/2 amps. **\$5.00**

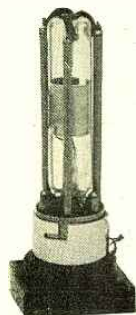

### The ORIGINAL AUDIOTRON ADAPTOR

Consists of a standard 4 prong base with appropriately placed brass pillars to accommodate five leads. Practical and convenient.

**\$1.75 EACH** Postpaid Pat. Applied For

New "VT" Socket, \$1.00

One look convinces you our Paragon Filament Rheostat is the best. The 6 ohm non-oxidizing resistance, permits fine adjustment on 4 or 6 volts. Cast in heat-proof Condensite 3/4" dia. for back or front mounting.

**\$1.75 Each, Postpaid**

**RADIO EQUIPMENT CO.**  
630 WASHINGTON ST. BOSTON, MASS.

### WATCH FOR OUR "AD" IN THE APRIL ISSUE

covering our new **Radio Ammeter ROLLER-SMITH COMPANY**  
15 Barclay St., New York, N. Y.

READ THE CLASSIFIED ADVERTISEMENTS ON PAGES 525-527

Great Scott, man! Have you more secret service men with you? Let's see. One, two, three, four, five."

The knowledge that the mysterious man posset was bewildering. He had counted exactly the number of men seated beside the operator in the government station at San Francisco.

"Five," went on the voice, "and that constitutes the whole secret service force, I suppose. Well, you can do nothing. I shall now make my demands."

Every operator listened breathlessly. Altho excitement was at its highest pitch, not one word was uttered and all waited intently for the voice to continue.

"I demand," said the man. "I demand Radium! Radium! Five ounces of Radium! Why do you laugh?" This he asked as one of the secret service men at the San Francisco station laughed loudly at the idea of transferring radium to Mars.

"Oh, I see," the voice proceeded. "You wonder how I shall be able to get it? On the island of San Burno I wish the radium placed. My method of obtaining it after being placed on the island will not be revealed. I warn you that any attempt to capture me will not meet with success, and if I discover that any attempt is to be made you may expect every wireless station to be blown to atoms. I mean exactly what I say; I have tremendous power."

The man continued to give precise instructions for placing the radium on the island, some hundred miles off the coast. The island would have to be vacated on the following day, the man on Mars told them. He would secure the radium on the night that the island would be unoccupied.

"Beware of any attempt to capture me," ended the voice, "I have power, power, tremendous power." Again came the whirl of a dynamo, then all was silent.

The ether was completely "dead." Not a sound could be heard in the phones of any set. When the voice had first started speaking Ralph Hamilton had noticed that the light in his room became darker. As the mysterious inhabitant of Mars ceased, the light became normal again. This was another condition that puzzled Hamilton. For the next few minutes he reflected upon his past experience in radio. Suddenly, an idea came to him and he smiled as he thought of it. The answer was simple and he would work on it immediately.

Altho it was nearly 2 o'clock in the morning and bitter cold without, Hamilton, with a slight smile upon his face, left the wireless room and made his way to the street.

Dawn was approaching as he again entered his room. His eyes were bright and the smile on his face could not be mistaken. Despite the hour, he gave no thought of sleep. The fact of the matter was that he was too excited to go to bed.

"Some invention," he murmured to himself over and over again; "some invention!"

The morning papers said more about the mysterious man on the planet of Mars. "Radium Demanded by Mars" was the headline in one local paper. Five ounces of radium could not be obtained in such a short time, the papers stated. Further, the United States Government had not the slightest intention of doing so. It seemed as if the man on Mars knew of this, for two powerful wireless stations in the United States were blown to atoms as the man had said, creating great agitation among government officials. Accordingly the government waited for the night in order to make terms with the inhabitant on Mars.

That night Mars did not wait until 1 o'clock to begin transmitting. The voice began at 11 o'clock instead.

"I see," began the angry voice, "you have not obeyed my instructions. No more chances will you be given. I have already blown up two stations, and I will proceed with the others immediately."

## Make Your Own WIRELESS and ELECTRICAL APPARATUS



**SAVE 1/2**

It's easy to make your own at home with the aid of these 8 up-to-date books that you can understand. Each has over 72 pages and over 60 illustrations, 3 color cover size 6x7 inches.

**LESSONS IN WIRELESS TELEGRAPHY** is a course in the elementary principles which you must understand to obtain good results.

**WIRELESS CONSTRUCTION AND INSTALLATION FOR BEGINNERS** gives complete details with working drawings for making simple but good sending and receiving apparatus and erecting aerials, etc.

**THE OPERATION OF WIRELESS TELEGRAPH APPARATUS** shows how to obtain best results and greatest ranges with all kinds of apparatus, how to tune the station to 200 meters, use a wave meter, apply for license, etc.

**EXPERIMENTAL WIRELESS CONSTRUCTION** gives details with working drawings for making more elaborate and efficient sending and receiving apparatus, complete sets, etc.

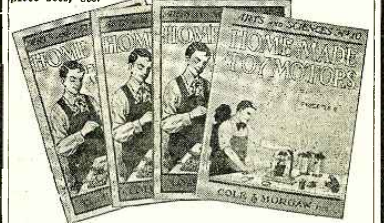

### HOME MADE ELECTRICAL APPARATUS

In Three Parts

**VOL. 1**—Contains working drawings and directions for making all sorts of Static Machines, Static Apparatus, Home Made Batteries, Storage Cells, Transformers, Rectifiers, etc.

**VOL. 2**—Contains working drawings and directions for all sorts of Voltmeters, Ammeters, Galvanometers, Switches, Rheostats, Telegraph Keys, Sounders, Telephones, Shocking Coils, Spark Coils, Experiments, etc.

**VOL. 3**—Contains working drawing and directions for making all sorts of Dynamos, Motors, Electric Engines, Miniature Lighting Plants, Wireless Telegraph Apparatus, Tesla Coils, Wireless Telephone, Electroplating Experiments, etc.

**HOME MADE TOY MOTORS**—Gives complete details with working drawings for making 12 simple but operative electric motors. Several built from sheet "tin." Others with castings.

**35c.** each postpaid any **THREE \$1.00**

GET THEM NOW  
PRICE MAY ADVANCE ANY DAY  
**COLE & MORGAN, Inc. Publishers**  
Dept. 112, 19 Park Place, New York



### VACUUM TUBE CONTROL PANEL

Most efficient and neatest panel manufactured.

Bakelite panel, graduated dials, mounted in oak cabinet. Variable grid condenser, rheostat, and tube receptacle mounted back of panel.

May be used in any circuit.

**PRICE-less Bulb (with V.T. Base or Audiotron mounting)—\$15.00**  
For Full information write

**DAYNOR RADIO ELECTRIC COMPANY**  
Box 105 Wilkingsburg, Pa.

## Compressed Air Motors

The New way of propelling your model aeroplane. Built of the finest materials. Guaranteed to be as represented or your money refunded. Engines and Model Aeroplanes built for you from your drawings at reasonable prices. Give us a trial and be convinced. Write for a circular of these wonderful motors. IT'S FREE.

**HEC AEROPLANE CO.**  
345 E. 49th Street New York City

His wrathful voice ceased and again the dynamo's whirl was heard until it diminished in tone. An hour later one of the Honolulu radio stations was reported by telegraph to be destroyed.

Nothing could be done to prevent the fiend from destroying the means of radio communication thruout the world. The thought of such a catastrophe was appalling, but the man could not be apprehended, as he was on Mars.

As soon as it was learned that the man on Mars had destroyed one of the Hawaiian stations, Hamilton made his way to the police station. For five minutes he was in consultation with the captain, and at the end of that time a small squad appeared at the captain's order. The policemen and Hamilton stepped into the police auto and after a few minutes' riding, and at Hamilton's order, they came to a stop before a shabby residence.

It was midnight and rather dark, but the rays from a street lamp illuminated the scene sufficiently for the party to be seen from the street. No sooner had they left the machine and entered thru the front gate than there was a blinding flash from the house, instantly followed by a loud explosion. The house they were about to enter crumpled and fell. Luckily none were injured by falling portions of the building, now a total wreck.

The wireless fiend was destroyed forever, and by his own hand! The morning papers again had huge headlines pertaining to the wireless fiend's destruction. Hamilton was featured as the hero of the day. Over night the young radio operator in San Francisco was known to the whole world. Newspapers read as follows:

"If it were not for the intelligence of Ralph Hamilton, one of America's amateur radio operators, no one knows what appalling disasters might have taken place. We owe to him not only the saving of many lives, but also his bravery in ascertaining the location of the 'wireless fiend' supposedly on Mars.

"The loudness of the wireless telephone signals," said Hamilton, "at first greatly puzzled me. I wondered why no other amateurs received them as strong. Also there was the matter of the light in my radio room. That was the clue that led to the identity of the mysterious man on "Mars." Every time the fiend started his machine the light seemed to diminish in brilliancy. When he stopt talking the light again became normal.

"Knowing how the lights in the neighborhood sometimes "blink" when amateurs are sending, I thought that the fellow was very close to me instead of being on the planet of Mars, as generally believed. Consequently, in the early morning hours I discovered his wonderful station only one block from me. The reason why he did not begin to transmit during the early evening is now obvious. He did not wish to have the people in the same block disturbed by the abnormal flickering of the lights. As was first supposed by everyone, he was using a dynamo for obtaining the necessary current to operate his instrument. I barely had a glimpse of his complicated apparatus. Massive coils for use in transmitting were scattered about the room and an indoor antenna was strung up. A huge instrument was in front of him containing numerous switches and dials which he rapidly manipulated.

"Even as I watched, the man spoke into a transmitter for a short time. When he finish speaking I could see, on a crystalline dial before him, the operators in the room at the San Francisco station. The man had a very complicated system of "radio-photography" whereby he could see before him whoever he was talking to.

"I did not see the fellow's features and I believe he had accomplices who aided in

## Radio Telephone & Telegraph Apparatus of Merit



**I**T is the earnest endeavor of this institution to render the utmost in service, quality, and courtesy to its patrons, and attend to their needs so as to warrant their continued patronage. We only sell meritable apparatus of proven worth, and stand ready at all times to back our liberal guarantee.

OUR NEW CATALOG IS READY

Send two cents and it will be mailed promptly.

Distributors for

THE DE FOREST RADIO TEL. & TEL. CO  
WM. J. MURDOCK CO. PERFECTION RADIO CO.  
AMERICAN RADIO & RESEARCH CO.

And all prominent and reliable mfgs.

Immediate deliveries on all goods listed in our catalog. We carry the largest stock of wireless apparatus in the middle west.

Address all correspondence to Dept. No. 67

**Young & McCombs**  
L. P. BEST PRES  
ROCK ISLAND, ILL.

### LEARN WIRELESS TELEGRAPHY

Fascinating and Educational Work—Big Salaries—Prepare Now

The United States Shipping Board is making heavy demands upon us for **Dodge-trained** wireless operators. Travel all over the world, secure, free, unsurpassed living accommodations and earn a big salary.

We Also Teach Morse (Wire) Telegraphy and Railway Accounting

School established 45 years. Endorsed by wireless, railway and telegraph officials. Low rates. Students can earn living expenses while attending school. **Catalog Free. Write Today.**  
**Dodge's Telegraph and Wireless Institute** 22nd St. Valparaiso, Indiana

Insure your copy reaching you promptly each month.  
Subscribe to RADIO AMATEUR NEWS— \$2.00 a Year.

You benefit by mentioning the "Radio Amateur News" when writing to advertisers.

# P N \$1. TO COUPON

Write your name and address plainly, mail us both, and by return mail you will receive your

## Skinderviken Transmitter BUTTON



Electro Importing Co.  
231-A Fulton St., N. Y.

Gentlemen—

Enclosed please find One Dollar. Ship at once one Skinderviken Transmitter Button to

Name .....

Address .....

City .....

State .....

wrecking the government wireless stations. I am sorry I did not immediately go to the police, but I could not resist the temptation to hear what he would demand on the following night.

"Had it not been for the government restrictions on amateur radio being removed, it is probable that much damage would have resulted before the man was found."

### Amateur Navy Type Short Wave Regenerative Set

(Continued from page 482)

a hand rubbed mahogany finish. The sides and top are 3/8" thick and the base is 5/8". It will be noticed that a mounting strip is screwed immediately behind the lower part of the panel.

Calibrate the set with the inductive coupling at about 45 degrees. However, it will be found that the set's calibration changes very little with variation of coupling as is the case when a loose coupler is used.

When using an amateur antenna with the normal inductance and capacity values

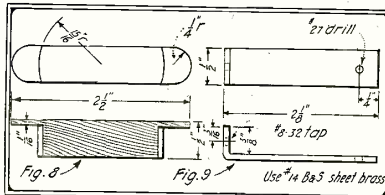

This is the Construction Details of Small Wooden Cleats and Brackets.

(355,000 cms. and .0002 mfd.) a variable series condenser of about .0008 mfd. maximum capacity should be used.

Resonance between the primary and secondary of this set may be obtained by the "click" method. If the circuit at first refuses to regenerate or oscillate, reverse the tickler leads.

The writer does not deem it necessary to furnish connection diagrams, as the ter-

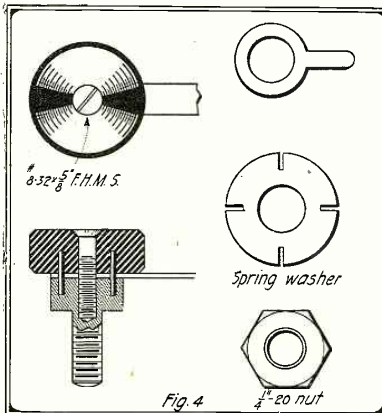

These Switches Are of Standard Pattern, Having Been Placed On the Market Recently.

minals are so brought out that most any circuit may be connected at will.

It is hoped that this design will give some helpful pointers to the constructor, and the writer would be glad to hear from anyone completing a likeness to it.

Much better results may be obtained with conductive coupling in an amateur vacuum tube radiophone than with inductive coupling. Greater energy is radiated with the former and the emitted wave is sufficiently sharp so that there is little chance for interference.

## Radio Diagrams and Formulae in Loose Leaf Form

The publishers of the CONSOLIDATED RADIO CALL BOOK have completed the preparation of diagrams and instructions on—

- Measurement of Capacity of a Condenser. (Substitution Method.) Calibration of a Variable Condenser. Two Diagrams and Curve. . . . . No. 1
- Measurement of Inductance of a Coil or Circuit. Two Methods—Two Diagrams. . . . . No. 2
- Measurement of Distributed Capacity of an Inductance. Diagram and Curve. . . . . No. 3
- Measurement of Fundamental Wavelength of an Antenna. Three Methods. Three Diagrams. . . . . No. 4
- Measurement of Wavelength of Distant Transmitting Station. Two Methods. Calibration of a Receiving Set. Two Diagrams. . . . . No. 5
- Measurement of Effective Antenna Capacity. Two Methods. Two Diagrams. . . . . No. 6
- Measurement of Inductance of Antenna and a Third Method of Measuring Effective Capacity of Antenna. One Diagram. . . . . No. 7
- Measurement of Antenna Resistance. Substitution Method. . . . . No. 8
- Schematic Wiring Diagram of Regenerative Audion Receiving Set Suitable for Receiving High Power Undamped Wave Stations. Connections shown are those used in most Navy and Commercial Receivers. . . . . No. 50
- Table giving the value of LC (Product of Inductance and Capacity) for wavelengths from 300 to 20,000 meters. Inductance in Microhenrys. . . . . No. 100
- Table same as above but with Inductance in centimeters. . . . . No. 101
- Schematic Wiring Diagram of Signal Corps Type SCR-68 Radio Telephone Transmitting and Receiving Set. . . . . No. 51
- Schematic Wiring Diagram of Type CW-936 (Navy Submarine Chaser) Radio Telephone and Telegraph Transmitter and Receiver. . . . . No. 52
- Schematic Diagram of Type S.E. 1100 (Navy Flying Boat) Radio Telephone and Telegraph Transmitter. . . . . No. 53

These diagrams and instructions are the most CLEAR, CONCISE, COMPREHENSIVE and CONVENIENT form of instruction that has ever been presented. They are printed on pages size 8 1/2 x 11.

Complete Set of 14 Sheets **75c**  
as described, sent postpaid

CONSOLIDATED RADIO CALL  
BOOK CO., Inc.  
41 Park Row, New York, N. Y.

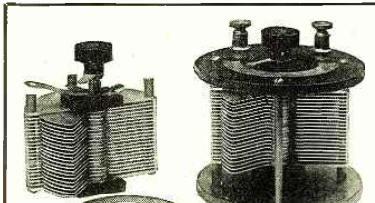

### THE "ILLINOIS" VARIABLE CONDENSER

Hard Rolled Aluminum Plates  
Three Styles, No. 1, Panel, No. 2, Open Type as shown, No. 3, Fully Encased. Anti Profiteer. Less than pre-war prices. Fully assembled and tested.

Sent Prepaid on Receipt of Price  
Style No. 1 No. 2 No. 3 Money back if not satisfied  
43 Plates, \$3.00 \$3.50 \$3.75 fied. Just return condenser  
23 " 2.50 3.00 3.25 ser within 10 days by in-  
13 " 2.25 2.75 3.00 sured P. P.

These condensers are made by a watch mechanic schooled in accurate workmanship. Personally we will need no introduction to Amateurs who have "listened in" for "time" and "weather" from 9. ZS.

G. F. Johnson, 627 Black Ave., Springfield, Ill.

### Switch Contacts!

Com'l Type N.P. contacts—size approx. Head 1/4" x 1/8", Shank No. 6 x 3/4" mach. screw, also one N.P. nut.

No. 5000 Contacts 35c per dozen (Postage extra)  
Send five cents for sample.  
Catalogue on request.

TOLEDO RADIO SPECIALTIES COMPANY  
Box 343 C. P. O. Toledo, Ohio

## Everything You Want To Know About A. C. Motors

is found instantly in the ELECTRICAL WORKER'S FRIEND. The only complete book of its kind for the man on the job or the student. Will make you an expert motor repairman. Contains 66 electric motor drawings with complete instructions for rewinding and reconnecting. Tells how to put each coil in the slots, how to set speed, alternations, cycles, poles, how to find the coil throw, number of coils per group and number of groups, etc.

Covers all practical reconnecting changes from one phase to another, from one voltage to another, or changing both the phase and voltage at the same time.

Written so you will understand it. You need this book—send for a copy today.

**\$4.00** or we will ship  
C. O. D. if you prefer  
Free Circular on Request

Henry F. Boshart  
P. O. Box 68, Homewood Sta., Pittsburg, Pa.

## American Electromotive Co.

Creators of Advanced Apparatus  
Enclose Stamp for Catalog  
319 East 68th Street New York

**The Differential Circuit**

(Continued from page 476)

of the static discharges. Receiver number two being tuned for 2500 meters, will not be affected by the 3000 meter station, but will be affected by the static discharges with an equal degree in amplitude as receiver number one. The pulsations, therefore, set up in the two-plate circuits by the static discharges will of course neutralize each other at the differential transformer. There being no opposing current set up in the receiver number two to counteract the vibrations set up in the plate circuit number one by the 3000 meter station, the differential transformer will therefore let pass these signals without any great loss in strength.

Again, if a nearby station is working on 3000 meters and both receivers number one and two are tuned for 3000 meters, no signals will be heard, regardless of the power used by the sending station. This will be understood by the fact that the two-plate circuits will simultaneously change in strength and the two magnetizing influences will again be exactly equal and opposite and no magnetic change will take place in the differential transformer.

Again, if a nearby station is working on 3000 meters and another is working on 2500 meters and receiver number one is tuned for 3000 meters and receiver number two is tuned for 2500 meters, there will be interference between these two stations. In order to tune out the 2500 meter station, receiver number two will change its tune to say 2750 meters, the 3000 meter station can now be copied without having interference from the 2500 meter station.

Note:—The differential circuit may be employed on one aerial with a *multiplex receiver*; that is, with a receiver constructed to receive two wavelengths simultaneously, but it is believed that the two inverted "L" type aerials placed at right angles to each other will prove more successful.

**The Tree Antenna**

(Continued from page 484)

One other possibility that has not been discussed is that the tree antenna might be acting like a loop. This is quickly disposed of by referring again to the extreme resistance, which would prevent oscillations.

In closing it may be stated that from the above it appears that the tree will act to some extent as an antenna if properly connected, and it might be termed a "resistance coupled" antenna. However, when used in the usual manner with a loose coupler it is safe to assume that the antenna consists solely of the wire used for a "lead in" and if an insulator were inserted at the point where the "lead in" joins the tree, a slight improvement in the received signals would probably be noted.

Many amateurs are not aware of the interesting traffic going on at 200 meters and below. This is due to improperly designed receiving sets. Amateurs using honeycomb inductances in conjunction with an average size antenna should use the smallest size inductance in the primary and secondary circuits. The secondary condenser should be cut out entirely. A popular short wave regeneration set for 200 meter work is the grid and plate tune variometer type. Excellent results are obtained with a conductively coupled tuner using a variometer rotor as a tickler.

**AMPLIFY YOUR RADIO SIGNALS**

With the new DETECTAGRAPH-TRANSMITTER, the amateur can amplify radio signals to such an intensity that he can hear the signals about his station without the need of the telephone head set.

By the addition of a loud talking telephone he is able to hear the messages many feet away from the instrument.

The super-sensitive DETECTAGRAPH-TRANSMITTER herewith shown is two and three-eighths inches in diameter, five-eighths of an inch thick and weighs less than three ounces. It is the most sensitive sound detecting device ever brought before the public.

The manner in which

the amplifying process is attained is by attaching with tape the DETECTAGRAPH-TRANSMITTER to the regular wireless receiver.

Not only is this instrument applicable for amplifying radio signals, but it can be used with equal satisfaction for magnifying other sounds. Phonograph music can be transmitted from one place to another by means of this instrument, and those who are afflicted with deafness will find enormous benefit by using this transmitter. It is the greatest device for building up your own loud talking telephone, detectograph and other devices. Can be used for any purpose where a sensitive detecting instrument is required.



Our Super-Sensitive Detectograph Transmitter. Price, \$8.00 Complete



Our Special No. 25 Loud Talking Receiver. Price, \$4.50 Complete



Detectograph Rheostat, especially made for amplifying circuits. Price, \$2.00 Complete



Super-Sensitive No. 40 Receivers to be used in connection with Detectograph-transmitters. \$10.50



The Detectograph Junior Deaf-Phone \$18.00

Equal to any \$35 instrument made. Output consists of Super-Sensitive Transmitter with cord connector; Super-Sensitive Ear Piece with small black cord; Black Single Headband; Black Case and Two Batteries.



Adjusted Model "B" Horn, with No. 20 High Grade Loud Talking Receiver, Cord Plugs and Desk Stand Base. Price, \$12.00 Complete



Adjusted Model "C" Horn, with No. 20 High Grade Loud Talking Wall Receiver, Cord Plugs and Wall Base. Price, \$12.00 Complete



This detecting instrument of marvelous sensitivity can be used for detecting secret conversations. Output consists of Sensitive Transmitter, 25-ft. Black Cord, Receiver, Headband, Case and Battery.

Order direct from ad.

Or write for free descriptive circular.

**G. BOISSONNAULT COMPANY**  
25 CHURCH STREET NEW YORK CITY  
Makers of Super-Sensitive Microphone Devices

**DEPENDABLE EQUIPMENT**

IS A MATTER OF CAREFUL SELECTION

OUR STOCK OF **RADIO APPARATUS** IS OF DISTINCTLY

HIGH GRADE MANUFACTURE, GUARANTEED AGAINST MECHANICAL AND ELECTRICAL IMPERFECTION

OUR NEW "BULLETIN 14" WILL BE READY FOR DISTRIBUTION SHORTLY. TEN CENTS IN STAMPS (may be deducted from first order of \$1.00) WILL BRING A COPY TO YOU.

**ATLANTIC RADIO COMPANY**

34 Battery March St., Boston, Mass.

**THE COMPLETE RADIO LINE**

Factory distributors for the famous Murdock, Signal and De Forest Instruments. Manufacturers of the famous "Red Head" Radio Phones and Arlington Tested Detector Minerals. Send for our splendid free Catalogue.

The Newnian-Stern Co. Dept. R. N. Cleveland, O.

**NEW PANEL RHEOSTAT**

(Pat. Appl'd. For) Built for panel mounting, bakelite, full nickel front, back stops, 1/2" x 3" back of panel. One hole in panel, that's for knob bushing. \$3.25 postpaid U. S. A. Send stamp for circular BREITENBACH'S RADIO SHOP Mills Bldg. Washington, D. C.

# FREE! AMATEURS! FREE!

Descriptive circulars of

## OUR "BETTER QUALITY" B-BATTERIES

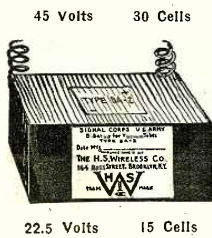

To enable every amateur to use our SUPER "BETTER QUALITY" B-BATTERIES they are now offered at a price within reach of all. Remember that our B-Batteries are sold to you on a MONEY-BACK BASIS. They are FULLY GUARANTEED, and your money CHEERFULLY REFUNDED if not satisfied. Our motto: "RETAILING AT WHOLESALE PRICES."

CAT. No.	Voltage of Cells	Amount of Cells	Type	Kind	Dimensions	Average Life	List Value	Our Price
BB-154	22½	15	BA-2	Signal Corps, U. S. Army	3¼"x2"x2½"	4 months	\$1.50	\$1.25
Postpaid add 10c. In Canada and foreign countries add 25c.								
BB-158	22½	15	BA-2	Signal Corps, U. S. Navy	6½"x4"x3"	8 months	2.50	2.20
Shipped by Express only in U. S. In Canada and foreign countries add 50c for postage.								
SBB-3012	45	30	EA-2	Spl. comb. Navy and Army	14" x8"x6"	1 year	6.00	4.35
Shipped by Express only in U. S. In Canada and foreign countries add \$1.00 for postage.								

AudioTron Amplifiers \$6.00. p.p.

ORDER through your DEALER. If he hasn't our B-Batteries order direct from us, but send his name and address. Write for B-Batteries circulars, etc.

**DEALERS:** We are now offering an attractive proposition for you. Some live territories now being allotted. Good discounts. Write now.

**THE H. S. WIRELESS CO., 164 Ross St., Brooklyn, N. Y.**  
Dept. A  
Exclusive representative for the Genuine AudioTron Amplifier

### A New Way To Get Your Fundamental

(Continued from page 475)

takes a great deal longer to read about than it does to use. It takes about a quarter of the usual time needed for the accurate determination of antenna fundamentals by any other procedure.

The writer hopes to go into the theory of the method in a simple graphical analysis, without the use of higher mathematics, in a future number, but enough has been said here to show the reasons for the methods employed in this very useful test.

It should always be remembered that if X is tuned to a shorter wave than the fundamental, Y is tuned to shorter wave than X, and if X is tuned to a longer wave than the fundamental, Y is tuned to a longer wave than X.

Thus X is a sort of tuning station between Y and A in the "musical" electrical scale of wavelengths as shown in Fig. 3.

### AUSTRALIAN NOTES

(Continued from page 476)

The electrical stores are now displaying wireless supplies, some of which are fairly modern, some obviously pre-war and some made from directions published in *Modern Electrics* or *Electrical Experimenter*. So far I have sought in vain for a regenerative receiver suitable for amateur wavelengths, the nearest approach discovered was an article in a local magazine on how to make one for 100-300 meters.

The majority of the ships on the coast here are equip with valve receivers, using three valves—radio frequency amplifier, detector and audio frequency amplifier, all the valves being operated by one common "A" and one common "B" battery. Since these batteries are of the accumulator type they are supplied in duplicate with the necessary "change-over" switches. The "B" battery consists of 80 cells (160V) each cell being made up of a test tube, lead plates (about 1 inch by 6 inches) and glass separator, the plates being "formed" by charging and discharging.

Several arc sets have recently been installed in the coast stations in addition to the existing spark sets. These are comparatively low power, being capable of transmitting about 1,500 miles daylight.

A low power spark station is being erected at Tonga to work with Suva (Fiji) and Apia (Samoa).

The Amalgamated Wireless (Apia), Ltd., have been negotiating for permission to erect a high power wireless station to work Carnarvon, Wales, direct, but so far the negotiations have not been successful.

Compulsory wireless on all ships carrying fifty or more passengers and crew is expected to be enforced under the "Navigation Act" very shortly.

"UNDAMPT."

#### THINGS TO REMEMBER.

If your feed-back audion set doesn't oscillate at first, try reversing the tickler leads. When using pencil line grid leaks, too much graphite reduces the strength of spark signals; too little causes the circuit to "howl." The "happy medium" may be obtained by experimenting. Examine your filament storage battery once in a while. A drop of water in time saves overhauling later.

"Loud Signals" does not spell efficiency in reception. You can't amplify what isn't detected.

### When You Buy A Radio Transformer,

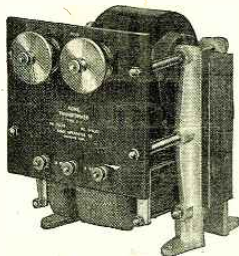

- 1 Get One That is Efficient, every Watt saved increases Radiation.
- 2 Get One of High Power Factor, which means higher Efficiency and less trouble with the house lights.
- 3 Get One That Draws Full Rated Power, on a Condenser small enough to allow sufficient Coupling for 200 Meter Work.
- 4 Get One Properly Designed for Rotary Spark Gaps. (If you use a Rotary Gap.)
- 5 Get One with Low Power Step for Short Distance Work, don't jam every one who is working at the same time.

In Other Words, Buy An ACME. No other Transformer combines all these Qualities, in fact very few have even two of these Good Points.

Carried in Stock by Leading Dealers in High Grade Radio Apparatus

**ACME APPARATUS CO.**

25 WINDSOR STREET

CAMBRIDGE, MASS.

FOR CLEAR RECEIVING  
THE SATISFACTORY  
**BURGESS "B" BATTERIES**  
SEVERAL SIZES



Write for Catalogue

**BURGESS BATTERY COMPANY**  
HARRIS TRUST BLDG. CHICAGO



**Radiophone Experiments**

(Continued from page 477)

towards the megaphone. The primaries were connected up in parallel to six dry cells. The secondaries were connected up in series with each other, and the main leads were fastened to binding posts at the top of the box.

A condenser and spark gap was used as shown in the diagram. This apparatus was capable of transmitting articulate speech about as far as a boy could throw a stone. So you see this experiment was not much of a success. However, I believe a successful radiophone might be constructed on the principle of using some kind of an induction transmitter. As a matter of fact most radiophone and radio telegraph systems of today depend upon the principle of induction.

I believe that the reason for the slow advancement of the radiophone is that too many people are experimenting solely with vacuum tubes and bulbs of different shapes and kinds filled with gases, instead of working on some other theory that is entirely different and more practical.

Lots of experimenting will eventually perfect the radiophone, and I venture to add that the American amateur will do his share towards its ultimate success.

**MODULATION IN AMATEUR RADIOPHONE SETS.**

Various modulation systems have been published and many amateurs complain that upon trying them out little or no success has been obtained. In several cases the trouble was located in the oscillatory circuit. Naturally, if no energy is radiated, there is nothing to modulate. A hot wire milliammeter in the antenna circuit will obviate difficulties from this source.

A microphone transmitter placed in series with the ground lead should give fair results. The fault to be found with this system, however, is that the entire output of the oscillator is not modulated.

The use of a vacuum tube modulator is a common practice at the present time, but the amateur is not in favor of this, as the additional expense is beyond his financial resources. Furthermore, if he has the means of purchasing several tubes, it is advantageous to use them all in the oscillatory circuit, thus increasing the range of the transmitter.

The best modulator, one which is gradually finding favor with the amateur, is the grid system.



## INTERNATIONAL RADIO

### TRANSFORMER

Type TXL-101 A

**Price \$16.75 f. o. b. Factory**

A Standard Transformer modified and re-designed for amateur use. Coils are 1/16" copper, edgewise wound on bakelite supports. Assembly secured to end plates by bakelite nuts. Secondary slides on bakelite rods. This elimination of metal through-out results in maximum efficiency.

**PRIMARY INDUCTANCE 8 micro henrys.**  
**SECONDARY INDUCTANCE 44 micro henrys.**

The Transformer illustrated above is only one of many newly designed radio specialties which we have ready for you. Write us for descriptive bulletins which are being issued covering all International Radio Products. Address Department No. 22.

**International Radio Telegraph Company**  
**326 BROADWAY NEW YORK, N. Y.**

**IF EVENTUALLY, WHY NOT NOW?**

After trying to do without a line protector and then using some makeshift device you will decide to use a DUBILIER STANDARD PROTECTIVE DEVICE. The protection of instruments, motors, generators, transformers, etc., up to 1 K.W. capacity must be accomplished by a reliable standard protective device.

The DUBILIER STANDARD PROTECTIVE DEVICE illustrated is equipped with bus-bars and lugs of 25 amperes capacity and are so moulded in the insulated container as to be slightly below the surface; this affords protection from short circuits. The capacity of each condenser unit is 0.02 mfd and a wiring diagram is impressed permanently in the moulded container.



- TYPE AM888, tested at 2000 volts, suitable for station up to 1 K.W. capacity** ..... \$4.00
- TYPE CD888, same as above, but tested voltage, 3000 volts** ..... 6.00



**PRICES ON OTHER DUBILIER PRODUCTS ON APPLICATION**

Dealers, jobbers and distributors—We have something interesting for you. Exclusive agents for Dubilier Condenser Company, A. H. Grebe & Co., Rawson Electrical Inst. Co., Richter & Byrnes, and others.

**PACENT ELECTRIC COMPANY, Inc.**  
Builders and Specialists of Radio, Electrical and Laboratory Equipment.

**150 NASSAU ST. Telephone Beekman 5810 NEW YORK CITY**

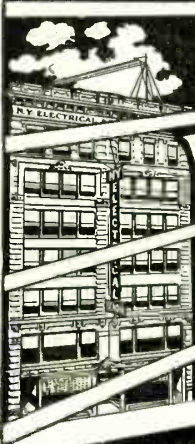
# THE NEW YORK ELECTRICAL SCHOOL

**THE N. Y. ELECTRICAL SCHOOL** is the pioneer and premier school of the "Learn by Doing" method. When you have completed this Course you shall be fully qualified to handle ALL branches of Electrical industry. The equipment of this School is unequalled and up-to-the-minute. No preparation needed to become a "learner" in this school. You can start to learn on any day of any week throughout the whole year. Send for catalogue.

**OPEN ALL SUMMER**

**NEW YORK ELECTRICAL SCHOOL**  
29-31 West 17th St. New York City

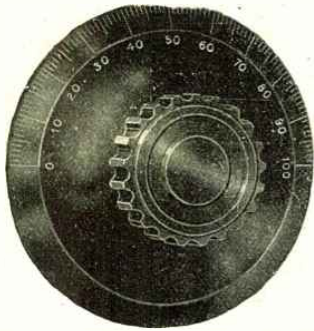

# RADIO MEN

Make your apparatus up to date. Indicating dials now available at a reasonable price.

Made of fine black polished composition with radial lines and figures accurately engraved and filled with brilliant white. Diameter of dial is 3 inches, and they are 3/16 inch thick. We can furnish dial alone, or with fine Bakelite Knob mounted. This knob has a set screw to clamp shaft of instrument to which dial is to be applied. If your dealer cannot supply you, send us his name with your order. Immediate deliveries.

- 3 inch Dial only.....75 cents Postpaid
- 3 inch Dial with Knob mounted...\$1.30 Postpaid

NEW CATALOG JUST OUT, ready for distribution at once. 30 pages of real, live, up to the minute illustrations. News and Descriptions of all standard Radio parts, including the above Indicating Dial. Sent anywhere upon receipt of 10c.

For sale at all Radisco Agencies and by

## A. H. Corwin & Co.

4 West Park Street

Newark, N. J.



“SERVICE”

“QUALITY”

## SEND US YOUR ORDERS

If you want prompt delivery of Grebe, DeForest, Bunnell, Acme, Murdock, Clapp-Eastham and all other standard apparatus.

### SPECIAL NOTICE

Our Radio Catalog has been Delayed. Catalog will be mailed upon request at the earliest possible date.

## DOUBLEDAY-HILL ELECTRIC CO.

719-21 Liberty Ave.  
Pittsburgh, Pa.

RADIO DEPT., DESK B

715-12th St. N.W.  
Washington, D. C.

### RADIO APPARATUS

Distributors—De Forest, Murdock, Clapp Eastham Apparatus. Perfection Tuners and Condensers. Benwood Rotary Quenched, Honey Comb Coils, etc. Phila. “Radisco Agency” The First Wireless School in America. Established 1911. Day and Evening Classes. Correspondence Course.

**PHILADELPHIA SCHOOL OF WIRELESS TELEGRAPHY**  
Parkway Bldg., Broad and Cherry Sts.

#### “P. W.” Audion Panel

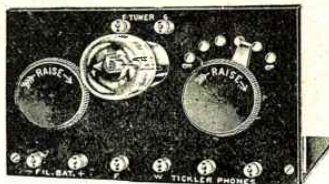

Special \$11.00 without bulb. Use any American made bulb. Parts, ready to assemble, \$8.50

### An Ideal Radio Cabinet

(Continued from page 480)

The panel with the radio instruments mounted can be inserted from the front and fastened into place. The storage batteries used for lighting the audion filaments and the “B” battery will find storage room in the lower part of the cabinet. The builder must remember that the weight of the battery alone should be taken in consideration and therefore the cabinet should be of the best construction, so that a disastrous breakdown can be avoided in the beginning.

In the design of the cabinet the particular points kept in mind were *ease of construction, good appearance, and minimum of space necessary*. These are primary requirements when anything of service and dependability is given the average amateur.

In order to adapt the cabinet to any panel, which many amateurs would want to do, as most of them have either the panel or cabinet type, small changes in dimensions will be necessary to accommodate the particular panel to be mounted. Sufficient constructional details have been shown in order to give flexibility and universality to the cabinet. The type and size shown is exceptionally well adapted for mounting both a radio receiving and transmitting set in one compact form. The transmitter proper, instead of being mounted directly on the front of the panel, is an ordinary desk telephone and can be located wherever convenient. In a future article it is proposed to give in detail the radio receiving set which has been mounted in this cabinet and which has given exceptional results.

### With the Amateurs

(Continued from page 489)

rotary gap, oscillation transformer, ammeter, voltmeter, radiation ammeter and the necessary switches. From the top down in the panel may be seen a clock, ammeter, voltmeter, hot wire ammeter with shorting switch, antenna switch, rotary gap motor switch, input power switch and line switch.

The receiving side consists of 200 meter, 600 meter and long-wave loose couplers, variometers and condensers connected into a modified “paragon” circuit with suitable telephone “flush” switches to change from one coupler to another. A Crystal detector is used for local work, while a tubular V.T. is used with two Western electric bulbs as amplifiers for long distance work. The cabinet on the left side of table is a wavemeter (inductance seen on top of small coupler) used ordinarily for determining wavelength of incoming signals.

The antenna is of the inverted “L” type, supported at the far end by a 75-foot iron pole and at the station end by a 55-foot bamboo pole.

To date the record transmitting distance for this set is Rosswell, New Mexico, about 900 miles. The normal input is 662 watts and the radiation five amperes.

EDWIN S. WATKINS, 6AY,  
2232 Huntington Ave.,  
Monterey Park, Alhambra, California.

#### COVERING FOR TABLE.

An excellent covering for the amateur’s laboratory table tops may be easily obtained. Cover the table with a heavy grade of wrapping paper, tacking it down at the edges. Apply several coats of heavy shellac or varnish and allow sufficient time for drying. A hard, clean and smooth surface is thus obtained.

READ THE CLASSIFIED ADVERTISEMENTS ON PAGES 525-527, YOU’LL FIND MANY GOOD THINGS THERE.

**CLUB GOSSIP**

(Continued from page 492)

soon found at 566 Main Street. A larger and more attractive room is now being re-decorated and in a short while it is expected that a complete sending and receiving station will be in operation.

At present we have about 40 members, but we have no doubt but that this number will be greatly increased by a membership contest that has just been inaugurated. The contest will continue for one month and at its close the winners will dispose of a "feed," which the losers must provide.

Since it is the policy of the Association to build up its membership from the bottom, a series of constructive lectures on "The Elementary Principles of Radio" will be presented by specially qualified members, for those whose knowledge of wireless is slight. A more advanced series has also been laid out to interest, primarily, the more advanced members.

Officers of the Association are: President, L. A. Bates; vice-president, E. Rice; secretary, S. A. Waite; treasurer, Dr. H. E. Watkins. Publicity committee, Charles C. Alford (chairman), Worcester, Mass.

**RADIO-SCIENTIFIC ORGANIZATION.**

The Radio-Scientific Organization, an organization for the advancement of radio and science in general, has recently been organized under the supervision of George E. Wibecan, Jr., radio-engineer and former Y. M. C. A. instructor.

The organization consists of the executive board and the board of directors. The board of directors are the respective heads of radio, electricity and chemistry. Their duty is to supervise their departments and give lectures twice a month pertaining to recent advancements made in science. This club offers splendid opportunities to those who are interested in advancing their knowledge along these subjects.

The qualification for membership is an elementary knowledge of science with reference to same.

Address all communications to James Randi, secy-treas., 38 Humboldt Street, Brooklyn, N. Y., or call 2ASR.

**K. C. RADIO SCHOOL AT BUFFALO.**

If the amateur radio operators of Buffalo and vicinity recently received strange musical sounds from their instruments let them not think they were in communication with some other planet inhabited by intelligent beings who are as advanced as we are more so in the science of radio-telegraphy. The cause will be less remote. Charles O. Stimpson, chief electrician at the naval radio station at the foot of Michigan avenue, who is an instructor at the Knights of Columbus evening school at Main and Tupper streets, has decided to do some experimenting for the benefit of the class and the entertainment of the amateurs of Buffalo, of whom there are many.

The school has bought the best instruments obtainable. Each student is furnished with a practise set and a textbook free of charge.

Classes are held three nights a week. The returned service man is urged to take advantage of the course.

**LOUISVILLE, KY., RADIO CLUB PROPOSED.**

Steps toward the organization of a radio club for the amateur radio men and boys of Louisville have been taken recently at a meeting held in the store of H. C. Tafel Electric Company, 220 West Jefferson street, according to a statement made by Henry L. Meyers, under whose leadership the club is being organized.

"Now that the ban which was placed on the sending of amateur messages during the war has been lifted, we hope to keep abreast of other cities in producing good radio men," said Mr. Meyers.

More than fifty letters have been sent out by the committee to men who will be asked to become members of the organization. The Louisville Radio Club has been chosen as the name for the organization.

**RADIO CLUB OF SYRACUSE.**

Convinced that amateurs in radio-telegraphy and radio-telephony have a legitimate and useful field, the Radio Club of Syracuse, N. Y., has laid the groundwork for more comprehensive activity than has marked its progress since it was formed early this year.

One of the first things the club plans to do is to establish permanent headquarters where it will be possible to have up-to-date wireless equipment for sending and receiving. Joseph A. Griffin had promised to provide rooms for the club in the Griffin square building, but the recent fire there disrupted those plans. The problem of headquarters was discussed at a meeting of the club Friday night.

Officers of the local club are: President, Dr. R. H. Hutchings; vice-president, C. C. Bean; secretary-treasurer, Donald C. Wood; librarian, Charles A. Hagaman; and instructor, Neil V. Flaherty, who spent three years in the navy as a radio operator.

**TEWNO WIRELESS PRODUCTS OF QUALITY**

In all of the products shown below you will find we have used the finest of materials and the most accurate workmanship. All material guaranteed against factory defects, as it has always been a principle with us to manufacture products of superior type but at a reasonable price.

**"Tewno" Variable Condenser**

The rotary variable condenser is a necessity for all experimental wireless work and two of them are to be found in almost any wireless station. The two most popular types are the 43 plate and 21 plate with capacities of .001 mfd. and .0005 mfd., respectively. The large size has 21 rotary aluminum plates and 22 stationary aluminum plates. The small size has 10 rotary and 11 stationary plates. The ordinary rotary variable condenser is mounted in a cheap round metal case with a cheap composition top and coarse scale. Its plates are 0.15" thick and the shaft is 3/16" in diameter.

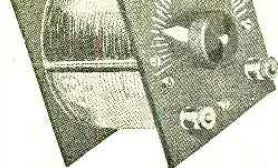

No. 53—21 plate—.0005 mfd. Price, \$4.75 No. 43—43 plate—.001 mfd. Price, \$5.50

**"Tewno" Receiving Transformer (Short Wave)**

Directly prior to the war, the amateurs were doing wonderful work with specially made short wave couplers of their own construction and through the use of Armstrong circuits or with straight audion circuits. Up to that time no manufacturer had placed such an instrument on the market.

In our short wave receiving transformer the amateur will find the embodiment of all of his ideals. It is designed for use on amateur aerials of from 150 to 200 M. fundamental wave length and with a small capacity of variable condenser across the secondary will easily tune to 600 M. The windings are of the very efficient type known as bank wound (an expensive process) and are of heavy stranded conductor in silk sleeving. They are wound upon non-shrinkable tubes. Variation is obtained by means of two 12-point switches mounted upon "Formica". Switches and contacts are satin finish, nickel plated, which is in accord with the Government's specifications. All other metal work is polished and nickel plated. Woodwork has a beautiful hand rubbed mahogany finish.

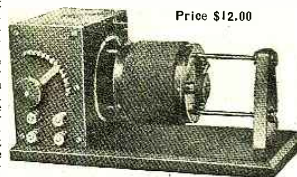

Price \$12.00

No. 23—Price \$12.00 Order today as orders will only be filled in rotation as they come in. Remit by postal money order or check.

The TEWNO COMPANY, 152 Chambers St., New York City

**The Latest Audion Control Cabinet**

Here is a compact and highly efficient unit that may be used with any and all receiving circuits.

The

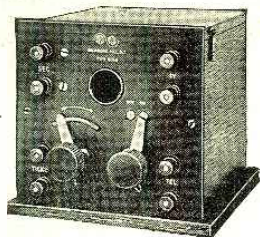

Price \$17.00 Without Tube

**Audion Control Cabinet Type RORH**

contains the grid condenser, grid leak, filament rheostat and two 20-volt dry batteries. Socket accommodates the standard 4-prong tube.

There are binding posts for secondary, tickler, phones and filament battery. Direct and simple connections may be made to all types of receivers. Free bulletin R-117 describes this unit. Complete catalogue 10 cents.

A. H. GREBE & CO. Inc., 72 Van Wyck Blvd., Richmond Hill, N. Y.

**HOOK'ER TO YER BULB.**



Any single wire aerial 25 x 40 feet will do anywhere.

A C/W 20,000 meter tuner for only \$8.00.

Wound with the celebrated INVOLUTE coils. The only tuner in the world for amateur use, licensed under Marconi Patent No. 763772, that gets all the European stations with one bulb and one wire aerial anywhere, using no tickler coil. No movable coils, no loose connections, no trouble. Condensers help in the tuning but are not needed to get the arc stations. Only one tuner of each kind sold at this price in each city. Act quick and if you are the second or third we will give the names of those ahead of you.

WE SELL THE COILS SEPARATELY FOR PANELS

Coils for any of our tuners boxed in small container, waxed, tapt, marked a.r.d with wiring diagram, for only \$6.00.

TRESCO—DAVENPORT, IOWA, or their dealers

Send five cents in stamps for our new catalog, having names and wave lengths of all world stations, wireless alphabet, and International abbreviations. Just off the press.

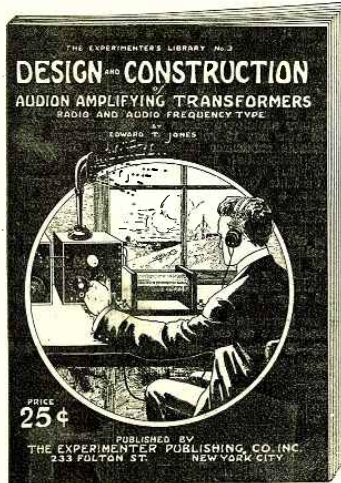

# JUST OFF THE PRESS

**Design and Construction of Audion Amplifying Transformers Radio and Audio Frequency Type**

This latest and important book by Mr. Edward T. Jones, late Associate Editor of *Radio News*, will be of great interest to all radio amateurs throughout the land. The transformers shown in these books have never been described in print before, and have usually been considered a manufacturer's secret. Anyone who has several vacuum tubes cannot afford to do without this book because it will enable him to build the necessary amplifying transformers very readily. The designs are very simple and rugged, and anybody can make them without trouble.

Mr. Jones, the author, is a practical man who is an experimenter himself and knows whereof he speaks. The book is printed on good paper and has an attractive cover in two colors. Paper bound. Size 5 in. x 7 in. Contains many illustrations, diagrams and working data necessary to build the transformers.

**PRICE, 25c Postpaid**

## Experimental Electricity Course in 20 Lessons

By S. Gernsback and H. W. Secor, E.E.

A Course on the theory and practice of Electricity for Experimenters. One of the most complete and comprehensive treatises of this special subject ever published. Written by the same authors as the famous "Wireless Course."

Every phase of experimental electricity is treated comprehensively in plain English. New Experiments are described and explained and nearly every application of Electricity in modern life is given in simple language.

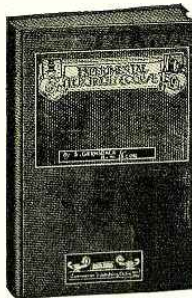

**The Best Electrical Text Book on the Market**

Size of Book is 6 x 9 in.

The book contains 128 pages and more than 400 illustrations.

Flexible cloth cover, per copy ..... 75c

Stiff cloth cover, per copy, \$1.25

Postpaid

## Wireless Course in 20 Lessons

By S. Gernsback, A. Lescarboursa and H. W. Secor, E.E.

A Course that tells you everything you want to know about "Wireless" starting off in lesson No. 1 by explaining the Principles of Electricity. By simple, easy stages, this wonderful Course takes you into "Wireless" by the use of such simple language so skillfully used that of necessity you must understand every word. There is a whole lesson devoted to the Theory and Mathematics of this epoch marking subject. The last lesson is devoted to a history of Wireless.

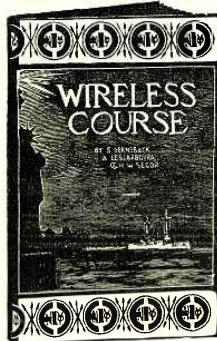

**More than 50,000 of this course sold (Eighth Edition)**

Size of book is 7 x 10 1/4 in., 160 pages, 350 illustrations, 90 tables.

Flexible cloth cover, per copy ..... 75c

Stiff cloth cover, per copy, \$1.25

Postpaid

### Two Remarkable Books

No. 1.—How to Make Wireless Sending Apparatus.

No. 2.—How to Make Wireless Receiving Apparatus. By 20 Radio Experts

Book No. 1 contains 100 pages, size 7 x 5 in., and 88 illustrations.

Book No. 2 contains 100 pages, size 7 x 5 in., and 90 illustrations.

Written and published entirely for the wireless enthusiast who wants to make his own radio apparatus. Only strictly modern instruments are described and the illustrations and descriptions are so clear and simple that no trouble will be experienced in making the instruments.



Book No. 1—How to make Wireless Sending Apparatus. 25c Postpaid.



Book No. 2—How to make Wireless Receiving Apparatus. 25c Postpaid.

**THE EXPERIMENTER PUBLISHING CO.**  
Book Dept., 233 Fulton Street New York

### KNOXVILLE RADIO CLUB PROPOSED.

A branch of the Interstate Radio Club of America may be established in Knoxville, Tenn., according to Horace L. Haynes, 110 West Gill avenue, who is vice-president of the national organization. Mr. Haynes will promote a plan which he hopes will culminate in the establishment of a local club. He invites all Knoxville boys who are interested in learning wireless telegraphy to communicate with him at his Knoxville address.

### PROGRESSIVE RADIO CLUB.

"The Progressive Radio Club" is the name selected by 15 amateur radio enthusiasts of Elmira, N. Y., recently, when they organized. Lyle H. B. Peer was elected president; Joseph Myers, vice-president; John Perkins, chief engineer.

The club is organized with the idea of meeting once a week for the exchange of ideas and experience with radio work. The club is open to all radio operators in the city and it is expected that the membership will be more than doubled in a short time.

Future meetings of the club will be held at the home of L. O. Adams, 750 East Market street, at 7:30 o'clock. The officers of the infant organization extend a cordial invitation to all radio operators to attend. Those who desire may communicate with President Lyle H. B. Peer, 409 Davis street, or Secretary John McNevin, 958 Columbia street.

### CORRECTION

Due to the fact that the November issue of RADIO AMATEUR NEWS was printed out of town during the printers' strike in New York City, several errors occurred in the "Statement of Ownership" notice. The notice is reprinted in correct form below:

### STATEMENT

Of the ownership, management, circulation, etc., required by the Act of Congress of August 24, 1912, of RADIO AMATEUR NEWS, published monthly at New York, N. Y., for Oct. 1, 1919.

State of New York, County of New York, ss.:  
Before me, a Notary Public in and for the State and county aforesaid, personally appeared Hugo Gernsback, who having been duly sworn according to law, deposes and says that he is the editor of the RADIO AMATEUR NEWS, and that the following is, to the best of his knowledge and belief, a true statement of the ownership, management (and if a daily paper, the circulation), etc., of the aforesaid publication for the date shown in the above caption, required by the Act of August 24, 1912, embodied in section 443, Postal Laws and Regulations, printed on the reverse of this form, to wit:

1. That the names and addresses of the publisher, editor, managing editor, and business managers are:

Publisher, The Experimenter Publishing Co., 233 Fulton St., New York City.  
Editor, Hugo Gernsback, 233 Fulton St., New York City.  
Business Manager, R. W. De Mott, 233 Fulton St., New York City.

2. That the owners are: (Give names and addresses of individual owners, or, if a corporation, give its name and the names and addresses of stockholders owning or holding 1 per cent or more of the total amount of stock.)  
Experimenter Publishing Co., 233 Fulton St., New York City.  
Hugo Gernsback, 233 Fulton St., New York City.  
Sidney Gernsback, 233 Fulton St., New York City.  
H. W. Secor, 233 Fulton St., New York City.

3. That the known bondholders, mortgagees, and other security holders owning or holding 1 per cent or more of the total amount of bonds, mortgages, or other securities are (If there are none, so state):  
None.

4. That the two paragraphs next above, giving the names of the owners, stockholders, and security holders, if any, contain not only the list of stockholders and security holders as they appear upon the books of the company, but also, in cases where the stockholder or security holder appears upon the books of the company as trustee or in any other fiduciary relation, the name of the person or corporation for whom such trustee is acting, is given; also that the said two paragraphs contain statements embracing affiant's full knowledge and belief as to the circumstances and conditions under which stockholders and security holders who do not appear upon the books of the company as trustees, hold stock and securities in a capacity other than that of a bona fide owner; this affiant has no reason to believe that any other person, association, or corporation has any interest direct or indirect in the said stock, bonds, or other securities than as so stated by him.

H. GERNSBACK.  
Sworn to and subscribed before me this 9th day of Oct., 1919.  
BEATRICE K. OWEN.  
(My commission expires Mar. 30th, 1921.)

# OPPORTUNITY AD-LETS

Follow these advertisements every month. Reliable advertisers from all over the country offer you their most attractive specials in these columns.  
 Classified advertising rate three cents a word for each insertion. Ten per cent discount for 6 issues, 20 per cent discount for 12 issues.  
 No advertisement for less than 20c accepted. Name and address must be included at the above rate. Cash should accompany all classified advertisements unless placed by an accredited advertising agency.  
 Objectionable or misleading advertisements not accepted. Advertisements for the May issue must reach us not later than April 10.

## THE CIRCULATION OF RADIO AMATEUR NEWS IS OVER 35,000

EXPERIMENTER PUBLISHING CO., INC., 233 Fulton Street, New York, N. Y.

### American Made Toys.

**We offer an opportunity to manufacturers with facilities for large production, also to homeworkers on smaller scale, to manufacture Metal Toys and Novelties.** Unlimited field and enormous business open for ambitious people. No experience required. No tools needed. Our castingrooms turn out goods complete. Since the different Toy Expositions, manufacturers are covered with orders until December. You can enter this field now, by manufacturing "American Made Toys." We furnish castingforms for Toy Soldiers, Army, Navy, Marine, Cannons, Machine Guns, Indians, Cowboys, Warships and other novelties. Castingforms complete outfit \$3.00 up. We buy these goods, direct from manufacturers. Yearly contract orders placed with reliable parties. We pay very high prices for clean painted goods. Samples furnished. "Bird-Whistles," great seller, just added to our stock list. Booklet, Information, Instruction free, if you mean Work and business. No others invited to write. Toy Soldier Manufacturing Co., 32 Union Square, New York.

### Aviation.

**100 Model Aeroplanes.** Good flyers. 15c brings working drawing and prices. F. Bruland, Redford, Mich.

### Business Opportunities.

**\$30 per 100 paid for names and addresses.** Particulars free. Victor-King Co., 36 Bromfield St., Boston, Mass.

**Young men to sell our card specialties.** Easiest selling novelties in the world. Outfit free. John W. Burt, Coshocton, Ohio.

### Books.

**Concordia Magazine contains** essays, short stories, travel stories, boy scout news, editorials, current events and poetry, formulas and plans. Two years' subscription 50 cents. Concordia Magazine, 9 Water, York, Pa.

**Star Amateur Electrician.** Pocket Size, 12c. Joel Tilberg, Proctor, Vermont.

**Magazines—Sixty Detective Story Magazines.** Price \$2.50. Donald Rankin, Cadiz, Ohio.

**Just off the Press.** Design and Construction of Audio Amplifying Transformers (Radio and Audio-Frequency Types). By Edward T. Jones, late Associate Editor Radio Amateur News. The transformers shown in this book have never been described in print before and have usually been considered a manufacturer's secret. The designs are very rugged and simple. A book that every radio "bug" should have. Written so you will understand every word. Price 25c postpaid. Experimenter Publishing Co., Book Dept., 231-A Fulton Street, New York City.

**Experimental Electricity Course in 20 Lessons.** By S. Gernsback and H. W. Secor, E. E. A course in the theory and practice of Electricity for the Experimenter. Every phase of experimental electricity is treated comprehensively in plain English. New experiments are described and explained and nearly every application of Electricity in modern life is given. 160 pages—400 illustrations. Flexible cloth cover, 75c postpaid. Stiff cloth cover \$1.25 postpaid. Experimenter Publishing Co., Book Dept., 233 Fulton Street, New York.

**Wireless Course in 20 Lessons.** By S. Gernsback, A. Lescarbours and H. W. Secor, E. E. Tells you everything you want to know about "Wireless"—theory, practice and history. A clear, concise course on every phase of this subject. 160 pages—350 illustrations, 30 tables. Flexible cloth cover 75c postpaid. Stiff cloth cover \$1.25 postpaid. Experimenter Publishing Co., Book Dept., 233 Fulton Street, New York.

### Blueprints.

**Blueprints—Learn Blueprint Reading—**from 33 large Blueprints of structures that what line you are in.—We show you how—An easy home study —It's job insurance—Get our circular—or send \$1 for the first four Blueprints—if satisfactory! order balance later. Chas. J. H. Freeth, Consulting Chief Draftsman, Mechanics' Improvement Association, Dept. 25, 1628 Lehigh Ave., Phila., Pa.

### Rubber Stamps.

**Rubber Stamps made to order.** McCaddon Company, Zanesville, Ohio.

### Scenery for Hire.

**Collapsible Scenery** for all plays. Amelia Grain, Philadelphia, Pa.

### Chemicals.

**Boys Look.** Chemicals and apparatus of all kinds for the Boy Experimenters. Write for our latest catalogue (Free). W. C. Hughes and Co., P. O. Box 210, Barbourville, Ky.

**Every Experimenter should have one of our handsome, wooden Test-Tube Racks.** Holds thirteen tubes. Price, 85c. David Altman, 225 East 110th Street, New York.

### Agents Wanted.

**Agents.** New wonderful money-maker: "Cow-tail Holder." Sells like wildfire. Enormous profits. Exclusive territory to live wires. Write immediately. Sample, 35 cents. L. Kirkegaard, Blair, Neb.

### Help Wanted.

**Secret Service Operatives and Detectives** are in demand. Earn big money. Travel everywhere. Fascinating work. Learn this profession by home study. Particulars free. American School of Criminology, Dept. R., Detroit, Mich.

**Be a Mirror Expert.** \$3-\$10 a day; spare time home at first; no capital; we train, start you making and silvering mirrors French method. Free prospectus. W. R. Derr, Pres., 579 Decatur Street, Brooklyn, N. Y.

**Earn \$25 Weekly,** spare time, writing for newspapers, magazines. Experience unnecessary; details free. Press Syndicate, 5665, St. Louis, Mo.

### For Inventors.

**Inventors:** Models, dies, tools. 28 years' experience, work guaranteed, lowest price. Manufacturing of specialties our hobby. Peerless Die & Tool Co., 121 Opera Place, D. B., Cincinnati, Ohio.

**Inventors—**We do experimental, model, tool, die and jig work; light manufacturing. Miller & O'Brien Mfg. Co., North Saint Paul, Minn.

### For Advertisers.

**Money?** Jacobus Art Ads. make small space pay big dividends, price \$5.00. Write today. Jacobus Service, 1073 Sanford Ave., Irvington, N. J.

**Send data and \$3** for attention compelling, order coaxing letter or circular. Mail Order Press, Swift Bldg., Cincinnati.

### Formulas.

**500 Formulas,** all easy, successful money-makers. Postpaid, 25c. Edgar James, 315 Douglass, Indianapolis, Ind.

### For Men.

**Detectives Earn Big Money.** Travel; great demand; experience unnecessary; we train you; write for free particulars. American Detective System, 1066 Broadway.

### Instruction.

**Mechanical Drawing** successfully taught by mail. Fifty cents each lesson. Pay-as-you-go. No other expense. Complete drawing outfit valued at \$20.00 free with the Course. One hundred genuine blueprint lessons. We will assist you to secure a good-paying position. Send for particulars and sample lessons. Albany Institute Mechanical Drawing, Desk #1, Box 84, Albany, New York.

### Motor Engines and Dynamos.

**Fittings for Model Boilers,** water gages, globe steam valves, unions and filling plugs. Castings for model marine engine, suitable for small steam power boats, complete set, \$3.00. Write Model Machine Shop Co., 415 E. 71st Street, New York City, N. Y.

**Propellers** for high powered air propulsion, and small propellers for motorcycle engines. 5 foot diameters 12 dollars, other sizes in proportion. Hub mountings, countershafts, bearings and sprockets to suit. Catalogue free. Crawford Motor and Aeroplane Mfrg., New Orleans, La.

### Office Devices.

**Addressographs,** Multigraphs, Duplicators, Folders, Multicolors, Mailometers, Sealers. Half price. Pruitt Company, 224 North Wabash, Chicago.

**Addressographs,** Multigraphs, Duplicators, Folders, Sealers. Bought, sold, guaranteed. Office Device Company, 154-Z West Randolph, Chicago.

### Electrical Supplies and Appliances.

**Water locating** by Mansfield's water finder is interesting and profitable. Particulars from Edwin Mansfield & Co., 94 Victoria Road, New Brighton, England.

**Experimental Electricity Course in 20 Lessons.** By S. Gernsback and H. W. Secor, E. E. A course of the theory and practice of electricity for the experimenter. Every phase of experimental electricity is treated comprehensively in plain English. New experiments are described and explained and nearly every application of electricity in modern life is given. 160 pages—400 illustrations. Flexible cloth cover, 75c postpaid. Stiff cloth cover, \$1.25 postpaid. Experimenter Publishing Co., Book Dept., 233 Fulton Street, New York.

### Health.

**Tobacco or Snuff Habit Cured** or no pay; \$1 if cured. Remedy sent on trial. Superba Co., SB, Baltimore, Md.

**Pyrroreha** (Rigg's Disease—Bleeding or Swollen Gums). H. E. Ketyl, D.D.S., M.D., pyrrroreha specialist for 15 years, has developed a successful home treatment for pyrrroreha. Purifying, healing, preventative. Full month's treatment, \$1 postpaid. Or, write for free booklet. Pyrorem Mfg. Co., 439 Seventh St., Brooklyn, N. Y.

**My-T-Fine Scalp Cleaner.** A new hair wash. Perfect dandruff eradicator. Cleans the scalp, strengthens the roots, preserves the hair; absolutely harmless; 25 cents postpaid. My-T-Fine Scalp Cleaner, No. 564 Central Avenue, Brooklyn, N. Y. Agents wanted.

### New Correspondents.

**Earn \$25 Weekly,** spare time, writing for newspapers, magazines. Experience unnecessary; details free. Press Syndicate, 5665 St. Louis, Mo.

### Printing.

**3,000 two color labels** \$1.25. Irvin J. Wolf, Station E, Philadelphia.

**Ask for Proofs** of attractive Cuts for Letter-heads, circulars, etc. "Mailpress," 2 Swift Bldg., Cincinnati.

### Patent Attorneys.

**Millions spent** annually for ideas! Hundreds now wanted! Patent yours and profit! Write today for free books—tell how to protect yourself, how to invent, ideas wanted, how we help you sell, etc. 301 Patent Dept., American Industries, Inc., Washington, D. C.

### Postcards.

**Beautiful Art postcards,** photographs; state wants. Samples, 25c. Art Studio 826 Calhoun Street, Ft. Wayne, Ind.

**The Capitol at Night.** Most wonderful art panel you ever saw, 1x2 feet, 30 cents, postpaid. Durso, Dept. 50, 25 Mulberry, New York City.

### Wanted to Buy.

**Send to Cleveland** by mail or express any old or broken watches, false teeth, old or broken jewelry, brooches, bracelets, old gold, silver, platinum, diamonds, magneto points, platinum wire, contact points or crucibles, mercury, and anything valuable. We pay the highest prices in cash by return mail. Goods returned in ten days if you're not satisfied. The Ohio Smelting & Refining Company, 207 Lennox Bldg., Cleveland, Ohio.

### Stammering.

**St-Stu-t-t-tering and Stammering** cured at home. Instructive booklet free. Walter McDonnell, 121 Potomac Bank Bldg., Washington, D. C.

### Song—Poems.

**Song-Writers' Manual & Guide Sent Free** Contains valuable instructions and advice. Submit song-poems for examination. We will furnish music, copyright and facilitate publication or sale. Knickerbocker Studios, 311 Gaiety Bldg., New York.

### Telegraphy.

**Telegraphy** (both Morse and Wireless) and railway accounting taught thoroughly and quickly. Big salaries now paid. Great opportunities. Oldest and Largest School, Est. 45 years. Catalogue free. Dodges Institute, 25th Street, Valparaiso, Ind.

(Continued on page 526)



storage batteries, parts, etc., included. A few Formica panels at \$1.00 each. Switch points, knobs and other supplies. Western Wireless Supply Co., 2317 Milwaukee, Chicago, Ill.

**Radio Cabinet Work** and woodwork in general manufactured to meet the special requirements of amateurs. Don't spoil that fine set you made by mounting in a crude home-made cabinet. Have your woodwork and cabinet work made by an expert. Send detailed drawings for estimate. Lattice mountings for DeForest panel units a specialty. Graham Stuckey, 722 Murray Street, Alexandria, La.

**Selling Out!** Wireless, electrical and chemical apparatus. Send stamp for list. Stewart and McLaughlin, Cadiz, Ohio.

**Wireless** apparatus made to your specifications. cabinet sets our specialty. Lee Brothers Co., 605 N. Walnut Street, Champaign, Ill.

**Wireless Bugs** of the modern type use "Leumite," the ultra-sensitive detector mineral; increases efficiency 100 per cent. Generous crystal, 25c. coin. Leumas Laboratories, 1306 Park Ave., New York.

**Knocked-Down** variable condensers for panel mounting. You assemble and save money. 43 plate, .001 mfd., \$2.75; 21 plate, .0005 mfd., \$2.25; 11 plate, .00025 mfd., \$1.75. Also long and short wave tuners, receiving cabinets, rheostats, transmitting condensers, binding posts, etc. R. E. Stowe, 623 Grand Ave., Dayton, Ohio.

**"Audion B Battery Control"**—Amateurs—Here's your chance to purchase the article you have wanted. Not at a \$30 price but a price within reach of all amateurs. An Audion B battery control. Control is 8x5x4 inches. Genuine mahogany with a beautiful hand-rubbed finish. Has 10 points for varying the voltage. Voltage variation from 8 to 45 volts. Points are silver plated, thus reducing all resistance. Large fancy smooth knob, with smooth running lever. All metal parts nickel-plated. Complete with Bes' Grade B Battery, only \$9.45. Less B Battery, \$6.35. Renewal B Battery, 45 volts, \$3.75. Large stock. Order now. Agents wanted. Radio Testing Station, 25 Sturges Street, Binghamton, N. Y.

**We buy and sell used apparatus**, what have you. State fully condition, makes, and price. Amateurs who are building apparatus—send us your list of what you need. We will quote you lowest price on market. Mail orders only. Radio M. O. Supply Co., 533 West End Ave., City.

**Receiving Condenser** without case, 25c. Coils wound. Radio equipment made to order. Philadelphia Radio Supply, 5714 Hazel Ave., Philadelphia.

**Look, Amateurs and Experimenters:** High frequency buzzers, while they last, \$85. Send Money Order. Radio Testing Station, 25 Sturges Street, Binghamton, N. Y.

**2500 Meter Navy Type Coupler**, \$7.95. Ask for circular. Penn Radio Apparatus Co., Greenville, Pa.

**Fixed Condensers.** Just right for audion circuits or mineral sets. Only \$50. Radio Testing Station, 25 Sturges Street, Binghamton, N. Y.

**Amateurs Attention—Loose Couplers** from 800—15,000 meters, \$2—\$20. Tubes wound to specifications. N. A. Radio Equip. Co., 510 Claremont Parkway, Bronx, N. Y.

**Tested Galena**—One large piece tested, super-sensitive galena sent postpaid for 15c. Radio Testing Station, 25 Sturges Street, Binghamton, N. Y.

**You** are being paid. Many operators are receiving much more than that. Our course in Radio Telegraphy, under the direction of S. W. Edwards, U. S. Radio Inspector, offers the highest class instruction available. New, complete equipment. Day or evening classes. Opportunity to earn expenses while here. Our day class prepares for First-Class Radio Operator's examination in three months, night class in 18 weeks. Before deciding where to get your Radio training, write for our Free Illustrated Booklet.

**"Amateurs"** look at these prices! Audio Tron cabinets with B, \$16. Marconi with B, \$20. One-step amplifiers, \$25. Two-step, \$35. No bulbs. Karet, 3632 Central, Cleveland, Ohio.

**Complete Receiving Sets**, \$7 and up. With 1,000-ohm receiver, tested mineral; guaranteed. Bulletin for stamp. Jenkins, 923 Purchase St., New Bedford, Mass.

**Genuine "Jupiter"** Aerial Wire, 1 cent per foot, \$9.00 per thousand. Seven strands. Number 22 solid copper. High conductivity. Strong large surface. Low resistance. No C, O, D's. Send postage: Lee A. Bates, 8 Moen Street, Worcester, Mass.

**Chicago Radio Apparatus Co.** announce opening of High Grade Radio Supply House to serve Chicago amateurs and others in the Middle West. Complete DeForest line, Brandes, Clapp-Eastham, Burgess "B" Batteries, Marconi Audions, etc. Apparatus in stock—send us your orders for Honeycomb Coils, Acme and Federal Transformers, Vacuum Tubes. Immediate delivery. Place orders direct from above catalogs or write for new one—late DeForest Catalog too, deduct from first order. Bulletins and Folders free—discount to Wireless Clubs—remember "Immediate Delivery" on above lines of apparatus. Give us a trial. Chicago Radio Apparatus Co., 3400 S. Michigan Ave., Chicago, Ill.

**How to Make Wireless Sending Apparatus.** 100 pages, 88 illustrations. Written and published entirely for the wireless enthusiast who wants to make his own radio apparatus. Contains more information on "how to make it" than any other book we know of. Paper bound, 25c postpaid. Experimenter Publishing Co., Book Dept., 233 Fulton St., New York City.

**Wireless Course in 20 Lessons.** By S. Gernsbach, A. Lescarbours and H. W. Secor, E. E. Tells you everything you want to know about "Wireless"—theory, practice and history. A clear, concise course on every phase of this subject. 160 pages—350 illustrations, 30 tables. Flexible cloth cover, 75c postpaid. Stiff cloth cover, \$1.25 postpaid. Experimenter Publishing Co., Book Dept., 233 Fulton St., New York City.

**How to Make Wireless Receiving Apparatus.** 100 pages—90 illustrations. Only strictly modern radio apparatus are described in this book and the illustrations and descriptions are so clear and simple that no trouble will be experienced in making the instruments. Paper covered, 25c postpaid. Experimenter Publishing Co., Book Dept., 233 Fulton St., New York City.

**Just off the Press.** Design and Construction of Audion Amplifying Transformers (Radio and Audio-Frequency Types). By Edward T. Jones, late Associate Editor Radio Amateur News. The transformers shown in this book have never been described in print before and have usually been considered a manufacturer's secret. The designs are very rugged and simple. A book that every radio "bug" should have. Written so you will understand every word. Price 25c postpaid. Experimenter Publishing Co., Book Dept., 231-A Fulton Street, New York City.

being paid. Many operators are receiving much more than that.

Our course in Radio Telegraphy, under the direction of S. W. Edwards, U. S. Radio Inspector, offers the highest class instruction available. New, complete equipment. Day or evening classes. Opportunity to earn expenses while here.

Our day class prepares for First-Class Radio Operator's examination in three months, night class in 18 weeks.

Before deciding where to get your Radio training, write for our Free Illustrated Booklet.

## DETROIT INSTITUTE OF TECHNOLOGY

303 Y. M. C. A. Bldg., Detroit

### Introducing THE NEW VIBRATONE JR. TRANSMITTING SET



This Set Illustrated Above Operates On 110 volts, D. C. or A. C. It is absolutely complete as shown. Needs no helix, spark gap, condensers, etc., etc. Simply connect to aerial, ground and electric circuit, and send.

**NO BATTERY EXPENSE**  
Runs all day for 2c. Sends 3 to 5 miles.  
**PRICE \$18 COMPLETE**  
With Key, Plug and 8-Foot Cord.  
Send for descriptive circular 136D today  
**WIRELESS EQUIPMENT CO., Inc.**  
19 Park Place, New York, N. Y.

You can be quickly cured, if you  
**STAMMER**  
Send 10 cents coin or stamps for 70-page book on Stammering and Stuttering, "Its Cause and Cure." It tells how I cured myself after stammering for 20 years.  
Benjamin N. Bogue, 856 Bogue Bldg., Indianapolis

# 25c Per Month WILL KEEP YOU POSTED

on the wonderful new developments in electrics, mechanics, physics, chemistry, radio, astronomy, inventions, physical research, medicine, etc. World progress accurately explained each month in plain, non-technical language. Profusely illustrated. Hundreds of original fascinating articles in every issue. 120 pages written by authorities on subjects of daily interest to you.

Broaden your knowledge and be able to talk intelligently about the latest scientific achievements. It's the well read man who succeeds in business and social life. Start with this month's issue. You will ENJOY reading it.

25c AT ALL NEWS STANDS—or direct by mail \$2.50 a year  
Experimenter Publishing Co. 233 Fulton St., N. Y. C.

## ELECTRICAL EXPERIMENTER SCIENCE AND INVENTION

The Undisputed Authority on Simplified Science and Mechanics

You benefit by mentioning the "Radio Amateur News" when writing to advertisers.

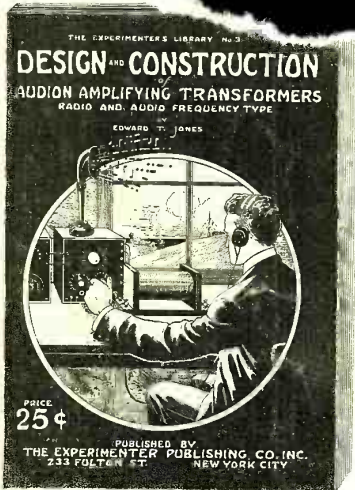

...time we will send all three for only 50c  
 ...ded with a one-year subscription to the  
**RADIO AMATEUR NEWS.** This offer is limited  
 —it may be withdrawn at any time. Don't wait, get  
 these books **NOW** and guarantee yourself twelve won-  
 derful numbers of the **RADIO AMATEUR NEWS.**

## Design and Construction of Audion Amplifying Transformers Radio and Audio Frequency Type

by E. T. Jones, late  
 Associate Editor of  
**RADIO AMATEUR  
 NEWS,** a wonderful  
 book—the only one of  
 its kind in print—

should be on the shelf within easy reach of every amateur. Every line of this book is written so that you can understand it. Every detail in the manufacture and construction of Audion Amplifying Transformers is described at great length. The book contains many illustrations and diagrams that make it a simple matter to build the Transformers described. Never before have these instruments been described in print. They have always been considered strictly a "trade secret."



### How To Make Wireless Receiving Apparatus

A wonderful book for the man who would construct his own apparatus. Size 5¼ x 7½ inches. Containing 100 pages and 90 illustrations. Compiled of the writings of twenty-five Radio experts. Every amateur should have this book in his wireless room.

### How To Make Wireless Sending Apparatus

In every detail equal to "How To Make Wireless Receiving Apparatus." Size 5¼ x 7½ inches. Containing 100 pages and 88 illustrations. Dealing at length on Quenched Spark Gaps, Rotary Gaps and Oscillation Transformers.

Any amateur in the "wireless game" can easily construct a complete sending and receiving station, and will have his choice of many varieties after reading these wonderful books.

Remember, all three will be sent you postpaid just as soon as we receive your subscription and 50 cents toward the cost of the books. You really get the books for only 10c, because the magazine **alone** would cost you \$2.40 if you bought the single copies each month.

**EXPERIMENTER PUBLISHING CO., Inc.**  
 231-A Fulton Street, New York City, N. Y.

R. A. N.  
 3-20

Experimenter  
 Publishing Co.,  
 231-A Fulton St.,  
 New York, N. Y.

Gentlemen:—You may send me the three books described in the "Radio Amateur News" and enter my name for a year's subscription to the "Radio Amateur News" for which I enclose \$2.50.

Name .....

Address .....

City..... State.....

*You benefit by mentioning the "Radio Amateur News" when writing to advertisers.*