

CIRCULATION LARGER THAN ALL OTHER RADIO MAGAZINES COMBINED

RADIO NEWS

REG. U.S. PAT. OFF.

20 Cents
March
1921

Over 100 Illustrations
Edited by H. GERNSBACK



"THE 100% WIRELESS MAGAZINE"

CUNNINGHAM

POWER

Type C-302

5 watt output

Price \$8.00



TUBES

**Demand
Cunningham
Tubes**

**The Name is etched
on the Tube**

**CW TELEGRAPHY AND TELEPHONY WITH CUNNINGHAM TRANSMITTER TUBES OFFERS THE ADVANTAGES OF
COMPACTNESS — RELIABILITY — LONG RANGE — LOW POWER — SHARP TUNING**

TRANSMITTER TUBE SPECIFICATIONS

Model	Output Conservative Rating	Filament Amps. Volts	Plate Voltage	Price	Delivery Date
C 302	5 watts	2.35 7.5	350-400	\$8.00	immediate
C 303	50 watts	6.5 10.	1000	30.00	Mar. 10th
C 304	250 watts	15. 12.	4000 Max.	110.00	Mar. 10th

Price of C 303—C 304 fob. New York or San Francisco

C 302 is mounted on the standard four prong receiving tube base. The larger tubes have special bases.

CUNNINGHAM POWER TUBES

are the latest product of the great Research Laboratory of the General Electric Co. The trade mark GE is the guarantee of their quality. Each tube is built to most rigid specifications. The output ratings are extremely conservative and in actual test deliver greatly in excess of their rated outputs.

GENERAL ELECTRIC QUALITY PLUS CUNNINGHAM SERVICE

Address All Communications to

TRADING AS
AUDIOTRON MFG. COMPANY
35 MONTGOMERY STREET
SAN FRANCISCO, CALIF.

If You Are Going To Buy A Headset Soon, Why Not Get A Good One Now?

Our high-impedance Navy Type Headset will do more to make your receiving satisfactory than any other headset

No matter how much money you spend to equip your station with the latest types of instruments, unless a Brandes Navy Type Headset, with the recent improvements, is a part of your equipment, you are not getting maximum receiving satisfaction.

There are four main points which you should consider in buying a headset. They are sensitiveness, durability, weight and price. We invite a rigid comparison of our improved Navy Type Headset with any other on either or all of these points.



"Navy Type"—50,000 ohms A. C., weight 9 oz., complete with head band and polarity indicating cord. Price \$14.00.



"Transatlantic"—25,000 ohms, A. C., weight 11 oz., complete with head band and polarity indicating cord. Price \$12.00.



"Superior"—2,000 ohms, D. C., weight 14 oz., complete with head band and polarity indicating cord. Price \$8.00.

BRANDES MATCHED TONE HEADSETS

You will notice that Brandes Matched-Tone Headsets are very light, but at the same time rugged in construction. There is no chance of any Brandes Matched Tone Headset losing its adjustment through rough handling as the shell is made of thick, hard aluminum and the cap of hard rubber. Brandes Headsets are permanently adjusted

to their highest point of efficiency and then carefully matched in tone. They remain this way indefinitely. All three of our models are equipped with an improved headband made of galvanized piano wire covered with strongly woven khaki. It is instantaneously adjustable to any size head and check nuts holds the ad-

justment. Rust proof and strongest and lightest of its kind on the market. Our headsets are also now equipped with new style conducting cords which indicate the polarity of the receivers. This eliminates any danger of demagnetizing the receiver when used in connection with vacuum valve detectors.

Try Our High-Impedance Navy Type Headset Without Risk

With recent improvements in our Navy Type headsets we have succeeded in bringing out a headset with an A. C. resistance of 50,000 ohms at 800 cycles, a thing which has never before been accomplished in a commercial headset. The Navy is peculiarly adapted to vacuum tube reception. It has a natural high pitch and will bring in thousand cycle notes clearly and distinctly and undamped waves may be read clearly and distinctly through static. The most exactly comparative tests have convinced us that our High-Impedance Navy Type Headset is the best on the market, regardless of price. It is the

most sensitive, most durable and at the same time, the lightest high-grade headset built. Our guarantee stands behind every one of these claims. If you need a reliable and super-sensitive headset you cannot afford to be without this new high-impedance model. Send us \$14 with the coupon in the corner of this page and we will send you a High-Impedance Navy Type Headset. Try it for 10 days. If it isn't far ahead of any headset you have ever seen and you are not absolutely satisfied with it, return the headset and we will refund your money immediately.

Transatlantic and Superior

These two models were primarily designed for use where the demands were not exacting enough to require a Navy Type Headset. They are both well made from good materials and will give highly satisfactory service. The Transatlantic is wound to 25,000 ohms A. C. and the Superior to 2,000 D. C. They are both equipped with our new style headband and polarity indicating cords.

They are good enough to carry the name "Brandes" and our guarantee of money back if not satisfied stands behind them too. If you want either of these sets check the proper square on the coupon.

WHAT OTHERS SAY

These testimonials were received before we improved our Navy Type Headset. If they were this good at that time, why not try them now?
 "After using a pair of your Navy Phones for ten years, I believe that I am qualified to say that there are none better."—F. C. L.
 "I have not found any of my friends' receivers to equal Brandes Navy in clearness, sensitiveness and lightness."—H. C. M.
 "Your Navy phones are light, durable, made right, look right, and work right."—H. I. V.
 "They must improve with age, for I have four other high price sets, but I always go back to the Navy Set."—C. B. H.
 "I have a pair of your Navy phones here which I took to France with me and used all through the war. They were the best phones we had and much lighter than any issued set."—B. V. D. (Names on request.)

USE THIS COUPON NOW

C. BRANDES, INC. (R. N.)
 Room 823, 32 Union Square—New York City.

Inclosed find \$..... Please mail me the items checked below. It is understood that I may return them within 10 days if unsatisfactory in any way and you will refund my money promptly.

- Put X here.
- Navy Type Headset (High-Impedance) \$14.00
 - Transatlantic Headset \$12.00
 - Superior Headset \$ 8.00
 - New Head Band (Fits old style Superior only) \$ 1.75
 - 16-page catalog, 5c coin or stamps.

Name

Address

City State.....

RADIO NEWS

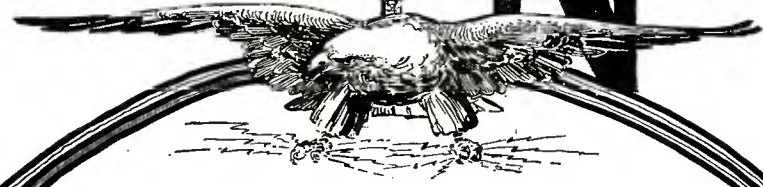

CONTENTS

VOL. 2 FOR MARCH NO. 9

	PAGE		PAGE
Editorial.....By H. Gernsback	589	The Use of AC Potential With Vacuum Tube Transmitters..By Jesse Marsten	604
The Radio Station at Rome. By B. Micchiardi, G. Pession and G. Vallauri	590	An Amateur's Variable Condenser. By C. Kent Duff	605
Awards of \$100 Portable Radio Prize Contest. Fourth prize winner.....	591	The New Paris Radio Station.....	606
Recent Attainments in Wired Radio. By R. D. Duncan, Jr.	592	Inside Dope on "Our" Set. By W. H. Winings	607
New Radio Instruments.....	594	Remotely Controlled Transmitter. By James W. H. Weir	608
A Practical Radio Receiver. By S. G. Cline	595	A Portable Receiving Set. By Eugene M. Riel	609
Notes on the Functioning and Construction of Resistance Coupled Amplifiers. By Robert E. Lacault	596	Daniels Wants Amateurs Controlled....	609
A Combined Short and Long Wave Receiver.....By Emil Spon	597	With the Amateurs.....	610
Commercial Radio Telephone at Avalon, Santa Catalina Island. By G. E. Hyde	598	Correspondence From Readers.....	612
Universal VT Control. By Howard S. Pyle	599	Club Gossip	613
Wireless Telegraphic Printing of the Creed Automatic System. By A. A. Campbell Swinton, F.R.S.	600	Radio Digest	614
Washington's Birthday Relay.....	602	Who's Who in Radio.....	615
The Latest. A Vaudeville Show by Radio	602	The Radio Constructor.....	616
First Amateur Transcontinental Spark Reception. By Leo E. W. Kirby and R. H. Butler	603	Junior Section	619
		Junior Constructor	620
		I Want to Know.....	621
		The Phantom and the Circuit. By Charles Osborne Parks	622
		Martian Madness...By Erald Schivo	624
		A Practical Wave-Length Chart. By John L. Reinartz	626

RADIO NEWS is published on the 25th of each month at 233 Fulton Street, New York. There are 12 numbers per year. Subscription price is \$2.00 a year in U. S. and possessions. Canada and foreign countries, \$2.50 a year. U. S. coin as well as U. S. Stamps accepted (no foreign coins or stamps) Single copies, 20 cents each. A sample copy will be sent gratis on request. Checks and money orders should be drawn to order of EXPERIMENTER PUBLISHING CO., INC. If you should change your address notify us promptly, in order that copies be not mis-carried or lost. No copies sent after expiration.

All communications and contributions to this journal should be addressed to: Editor, RADIO NEWS, 233 Fulton Street, New York. Unaccepted contributions cannot be returned unless full postage has been

included. ALL accepted contributions are paid for on publication. A special rate is paid for novel experiments; good photographs accompanying them are highly desirable.

RADIO NEWS. Monthly. Entered as second-class matter June 6th, 1919, at the Post Office at New York, N. Y., under the Act of March 3, 1897. Title registered U. S. Patent Office. Copyright, 1921, by E. P. Co., Inc., New York. The Experimenter Publishing Co., 233 Fulton Street, N. Y., N. Y. The contents of this magazine are copyrighted and must not be reproduced without giving full credit to the publication.

RADIO NEWS is for sale at all newsstands in the United States and Canada; also at Brentano's, 37 Avenue de l'Opera, Paris.

Published by EXPERIMENTER PUBLISHING CO., INC. 233 Fulton Street, New York City
 H. GERNSBACK, President S. GERNSBACK, Treasurer R. W. DE MOTT, Secretary

Never in the History of Radio Were These Prices Approached

Improved Navy Type Receiving Transformer Again
Reduced from \$27.50 to the startling price of **\$16.95**

Improved Arlington Receiving Transformer Again
Reduced from \$15.00 to the startling price of **\$7.75**

Mail 12 cents

in stamps or coin (not sent otherwise), which amount you are privileged to deduct on first dollar purchase. Revised price list to first edition of catalog, with prevailing prices, mailed on request.

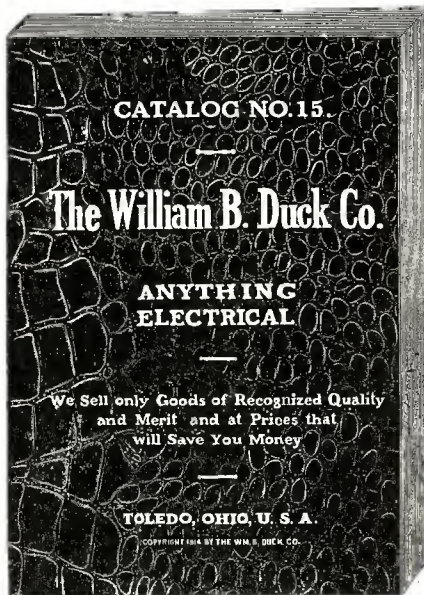

Other Substantial Reductions On Items in Catalog No. 14

- No. R40 Rec. Set.....\$22.50
- No. R41 Rec. Set..... 38.50
- No. R41a Rec. Set..... 28.50
- THORDARSON TRANSFORMERS**
- 1 K.W. Type R..... 40.00
- 1/4 K.W. Type R..... 28.00
- 1/2 K.W. Type R..... 22.00
- 1 K.W. Type RS..... 30.00
- 1/4 K.W. Type RS..... 20.00
- 1/2 K.W. Type RS..... 15.00
- No. A1792 Thord. Con..... 25.00
- Nos. 50, 51, 52
- Switch Contacts, each08
- No. 1023 Mica Con..... .60
- No. B 670 Det. 2.75
- No. A862 Det. 2.75
- No. A1915 Det. 1.50
- No. A367 Murdock Cond. 4.50
- No. A1002 Rec. Set..... 9.75
- No. A1916 Con. 1.65
- No. 61x08A Tuning Coil 2.95
- No. 61x10 Tuning Coil 4.95
- No. 14 Aluminum Wire, per lb..... .90
- All Binding Posts reduced 83 1/3%.

Only a few of the Many New Radio Instruments in Catalog No. 15

- Type C-300 Audio Tron Bulb..... \$5.00
- Type C-201 Audio Tron Bulb..... 6.50
- "UV" 200 Radiotron Bulb..... 5.00
- "UV" 201 Radiotron Bulb..... 6.50
- No. A200 Control Panel..... 7.50
- A complete line of new detector regenerative and amplifying sets.
- Connecticut Variable Condenser.... 6.50
- Turney Spider-Web Unit..... 6.00
- No. 550 Murdock Socket..... 1.00
- No. 3660 Murdock Condenser 4.00
- No. 3661 Murdock Condenser 4.25
- No. 3662 Murdock Condenser 5.00
- No. 3680 Murdock Condenser 3.25
- No. 3681 Murdock Condenser 3.50
- No. 3682 Murdock Condenser 4.25
- No. 3664 Murdock Dial Assembly .. 1.25

A complete line of Acme C. W. Apparatus and Tuska C. W. Inductances.
Burgess "B" Batteries.

Substantial Reductions

on many other radio instruments in our catalog No. 14. Circular with reduced prices and a large number of new instruments mailed on request.

"The Greatest Radio Catalog In The World" —

The Universal Verdict of Tens of Thousands of Radio Amateurs

DUCK'S No. 15 BIG 225 PAGE WIRELESS CATALOG. JUST OUT

A Veritable Treasure House of Everything Worth While and Dependable in Radio. The largest, most comprehensive, artistic and educational wireless catalog published. The Beacon Light to guide you right in the selection of your radio purchases, and at prices that will command your attention. Every instrument guaranteed with privilege of return if not satisfied.

The following prices shall prevail until further notice on the following items in our Catalog No. 14.

Concerning our improved type Navy and Arlington Receiving Transformers, our previous reductions were substantial. The prices below show are even lower than pre-war prices and when these instruments did not possess the existing marked and exclusive features.

These instruments can be bought nowhere else. These prices, seemingly unjustified, are subject to advance at any time. We are taking a chance at a reasonable profit on an enormous anticipated quantity production.

Model 5BB Navy Type Receiving Transformer, Regular Price, \$27.50 Special Price only \$16.95

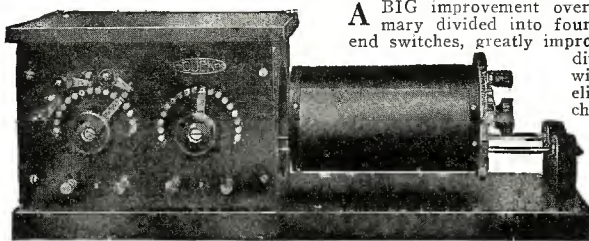

A BIG improvement over our former model. Primary divided into four sections, with three dead end switches, greatly improving selectivity. Secondary divided into three sections, with two dead end switches, eliminating harmonics. The change in the construction of the guide rod support makes it possible to obtain a looser coupling. It is a wonderful improvement over our old model, both in appearance and performance.

Improved Arlington Receiving Transformer, Regular Price \$15.00 New Price, Only \$7.75

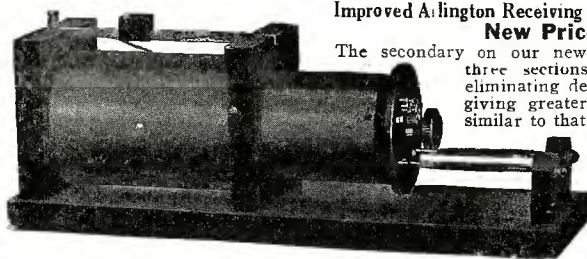

The secondary on our new type Arlington is divided into three sections, with two dead end switches, eliminating dead end effect and harmonics and giving greater selectivity. The end support is similar to that on our Navy, permitting a looser coupling. The base and primary end pieces have a spline to prevent warping or damage in transit. This feature is also on our Navy. It is a beautifully finished instrument.

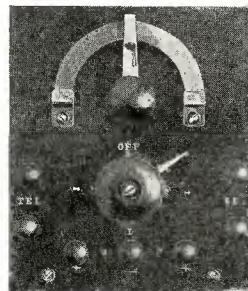

No. A200

An excellent Audion Control Panel for use with new four-prong bulbs. Grid leak and grid condenser are mounted on rear of panel. New type panel rheostat mounted on center of panel. The formica panel is attached to a wood base, upon which is mounted the tube receptacle.

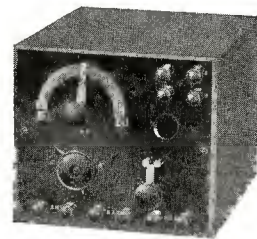

No. A201

No. A200 Panel Detector Sets, less batteries and bulb..\$7.50
No. A201 Cabinet Detector Set, less batteries and bulb..15.00

Send 12 Cents for a copy of
Our Big Catalog Today

THE WILLIAM B. DUCK CO., 231-233 Superior St., Toledo, Ohio

ATLANTIC RADIO

READ every word of this important announcement. You will find many exceptional offers, some of which will surely appeal to you. Each item listed on this page is in stock at both our stores, ready for instant delivery, either at the store or by mail. As you know, the Atlantic Radio Co. has an enviable reputation for prompt and accurate mail shipments to over a dozen different countries.

MARCH BULLETIN

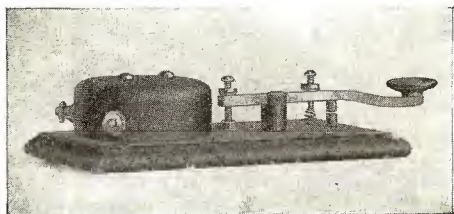

"Ajax" Learner's Key and Buzzer Set
Solid brass, lever type key, bakelite knob and high tone adjustable buzzer, with silver contacts and two adjusting screws located on top of buzzer. A wide range of tone can be had by a very slight turn of the screws. All brass fittings, grained and lacquered.

Price, \$1.75
(Shipping weight 1 lb.)

"AJAX" SENDING KEY

Lever type, all brass, machine made, heavy contacts, Bakelite base and knob., size overall 5" x 2 1/4". Price\$1.50
(Shipping weight 1 lb.)

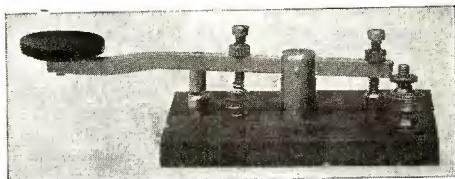

MISCELLANEOUS—EVERY ITEM AN EXCEPTIONAL VALUE

- A. R. Co. Amplifying Trans-former\$5.00
- Corwin 3" Dial, with knob. 1.30
- Corwin 3 7/8" Dial, with knob 1.70
- G. A. grid condenser..... .35
- G. A. telephone condenser.. .35

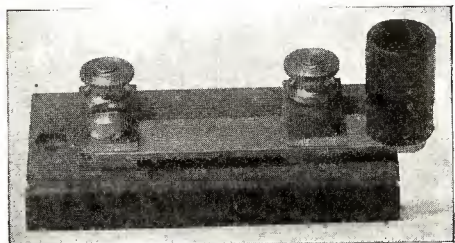

"Ajax" Single Pole, Single Throw Switch
Useful for a variety of purposes. Size 2 1/2" x 1 1/8". Price.....40 cents
(Shipping weight 1 lb.)

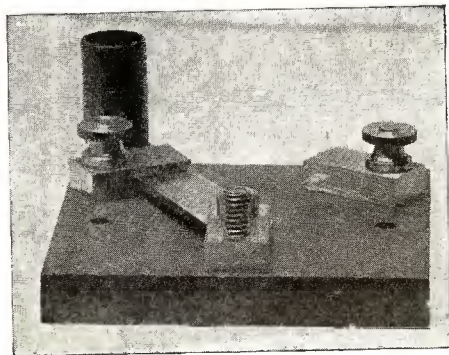

REQUEST Bulletin 14—complete information concerning all types of radio equipment—receiving sets, transmitting sets, transformers, condensers, small parts, etc., *Mailed Free on request.*

SPECIAL
Type T-A-W Roller-Smith hot wire radio AMMETER
Three models, 0-1, 0-2 1/2, 0-5
at **\$5.00** each
(Shipping weight 1 lb.)

Radiotron Trans-mitting Tube UV-202
Now Ready for Distribution:
A 5-watt transmitting tube, taking a maximum current of 2.35 amperes at 7 1/2 volts, normal plate voltage 350 volts.
Price \$8.00 Postage ten cents



\$11.00

Paragon-Radiotron Combination

Represents a great saving in a Vacuum Tube Detector outfit; complete as shown, **ONLY.....\$11.00**
Standard Radiotron UV 200 Vacuum tube\$5.00
Paragon Detector Unit, complete with tube socket, rheostat, grid condenser and grid leak.....\$6.00
The greatest value ever offered!

(Shipping weight 2 lbs.)



THE "AMPLIFONE"

solves the question of a loud speaking device at a price within the amateur's reach. Price.....\$20.00
(Shipping weight 10 lbs.)

- G. A. combination grid leak and condenser50
- C. E. Mica and Copper Foil grid condenser60
- VACUUM TUBES**
- Radiotron UV 200 (Detector)\$5.00
- Radiotron UV 201 (Amplifier) 6.50
- Electron-Relay (Detector). 6.00
- "B" BATTERIES**
- Radisco 22.5 volt (Small)..\$1.50
- Radisco 22.5 Volt (Large).. 2.65
(Tapped at six points)
- "A" BATTERIES**

We recommend the Eveready 6IG 60, 6 Volt 60 Ampere battery for filament lighting. 18 months guarantee. Price, \$21.50
VT SOCKET SLEEVES
(Without base or contacts)
35 cents each. Postage 5 cents. While they last. Get one and make your own tube socket.

"Ajax" Single Pole, Double Throw Battery Switch
(At Left)
Machine made, all brass, 25 amperes, bakelite base and knob, adjustable for wear, grained and lacquered. Size 2 1/2" x 2 1/4". Price, 50 cents.
(Shipping weight 1 lb.)

A REAL BUZZER
(At Right)
"Hytone" buzzer, just the thing for test or practice.
50 cents each
(Shipping weight 1 lb.)

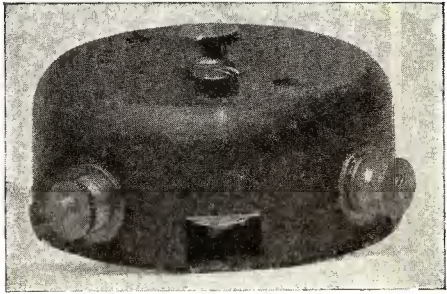

ATLANTIC RADIO COMPANY, Inc.
88 Broad St., Boston, 9, Mass. Branch, 15 Temple St., Portland, Maine



RADIO NEWS

H. GERNSBACK—Editor
ROBERT E. LACAULT—Associate Editor

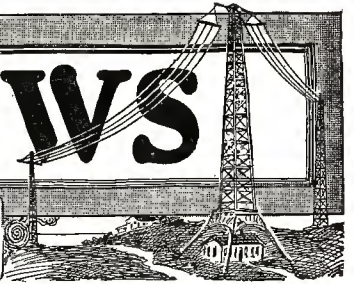

Vol. 2

MARCH, 1921

No. 9

Amateur Radio Telephony

RADIO telephony has been with us for a great many years now, and while this branch of the art has not developed as readily as Radio telegraphy, still, all the principles are well understood by everyone interested.

But the development has been very slow as far as the amateur is concerned, and it does not at all receive the attention it deserves. Amateurs still look upon a radiofone set with awe and it is seldom indeed that they can be induced to work up sufficient courage to put together a set. Most of the amateurs that one meets have in their possession ready-made equipment, but few if any, think it worth while to spend the time and energy to construct a set themselves.

Now, of course, there is nothing that is unknown or really very difficult today about a radiofone transmitter, and any amateur who has in his possession two or three good vacuum tubes can do a little sending. To be sure with such an equipment he cannot expect to transmit over considerable distances, but for work about town, sending out phonograph concerts and the like, such a set is really ideal. On the other hand nearly every amateur worth while has in his possession right now the equipment necessary to receive radio telephone messages, so there is no difficulty at all here. The difficulty if any, lies chiefly in the transmitter, and the disinclination of many amateurs to do a little work, a little hard thinking and to have enough patience to put a set into operation.

It is really amazing and well-nigh astounding that most amateurs still persist in pounding the key and sending out dots and dashes. This not alone takes considerable time, because such transmission is slow, but the physical work is considerable. The average amateur cannot transmit more than about 20 words a minute and he seems to think this is good work. During the same time you can speak 200 words into a radiofone and besides you get the human element into your message as well.

Have you ever stooped to think how clear the nightly ether would be if all amateurs were using radiofone equipment instead of radio telegraphy? If it takes one minute to send twenty words in code and one minute to transmit 200 words over the radiofone, it becomes apparent that there would be very little jamming because everyone concerned would get there so much quicker; for this reason it would not be necessary for each individual to "hog the ether" for hours at a time as is the case now.

For experimental purposes much time can undoubtedly be saved. Take for instance where one experimenter calls up a friend. He repeats six times or more such a tremendously important message as "How do you get my spark?" This takes him perhaps five minutes to do, and

by the time he is thru, the party at the receiving end has probably received the first few dots and dashes strong and the rest weak. Then follows the endless chain of flashes back and forth until the distant party "receives him O. K." It is particularly this sort of thing that jams the ether uselessly and brings amateurs into disrepute. Anyone who does not believe this, only needs to pick up his receivers any fair evening, and he will be speedily convinced. The same information over the radiofone can be accomplished in a very small fraction of time necessary to send the telegraphic signals, as is readily understood.

Of course, the amateur cannot be accused that he does not know all this, but still he drudges on the old way punching the key to his heart's content. At the same time we do not wish to be too hard on the amateur because after all there is some justification for his sticking to the key. Unless he expends a great deal of money his radiofone set will not transmit as far as his low-priced radio telegraph set. But how many amateurs are there who are really so crazy to do long distance work and transmit even one hundred miles? If the thing were sifted down carefully, it probably would be found that most amateurs would be content to speak with their friends within a radius of 20 miles, and this the radiofone can readily accomplish. In his heart of heart the amateur knows this to be true, but just now he has the vainglorious craze for long distance transmitting. In time the amateur will come to recognize that after all it is not such great fun to send messages to some unknown stranger a hundred to two hundred miles away, and he will probably be content to have his voice heard by his friends about his town and environs. Incidentally, when this happens, we will not be bothered so much with radio legislation as we are now.

The trouble with us is that everyone of us wishes to be heard all over the planet and we thereby interfere with legitimate business, and secretly we know that this is wrong. We are much too apt to abuse the privilege which our country bestowed upon us amateurs. We should thank our stars that we have such liberal laws that permit us to do most anything, but we insist upon overstepping our rights at every hand. Compare this with amateurs residing in Great Britain who cannot use more than 10 watts power at any time and there are many countries where no transmission is allowed at all.

So as long as we have to contend with a necessary evil, why not let us reduce this evil as much as we can so that we cause no annoyance to legitimate business. And the writer believes that the radiofone, as far as the amateur is concerned, is the right way out.

H. GERNSBACK.

The Radio Station at Rome

By B. MICCHIARDI, G. PESSION and G. VALLAURI

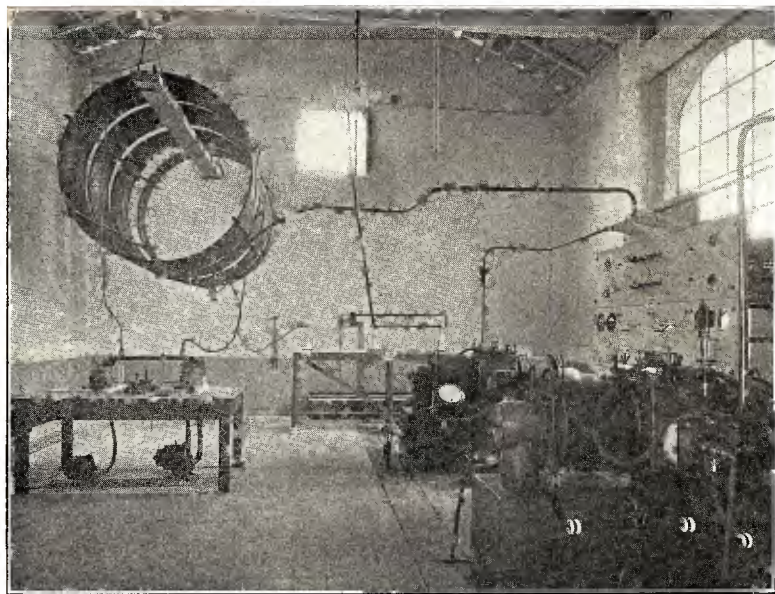

The transmitting room at Rome. On the right are the two arcs and the control switchboard, while at the left, under the aerial inductance, is the manipulating device. The latter is cooled by a blower which may be seen under the table.

IN 1917, the Italian Government decided to construct a high-power radio station capable of handling traffic with the Red Sea Italian colonies, and of communicating with North America. This task was undertaken by the Royal Navy, which is at present in charge of all radio communication between Italy and its colonies.

Rapid communication with the main offices of the Government was necessary. Further, the station had to be situated in readily accessible territory, on moist soil, in a region not intensely cultivated or covered with trees, and in the neighborhood of supply stations for electricity and gas. A tract of land in the Tiber valley, immediately below the Basilica of San Paolo, in Rome, was accordingly selected.

THE SYSTEM EMPLOYED.

Communication was to be established in two almost opposite directions, the true bearing along a great circle thru Rome being, for Massaua, 130.5 deg., and, for New York, 300.9 deg. The respective distances are 2,440 and 4,300 miles. The necessity for haste led to the adoption of certain existing buildings, and also dictated the choice of the system to be used. Continuous waves generated by the Poulsen arc were selected. The Royal Navy had used the arc successfully in other small stations. An antenna was provisionally chosen, having the shape of an equilateral triangle, supported by three cables (spreaders) more than 610 ft. in height, with the down leads coming from one of the sides. Later, a second set of down leads was brot from the interior of the elevated triangle. For the antenna supports wooden masts, having a triangular latticework structure, were adopted. Such masts had been previously employed successfully in America.

The plans of the station were rapidly worked out in May, 1917.

The radio transmitting apparatus and its switchboard were furnished by the radio engineer, Mr. Cyril F. Elwell, who supervised its construction in Italy; the generators were furnished by the Marelli Company, and the principal controlling switchboard was supplied by the Magrini Company and provided with "C. G. S." measuring instruments, and at the end of October, 1917—that is, in less than five months—the station was ready.

TRANSMITTING APPARATUS.

The installation of transmitting apparatus is shown in Fig. 1. The transmitting room is divided into two parts, one for the generating machinery and the other for the arc. The generating machinery consists, at present, of a single set, but a second will be shortly added. The power supply is obtained from the Società Anglo-Romana at 8,500 volts (three-phase). There is a small 30 k.v.a. transformer stepping down to 220 volts for the lighting lines, and another 500 k.v.a. transformer providing 525 volts for the principal set and all auxiliary motors. This room is on the ground floor, and the conductors to the transmitting room consist of underground cable. An overload circuit-breaker is inserted in the transformer primary.

The motor generator set consists of two direct-connected machines, running at 645 revs. per min. The motor has the following constants: 387 kw., 500 v., 530 amperes, 44 \sim , power factor 88 per cent., and full-load efficiency 93.5 per cent. The direct-current generator has two commutators which can be connected in series or parallel. It is considerably over-compounded, and is separately excited at 110 volts. At full output and with two commutators in series it yields 350 kw., 1,200 volts 291 amps., efficiency 93 per cent. The two halves of the series excitation winding can be connected in parallel or in series, giving various characteristics. The machines have been designed with generous dimensions, as overheating did not even exceed 40 deg. for any electrical part. A severe test of dielectric strength—*i. e.*, the application for a 10-minute period of an effective alternating voltage of 5,000 volts—was carried out on the dynamo windings.

A diagram of the switchboard for controlling the principal unit and the auxiliary units is given in Fig. 2. Two overload circuit-breakers were provided—namely, an oil breaker in the three-phase circuit and an air-breaker in the direct-current line. Means were provided for protecting the dynamo from radio frequency currents originating in the arc and against possible earthing of the antenna.

The antenna is separated from earth by a condenser and the framework of the dynamo (and therefore that of the entire unit) is insulated from earth, the base

plate of the set being supported on a framework of beechwood previously boiled in paraffine. An insulation resistance between frame and earth of several tens of megohms is thus obtained. To prevent any appreciable oscillating current from reaching the windings of the dynamo and thus giving rise to dangerous P. D.s therein (1) there are inserted in the supply line of the arc large choke coil inductances; (2) the terminals of this line are connected to each other thru an ohmic resistance (shown in Fig. 2 in the upper portion of panel B) consisting of 20 incandescent lamps connected in series with the middle point of the series earthed; (3) the terminals of the machine are shunted by two sets of condensers, that connected to the positive pole being 0.1 mfd. and that connected to the negative pole 2 mfd., the junction point of the sets being connected to the frames of the motor generator set. This last shunt includes two ammeters, which under normal operating conditions for the arc indicate an oscillating current of about 0.5 ampere.

ARC EQUIPMENT.

The assembly of arc equipment comprises two similar arcs, an operating switchboard, an antenna inductance, and a table on which are mounted the keys and all other transmitting accessories. The two conductors of the arc supply circuit (direct-current 1,200 volts and 300 amperes) before leaving the generator room, pass thru two current-limiting inductances, each of 500 millihenrys (the reactance of which is still further increased owing to the mutual inductance).

On the arc switchboards are a commutator for changing over from one arc to the other, with two extra choke coils and, for each arc, an overload circuit-breaker, a starting resistance provided with electric remote control, an ammeter, and a voltmeter. All auxiliary control apparatus is supplied with 110-volt current and connected thru an interlocking arrangement which prevents the arc circuit closing until all necessary preliminaries have been carried out. The diagram shows several of the interlocking circuits.

(Continued on page 632)

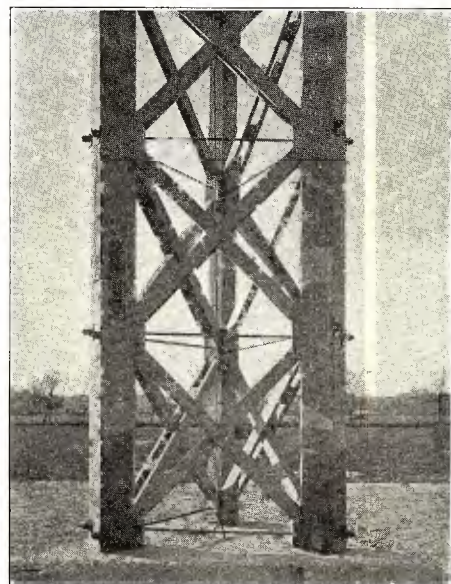

Detail of Construction of the 750-Foot Towers, Entirely Made of Wood, Supporting the Aerial at the Rome Radio Station.

Awards of \$100 Portable Radio Prize Contest

FOURTH PRIZE WINNER

A Pocket Wireless

By Raymond M. Moore

WHY not install a wireless in your billfold? Especially when you're broke! After reading in RADIO NEWS about a prize for the smallest portable radio outfit I decided my billfold would be of more use carrying a wireless than money. This is the method I used:

Take a billfold or card case of the ordinary kind that folds over twice.

The coil to the extreme right is the secondary and is constructed on the pancake style in the following manner: Take a piece of cardboard or wood $\frac{1}{2}$ " x $1\frac{3}{4}$ " x $\frac{1}{4}$ " and paste a piece of cardboard 2 " x 4 " on either side so the first piece forms a core for the coil. Then wrap 450 turns of 31 S.S.C. wire on this, taking a tap every 90 turns. This makes a coil about 2 " x $3\frac{1}{4}$ ". Break frame away from it and fasten on the billfold with an ordinary needle and thread, running the taps under the primary to switch.

The primary is placed on the center of the fold and is constructed and fastened on much the same principle as the secondary. It consists of 820 turns of No. 28 S.C.C. wire, a tap on the first 80 turns and every 40 thereafter, making seven in all.

The extreme left of the fold is given over to the panel or control. This is a piece of fiber or some stiff insulating material $1\frac{3}{4}$ " x $4\frac{1}{4}$ " x $\frac{1}{8}$ " and is slitted under the transparent cover where identification card belongs. On this are mounted the primary and secondary switches, the crystal detector and binding posts. The condenser is also mounted here.

The primary switch is of the usual rotary type and has a 1" radius. The small fiber handle is grooved and slitted on a lever as there is hardly enough room for a screw in it. Since such small switch points are hard to get, it is of interest to know I took these out of old electric light sockets. They are just right. The bearing for the primary switch is also the antenna binding post. Both switches increase counter clockwise.

The secondary switch is much the same as the primary, but is a little longer to allow for the condenser which is mounted

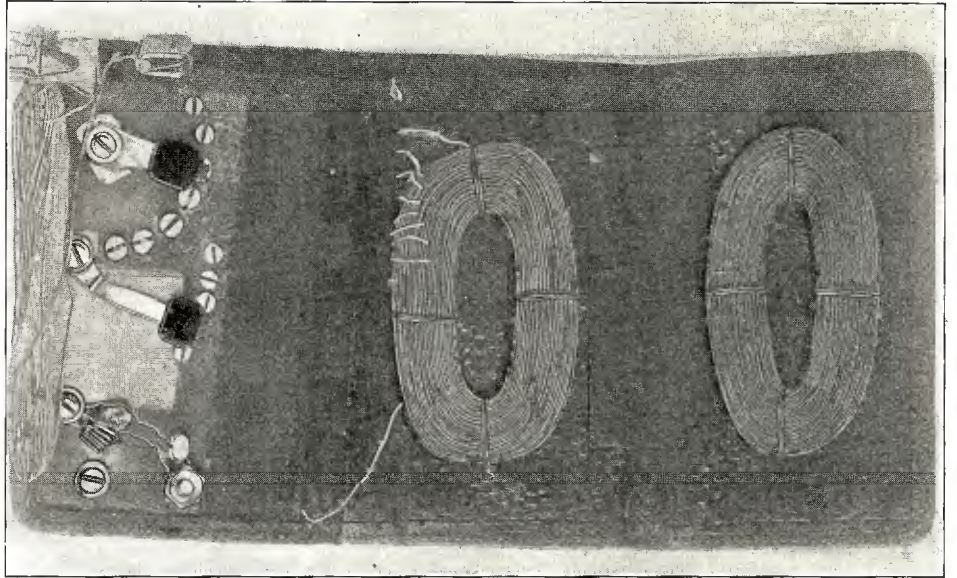

Inside View of Mr. Moore's Pocketbook Receiver. Note on the Left the Switches Controlling the Primary and Secondary and the Detector. The Aerial is Wound Around Two Pegs and Fitted With Clips for Contact to Some Other Aerial for Long Waves.

under it. It has a radius of $1\frac{1}{2}$ " and uses the upper fone binding post as a bearing.

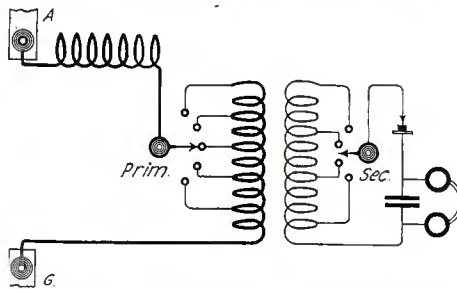

Hook-up of the Portable Receiving Set Fitting a Pocketbook.

The condenser which is mounted between the two middle binding posts or the fone binding posts is $1\frac{1}{4}$ " x $1\frac{1}{4}$ " square and has flaps on each side to connect to posts. It is of the usual stoppage variety.

The detector cup or clip is also directly connected to the lower fone binding post and is set down in the panel. It should be made of good spring brass to hold the crystal well. The cat whisker wire is fastened on the lower right post.

The post directly below the detector cup is the ground. About 10 feet of wire are fastened to this for use as ground connection with a clip on the end which can be hooked to anything handy in the ground line or to a tinned spike driven into a tree trunk. This is wound over the antenna holders when not in use.

The coil on the left of the panel is the antenna, or if not needed for that, the fixt loader. It is made of about 100 feet of No. 28 wire and is wound on two pieces of wire bent in U shape and a long tail which is inserted between the end of the panel and the end of the fold. As much wire can be put on as is convenient and needed to give satisfaction. One end of this is fastened to the antenna binding post and the other to a clip similar to a ground clip.

This makes an outfit which is complete. except for the fones, in $19\frac{1}{4}$ cubic inches

or an overall measurement of $4\frac{3}{4}$ " x $3\frac{1}{4}$ " x $1\frac{1}{4}$ " when folded to carry. In fact it is no bulkier than the ordinary well-filled billfold. The coupling is varied by opening and closing the right hand flap.

Care should be taken in placing the coils to see that when closed the primary is directly below the secondary. This is done to secure the best coupling.

Editor's Note:

This portable set is certainly new in design and of a novel and original form. Tested in the RADIO NEWS laboratory it has given good results. With an aerial, Arlington time signals were received as well as many other stations around New York City.

In a letter, Mr. Moore told us that this set was built by him while he was in bed, recovering from a long illness and that Radio was a great help in passing the hours away.



Photograph of Mr. Raymond M. Moore, Designer and Builder of the Set.



This Shows the Size of the Set When Folded. Two of the Binding Posts are for Aerial and Ground, the Two Others for the Fones.

Recent Attainments in Wired Radio

By R. D. DUNCAN, Jr.*

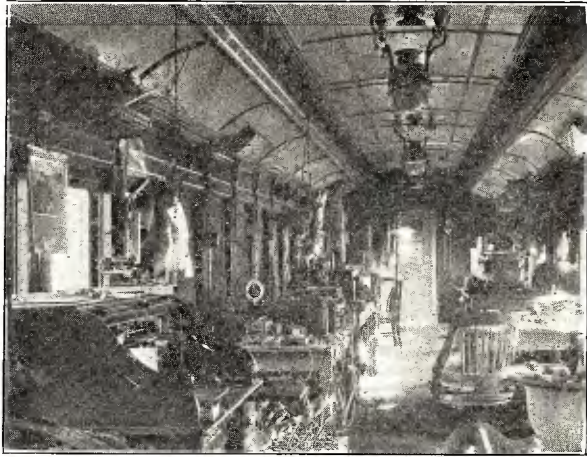

General View of the Inside of the Moving Station Used for the Tests on Wired Radio.

THE publication in 1911 by Major (now Major-General) George O. Squier, of a paper on "Multiplex Telephony and Telegraphy," marked an epoch in the scientific progress of the telephone and telegraph art. Tho the problem of multiplex telephony and telegraphy had engaged the attention of a number of inventors prior to General Squier's work, the ideas underlying the schemes which hitherto had been proposed were based, almost without exception, upon the principles and practices of the old telephone art. The great advance made by General Squier, and that which made the use of high (radio) frequency carrier currents successful, was the combined utilization of tuned circuits, and a detector or rectifier at the receiving terminus. By this achievement the principles common to the radio art were made available to the older wire systems and a new method of transmission of intelligence was created.

The utility of wired radio was early realized in this country by certain of the telephone and telegraph companies, and its practical development in the realm of low frequency carrier currents has been carried to an advanced and commercial stage; long-distance telephone and telegraph lines employing the system are in daily operation between a number of large cities. That this country is not alone in the development of this new art is evidenced by the publications of Wagner, Faszbender and Habann, in Germany, and by Marumbo in Japan. The two former papers contain interesting accounts of the development of wired radio apparatus in Germany during the war; the latter paper, tho quite brief, is also of great interest, as it contains descriptions of methods and apparatus used where a high voltage power line was employed for transmission means.

PRELIMINARY EXPERIMENTS.

The practical development of wired radio was not pushed vigorously during the war by the Signal Corps, U. S. Army, as military requirements demanded apparatus of a more purely radio nature. A limited number of field telegraph sets operating on low frequencies were developed and manufactured. In an attempt to find use for a large quantity of radio telephone apparatus which had been purchased during the war, and which was then idle, experiments were commenced in the early part of 1919 with a view to investigating the possibilities of adapting this apparatus to wired radio communication.

In the experiments described, it was originally intended to employ frequencies

of the order of 75,000 cycles per second for carrier purposes since in common with the prevailing opinion it was believed that the excessive values of attenuation which, it was thought, must occur at the high frequencies, would be prohibitive of transmission over anything but the very shortest distances. Accordingly, efforts were first directed towards altering the constants of the transmitting apparatus so that frequencies of this order of magnitude could be obtained. However, the radio telephone apparatus which was to be employed was originally designed for operation at high frequencies (short wave-lengths) and on relatively small antenna capacities; from experiment it was found that if the original intention of using low frequencies was adhered to, a considerable change in the construction of the apparatus would be required. As a consequence it was decided to abandon the low frequency idea and to utilize, what had heretofore been considered the extremely high frequencies, as a carrier means.

One distinct advantage which was anticipated and which does result from the use of very high carrier frequencies is the elimination of speech distortion so common to long-distance wire telephony. In accordance with radio telephonic theory, three frequencies will be present in load circuit (antenna or telephone lines), if the modulating frequency contains no harmonics, *viz.*, respectively, the main carrier frequency, and the sum and the difference of the main carrier frequency and the modulating frequency. If harmonics are present in the modulating frequency, then in addition to the three main frequencies, there will be additional frequencies corresponding to the sums and differences of the main frequency and each of the harmonics. Assuming that the fundamental frequency of the voice is 800 cycles per second, and the limiting harmonic to be 3,000 cycles per second, it is readily seen that at high carrier frequencies, the band of frequencies which is transmitted, is so small a percentage of the main carrier frequency that the attenuation to all frequencies within the band is practically the same. The elimination of speech distortion due to this cause thus automatically results.

The experiments were conducted on a wire belonging to the Postal Telegraph Company, running between Washington and Baltimore, a distance of 66 wire miles (106 Km.). The line was aerial thruout the distance of transmission and contained a single section of overhead cable approximately one quarter of a mile in length; in the experiments the transmitting and receiving apparatus was connected between the line and the ground. The carrier frequency employed was 600,000 cycles per second. Thruout the entire tests the line was in ordinary duplex telegraph operation; no interference either from the ordinary telegraph operation, or from the wired radio, was experienced by either system. The normal

range of the apparatus when functioning as a "radio" telephone in communication with similar apparatus, is ten miles; it is seen that by the methods of wired radio, the range of communication was increased many times.

For telegraph purposes, only a vacuum tube transmitter was developed for operating directly from a 220-volt direct current lighting source.

The results of these preliminary experiments were of unusual interest, as it was demonstrated that transmission over relatively great distances could be accomplished with frequencies greatly in excess of the value which had heretofore been taken as the upper limit. From a practical standpoint, a number of questions arose requiring further investigation, of which probably the most important was that of determining the relative parts played by radiation and by true conduction, and of the distances over which satisfactory transmission might be expected to be obtained.

LATER EXPERIMENTS.

Further investigation along this line was made possible thru the courtesy and cooperation of the New York Central Railroad Company. Thru their General Superintendent of Telegraphs, Mr. E. C. Keenan, a pair of telephone lines running between New York City and Albany, N. Y., and two railway passenger coaches, stripped of their seats, were placed at the disposal of the Signal Corps. These cars were equipt with special and standard types of radio telephone and telegraph apparatus and auxiliary equipment, storage batteries, receiving and amplifying equipment, etc. An oscillograph was included as a part of the equipment of one car, for the purpose of studying telephonic modulation. During the actual field tests the two cars served as the abode of the members of the party. Views of the two coaches and an interior view of the coach which served as the first station, are shown in Figs. 4 and 5.

Experiments on the New York Central telephone lines were commenced the latter part of 1919. They had as their primary object a study of the possibilities of establishing communication over fairly long sections of line when employing extremely high carrier frequencies. The electrical properties of the telephone lines when serving as the load on the radio frequency generator were also to be studied, since from the information thus obtained, artificial line loads might be constructed upon which the development of future transmitting and receiving equipment could be based.



Inside View of the Coach Used as a Fixed Station, Showing the Microphone and Receiving Set Used for the Tests.

*Radio Engineer Signal Corps, U. S. A.

Two arrangements of the special transmitting apparatus were employed, one in which the telephone lines were coupled directly to the radio frequency generator circuit and one in which the modulated radio frequency power was first amplified by a bank of vacuum tubes connected in parallel, and then fed into the line load. The generating and modulating apparatus is shown at the left in Fig. 5; the power amplifier is shown to the right.

The type VT-2 vacuum tube was used for transmitting, two operating in parallel, in both the generating and modulating systems, and from one to four tubes in parallel in the power amplifier. Plate voltage for operating the transmitting tubes of the fixed station was furnished by a motor generator set driven from 110-volt power lines; in the mobile car plate voltage was furnished by dynamotors operating from storage batteries. The transmitting apparatus was arranged for telephonic operation and for both continuous wave and buzzer modulated telegraph operation.

The method of connecting or coupling the line load to the radio frequency generating unit is novel and possesses several features which are of value in duplex telephony. One annoying source of trouble in duplex telephony is interference produced on the receiving apparatus by the stray electric and magnetic fields of the transmitter. Experiment has shown that the electric field may be confined to within known limits by shielding of the apparatus; the magnetic field, however, cannot be restricted by shielding and its disturbing effects may be minimized only by the proper design and displacement of the inductive and current carrying elements of the circuit. In the present circuit, energy is furnished to the lines thru the means of a closed iron core transformer whose primary is connected, in series in the plate circuit, with the "frequency determining circuit." This transformer is designed to have a minimum magnetic leakage and its use permits of the further use of an inductance, in the frequency determining circuit, of a compact form which has a very restricted magnetic coupling field. The requirement for a minimum magnetic disturbance due to this inductance is equivalent to the requirement of a minimum value of ampere turns of the inductance effective at a given point in space. A theoretical consideration of this type of circuit shows that for a given frequency, and constant number of turns in the frequency determining inductance, the disturbing magnetic field will be a minimum and the line current a maximum when the ratio of the capacities interposed respectively between plate, grid and common negative point of filament is made large. When this is the case, the effective resistance of the frequency determining circuit is small and the major portion of the high frequency power converted by the vacuum tube is expended in the load. Experiment confirms these conclusions. The increase in

ratio of the plate to grid capacities in this type of circuit, aside from other practical considerations, is limited by its effect upon the telephonic modulation it was found that if carried to an extreme, the degree of modulation was considerably reduced. The iron core transformer is seen in the foreground of the photograph of the generator unit in Fig. 5.

The receiving equipment, shown in Fig. 4, consisted of a standard radio receiver and a two-stage audio frequency amplifier. The type VT-1 vacuum tube was used thru-out. The apparatus employed in the later experiments was entirely experimental in character and was designed to obtain a high degree of flexibility in power output and in frequency. It was intended in no manner to represent a finished product.

In adjustment of both the transmitting and receiving apparatus, the lines were tuned to resonance by means of the series line capacity. The tuning, while not as sharp as obtained with a radio antenna, revealed a distinct resonant point, and could be made broad or sharp at will, by altering the magnitude of the loading or coupling inductance.

The transmission and reception tests



The Two Cars Used by the Signal Corps During the Experiments of Wired Radio.

were conducted on a pair of telephone lines running from New York City to Albany, N. Y., paralleling the Putnam and Harlem Divisions of the New York Central Lines, and the Boston and Albany Railroad for a short distance into Albany. The lines were aerial thru-out the length effective in these tests and were transposed approximately every half mile; short lengths of overhead cable were included at three intermediate points where the lines entered stations for test purposes. These lines constituted the main telephonic channel of the New York Central Railroad between New York City and Albany and were in almost continuous operation. Besides being in ordinary telephonic operation the lines were composited, each wire of the pair operating a Morse circuit to ground. Thru-out the experiments no interference with either system was produced by the other.

Telephonic and telegraphic communication was established over the pair of wires from Elmsford, N. Y., just north of New York City, and Albany, N. Y., a distance of 130 miles (209 Km.). A good quality of speech and both continuous wave and buzzer modulated telegraph signals were obtained. The carrier frequency varied from 600,000 to 300,000 cycles per second (wave-length 500 to 1,000 meters). The high fre-

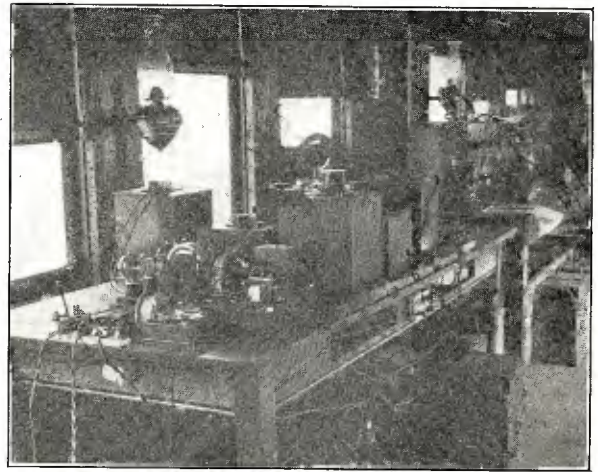

Close View of the Complete Transmitting and Receiving Equipment Installed in the Movable Station.

quency power output varied from less than one-half watt to twenty watts, depending upon the apparatus used. It is to be observed in this respect that when dealing with radio telephone circuits, in contradistinction to those used in radio telegraphy, an indication of maximum current into the load is not always indicative of most efficient operation. What is sought and that which is the most effective at the distant receiving station, is the faithful and complete telephonic modulation of the power output that is available. A large power output incompletely or imperfectly modulated is no more effective than a smaller one more completely modulated and modulated with less distortion. Views of the transmitting and receiving equipment of both the fixed and mobile stations are shown in Fig. 3.

In the Washington-Baltimore experiments, as well as in the later ones, evidence of the existence of standing waves on the telephone lines was obtained; this was quite noticeable in the moving-train experiments later described. Standing waves, as is well-known, are produced by reflection from either the far end of the line, or from intermediate points where there occurs a sudden transition in the electrical properties such as produced by the introduction of short lengths of cable, changes in the size of conductor. In the latter case, unless the reflection is complete, a portion only of the outgoing wave will be turned back, and a portion will proceed unreflected; as a result there will occur partial reflection and partial unreflected transmission. The location of the receiving apparatus with respect to the transmitter, when standing waves are present, is therefore determined largely by the wave-length or frequency of the carrier wave, since for efficient reception, it is necessary to avoid both voltage and current nodes. It was found that altering the frequency at the generator terminal apparently did not produce an effect in moving the nodes and loops along the lines equivalent to that of moving the receiving apparatus.

In the preliminary experiments previously mentioned, and in the earlier New York Central tests, one overhead wire with a ground return was employed. A comparison of this arrangement with an all-metallic circuit showed that the latter was the much superior of the two, both as to volume of speech received and elimination of external disturbances such as that produced by nearby radio stations. The reason for this improvement is attributable to the pronounced energy radiating and absorbing properties possessed by the one elevated wire with ground return. Both the direct current and "skin effect" resistance of a metallic loop should be equal to approximately twice that of one wire and ground. Theory indicates, however, that the resistance introduced by radiation is proportional, among other factors, directly to the effect-

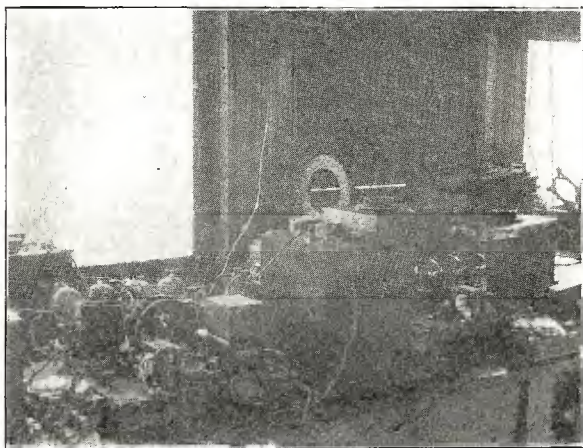

On the Left is Shown the Generating and Modulating Apparatus, While on the Right are the Tuning Elements of the Circuit and the Power Amplifier.

(Continued on page 640)

New Radio Instruments

British Apparatus

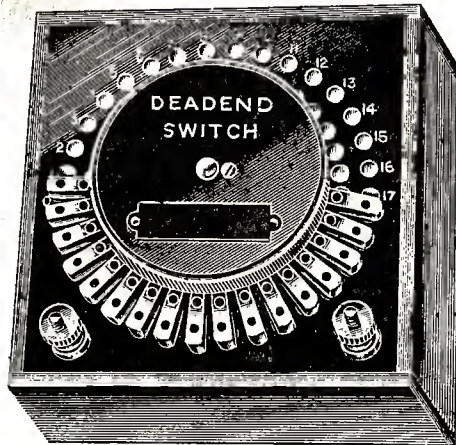

Here is a New Dead-end Switch Fitted With a New Type of Points Giving Smooth and Good Contacts.

THE photograph of Fig. 1 shows a new dead-end switch.

This piece of apparatus has been designed to eliminate detrimental effects of "dead-ends" on that part of a coil not in use when a section of the same has been tapt off and which is still mechanically connected. By means of this switch, these effects are entirely eliminated, as the coil is then tapt off in sections and the

requisite number can be put in for tuning by means of the rotary arms. The remaining parts of the coil are then mechanically disconnected.

The value of a switch of this description is well known to experimenters versed in valve reception. Contact is made on the double row of studs by flat-bottomed spring plunger contacts, and the studs are mounted flush so that a perfectly smooth and even contact is obtained.

THE MULTIFIER.

In Fig. C is a new audio frequency amplifier called the multiplier. It is fitted with three valves and is suitable for connection to any type of valve receiving set. It is possible to read signals 200 feet from the fones with this instrument, while if used in connection with a loud speaker, it is possible to entertain a large audience with either Morse signals or telephony.

The valves are coupled with the very finest type of transformers and a telephone transformer is also added to prevent ruining the insulation of the fones and shocks. Among other advantages the multiplier operates efficiently with signals of any wave-length, while the howling noises, so fa-

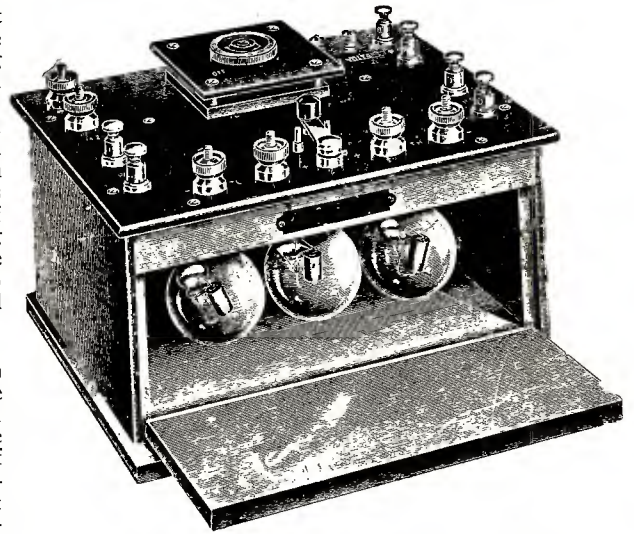

A Typical English Amplifier. Note the Compactness of this Piece of Apparatus in Which the Three Transformers and Three Tubes Are Enclosed.

miliar with most amplifiers, are reduced to a minimum. The valves are enclosed in the cabinet, thereby practically eliminating the risk of breakage. In addition to which it does away with the very trying glare so irritating to the eyes of the constant user.

Photo courtesy of Gamages Co.

A New Code Teacher

A SHORT time ago a new automatic sending machine, a photograph of which appears on this page, made its appearance in the radio world.

This set is quite new in design and its compactness and ruggedness make it the ideal instrument for teaching the code to radio students.

Beside the automatic transmitter is a buzzer having a high pitched note and a key for sending exercise. The clockwork running the drum is very strong and can work for a long time without winding. The speed is adjustable so that any speed of transmission is obtainable.

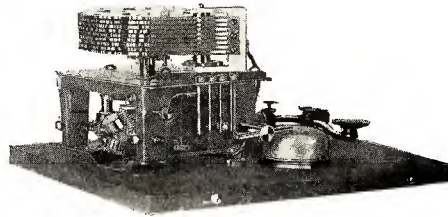

A New Type of Automatic Transmitter With Many New Features. The Discs May Be Automatically Changed in Any Desired Order.

The new feature in this instrument is the drum with a new device for changing the message sent automatically. The drum is made of aluminum and the dots and dashes are raised on the circumference; the space between is filled with an insulating compound and turned on a lathe. The surface is therefore absolutely smooth.

The circumference is divided into five sections for the reason explained below.

The contacts on each of the nine messages are made by springs which are permitted to touch the drum one at a time by an automatic system; the contacts are made

(Continued on page 638)

A Practical Receiving Set

THE accompanying illustrations show a new receiver which has been carefully designed and built for ship stations by a well-known Radio firm.

This instrument, which has a range of wave-lengths of 250-3000 meters, is fitted with two detectors and a switch controlling the wave-length by scales, the tuning for each of these scales being obtained by a variometer. Another switch changes the coupling between the primary and secondary.

In the front view of the receiver, under the detectors, is the switch to change from a detector to the other, the switch cutting out both of them when transmitting. This is particularly useful when the transmitter is located near the receiver, for the energy induced into the receiver is so strong that the detector gets out of adjustment most of the time.

A test buzzer is also fixed on the receiver; it may be seen in the lower left hand corner of the panel. The back view of the panel shows how all the apparatus is fixed on it and the bank wound coils as well as the wave-length switch are in the upper left hand corner.

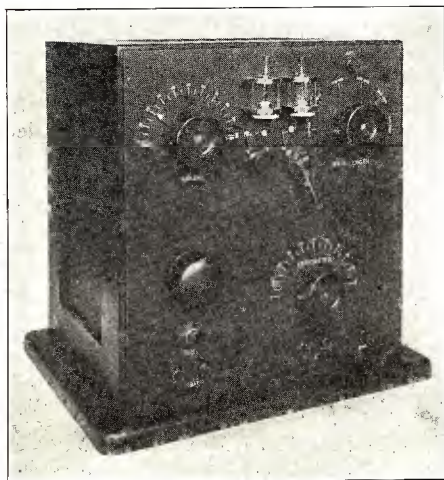

This Neat and Efficient Receiver Has a Range of From 250 to 3,000 Meters and Was Designed for Use Aboard Ships, But it May Be Used as Well by the Amateur to Receive Time Signals and Other Messages.

Photo courtesy of Emil Simon Co.

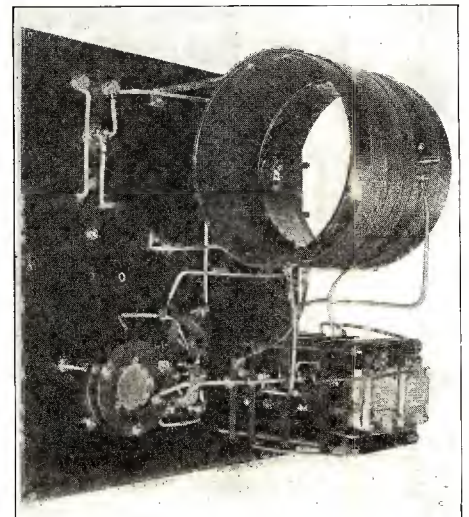

Inside View of the Practical Receiver. Note in the Lower Right Hand Corner the Combination Switch Changing the Range of Wave-Length of the Variometer Placed Above.

A Practical Radio Receiver

By S. G. CLINE

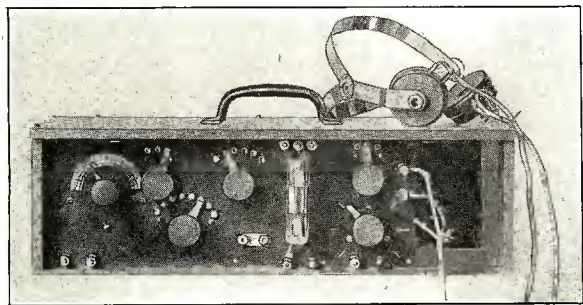

Front View of the Well Planned Portable Receiving Set Designed and Built by the Author. This Set Gives Very Good Results and is Very Sensitive.

THE accompanying photographs and diagram are of my set which is expressly adapted for the use of tourists as there are a great many on the Pacific coast at the present time.

This set is both simple and flexible as well as efficient and stable in operation. The single bulb detector acts as detector, oscillator and amplifier for damp or undamp waves from 600 to 17,000 meters. The reason for the choice of a V.T. detector instead of a crystal is that with a V.T. the set will operate any place on most any kind of an aerial and bring in far more distant stations.

The set was used on a trip into the mountains and the results were all that could be wished for from a portable receiver.

The aerial used was a single wire 200 feet long with an insulator at each end. To elevate one end of this aerial 100 feet of large size fish-line were used, on one end of which was tied a heavy lead sinker. First a tree with a limb protruding about fifty feet or more above the ground was located near the camp. It was an easy matter to swing the lead sinker and line over

the limb, the sinker bringing it back to the ground. The aerial insulator was tied on the other end of the line and drawn up to the limb. The other end of the aerial wire was fastened to a small tree a few feet from the ground and the set connected.

When used in camp, current for the filament was taken from the storage battery of my car; otherwise four dry cells wire used and held up very well as once the valve oscillates and signals are being received the filament voltage may be dropt a great deal. Two grounds gave the best

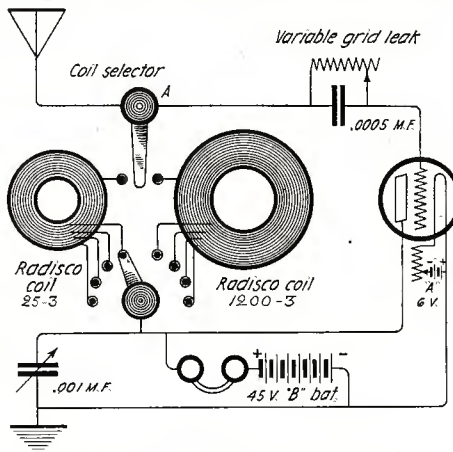

Complete Hook-up of the Light and Efficient Portable Receiver for Vacationists.

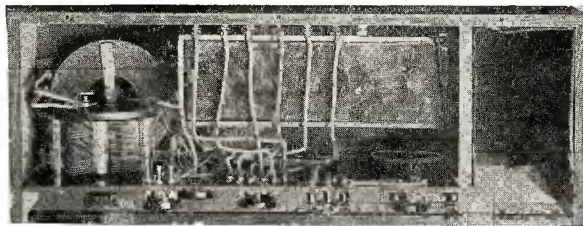

Top View of the Receiver With the Cover Removed. On the Left Can be Seen the Condenser and One of the Coils; in the Center the "B" Battery and on the Right the Compartment for the Fones.

results. A single wire counterpoise lay on the ground under the aerial and a metal pin was driven into the ground.

Choice was made of receiving the time from three stations; NPL and NPK spark, and NPG arc, and numerous other stations were easily heard, the faintest of which was NPM.

This set is comprised of a cabinet made from a panel taken from an old black walnut bedstead discovered in an attic. The panel is Bakelite-Dilecto 1/8" x 5" x 14", polisht. There are two tapt Radisco coils, one numbered LRD325-3, for short waves; and one LRD1200-3, for long waves; switch A changes to either of the two coils. The first four contacts of switch B are connected to the small coil and the next four to the large coil. To the left of the V.T. tube is the "B" battery switch.

Below this switch is the variable grid leak, variable by pencil. The grid condenser is made of two pieces of thin brass one inch square separated by a sheet of mica. To the right of the panel a space three inches wide lined with green felt is provided for the head fones.

The variable condenser is a Murdock of period .001 mfd. capacity.

A Wire Length Counting Machine

By RAYMOND ROOF

WHEN winding loose coupler, inductance or honeycomb coils it is very useful to know the length of wire used. Having built a honeycomb coil machine which has been described in this magazine previously, I decided to make this wire length counting machine to use in connection with the winding one.

The description which follows gives enough detail to help any experimenter in the construction of a similar machine.

The frame on which the different parts are fixt is a board of hard wood.

A is a piece of wood exactly 12 inches in circumference, B is another, approximately the same size. A is screwed onto

the board so that it turns easily; a brass washer is placed between it and the board. B is fastened to C by means of a bolt and two nuts, one on each side of C. A groove is cut out of the board for the head of the screw.

C is pivoted on the block E. D is a weight to hold the two rollers in contact. I I are two pieces of wood with holes thru which the wire is threaded.

F is the counter, a part of an old speedometer in my case. It is operated by means of the lever G which is pivoted at O. H is a nail on A which raises and lowers the lever G. The counter is operated by means of a ratchet and pawl and a spring pulls down the lever G.

With the accompanying photograph and diagram the functioning is easily understood.

To start with, the counter is set at zero, the wire to measure inserted between the two wheels and the guide I.

When pulled, the wire, by friction makes the two wheels turn and at each turn the nail H which is fixt on the lower wheel lifts up the lever G; at the other end of G, the spring pushes the first dial of the counter 1-10 of a turn.

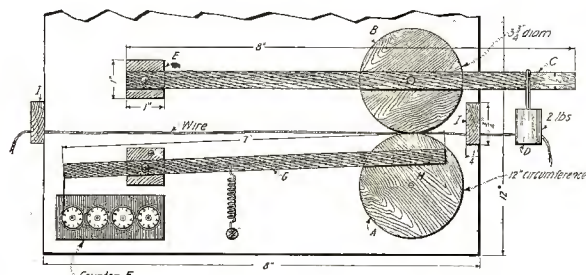

Scheme Showing Every Detail and Dimension of the Machine Which May Easily Be Built by an Amateur.

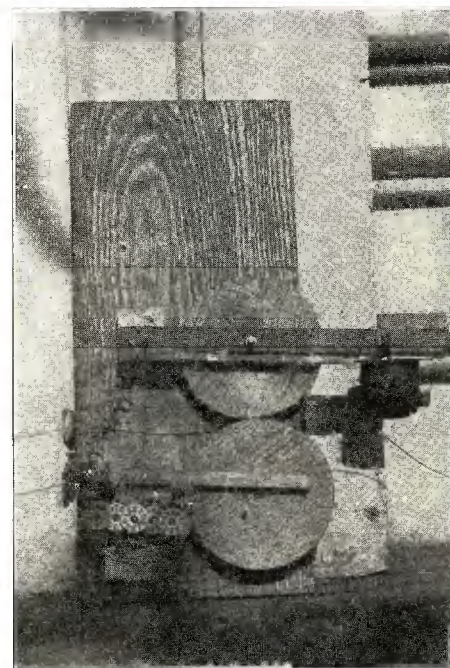

Front View of the Wire Length Counting Machine

Notes on the Functioning and Construction of Resistance Coupled Amplifiers

By ROBERT E. LACAULT

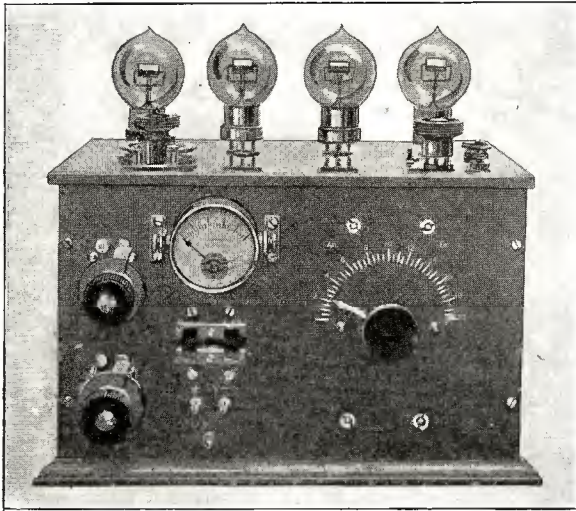

A Four-Stage Radio Frequency Amplifier Using Resistance Coupling. The Hook-up of This Apparatus is Shown in Fig. 3.

ALTHOUGH every experimenter has heard of the Radio frequency amplifiers, very few of them have made any experiments with resistance amplifiers, probably owing to the lack of information and practical data on the subject.

In this article we shall explain clearly the functioning of the resistance amplifier and show how some good experimental instruments may be built by the amateur.

At first, it must be remembered that this type of amplifier does not amplify strong signals, as would be the case with a transformer coupled instrument, but they present the great advantage of functioning with the maximum of sensibility for weak reception. It is therefore possible to receive some signals which would be impossible to detect by any other system, and thus avoid the strong statics being amplified.

Besides this, by a special process, it is possible to receive undamped waves without the use of an oscillating circuit or a separate heterodyne and owing to their great sensibility they are especially useful for reception with loop aerials.

The typical diagram of a resistance amplifier is shown in Fig. 1. The number of tubes used may vary from two to eight, but the same system of coupling is used.

The oscillations, to be amplified, are ap-

plied on the grid of the first V. T. thru a fixed capacity C_1 . The grid filament circuit is shunted by a resistance R_1 of a few megohms connecting the grid to the positive side of the filament.

The plate is connected to the positive of an 80-volt B battery thru a resistance Ω' having a value about 70 times smaller than the resistance R_1 , the negative of the B battery being connected to the positive of the filament battery. At last this resistance Ω' is connected to the grid filament circuit thru a fixed capacity C_2 .

The high frequency oscillations coming from the receiving circuit impress some potential variations on the grid of the first tube. These variations of potential in the grid produce amplified variations of the plate current, thus variations of potential at the ends of the resistance Ω' . These last variations are applied into the grid of the second V. T. thru the condenser C_2 and the same process is reproduced in the next tube.

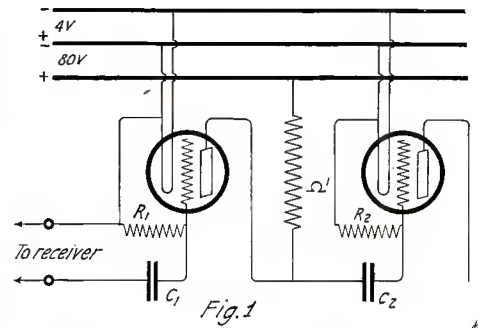

This Diagram Shows the Typical Connections of a Resistance Amplifier.

able for frequencies greater than 100,000 ($\lambda = 3,000$ meters) and a value of .004 mf. for audio frequencies.

It may be seen that this arrangement of valves with grid condensers shunted by a leak is able to produce rectification when the oscillations are strong enough to bring the point of functioning, as regards grid potential to a suitable part of the characteristic curve; therefore the V. T.s act at the same time as amplifier and detector.

CONSTRUCTION DETAILS.

In Fig. 2 is shown a photograph of a four-step resistance amplifier and in Fig. 3, a diagram of same.

In the photograph on the right may be seen the condenser used for the reaction effects between plate and grid for the reception of undamped waves, and in the center the milliammeter, the jack in which two pairs of fones may be plugged in and the pins on which a plug connected to the batteries is fixed when in use.

In the diagram the reaction condenser is shown on the left. It has one movable plate and two fixed plates connected to the plates of the first and fourth V. T. This allows the regulation of the reaction effect.

The value of the various resistances and capacities is given on the diagram and for the benefit of the amateur we will give a few details enabling him to build an am-

(Continued on page 648)

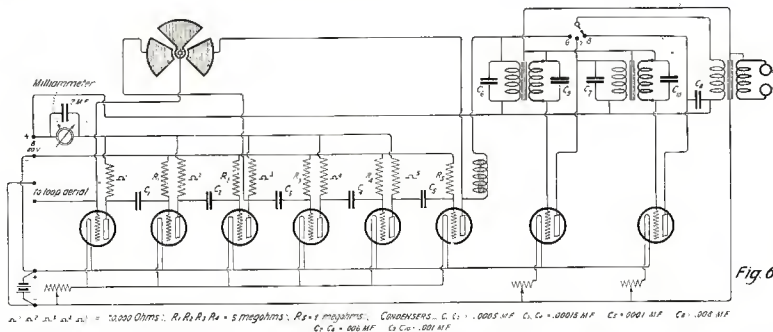

This Eight-Step Radio Audio Frequency Amplifier is the Most Sensitive Actually Used, and Gives Wonderful Results With Only a Small Loop Aerial.

Some very small currents may therefore be detected.

To receive undamped waves without any other instrument, the plate of the last V. T. is coupled to the grid of the first thru a small variable condenser, which is adjusted so that the tube oscillates, producing in the circuits oscillations of a frequency in the neighborhood of those received. Beats are then produced and the undamped signals are made audible.

In these amplifiers the various resistances are of the non-inductive type and the capacity of the condensers coupling the grid to the plate of the various tubes must be chosen so

that its reactance $\frac{1}{C\omega}$ remains

small in regard to the four megohms' resistances. They give especially good results for all frequencies greater than the one for which this condition is filled. For instance, a capacity of .00005 mf. is suit-

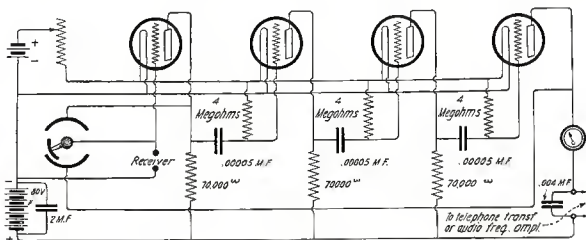
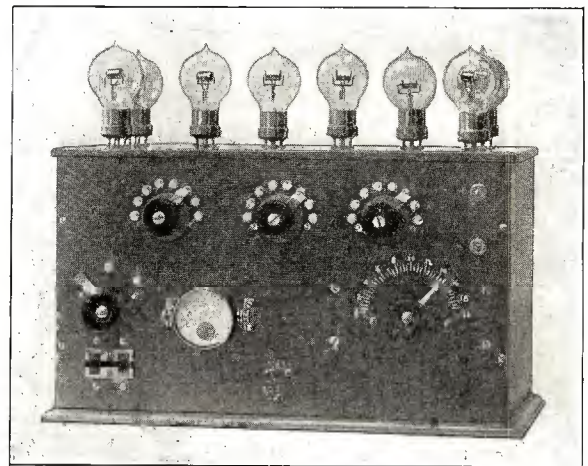

Fig. 3

This Four-Step Resistance Amplifier May Be Used Alone or With a Two- or Three-Step Audio Frequency One Hooked Up in Place of the Fones.



Photograph of the Combined Eight-Step Amplifier. On the Top of the Panel are the Three Filament Rheostats and on the Left the Reaction Condenser with Which a Regenerative or Autodyne Effect is Obtained.

A Combined Short and Long Wave Receiver

By EMIL SPON

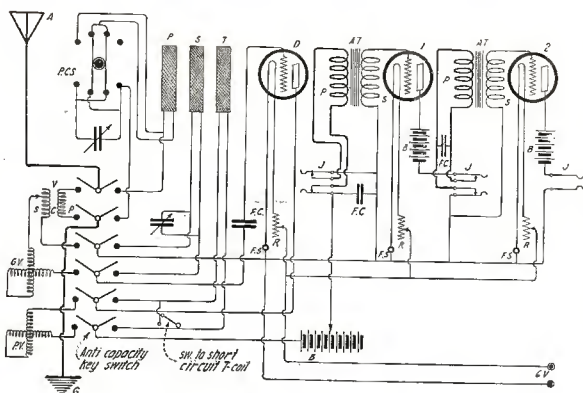

Hook-up of the Combined Short and Long Wave Receiver and Two-Step Amplifier Designed by Mr. Spon.

IN describing the short and long wave receiving set which I have recently built, I wish to state that the particular idea in view at the time of construction was that of time and labor saving in receiving.

The operation of this set is really remarkable and its construction is very simple as will be obvious by the following description.

The cabinet was made according to my specifications by a well-known wireless firm. It is made of weathered oak, golden finish. The overall dimensions of this cabinet are 22½" high by 19½" wide and 7⅝" deep. Material to be ¾" thick.

The front panel is of bakelite ⅜" thick by 21" high by 18" wide. Oval head wood screws No. 6 by ½" long, nickel plated, are used for fastening this panel to cabinet frame. The location of these screw holes is given on drawing of panel. It must be remembered that these screw holes are to be countersunk to have the screw come flush with outside of the panel. Care should be taken when countersinking these holes so as not to make them too deep. Full dimensions as to location of holes for the various instruments will be found on

drawing governing the front panel. After the drawing of the front panel has been carefully studied it is advisable to note what type and make of instruments I am using as this layout is especially laid out for the following type and make of instruments:

The short-wave regenerative set which is at the bottom of the cabinet consists of two standard variometers and variotuner, manufactured by the Pennsylvania Wireless Mfg. Co. of New Castle, Penna. The primary switch which has nine taps of ¼" switch points, nickel plated, 1" knob, is located on the lower left hand side of the cabinet between variotuner and grid variometer. This regenerative set ranges from 150 to 600 meters.

On the vertical center line of the cabinet, just below the horizontal center line, the DeForest adjustable triple inductance coil mounting unit number ULC-100 with composition panel removed. Care should be taken in locating screw holes and binding screws for fastening this coil unit as these are not located on the drawing. The best way for locating these is by scribing them from the composition panel which comes with the unit after the same has been removed by placing on bakelite panel of cabinet. This, however, is not difficult, as I have shown exactly where to lay this small composition panel which you have now taken from this unit. The same rule applies to the primary condenser switch, altho I have shown the location of the main hole on my drawing.

Now we are ready for the condensers which are located on the same horizontal line with the coil unit. The condenser to the right is for the secondary inductance coil and the condenser on the left is for the primary.

Both are .001 mfd. of Chelsea make. The location of the screw holes for fastening these Chelsea condensers is also done by scribing, but it must be remembered that these will be scribed from the back of the panel by first drilling a hole for the shaft as I have shown on the drawing, then place the shaft in same and scribe the holes.

These holes are to be countersunk a trifle deeper so as the dial which operates over these screws will have a free traveling surface. I also wish to say that I have eliminated the pointers and scales which

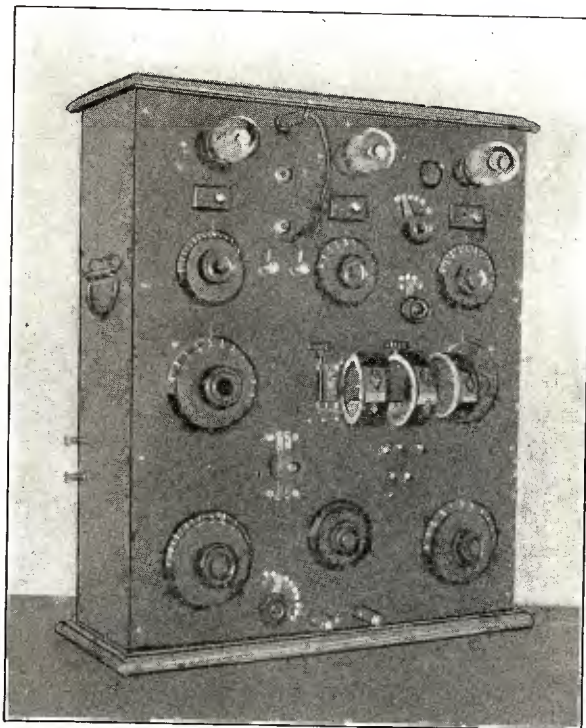

Front View of the Short and Long Wave Receiver Showing the Honeycomb Coils and the Control Knobs of the Variometer and Condensers.

come as a regular equipment on this type of condenser, and am using a 4" Corwin dial and knob. The holes are to be drilled in these dials and knobs to fit the condenser shaft. The holes which are regularly drilled in this type of knob and dial are not quite large enough. It may also be stated that the size holes which are drilled in the dial and knob of this make are sufficiently large to take care of the shafts of the variometers and variotuner of the short-wave set. The variotuner shaft, of course, is smaller, therefore a 3" dial is used.

Between unit coil mounting and the secondary condenser above the horizontal center line of these instruments, a hole is located as shown on the drawing for the three-point switch, fitted with a 1" knob

(Continued on page 656)

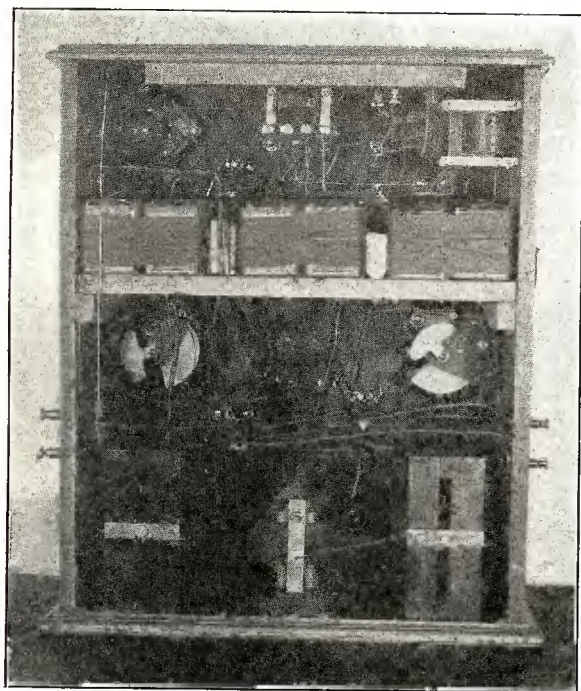

Photograph Taken With the Back Panel Removed and Showing the Arrangement of the Various Parts Inside the Receiver. Note the "B" Batteries Wound With Tape.

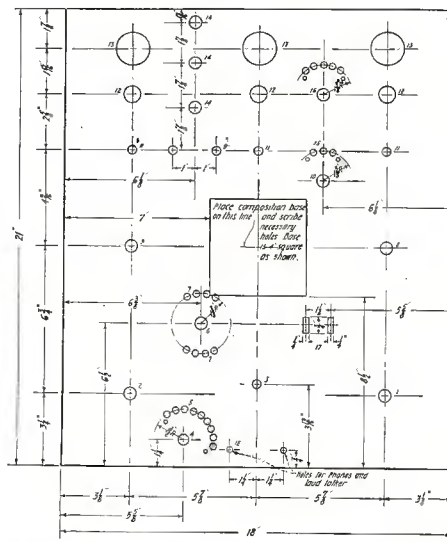

Layout of the Panel. In This Sketch All Necessary Dimensions Are Given for the Benefit of the Amateur Who May Build a Similar Receiver.

Commercial Radio Telephone at Avalon Santa Catalina Island

By G. E. HYDE

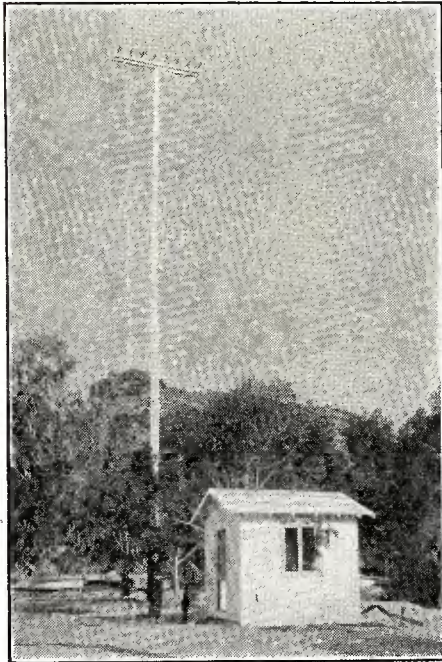

Fig. 3. Close View of the Radiofone Sending Station Which is Erected on the Beach Near Avalon.

BETWEEN Santa Catalina Island, California, and Long Beach a commercial radio telephone is operated, probably the first of its kind in the world.

At Avalon, Santa Catalina Island, the radiofone automatically connects with the different hotels, stores and subscribers of the island. At the Long Beach end, on the mainland it connects with any telephone in the United States.

Day by day, hour after hour conversations flash back and forth between the island in the Pacific and the mainland, most of the calls coming from Los Angeles, with hardly ever a hitch in its smooth operation. A subscriber in Los Angeles, for instance, might wish to talk with a friend at Avalon. He calls Avalon long distance and gives his number and is connected with the radiofone transmitter at Long Beach, thru the usual telephone exchange. His voice is transmitted via radio to Avalon, connected thru the local exchange to his party and the conversation is on.



Fig. 4. This Sketch Shows the Geographical Position of the Two Stations on the Shore and on the Island.

The Avalon station is located at Pebbly Beach, one mile from Avalon proper.

Fig. 2 shows the two masts of the transmitting antenna, which is utilized exclusively for transmission. It will be noted that the antenna is composed of eight wires all connected in the middle by a metal bar, from which the lead-in extends downward to the house containing the transmission instruments, immediately in the foreground. The house in the rear contains the receiving "Loop" and control instruments which are in charge of a licensed commercial operator who, however, does not "put thru" the calls coming in, but sees that the receiving and transmitting instruments are in constant working order.

In Fig. 3 a close-up of the transmission house shows the lead-in dropping from the antenna to a lightning switch before it enters the house.

In this little room is located the high voltage direct current generator which supplies current for the transmitting vacuum tubes, switchboard for the vacuum tube control, storage batteries, tuning inductances, etc.

One may get a better understanding of this radiofone service by referring to Fig. 4, which shows the geographical position of Avalon and Long Beach with respect to each other and the mainland.

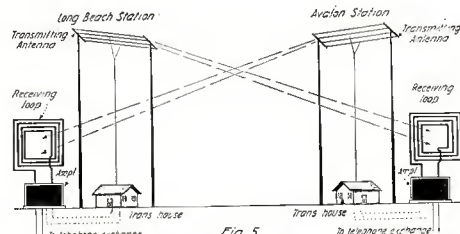

The System of Sending and Receiving Used at the Radiofone Stations.

At Inglewood is located the Naval Radio NPX (transmission), while at San Pedro is the NPX (control) station.

At Avalon is also a Naval Radio (NZL). Later on it will be explained how interference is reduced to a negligible factor by the use of a "Wave Trap" at the NZL station.

Referring to Fig. 5 it will be seen how the transmission antennæ radiate waves that set up minute currents in the receiving loops, which currents are then amplified by a multi-stage amplifier before being sent out over the telephone lines.

In a recent test the writer "listened in" from a shipboard station on the Pacific to voice control from Avalon to mainland, thence overland to New York via the telephone lines which were connected with a radiofone, which in turn transmitted the voice to a ship over 200 miles out on the Atlantic.

The voice control was a little distorted, but the conversation could be understood thruout the test, which lasted about ten minutes.

A peculiar radio phenomenon is sometimes observed by other radio stations listening in, in that when the NPX Naval radio is transmitting (500-cycle spark) the spark note will change from the clear 500-cycle note to a hissing sound. This may probably be due to either of two effects: the 500-cycle spark being pickt up by either of the loops at Avalon or Long Beach and re-radiated on the carrier wave of the fone

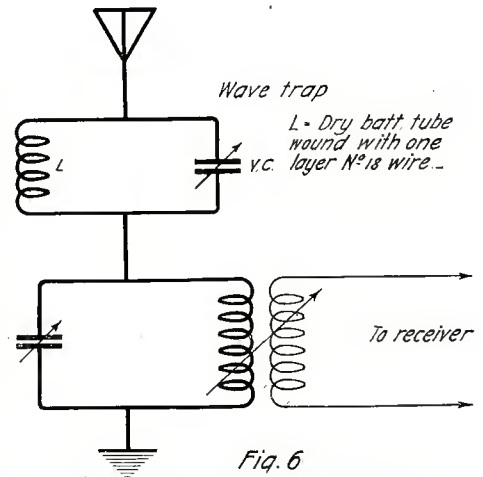

Here is the Hook-up Used at NZL to Avoid Interference from the Radiofone.

transmission, or it may be due to a heterodyne effect between the 600-meter wave of the NPX radio and the 425-meter wave of the radiofone.

The writer is inclined to favor the heterodyne theory for the reason that on another occasion he was able to copy the San Diego Naval Radio (Arc) on a crystal detector while the fone transmission carrier wave was radiating.

On this radiofone circuit it is also possible to transmit telegraph signals, while conversations are being carried on, by superimposing a high pitched harmonic on the carrier wave. This does not cause any interference with the conversation.

The carrier wave transmission is run all thru the day for about 14 hours' continuous service, so that it is not necessary to start and stop the transmitter motor generator set for each call.

In Fig. 6 is shown a diagram of the "Wave Trap" which was installed at the NZL Naval Radio at Avalon to cut out interference from the radiofone. As will be seen it is a very simple affair consisting

(Continued on page 638)



Fig. 2. The Transmitting Station at Avalon. The Receiving Loop is Fixt Up on the Other Small Cabin which May Be Seen in the Back-Ground.

Universal V. T. Control

By HOWARD S. PYLE

THE V.T. control unit described here-with, is truly universal, in that any known circuit may be used, and any of the four prong tubes now on the market, whether requiring critical variation of the "B" battery or not are equally adaptable to use at highest efficiency in the unit described.

The unit is housed in a mahogany cabinet, finish with several good coats of mahogany oil stain, a coat of filler and then varnish. The panel is of $\frac{3}{8}$ " bakelite, set flush into the cabinet, resting on supporting blocks at each corner, and to which it is attached by means of corner wood screws. The dimensions of the panel are close to eight by five inches, which size will answer very well. In addition to the cabinet and panel, the following apparatus is required, and it is recommended that it be bot from the manufacturers mentioned, and it has been carefully chosen to make a combination of the best to be had:

- 1 Paragon rheostat
- 1 Ace V.T. socket with grid leak
- 1 Mica-copper grid condenser
- 1 Graphite potentiometer sector
- 2 Ace etched metal dials
- 2 Sears-Roebuck Marconi knobs
- 8 Tresco rubber binding posts
- 2 Ace fone posts
- 2 Sears-Roebuck Midget switches
- 4 NP switch points

The panel is drilled as shown in the diagram, and the seven holes for filament view are slightly countersunk for the sake of appearance. The panel should be well polished after drilling and before assembly of apparatus thereon.

The right hand dial controls the rheostat for filament control, and it is directly behind the shaft hole in the lower right that the Paragon rheostat is secured. This is preferably done with the mounting screws furnished, but if the panel and base of the rheostat are thoroly washed in gasoline, a thin coat of glue may be applied to the rheostat base, and then clamp to the panel, and allowed to set, when it will be found to be firmly fixt, and eliminating supporting screws. The Ace dial is slt on the shaft in place of the pointer furnisht, and the

rheostat adjusted, which finishes it.

The potentiometer sector is secured to the rear of the panel opposite the rheostat by means of two small copper clips shown in diagram. These are in turn held to the panel by 6-32 machine screws, and the clip ends of the copper supports soldered to the potentiometer graphite at the coppered tips. A long 8-32 machine screw forms the shaft, and a knob and Ace dial are attached to the head. The shaft then passes thru the panel; a spring is slt on, then a nut, the contact arm, another nut and the whole assembly soldered. The contact arm consists of a piece of phosphor bronze, of the shape and dimensions shown. It is fitted with a graphite tip at the contact end, and a small hole drilled at the other end, to slip over the shaft. The graphite contact tip may be obtained by breaking out the carbon element in a tubular flashlight battery, and cutting it down almost to the brass cap in which it is set. The cap is then soldered to the switch arm and a very satisfactory contact results. This finishes the potentiometer.

The two midget switches and the switch

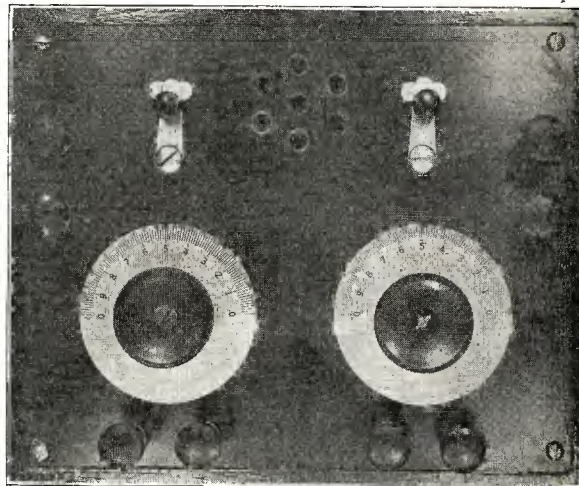

Here is the Ideal Control Cabinet for Amateurs—Simple, Good Looking and Easy to Build Are Its Principal Features.

points are placed in their respective holes, one above each dial. The left hand switch cuts in or out the "B" battery, while the one on the right serves to short the tickler posts. The other posts are arranged for the filament battery leads, "B" battery and tuner connections. The Ace fone posts provide special connection for fone tips and prevent breaking of the cord.

The socket with its attached grid leak is supported by a brass angle, shown in the drawing, which is secured to the socket by means of small screws thru the two holes provided. The opposite end of the bracket is attached to the panel by being caught under the screw of one of the tuner posts. The socket is therefore held in a horizontal position, which brings the bulb filament directly behind the view holes. The mica condenser is supported by its connecting wires, directly under the socket.

The standard hook-up using tickler feed-back is used, and all connections made with No. 14 bare copper, preferably run in empire tubing, or they may be black enameled.

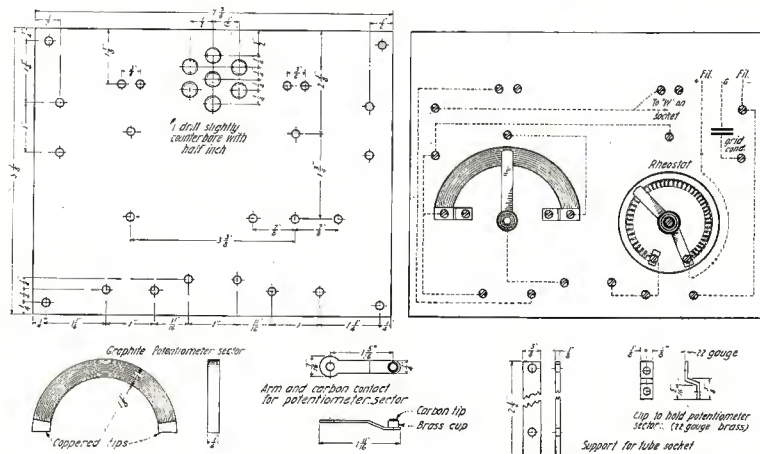

Lay-out of the Panel and Hook-up of Pyle's Small Cabinet. Note That Dimensions are Given for the Small Brass Parts to be Built.

A Simple and Efficient One-Tube Circuit

By G. W. ADAMS

THE following is a description of a very efficient and simple one-tube reaction circuit recently described by

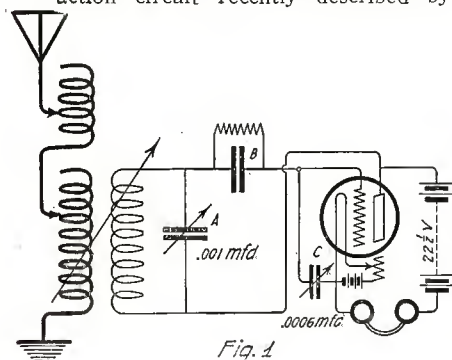

An Improvement of the Ultraudion Circuit That Every Operator Should Try; It's Very Sensitive.

Mr. Reed before the Wireless Society of London. The originator of this circuit, Mr. Reed, claims that it is as sensitive as most amplifiers employing three tubes.

This circuit is very popular with English amateurs who with their restricted antennæ (maximum 50 feet high by 50 feet long) have made some remarkable receiving records, notably receiving WSO, WII, and NSS in daylight at a fine readable strength. A study of this circuit will show that it is in many respects very similar to De Forest's ultra-audion. The tube used should not be too hard and should preferably contain a small amount of gas like the Radio Corporation's U. V. 200 which works admirably in this circuit.

The circuit as usual has a standard grid condenser and leak, B (Fig. 1), while the coupling condenser C should preferably be about .0006 mfd. A standard B battery

of 22½ volts is required and with the telephones completes the circuit. When standing by for spark signals the filament rheostat should be in such a position that the bulb burns at normal brilliancy, and condenser C should be at minimum value. When signals arrive, increase filament brilliancy slightly, and put in a little capacity, altho not too much or the spark note will be distorted. For C. W., adjust the rheostat and put more capacity in with condenser C until signals are at full strength, when this receiver will be found very stable and will keep in self-oscillation for hours.

With this circuit and honeycomb coils wound by himself the author received regularly day and night signals from NSS, WSO, POZ and YN while lying in the harbor at Buenos Aires—a very good performance for one tube.

Wireless Telegraphic Printing on the Creed Automatic System

By A. A. CAMPBELL SWINTON, F. R. S.

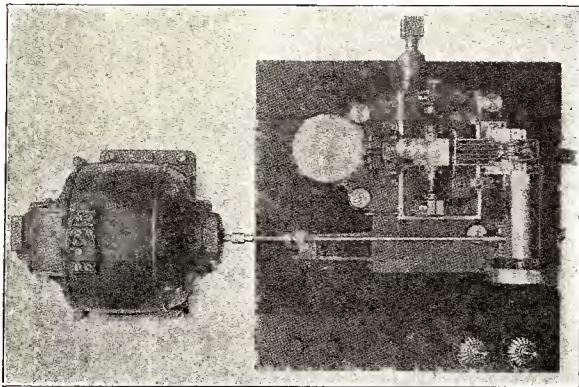

Top View of the Punching Machine Showing Clearly the Motor, the Relay and the Valves. A Diagram Explaining its Functioning is Shown in Fig. 3.

A DESCRIPTION of the Creed Automatic System of Wireless Telegraphic Printing as delivered in a lecture before the Wireless Society of London will be given the readers of RADIO NEWS in the following paragraphs.

So far as the purely wireless instruments are concerned, they are nothing very special. There is a small aerial on the roof of the building and connected to this, thru the ordinary tuning inductances and adjustable condenser, there is a 5-valve resistance amplifier working in connection with a 3-stage audio frequency one, to which the telephones and the other apparatus are connected. This latter consists, first, of a low frequency transformer connected to the grid of a separate single tube, a 15-volt dry battery being connected in the grid circuit so as to make the grid negative. This is for the purpose of reducing the permanent plate current. Then, in the plate circuit of this valve we have a special relay, designed by Mr. R. Carpenter of the Creed firm, which in turn is connected to a standard post office relay thru two resistances, each of about 1,000 ohms. This post office relay in turn, operates a power relay, also of Mr. Carpenter's design. This latter relay has no electric contacts, but its tongue directly operates the pneumatic slide-valve of the Creed receiver. You will see that it is a rather complicated system and one of the difficulties that we have experienced is due to the effects of the kick-back from these relays. This is very apt to react upon the wireless apparatus and cause a sort of electric bell continuous action. This is not very easy to get rid of, particularly if a frame aerial is employed, and it is for this reason that we are not using a frame aerial, tho such an instrument in the ordinary way works very well in a room. For working these relays, however, an aerial on the roof gives more satisfactory results.

Next, the Creed apparatus will be explained. It is somewhat complicated and hard to understand.

THE CREED APPARATUS.

In the first place, the message to be received on the Creed instruments will be sent automatically by means of punched paper tape, with a transmitter operated on the Wheatstone principle. As will be understood, these Wheatstone transmitters send ordinary Morse alphabet, but they do so by means of punched paper tape. Further, what the Creed receiver does is to

take the Morse signals that it receives, and from them reproduce an exact facsimile, in punched tape, of the original tape with which the message was sent. Then finally, this tape punched by the Creed receiver, is put thru the Creed printer, which from it brings the message in Roman type.

Fig. 1 will enable you to understand this more clearly. At the top of the figure is represented the letters FL repeated twice over, as received in ordinary Morse code. The middle portion of the figure represents the tape with holes punched therein, corresponding to the signals. The small holes along the center of the tape are merely for the purpose of regulating the speed and may be disregarded. The holes that represent the signals are those on the edges of the tape. When two of these holes are vertically above one another this represents a dot, and when they are inclined to one another they represent a dash.

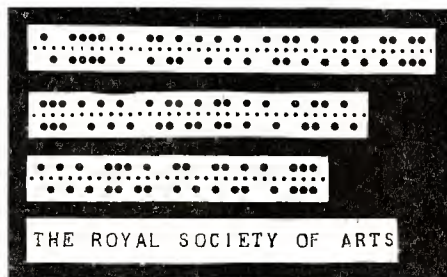

Fig. 7.

Tape Perforated by the Creed Perforator Shown in the Photograph and the Same Sentence as Printed in Roman Type by the Automatic Typewriter.

Finally, at the bottom of the figures we have the letters printed by the Creed printer in Roman type, these particular letters having been printed from Paris recently.

Fig. 2 is the Creed receiving instrument, and as it is merely a general view of the instrument together with the electric motor that drives it, it does not show very much.

DIAGRAM OF APPARATUS.

Fig. 3 shows in diagrammatic form the construction of the apparatus. A represents Mr. Carpenter's power relay. This relay has no electrical contacts, but its armature, b, is provided with a light tongue, 1, to the free end of which is attached an exceedingly light-balanced slide-valve, 2; this is adapted to control the supply of air to the small relay engine, 3, the piston, 3a of which, is thus moved from side to side in accordance with the line signals which actuate the relay tongue. The movements of the piston, 3a, are transmitted by means of the rocking levers, 4, to the piston valve, 5, of the main engine, thus controlling the double-acting piston, 6. From each side of this piston a rod projects thru the cylinder cover and thrusts in either direction the adjacent arms of the three-armed bell-crank levers, 7 and 8. Upon the arms, 10 and 11,

are hard steel strikers, 12 and 13, the free ends of which are bifurcated for the purpose of thrusting against the adjacent heads of the rods, 14, and punches, 15. These rods and punches are mounted and guided in a separate block with the die-plates and the feed-wheel spindle. The correcting rods, 14, have flattened points, 16, terminating in a V-shape (shown separately at bottom right-hand Fig. 3), and when thrust forward are adapted to enter the slots in the correcting wheels, 17. Retracting springs are provided, as shown, to restore the rods and punches to their normal position against stops. The paper-strip, 18, which is previously center-holed, is led up between the die-plates, past the punches, and engages with the feed-wheel, 19, mounted upon the spindle, 20, to which the correcting wheels, 17, are also fixed. When the points, 16, of any correcting rod, 14, are thrust by the striker between the teeth of the wheel, 17, the rod adjusts and holds the latter as well as the feed-wheel, 19, and the tape in such a position that the corresponding punch, 15, will perforate the paper exactly opposite the feed-holes. Mounted upon an extension of spindle, 20, is a friction disc, 21, driven by the friction blocks, 22, fixed upon the pivoted arms, 23, which are attached to the motor-driven spindle, 24. This spindle rotates the feed-wheel, 19, at approximately the same rate as the feed-wheel of the transmitter. For adjusting the driving tension the spring, 25, is arranged to slide longitudinally on the rods, 23.

ACTION OF MACHINE DESCRIBED.

The action of the machine is as follows: A line marking current in the relay coils moves the armature, b, to the right, caus-

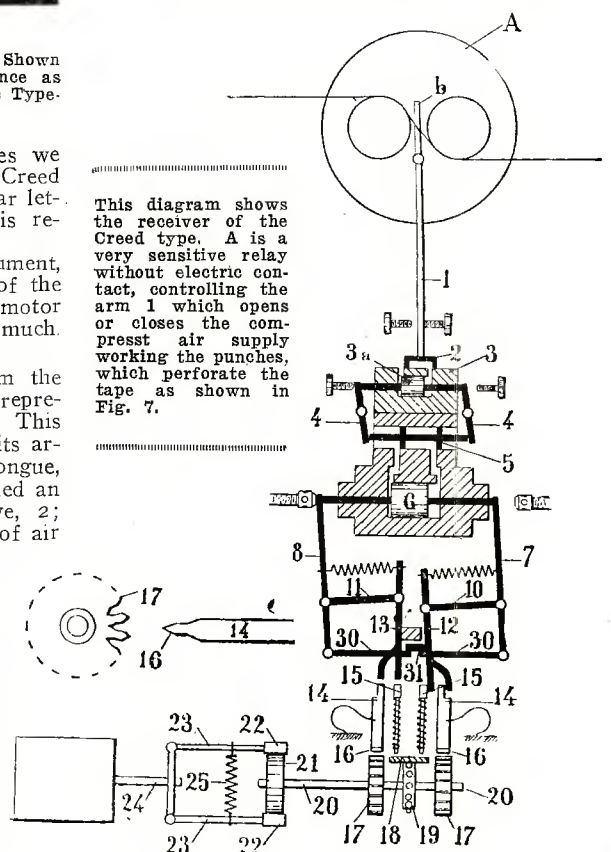

This diagram shows the receiver of the Creed type. A is a very sensitive relay without electric contact, controlling the arm 1 which opens or closes the compressed air supply working the punches, which perforate the tape as shown in Fig. 7.

Fig. 3.

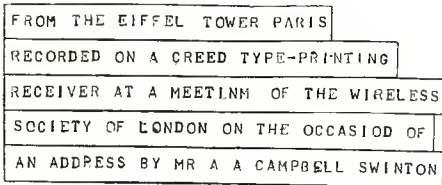

Fig. 6.

Photograph of a Message Registered on Tape by the Creed Typewriter.

ing the tongue, 1, to move the valve sharply to the left. The piston, 3a, of the relay engine is thus caused to move to the right and the valve of the main engine in the opposite direction. This causes the main piston to be driven to the right. The movement is transmitted by means of the bell-crank, 7, and the link, 30, to the bell-crank, 8, which in turn causes the left hand striker, 13, to thrust the tooth of rod, 14, between the teeth of the wheel, 17, adjusting if necessary, the position of the feed-wheel and forcing the corresponding punch, 15, thru the tape, 18. The tappet piece, 31, formed on the link, 30, now comes in contact with the striker, forcing it from the rod and punch and permitting them to spring back to their normal position. On the reversal of the line-current the relay tongue is moved in the opposite direction causing a reversal of the engine, when another operation similar to that described is performed by the right hand striker, 12, upon the right hand correcting rod and punch. As the complete operation of thrusting and releasing the punches occupies only the 300th part of a second, the time during which the feed-wheel is arrested is practically negligible and the difference between dots and dashes in the tape depends entirely upon the time interval between successive spacing and marking contacts, during which the tape is allowed to run on. Even between the marking and spacing currents for a dot, there is an appreciable interval during which the slip has traveled a little. The right hand punch and the corresponding correcting wheel are given a lead—so that altho the spacing punch is actuated later, the spacing perforation appears opposite the same center hole as the marking perforation.

MACHINE WITH A MEMORY.

That is a description which is difficult to follow, but the result is, as you have seen in Fig. 1, that a dot produces two perforations on the tape, immediately one above the other, and a dash two perforations, which are inclined at an angle.

Fig. 4 is the printer. You will understand that in receiving on this system it is first of all necessary to get a punched tape. This is put thru a further machine, which is really a sort of typewriter and converts the signals as recorded on the punched tape in Morse characters into actual Roman type. The machine is very remarkable in that it is a machine with what might be termed a memory. Supposing the machine

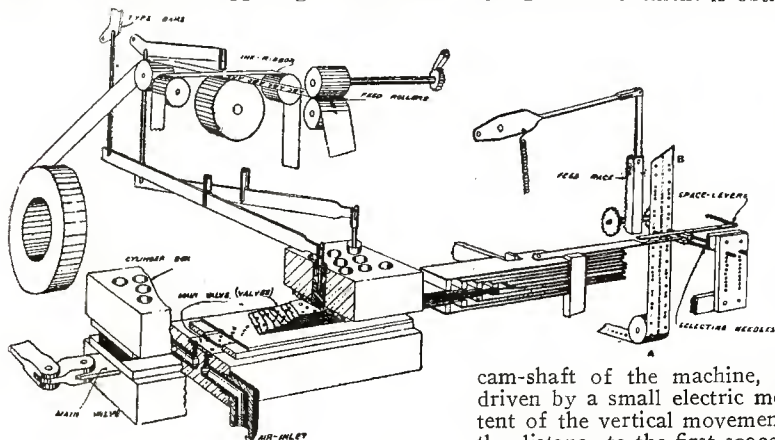

Fig. 5.

gets, say three dots, then it has to remember what it has got. If subsequently it gets another dot, then it has to print the letter H. Supposing, instead of another dot it gets a dash. It has to print the letter V. For numbers it has to be able to remember five signals before it knows what to print.

Fig. 5 is a diagrammatic sketch of how this instrument works. Only a small portion of the mechanism is shown, but an idea can be given of how it works. The received perforated slip is passed into the machine at A and out at B, while the slip on which the printing takes place is drawn by a pair of feed rollers from the roll on the upper left hand side between the connecting rods of the type bars and over the printing plates.

The perforated tape is fed forward, letter by letter, in a guide-way in front of a series of ten pairs of selecting needles, one needle of each pair being mechanically connected to a series of ten slide-valve plates. Each of these valve-plates can be made to occupy one of two positions, thus providing a number of different combinations, every one of which opens one complete and particular passage thru the ten slide-valve-plates. Air, under pressure, can thus be admitted to any one of a number of small cylinders, each containing a piston acting

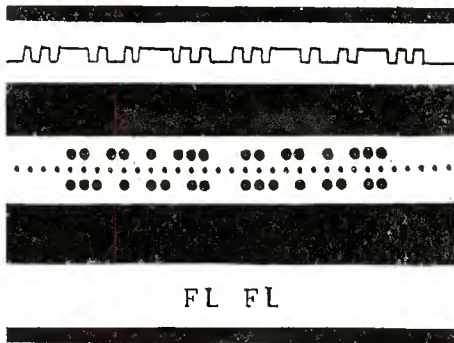

Fig. 1.

Perforated Tape as Used in the Automatic Transmitters is Used in the Creed System. The Upper Tape Shows the Signals as Recorded at the Receiving Station.

on the end of a lever connected to a type bar.

The perforated slip is fed forward by a star-wheel fitted to a spindle carrying a toothed wheel, which is rotated as required by a movement of a rack. The rack is given by a vertical motion for feeding purposes and a sideways motion for acting on any slide-valves that may have been selected. Its movement is obtained from the

Diagrammatic sketch showing how the automatic printing machine works. On the right can be seen the selecting system which has to find the order of the dots and dashes before printing any letter or number.

RESEMBLES A TYPEWRITER.

This instrument is by no means easy either to explain or understand, but in its main features it is not unlike an ordinary typewriter in which the printing levers, instead of being actuated by the fingers of an individual, are each connected with the piston of a small pneumatic cylinder. There

(Continued on page 640)

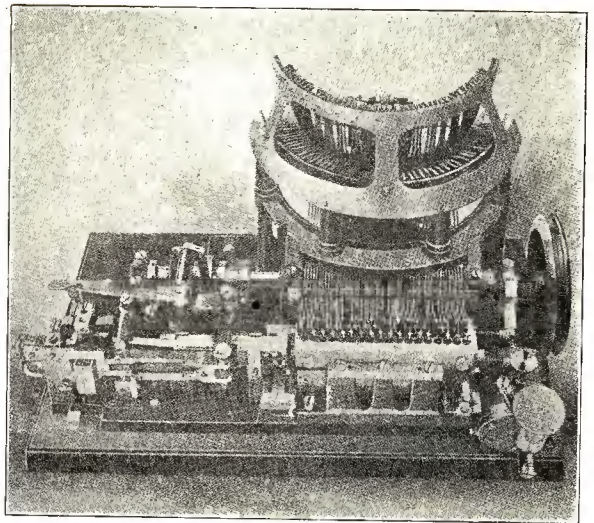

The Automatic Typewriter of the Creed System Printing the Messages in Roman Type on a Tape as Shown in Fig. 6.

for this limit there is a group of ten space levers, normally in the path of the rack and preventing its downward movement. Each space lever is also in the path of one pair of selecting needles and when either needle of a pair passes thru a perforation that space lever is moved out of the path of the rack. Hence, with any letter or figure of the Morse code there is a clear downward path for the feed-rack until it reaches a space signal. A sideways movement is then given to the rack, putting it in gear with the toothed wheel. Next the rack is given an upward motion, causing the toothed wheel to turn and the perforated tape to be fed upward by the amount of the particular letter that has just passed. The rack is then moved sideways again, clear of the toothed wheel, ready to descend as far as the next space signal.

At the same time, the extension is free to move in a direction at right angles to the needle. Each valve extension is provided with a shoulder which comes into the sideways path of the feed-rack when that particular extension has been selected. At the correct moment, determined by the position of a cam on the main spindle, the rack is moved sideways and engaging with the shoulders of the valve extensions which have been selected, moves the corresponding slide-valve into their second position. Another cam opens a main valve, admitting air under pressure, to the slide-valve chamber, whence it passes thru the ten valve-plates by the one hole available in that particular setting of the valves, forces up the particular piston and prints the corresponding letter. Another main valve is then opened to allow the air to escape and the selected slide-valves are returned to their normal position.

Altho more than the required number of selecting needles for any particular letter may pass thru the tape, only the proper number of slide-valves are acted upon by the rack, on account of the spacing lever preventing the rack descending beyond the required amount.

It will be observed that there are twenty selecting needles, but only ten acting on the lower row of holes in the perforated slip are attached to valves the other row of needles is not necessary for selecting purposes, but is required for shifting the spacing levers for the first portion of a dash signal.

Washington's Birthday Relay

AMATEUR wireless all over the world was given a chance to compete for prizes in the National Relay on the night of February 21, when President Harding's Washington's birthday greeting was broadcasted. The idea of the relay was to deliver the message to as many city, county, state and national officials as possible and the English amateurs were asked to send the greetings to the King of England.

Half of the message was sent from Hartford, Conn., and the other half from San Francisco, with the exception of two words which were sent from Rock Island, Ill. This gave all the stations an equal chance.

The message consisted of 30 words and was as follows:

"May the spirit of Washington be our guide in all national aspirations and may the current year mark the return of tranquility, stability, confidence and progress for the entire world."

"WARREN G. HARDING."

There were five reasons for the relay, as follows:

1st. To start a keen, good-natured rivalry between the many amateurs of the U. S. and Canada who have made some wonderful claims on receiving.

2nd. For the good of the game, to give a big event once a year and give the boys who cannot do long distance work a chance to do some real long distance receiving and an incentive to better their stations if it is possible.

3rd. So that all may join in one grand big picnic once a year and enjoy some real sport. This was the biggest wireless event of the year, something to discuss and talk about for a long time.

4th. To show our new President what we can do, and in event of any unfavorable future legislation—we will at least have all those we deliver the message to as allies.

5th. To stimulate interest in amateur wireless thruout the world.

Great credit for the successful promotion and management of the relay is due to Mr. W. Kirwan of the Electric Supply firm TRESCO, of Davenport, Iowa. Mr. Kirwan is a real live wire booster for amateur work. He planned the relay and bore all the expense of it himself.

The judges were Edwin H. Armstrong, of Yonkers, N. Y., and Hiram Percy Maxim, of Hartford, Conn., president of the A. R. R. L. A. N. Goldsmith, secre-

tary of the Inst. Radio Engineers, was the referee.

The prizes to be awarded are as follows: A. W. Hallbauer, 1001 N. Lockwood Ave., Chicago, Ill.

1—Pair Lattice Variometers.
Radio Distributing Co., Newark, N. J.

1—Radisco—Vario Coupler.

Clapp-Eastham Co., Cambridge, Mass.

1—Type Z.R.F. Regenerative Receiver.

Chicago Radio Lab., Chicago, Ill.

1—Zenith Regenerator—same as in use at 9ZN.

Tresco, Davenport, Iowa.

1—Hook'er to Yer Bulb—20,000 meter C. W. tuner.

Eugene T. Turney Lab. Radio Hill, Holmes, N. Y.

1—Spider Web Unit complete.

Coto Coil Co., Providence, R. I.

1—Complete set of Honeycomb Radio Inductance coils.

C. D. Tuska Co., Hartford, Conn.

1—Type 181 Inductance—see their catalog.

1—Type 182 Inductance—see their catalog.

A. H. Grebe & Co., Richmond Hill, N. Y.

1—C R 3A Receiver.

General Radio Co., Cambridge, Mass.

1—One step audion amplifier that sells for \$28.00. Some amplifier too.

Montgomery Ward Co., Chicago and Kansas City.

1—Two step amplifier—this is a beauty, boys.

Signal Elec. Mfg. Co., Menominee, Mich.

1—R37—Tuner set—listing at \$37.50.

Electrical Specialty Co., Columbus, Ohio.

1—New design Regenerative Receiver—selling for about \$50.00.

Federal Telefon & Telegraph Co., Buffalo, N. Y.

1—New type—260 W.—Microfone for Radiofone.

John Firth Co., Inc., New York, N. Y.

1—No. 0-3 Midget Advance Eldregc Meter.

2—No. 0-1 Model H Eldregc Meters, H. W.

2—No. 0-5 Model H Eldregc Meters, H. W.

5—Pairs Brownlie adj. Wireless fones.

C. Brandes, Inc., New York, N. Y.

1—Pair of the new Navy type Wireless fone receivers, 50,000 ohm A/C impedance.

W. J. Murdock Co., Chelsea, Mass.

1—Pair of their well-known No. 55 wireless fones, 2,000 ohms.

Sears-Roebuck Co., Chicago, Ill.

1—Large tuner, Navy type, or if lady wins prize—a real BABY CARRIAGE—if she would rather have it. Better prepare, girls.

Illinois Watch Co., Springfield, Ill.

1—Illinois watch.

Shotton Radio Co., Scranton, Pa.

1—Schramco—Oscillation Trans. with shielded clips.

Atlantic Radio Co., Boston, Mass.

1—C. E. Antenna Switch.

Klaus Radio Co., Eureka, Ill.

1—of their Radio Storage batteries.

Thordarson Elec. Mfg. Co., Chicago, Ill.

1—Type R/S— $\frac{1}{4}$ -KVA—Transformer.

Acme Apparatus Co., Cambridge, Mass.

1—Acme 200 Watt C. W. Mounted transformer.

Chelsea Radio Co., Chelsea, Mass.

offered an excuse about size of box sent—it only had—

1—No. 3 Condenser with Bakelite Dial.

1—No. 21 Variable Grid Leak.

1—No. 41 Bakelite Dial and Knob. Some prize, boys—shall we keep them?

Connecticut Tel. & Elec. Co., Meriden, Conn.

2—Connecticut Variable Condensers.

Karlowa Radio Co., Rock Island, Ill.

1—C. W. 20 B. Enclosed Rotary Gap.

Wireless Mfg. Co., Canton, Ohio.

Choice or N. S. R. 300 Rotary Gap or N. S. R. 600 Rotary Gap.

The wilcox Laboratories, Lansing, Mich.

1—No. 14A Rotary Gap.

E. T. Cunningham, Audiotron Mfg. Co. San Francisco, Cal.

1—C-301 Detector.

1—C-301 Amplifier.

Radio Corporation of America, New York.

6—U. V.-200 Radiotrons.

6—U. V.-201 Radiotrons.

Q. S. T. Magazine, Hartford, Conn.

5—Yearly subscriptions.

RADIO NEWS MAGAZINE, New York.

5—Yearly subscriptions.

Pacific Radio News Magazine, San Francisco, Cal.

10—Yearly subscriptions.

Radio Topics Magazine, Chicago, Ill.

1—2-Year subscription.

Amrad—American Radio & Research Corp., New York, N. Y.

1—\$50.00 coupon for your pick from their catalog of apparatus to this amount.

Full details of the Relay and prize winners will be announced in this magazine later. England and Alaska will be heard from.

The Latest

A Vaudeville Show By Radio 2XX

MR. ROBERT F. GOWEN, chief engineer of the DeForest company, announces a novelty in the season's opening of his station 2XX at Ossining, New York, with a Radio vaudeville show. He has been exceedingly fortunate in obtaining the services of the Duncan Sisters, now playing to capacity on Broadway with Fred. Stone in "Tip Top." These young ladies have taken New York theater-goers by storm with their singing and are booked to head the bill in this new type of Radio entertainment to be furnished by 2XX. Mr. Gowen hopes to get Irvin S. Cobb, the famous humorist, to introduce the Duncans to the Radio world and to tell some of his famous stories. Plans are being made to have an orchestra and other acts. There will positively be no phonograph music. The performance will

start at 9 P. M. Arlington time, Sunday, March 13th, and a wave-length of 400 meters will be used.

Inasmuch as this is an entirely novel type of radio telephone entertainment furnished by Broadway celebrities, it will be appreciated if as many amateurs as possible stand by during the performance in order that all may enjoy it.

Amateurs are requested to report by mail to Mr. Gowen the number of people listening at their stations in order that the size of the audience may be obtained for the performers. This is most important in order to obtain data on the size of the radio audience, as well as the range of the transmitting set. As far as we know, there is no data available as to how many amateurs listen nightly east of Denver and results of this experiment, therefore, should

be exceedingly valuable if all amateurs will co-operate by dropping Mr. Gowen a line as requested. Also it is only fair that we should do our share in getting this data to the performers who have so kindly offered their services for our entertainment.

Address: R. F. Gowen, Ossining, New York.

Editor's Note:

We strongly urge all the boys to keep quiet and stop transmission during this interesting Radio vaudeville in order to allow everybody to hear it and to help Mr. Gowen along in his experiment.

Remember, boys, that if the results are satisfactory it means more fun for the future.

First Amateur Transcontinental Spark Reception

By LEO E. W. KIRBY AND R. H. BUTLER

IT was five minutes to three, on the morning of January 4th. While the country slept, Howard D. Selvage was busy at the controls of his home-designed, home-made radio station at Irvington, New Jersey. All night long he had been listening, experiencing the thrills that keep every real radio "bug" continually waiting to hear the secrets of the air.

Suddenly, clear and true, he heard 6EA calling 6GO by spark—the first time any amateur station had caught a transcontinental wireless spark message.

Excited and thrilled with his unexpected accomplishment, Selvage immediately rushed off letters to the coast to verify his astonishing feat. The call book showed that 6EA was H. C. Seefred, of Los Angeles, and that 6GO was Gordon Bennett, of Oakland, Cal. As soon as Mr. Burselson's speed artists succeeded in rushing the replies, Selvage received proof of his accomplishment—letters from both the coast amateurs that verified the details of his reception in every particular. Their letters are reproduced later in this article.

H. C. Seefred is probably the best known amateur operating on the coast. He has an unusually well equipped station for an amateur, and had previously succeeded in establishing several records for long distance transmission. He had been heard in Juneau, Alaska (KDU), in Honolulu, and as far east as Fort Wayne, Indiana (9ME). The fact that his spark had been heard on the Atlantic coast, however, seemed too good to be possibly true until reference to his log book showed that the message which Selvage's letter quoted, absolutely corresponded to his record of transmission. Inasmuch as Gordon Bennett, the amateur on the other end of the Coast conversation, found that his records also coincided to the claim, there is no room for doubt that an amateur has actually accomplished wireless spark communication clear across the United States.

A few months ago, 3RF (Roanoke, Va.) and 2TT (New York) claim to have heard "6" stations. As Seefred's letter states, however, a careful investigation failed to produce any verification of these records, and Mr. Selvage is apparently entitled to the distinction of hearing the first actual transcontinental spark reception.

Mr. Selvage's station is located at his home, 45 Durand Place, Irvington, New Jersey. The apparatus was designed by Arthur C. Wester, of Hilton, New Jersey, and was erected by these two. Wester is a prominent member of the Radio Club of Irvington and is well known in local radio circles. Altho he is only seventeen years old, he has been interested in radio for nearly three years and has been very successful in designing radio apparatus. The Selvage station contains several advanced ideas of Wester's which have worked out very successfully in actual practice.

The station consists of a detector, three stages of radio amplification, and a loose coupler in miniature form, entirely home-made. A regenerative circuit is of course employed in conjunction with a tickler feed-back. Selvage used A-P tubes and Baldwin fones at the time of his record

breaking reception.

His aerial consists of 3 wires; seven strands of No. 20 phosphor bronze wire, three feet apart. It is sixty feet high at one end seventy at the other. The length is over 175 feet. There is a lead-in twelve feet long. A gas and water radiator, several rolls of chicken wire, and a quantity of lead piping is buried in the ground under the antenna. The illustration shows Selvage at the side of his apparatus, and any amateur will see that he has a well equipped station to be proud of.

H. C. Seefred's letter which follows gives a good idea of his sending apparatus, and also of the conditions that confront the coast amateurs.

Mr. H. D. Selvage, Jan. 10, 1921.
Irvington, N. J.

Dear Sir:—Your letter of January 4th was received today concerning the reception of my signals heard at your station 2KF. The call letters which you heard me call, the wave-length, the time and date (January 4th at 2:55 A. M. E.S.T., which would be about 11:55 P. M. on January 3rd, Western time) is O.K. after referring to my log

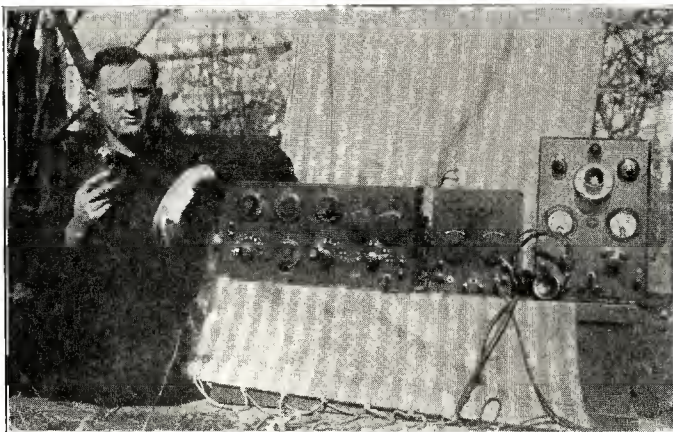

Photograph of Mr. H. D. Selvage and His Complete Set. Note the Radiophone of Good Appearance on the Right and the Receiver with Which He Picked Up Mr. Seefred's Sigs.

book.

I have heard and worked 6GF, 6GO, and 6AK several times, but that night I, troubled with "QRM" from steady buzz caused by high tension leakage, was unable to hear much except the above mentioned ones and others around San Francisco, who are strong here. As this buzz was in, I was only on the job a short period and then went to bed. We are also troubled with "QRM" from NPX arc and spark only eight miles away. But when all of this is out we are able to hear quite a distance. Have heard TWO (5) stations, eight (7) stations and a large number in the sixth district.

Have been heard by KDU (Juneau, Alaska) to the north; Honolulu, Hawaii, to the west; a ship 650 miles to the south and 9ME (Fort Wayne, Indiana) to the east. (Your reception of my sigs will break all my former records and also to the east.)

At present I am using one stage of amplification (expect to have two stages soon) in connection with a home-made variometer type regenerative receiver and Baldwin fones.

Starting January 1st, I am now using $\frac{3}{4}$ K.W. New Year's day we put in a new ground system composed of four wires—

six strands of No. 9 galvanized wire 40 feet wide and 70 feet long—all wires connected at the ends also to the water pipe and other ground wires, also wire fence around yard. All of this is under the antenna.

My spark note is medium between high and low approximate; wave-length is 200 meters. Tunes fairly sharp. Using six-inch couplings on O. T.; radiation is over 5 amps. (Only have a 5 amp. hot-wire meter and I run it off the scale.)

Have been heard in twenty states (including your state), also Alaska, Canada, British Columbia, Hawaii, off Mexico and at sea.

All my apparatus is home-made.

Another thing I want to tell you, we received two letters several months ago from 3RF (Roanoke, Va.) and 2TT (N. Y. City). Former said he heard a radiophone sign 6UG (listed at Piedmont, Calif.). We wrote this party and he answered saying he had none. Latter said he heard 6QV (listed at Pasadena, Calif.). We called others in that town by radio, replying that they had never heard such a station. We have never heard either of these "6" stations.

Now as for your reception of my "sigs" you are correct in hearing me and the calls of the stations I called.

I want to congratulate you on your very excellent receiver. Would like to have you send the good news to the Radio magazines.

Please listen for me again and let me know by mail.

Thanking you many times,
I am,

Very truly yours,
(Radio 6EA) H. C. SEEFRED.

Gordon Bennett's letter, also verifying 2KF's 3,300 mile reception, says in part:

Jan. 8th, 1921.

My sending set is as follows: one K.W. Clapp Eastham transformer, twelve thousand volts secondary. The gap is the latest thing in rotary quench gaps which I have built in the shops with an oil condenser. The pole is an eighty foot stick with vertical antenna.

The receiving set is a regenerative two-step amplifier using Western Electric bulbs and Baldwin fones. Until now my sending range is about a thousand miles or thereabouts. I have been heard in Boise, Idaho, and Phoenix, Arizona. In your next letter, I wish you would let me know about the number of six stations that you fellows hear back there in New York. You spoke about 6EA and 6ZE. Both these fellows have fine sets and have my records beat so far. 6ZE is assistant radio inspector in San Francisco.

The great trouble around this coast is that the QRM is fierce right now. At six P. M. there are at least ten fellows within five miles from here trying to work at the same time, but later in the evening it is fine going.

This surprising amateur record, following as it does, so closely after Hugh Robinson's (2QR) feat of sending to Scotland is particularly significant.

Apparently the range of low-powered, short-wave transmission has been greatly underestimated. Other amateurs should feel greatly encouraged to try for long distance records themselves. Seefred and Sel-

(Continued on page 644)

The Use of A.C. Potential With Vacuum Tube Transmitters

By JESSE MARSTEN

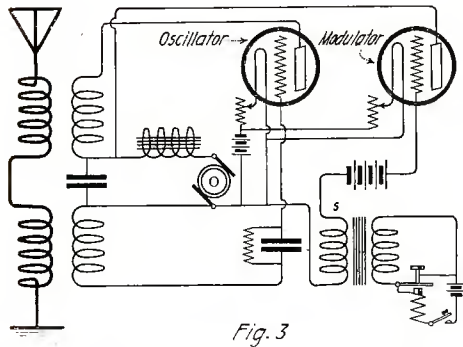

Fig. 3

Here is the Modulated Buzzer Method. When a Microphone is Connected in Place of the Buzzer Radio Telephony May Be Accomplish.

THE existing methods utilized by amateurs and others for tone transmission with vacuum tube generators may be enumerated as follows:

1. Use of a chopper or interrupter in the antenna, plate circuit, or other equally effective position. The action of the chopper is to break up the continuous wave train into a series of wave trains at an audible frequency, Fig. 1.

2. Use of a buzzer or other similar device for modulating the radio frequency output of the valve. Any of the accepted methods is applicable, as the insertion of the buzzer in the grid circuit of the R. F. oscillating tube, Fig. 2, or the use of the buzzer in conjunction with a modulating tube, Fig. 3.

These are the principal methods used with greater or less success. Of them all the use of the buzzer with modulation amplifier tube gives probably the best over-all results. With all these methods the radio frequency oscillations are generated with direct current potentials on the plate, or if alternating currents are used, they are first rectified and then applied to the plate. However, it is quite conceivable that a very large number of amateurs have not available the D. C. necessary voltage, and cannot afford the purchase of a D. C. generator. But they have readily available alternating current power, either 60-cycle, or 500-cycle (from old spark sets), the voltage of which they can readily step-up by transformers which they have, or carefully

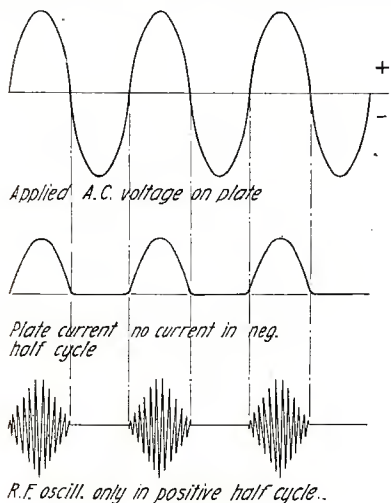

Fig. 4

Diagram Showing How C.W. "Trains" Are Formed by the Use of A.C. as Plate Supply.

made home-made transformers, to the voltage required by the tube. Of course it may be argued that if A. C. power is available it can be rectified and D. C. thus applied to the plate of the tube. But this is not overcoming the difficulty of lack of apparatus (D. C. generator), it is simply substituting expensive apparatus of another sort for the D. C. generator. For rectifying A. C. implies the use of two rectifier tubes, large smoothing out condensers, and heavy choke coils, all of which means money and may come to the cost of a new D. C. generator.

The writer wishes to offer a suggestion in this article which will bear experimentation. It overcomes the amateur's difficulty described above and at the same time gives another means of tone transmission with vacuum tube oscillators. The method considered is the use of alternating voltages on the plate of the oscillating tube. The voltage derived from the power line or A. C. generator is stepped up by a suitable transformer and this potential applied to the plate. During some experimental work done with a special type of vacuum tube the writer had occasion to use the method here described, with more or less successful results, but due to lack of time was unable to do much work on the subject.

In view of the fact that the A. C. is applied directly on the plate of the oscillator, the plate will be alternately at positive and negative potentials for successive half cycles, with respect to the filament. During the half-cycle that the plate is negative the tube is inoperative, consequently there will be a series of continuous wave trains every other half-cycle of the applied A. C. potential, as in Fig. 4. In other words, the application of the A. C. potential on the plate is equivalent to an electrical chopper or interrupter. The interruption takes place once every cycle and hence the tone frequency will be that of the applied plate voltage, in the case of a 500-cycle generator a 500-cycle note will be heard, etc. The tone transmission with 500 cycles will be satisfactory (this was the frequency used in the experiments mentioned above). With 60 cycles the frequency is too low for tone transmission, but could be used for beat reception. It is true there will be the 60-cycle modulation, but this is a very low frequency note and can easily be ignored when receiving beats of 800 to 1,000 cycles. The high pitched musical note attracts practically all of the auditor by attention.

The question of course arises, will the tube oscillate with A. C. potential thus applied to the plate, and how does it differ from D. C. operation? Well, there is no reason why the tube should not operate with A. C. on the plate, if the constants of the circuit are properly chosen, which condition applied equally well for operation with D. C. on the plate. Then again experience shows that the tube will oscillate with A. C. The circuit will oscillate every other half-cycle of the applied A. C. (positive half-cycle). And assuming that the filament current is not low enough to cause saturation at the peak voltage of the applied plate potential, the radio frequency power will vary during each positive half-cycle directly as some power of the A. C. voltage on the plate, Fig. 4.

If the constants are properly chosen and the ordinary electrical precautions are observed, a tube which will oscillate on D. C. will also oscillate with A. C. on the plate. Some of these precautions and considera-

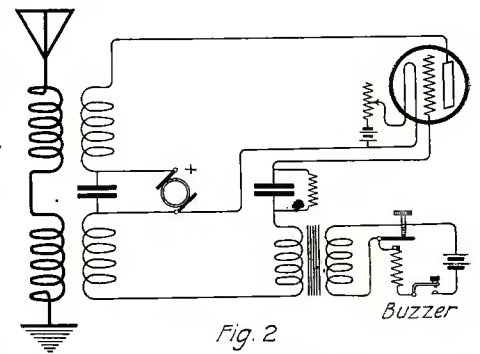

Fig. 2

In This Circuit a Buzzer is Used to Change the Potential of the Grid and Produce Interrupted C.W.

tions as they arose in the experiments mentioned before will be outlined here. The circuit used is that shown in Fig. 5.

In the first place the transformer has a transformation ratio of, say, 10. If the primary voltage is 100 the secondary steps it up to 1,000, which is, let us say, the voltage necessary for the tube. But when the tube load is thrown on the transformer, no oscillations result and the voltage across the secondary is found to be much under 1,000. This is a condition which actually occurred. This indicates that the resistance of the tube is much lower than the impedance of the transformer, and as a result most of the secondary voltage is consumed in the transformer. The high transformer reactance may be either in the windings or in leakage or both. It is important therefore that the transformer reactance be low, so that most of the secondary voltage be consumed in the tube itself, where it produces results.

Another consideration is that the value of the condenser C_0 be properly chosen. In Fig. 5 the object of the condenser C_0 is to by-pass the radio frequency and at the same time block the plate potential, to prevent it from short-circuiting L_0 to ground. C_0 must therefore be a capacity which will easily pass radio frequency and which will at the same time offer a very high reactance to the plate audio frequency voltage. A capacity of the order of 0.001 microfarads satisfy this condition. Also it should be noticed that C_0 is practically across the secondary of the transformer. Unless care is taken it may be found, as actually happened, that the reactance of the transformer is such that resonance is produced in the low frequency circuit, or near resonance, resulting in very high potentials, which may be dangerous to the tube.

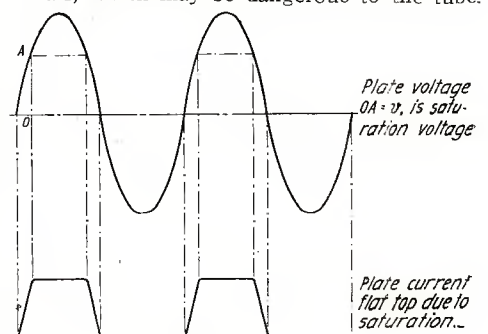
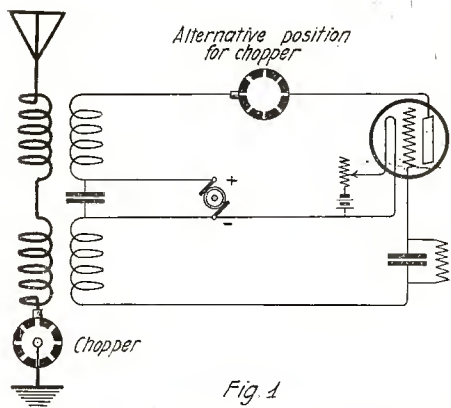

Fig. 6

Typical Saturation Curve of a C.W. Set Supplied With A.C.



In This C.W. Circuit a Chopper is Used to Cut the Waves Into Trains Which Are Audible With an Ordinary Receiver.

As above this simply requires the choosing of the right value for C_p . Thus in the case of the writer a capacity of 0.004 microfarads with the particular transformer used produced very high voltages at 500 cycles,

which produced such a high plate current that the filament burned out. Reduction of the capacity to 0.001 to 0.002 microfarads gave good results. It is such electrical and radio considerations which, if properly taken care of, as in any other type of set, will help towards the satisfactory operation of the tube.

Now it will be interesting to consider some few other features in the operation tubes with A. C. on the plate. The phenomenon of filament saturation has a decided effect on the operation of the tube with A. C. on the plate. If the filament current is adjusted to such a value that the total electron emission is drawn over as current at a voltage $v = OA$ (see Fig. 6), then the voltages higher than $v = OA$ are not effective in increasing the plate current. In order to utilize effectively the voltages above $v = OA$, it is necessary to increase the filament current so that the saturation current is increased. This was actually found to be the case, for increasing the A. C. on the plate always necessitated increasing the filament current to obtain the best output. It will also be evident that

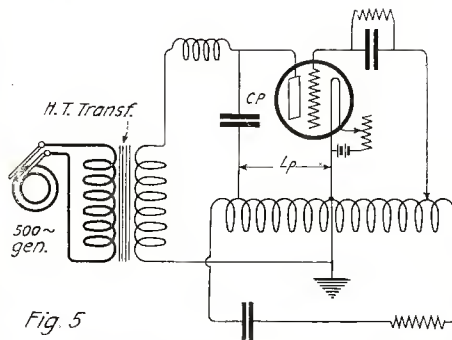

Fig. 5

Hook-up of a C.W. Transmitter Supplied With 500 Cycles A.C. as Plate Current.

for voltages below the saturation voltage $v = OA$, the filament emission is not fully utilized, and that for the negative half of the wave the tube remains idle.

For a given output from a tube with given D. C. plate voltage, what is the relation between the A. C. values of voltage

(Continued on page 642)

An Amateur's Variable Condenser

By C. KENT DUFF

SEVERAL variable condensers constitute an essential part of any radio receiving set but to many amateurs of limited means the cost is a considerable item and those who like to build their own apparatus find the usual construction of variable condensers difficult to copy successfully without more facilities than are ordinarily available. The condenser described below is inexpensive, easy to construct, and in electrical characteristics is satisfactory and in some respects even better than the usual type.

In principle, the condenser consists of two metallic plates hinged together and variable in relative position by means of a screw bearing on one of them. This principle has been applied by the writer in the following way. Each plate consists of a sheet of tinfoil glued on the surface of a piece of hardwood which has been impregnated in paraffine for purposes of insulation and also to keep the wood from warping. The wood, which may be $\frac{1}{2}$ inch to $\frac{3}{4}$ inch thick, should be immersed in the melted paraffine at a temperature not over 120 degrees Centigrade until all bubbling ceases. It should be left in the paraffine bath while the latter is allowed to cool slowly and may be removed when solidification begins. The temperature reached will insure that all moisture is driven off and the slow cooling allows the paraffine to enter all the pores, thus permanently displacing all air and moisture. After impregnation the wood should be planed as flat as possible and the tinfoil smoothly applied with a thin layer of good glue. The tinfoil may extend to the edges of the wood except on the side

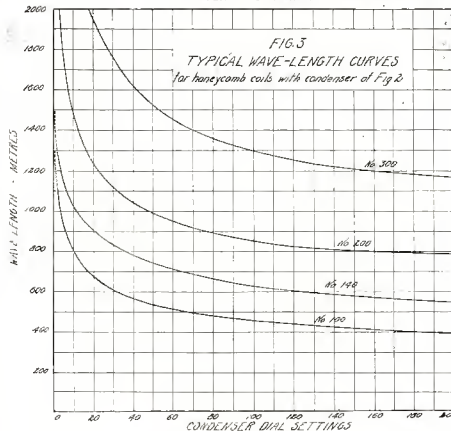
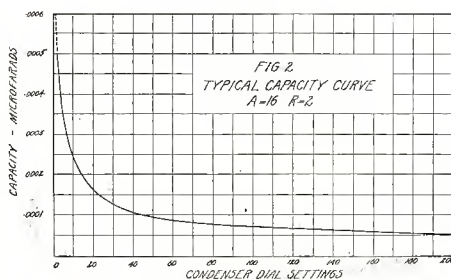

Capacity and Wave-length Curves Obtained with the Duff Type Condensers.

next the hinge where a small margin should be left. Electrical connection to the plate may be made by a strip of brass screwed over a projecting edge of the tinfoil. In order to prevent the plates from coming into contact and short-circuiting, one plate should be covered with a thin layer of insulating material which will at the same time materially increase the maximum capacity of the condenser. For this purpose mica will be found most satisfactory on account of its high specific inductive capacity and low leakage and dielectric hysteresis loss. The mica should not be thicker than five thousandths of an inch and need not necessarily be in one piece. In attaching the hinge, great care must be taken to make the plate surfaces come together perfectly or the maximum capacity may be much less than anticipated.

The condenser may be mounted in various ways according to circumstances or to suit the ideas of the constructor. Two

methods are here suggested. Fig. 1 shows a system suitable for a condenser built as an individual unit. One plate is glued on to the bottom of the box and the screw bears directly on the hinged member. A spring or elastic band tends to hold the plates apart. Another method which is peculiarly adapted to cabinet sets, is illustrated in the photographs which show front and rear views of a partially assembled receiving set containing two variable condensers mounted on the ends of the cabinet. The adjusting screw projects thru the front panel and bears on a brass plate which is fastened under the hinge. The screw, which is $\frac{1}{4}$ -inch in diameter with 20 threads per inch, works in a $\frac{1}{4}$ -inch nut fastened to the back of the panel. It may be mentioned in passing that the honeycomb coil mounting in this receiving set is similar in principle to the condenser mounting, that is with hinge and screw.

As to the dimensions of the various parts of the condenser, many combinations are possible. The two most important factors in the design are plate area A , the active area of one plate in square inches, and R , the ratio of l_1 to l_2 in Fig. 1 where l_1 is the distance from the center of the plate to the axis of the hinge and l_2 is the distance from the center of the adjusting screw to the axis of the hinge. The value of A determines the maximum capacity of the condenser, while the value of R determines the sensitivity of adjustment and the number of turns of the screw necessary to produce the desired range of capacity. It is best to make R between 2 and 3 when a good range of capacity can be obtained

(Continued on page 644)

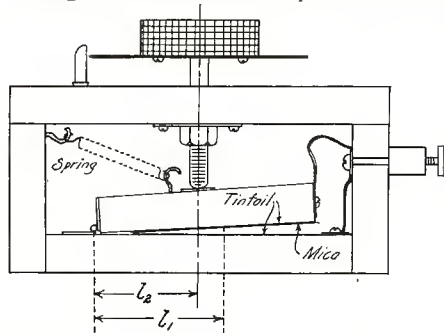
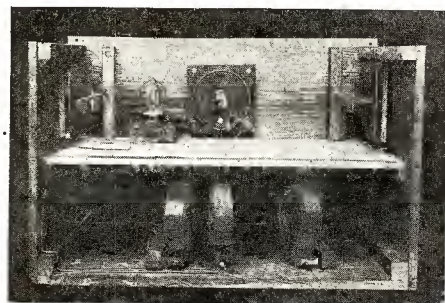

FIG. 1

A Variable Condenser of a New Design for the Amateur. With the Curves Given, Using Honeycomb Coils, a Wave-meter May be Built With Such a Condenser.



Inside View of a Receiving Set in Which the Primary and Secondary Condensers Are of the Type Described in This Article. They May Be Seen on Each Side of the Upper Shelf.

The New Paris Radio Station

By the Paris Correspondent of Radio News

THE telegraph lines connecting Paris to the rest of the world are now insufficient for the great amount of traffic handled. Many "urgent" telegrams are delayed 24 hours and ordinary messages are often several days late. For instance, on December 30th 3,977 telegrams were waiting to be sent in the near and far east, but thanks to Radio this will be ended shortly.

Actually, the few cables working permit only 9,000 words a day to be sent to South America and 18,000 words to the United States.

The price of submarine cable is so high that it is, at the present time, practically impossible to lay any new ones, especially since the heavy traffic to be handled would necessitate more than 20 new cables being installed between France and North and South America only.

Radio does away with all this. Due to the modern systems, speed and intensity of traffic may be obtained and will shortly completely replace the cables.

FOUR IMPORTANT STATIONS.

France possesses at the present time four important stations.

First, the Eiffel tower, whose rôle is especially a military and scientific one: the aerial is high, but nevertheless small; the antennæ has an energy of 50 k.w. This station sends time signals and weather reports, the measurement of longitude, communications of a military and diplomatic character, etc.

The FL station therefore can't be used for commercial traffic.

Second, the Nantes station, which is for the Navy what the FL tower is for the Army.

This station, which is equipt with six 600-foot towers and puts 100 k.w. in the aerial, insures constant communication with the battleships, sends the navigation warnings, etc. Neither can it be used for public communication.

Third, the Lyons station, built during the war and for war use, especially communicates with Russia. It has been improved and extended in accordance with the needs of the time. The power in the aerial is 150 k.w., but the aerial itself is still insufficiently developed and can't be extended any more. It may be used for communication with the United States, but can't be counted upon for constant traffic as it also has some time signals and press to send.

The communications kept up by YN are those of North and Central Africa corresponding to its normal range which is good in proportion to the power used.

Fourth, the Bordeaux station, equipt with an aerial 835 feet high and a power of 500 k.w. in the aerial. It is the most powerful in the world at the present time. In fact, altho very efficient, it is also insufficient, for at distances of 8,000 miles it was shown by experiment that it was not received regularly, especially in South America.

HIGH POWERED STATION NEEDED.

Lyons and Bordeaux are too far from the capital, and the messages are often delayed between these towns and Paris owing to the heavy traffic or an accident happening, such as lines broken by storms, etc.

It is therefore necessary to have as soon as possible, at least one very high-powered station near Paris able to insure constant and fast communication between America, India, China, Japan, South Africa, etc., and France.

This is the first part of the program, the second of which consists of building at the same time and if possible of the same type, some stations in the countries with which France has the greatest need of liaison.

The new Paris Radio Station will be the pivot around which the other stations will be installed.

Built at Sainte Assise near Cesson and Melun and connected to Paris, which is only 25 miles away by two good roads and two railway lines, the Radio center will be composed of two sending stations, one for transcontinental traffic and the other for intercontinental communication. It will be equipt also with two receiving stations and a Radio central office in the heart of the business district of Paris.

TWO STATIONS IN ONE.

The transcontinental station will be equipt with one 835-foot tower and the installation will be so arranged that it will be possible to effectuate either one transmission with a power ranging from 12 to 100 k.w. in the aerial or two transmissions (at the same time) with a power of

another in the same field, but will be quite separate and act as different units.

The receiving stations, which will count five to seven for each sending station, will be erected in a small building and will be equipt with the most sensitive and up-to-date instruments. These receivers allowing the reception without aerial of the most distant stations register several transmissions at the same time, without any interference from nearby stations.

They are the last word in Radio equipment and function with automatic writing machines permitting very high transmission speed.

60,000 WORDS AN HOUR WITH FIVE RECEIVERS

Each receiver can register more than 200 words a minute; with five receivers it is possible to register and decipher 1,000 words a minute, that is to say 60,000 words an hour.

These transmitters are able to send 24,000 words an hour. This number may be doubled for short distance communication using vacuum tube transmitters with which the same sending speed is obtained.

Considering both transmission and reception the Radio center can send 100,000 words hourly, making an enormous daily traffic of 2,000,000 words.

It is interesting to compare these numbers with those given for the best cables, which is 30,000 words a day for the United States on a cable working continuously both ways.

RADIO OFFICE IN HEART OF PARIS.

The center will be finally completed by a Radio office installed in the business district in Paris and connected to all post-offices of the capital by special wires. Then without delay the messages will be sent to the Radio office in which the automatic transmitters will be operated, controlling the machines at the Radio stations.

In a word, the systems used allow the exchange at the same time of messages going both ways (duplex system), the transmission and reception of several messages at the same time, both ways (multiplex system), and the automatic reception at tremendous speed of the messages traveling over the world.

While awaiting the opening of these stations to public traffic, the post-office and the Compagnie General de T. S. F. have taken steps to open to the public a few of the Radio "lines" which are so much needed.

TEMPORARY STATIONS OPEN.

Some temporary installations, equipt with modern apparatus, are already open in France and England and after being tested give very satisfactory results.

The Paris-London "line" was open to public service on January 18. Since the first day a speed of 160 words a minute was realized, this giving a total traffic of 10,000 words an hour both ways.

So, thanks to Radio, this communication between Paris and the rest of the world so congested for a long time owing to the insufficient number of wires, is now as satisfactory as in the best pre-war days.

It is planned to erect ultra powerful stations in all the great capitals and it is expected that in a few years Radio exclusively will be used for intercontinental communications.

At this time each country will be connected with all its colonies and the ether will be used extensively instead of the cables which cause so much trouble.

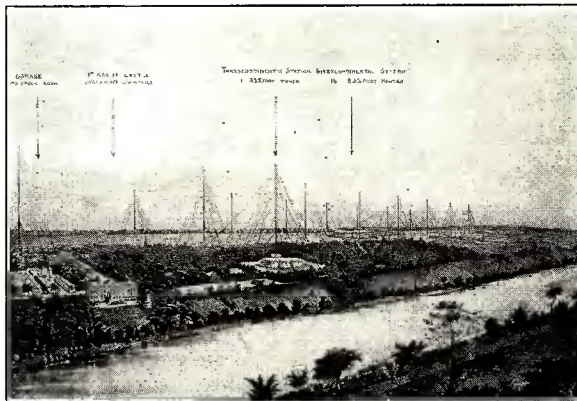

A General View of the Two New Powerful Stations as They Will Appear When Built. The River in the Foreground is the Seine.

from 12 to 50 k.w.

The current will be furnished by the power plant of the city or by the machines belonging to the station consisting of 160 h.p. Diesel engines running generators and will be transformed into high frequency currents by some high frequency alternators delivering directly 25 k.w. in the aerial.

The intercontinental station will be the most powerful in the world. The Lafayette Station, which was described in the February issue of RADIO NEWS, has an aerial built on eight 835-foot towers; the new Paris Station will have a double inverted L aerial erected on sixteen 835-foot towers and will cover a surface of two miles by 660 yards.

Three high frequency alternators, each delivering 500 k.w. in the aerial, will allow two transmissions to be made at the same time, each with 200 to 500 k.w.; or only one transmission with a power of 200 to 1,500 k.w. in the aerial by coupling the three alternators.

The power supply will be as for the transcontinental station, either the city plant or a special plant installed in the station and consisting of three 1,400 h.p. Diesel engines running dynamos.

24,000 WORDS AN HOUR.

In both of these stations and for single or duplex traffic, 100 words a minute can be manipulated, giving a spread of 24,000 words an hour.

The two stations will be built near one

Inside Dope on "Our" Set

By W. H. WININGS

(Author's Note:

This inside dope is told, not that it may cause any ex-gob to reconsider his former commanding officer's entreaties on the subject of shipping over, but with a hope that some highly enthusiastic amateur who has had his dreams battered down before his very eyes may have his spirit and lost enthusiasm boosted or rejuvenated once more. I have seen and heard of so many cases of complete dissatisfaction upon the trial by amateurs of various styles of the continuously variable inductance type of regenerative sets and the ultimate conclusion in each case that "it won't work," that I want to point out the fact that the "idea" is all right if the apparatus isn't.)

ONCE upon a time of war there lived some radio gobs in an old evacuated vessel which was not haunted or anything, and was sold to the government as a serviceable coal barge, its filament having been long since burned out. We always had to hook on an amplifier when we went to sea or the old scow never would come in at all. We might have faded entirely into the mists of the ocean had it not been for that extra lead we used from the dead circuit over to the faithful amplifier. Often we stayed in port for months at a time simply because nobody could pick us up. Somehow we always had a broad wave to contend with, too, when we went out to sea.

But, as I started to say, the sum of these gobs was four. However, only three of them were real gobs. The other was a half-breed. He didn't smoke. That was I. But occasionally, when the room in which we had all our adventures became too highly exhausted of gas, I would light a pill and place it somewhere within the receiving radius of my nose. The gas thus produced always made everything more sensitive.

Up in the harbor of a little town in Nova Scotia once rested our portable dwelling. It was there that things happened. Nothing ever was outside of Shelburne, N. S., anyway.

One pretty day when the thermometer wasn't showing very much radiation from the sun, the four of us sat dreaming of the fireside at home. Signals rarely came in on our set. It was the electrostatically coupled type of receiver and we used it in conjunction with a triple detector stand. With us poor gobs who had never known anything that would take the place of the good old Paragon receiver, this improvement didn't have much pull. It discouraged the good intentions we had. We all swore that if we ever got home again and found that Allahabad or Yen Tsu was operating a quarter inch spark coil, we would build a regenerative set that would bring him in all over the town.

There we sat, the smoke thickening. I firmly believe that one reason for the failure of the set was that the smoke in that apartment was so thick that it formed an ohm on the end of the cat whisker. All of a sudden the operator on watch, for he was usually the most distracted and downcast of the four, opened up, not the set, but his mouth, with, "By jeez, let's make this raft a helluvagudset!"

"Gotcha!" says I right heartily, for I always that there was never anybody that liked to experiment and build apparatus better than I.

WE ORDER THE PARTS.

We studied the matter over from financial and all other standpoints. I could fur-

nish the necessary funds, for I was always rich, owing to my strict temperance habits. If my memory hasn't failed me, I had about twenty-five dollars at that time. That would furnish about everything we needed, we estimated. The biggest question was, "Would we be in that port when the order arrived?" We finally decided we would take the chance anyway, for what is a little bit of kale to a gob? So, having previously secured one of a reliable company's catalogs, we ordered from it switches, binding posts, knobs, switch points, wire, tron bulbs, a variable condenser, rheostat, a 600 meter coupler, grid condenser and I don't know what else. We didn't need a storage battery; luckily the ship had been provided with a few six-volt batteries which were kept in fair condition by the electricians. We had oodles of No. 6 Columbia Dry Cells which we used for plate voltage.

In exactly a month and a few days our order arrived. We left Shelburne a day or two later never to return. (Did I say "Never to return?" I meant as a crew. There was a girl or two in Shelburne, I believe.)

When we left the old port we were busily engaged in putting two and two together.

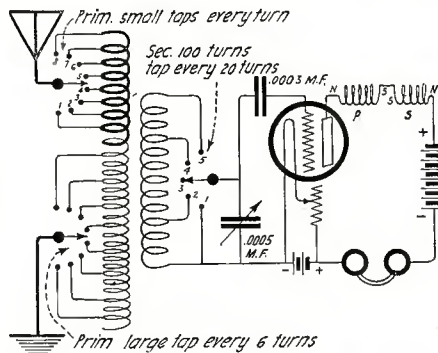

Here is a Set That Works and You May be Sure of it Since Winings Says So.

A stop was made at Boothbay Harbor, Maine, on the way to Boston, and it was as we left Boothbay that we discovered that two and two are really four.

THE SET DE LUXE.

Now, you fellows who are looking for results rather than discriminating (and you won't be in the least indiscriminating if you follow my suggestions), and who are trying to get the most for your money, just pass your lamps over the following and then act. If you have ever had an audiotron and it is still functioning properly, then I dare say you have all the other necessary articles that will be necessary to incorporate into the real "dx" receiver. If you haven't the audiotron, get one. Perhaps it has a twin sister or brother that will work as well, but I am skeptical. Here are the exact requirements for the set de luxe:

- 2 couplers.
- 1 .0005 mfd. variable condenser.
- 1 .0003 mfd. grid condenser.
- 1 double filament audiotron bulb.
- 1 rheostat.
- 1 6 volt storage battery.
- 1 22.5 volt "B" battery.
- 1 Headset.

Enough lamp cord for connections.

One of the two couplers may have fine coupling, but of course loose coupling would improve the tuning of the set. The other must be loose coupled. The variable condenser should be of the size stated because it will give ample capacity and, more-

over, will afford more precise tuning. However, a larger one may be employed very satisfactorily. The best grid condenser for the audiotron detector bulb is one made of two sheets of tinfoil each about 1" x 2 1/4" between which is clamped a piece of thin waxed paper or mica. The rheostat may be any one of a number of satisfactory types, preferably of about five ohms resistance, in order to give finer adjustment of filament current as the tron bulb is rather "touchy." Regarding the remaining articles in the list, be sure that they are not inferior grade and your success is assured.

Almost every amateur has gone to his present stage in knowledge of radio by way of the little mineral detector set which employed the loose coupler, and if he (or she) is like most of us, he will be able to uncover a coupler or two that was stowed away in the attic. Where only one coupler is available another will have to be constructed, and this one, in order to simplify construction, may be the fixt coupler. The primary should be of fifty turns of No. 24 D. C. C. copper wire, wound on a tube four inches in diameter. Slider or switch variation may be used, switch being preferable. In case switch is used, tap every sixth turn until seven taps are taken off, then tap every remaining turn which will give seven more. These fourteen taps plus the two coil ends will require sixteen switch points, eight to each switch, giving large and small steps of variation. The secondary should be wound on a tube two inches in diameter and should be of No. 28 D. C. C. copper wire. Wind on 100 turns and tap every twenty turns, making five taps for secondary control. Mount the secondary immediately within and in closest inductive relation to the primary. The switches may be mounted on a panel that suits your own particular taste. Binding posts for the primary and secondary terminals will make the instrument handy.

CONSTRUCTING A CONDENSER.

If you already have a grid condenser or condenser of known capacity that is approximately .0003 mfd., it may be employed. Otherwise, it will be necessary to buy or construct one. This one is easily constructed:

A block of wood 3" x 3" is drilled so that two holes that are large enough to clear an 8-32 machine screw are opposite each other, 1/4" from the edges and midway between the corners of the corresponding edges. Drill out, on one side, enough in each hole with a larger drill so that the heads of the machine screws to be used may be countersunk. This block will serve as a base for the condenser. Take the screws from two binding posts and set them up thru the base. Cut a strip of smooth cardboard 1" x 3" and punch holes thru it at each end so that when it is placed over the block of wood it will be parallel with and one inch from the edges of the block and at the same time fit down over the two machine screws. Cut two pieces of tinfoil each 1" x 2 1/4" and in one end of each make a hole so that the pieces will fit down evenly over the machine screws at opposite ends of the cardboard and at the same time overlap each other an inch and a half. Put one piece on at one end. Get some sheet brass and cut two pieces each 1" x 5/8" and in each drill a hole that will be half way between the ends and 1/4" from one side and the same size as those in the base. Fit one piece over the screw and on the foil that has been laid and clamp down tightly with one of the binding posts so that the

(Continued on page 646)

Remotely Controlled Transmitter

By JAMES W. H. WEIR

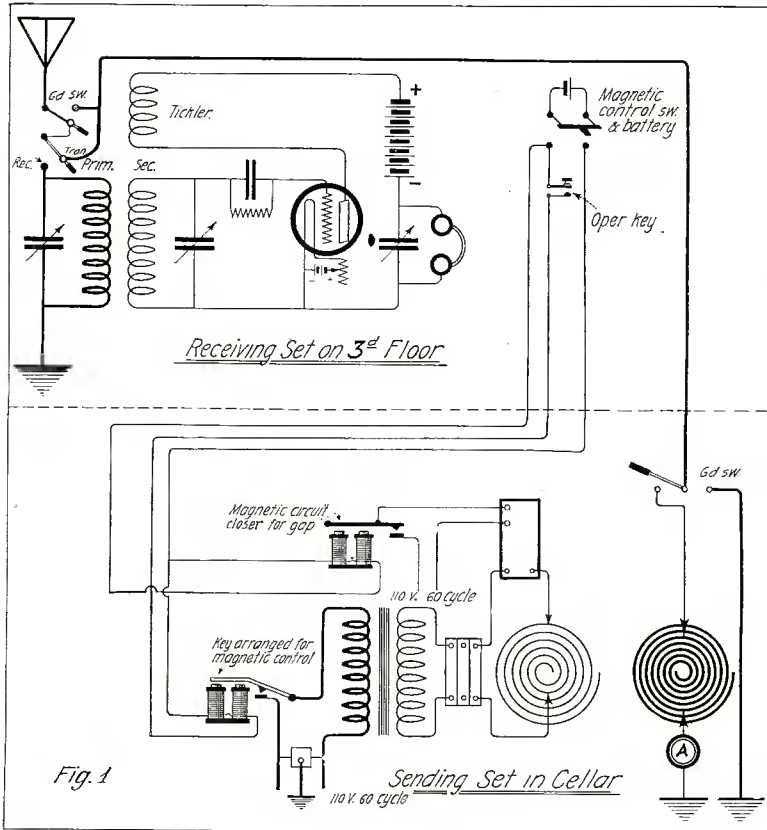

Fig. 1

MUCH has been said regarding varied methods of transmission and reception of wireless signals, but there has been little, if anything, ever mentioned concerning the operation of a transmitting station by a remote control.

The diagram shown in Fig. 1 gives a clear idea of the connections necessary in operating a transmitting set, located some distance from the operator, by means of a three wire magnetic control circuit. In this case, the transmitting set is located in the cellar approximately 60' from the operator.

The lower half of Fig. 1 represents the equipment in the cellar. It consists of a ¼ K. W. Thordarson transformer, three sections of Murdock moulded condenser, rotary spark gap, oscillation transformer, ammeter, ground switch, and kick-back preventer. The wireless key at this end is provided with an armature which is acted upon by a small bell magnet. A similar arrangement closes the 110 V. circuit to the motor of the gap and, at the same time, lights a red lamp as a warning that the circuits, primary and secondary, are alive.

The circuit controlling these magnets has its source of power on the third floor and

consists of three wires, two positive and one negative, running thru the chimney flue to the cellar. A positive and negative

lead go directly to the motor circuit-closer. The other positive goes direct to the key control which has its negative line tapt from the motor circuit-closer. All connections of the secondary circuit to the ground switch are of strip copper 1 ¼" wide and all splices are soldered.

The upper half of the diagram, Fig. 1, represents the receiving circuit, consisting of honeycomb inductances and condensers. This circuit, which was used by Mr. A. Groves, is very satisfactory and for this type of inductance cannot be improved.

Referring to Fig. 2, an exact drawing of my station located on the third floor of my residence, we find 1 representing the leads to a 6 V. storage battery controlled by switch 2 which, on turn, closes the gap motor control and turns the current into the key magnet control ready for instant response when operator works the telegraph key at 3. This key is provided with two sets of contacts, one pair entirely insulated from the other, to which a battery and buzzer may be connected in order to distinguish the transmitted signals. Switches 4 and 5 are used to connect and disconnect receiving and transmitting apparatus from the antenna, as is shown to left of Fig. 1. Six is a plug and socket used as an additional break in the receiving circuit when transmitting.

There are four battery connections in the front of the panel and a small rheostat is used to control the filament current. An "on and off" switch is provided to control the "B" battery. Binding posts for two sets of fones are provided at 8.

Giving a radiation of about two amperes and a good sharp wave, this arrangement has proved both satisfactory and convenient.

Here is the table on which are the receiver and the necessary control switches closing the transmitting circuits placed in the cellar of the house.

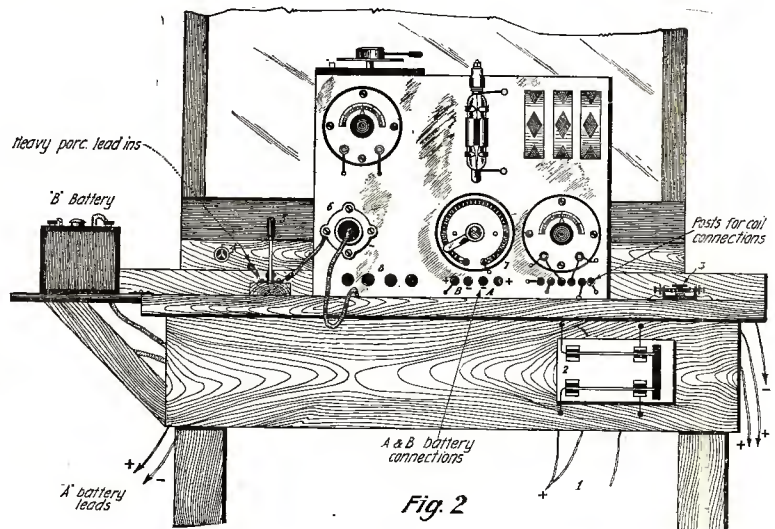

Fig. 2

Directions for Making an Inexpensive Oil Condenser

By CHAS. R. AVERILL

ANY one desiring an oil condenser and not being able to pay the present high market prices, can make one for, approximately, \$3.00 for ½ K. W. or \$5.00 for 1 K. W.

First, secure from some garage two old rubber jars 7" x 6" x 2 ½" (inside measurements). Clean thoroughly and dry. They will probably cost nothing; at the most, not over one dollar.

Second, have a tinsmith cut, from 12 to

24 plates, according to capacity, of the thinnest tin available, 5" x 5" pieces, which will cost about 50c or 75c. Get some photo plates from some photographer, 6" x 8". These will probably cost 3c a piece.

Third, get one quart, or one and one half quarts, of good thin oil (not coal oil). You will then be ready to assemble the parts:

Cut the glass to fit even with top of jar. Cut from one side of each tin plate, a

strip ¼" in width, extending to within ¾ inch of the end. Bend this ¾ inch to side as a lead.

Place the tin and glass as in a common glass and tinfoil condenser, with leads at the top of jar, as many as will go in each jar. Fill the jar, to within ½ inch of the top, with oil and connect all leads on each side, making just two main leads. All will then be complete. Use two of the jars for 1 K. W. and one of the jars for ½ K. W.

A Portable Receiving Set

By EUGENE M. RIEL

HEREWITH is described a receiving set, the construction of which is somewhat radical, as it uses no aerial of any kind. It is only in an experimental stage, but for short distances it is very useful. A radio club or a troop of Boy Scouts on a hike always want to keep in touch with the nearby home station, and with this set all that is necessary is to raise the lid and connect the batteries; there being no aerial to unfold and hoist in the air.

The box is 10x10x18 inches over all, constructed of 1/2-inch hardwood with one side on hinges so that it can be raised when in use, the case lying on the other side. Brass corner-pieces and angle strips make the case stronger and add much to its appearance. It is also fitted with a handle for carrying and a hinge hasp.

Two and a half inches from the top a 1/4-inch Bakelite panel is mounted by means of 1/2-inch cleats. On this panel are mounted the following instruments, as shown in the sketch: (1) The loop coil which is used for an aerial; (2) a variable condenser of .001 M.F. capacity for tuning; (4) a rheostat for the filament of the audion bulb. The bulb itself (3), or, rather, the socket for the bulb, is mounted in a recess 4 inches below the top of the panel, as shown. Binding-posts are provided for attachment of A and B batteries and also the telephones, for which a space is provided by the setting of the panel below the top of the case.

The coil (3) is preferably a Litz wire-wound coil of small distributed capacity, but not of the honeycomb or lattice type, because the zigzag winding of the wire will not permit a directional effect. Sixty-five turns of wire, bank-wound on a circular wooden form 2 inches in diameter,

Here is a simple portable receiver using no aerial; a bank wound coil is used as a loop. For short range this set gives good results.

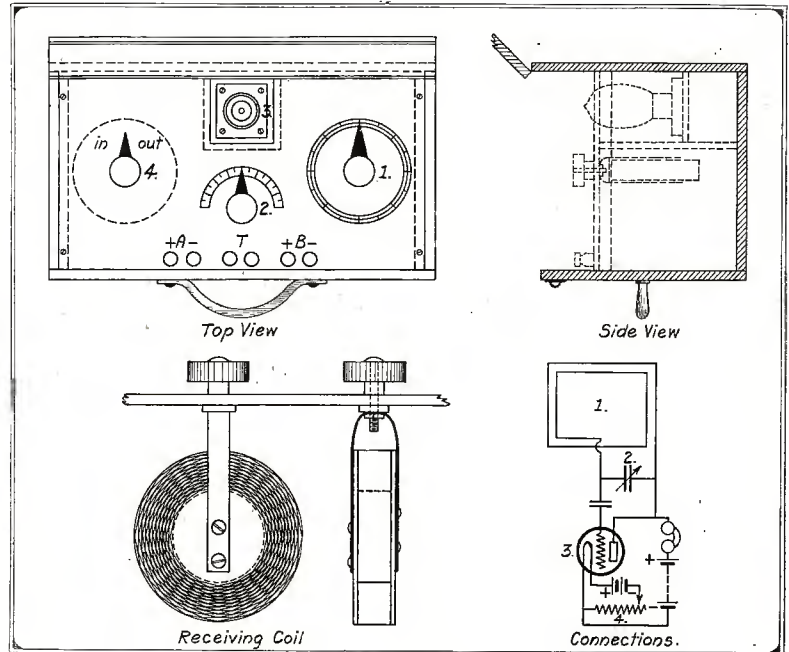

as shown, will be about right for 200 to 400 meters wave-length.

The connections are self-explanatory, the condenser (5) being the grid condenser.

If desired, there is room in the case for the B battery. Any amount of wire can be wound on the coil, to receive any wave-length desired.

To receive, adjust the plane of the coil

in the direction of the sending station and tune the signals in with the variable condenser. It must be understood, of course, that this set will not respond to signals transmitted from great distances. Good receiving depends primarily on the power of the local transmitter, as well as upon the most effective tuning of the receiver and functioning of the vacuum tube.

Daniels Wants Amateurs Controlled

SECRETARY OF THE NAVY DANIELS sent the following letter to Senator Page. Mr. Daniels at last shows his true colors.

Our Washington Attorney reports that this bill will not come up before the present Congress.

My dear Senator Page:

I have your letter, in which you request further report and recommendation on S-4038, to regulate the operation of and foster the development of radio communication in the United States, and am pleased to submit the following as my conclusions reached after much and careful consideration of the board subject of communications.

As you will see from my last annual report, I am firmly convinced that the only satisfactory method of regulating the operation of radio stations in the United States is to vest the ownership of such stations in the Government. I am fully aware of the opposition that exists to Government ownership of public utilities, but I think that careful consideration of the subject will convince you and your Committee that if there is one thing in which there should be monopoly it is monopoly of the air, and that this monopoly should not be given over to private interests.

The experience we had before our declaration of war, and voluminous evidence that we subsequently obtained, showed conclusively that high-power radio stations within our borders had been constantly engaged in the transmission of unneutral messages, and I feel that it is unnecessary for me to point out to you the consequences

which might flow from such practice. Even so careful a guardian of the rights of individuals as Senator Knox once remarked to me that his experience as Secretary of State had convinced him that control of the air should be a Government monopoly, and I am sure that he must have good reasons for this belief.

You probably know that the Navy Department now owns and operates no less than eight high-power radio stations of the first rank, capable of effective communication with European, Asiatic, and South American countries, and that its war-time operation of these, and of other stations which have since been returned to their owners, was in every respect satisfactory. In addition to these, we also own a complete chain of coastal stations, as well as radio compass stations which admirably serve the interests of our growing merchant marine as well as those of naval communication. The Government's investment in this field of communication is, therefore, a large one—much larger than that of any private American corporation or of all such private corporations combined—and I am convinced that its interests should be considered paramount.

In the past, I have consistently recommended Government ownership, operation and control—in my annual reports, in letters to Congressional Committees, and in hearings before these Committees. Experience gained during the late war has served only to confirm my judgment that Government ownership and control of all radio stations, both afloat and ashore,

should be vested in some Department of the Government, and that as the Navy Department has the necessary equipment and personnel for undertaking the work, that that Department is the logical one for such control.

One grave danger that confronts us is the possibility—I might even say the probability—of a combination, thru interlocking directorates, of the private cable interests with private radio interests; for it is not inconceivable that the interests that own and control the cables might also be interested in a radio corporation whose special interests might be served by the provisions of the pending Bill. Should such a combination of interests exist, I need not tell you that the interests of the public would suffer. With the Government in control of radio as a competitor of the cables, there would be every assurance that cable rates would be just and reasonable, and we should also have every reason to believe that competition would be secured in the supply of important radio material, which would not be the case if companies now engaged in the manufacture of material should become interested in the joint ownership and operation of radio stations.

For the above reasons, it is my firm conviction that all radio stations, except those of amateurs, should be owned and operated by the Government, and that amateur stations should be under Government control.

Sincerely yours,
/s/ JOSEPHUS DANIELS.

Hon. C. S. Page, U. S. S.
United States Senate.
Washington, Feb. 14th, 1921.

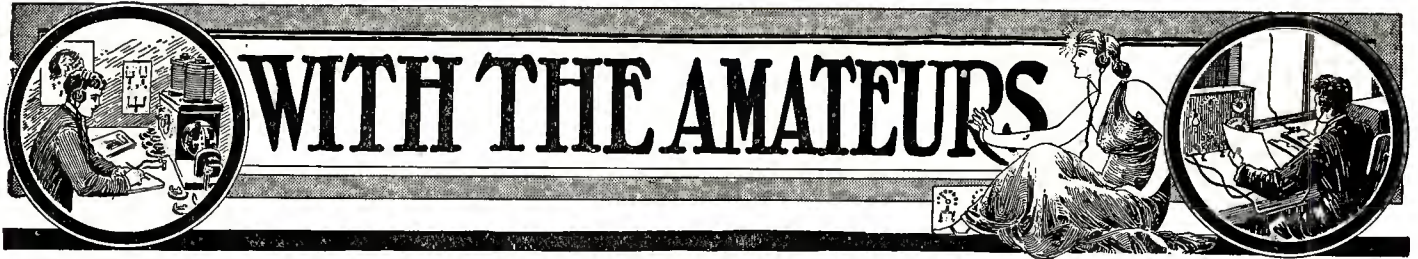

THIS Department is open to all readers. It matters not whether subscribers or not. All photos are judged for best arrangement and efficiency of the apparatus, neatness of connections and general appearance. In order to increase the interest in this department, we make it a rule not to publish photographs of stations unaccompanied by a picture of the owner. We prefer dark photos to light ones. The prize winning pictures must be on prints not smaller than 5 x 7". We cannot reproduce pictures smaller than 3 1/2 x 3 1/2". All pictures must bear name and address written in ink on the back. A letter of not less than 100 words giving full description of the station, aerial equipment, etc., must accompany the pictures.

PRIZES: One first monthly prize of \$5.00. All other pictures published will be paid for at the rate of \$2.00.

Gordon W. McClain's Station

This Month's Prize Winner



The aerial consists of four wires forty feet high and seventy-five feet long. It is used at present for both transmitting and receiving. A counterpoise consisting of a number of copper wires of the same gauge as the aerial lie directly beneath it at an elevation of three feet from the ground

and is used instead of an earth connection.

The transmitting panel holds a one-half kilowatt transformer, the power of which is variable by means of taps of the primary attached to a switch on the front of panel, signal glass plate condensers vari-

able capacity by means of a fan switch, a variable speed rotary gap of sawtooth design, and a hinged pancake type oscillation transformer with four-inch copper ribbon on the primary, and two-inch on secondary. The marble switchboard controls and measures all powers. I have only lately connected this transmitter up so have not had time to do any long-distance work, but have been heard by 3GS in Bridgeburg (near NNZ) and intend to try and work further.

The receiving unit employs honeycombs for tuning, electron relay for detecting, and class II Marconi V.T.'s for amplifying. It also has a small crystal attachment for local reception. Since taking the picture I have under construction another panel which will embody honeycombs, variometer regenerative, and crystal units. A photo of this will be sent when I complete it. A few of the stations I heard during the latter part of December were:—NBA, NPM, NPL, NPG, NPA, NPZ, NAU, XDA, LGG, IPF, PZR, BZQ, BZW, BZM, FL, VAL, VBG, MAA, IBBL, 9ZN and radio-telephone from 2XR, etc.

The panel at extreme right of photo is the radiofane.

In conclusion I may say that I will be pleased to converse with any American amateurs.

G. W. McCLAIN,
Opr. 3GE,
342 Brunswick Ave.,
Toronto, Can.

Station of Edwin Y. Webb

This is a photograph of my radio outfit, which has been giving me very satisfactory results in every respect.

I made the large set last summer, and the small one about three months ago. The large set on the left of the picture enables me to hear most of the large stations of the world. I can copy NPM, NPC, NPN, NPL, POZ, YN, XDA, and many other distant stations, very easily with only one audion. I can copy POZ in the daytime very easily.

I can hear NSS, NDD, and WSO fifty feet from the fones without a horn, while Belmar, N. J., and San Diego come in loud enough to copy all over the room.

My aerial is 300 feet long on 70 foot poles, made of eight strands of aluminum wire, 1 1/2 feet apart.

The coupler of this set is designed to tune up to wave-lengths of 20,000 meters, which is higher than the wave-length of Annapolis. There is also in the cabinet two loading coils (one for the primary and one for the secondary) and several other things that go to make the set.

The two switch arms on the lower left of the set are for regulating the primary (one for taking every 40 turns and one for taking two turns), while the one on the lower right is for regulating the secondary.

I use parts of several hook-ups, being able to receive damp as well as undamp

signals. I can also use a crystal detector by throwing the small switch (just below the audion) on the center tap.

I made this set without help from anyone—except the help of the Electrical Experimenter, which is my old standby, and whenever I want to settle an argument be-

Ed does some fine reception work with his two home-made receivers, and we are glad to tell him that his set looks very good. Don't you think so, boys?

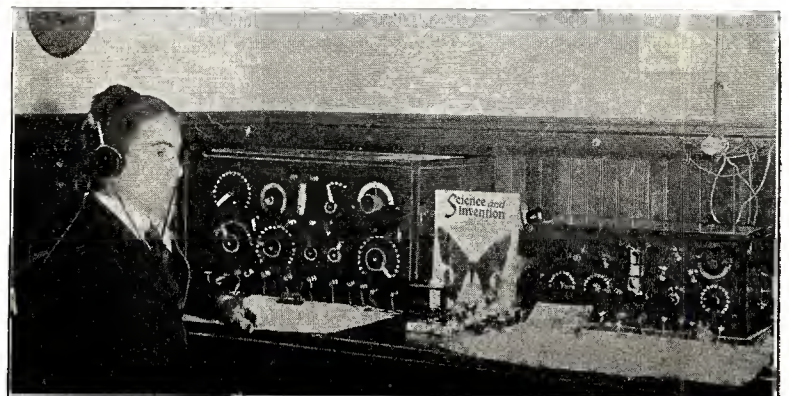

tween a friend and me, to my stack of Experimenters I go.

The small set is the large set's baby brother, as I made them both alike, only one being smaller.

With this small set I copy ships from New York to Panama, some of them coming in loud enough to hear 30 feet from the fones, which are the Baldwin Navy Standard Type. NAA comes in loud

enough to hear 50 or 60 feet from the fones, at which time it is hard on my ears to keep the headset on. NAO, NAR, NAT, NAP, NGE, NGL, NFI, NAH and all stations in Panama and the West Indies, or practically every station on the Atlantic coast as far south as South America come in very clear.

I can get the time from seven different places: NAA and NSS at 10 p. m. and

12 m.; NBA at 1 p. m.; XDA at 7:30 p. m. and San Diego at 3 p. m.; NPM at 7:00 p. m. and POZ.

I would be glad to hear from you, Fellow Radio Bugs, and will be glad to exchange pictures of our sets.

EDWIN YATES WEBB, JR.,
215 South Washington St.,
Shelby, North Carolina.

W. E. Seamon's Station

Following is a brief description of my radio station, call 8AOE.

The aerial is of the inverted L type, 2-wire, on 12-foot spreaders and is 40 feet high. A single wire 200 feet long is also used, for receiving only.

My transmitting set consists of a 1-k.w. open core transformer, pancake type oscillation transformer, plate glass condenser, variable impedance coil to enable low power to be used for local work, belt driven rotary gap and "bug" key.

A short wave regenerative receiving set is used for amateur work, with variometer in grid and plate circuits, a vario-coupler and ER bulb, and necessary condensers, and Brandes navy fones. A loose coupler is also used for longer waves. All apparatus has been arranged with a view to compactness and ease of operation.

Amateur stations in first, second, third, fourth, fifth, eighth and ninth districts are copied nightly. NAU, San Juan, Porto Rico, is heard occasionally.

W. A. SEAMON, Findlay, Ohio.

Frank J. Dodd's Station

This is a picture of my Radio station, official call of which is 4DX.

My sending set at present consists of

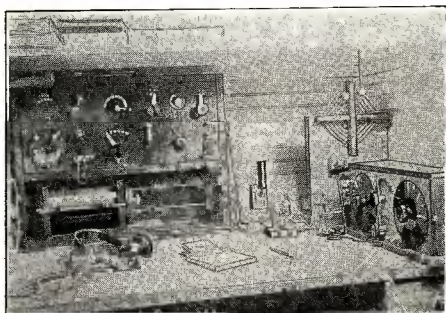

Frank is a Clever Boy. He Uses 10 Cent Records as Dials and They Look Fine. His OT is O. K., Too.

spark coil, condenser, gap and helix. The transmitting panel can be seen in the picture.

My ground switch is located on the outside of building, but is arranged so that it can be operated from the inside.

My receiving set consists of NAA loose coupler, two 23-plate condensers, crystal

The accompanying photograph is of my station and I have constructed most of the

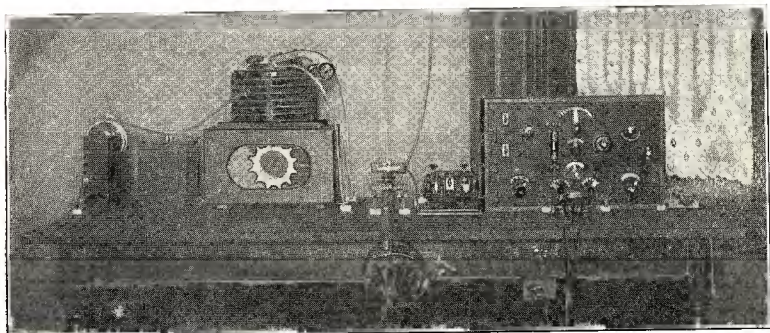

A good looking set made by a clever ham is this one. Another clean and efficient set and we would like to see more just like it.

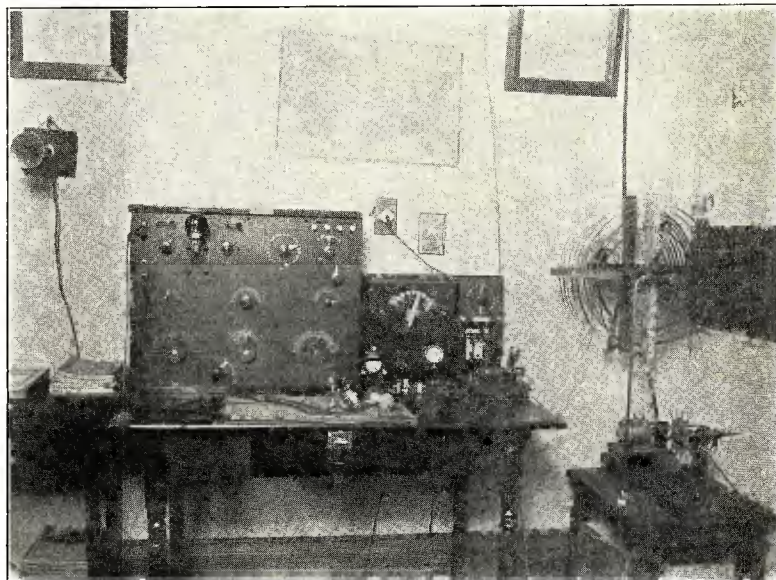

:- :-

and audion detector, Murdock fones, and 10,000 meter load. The side mounting of the loose coupler makes it very convenient to tune. On the extreme right of photo may be seen regenerative tuner which I made very cheaply, and in using same in connection with my loose coupler stations come in with a very great increase in signal strength. The circuit I use with regard to the loose coupler and regenerative is one I originated. I intend to send in later on instructions regarding construction of regenerative.

Regarding stations received, the following are most common: NAA, NAO, NAJ, NAR, NAT, NEV, NSF, ships, commercials and amateurs.

My aerial is a four wire 50 feet high and about 60 feet long. FRANK J. DODD

1103 Vernon St., La Grange, Ga.

PAUL THOMA'S STATION.

My apparatus consists of a one-step amplifying circuit, using a Navy type loose coupler, and a pair of Murdock No. 55 receivers. My set is neat and efficient.

My sending set is not working as I am waiting for my license. Then I will use a 1/2-kw. My aerial consists of two wires about 85 to 100 feet long and well insu-

Station of Ralph P. Bucher

instruments myself. I hear many of the one, two, eight and three district stations

Paul Thoma's Station

lated. It is on top of a seven-story house on poles fifteen feet high and has many guy wires attached. I have a detector cir-

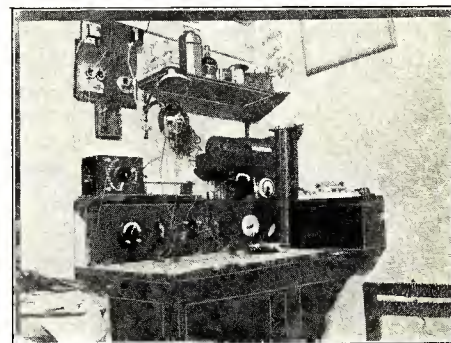

A Typical "Bug" Station With its Line of Loose Couplers. A Good Little One Tho.

cuit using a vacuum tube on a De Forest panel as seen in the picture.

I have a variable condenser of 43-plate capacity and a fine crystal receiver detector. I have a large loading coil which I sometimes hook up to hear long distance signals. I am 16 years of age.

and occasionally hear a four or five district station on a single bulb. I believe this is as good a record as any amateur's in this district. My transmitting set is of 1/2 kw. and may be seen on the left of the photograph. I enclosed my rotary gap in a noiseproof box with a glass front allowing the spark to be seen while sending.

In my receiving cabinet is a short wave set and I use honeycombs for long wave reception. I have been engaged in Radio for a number of years and take a great interest in my station.

RALPH P. BUCHER,
3PC,
5223 Greenway Ave.,
West Philadelphia, Pa.

Here boys! Look how neat this one is. You can call Ralph a regular op. for he has no junk, but a real set on his operating table.

Correspondence From Readers

WHY VACUUM TUBES ARE HIGH. MAKER DEFENDS VACUUM TUBE PRICES.

Editor RADIO NEWS:

My attention has been called to a letter by W. R. Hoffman, which you printed on page 380 of your December issue in RADIO NEWS. I also noted Mr. Hoffman's complaint on the price being charged for vacuum tubes.

We have had practically no complaints at all as to the price of vacuum tubes and where there have been complaints, we have found that it was due to some individual unfamiliar with manufacturing costs and marketing costs, comparing the price of a vacuum tube with the price of a Tungsten Lamp. This is a very plausible comparison, but an investigation of the actual facts shows that the comparison is a most unfair one. *The manufacturing cost of the base on a V.T. tube is equal to the manufacturing cost of a complete incandescent lamp.* Incandescent lamps are made by the millions entirely by automatic machinery, whereas the market for vacuum tubes is extremely limited and they are manufactured only in thousand lots. In this class of manufacture, quantity plays an extremely important part in determining cost. The manufacture of vacuum tubes, compared to incandescent lamps is similar to screw machine products turned out by hand on a lathe, as compared to a full automatic screw machine. One attendant can supervise four or five automatic machines, whereas an individual skilled operator is required on hand production.

In the manufacture of vacuum tubes, it can never be known until the final operation, whether the product will be up to standard. A good filament in a vacuum tube does not mean a sensitive tube, and in the event the tube is not sensitive, such a tube is a total loss. I can state that the list price of the type C-300 tube is truly based on manufacturing cost, and does not pay the same margin of profit to the distributors that other electrical apparatus pays. There is, therefore, no profiteering as far as the trade is concerned, and I can state that there is absolutely no profiteering on the part of the manufacturer. If the development expense on vacuum tubes were included in the cost of production, then vacuum tubes would have to sell for over \$10.00.

To insure a vacuum tube of sensitive and uniform operating properties every operation must be performed within very close limits. The grid and plate spacing, with respect to filament, must be very accurate, and if the vacuum is not right, the final product will not be right.

Mr. Hoffman's statement that French tubes are hand-made, whereas American tubes are machine-made, is not correct. The French organized vacuum tube production on an extremely large scale during the war, and Mr. Hoffman states that the equivalent price at normal exchange rates, which is the only fair basis on which to figure, for the French tube, is \$4.00. Labor is cheaper in France, and in my opinion, their product is inferior to the American tube. I cannot understand Mr. Hoffman's statement that the American manufacturer charges double what the French do for their product. Exchange rates do not affect the cost of manufacture, altho under the present unfortunate condition from France's standpoint, it is possible to buy their merchandise at a very heavy discount at present exchange rates.

I can assure you that it is the sincere desire of all of the legitimate vacuum tube

manufacturers to reduce the price of vacuum tubes. Our Double Filament Tube formerly sold at \$6.00, and a superior article, the type C-300, now sells at \$5.00, and if cost of production warrants a decrease at a later date, the benefit of that decrease will be given to the amateur. Let me again repeat that no vacuum tube manufacturer is getting rich on the sale of vacuum tubes, as the market itself is too limited.

The type C-301 tube which is identical in appearance with the C-300 lists at \$1.50 higher, and I can state that this addition in list is absolutely justified by the additional cost of manufacture and that that additional cost does not appear to the naked eye. The Molybdenum sheet used in the plate costs 40 cents and the evacuation process to enable the C-301 tube to operate at voltages up to 100 explains part of the additional cost in manufacture. The loss in production, due to insensitive tubes, is a big item determining the cost.

E. T. CUNNINGHAM
Audiotron Mfg. Co.,
San Francisco, Cal.

SUGGESTION FOR ARTISTS.

Editor RADIO NEWS:

Just a line to tell you I like RADIO NEWS very much. Why not let some of our artist friends send in some ideas for covers?

Yours for radio,
JULIUS H. FUNTMAN,
New York City.

Now here is a real suggestion. Yes, why not? We are mighty tired of doping out ideas for the monthly cover design, and very frequently our "juice" runs low. So why not "let George do it?" It's easy to criticize our covers, so we'll see what you fellows can do by way of improving RADIO NEWS' appearance?

Until further notice therefore we will receive suggestions for our cover designs, which may be either technical, or "human interest" ideas. We will pay \$10.00 for each idea used. The name of the originator will be published in the respective issue.

RULES.

Sketches not absolutely necessary, tho welcomed.

Description must be 50 words or less.

One, and not more than three titles for the design must be given.

Use only one side of paper. No penciled matter accepted. Be brief. No manuscripts to this contest can be returned.

This contest is open freely to every one, and in the event that two people send in the same matter so as to "tie" for the prize, then the sum of \$10.00 in cash will be paid to each one.

THE REASON OF HIGH PRICE OF VACUUM TUBES.

Editor RADIO NEWS:

In connection with the price of vacuum tubes, it must be remembered that the French market is surfeited with a supply of excess war material, which is being offered at cut prices. The same situation would obtain, undoubtedly in this country, if the War and Navy Departments should

place on the market the very large stocks of tubes which they now have in their possession. It is my understanding that these two departments have enough receiving tubes on hand to take care of their requirements for some three or four years, and it is only because of their fairness to local industry and possibly due to a phase of the patent situation, that this country also is not flooded with tubes.

It is comparatively easy for an amateur to sit down and figure out what to him should appear as the cost of a tube, based largely on raw material, but he should remember that the cost of working this material into the finished product is many times the actual cost of the material, and in addition, that the cost of pumping a vacuum tube correctly is much greater than all other costs connected with its manufacture. Besides these costs, a fair percentage for rejections and replacements must be taken into account. In addition, this company is compelled to pay royalties under two patents and must make a list price so that suitable discounts can be given dealers and jobbers in order that the line may be handled. The undersigned is not going to attempt a defense of present methods of distributing electrical goods, i. e., via jobbers and dealers, but it might be well for the amateur to realize the advantages he gains by being able to go to a dealer and obtain immediate delivery of any item which he requires, and for this privilege the jobber who supplies the dealer is getting from 40 to 50 per cent. off the list price.

Radio equipment, contrary to all other electrical goods, has in the past been largely a matter of mail order business and the margin between the list price and cost price was consequently quite low. Recently, however, radio manufacturers have decided to follow the plan of other electrical manufacturers, that is, to distribute their goods thru legitimate business channels, the jobber and the dealer, and this has necessitated higher costs. However, it should be borne in mind that in the early part of last year, when there were no based tubes on the market, this company jumped into the breach to supply the amateur's needs, at a large financial risk, threats of patent suits, and so on. We believe the fair treatment we have accorded our customers and the excellence of our product entitles us to consideration by the amateur, but unless he can revolutionize present marketing conditions and eliminate the high discounts which we are compelled to give the jobber and dealer, who are also catering to his needs, we do not see how our prices can be reduced.

PACIFIC RADIO SUPPLIES CO.
ELLERY W. STONE,
General Manager.

RELAY WORK ENTHUSIAST WOULD LIKE CALLS HEARD PUBLISHED.

Editor RADIO NEWS:

Referring to your note at the bottom of Mr. H. S. Gowan's letter on page 437 of the January issue of RADIO NEWS.

I have always been of the same opinion as Mr. Gowan, that is that RADIO NEWS was against relay work. You never mention anything about such work in the magazine is the reason I suppose I have this opinion. I think relay work ranks next to experimenting or even on an equal with it.

Why don't you people publish the calls heard by the various stations? I have no transmitter but take an interest in seeing

(Continued on page 654)

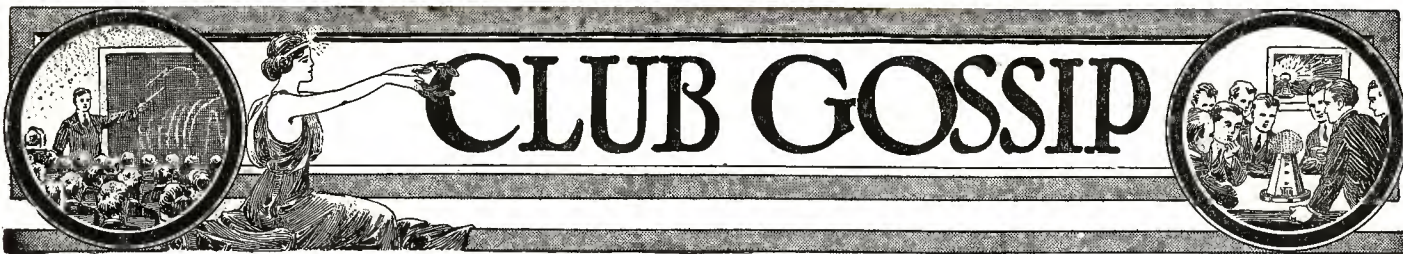

RADIO CLUB OF BROOKLYN, INC.

At a recent meeting of the club held on Jan. 26th, a paper was presented and read to the club members by Mr. Wm. Diehl, on the different uses in which alternating current could be used in C.W. transmission.

At the last meeting of the club, Mr. Pierre H. Boucheron, of the Radio Corporation of America, delivered a lecture entitled "Amateur Radio and Its Future," which was published with permission of the club in the last issue of RADIO NEWS.

The club has adopted a policy of publishing papers read before its members thru RADIO NEWS, and its own publication, "The Log," which will be resumed again in the near future. The club also wishes to announce that it will exchange publications with all other radio clubs upon receipt of their addresses. All information concerning the publication should be addressed to Mr. Lloyd Jacquet, editor, 509 16th Street, Brooklyn.

The smoker and stag which was held by the radio club February 5 was attended by 280 radio men and their friends. Among those present were Messrs. Arthur Batcheller, Edwin Beane, chief assistant radio inspector of the second district; Dr. Greene, of the Radio Corp. of America; Robert E. Lacault, of RADIO NEWS, and representatives from Wm. J. Murdock Co., Radio Club of America and Associated Press Service.

Among the prominent amateurs present were 2RB, 2CT, 2HM, 2VA, 2CS and 2RM. The Radio Club of Brooklyn wishes to thank all of its friends for their co-operation in making this affair a success.

Secretary, Mr. John Bullwinkel, 473 Park Place, Brooklyn, N. Y.

LONG BEACH RADIO AND RESEARCH ASSOCIATION

The Long Beach Radio and Research Association was organized December 20th, 1920, by a few live wire amateurs to carry on and to further radio in this city. The officers of the association are: Mr. Moore, president; Mr. Lithgow, vice-president; Mr. Stiles, secretary-treasurer, and Mr. Collier, corresponding secretary.

The association boasts its own club room and a total of twenty members. At present you are not required to pass a test to obtain admittance into the association. The dues are fifty cents a month per member; this money goes to defray the association's expenses and to buy magazines and needed apparatus.

Meetings are held every Monday night at 7.30 o'clock at the club room, where lectures which have been assigned at the previous meetings are given.

Anyone desiring to communicate with a live-wire association out for members should correspond with the secretary, Mr. W. A. Stiles, 445 Cedar Avenue, Long Beach, California.

YONKERS RADIO CLUB.

The Yonkers Radio Club held its regular monthly meeting on Saturday, February 5th. The officers take this occasion to thank the active members of the club in their efforts to enlarge the active membership. The last meeting was quite a surprise to the old timers in that the number of new members enlisted was considerably more than expected. The purpose of the meeting was well brought out to the members and also the prospective members in that the life and very existence of the club depends on the support and co-operation of all the Westchester County amateurs. This was more than necessary as the showing at the meeting was a huge success and surprise to the old members. Over 45 old timers as well as new members turned out to the SOS.

Among the many topics that were disputed and talked of was the proposed Poindexter Bill for the crushing of amateur radio traffic regulations governing traffic dispatch in the entire county of Westchester. The entertainment committee surprised us all by announcing at a very near date the engagement of Maj. J. Armstrong for the purpose of giving the members some light and inside dope on his famous radio frequency amplifier. You can be sure that the members are looking forward to the date with anxiety.

Mr. Coue (2HZ) gave the junior members some very good information of the use of V.T. bulbs in conjunction with spark coils so that the spark coils which are always a problem to local clubs on account of decrement characteristics, etc., could be operated without the usual QRM sensation so often caused by the unintentional use of same. I think that this step is one in favor that should be looked into by other clubs where they

have the same trouble that we have. This information can be obtained, namely the circuits, apparatus necessary, etc., from Mr. R. N. Lindgren, corresponding secretary of the club, also information relative to other problems confronting newly organized clubs will be gladly given by applying for same to this address R. N. Lindgren (2AYH), corresponding secretary, 253 So. Broadway, Yonkers, N. Y.

INGERSOLL RADIO ASSOCIATION.

The Ingersoll Radio Association was organized December 3rd for the purpose of promoting interest in radio telegraphy in Ingersoll. H. R. Byerley and W. M. MacKay were elected as president and vice-president respectively.

The club consists of about 25 members. It is the intention of the club to install a two-step amplifier at the club rooms. The club rooms are excellent in every respect and have a splendid situation to erect a 500 foot aerial.

A photo of the radio set of the club appears on this page. The call signal of this station is 3KG. Any amateurs within range (250 miles), please call.

All correspondence will please be made with the corresponding secretary, C. R. Patience, and be addressed to Ingersoll, Ontario.

MARYLAND RADIO ASSOCIATION. (BALTIMORE, MD.)

The second meeting of this club was held at the Radio School of the Y. M. C. A. here, on the night of January 25.

This club was formed very recently and now has to its credit 26 members.

It was decided at this meeting that all ama-

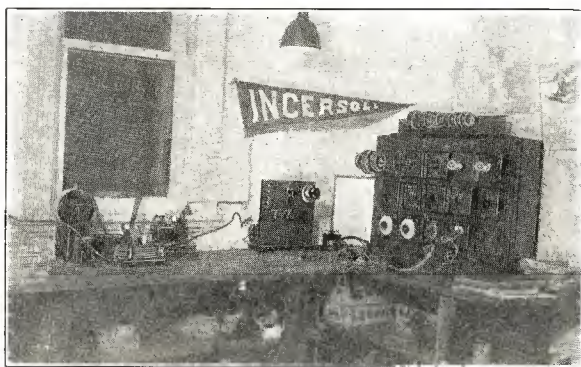

Station 3KG of the Ingersoll Radio Association. Note the Complete Panel Receiving Set and the Radiophone.

teurs should stop operating their transmitters at 10.30 P. M. every night except Saturday, this night being left open until 11.30 P. M.

We also drew cards to form a "Wouf-Hong" to help reduce local QRM. The party who drew the black ballot is to be named the above. Who drew it no one knows, as there were eight who drew the ballots.

As there are several DX stations here doing long distance work, we named two stations as "clearing stations." It is the duty of these stations to keep the ether clear as much as they can during the relay hours. This is to be worked like this: if an amateur hears a local or long distance station calling he must first call the nearest clearing station and ask permission to work it. If the regular DX station is not working at the time then the clearing station gives him the "all clear" signal, then he may go ahead and work the party.

We also decided to affiliate with the American Radio Relay League at this meeting. We had been in touch with the same and only had to sign the papers. When asked if they should be signed it received a hearty welcome.

Our club will hold its meeting the first and last Tuesday of every month, at the same place.

UNIVERSITY HIGH SCHOOL RADIO CLUB.

A special meeting of the club was held on Wednesday evening, January 19, at the home of the president, Russell E. Calhoun. The feature of the meeting was a speech by radiophone, given by Sergeant Tavers, of the Signal Corps Radio School, at the Presidio, San Francisco, 8XW. The speech was received with a single audiotron bulb and with the aid of a loud speaker was amplified

to such an extent that it could be heard very plainly at a distance of 50 or 75 feet. The subject of the speech was the installation and operation of a radiophone. Sergeant Tavers gives regular radiophone concerts on Wednesday evenings, and Sunday mornings and evenings. Many amateurs around San Francisco Bay and distances up to 200 miles listen in regularly to these concerts. The club would like to communicate with other clubs which have tried radiophone speeches.

Also a short talk was given by Justin B. Toles on his experiences as an amateur before the war. An interesting Tesla coil demonstration was given.

This club was formed about six months ago in the University High School, Oakland, Cal. The officers are: President, R. E. Calhoun, 6FZ; secretary, H. R. Greer, 6TI; chief operator and radio engineer, Chas. Wilson, 6LE; honorary treasurer, D. McCay (faculty).

SPRINGFIELD RADIO ASSOCIATION.

Friday and Saturday, January 7 and 8, Assistant Radio Inspector Walter Butterworth was in Springfield. Friday evening Mr. Butterworth addressed the members of the Springfield Radio Association on the government's attitude toward the amateur, radio laws and their interpretation and sharp tuning of transmitters. He also tuned several Springfield stations, including 1UAV, and made suggestions for improving the new 1 K.W. of the S. R. A., which is to go into active operation as soon as a station license is obtained.

Saturday morning, in a room of the Springfield Technical High School, Mr. Butterworth began examinations for amateur first grade licenses. Twenty-five amateurs took the test. Of these, five were from outside points, as Hartford, Westfield, etc. The rest were members of the S. R. A. Results show that many members passed and the club will soon have every member as licensed operator. At present, there are over fifty members. An RA-6 has just been purchased and a radio telephone is well under way.

NORTH SHORE RADIO CLUB OF CHICAGO.

The North Shore Radio Club of Chicago was formed several months ago among the amateurs of Rogers Park and Edgewater. Its purpose was to give the local radio men a chance to come together at a weekly "hamfest" without QRM from the more prominent DX men. Dues are 25c a month. With this money we buy apparatus for the use of the members. We have already bought a wave-meter and are planning to buy other pieces of apparatus. We extend a hearty welcome to all amateurs of this vicinity to attend any of our meetings, which are held Saturday nights at 8 o'clock, at 7460 Sheridan Road, Chicago. We are a local "QRM club" for protection, the motto of which will be "Do unto others as they do unto you."

CEDAR RAPIDS RADIO CLUB.

The Cedar Rapids Radio Club was organized on January 10, with a membership of eight, which to this date has increased to twenty, with the expectation of at least as many more within a short time.

Mr. Wm. Edgar, a member of the A. R. R. L. and a man who is well versed on the wireless subject was elected president. George Christle, an amateur of several years' experience, was elected vice-president. Clarence E. Valliere, also an amateur of several years experience, was elected secretary and treasurer. Mr. C. J. Mikesch, who has had thirty-five years' experience in telegraphy was elected an honorary member.

This club is divided into two classes, seniors and juniors. The seniors are those who are over eighteen years of age and who can transmit and receive at least five words per minute; the juniors are those who are under eighteen years of age and who are interested in the art.

This club will be glad to hear from any other club with a view to exchanging ideas pertaining to wireless and electricity in general.

All those wishing to join this club please address Clarence E. Valliere, 942 18th Ave., West, Cedar Rapids, Iowa.

METEOR RADIO CLUB OF INDIANAPOLIS.

On January 29, 1921, a meeting was held at the home of DeWitt McClurg of this city, at which the Meteor Radio Club was formed. Officers were elected to serve a term of six months. The

(Continued on page 652.)

Radio Digest

SECOND DISTRICT AMATEUR RADIO CONVENTION-EXHIBITION THIS MONTH.

The second district amateur radio convention-exhibition, under auspices of the Executive Radio Council of the second district, will be held March 16, 17, 18 and 19 at the Hotel Pennsylvania in New York City.

Lectures and talks will be given every day by prominent persons in the Radio field and all of the latest equipment will be on exhibition and will be demonstrated. The glass-enclosed roof garden of the hotel will be the exhibit hall and lectures will be given in the adjoining Butterfly Room.

The convention and exhibition will be open every day from 2 p. m. to 10:30 p. m. The first three days will be devoted to business and the last day will be given over to sociability and getting-together. On the night of the nineteenth a banquet will be given for everybody and all radio enthusiasts are urged to be present. The banquet charge will be \$3.00 and 500 can be accommodated. Application for banquet tickets can be sent to Mr. Fred C. W. Thiede, 486 Decatur Street, Brooklyn, N. Y. A season badge, covering the four days, will be sold at the door to all radio operators, engineers and any one identified with radio.

CONCERTS EVERY NIGHT.

Many of the amateurs are enjoying the programs sent out by radiofone every evening from the Westinghouse station (KDKA) in East Pittsburgh, Pa. Music and technical information is broadcasted from 8:30 to 9:30 on a wave-length of 330 meters.

Programs of the same order are radio-foned every Friday evening from 9:00 to 10:00 from NSF at Anacostia, D. C. The wave-length used is 350 meters.

A DIRECTION FINDING THEORY.

By E. J. PILKINGTON.

The following theoretical new idea conceived while working on the new navy radio compass has never actually been tried out by experiment, but it can undoubtedly be the means of entertaining many readers who have an inventive turn of mind and wish to develop it further.

Experiments have already been conducted on rotating copper disks in the earth's magnetic field, but the current generated has been almost negligible, however, enough to be of use in our case. There are places and times when this type of mechanism could be used to advantage.

Fig. 1 shows a rapidly rotating disk at right angles to the lines of force of earth's magnetic field. With disk in this position the current generated will be of a maximum value. If we turn this disk as shown by arrow in a horizontal direction the current will diminish to zero at 90° from original position.

Continued rotating will bring current back to maximum value again (180° from start).

If mounted on the shaft of this rotating element a slip ring with an insulated segment "d" Fig. 2 to interrupt current generated in disk and primary "P" we can from the secondary winding "S" Fig. 2 connect up to an audion three or four step amplifier and make audible in telephone head receivers the intermittent current generated.

It is obvious from diagram that when axis of disk is in the magnetic north and south line we receive a more intense signal than when in any other relative position.

In Fig. 3, with rotating disk 6 and dials 5 and 2 built as a unit to rotate in a horizontal plane in relation to a fixed dial 1, in a fixed position in relation to lubber line of ship A.B., we can as in above explanation determine the N-S line of Fig. 3.

SOUTH AMERICAN TIME SIGNALS.

The International list of Radiotelegraph stations fails to mention the Rio de Janeiro, Brazil (SOH) station sending time at 00:00 and 14:00 (G. M. T., Radio) on 1,900 meters. This station can be received 400 to 600 miles on a crystal detector and with an amplifier it is possible to pick up

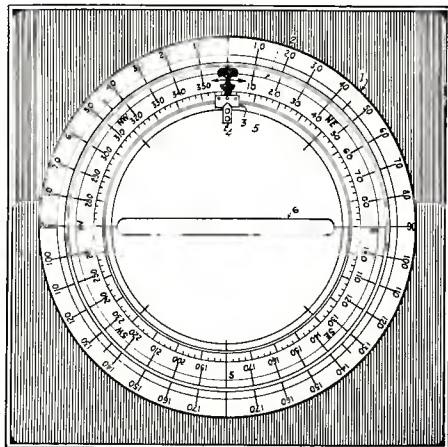

Type of Compass Dial Used With the New Direction Finding Device.

SOH time signals as soon as NAA is normally out of range. This would be likely to occur at the Equator, making it possible for the operator to have a means of checking the ship's chronometer always at the disposal of the ship's master.

The method used is similar to that of the Eiffel Tower. From the 57th to the 58th minute Xs are sent at intervals followed by a group of three dashes of which the last dash marks the 60th second. "N"s are sent

GOVERNMENT CONTROL.

(Extract from a statement by Mr. Owen D. Young, Chairman of the Board of Directors of the Radio Corporation of America, appearing before a sub-committee of the Committee of Interstate Commerce, United States Senate, January 11, 1921, conducting hearings on Senate Bill S. 4301, A Bill to Prevent the Unauthorized Landing of Cables in the United States.)

"I understand that it is proposed that some department of the government, or some commission, either existing or to be created, should assume control of communications, including radio. May I say that, as to radio, I think this would be unfortunate at the present time? The art is so new and the development so uncertain that the control of that development should, for the time being, be in the hands of those responsible for the investment.

"In radio particularly, engineers differ widely as to the best methods of development to pursue. We know that from our own organization. Each man is certain that his own particular notion is the one, and the only one, on which progress can be made.

"If you have a government commission you are bound to have on it the reflection of some opinion, and with the great coercive power of such a commission you are likely to impair the development of the art, because, after all is said and done, a government commission, while it may be useful to control a developed enterprise in the public interest, is not, broadly speaking, useful in aiding the development of an enterprise.

"Therefore, I sincerely hope, for the time being, radio will not be subject as to its development to government control in any form. I say this with the firm conviction that developed agencies of communication are properly subject to government control in the public interest, and when radio reaches the point where it is sufficiently developed so that it may earn returns on the investments made, it will be quite time, in the public interest, in my opinion, to subject it to government control.

"I am advised also that there is considerable controversy as to the appropriate department to control communications. I desire to take this opportunity of saying

that our experience with the Department of Commerce in its administration of the law applicable to radio has been entirely satisfactory. The department has shown the greatest care and competence in dealing with these questions. The Navy has been of assistance to us, and our understanding with the Navy is the better insured because on our invitation, and I understand, with the approval of appropriate authority, Admiral Bullard sits with our board of directors, but not as a member of it, for the purpose of learning what the Radio Corporation is doing or proposes to do, and of advising us, whether, from the standpoint of his department our proposals are satisfactory."

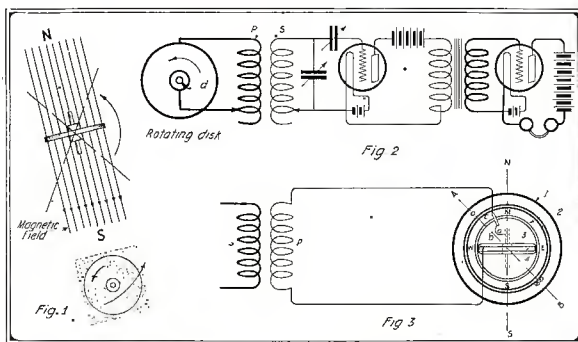

It Would Prove Interesting to Experiment With This New Electro Magnetic Direction Finder Which as Yet Works Only in Theory.

at intervals during the next minute with the three dashes as before. During the last minute "G"s are sent. The last dash of the group of three marks the hour precisely.

The only other South American Atlantic Coast station sending time is Buenos Aires (LIA) on which data will be found in the Berne list.

Neither of these stations send time signals on Sundays or holidays.

CONSOLIDATED RADIO CALL BOOK.

RADIO NEWS has received a copy of the new Call Book. This third edition is greatly enlarged and contains much valuable information for all classes of operators, professionals and amateurs, with the call letters of every station in the world.

With the book is given a colored wireless map of the world which will prove very valuable in every station.

Who's Who in Radio

No. 2

Dr. J. A. FLEMING

JOHAN AMBROSE FLEMING was born at Lancaster on November 29th, 1849, and was the eldest son of the Rev. James Fleming, D.D., and Mrs. Mary Anne Fleming.

He was educated at University College School. At 16 he matriculated in the University of London and then entered University College. In 1870 he obtained the Degree of B.Sc. in the University of London with high distinction, and shortly afterwards was appointed Science Master in Rossall School, Lancashire. Here he remained for two years and then resigned to return to London. For a year he acted as private assistant to Sir Edward Frankland, the eminent chemist, and also as a demonstrator in the Chemical Laboratories of the Science Schools at South Kensington. In 1874, Dr. Fleming was appointed Science Master in the Military Department of Cheltenham College, where he stayed for three years and made his mark as a teacher. In 1877 he resigned this position to enter the University of Cambridge with the object of working under Professor James Clerk Maxwell in the then recently completed Cavendish Laboratory.

He placed his name on the books of St. John's College, Cambridge, having gained there an open entrance Science Scholarship at that college and was made in due course a foundation scholar and also awarded the Hughes and Wright Prizes at college examinations. His college tutor was Dr. Parkinson, his mathematical tutor was Mr. W. H. Besant and he attended the lectures of Professors Maxwell and Stokes.

BEGINS ELECTRICAL WORK.

During the period when he was working for his Cambridge degree he spent much time in the Cavendish Laboratory on a piece of work suggested to him by Professor Clerk Maxwell, viz., the Comparison of the British Association Standards of Electrical Resistance. The B. A. Committee on Electrical Units had constructed certain coils of wire of various alloys which they considered represented in electrical resistance at marked temperatures the value of the ohm or theoretical unit. In course of time these alloys underwent a change and when tested at marked temperatures they no longer agreed in resistance. Hence an uncertainty existed which, if any, of these coils, physically represented the true ohm. Dr. Fleming designed a special form of resistance bridge or balance and determined by careful experiments the variation of resistance of each of these coils with temperature and set off the results in a series of curves. Marking a point on each curve corresponding to the temperature at which that coil was intended to be used, these points were found to differ considerably in their ordinates. The most probable value was then obtained by taking the center of gravity of all these points and thus finding out the temperature at which one of the coils most nearly represented the ohm. Dr. Fleming embodied the results of his work in a large chart. Lord Rayleigh and others subsequently determined the true value in absolute measure of this selected B. A. coil and found that it deviated considerably from the theoretical ohm of a thousand million centimeters per second.

In 1879, Dr. Fleming gained by examination the degree of D.Sc. in the University of London and shortly afterwards the Cambridge B.A. degree with first class honors in the Natural Science Tripos.

ASSISTS IN ORGANIZING LABORATORY.

After graduation he was appointed by Professor James Stuart, Lecturer on Applied Mechanics in the University and assisted Professor Stuart in organizing the then newly established Engineering Laboratory at Cambridge.

In 1881, Dr. Fleming was appointed the first Professor of Mathematics and Physics in University College, Nottingham.

APPOINTED ELECTRICIAN FOR EDISON CO.

In 1882, domestic electric lighting on a large scale began to be developed in England owing to the invention and perfection

meeting of the society on "The Contact Theory of the Galvanic Cell."

GIVEN CHAIR AT UNIVERSITY COLLEGE.

In 1884 the Council of University College, London, decided to establish a Professorship of Electrical Engineering and Dr. Fleming was requested to give a course of lectures on the subject and in 1885 was appointed the first occupant of the newly established Chair which he still holds.

Between the years 1885 and 1890 his attention was much taken up with scientific problems connected with the incandescence electric lamp and with the questions connected with patent litigation on the carbon filament lamp.

Outside of University College, he soon became widely known as a teacher possessor of unusual powers of lucid exposition on difficult scientific subjects and in consequence his invitations to lecture were very numerous.

GIVES MANY LECTURES.

At the Royal Institution of Great Britain he gave in the course of 30 years about 50 lectures, including eight Friday evening discourses, three courses of Christmas lectures, and 24 afternoon lectures, including four courses of Tyndall lectures. At the Royal Society of Arts he gave seven courses of Cantor lectures, in all 27 lectures, and two other evening lectures. Before the British Association he lectured twice, at Liverpool giving the popular lecture on "The Earth a Great Magnet," and at Dover in 1899, he gave the evening lecture on "The Centenary of the Electric Current" to a very large audience.

He was for many years a Gilchrist lecturer and addressed large popular audiences in many towns. In all about 100 or 120 such public lectures were given by him in the course of 25 years in all parts of England, always commanding large and interested audiences. In these lectures he made a specialty of telling experimental illustrations in which he was very successful. His wide and thoroly practical knowledge of electrical physics and electrical engineering caused his advice to be sought by many electrical firms and corporations.

In 1879 he acted as electrical adviser to the Edison Telephone Company and gave assistance in the legal contest with the General Post Office. In addition to acting for the Edison and Swan United Electric Light Company as their adviser in scientific and patent questions from 1883 to 1893, he also assisted the London Electric Supply Corporation and the City of London Electric Lighting Company in a similar capacity and advised the Corporations of Taunton, Exeter, Plymouth, Douglas, and Peterborough on their electric lighting installations.

When wireless telegraphy by electromagnetic waves was made a practical success by Senator Marconi, Dr. Fleming was engaged as scientific adviser to Marconi's Wireless Telegraph Company and assisted in designing the arrangements for the first high power radio-station at Poldhu in Cornwall, for the early transatlantic radio telegraphy.

INVENTION OF THE THERMIONIC VALVE.

One of his principal contributions to practical advances in connection with wireless

(Continued on page 660)



Dr. J. A. Fleming, Who Discovered the Rectifying Properties of the Two Electrode Valve.

of the incandescence electric lamp by Edison and Swan. The Edison Electric Light Company was formed in London to operate Mr. Edison's inventions and especially his system of public electric supply from central stations. Dr. Fleming was appointed electrician to the new company and in consequence he resigned his professorship at Nottingham.

In 1884, the Edison and Swan interests united, and Dr. Fleming was retained in the position of Scientific Electrical Adviser to the United Companies.

In 1882, he was elected a Fellow of St. John's College, Cambridge, and shortly afterwards a Fellow of University College, London, and a member of the Institution of Electrical Engineers. He was one of the original members of the Physical Society of London and when that society was founded in 1874 by the late Professor Frederick Guthrie, Dr. Fleming was invited by him to read the first paper at the inaugural



A Complete Radio Telefone Set

By FREDERICK J. RUMFORD, E. E.

NO doubt many are puzzled at their failure to receive radio telephone messages. One reason for this is that the average radio telephone station, experimenting along these lines, uses one or more vacuum tubes on oscillating circuits, with a wave-length considerably below 200 meters.

The writer has been carrying on experiments along the lines of radio telephony for a considerable length of time and has obtained successful results with the outfit described in this article. It has proved to be a very interesting subject, and it is our opinion that all "radio bugs" who care to delve still further into this subject will find it so.

I have designed the described outfit for the use of the amateur who is handicapped in his experimenting by a shortage of the "hard cash." Like everything else, it costs to have a "hobby," especially one like wireless, providing one buys his outfit all made up.

The amateur, in order to try experiments along this line, should have, primarily, a vacuum tube, either an audiotron or a Marconi V.T. The next item necessary is the "B" battery for the plate, which must have a potentiality of not less than 150 volts. The experimenter can use nine or ten of the 22-volt unit batteries, but a still better way would be to use between 40 and 50 small flashlight batteries. My reason for suggesting the use of these is that when one of these batteries is burnt out or is low, it can be readily replaced, whereas if the unit batteries are used, and one of the cells should get low or "go dead," it cripples the rest of the unit.

Those of us who are fortunate enough to possess a motor-generator outfit will obtain the best results for the plate voltage, of course. Some motor generators delivering 275 volts may be had for about 45 dollars, but it is not absolutely necessary for one to have a motor-generator outfit, altho in the long run an investment of this nature proves to be the least expensive.

OUTFIT IS COMPLETE RECEIVING SET.

The necessary articles for the making of the outfit may be found in the average radio fan's workshop. As will be seen by the accompanying cut, this outfit can be used for the transmission of radio telegraph and telephone messages, the telegraph messages being made possible by the insertion of an ordinary telegraph key in the ground lead; also, this outfit comprises a complete receiving set for either radio telephone or telegraph messages of continuous wave.

Conductive coupling is used between the antenna and the tube circuits shown, as I have found that I have been able to obtain better results by the use of radio telephone circuits of this nature.

With this circuit the amount of energy

transmitted to the antenna is much greater than by using a loose coupler arrangement. The results obtained are sharp enough to cause interference of no value.

It is a good idea for the experimenter to pay particular attention to the making up of the variable inductance coil, especially the mounting of the sliding rod and sliders.

CONSTRUCTION OF THE PANEL.

Fig. 1 represents the general layout of the front view of the panel; dimensions are shown by the dot and dash lines; correct positions of the various articles and apparatus are shown by the dotted lines.

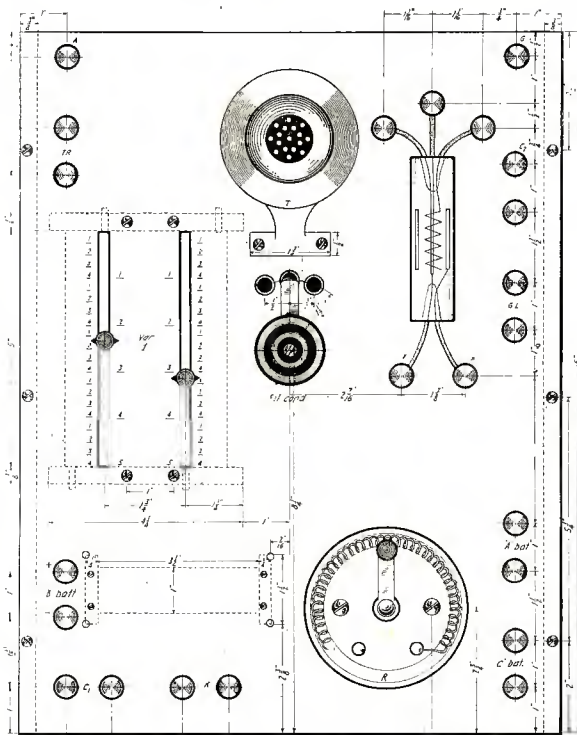

Dimensions and General Layout of the Panel on Which All the Elements of the Radiophone are Placed.

There is a wire from the positive side of the "B" battery to which a clip is attached that is used for the changing of the plate voltage. This clip can be connected to any battery of the "B" battery unit at will. This wire will run to whatever place the builder may have his "B" batteries located A, represents aerial; G, ground; K, key; C1 and C2, variable condensers; G. L., grid leak of 10,000 ohms; R, rheostat; A. B. C., batteries; Var. I., variable inductance; SK, slider knobs; T, transmitter; T. R., telephone receivers; R. C., repeater or induction coil; P, primary; S, secondary; Fil. Con., filament control switch.

Fig. 2 shows the general wiring diagram of the whole outfit connected up ready for use, including external hook-ups.

Fig. 3 shows the mounting of the variable inductance on the back of panel with

the position of sliders, etc., also, the mounting of the repeating or telephone induction coil.

Fig. 4 shows one of the sliders, the arrows indicating the different parts of its make-up and the method of the winding of the string and wire side by side.

The panel may be of bakelite, rubber or oak. In this instance oak was used, as it may be obtained cheaper than the others.

The dimensions of the panel are 15" high, 11 3/4" wide, and 3/8" thick.

After drilling holes the panel should be sandpapered to a smooth finish, then painted or varnished. Dull black paint was used on the panel described. Before painting be sure and have two elongated holes cut in the panel 5" long and 1/4" wide. These holes are for moving the sliders from the outside of the panel.

You should have your panel engraved, as shown in Fig. 1, so that you will be able to keep tabs on the different stations the pointer shows. This should be done before the panel is painted. The writer has his marked off into 1/4" indications on the front of the panel.

MOUNTING APPARATA ON PANEL

After the panel has dried, the next step is to mount the different articles and apparatus. It is advisable to mount the panel or brackets, as shown in Fig. 3, as by doing so it will leave the wiring easier for various changes of the different hook-ups. The form on which the variable inductance is wound can be either bakelite, mica, cardboard, or rubber. Cardboard has been used on the outfit described. Before the winding is started it is best to give the form a good coat of an insulating compound, such as shellac or melted paraffine. After this is thoroughly dry, the tube is then ready to have the wire wound on it. The tube is 3 1/2" in diameter and 5" long with a wall 3/8" thick.

The string should be No. 30 gauge and about 100 feet should be purchased. Then take a bar of paraffine, melt it in a deep pan and dip the whole length of string into it, letting it stand for about fifteen minutes. Take the string out of the paraffine and let it dry for about ten minutes. The string is now ready to wind on the form along with the wire. The wire used is No. 23 D.C.C. magnet wire. There will be 03 turns in all and about 90 feet of this wire will be needed. The coil should be wound so as to have a turn of the string between each turn of the wire and so on until the coil is wound. You should then take a very sharp knife and peel the wire back the whole length of the coil on both sides to allow for the moving of the slider contacts. Great care should be taken and one should be very careful that he does not cut into the wire, as by doing so he would cause an open circuit in the coil.

MAKING SLIDER ATTACHMENT

For the slider attachment 10" of 1/4" brass rod (square) should be purchased and cut in two. Drill on each end of these rods with a very small drill, and then tap. Two small sliders can be obtained at almost any wireless supply house at very little cost, and they must be fitted with longer knob rods and pointer affix so as to indicate the different positions of the sliders. They should then be placed on the slider rods with their contact surfaces facing each other. Two pieces of pine wood 5" long, 4 1/4" wide and 3/8" thick should be obtained and two holes drilled in each one of the pieces, so as to allow two threaded rods to pass thru, having nuts on the inside and the outside for the two rods at each end. These rods should be placed so they will come in the center of the coil.

To assemble the complete variable inductance, take the slider rods and have them screwed to the two wooden pieces, then have your center rods drawn up tight and the nuts tightened. By so doing you will have the coil held firmly between the two wooden pieces. To mount the coil on the back of the panel it is necessary to have four screws work in from the front. These screws will screw into the wooden pieces that hold the coil between them and will hold it on the back of the panel.

The bracket should be made up of 3/8" angle irons and have a good coat of black paint applied to it. All wood and machine screws used on this outfit are of brass or copper. If one wishes to shellac the windings of the variable inductance, he should use very little shellac, because it forms an imperfect dielectric, causing energy losses. The three contacts used for the filament control switch are 1" long with a head 1/8" long and 1/4" in diameter, of either copper or brass. The switch knob is 1 3/8" in diameter and swings within a radius of 1 1/2". The switch blade is either of copper or brass and the switch knobs are of a composition of rubber.

SOLDER ALL CONNECTIONS.

It is advisable to use ridged wiring on the back of the panel, because there is less chance of its getting broken and it is easily accessible for any different changes of wiring or hook-ups.

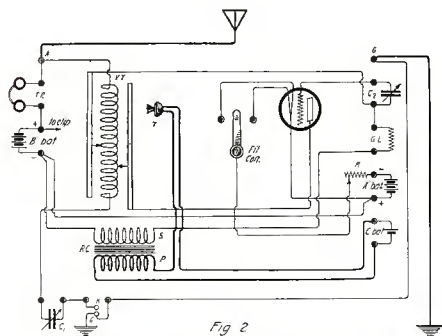

Diagram of Connections for the Simple Radio-telephone Circuit Using Only One Tube for Transmitting and Receiving.

ing or hook-ups. It is better to solder all connections wherever it is possible, as all possible chances of energy losses will be eliminated, and a connection of this kind is more staple and lasting. The writer has tried all tubes and found that the double filament audiotron is best suited for use in this particular instance.

In Fig. 1 the B.C. repeater coil can be an ordinary telephone with a one to three ratio between the primary and the secondary windings. A telephone induction coil will work very nicely or most any high resistance coil with a soft iron core center, having a primary and secondary winding with the above given ratio. A one-inch spark coil which has been used has proved very good. The coil described in this article is one that was purchased from the Electre Importing Company of New York City.

The transmitter was also purchased from them. Most any carbon grain transmitter or microphone will do the trick, but the writer wishes to caution the experimenter in regard to using telephone receivers. As will be seen in Fig. 2, the telephone receivers are in series with the "B" battery, and, therefore, the amateur should not use telephone receivers under 2,000 ohms resistance. If he does, he is apt to burn them out, and with receivers at the price they are, you can't very well afford to do such a thing. It is better to use fones of 3,000 ohms resistance. The writer would also warn the amateur to shunt a jumper or a piece of wire across the binding posts marked K, keu, when not using the outfit to transmit radio telegraph messages. When using the outfit to receive, by means of the clip that is connected to the "B" battery binding post on the positive side, the voltage can be cut down to 30 or 40 volts. By the above means different and various voltages can be obtained at will.

In the making of the grid leak, a piece of paper, preferably stiff drawing paper, should be pasted onto a piece of wood, and a line drawn with ink about 6" long. Have the line fairly thick, then drill a hole and insert a binding post at each end of the line and then shunt it across G.L. on Figs. 1 and 2. It should be about 10,000 or 12,000 ohms resistance.

BATTERIES AND AERIAL.

The "A" battery used with this outfit was a 6-volt 60-ampere storage battery and the "B" battery is made up of fifty No. 703 Eveready flashlight batteries all wired in series. The "C" battery may be two ordinary dry cells giving a volt and a half apiece. This battery connects with the repeater coil and the transmitter. The natural period of the aerial should not be over 140 or 150 meters in length. The writer has used an aerial 65 feet long of two wires. The rheostat used for the filament with this outfit has a resistance of 15 ohms. It is also advisable to shunt the "B" battery with either a fixt or variable condenser of .001 capacitance. The binding posts can be either copper or brass, whichever is preferred. It is advisable to have a screw

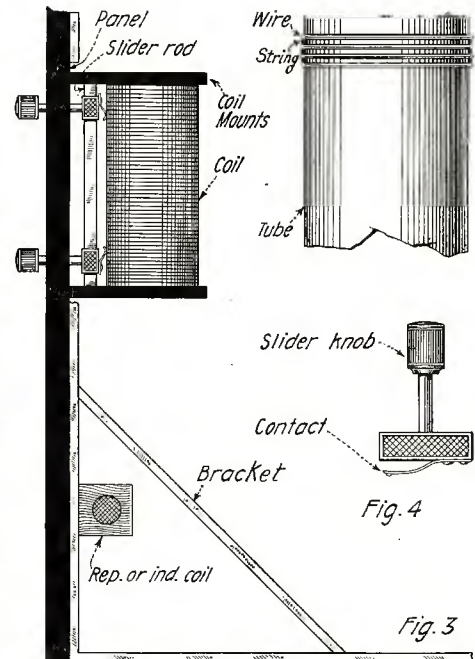

Side View of the Panel Showing How the Inductance is Fixed and Details of the Slider and Winding. Note the String Placed Between Each Turn of Wire.

about 2" long and 1/8" in diameter. Use plain brass washers. There are 23 binding posts. Of course, the experimenter who has a two-slider tuning coil can use it, but the writer thinks it is best to make up a complete new one like the one described in this article. The two variable condensers used with this outfit, C1 and C2, are shunted across the posts marked C1 and C2 should have a capacitance of .0005 mfd. In regard to the selection of the telegraph key, I would advise getting one with a circuit closing switch. If the diagrams and the descriptions are worked out carefully, the constructor will be more than pleased with the results obtained. The diagrams are self-explanatory, and if closely followed will enable the experimenter to build up this outfit correctly.

Different experiments have been tried in connection with this outfit such as the following: connecting this circuit with a loop which brot very good results; connecting a loading coil that has been wound with bigger wire in series with the aerial and the variable inductance. This last connection will increase the wave-length of the transmitting outfit. In the course of his experimentation one will come across a number of good circuits which will prove of great value to this outfit.

It is advisable for the experimenter, when using high voltage for the plate on the audiotron, to connect his different voltages in gradually so as not to burn out his tube, and the tube used should be one that has been tested out to its highest efficiency, otherwise you are apt to encounter difficulties.

Transmitting Condenser

HAVING quite a few old phonograph records at home I proceeded to make a condenser for transmitting as follows:

Select the best records, that is the ones that are not warped very badly. If you find most of the records warped (as many of them will get in that condition lying around) place a record between two heavy sheets of glass, plate glass being the best, heat the glass slightly and let cool. The record will come out flat.

Coat every other record with tinfoil from about an inch from the edge and covering the hole in the center. Take the remaining records and coat with tinfoil from an inch from the edge to within an inch of the hole in the center. Place a small lug at the outer edge of the latter plates, projecting about one inch and making connection with the tinfoil.

Assemble the plates, alternating each kind. Then place a long machine screw

thru the center hole making connections with every other plate. This bolt will do three things: First, bind plates together; second, make one terminal of the condenser; third, serve to bolt condenser to the table, wall etc., thru a piece of insulating material such as bakelite or hard rubber. Connect the outside lugs together with a machine screw and nut for the terminal.

Contributed by
ROBERT EUCHENHOFER.

A Vacuum Tube Control Cabinet

By LEE M. HARTWELL, Jr.

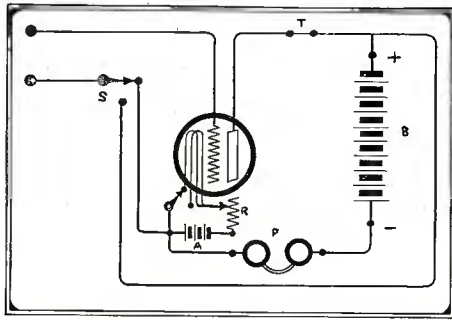

Hook-up of the Control Cabinet. Note the Switch S Making the Connection for the Ultra-Audion Circuit.

AFTER giving several designs of tube controls the "once over" and not seeing anything which I thought suitable or good enough to answer the purpose, the following requirements for a good tube-control cabinet were set down, and the instrument constructed in accordance with these ideas:

First—Ease and centralization of control. That is to say, the controls must be all in one place where they can be easily and quickly reached and must be easy to operate.

Second—Flexibility. Change from one hook-up to another must be made quickly. As the audiotron was used, provision should be made for a rapid change from one filament to the other.

Third—Provision must be made for experiment. Experimental hook-ups should be easily made without tearing up any inside wiring.

Fourth—Appearance. The instrument should be neat and well designed. With these requirements in mind, the instrument was designed and constructed. It has given such efficient and reliable service, and our august editor has been sending out such howls, CQ's, SOS's and QST's, etc., about the dearth of suitable articles on radio construction, that it was decided to divulge this information.

The panel is the first part to be considered. Mounted on its face, it has the rheostat control knob, the binding posts for the tube connections, the grid circuit, the 6-volt battery, the 40-volt battery, the fones, a break-in-the-plate circuit for a tickler and a condenser across the fones. The binding-posts are merely 8/32 machine screws held onto the panel by means of hexagonal brass nuts and capped with a little black composition knob. The power binding-posts have slightly larger knobs than the others, in order to distinguish them.

The two-point switches are provided, for changing the filaments and audion and ultra-audion circuits.

The panel is of 1/8-inch hard rubber. The exact size is not given, as the experimenter will, and should have, certain original ideas concerning the appropriate size of the panel. Also, tubes, rheostats and switches may differ in size. A small walnut cabinet was constructed to fit the panel and finish with shellac and oil.

A back-mounted rheostat was employed, and, as the two switches were of the De Forest type, a knob was obtained to match. A general idea of the placing is given in order that the constructor may work out his own ideas.

The wiring is the most important part. See that all connections are soldered and shellacked to prevent oxidation, and later, when assembled, that all nuts are tight. "Bus" wiring is the only kind to be considered. All wiring was done with No. 12 enameled solid wire. Stranded wire is better, if you can get it. Bends should be made at right angles, and the grid circuit should be kept as far as possible from the plate circuit. Be sure to use solder wherever you can, because it is the loose connections that

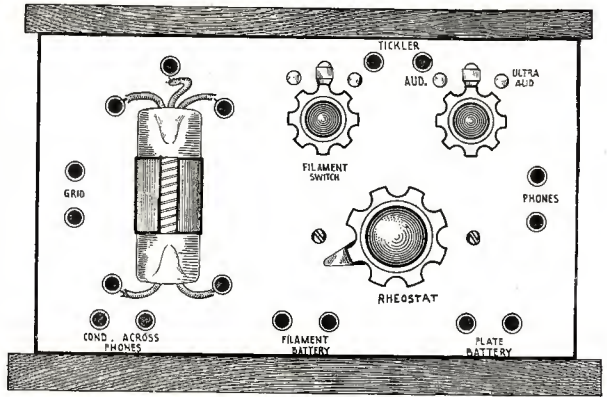

Front View of the Audion Control Cabinet in Connection With Which Any Circuit May Be Used.

make a jazz band out of an otherwise well-behaved audion hook-up. Also, it is the solidly connected set that makes the weak ones "come in" in a readable condition. That is the time when careful, painstaking construction will bring 'em in, while slipshod makeshifts keep 'em out.

Well-designed, mechanically perfect instruments (electrically perfect is understood) are the only things to be considered by anyone who has the slightest glimmering of intelligence. When an emergency arises, you want to be absolutely certain that your instruments are as near perfect as you can make them, and will rise to the occasion.

When using the ultra-audion hook-up a small variable condenser should be shunted across the fones. The capacity is lessened until the point is reached where the tube oscillates. Just before this point is the most sensitive point, where the feed-back amplifies, but does not make the tube oscillate.

The main idea is to give the constructor an idea to work out, without leaving too much to his imagination.

Switch for Back of Panel Mounting

By THOS. W. BENSON

THE ideal radio set is one in which all variable factors are controlled by knobs, no live parts being in evidence on the front of the panel. Where the design calls for the use of multipoint switches the usual form of such switches make them unsuitable for back of panel mounting.

In order to provide a multipoint switch that could be mounted back of the panel and be positive in action the switch described and illustrated herewith was devised. Its construction is somewhat cheaper than switches employing machine contacts, eliminates entirely the possibility of shorting the contacts and assures the centering of the switch blade on the contacts.

The simplest form of this switch is shown in Fig. 1. The contacts consist of a number of small clips cut from strip copper or brass and bent to the shape shown. These contacts or clips are fitted over a strip of fibre that has been clamped in a vise and one edge filed into a wave shape, the clips resting in the hollows of the waves. The fibre strip is then bent into a semicircle of the proper radius and held there by attaching screws or bolts thru holes in the ends of the clips. Any number of contacts may be used and "off" points readily provided.

The switch blade is made from a strip of spring brass soldered to a disk of metal

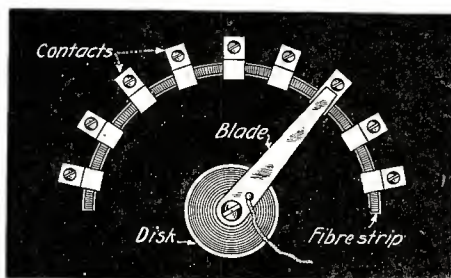

View of switch from back of panel when mounted.

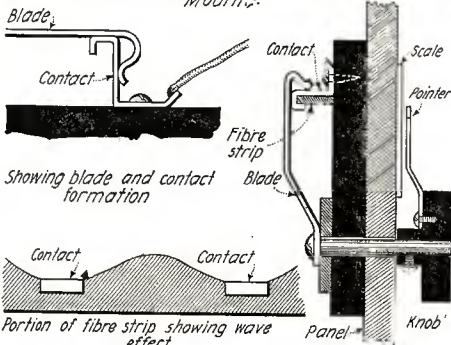

With This System of Switch, a Needle or Dial May Be Used on the Front of the Panel and the Contacts Are Better Than With the Ordinary Type of Switch.

attached to the pivot. The most satisfactory method of making connection to the blade is to solder a length of flexible wire to the disk and not to rely on sliding contacts. The end of the switch blade is bent as shown in the illustration to give a good bearing surface on the stationary contacts. The sides of the blade are slightly curved to permit it to ride easily over the high spots on the fibre strip.

The base supporting the switch parts can be attached to the rear of the apparatus panel by two screws that serve to hold a scale. The shaft protruding thru the front to take the knob used for operating the switch. Connections are made to the stationary contacts by soldering leads to bent up ends.

It will be apparent that this switch overcomes all the defects usually found in concealed multipoint switches. The operator can feel the switch blade snap into place on each contact and is assured that it is always centered.

With slight modifications this form of switch can be adapted to meet various requirements. Where the simultaneous control of two circuits is required, two blades mounted on an insulating block and playing over two oppositely arranged sets of contacts will meet the situation.

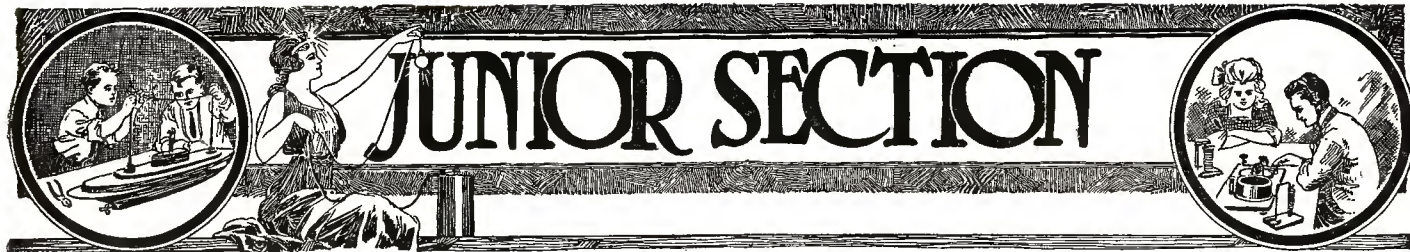

Junior Radio Course

Regenerative Amplification and Heterodyne Reception

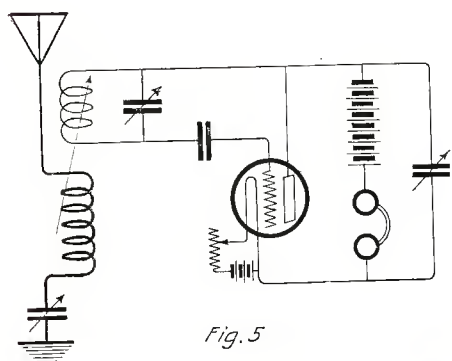

Fig. 5
This Utradion Circuit Uses Capacity Instead of Inductive Coupling Between the Plate and Filament.

REGENERATIVE AMPLIFICATION.

It has been shown by Mr. E. H. Armstrong that amplification similar to that obtained with several stages may be secured with a single tube. Instead of feeding the voltage of the secondary of a transformer into the grid circuit of a second tube used as amplifier it is fed back into the grid circuit of the Detector tube so as to increase the voltage operating upon the grid. This results in an increased amplitude of the plate-current alternations, which likewise being fed back into the grid circuit increases the voltage operating upon the grid.

One form of the so-called feed-back circuit for rectifying and amplifying damp oscillations is shown in Fig. 1. The operation of the circuit, used as a receiving device, is the same as that described in a previous lesson for the case of a condenser in the grid lead. The condenser C₂ is merely to provide a path of low impedance across the fones for the high frequency oscillations. The coils P and S constitute the feed-back by means of which the oscillations in the tuned circuit are reinforced. The mutual inductance between S and P must be of the proper sign so that the e.m.f. fed back aids the oscillations instead of opposing them.

GENERATION OF OSCILLATIONS.

If the coupling between the coils P and

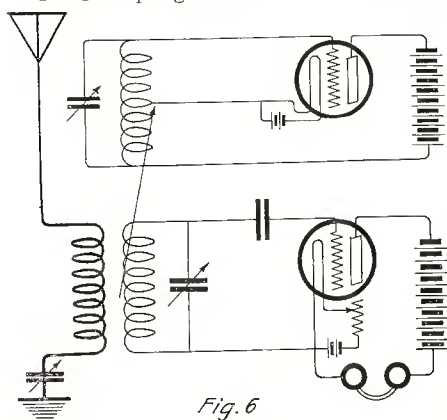

Fig. 6
How Beats are Produced by the Use of a Separate Heterodyne Which Acts as a Small Transmitter Closely Coupled to the Receiver.

S in Fig. 1 is continuously increased and the values of L, S and C and the resistance of this circuit are suitable within certain limits, the e.m.f. fed back by the coil P into the oscillatory circuit at any instant will become greater than that required to just sustain the oscillations in the circuit. In this case any oscillation, however small in the circuit L, S, C, will be continuously built up in amplitude until a limit determined by the characteristics of tube and circuits is reached. In other words, the tube self-generates alternating current of a frequency determined by the natural frequency of the oscillatory circuit, as explained in the last lesson, making possible the reception of undamp waves by the beat method.

RECEPTION OF UNDAUGHT OSCILLATIONS.

If two sources, which separately furnish undamp oscillations of, say 100,000 and 101,000 frequency, as shown in (a) and (b) of Fig. 2, act together upon the same cir-

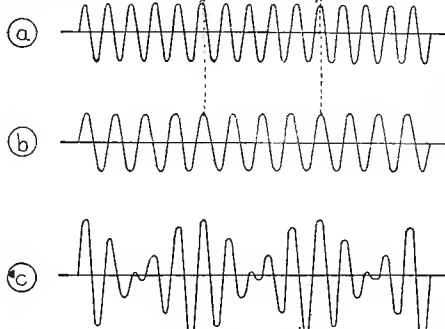

Fig. 2. This Diagram Shows Clearly How Beats Are Produced in the Auto or Heterodyne Reception.

cuit, the resultant oscillations in the circuit, obtained by adding the components, will be of the form shown in (c). The amplitude of the combined oscillations will rise and fall, becoming a maximum when the component oscillations are in phase, point x, Fig. 2, and a minimum when they are 180 degrees out of phase. The beats of periodic rise and fall in amplitude occur at a rate equal to the difference in frequencies of the two oscillations. Thus, the beat frequency in the case assumed above would be 101,000 - 100,000 = 1,000 per second. If rectified, these beats will produce a note in a telephone of like frequency. In the reception of undamp signals by this method, called the heterodyne method, the incoming signals represent one component oscillation. The other oscillation is generated in the receiving apparatus and both act in the same circuit. The rectified resultant furnishes a musical note in the fones, the pitch of which can readily be altered by varying the frequency of the local source of oscillations.

The vacuum tube may serve as a convenient source of local oscillations and at the same time as an amplifier and detector of the received signals. This is called the autodyne method. Numerous circuits may be utilized to produce these results, of which that shown in Fig. 1 may serve as an

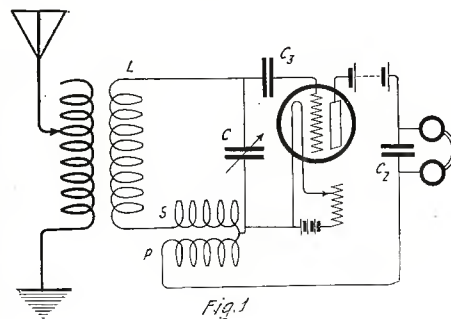

Fig. 1
The Typical Armstrong Feed Back Circuit. Better Known Among the Amateurs as the Regenerative Circuit.

illustration. Incoming signals set up oscillations in the antenna. By means of the coupling between the antenna and coil L oscillations of the same frequency are set up in the circuit LC, and as explained above are amplified on account of the feed-back between S and P. Further, the coupling between S and P is such that the tube oscillates, the frequency of these oscillations depending largely upon the constants of the circuit LC. If this latter frequency is adjusted to be slightly different from that of the incoming oscillations, beats will result and the potential of the grid will follow the beat oscillations.

Just as explained in a previous lesson, in the case of reception with a grid condenser, there will be an increased flow of negative electricity from the filament to the grid when this latter is positive and its mean potential will be lowered. Thus, as the oscillations in the beat are increasing the potential of the grid will become lower. The plate current will follow the variations in potential of the grid, reproducing the beat oscillations and decreasing in mean

(Continued on page 623)

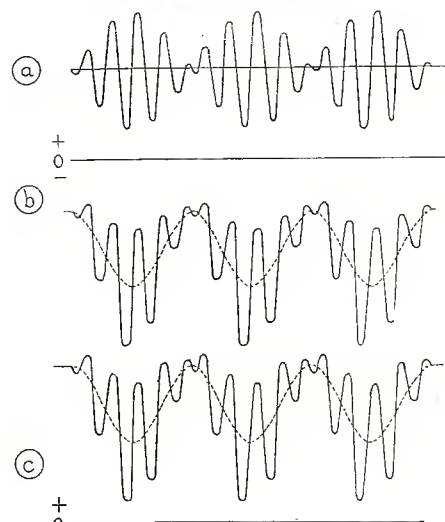
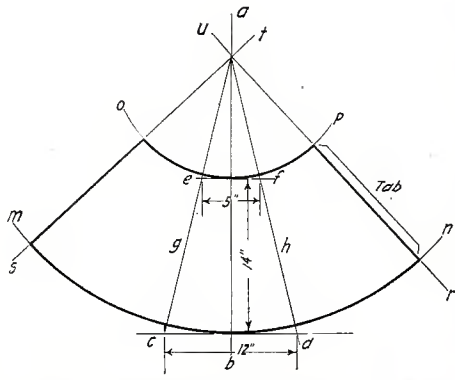

Fig. 4. Curves Showing How the Beats Obtained Are Detected. In A the Beats Are in the Secondary Circuit; B is the Grid Potential and C the Plate Current. The Dotted Lines Show the Mean Current.

Junior Constructor



With This Sketch it is Very Simple to Make Cones of Any Desired Dimension Without Wasting Pounds of Paper.

AN ACCURATE CONE.

Every experimenter has at one time or other encountered the need for conical lamp shades, conical tubes for the secondaries of high frequency resonators, tuning coils, loud speaking horns, etc. The average "ham" would take a piece of paper, roll it into some shape, approximating that which he wanted, then clip off the corners and there was a "perfect" cone.

The process I am about to describe will enable one to make an accurate cone to predetermined dimensions.

Take a piece of paper of adequate size, and draw the vertical line a-b thru the center. Now suppose we want a cone 12" diameter at the bottom. Draw the line c-d, 12 inches long, at right angles to a-b and with a-b as its center. Our cone will be say 14" high and 5" diameter at the top. Measure up 14" from the intersection of the lines a-b and c-d, and draw the line e-f, 5" long. Draw the diagonal line g, touching the tips of the lines c and e, and ending at the line a-b. Draw a similar line h touching points d and f.

We now have a triangle, the apex, x, being formed by the intersection of the diagonal lines g and h. Now take a large compass (the pencil, pin and string variety will do fine), place the point on x and adjust the compass until the pencil point touches the intersection of the lines a-b and c-d, describe an arc of about 90°, m-n. Leaving the point on x, describe another 90° arc, o-p, touching the point of intersection of the lines a-b and e-f. Draw line s-t through x to a point on m. Draw the line u-v at right angles to s-t. Leave an overlap tab on one end and then it is ready to be cut out. This method may appear quite hard to the uninitiated, but it is really quite simple and very accurate.

Contributed by KENNETH SWEZEY.

FIXT-VARIABLE CONDENSER.

Where a large variable capacitance is required, larger than that afforded by the standard 43-plate variable condenser, use is made of the fixt-variable condenser, a condenser made up of several small fixt condensers with a suitable switching arrangement which will enable the operator to connect as many of these small condensers in parallel as is required, thus varying the capacitance in steps. A gradual variation of capacitance between the steps is sometimes required, in which case a standard variable condenser is shunted across the fixt-variable condenser.

The usual switching arrangement in which a number of switch points are connected together by means of a pie-shaped contact blade, is rather unsightly and cumbersome, and in the following method, is superseded by a commutator switching ar-

rangement, as shown in Figs. 1 and 2. This unique method insures a smooth running instrument, and in addition presents an attractive appearance when incorporated on a panel with other instruments.

With the aid of the drawings, little difficulty should be experienced in constructing the instrument, altho a few words may not be amiss. The method of switching in the desired number of condenser units is clearly shown in Fig. 2. At the position shown, with the pointer at the extreme right, all the condenser units are in use; that is, the capacity is maximum. By turning the commutator counter clock-wise the units are disconnected, one by one, from the stranded lamp cord and binding post A. With the pointer at the extreme left, all the units are disconnected; hence, the capacity is zero. Any small commutator can be used, preferably one having a large number of segments, such as those used on direct current fan motors.

The stranded lamp cord, held taut by the spring, rubs on the commutator as it is turned. The spring is insulated from the binding post B. The tension of the spring, together with the rubbing of the cable, insures a clean electrical contact having a minimum resistance. A brass clip, large enough to fit snugly over the condenser units, is fastened to the commutator, as shown in Fig. 1. This allows the condenser to be turned with the commutator, preventing the use of flexible connectors from the condenser units to the commutator segments. One flexible connector, however, is required for connecting one side of the condenser units to the binding post B.

The condenser units may consist of two or more tinfoil sheets separated by mica or paraffine paper sheets. They should be securely bound together with insulating tape to prevent any possible mechanical injury or short circuits. For obvious reasons the size and number of units employed is left to the discretion of the builder.

With this type of condenser, a wide range of gradations can be covered, with limits bounded only by the size of units and fineness of the commutator employed.

Contributed by CLYDE J. FITCH.

HOO-K-UP FOR INDUCTION COILS.

I have reasons to believe that many of you amateurs have several old spark coils lying around that are not being used for anything, and no doubt most of them were discarded because their vibrators were out of order or were burnt out. However, if you have one good spark coil (that is, one with a good vibrator), you can make use of

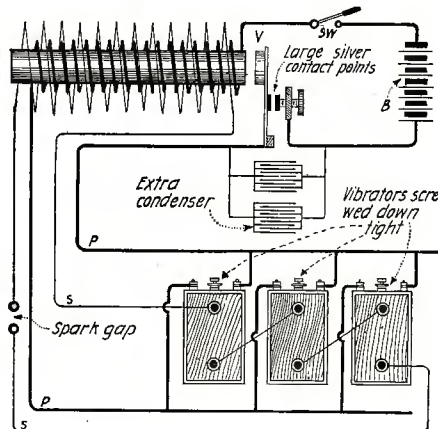

Bugs! Why Not Use Your Old Ford Coils This Way and Obtain More Juice?

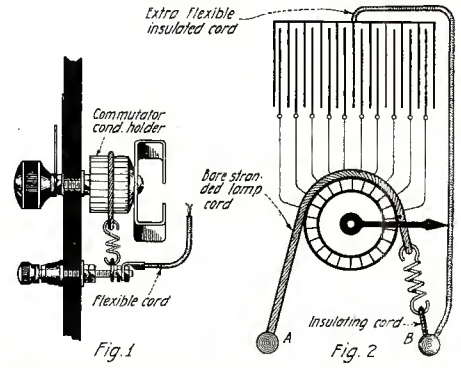

With an Old Motor Commutator You Can Make a Fine Variable, Boys. Look Here and See How Simple It Is.

old spark coils providing their primaries and secondaries are not damaged in any way. It makes no difference whether they have vibrators or not, as the vibrators are not used, but the primary condensers, however, may be employed to advantage.

We know that if we connect two or more spark coils in series or in parallel with each other to a battery, the vibrators will not work in unison, or, in other words, they do not vibrate in synchronism, and consequently oppose each other more or less. By using one vibrator to interrupt the current thru all of the primaries of the induction coils at the same instant it will readily be seen that the induced e.m.f.'s of the secondaries will reach their maximum e.m.f.'s at the same instant, and by connecting the secondary terminals in series with each other, the induced voltage will equal the sum of the individual maximum voltages of each induction coil.

The silver contact points on the vibrator coil should be extra large in order to be able to carry the heavy current. Extra condensers should be shunted across the contact points to eliminate sparking. The coils should all be of the same capacity and have the same voltage output in order to give good results; however, different size spark coils can be used by connecting them in such a manner that their combined voltages equal the line voltage, or they can be connected so that their combined voltages when connected in series equal the voltage of one large coil.

For example, say that you have two 1/2-inch coils and two 1-inch coils (the best coil being used as the vibrator coil, of course) and you wish to connect the two 1/2-inch coils so that their secondaries will not be subjected to the voltage strain of the 1-inch coils.

In order to do this you must connect the secondaries of the two 1/2-inch coils in series with each other, and if all the coils are connected in series with the main line circuit the voltage, as explained before, will be the sum of the voltage of each coil. If the two 1-inch coils are connected in parallel, the two 1/2-inch coils must be connected in series with each other and their outside terminals shunted across the main line circuit.

In this case the voltage would not be the sum of the voltages of each coil, but would be the voltage of any one of the large units, but the current would be three times as strong as the current was when the coils were connected in series.

This system does not compare with using an electrolytic interrupter, of course, but can be used in case of emergency or in case you cannot afford to buy an electrolytic interrupter at the present time.

Contributed by

FORREST R. KINGMAN.



LOUD TALKER.

(168) Mr. George Hunter, Jr., of St. Johns, Michigan, asks the following questions:

Q. 1. Please tell me how to construct a loud talker.

A. 1. You will find on page 211 of the October, 1920, issue of RADIO NEWS, complete data for the construction of a loud talker.

Q. 2. Could I use two spark coils at once in transmitting?

A. 2. Yes, by connecting the secondaries in parallel and the primaries in series and blocking one of the vibrators. In this case the voltage should be doubled.

Q. 3. Does shellac or varnish affect the efficiency or sensitiveness of a loose coupler when put on the windings?

A. 3. No, on the contrary it protects it.

ARC GENERATOR.

(169) Mr. A. Greenberg, of New York City, asks:

Q. 1. How many pounds of wire should be used on the blow-out magnets of a 1-k.w. arc generator?

A. 1. About 16 pounds of No. 13 wire for each coil.

Q. 2. How many turns of a cable should I wind on the primary and secondary of an oscillation transformer for the above arc?

A. 2. About 10 turns on the primary and 20 on the secondary.

Q. 3. How long should the aerial be to tune to 200 meters?

A. 3. A good aerial may be made of two wires spaced three feet apart, 85 feet long and 65 feet high.

A. C. FOR V. T. DETECTOR.

(170) Mr. E. D. Blair, of Winona, Minn., asks:

Q. 1. How may I use A. C. to light the filament of a V. T. in the De Forest one coil circuit?

A. 1. A diagram showing how to do this appears on this page.

Q. 2. Is tinned copper wire as good for an aerial as plain copper wire?

A. 2. Yes, and it doesn't corrode so fast when exposed to weather.

LOOP AERIAL.

(171) Mr. Charles Blanchfield, of New York City, inquires:

Q. 1. Can results be obtained by using a loop aerial on the ground floor of an apartment, by using a 600-meter tuning coil, galena crystal detector and is it possible to receive radiofone?

A. 1. Yes, but such a set is not very sensitive. To obtain good results a V. T. detector and if possible an amplifier should be used.

AUTOMOBILE BULBS.

(172) Mr. Wallace W. Sofleiss, of Richmond Hill, N. Y., wants to know:

Q. 1. Can double filament automobile bulbs, having an external grid, be used successfully for receiving?

A. 1. Yes, they may be used for experiments, but they are not very sensitive.

RADIO TELEPHONE.

(173) Mr. B. H. Anderson, of Detroit, Mich., asks:

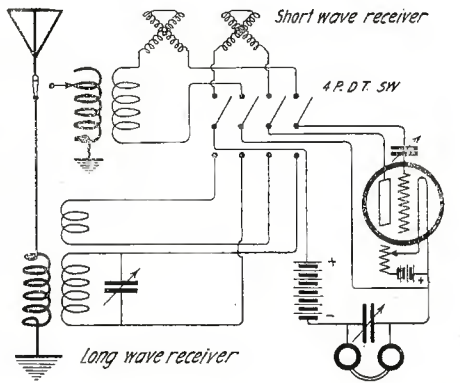

Here is How to Use the Same V. T. Detector With a Short Wave Regenerative or a Honeycomb Coil Set. A Telephone Switch Does the Trick.

Q. 1. Is it possible to change the circuit on page 436 of the January issue of RADIO NEWS, to a radio telephone by putting a modulation transformer, battery and transmitter in where the sending key is?

A. 1. You won't obtain good modulation this way. We advise you to read the article on page 524 of the February, 1921, issue of RADIO NEWS, and use the circuit given on this page, which is more efficient for telephony.

Q. 2. Could I use a storage battery stepped up by an Acme C. W. transformer for the plate voltage of this set? If so, what size transformer should I buy?

A. 2. No. You cannot step up the current of a storage battery with a C. W. transformer, but you could use a small spark coil delivering the correct voltage with rectifier tubes for the supply to the plates of the tubes.

WAVE-LENGTH.

(174) Mr. Louis R. Huber, of Tipton, Iowa, is anxious to know:

Q. 1. Does the diameter of the aerial wire affect the wave-length? For example, would a wire No. 12 gauge have a wave-length greater than a No. 14 gauge wire?

A. 1. No, the wave-length is not affected appreciably by such a small difference in the size of the wire used.

Q. 2. Which is the better for receiving, one wire 150 feet long or two wires 75 feet long?

A. 2. If the space surrounding the antenna is clear, the same results may be obtained with both.

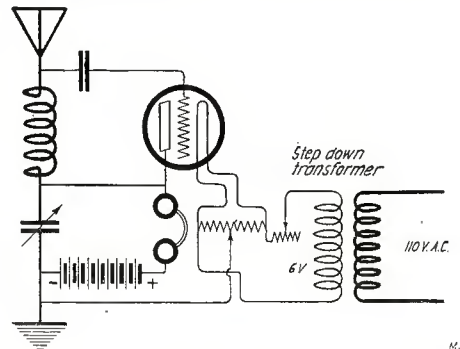

With a Set Connected as Shown, the Filament of the V. T. May Be Supplied With A.C. as Well as in Any Other Receiving Circuit.

Q. 3. What is the wave-length of an aerial 50 feet long, two wires, the separation being 1½ feet, 20 feet high, inverted L type?

A. 3. The natural wave-length of such an aerial is about 100 meters.

AMATEUR RADIOFONE.

(175) Mr. G. C. Armstrong, of Britt, Iowa, asks:

Q. 1. Please publish a hook-up using honeycomb coils, also a tickler, necessary condensers and audion detector.

A. 1. A hook-up for such a set was published on page 462 of the January, 1921, issue of RADIO NEWS.

Q. 2. Would the radiofone described in the June issue of RADIO NEWS (page 689) be all right for amateur wave-lengths?

A. 2. Yes, this set may be tuned to 200 meters or less.

Q. 3. Could the direct current be obtained another way and work all right?

A. 3. Yes, any supply of D. C. may be used for a radiofone as long as the voltage is sufficient to obtain good results.

TRANSMITTING CONDENSER.

(176) Mr. Arlyn Peterson, Jr., of Dallas, Oregon, inquires:

Q. 1. Will you please publish in RADIO NEWS how to make a good condenser for the transmitting set described by Frederick J. Rumford, in the January number of RADIO NEWS?

A. 1. A good transmitting condenser may be made of seven photographic plates 8 x 10 inches, used as dielectric between six tinfoil armatures 6 x 8 inches with a lug for connections. Each armature is made of three plates.

POTENTIOMETER.

(177) Mr. Joseph G. Telmosse, of Shalinigan Falls, Quebec, wants to know:

Q. 1. What is the resistance of the potentiometer to put across the filament terminal of a V. T. supplied with A. C.?

A. 1. The resistance of this potentiometer may be from 50 to 300 ohms.

COMBINATION SWITCH.

(178) Mr. Ralph Mercer, of Ashland, Ohio, asks:

Q. 1. How can I use the same V. T. detector with a regenerative set and a honeycomb coils receiver, switching it from one to the other?

A. 1. A hook-up for this appears on this page.

SIMPLE RADIOFONE.

(179) Mr. J. C. Oille, of Toronto, Can., wants to know:

Q. 1. In the January, 1920, issue of RADIO NEWS, on page 370, you published a hook-up for radiofone transmission. Would a 2,000-meter loose coupler be adapted to this hook-up?

A. 1. Yes, but a smaller one would be more efficient for 200 m. transmission.

Q. 2. What kind of transmitter is used in this circuit?

A. 2. Any good microphone may be used.

Q. 3. What is the radius of this set with a three-strand 50-foot aerial 60 feet high?

A. 3. The range of such a set depends entirely upon the voltage applied on the (Continued on page 646)

The Phantom and the Circuit

By CHARLES OSBORNE PARKS

WHEN I first met Bill Phelan, I was a very much harassed "shave-tail" presiding over a dugout that was much too full of telephone apparatus and alleged signal corps electricians, somewhere in the rear of the Saint Mihiel Drive. It was a very important "central" and as the drive progressed, matters became worse and worse. Just when things had reached a pass where it seemed that if the drive was to proceed in our sector it would have to do so without any fone orders, Bill crowded himself into the dugout. I say that he crowded in, advisedly, for tho our dugout was small, Bill was one of those expansive persons who gave the impression of crowding in even when they were entering a half empty ball room. He briefly reported that he was a signal corps sergeant sent down by "Black Jack" himself to see if he could help straighten out the mess.

Well, that is what he did. Three hours after Bill appeared on the scene, my troubles ceased. The man was no ordinary dub with a pair of pliers and a roll of friction tape stuck on him, as I had come to regard all so-called electricians. He understood juice in all its phases, fancies, whims and tantrums. When anything went wrong he didn't have to make a systematic search for the cause of the trouble, he knew by some sixth sense just where it lay and his resource was unailing.

When our outfit reached Pontenazin, I lost sight of him and thereafter I often wondered what had become of the "Best Sergeant in the Signal Corps." I so elected him myself, and was willing to back him against all comers.

* * * * *

I was walking down Maiden Lane when a great paw was laid none too gently on my shoulder, and a tremendous voice boomed in my ear, "Why, here's the little Skipper, as sure as I'm alive!" I turned and recognized Big Bill himself. After a little conversation he invited me up to his office. When we alighted from the elevator on the sixth floor of a neighboring office building he led the way to a door bearing the legend, "William Dillingham Phelan, Gems and Pearls."

He ushered me into an expensively furnished waiting room where we were met by a corps of deferential clerks, and on thru to his private office. That private office, I'll venture to state, was unique in, or out of, the civilized world. It was a spacious affair as if designed to give its huge tenant breathing space, but the strangeness and paucity of its furnishings was what arrested my attention. In one corner near the window was a large flat topped desk and a few chairs; across the room, a good ten feet from the door and further than that from the desk, stood a grandfather clock, and a weird appearing contrivance which I rightly guessed was a safe. The floor was covered with a rug that seemed four inches thick, but there the furnishing ended. The room in fact gave an impression of bareness, not to say emptiness.

We seated ourselves at the desk and continued our conversation. Presently Bill noted how my eyes wandered over the room.

"Rather Spartan, eh, Skipper?" he laughed inquiringly. I admitted that that was the impression I received. "Well, there are various good reasons," he said. "In the first place I like it. In the second place it enables me to hold my clients' at-

tention when I'm making a sale; and then it has tactical advantages. I often have a half million in gems in the safe, and I have to take precautions. The rug has burglar alarm matting under it for ten feet in every direction from the safe.

"And by the way, that safe might interest you, it seems to attract your attention. A little invention of my own, and I must confess that I'm quite proud of it." We rose and crossed over to the strong box. "As you see," he continued, "it is a perfect sphere, and you can rotate it in any direction with one finger." He demonstrated its workings and a gong in the base clanged loudly. "Does that every time it's moved," he explained. "The sub-base is held down to the concrete floor by expansion bolts, the body is put on the rollers, the base and the arms are put over the whole, and the sub-base and base are electrically welded together all the way around, covering the heads of the bolts. These three curved arms come up over the top of the sphere so that it is impossible to get it off the base without either digging away the concrete, cutting all around the base, or cutting thru two of the arms. The arms are

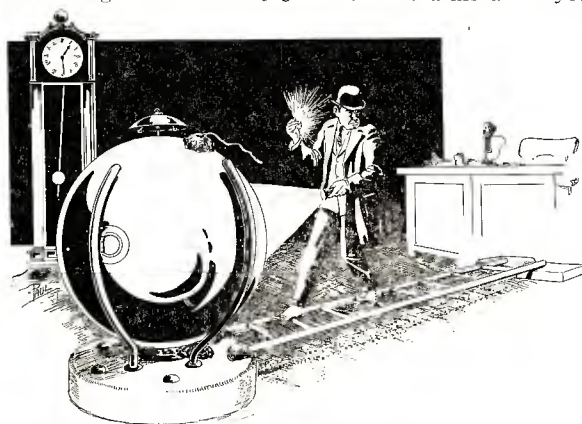

"I'll Say She's a Lulu! I'll Have to Use Some Powder to Get Thru That. Start Her Off With Half a Cup and See How Much of an Impression That Makes."

three inches in diameter and made of self-hardening tungsten steel. The ball of the safe body is made of the same material four inches thick. The door is just six inches in diameter, and so nicely machined that it fits air tight. You can barely see where it goes in," he turned it toward me for inspection, "and as it is held in place by a time lock, there is no combination dial or other point of weakness on the outside of the safe body."

"Great!" I exclaimed admiringly, "I should think any ordinary burglar, or even an extraordinary burglar, would be frightened away by the sight of the thing."

"Guess again," quoth Bill cheerfully, "I have very good reason to believe that some ambitious burglar intends to visit me in the very near future. Come here." He led the way to the office door and opened it. "See those two brass plugs on the jamb, and those two on the edge of the door? Well, they make the connection for the burglar alarm on the door when it is shut. Now look again," he scratched one of the plugs with his thumb nail and raised a white powder, "see, they have all been varnished over with clear shellac." Bill closed the door and we returned to our seats by the desk. "Now, a man who is smart enough to sneak in here and dab a little clear shellac on the contact points of the burglar alarm to that door," he continued with conviction, "or to corrupt one of my

highly recommended and heavily bonded clerks to do it for him, is no ordinary beetle-browed crook.

"You understand how that alarm works of course? When the knob of the door is turned it makes a contact and rings a gong at the headquarters of the company that carries my insurance. It is supposed to be the latest thing and harder to beat than the ordinary trap switch. Of course I have the windows wired too; I'm taking all the usual precautions, but I have an ace in the hole, a third line of defence as it were." He dropt his voice to a confidential whisper. "See that clock?" I confessed that I had noticed it. "Well, that is something new under the sun. It's the first wireless burglar alarm. I figured out a long time ago, that any system that depended upon a closed or open circuit for its action could easily be beaten by a criminally inclined gentleman of little more than average intelligence. Hence the wireless burglar alarm. Our burglar doesn't need to touch a thing to set a gong ringing in my uptown apartment; but come within twenty feet of it and the little bell starts to ring. I'll show you how it works later. Just at present I want you to come up to my little flat and have supper with my wife and me.

"Just a moment." He approached the clock and opened the door at the front of the cabinet. I saw that the interior was rather full of apparatus. A telephone transmitter was at about the height of his chin. He threw a switch and held a watch case receiver to his ear. A conversation ensued for all the world as if he were talking over the ordinary desk instrument. "Hello, Ruth? How does the gong go? Good. By the way, I'm bringing an old Army friend of mine up to dinner. Sorry I didn't know sooner or I would have called you up earlier. Yes, we're coming right up; be there in less than half an hour." He hung up, made one or two final adjustments and closed the door.

Less than thirty minutes later he ushered me into a very attractive little apartment, and introduced me to his wife. They were the usual combination of the long and short of it; Mrs. Phelan was as petite and slight as Bill was big and robust.

After an exceptionally palatable meal at which Mrs. Phelan showed herself a gracious hostess, Bill and I retired to the latter's workshop.

"Now you may, or may not, have heard," began Bill, "of the numerous burglaries that have been going on in the wholesale jewelry district. I'm more or less reliably informed that one insurance company alone, has paid out more than \$3,500,000 because of them. All of the trouble is laid to one lone worker, who because of the way he seems to enter and leave heavily guarded and alarm protected premises without detection, has been nicknamed the 'Phantom.' He seems to be in league with the Devil and to wear a horseshoe in every pocket. The police and all of the detective agencies seem to be helpless and hopeless. I imagine, tho," he smiled grimly, "that the gentleman will rather come to grief if he tackles my shop tonight. That wireless alarm is something that no amount of fore-thot can guard against."

"Tell me, what is the principle on which it works?" I inquired.

Phelan drew a block of scratch paper toward him and rapidly and accurately sketched the accompanying diagram. "There are, as you will recollect, what apparently are ornamental posts of ebony up each side of the clock cabinet. Now the one on the right hand side is a blue steel bar exposed to the air, the one on the left is enclosed in a thin glass tube. When the temperature of the room changes gradually and naturally the two bars expand at the same rate, but when a source of heat, such as a human body, is suddenly introduced into the room, the bar on the right expands ever so slightly. This expansion is magnified several thousand times by this lever gear, until it is great enough to close the circuit. The primary circuit thus closed, closes an operating circuit by means of this time switch arrangement. The operating circuit in turn closes the sending circuit, cuts in and shorts the telephone circuit. At the end of three minutes the operating circuit is opened by the time switch and the telephone begins to function. The length and frequency of the sending waves are very carefully tuned. My receiving station is very finely tuned, and by using a six-stage amplifier I am able to have it ring a gong here. To guard against mistakes I have the clock so arranged that when the circuit is once closed it remains so for exactly three minutes. At the end of that time the telephone is cut in. I have a very delicate microphone on the telephone, and with the six-stage amplifier on this end, and a loud-speaking receiver, I can hear the flies crawl in my office. Occasionally hitting the wave-length and frequency, but there is no danger of making a mistake. If I don't get the steady ring for three minutes and then the fone, I know that everything is O. K.

"You saw the varnish on those contacts this afternoon. I also received word today that my private watchman has been suddenly taken ill. I have received some unusually large shipments lately, and have not disposed of them as yet. Putting two and two together, I deduce that the 'Phantom' will call at my office between twelve and one A. M. If you want to stick around you may see a little fun. I'm not afraid to let the 'Phantom' in my office for a few moments, for even he cannot get that safe open in much less than half an hour."

I laughed scornfully. "How is anyone going to open a practically rigid, diamond hard sphere, which is almost anything except stable, in half an hour?"

"It sounds like a tall order," Bill agreed, "but at the same time I think that I could do it. I'll not say how just now, but if the 'Phantom' does not disappoint us, he will be caught red-handed, and you will get a chance to see how the most ingenious safecracker of all times goes about his trade."

Mrs. Phelan joined us at that moment, and after Bill had explained his great expectations to his wife the conversation became general. Ruth Phelan was a remarkable conversationalist, and even Bill showed symptoms of being able to talk of something beside his pet inventions. Time could not be said to drag and I was very much surprised indeed that the clock showed 1:30 A. M., when the gong finally rang. It rang

for exactly three minutes and then stopt. Bill plugged in a loud speaking receiver. A loud thump came from the horn followed by a clang while an undertone of noise like the puffing of an enormous steam engine seemed to play an accompaniment to the racket.

"Too strong," commented Phelan, "I'll cut her down a bit. His breathing will be annoying if I don't. Ruth, will you please call up Blank's Agency, and have them send a squad of men around to the office to detain my caller until we can arrive." While his wife did as requested Bill and I gave all our attention to the receiver. Phelan had, as he said, toned it down a bit, and it was as if he were listening to someone in the same room on the other side of an opaque but very thin curtain.

Evidently the intruder was accustomed to think out loud. "She's a Lulu," announced the horn, "I'll say she's a Lulu. S'wonder the d---n fool that threw it together couldn't a thot a sumpin' else that would make it easier to get into." A metallic clank ensued. "Huh, diamond hard. * * * Don't dare turn the door around either, for fear she'll ring a pretty little bell. * * * Well, I'll just block the rollers, an' avoid accidents."

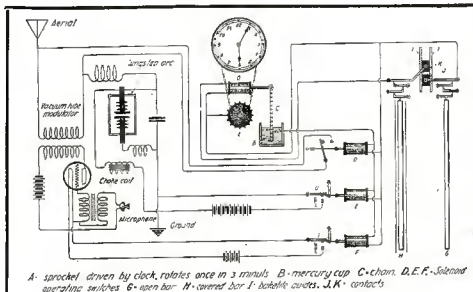

OPERATION OF THE CIRCUIT

With any sudden increase in temperature of room bar G expands faster than bar H; this expansion being greatly magnified by lever gear brings contact J against contact K closing primary circuit. This circuit energizes solenoid O bringing chain C into engagement with sprocket A, closing operating circuit. As A revolves once in three minutes C is lifted from mercury cup D in three minutes opening operating circuit. When the operating circuit is closed it energizes (1) solenoid D cutting out telephone transmitting set; (2) it energizes solenoid E closing transmitting circuit; (3) it energizes solenoid F cutting in filament circuit of telephone set. Until C is lifted from B the set sends out a steady buzz at predetermined length and frequency. Then operating circuit is opened at CB. D is de-energized and a spring opens the switch cutting in telephone set. U and T are trap switches and unaffected by the de-energizing of solenoids E and F.

Mrs. Phelan joined us and reported that the Agency's men had departed for the office. The soliloquy of the intruder continued. "Mighty fine piece of work; hate to spoil it but I just must have all the pretty pretties inside." More metallic noises ensued. "Bet the old boy that owns this dump is home fast asleep, feelin' his joint is perfectly safe. * * * Huh! well, it ought to be, after him fixin' it up with trick windows, and door locks, an' fancy alarm mattin', and fool safes. * * * Well, the only one he's gonna fool this time is the insurance company. Bet they don't charge him much of a premium after seeing 'll of his fancy work." We could distinctly hear the approach of muffled footsteps, but

the burglar apparently oblivious continued to work and think aloud. "Let's see now, this here overgrown ball bearin' is prob'ly two or three inches thick. I'll have to use some powder to get thru that. Start her off with half a cup, and see how much of an impression that makes. * * * Darn this clay, I should have wet it just a little more. * * * There, guess that's about right for the powder. Now where is my ribbon? Here she is. Now a match, an' we'll see what we'll see."

A door squeaked distinctly. "Hands up!" commanded another voice.

"Come on!" cried Bill, cutting off his filament circuit and unplugging the receiver, "let's hurry down and interview the 'Phantom' before they drag him off to the hoosgow. Ruth, will you please fone them that we are coming?"

When we arrived at Phelan's office there seemed to be a deal of activity. A police patrol and a touring car were parked before the building. In the office itself were several police officers and the detectives from the Agency. The object of their attention was a handsomely tailored but rather coarse featured young gentleman, whose wrists were decorated with "nippers." Said young gentleman had evidently been asked many questions, but was evidently as reticent when he had an audience as he was loquacious when by himself.

"We got him, Chief!" cried one of the plain clothes men upon spying Phelan. "But how the devil did you know he was here?"

Bill laughed aloud. "Some more of my foolishness that you people wouldn't listen to. See what good your matting and all the rest of your junk did? Well, my little wireless burglar alarm did the trick."

We then investigated the operations of the burglar. A window cleaning ladder about twelve feet long with one end on the base of the safe and the other on one of Bill's mahogany desk trays inverted, had afforded the means of crossing the alarm matting around the safe. The rollers had been carefully wedged so that the safe could not turn and ring the gong. On top of the steel ball was a cup of modeling clay nearly filled with a silvery white powder. The strip of magnesium ribbon protruding from the top announced its nature. It was "Thermite."

When the officials had departed with their prisoner, Phelan reset the wireless alarm, and we left also. Phelan tried to insist that I return home with him, but I begged off, pleading that it was now three o'clock and my hotel was close by.

"Well, good-bye," Bill called as he stepped into a taxi that he had foned for, "I guess I've had my last early morning call from the 'Phantom.'"

"Guess you have," I agreed. "Good-bye for the present, and thanks for an interesting and wholly pleasant adventure."

He drove off, and as no other cab was in sight I set off for my hotel, which was barely five blocks distant, afoot.

Yes, I thot as I walked along. Phelan has had his last early morning call from the "Phantom." I did not know who the industrious gentleman was who had entered Phelan's office at such an unseemly hour, but I knew that I never should.

Whv? *I am the Phantom.*

Junior Radio Course

(Continued from page 619)

value as the mean potential of the grid is lowered. The curve (a) of Fig. 4 represents the heat oscillations, which may be compared to damp wave trains very close to one another, in the circuit, LC. In (b) is shown the oscillations of the grid potential, the mean potential being indicated by a dotted line. In (c) is shown the plate current, the mean value of which is also shown by a dotted line. The telephone cur-

rent will likewise correspond to this mean value and hence the note will correspond to the beat frequency.

In Fig. 5 is shown the DeForest circuit for the reception of undamp oscillations and called the "ultraudion." The oscillatory circuit is connected between the grid and plate with a condenser in the grid leak. The variable condenser C₂ shunted across the plate battery and fones is important in

the production of oscillations; in general, its value cannot be increased beyond a certain point without stopping the oscillations.

By this heat method high sensitiveness and selectivity are attained in receiving. Interference is minimized because even slight differences in frequency of the waves from other sources result in notes either of different pitch or completely inaudible.

Martian Madness

BY ERAUD SCHIVO

"MY dear Mr. Davidson, consider the danger," remonstrated Professor Wiegand. "What if the cable should break? It is quite probable you know."

"No, Professor, it is not probable in this case. The balloon will be controlled by an ex-service man who had charge of such work while a member of the signal corps. I assure you there is no danger."

"We shall ascend a thousand feet?" the professor queried dubiously.

"Yes, only a thousand feet. Think of the great fame, Professor, which may result from our experiment. If successful, your reputation will be established. People will speak of you after centuries have elapsed. For days your name will be in the headlines of the newspapers. Your picture will decorate the front page. You will be the idol of the public! What say, Professor?"

Publicity! How Professor Wiegand loved that word. His entire life was consecrated to the advancement of science. Success had been limited due to the lack of funds. Opportunity now knocked at his door. Danger! What cared he for a little peril? Davidson's alluring words, altho somewhat exaggerated, had awakened the scientist's ambition. He would be able to test the new atmospheric instruments, recently invented by himself. He was as a school-boy anticipating adventure, all eagerness and impatience.

"Count on me, Mr. Davidson," said the little professor enthusiastically, "and I thank you for the magnificent opportunity you offer me. How many will accompany you?"

"My son, Merton, will be the only other person beside yourself. It was because of his incessant pleading that I determined to participate in such an unusual undertaking. He is extremely interested in radio communication. His reasoning is logical and I believe he is correct in many of his assertions. I am not very familiar with the wireless codes, but the signals he believes to be transmitted from Mars are certainly unlike any others he is capable of intercepting."

"To what degree are these peculiar signals different?" questioned the professor, intent on the last words of Davidson.

Davidson offered the professor a cigar from a box before him, then chose one for himself, lighting it with deliberation, before he replied.

"There are three differences: first, there is the wave-length. My son says he knows of no station with a wave-length over twenty-five thousand meters. Yet the signals from this particular station are indubitably between fifty and sixty thousand meters. Second, is the screeching note. It sounds like the wind on a stormy night racing thru the aerial wires. The third difference I am unable to distinguish. It requires one who understands the code. Merton tells me he does not recognize it as any of the codes used commercially, nor is it the navy code."

"Your son has told no one of hearing these signals?"

"No one except myself. He wishes to actually communicate with the strange station prior to making it public. Therefore the balloon experiment."

The professor was about to ask another question when a knock sounded at the door.

"Come in." Davidson expected a telephone call. He was surprised at the entrance of Merton, as he supposed the boy to be directing the arrangements necessary for the proposed venture.

Face flushed with excitement, Merton approached the table. The professor gave him an intent, searching look.

"An intelligent fellow," was his verdict.

"Say, Dad!" exclaimed Merton, "everything is in readiness. The radio balloon works like a charm. Goes straight up and carries the transmitting apparatus as if it were a feather. Surely it will attain a

The experiment might not be a success if the transmitting apparatus were near the ground as would be the case if it were in the first balloon."

"Wonderful," murmured the professor. He remained thoughtful a moment, then said to Merton with a somewhat sarcastic smile, "Why the first balloon, if the instruments for sending and receiving are to be separated? Why not leave the receiving apparatus here in the house and control the transmitter from here without the necessity of ascending ourselves?"

Mr. Davidson looked at Merton with discomfiture. Why had he not thought of that possibility?

Merton, who had remained standing, glanced at the little old man who was still smiling and had folded his arms in a very superior sort of way.

"There are several reasons for ascending to a certain height," responded Merton confidently. "Dad no doubt neglected to mention that I could receive only one station and that station very weak; in fact the signals are not readable, tho I am certain they are not in a code used commercially. By having the receiving instruments and aerial one thousand feet above the ground, I see no reason for our being unable to pick up other stations, and the one I do receive, much louder. I have added several steps of amplification to the receiver but the results are unsatisfactory."

The professor's smile diminished as Merton proceeded. Apparently, too, expense was nothing to the Davidson family when satisfaction was desired.

"You are well versed in the matter, Merton," the professor commended. "I sincerely hope we shall be successful. My extensive scientific research is at your service."

"Thank you, Professor, I know you will be of great help to us. If successful no one will doubt us with your having specifications of the experiment."

The man seemed pleased. "Everything is in readiness you say? When shall we perform this communication with Mars?"

Merton considered. "That depends on the time required for you to ascertain the details which it will help us to know. The position of the planet at the present time, that is, its distance from the earth, the atmospheric conditions and so forth."

"I can attend to everything tomorrow," declared the professor, anxious to experiment with his own inventions.

"Tomorrow night then?" questioned Merton eagerly, studying his father's expression for any objection that might be forthcoming. There was none.

"Tomorrow night's right, Professor," he yelled joyfully as he ran from the room. "S'long, I've lots to do."

II.

The following day dawned clear and beautiful. No wind stirred in the tree-tops surrounding the Davidson home, which was the first thing Merton noticed on arising after a night of fitful dreams. The bal-

(Continued on page 626)



"M A R S—M A R S" Repeated the Faint Signals. "We Got 'em, We Got 'em" Shouted Merton, Grasping the Key to Answer.

height of five miles."

"What's this I hear?" interrupted the professor. "What do you mean by five miles? Your father told me we only ascend one thousand feet."

"Correct, Professor," Mr. Davidson declared, "we shall only ascend one thousand feet. The transmitting apparatus will ascend five miles if possible."

"I don't quite understand," said the little man as if puzzled. "Do you mean there will be two distinct balloons?"

"Yes, one for us and one for the transmitting apparatus; each will have its respective cable. In the cable of the second balloon are copper wires which will conduct the electricity to the instruments. The second balloon is Merton's idea. Professor.

MURDOCK No. 55

The Prices
Are Unus-
ually Low.

The Qual-
ity is Re-
markably
High.

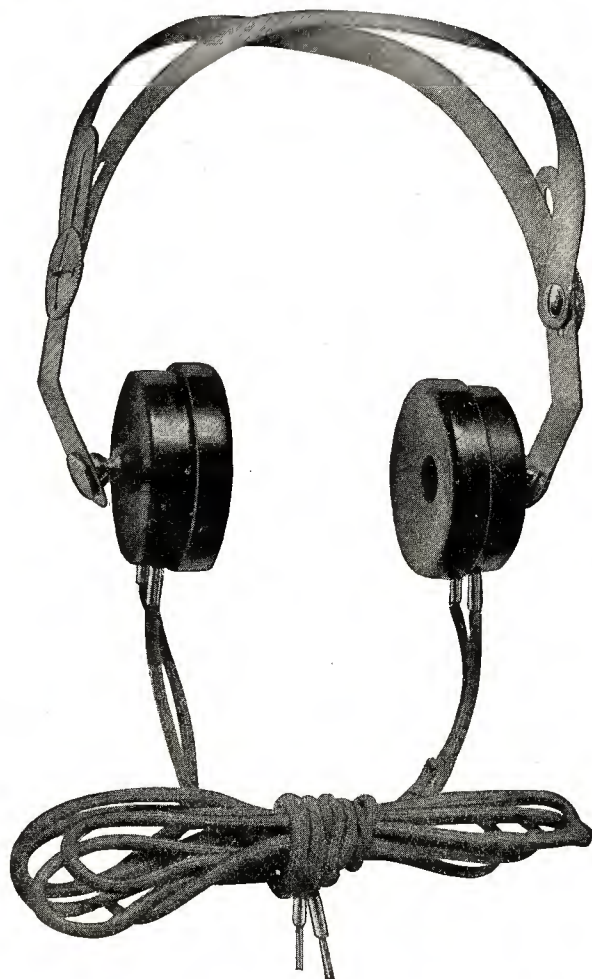

**2000
OHM
DOUBLE SET
\$4.50**

**3000
OHM
DOUBLE SET
\$5.50**

REAL RADIO RECEIVERS

backed by a liberal trial offer and an absolute money-back guarantee. No written argument in their favor can compare with the convincing proof of their actual performance. We simply urge a TRIAL, for we know that their sensitive operation will tell more surely than verbal claims, their exceptional value. Ask your dealer for them.

BULLETIN No. 20 will be sent on request.

WM. J. MURDOCK CO.

50 CARTER STREET
CHELSEA, 50, MASS.

509 MISSION STREET

SAN FRANCISCO, CALIF.

"Old Town Canoes"

IT'S just like gliding through space to idle along in an "Old Town Canoe." Lazy paddle strokes keep you moving ahead. Vigorous ones give you a burst of speed that can't be beaten. For an "Old Town" is the lightest, fastest, steadiest canoe you ever paddled.

The built-in strength of an "Old Town Canoe" makes it last for years. Send for the catalog. There are 3,000 canoes in stock. \$67 up from dealer or factory.

OLD TOWN CANOE COMPANY
133 Fourth St., Old Town, Maine, U. S. A.



LEARN ELECTRICITY

Make your successful future a certainty. We teach by practical work and scientific methods under practical working conditions. Specialists for 15 years in training young men for



Electrical Engineering with B. S. Degree in 3 Years
A place for every student regardless of age or education. Up-to-date laboratories—faculty of 90 experts; individual instruction. "Earn while you learn" system. Low tuition; athletics and student activities. Write for latest catalog and full details. New term soon starting.
SCHOOL OF ENGINEERING OF MILWAUKEE
Dept RN3 373 Broadway, Milwaukee, Wis.

HEY!! 'BUGS'

Here's something NEW. It's the GUSTAFSON VERNIER DIAL CONTROL. A neat little device and a necessity on every receiving outfit, gives a fine vernier or micrometer adjustment to your dials. NO CAPACITY EFFECT, rapid adjustment, cannot get out of order; can be applied to your present cabinet in two minutes. The vernier indicating dial is graduated in hundredths, giving very fine adjustment, long handles permitting adjustment without "body effect." Everyone that sees it says: "It's the grandest thing I ever saw, don't see how I ever got along without it, and so simple, practical and neat; you ought to sell a million" AND WE WILL! at the price—SPECIAL INTRODUCTORY OFFER \$1.00 ea. 3 for \$2.50 or \$9.00 a dozen postpaid.

Better get yours now, before we are swamped with orders. Orders strictly filled in rotation as received. We have a large supply, but they won't last long. Order yours NOW.
GUSTAFSON BROS. Quality Apparatus 1402 N. Hickory St. Joliet, Ill.
WATCH FOR THE BIG ANNOUNCEMENT !!

Paragon Audion Control Panel

(Consists of all necessary apparatus with the exception of Tube and Battery)

— Price \$6.00 Postpaid —

The addition of an Acme Amplifying Transformer makes an efficient Amplifying Unit at a reasonable price. ACME (semi-mounted) AMPLIFYING TRANSFORMER.

— Price \$5.00 Postpaid —

Write today.

Federal Radio & Research Laboratory
20 Rush St., Somerville, Mass.

TELEGRAPHY

(Both Morse and Wireless) and RAILWAY ACCOUNTING taught thoroughly and quickly. Big salaries now paid. Great opportunities for advancement. Oldest and largest school; established 46 years. Endorsed by Telegraph, Railway, Radio, and Government officials. Expenses low—opportunities to earn large portion. Catalog free.

DODGE'S INSTITUTE

D Street, Valparaiso, Ind.

A Practical Wave-Length Chart

BY JOHN L. REINARTZ

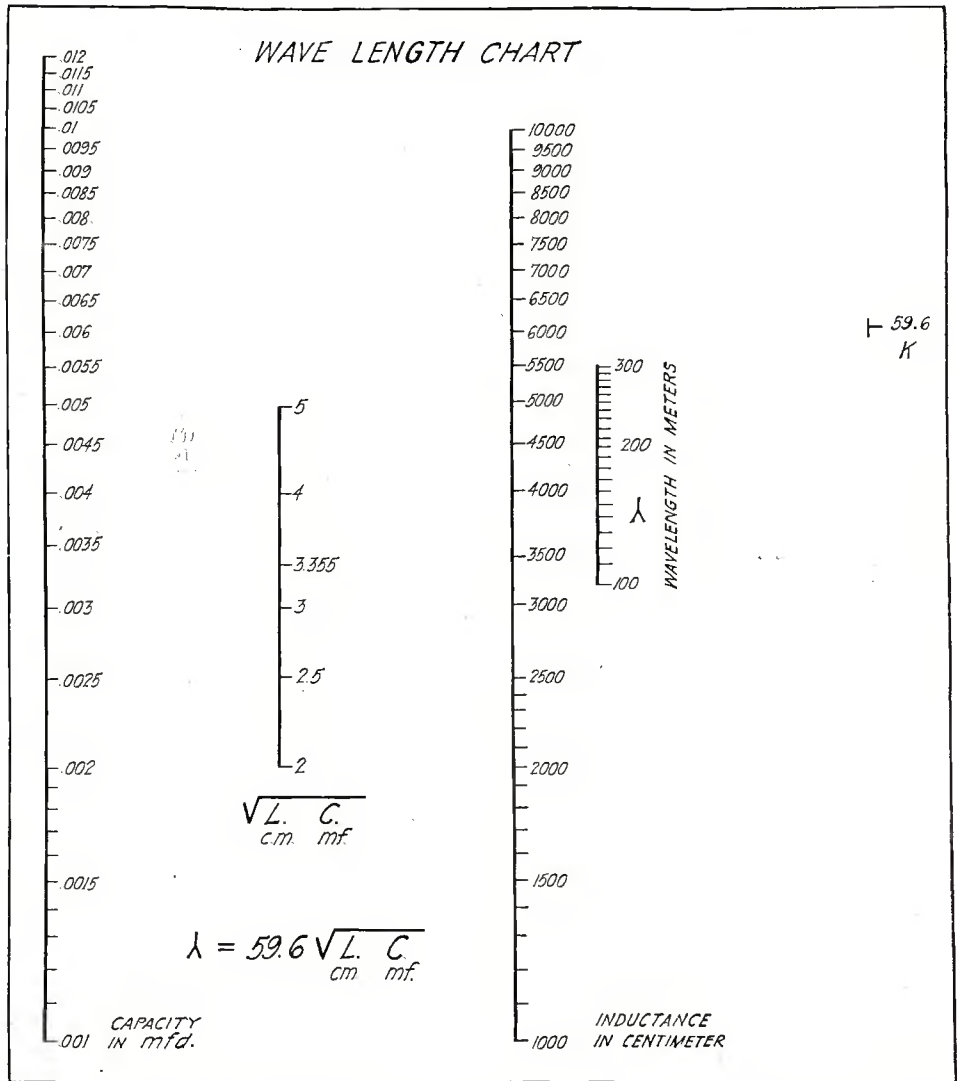

To Use This Chart Place a Ruler From the Correct Points on the Capacity and Inductance Lines. Note the Place Where it Crosses the Line \sqrt{LC} , and Place the Ruler From the Value Found to 59.6 K. The Direct Wave-Length May Be Read on the Wave-Length Line.

Martian Madness

(Continued from page 624)

loons would ascend much better without it.

He was jubilant and whistled merrily when, after an appetizing breakfast, he proceeded to the part of the grounds where the balloons were located.

Statts, ex-service man, was on the job.

"Fine day, Merton," he called in greeting, "we couldn't wait for better."

"Yes, Statts, but remember that the experiment takes place after dark. The wind might come up then. However, we shall ascend the radio balloon during daylight."

Statts only muttered an unintelligible comment. He had little faith in the venture. Talking with Mars was plain madness in his opinion.

"Say, Statts," called Merton from a distance, "don't they seem big when you're close to them?"

"Um," mused Statts, "some I saw during the war would hold five or six of these."

The two gas bags, securely fastened with substantial cables, really did appear immense. As a matter of fact, as Statts said, balloons were sometimes made five or six times larger, but these would serve the purpose intended for them. The car on

each balloon was constructed of willow, a strong and light material. One already held the transmitting instruments, the other the receiving apparatus. There was space in the latter for the accommodation of passengers.

Merton worked all day on the sets, adjusting first one thing and then another. He was uninterrupted except for the intrusion of a young man who eyed the balloons in bewilderment. He quickly disappeared when Merton called to him.

The transmitter was now in perfect order. Merton covered it in such a way as to protect it from the weather and yet not impede its working satisfactorily. He then looked over the aerial wires which were to hang from the balloons. After a general inspection he left the grounds, first giving Statts strict instructions to remain until he returned. Darkness would fall in a few hours.

But Statts was hungry and determined to have some dinner. As soon as the boy departed he left the balloons unguarded and started for a nearby restaurant.

Immediately upon his disappearing from sight a young man approached the basket holding the transmitting set. It was the same fellow who had entered the grounds while young Davidson had been testing the machinery. No doubt he had remained in the vicinity, waiting his chance.

(Continued on page 630)



Specify No. 766, Eveready Wireless Station Battery. Standardized for use in the U. S. Navy



Specify No. 763, Eveready Airplane Wireless Battery. Standardized for use in the U. S. Signal Corps Aviation Section

This battery was built for you

THE Eveready engineers, with their wonderful background of battery experience and with a full knowledge of your problems, have designed the Eveready Vacuum Tube Plate Battery for you.

They say to you that this battery is crammed with electrical energy that is fairly itching to send your dots-and-dashes zipping through the air-lanes.

Your guarantee of highest quality is the Eveready trade-mark, like that shown below, plainly lettered on every battery. Get what you ask for. Look for the Eveready trade-mark that identifies the genuine. Sold by leading dealers everywhere. Name of dealer in your locality on request.

AMERICAN EVER READY WORKS

of National Carbon Company, Inc.

226 Thompson Avenue, Long Island City, New York

Chicago

Atlanta

San Francisco

EVEREADY

VACUUM TUBE PLATE BATTERIES

NOW is the TIME to LEARN

Know A Dignified
Uncrowded Profession

AT HOME

The Demand for Good Wireless Operators

The New York Wireless Institute—America's foremost, fastest growing Wireless Institute gives you the best instruments, theory, text books and diagrams available. We will **MAKE YOU AN EXPERT WIRELESS OPERATOR AT HOME**, qualifying you for first grade license, in your spare time, quickly, easily, thoroughly, in shortest possible time at lowest cost. No previous training necessary. Our Home Study Course prepared by Mr. L. R. Krumm, formerly chief Radio Inspector, Bureau Navigation, New York, now in position of greater responsibility with one of the largest commercial Radio Corporations in the United States. Our Radio Experts able to impart their practical and technical knowledge to YOU in an easy to-understand way will direct your entire Course. The graded lessons mailed you will prove so fascinating that you will be eager for the next one. The instruments furnished free will make it as easy for you to learn the Code as it was to learn to talk. *All you will have to do is to listen.*

FREE WIRELESS TELEPHONY COURSE

We have incorporated in our institute an up-to-date and Complete Course in Wireless Telephony, written by our Chief Instructor, Mr. L. R. Krumm.
THIS COURSE IS ALSO FURNISHED FREE

BIG SALARIES

Wireless operators receive salaries from \$125 to \$200 a month and it is only a stepping stone to better positions. There is practically no limit to your earning power. Men who but yesterday were Wireless Operators are now holding positions as Radio Engineers, Radio Inspectors, Radio Salesmen at salaries up to \$5,000 a year.

TRAVEL THE WORLD OVER

A Wireless Operator can visit all parts of the world and receive fine pay and maintenance at the same time. Do you prefer a steady position without travel? There will be many opportunities for you at the numerous land stations or with the Commercial Wireless or with the Steamship Companies.

The New Intercity Wireless Company will need hundreds of new operators.

U. S. SHIPPING BOARD will testify to the great value of our instruction.

ENDORSED BY
United States Government

by allowing our graduates highest credit of any Wireless School in first grade license examinations.

NEW YORK WIRELESS INSTITUTE

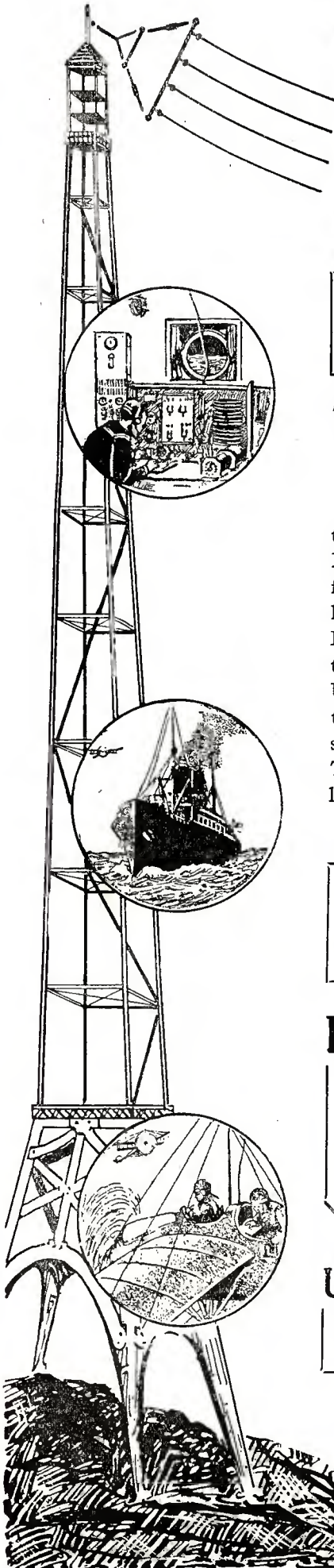

MAKE BIG MONEY WIRELESS

COME

In Shortest Time
At Lowest Cost



Operators Far Exceeds the Supply What Students Write

FREE

INSTRUMENTS AND TEXT BOOKS

We furnish free to all students, during the Course, the wonderful receiving and sending set exactly as shown in the illustration. This set is not loaned, but given to all students completing the Course. One cell of dry battery all that is required. No additional wiring, aerials, etc., needed. The wonderful Receiving and Sending Set, Text Books, etc., all become your property upon completing the Course. We also include an up to date and complete course in Wireless Telephony, written by our Chief Instructor, Mr. L. R. Krumm.

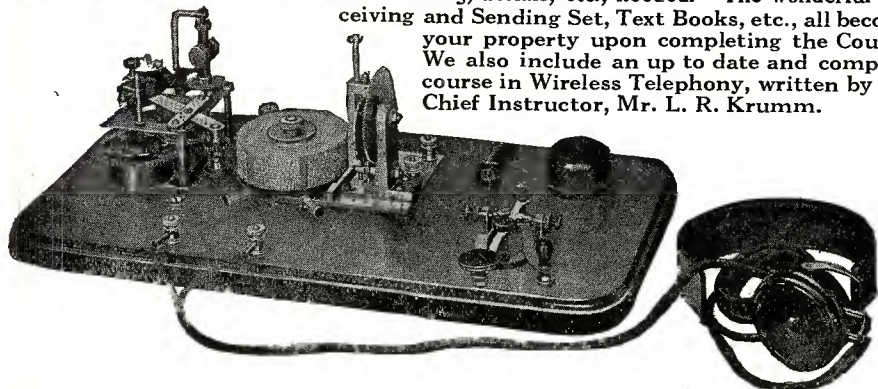

The transmitter pictured is the celebrated Omnigraph, used by several Departments of the U. S. Government and by the leading Universities, Colleges, Wireless and Technical Schools throughout the United States and Canada.

Thousands have learned telegraphy with the Omnigraph. Place the phone to your ear and this remarkable invention will send you wireless messages, thousands of different ones, the same as though you were receiving them thru the air from a wireless station hundreds of miles away.

When you apply for your license the United States Government will test you with the Omnigraph—the same model Omnigraph as we furnish to our students. Ask any United States Radio Inspector to verify this.

Medina, N. Y.,
November 28, 1920.
Dear Sirs:—
I have found the Theory Course, the Omnigraph Set and Text Books most satisfactory. I think your Wireless Course is the best and easiest to learn for it's interesting from the beginning to end, and the way the questions are written gets you interested at once.
Yours truly,
Signed (S. B.)

Milford, Conn.,
Oct. 25, 1920.
New York Wireless Institute,
New York City.
Dear Sirs:—
I received your letter and am very glad to tell you that I am completely satisfied with your course. It sure is an easy way to learn.
Thanking you for your kind attention, I am,
Sincerely yours,
Signed J. H. A., Jr.

Sea Cliff, L. I.,
December 6, 1920.
Dear Sirs:—
Received your letter of December 1, and was very pleased to learn of the lessons in Wireless Telephony to be given to the students of your school. It shows you do not overlook any phase in order to furnish the students with "up to date dope in the Radio line". And I am sure it will be as explicit as your Theory course of Wireless Telephony.
The course is as thorough and explicit as one could ask for and I wouldn't hesitate a moment in recommending it to any of my Radio friends.
Respectfully yours,
(Signed) C. D. H.

(Names and address gladly furnished on application.)

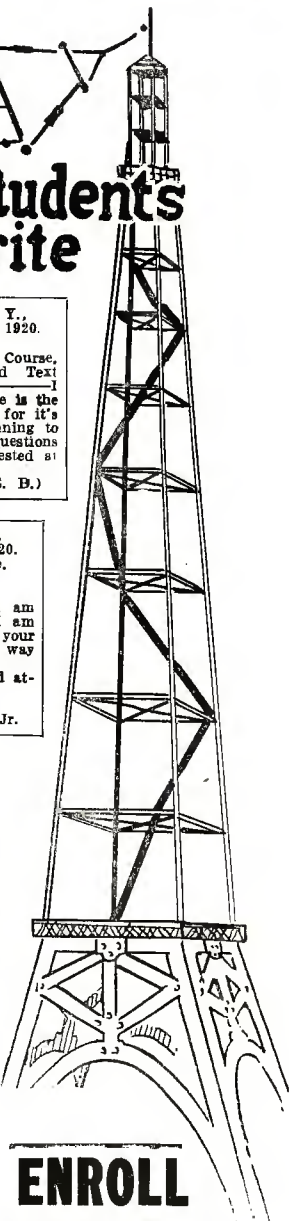

—Easy Payment Plan—
A small payment down will enroll you. We will make the payments so easy that anyone ambitious to enter the fastest growing profession—Wireless—may do so.

Send for FREE Booklet
Without obligating you in any way, send for our booklet, "How to Become an Expert Wireless Operator"—it is free. Mail the coupon below, or postal or letter—but do it today.

ENROLL NOW

Free Post-Graduate Course
A month's Post-Graduate Course, if you so desire, at one of the largest Wireless Schools in N. Y. City—the Wonder City—the largest port in the World and Headquarters of every leading Wireless and Steamship Company.

NEW YORK WIRELESS INSTITUTE
Dept. 201, 258 Broadway New York City
Send me, free of charge, your booklet "How to Become an Expert Wireless Operator," containing full particulars of your Course, including your FREE INSTRUMENT OFFER.
Name
Address
City or Town
State

WIRELESS INSTITUTE, Dept. 201, 258 Broadway New York City

(Continued from page 626)

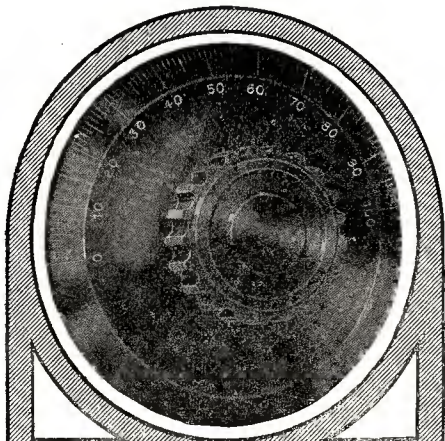

CORWIN DIALS

Judged by time, Corwin Dials are the oldest on the market; judged by design, they are the newest; judged by performance, they are the most satisfactory; and judged by price, they are the best value obtainable.

3" Dial, 75c—with knob. \$1.30
3 7/8" Dial, \$1.00—with knob, \$1.70

At all Radisco agencies and other reliable dealers, or sent postpaid anywhere

A. H. CORWIN & CO.
4 West Park St., Newark, N. J.

COMBINATION No. 4

Our Combination No. 4 is the greatest offer we have had the opportunity to offer to the trade for some time.

Here it is:	Reg. Price
8 "Electrose" Ball Insulators, at 50c each	\$4.00
2 "Electrose" 10" Strain Insulators at \$1 each	2.00
400 ft. No. 13 B. & S. gauge Aerial Wire, at 85c. per 100 ft.	3.40
	\$9.40

COMBINATION OFFER
Good until March 15th. . . . } **\$7.00**
Allow postage for 12 lbs.

Our new catalog, listing and illustrating an array of the latest and best apparatus is now ready. Send 10c for your copy. The 10c will be refunded on your first purchase of \$1.00 or more.



Penn Radio Apparatus Co.
Dept. 4, Reading, Pa.

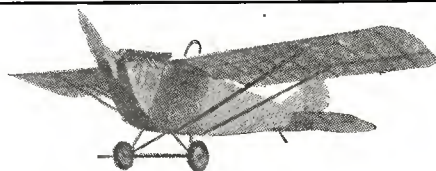

Build Model Planes

Wading River models are exact scale reproductions of real planes, that's why they fly. You can't go wrong with Wading River plans and parts. Send 10 cents for new 56 page catalogue, showing 25 different models that you can easily build.

WADING RIVER MFG. CO.
Dept. H, 672 Broadway, Brooklyn, N. Y.

With a jerk he removed the cover and in a few seconds had disconnected the rotary spark gap and extracted it from the basket. Then followed the other instruments; condensers, oscillation transformer and step-up transformer. Carrying the rotary gap, condensers and oscillation transformer, he vanished into the surrounding shrubbery, returning in a few minutes empty-handed. He partly filled the transmitting basket with rocks, threw in a few large bricks and covered it as before. He seemed undecided about attempting to purloin a few receiving instruments when an approaching footstep caused him to grab the step-up transformer and run for the thicket. In a second or two the soft purr of an engine could be heard and then the shifting of gears.

"Everything ready," grunted Statts, returning to the scene a few moments later, "and here comes Merton and his dad. Professor's with 'em, too."

"Ready?" cried Merton, "let's hurry and put up the radio balloon, Statts."

Statts moved to obey. Slowly the cable was played out. Higher and higher rose the balloon until it was but a mere speck. Still it soared on and on until lost to sight.

"How many miles did you let out, Statts?" asked Merton.

Statts figured. "Five miles."
"That's sufficient," said Merton, "we don't want to lose it."

Statts anchored the cable and turned to Mr. Davidson for further orders. Darkness was fast approaching.

"We may as well get started," said Mr. Davidson nervously. "Only one thousand feet now, Statts"

They entered the basket. The professor climbed in first, a small bag clutched tightly in one hand. Mr. Davidson trying to be energetic, tumbled in, nearly damaging the instruments.

Suddenly all felt a peculiar sensation as the balloon started upward. The distance from earth lengthened gradually, as the minutes passed. Professor Wiegand crept to the side continually, glancing over nervously as if he expected the cable to break at any moment.

Far to the west glowed the last rays of the sunset. Soon darkness enshrouded the balloon's occupants. No faintest breeze disturbed the almost oppressive stillness.

Merton gingerly adjusted fones on the heads of the two older men. He then switched on the filament current and five bulbs emitted a bright glow. At the wavelength of twenty-four hundred meters the mighty roar of a local station could be heard. Merton tuned higher; he passed the sixteen thousand mark. Many stations from all over the world could be heard. Thirty, forty and then fifty thousand meters were passed. No signal now interrupted the current flowing in the bulbs.

Minute after minute the three waited patiently. A half hour passed; then another ten minutes, when suddenly loud and clear came a high screeching note. The three experimenters listened intently; letters forming an unknown code were sent without any disorder. There was no fading of the signals. They seemed of immense power.

"Mars," yelled Merton, excitedly. He signaled to Statts with a powerful flashlight. Statts below put on the power which controlled the transmitter. Merton presst the key, made a few test letters and called again.

"M-a-r-s, M-a-r-s," the key clicked. He then signed with his own call. Likely his signals were heard by many amateurs, and they wondered what new stunt Merton was performing. He failed to observe that no spark was made at the moment of contact.

The three men strained their ears for the answer.

"Mars, Mars," whistled the distant station.

"Got them," cried Merton, "my God, they answer me."

The professor was speechless with excitement. Great drops of perspiration gathered on the older Davidson's forehead. Again Merton presst the key.

"M-a-r-s," he called, "World, calling, World, how do you receive us?"

Fones were held tightly to ears as they listened for return signals.

"Mars, Mars," repeated the strange signals, then followed a succession of unreadable code."

"They can't understand us," whispered the professor. The signals now subsided.

Merton called again and again but heard nothing more on the high wave-length. Thru the night Merton and his father listened. The professor was testing his atmospheric instruments while the two waited patiently. Merton listed the many stations he received after lowering the wave-length a few minutes past midnight. The stations listed, over one hundred in number, were all remote from the United States.

At last morning dawned another perfect day. By a pre-arranged signal Merton attracted Statts' attention, directing that the balloons be hauled in.

In less than an hour the three stepped on solid ground, the professor with a sigh of happiness, Mr. Davidson with a grunt and Merton with a victorious yell to Statts.

"We got them, old man," he cried, "we got them. How long before the other balloon will be in?"

"Can't tell exactly, but it will be quite a while," he answered.

The professor and Davidson were already on their way to breakfast.

(Continued on page 662)

HE MUSTA BEEN "LIT UP"!

For Sale: An audiotron by a wireless operator with one filament burnt out.

Grid Condensers Selling Like Hot Cakes

Prepaid 25 cents



Prepaid 25 cents

Hermetically Sealed

100% Efficiency

Prices must go down. We are the first to start the ball rolling. Selling these condensers faster than we can turn them out. Everybody satisfied.

Crescent City Radio Company
P. O. Box 1104 New Orleans, La.

PARAGON RHEOSTAT

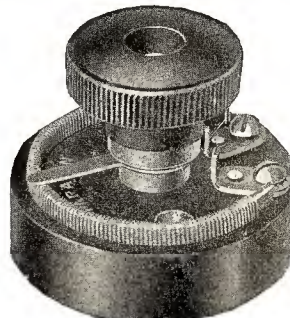

Suitable for either front or back of panel mounting \$1.75
Unmounted coils. Wound with No. 24 enameled wire.
9" long x 2 1/2" dia. \$1.00
10" long x 3" dia. 1.25
(Send 5c for catalogue)

MC MAHON RADIO SUPPLY CO.
56 West Ave.,
SOUTH NORWALK, CONN.



The Recognized Symbol of Superior Performance

Investigate These Leaders

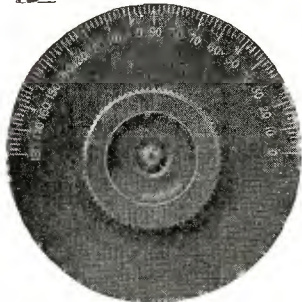

Knob and Dial
\$1.80

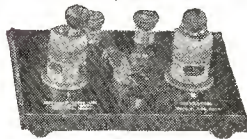

Duplex Detector
\$5.00



1/4 K.W. Quenched Gap
\$12.00

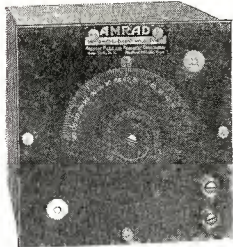

S. W. Variometer
\$14.50

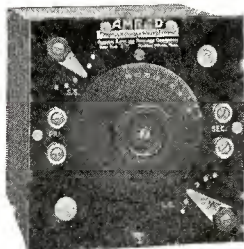

S. W. Coupler
\$17.50

ONLY A FEW OF THE 60 AMRAD ITEMS CAN BE ILLUSTRATED HERE. SEE THE ENTIRE LINE AT YOUR LOCAL DEALER'S. IF HE DOESN'T STOCK, ORDER THROUGH HIM AND HELP BUILD UP A CONVENIENT SOURCE OF SUPPLY FOR YOU AND YOUR FRIENDS.

KNOB AND DIAL—Either 180° or 90°. Wide adaptability. Good workmanship. Low price. Extremely popular everywhere (Bulletin R.)

DETECTOR STANDS—Efficient and economical from any viewpoint. Prices recently reduced 30%. Single type \$2.50. (Bulletin T.)

CABINETS—PANELS—These are exactly the same design and quality as used in all our receiving units. Very practical and good looking (Bulletin R.)

PANEL RHEOSTAT—Single rheostat can control two vacuum tubes. Suitable for 180° dial. Smooth running. Base of porcelain. (Bulletin S.)

AMPLIFORMERS—Omission of lap joints makes amplifying power nearly twice that of ordinary transformers. Two types, mounted and unmounted. Unmounted type, \$3.00. (Bulletin S.)

TUBE BASE—More efficient than the most expensive, but lowest in price. Bakelite base; long navy springs. (Bulletin S.)

QUENCHED GAPS—Efficient, practically noiseless; a great help in reducing QRM. Economical in operation. New leak-proof gaskets further increase efficiency. Three types. Successful coast to coast relay recently conducted solely by Amrad Gap stations. (Bulletin Q.)

B BATTERY BOX—First of its kind to house B Batteries, regulate their voltage and protect VT filaments against burn-out. (Bulletin V.)

VT DETECTOR—Includes many practical features such as 10 binding posts permitting use of any circuit, adjustable grid condenser and interchangeable grid leak. (Bulletin V.)

VARIOMETERS AND COUPLERS—Dielectric losses reduced by special construction without sacrificing ruggedness. Exceptional efficiency. Two types, short and medium wave, mounted and unmounted. (Bulletin V.)

VARIABLE CONDENSER—Smooth running 43 plate condenser enclosed in standard cabinet. Cuts dielectric losses by preventing accumulation of dust on condenser plates.

2-STAGE AMPLIFIER—Tested design guarantees highest efficiency. No "howling" circuits. Suitable for power tubes up to 300 volts. A quality product and the lowest priced two-stage amplifier on the market. (Bulletin V.)

Order from your dealer. Bulletins sent free upon receipt of your dealer's name. Complete Amrad Catalog forwarded for 10c in stamps.

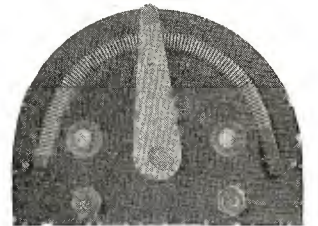

Panel Rheostat
\$1.75



Tube Base
\$9.00

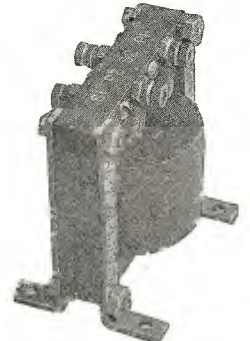

Mounted Amplifier
\$7.00

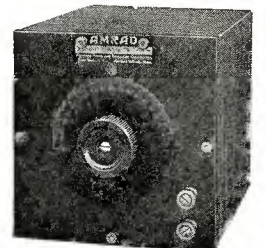

Variable Condenser
\$9.85

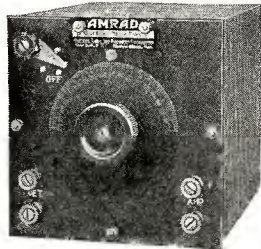

B Battery Box
\$9.85



VT Detector
\$15.00

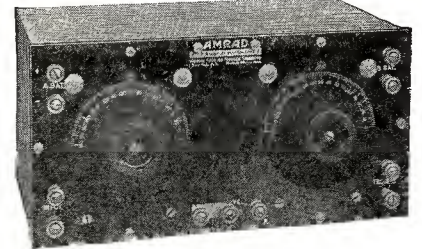

2-Stage Amplifier
\$39.50

AMERICAN RADIO AND RESEARCH CORPORATION

15 Park Row
New York

Address all Communications
to New York Office

Factory and Laboratory
Medford Hillside, Mass.

More than they expected—

EVERY month since the Corwin Mail Order Service was started, hundreds of amateurs have ordered apparatus, expecting prompt shipments and fair prices. And invariably, the carefulness with which their orders were filled, and the perfect

condition in which the goods arrived, have even exceeded their expectations.

If you think that no mail order service can be thoroly satisfactory, perhaps a trial of Corwin Service will surprise you, also. See if you need any apparatus in this list.

Universal-Coil Mounting Plugs

Anyone can easily make smooth-running mountings with these plugs. No bending, no filing,—they are made to fit exactly in the first place. Suitable for Radisco and all hand-wound coils. A few minutes' work with these plugs will save you dollars that can be put into better apparatus.

Price, 80 cents, postpaid

VARIABLE CONDENSERS

A. R. Co., .001.....	\$6.25
A. R. Co., .0005.....	5.00
With No. 67 Dial add \$1.00.	
Murdock 366.....	4.75
Murdock 367.....	4.75
Murdock 368.....	3.75
Clapp-Eastham 800.....	7.50
Clapp-Eastham 800A.....	9.50
Clapp-Eastham 800B.....	11.50
Complete with dial.	
Shipping weight One Pound	

GRID CONDENSERS

Radisco, Postage 3 cents.....	.35
-------------------------------	-----

ANTENNA SWITCHES

Murdock, 3 lbs.....	4.50
Clapp-Eastham, 10 lbs.....	12.50

OSCILLATION TRANSFORMERS

Radisco No. 5.....	15.00
Via Express collect only.	

RADIO CRAFT PRODUCTS

Detector.....	15.00
Two Step Amplifier.....	50.00
Detector and 1 step.....	45.00
Detector and 2 step.....	70.00
Postage paid.	

"B" BATTERIES

Radisco No. 1, 2 lbs.....	1.50
Radisco No. 5, 5 lbs.....	2.65
Eveready Storage battery prices on application.	

TUSKA C. W. APPARATUS

181 Coil, 2 lbs.....	7.50
182 Coil, 2 lbs.....	10.00
183 Coil, 3 lbs.....	12.50
170 Filt., 8 lbs.....	16.00

AERIAL WIRE

7 x 22 tinned copper	
100 feet, 2 lbs.....	1.25
200 feet, 4 lbs.....	2.40
500 feet, 8 lbs.....	6.00

VACUUM TUBES

Electron Relay.....	6.00
VT Amplifier, 1 lb.....	7.00
VT Extra Hard.....	7.50

AMPLIFYING TRANSFORMERS

A. R. Co., 1 lb.....	5.00
Federal, 1 lb.....	7.50

JACKS AND PLUGS

Federal Closed Circuit.....	.85
Federal Open Circuit.....	.70
Federal Double Circuit.....	1.00
Federal Plug.....	2.00
Postpaid.	

ALL RADISCO COILS and Wireless Press Books.

ROTARY SWITCHES

Clapp-Eastham, No. 19.....	1.00
Clapp-Eastham, No. 19A.....	.85
Our Own, No. 1.....	.40
Our Own, No. 2.....	.55
Postage.....	
	.05

CORWIN DIALS

No. 66, 3".....	.75
No. 67, 3" with knob.....	1.30
No. 68, 3 1/2".....	1.00
No. 69, 3 1/2" with knob.....	1.70
Postpaid.	

RECEIVERS

Murdock No. 55, 2000 ohm.....	4.50
Murdock, No. 55, 3000 ohm.....	5.50
Brandes Superior.....	7.00
Baldwin C.....	16.50
Baldwin E, improved.....	20.00
Brownlie, New.....	12.50
Shipping weight 2 Pounds	

CONTACT POINTS

CP-No. 1 Brass, dozen.....	.25
CP-4 Brass, dozen.....	.35
CP-5, Nickel Plated, dozen.....	.45
Postpaid.	

VARIO-COUPLER

Radisco No. 2.....	8.50
Radisco No. 2D.....	9.50
3 pounds.	

All orders for apparatus not listed as postpaid must be accompanied by postage charges.

A. H. CORWIN & COMPANY

Dept. B2 4 West Park Street, Newark, N. J.

PROUDFOOT SPECIALS

Our \$9.75 Coupler, Special for March.....	\$7.50
Vacuum Detector Cabinet.....	12.50
Amplifier Cabinet.....	18.00
Detector and One-Stage Amplifier.....	25.00
Detector and Two-Stage Amplifier.....	35.00
Regenerative Set with Detector and One-Stage Amplifier.....	45.00

These instruments are the equal or superior of any other instrument on the market. ABSOLUTELY GUARANTEED. PRICES ARE LOW because of quantity manufactured. We have already SOLD HUNDREDS of these instruments. ORDER EARLY because demand is greater than present output.

G. M. PROUDFOOT, 361 East Ohio St., Chicago, Ill.

A welcome addition to your library! Send \$2.00 today, plus postage for 7 lbs., and your copy of bound volume No. 1 of Radio Amateur News will come forward by return mail. Experimenter Publishing Company 236a Fulton Street, New York City

The Radio Station at Rome

(Continued from page 590)

The Poulsen arc is provided with a rectangular magnetic circuit, the lower portion being enclosed in a masonry base. Magnetizing coils, which are normally in parallel, are connected to the negative pole of the generator, and consist of 356 turns made up of two flat copper strips, each having a cross-section of 0.28 by 0.32 in. The air gap has a normal length of 3.2 in. The intensities of the magnetic field for various exciting currents and different values of air gap were determined. Within a range of 6 in. from this axis, the influence of the yoke is insufficient appreciably to distort the magnetic field, which therefore remains practically symmetrical.

WAVE-LENGTH.

Normal operation of this radio telegraphic station is carried on at a wave-length of 11,000 meters, with a supply current of 220 amperes, and consequently with a field intensity in the center of the gap of 6,700 gauss. When working on a shorter wave of approximately 7,000 meters, the supply current diminishes to 150 amperes and the field intensity to 5,750 gauss. The copper anode is cooled and the water, having passed thru this anode, continues on its

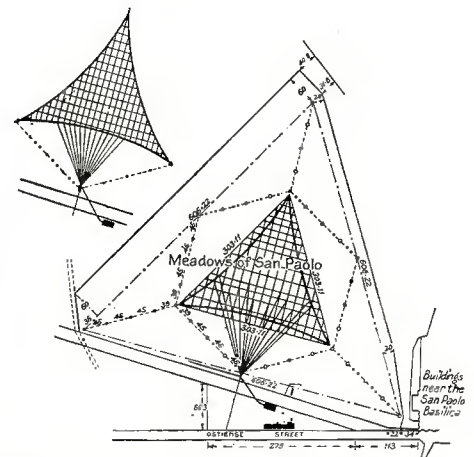

Bird's Eye View of the Triangular Antenna at Rome Radio Station.

way to cool the arc chamber. The carbon cathode is 2 in. in diameter, and is slowly turned round on its own axis. Regulation of the distance between the electrodes is carried out by hand.

The arc is struck by bringing the electrodes momentarily into contact, a suitable starting resistance being inserted and gradually cut out as the arc is lengthened. The hydrocarbon atmosphere required for operation of the arc consists of illuminating gas. The anode of the arc is directly connected with the antenna thru a large inductance of a maximum value of self-inductance 3,060 microhenrys. The cathode is connected thru the antenna ammeter to one terminal of the grounding condenser; the other condenser terminal is connected to earth. This condenser consists of 80 paper condensers in parallel, each having a capacity of 2 mfd.

EARTHING ARRANGEMENTS.

The earth connection consists of 18 plates buried at such a depth as to be permanently moist and of 36 copper wires each 98 1/2 ft. long, radiating outward from the station. The antenna is supported on three latticework wooden masts, each 714 ft. high, arranged at the vertices of an equilateral triangle.

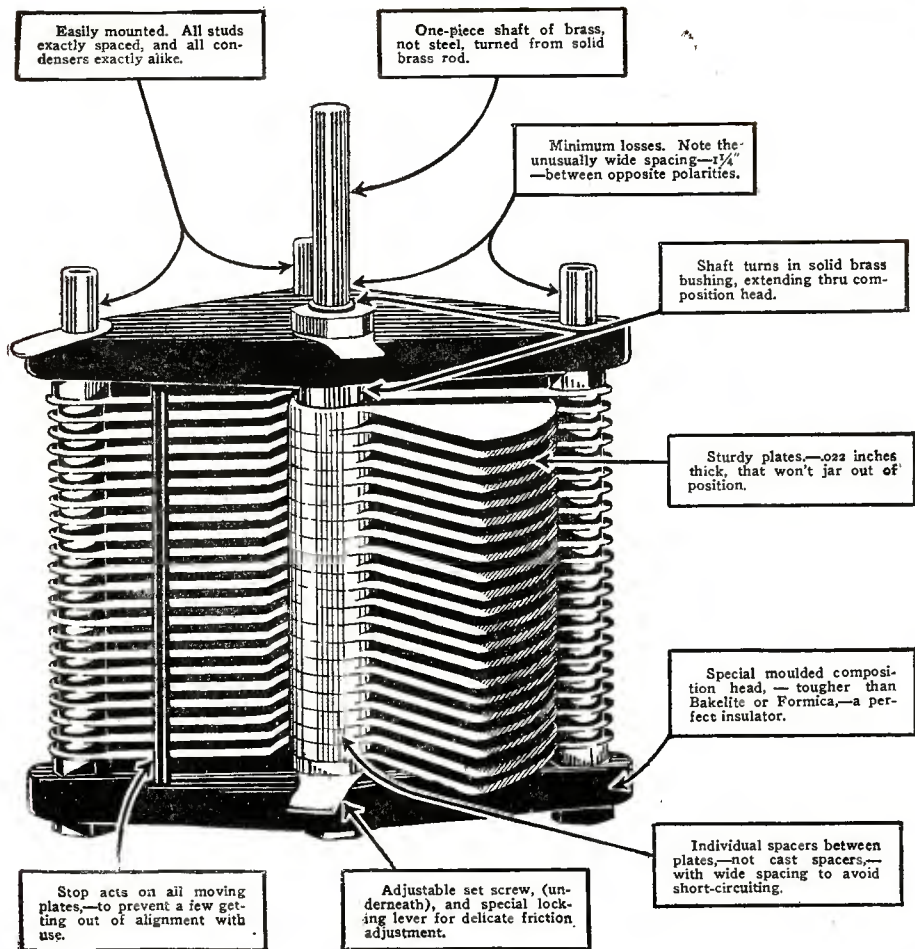

Announcing



(Trade Mark)

Standardized
Variable
Condensers

9 ABC Features

READ carefully the 9 improvements, described above, that lift ABC commercial grade condensers out of the ordinary amateur class. Then remember, that just as important as these superiorities of design, is the entirely standardized production. ABC condensers are produced entirely by automatic machinery,—every detail is mechanically perfect,—and all parts are instantly interchangeable!

Think, also, of the tremendous savings of ABC standardized, quantity methods, in the only radio factory of its kind, and you will realize how we can sell a condenser of commercial quality, *with these 9 valuable features*, at prices within the amateur's reach!

If, after that, you still cannot understand how a professional quality condenser can be sold at these prices, just remember, that altho no one has ever wanted it, you are always protected by the ABC guarantee, "Your money's worth, or your money back!"

Send 5 cents for a copy of our new folder, describing the entire ABC line, including ABC sectional units, ABC standardized small parts, the Vibratone Jr. transmitter, etc.

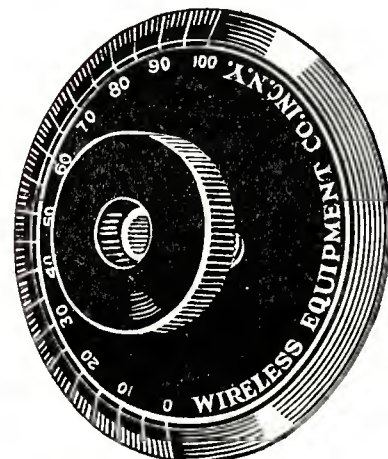

ABC 3" Brass Dials

All ABC condensers are equipped with these non-warping dials of solid brass, and knobs of the same composition material as the head. Price, both assembled and unassembled, always includes knob and dial.

Dials, sold separately, price \$1.00; postpaid or at your dealer's.

Price list of ABC condensers

List No.	Price
650-43 43 plates	\$6.50
Unassembled	5.45
650-21 21 plates	5.25
Unassembled	4.45
650-11 11 plates	4.50
Unassembled	3.60
650-3 3 plates	3.50
Unassembled	2.70

(This last type is used as a vernier condenser for extremely sharp tuning, or as an excellent variable grid condenser.)

Professional Radio Equipment at Amateur Prices



WIRELESS EQUIPMENT CO. Inc.

A.B. Cole
Pres.



188 GREENWICH ST. NEW YORK CITY

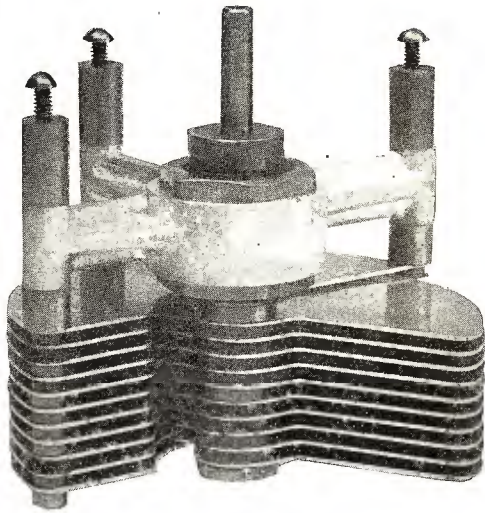

THE CONDENSER WITH A BACKBONE

Our new variable air condenser is ready for the market—for you. It is built—not assembled—with a rigid aluminum casting for a foundation. The plates are of .032 half hard aluminum sheet. The entering edge of the rotary plates is rounded off so that the calibration curve is practically straight. This condenser has but one bearing, of spring controlled double-cone type, which insures smooth, uniform rotation and also automatically takes care of any wear. This condenser can be mounted in either horizontal or vertical position.

Price Unmounted as shown **\$5.00**

We also have in stock for immediate shipment 20/38 S. C. C. Litz—Price, per 100 ft.....40c.

The above articles shipped postpaid upon receipt of remittance. To avoid delay or possible loss, remit by Postal Money Order.

COTO-COIL CO., 87 Willard Avenue
Providence, R. I.

TESTS AND MEASUREMENTS.

The construction of this antenna provided an opportunity to carry on tests and measurements of unusual technical interest. At a given wave-length, the current received by a radio station at a definite distance is inversely proportional to the product of the effective height of the transmitting antenna multiplied by the current in its earth lead. In general, diminished values of effective height correspond to increased values of capacity. Indeed, to increase the capacity the number of antenna wires can be increased within certain limits, which, however, results in increased weight. Consequently, for mechanical reasons, the sag of the wires must be increased, thus diminishing the geometrical height, and, in general, also the efficiency. A similar result is obtained if the antenna is prolonged by obliquely descending leads or if the number of wires in the down lead of the antenna is increased.

At San Paolo attempts were made to obtain a maximum effective height. For this reason an antenna was constructed, made up of a network of wires stretched between three steel spreaders or cables suspended between the three masts. Consider-

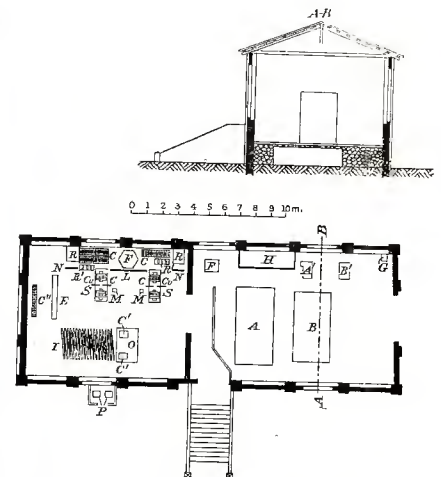

FIG. 1.—GROUND PLAN AND ELEVATION OF ROME RADIO STATION.

- A 250 kw. Set.
- B 200 kw. Set.
- A' B' Auxiliary 110 Volt Set.
- C Shunt Capacity across Arc.
- C Keys.
- C Ground Condenser.
- E Antenna Switchboard.
- F Choke Coils.
- G Illuminating Gas Aspirator.
- H Motor-generator Switchboard.
- I Antenna Inductance.
- L Arc Switchboard.
- M Motor for Rotating Cathodes.
- N Panel Board Carrying Contacts of Starting Arc Resistance.
- O Operating Table Carrying Keys.
- P Blowers for Keys.
- R Arc Starting Resistances.
- S Resistance of Arc Shunt Circuit.
- S Position Axis.

The Photograph on Page 590 Shows the Inside of the Room Placed on the Left of This Plan.

able tension was placed on the wires to insure that the capacity area of the antenna should be at the greatest possible distance from the ground. The shape of the antenna consequently became that of a sort of triangle with curved sides, these sides being the three steel cables mentioned below (Fig. 3). Ultimately the down leads were reduced to 13 in number, very close to each other, and were stretched between the radio station and the mid-point of the nearest side of the triangle. The total resulting capacity was 0.0099 mfd., and it was possible without trouble, to secure an antenna current of 140 amperes at a wave-length of approximately 10,000 meters.

Arrangements were then made to measure the effective height of this antenna by the aid of an experimental loop antenna, consisting of a rectangle of copper wire, set up at Fiumicino in a vertical plane passing thru San Paolo. This latter station was started up and the current induced in the loop antenna when tuned to resonance, was measured. From the known value of the resistance of this experimental antenna, it was possible to calculate the E.M.F. induced, and therefore the effective

ANNOUNCEMENT

ANNOUNCEMENT

THE KARLOWA RADIO CORP.
STOCK ROOMS, 5TH FLOOR BEST BLDG.
MAIN OFFICE, 611 BEST BLDG., ROCK ISLAND, ILL.

**HAS PURCHASED THE ENTIRE RADIO BUSINESS OF
THE YOUNG & McCOMBS CO., OF ROCK ISLAND, ILL.**

The new organization solicits your orders as they have heretofore been placed with the old company. A new catalog is in preparation, and until it is issued, you are requested to make your selections from Catalog B and Supplements of the former Young & McCombs Co. Immediate deliveries are guaranteed on all items. Address all orders and correspondence to

THE KARLOWA RADIO CORPORATION

611 BEST BUILDING

ROCK ISLAND, ILL.

READ the CLASSIFIED ADVERTISEMENTS on PAGES 668-671. YOU'LL FIND MANY GOOD THINGS THERE.

FOR EVERY RADIO STATION

THE MAGNAVOX COMPANY

ANNOUNCES

A NEW DEVELOPMENT

THE

RADIO MAGNAVOX

TYPE R-3



PRICE WITHIN REACH OF ALL
AT

\$45.00

DEALERS WANTED Everywhere

The Radio Magnavox is constructed under the same patents and on the same Electro-Dynamic principle as the Magnavox Radio Telemegafone and will emit the same volume of sound with a slight increase of field current. A 6-volt Storage Battery with Rheostat is recommended for continuous operation.

Consult



PATENTED IN U.S.A. AND FOREIGN COUNTRIES

OAKLAND - CALIFORNIA

THE WORLD'S TUNER MARKET

Y N — France — P O Z — Germany — I D O — Italy. Read in the U. S. with one bulb and single wire aerial 25 ft. high by 40 ft. long. Read unsolicited testimonials and note we always give names. Verify these—we will accept your decision then.

TRESCO TUNERS wound with involute coils have lived to see all others funny wound coils die a natural death.



5000 to 20000 M.....\$10.00 add P. P. Type B.S.
 700 to 5000 M..... 10.00 add P. P. Type A.S.
 200 to 700 M..... 10.00 add P. P. Type C.S.
 Coils of either for panels \$6.00 plus P. P.

MAINE Portland—1-9-21.

Copying Y N — P O Z — O U I easily with one bulb. Thought honey combs were there but there is no comparison.

Ex-ship operator. Paul Girard.

ALASKA Ketchikan—1-3-21.

Copying P O Z — O U I — with Tresco tuner with one bulb. Got this from Pyle your agent. A Tresco booster.

Member A R R L. T. Stocking.

AUSTRALIA Cowra, N. S. W.—11-26-20.

Tresco Tuner is a dandy—getting all the continental arcs—more later. Merry Xmas. C. S. Bonwill.

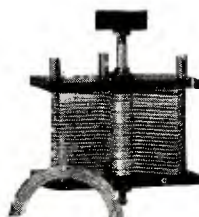

Knocked-Down Condensers

Assemble them and save money.

11 Plate.....\$1.80
 21 Plate..... 2.25
 41 Plate..... 3.20 Add P. P.

If you want us to assemble them for you add \$1.00, plus P. P., to above prices. Shipping weight 2 lbs.

100 brings a wonderful catalog of 16 pages. 100 testimonials and freak hook ups for our tuners.

TRESCO, Davenport, Iowa

WIRELESS

You should have it even if only superficially interested. Around about you every day you read of some marvelous occurrence in which wireless played a distinguished part. It may not be entirely clear to you. The Manual will explain it. To the student of Wireless Telegraphy, the Manual contains much that is indispensable to a proper understanding of the art.

It contains 200 pages, fully illustrating and describing the many instruments used in Radio. 45 pages cover general instructions, diagrams, station calls, tables, codes and other information.

The book is printed on highly finished paper with a two-color cover and measures 9 x 5 3/4 inches.



MANUAL M12

Containing as it does a fund of valuable information not generally contained in a catalogue, it approaches nearer a text book in the fascinating field of wireless telegraphy. No expense has been spared to make it accurate and reliable. No Wireless Experimenter Should be Without the Mesco Wireless Manual. We ask 25 cents (25c) for it—give you a coupon receipt which can be applied on any future order.

Send your name and address now, and get one of the most complete, comprehensive and reliable wireless books published.

MANHATTAN ELECTRICAL SUPPLY CO. INC.

17 Park Place
New York

114 S. Wells St.
Chicago

1106 Pine St.
St. Louis

604 Mission St.
San Francisco

value of the magnetic field. Knowledge of the field intensity permits the calculation of the height of a vertical antenna with quasi-stationary current distribution equivalent to that at San Paolo—i. e., the effective height of the latter antenna. The value actually found was 151.2 meters for wavelengths between 6,500 and 10,000 meters.

In a second series of trials, the antenna at San Paolo was modified in order to increase its capacity. More wires were stretched across the upper portion of the antenna, thus filling up the empty space between the catenary arcs of the steel supporting cables, and the length of the down lead was considerably increased by connecting to the triangular antenna at various points on its upper surface. Thus, the length of the down leads and their distance apart were both increased. The capacity of the new antenna was 0.0112 mfd., and its effective height 138.3 meters (422 ft.).

To obtain the same voltage as formerly secured with the first antenna by 140 amperes, it was necessary to have 158.5 amperes in the antenna. The products of the effective height in kilometers by the current in the antenna in amperes were respectively, in the two cases, 21.2 and 21.9. Thus, the second antenna was superior to the first, and was therefore retained. The total resistance of the antenna was measured by the impulse excitation method, and therefore with damp current. The results obtained are shown in Fig. 4, and agree well with expectations in both dry and rainy weather.

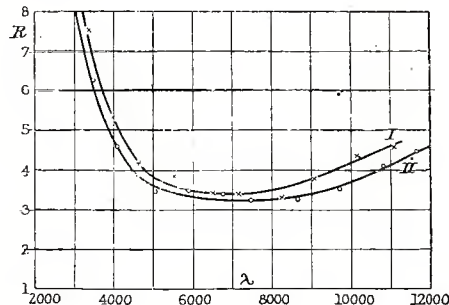

Curves Showing the Relation Between the Resistance of the Antenna and the Wave-Length.

WORKING METHODS.

Signalling is accomplished by short-circuiting a number of turns of the antenna inductance, thus reducing the wave-length in the intervals between signals. These two waves, the "working" (sending) wave for the longer and the "stand-by" (compensation) wave for the shorter, differ by 180 meters when the transmitting wave is 11,000 meters. The existence of two waves is a disadvantage, since it increases interference with other radio stations. Investigations are in progress on methods of eliminating the compensation wave by the use of an artificial absorbing antenna during the spaces between signals. The short-circuiting of the turns of the spiral is done by a number of relay breaks with large silver contacts cooled by air currents. The relays are controlled by a hand key. In order to use a high-speed interrupter, controlled by a Wheatstone transmitter, experiments are being carried out on pneumatically operated keys. Shunted across the arc is an oscillatory circuit of short wave-length, consisting of a capacity of 0.005 mfd. and an ohmic resistance reducing the current in the shunt circuit to two-thirds that in the antenna. The addition of this shunt is advantageous as it permits an increase of 70 per cent. in the effective antenna current.

A number of observations were obtained, keeping constant the supply voltage, the

Insure your copy reaching you each month. Subscribe to Radio News—\$2.00 a year. Experimenter Pub. Co., 236-A Fulton St., N. Y. C.

There is one thing more pleasing than Radisco prices—the actual performance of Radisco apparatus!

A. R. CO. AMPLIFYING TRANSFORMER

Unusual amplification and quietness of operation distinguish the station equipped with the A. R. Co. transformer. In designing this piece of apparatus, particular reference was given to the correct ratio of impedance and turns between primary and secondary.

Another feature which makes this transformer a desirable piece of apparatus, is the simple but very effective mounting of bakelite strips, supporting the laminated closed core and coil, allowing for quick mounting in case or on panel.

A-4 Amplifying Transformer \$5.00
Shipping weight 2 pounds

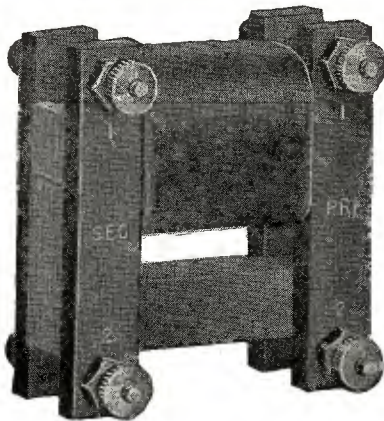

YOU can sometimes equal Radisco quality, but never at Radisco prices.



EVERY single instrument sold by Radisco dealers, under the Radisco trade mark, is unquestionably the best buy on the market, for its particular purpose. You can always count on Radisco equipment for dependable performance.



THE close co-operation of Radisco instruments is an additional feature that adds much to the efficiency of the complete Radisco station, without adding one cent to the cost.

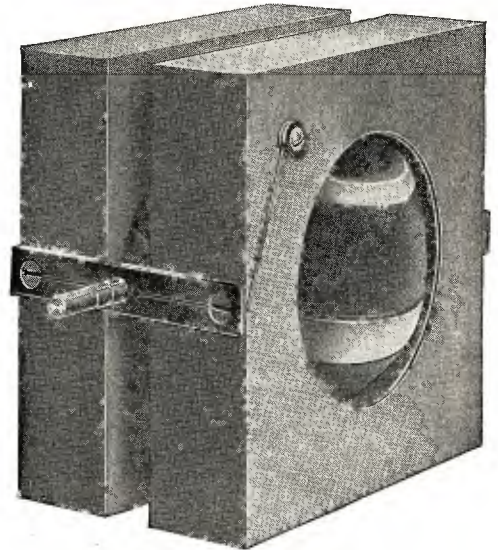

RADISCO VARIOMETER

The latest addition to our Radio family. Like all other Radisco products it has been produced to anticipate and supply the demand for a good short wave instrument, qualified to withstand the acid tests of radio work.

For the radio man who desires an instrument of this character our variometer makes a distinct appeal. Made in one size 4 3/4" high, 3" wide, 5" deep and the shaft is of 3/4" brass, just the right size to fit the number 69 dial; forms are turned from thoroughly seasoned wood and substantial brass bearings provided.

No. 1 Variometer \$7.00
No. 1D Variometer with dial 8.50
Shipping weight 3 pounds

— THESE PROGRESSIVE DEALERS CARRY THE ENTIRE RADISCO LINE —

ALBANY, N. Y.
Shotton Radio Mfg. Co.
8 Market St.

ASHVILLE, N. C.
Hi-Grade Wireless Instrument Co.

ATLANTIC CITY, N. J.
Paramount Radio Supply Co.
518 N. Connecticut Ave.

BEINVILLE, QUEBEC, CAN.
Canadian Radio Mfg. Co.

BOSTON, MASS.
Atlantic Radio Co.
88 Broad St.

BROOKLYN, N. Y.
Kelly & Phillips
312 Flatbush Ave.

CHICAGO, ILL.
Chicago Radio Laboratories
1316 Carmen Ave.

EUREKA, ILL.
Klaus Radio Co.
Branch, Peoria, Ill.

KANSAS CITY, MO.
McCreary Radio Supply
4th and Delaware Sts.

LOS ANGELES, CALIF.
The Wireless Shop
511 W. Washington St.

MONTREAL, QUE., CANADA
J. B. Miller
136 Vendome Ave., N. D. G.

NEW BRUNSWICK, N. J.
Geo. N. DeLaplaine
306 George St. and
8th and Magnolia Sts.

NEW ORLEANS, LA.
Rose Radio Supply
604 Gravier St.

NEWARK, N. J.
A. H. Corwin & Co.
4 West Park St.

OMAHA, NEBRASKA
O-B Radio Supply Co.
406 Crown Building

PHILADELPHIA, PENN.
Philadelphia School of Wireless
Telegraphy
Broad and Cherry Sts.

PROVIDENCE, R. I.
Rhode Island Elec. Equip. Co.
45 Washington St.

PITTSBURGH, PENN.
Radio Electric Co.
3807 Fifth Ave.

PORTLAND, ME.
Atlantic Radio Co.
15 Temple St.

SEATTLE, WASH.
Northwest Radio Service Co.
609 Fourth Ave.

SCRANTON, PENN.
Shotton Radio Mfg. Co.
P. O. Box 3
Branch, 8 Kingsbury St.
Jamestown, N. Y.

WICHITA, KAN.
The Cosradio Co.
1725 Fairmount Ave.

TORONTO, ONT., CAN.
The Vimy Supply Co.,
567 College St.

RADIO DISTRIBUTING CO., Newark, N. J.

This Mark



Your Guarantee



699 Boylston St.
Boston, Mass.

TEL.
BACK BAY
5 9 6 4

DO YOU KNOW ???

That the EASTERN RADIO INSTITUTE offers more undeniable advantages to those interested in studying Commercial Radio than any other school in New England, if not in the country?

DO YOU KNOW that the EASTERN RADIO INSTITUTE is the **OLDEST, LARGEST** and **BEST EQUIPPED** radio and telegraph school in New England?

To make this unmistakably clear we can give the following facts:

The EASTERN RADIO INSTITUTE was founded in 1913 and is now **OVER SIX YEARS OLDER** than ANY OTHER Radio and Telegraph school in New England! All schools starting before us are **NO LONGER IN EXISTENCE!** WE ARE THE PIONEER SCHOOL.

The EASTERN RADIO INSTITUTE actually has **HUNDREDS** of earnest and intelligent students now in attendance. We have given instruction at this date to over **4,000** different students and have actually enrolled, graduated and placed more Commercial operators than **ALL OTHER SCHOOLS IN NEW ENGLAND COMBINED!**

The EASTERN RADIO INSTITUTE is equipped with **THOUSANDS** and **THOUSANDS** of dollars worth of splendid panel spark sets, Federal Arc apparatus, panel receiving sets, storage battery equipment, etc.

DO YOU KNOW that the EASTERN RADIO INSTITUTE has **ALWAYS** placed every graduate in a good position, kept them employed and can actually **GUARANTEE** these positions?

DO YOU KNOW that our graduates may be found all over the world as Chief Operators, Teachers in other Radio Schools, Chief Radio Inspectors, Engineers, Directors of Corporations, Superintendents etc?

DO YOU KNOW that we are the **ONLY** school in New England giving instruction upon actual Federal arc apparatus?

DO YOU KNOW that our systematically planned and thoroughly executed course of practical instruction positively brings **RESULTS**—Your Commercial first grade license.

Certainly these advantages must be apparent to you. Besides it costs no more to take our course, thus availing yourself of our **YEARS** of **RESULTS** and **SUCCESS**. **SUCCESSFUL** graduates of the EASTERN RADIO INSTITUTE are found all over the world! Why not be one?

DAY AND EVENING CLASSES. START ANY MONDAY

Our latest, illustrated prospectus is free. If you cannot visit the Institute send for one. If there is any further information or assistance our organization can give you please command me!

Sincerely yours, F. D. PITTS, Director

A RAY-DI-CO "HYLO" THE DOUBLE DUTY MACHINE

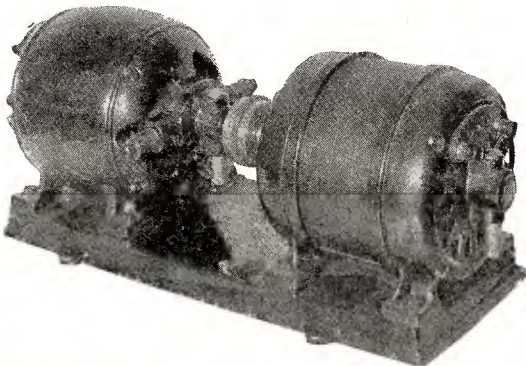

Supplies the high voltage for the plates. **ELIMINATES DEAD** storage batteries at critical moments. **NO MORE** troublesome **CHARGING**, **NO** spilling of **ACIDS**. One turn of the switch and you are supplied with the filament current as well as the plate current. The most effective operating point of the tube is often dependent upon a critical filament voltage and a discharged battery may loose you a DX record. Built in capacities from 30 watt to 175 watts, voltages from 100 to 500 volts for the plates, and from 4 to 10 volts for the filaments. Can be used for receiving circuits, power amplifiers, etc.

Prices upon request, state capacities and voltage desired. Special voltages may be furnished.

RAY - D I - C O
(Ray-Dee-Ko)

2653A N. Clark St.

Radio 9 AG

Chicago, Ill.

arc shunt circuit and the width of the air gap in the magnetic circuit of the arc. In each case the electrodes were adjusted to the best distance apart. A number of quantities were measured as functions of the wave-length.

RECEIVING ARRANGEMENTS.

The radio station at San Paolo has two receiving stations. One of these is of the ordinary type, installed in a small room adjoining the transmitting station. This room is lined with metallic netting connected to earth, in order to protect the receiving apparatus against excessive induction from the transmitter. An underground wire joins the receiving room with the transmitting room in order to carry antenna current into the former. There have been installed receivers of the Royal Navy type. Other underground conductors permit control of the transmitting relays by a key situated in the receiving room.

The second receiving station, situated near Monte Rotondo, was intended to permit duplex operations in working with America. It receives from America by means of a loop antenna, the plane of which points at the American transmitting station, and is perpendicular to the line adjoining Monte Rotondo and San Paolo. Accordingly, reception is only slightly influenced by transmission at San Paolo, and thus the American station can be received at any time.

The total number of words transmitted and received in one year from the San Paolo station and the Monte Rotondo (July, 1918, to June, 1919) is 728,249. The cost of this station, in round numbers is a little less than 1,000,000 Italian lire (£40,000 at pre-war exchange rate).

From June 1st to October, inclusive, reception is difficult from eight o'clock onwards. Strong atmospheric disturbances begin at about three o'clock in the morning and by eight o'clock have reached a considerable intensity, which then gradually increases.

November and December are the best months for reception, but reception from America was never interrupted, except during times of heavy storm near the receiving station.

**Abstract of the "Proceedings" of the Institute of Radio Engineers.*

A New Code Teacher

(Continued from page 594)

in any desired order so that the message may be varied ad infinitum at the will of the operator.

By means of pins which may be seen on the photograph of the instrument, and, which when introduced into holes drilled in the drum, make a camshaft turn a fraction of a turn, one spring comes in contact with the drum at a time exactly between two fractions of a message.

The drum is easily removable to be replaced by others of the same type, making this instrument the most practical code teacher actually known.

Commercial Radiofone at Avalon, Catalina Island

(Continued from page 598)

of a coil and variable condenser which forms a closed circuit.

By tuning the two circuits a point is found where the fone conversation is almost entirely eliminated while the spark signals come in at their normal maximum.

The call letters of the Avalon radiofone are KUVX and those of Long Beach radiofone KUXT. These stations are operated by the Pacific Telephone & Telegraph Co.

Order Your Radio Goods by Mail—from Continental!

THE sensational success of the Continental Store in New York has led to the extension of Continental Service to all parts of the U. S. and Canada. Customers here in our store have marvelled at finding such complete assortments in one store; they have wondered at a radio store so up-to-date in new apparatus; they have been delighted with the courteous, interested attention they received.

Every advantage of our location—in the heart of New York—of our standing with the leading manufacturers; of our ideals of service and the square deal, are now available for you, wherever you live. Order your radio needs direct from this advertisement, and expect: shipments the day your order is received—exact compliance with the terms of your order—and apparatus that is packed to arrive in perfect condition. Make your remittance, preferably by check or P. O. Money Order. If you have never experienced Continental Service before, you are due for a pleasant surprise.

Amplifying Transformers
 No. A-2 Acme, mounted \$7.00
 No. A-2 Acme, semi-mounted 5.00
 No. A-2 Acme, unmounted 4.50
 No. 226-W Federal.... 7.50

"B" Batteries
 No. 7628 Standard, 22.5 V small 1.50
 No. 7625 Standard, 22.5 V large 2.65
 No. 7650 Standard, 22.5 V variable 3.50
 No. 766 Eveready, 22.5 V large 3.50
 No. 763 Eveready, 22.5 V small 2.25
 No. 703 Eveready, flashlight cells, set of 10, 45 V 3.50

Books
 Practical Wireless. By Bucher 2.25
 Experimenters Manual. By Bucher 2.25

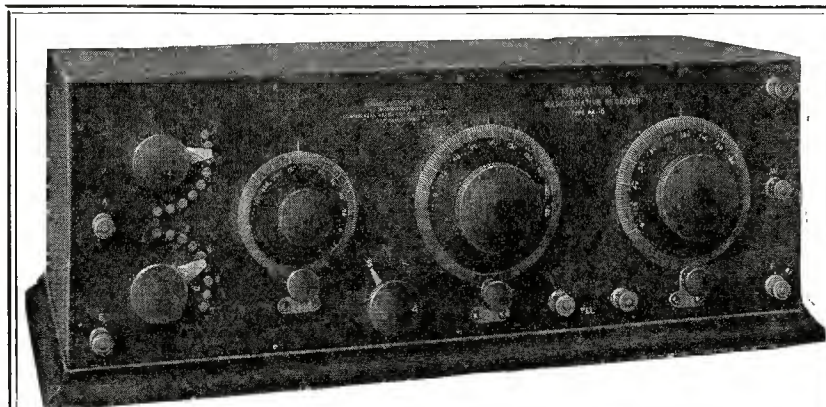

Licensed Under Armstrong and Marconi Patents.

PARAGON R. A. TEN

(Reg. U. S. Pat. Off.)

Amplifying Short Wave Receiver

THERE are plenty of receiving sets for less money than Paragons. However, the difference in performance is invariably far greater than the difference in price. A genuine Paragon R. A. Ten costs Eighty-five Dollars, BUT, *It's a Paragon*—there is no better. Check up these superiorities against any other receiving set:

- Wave length, 160 to 1000 meters
- Amplification 100 times.
- No dead end losses whatever.
- Vernier attachments on all controls.
- Coupling has scale of 180°.
- 24% greater selectivity than even the Paragon R. A. 6!
- Free from all body capacity effects.
- Guaranteed for two years.
- "The weaker the signal, the stronger the amplification."

Price Eighty-five Dollars

For Your Own Protection:—Genuine Paragons are made only by Adams-Morgan Co., and sold by Continental and affiliated dealers.

If it isn't an R. A. Ten, it isn't a Paragon,—Look for the full name engraved in the Bakelite Panel.

Vacuum Tubes. By Bucher \$2.25
 How to Pass U. S. Exams. By Bucher... .75
 How to Conduct Radio Club. By Bucher... .75
 Practical Wireless Stations. By Bucher... .75
 Radio, Telephony. By Goldsmith 2.50
 Radio Ins. and Measurements 1.75
 Elem. Princ. of Wireless. By Bangay:
 Part 1 1.75
 Part 2 1.75
 Both for 3.25
 Robinson's Manual of Wireless Tel. 2.50
 Consolidated Call-Book (new edition) 1.50
Audion Control Panels
 No. RORA Grebe, in Cabinet 12.50

Get Our New 112-Page Catalogue

It contains undoubtedly the widest assortment of radio goods ever assembled together. The appendix contains valuable tables for quick figuring of all radio calculations, as well as the conventional signals, abbreviations, etc. This catalog mailed anywhere in the world for 25 cents

Send for your copy today

No. RORH Grebe with tickler connections \$17.00
 No. ZRD Clapp-Eastham (new type).... 12.00
 No. Y-1 Acme (latest model) 10.00
 No. P-500 DeForest, audion ultra-audion type with 45 V "B" battery 24.00
 Adams-Morgan "Paragon" special, just out 6.00
 A1-10 Radio-Craft.... 15.00

Loose Couplers
 No. A-1 Arnold, 3500 meters 22.00
 No. Y-673 Clapp-Eastham, 3000 meters 14.00
 No. 344 Murdock, 1500 meters 9.00

No. RKAB Grebe Variometer — coupler, 1000 meters, in cabinet \$25.00

Variable Condensers
 Connecticut, 41-C, .001 M F D 6.50
 Connecticut, 42-C, panel mounting 6.50
 Gen. Radio, 182 A, .007 M F D 12.00
 Murdock 366, .001 M F D 4.75
 Murdock 367, .001 M F D 4.75
 Murdock 368, .0005 M F D 3.75
 Chelsea 140, .0012 M F D 5.00
 Chelsea 240, .00068 M F D 4.50

Our Word of Honor to You Is Our Guarantee, —Let Us Prove It!

We have never heard of anyone who was disappointed at the treatment he received at our store. You may be sure, we will do everything in our power to preserve this reputation, in our dealings with you.

Storage Batteries
 10004 6 V 60 Ampere Battery 20.00
 10005 6 V 80 Ampere Battery 26.25
 All batteries are shipped fully charged.

Anti-capacity Switches
 No. 1424 W, D P D T 12 springs 2.80
 No. 1426 W, D P S T 4 springs 2.55
 No. 1427 W, S P S T 4 springs 2.60

Telephone Jacks
 1421 W Open Circuit Jack70
 1422 W Closed Circuit Jack85
 1423 W, Two Circuit Jack 1.00
 1423 W Plug 2.00
 Special Cicco Plug.... 1.50

Duo Lateral Coils
 Un-mount-ed.
 DL 25 1.65
 DL 35 1.70
 DL 50 1.75
 DL 75 1.85
 DL 100 1.95
 DL 150 2.10
 DL 200 2.20
 DL 250 2.30
 DL 300 2.45
 DL 400 2.60
 DL 500 2.75
 DL 600 3.05
 DL 750 3.30
 DL 1000 3.55
 DL 1250 3.85
 DL 1500 4.10

Mount-ed.
 DL 25 1.90
 DL 35 2.00
 DL 50 2.10
 DL 75 2.20
 DL 100 2.30
 DL 150 2.40
 DL 200 2.50
 DL 250 2.60
 DL 300 2.70
 DL 400 2.80
 DL 500 2.90
 DL 600 3.00
 DL 750 3.10
 DL 1000 3.20
 DL 1250 3.30
 DL 1500 3.40

CONTINENTAL RADIO AND ELECTRIC CORPORATION

J. DI BLASI, Secretary

Our word of honor to you is our guarantee. Let us prove it.

J. STANTLEY, Treasurer

DEPT. C 32

6 WARREN STREET

NEW YORK

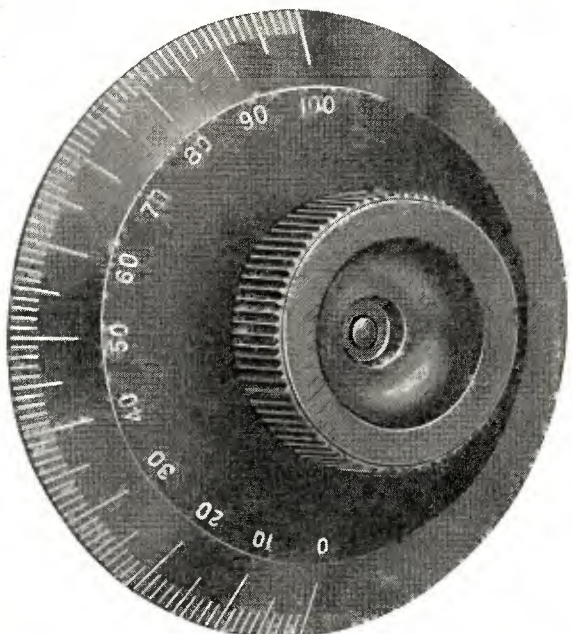

Chelsea Bakelite Dial No. 41

The Chelsea dials are made of genuine bakelite, beautifully finished, and bear a 100 division semi-circular scale. This scale is of white characters and so constructed as to be both deep-set and sharply defined. These divisions and characters are permanent and will neither wear off nor fall out.

The dial is 3 1/4" in diameter, 1/4" thick, with a long, sloping, easily read marking. The edge is sharp and permits accurate settings to be made. The knob also is of bakelite 1 3/8" in diameter, with a fine, straight knurled edge, which greatly aids the making of fine adjustments. These two parts are permanently fastened together by a long brass bushing which also serves to carry the set screw for attaching to the instrument shaft, and more important to give perfect alignment in use.

Chelsea bakelite dials run true and will not warp.

Dials only, without knob and bushing, are furnished with our well-known elongated hole, and may be placed upon any of our unmounted condensers now in service.

The complete dial and knob is made to fit either 3/16" or 1/4" shaft. Specify size when ordering, otherwise the 1/4" hole will be furnished.

Panels equipped with our circular dials are both easier to operate and more attractive.

Chelsea dials are beautiful in appearance, low in price, accurate and durable in service, unexcelled by any, at any price.

Dial only, \$.75 Dial and knob complete, \$1.00

*Purchase from your dealer
Bulletin sent upon request*

CHELSEA RADIO COMPANY 17 FIFTH STREET
CHELSEA 50 MASS.
Manufacturers of Radio Apparatus Moulders of Bakelite

Recent Attainments in Wired Radio

(Continued from page 593)

ive distance between the conductors, which in the case of an elevated wire with ground return, is equivalent to the distance between the wire and its "electrical image" in the earth or to twice its physical height above the ground. This distance, of course, is many times greater than the spacing between the two metallic conductors and hence at frequencies where the radiation plays an important part, the effective resistance of the latter system should be much less than the wire-ground system. This conclusion is borne out by the tests referred to and by actual resistance measurements which are described later on.

The question of cross-talk was investigated, as it was believed that at the high frequencies inter-line disturbances might be prohibitive of utilizing the same carrier frequency on more than one line or pair of lines on the same pole. In the Washington-Baltimore tests, it was found that it was possible to receive signals with the lead wire to the receiving apparatus disconnected from the line in question and held in the immediate vicinity of the same or wrapt around, but not making contact therewith. Signals of reduced intensity were also received with the lead wire connected to other immediate adjacent lines on the same cross-arm. Complete elimination of cross-talk to other lines, however, was obtained when the first few miles of conductor adjacent to the transmitting apparatus ran thru underground cable. When employing an entire metallic circuit, at the very highest frequencies used, there was a complete absence of cross-talk to the other conductor pairs on the same pole line.

The problem of multiplexing the lines was also studied, but limitations in time available for field operations did not permit of utilizing the degree of thoroughness which the successful solution of this intricate problem demands.

As a prerequisite to the solution of the main problem of multiplex there are the solutions of the two allied problems of multiple transmitter operation and duplex telephony; by duplex telephony is meant simultaneous transmission and reception, accomplished without the assistance of switching devices. The difficulties encountered in multiple transmitter operation are not serious and are easily overcome; those encountered in duplex telephony, however, if the band of frequencies available is restricted, are most serious, and become almost insurmountable if the receiver sensitivity is at all heightened by the use of radio frequency amplifiers. Utilizing artificial line loads, the design and construction of which is described elsewhere in this paper, the problem has been successfully solved in the laboratory at the present writing.

Wireless Telegraphic Printing of the Creed Automatic System

(Continued from page 601)

are as many cylinders and pistons as there are characters to be printed and the wonderful part of the mechanism is that whereby the cylinder connected with any particular letter that has to be printed is connected to the air supply at the right moment. This is effected by the sliding per-

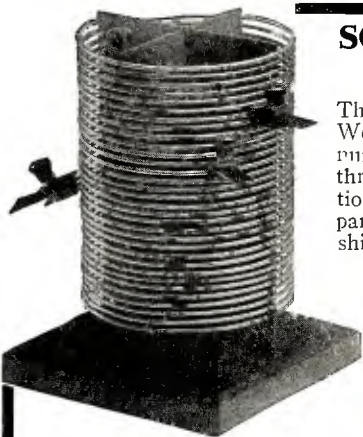

SOMETHING NEW IN C. W. INDUCTANCES

The Radio Service Type S50 C. W. Inductance is Wound on a slotted bakelite form of 31 turns of number 9 hard drawn copper wire. Supplied with three clips making adjustment variable to any fraction of a turn. Tunes to 350 meters and suitable for panel or bench mounting. Materials and workmanship the finest obtainable and the price is *only* \$8.50.

If you are starting to build a C. W. set the Radio Service Inductance will start you on the right track or if you already have a C. W. Set and you are not getting the proper results try one of these inductances and you will be surprised at the increased operating efficiency.

Ask your dealer to show you one of these inductances. If he can't supply you, we will ship you one post paid.

Reduced Prices On Our Products

- Type S-11—Audion Control Panel (as illustrated) \$6.00
- Genuine Bakelite Panel, Navy cage type rheostat and socket.
- Type S-14—Navy Cage Type Rheostat 2.00
- Type S-27—Insulate Knob Binding Post60
- Type S-23—1 1/8" Bakelite Knob, tapped 8/32"15
- Type S-17—Nickel Plated Crystal Cup.. .25
- Type S-24—Aluminum Socket only..... .50
- Type S-10—Single Tube..... 1.10
- Type S- 3—Double Tube..... 2.50
- Type S- 4—Triple Tube..... 3.50
- Type S-40—Variable Grid Leak .5 to 3 megohms75

(Increases your signal audibility.)

All leading dealers or by mail from

RADIO SERVICE & MFG. CO.
Lynbrook, L. I. New York

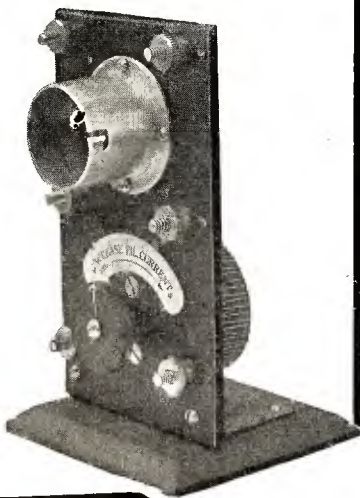

The ESCO Regenerative Receiver

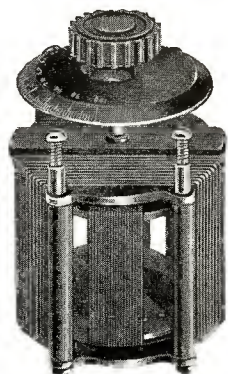

THE VARIOMETER

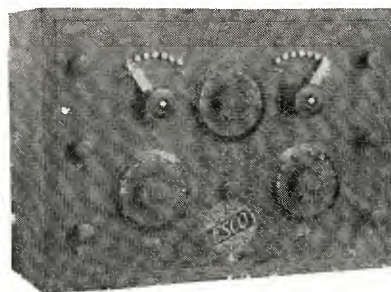

THE SET

This is to announce the arrival of a new type of vario-coupler and variometer of an entirely revolutionary design.

The ESCO regenerative receiver combines the above instruments to such good advantage that unparalleled results are being reported by its use.

The vario-coupler is made of Bakelite; no wood is used in its construction and as a result we have an instrument that is not only more efficient but also very superior to those now on the market. The windings themselves are unique in that the primary and secondary are in most places only separated by air instead of the usual wood forms now in common use. This cuts down dielectric losses to almost nothing. In fact, these windings are separated from each other by a space less than $1/32$ of an inch in width. In consequence very fine tuning is obtained. The primary of the coupler is controlled by two switches marked L and S. The S switch controls single turns for six turns and the L switch controls six turns at a time. The switch levers are laminated and made of the best nickel-plated phosphor bronze.

The variometers are manufactured on the same design as the coupler and are of the same excel-

lent construction. The tuning of the set is effected by the Grid variometer and regeneration is controlled by the Wing variometer.

The wave length of the ESCO regenerative receiver is 150 to 500 meters and can be increased by use of a variable condenser in the circuit. The receiving range is greater than that of any similar set now on the market. Radio telephone reception is clear and loud because of the peculiar construction of the tuning instruments thru which extremely precise tuning can be accomplished. For short wave C. W. reception unbelievable distances have been covered.

The cabinet of the outfit is of quartered oak finished with the skill acquired only by long years' experience in wood working. The panel is of black polished Formica and the dials are black Bakelite with graduations of 1-100. Binding posts are of black Bakelite.

On Trial Tests the following Radio Telephone Stations were heard

Call

WA-7 McCook Field, Dayton, Ohio
 UC University of Cincinnati
 WL-1 Speedway, Indianapolis, Ind.
 1-XF Westinghouse, East Pittsburgh, Pa.

Call

Deal Beach
 NSF- Bureau of Standards,
 Long Island.
 8XB Precision Equipment Co.
 Ossining, N. Y.

The price of the ESCO regenerative set is \$50.00 f. o. b. Columbus, Ohio. Shipping weight is 11 pounds. Order from us or through your dealer. Dealers write for our proposition.

Send 15 cents for our large illustrated catalog. This amount will be refunded on your first order for \$1.50 or over. High printing costs make free distribution impossible.

The Electrical Specialty Company

Two Offices for your convenience

Dept. M, 48-50 So. Front St.
 Columbus, Ohio

Dept. M, 20 N. 9th Street
 Philadelphia, Pa.

CO-OPERATIVE RADIO BUYING

Co-operative buying brings the amateur the best in radio equipment at a saving. It also brings the best of service. The following items are indicative of the large and varied assortment we handle. Remit these list prices and you will learn what co-operative buying means. Stamp brings detailed information.

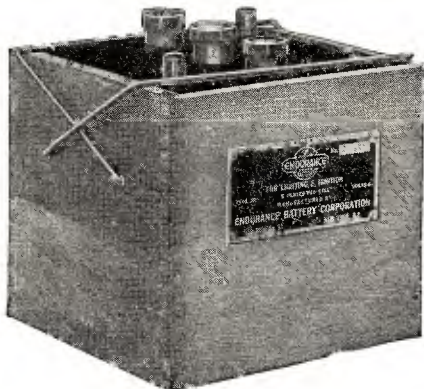

SPECIAL BATTERIES

- 6 volt 20-40 ampere battery.....\$12.50
- 6 volt 40-60 ampere battery..... 21.00

MARKO BATTERIES

- 4 volt 20-40 ampere hour..... 10.00
- 6 volt 20-40 ampere hour..... 15.00
- 6 volt 40-60 ampere hour..... 18.00
- 6 volt 60-80 ampere hour..... 22.00

(War tax included in list prices)

B. BATTERIES

- Cyclone 22½ volt small..... 1.25
- Cyclone 22½ volt large..... 2.40
- Eveready small, 22½ volt..... 2.25
- Eveready large, 22½ volt..... 3.50
- Eveready large, variable..... 3.65

Write us your radio requirements whether it be a complete set of any size or a unit for your set of any standard make. We will give you the best of service at a guaranteed money saving.

MUTUAL PURCHASERS ASSOCIATION 2 Stone St., Dept. R-3
NEW YORK CITY

SOUND AMPLIFIERS

Doolittle Amplifone, Type "A".....\$20.00

VT TUBES

- Radiotron detector UV-200..... 5.00
- Radiotron amplifier UV-201..... 6.50
- Moorhead electron relay..... 6.00
- Moorhead amplifier..... 7.00

HONEYCOMB COILS

- | | |
|-------------------|-------------------|
| DL- 25.....\$1.65 | 130- 375 meters |
| DL- 35..... 1.70 | 180- 515 meters |
| DL- 50..... 1.75 | 240- 730 meters |
| DL- 75..... 1.85 | 330- 1030 meters |
| DL- 100..... 1.95 | 450- 1460 meters |
| DL- 150..... 2.10 | 660- 2200 meters |
| DL- 250..... 2.30 | 930- 2850 meters |
| DL- 300..... 2.45 | 1300- 4000 meters |
| DL- 400..... 2.60 | 2050- 6300 meters |
| DL- 500..... 2.75 | 3000- 8500 meters |
| DL- 600..... 3.05 | 4000-12000 meters |
| DL- 750..... 3.30 | 5000-15000 meters |
| DL-1000..... 3.55 | 6200-19000 meters |
| DL-1250..... 3.85 | 7000-21000 meters |
| DL-1500..... 4.10 | 8200-25000 meters |

AMPLIFYING TRANSFORMERS

- Acme "Latest" type..... \$5.00
- Federal, fully mounted..... 7.50
- Radisco, fully mounted..... 5.00

AUDION CONTROLS

- Grebe RORA cabinet..... 12.50
- Y-1 Acme in cabinet..... 10.00
- A. M. New Paragon..... 6.00

COMPLETE SETS

- Amateur wave lengths..... 15.00
- Commercial ship station..... 25.00
- European stations..... 50.00

forated plates, which constitute a very elaborate form of slide-valve controlling the access of air to the whole of the cylinders but admitting the pressure to only one cylinder at a time. The motions of these sliding plates are in turn controlled by the little pins, which are all the time feeding for the holes in the perforated tape as it passes by and working in and out of these holes.

Fig. 6 is reproduced in facsimile from a message received by the Wireless Society of London from Paris. Fig. 7 shows another portion of the message with the corresponding portion of tape punched by the receiving apparatus.

Paper read by the author before the Wireless Society of London.

The Use of A.C. Potential with V.T. Transmitters

(Continued from page 604)

and D. C. values? The following simple analysis will show this.

Assume that the filament operates at a constant given filament current. The given D. C. plate voltage is v_1 , which draws a plate current of i_1 . Then the power input into the tube operating on D. C. is

$$P_1 = v_1 i_1 \quad (1)$$

We are interested in knowing what the A. C. potential will have to be to obtain the same power input. Let us assume for the start that the A. C. potential is active all the time (actually it is active but one-half the time). Let V_{max} and I_{max} represent the maximum amplitudes of the A. C. plate potential and plate current. Then the power input is given by P_2 which is

$$P_2 = V_{eff} \times I_{eff} = \frac{V_{max}}{\sqrt{2}} \times \frac{I_{max}}{\sqrt{2}} = \frac{V_{max} I_{max}}{2} \quad (2)$$

In order for P_2 to equal P_1 the following must hold

$$\frac{V_{max} I_{max}}{2} = v_1 i_1$$

$$\text{or } \frac{V_{max}}{\sqrt{2}} = v_1 \text{ and } \frac{I_{max}}{\sqrt{2}} = i_1$$

or, for the same power the effective values of A. C. plate potential and plate current are equal to the D. C. values, which is what we should have expected at the start, from the laws of alternating currents. But the plate potential is active only one-half the time, hence the power input into the tube must be half that given above in equation (2), namely

$$P_2 = \frac{1}{2} \times \frac{V_{max} I_{max}}{2} = \frac{V_{max} I_{max}}{4}$$

which is the actual input when A. C. is used. Now in order that this power, which is the input using A. C., be equal to the D. C. power P_1 , then $P_1 = P_2$, or

$$v_1 i_1 = \frac{V_{max} I_{max}}{4}$$

$$\text{or } V_{max} I_{max} = 4 v_1 i_1 \quad (3)$$

which is the relation which must be satisfied if the A. C. power equals the D. C. power.

If now the tube is worked so that the effective plate current on A. C. is equal to the plate current with D. C., which is reasonable for economical operation of the filament, then

REMLER No. 93 A—BATTERY — POTENTIOMETER

Increases detector sensitiveness and signal audibility.

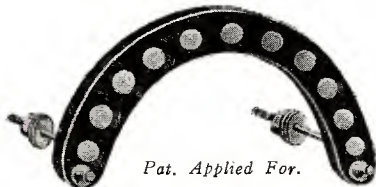

- No. 93—Remler A-Battery Potentiometer Unit only, with studs for panel mounting **.75c**
- No. 94—Remler Rotary Lever Switch for use with No. 93 Unit **.45c**

THE plate voltage of any detector tube must be carefully adjusted for maximum sensitiveness and signal audibility. Potentiometer control provides close adjustment with ease of operation. This new Remler Unit with metal inserts provides positive definite electrical contact and eliminates the uncertainty of carbon to graphite contact. This Remler Unit is not brittle and is connected across the A-Battery to control the plate potential over a six volt range by half-volt steps. Circuit diagram furnished with each unit.

"Apparatus that Radiates Quality."

REMLER RADIO MFG. COMPANY

163 Sutter Street

E. T. CUNNINGHAM, Sales Mgr.

San Francisco

HOT WIRE AMMETER

Special Flush Mounting \$ **8**

Hot wire ammeter Roller Smith with scale 0-1, 0-2½, 0-5.

Sent postpaid for \$8, while they last.

PHILADELPHIA SCHOOL OF WIRELESS TELEGRAPHY
PARKWAY BLDG. BROAD AND CHERRY STREETS

RADIO APPARATUS

*Distributors of Reliable Radio Apparatus
to Schools, Colleges and Experimenters
All Over the World!*

"PITTSO"

The sign of service and prompt delivery.

Why not let us prove it!



"SPECIAL"

Our New Catalog No. 22 is just out.

Insist upon your copy!

AMRAD APPARATUS

Type A. VT detector in cabinet.....	\$15.00
" " One-step amplifier	21.00
" " VT detector and 1 step.....	34.50
" " VT two-step amplifier.....	39.50
No. G-1 1 K.W. quench gap.....	41.50
No. G-2 ½ K.W. quench gap.....	24.50
No. A-2 ½ K.W. quench gap resistance.....	5.95
No. G-3 ¼ K.W. quench gap.....	12.00
Type D Variometer in cabinet.....	14.50
" " Vario-coupler in cabinet.....	17.50
" " E Crystal receiving set.....	23.50
Amrad Lightning switches, 100 Amp.....	9.85

F. D. Pitts Co., Boston, Mass.

ACME APPARATUS

No. F-1 ½ K.W. trans., bakelite panel type...	30.00
No. M-2 Oil condenser .0035 M.F. Self-heating, good value	29.00

F. D. Pitts Co., Boston, Mass.

BUNNELL APPARATUS

No. B-1 Three slide tuner, 2000 meters. A Dandy	4.95
No. 7751 Mascot spark gap, 1 K.W. size, heavy duty	2.95
No. 8854 Jove crystal detector.....	2.00

F. D. Pitts Co., Boston, Mass.

CLAPP-EASTHAM APPARATUS

No. 652 Large oscillation transformer, 1 K.W. size. Splendid value.....	17.50
No. ZRL 400 Watt power transformer, unmounted type	12.95
No. 651 Oscillation trans., suitable up to 1 K.W.	14.95
No. F-656 Large plain spark gap, marble base, heavy points	3.75
No. Z-5002, 10 Step variable inductor.....	13.95
No. F-659 Type D variometer coupler, 1500 meters	12.95

F. D. Pitts Co., Boston, Mass.

DE FOREST APPARATUS

No. LL-300 Litz coils.....	1.96
No. LL-750 Litz coils.....	2.75
No. LL-1000 Litz coils.....	2.95

No. UCV-1500, .0015 M.F. variable condenser on unit panel.....	13.95
No. CV-1500, .0015 M.F. variable condenser, unmounted.....	13.90
No. CV-500A, .0005 M.F. variable condenser, without knob and pointer.....	3.95
No. CS-1502, .0015 M.F. bridging condenser, in cabinet.....	5.95
No. CS-3002, .003 M.F. bridging condenser, in cabinet.....	5.95
No. US-400 2-point Audion, Ultra Audion switch on unit panel.....	1.95
No. 1 Small variometer tube.....	.25

F. D. Pitts Co., Boston, Mass.

GREBE APPARATUS

No. PDA, 4" 0-100 bakelite dials.....	3.00
No. PDB, 4" 0-50 bakelite dials.....	2.75
No. PDC, 3" 0-100 bakelite dials.....	2.50
No. PDD, 3" 0-50 bakelite dials.....	2.25
No. PSA Switch arm.....	.95
No. RORA VT control cabinet.....	12.50
No. RORZ 4 tube mount, ideal for radiophones	11.95

F. D. Pitts Co., Boston, Mass.

KILBOURNE AND CLARK APPARATUS

No. K-1 ¼ K.W. power trans., mounted.....	9.95
No. K-2 ¾ K.W. power trans., unmounted....	7.95
No. K-3 Change-over switch, bakelite base, very rugged	4.95
No. K-4 Hand key. A beauty.....	3.95

F. D. Pitts Co., Boston, Mass.

INTERNATIONAL RADIO APPARATUS

No. RTD-102A VT control panel.....	13.95
No. RTA-104A 1 step amplifier.....	23.95
No. TXL-100A Oscillation transformer up to 1 K.W.	14.95

F. D. Pitts Co., Boston, Mass.

FIRTH APPARATUS

Type C Baldwin telephones.....	16.50
Type E Baldwin telephones.....	20.00
Type F Baldwin telephones.....	21.00
Baldwin head band only.....	1.75

F. D. Pitts Co., Boston, Mass.

THOROARSON APPARATUS

No. T-1 Type R ¼ K.W. power transformer..	14.95
No. T-2 Type R ½ K.W. power transformer....	22.00
No. T-8 8-point rotor.....	5.00
No. T-16 16-point rotor.....	5.00

F. D. Pitts Co., Boston, Mass.

MISCELLANEOUS APPARATUS

HOYT jeweled bearing 0-3 amps., flush mounting D. C. ammeters, 3" dia. A splendid value	6.95
TUSKA ticklers, in cabinet, will make any circuit regenerate	6.95
WIRELESS SPECIALTY, eaton oscillators, in beautiful oak cabinet.....	13.95
RADIO APPARATUS, 3500 meter couplers mahogany throat. Gets NAA fine.....	24.95
STERLING voltmeters, 3" diameter, 0-50 N.P. front of board mounting. Just the thing for "B" batteries	2.95
CENTURY induction motors 1/10 H.P., R.P.M., 1750, runs on 110 or 220, just the thing for Benwood or Bell gap.....	29.95

COUCH Yankee well phones, ideal between house and radio shack, per pair.....	11.95
PITTSO heavy 3 ft. double telephone cords, ideal connectors. While they last.....	.19
TECO Honey-comb coil stands, mounts two Murdock var. condensers, using Honey-comb coil adapters, one of which is movable for coupling, stands only (makes splendid coupler)..	1.95
WAYNE 50 watt, bell ringing transformers, 20 voltage variations, 4 to 30 volts.....	4.95
HAYWARD rotary spark gap, operates on 6 volt battery, or on 110 volt thru step down trans. Can be used up to ½ K.W.....	9.95
SLEEPERS Radio Experimenters' Handbook. All the new apparatus illustrated and described..	.95
DE FOREST Amateur's Handbook. "How to Set Up a Wireless Station".....	.10
PITTSO No. 22 and 24 specially insulated magnet wire, great for variometers, etc. While it lasts, per lb.....	1.19

F. D. Pitts Co., Boston, Mass.

Important! Our new catalogue No. 22 illustrating, describing and pricing our immense stock of radio apparatus sent upon receipt of 10 cents. Insist upon receiving your copy! "Over 100 Pages, Over 150 Illustrations, Over 600 Items."

Pittsco service reaches all over the world! Why not let it reach you!

F. D. PITTS CO., Inc.

12 Park Square

Dept. C

Boston, Mass., U. S. A.

Cable address "PITTSO" Boston

ACE

"IF IT'S RADIO WE HAVE IT"

We list below a few good values, taken at random from our large and complete stock, which, in addition to our own products, includes accessories manufactured by other reliable concerns such as Acme, Adams-Morgan, Amrad, Atlantic Radio Supplies, Benwood, Bunnell, Burgess, Chelsea, Clapp-Eastham, Connecticut, De Forest, Electrore, Federal, Firth, General Radio, Jewell, Harlowa, Klitzen, Magnavaux, Marko, Murdock, Pacent, Radio Corp. of America, Radio Electric, Radisco, Skinderviken, Somerville Radio, Thordarson, Wireless Press, Wixico.

ANTENNA MATERIAL		CRYSTAL RECEIVER\$23.50	
Bamboo Spreaders		CRYSTAL DETECTOR 2.80	
8 ft. lengths.....	\$1.00	RECEIVERS	
12 ft. lengths.....	2.25	Baldwin Navy.....	16.50
16 ft. lengths.....	3.00	Brandee Superior.....	8.00
7-22 Std. Wire, per ft.....	.01 1/4	Murdock 55-3000.....	5.50
10" Electrore.....	.75	Murdock 55-2000.....	4.50
Ball type Electrore.....	.35	STORAGE BATTERY	
AMPLIFYING TRANSFORMER		Marko 6V 40A CAP.....	16.25
Acme Semi-mounted.....	5.00	Marko 4V 40A CAP.....	10.75
ANTI-CAPACITY SWITCH.....	2.80	VACUUM TUBES	
ANTENNA SWITCH.....	4.50	E. R. Detector.....	6.00
LIGHTNING SWITCH.....	4.50	Amplifier.....	7.00
BURGESS B. BATTERIES		Ex. Hard Transmitter.....	7.50
22 1/2 V-1200 hrs.....	3.50	Radiootron Detector.....	5.00
4 1/2 V-200 hrs.....	.40	ACE VT SOCKET.....	1.50
CONDENSERS—VARIABLE		WIXICO MOUNTING	
Connecticut .001.....	6.50	For D-L or H-C Coils	
C-E Bal. with dial.....	9.50	Table Type.....	8.00
C-E .0006 with dial.....	7.50	Panel Type.....	6.00
Murdock mtd .001.....	4.75	VARIOMETERS	
Murdock Interior .001.....	4.25	Amrad Mounted.....	14.50
Murdock .0005 mtd.....	4.00	C-E with dial.....	8.50
INSTRUCTION BOOKS		Radisco with dial.....	8.50
Experimenter's Manual.....	2.25	Klitzen mtd. in cab.....	9.00
Practical Radio Tel.....	2.25	WAVEMETER	
Audel's Easy Lessons.....	.50	Amrad.....	8.50

MAIL ORDERS RECEIVE PROMPT ATTENTION. SEND 3c STAMPS FOR CATALOG.

THE PRECISION EQUIPMENT CO.

2437-2439 Gilbert Avenue Dept. A Cincinnati, Ohio

"You May Pay More But You Can't Buy Better."

LISTEN IN On the World at Work and at play

with a



Continuous-Wave Telephone Receiving Set

In the MAGECO instrument pictured the amateur is offered the smallest complete instrument of its kind on the market, representing the latest development in continuous-wave receivers. By proper setting of the regenerative adjustment you can receive continuous-waves (radio telephone messages) as well as spark signals (radio telegraph messages). This makes it possible to "listen in" on advance newspaper stories, messages from ocean and lake liners, big business deals, amateur conversations, radio musicals given by many big theatres; in fact, you can pick up interesting and entertaining messages from over the whole continent when sending conditions are right and the instrument is adjusted for the proper wave length.

Guaranteed Mechanically Perfect

MAGECO instruments combine quality with moderate price and are guaranteed to be mechanically perfect. They are fully and carefully tested before leaving our factory. The instrument above is enclosed in birch-mahogany cabinet with binding posts and controls arranged for quick, easy handling. Blue print of hook-up and directions go with every MAGECO instrument.

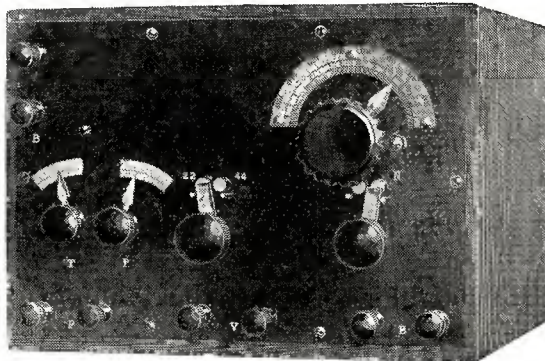

C-W. No. 5

SEND 10c TODAY FOR CATALOG.

The instrument described here is but one of the MAGECO line of quality instruments illustrated and described in the New Idea Perpetual Catalog. Send 10c in stamps today for your copy. Catalog is loose-leaf and additional sheets listing new instruments and giving interesting Radio information will be sent you at regular intervals without extra charge. In this way your MAGECO catalog is always up-to-date. Don't wait; send for catalog TODAY.

Complete with Blueprint of hook-up and directions, less bulb.

\$42.50

V. T. Bulb \$5 extra

The Marshall-Gerken Co.

23 Radio Bldg. Toledo, Ohio

YOUR RECEIVING COIL PROBLEMS SOLVED

Here is a coil of low distributed capacity, wide wave-length range, and which requires no auxiliary mounting. Only four sizes required to cover all ranges from 150 to 22,000 meters using a .001 M.F. condenser. Coupling varied by changing distance between coils. Adapted for experimental use as well as for permanent installations.

PRICE \$6.00 EACH

Fully described in Bulletin 302N

GENERAL RADIO CO.

CAMBRIDGE 39-MASSACHUSETTS

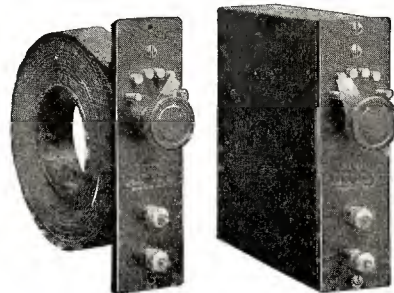

TYPE 226
4 STEP INDUCTOR

WHETHER YOU ARE IN THE MARKET TO BUY OR SELL, THE CLASSIFIED COLUMNS OF RADIO NEWS WILL GET RESULTS FOR YOU. TRY THEM.

$$I_{eff} = \frac{I_{max}}{\sqrt{2}} = i_1$$

$$\therefore I_{max} = \sqrt{2} i_1$$

Substituting this value of I_{max} in eq. (3), we have

$$V_{max} \sqrt{2} i_1 = 4 v_1 i_1$$

$$\text{or } V_{max} = \frac{4 v_1 i_1}{\sqrt{2} i_1} = \frac{4 v_1}{\sqrt{2}} = 2 \sqrt{2} v_1$$

$$\therefore \frac{V_{max}}{\sqrt{2}} = V_{eff} = 2 v_1$$

which shows that for the same effective plate current, the effective A. C. voltage on the plate must be twice the D. C. voltage to give the same power.

This may seem to be rather high in order to get the same power on A. C. as on D. C., but considering that a special D. C. high voltage generator is required, and considering the facility with which the high A. C. voltages are obtainable, the argument loses its strength. Some experimental work along this line might bring out some very interesting results.

An Amateur's Variable Condenser

(Continued from page 605)

with about two complete revolutions of the screw. The area A should be between 20,000 C and 30,000 C where C is the desired maximum working capacity in microfarads. The actual maximum capacity of the condenser will be considerably greater than the value of C in the above formula provided the plates are accurately hinged, but it is not desirable to have the working range extend to the maximum possible capacity of the condenser because the adjustment is very sensitive around these maximum values. This is seen by reference to Fig. 2, which shows a typical capacity curve for a condenser of this type. In this case $A = 16$, $R = 2$, maximum working capacity = .0005 microfarads, minimum capacity = .00005 microfarad. Two full revolutions of the screw cover the working range, the dial being divided into the 100 parts. The dial is set to indicate zero when the plates are as close together as possible giving the maximum capacity. By turning the screw to the left the plates are separated and the capacity diminishes. Fig. 3 shows the wave-length curves of four home-made honeycomb coils used with this condenser in the secondary circuit of a receiving set. Since most efficient reception is secured by using minimum capacity in the secondary circuit, the low values of capacity are most frequently used. With the appropriate coil, some condenser setting between 25 and 200 will tune any given wave-length within the range of the set except the maximum wave-lengths of the largest coil.

First Amateur Transcontinental Spark Reception

(Continued from page 603)

vage are already co-operating in efforts to duplicate their record, and it would certainly be encouraging if other stations were to pick up transcontinental messages. Any amateurs who succeed in duplicating this spark transmission feat, themselves, are invited to send in the glad news to this magazine at once. Here's hoping that we won't have to wait long, and in the meantime, our heartiest congratulations to the amateurs who hold the record for the first spark-transmission messages across the country.



Make your home built apparatus good
Use WILCOX Standardized Parts.

Buy from your dealer or order from
this ad. All prices postpaid.



Type 5A Variometer Parts

Set No 1 contains carefully turned wooden parts including winding form. Price \$2.50. Set No. 2 contains all parts including 3 inch Type 116 Indicating Dial. Price \$5.00.

Type 1C Variocoupler Parts

Set consists of No. 1C1 vario-coupler rotor, bakelite tube for primary, shaft, two No. 101 switches, 14 switch points, 4 binding posts, one No. 116B dial 0° 90° wire for winding, and instructions for assembling. No. 1CF1 Variocoupler Parts, \$5.00.

SPECIAL OFFER

This is your chance to get a high grade short wave regenerative set at about one-quarter the usual price. Mention this ad and we will send two complete sets variometer parts, one set variocoupler parts, one bakelite panel 3/16" x 6" x 18", all for \$17.50, postpaid.

IMPROVEMENT

being the only reason for change in design of WILCOX Apparatus, we are pleased to announce the following advance. All knobs on Wilcox switches, dials, etc., will be knurled unless otherwise ordered.

When we designed the WILCOX knob we discarded moulded composition and chose the more expensive lathe-turned knob of genuine hard rubber. We did this because of the superior appearance and insulating qualities of the latter.

Now we have developed a method of insuring an easy grip without spoiling the appearance of our knob—in fact it greatly improves it. The secret lies in not extending the ridges quite to either edge of the knob. You'd be surprised how much further it puts our knob ahead of all others.

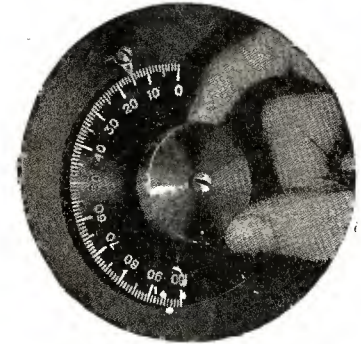

Type 116 Indicating Dials

Of polished hard rubber accurately engraved, filled with brilliant white. Furnished complete with knob and bushing to fit 3/16 inch shaft. 90° scale 0-50 or 180° scale 0-100; also 360° 0-100 scale in 2 inch size.

2 inch diameter.....\$1.25
3 inch diameter.....\$1.50

No increase in prices.



Type 121 Rheostat

Suitable for table or back of panel mounting. Has turned aluminum case, convenient binding posts and 8 ohm resistance unit with all off and all on positions. Long bearing and special designed blade insure smooth running and positive contact. Only occupies space 2" in diam. on your panel.

No. 121A with Type 116 Dial \$2.50. No. 121B with Knob and Pointer \$1.75.

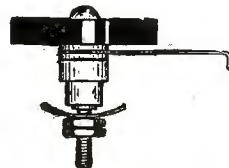

Type 101 Panel Switch

A beautiful and efficient rotary switch for general use. Furnished in two sizes. 1" radius brass finish 40c. Nickel finish 50c. 1 1/2" radius brass finish 50c. Nickel finish 60c.

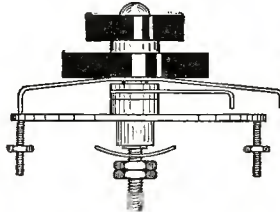

Type 102 Panel Switch

A compound switch consisting of two electrically independent switches mounted with concentric knobs. 1 1/2" radius brass finish \$1.10. Nickel finish \$1.25.

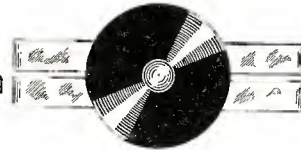

Type 103 Panel Switch

A rotary panel switch which is double pole and double throw. Will change variable condenser from series to parallel, etc. 1 1/2" radius brass finish 75c. Nickel finish 85c.



Type 14B Rotary Disk

The same style rotor as used on our famous belt driven gap, only with bakelite center and brass bushing to fit your motor shaft. Size is 4 1/4" diam. and 9/16" thick. This rotor being light and perfectly balanced will give excellent results on any small high speed motor. State size of shaft when ordering. No. 14B Rotary Disk \$6.00.



Type 104 Panel Switch

A complete unit for back of panel mounting. The latest and best in rotary panel switches. Better looking, more efficient and easier to mount. Complete with Type 116 Dial and 5 contacts \$2.25. Complete with Type 116 Dial and 11 contacts \$2.50.



Variocoupler Rotor

A carefully turned hardwood form for the secondary coils of variocouplers, etc. Size is 3 1/2" in diameter and 2" wide. No. 1C1 Rotor \$1.00.

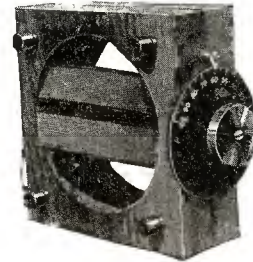

Type 5A Variometer

Made from Wilcox Variometer parts, completely assembled as illustrated, may easily be mounted on panel if you wish. Wave length range in average circuit with coils in series about 175-450 meters. No. 5A Variometer \$8.

Type 126 Tube Socket

Made of genuine bakelite dielecto and solid brass. Is small and convenient for back of panel mounting.

No. 126A Audion Socket 75c.

Switch Contacts

Smooth shank contacts with heads 3-16 x 1/8 inch—14 other styles in our catalog.

No. 111E Brass.....2c
No. 111F Nickel.....3 1/2c

Type 131 Binding Posts

A high grade binding post for use on panels, etc. Has moulded composition top with brass collar and screw.

No. 131A small size, suitable for receiving sets. 10c. No. 131B large size, suitable for power work 20c. State thickness of panel and whether brass or nickel finish is desired.

2500 MILES with this

WILCOX Gap

and a 1 KW Acme Transformer.
Actual input about 900 watts.

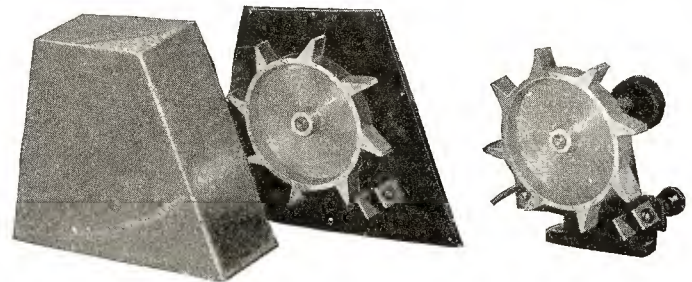

Enclosed Type \$17.50 { POST PAID } Open Type \$10.00

SPECIFICATIONS

ROTOR—Solid aluminum alloy casting pressed directly on to the shaft. Lathe turned inside and out and accurately balanced.

STATIONARY ELECTRODES—Copper, easily adjustable and large enough to provide ample cooling.

BEARING—Tool steel shaft runs in bronze bearing 2 1/2" long, insuring long life and accurate alignment.

DRIVE—Optional, belt or direct connected. This gap

requires less power than any similar one now on the market.

HOUSING—The enclosed type has a cast aluminum cover accurately machined to fit a bakelite panel which carries the stationary electrodes. This housing may be fitted to the open type gap at any time.

EFFICIENCY—We claim an efficiency for this gap second to none. It quenches well, has clear tone, short leading spark and short leads.

Our Catalog Sent for 5 cents

THE WILCOX LABORATORIES
LANSING MICHIGAN Dept. G

Dealers—We want you to stock our goods. Write us

DATE Jan 20 1921
RADIO BX-5
HEARD YOU CALLING OR WORKING by ON Jan 20
AT 8:50 ON 375 METERS
AUDIBILITY very good
TONE high (very good)
REMARKS seems good with but very slowly
RECEIVER AND DETECTOR USED later and short wave receiver
PLEASE CONFIRM DESCRIBING YOUR APPARATUS
YOURS FOR BETTER AMATEUR RADIO
L. D. MEALER
RADIO GAK (OLD SKU)
WALNUT GROVE, CALIF.
ON SACRAMENTO RIVER

ATTENTION CHICAGO RADIO MEN

The Chicago Radio Apparatus Co., formerly located at 3400 So. Michigan Ave., announce their Incorporation and removal to 508 So. Dearborn St.

On and after March 1st we will be in our new Loop store and will henceforth do business under the name of Chicago Radio Apparatus Co., Incorporated. Through the acquirement of added resources we will be able to carry each and every piece of Radio Apparatus of merit and our stock will be the largest and most complete in the Middle West.

Our retail sales will be in charge of MR. CLARENCE KLENTZ, who is without question the most able Radio Salesman in Chicago, and it is with extreme good fortune that we have been able to secure his services.

Local Customers:

We thank you for your hearty support which has made our expansion possible. In our new store you can easily reach us from any part of the city and we urge that you come and inspect our new apparatus without delay. **OPEN SATURDAY AFTERNOONS.**

Mail-Order Customers:

We thank you, too, for your trade during the past and in our new location, with greatly enlarged stock and personnel, you will secure even more prompt response to your inquiries than ever before. "IMMEDIATE DELIVERY" will continue to be our motto—every order shipped the same day it is received. We will have a new, big catalog ready for you soon—watch for announcement. Send now for complete set of bulletins. Blue Print of a Radio Telephone Transmitter for 10c in stamps. *Kindly send all communications to our new address.*

"Give us your business—we'll give you SERVICE you will like".

CHICAGO RADIO APPARATUS CO., Incorporated
508 SO. DEARBORN ST., Room 210 CHICAGO, ILL.
One-half block south of Dearborn St. "L" Station.

AMATEURS PREFER

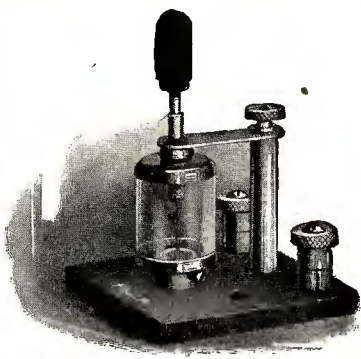

The FADA shop makes a specialty of high class panel engraving. We will engrave panels, following your instructions accurately, at a cost of 9 cents per letter. Out-of-town orders should include remittance in advance.

FADA Crystal Detectors. The amateur of today is the greatest critic of details, therefore he is the best advertisement we can have.

THE BEST FEATURES of the detector used in the Signal Corps Field Sets during the war are embodied in this type. All metal parts are brass, with highly polished nickel plating. A distinctive feature is the square, well-grained Bakelite base which is adaptable to any style of apparatus. The glass dust shield is extra heavy so that exposure from breakage is practically impossible. The contact spring is of the conical self-centering type. The sliding rod in the cup cover may be quickly adjusted to move easily or with effort. This is a valuable feature. A split collar, carefully fitted, does the trick. Only the best galena crystals are used and they are selected by careful tests.

And so FADA instruments are kept simple, but scientifically correct.

Type 101-A, \$3.00. Overall dimensions, 3½" x 2½" x 2½"

Weight 4 ounces

At your dealer's, or by mail, postpaid

Frank A. D. Andrea

1882-A Jerome Avenue

New York City

★ MR. AMATEUR ★

ORDER—From This Ad at ONCE

And Place Your Name on Our Mailing List, in Order That You May Receive Our SPECIAL MONTHLY LETTERS.

RTS Hard Rubber Binding Posts, each 13c	RTS Grid Condensers 30c
RTS Shielded Oscillation Transformer Clips, each 37c	RTS Grid and Grid Leak Condensers 50c
RTS Switch Points, 7/32" x 7/32" x ¼", with screws, per doz..... 24c	RTS Fixed Phone Condensers 40c
RTS Tested Galena, per box 24c	RTS Variometers \$5.50
RTS Switch Levers, 1½" Radius, each 42c	RTS Variocouplers \$7.50
	RTS Service is FREE.

WHEN ORDERING ALLOW SHIPPING EXPENSE.

RADIO TESTING STATION, Binghamton, N. Y.

MONEY for You

Add to your Salary—Make extra Pin Money. Start a lucrative business of your own. Spend an hour each day taking subscriptions for the "Radio News." We'll pay you well and you'll enjoy the work. Write for full particulars. Circulation Dept., RADIO NEWS, 236A Fulton St., New York City.

I Want to Know

(Continued from page 621)

plate of the V. T. and which may vary from 100 to 500 volts. With 300 volts a range of about two miles will be obtained under good conditions using a sensitive receiver.

STEP-UP TRANSFORMER.

(180) Mr. Francis Piazzi, of Santa Rosa, Calif., would like to know:

Q. I. I have a transformer core of sheet transformer iron, 6" wide, 7½" high, 1¼" thick. The "hole" inside made by the core is 3" x 4½". I want to know how to use this core to make a step-up wireless transformer which will be either ¼ or ½ k.w. I want to know what size and kind of wire to use for the primary and secondary, how many turns of each, where to take taps, if any, and other necessary details. It is to be used on 110 volts A. C.

A. I. With this iron core you may build a ¼-k.w. transformer for 110v. 60 cycles, as follows: Primary winding, 260 turns of No. 140 c. c. wire wound in five layers; secondary, 35,438 turns of No. 35 d. c. c. wound in 16 pies. Secondary voltage, 15,000 volts primary current, 2.8 amperes.

Inside Dope on "Our" Set

(Continued from page 607)

outside edges are all even. Saturate a cigarette paper with hot paraffine and with it cover the remaining portion of tinfoil. Place the other piece of tinfoil at the other end of the cardboard after the manner of the first. Put the other strip of brass on this end and likewise the other binding post. A second piece of cardboard 1" x 1¾" covers the exposed portion of the last piece of foil. The whole unit should now be clamped to the base with a piece of wood 1¾" x 3" placed across the unit and fastened with screws to the base.

By hooking up the instruments listed in the manner shown in the diagram, and being very careful to wire the coupler in the plate circuit exactly as per diagram, you ought to experience no difficulty, after a little experimenting with knobs and switches, in getting signals that are regenerated to 100 degrees of amplification. This degree of signal strength compares with and even supercedes that of some tickler type regenerative sets to which have been added a two-step amplifier. It will beat any tickler type receiver set for set. Don't get discouraged if your bulb doesn't oscillate well—you should rather work to keep it from oscillating for the reception of spark signals. In order to get best results the bulb should not oscillate until the secondary and plate circuits have been turned almost exactly in resonance.

THE OPERATOR AT FAULT.

The best performance given us by this set, in which we used the fixt coupler for primary and secondary, was the reception of the British station, BZL, in British Guiana, South America, a distance of approximately 2,500 miles. At that time the station was rated in the call book as a 2 K.W. I copied him several feet from the fones as we were leaving Boothbay, Maine.

Perhaps the fault of receiving in a great many cases belongs to the operator and not to the set. Several of you may have sold your Paragons or your Grebes because you thought them no account. I dare say your fingers were all thumbs and you couldn't turn the knobs just right. Perhaps you tried to use an amplifying bulb. Nothing could insult the set like that. At least, be

(Continued on page 665)

SECOND DISTRICT AMATEUR RADIO

Convention-Exhibition

A Real Convention of Radio Amateurs and a
Real Exhibition of Amateur Radio Equipment

WILL BE HELD AT

The Pennsylvania Hotel - New York

MARCH 16 - 17 - 18 - 19

THERE have been automobile shows, marine shows, electrical shows, business shows, and what not, but this is going to be a real simon-pure amateur radio show, and the biggest thing yet done in the history of amateur radio.

There will be plenty of lectures and talks to give amateurs all the latest "dope," and actual demonstration of exhibited equipment of all kinds will give every radio man his chance to actually see and hear what all the latest types of apparatus will do in actual operation.

The glass-enclosed roof garden of the hotel will be the exhibit hall, and the adjoining Butterfly Room affords an excellent lecture hall, with adequate seating capacity. Only papers of vital interest to amateurs will be presented. Manufacturers who are exhibitors and who desire to describe their equipment will be included in this program.

The first three days will be devoted to business. The last day will be devoted to general sociability. A banquet for everybody, male and female, will be held on the night of the nineteenth. And it's going to be **SOME** banquet. This refers both to the dinner and what will be done and who will do it. All the big men of radio will be there.

THIS convention-exhibition is being held under the auspices of the Second District Executive Radio Council. It is non-partisan, non-sectarian, non-everything—just a straight out and out Second District Amateur Radio Affair, sponsored by all the radio clubs of the Second District.

There has never been such an opportunity for material gain, for acquiring knowledge, the making of personal acquaintances, and for general good, in this country before. It will be the biggest thing ever done in the history of amateur radio.

The Convention and Exhibition will be open to everybody from 2 P. M. to 10:30 P. M. daily. A season badge will be sold at the door to all radio operators and engineers, etc., for 25 cents, covering the four days. A one time admission charge of 25 cents will be made in case of the general public not identified with radio.

The banquet charge will be \$3.00. The number which can be accommodated is limited to 500. Tickets will be allotted up to this number only, in the order in which applications are received. Applications for banquet tickets can be sent to

FERD. C. W. THIEDE, *Cor. Secy.*,
486 Decatur Street,
Brooklyn, N. Y.

Tickets are also on sale at

Continental Radio & Electric Corporation,
6 Warren Street, New York.

Manhattan Electrical Supply Company,
17 Park Place, New York.

J. H. Bunnell Company,
32 Park Place, New York.

American Electro Technical Appliance Company,
235 Fulton Street, New York.

EXECUTIVE RADIO COUNCIL—Second District

COMMITTEE

J. O. SMITH, *Chairman*

J. DI BLASI
R. H. McMANN

A. F. CLOUGH
F. C. W. THIEDE

C. G. TABER
C. E. PEARCE

C. J. GOETTE
E. W. DANNALS

D-L - COILS NEARLY GIVEN AWAY

Order Now

Shipped day order
received — 50% off
list price.

Best coils will be given out first. All are good; some slightly shop worn. This is an exceptional opportunity to get a complete set of coils covering all wave lengths at prices never equalled before in the history of Radio.

Act promptly while supply lasts

American Electro Technical Appliance Co.
235 Fulton Street, New York

DO IT THE EASIEST WAY!

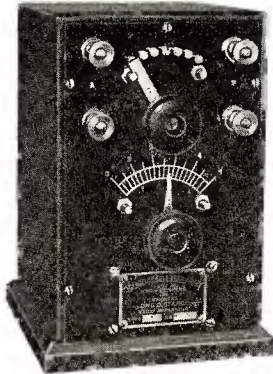

C. R. L. Regenerette

And not only that but combine ease and convenience with efficiency. With our C. R. L. Regenerette you can convert your loose coupler into a modern Regenerative Receiver with absolutely *no* changes in construction. Just modify your connections slightly and bring your set up to date. Full instructions supplied for connection and operation. The Price?

Only \$15.00

CHICAGO RADIO LABORATORY
1316 CARMEN AVE., CHICAGO, ILL.

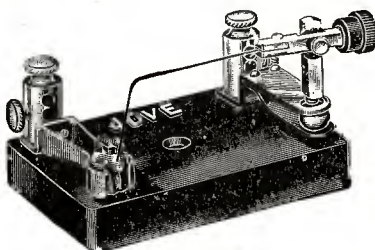

(GHEGAN PATENT)

Bunnell INSTRUMENTS
Always Reliable

JOVE DETECTOR

Handiest, Handsomest, Best

Sample by Mail, \$2.00

Tested Galena Crystal, 25c

We are distributors of the Standard Electric Novelty Co.'s Type B "Cyclone" Audion Batteries. Also of De Forest and all the leading manufacturers of High Class Wireless Apparatus. Send stamp for new edition 42RN Catalog.

J. H. BUNNELL & CO., 32 Park Place, New York

only by paying the most strict attention to details of apparatus, design, construction, and shielding.

MOVING-TRAIN EXPERIMENTS.

A very interesting application of wired radio is that of establishing communication with a train while in motion. The utility of such a system for insuring greater safety of travel, transmission of business information, etc., is readily realized. In 1914 and 1915 experiments were carried on by the Delaware, Lackawanna and Western Railroad with a view to establishing such a service by *radio*. According to reports published at that time transmitting powers in the neighborhood of one kilowatt and antennae averaging 150 feet in height and between 200 and 400 feet in length were employed. With this arrangement, telephonic communication of a more or less satisfactory character was obtained between a moving train and a fixed station for distances up to 50 miles (80 Km.). It was reported that the directional properties of the transmitting and receiving antennae utilized in these tests were very noticeable; when the train was in movement over a section of track containing numerous curves, the received signals fluctuated greatly in intensity. As adapted for this purpose, wired radio utilizes the telephone conductors paralleling the railroad tracks as a properly directed path for the carrier frequency currents. The transmitting and receiving apparatus at the fixed station was connected between one aerial wire and the ground; in the moving station the apparatus was connected to a closed loop, properly orientated with respect to the telegraph wires. The transfer of energy from the elevated wires to the loop, or *vice versa*, is effected by the inductive action of the electromagnetic field. Employing this system and with high frequency powers in the neighborhood of two watts, an excellent quality and quantity of telephonic speech and telegraphic signals were obtained between the two railroad coaches, one stationary and the other in motion, over distances ranging up to ninety miles (145 Km.). During the moving-train tests, the presence of standing waves on the lines was again verified; the signals received in the moving station varied periodically in intensity as the car was under way.

Notes on the Functioning and Construction of Resistance Coupled Amplifiers

(Continued from page 596)

plifier which, when used with an audio frequency amplifier, gives wonderful results using only a small loop aerial.

We shall say, first, this resistance amplifier is especially sensitive for wave-lengths over 800 meters, but using the Armstrong circuit which has been described in the February and March, 1920, issue of this magazine with separate heterodyne it may be used as well for short wave reception.

In the construction of this instrument two things are important, at first the connections from the tubes to the capacities and resistances should be as short as possible and all contacts should be soldered. The 70,000 ω resistances may be made of a piece of cardboard about 2" long and $\frac{3}{4}$ " wide blackened with a soft pencil. With a millimeter and a 70-volt battery it is easy to make these resistances, which to be correct must only allow a one milliamper current to pass thru.

In order to make a good contact at each end it is advisable to place a lead or tin washer between the blackened surface and the nuts which are used as binding posts.

Insure your copy reaching you each month. Subscribe to Radio News—\$2.00 a year. Experimenter Pub. Co., 236-A Fulton St., N. Y. C.

WANTED—FOR CASH

Used Radio Apparatus of all Standard Makes

Our used wireless apparatus department, connected with our local retail store at 233 Fulton Street, New York City, is anxious to buy any radio instruments you may have for sale. These goods are for our New York customers only—we **sell no used radio apparatus by mail.** But we do have a tremendous call at our store for fine class goods and we will be glad to hear from you if you have any that you would like to dispose of.

WE PAY CASH

for all such merchandise that we buy, and this is an invitation extended to the radio fraternity to sell us their radio apparatus for which they have no further use. Write us in your first letter what make apparatus you have to sell, and **your lowest spot cash price.** It must be understood that all transportation is to be paid for by you. All goods to be sent to us prepaid either by parcelpost, express, or freight.

We can use only standard apparatus, no obscure instruments or home-made apparatus can be considered in any event.

If you have friends who wish to dispose of such apparatus, show them this advertisement. Also please note that your letter must state in just what condition the instruments are and that no goods must be sent to us unless we send you a written order to do so.

We invite amateurs residing in New York or vicinity to call at our store and inspect the used radio apparatus which will be placed on sale shortly after this advertisement appears.

Address all letters to

Used Apparatus Department

ELECTRO IMPORTING COMPANY

(Established 1904)

231 Fulton Street

New York City

Averaged 82% out of a possible 90%

Practical course on the application of Vacuum Tubes to all forms of C-W Transmission and Reception start Thursday February Tenth.

Thirteen graduates of the MASSACHUSETTS RADIO and TELEGRAPH SCHOOL during the Six Weeks' examination period between November 1st and December 15th, 1920, established this record on their U. S. Government Examinations for First Grade Commercial Operator's license. Their average attendance was 5.1 Months.

The fact that a new United States Radio Inspector did the examining, using new and original questions unfamiliar to the graduates, speaks all the more favorably of our system and methods.

To produce Ten graduates, who, within the short period averaging a little Over Five Months, obtained such a high average, is the best way we know of to convince you of the merits of this school. Results Count.

Names, addresses and full data sent on request to anyone.

Why not avail yourself of this service. It costs no more.

SEND FOR FREE LITERATURE.

MASSACHUSETTS RADIO AND TELEGRAPH SCHOOL

18 Boylston Street, Boston, Mass. Tel. Beach 7168

R. F. TROP

G. R. ENTWISTLE

Just What You Have Been Looking For "Reynrad" Short Wave Coils

"Reynrad" Short Wave Coils are wound with green silk wire on black bakelite tubing. 4 inches in diameter, and mounted with standard plugs. Much finer adjustment and louder signals are obtainable by the use of these larger diameter and single layer coils.

Often times strongest signals are obtained when coils are widely separated instead of being pulled close together, as in the case of most short wave coils.

Finer adjustment, louder and more signals are positively guaranteed by the use of "Reynrad" Short Wave Coils.

Wave length range 150-300 and 300-600 meters. State wave length range desired. A set of four coils make your station equally efficient on all waves from 150-600 meters.

Price \$2.00 each

6 cts. in stamps will bring our catalog and place you on our mailing list.

"REYNRAD"

Symbol of Quality

REYNOLDS RADIO SPECIALTY COMPANY

729 South Prospect Street

Colorado Springs, Colorado

Canadian Amateurs

Write to our nearest branch for Price List "B" of Radio Apparatus, Supplies and Publications.

Scientific Experimenter Limited

Dominion Bldg., Vancouver, B. C.

Arcade Bldg., Halifax, N. S.

Head Office, 11 St. Sacrament St.

Confederation Life Bldg., Winnipeg, Man.

Vaughan Electric Co., 94 Germain Street St. John, N. B.

MONTREAL, QUEBEC

93 King St. E., Toronto, Ont.

Board of Trade, St. John's, Nfld

Show Rooms, 33 McGill College Avenue



THE WIZARD "B" BATTERY

A Special Introductory Offer To Amateurs

15% OFF LIST PRICES

- | | |
|---------------------------------|-------------------|
| No. 623 Small B Battery..... | List Price \$1.50 |
| No. 625 Large B Battery..... | 2.50 |
| No. 625 Variable B Battery..... | 3.50 |

The above batteries are manufactured according to government specifications. Sent free of parcel post charges. Money back if not satisfactory.

Watch for our advertisement in April issue

1315 42nd STREET

DEPT. R,

BROOKLYN, N. Y.

BOUND VOLUME No. 1 RADIO AMATEUR NEWS

12 issues—July, 1919—June, 1920—Attractively Bound, Only \$2.00 (plus postage). Shipping weight 7 lbs. No delay. Get yours today—Experimenter Pub. Co., 236a Fulton Street, N. Y. C.

The four megohms' resistances are made the same way, but only a few lines are drawn with Chinese ink between the two posts.

When finished these resistances are clamped firmly between two thin pieces of bakelite and the whole thing dipped into hot paraffine; this is to avoid alteration of the resistances by outside temperature.

Diagram Fig. 4 shows the reaction condenser, with the necessary details of construction. The space between the movable and fixed plates is to be found by experiment and for this reason the movable plate can be adjusted on the shaft.

COMBINED RADIO AUDIO FREQUENCY AMPLIFIER.

The latest development in the resistance amplifier is the addition of one or two steps of audio frequency amplification into the same apparatus. Fig. 5 is a photograph of an 8-step amplifier especially designed to be used in conjunction with a loop aerial. It has six steps of Radio frequency and two steps of audio frequency amplification.

In the diagram Fig. 6, the values of the capacities and resistances are given. As will be noted the coupling capacity has a different value for each step. This has been found to give better results for all round work and maximum sensibility at all wave-lengths.

A choke coil wound on an iron core and having a resistance of about 8,000 ω is connected in series with the primary of the first transformer.

A three-point switch, S, allows the use of six, seven or eight steps of amplification, the eight steps being only used for great sensibility for distant stations or very weak signals.

The fones are jacked up to the secondary of a transformer having a 1/1 ratio, this being only a protective device which avoids the H. T. current to pass in the telephone receivers' coils and destroy the permanent magnetism of the magnets.

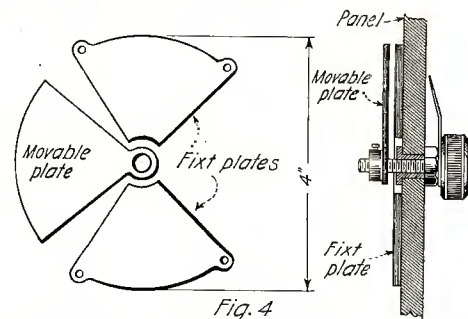

Diagram of the Reaction Condenser. The Distance Between the Movable and the Fixed Plates is to Be Found by Experiment.

It will be noticed that the iron cores of the various transformers and the case of the receivers are connected to the end of the secondary windings, this to avoid howling. The batteries should be well insulated from the ground.

The amateurs who build such an amplifier must not expect to receive signals as strong as with a loud talker, for it is not a loud talker but an ultra sensitive apparatus with which the faint dots and dashes of a distant station which could not be detected by any other device may be heard, as well as the music or speeches sent by Radiophone.

Using only the operator's body as an aerial several stations were heard and various types of very small aerials such as a loop wound on a cigar box gave good results. It is not advisable to use this type of amplifier with an aerial, unless with an extra coupling between the primary and the secondary.



(Illustration exact full size)

Z. R. S. Miniature knife switch is supplied unmounted only, for panel mounting and will harmonize with other fine products of the instrument maker. There is nothing else like it on the market.

Double pole, single throw - - - - 80c
 Double pole, double throw - - - - 90c

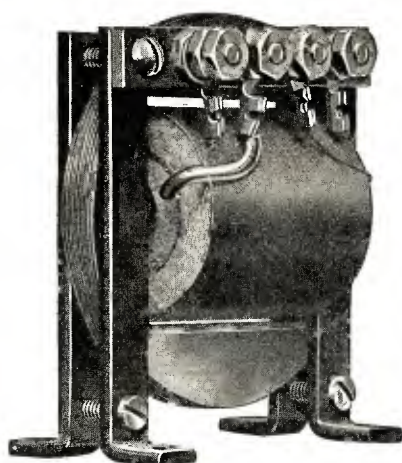

Modulation transformer - - - - \$4.50
 Choke coil .8 Henry - - - - \$3.75
 Amplifying transformer - - - - \$4.00

All these are mounted as shown in the illustration and will give you results second to none.

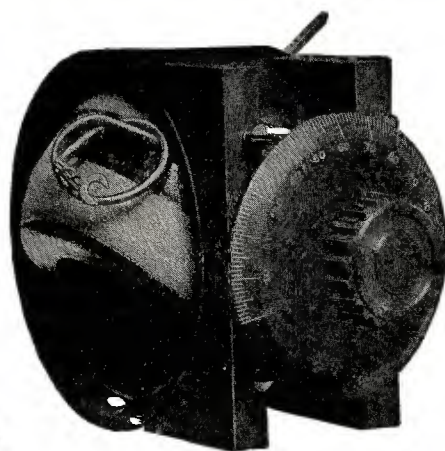

Type Z.R.V. Variometer has unit construction with bakelite shell and hard wood ball. Has low dielectric losses and a range of inductance of 1.25 mil henry maximum to .1 mil henry minimum. Is readily used on table or mounted on panels.

Complete with 3" dial and knob - \$6.50
 Without dial or knob - - - - \$5.75
 Variocoupler of same construction - \$7.50
 Complete Regenerative set - - - \$38.00
 Regenerative panel set with detector - \$85.00
 Regenerative set detector and 2 stage amplifier, combined panel - \$140.00

Complete Catalogs
 6c Stamps

CLAPP EASTHAM COMPANY

120 Main Street,

Cambridge Mass.

ALL GOOD DEALERS CARRY OUR PRODUCTS IN STOCK



Any Amateur Can Talk

30 Miles by Wireless Telephone

With this New Midget

"Radiophone" * Transmitter

(Type OT-3)

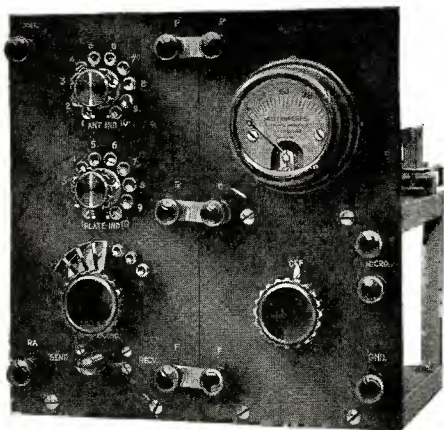

AERIAL OSCILLATING CIRCUIT PANEL. Contains all necessary controls, and transfer switch. Price this Panel - \$55.00

POWER TUBE PANEL. Contains tubes, Ammeter and filament rheostat. Can be clamped to other Panel to form single unit. Price this Panel - \$45.00

* "Radiophone" name copyrighted.

HERE is the most remarkable radio telephone for its size ever made. Complete in every detail. Works on any source of direct or alternating current, supplying up to 500 volts. Tuning done by tapped switches. Tests show 30 mile telephone range, which can be bettered under actual conditions.

Set mounted on two separate Bakelite panels, clamped together as shown. Best materials and workmanship thruout. Each panel 4½ x 9 in. Prices listed are without tubes, microphone or power supply. Find out more about this newest DeForest production at once. Get your order placed early to assure prompt delivery, either thru your regular dealer or direct from us.

DeForest Radio Telephone & Telegraph Co.

Inventors and Manufacturers of High Grade Radio Apparatus

1401 Sedgwick Avenue - New York City



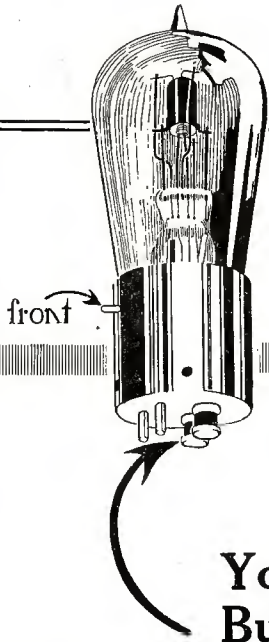

Specifications: Carrying capacity 1 Amp. Size 3/4" over all.

You Cannot Burn Out a Bulb Protected Like This!

Both for every operator now using a bulb and for all experimenters who have not added vacuum tubes to their sets because of the cost and loss involved in burning out, this tiny fuse attachable directly to the filament terminal of any vacuum tube is worth its weight in gold.

There is no necessity of burning out a \$5 to \$19 Vacuum Tube which can be perfectly protected by the

"RADECO" Safety Fuse 3 for \$1 For Vacuum Tubes

Pat. Pending
Postage Prepaid

This fuse is designed to protect the bulb against any amperage ordinarily used in amateur or commercial radio.

It is easily applied directly upon the filament terminals of any standard tube used with any standard socket. Simply clean filament terminals and slip on. It does not interfere in any way with the sending or receiving efficiency of the station. Although one fuse will offer adequate protection, two fuses—one over each filament terminal—will protect the filament indefinitely.

A "short" is unknown to the tube protected with a "RADECO" Safety Fuse.

Every radio operator in the United States needs the "Radeco" Safety Fuse. Send today certified check or money order. Your order filled by return mail.

Dealers!

Every radio man in your territory will find the "RADECO" Safety Fuse a money saving necessity. This business is yours if you stock up quickly. Let us KNOW AT ONCE. We will send you attractive discounts by return mail.



"Radeco" Bindo-Post

Something new. Increases carrying capacity 100%. Machine made. Nickel-plated. Will not cut finest wires. Turn screw cap to set sliding lug. Order by mail today.

Small	Large
25¢	30¢
EACH	EACH

Radio Equipment Co.

630 Washington Street *Fourth Floor* Boston 11, Mass.

VACUUM TUBE CONTROL UNIT Type MW

Adaptable to any modern hook-up. Best appearing and highest type Vacuum Control Unit at the price in the market.

Grained formica panel, 5 1/2" x 6 3/4", lettered in white, graduated rheostat dial, variable plate control. Tube socket (standard 4 prong).

Grid condenser and leak mounted in back of panel and so wired that it can be adapted to any modern hook-up.

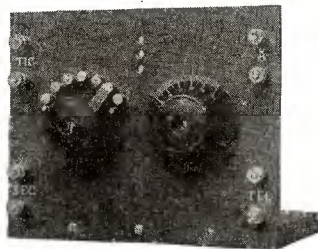

Price \$10

Parcel post prepaid in U. S. A. Immediate shipment.

WRITE for descriptive Booklet MW. Sent free on request.

THE MIDWEST RADIO COMPANY, CINCINNATI, OHIO
DEPT. A 3423 DURY AVENUE

Club Gossip

(Continued from page 613)

results of the election were as follows: DeWitt McClurg, president; Donald Miller, secretary-treasurer, and Max Gordon, chief operator

After the election of officers the plan for building a large set for club purposes was discussed. Code practice was held for the rest of the time.

We expect to have several lectures given by prominent radio men of this city in the near future. Code practice both for persons just learning the code and those who have been operators for quite a while is to be given at each meeting.

There have been numerous complaints from amateurs of this city about persons transmitting with "plain aerials." We hope that this club will be of assistance in discovering these persons. It is our aim to better amateur radio conditions in other ways also in this vicinity.

Meetings are to be held each Saturday night at our club room, 2058 N. New Jersey Street. We invite other clubs to correspond with us. Address correspondence to the Meteor Radio Club, 2058 N. New Jersey Street.

MUSKEGON RADIO ASSOCIATION.

A meeting was called at the Bunker School, Muskegon, Michigan, Thursday, January 20, 1921, at which a club was organized called the Muskegon Radio Association. The following officers were elected: President, Geo. E. Jensen; vice-president, Norman Deitz; secretary, Russell A. Jensen; treasurer, Clarence Redman; librarian, Charles Fonger.

The organization has an efficient receiving apparatus; no transmitter has been installed yet, but we expect to install a radiofone transmitter later on. This club was organized for the purpose of studying wireless telegraphy and telephony. The members will be classed according to their ability in receiving, in the following classes: Elementary, those who have no knowledge of wireless; student members, those who can receive three to five words per minute; junior members, those who can receive five to ten words per minute; senior members, those who can receive ten words or more per minute.

Classes in code practice and elementary theory and design will be instructed by Harold W. Taylor.

The class is under the jurisdiction of the Muskegon Board of Education. Any one wishing to become a member should call at the Bunker School on our meeting nights—every Monday and Thursday—hours 7.15 to 9.15, or write to the secretary, Russell A. Jensen, Illinois Cottage, Lake Michigan, Muskegon, Michigan.

SAGINAW HIGH SCHOOL RADIO CLUB.

The Saginaw High School Radio Club was re-organized recently under the direction of Mr. Trafton Smith. Meetings are held each week. Owing to faculty restriction, membership is limited to a very small number.

The apparatus which is located in the physics laboratory of the school includes a powerful transmitter. Some of the apparatus was built in the school shops.

Practically all of the members have their own apparatus as well. Among the most active are: Calvin Wadsworth, Jr., George Hesse, Jr., Leonard Hall, John E. Markham and Trafton Smith, all of whom are well known in Saginaw's radio world. Correspondence with other radio clubs is desired. Communications should be addressed to John E. Markham, secretary, S. H. S. R. C., Saginaw High School, Saginaw, Michigan.

OXFORD RADIO CLUB.

The regular meeting of the Oxford Radio Club of Revere, Mass., was held February 8. An instruction committee was formed to aid those not holding government licenses, to secure them. A membership drive was inaugurated as it is the purpose of the club to have as members all the amateurs of Revere. All Revere' amateurs are requested to get in communication with the secretary, L. Burns, 65 Revere Street, Revere 51, Mass. (Radio 1WAL.)

WIRELESS CLUB OF Y. M. H. A.

Sunday evening, Jan. 16th, was the first dance of the Wireless Club at the "Y's" Annex. Crowds beyond our expectation came pouring in. Everything ran off as smoothly as if the affair had been planned months ahead instead of only a few weeks. Sidney Weiss, our president and instructor, certainly did the work of a whole committee and is the cause of the success. Splendid success, indeed, was shown by the money taken in at the door by Selma Zukor and "Bill" Hershewitz. We were out to make enough money for a radiofone and now we're satisfied. Our membership register showed up a great deal better this Thursday evening. The Wireless Club of the Y. M. H. A. meets every Thursday evening, 8 o'clock sharp, at "Y" building, Broadway and Rodney St., Brooklyn. We are out for members. Communicate with Selma M. Zukor, 197 Floyd St., Brooklyn, N. Y.

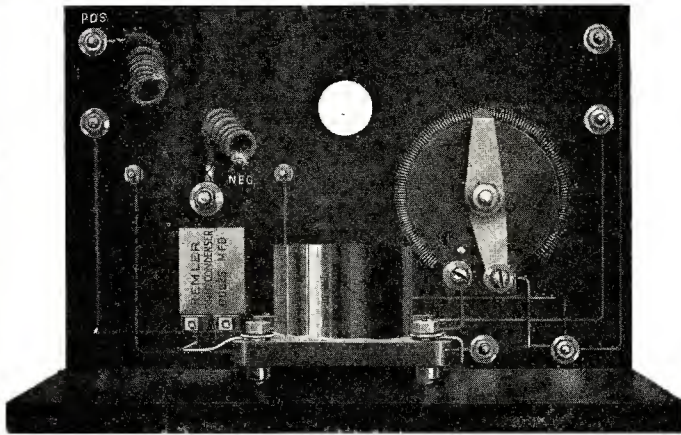
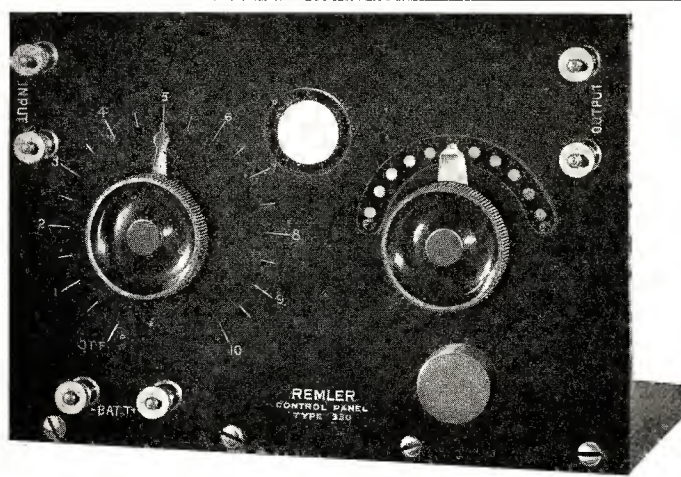

REMLER TYPE 330 VACUUM TUBE CONTROL PANEL

FOR THE NEW TYPE C-300
DETECTOR TUBE

*Maximum Value and Quality Through
Quantity Production*

**THESE SPECIFICATIONS SPEAK
FOR THEMSELVES**

Genuine bakelite, highly polished, 5" x 7 1/4". White filled engraving. Special smooth running rheostat back mounted. All bakelite VT socket. The new Remler positive metal contact potentiometer for controlling plate voltage. Variable grid leak. Fixed grid condenser. Busbar wiring. Hardwood base. All metal parts polished nickel **Price \$8.00**

DEALERS: Send for our trade proposition on Remler Apparatus.

"Apparatus that Radiates Quality"

REMLER RADIO MFG. COMPANY
163 Sutter Street, San Francisco, Cal.



602

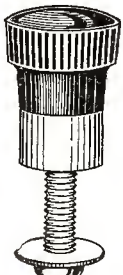

800



181

"SHRAMCO SPECIALTIES"

Large Stock

Immediate Shipment

- No. 90—Shramco Reo, 6 ohm, Panel Type Rheostat, each \$2.00
- No. 60—Shramco Oscillation Transformer, with four shielded clips, each 10.00
- No. 61—Shramco Shielded Oscillation Transformer Clip, each30

BRASS SWITCH POINTS

	Doz.	50	100
No. 626—1/4" dia. x 3/8" high, with brass screw	\$.30	\$1.10	\$2.00
No. 627—1/4" dia. x 1/2" high, with 3/8" threaded shank fitted wth nut and washer36	1.25	2.25
No. 628—1/4" dia. x 1/4" high, with brass screw30	1.00	1.75
No. 630—1/4" dia. x 1/8" high, with 1/2" threaded shank fitted with nut and washer36	1.25	2.25

COMPOSITION KNOBS—We Carry 15 Other Styles

	Ea.	Doz.
No. 602—1" dia. with 8-32 brass bushing	\$.08	\$.85
No. 618—1" dia. with 8-32 brass shank 1" long10	1.10
No. 606—1 1/4" dia. as used on No. 750 Switch15	1.65

BINDING POSTS

No. 800—Panel Type, complete as shown10	1.10
No. 600—1/2" Brass Type with brass screw and washer06	.65

PANEL SWITCHES

	Each
No. 750—Bushing Type, 1 1/2" Radius as shown, each75
No. 751—Brass Finish, 1 3/4" Radius, each40
No. 530—N. P. Finish, bushing type, 1" Radius, each60

VACUUM TUBES, ETC.

No. 180—Electron Relay Detector Tube, each	6.00
No. 181—Moorehead Amplifier Tube, each	7.00
No. 165—V. T. Socket for 4-prong base tubes, each	1.00
No. 101—Grid Leak and Grid Condenser combined, each50
No. 102—Grid Condenser, .0005 Mfd., each35

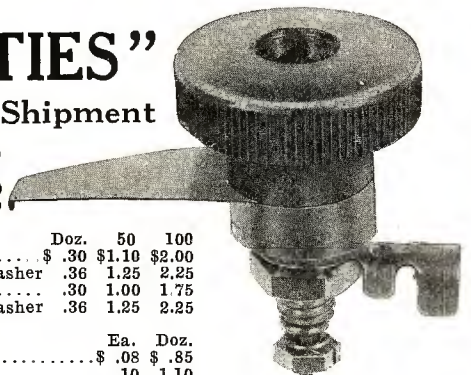

750

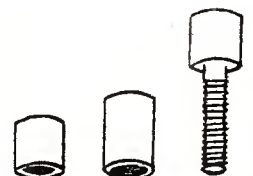

628

626

627

Postage on above extra. Send 5c in stamps for our Catalog K showing complete line of high grade apparatus.

Look for us at the 2nd District Radio Show—Hotel Pennsylvania, New York City
March 16-17-18-19—Booth 13

SHOTTON RADIO MANUFACTURING CO.
SCRANTON, PENNSYLVANIA

**PLATE BATTERIES!
Give Your Bulb a Chance!**

Economy Radioplate Batteries are genuine lighting flashlight batteries soldered together with 1/4-inch brass strip connectors which also serve as taps. We are proud of having put this battery on the market. It represents our effort to give you Maximum Battery Quality for your money.

Two sizes, you know best if you need either or both.

Ersco No. 503 22 1/2 Volts, Price \$2.00
Ersco No. 803 36 Volts, Price \$3.20
Made for Long Life and Heavy Duty. "Always Something Doing" with Ersco Batteries on your plate. Don't forget our Black Fiber Panels. Paragon size 7 x 20 x 1/4 inches, price \$3.00 or cut to any reasonable size at 2 1/2 cents per square inch.

Make a one-step amplifier complete for \$22. You need 1 Paragon Moulded VT Control Panel (has socket, rheostat, grid condenser and leak all on a base about 5 by 3 inches), price \$6; 1 VT, price \$7; 1 amplifying transformer, price \$5; and 2 Ersco Radioplate Batteries No. 503, price \$4. Total \$22.

We will supply these parts separately or altogether at the prices listed.

We ship parcel post paid anywhere in the United States.

Mail orders should be accompanied by remittance. Reference, Merchants and Manufacturers National Bank, Newark, N. J.

ECONOMY RADIO SUPPLIES CO.
232 Sanford Street East Orange, N. J.
"Always Something Doing"

TUSKA C. W. INDUCTANCE

Type 181
Unmounted

PRICE
\$5

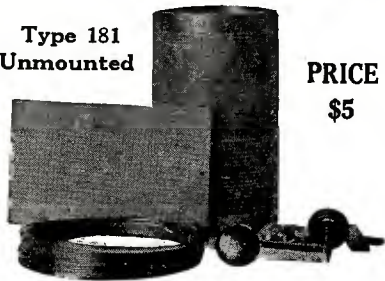

Use a Tuska C. W. Inductance in your new tube set. Send your dealer's name and 5 cents for our illustrated C. W. Booklet.

THE C. D. TUSKA COMPANY
HARTFORD, 3 - CONN.

**Learn Mechanical
DRAWING**

EARN \$35 TO \$100 A WEEK

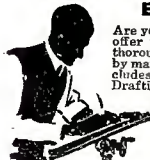

Are you earning less than this amount? If so my offer will interest you. I offer to give you a thorough, practical training in mechanical drawing by mail, in your spare time, at home. Course includes highest quality set of instruments and Drafting equipment. Guarantee to give you a thorough, practical training that qualifies you for a high salaried position as a professional draftsman. My graduates are everywhere with big concerns everywhere. Write for free book of information "Your Future in Drafting". Roy C. Clifton, Pres.

Columbia School of Drafting, Dept. 1405,
14th and T Sts., Washington, D. C.

RADIO CLUB PINS

Special folder of designs and prices in addition to regular school pin and ring catalog free on request. Be sure to see these new numbers which will put new life in your club

Metal Arts Co., Dept. 11, Rochester, N. Y.



WESTMOUNT HIGH SCHOOL RADIO CLUB.

A formal installation, at which were some twenty pupils interested in radio telegraphy, took place in the physics room on January 12. A constitution and a set of by-laws were adopted and the following officers were elected. R. E. Howe, honorary president; S. Weitzer, president; D. Sharpe, vice-president; E. Plow, secretary-treasurer. The question of fees and the days of meetings were decided upon. Two meetings are to be held every week, one meeting per week being devoted entirely to code practice and the other to lectures and "listening in."

The purchase of certain equipment was then voted for and the active members intend assembling an up-to-date and reliable receiving and transmitting set.

An aerial has been erected composed of stranded wire. The aerial is 145 feet long of two wires spaced 15 feet apart and about 70 feet above the ground.

We should like to hear of the activities of other high school wireless clubs.

**Correspondence from
Readers**

(Continued from page 612)

the distance my friends make. I intend to get a transmitter soon and then I would like to see if I am making any great distance.

So I hope the rest of the amateurs will agree with me and ask you to publish these "calls heard."

I noticed in the November issue of RADIO NEWS Mr. Maher's letter in regard to the picture on the September issue. I think Mr. Maher should learn the old saying, "Never judge a book by its cover." At least that holds good here. Your covers first attracted me and now I couldn't do without my RADIO NEWS. I have got much valuable information from it. My suggestion is "More foolishness on the outside and less on the inside." I have my doubts as to whether I will be alone or not when I say, "Let RADIO NEWS remain as it is and continue to be successful."

IRVIN P. STEPHENS,
329 Houston St.,
St. Charles, Mo.

DON'T PUBLISH CALLS HEARD!

Editor RADIO NEWS:

Just a line to compliment you on your January issue of RADIO NEWS. It is the best issue that you have ever had. I have read RADIO NEWS from the first copy. Your covers are fine and I sincerely hope you will not listen to Mr. Maher, who kicks about your covers. Some of your readers want "calls heard" by stations to be printed in RADIO NEWS. It is useless "truck" some publications use to fill up space, which might be used for valuable articles.

I sincerely hope to see your February issue better than January's and hope to see your circulation grow larger. I don't doubt that it will if you continue your good work of the past.

PETER T. SADOWSKY
600 Jackson Ave.,
Bronx, N. Y.

THE GOOD BOOK.

Editor RADIO NEWS:

Altho you have never heard from me before, I think it's about time I express my opinion on your issue which I have personally named "The Good Book," and to explain this expression—a friend of mine calls the books from which he obtains his electrical information good books, thus I named RADIO NEWS.

All I know about wireless has been taught me by articles in your publication, and if I'm looking for a new hook-up or want information in the construction of some new article I need I dig up my copies of RADIO NEWS and if I don't find it I know it will be in some future issue.

**BALDWIN PHONES
Special Reduction**

The U. S. Navy, the British, French and several other European Governments, in addition to most professional operators, have adopted BALDWIN PHONES as their standard of electromagnetic receiver excellence.

The reason for this preference is apparent. Exceptional sensitiveness combined with ruggedness gives BALDWIN PHONES their popularity. The diaphragm is made of the finest quality selected mica with the force concentrated at the exact center as in high grade phonograph reproducers. This feature is highly important in the reception of radiophone music.

The small armature is pivoted and designed to act as a fulcrum when connected to the diaphragm by a small link. There is no tension or springing of metal as in ordinary receivers. Four pole pieces of a single solenoid act upon both sides of a highly balanced armature.

Signals that cannot be heard with the best types of ordinary receivers become easily readable with the BALDWIN PHONES.

Original Type "C".....	\$15.50
Regular Price	16.50
Improved Type "E".....	19.00
Regular Price	20.00
Lighter Type "F".....	20.00
Regular Price	21.00

All types are supplied with the standard Baldwin self-adjusting, self-locking headband which is most comfortable to wear.

These BALDWIN MICA DIAPHRAM AMPLIFYING TELEPHONES, which are shipped direct to us from John Firth & Co., Inc., are absolutely guaranteed to prove fully satisfactory.

The Kehler Radio Laboratories
901 West First St., Dept. R, Abilene, Kansas

Canadian Amateurs

BUY in CANADA and save \$\$\$\$\$\$

Here are a few additions to our stock Variometers and Variocouplers.

Transmitters for Wireless Telephone \$2.50
Transmitters, Spoon type..... 7.25

Brown's Famous Receivers

4000 Ohm with cord.....\$19.25
8000 Ohm with cord..... 20.50
Shipping weight 2 lbs.

Send for our list .05c

THE VIMY SUPPLY CO.
567 College Street TORONTO, ONT.

RADIOTRONS!

Positively the last word in vacuum detectors. Unexcelled for use in amateur regenerative circuits.

Radiotron U.V. 200 (Detector and amplifier)\$5.00.
Radiotron U.V. 201 (Pilotron type) 6.50

Send for special bulletins, and price list of accessories TODAY. We can supply your wants immediately. Give us a trial and be convinced.

Independent Radio Supply Co.

1426 S. Clifton Pk. Ave., Chicago, Ill.

**Brass Binding Posts - 5c each
Switch Points, nickel 4c each**

All Types and Sizes
All kinds of Wireless Supplies

DREYFUSS SALES CORP.
4th Floor, 150-152 Chambers St. New York, N. Y.

—and here is proof

A-P tubes transmit to Scotland—

3,000 miles transmission. There's a DX record for you, and there are others, many others—with A-P tubes. Results count—that's what you're after, isn't it? Results prove that A-P tubes are the best tubes made, the tubes you should use; and here are some of the results:—

1. Using three **A-P transmitting tubes** in a radiophone set, Hugh Robinson of Keyport, New Jersey, not only transmitted phonograph music, but actually talked to Scotland, and was distinctly heard on three separate occasions during November and December, 1920. Distance covered approximately 3,100 miles by great circle.
2. With a single **A-P Electron Relay**, an amateur in New York (name on request) repeatedly hears communications between California amateur spark stations.
3. San Francisco amateurs (names on request) regularly receive day and night European communications from Carnarvon, Nauen, Bordeaux, and Rome, with moderate single-wire antennas and a single **A-P Electron Relay**.

For sure results, for better results use A-P tubes and only A-P tubes. Licensed by the Radio Corporation of America under DeForest Audion and Fleming patents, for amateur and experimental use in radio communication. Equipped with the SHAW condensite (four-prong) base.

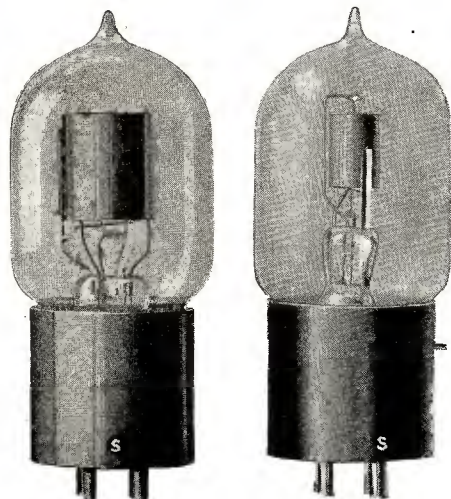

The A-P Electron Relay, equipped with the SHAW standard four-prong base. Price \$6 and worth it. Order from your dealer.

The A-P VT Amplifier-Oscillator, equipped with the SHAW standard four-prong base. Price \$7 and worth it. At dealers.

A combination of two or more A-P VT tubes as amplifiers with an A-P Electron Relay as the initial detector or oscillator is the ideal receiving combination for long distance amateur or long wave reception. Only with such a combination can full efficiency be attained.

The Atlantic Radio Supplies Co.
8 Kirk Place, Newark, N. J.

The Pacific Radio Supplies Co.
638 Mission St., San Francisco, Cal.

Distributors for Moorhead Laboratories, Inc., Manufacturers of

The A-P VACUUM TUBE Combination

"Greater Boston Amateurs"
Our location means low overhead and our shop at your disposal means better service. Open Friday nights 8 to 11 P. M.

A BID FOR BIGGER BUSINESS

PLACE YOUR ORDER DIRECT FROM THIS AD. NO C. O. D'S

Have you noticed our phenomenal growth? There's a reason! 90% of our shipments are made within 48 hours and postpaid!

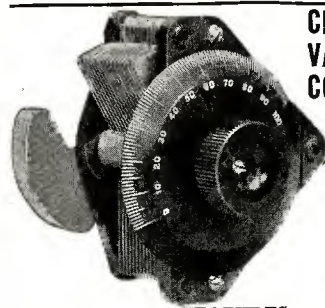

CHELSEA VARIABLE CONDENSERS

No. 3 BD \$4.75
.0011 MFD.
With Dial
No. 4 BD \$4.25
.0008 MFD.
With Dial
Dial Only, 70c.
Made of real bakelite, 3/4" Dia. Accurately moulded—won't warp.

FEATURES

All bakelite insulation means sharp tuning—die-cast assemblage means extreme ruggedness; heavy bronze to steel bearings mean long life; counter balance and new dial mean ease of operation. Truly, a fine condenser.

NEW! CHELSEA DIAL INDICATOR, \$1.00

Consists of knob and dial moulded in one piece, with 3/4" bushing and set screw. Not to be compared with cheap, lop-sided composition dials. Guaranteed to please you.

TYPE CSU NAVY DIAL INDICATOR, \$2.80

Supplied with No. 3 or No. 4 Chelsea condenser for \$1.75 extra. See Pacific Radio News for complete description, or our bulletins—sent for 4c.

SORALA \$10 VT SOCKET \$1.10

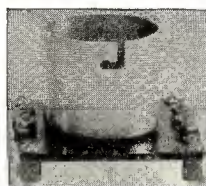

Spun aluminum shell, 2 1/4" x 2 1/4" bakelite base, engraved in white, to designate connections, contacts of nicked bronze brought out to ample connectors. Workmanship up to Navy standards. Won't warp or melt. Guaranteed to please you.

Double VT Socket, Radio Service make... \$2.50
New! Grebe CR-5, actually in stock... 80.00
6-Step, 1/2-3 Meg. Var. Grid Leak... 75c

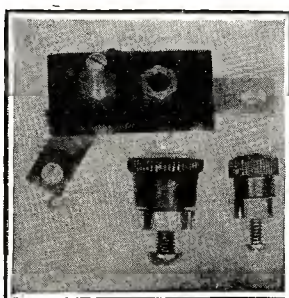

SORALA HC-COIL ADAPTOR

With Bakelite Insulation!

Sold in New England by us, F. D. Pitts Co. and A. P. Merchant & Co. Southern Agents, Rose Radio Supply, New Orleans, La.

Other territories still open.

Utility Recognized Demand Increased Production Increased and Price Reduced
65c
LARGE INSULATED BINDING POST, 18c.
\$1.65 Per Doz.; \$14.00 Per 100.
MEDIUM INSULATED BINDING POST, 12c
\$1.25 Per Doz.; \$9.00 Per 100

We have discontinued the repair of vacuum tubes and have a few Western Electric VT-1 amplifier tubes, unclaimed, for disposal; life, 5,000 hrs. Guaranteed to oscillate on 22 volts. Fil. current 1.1 amp.

W. E. VT-1 AMPLIFIERS \$7.50 POST PAID

"Sold at cost of repair and handling."
DISCONTINUED GEN. ELECT. VT'S
While they last \$4.25 have similar operating characteristics to GE Radiotrons.

RADIOTRON UV 200, \$5.00 POSTPAID
RADIOTRON UV201 \$6.50 POSTPAID

"Four-page booklet given with each VT."
GRID CONDENSERS, .0005 and .0025, 25c.

Special—W. E. MICROPHONE TRANSMITTERS

Heavy current type, \$4.75 postpaid. (No case or mounting bracket.) With case and bracket, \$6.25

No. 323W WEST. ELEC. TRANSMITTER, \$4.00
(With mounting bracket, 50c extra.)

W. E. ARMY-NAVY STANDARD HEAD PHONES,
2200 ohms, list price \$15; small lot, \$12.75.



SORALA METER SERVICE

means that we'll pay the postage and ship by return mail!

The immense popularity of our Type J Meters has made possible larger production, which with lower raw material costs, allows a

PRICE REDUCTION TO \$6.00
on all Ammeters and Milliammeters!

D. C. Ammeters, 0-3 and 0-5 ranges. Milliammeters, 0-50, 0-100, 0-300 and 0-500 M. A.

Type J 0-100 Voltmeters... \$8.00
Type J 0-500 Voltmeters... 16.00
Type J 0-1000 Voltmeters... 24.00

These include external resistances and are of the D'Arsonval type. Must not be confused with inaccurate meters of no reputation.

GENERAL RADIO FLUSH TYPE A.C. HOT WIRE AMMETERS; NEW PRICE \$7.75

Ranges, 0-1/4, 0-1/2, 0-1, 0-2 1/2 and 0-5 amperes used for radiation or filament current indication.

ACME 200 WATT CW TRANSFORMER
Unmounted, \$16.00—Mounted, \$20.00

Blue print and directions given with each one on how to pass 500 M. A. of plate current, with a chemical rectifier. "Simplest thing in the world, and very inexpensive." Shipping weight, 20 lbs.

ACME CHOKE COILS
Single Coil, 150 M. A. \$4.00
Double Coil, 150 M. A. 6.00
Single Coil, 500 M. A. 6.00
Double Coil, 500 M. A. 8.00
W. E. 21AA 1,000 V. Condenser, 1 Mfd. 2.50

Distributors of all Standard Makes of Radio Apparatus. Dealers—New Discounts

SOMERVILLE RADIO LABORATORY

WINTER HILL, 45, MASS.

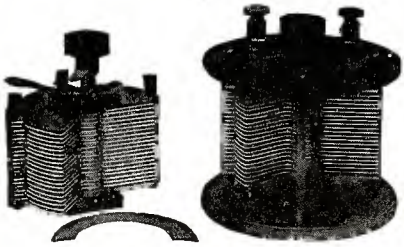

THE "ILLINOIS" VARIABLE CONDENSER
The Condenser with "Star Spring" Tension
MADE RIGHT - STAYS RIGHT
Hard Rolled Aluminum Plates

These condensers are made by a watch mechanic schooled in accurate workmanship and who can't get over the habit of critical inspection.

Three Styles; No. 1, Panel; No. 2, Open Type as shown; No. 3, Fully Encased. Anti-Profitteer. Less than pre-war prices. Fully assembled and tested.

Style No. 1	No. 2	No. 3	Money back if not satisfied.
67 Plates, \$7.00	\$	\$ 4.75	Just return condenser within 10 days by insured Parcel Post.
43 " 3.50	4.50	4.75	
23 " 2.75	3.75	4.00	
13 " 2.25	3.25	3.50	

With Style No. 1, we will, if desired, furnish 3 inch Dial with large knob, instead of Scale and Pointer.

Extra Price 75 cents.

Sent Prepaid on Receipt of Price.

Except: Pacific States, Alaska, Hawaii, Philippines and Canal Zone, add 10c. Canada add 25c.

Foreign Orders other than Canada not solicited.

Kindly note: We issue no Catalog, and make no "trade discounts." We set our prices at the lowest limit, and leave the "middle man" out for the sole benefit of the "consumer."

G. F. JOHNSON

625 Black Ave. Springfield, Ill.

Canadian Radio Experimenters
Lateral Wound Coils.

Turns	App. Wave-Length	Price
25	180—375	\$0.55
40	225—575	.60
75	240—740	.70
100	460—1480	.80
175	750—2400	1.00
325	1375—4500	1.25
550	2250—7700	1.50
750	3000—11200	1.75
1200	6000—20000	2.50

Special Sizes to order

Plugs, Bands and Screws for Coils...	.75
Audio-Tron Detector	8.50
Audio-Tron C 300 Detector	7.50
Audio-Tron C 301 Amplifier	8.50
Radiotron U.V. 202 plate voltage 350 film current 2.35 amp. Transmitting Tube	12.50
Vario-Couplers and Variometers	4.25

Send 5c for 20 page catalogue

J. M. PAQUIN

The Electrical Shop

787 Queen St., West, Toronto, Ont.



The Midget "FIVE-IN-ONE" Slide Rule is a combination Mannheim, Log-Log, Add and Subtract, Polyphase and Binary Slide Rule. It will instantly add, subtract, multiply and divide any combination involving whole numbers, fractions, decimals and mixed numbers. Gives every possible root and power of every quantity. The graduations are printed on metal coated with white celluloid and are grease and waterproof. While it is the most versatile calculator ever invented, its operation is simple and easily understood. Diameter 4".

Price with 16-page Instruction Book, \$1.50. Leatherette carrying case 50c extra. Catalog free. Your money back if you are not satisfied. Gilson Slide Rule Co., Niles, Mich

RADEQ AUDION CONTROL PANELS

Not the smallest but the best on the market. Polished Formica panel 6" x 7 1/2", mounted on oak base and equipped with rheostat, tube socket, grid leak, condenser and nickel plated binding posts. Price without B battery or tube \$10.00.

A. C. PENFIELD, Conneautville, Penna.

I am one of the many amateurs, limited in my wireless work on account of the high cost of materials, and I know there are others who will agree with me that the time has come when this unnecessary profiteering on wireless goods should and must cease. When it does there will be more amateurs and many of us can afford to have more up-to-date outfits and take more interest in the amateur world.

JAMES T. DEMILT,
Smithtown Branch, L. I.

(2ACE) *(Editor's Note. We receive letters from readers every day asking for information and hook-ups which have been published several times in RADIO NEWS.*

We strongly advise them to do as Mr. De Milt, i. e., look in the back issues they have and especially in the "I-Want-To-Know" columns, where they will find the information they want.)

A Combined Short and Long Wave Receiver

(Continued from page 597)

and 1/4" switch points for short circuiting the tickler coil when one wishes to receive a spark station. Stops should be placed so as the contact arm forms a central contact with the last switch point on either side. Stoppers, 3/8" in diameter by 1/2" long, are preferable to use on this switch. Below the tickler switch (location shown

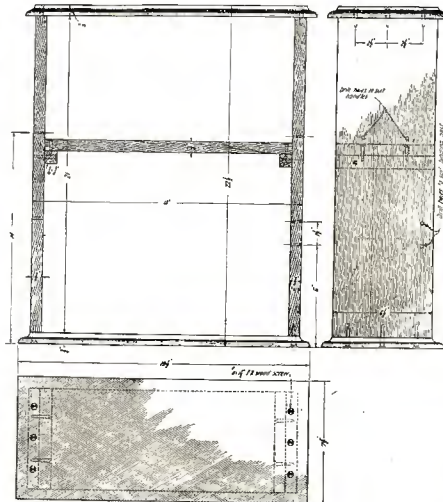

Constructional Details and Dimensions of the Cabinet.

on drawing) you will find two slots for the anti-capacity switches. The diagram shows a six-pole double-throw switch, but as this was unobtainable at the time of construction I use two 4-pole double-throw switches instead, therefore I left 6 posts unconnected. This, however, has no effect on the working of the set. The main object of these anti-capacity switches is to receive either long or short wave by means of throwing them in either the up or down position. (See Wiring Diagram.)

This is where one saves time when desiring to change from long to short wave. Disconnecting and reconnecting is entirely eliminated by means of the key switches.

Above the long-wave set I have located holes for my rheostats. The rheostats I am using are of the Remeler make, back mounted. Care should be taken again in fastening these rheostats, operations will be exactly the same as those used in fastening the variable condensers.

The rheostat on the right is for the detector. The center rheostat controls the

Hams—

Why not get in on the long wave stuff?

Use Radisco Coils

Here is a combination that gets fine results for everybody that uses it—

- LRD 1200 for Primary
- LRD 1200 for Secondary
- LRD 550 for Tickler

Special Introductory Offer—

This combination sent anywhere in the U. S., postpaid, for \$6.00. Send your order to-day. The coils will be shipped immediately, and you can start right in on your long range work.

Kelly & Phillips

312 Flatbush Avenue Brooklyn, N. Y.

ILL TELL THE WORLD

—they satisfy!

- what? **RADIOTRONS:** The Most Sensitive Amateur V. T.
- U. V. 200 Detector.....\$5.00
- U. V. 201 Amplifiers..... 6.50
- Build your own Amplifier with the Transformer designed for these V. T. S.—Federal Amps. Trans \$7.50
- Cage Type Filament Rheostats, \$2.00
- G. A. Grid or Phone Condensers, .35
- C. A. Grid Leak Condenser.... .50

"SWEET AND LOW"

may be a good title for a song—but it's not a good way to get your Radio Signals!

"LOUD AND CLEAR"

that's the tune you'll be singing when you've hooked up with a

- Doolittle Amplifone\$20.00 or a pair of "Baldies:"
- Type E—Improved Phones....\$20.00
- Type F—Light Weight..... 21.00

(Just lay them on the table and let Caruso sing you to sleep.)

Turney Spider Web Inductance—Complete Short Wave Tuner...\$8.00

We handle a complete line of Eldredge Meters and Accessories for building your own sets. Write us your troubles. Free advice from our experts. 12 Years Radio Experience.

RADIO SUPPLY SERVICE, 2 DB.

Cor. Fulton Ave. and Clinton Place, MT. VERNON, N. Y.

1/4 H. P., 110 volts, A. C., 60 cycle, single phase, 1750 R. P. M. MOTORS

LARGE QUANTITIES NEW WASHING MACHINE MOTORS

These are of standard manufacture and carry the full factory guarantee. Shipped in original boxes. Complete as cut. Suitable for operating Coffee Grinders, Cream Separators, Bottle Washers, Air Compressors, Small Tappers, Etc.

Multiple Cash or Money Order We will send C.O.D. subject to full instructions. Money Back Guarantee.

Special Small Motors and Generators Write for Catalogue Special Quantity Prices—Value \$22.50

\$22.75 Each

MANUFACTURER'S DISTRIBUTOR
GHAS. H. JOHNSTON - Box 16 W. E., Pittsburgh, Pa.

SEND five cents in stamps for catalogue N 15 with bulletin No. 1. This gives our line of short wave apparatus, and also revised prices on other material.

DAVID KILLOCH COMPANY
57 Murray St., New York City

CONNECTICUT RADIO EQUIPMENT

Variable Condensers, Transmitters, Head Bands, Panel Switches, Etc.

Connecticut Tel. & Elec. Co., Meriden, Conn.



THE VARIABLE STANDARD VT BATTERY

NO. 7650—PAT. PENDING



"SERVIMUS"

is especially adaptable for use with the latest types of gaseous content vacuum tubes.

Its variable features and method of variation are found in no other "B" battery, and this combined with the long-life features of the STANDARD VT BATTERY make it the desirable one for you to use.

PRICE \$3.50 COMPLETE WITH PLUG.

STANDARD VT BATTERIES are also sold in the non-variable types such as type No. 7623, priced at \$1.50 and type No. 7625, priced at \$2.65. These are REAL cast-en bloc batteries, made for unexcelled service and full satisfaction.

AMATEURS—Buy our products from your dealer.

DEALERS—Have you our proposition?

PACENT ELECTRIC COMPANY, Inc.

LOUIS GERARD PACENT, President

Wireless Improvement Company's Complete Line

Sales Agents for Dubilier Condenser Company, Electrical Products Mfg. Co., Richter-Schottler Co., H. W. Sullivan of London, Rawson Electrical Instrument Co., C. Brandes, Inc., and others.

150 NASSAU STREET

Telephone Beekman 5810

NEW YORK CITY

FIRTH RADIO

SPECIALTIES

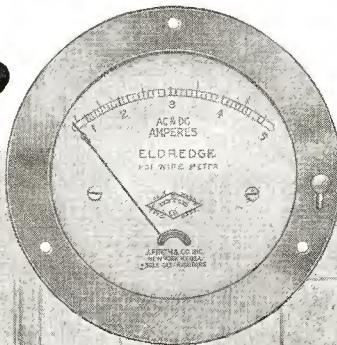
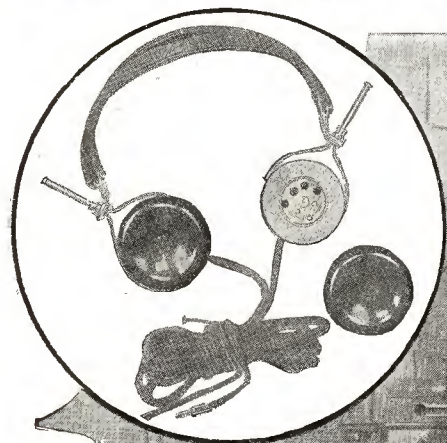

BALDWIN PHONES

Famous mica diaphragm, super sensitive phones,—used by H. D. Selvaige in the first trans-continental amateur spark reception,—used in the trans-continental relay on Jan. 18,—used by the U. S. Navy, the British and French governments, commercial operators all over the world, and by thousands of leading amateurs.

Original Type "C"\$16.50
Improved Type "E" 20.00
Type "F" 21.00

ELDREDGE METERS

Each one has hand-calibrated, individually-engraved scale dimensions. Distinguished by their high polish nickel finish, unvarying accuracy over 25 years of service, and the reasonable prices.

Radio Frequency Ammeters and Milli-ammeters \$7.00
(Model Shown)

Advance "Midget" Ammeters and Voltmeters, 12 ranges, AC and DC, \$8.00
Model S-D, specially designed for 60 cycle transformer primary circuits. Voltmeters, \$10.00; Ammeters, \$9.50.

BROWNLIE PHONES

Can be instantly adjusted for changes in signal strength and pitch. Adjustable feature makes them the most sensitive and selective of all metal diaphragm telephones.

Single solenoid core is directly under the exact center of the diaphragm. Eight sensitive springs for support, allow the diaphragm to vibrate thruout its entire area.

One model, 2,000 ohms, light weight, rugged, equipped with Improved Baldwin type head-band. Price \$12.50.

Ask your dealer for booklets describing any of the above Firth Specialties, If he lacks a supply write, mentioning his name and address, direct to

JOHN FIRTH & COMPANY, Inc., 18 Broadway, New York

ACME

Anti - Light - Blinker

THE ACME Apparatus Company has devised a method for eliminating the blinking of lights when sending telegraph code with spark transformers. This apparatus will help amateur radio by stopping the complaints from neighbors and power companies.

ONE-HALF KILOWATT \$5.00
ONE KILOWATT 7.50

Both sizes provided with one-quarter and one-half power steps.

WRITE FOR BULLETINS

ACME APPARATUS CO.

25 Windsor Street, | Cambridge 39, Mass.

Transformer and Radio Engineers and Manufacturers



LEARNERS' KEY AND BUZZER SETS

With code, easily tuned buzzer (2 adjusting screws), silver contacts.

WITH LEVER KEY PRICE \$1.75
WITH FLAT SPRING KEY \$1.25

"Hytone" Buzzers, unmounted.....\$0.60
Lever Keys unmounted..... 1.00
High grade lever type sending key, Bakelite base and knob..... 1.50
(All postpaid)

Special equipment, binding posts, contacts, etc., made to order. Prompt deliveries, low prices. Send in your sketches, estimates free.

AJAX ELECTRIC CO.
Palmer St. Cambridge. 38, Mass.

INFRINGEMENT STOPS

Because We Have the Control of All That Were Made. "EXIDE BATTERIES."

Special 3 Cell 6 V. 35 Amp. at.....\$10.00
Special 6 Cell 6 V. 70 Amp. at..... 18.00
Special 3 Cell 6 V. U. S. L. at..... 6.50
Special 6 Cell 6 V. U. S. L. at..... 10.00
Or any other combination of amperes or voltage. Prices on request.

Another Achievement of That Wizard "MIDGET" DETECTOR AND TWO STEP 100 to 10,000 METERS WAVE LENGTH.

DETROIT RADIO LABORATORIES, Inc.
3861 Gratiot Ave., Detroit, Michigan

STANDARD RADIO EQUIPMENT

AGENTS FOR
MURDOCK FEDERAL TEL.
BRANDES AMERICAN RADIO
BURGESS AUDIO TRON
GREBE CHICAGO RADIO LAB.
BENWOOD SPEC. DUBILIER
DE-FOREST TRESCO AND OTHERS
U. of I. SUPPLY STORE, Inc.
627-29-31 SOUTH WRIGHT STREET
CHAMPAIGN, ILLINOIS

one-step amplifier and the rheostat on the left controls the two-step amplifier.

Directly above these rheostats, the small push switches are located on the same vertical center line. Each switch controls a filament individually. These switches may be obtained in most any automobile accessory, they are known as dashboard switches.

Directly above these switches and on the same vertical center lines are placed the three Murdock sockets, holes located on drawing. The socket on the right is for the detector and I am using an electron relay tube. The middle is for the first stage and am using a Marconi V.T. class two bulb. The socket on the left is for the two-stage and I am using a Marconi V.T. class two bulb in it also.

The three jacks are located centrally between the first and second stage on a vertical center line. The lower jack is for the detector and is of the double circuit type. The middle jack is for the first stage which is also double circuit. The upper jack being the second stage, single circuit.

Above the tickler switch and on the same vertical center line, is located the five-point B battery control switch for the detector. This switch has also a one inch knob.

On the same horizontal center line and between the first and second stage rheostats will be found two binding posts (location shown on drawing). On to these binding posts the telephone plug is connected by means of a short piece of telephone cord, then on the inside of the cabinet two wires are run from these binding posts to two more binding posts located underneath the variotuner dial about 3/4" up from the bottom of the bakelite panel 2 1/2" apart. The head set and loud talker are connected to the latter two posts. Head set and loud talker connection may be made underneath the operating table by drilling two small holes thru the table. Wires are then run thru the table to these posts. One may then have a clear writing and operating space without any wires in view whatever.

A rear view of this set shows a shelf on which the B batteries are supported. (Shown on drawing by dotted lines.)

Twelve Star Bright flash cells are used for each tube. For the detector five of these are varied by the five-point switch.

The two amplifying transformers are of the Acme make.

On the left side of the cabinet I have located, near the rear end, two binding posts about 1 1/2" apart, approximately 6" from the bottom of the cabinet. These are for the aerial and ground.

On the right side of the cabinet I have two more binding posts, location about the same as those on the opposite side. These are for the A battery.

On the back side of the cabinet I have a bakelite panel 1/8" thick by 21" high by 18" wide. This is held firmly in place by a number of small oval headed wood screws which should be nickel plated the same as those which fasten the front panel to the cabinet frame.

The handles were then put in place on the sides of the cabinet about 14" from the bottom. These were also nickel plated and that completed the cabinet.

Upon completion of this cabinet, I find it to be the quietest and most sensitive of any I have ever tried. There is absolutely no howling or cross currents whatsoever. It is indeed very convenient to operate. Foreign stations of a high wave-length are heard very loud. These signals and also music can be heard from between 50 and 700 feet from the loud talker. My loud talker is also homemade.

It consists of a Baldwin receiver and a phonograph horn. Many times music has been heard loud enough to dance by.

Everything, including B batteries and bulbs, less honeycomb coils, should cost no more than \$125.00, but if this same equip-



NEW YORK BOSTON

Offers a thorough course in all branches of wireless telegraphy. Radio Operators earn at the start \$125.00 per month, and first class board, etc., free.

Our school prepares you for your license in three to four months. Positions guaranteed to first grade licensed operators.

Day and evening classes. The leading Nautical School in U. S. A. Established 1804.

CAPTAIN F. E. UTTMARK, Principal
Write, call or phone for illustrated booklet.

8 STATE ST., NEW YORK, N. Y.

Facing Battery Park, N. Y.
Telephone, Bowling Green 8079

UTTMARK'S for Nautical Education

NEW ORLEANS RADIO

APPARATUS and SUPPLIES

ROSE RADIO SUPPLY
604 Gravier St., New Orleans, La.
Send 10c for Latest Catalog

5c. Sent For our Loose-leaf CATALOG Introduces you to

Parkin Apparatus Marko Batteries Radiotrons Bakelite Rheosoc

SERVICE

A. K. LAING, RADIO SUPPLIES
Pelham Manor, N. Y.

MASTER CONTINENTAL CODE DODGE SHORT CUT ONE HOUR METHOD INSURES SUCCESS

Thousands have. Everybody can. Testimonials free. Investigate and win. Costs 50 cents, Saves 50 dollars.
C. K. Dodge, Box 200, Mamaroneck, N. Y.

SPECIAL!

6V. 35-40A Storage Batteries
Guaranteed 1 year Repairs free
Price \$18.75
ELJAY BATTERY CO.
30 N. CICERO AVE., CHICAGO, ILL.

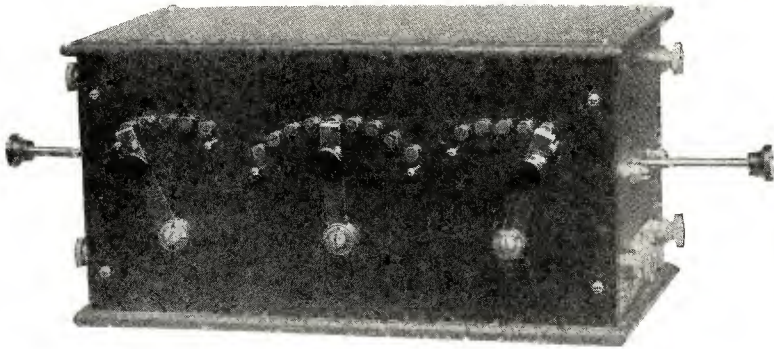

\$18.00 Wonderful Value

Only by seeing—and using—can the advantages of this 200-600 meter regenerative tuner be appreciated. It is at home in any company.

Mr. Lewis E. Springer, 6 Woodruff Place, Auburn, N. Y., writes: "I have been using one of your 200-600 meter regenerative tuners for some time and find it very satisfactory. It works exceedingly well on all C. W. and phone stations. I have used practically every type of receiver and cannot say too much for your tuner."

It is finished in quartered oak cabinet with polished hard rubber panel. It's the finest and best on the market. Price only \$18.00

New Long Wave Regenerative Tuner with a Kick like a Mule

One of These Long Wave Regenerative Tuners Will Bring Joy and Happiness to You.

It is really wonderful what you can do with one of these Tuners. You may listen to N. A. A. or other stations around 2,000 meters or you may quickly and easily tune in the big stations up to 20,000 meters without using loading coils.

No shifting of coils, no loose connections, but a tuner for long waves that has no equal. You can pick up distant stations through interference, that heretofore have been beyond your control. When used with but one audion or vacuum tube detector it has a kick like a mule.

Robert E. Eccles, 201 Genesee St., Auburn, N. Y., says: "I have heard more stations and louder signals than I was ever able to hear with a separate tuner with loading inductances. I find it very selective and efficient. One must use this tuner to appreciate its worth."

Price in quartered oak cabinet, \$34.50. Hard rubber panel, \$40.00.

Send a 2-cent stamp for bulletins

COLBY'S TELEGRAPH SCHOOL, Auburn, N. Y.

\$34.50

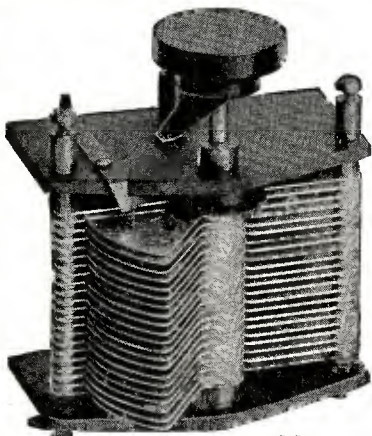
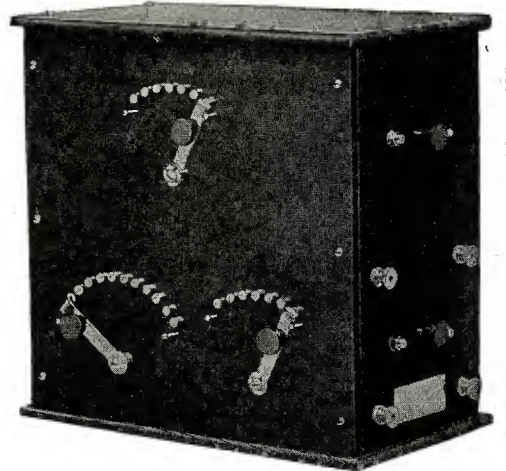

43

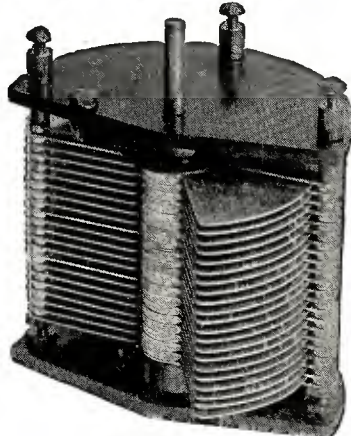

4300

WIRELESS SHOP VARIABLE CONDENSERS

Are Recognized as

QUALITY INSTRUMENTS

They are being used by several manufacturers of high grade equipment, by the Bureau of Standards, and by the AMATEUR who recognizes QUALITY, in all parts of this country as well as in several foreign lands.

Why Not Make the Condensers in Your New Set "WIRELESS SHOP VARIABLES?"

You can't go wrong, as they are fully guaranteed to give satisfaction, or we will cheerfully refund your money. What more could you ask. Ask some of the other fellows how they like their "Wireless Shop Variables."

The rugged construction of these condensers and the quality of workmanship will surely please you if you want, and expect to have, *only the BEST*. Made in two styles and eleven sizes. EVERY DETAIL RIGHT. Aluminum plates and spacers. FORMICA Insulation.

"Series T"

No. 20	2 plate	Vernier	\$2.00
No. 70	7 plate	.0001 m.f.	2.35
No. 130	13 "	.0002 m.f.	2.75
No. 170	17 "	.0003 m.f.	3.15
No. 230	23 "	.0005 m.f.	3.60
No. 310	31 "	.0007 m.f.	4.30
No. 430	43 "	.001 m.f.	5.25
No. 630	63 "	.0015 m.f.	7.50

Include postage for 1 pound

PRICES

"Series L"

No. 2300	23 plate	.00075 m.f.	\$6.00
No. 4300	43 "	.0013 m.f.	8.00
No. 6300	63 "	.002 m.f.	10.00

Include postage for 2 pounds

Prices include knob and pointer and mounting screws. Indicating dial furnished, instead of knob and pointer, at 75c additional.

WATCH OUR AD NEXT MONTH FOR A NEW RADIO-PHONE AND "CW" VARIABLE.

THE WIRELESS SHOP

A. J. EDGCOMB

511 West Washington St.

Los. Angeles, Cal.

Western dealers write to the Leo J. Meyberg Co., San Francisco, Cal., for sales proposition. You will find "Wireless Shop Variables" a profitable line.

MAGNET WIRE

We are prepared to furnish best grade magnet wire on 1/4 and 1/2 lb. spools at the following revised prices:

PRICE PER 1/4 LB. SPOOL

B&S Ga.	Single Cotton	Double Cotton	Single Silk	Enameled
No. 22	\$0.56	\$0.68	\$0.62	\$0.45
No. 24	.60	.77	.67	.47
No. 26	.65	.88	.71	.49
No. 28	.75	1.10	.85	.52
No. 30	.85	1.24	.97	.53
No. 32			1.15	.55
No. 34			1.52	.59
No. 36			1.77	.69

Price on 1/2 lb. spools double above list.

All prices are net and include cost of spool and delivery charges via Parcel Post to any Post Office address in the United States; safe delivery guaranteed.

Send for Circular 21-A giving prices on other sizes, insulations and quantities of Magnet Wire. This circular lists "WIRE FOR EVERY WIRELESS PURPOSE."

KEYSTONE WIRE COMPANY
P. O. Box 120 SCRANTON, PA.

What a Dime Will bring You From the Nations Capital

The little matter of 10 cts. will bring you the Pathfinder eight weeks on trial. The Pathfinder is an illustrated weekly, published at the Nation's center, for all the Nation; an independent home paper that prints all the news of the world and tells the truth now in its 28th year. This paper fills the bill without emptying the purse; it costs but \$1 a year. If you want to keep posted on what is going on in the world, at the least expense of time or money, this is your means. If you want a paper in your home which is sincere, reliable, entertaining, wholesome, the Pathfinder is yours. If you would appreciate a paper which puts everything clearly, strongly, briefly—here it is. Send 10c to show that you might like such a paper, and we will send the Pathfinder on probation eight weeks. If you do not repay us, but we are glad to invest in new friends. Address: **PATHFINDER, 498 Langdon St., Washington, D. C.**

Washington has become the World's Capital and reading the Pathfinder is like sitting in the inner council with those who mold the world's destiny.

SIXES & SEVENS

Save time and freight by getting your apparatus from us. We carry full AMRAD and RADISCO stocks. Order from their catalogs. Also DeFOREST, TRESKO, MURDOCK, THORADSON and others.

A-P Amplifier Tubes.....	\$7.00
A-P Detector Tubes.....	6.00
Federal Transformers.....	7.50
Tube Bases.....	1.00
Grid Condensers.....	.30
Rheostats.....	1.50
2-Stage Amplifiers.....	40.00
45-Volt B Batteries.....	5.00

NORTHWEST RADIO SERVICE CO.
609 Fourth Ave., Seattle, Wash.



LEARN WIRELESS

at the largest radio school in the Central States. Modern complete equipment. Experienced instructors. Dormitory in connection. Students may earn expenses if necessary. Write today for catalogue and full information.

CENTRAL RADIO SCHOOL
Independence, Mo

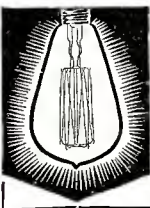

Charge Batteries—Make Your Own Light

The HB Lighting and Battery Charging Set makes electric light as low as per kw. and at the same time brings profits of \$100 to \$150 per month charging batteries. Operates from line-shaft or engine.

Small Payment Puts This Money-Maker in Your Garage or Shop. Balance on easy terms. Profits pay for outfit. Absolute Money-Back Guarantee. Ask our Service Department about proper size for your needs. In this ad to your letter-head and write TODAY for information.
Hobart Brothers Company, Box N36, Troy, Ohio

went were purchast in cabinets such as those which are sold on the market today, it would cost upwards of \$200.00 and would be very inconvenient to operate as well as occupying a large amount of space.

Anyone desirous of building such a set, by a little study of the wiring diagram and drawings, also an occasional view of the photographs submitted and particular notice of the construction of the anti-capacity key switches, should have no difficulty in enjoying the same success as myself.

I would be very glad to help out any of my amateur friends in building such a set in the event of any object which is not quite clear to them.

Who's Who in Radio

(Continued from page 615)

telegraphy was his notable invention of the thermionic valve which in course of its development revolutionized the methods of wireless telegraphy. Dr. Fleming was the first to apply the electron emission from an incandescent filament in a high vacuum to the construction of a very sensitive detector for the electromagnetic waves used in wireless telegraphy. This was subsequently described by Mr. Justice Sargent in the British High Court of Justice as a pioneer invention of great public utility. His priority of invention was also upheld by three great legal decisions in the United States courts. In the course of 20 years a large number of patents have been taken out by Dr. Fleming for inventions and improvements in connection with wireless telegraphy.

WRITER OF MANY BOOKS.

In addition to this technical work he found time to write fifteen text books and treatises, most of which secured a world-wide circulation, and went thru many editions. The best known of these books is his treatise on "The Alternate Current Transformer," his large book on "The Principles of Electric Wave Telegraphy," his elementary "Manual on Radiotelegraphy and Telephony" and his book on "The Thermionic Valve." Many of his books were the outcome of courses of public or university lectures such as his Royal Institution Christmas lectures on "Waves and Ripples in Water, Air, and Ether," and his book on "The Propagation of Electric Currents in Telephone and Telegraph Conductors." Also the result of his teaching work at University College was the publication of the books "Magnets and Electric Currents," "A Handbook for the Electrical Laboratory" and his widely used "Electrical Laboratory Notes and Forms."

His Cantor lectures at the Royal Society of Arts on "Hertzian Wave Telegraphy" which attracted much attention were republished in America, and translated into German and Japanese. In addition to the authorship of text books appealing to technical students, Dr. Fleming was the author of about 100 scientific papers and memoirs published in the proceedings of various learned societies. Of these 27 were communicated to the Royal Society, 37 to the Physical Society and 9 to the Institution of Electrical Engineers. Eight were Friday evening discourses published on the proceedings of the Royal Institution and eight were courses of Cantor lectures before the Royal Society of Arts. The remainder were papers published in "The Philosophical Magazine" and other journals.

These researches may broadly be divided into five groups according to subject, viz. (1) Alternating Current Phenomena, (2) Low Temperature Researches, (3) Photometry and Electric Lamps, (4) Wireless

RHAMSTINE ★ Radio Products

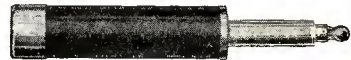

PLUG and JACK

Complete - \$1.50 Add Postage - 4c

An efficient and attractive nickel-plated plug and jack is now available at a moderate price. Phone cords easily attached to the connections in the plug—the Jack possesses contacts which automatically place the amplifying transformer in the circuit. Phone Plugs and Jacks can be used in any set and are indispensable in one- and two-step amplifiers.

Order yours today and do away with binding posts and switches. Circular upon request.

J. THOS. RHAMSTINE★
2152 E. Larned St. Detroit, Mich.

An especially attractive proposition for Dealers.

*Radio Plugs and Jacks.

Radio Apparatus

DISTRIBUTORS OF AMRAD
MURDOCK—BUNNELL
CLAPP—EASTHAM
DE FOREST, ETC.

A FEW OF OUR PARTS

Double Filament Audiotrons.....	\$6.00
(Including Postage)	
Acme Amp. A2 Transformers.....	4.50
Murdock No. 55 Real Radio Receivers, 2000 ohms.....	4.50
Murdock No. 55 Real Radio Receivers, 3000 ohms.....	5.50
Murdock V.T. Sockets.....	1.00
Murdock Doctor Stands.....	.75

THE WHITALL ELECTRIC CO.

Bridge St. and Stearns Sq., SPRINGFIELD, MASS.

The Smallest Audion Control Panel Made

Equipped with socket, rheostat, a battery switch, binding posts, and a grid-leak condenser. Price \$6.50. At your nearest dealer or from

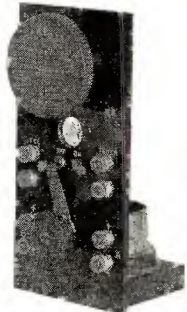

WORTH RADIO CO.

1843 East 12th Street Brooklyn, N. Y.

FREE! Colors & Brushes for Show Card & Sign Writing

Make \$10 to \$25 daily! Make Show Cards, Signs, Advertising Posters and Glass Signs. Big demand! Interesting, profitable profession. Easy to learn in few weeks by unique, novel method; something new! Our wonderful 50-lesson course includes individual instruction by correspondence from expert artists; total cost only \$15. Every student given \$15 assortment of finest "Millierine" colors and brushes—**FREE! SEND NO MONEY**—Send name and address and receive complete course and Free outfit. Pay \$3 on arrival and \$1 weekly for 12 weeks. Success guaranteed or money refunded. Earn enough first week to pay for course. Send **TODAY**.
Empire AC Institute, 2050 Amsterdam Ave. New York, N. Y.



PIGEONS PAY

Easy raised, any small building, very little space required. Build their own nests, feed their own young. Very profitable business. Get your start with a few good pairs. Write today for 1921 Circular.

Pigeon Supply House, Hanover, Pa.

THE BENWOOD "SUPER" ROTARY DISC.

again we have

SOMETHING NEW

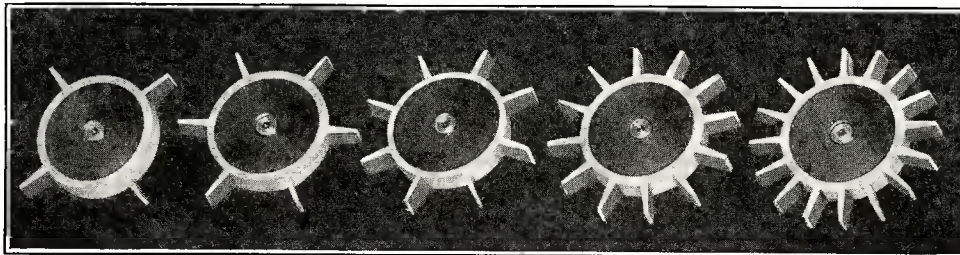

Lighter than the old style BENWOOD discs and yet has the same wide sparking surface. The teeth are longer and far more accurate than has ever been produced before. Complete disc weighs only one-half pound when fully made up. Is of ample size for any 1 KW installation and yet is so light and evenly balanced that the smallest fractional high speed motor will run it with ease.

DIMENSIONS:- Diameter, 6 inches - width, 3-4inch - weight, 1-2 pound

Is complete with black fibre center and heavy brass bushing with set screw for fastening to the motor shaft. This is the identical disc that is furnished with the New "SUPER BENWOOD" rotary quenched spark gap.

As shown by the cut these discs are furnished in 4, 6, 8, 12 and 16 points at no extra charge, merely specify which type you desire. Drilled to fit any sized motor shaft, just designate the size of the shaft on your motor. Each bushing is drilled twice and then reamed to the size desired, thus assuring the purchaser of the utmost accuracy.

ONLY \$7.00 EACH

Specify size of motor shaft.

The Benwood Co., Inc., 1300 Olive St., St. Louis, Mo.

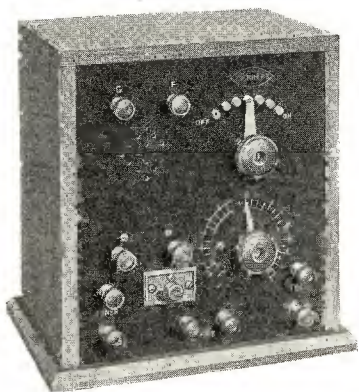

Type "D"

The EV-RA-LAB Type D Audion Control Unit may be used with any type tube on the market and has a seven point switch for varying the high voltage battery. This feature alone makes this Unit the one for your station. For batteries and tubes see list below.

Price without cabinet, \$12.00

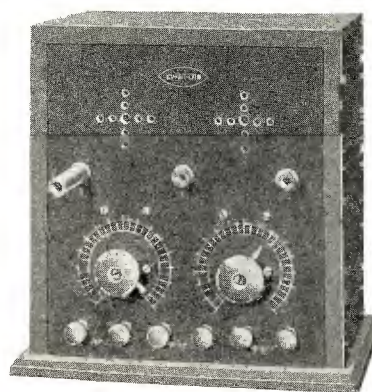

Type A-2

The EV-RA-LAB Type A-2 is a neat and highly efficient instrument, made of the finest materials and workmanship. Give maximum amplification without any interfering noises. The coils have the correct impedance value for modern amplifying tubes. One plug included. For batteries and tubes see list below.

Price without cabinet, \$35.00

The following parts used in the construction of Audion Control Apparatus in stock ready for immediate shipment, PREPAID.

Cabinet, Oak, for above Units.....	\$3.00	EV-RA-LAB Switch Arms50
A-P Electron Relay	5.75	Formica Panels 8 x 9 x 1/8.....	.75
A-P Amplifier-Oscillator	6.75	Paragon Rheostat	1.75
Eveready tapped batteries, 45 volts	4.50	Federal Plugs	1.95
Burgess, large, 45 V.....	7.00	Federal Jacks95
Burgess, small, 45 V.....	4.50	Switch Points, per dozen40
Acme Amplifying Coils, UM.....	4.25	Binding Posts, hard rubber125
Single Gang Pull Switches.....	.30	20,000 Meter Coils	5.75
Marconi Knobs, 1 1/2 in.....	.10	Murdock VT Bases	1.00

Dealers—we have an attractive proposition for you.

EVANSVILLE RADIO LABORATORY, 1103 South Third St., Evansville, Indiana

BULLETIN "A"

R
KLAUS
D
I
O

We are pleased to announce the following price reductions:

KLAUS RADIO STORAGE BATTERIES

35 Amp. size (\$20.90).....\$15.00
45 Amp. size (26.00)..... 18.00

KLAUS LOOP AERIALS

complete with instructions for assembling and operating\$4.75

Amateurs, Dealers, Schools, Radio Clubs—
Have you received our proposition?

KLAUS RADIO CO. Eureka, Illinois

Distributors for		
De Forest	Amco	Federal
Grebe	Amrad	Tborderson
Murdock	Baldwin	Moorhead
Acme	Brandes	Radio Corp.

A Business Opportunity

A business making radio apparatus which has sold readily to some of the largest dealers in the country seeks a responsible and active selling agency.

The plant of the advertiser is so equipped that it can turn out a product that stands a high test and at the same time meets all competition.

We seek this selling agency for these reasons:—

- 1st. We want an effective sale throughout the country instead of to a limited number of large users.
- 2nd. Our business is young and our efforts are best utilized in manufacturing.
- 3rd. We want an assurance through our selling agency that, if given the product, our own financial worries will be considerably modified.

Radio is the big thing for the next few years. There are now over 100,000 active private stations in this country.

Address Box 28
Care Experimenter Publishing Co.

RED-HEAD RADIO PHONES NOW \$8.00 PRE-PAID

1921 Model 3000 Ohms

Incomparably the World's Greatest Phone Value. Guaranteed identically the same head-set as previously sold for \$12.50. Increased production and decreased manufacturing costs make the new low price possible.

EXQUISITELY SENSITIVE RUGGED AND STURDY

Aluminum backs, military type head-band, bakelite ear caps, strain loops and posts, extra thin diaphragm, superb workmanship, beautiful appearance, 3 000 ohms resistance—these are a few of the features which have made Red-Heads a triumph in radio phone building.

Send us \$8.00 for Red-Heads today. You take no risk. If Red-Heads do not satisfy we will refund your money.

RED-HEAD RADIO HEAD-SET EIGHT DOLLARS, COMPLETE, PREPAID

Price subject to change without notice.

THE NEWMAN-STERN CO. Newman-Stern Bldg. Cleveland, O.

Write for Free Catalogue.

You can be quickly cured, if you STAMMER

Send 10 cents for 288-page book on Stammering and Stuttering. "Its Cause and Cure." It tells how I cured myself after stammering 20 yrs. B. N. Bogue, 868 Bogue Bldg., 1147 N. Ill. St., Indianapolis.

Telegraphy and High Frequency Currents, and (5) General Physics and Electric Measurements.

GIVEN HIGH AWARDS.

The Institution of Electrical Engineers marked their sense of the value of two other papers, viz., one on "The Photometry of Electric Lamps" and the other on "The Conductivity and Power Factor of Dielectrics" by twice awarding to Dr. Fleming their "Institution Problem" which is their highest award. The Royal Society of Arts also bestowed on him a Silver Medal and the Society of Engineers awarded him their "Bernays Prize."

Among the papers read by him to the Institution of Electrical Engineers one was on "Researches on Alternate Current Transformers" in which certain questions in dispute as to the relative value of different types of transformers and the best mode of measuring the energy losses were definitely settled. In this paper Dr. Fleming first suggested the now generally used term "Power Factor" and first drew attention to certain remarkable effects on suddenly switching in transformers on a high tension circuit.

It is generally agreed that his published papers, lectures and books on the subject of Wireless Telegraphy and High Frequency Electric Currents have very greatly assisted in the development of wireless telegraphy and in elucidating its very complex phenomena.

HIS STUDENTS WIN FAME IN SCIENCE.

During the thirty-six years' occupancy by him of the Chair of Electrical Engineering in University College, London, more than 1,000 students passed under his instructions and the courses of advanced lectures which he delivered year by year were nearly always attended by as many students as his lecture room could hold. Many of his students are now found occupying positions of great distinction in the engineering and scientific world.

In 1897 after the decease of Sir John Pender an influential committee was formed to create a memorial to him and among other resolutions it was resolved to bestow a sum of £5,000 on University College, London, for the endowment of the electrical engineering laboratories which henceforth were to be called the Pender Electrical Laboratories.

In recording this result in their annual report the Council of University College said: "The Council has pleasure in recognizing that these very satisfactory resolutions, in so far as they affect this college, are largely due to the energy, tact, and devotion of Professor Fleming, who, putting personal considerations on one side, has worked with unremitting zeal on behalf of the department under his care."

Many students have come from Japan, Holland, Denmark and Russia to work in Dr. Fleming's research laboratory at University College, having been influenced so to do by his published books and researches and his reputation as a teacher.

Martian Madness

(Continued from page 630)

"See you after breakfast and a little nap, Stats. I'm anxious to look at the sending instruments."

It was some hours later when Merton returned. Both balloons were anchored. Stats was working around the gasoline engine which controlled the balloons.

"All here," he called to Merton, "haven't looked in myself yet."

Merton lifted the cover which had pro-

(Continued on page 665)

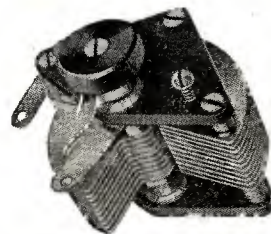

"EMPYREAN" VARIABLE CONDENSER

For Panel Mounting

This instrument is designed to meet the most rigid physical and electrical tests. Easily mounted on any panel up to three-eighths inches in thickness. Aluminum plates .026 inch bearing plates of 3/16" Formica. Furnished complete with screws, knob, pointer and scale.

48 plate condenser—over all dimensions—2" x 3 1/4" x 4 1/4".....\$4.50
21 plate condenser—over all dimensions—2" x 3 1/4" x 3".....\$3.65

Post paid in U. S.

Empyrean Radio Company

1122 Masonic Temple Building
Chicago, Ill.

! AMATEURS !

Visit Our Retail Department

We carry a complete line of Radio Apparatus and Parts.

Service and Satisfaction Guaranteed

EMPIRE RADIO EQUIPMENT CO.
271 West 125th St. (Near 8th Ave.) N. Y. City

Experimental Laboratory Apparatus

Most complete catalogue in print—just issued. Describes over five hundred chemicals and apparatus—including electric furnaces, microscopes, balances, weights, glassware, books and Practical Chemical Outfits—all fully illustrated. A combined handbook and catalogue for the chemical experimenter. Let us tell you how to get a free copy.

D. ALTMAN COMPANY

Dept. D
223-225 East 110th Street New York, N. Y.

DETROIT AMATEURS

Come see the new Parkin Condenser, .001 mf, non-short-circuiting, balanced, easy to mount. Price \$1.50 and \$2.00.

Heavy Gray Cardboard Tubing
3" and 3 1/2" dia. 2 1/2c per in., 25c per ft.
4" and 4 1/2" dia. 3c per in., 30c per ft.
Tuners, Loose Couplers, and B Batteries

Postage Extra Circular for stamp
Jeffery-Crawford Co., 2173 Hillger Ave. DETROIT, MICH.

:-: OFFER :-:

The Westchester Radio Service offers its entire facilities to all interested amateurs in Westchester County. Distributors for AMRAD, Radio-Craft, Dubilier, Radio-Service products.

Westchester Radio Service

253 So. B'way, Yonkers, New York



This Learners Set \$2.00. Without the buzzer \$1.00. Send for circular and code card. C. L. Redding and Co., 202 Main St., Everett, Mass.

Postpaid
\$1.50



Export
\$1.60

LEADS THEM ALL!

The Theraphone Master Model Mouthpiece is unequalled for tone purity, distinctness and range. Chuck full of merit, it is a wonder of charm and interest for the transmission of music and song. Just the thing for all difficult stunts and real results. Dependable even under unfavorable conditions. *Get one today!*

The EVOLUTION PHONE CO., Inc.
48-KM Greenwich Ave. New York City

"EVERYTHING IN RADIO"

WESTERN RADIO ELECTRIC COMPANY

SEND FOR OUR LATEST

STOCK BULLETIN AND PRICE LIST

550 South Flower Street

Los Angeles, Cal.

Quality On A Production Basis

PRODUCTION at the G. A. means holding down costs by the elimination of non-essentials, building in large quantities, and taking a small profit on individual sales but making many of them.

There is the secret of the low prices on G. A. Laboratory Type Detectors and Amplifiers. They are fitted with the finest parts—bakelite panels, Paragon rheostats, Ace sockets, Federal transformers, and G. A. grid leak condensers—parts that are seldom found on the most expensive equipment, yet the prices are lower than of the cheapest cheap apparatus.

How else can you buy a Detector and one-step Amplifier for \$23.90. A two-step for \$33.90? A Detector and two-step for \$40.85? Or a three-step for \$50.85? And without the sacrificing and sidestepping to hold down the prices.

- DETECTOR: As illustrated, without tube, shipping weight 1 lb..... \$6.95
- AMPLIFIER: As illustrated, without tube, shipping weight 2 lbs..... 16.95
- RADIOTRON: Detector, weight 1 lb., \$5.00; Amplifier, 1 lb..... 6.50
- B BATTERY: 22.5 volts, small size 1 lb., \$1.25; large size 5 lbs..... 2.00
- STORAGE BATTERY: 6 volts, 60 A. H. Endurance, 2-year guarantee 20.00
- TUBULAR AUDIOTRON: Original type, 2 filaments, 1 lb. 6.00



The General Apparatus Company, Inc.

570-N West 184th St., at St. Nicholas Ave.

New York City

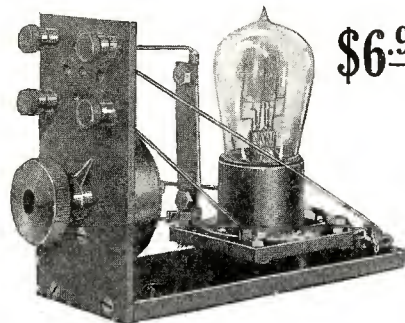

\$6.95

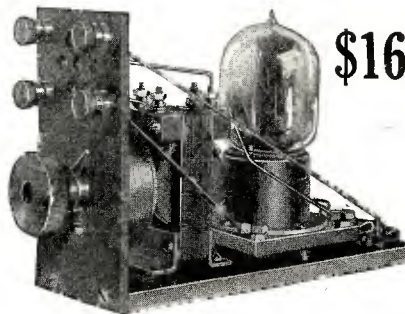

\$16.95

Another Grebe Triumph!

150-3000 Meters

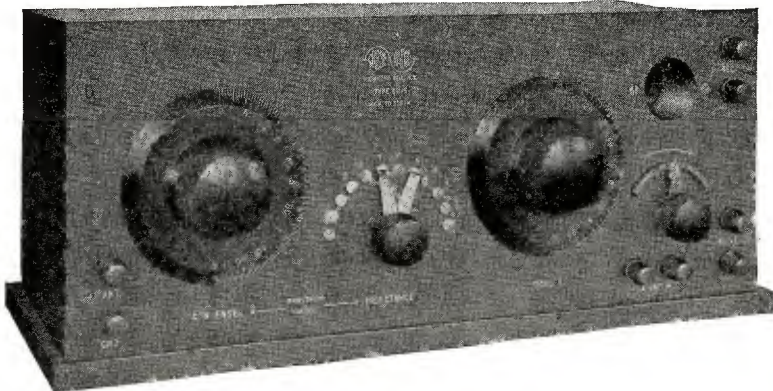

After much experimental work, we have succeeded in adopting the Armstrong Regenerative circuit to a receiver having a wave-length range of 150-3000 meters. The result is the



**TYPE CR-5
REGENERATIVE RECEIVER**

This is a complete receiver. The only additional equipment needed are 'phones, batteries and a detector tube.

Included in its range are amateur, navy and commercial wave-lengths, special land stations, ship CW stations, navy low-wave arcs, all radio 'phone work and "Time." In operation, it is the last word in simplicity.

Ask to see it at your dealers' today.

GREBE RADIO apparatus is licensed under the original Armstrong and Marconi patents.

- Central Radio Institute, Independence, Mo.
- Continental Radio and Electric Corp., New York.
- Detroit Electrical Co., Detroit, Mich.
- Doubleday-Hill Electric Co., Pittsburgh, Pa.
- Electrical Specialty Co., Columbus, Ohio.
- Holt Electric Utilities Co., Jacksonville, Fla.
- Hurlburt Still Electrical Co., Houston, Texas.
- Kelly and Phillips, Brooklyn, N. Y.

- U. of I. Supply Store, Champaign, Ill.
- Klaus Radio Company, Eureka, Ill.
- Manhattan Electrical Supply Co., New York, Chicago, St. Louis.
- Leo. J. Meyberg Co., San Francisco, Cal.
- Pacent Electric Co., Inc., New York City.
- F. D. Pitts Co., Inc., Boston, Mass.
- Philadelphia School of Wireless Telegraphy, Philadelphia, Pa.
- Western Radio Electric Co., Los Angeles, Cal.

A. H. GREBE & CO., Inc.,

72 Van Wyck Blvd., Richmond Hill, N. Y.

The Third Edition of the Consolidated Radio Call Book Very Greatly Enlarged

192 pages. (32 pages more than 2nd edition,) better paper, stiff covers etc.

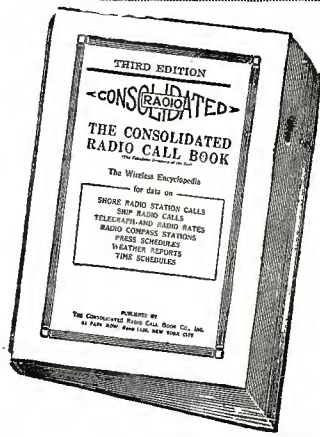

Some of the special information contained in the new book: Radio rate sheet (charges to and from vessels, etc.); Cable rates; Table for finding cable charges to various points; Weather reports and hydrographic reports of the world; Time signal section of the world; American radio compass stations; French radio compass stations; British radio compass stations; Canadian radio compass stations; General information section; International abbreviations; High power radio stations of the world; Press schedules of spark stations.

The Consolidated Radio Call Book is the only book in print officially listing all the Radio calls as issued by the Bureau of Commerce. Every vessel and land station in the world is represented and listed alphabetically, according to names of vessels or land stations, and according to call letters; Revision of American coastal stations under U. S. Naval control, and their new calls.

Every New Amateur Call Is Listed

SPECIAL—Given Free with Each Copy

A Wireless Map of the World in colors is given absolutely free with each copy. This map shows the locations of all the high powered RADIO stations in the world, including the time signal stations. In addition it tells at a glance how far away any of these stations are. Of greater interest are the time zones, which enable the amateur to compute instantly the correct time for the zone in which he is located from any time signal station.

The second edition of 10,000 copies was exhausted in ten days. The third edition is selling just as quickly. Don't wait until it is all gone. Order at once, either direct from us or from your favorite dealer.

Price \$1.50 Prepaid

Order Direct from us or for sale by the following responsible Dealers:

American Electro Tech. Appliance Co., New York City	Linze Electrical Supply Co., St. Louis, Mo.	Radioelectric Shop, Cleveland, Ohio
American Hardware Stores, Bridgeport, Conn.	Manhattan Electric Supply Co., New York, Chicago	Ray-Di-Co., Chicago, Ill.
Atlantic Radio Co., Boston, Mass.	McCarthy Bros. & Ford, Buffalo, N. Y.	Reuter Electric Co., Cincinnati, Ohio
Bamberger & Co., L., Newark, N. J.	McClurg & Co., A. C., Chicago, Ill.	Riverside Laboratory, Milwaukee, Wis.
Benwood Specialty Co., St. Louis, Mo.	Meter Electrical Construction Co., Oshkosh, Wis.	Rose Radio Supply, New Orleans, La.
Brodie Electric Co., Los Angeles, Cal.	Meyberg Co., Leo J., San Francisco, Cal.	Saunders Co., Geo. S., Boston, Mass.
Bunnell & Co., J. H., New York City	Mohawk Electrical Supply Co., Syracuse, N. Y.	Schmidt & Co., Rudolph, Rochester, N. Y.
California Electric Co., San Francisco, Cal.	New Era Shop, Milwaukee, Wis.	Sears, Roebuck & Co., Chicago, Ill.
Catton, Neill & Co., Honolulu, T. H.	Newman-Stern Co., Cleveland, Ohio	Service Radio School Washington, D. C.
Central Radio Co., Independence, Mo.	Nola Radio Co., New Orleans, La.	Shaffers, Norfolk, Va.
Chicago Radio Apparatus Co., Chicago, Ill.	Noll & Co., E. P., Philadelphia, Pa.	Shotton Radio Mfg. Co., Scranton, Pa.
Continental Radio & Electric Corp., New York City	Northwest Radio Service Co., Seattle, Wash.	Smith Bros., Sarnia, Ont., Canada
Cutting & Washington Radio Corp., New York City	N. S. W. Bookstall Co., Sydney, Australia	Smith Novotoy Electric, Inc., Charlotte, N. C.
Detroit Radio Laboratories, Detroit, Mich.	Pacent Electric Co., New York City	Southern Electrical Supply Co., San Diego, Cal.
Dewey Sporting Goods Co., Milwaukee, Wis.	Paramount Radio Supply Co., Atlantic City, N. J.	United Radio Telegraphers' Assoc., Baltimore, Md.
Doubleday-Hill Electric Co., Pittsburgh, Pa.	Parks, Henry Francis, Butte, Mont.	Western Radio Electric Co., Los Angeles, Cal.
Electro Importing Co., New York City	Pearlman's Book Shop, Washington, D. C.	Whitall Electric Co., Westerly, R. I.
Findley Electric Co., Minneapolis, Minn.	Penn Radio Apparatus Co., Reading, Pa.	White & Boyer Co., Washington, D. C.
Fuller Co., Seth W., Boston, Mass.	Pennsylvania Marconi Wireless School, Philadelphia, Pa.	White Co., The Columbus, Ga.
Gurd & Co., Wm., London, Canada	Philadelphia School of Wireless Telegraphy, Philadelphia, Pa.	Williamson Electric Co., H. E., Seattle, Wash.
Hico Wireless Supply Co., Marion, Ill.	Piedmont Electric Co., Asheville, N. C.	Wilmington Electrical Specialty Co., Wilmington, Del.
Holt Electric Utilities Co., Jacksonville, Fla.	Pioneer Electric Co., St. Paul, Minn.	Wireless Mfg. Co., Canton, Ohio
Jenkins, Lester I., New Bedford, Mass.	Pitts Co., F. D., Boston, Mass.	Wireless Press, New York City
Katzenbach & Co., F. S., Trenton, N. J.	Post Office News Co., Chicago, Ill.	Wireless Shop, Los Angeles, Cal.
Kendall Co., W. D., Worcester, Mass.	Precision Equipment Co., Cincinnati, Ohio	Young & McCombs, Rock Island, Ill.
Killoch Co., David, New York City	Radio Distributing Co., Newark, N. J.	Young Men's Christian Assoc., Los Angeles, Cal.
Kluge, Arno A., Los Angeles Cal.	Radio Electric Co., Pittsburgh, Pa.	Zamoiski Co., Jos. M., Baltimore, Md.
Krause & Co. A. F., Detroit Mich.	Radio Equipment Co., Boston, Mass.	
Lehigh Radio Co., Bethlehem, Pa.		

Published by

Consolidated Radio Call Book Co., Inc.

41 Park Row, New York City

(Continued from page 662)

tected the instruments. "Rocks," he yelled, "Statts, come here, look, rocks, who—, say, were you on the lookout all morning?"

"Sure was," replied Statts stoutly, "never moved from the place and I was mighty tired too, I had no sleep last night."

Merton was puzzled. "I can't understand it," he said, perplexed. "See here, Statts, did you leave the place last night while I was at dinner?"

Statts thot a moment and then answered truthfully, his job was finisht or soon would be.

"I left last night for something to eat," he stated sullenly, "I had to eat, you know."

Merton looked sick with disappointment. His spirits were too low to even censure Statts for his neglect. "The apparatus was stolen then," he muttered. "Mars—how could they have answered if I did no transmitting?"

Sadly he walked homeward. The stolen instruments bothered him little, but the frustrated hopes and the humiliation of having to confess his failure cut deeply.

Professor Wiegand glanced up from a radio magazine when Merton entered the library. "Why so sad, my boy?" he asked.

Merton told him.

"That's a good one on you," murmured the scientist, "and here's another." He handed him the radio magazine and pointed to a headline. Merton read:

"Japanese to Communicate with Mars." A paragraph below followed:

"A Japanese station built especially for communication with Mars is at present under construction in Japan. The wavelength of the station will be between fifty and sixty thousand meters. It is proposed to use the same power as in commercial stations, the only differences being in wavelength, a high pitched note and the tremendous antenna."

"This magazine is six months old," stated the professor, "no doubt this is the station we heard, they talk in Japancse code, you know, only the word Mars being transmitted in English."

"The experiment has failed," said Merton huskily. "It's sure a disappointment."

"Well, it needn't be, Merton," consoled the little man, "for the experiment was successful in another way."

Eyes aglow the professor explained what he had discovered in regard to instruments for the measuring of atmospheric conditions.

"I was not the only one to benefit, my boy," the scientist finisht, "think of the discovery you have made."

"The discovery I made?" repeated Merton, puzzled. "What was it, professor?"

"You don't know?" the professor's eyes were twinkling, "why, Merton, you discovered the meaning of 'Martian Madness.'"

Inside Dope on "Our" Set

(Continued from page 646)

sure it is a *Detector* bulb. In tuning, remember to tune the primary and secondary, respectively, first, with plate inductance as nearly nil as possible, then gradually tune in the inductance in the plate circuit and—hold your breath!

(Author's final suggestion:—If this set doesn't work, use something else. Try the Tungar or Electrodyne bulbs!)

C. W. STUFF.

First Amateur: Jack, all the insulation has been stript from my coupler.

Second Bug: Howzat?

First Ham: Receiving sharp waves.

P. H. CULLOM.

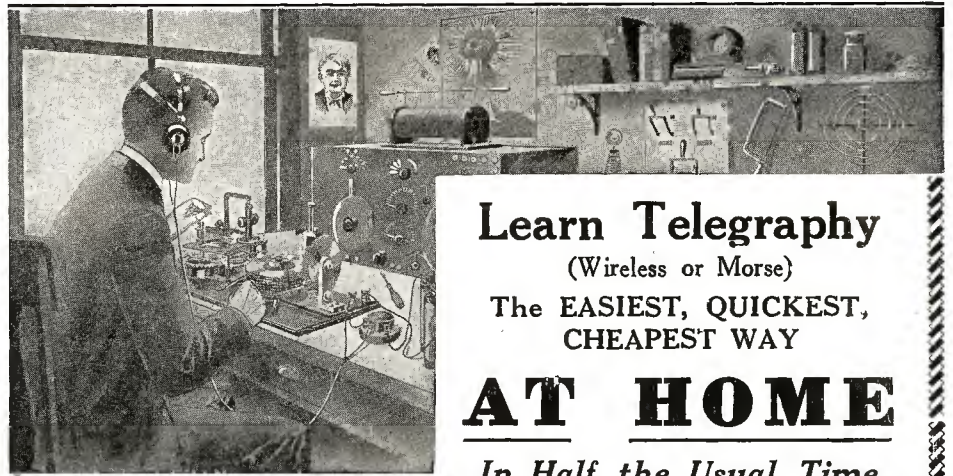

Learn Telegraphy

(Wireless or Morse)

The EASIEST, QUICKEST, CHEAPEST WAY

AT HOME

In Half the Usual Time

WITH THE OMNIGRAPH

"Just Listen—The Omnigraph will do the teaching"

The Omnigraph is an *Automatic* Transmitter that teaches you both the Wireless and Morse Codes, at home, without any expense except the cost of the machine itself. Merely connect to battery and your Buzzer, or Buzzer and Head Phones, or to your Sounder and the Omnigraph will send unlimited messages by the hour, at any speed you desire.

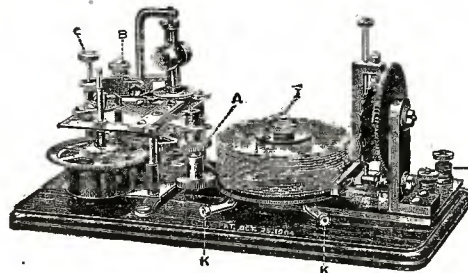

USED BY THE U. S. GOVERNMENT

The Omnigraph is used by the Government in testing all applicants applying for a Radio License. It is also used extensively by the large Universities, Colleges and Telegraph Schools throughout the Country for teaching Wireless and Morse. Hundreds of the Army's skilled operators who served during the war learned with the Omnigraph.

Let The OMNIGRAPH Teach You Wireless

For a few dollars you can have a complete outfit that will make you an experienced operator in the shortest possible time. No hard, laborious work—just learn by listening. The Omnigraph is adjustable so you can start receiving messages slowly, gradually increasing the speed as you become proficient.

You'll be surprised how quickly you will attain speed. Even if you are already an operator the Omnigraph will help you. It will make you more proficient, more accurate and more confident. Thousands of Omnigraphs are in use today and thousands of operators owe their success to them.

Write for Free Catalog

Send for a catalog today, showing the 3 different models, \$14 to \$30. Every Omnigraph is sold with the absolute guarantee that you must be satisfied or your money back for the asking. Mail the coupon today—the catalog will come to you by return mail.

The Omnigraph Mfg. Co.
26 F. Cortlandt St., New York City

The Omnigraph Mfg. Co.
26 F Cortlandt St.,
New York City

Gentlemen:—

As per your ad in RADIO NEWS please mail me your free catalog of Omnigraphs.

Name

Address

City..... State.....

Condenser
No.
3

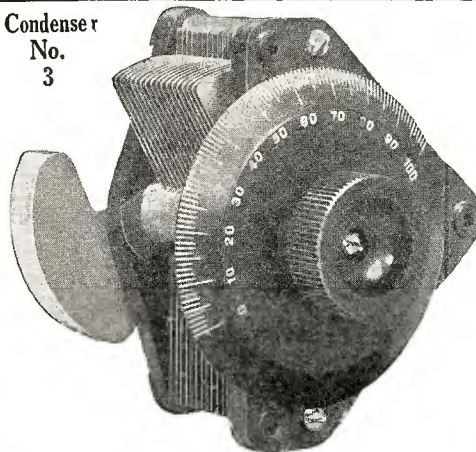

CHELSEA

Variable Condensers

(Die-Cast Type)

- No. 1.—.0011 m. f. mounted\$5.00
- No. 2.—.0006 m. f. mounted\$4.50
- No. 3.—.0011 m. f. unmounted\$4.75
- No. 4.—.0006 m. f. unmounted\$4.25
- Bakelite Dials only75

Top, bottom and knob are genuine bakelite, shaft of steel running in bronze bearings, adjustable tension on movable plates, large bakelite dial reading in hundredths, high capacity, amply separated and accurately spaced plates.

Unmounted types will fit any panel and are equipped with counterweight. Purchase from your dealer; if he does not carry it, send to us.

Bulletin upon request.

CHELSEA RADIO COMPANY
17 FIFTH STREET, CHELSEA, MASS.
Manufacturers of Radio Apparatus and Moulders of Bakelite

*To my friends:
 Here is a vital
 message for you
 that you may start
 to prosper on the road
 to prosperity
 H. Gernsback*

Your Savings Bank Pays You Only 4% Interest

We offer you an Investment that will pay you 7% and the chance of a Profit

You, who are readers of this magazine, know how the Experimenter Publishing Co. has grown during the past eight years. Three years ago we were publishing only one magazine, ELECTRICAL EXPERIMENTER (now known as SCIENCE AND INVENTION). This publication was only 72 pages with a very small circulation. Today it is one of the twenty-five largest monthly publications in the United States (in point of advertising carried)—every issue contains 104 to 120 pages and its circulation has increased to over 170,000 copies monthly.

RADIO NEWS was started only a year ago last July. You know the story of the growth of this magazine as well as we do. Today it is the greatest wireless magazine the world has ever known. Its circulation is larger than the total circulations of all the other radio magazines in the United States combined. RADIO NEWS carries by far more advertising each month than any other wireless magazine

—in fact its advertising lineage is greater than many of the so-called big general magazines that you all read.

The Experimenter Publishing Company has made money consistently year after year. The surplus has been put back into the business to develop the property until today we have a business that has an annual turnover of two-thirds of a million dollars. And this was accomplished on a very small and limited capitalization.

Last year, despite the terrific increases in the cost of paper, printing, art work, engravings, labor—in fact, everything—we showed a very substantial net profit. The net profits for the year 1920 amounted to over \$42,000. Now with costs coming down, we have the opportunity of making these two magazines the greatest of any class magazines in the country. We want to see SCIENCE AND INVENTION running over 200 pages every month—we want to see RADIO NEWS with 150 or more. We want to double the circulation so the advertising will be worth more to the advertisers allowing us to enlarge and improve the magazines still further. We want to place our two magazines beyond any competition, whatsoever. And we can do it with a little more capital.

We Invite You to Become Our Partners

We will sell to our subscribers 1,000 shares only of 7% non-cumulative preferred stock of a par value of \$100 per share. You can invest any amount you want from \$100 up in multiples of one hundred. Every share of preferred stock pays guaranteed dividends of 7% yearly—nearly twice what you get from a savings bank. In addition, as the magazines grow and the company gets stronger and stronger each year, the stock becomes worth more and more. In this way you have the opportunity of making a safe, profitable investment and one with speculative possibilities as well.

If you can invest more than \$500 let us show you how your money can earn about 10% interest instead of 7%. We have a special proposition for investments of \$500 or over; write for it today.

If you do not wish to pay cash for your shares we offer our special installment plan—pay as you go along. Write us about this today.

You surely have some surplus funds available. Take advantage of this opportunity of investing them in a stock that combines safety, high yield, and the chance for a profit on the principal. Fill out the enclosed subscription blank for as many shares as you can carry and return today.

H. GERNSBACK, President
Experimenter Publishing Company
 Established 1913
233 and 236 Fulton St. New York City

Application for Seven Per Cent Non-Cumulative Preferred Stock of the Experimenter Publishing Company

EXPERIMENTER PUBLISHING CO.,
 233 Fulton St.,
 New York, N. Y.

Gentlemen:—

Please accept my subscription for shares of your 7% non-cumulative preferred stock at the par value of \$100.00 each share. I enclose my check for \$..... herewith.

Name

Address

City

State

SPECIAL PREMIUM OFFER

With a Year's Subscription to Radio News or Science and Invention (Electrical Experimenter)

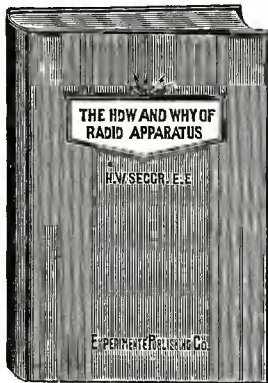

This newest of Radio works, bound in flexible velum and hand sewed, has 160 pages. Size of book 6 x 9 inches.

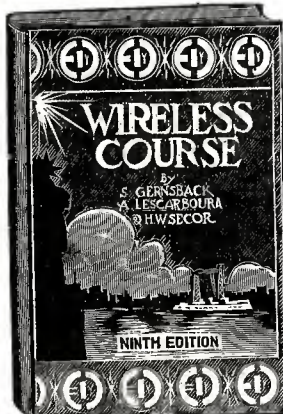

Book is bound in flexible Velum; has 160 pp. Size 7 x 12 inches.

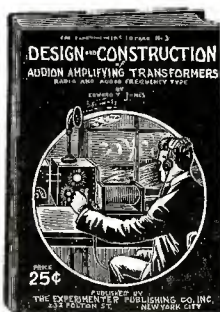

Printed on heavy paper, paper bound. Size 5 x 7 inches. Fully illustrated. The latest book out.

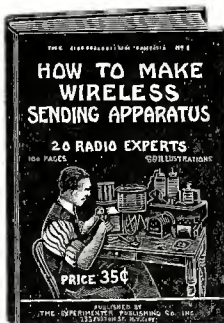

Book has 100 pages. Size 5 x 7 inches. 88 illustrations. Paper cover printed in two colors.

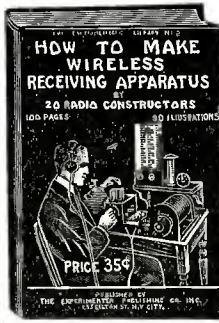

Book has 100 pages. Size 5 x 7 inches. 90 illustrations. Paper bound, in two colors..

Offer A
 Science and Invention
 (Electrical Experimenter)
 for one (1) year with
 The How and Why
 of Radio Apparatus

REG. PRICE
 \$3.00
 \$1.75
 \$4.75

SPECIAL PRICE OFFER, A or C, \$3.75

Offer B
 Radio News
 for one (1) year with
 The How and Why
 of Radio Apparatus

REG. PRICE
 \$2.00
 \$1.75
 \$3.75

SPECIAL PRICE OFFER, B or D, \$2.75

Offer E
 Science and Invention
 (Electrical Experimenter)
 for one (1) year with
 Wireless Course in 20
 Lessons

REG. PRICE
 \$3.00
 \$1.25
 \$4.25

SPECIAL PRICE OFFER, E or G, \$3.50

Offer F
 Radio News
 for one (1) year with
 Wireless Course in 20
 Lessons

REG. PRICE
 \$2.00
 \$1.25
 \$3.25

SPECIAL PRICE OFFER, F or H, \$2.50

Offer C
 Science and Invention
 (Electrical Experimenter)
 for one (1) year with
 A Thousand and
 One Formulas

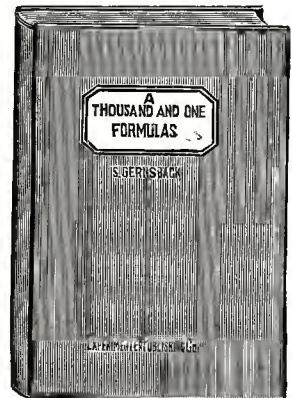

A Laboratory Handbook for the Experimenter. Bound in flexible velum. 160 pages. Size 6 x 9 inches.

Offer D
 Radio News
 for one (1) year with
 A Thousand and
 One Formulas

Offer G
 Science and Invention
 (Electrical Experimenter)
 for one (1) year with
 Experimental
 Electricity Course

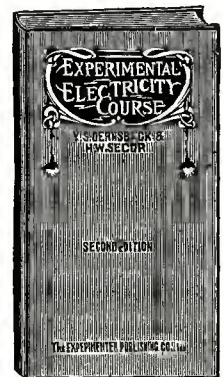

Book is bound in flexible Velum; has 160 pp. Size 5 x 9 in.

Offer H
 Radio News
 for one (1) year with
 Experimental
 Electricity Course

Offer K
 Science and Invention
 (Electrical Experimenter)
 for one (1) year with
 Design and Construction of
 Audion Amplifying-Trans-
 formers.
 How to Make Wireless Send-
 ing Apparatus.
 How to Make Wireless Re-
 ceiving Apparatus.

Reg. Price	\$3.00	Special Price to you
		\$3.25
	.95	
	\$3.95	

Offer L
 Radio News
 for one (1) year with
 Same Books as Offer (K)

Reg. Price	\$2.00	Special Price to you
		\$2.25
	.95	
	\$2.95	

EXPERIMENTER PUBLISHING COMPANY, Inc.
 236-A Fulton Street, New York City, N. Y.

Dear Sir:

I accept your offer Enclosed find \$.....
 in payment of premium and one year subscription.

Name

Address Town..... State

OPPORTUNITY AD-LETS

Follow these advertisements every month. Reliable advertisers from all over the country offer you their most attractive specials in these columns.

Classified advertising rate six cents a word for each insertion. Ten per cent discount for 6 issues, 20 per cent discount for 12 issues. Name and address must be included at the above rate. Cash should accompany all classified advertisements unless placed by an accredited advertising agency. No advertisement for less than 10 words accepted.

Objectionable or misleading advertisements not accepted. Advertisements for the May issue must reach us not later than April 10.

THE CIRCULATION OF RADIO NEWS IS OVER 40,000

EXPERIMENTER PUBLISHING CO. INC., 233 and 236 Fulton Street, New York, N. Y.

Automobile Accessories.

Auto Motors Supplies.—Buick, Michigan, Stoddard-Dayton, E. M. F., Cadillac, Overland, Continental and Buda Motors. All types \$50 each and up. Special High Tension Magnets 2 and 4 cylinder, \$9.50 each. Electric & Gas Head Lamps, Coils, Carburetors, Air Compressors, Generators, Starters, etc. Write for catalog. Address Motor Sales Dept. 16, West End, Pittsburgh, Penna.

Aeronautics.

Aviation—Motor 30/40 H.P., 2 cyl. opposed air cooled, weight 128 lbs.; ideal motor for light aeroplanes, motor sleds, wind wagons, hydroplanes, etc. Price only \$325—complete with propeller ready to run. Aircraft Inc., 338 Coney Island Ave., Brooklyn, N. Y.

Send for the most remarkable flying novelty ever created. Attains a height from 50 to 100 feet. 25 cents. S. P. Lux, 1582 Pitkin Ave., Brooklyn, N. Y.

Motor Engines and Dynamos.

Special Garage Motors: New; manufactured by General Electric Co. 1/2-Hp., \$22.75; 1-Hp., \$38.50; 2-Hp., \$126.50; 3-Hp., \$146.50; 5-Hp., \$188.50. All sizes both single and Polyphase Motors for immediate delivery. Special charging generators all voltages. Write for catalog. Motor Sales Dept. 16, West End, Pittsburgh, Penna.

Your Opportunity to buy motors. We have a large stock of motors new and used at bargain prices. All sizes and makes. Write us you want. Harry Gleigh, 490 Sixth Ave., New York City.

Motor Bargain—Dichl 1/20 H.P. Universal 110 V. with pulley. Never used. Price \$6.75, prepaid. Alsop Engineering Co., 200 West 72nd St, New York City.

Motorcycles—Bicycles.

Don't Buy a Bicycle Motor Attachment until you get our catalogue and prices. Shaw Mfg. Co., Dept. 1603, Galesburg, Kans.

American Made Toys.

An Opportunity for Home Workers on small scale and manufacturers on large scale to make American Metal Toys, Army, Navy, Machine Guns, Cannons, Warships, Indians, Cowboys, Wild Animals, Whistles, Bird-Whistles, Religious designs and other toys and novelties. Greatest chance for industrious people to have an independent business. Enormous demand for cheap toys offers unlimited field and great future all over United States and foreign countries. Experience, or tools not necessary. Hundreds and more made complete per hour. Casting forms, complete outfit from \$3.00 up. We buy these goods paying fixed prices. Attractive prices offered for painted goods. A strictly business proposition. No one need apply unless he means business. Booklet and information furnished free. We have no sales agents and we warn against worthless and cheap imitations. Toy Soldier Manufacturing Co., 1696 Boston Road, New York.

Help Wanted.

Detectives Earn Big Money. Excellent opportunity. Travel. Great demand everywhere. Fascinating work. Experience unnecessary. Particulars free. Write, American Detective System, 1968 Broadway, New York, N. Y.

Be a Mirror Expert. \$3-\$10 a day; spare time home at first; no capital; we train, start you making and silvering mirrors, French method. Free prospectus. W. R. Derr, Pres., 579 Decatur St., Brooklyn, N. Y.

Earn \$25 Weekly, spare time, writing for newspapers, magazines. Experience unnecessary; details free. Press Syndicate, 5665, St. Louis, Mo.

Young Men!—Train now for wireless or railway operator or station agent. Largest and only officially endorsed school in Canada. Correspondence and resident courses. Free Book R explains. Write Cassan's Wireless School, Toronto.

Stop Daily Grind. Start silvering mirrors, auto headlights, tableware, etc. Plans free. Clarence Sprinkle, Dept. 48, Marion, Indiana.

U. S. Government wants hundreds of railway mail clerks immediately, \$135 month. List positions free. Franklin Institute, Dept. J136, Rochester, N. Y.

Business Opportunities.

Acre pecans and oranges with beach club lot, \$100. Easy terms; big returns. Dept. "R," Suburban Acres Co., Ocean Springs, Miss.

Tarman's Fur Farms, Quincy, Penna. Breeders and dealers in live foxes, scentless skunks, mink, dogs, birds, traps. List free. Pamphlet on Fur Farming, 25 cents.

Free Illustrated Lesson in advertisement writing, also agate ruler for practice, both mailed you free anywhere, to introduce my new method. Big demand for good writers, \$3,000 to \$10,000, or do writing home evenings, country or city, selling it far away by mail as I have. I made \$100,000 in recent years. Just your address on postal brings all free, postpaid. C. H. Williams, Department C, Cortlandt Street Building, New York.

Big Money in Your Spare Time manufacturing letters for signs; no experience—free particulars. H. F. McPherson, 675 Brown Ave., Butler, Pa.

Substantial Manufacturing Corporation wants capable men to establish branch and manage salesmen; \$300 to \$2,000 necessary. Will allow expenses to Baltimore as explained. Address Mr. Clemmer, 603 N. Eutaw St., Baltimore, Md.

If You Want to Sell or Exchange your farm, unimproved land, city property or patent, write me. John J. Black, 194th St., Chippewa Falls, Wis.

The GEORGE N. GARRISON COMPANY EAST ORANGE, NEW JERSEY

February 12, 1921.

RADIO NEWS,
233 Fulton Street,
New York City.

Gentlemen:—

A few "cold facts," without exaggeration, may be of interest to you and to the readers of your Classified Columns.

In the January, 1921, issue of your magazine appeared a 21-word advertisement by the writer, offering for sale certain "Honeycomb" coils. The coils were sold the second day after the magazine appeared on the local news stand and, to date, I have received just 77 replies, a goodly number of which contained Money Orders or checks. Replies are still coming in in each mail and I have been considering inserting a notice in your magazine to the effect that the coils have been sold.

The total cost of each reply was 1.6 cents. Any magazine that is capable of "pulling" as has RADIO NEWS, assuredly deserves the commendation of

Cordially yours,
(Signed) G. N. Garrison,
2AWM.

Books.

Chemical Label Book, containing one hundred gummed, attractively printed names of chemicals and reagents most used in the laboratory. 35 cents prepaid. Nothing like it at the price. Neat, useful, handy. D. Altman Company, 223-225 East 110th Street, New York.

For Sale.—"Wireless Ages" back to 1913. James Alcorn, Titusville, Penna.

We Buy and Sell back issues of Radio Amateur News and Electrical Experimenter. Boston Magazine Exchange, 109 Mountfort St., Boston, Mass.

Electricity, Magnetism, induction, experiments, dynamos, armature windings, all explained in 22 chapters, 348 pages, in Hawkins' Electrical Guide, Vol. 1; postpaid, \$1.00. Stratton Electric Co., 215 Federal Street, Greenfield, Mass.

The Amateur Electrician. Pocket size, 20c (coin). Joe Tillberg, Proctor, Vermont.

Job—The Quick-Writing System—A simplified long-hand system that doubles your writing speed and can be learned in five evenings. Excellent for taking radio messages and can double sending speed between amateur stations. Send for descriptive circular. Manual \$2.00. Milton Wend, Tribune Bldg., New York City.

Correspondence Courses.

Dollars Saved. All kinds of used correspondence courses sold. (Courses bought). Lee Mountain, Pisgah, Alabama.

Chemicals.

Value! That's Me All Over! I'm a handy little label book, containing one hundred gummed, attractively printed names of chemicals and reagents most used in the laboratory. Best little investment you ever made. Neat, convenient. 35 cents (coin) will bring me to your laboratory, prepaid, together with interesting chemical literature. D. Altman Co., 223-225 East 110th St., New York City.

For Advertisers.

Don't Wait for Business.—Advertise and get it. We will help you. Jacobus Service, 41 Bruen, Irvington, N. J.

Advertise in 100 Magazines. Words 9c each; three times 18c each. Concordia Magazine, 9A Water, York, Penna.

For Men.

Safety Razor Blades sharpened, two cents each; good work; quick service. Send today. C. Westroem, Liberty and Denman, Cincinnati, Ohio.

Health.

Fyorrhea (Rigg's disease—bleeding or swollen gums)—hundreds have been helped by "Pyorident" the successful home pyorrhea treatment. Purifying, healing, preventative. Full month's treatment, consisting of a very beneficial massage paste and an antiseptic tooth-cleansing paste to be used in place of your ordinary dentifrice, together with full directions for treatment. \$1 postpaid. Or write for free booklet "R." Pyorident Mfg. Co., 439 Seventh St., Brooklyn, N. Y.

Tobacco or Snuff Habit Cured or no pay; \$1 if cured. Remedy sent on trial. Superba Co., S.B. Baltimore, Md.

Jewelry

Heavy 14K Gold Filled Rings, guaranteed five years or money back. Genuine pigeon blood reconstructed rubies, pink sapphires. Price \$1.55. DeColigny & Co., 234 N. 64th St., Philadelphia, Pa.

Watch Repairing—Expert workmanship. Quick service. North Side Watch Repair, 26 Hackney St., Pittsburgh, Pa.

Mailing Lists.

Canadian Lists of automobile owners, agents, garages, repairers, dealers, \$3 per 1,000. Lasnier Agency, Bathurst, N. B., Canada.

Novelties.

Genuine Indian Baskets. Wholesale catalogue. Marion Gilhams, Highland Springs, California.

Indian Relics—Fifty extra fine flint ridge spears and arrows, \$5. Harry B. Garber, Quaker City, Ohio.

News Correspondents

Earn \$25 Weekly, spare time, writing for newspapers, magazines. Experience unnecessary; details free. Press Syndicate, 566 St. Louis, Mo.

Office Devices.

We Buy for Cash, Rebuild and Sell for about half new price, multigraphs, addressing machines, duplicators, etc. Don't be misled by firms infringing on our name. We are the original Office Device Company, 154-C West Randolph, Chicago.

Postcards

Blue Bird Correspondence Club. "To promote happiness." Club magazine dime. Swap Bulletin, New York—Detroit.

Postcards of Beautiful Girls—Sample and catalogs, 10c Smith's Art, A6735 Elizabeth, Chicago.

Two Swell Bathing Girl Calendars, 25c. Durso, Dept. 50, 25 Mulberry, New York City.

Patent Attorneys.

Patents Secured—Prompt service. Avoid dangerous delays. Send for our "Record of Invention" form and free book telling How to Obtain a Patent. Send sketch or model for examination. Preliminary advice without charge. Highest reference. Write today. J. L. Jackson & Co., 133 Ouray Bldg., Washington, D. C.

Patents—Send for free book. Contains valuable information for inventors. Send sketch of your invention for free opinion of its patentable nature. Prompt service. Twenty years' experience. Talbert & Talbert, 4927 Talbert Bldg., Washington, D. C.

Mr. Inventor! Investigate the possibilities of obtaining your own patent. Save \$40 to \$100. We prepare drawings, specifications and claims you file. Quicker action. Let us explain. Enclose stamp. The Plan Bureau, 1929 McCausland Ave., St. Louis, Mo.

Millions Spent Annually for ideas. Hundreds now wanted! Patent yours and profit! Write today for free books—tell how to protect yourself, how to invent, ideas wanted, how we help you sell, etc. 301 Patent Dept., American Industries, Inc., Washington, D. C.

Personal.

Don't be a round peg in a square hole! Have your character analyzed for \$1. Send photographs, birth, data, color of eyes, etc. Moak, Lafayette St., Arlington, Mass.

Astrology—Stars tell life's story. Send birth date and dime for trial reading. Eddy, 4307 Jefferson, Kansas City, Mo. Apartment 30.

Phonographs.

Build Your Own Phonograph. Big Saving. Blue prints, parts price list, instructions free. Associated Phonograph Co., Dept. R-N, Cincinnati.

Printing.

5,000 1 1/2 x 2" labels, \$2.50. Save 30%. Wolf, Sta. E., Desk J. Philadelphia, Pa.

Stationery and Printing, loose leaf hooks, rubber stamps, etc. H. Blacker, 3527 New Queen St., Philadelphia, Pa.

Your Name and Address and radio call printed in society script type on 50 calling cards for 35c. Damon Novelty Co., 6 Church St., East Weymouth, Mass.

Everything Printed—Long run specialists. Samples. Quality Printery, Marietta, Ohio.

Scenery for Hire.

Collapsible Scenery for all plays. Amelia Grain, Philadelphia, Pa.

Stamps and Coins.

California Gold Quarter size and Colombia nickel coin 30c; Italy 10 Centimes and catalog 10c. Homer Shultz, King City, Mo.

500 Different Stamps, \$1.40; 200, 30c.; 100, 13c.; approvals. Michaels, 5600 Prairie, Chicago.

100 Different Stamps, Nicaragua, Salvador, Victoria, Brazil, Chile, large pictorial French Colonies, etc., album with perforation gauge, only 10c silver. Stamp collections and accumulations bought. Clarence Gibbs, 8932 Juniper, Los Angeles, Calif.

Stammering.

St-Stu-t-t-tering and Stammering cured at home. Instructive booklet free. Walter McDonnell, 121 Potomac Bank Bldg., Washington, D. C.

Song Poems.

Song Writer's Manual and Guide sent free. Contains valuable instructions and advice. Submit song-poems for examination. We will furnish music, copyright and facilitate publication or sale. Knickerhocker Studios, 311 Gaiety Bldg., New York.

Telegraphy.

Telegraphy (both Morse and Wireless) and Railway Accounting taught quickly. Tremendous demand. Big salaries. Great opportunities. Oldest and largest school; established 46 years. All expenses low—can earn large part. Catalog free. Dodge's Institute, M. St., Valparaiso, Ind.

Typewriters.

Simplex Typewriters—Guaranteed; 2 sizes. \$2.50 and \$4.25, prepaid. Smith's Company, E6735 Elizabeth St., Chicago.

Tricks, Puzzles and Games.

Tricks, escapes, puzzles, photos, books. Catalogue free. Magcraft Co., Dept. F, Box 251, Detroit, Mich.

Electrical Supplies and Appliances.

Storage Batteries for automobiles. We furnish all parts and moulds for making them. Sample plate, 40c. Foreign countries, 50c. Windsor Specialty Co., 5419 Windsor Ave., Chicago, Ill.

Electric Wiring Diagrams, wireless, etc., 25c each, no stamps. Special prices on special work. D. F. Dunsmore, Hamilton, W. Va.

Electricians—Wiremen, linemen, send your name and address for descriptive literature of our modern blue print chart method of electrical wiring. Over 350 practical diagrams. Electrical Wiring Diagram Co., Box C-173, Altoona, Pa.

Don't Miss This Opportunity—Big bargain in storage batteries. We have four 6V-80 A. H. batteries in excellent condition. The first four \$15 orders takes them. Harry Gleich, 490 Sixth Ave., New York City.

Just Off the Press. Design and Construction of Audion Amplifying Transformers (Radio and Audio-Frequency Types). By Edward T. Jones, late Associate Editor Radio Amateur News. The transformers shown in this book have never been described in print before and have usually been considered a manufacturer's secret. The designs are very rugged and simple. A book that every radio "bug" should have. Written so you will understand every word. Price 25c postpaid. Experimenter Publishing Co., Book Dept., 236-A Fulton St., New York City.

Wireless.

Grid Condensers prepaid anywhere, 50c each. Ingenious invention makes it possible to hermetically seal very small capacitances in very small compartments. Not exposed to changes of atmosphere. 100% efficiency performance test. Works with any type tube. Crescent City Radio Company, Dept. D., P. O. Box 1104, New Orleans, La.

All Amateur Apparatus bought or made in accordance with The Radio Buyers' and Builders' Handbook invariably re-sells very profitably. Study my June and July display advertisements in Q. S. T., see why, and get your copy now. R. Clark, Barnes Rd., Newton, Mass.

Electrolytic Rectifiers—Will operate your audion plate circuits on A.C. perfectly when used with ordinary filter circuit. Half pint size, extra charge of chemicals, renewal electrodes, per set of four, \$2. No objectionable noise even in amplifier sets. Satisfaction guaranteed. Free circular. Geo. M. Gilbert, 746 Chenango St., Binghamton, N. Y.

Brand New—Two .0015 DeForest Vernier type variable condensers for \$30; \$24 navy type coupler for \$15. Clifford LaFaber, Marietta, Ohio.

Blue Prints—Twelve proven receiving circuits, each on separate sheet, all for 40c. Ten proven radio phone and two combination VT hookups for transmitting, 50c. Wireless code on large blue print 25c. The Plan Bureau, 1929 McCausland Ave., St. Louis, Mo.

Our Special for This Month. This month we are making a special offer on Chelsea Apparatus, and for one month we are making an offer of 5% less than list prices and all goods fully guaranteed and will be shipped by insured parcel post paid. We handle all the best grades of radio apparatus and practically make shipment the same day the order is received. Radio Mail Order Supply Co, 533 West End Ave., New York City, N. Y.

Radio Phonists Attention: High voltage generators. We supply motor generator units in various capacities especially designed for radio phone work. Low powered rotary converters, dynamotors, fractional H.P. motors, storage batteries. Various types of meters, condensers, navy type 4" nickel finish brass engraved dials, spark gap rotors, synchronous spark gaps. Ray-di-co radio phone sets furnished knocked down ready for assembling and your connection. Become acquainted with our service. Ray-di-co, 2653A N. Clark St., Chicago, Ill.

Flexible! Flexible! Flexible! Suppose you had a loose coupler that was so flexible as to have any degree of coupling and any variation of inductance of either primary or secondary in half turn steps with no losses due to unused turns. Wouldn't these conditions be ideal? This new and entirely different type of coupler is capable of just that. It has no sliding contact switches, no exposed coils. It is equally efficient on all wave lengths up to 3,000 meters. You can tune it so accurate that your variable condenser in the secondary will be superfluous. You therefore cut out that loss and increase the strength of your signals simultaneously. It was designed by an ex-radio officer of the U. S. army. The price is \$22.50. You will like it. Money back if not satisfied. G. H. Jones, care Alabama Power Co., Birmingham, Ala.

Something New—220 V. D.C. direct from any 110 V. A.C. circuit at a practically constant potential suitable for CW or radiophone transmission. This little instrument is only 3 1/2" x 6 1/2" x 5" high and will take up to 150 V. A.C. and deliver up to 300 V. D.C. Ample supplies three tubes. Noiseless in operation. Requires no attention. Lasts forever. In handsomely finished oak box with bakelite cover. Price \$20 postpaid. C. J. Fitch, 181 W. Housatonic St., Pittsfield, Mass.

(Wireless continued)

For Sale—Copper plated leyden jars of a standard make. Two in parallel equal to a standard make mica condenser costing \$33. Special at \$3 each. A. B. Brown, 304 W. 13th St., Norfolk, Va.

Variometer Coils—Perfect spherical, 50c each. Blueprint instructions for making variometer 10c, free with set of four coils. 120 Christie, Ridgefield Park, N. J.

Grid Condensers—Special till May 1st, 30c. Grid leak and condenser, combined, 50c. Pyle & Parkhurst Radio Co., Webster City, Iowa.

"Tensbun" Amateurs—Famous "Wets" grid condensers. Special this month only, 20c each or three for 50c. Regular price 30c. Dealers write for proposition. Wireless Experimental Testing Station, Stuart St., Binghamton, N. Y.

Audion Receiving Panels—without bulbs \$20, with, \$25, including B batteries. Southern Radio Supply Co., Sanford, N. C.

Radio Phonists' Attention—Money refunded if this phone set does not work. Here is a phone set that costs only \$17.40 to construct and when the audiotron sold by the Kehler Radio Laboratories, whose ad appears in other pages of this magazine, is used in conjunction with this circuit, will transmit 15 miles. "B" batteries are used and results guaranteed. Enclose \$1 for blueprint and directions. H. D. Selvaige, 1096 Clinton Ave., Dept. R, Irvington, N. J.

Wanted—DeForest receiving units. I mean business. H. Isaacson, 900 Riverside Drive, New York.

Who Mastered Continental code in one hour and by what method. C. K. Dodge, Box 200, Mamaronck, N. Y.

"Stop! Look! Think!" We guarantee you 5 to 30% discount on all new standard radio receiving sets, radiophones and accessories. Loud speakers, regenerative sets and radiophones a specialty. We sell at a close margin as our policy is smaller profits with a larger volume of business. "Remember us." The Kehler Radio Laboratories, Dept. R, Abilene, Kansas.

Build Your Own Regenerative—Seamless, gray cardboard tubes of highest quality for winding forms. Variometer 3 3/8 x 2 in. and 4 7/8 x 2 1/2 in., per set, 25c. Variocoupler, 3 7/8 x 2 in. and 4 7/8 x 4 1/2 in., per set, 35c. 3,500 meter loose coupler tubes, 3 3/4 x 7 in. and 3 7/8 x 7 in., per set, 45c. 6,000 meter loose coupler 3 7/8 x 7 in. and 4 7/8 x 7 in., per set, 60c. Loading coils, 3 3/4 x 14 in., 35c each; 3 7/8 x 14 in., 40c each; 4 7/8 x 14 in., 50c each. Order today. We'll ship them right off, postpaid. The Taylor Company, Box 1043B, Lowell, Mass.

Extra 500 cycle 1/2 K.W. generator with exciter on shaft; exciter can be used as motor to drive generator. Complete with 500 cycle transformer. Outfit used on aeroplane, \$75; 4 5 mf. condensers, each \$3.75; 15 dial omnigraph, new, \$12; DeForest variometer, \$9; new two-flament audiotrons, \$3.50 each; DeForest grid variable, \$3.75 mounted; Blitzing amplifying coil, \$4; Murdock antenna switch, \$3; long wave coupler, \$3; cabinet type coupler, \$4; large loading coil, \$3. Harry F. Smejkal, 1349 First Ave., New York City.

Storage Batteries increase the efficiency of your V.T. 6 V. 40 Amp., \$14.70; 6 V. 60 Amp., \$18. These are Marko standard batteries and are not Christmas batteries at reduced prices. Marko Storage Battery Service Station 250 Hamilton St., Harrisburg, Pa.

Make Your Station Look Alive—Show a set of high class warning signs. Five wordings—Danger, High Voltage, Do not touch the instruments; please be quiet while operator is receiving; Government licensed radio station; Experimental radio laboratory; No admittance. 2 for 25c; all five for 50c. Postpaid. The Taylor Company, Box 1043 B, Lowell, Mass.

Panel—Regenerative tuners, audion detectors, together or separate, guaranteed 1,000 miles; parts, all kinds; anything made to order. Write us. Miller Radio, 1814 York, Des Moines, Iowa.

High Grade jack and plug, 60c; Litz wire, 25/32 1c. per ft.; mica grid cond., each 20c; mica phone con., each, 45c; signal corps tel. transmitters, carbon cup type, each, 60c; navy loose coupler 3,000 meter, each, \$8.50; other great bargains. Send for price list. Haupt Electric Supply Co., 2442 Ogden Ave., Chicago, Ill.

For Sale—All kinds of radio apparatus. List free. Charles Carroll, 793 Jackson St., Milwaukee, Wisconsin.

Let Us Build you a CW transmitter. Write for description and price. Address BQ, 1625 Tower Ave., Superior, Wis.

CW Units, variocouplers, bakelite construction, \$6; variometers, inside windings, \$5; oak cabinets, all sizes, with or without bakelite panels; VT control units, series-parallel panel switch, 50c. Mead Bakelite Radio Apparatus, 975 Putnam Ave., Brooklyn, N. Y.

1/32 Aluminum Plates for a 4 in. condenser, 4c. each; 3/4 spark coils, \$5; transmitting condenser, \$2. Braun, 262 Palisade Ave., Jersey City.

(Continued on page 670)

(Continued from page 669)

(Wireless continued)

A 15-Mile Radiophone. Out of a large stock of genuine double filament audiotrons, we have carefully selected and tested a limited number of tubes which are especially adapted to be incorporated in a simple radiophone operating on "B" batteries. We recommend Mr. H. D. Silverages' circuit which has been thoroughly tried and proven by a great many amateurs who have talked over remarkable distances. Only \$6 each until April 15. The Kehler Radio Laboratories, Dept. R., Abilene, Kansas.

Hawaiian and German Stations read with a single bulb. Are you satisfied with your receiving set? Would you like one that will receive 6,000 miles? Would you like to build one and quit experimenting? One that will equal any regardless of claims or price? If so, get our simple diagram of a complete short and long wave receiver 175 to 20,000 meters with which we can read Honolulu, San Diego, California, German and English stations and practically all the high powered foreign and domestic stations, on a single bulb. Amateurs as far West as New Mexico, and numerous telephone and musical concerts come in good. Diagram and complete instructions leaving nothing to guess about will be promptly mailed for 50 cents in stamps or coin. Virginia Novelty Company, Martinsburg, W. Va.

Tin Foil—Big bargain. We have 84 lbs. of tin foil. Just the thing for your condensers. Send 25c. for 1 lb. We carry magnet wire and a full line of electrical apparatus. Harry Gleigh, 490 Sixth Ave., New York City.

Stop! Look! and Act! For thirty days we are offering the genuine double filament double life audiotron for \$5 each. This tube still remains the most sensitive detector and oscillator, barring none. POZ and other foreign stations copied on one tube in our state. Unsatisfactory tubes replaced free of charge. The Kehler Radio Laboratories, Dept. R., Abilene, Kansas.

Just Off the Press. Design and Construction of Audion Amplifying Transformers (Radio and Audio-Frequency Types). By Edward T. Jones, late Associate Editor Radio Amateur News. The transformers shown in this book have never been described in print before and have usually been considered a manufacturer's secret. The designs are very rugged and simple. A book that every radio "bug" should have. Written so you will understand every word. Price 25c postpaid. Experimenter Publishing Co., Book Dept., 236-A Fulton St., New York City.

Experimental Electricity Course in 20 Lessons. By S. Gernsback and H. W. Secor, E. E. A course of the theory and practice of Electricity for the Experimenter. New experiments are described and explained and nearly every application of Electricity in modern life is given. 160 pages—400 illustrations. Flexible cloth cover, 75c postpaid. Stiff cloth cover, \$1.25 postpaid. Experimenter Publishing Co., Book Dept., 236-A Fulton Street, New York.

Wanted to Buy

It is Like Finding Money when you mail us old or broken watches, false teeth, brooches, bracelets, old or broken jewelry, old gold, silver, platinum, diamonds, magneto points, platinum wire, contact points or crucibles, mercury and anything valuable. We pay the highest prices in cash by return mail. Goods returned in ten days if you're not satisfied. The Ohio Smelting & Refining Co., 207 Lennox Bldg., Cleveland, Ohio.

Exchange.

1/2" Spark Coils, unmounted, \$1.75; 1/4" spark coils, unmounted, \$1; 2 M. F. condensers, 30c; telephone transmitters, 75c; receivers, 50c; plugs, 50c; with cord and jack, \$1; army telephone exchanges, \$2 per line, complete with plug, cord, jack, drop, signal and lamps, red fibre tubes 1 3/4" x 1 3/4" x 3/16", 50c; red fibre tubes 9/16" x 1 3/4" x 1/8", 25c. No junk or home made goods. S. Bernstein, 3262 Ogden Ave., Chicago, Ill.

Buy or Sell—You can do either just by sending us names of articles. 10c each article per month. We send you names of persons wanting to buy or sell these articles twice monthly. Let us convince you. International Advertising Agency, 1307 Chartres St., Houston, Tex.

Sell Chambers coupler, \$7; Tesco 20,000-meter coils, \$5; 10,000-meter tuning coil, \$6. Wallace Quin, 6028 Christian St., Philadelphia, Pa.

Wanted—DeForest radio telephone oscillation transmitter and 15 unit receiving set with loud speaking receiver, must be in perfect working order and of recent make. State your lowest cash price. Jos. C. Miller, Fourth Ave., North Saint Paul, Minn.

For Sale—Vario selective coupler, 1/2" spark gap, beginners' telegraph set, volt amp. dynamo, small Knapp motor, .22 cal. rifle, best pocket camera, Oliver typewriter and Victor code records. Write Homer Monto, 639 Oswald St., Toledo, O.

Trade—Typewriter for receiving apparatus or sell for \$25. J. Langford, Manchester, Ill.

(Exchange continued)

Swap \$40 regenerating receiver for storage battery or sell for \$25. Variometers, \$3.50. Govern, Edwardsville, Penn.

For Sale—1 K.W. Thordarson, \$15; also high speed Murdock rotary gap, 1 K.W. oscillation transformer. Z. Fenner, Colfax, Iowa.

Giving my large mahogany panel receiving set for \$30. Smaller motorboat, portable, receiving set, \$15; new 3,000-ohm phones, \$5; set, key, gap, switches, four 1" spark coils, \$10—\$20 apparatus, etc., \$5. Want good violin, X-ray, etc. Alfred Embovitz, Washington Depot, Conn.

Here's Your Chance—Complete receiving outfit. Write for photo and description. Edw. F. Durbeck, Snyder, Oklahoma.

Radio Receiving Apparatus for sale. Stamp brings particulars. Bryce Ballinger, Miami, Okla.

Wanted—One, three-quarter or half-K.W. Thordarson or Packard transformer and Paragon regenerative receiver. W. J. Blome, 3800 Liberty Heights Ave., Baltimore, Md.

For Sale—Charging generator, never used, output 8.9 volts, 20 amps. Write. Fred J. Alles, 14 Garnet Lane, Wilkes-Barre, Pa.

Swap—Twin cylinder Indian motorcycle for complete 1/2 K.W. transmitting set. Write. Glenn Anderson, Oakland, Nebr.

For Sale—Navy coupler, \$16 Kenneth Swan son, Lancaster, New York.

Sale—Complete sending and receiving apparatus, including in part, 3,500 m. loose coupler, 4 in. spark coil, antenna, \$30. Write Ed. Herbolshemer, R. No. 2, Princeton, Illinois.

For Sale—2 Willard storage batteries, 6 v. 90 amp., \$12, and 6 v. 150 amp., \$25; regenerative receiver, \$10; detector and two-step amplifier, \$25; Brandes receivers, \$6. Selling out; send for list. Herman Seikel, Dover, O.

Bargain—Complete sending and receiving radio set, all inquiries answered. M. O. Windisch, Mamee, Ohio.

Genuine "Jupiter" aerial wire now back to the old price of 1 cent per foot, \$9 per thousand. Seven strands No. 22 solid copper. 100% conductivity. No C. O. D's. 15 lbs. per 1,000 feet. Send postage. Lee A. Bates, 8 Moen St., Worcester, Mass.

Sell or Exchange—2 H.P. 550 V. D.C. motor, in perfect condition. Will make good generator for C.W., \$45; short wave regenerative receiver. Brings in spark and phones great, \$40. Edward Webb, 117 E. Main St., New London, O.

For Sale—Type CR-6 Grebe regenerative receiver complete with detector and two-step amplifier in perfect order. Wave length range 170-680 meters. Cost \$185, will sell for \$110. Guaranteed to be O. K. Am only selling because I have purchased combination long and short wave set. Also have Grebe two-step amplifier which I will sell for \$45. Floyd L. Vanderpool, Litchfield, Conn.

For Sale—1/2 K.W. Packard transformer and 4 sections Murdock condenser in rack. Costs \$52 new, price \$32. Francis H. Tratt, 705 Main St., Whitewater, Wis.

Sell—Electro navy type loose coupler, never used; \$18 takes it. Benton Sartain, So. Pittsburg, Tennessee.

For Sale—Packard half, \$15; \$5 dial omnigraph, \$6. Bayard Shumate, Lebanon, Indiana.

Selling Out—3,000-meter loose coupler, audion, one-step amplifier, and other instruments. Bargains. Write V. S. Scott, Sidney, Ohio.

Sell—School of Engineering of Milwaukee, tuition account. Any course. Particulars. Arthur Sacha, 3453 E. 110th St., Cleveland, Ohio.

For Sale—22 Stevens single shot rifle, \$4; NAA loose coupler, \$4.50; No. 0 Brownie camera, \$1.50; No. 2 Brownie developing box, \$1.50; No. 0 portrait attachment, \$5; Trot line, new, 50c; lighting switch, \$1. Clark Rice, Jr., Main Street, Baton Rouge, La.

For Sale or Exchange—DeForest and Universal apparatus. All inquiries answered. Write H. Paxton, 415 Greenbrier Ave., Charleston, W. Va.

Opportunity—1/4 K.W. Clapp-Eastham complete transmitter, \$38, C. O. D. Complete honeycomb receiver, \$21. Roland Place, Sprague, Fall River, Mass.

Will Exchange—Two Gray-Davis battery charging generators, 8 V. 10-15 amperes equipped with automatic cut-out and voltage regulators; fine condition for D.C. generator 1/2 kilowatt or larger any voltage between 6-40. Want engine driven turning lathe, 10 in. swing or smaller. Frank Pantel, Muscatine, Iowa. R. 1.

Wanted—Goodell-Pratt lathe, also milling attachment. Motor. Sell or trade. Large ebony panel. VT2's and VT1's. Radiophone and receiving apparatus, etc. Complete list free. Carroll Pfeeger, Milton, Pa.

For Sale—2 DeForest V.T. 21 (2) Marconi V.T. amplifiers; (1) radiotron, \$4.50 each; 1" spark coil, \$4; 2 tube radiophone panel set, \$35. William H. Ogle, Jr., 1794 Anthony Ave., New York.

(Exchange continued)

For Sale—300 feet of bare copper wire, \$3; also one .22-cal. Winchester model 1906 rifle, \$20, in perfect condition. Robert Minerly, 4 Toothe Place, Meriden, Conn.

Let's Swap Buy! Sell! What'ye got? What'ye want? Dime quarterly. Swap Bulletin, New York—Detroit.

For Sale—Navy 6,000-M. coupler, \$15; small 1,500-M. coupler, \$5; 3/4-in. spark coil, \$3; gap, \$1; 2 filament rheostats, 60c each. Lester F. Wertz, Temple, Penna.

Long Wave Receiver—Range 2,000 to 20,000 meters. Standard make, complete and perfect. Used one week. Tapped honeycomb coupler. One primary and two secondary variable condensers. Grid condenser, switches, dials, etc. On formica panel. Solid mahogany cabinet, \$60 set. First money order for \$48 gets it. John Loofbourow, Norwood National Bank Building, Norwood, Ohio.

For Sale—A one-step radio frequency receiver, \$30; 1 audion control cabinet, \$15; 1 inductance cabinet, \$15; 1 A. P. amplifier tube, used 5 hours, \$5.50; 1 Federal audio frequency transformer A1 condition, \$5; 1 choke coil, \$1; 1 Arlington receiving transformer in A1 condition \$5, and the following mounted honeycomb coils L75, L200, L400, L750, all for \$6. Write for full description of ter, Pa.

Short Wave regenerative receiver, standard make; unused; tapped coupler coils, variometer, grid condenser, switches, etc., mounted on formica panel; solid mahogany cabinet; guaranteed perfect, \$45 set. First \$30 money order gets it. John Loofbourow, Norwood National Bank building, Norwood, Ohio.

Will Exchange four-inch Mesco coil, adjustable spark gap, Lyden jars, heavy duty key for attachments for Goodell-Pratt lathe. Meade, 1054 Putnam Ave. Brooklyn, N. Y.

New 3-Panel DeForest receiving set, mounted. Murdock phones, two honeycomb coils, \$15. H. Allenberg, 615 West 24th St., Minneapolis, Minn.

Wanted—Alexander Hamilton Institute Course. Late issue preferred. State price. E. S. Bowles, 210 Birch St., Charleston, W. Va.

If You or Your Friend have a private experimental shop in Chicago write me stating age and equipment. L. J. Beindorfe, 3139 Palmer Sq., Chicago.

Wanted—Five-dial omnigraph, cheap. Charles M. Butler, 70 Arlington St., Hyde Park, Mass.

For Sale—Baldwin type C phones, \$10; DeForest mounted honeycombs, 75 to 1,500, 40% off list; Moorhead amplifier tube burned 20 hours, \$4; Chelsea panel variables, .001 m.f., \$3; .0005 m.f., \$2.50; DeForest three-coil mounting, \$3; 2 Burgess B batteries, used short time, each, \$1; Mesco key, 75c; "Bucher's Wireless Experimenters Manual" and "Vacuum Tubes," \$1.25 each. Everything perfect condition and sent C. O. D. J. K. Brennan, Jr., Eolia, Missouri.

For Sale—Radio apparatus. Inductances, condensers, vacuum tubes, rheostats, detectors, other standard supplies; Hawkins Guides A. L. Chapman, 30 South Main, Winsted, Conn.

New 15-Dial Omnigraph, \$20; half-inch unit transmitter. Write for particulars. H. Davie, Bolivar, N. Y.

To Exchange for variable condensers and head set; 45 Electrical Experimenters from 1916-21; 1 6 V. 6 Amp. dynamo motor, and 1 110 V. A.C. Hamilton Beach motor with cord and plug. Wyanman Davenport, Plainview, Texas.

Bargain—8-mile radiofone sets, receiving and sending complete in cabinet. Price \$42. Send for detailed photo. Joseph Davich, B. 968 New Britain, Conn.

Omnigraph—Largest size, 15 Continental dials, buzzer included. Will sell all, in perfect condition, for \$18. L. R. Ferguson, LeRoy, N. Y.

For Sale—Mesco 2-inch spark coil with condenser, key, gap and helix, \$10. Mignon 3,500 meter cabinet, \$10. F. W. Frost, Princeton, N. J.

For Sale—Murdock 43 and 23-plate variables, \$3 and \$2.50 respectively; 2 audiotrons, \$4.50 each; Tesco unmounted long wave tuner, \$4.50; 15-Dial omnigraph, \$11; 3 Radisco coils, No. 325, 75c each; Chelsea oscillator, \$2.50. A. Gustafson, 325 Jay St., Brooklyn, N. Y.

Bargain—Duck's Arlington coupler, new, \$7. R. Hardenbergh, 1017 Logan Ave., No. Minneapolis, Minn.

For Sale—Act at once. Complete sending and receiving set. Must sacrifice. Owner leaving town. For particulars address Eli Harris, 490 Argyle Road, Brooklyn, N. Y.

For Sale—Paragon R. A. 200 Universal range receiver, 200-20,000 meters, first class condition, \$150. A. J. Higson, 84 Romane Ave., Jersey City, N. J.

For Sale—Amrad hundred watt six volt induction coil, \$25; 2 Dubilier .0024 mica condensers, \$4 each; Murdock oscillation transformer, \$3; Amrad quenched gap, 1/4 K.W., \$8; Boston key, bakelite base, \$5; all above used only three months, and in first class condition. Reason for selling, building c. w. set. A. Hintze, 131 8th Ave., New York City.

(Continued on page 671)

(Continued from page 670)

(Exchange continued)

For Sale—Wireless transmitting and receiving apparatus. Spark set. New. James Hoban, Cheboygan, Mich.

Bargain—Complete or parts of sending and receiving set very cheap. Send for information. Allan Hardie, 26 High Street, Westfield, Mass.

For Sale—Cheap, 1/2 K.W. transformer coil and electrolytic interrupter. Both for \$10; 1 transformer reduces 110 V. A.C., \$3, or trade for Connecticut variable condenser Herbert Lee, Mt. Vernon, S. Dak.

For Sale—Honeycomb coil tuner similar to DeForest type T-100; DeForest three-coil mounting; Universal condensers, etc. Good as new and gives excellent results. \$30 C. O. D. prepaid, takes it. J. Marcus, 87 Kelly St., Rochester, N. Y.

For Sale—2 Acme amplifying transformers fully mounted, each \$5.50; Duck improved navy type coupler, \$21; 1/6 H.P. A.C. motor, \$15; W. E. loud talker, \$10; 2 DeForest .0005 variable condensers, each \$4; 2" spark coil, \$9.50; Marko 4 V. 40 a. storage battery, \$5. E. Merkel, 156 E. 85th St., New York City.

For Sale—1 radio laboratory complete, including all kinds of radio material. Write for list. Grant Martin, 284 Graham Ave., Brooklyn, N. Y.

For Sale—Loose coupler, 3,000 meters, \$8; 2 inch coil, \$7; audion panel \$7; Marconi V. T., \$5; one-step amp., \$10; insulators; Murdock silicon detector. Send for list. Wm. Ortung, 282 Marion St., Brooklyn, N. Y.

Navy Transmitter—1 K.W. transformer, 240 cycle 3 K.W. motor generator, synchronous gap on shaft, Leyden jar condenser, oscillation transformer, aerial switch and key \$285; 2 10-inch coils, \$35 each; 1 DeForest impedance, \$8; 20 Marconi copper Leyden jars, \$3 each; 4 E. I. Co. 1/2 K.W. sets, \$12.50 each. G. P. Smith, 32 West 135th St., New York City.

For Sale—Duck's 7721 loose coupler, \$7; never used. John Showalter, 1048 Falls Ave., Wabash, Indiana.

For Sale—2 D. F. spark set; an installing radio-phone; 1 K.W. Thordarson transformer; Dubilier .007 2400 volt condenser oscillation transformer semi-quenched noiseless rotary R. & M. induction motor. Zero to 5 General Radio ammeter. Will sell separately. Make offer. All letters answered. H. G. Silbersdorf, 641 PAVONIA AVE., Jersey City, N. J.

Cabinet, \$3.00; 3,500 meter receiving set without phones, \$10; Scout fire and music, \$2. Smith, 276 Griffith St., Jersey City, N. J.

For Sale—Radio receiving set, cheap. For particulars, write, Robert Shelby, 1114 W. 9th St., Austin, Texas.

Trade—Shaler vulcanizer, cost \$60; books, magazines, Popular Mechanics, Popular Science, Electrical Experimenter, Sept. 15 to April 16, wireless, mail order, hypnotism and electrical courses, for lightning switch, insulators, aerial wire, variable condensers, omnigraph, audion detector. J. G. Schroeder, Wisner, Nebr.

Bargains—Long wave undamped receiver, \$30. Arlington coupler, \$5; 33 Wireless Age, 20 Wireless World, 10 Q. S. T., Navy Manual Bishop's handbook year book, \$6; leadin insulator, \$1.25. John Smith, 3650 Marvane, Philadelphia.

1 Mile Ammeter, \$7.50; 1 modulation transformer, \$5.50; 2 rheostats, \$1.50; 2 Universal V.T. sockets, \$3. Sidney Sussman, 2917 Jamaica Ave., Richmond Hill, New York City.

For Sale—Complete audion receiving set, \$40 or trade. Chas. V. Simmons, 421 Baltimore St., Waterloo, Iowa.

Hawaiian and German stations read with a single bulb. Are you satisfied with your receiving set? Would you like one that will receive 6,000 miles? Would you like to build one and quit experimenting? One that will be equal to any regardless of claims or price. If so, get our simple diagram of a complete short and long wave receiver 175 to 20,000 meters with which we can read Honolulu, San Diego, California, German and English stations and practically all the high-powered foreign and domestic stations, on a single bulb. Amateurs as far West as New Mexico, and numerous telephone and musical concerts come in good. Diagram and complete instructions leaving nothing to guess about will be promptly mailed for 50 cents in stamps or coin. Virginia Novelty Company, Martinsburg, West Virginia.

Triple honeycomb receiver—all wavelengths, including new tubular 'tron, 4 amateur coils, \$30; new Titan 6 V. 40 A. battery, \$13. Penn Voght, Acheson Ave., Washington, Pa.

Sale—Saw-tooth rotary gap, \$15; Hayward rotary gap, new, \$11; oscillation transformer, \$4. Donald Watts, Clear Lake, Iowa.

Swap—Diamond stud scarf pin, perfect white stone, worth \$50, for receiving instruments of a like value. M. M. Wrenn, 1613 W. Lexington St., Baltimore, Md.

Sale—Navy coupler, \$8; Prandtes phones (Superior), \$5.50; 43 plate variable, \$3.50. Frank Waldeck, 511 Sutton St., Philadelphia.

NEW AND POPULAR BOOKS

The How and Why of Radio Apparatus

By H. W. SECOR, E. E.

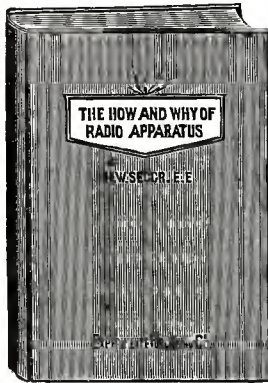

Postpaid\$1.75

The newest book on radio matters. The treatment is made as understandable and as free from mathematics as possible, it at the same time, incorporates a wealth of technique and instruction for the Radio Amateur—the Radio Operator—the Installation and Designing Expert—as well as teachers and students of the subject in general. Cloth bound in Velum de Luxe, Gold stamped and Hand Sewed has 160 pages. Size of Book 6 x 9 inches. The How and Why of Radio Apparatus.....\$1.75

A Thousand and One Formulas

By S. GERNSBACK

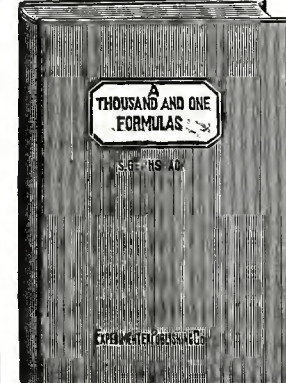

Postpaid\$1.75

A Laboratory Hand Book for the Experimenter and for Everybody who wants to "do things." The recipes and formulas are classified in such a manner as to be available at once, without long research. Besides there are a score of tables and hundreds of illustrations and Diagrams. Book is cloth bound in Velum de Luxe, Gold stamped and hand sewed. It contains 160 pages. The paper has been especially selected to stand rough handling in laboratories. Size 6 x 9 inches. A Thousand and One Formulas as Described. Postpaid, \$1.75

Wireless Course in 20 Lessons

By S. Gernsback, A. Lescaurba and H. W. Secor, E. E.

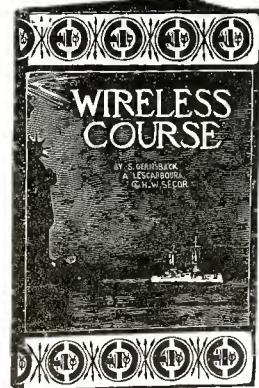

more than 50,000 of this course sold (Eighth Edition) Size of book is 7 x 10 1/4 in., 160 pages, 350 illustrations, 90 tables. Stiff cloth cover, per copy, \$1.75 Postpaid

A Course that tells you everything you want to know about "Wireless" starting off in lesson No. 1 by explaining the Principles of Electricity. By simple, easy stages, this wonderful Course takes you into "Wireless" by the use of such simple language so skillfully used that of necessity you must understand every word. There is a whole lesson devoted to the Theory and Mathematics of this epoch marking subject. The last lesson is devoted to the history of Wireless.

Experimental Electricity Course in 20 Lessons

By S. Gernsback and H. W. Secor, E. E.

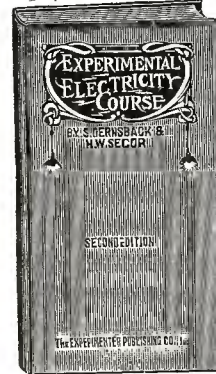

Size of Book is 6 x 9 in. The book contains 128 pages and more than 400 illustrations. Stiff cloth cover, per copy, \$1.25 postpaid

A Course on the theory and practice of Electricity for Experimenters. Written by the same authors as the famous "Wireless Course." Every phase of experimental electricity is treated comprehensively in plain English. New Experiments are described and explained and nearly every application of Electricity in modern life is given in simple language. The Best Electrical Text Book on the Market

Handy Binder for Radio News

Holds and preserves 12 issues, each of which can be inserted or removed at will, without tools. Will keep your magazines perfectly for all time or just preserve them like new till you bind them permanently. Made of heavy material, extra strongly reinforced at the back and covered with handsome red cloth, suitably lettered in gold. 65 cents, plus postage for 2 lbs.

Bound Volume No. 1

Radio Amateur News
12 Issues
July, 1919—June, 1920
Attractively Bound

12 artistic covers,
1151 illustrations,
145 feature articles and stories,
A Radio Map of the World, and
Many other interesting features for the Radio bug.

Only **\$2.00**
(Plus Postage)
Shipping Weight 6 lbs.

A Most Valuable Asset to Your Library

Order Today

The Experimenter Publishing Co.

Book Dept., 236 Fulton Street

New York

The first four books mentioned above are also for sale at the best book stores. If your dealer cannot supply you send us his name and address or order direct from us.

RADIOTRONS

POWER TUBES



**RADIOTRONS
FOR POWER WORK
ARE HERE**

**U. V.—202
RATED AT 5 WATTS
PRICE \$8.00**

MODEL U. V. 202	MODEL U. V. 203	MODEL U. V. 204
5 watt	50 watt	250 watt
Price \$8.00	Price \$30.00	Price \$110.00
Filament V.—7½ volts	10 volts	12 volts
Filament current—2.35 amps.	6½ amperes	15 amperes
Plate V. 350 volts	1000 volts	2000 volts

Deliveries Begin March 10th

These Radiotrons are new types of Vacuum Tubes of improved operating characteristics, especially designed to provide long operating life.

A complete line of Radiotrons for radio detection, amplification and other power work are now available.

See your nearest dealer for full information

The Radio Corporation's tubes are covered by patents dated November 7th, 1905, January 15th, 1907, and February 18th, 1908, as well as by other patents issued and pending. Tubes licensed for amateur and experimental use only. Any other use will constitute an infringement.

Address all orders and inquiries to

**SALES DIVISION, COMMERCIAL DEPARTMENT
RADIO CORPORATION OF AMERICA
233 BROADWAY
NEW YORK CITY**

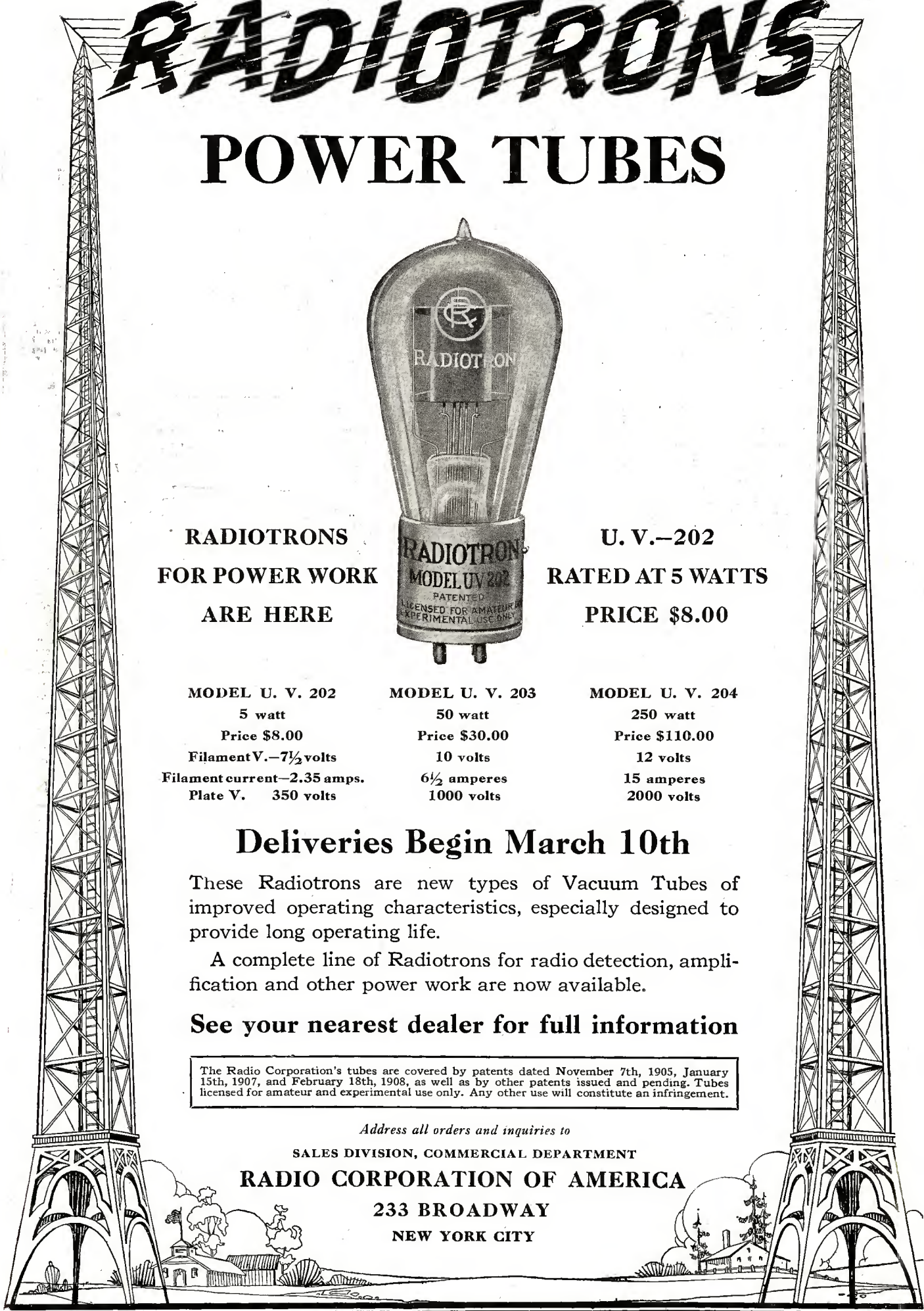



Every Electrical Man Wants These Books and we ship them for your inspection **FREE**

Flexible
Covers
—
Handy
Pocket-
Size
Volumes

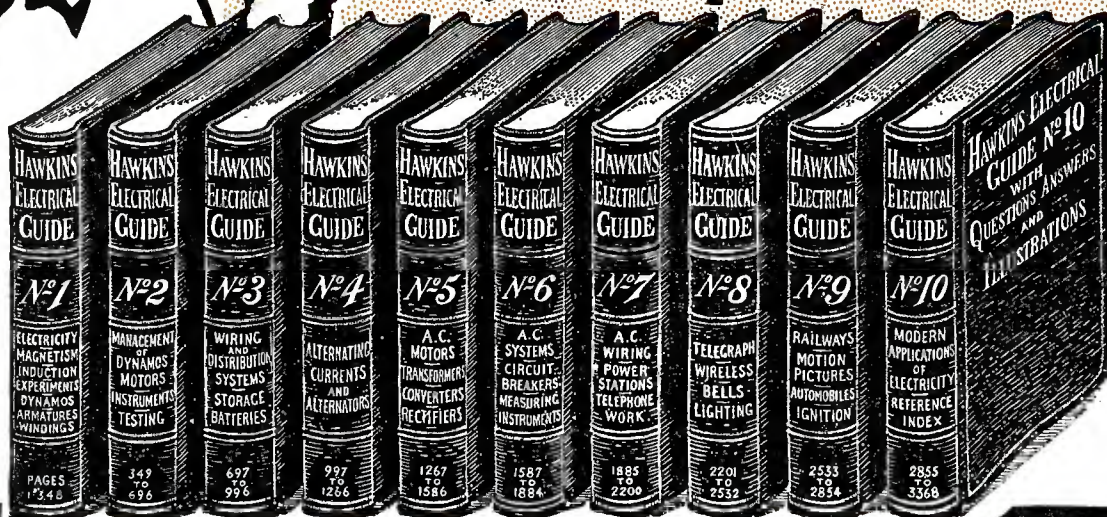

10
Volumes
3500
Pages
4700
Pictures
\$1 Per
Volume
\$1 Per
Month

Just what you need to know to succeed in **ELECTRICITY**

EVERY electrician, every engineer, every mechanic should know about these wonderfully helpful instructive books, which give in plain words a complete working knowledge of electrical engineering in all its phases.

You run into some new electrical problem almost every day. The information you need to help you in your every day work is in

HAWKINS ELECTRICAL GUIDES

These books place electricity at your finger ends. They cover every imaginable subject, principle, theory, problem, trouble, and way of doing things electrically. Every subject is indexed so that you can turn right to it. They are a study course and a reference guide in one, written in plain every day language—no wasted words—only what you need to know—chock full of up-to-the-minute electrical knowledge. The guides are a complete course in electrical engineering. They will help you in every detail of the day's electrical work. You can't ask an electrical question that Hawkins Guides can't answer.

Pocket-Size Flexible Covers

The books are small enough to slip into your coat pocket—handsomely bound in flexible black covers. You can carry each volume with you until you have mastered its contents. 3,500 pages of actual information and 4,700 illustrations. Once you see these books and put them into actual use you will never again want to be without them. Try it at our expense.

SEND NO MONEY

It will cost you nothing to receive these books—to look them over—ask them all the questions you can think of—use them in your work—study them—pick up some information that will increase your earning ability. We will ship you the entire set of 10 volumes entirely FREE.

This is a sign of our confidence in the guides. Pure gold does not object to being tested. Keep them for seven days and if you do not decide that you can't get along without them, return them to us and owe us nothing.

When you decide to keep them you only have to pay \$1.00 down and remit the balance of \$9.00 on the easy payment of \$1.00 a month till paid for.

Use this coupon to get the books. It will pay you many times over

THEO. AUDEL & CO.
72 Fifth Ave. New York, N. Y.

SEND NO MONEY—USE THE COUPON

READ THIS PARTIAL LIST OF CONTENTS

- No. 1** Contains 348 pages, 388 illustrations. Electrical signs and symbols—static and current electricity—primary cells—conductors and insulators—resistance and conductivity—magnetism—induction coils—dynamo principles—classes of dynamos—armatures—windings—commutation—brushes, etc.
- No. 2** Contains 348 pages, 394 illustrations. Motor principles—armature reaction—motor starting—calculations—brake horsepower—selection and installation of dynamo and motors—galvanometers—standard cells—current measurement—resistance measurement—voltmeters—wattmeters—watt hour meters—operation of dynamos—operation of motors, etc.
- No. 3** Contains 300 pages, 423 illustrations. Distribution systems—wires and wire calculations—inside, outside and underground wiring—sign flashers—lighting protection—rectifiers—storage battery systems, etc.
- No. 4** Contains 270 pages, 379 illustrations. Alternating current principles—alternating current diagrams—the power factor—alternator principles—alternator construction—windings, etc.
- No. 5** Contains 320 pages, 614 illustrations. A. C. Motors—synchronous and induction motor principles—A. C. commutator motors—induction motors, transformers; losses, construction, connections, tests—converters—rectifiers, etc.
- No. 6** Contains 298 pages, 472 illustrations. Alternating current systems—switching devices—circuit breakers—relays—lightning protector apparatus—regulating devices—synchronous condensers—indicating devices—meters—power factor indicators—wave form measurement—switch boards, etc.
- No. 7** Contains 316 pages, 379 illustrations. Alternating current wiring—power stations—turbines; management, selection, location, erection, testing, running, care and repair—telephones, etc.
- No. 8** Contains 332 pages, 436 illustrations. Telegraph—simultaneous telegraphy and telephony—wireless—electric bells—electric lighting—photometry, etc.
- No. 9** Contains 322 pages, 627 illustrations. Electric railways—electric locomotives—car lighting—trolley car operation—miscellaneous applications—motion pictures—gas engine ignition—automobile self-starters and lighting systems, electric vehicles, etc.
- No. 10** Contains 513 pages, 599 illustrations. Elevators—cranes—pumps—air compressors—electric heating—electric welding—soldering and brazing—industrial electrolysis—electro plating—electro-therapeutic—X-rays, etc.

Also a complete 126-page ready reference index of the complete library. This index has been planned to render easily accessible all the vast information contained in the 10 electrical guides. There are over 13,500 cross references. You find what you want to know instantly.

THEO. AUDEL & CO.
72 Fifth Ave.
New York, N. Y.

Please submit me for examination Hawkins Electrical Guides (price \$1 each). Ship at once, prepaid, the 10 numbers. If satisfactory I agree to send you \$1 within seven days and to further mail you \$1 each month until paid.

Signature.....

Occupation.....

Employed by.....

Residence.....

Reference..... R. N., March

What Electrical Men Say Helped Him Make Good

"It is only right for me to recommend highly the Hawkins Guides, for they have been of the greatest assistance to me in placing me in my present position as Superintendent of Construction Department of one of Ohio's largest Electrical Companies. I would like to see every man have a set of Hawkins Guides."

Geo. Knecht, Columbus, Ohio.

In the Naval Electrical Dept.

"The Hawkins Guides are great help to me in the Naval Electrical Department, which they cover very thoroughly."

C. J. Cornell,
U. S. Receiving Ship, Brooklyn, N. Y.

Superintendent

"I am now superintendent of the Dunnville Hydro-Electric Systems, and Hawkins Guides were a great help to me in holding down a responsible position."

W. E. Swartz, Dunnville, Ontario.

Wireless Operators

"I have worked wireless for ten years—but I wish I had these books years ago, as they have saved me a great deal of trouble."

H. Marshall,
Steamer M & B No. 2,
Walkerville, Ont.

LEARN WIRELESS At Home By Mail



MERCHANT MARINE



LAND COMMERCIAL RADIO



TRAIN DISPATCHING



AERIAL MAIL

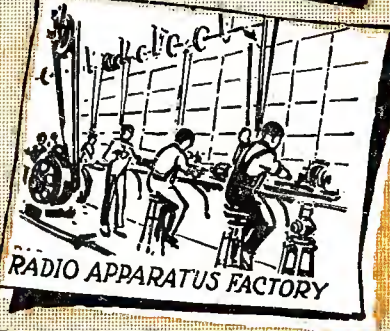

RADIO APPARATUS FACTORY

WIRELESS Operators Wanted at Once—For Merchant Marine, Commercial Land Radio Service, Radio Supply Factories, U. S. Navy Government Service and Aerial Mail. National Radio Institute experts will teach you Wireless at your home by mail, through fascinating course of copyrighted lessons and our famous Automatic Natrometer.

Read About This Splendid Opportunity for the Young Men of America.
Salaries up to \$3,500

At the very start our graduates are paid \$125 a month which with their allowance for room and board is the equivalent of about \$200 a month. Promotion is sure and steady for the well-trained Wireless man. One of our graduates has risen to \$6,000 a year. Positions and pay are as follows: Supercargo and Wireless Operator—\$175 a month; Radio Mechanic \$1,500 to \$2,000 a year; Radio Aid—\$6 to \$8 a day; Radio Inspector—\$1,500 to \$3,000 a year; Radio Engineer—\$6,000 a year up; Radio Draftsman—\$7 to \$10 a day.

Travel Without Expense

As a Wireless Operator you can travel, visit foreign countries, increase your knowledge of world affairs while drawing excellent pay. On shipboard you are rated as an officer with fine living quarters. If you do not care to travel, there are positions nearer home at Land Radio Stations and Offices.

Experts of Nation's Capital Teach You Wireless at Home

The National Radio Institute is headed by experts of the Nation's Capital who have been closely allied with government training of men for wireless positions. Instruction of students is under direction of Jas. E. Smith, former director of Radio Dept. Howard University, and E. R. Haas, formerly of the Radio Division of Yale University. These experts, assisted by a large staff of well-known Radio men, will teach you Wireless by mail, in your home, quickly and easily, in a fascinating practical way, just as they have already taught hundreds of students throughout the world.

Remarkable Automatic Wireless Instrument FREE

In addition to all necessary text books, including a full set of our up-to-date, copyrighted Lesson Pamphlets, for home study, we present FREE to each student, while taking the course, our remarkable Automatic Wireless Instrument—The Natrometer. It transmits messages in 600 different combinations just as though coming from thousands of miles away. It can be regulated to any speed from 1 to 30 words a minute, works automatically without use of aerials, and comes to you complete with phones, etc., in a neat carrying case. Teaches you practical Wireless at home in a simple though scientific way. It is yours to keep upon completion of the course.

Pay as You Learn

A small first payment will start these practical lessons on their way to you. You pay as you learn. Many of our students secure wireless positions before completing the course.
Oldest and Largest Correspondence School of Wireless in America

The National Radio Institute, established in 1914, is today the oldest and largest Wireless School in America teaching Wireless by mail. Our graduates are making good all over the world. We are fully recognized by the U. S. Department of Commerce which allows our graduates five to ten points credit when taking First Grade Government License examinations. The National Radio Institute heads the printed list of Wireless Schools recommended by the U. S. Shipping Board.

Special Free Offer

Students who enroll promptly receive in addition to our complete course in Wireless Telegraphy, a complete Special Course in Wireless Telephony, and if you wish, a one month Post Graduate Course at our big Washington School. These special privileges are free only to N. R. I. Home Study Students.

NATIONAL RADIO INSTITUTE
Dept. 502 WASHINGTON, D. C.

FREE

Write Today for FREE BOOK

Send the following coupon, or a post card today for a copy of our interesting book "Wireless. The Opportunity of Today."

MAIL THIS COUPON TODAY

National Radio Institute,
Dept. 502, Washington, D. C.
Send me your FREE book, "Wireless the Opportunity of Today." Tell me about your Home Study Course in Wireless Telegraphy and Telephony—and free post-graduate course—and your Special Instrument offer.
Name
Age..... Occupation.....
Address
City..... State.....