

OVER 300,000 COPIES OF THIS ISSUE PRINTED AND DISTRIBUTED

RADIO NEWS

REG. U.S. PAT. OFF.

25 Cents
March

1924

Over 200 Illustrations

Edited by H. GERNSBACK

THE CRYSTAL LOUD SPEAKER

See Page 1227

IN THIS ISSUE:

Dr. J. A. Fleming, F. R. S.
John V. L. Hogan
Dr. Karl Rottgardt
W. P. Powers



THE 100% RADIO MAGAZINE

CIRCULATION LARGER THAN ANY OTHER RADIO PUBLICATION

Winners of the

Cunningham

\$5000 Window Trim Contest

held during
Cunningham National Tube Week
September 24th to October 1st 1923

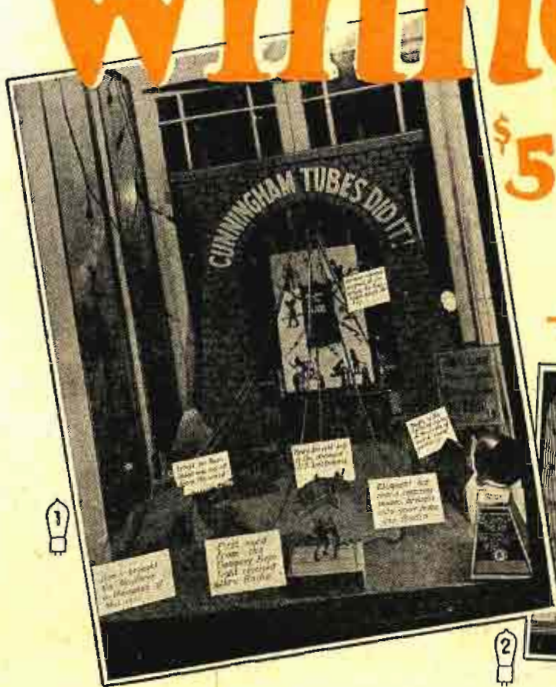

The Judges for the Cunningham \$5,000 Window Trim Contest held during Cunningham National Radio Tube Week, September 24th to October 1st, 1923, have after due deliberation, from a disinterested and unbiased viewpoint, allotted the fifty-one prizes as stipulated in the rules of the contest, declaring a tie for sixth place. Following are the names and addresses of the Radio Dealers who shared in the awards and the manner in which the prizes were awarded:

Lester's Radio Shoppe, Los Angeles, Calif.	\$1000—First Prize	There being a tie for sixth place, the same prize has been allotted to the two dealers participating in the tie, increasing the total amount of the prizes from \$5,000 to \$5,100.	
Hennepin Hardware Company, Minneapolis, Minn.	750—Second Prize		
Electrical Appliance Shop, Los Angeles, Calif.	500—Third Prize	Geo. C. Wille & Company, Canton, Ohio	\$100—Sixth
Warner Hardware Company, Minneapolis, Minn.	250—Fourth Prize	Heck Drug Company, Indianapolis, Ind.	100—Sixth
Pineus & Murphey, Alexandria, La.	150—Fifth Prize		

\$50 HONORABLE MENTION

The forty-five prizes as stipulated in the rules of the Contest are awarded to the following Cunningham Radio Tube Dealers for windows of Honorable Mention:

Banister & Pollard Co., Newark, N. J.	Lindemann Auto & Machine Co., Enderlin, No. Dak.	E. M. Sargent Co., Oakland, Calif.
W. E. Berry—Radio, Waco, Tex.	Louis D. Rubin Elec'l Co., Inc., Charleston, S. C.	Selby & Reed, Martins Ferry, Ohio
Jesse C. Cutler, Brookings, So. Dakota	Mason, Fyfe & Parfurst Radio Co., Webster City, Ia.	Jerry H. Smith, Decatur, Ill.
Ehrler Radio Co., Chicago, Ill.	Mid-Continent Radio Corp., St. Worth, Tex.	Southern Pkg. & Elec. Co., Taylor, Tex.
Equipment Sales Co., San Diego, Calif.	Midwest Radio Co., Kansas City, Mo.	Stoehrer's Electric Shop, Oxnard, Calif.
Ervin's Electrical Co., Parsons, Kans.	Murphy Maclay Hardware Co., Great Falls, Mont.	Il. C. Tafel Co., Louisville, Ky.
Eves Hardware Co., Denton, Tex.	Newark Radio Supply Co., Newark, N. J.	The Broadest Shop, Washington, D. C.
Portner Camera Supply Co., Sterling, Colo.	Oscar A. Hochsmann, Fond du Lac, Wis.	The Brown Pharmacy, Chanute, Kan.
C. H. Gilliam's Radio Store, Brownwood, Tex.	Paramount Radio & Elec. Co., Atlantic City, N. J.	The Meser Supply Co., Seattle, Wash.
Robert A. Goodall, Ogallala, Neb.	H. Y. Parrott, Dennison, Tex.	The Radio Distributors, Long Beach, Calif.
Thos. J. Green, Winona, Minn.	Pfaff Electric Co., Cleveland, Ohio	The Salzer Electric Co., Cleveland, Ohio
Haskell Electric Co., Holyoke, Mass.	Prest Electric Co., San Bernardino, Calif.	Thibaut & Mastor Bros., Marion, Ohio
Lazar & Son Music Center, Chicago, Ill.	P. S. Radio Service Co., Cleveland, Ohio	Weed's Radio Shop, Portland, Ore.
Long Beach Radio Shop, Long Beach, Calif.	QST Radio Shop, Tacoma, Wash.	Willett Electric Co., Raymond, Wash.
H. Lesser & Company, Cleveland, Ohio	Radio Sales & Repair Co., Cleveland, Ohio	Wolf Electric Co., Deaver Falls, Penn.

We take this occasion to extend our deep appreciation to the thousands of Radio Dealers located all over the country who so whole-heartedly entered into the contest and while many of them did not carry off one of the prizes they nevertheless have placed themselves in the front ranks of live Radio Dealers in their respective localities and have the hearty co-operation and earnest support of this organization.

E. J. Cunningham Inc.

Home Office: 182 Second St.
San Francisco, Calif.

154 West Lake Street
Chicago, Illinois

30 Church Street
New York City, N. Y.

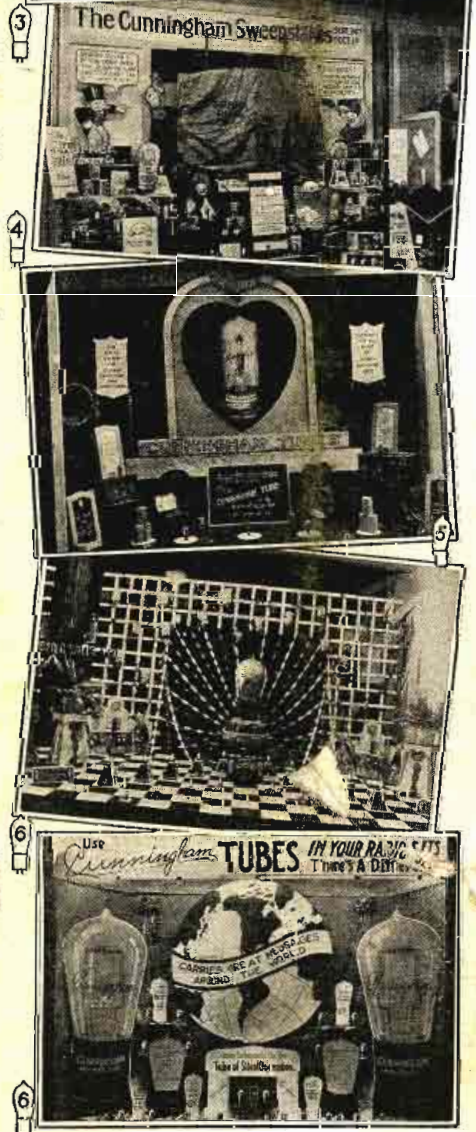



MODEL D, N & K Head Set, 4000 ohms. 2 1/4 in. diaphragm. Beautifully finished with heavily nickeled brass casing and comfortable, sanitary leather covered head bands. 6 foot cord, durable contact tips. Retail price \$8.50

The Phones That the Fans Are All Talking About

YOU have been hearing radio enthusiasts talk about "That imported head set that gives such wonderful tone"; "The head set that is so comfortable to put on"; "The head set with the big phones". It's the N & K 4000 ohm Head Set that they are all talking about.

In less than a year, with practically no advertising, thousands and thousands of these phones have been put into use by radio set owners. So enthusiastic have they become that they have broadcasted the story of the N & K's unusual quality from one end of the country to the other. In homes where several different kinds of head sets are in use, there is always a "scrap" as to who shall use the N & K. Even people who are hard of hearing get clear results with it.

There are very good reasons for this popularity: The N & K's design was originated by one of the world's leading makers, famous over a quarter century for scientific and telephone apparatus. It provides *extra large phones*, 2 1/4 inch diaphragm, with these four results: broader range—equally good on high and low tones; greater comfort to the wearer; the exclusion of outside sounds; and a greater diaphragm area, producing a perfect mellow tone. The casing of heavily nickeled brass—instead of flimsy stamped aluminum—provides a perfect sound chamber, and a special device insures absolutely uniform distance between diaphragm and poles.

Send coupon today for full information about the N & K Head Set.

TH. GOLDSCHMIDT CORPORATION
 15 WILLIAM STREET NEW YORK, N. Y.

Dealers:

N & K Head Sets mean easy sales, excellent profit. Use them to demonstrate your radio sets, especially the small ones, and sell the set every time. Show your customers the sanitary leather-covered head bands, which can be easily cleaned. And take advantage of the important fact that there are no come-backs on N & K Head Sets. As one N & K dealer says after handling them for a year: "I have yet to see one pair come back for repairs." We are exclusive distributors for U. S. and Canada for this famous imported set. We guarantee them fully and carry a complete stock of spare parts. Write for discounts.

-----MORE INFORMATION-----

Dept. R-3, Th. Goldschmidt Corp.
 15 William Street, New York, N. Y.

Please send me folder describing your new Model D 4000 N & K Head Set in detail.

Name

Street

City State

I usually buy radio supplies of (name of store)

Address

RADIO NEWS

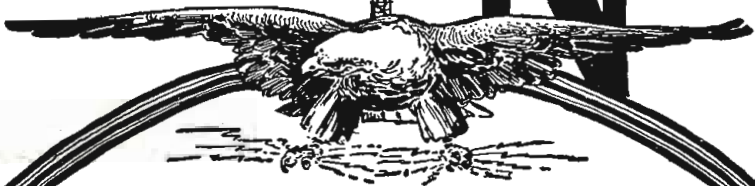

Published by EXPERIMENTER PUBLISHING COMPANY, INC.,
 Publishers of "Radio News," "Science and Invention" and "Practical Electrician."
 Publication Office: Jamaica, N. Y. Editorial and General Offices: 53 Park Place, N. Y. City.
 H. GERNSBACK, President. S. GERNSBACK, Treasurer. R. W. DEMOTT, Secretary.

MEMBER: AUDIT BUREAU OF CIRCULATIONS

VOL. 5 **CONTENTS FOR MARCH** No. 9
 1924

Page	Page
Editorial By H. Gernsback 1221	A Radio Hotel..... 1241
Recent Novelties in Thermionic Tubes for Radio Work..... By J. A. Fleming, D.Sc. 1222	Re-broadcasting, a New Era in Radio..... 1242
Radio Waves Picked Up Eighty Feet Under- ground 1224	With the Amateurs..... 1243
The Trans-Atlantic Broadcast Tests. By George E. Oliver 1225	The Operation of Close Coupled Transformers, By W. P. Powers 1246
Radio Benefits Camp Veterans, By Carrol George Lake 1226	C. W. and Radiophone Transmitters, Part VI, By L. R. Felder 1247
A Crystal Set Loud Speaker..... 1227	A DX Receiver for Amateur Waves, By L. W. Harty 1248
What Listeners-in Want..... 1227	Reminiscences of a Radio Inspector. By C. A. Reberger 1249
Fans of Yesterday..... By One of Them 1228	Modern Radio Apparatus—Condensers. By Jesse Marsten 1250
The Development of Wired Radio in Germany, By Dr. Karl Rottgardt 1230	Building a Neutrodyne and Making It "Neut." By Lester D. Cushman 1252
Tuning and What It Means, By John V. L. Hogan 1232	Make That Single Circuit Selective. . By John H. Bostock 1253
The Ultradyn Receiver, Part II, By Robert E. Lacault 1234	The All-Purpose Receiver... By M. B. Sleeper 1254
Another Historic Event in Amateur Radio, By Laurence S. Lees 1236	The Weagant Receiving Circuit, By Paul G. Watson 1256
Radio Oddities 1237	Lightning Protection for Antennae, By J. R. McFarlin 1257
Veteran Announcer Tells of His Experiences 1237	Awards of the \$50 Radio Wrinkle Contest..... 1258
Co-operation Necessary in Radio Traffic Problems 1239	Radio News Laboratories..... 1260
The Sad Story of AZZ.. By Ellis Parker Butler 1240	Radio Map of the United States..... 1262
	Correspondence from Readers..... 1264
	I Want to Know..... 1265
	Calls Heard 1328
Index to Advertisers..... 1208	

General Advertising Dept., 53 Park Place, New York City. Western Advertising Representatives, Finucan & McClure, 720 Cass Street, Chicago, Ill. Kansas City Repre-
 sentative, Geo. F. Dillon, Republic Bldg., Kansas City, Mo. Pacific Coast Advertising Representatives, A. J. Norris Hill Co., Hearst Bldg., San Francisco, Cal.

RADIO NEWS is published on the 10th of each preceding month. There are 12 numbers per year. Subscription price is \$2.50 a year in U. S. and possessions. Canada and foreign countries, \$3.00 a year. U. S. coin as well as U. S. Stamps accepted (no foreign coins or stamps). Single copies, 25 cents each. A sample copy will be sent gratis on request. Checks and money orders should be drawn to order of EXPERIMENTER PUBLISHING CO., INC.

All communications and contributions to this journal should be addressed to Editor, RADIO NEWS, 53 Park Place, New York, N. Y. Unaccepted contributions cannot be returned unless full postage has been included. All accepted contributions are paid for on publication. A special rate is paid for novel experiments; good photographs accompanying them are highly desirable.

RADIO NEWS. Monthly. Entered as second-class matter at the Post Office, at Jamaica, N. Y., under the act of March 3, 1897. Title registered U. S. Patent Office. Copyright, 1923, by E. P. Co., Inc., New York. The Experimenter Publishing Co., 53 Park Place, N. Y. The contents of this magazine are copyrighted and must not be reproduced without giving full credit to the publication. Copyright in Germany. Publication and reproduction of articles in Germany is reserved for Radio, Berlin 42, Germany.

RADIO NEWS is for sale at all newsstands in the United States and Canada.

also at The International News Co., Ltd., Bream's Building, London E. C. 4, England, and at Brentano's, 37 Avenue de l'Opera, Paris.

HOW TO SUBSCRIBE FOR RADIO NEWS. Send your name, address and remittance to Experimenter Publishing Co., 53 Park Place, New York. Mention the name of the magazine you are ordering. We also publish SCIENCE AND INVENTION and PRACTICAL ELECTRICIAN. Write early.

RATES AND TERMS. The subscription rate for RADIO NEWS is \$2.50 per year. (12 numbers). When remitting do so by check, money order, or registered letter if cash is enclosed. Avoid sending cash through the mail if possible. Subscriptions for less than one year are not accepted. Subscription may be made in combination with SCIENCE AND INVENTION or PRACTICAL ELECTRICIAN with considerable saving.

POSTAGE. We prepay postage in all parts of the United States, Mexico and island possessions. For foreign or Canadian subscriptions we require 50 cents in addition to the subscription price for additional postage charges.

CHANGE OF ADDRESS. Notify us as far in advance as possible. It requires several weeks to make an address change on our records. Always write clearly, giving your old address as well as your new.

ON EXPIRATION of your subscription we enclose a renewal blank in our last number to you; we stop our delivery to you on expiration.

Built to Grace a Drawing Room



Grebe Broadcast Receiver
Type CR-12. A 4-tube Receiver combining Regeneration and Tuned R. F. \$175.00
(Accessories extra)



"There is no calamity greater than discontent; no vice more sickening than covetousness."

—Lao Tzu.

Contentment comes with possession of the best. Covet not thy neighbor's Grebe Receiver, acquire one for thyself.

Doctor W. H. A.

WHAT delight for all in the ever-fresh programs during the long, wintry evenings to come. Today's broadcasting better than yesterday's; tomorrow's more fascinating than today's. Tune in on this realm of entertainment, with a

GREBE Broadcast Receiver

Supplied in two types, each an Instrument of rich, dignified beauty—the product of more than ten years of skillful development.

CR-12 is a 4-tube Instrument in which are combined Regeneration and Tuned Radio Frequency Amplification.

CR-14 is a popularly-priced 3-tube dry cell Receiver employing Regeneration. The sockets accommodate UV-199 or C-299 tubes without adapters.

Both have beautiful walnut cabinets, employ concealed dry batteries and are extremely simple and economical to operate. Ask your quality dealer for a demonstration, or write us for full particulars.

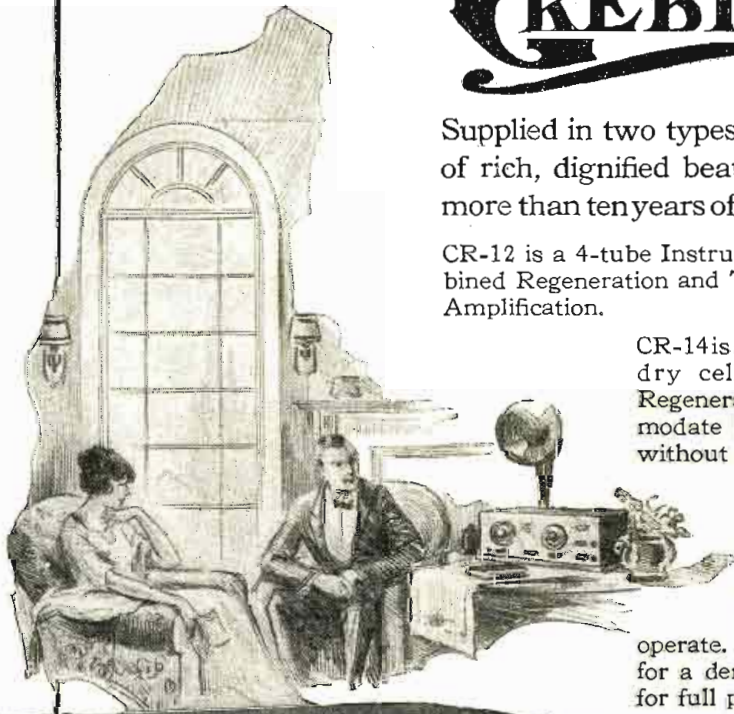

A. H. GREBE & CO., Inc.
Van Wyck Blvd., Richmond Hill, N.Y.

Western Branch: 451 East 3rd Street,
Los Angeles, Cal.

Grebe Broadcast Receiver
Type CR-14. A 3-tube Receiver of exceptional value \$110.00
(Accessories extra)

Licensed under Armstrong
U. S. Pat. No. 1,118,149

Index to Advertisers

Name	A	Page	Name	Page	Name	Page	Name	Page
Ackerman Brothers Co., Inc.		1308	Dubilier Condenser & Radio Corporation	1292	Liggett & Myers Tobacco Company	1296	Radio Units Inc.	1272
Acme Apparatus Company			Duck Company, The Wm. B.	1341	Listen-In Publishing Company	1362	Randel Wireless Co.	1326
Adams-Morgan Company	1295, 1319		Durkee-Thomas Products Company	1304	Mc		Randolph & Co.	1367
Aetna Variable Condenser Co.		1337	E		McKenzie Engineering Company	1342	Rauland Mfg. Company	1301
Aitken Radio Company		1314	E. I. Company, The	1348	M		Reliable Parts Mfg. Co., The	1328
Ajax Electrical Specialty Co.		1353	Eagle Radio Company	1300	M. & M. Company, The	1350	Remler Radio Mfg. Company	1316
Allen-Bradley Company	1220, 1372		Eisemann Magneto Company	1280	Magnavox Company, The	1303	Roll-O Crystal Co.	1369
Alter & Company, Harry		1322	Ekko Company, The	1276	Marko Storage Battery Company	1332	Rosendal & Company	1318
American Art Mache Company		1358	Electrad, Inc.	1329	Marshall-Gerken Company, The	1330	Rose Radio Supply	1310
American Hard Rubber Company		1333	Electrical Research Laboratories	1297	Martin-Copeland Company	1307	Royal Mfg. Company	1343
American Radio Mfg. Company		1365	Electric Service Supplies Company	1312	Marvel Radio Specialty Company	1332	Rusonite Products Corporation	1338
American Radio & Research Corp.		1312	Electric Specialty Company	1302	Mead Cycle Co.	1364	S	
American Specialty Company		1340	Electric Storage Battery Co., The	1277	Mecky Company, The A.	1324	S. & R. Radio Company	1325
American Transformer Company		1320	Electro Importing Company	1360	Michigan Radio Corporation	1353	Sahara Dry Battery Company	1386
Anderson, R. G.		1353	Elgin Radio Supply Company	1298	Midwest Radio Company, The	1315	Salisbury Bros. Furniture Co.	1362
Andrae & Sons Company, Julius		1324	Erie Fixture Supply Company	1318	Mitchell & Company, R.	1324	Samson Electric Company	1282
Andrea, Inc., F. A. D.		1275	Evans & Co., Victor J.	1366	Modell's	1321	Saturn Mfg. & Sales Co., The	1274
Atwater Kent Mfg. Company		1271	Experimenter's Information Service	1289	Montgomery Ward & Company	1298	Scientific Electric Works, The	1334
Automatic Electrical Devices Co., The		1306	F		Montrose Mfg. Company	1306	Service Battery Company	1346
B			Fahnestock Electric Company	1350	Morrison Laboratories, Inc.	1272	Shamrock Mfg. Company	1322
Babson Bros.		1269	Fansteel Products Company, Inc.	1369	Multiple Electric Products Co., Inc.	1309	Sherman Radio Dist. Corp.	1358
Bakelite Corporation		1359	Ferbend Electric Company	1355	Mu-Rad Laboratories, Inc.	1286	Shipman-Ward Mfg. Company	1330
Barawik Company, The	1217-1218-1219		Fiseher & Company, G. H.	1356	Murdock Company, Wm. J.	1268	Sidbenel Radio Equipment Mfg. Company	1334
Bates & Company		1284	Formica Insulation Co., The	1287	Myers Co., Ltd., E. B.	1316	Signal Electric Mfg. Company	1283
Bemco Mfg. Co.		1354	Freshman Company, Inc., Chas.	1274, 1342	N		Simplex Radio Supply Company	1343
Benson Melody Company		1369	Frost, Inc., Herbert H.	1284	Nassau Radio Company, Inc.	1354	Sinclair, Mr.	1298
Bleadon-Dun Company		1332	G		National Airphone Corporation	1214, 1215	Southern Radio Corp. of Texas	1356
Blue Seal Mfg. Company		1364	General Instrument Corp.	1354	National Carbon Company	1212, 1213	Southern Toy Company, The	1336
Bogue, B. N.		1272	General Radio Corporation	1308	National Industries, Inc.	1357	Specialty Service Company	1322
Boice, W. & J.		1272	Gilfillan Bros., Inc.	1281	National Radio Institute	1209	Springfield Wire & Tinsel Company	1280
Boonton Rubber Mfg. Co.		1363	Globe Electric Company	1366	Nazeley Company, J.	1358	Standard Radio Company	1351
Box 155		1318	Golden-Leutz Corp.	1317	Newman-Stern Company, The	1364	Steinmetz Wireless Mfg. Company	1346
Box 233		1364	Goldschmidt Corporation, Th.	1205	New York Coil Company	1371	Sterling Mfg. Company, The	1338
Boyd's Radio Lists		1371	Goodell-Pratt Company	1298	N. Y. Institute of Photography	1358	Stevens & Company	1342
Brach Mfg. Company, L. S.		1327	Gould Storage Battery Company	1336	O		Stransky, John A.	1338
Brandes, Inc., C.		1311	Great Lakes Radio Company	1273	O. & T. Electric Corporation	1328	Stromberg-Carlson Telephone Mfg. Co.	1366
Branston, Inc., Chas. A.		1294	Grebe & Company, Inc., A. H.	1207	Omnigraph Mfg. Company, The	1294	Sumner, D.	1350
Bremer-Tully Mfg. Co.		1340	H		O'Neil Mfg. Company	1365	T	
Bristol Company, The		1310	H. & H. Radio Company	1290	Owen, Richard B.	1312	Telephone Maintenance Company	1326
Brown Company, Thomas		1330	Halldorson Company, The	1316	Ozarka, Inc.	1356	Tresco	1274
Brownlie, Roland		1357	Hanes-Zener Company	1359	Ozment, C. J.	1350	Triangle Electro Trading Co., Inc.	1320
Bunnell & Company, J. H.		1358	Harvard Radio Laboratories	1278	P		Trimm Radio Mfg. Company	1276
C			Hayden Radio & Research Co., A. C.	1356	Pacent Electric Company	1342	Tuska Company, The C. D.	1293
Cannon & Miller Sales Corp.		1346	Heath Radio & Electric Mfg. Company	1356	Pathe Phonograph & Radio Corp.	1351	Twitchell, S. A.	1354
Carter Radio Company	1304, 1308		Hesslein, Wm.	1356	Phenix Radio Corp.	1367	U	
Central Radio Laboratories		1347	Holtzer-Cabot Electric Company, The	1278	Pignolet Instrument Company, Inc.	1355	U. S. Mfg. & Dist. Company	1353
Chemical Institute of New York, Inc.		1216	Hommel & Company, Ludwig	1300	Pioneer Radio Corporation	1288	U. S. Tool Company, Inc.	1346
Chevrolet Motor Company		1279	Hygrade Electrical Novelty Company	1324	Post Electric Company	1362	Union Radio Corporation	1270
Chicago Salvage Stock Store		1305	I		Precision Coil Company, Inc.	1364	United Electric Stores Company	1302
Chicago Solder Company		1331	Insulation Products Company	1365	Precision Equipment Co., The	1210	United Mfg. & Distributing Company	1361
Clapp Eastham Company		1357	J		Press Company, The	1340	Unity Mfg. Company	1288
Clearstone Radio Company, The		1314	Jackson Radio Company	1366	Press Guild, The	1290	V	
Connecticut Tel. & Electric Company		1306	Jones, Howard B.	1326	Progress Press	1363	V-De-Co Radio Mfg. Company	1340
Consolidated Instrument Co. of America		1282	K		Progressive Specialty Co.	1336	Valley Electric Company	1340
Conrad Company, The		1344	K. Electric Company	1276	Pyramid Products Company	1296	Veritas, M.	1300
Continental Fibre Company, The		1338	Kellogg Switchboard & Supply Company	1299	R		Vesco Radio Shop	1284
Continental Radio & Electric Corp.		1310	Kennedy Company, The Colin B.	1304	Radiall Company	1336	W	
Copper Clad Steel Company		1350	Kensington Radio Supply Company	1363	Radio Corporation of America		Walbert Mfg. Co., The	1318
Coto-Coil Company		1339	Kilbourne & Clark Mfg. Company	1325	Radio Equipment Company, Back Cover		Walker Company, Inc., G. E.	1276
Coyne Electrical School		1342	Killoch Company, David	1346	Radiogram Corporation, The	1341	Walnut Electric Mfg. Company	1330
Crosley Mfg. Company		1211	Kimley Electric Company, Inc.	1274	Radio Guild, Inc., The	1335	Weisenmayer, R.	1320
Cunningham, Inc., E. T.			Klaus Radio & Electric Company	1336	Radio Industries Corporation, Inside Back Cover		West Angus Show Card Service, Ltd.	1274
D			L		Radio Instruments Company	1334	Western Radio House	1310
Dalton, Whittier, True Company		1364	Lacey & Lacey	1366	Radio Parts Mfg. Co.	1340	Western Rubber Mould Co.	1342
Dayton Fan & Motor Company		1345	Lambert, Leon	1350	Radio Products Mfg. Company	1306	Westinghouse Union Battery Company	1285
Delta Electric Company		1314	Lancaster & Allwine	1366	Radio Rabat Company, The	1322	Weston Electrical Instrument Company	1308
Dey's Radio Service		1316	Lefax, Inc.	1304	Radio Research Laboratories	1362	Wheeler-Green Electric Company	1328
Diamond Electric Specialties Corp.		1314	Leich Electric Company	1300	Radio Specialty Company	1323-1347	Willard Storage Battery Company	1291
Diamond State Fibre Company		1349			Radio Stores Corporation	1267	Wilmington Fibre Specialty Company	1302
Dictograph Products Corp.		1354			Radio Tube Exchange	1332	Wireless Mfg. Co., The	1320
Dieterich, Albert E.		1364			Radio Tube Laboratories	1361	WorkRite Mfg. Company, The	1343
Dixie Supply Company		1345			Radio Tube Repairing Company	1328	World Battery Company	1362
Dobbins, Ray		1346					Y	
Dodge Radio Short Cut		1342					Y.M.C.A. Radio School	1346
Dodge's Institute		1338						

"This Free Book Showed Me the Way to Big Money in Radio"

It has Started Thousands on the Road to Independence and Success—has Lifted Them Out of the Rut of Office Routine and Helped Them Become Experts in This Fascinating, Profitable Profession. Let It Do the Same For You.

SIX months ago I was what you might call "a handy man about the office." I had what I considered a good job with a large manufacturing concern. Having taken a two years' business course, I knew enough of stenography and elementary bookkeeping to be of real value in general office work.

I took special dictation from the President, assigned general correspondence to the regular typists, was responsible for the purchase of office supplies, approved petty cash vouchers for the errand boys and clerks, and was entrusted with the responsibility of making deposits at the bank and bringing in the payroll.

In addition to these, I was often privileged to arrauge accommodations for the President when he went off on a trip. And when he wanted some personal matter attended to, such as purchasing theatre tickets or having his evening clothes brought down to the office, I was always selected for such tasks. I was, in fact, an assistant to the President. And accordingly I was paid \$40 a week.

I won't say that I was satisfied with this salary—although it was more than the other clerks were getting—but the fact that the President had confidence in me gave me a certain standing among the others which kept me fairly contented.

Then one day, having a little extra money on hand, I bought a small radio receiving set. Several of my chums had radio outfits

and I had always wanted one in order to enjoy the broadcast programs in the evenings at home. There was ordinarily nothing unusual about this, yet that little radio set changed my whole slant on life and opened up my future overnight.

I didn't know a thing about radio, but I soon got onto the tricks of operating a receiving set and rapidly became a real "fan." But much to my surprise, I got more fun out of the mechanical operation of my set than I did from the music, speeches, reports and regular programs of the nearby stations.

Then I began to take my set apart, reassemble it and experiment. I rigged up an outdoor aerial and installed a tube set. Then I bought a loud speaker and gradually added part by part until I had a first class outfit with a wave-length capable of "picking up" the programs from distant stations.

Naturally, I didn't stop there. Several of my friends had "sending" sets and I wanted nothing less. I began to study the code and longed for the day when I could get a license and have a "call letter" of my own. My routine, humdrum work at the office began to lose its appeal. I could hardly wait until evening came so that I could get home to the "work" I actually enjoyed.

One day the traffic manager at the office mentioned that he was going to buy a radio and flattered me by asking my advice. I offered to help him select a set and install it. He told me to go ahead, rig one up for him and let him know what I wanted for my trouble. It wasn't trouble—it was *real fun*—and I made \$30 for a single night's amusement.

That set me thinking. Why not get into radio in earnest? Two fellows I knew had given up office work and were making big money as Certified Radio-tricians. One was a salesman for a large radio manufacturer, with a fine office of his own in his home town; the other was a ship operator, traveling around the world, seeing the things I had always wanted to see—and getting *big money* for doing it.

I decided to study radio and train for a real job. But I wasn't in a position to give up my work at the office, for I had saved little or nothing, and had to contribute something at home every week.

Then one day I noticed an advertisement in *Radio News*. The heading first attracted me, for it read—"Men Wanted in Radio—You Can Train at Home for One of These Big-Paying Positions—This Free Book Will Tell You How." Here was a chance, I



thought. At least it wouldn't cost anything to get the book for it was *free*.

I sent for the book—"Rich Rewards in Radio." That was six months ago. What this free book meant to me is best explained by the fact that, as a Certified Radio-trician, my income this year will be at least \$5,000. And that's only the beginning. For I can already see the enormous possibilities for trained men in this fascinating, profitable profession. And I'm going to get my share of the big money being made by those who are "growing up" with this fast growing industry.

Thanks to the splendid training which I got from the National Radio Institute, *in my spare hours at home*, and with a Government First Class License in my pocket, the rest is up to me. But the opportunities for money, independence and success are unlimited in radio and I'm going to go the limit.

I won't attempt to tell you all the details of the wonderful opportunity that awaits you in radio. The Free Book of the National Radio Institute—the same one that I sent for—will tell you all you want to know. It showed me the way to *big money in radio*—it lifted me out of the rut of office routine and made me an expert in this fascinating profession. Why can't it do the same for you? It *can*—the 40 page, fully illustrated free book will tell you how. The coupon will bring it to you—without obligation. Why not send for it—TODAY.

NATIONAL RADIO INSTITUTE
Dept. 13CA WASHINGTON, D. C.

NATIONAL RADIO INSTITUTE.
Dept. 13CA, Washington, D. C.

Without obligation on my part, please send me the free book, "Rich Rewards in Radio," with full details as to how I can quickly train for the position of "Certified Radio-trician" in my spare hours at home. Also tell me how your free Employment Service will help me secure a good paying position.

Name

Street

City..... State.....

PICK OUT THE JOB YOU WANT WE WILL HELP YOU GET IT

This is a brief list of the positions in the Radio field today, and the salaries paid—

- Broadcasting Station Operator, \$125 to \$250 a month.
- Commercial Land Station Operator, \$150 a month and up.
- First Class Ship Operator, \$105 a month in addition to all expenses paid.
- Radio Engineer, up to \$10,000 a year.
- Radio Inspector, \$1,800 to \$4,500 a year.
- Radio Salesman, \$2,000 to \$10,000 a year.
- Radio Mechanic, \$1,500 to \$4,000 a year.
- Radio Instructor, \$150 to \$250 a month.
- Radio Draftsman, \$7 to \$15 a day.
- Radio Executives up to \$10,000 a year.

NOTE: RADIO FIRMS

Secure Practical Radio Experts Among Our Graduates. Write today.



This new Ace Type 3B Armstrong Regenerative Radio Receiver is the height of perfection. It is equal to a combination of the Ace Type V and the Ace two-stage amplifier. For volume and distant reception it out-performs most sets costing a great deal more. The new Ace Type 3B has a filament switch which eliminates necessity of turning out rheostats when set is not in use. Sells for \$50.00 but worth much more. Has genuine mahogany cabinet with engraved panel.

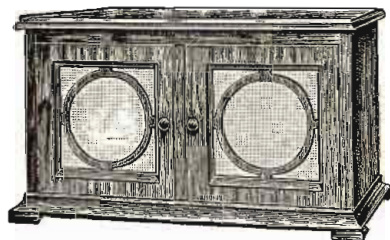

ACE TYPE 3C CONSOLETTE

This is the last addition to the Ace Family. Has beautiful solid mahogany, wax finished cabinet. Set consists of a regenerative tuner, detector and two stages of amplification with built-in loud speaker. Due to the particular method of winding Crosley coils it is exceptionally selective. Has sufficient room inside Cabinet for dry batteries, making a complete self-contained long range receiving outfit. Phone jack for tuning with head phones; Crosley multistat; filament switch, engraved Formica panel. Uses all kinds of tubes. An efficient set at a remarkable price, \$125.00—without tubes or batteries.

Send for free booklet entitled "The Simplicity of Radio" by Powel Crosley, Jr.

DEALERS:—Write on your letterhead for attractive sales proposition.

Determining Quality

A RADIO set or product is no better than the science and skill that creates it.

Those men in this Institution who are intrusted with the responsibility of producing up to the standards of Powel Crosley, Jr., are experts who have won national recognition in their chosen scientific field.

Honest Merchandise uses Truth in Advertising

Ace Type 3B and Ace Type 3C Consolette manufactured under Armstrong U. S. Patent No. 1,113,149

THE PRECISION EQUIPMENT CO.
322 VANDALIA AVE. POWEL CROSLEY, Jr., Pres. CINCINNATI, OHIO

The WANDERING MINSTREL of TODAY

HOW far have we progressed from the days when the minstrels, singing their self composed ballads to the accompaniment of harp or lute; or telling their stories illustrated with crude mimicry; wandered from castle to castle in old England furnishing to the nobility, practically the only entertainment available.

Today every American, no matter how far removed from the centers of activity has within his reach up-to-the minute news and amusements that would have delighted the hearts of the nobility of old. The air is filled with merriment waiting to be captured and brought to your very fire-side.

Radio is the magic wand that attracts to you the desired entertainment, Crosley Radio Receivers are the instruments by which this entertainment may be clearly and distinctly converted into a true reproduction of the original voice thousands of miles away.

You can own and enjoy a Crosley Radio Receiver. Unique features and quantity production have enabled us to offer the greatest value in radio ever produced. Actual tests by hundreds of satisfied users in all parts of America have proven that in performance, Crosley Instruments are unexcelled. And the prices are remarkably low.

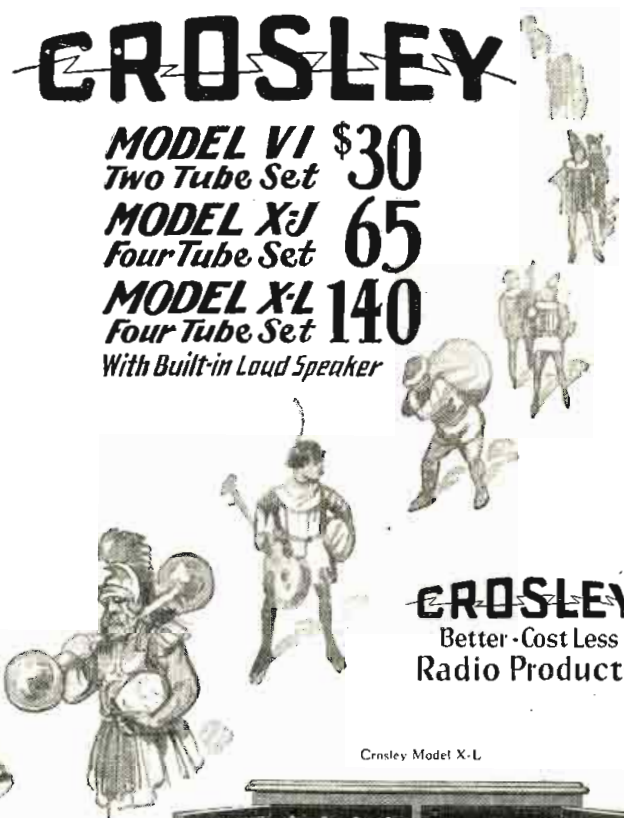

MODEL VI \$30
Two Tube Set

MODEL X-J 65
Four Tube Set

MODEL X-L 140
Four Tube Set
With Built-in Loud Speaker

CROSLEY
Better - Cost Less
Radio Products

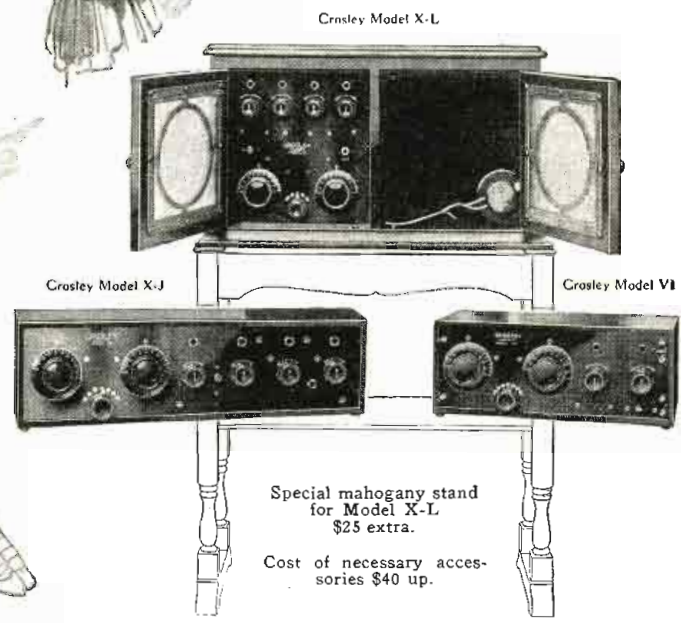

MODEL VI—\$30. A wonderfully efficient two tube set, one stage of Tuned Radio Frequency Amplification and Detector.

MODEL X-J—\$65. A four tube radio frequency set combining one stage of Tuned Radio Frequency Amplification, a Detector and two stages of Audio Frequency Amplification. A jack to plug in on three tubes for head phones, the four tubes coupled up for loud speaker.

MODEL X-L—\$140. A duplicate of Model X-J except the arrangement and mounting into a beautiful cabinet with the addition of a built-in loud speaker and space in the cabinet provided for housing the necessary batteries.

Crosley Manufacturing Company owns and operates broadcasting Station WLW.

Let a Crosley Radio Receiver Bring Perpetual Entertainment to Your Home.

For bringing in distant stations no set can excel it.

For Sale By Good Dealers Everywhere

Crosley Manufacturing Co.

Powel Crosley Jr., President

322 Alfred Street

Cincinnati, Ohio

—The Largest Manufacturers of Radio Receivers in the World—

Mail This Coupon Today

CROSLEY MANUFACTURING COMPANY,
Powel Crosley Jr., President,
322 Alfred St., Cincinnati, Ohio.

Gentlemen:—

Please mail me free of charge complete catalog of Crosley instruments and parts. I enclose 10c for which also send your booklet entitled: "The Simplicity of Radio," by Powel Crosley, Jr.

Name

Address

"THE AIR IS FULL OF THINGS YOU SHOULDN'T MISS"

EVEREADY

Radio Batteries

-they last longer



Eveready gives you the right battery for every radio use!

EACH Eveready Radio Battery represents thirty years of battery building experience. Each Eveready Battery represents millions of dollars invested in men, methods and machinery. Overseeing Eveready production is the greatest battery laboratory known to science, where every particle of raw material is required to pass Eveready's exacting tests. To insure Eveready serviceability, batches of Eveready Batteries are constantly being set aside for performance tests. And, finally, daily shipments keep dealers supplied with fresh Eveready Batteries, packed full of power.

To be certain of battery satisfaction, insist on Eveready Radio Batteries—they last longer.

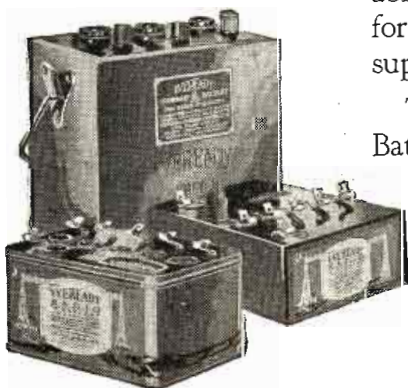

NATIONAL CARBON COMPANY, INC., New York, San Francisco
Headquarters for Radio Battery Information

CANADIAN NATIONAL CARBON CO., Limited. Factory and Offices: Toronto, Ontario

Informative and money-saving booklets on radio batteries sent free on request. If you have any radio battery problems, write to G. C. Furness, Manager, Radio Division, National Carbon Co., Inc., 122 Thompson Ave., Long Island City, N. Y.

"THE AIR IS FULL OF THINGS YOU SHOULDN'T MISS"

EVEREADY Radio Batteries *-they last longer*

The radio dry cell triumphant

For economical, satisfactory radio, light the filaments of your dry cell tubes with the Eveready Dry Cell Radio "A" Battery. Will unflinchingly outlast any other at $\frac{1}{8}$ ampere current. Full instructions for getting this Economical Eighth, on labels and in our booklets. This remarkable cell is the culmination of dry battery science. The vital life-giving ingredients compounded in special equipment make it long-lived on radio tubes. This battery will exceed your expectations in economy and performance.



Equal to all demands

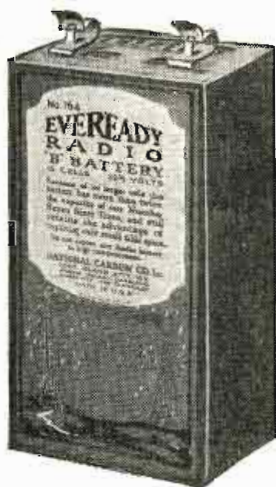

Power flows from your "B" Battery, power that gives life to your headphones or loud speaker. Some tubes draw more "B" Battery current than others, but whatever the tube or tubes you use, Eveready "B" Batteries will give you maximum results. Eveready "B" Batteries are made in six sizes, for all possible uses. There is one for every set, large and small. Always use the biggest possible battery, for the bigger the cells the more energy they contain in proportion to their cost and the longer they last. Where table space is limited, buy this vertical Eveready "B" Battery No. 764, 22½ volts, equipped with two Fahnestock Spring Clips. This is a marvel of compact capacity. Its base measures about the same as the smallest flat "B" Battery, but it is twice as high and lasts more than twice as long as its midget brother.

This battery is a wonder worker

Eveready's biggest contribution to economical and more satisfying radio is the Eveready "C" Battery, a triple-use, universal battery. You have an "A" Battery for the filaments, a "B" Battery for the plates, and here is a "C" Battery which maintains the grids of amplifying tubes at the potential where they operate with least distortion. It will make the loud speaker respond with a new fullness and naturalness of tone, and save much money by making the "B" Battery last still longer. Connect it with the grids of audio frequency amplifiers (full directions on the label and in our booklets) and notice the big difference. Can also be used as an "A" Battery for 199-type tubes in portable sets, and as a "B" Battery booster. Eveready Radio Battery No. 771—use it!



ANNOUNCING NEW

MONODYNE AMPLIFIER

\$850

Without
Tube

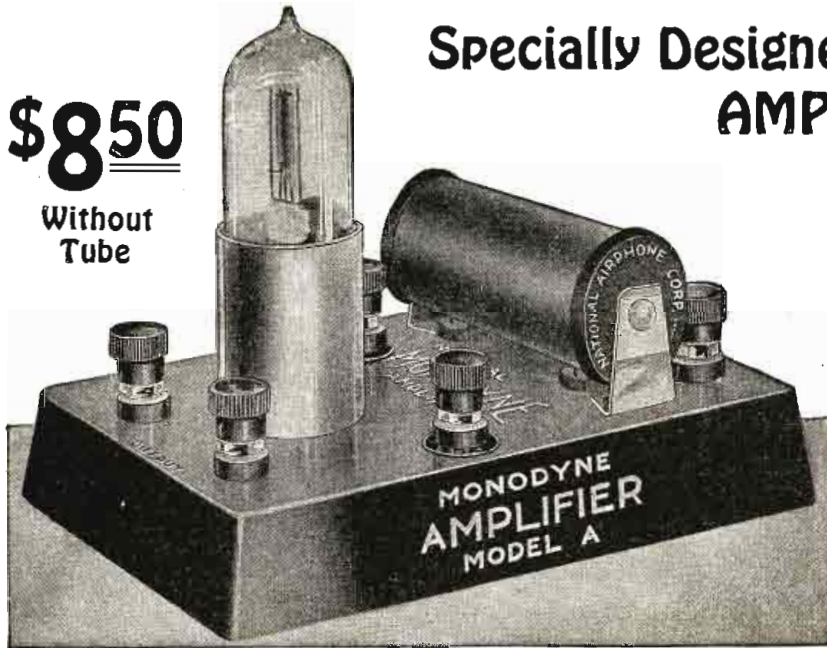

Specially Designed for
**AMPLIFICATION of
MUSIC and VOICE**

One or More Stages
Will Operate
a Loud Speaker

Worthy Companion of the
National Monodyne
"The Set that Revolutionized
Radio"

Exceptional Power. Freedom from Distortion and Howling

The NATIONAL MONODYNE AMPLIFIER is as radically different from all other Amplifiers as the Monodyne is from all other Radio Receivers. Entirely new Audio Frequency Transformer amplifies without distortion. Amplifier is compact and rugged. Construction of same size and style as the National Monodyne tube set.

The NATIONAL MONODYNE AMPLIFIER, while especially designed to match the MONODYNE receiver, can be used with any other radio outfit whose intensity it is desired to amplify. The NATIONAL MONODYNE AMPLIFIER will work with any standard tube on the market, although WD12 and UV199 Dry Battery tubes are recommended.

Dealers, Jobbers and Distributors—Send for Samples and Prices

IF YOUR DEALER CANNOT SUPPLY YOU MAIL THIS COUPON DIRECT TO US

SEND NO MONEY

NATIONAL AIRPHONE CORPORATION
18 Hudson St., New York, U. S. A.

R.N. 3

Please send me prepaid the articles crossed, for which I will pay postman upon delivery the advertised price.

- One National Monodyne
- One Audio Amplifier
- One Interference Eliminator
- One Panel Detector

NAME

STREET

CITY..... STATE.....



18 HUDSON ST.

NEW YORK

NATIONAL Apparatus of Simplicity and Perfection

For Reflex and Crystal Sets

The Monodyne circuit is one of the most radical advances in Radio engineering. Parts heretofore considered essential are omitted. One simple tuning control gives selectivity, equal if not superior to sets costing hundreds of dollars.

NATIONAL
"GOLD-GRAIN"
DETECTOR



\$1.00

Actual Size FOR PANEL MOUNTING

Only One
Tuning Control

All Wave Lengths

NATIONAL
MONODYNE
PAT. TRADE MARK PDG.

No Storage
Batteries

TUBE SET
MODEL GT-1

\$10.00

Including
Two
Inductance
Coils
Without
Tube

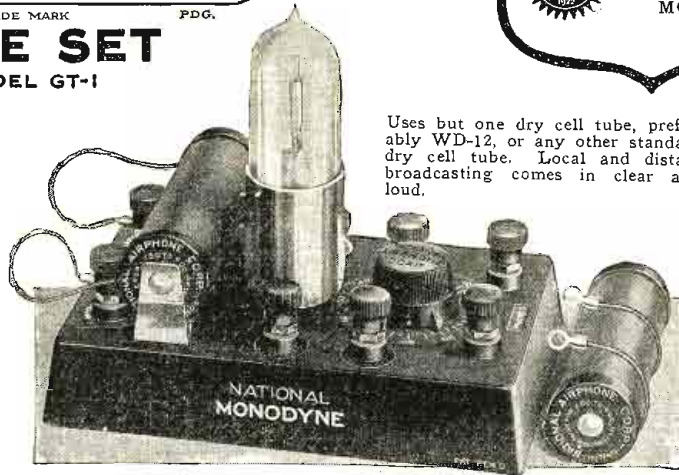

Uses but one dry cell tube, preferably WD-12, or any other standard dry cell tube. Local and distant broadcasting comes in clear and loud.

NATIONAL
**INTERFERENCE
ELIMINATOR**

The National Interference Eliminator can be used with any and all radio outfits no matter what make, tube or crystal sets. Will bring in stations you never heard before. Nothing else required with set as illustrated. Just connect it with two short wires to your outfit.



THE SINGLE TUBE

Performs the Function of 2-Tubes

AS RADIO FREQUENCY AMPLIFIER
AND DETECTOR

\$7.50



3000 Miles
on the
MONODYNE

On Tuesday night, Nov. 27th, between 10:12 and 10:21, I heard on your National Monodyne Single Tube Set, hooked up with two stages of amplification, London, England, broadcasting speech, piano and violin solo. I also heard Liverpool, between 10:26 and 10:30 broadcasting dance music very clear.

FRANK DONDA,
241 East 56th St.
New York City.

An Absolute Necessity to Clear Reception
Eliminates broadcasting and code-signal interference
Can be used to increase or shorten wave lengths

Dealers, Jobbers and Distributors—Send for Samples and Prices:

NATIONAL
AIRPHONE
CORPORATION
Reg. U. S. Pat. Office

18 HUDSON ST.

NEW YORK

SEND NO MONEY

NATIONAL AIRPHONE CORPORATION
18 Hudson St., New York, U. S. A.

R.N.3

Please send me prepaid the articles crossed, for which I will pay postman upon delivery the advertised price.

- One National Monodyne
- One Audio Amplifier
- One Interference Eliminator
- One Panel Detector

NAME

STREET

CITY STATE



Dr. T. O'Conor Sloane will teach you **CHEMISTRY** Right in your own Home



Good Chemists Command High Salaries



T. O'CONOR SLOANE.
A.B., A.M., LL.D., Ph.D.
Noted Instructor, Lecturer and Author. Formerly Treasurer American Chemical Society and a practical chemist with many well known achievements to his credit. Not only has Dr. Sloane taught chemistry in the class-room but he was for many years engaged in commercial chemical work.

Industrial firms of all kinds pay tempting salaries to get the right men. Salaries of \$10,000 to \$12,000 a year are not unusual for chemists of exceptional abilities. Chemistry offers those who are ambitious and willing to apply themselves conscientiously the greatest opportunities of any vocation. Why be satisfied with small pay and hard, thankless work—learn the profession of Chemistry and your salary will depend only upon your own efforts and your own abilities.

The work of the chemist is extremely interesting. If you are fond of experimenting, if you like exciting and fascinating work, take up Chemistry. To the man who is dissatisfied with his present job, to the young man just deciding on his life work, Chemistry holds alluring charms, and countless opportunities. If you want to earn more money, the way is open through our course in Chemistry.

Now Is The Time To Study Chemistry

Never before has the world seen such splendid opportunities for chemists as exist today. The war has awakened the United States to the need of trained chemists and chemical engineers. Everywhere the demand has sprung up. In factories, mills, laboratories, electrical shops, industrial plants of all kinds, chemistry plays a vital part in the continuation and expansion of the business. In every branch of human endeavor the need for chemists has arisen. No profession offers such alluring opportunities and the next development in this science that this country has ever seen.

ten years are going to show the greatest development in this science that this country has ever seen. Those who have the foresight and ambition to learn chemistry now will have the added advantages and greater opportunities afforded while the chemical field is growing and expanding.

You Can Learn At Home NO PREVIOUS SCHOOLING NEEDED

Dr. Sloane will teach you Chemistry in a practical and intensely interesting way. Our home study course written by Dr. Sloane himself is practical, logical and remarkably simple. It is illustrated by so many experiments that are performed right from the start that anyone, no matter how little education he may have, can thoroughly understand every lesson. Dr. Sloane teaches you in your own home with the same individual and painstaking care with which he has already taught thousands in the class room. He will, in addition, give you any individual help you may need in your studies. This personal training will be of inestimable value to you in your future career.

Experimental Equipment Given to Every Student



We give to every student without additional charge, this chemical equipment including fifty pieces of laboratory apparatus and supplies and thirty-nine different chemicals and reagents. The fitted heavy wooden box serves not only as a case for the outfit but also as a laboratory accessory for performing countless experiments. Full particulars about this special feature of our course are contained in our free book "Opportunities for Chemists."

DIPLOMA AWARDED TO EACH GRADUATE

Upon graduation each student is awarded our Diploma in Chemistry, certifying that he has successfully completed his studies. Your name on this certificate will be a source of pride to you all your life, as well as an aid to obtaining a position in Chemistry.

Easy Monthly Payments

You do not have to have even the small price of the course to start. You can pay for it in small monthly amounts or earn it as many others are doing. The cost is very low, and includes even the Chemistry outfit—there are no extras to buy with our course. Write us and let us explain how you can qualify for a trained technical position without even giving up your present employment.

SPECIAL 30 DAY OFFER

Besides furnishing the student with his Experimental Equipment, we are making an additional special offer for a short while only. You owe it to yourself to find out about it. Write today for full information and free book, "Opportunities for Chemists." Send the coupon right now while it is fresh in your mind. Or just write your name and address on a postal and mail it to us.

What Well-Known Authorities Say About Our Course

From Hudson Maxim,
"Dr. Sloane has done a much-needed work in a much better way than anything of the kind has, heretofore, been done."

"Dr. Sloane has a remarkable faculty of presenting Science for self-instruction of the student in such a clear and understandable way as to be most readily grasped and assimilated."

"I, therefore, unreservedly recommend and place my highest indorsement on his work."

From Dr. W. W. de Kerlor,
"I can not recommend your course too highly and I congratulate both you and Dr. Sloane on same."

From John A. Tennant,
"This is something which has long been needed. Your long experience in the teaching of chemistry... assurance that the course will be practical as well as plain to the untrained students."

What the Students Say:

"Your course has been worth \$50,000 to my concern."

"This is just like reading some fascinating fiction story."

"I have just been made Assistant Chemist of my concern."

"Your course is just what a person wants to start in the wonderful science of Chemistry."

"I find that your course is very interesting. I wait patiently for the next lesson."

"I find the study of chemistry more and more interesting at every lesson and you may be sure that I am getting into studying habit even more than I ever did even in my school days."

"I like the lessons so much that I honestly would not sell them for many times their price."

"I am taking this opportunity to express my satisfaction with your chemical lessons."

"I now have a fine position as chemist at the Du Pont Dye Works. It was thru your course alone that I have been so successful."

"I have written to different people about your course and they speak very highly of same."

"If I don't learn it isn't your fault for I find that your lessons contain a whole lot."

(Names and addresses on request)

CHEMICAL INSTITUTE OF NEW YORK
Home Extension Division 3
66-R-West B'way
New York City

Please send me at once, without any obligation on my part, your free Book "Opportunities for Chemists," and full particulars about the Experimental Equipment given to every student. Also please tell me about your plan of payment and your special 30 day offer.

NAME

ADDRESS

CITY..... STATE.....

Don't Wait—Mail the Coupon NOW!

CHEMICAL INSTITUTE of NEW YORK, Inc.

66—R, WEST BROADWAY Home Extension Division 3 NEW YORK CITY

IT IS EASY TO BUILD YOUR OWN RADIO SET

Guaranteed Quality Goods

at money saving prices. There are no strings tied to our prices. Order what you want—be your order large or small. You will get immediate service from the most reliable exclusive radio supply house. Before you consider buying elsewhere, ask your banker as to our responsibility and financial rating. You will find that we stand high in the commercial world and we have earned our standing only through fair dealing, prompt service and by offering merchandise of high quality at prices unequalled by others.

FAHNESTOCK CONNECTORS



P366 Single. Dozen 25¢
 P367 Double. Dozen 35¢
 Handy and convenient for making or making connections on binding posts or other parts of instruments. Wires held firmly in spring grip but may be instantly removed.

UNIVERNOR CONTROL DIAL

P918 For 3/16 inch shaft.....\$1.15
 P919 For 1/4 inch shaft 1.15
 Replaces ordinary knob or dial. Gives perfect vernier control on condenser, variometer, variocoupler, tickler, etc. Positive easy action. Looks fine. Easily installed. Especially desirable in tuning neutrodyne sets.

RADIO SWITCH

P287 Each 28¢
 Cuts current on and off instantly by a push or pull. Very neat. Well made. Durable. Saves tubes and batteries.

BEZELS

P399 Diameter 3/4 inch. Each.....15¢
 P400 Diameter 1 1/4 inch. Each.....15¢
 Polished nickel finish. Finest quality. Fit any thickness panel. Greatly improve appearance of panel.

CABINETS

Fine looking cabinets solidly built. Elegant hand rubbed dark mahogany finish. You will be proud of your set mounted in one of these cabinets. Hinged tops. Front rabbeted to take panels. Panels not included. Prices are transportation paid. Note that our prices are prepaid.

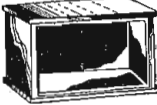

Panel Size Inches	Inside Dimensions			Art. No.	Price Each
	High	Wide	Deep		
6x7"	5 1/4"	8 3/4"	7"	P420	\$1.95
6x10 1/2"	5 3/4"	10"	7"	P422	2.45
7x10"	6 1/2"	9 1/4"	7"	P421	2.60
7x12"	6 1/2"	11 1/2"	7"	P424	3.05
7x14"	6 1/2"	13 1/4"	7"	P423	3.25
7x18"	6 1/2"	15 1/4"	7"	P426	3.45
7x21"	6 1/2"	17 1/4"	7"	P425	3.85
7x24"	6 1/2"	19 1/4"	7"	P429	4.35
7x26"	6 1/2"	21 1/4"	7"	P431	5.50
9x14"	8 1/2"	13 1/4"	10"	P428	3.55
12x14"	11 1/2"	13 1/4"	10"	P430	4.00
12x21"	11 1/2"	24 1/4"	10"	P432	5.05

RADIO "BAKELITE" PANELS

Notice our very low prices on this fine quality material. Others ask as much for hard rubber panels which are worth much less. We supply genuine Bakelite, Condensite Celeron or Formica, all of which are materials with practically identical mechanical, chemical and electrical properties. Machines well without chipping. Won't warp. Waterproof. Highest mechanical and dielectric strength. Attractive natural polished black finish which can be sanded and oiled. Note that our prices are prepaid.

Panel Size Inches	1/2" thick		3/16" thick		1/4" thick	
	Art. No.	Price	Art. No.	Price	Art. No.	Price
6x7"	P450	\$5.50	P460	\$8.80	P470	\$1.15
6x10 1/2"	P451	8.80	P461	1.10	P471	1.73
7x14"	P458	1.38	P468	1.73	P478	2.76
7x18"	P453	1.78	P463	2.27	P473	3.56
7x21"	P457	2.05	P467	2.65	P477	5.10
7x24"	P459	2.42	P469	2.97		
7x26"			P462	3.25		
9x14"	P454	1.85	P464	2.35	P474	3.58
12x14"	P455	2.42	P465	2.77	P475	4.78
12x21"	P456	3.62	P466	4.25	P476	7.13

RUBBER COMPOUND PANELS

Made of a special compound having a rubber base. Equal in appearance and in all essential points to any other class of panels. Fine smooth polished finish. Can be drilled or cut without chipping. Guaranteed not to warp and to be a perfect insulator for radio use. Smooth, clean edges. Thickness 3/16 inch. Size given is in inches.
 P481 7x10...\$0.88 P484 7x18...\$1.60
 P482 7x12...1.05 P483 7x21...1.85
 P483 7x14...1.22 P486 7x24...2.10

PANELYTE RADIO PANELS

A new practical radio panel. High dielectric strength, rigid and durable. Easy to drill, tap or refinish. Black in color, polished on one side, matte grain on other side. 3/16 inch thick.
 P487 7x10...72¢ P490 7x18...\$1.28
 P488 7x12...84¢ P491 7x21...1.44
 P489 7x14...96¢ P492 7x24...1.69

Over 30,000 Barawik Radio Sets Are Operated All Over the World

All of these sets were built with Barawik Standard Radio Parts mostly by persons without any previous radio experience. These home-made sets equal in results the best factory made sets—many are even superior and at a cost only a fraction of the cost of the factory made sets. You can easily equal these results by following directions given in the numerous magazine articles on radio. Also directly below you will find listed Blue Prints, Instruction Packs and Books. With the help of these anyone can successfully make a Radio Set.

RADIO BOOKS

That every Home Builder and Amateur needs. Written in plain simple language everyone can understand.

- P631 100 Radio Hookups. Each.....25¢ Shows hookups from the simple crystal set to the more elaborate and latest tube circuits. Numerous types of Reflex super-Regenerative, super-Heterodyne, Neurodyne, Reinartz, Flewelling, Bishop, etc.
- P632 How to Tune Your Radio Set. Each.....25¢
- P633 How to Build Loud Talkers. Each.....25¢
- P634 How to Make Radio-Phone Receiving Sets. Each.....25¢
- P635 How to Make Radio Frequency Amplifiers. Each.....25¢

SPIDER WEB COIL FOR REINARTZ CIRCUIT

P296 Each.....\$1.30
 Lists for \$2.50. A very unusual bargain. Made of green silk covered wire, spider web wound on green silk covered wire. Produces wonderful results. Fibre strips and wooden rod for mounting included. Directions furnished.

ULTRA AUDION COIL

P297 Each.....\$1.85
 Spider web wound on green silk covered wire. Four taps. Produces wonderful results. Fibre strips and wooden rod for mounting included. Directions furnished.

COCKADAY COILS

P298 Per Set.....\$1.95
 Complete set coils for Cockaday circuit. Properly calculated and made to give best results on this new wonder circuit.

NEUTRODYNE TRANSFORMERS

P571 Each \$1.75. Per set of three.....\$4.95
 An air core transformer for use in neutrodyne method of reception. Can also be used for tuned radio frequency or as a fixed coupler with condenser across secondary. Proper design for results and efficiency. Great silk windings on bakelite tubes with adjustable mounting brackets to fit most any condenser.

NEUTRALIZING CONDENSERS

P572 Per set of two.....40¢
 Simple, inexpensive, effective precision type. Micrometer adjustment is attainable. Easily mounted in circuit.

STANDARD NEUTRODYNE PARTS

P851 WorkRite Neuroformer (combined transformer and condenser). Each.....\$4.78
 P852 WorkRite Neurodyne Kit.....\$14.95
 Includes 3 WorkRite Neuroformers, 2 WorkRite Neurodrons, panel layout, paper template and book of instructions.

P854 Ansco Compensating Condenser

Each.....\$2.89
 A 3 electrode condenser for balancing the grid charge on amplifying tubes. Stops all local oscillations without detuning amplifier. Shielded against hand capacity. Complete with 2 inch dial. Provides perfect and rapid control of tube.

P853 WorkRite Neurotron

Each.....43¢
 A very accurate and easily adjusted condenser for neutralizing tube.

P855 Fada Neurodyne Parts

.....\$25.00
 A combination package of three neuroformers and two neurodrons with instruction book.

P856 Fada Parts for 4 tube set

Complete.....\$64.00

P857 Fada Parts for 5 tube set

Complete.....\$65.60

Contain all necessary parts including drilled panel, careful instructions, sockets, dials, condensers, transformers, bus bar wire and fine mahogany finish cabinet.

ANTENNA LEAD-IN

P259 Each.....25¢
 Solves a hard problem. With it you can bring in the antenna wire without drilling a hole for an insulator. Place on window sill and window can be closed down tight and locked as before. Takes but a minute to install. Perfectly insulated. Can be bent into any shape. Made of copper strip properly insulated. Neat and durable.

We offer our agents 20 percent discount on new all standard goods not listed on these pages. Send us your order—we give you the right price.

PRINTS OF POPULAR CIRCUITS

These prints give a full-size panel layout schematic hookup, hook-up showing parts wired and explanatory notes. With them as a guide anyone can build a set that will operate perfectly and bring in the long distance stations.

- P621 One Tube Reflex and Amplifier. Each.....10¢
- P622 Single Circuit Tuner. Each.....10¢
- P623 Reinartz Tuner using Spider Web Coil. Each.....10¢
- P624 Radio and Audio Frequency Amplifier. Each.....10¢
- P625 Short Wave Regenerative Set, using two Variocouplers. Each.....10¢
- P626 Honeycomb Coil Circuit and Amplifier. Each.....10¢
- P627 Cockaday. Each.....21¢
- P628 5-Tube Neurodyne. Each.....21¢

Complete Sets of Parts for Popular Circuits

Only high grade parts are used in these sets and each part is guaranteed to be perfect. Each one of these circuits has been tried and successfully operated under many different conditions. The detailed instructions and diagrams supplied with each set make it easy for any one without previous experience to build an outfit that will give most satisfactory results.

HAZELTINE NEUTRODYNE 5 TUBE CIRCUIT

P858 Complete set parts.....\$38.50
 Essential parts licensed under Hazelitine patents. A set that will give really wonderful results. Only the highest grade parts are used. The following items are included:
 1—7x24x3/16 Formica panel.
 2—Rheostats with dials.
 3—4 inch Bakelite dials.
 4—Bakelite sockets.
 5—Composition top binding posts.
 6—0005 Bakelite end variable condensers.
 7—7x24 high grade cabinet.
 8—Neuroformer transformers.
 9—Neutralizing Condensers.
 10—Variable grid leak and condenser.
 11—Barawik audio transformers.
 12—Base board for mounting.
 13—30 ft. tinned bus bar wire.
 Instructions for assembling and wiring.

ERLA SINGLE TUBE REFLEX CIRCUIT

P859 Complete set parts.....\$18.95
 The following parts are included:
 1—Erla Reflex No. 1 Transformer.
 2—Fixed detector transformer.
 3—Variocoupler silk windings on bakelite tube.
 4—0005 Bakelite end Variable Condenser.
 5—Bakelite standard base sockets.
 6—002 Mica condenser.
 7—001 Mica condenser.
 8—Fixed detector.
 9—High grade rheostat.
 10—3 inch polished black dials.
 11—Binding posts with composition tops.
 12—dozen switch points and 4 stops.
 13—Switch levers.
 14—7x14 1/2 Bakelite panel.
 P425 Fine 7x14 Cabinet mahogany finish. Extra.....\$3.20

AUTOPEX CIRCUIT

P860 Complete set parts.....\$13.25
 A single tube circuit that brings in signals loud enough for a table talker. The following parts are included:
 1—Wood form Variometers silk windings.
 2—7x12 1/2 Bakelite panel.
 3—3 inch polished black dials.
 4—250 turn honeycomb coil.
 5—Bakelite socket with standard base.
 6—ohm rheostat.
 7—Composition top binding posts.
 8—Name plates.
 9—30 feet bus bar wire.
 10—Consolidated Autoplex pattern.
 11—Fine 7x12 cabinet mahogany finished.

COCKADAY CIRCUIT

The following parts are included:
 P861 Complete set parts.....\$11.35
 1—Set Cockaday Coils.
 2—3 inch polished black Bakelite dials.
 3—Bakelite socket for standard base.
 4—Freshman grid leak and condenser.
 5—Vernier Rheostat.
 6—Double Circuit Jack.
 7—Composition top binding posts.
 8—High grade switch levers.
 9—dozen polished nickel switch points.
 10—7x13 1/2 Formica panel.
 11—250 turn honeycomb coil.
 12—0005 Bakelite end variable condensers.
 13—Base board for convenient assembling.
 14—30 feet nickle plated bus bar wire.
 Diagram and instructions.
 P423 Cabinet extra.....\$3.20

MIGNON VERNIER VARIABLE CONDENSERS

P827 .0002 M.F. Each.....\$2.30
 P828 .0005 M.F. Each.....2.70
 P829 .001 M.F. Each.....2.95
 Highest grade instruments. Accurate reading. Extremely low dielectric losses. Independent friction control insures perfect positive adjustment. 3/4 inch shaft. No dial included.

"CONSOLIDATED" RADIO PLAN

PACKETS
 Designed and laid out by the foremost radio engineers. With their help you can build an outfit that will give the finest results. Every packet contains complete instruction for the construction and tells what tools and parts are needed. Detailed directions for drilling, mounting and wiring, also how to handle set after it is built. Thousands of sets have been built from these plans and are in perfect operation. Folder giving detailed description of each packet sent on request. For more complete description of these packets see the Consolidated Co. advertisement in this magazine. Price per packet.....42¢
 Order item wanted by article number.

- P640 How to make a Neurodyne Receiver.
- P641 How to make a Reinartz Receiver.
- P642 How to make a Regenerative Receiver.
- P643 How to make a Cockaday Receiver.
- P644 How to make a Reflex Receiver.
- P645 How to make Detector and Amplifier Units.
- P646 All about aerials and their construction.
- P647 Twenty Radio Diagrams of Latest Hook-ups.
- P648 14 Radio Formulas and Diagrams.
- P649 How to make an Autoplex Receiver.
- P650 How to make the 5T100.

Complete Sets of Parts for Popular Circuits

Only high grade parts are used in these sets and each part is guaranteed to be perfect. Each one of these circuits has been tried and successfully operated under many different conditions. The detailed instructions and diagrams supplied with each set make it easy for any one without previous experience to build an outfit that will give most satisfactory results.

FLEWELLING CIRCUIT

P864 Complete set of parts.....\$12.39
 The following parts are included:
 1—7x12x3/16 panel.
 2—.0005 Bakelite end variable condenser.
 3—.006 Mica condenser for standard base.
 4—2 coil honeycomb mount.
 5—Variable grid leak and condenser.
 6—50 turn honeycomb coil.
 7—75 turn honeycomb coil.
 8—Coil mounts with straps.
 9—3 inch polished black dial.
 10—Bakelite socket for standard base.
 11—Vernier 6 ohm rheostat.
 12—Binding posts with composition top.
 13—Base board for assembling.
 Instructions for assembling, and wiring.

REINARTZ CIRCUIT

P862 Complete set parts.....\$10.75
 The following parts are included:
 1—7x18x3/16 Bakelite panel.
 2—Bakelite socket standard base.
 3—Vernier Rheostat.
 4—.0005 Bakelite end variable condenser.
 5—.00025 Bakelite end variable condenser.
 6—3 inch polished black dials.
 7—Switch levers.
 8—Green silk insulated coil.
 9—Freshman variable grid leak with condenser.
 10—dozen insulated top binding posts.
 11—30 ft. tinned bus bar wire.
 12—Instructions for assembling and wiring.
 P426 Fine 7x18 Cabinet mahogany finish. Extra.....\$3.45
 (Note—The above does not include amplifier. Set can be supplied with 2 additional sockets, 2 audio transformers, 2 additional rheostats, and size 7x21 panel.)
 P863 Complete with two stage amplifier.....\$17.95
 P425 Fine 7x21 Cabinet mahogany finish. Extra.....\$4.65

ULTRA AUDION CIRCUIT

P865 Complete set parts.....\$8.95
 The following parts are included:
 1—Spider web coil with taps.
 2—.0005 Bakelite end variable condenser.
 3—7x12x3/16 panel.
 4—Bakelite socket for standard base.
 5—Variometer with silk windings.
 6—Vernier 6 ohm Rheostat.
 7—Variable grid leak condenser.
 8—Binding posts with composition tops.
 9—Base board.
 10 feet nickle plated bus bar wire.
 Diagrams and instructions.
 P424 Fine 7x12 cabinet mahogany finish. Extra.....\$3.05
 The ultra audion circuit gives fine results with two stages of amplification added. Set as above with 7x18 panel and 2 audio transformers, 2 additional bakelite sockets and 2 additional rheostats.
 P866 Complete.....\$15.95
 P426 Fine 7x18 cabinet mahogany finish. Extra.....\$3.45

LIGHT SOCKET ANTENNA

P251 Each.....97¢
 Screws into any light socket. Replaces the regular out door antenna. Very satisfactory for nearby stations and under unfavorable conditions will bring in distant stations. Easy to install. No danger. Gives clear reception with little static interference. Ideal for people in apartment buildings.

RADIO SOLDER SET

P538 Complete.....83¢
 Handy for soldering radio connections or for general small repair jobs. Consists of soldering copper with handle, sal ammoniac, soldering salts, solder and sand paper.

BUILD YOUR SET BETTER-AT LOWER COST

SUPERIOR 180° VARIOCOUPLER
P521 Each. . . . \$1.10
A wonderful value. produces excellent results. Green silk windings on black fibre tubes. Rigid mounting support for table or panel mounting. Primary tapped for fine tuning. 1/4 inch shaft. Range 200 to 600 meters.



SUPERIOR VARIOCOUPLER
P523 Each. . . . \$3.35
A handsome instrument of superior design and construction. Stator tube and rotor ball of moulded red brown bakelite. Large size green silk windings insure highest efficiency. Table or panel mounting. 1/4 inch shaft. Superior results in circuits for 180 to 650 meters. Tapped primary for finest tuning. Noiseless contacts. P526 Special single circuit type. . . . \$3.75



SUPER MOULDED VARIOMETER
P412 Each. . . . \$2.48
Polished black moulded rotor and stator forms. Maximum inductance with greatest efficiency and minimum distributed capacity. A high grade instrument that will get the best results. Wave length 180 to 600 meters.

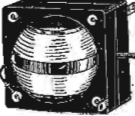

EXCEL MOULDED VARIOMETER
P524 Each. . . . \$4.45
A wonderful value at our price. Properly designed and constructed. Polished black bakelite rotor and stator forms. Large size green silk wire insures greatest efficiency. 1/4 inch shaft. Noiseless pitgal connection. Table or panel mounting. Split stator winding with binding post connections.

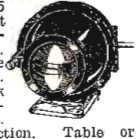

SUPERIOR VARIOMETER
P525 Each. . . . \$3.68
Forms moulded of red brown bakelite. A neat handsome instrument. Green silk windings calculated for highest efficiency. 1/4 inch shaft. Noiseless pitgal connections. Table or panel mounting. Produces superior results in any type circuit 180 to 650 meters.

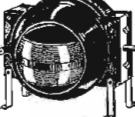

RADIO INDUCTANCE COILS
Carefully made—fine looking coils. Highest efficiency. Low distributed capacity effect. Low resistance—high self inductance. Very firm impregnation. Range given is in meters when used with .001 variable condenser. Mounted coils have standard plug mountings.



Turns	Range	Art No.	Not Mtd.	Art No.	Mtd.
25	120-250	P301	\$2.25	P320	\$7.75
35	175-450	P302	.30	P322	.90
50	250-720	P303	.32	P323	.96
75	390-910	P304	.37	P324	1.02
100	500-1450	P305	.52	P325	1.07
150	600-2000	P306	.57	P326	1.11
200	900-2500	P307	.66	P327	1.20
250	1200-3500	P308	.72	P328	1.23
300	1500-5000	P309	.76	P329	1.30
400	2000-5000	P310	.91	P330	1.51
500	2800-6100	P311	1.06	P331	1.57
600	4000-10000	P312	1.20	P332	1.72
750	5000-12000	P313	1.36	P333	1.87
1000	7900-15000	P314	1.64	P334	2.18
1250	9750-19500	P315	1.86	P335	2.35
1500	14500-26500	P316	2.11	P336	2.50

INDUCTANCE COIL MOUNTINGS
P340—5 Coil. . . . \$3.35
P341—2 Coil. . . . Each 2.67
Sturdy, rigid durable construction. Made of polished black bakelite.

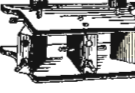

BACK OF PANEL MOUNTING
Mounts back of panel, with knobs or dials on front of panel. Helps make a neat efficient set. P342—Each. . . . \$4.45

COIL MOUNTING PLUGS
Moulded of genuine bakelite. P344 Plug for mounting "honeycomb" inductance coil. . . . 36c
P345 Stationary plug to fasten mounted coil stationary to panel. . . . 42c



SPIDER WEB COILS
P290—25 turn 39c P292—50 turn 47c
P291—35 turn 42c P293—75 turn 54c
P294—100 turn. Each. . . . 68c
A new popular type of inductance of highest efficiency. Lowest distributed capacity and lowest high frequency resistance. Firm green silk windings with fibre mounting strips.

YOU SAVE MONEY WHEN YOU BUY FROM US
We Pay Transportation Charges East of the Rockies
THE PRICES QUOTED DELIVER THE GOODS TO YOUR DOOR
FAST SERVICE—TRY US AND BE CONVINCED
THIS GUARANTEE PROTECTS YOU—Examine the goods we ship you. They must suit you in every respect. If you are not satisfied with your purchase return the goods at once and we will refund the price you paid.

OUR SPECIAL VARIOMETER AND VARIOCOUPLER
Build into your set reliable instruments. You can depend on this variometer and variocoupler to give you the best results in any circuit working from 180 to 650 meters. In design and construction they are the best. Only the highest grade materials are used. The prices quoted save you 30 to 40 per cent. Why pay more?
P418 Variocoupler. Each. . . . \$2.45
The most efficient type of coupler, insures better tuning and louder signals. Primary and secondary wound on natural uncolored genuine bakelite tubes. Handsome green silk windings. Primary tapped for fine tuning. Can be panel or table mounted. 3/16 inch shaft.
P410 Variometer. Each. . . . \$2.10
Perfect in design and construction. Accurate wood forms thoroughly seasoned. Correct inductive ratios. Solid baked windings. Plenty of large sized wire insures highest efficiency. A strong high grade instrument that will give you lasting service, 3/16 inch shaft.

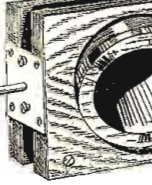

SOLID BARE COPPER WIRE
Solid bare copper wire for aerials, leads or wiring instruments.
Solid Bare Copper Wire, size 14. . . .
P240 100 ft. coil. . . . 48c
P242 500 ft. coil. . . . \$2.25
Solid Bare Copper Wire, Size 12. . . .
P244 100' coil 67c P245 500' coil \$3.05

STRANDED ANTENNA WIRE
Cabled of fine copper strands. Very flexible. High tensile strength. Best for aerials.
P248 100' coil 58c P249 500' coil \$2.75

MAGNET WIRE
Insulated copper wire. Best quality even drawn wire, one piece to a spool. Prices quoted are for 3 oz. spools unless otherwise stated. Note, our prices are prepaid.
Double Cotton Covered Enameled Insulation Green Silk-Covered
Number P990 Number P992 Number P991
Gauge Price Gauge Price Gauge Price
18 39c 20 35c 20 \$0.75
20 48c 22 45c 2290
22 60c 24 50c 24 1.05
24 65c 26 55c 26 1.15
26 80c 30 60c 30 (4oz.) . . . 1.80
28 95c 32 65c 32 (4oz.) . . . 1.00
30 \$1.15 36 85c 36 (4oz.) . . . 1.30

ANTENNA INSULATORS
P260 Size 1x3 1/4. Composition, metal eyelets. Two for 17c
P263 Ribbed Porcelain insulator, 2 1/2 in. long. Ea. 6c Dozen 55c
P265 Ribbed porcelain insulator—5 inches long. Each 15c

LEAD-IN INSULATORS
P270 For 4 inch walls or less. . . . 42c
P271 For 9 inch walls or less. . . . 69c
The only practical lead-in insulator for aerial wires. Small, neat, effective, durable. Fits 1/8 inch hole. Securely locked by two adjustable nuts.
OUTDOOR LIGHTNING ARRESTER
P980 Price \$1.55
Protect your instruments with this lightning arrester. Weatherproof porcelain case. Air gap type. Permanent. Durable. Underwriters approved.

JEWELL LIGHTNING ARRESTER
P981 Each 85c
A dependable protector, always on guard. Small and compact. Weatherproof porcelain case. Easily fastened and connected. Underwriters approved. Lists for \$1.10.

PANEL MOUNTING VARIABLE CONDENSERS
These are especially high grade condensers and we guarantee them to be mechanically and electrically perfect. Fine polished end plates of heavy bakelite. Shafts 1/4 inch diameter. Sturdy, heavy aluminum alloy plates perfectly spaced to insure smooth, even, reliable capacity. Our low prices save you money. These condensers are of the very best make and are not to be compared with many inferior, cheap condensers offered. We guarantee them to please you or your money back. The vernier style has one separately controlled plate which permits of the finest tuning. Quality considered, these values are unapproached by others.
REGULAR STYLE
P815—3 plate 58c
P816—5 plate 97c
P814—11 plate .00025 mfd. . . . \$1.13
P813—31 plate .0005 mfd. . . . 1.27
P812—43 plate .001 mfd. . . . 1.47
VERNIER STYLE
Including Dial and Knobs
P825—14 plate .00025 mfd. . . . \$2.45
P826—26 plate .0005 mfd. . . . 2.70
P826—46 plate .001 mfd. . . . 2.95

COPPER FOIL
P988 Per piece 25c
Thin copper foil for shielding panels. 6 inches wide, 2 feet long. .005 in. thick.
RADIO SOLDERING IRON
P540 . . . \$1.50
Soldered connections in radio sets produce better results. This guaranteed iron is exactly right for radio work. A neat solid connection quickly and easily made. Operates on any lighting current 100 to 250 volts. 6 ft. cord with attaching plug. Length 13 inches. Heats quickly, will not overheat.
Heavier irons for general repair work. Wonderful values at our prices.
P541 Medium size \$3.48
P542 Large size 4.25

ENCLOSED VARIABLE CONDENSERS
One of the best made condensers. Rigid, accurately spaced aluminum plates. Formica ends. Engraved scale. Knob and pointer. Clear transparent case.
P806 43 plate .001 Mid. . . . \$2.80
P808 21 plate .0005 Mfd. . . . 2.45

INDUCTANCE COIL MOUNTINGS
P340—5 Coil. . . . \$3.35
P341—2 Coil. . . . Each 2.67
Sturdy, rigid durable construction. Made of polished black bakelite.

REGULAR STYLE
P815—3 plate 58c
P816—5 plate 97c
P814—11 plate .00025 mfd. . . . \$1.13
P813—31 plate .0005 mfd. . . . 1.27
P812—43 plate .001 mfd. . . . 1.47
VERNIER STYLE
Including Dial and Knobs
P825—14 plate .00025 mfd. . . . \$2.45
P826—26 plate .0005 mfd. . . . 2.70
P826—46 plate .001 mfd. . . . 2.95

OUR SPECIAL AUDIO FREQUENCY AMPLIFYING TRANSFORMERS
P550 Each \$2.25
In quality of tone and volume of sound, the things a transformer is built for we guarantee it to equal or surpass any other transformer. Neat in appearance. Carefully made. Fully mounted with plainly marked binding post connections. Wonderful results on one, two or three steps without distortion or howling. A quality item in every respect.

NATIONAL SHIELDED TRANSFORMER
P551 3 1/2 to 1 Ratio. \$2.48
P552 5 to 1 Ratio. . . . 2.68
Note that our price is prepaid. The same high grade style of transformer as above enclosed in a metal case which completely shields it from any outside magnetic influences. Free from howling and local disturbances.

OTHER STANDARD BRANDS AUDIO FREQUENCY TRANSFORMERS
Fresh clean stock in original containers.
P232 THORADSON Ratio 3 1/2 to 1 \$3.30
P233 THORADSON Ratio 6 to 1. 3.70
P553 Acme. Each 4.20
P554 Coto. Each 4.45
P555 Federal. Each 4.45
P712 Radio Corp. Each 5.70
P234 All American 10 to 1 Shielded 3.80
P235 All American 5 to 1 Shielded 3.60
P230 All American 3 to 1 Shielded 3.60

TRICOIL RADIO FREQUENCY AMPLIFYING TRANSFORMER
P500 For 201A or 301A
Tubes \$1.58
P561 For 199 or 11 or 12
Tubes 1.58
This transformer will produce wonderful results in any type of regular or reflex radio frequency circuit. Perfect for one, two or three stages. Compact, convenient form, easily mounted. Range 175 to 600 meters.

OTHER STANDARD BRANDS RADIO FREQUENCY TRANSFORMERS
P568 Our special—as good as any of them \$.48
P502 Dubilier. Each 4.45
P563 Coto. Each 4.45
P565 Acme. First stage. Each 4.45
P566 Acme. Second stage. Each 4.45
P567 Acme. Third stage. Each 4.45
P714 Radio Corp. Each 5.95
P995 All American. Each 3.95
P575 Erla. First stage. Each 3.45
P576 Erla. Second stage. Each 3.45
P577 Erla. Third stage. Each 3.45
P578 Erla. Reflex No. 1, 2 or 3. Ea. 4.35

LONG NOSE PLIERS
P870 Price. 95c
The handiest pliers for radio work. Made of fine hardened steel. Length, 5 in.
DIAGONAL JAW NIPPERS
P972 Price. . . . 95c
For fine electrical work. Made of hardened steel. Length, 5 inches.

FOUR IN-ONE Screw-Driver
P974 Each 55c
Especially suitable for radio work. Will handle any size screw used. Smaller drivers nest inside larger one and are held in place with screw cap. Made of steel, nickel finished.

TINOL
P969 Per tube. . . . 19c
A combined solder and flux in handy form. Put a little on the connection, heat with a match, torch or solder iron and you have a neat electrically and mechanically perfect joint.

AUTOMATIC BLOW TORCH
P543 Each \$1.19
Burns denatured alcohol. Automatically generates pointed flame in a few seconds. Easy to solder joints in hard places. Lights with a match. Burns 20 minutes on one filling. 5 1/2 inches high, 7/8 inch diameter cylinder. Works fine with Tinol listed above.

SUPER BLOW TORCH
P544 Each 39c
Burns denatured alcohol. Vest pocket size. Blowing on tube produces a hot pointed flame. Lights with a match. Works fast. Burns 10 minutes on one filling. Easy to solder joints in hard places 3 in. high. 7/8 in. cylinder. Long rubber tube. Produces fine joints with Tinol listed above.

WITH BARAWIK QUALITY RADIO GOODS

VACUUM TUBES

Standard Brands—Cunningham, Radiotron. Every one guaranteed new and perfect. We will ship brand stock unless you specify otherwise.

P105 Detector UV200 C300 Each \$4.18
 P112 Amplifier, UV201 AC301A Each 4.18
 P118 5-Watt Transmitter. 7.70
 P107 WD11 A1. Each. 4.18
 P104 WD11-C12. Each. 4.18
 P102 UV199 C208. Each. 4.18
 P104 UV199 Adapter fits 199 tube to standard socket.39
 P108 WD11 Socket. Each. 31
 P109 WD11 Adapter. Each. 45

BAKELITE TUBE SOCKET

P140 Standard base. .39c
 P141 UV199 base. .39c

Moulded of genuine red brown bakelite. Binding post connections. For table or panel mounting. Neat and strong.

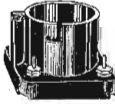

199 SOCKET

P145 Each.59c

Moulded of high insulating material. Sponge rubber base prevents ringing in tube. Plainly marked binding post connections. Neat and compact.



STANDARD TUBE SOCKET

P150 Each.76c

Bakelite base. Polished nickel plated tube. Highest quality socket on the market. Best insulation. Positive contact. Marked terminals. For base or panel mounting.



FILAMENT CONTROL RHEOSTATS

P132 6 ohm. Each.38c
 P129 20 ohm. Each.40c
 P131 30 ohm. Each.44c
 P135 6 ohm Vernier.95c

Best grade. Will give real service. Durable and lasting. High heat resisting base, diam. 2 1/4" in. Tapered polished black knob 1 1/4" diam. Potentiometers. Match above rheostats. Same high grade construction.

P151 200 ohm. Each.50c
 P152 400 ohm. Each.55c

OTHER STANDARD BRAND RHEOSTATS AND POTENTIOMETERS

P207 Filkostat. Each. \$1.90
 P208 Bradleystat. Each. 1.74
 P209 Bradleymeter 200 ohm. Each 1.89
 P210 Bradleymeter 400 ohm. Each 2.89
 P211 Howard 6 ohm Plain Rheo. Ea. .85
 P212 Howard 6 ohm Ver. Rheo. Ea. 1.25
 P213 Howard 25 ohm Plain Rheo. Ea. .85
 P214 Howard 25 ohm Ver. Rheo. Ea. 1.25
 P215 Howard 40 ohm Plain Rheo. Ea. .85
 P218 Howard 40 ohm Ver. Rheo. Ea. 1.25
 P217 Howard 20 ohm Potentiometers. Each. 1.25
 P218 Howard 400 ohm Potentiometers. Each. 1.69
 P219 Klossner 6 ohm Vernier. Each 1.19
 P221 Klossner 30 ohm Vernier. Each 1.45
 P222 Amerite with mounting.95

SUPERIOR RHEOSTATS

P153 6 ohm. Each.69c
 P154 20 ohm. Each.76c
 P155 30 ohm. Each.83c

The finest rheostat. Smooth, even action. Best design, best workmanship. Supplied with attractive dial and knob. Potentiometers to match above rheostats with dial and knob.

P156 30 ohm.98c

QUICK ACTING RHEOSTAT

P124 6 ohm. Each.79c
 P125 15 ohm. Each.88c
 P126 30 ohm. Each.99c

Vernier adjustment at every degree of resistance. Pushing knob in turns off the filament.



COMPOSITION DIALS

P921 Diam. 2 in. for 3-16 in. shaft. Ea. 16c
 P922 Diam. 2 in. for 1/4 in. shaft. Ea. 16c
 P923 Diam. 3 in. for 3-16 in. shaft. Ea. 22c
 P924 Diam. 3 in. for 1/4 in. shaft. Ea. 22c
 P925 Diam. 3 3/8 in. for 1/4 in. shaft. Ea. 27c

Handsome dial moulded in one piece of polished black composition. 2 inch size has 270° scale marked 0 to 100 finely engraved in contrasting white enamel. 3 inch size has 180° scale marked 0 to 100.

BAKELITE DIALS

P931—2 in. Diam. for 3-16 in. shaft. Each. .35c
 P932—2 in. Diam. for 1/4 in. shaft. Each.35c
 P933—3 in. Diam. for 3-16 in. shaft. Each. .39c
 P934—3 in. Diam. for 1/4 in. shaft. Each.39c
 P935—4 in. Diam. for 1/4 in. shaft. Ea. .48c

Moulded in one piece of genuine bakelite in polished black finish. Finely engraved scale in contrasting white enamel. Sure grip knob that fits the fingers. Higher grade dials for good sets. Match perfectly.

VERNIER DIAL ADJUSTER

P941 Each.19c

Easily installed at edge of dial, gives finest vernier adjustment of condenser or inductance. A great value. Polished black knob.



WE PAY TRANSPORTATION CHARGES East of the Rockies

RESERVE THESE PAGES—ORDER FROM THEM AND SAVE MONEY
 FAST SERVICE—TRY US AND BE CONVINCED
 THE PRICES QUOTED DELIVER THE GOODS TO YOUR DOOR
 OUR GUARANTEE PROTECTS YOU—We handle only the best goods, carefully tested and checked by expert radio engineers. You are assured of getting guaranteed apparatus that will give superior results. And while our goods are best, our prices are lowest. Our goods equal or surpass the claims we make for them. We do not attempt to deceive or mislead. Our reputation for fair dealing is our most valued asset.

HOW TO ORDER—Write your Order plainly, state Article Number, Description and Price of items wanted. Send Postoffice or Express Money Order, Certified Check or Bank Draft for Total of Order. Prompt Shipment is assured when these directions are followed.

ENCLOSED DETECTOR

One of the finest crystal detectors on the market, supersensitive galena crystal enclosed in heavy glass shield. Quick, positive adjustment. Brass parts polished nickel finish.

P730 Each.89c



GALENA DETECTOR

Easy fine adjustment. Crystal mounted in cup. Moulded base and knob. Brass parts polished nickel finish. An unequalled value.

P732 Each.59c



DETECTOR CRYSTALS

P736 Galena, Arlington tested, piece 19c
 P738 Silicon, Arlington tested, piece 19c
 P735 Tested, Galena, Mounted, piece 9c
 P737 Tested, Silicon, per piece. 9c
 P739 Genuine million point crystal. Ea. 29c

STANDARD BRAND FIXED CRYSTAL DETECTORS

The latest development in Crystal Detectors. Give better results and more reliable than old style. Used in Reflex circuits.

P742 Grevol Detector. Each. \$1.48
 P743—B Metal Detector. Each. 1.39
 P744 B Metal Crystal. Each.45
 P741 Gold Gratin Detector. Each.63
 P745 Yellow Tip Detector. Each. 1.79
 P746—Du-Tec Crystal. Each.27

SUPERIOR VARIABLE GRID RESISTANCE

P167 Each.80c
 P168 With .00025 Condenser.98c

Eliminates hissing, clarifies signals. Capacity smoothly varied from 0 to 6 megohms by half turn of knob. Easily mounted on any panel.

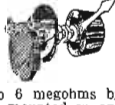

TUBULAR GRID LEAKS AND CONDENSERS

Very convenient. Permit of quick change of leaks or condensers of varying capacity. Cut shows leak mounted. Leaks and condensers have same appearance. Each part priced separately.

P849 Grid Leak, Each.15c
 Resistances—1/2, 1, 1 1/2, 2, 3, 5, 7, and 10 megohms. Specify which size is wanted.

P831 Grid and Plate Condensers. Ea. 39c
 Capacities .00025, .0001, .00025, .0005 mfd. Specify which size is wanted.

STANDARD BRAND VARIABLE GRID LEAKS

P177 Freshman back of panel style.59c
 P178 Freshman back of panel style with .00025 Condenser 79c
 P171 Freshman base mounting type with .00025 Condenser. 79c
 P172 Durham Variable Grid Leak with mounting.89c
 P173 C.R.L. Variable Grid Leak. \$1.19
 P175 C.R.L. Variable Grid Leak with grid condenser. \$1.48

FRESHMAN MICA CONDENSERS

P512 .00025 mfd. 26c
 P513 .0005 mfd. 26c
 P514 .001 mfd. 31c
 P515 .002 mfd. 31c
 P516 .006 mfd. 60c
 P517 .01 mfd. 80c



DUBILIER MICADON TYPE 601

P502 .001.28c P507 .0025.32c
 P503 .0025.28c P508 .003.40c
 P504 .005.28c P509 .005.40c
 P505 .001.32c P510 .005.48c
 P506 .002.32c P511 .006.60c

BARAWIK QUALITY HEADSETS

P770 Per Set. 2000 ohms. \$2.98

These headsets have proven on rigid tests to be one of the very best on the market. The tone quality is excellent with an unusual volume. Skilled workmen make them from only the best selected materials. The receiver cases are fine polished finish with polished black ear pieces. Fabric covered head band comfortably and quickly fitted to the head. Supplied with 5-foot cord. These sets were designed to sell for much higher prices than we ask, and at our price are a wonderful bargain. We guarantee that you will be pleased with them and agree that they are the best value by far yet offered. If they don't suit you we will cheerfully return your money.

STANDARD BRAND HEADSETS

P754 Baldwin Type C with universal jack plug \$10.45 P764 Frost, 2000 ohm \$3.30
 P758 Western Electric \$9.50 P766 Frost, 3000 ohm \$3.95
 P756 Red-Head, 3000 ohm. \$5.78 P757 Murdock 58, 2000 ohm. \$3.25
 P768 Brandes, 2000 ohm. \$1.90 P752 Murdock 58, 3000 ohm. \$3.90
 P769 Brandes, 3000 ohm. \$6.75 P759 Dictograph Aristocrat. \$6.60



PLATE CIRCUIT "B" BATTERIES

You can make real savings on these batteries. We guarantee them to equal any on the market regardless of price. Extra long life. Don't throw away your money on cheaper inferior useless batteries.

P180 Signal Corps type, small size. 15 cells, 22 1/2 volts. Each. \$1.10
 P182 Large size, 5 taps 16 1/2, 18, 19 1/2, 21 and 22 volts. Each. \$1.45
 P184 Variable Large Navy size, 16 1/2 x 4 x 3 inches, 5 taps, giving range from 16 1/2 to 22 1/2 volts in 1 1/2 volt steps. Each. . . \$1.95
 P188 Combination Tapped 45 volts, 30 cell, 13x4x3 battery. Tapped to give 45, 22 1/2, 21, 19 1/2, 18 and 16 1/2 volts. Handles both detector and amplifier tubes. Ea. \$3.28



"B" BATTERY METER

P189 Each.98c

Reads 0 to 50 volts. Accurately tells you the exact condition of your "B" Battery. Convenient watch size. Polished nickel case with wire lead.



STORAGE "A" BATTERY

A high grade battery. Guaranteed for three years. Made of best new materials. Full capacity. The best battery buy on the market. Try one of these batteries on your set for 10 days. If at the end of that time you are not fully satisfied with the battery return it and we will refund the purchase price.

P194 6 volt, 40-80 amp. size. Ea. \$ 9.90
 P196 6 volt, 80-120 amp. size. Ea. \$13.25

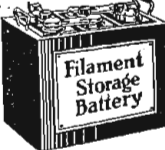

HOMECHARGER BATTERY CHARGING RECTIFIER

Charge your battery at home overnight for a few cents. Simply connect to any 110 volt 60 cycle light socket, turn on current and rectifier does the rest automatically. Will work for years without attention. Simple connections. Give a full charge which batteries should have. You can make it pay a profit charging your friends' auto batteries. Long connecting cords with pair of battery clips.

P201 For 6 volt battery. \$12.95
 P203 For 12 volt battery. 12.95



HYDROMETER

P190 Each.48c

Accurately tells you the condition of your storage battery. Helps you keep your battery in better condition.

BATTERY CLIPS

P198 Two for.28c

Clip onto storage battery terminals, lead coated. Make positive non-corrosive contact at all times.



WIRE CONNECTING CLIPS

P199 Per dozen.30c

Small connecting clips for quickly fastening leads on to binding posts, etc. Handy and useful. Every radiolist should have at least a dozen.



MELOTONE LOUD SPEAKER

P611 Price \$4.85

One of the best popular priced speakers. Talks loud and clear. Compares favorably with more expensive ones. Fibrous horn. Heavy metal base. Five foot cord. Nickel plated goose neck. 6 1/2 in. bell. Size over all 14 1/2".



STANDARD BRAND LOUD SPEAKERS AND UNITS

P610 Murdock Loudspeaker. \$4.38
 P613 Barawik with Baldwin unit. 9.75
 P615 Pathe Loudspeaker. 15.95
 P616 Atlas Loudspeaker. 22.50
 P612 Magnavox M1 Loudspeaker. 29.50
 P614 Magnavox M1 Loudspeaker. 29.50
 P617 Music Master Loudspeaker. 27.00
 P755 Genuine Baldwin type C unit 5.10
 P619 Murdock Special Unit. 2.60
 P618 Brandes Table Talker. 8.75
 P620 Baldwin Loud Speaker. 22.50
 P609 Dictograph Dictogrand. 21.50
 P608 Atlas Unit. Each. 10.75
 P607 Western Electric Unit. Each. 10.75

PHONODAPTER

P771 Each.39c

The Phonodapter will fit any phone. Metal tube fits any standard phonograph. Make your phonograph a loud talker. Fits Columbia, Victor and Sonora phonographs. Made entirely of pure soft rubber with brass tube insert.



Noiseless - Permanent
 1/4 to 10 Megohms



E. T. FLEWELLING

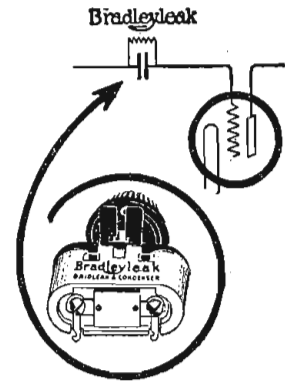

Retail Price
\$1 85
 Condenser
 .00025 MF
 35¢ Extra

“The Bradleyleak is the best
 Grid Leak I have tried”
 - SAYS FLEWELLING -

E. T. Flewelling, inventor of the famous Flewelling circuit, recently tested a number of Bradleyleaks in his laboratory and after a thorough test writes as follows:

“The radio market has been sorely in need of apparatus of such a high type as the Bradleyleak, and I feel that you are to be congratulated because of the action of this grid leak as shown under test. I do not hesitate to say that, so far as my tests are concerned, *it is the best grid leak that I have tried* and the only leak that comes anywhere near approaching the ideal. It is a high-grade piece of apparatus in every respect and I am only too glad to congratulate you again.”

The Bradleyleak is the result of 20 years' experience in the manufacture of graphite disc rheostats. It contains no carbon or metallic powder. *It is distinctly a disc rheostat.* A smooth range from 1/4 to 10 megohms is obtainable without steps or jumps by simply turning the adjusting knob. The Crosley laboratory found it unaffected by atmospheric conditions.

Many of the new circuits, such as the Flewelling or other highly-selective circuits, work best when equipped with the Bradleyleak. Try one on your radio set and you will be amazed with the improved operation.

Mail this Coupon — Today!

ALLEN-BRADLEY CO.
 287 Greenfield Ave., Milwaukee, Wis.

Please send me your folder describing the Bradleyleak and its construction.

Name

Address

Allen-Bradley Co
 Electric Controlling Apparatus

287 Greenfield Ave. Milwaukee, Wisconsin



Manufacturers of graphite compression rheostats for over 20 years.

Is Your Grid Leak Correct?

The following table gives the approximate values of grid leak resistance recommended by vacuum tube manufacturers:

Audion(DeForest) DV-6,	2 Megohms
C-200	2 Megohms
C-299	2 to 5 Megohms
C-301-A	2 Megohms
UV-199	2 to 5 Megohms
UV-200	2 Megohms
UV-201-A	2 Megohms
WD-11	3 Megohms, or more
WD-12	3 Megohms, or more



EDITORIAL AND GENERAL OFFICES, 53 PARK PLACE, NEW YORK

Vol. 5

MARCH, 1924

No. 9

Future Developments of Radio

By H. GERNSBACK

STRANGE as it may seem, there are still many people who have an idea that radio is only a fad, and that it will not last—all this, in spite of the fact that the industry during the last two years has leaped from an annual turnover of approximately \$8,000,000 to about \$200,000,000 per year. These same doubters do not seem to appreciate the fact that radio is well on the road to becoming one of the 10 leading industries in our country. There are many well-wishers, however, who believe that it will soon be on the same level as the automobile industry is today.

We hear, on all sides, the cry that radio cannot last because it is not built upon a solid economic foundation. The argument is that the entire radio industry is founded upon broadcasting—which, of course, is true. The line of reasoning then is, that sooner or later the broadcast stations will find that it does not pay them to broadcast entertainments free, and that they will eventually shut down. And naturally, if that does happen (so the critics say), the entire industry will go up in smoke. They even go so far as to make analogies with the automobile industry, claiming that it would be just as logical for an automobile manufacturer to sell a car to his customer and then provide him with free gasoline.

The trouble with these pessimists is that they preach only half (or near) truths. In the first place, there is no parallel between the radio industry and any other industry, (this the writer has pointed out in his editorials for the past 15 years), just as there is no parallel for the motion picture industry. The two are distinctly new thoughts on this planet. They never existed before.

The "Doubting Thomases" may rest assured that if there should at any time arise a threat, or even a near threat, to do away with free broadcasting, the industry will then rise to the occasion and meet that emergency. Of course, there are some people who claim that broadcasting should be paid for by a Federal tax. Personally, the writer does not believe in any such measure. He is of the opinion that this would be the worst blow that could be dealt the industry at this time.

Broadcasting, as it is carried on in America today, is distinctly an American institution. It is founded upon a broad and human basis. That the policy is right has been proven by the extraordinary, as well as the tremendous growth of radio in this country. If any argument were necessary, we would only need to point to England, France, Germany, Australia and other countries, which have recently taken up radio in conjunction with a Governmental tax. What is the result? The industry has been seriously stifled.

Take the second greatest country, from the standpoint of the radio industry—England. What is the situation there? The percentage of stations, as compared to the United States, is very small, that is, licensed stations which pay a tax to the Government. On the other hand, so-called "bootleg" stations, i. e., those which operate without paying a tax, are said to be so great in number as to constitute a scandal.

No, we do not believe that broadcasting should be regulated by a Federal tax. We believe that in due time the radio industry will solve the problem, if it threatens to become serious. Probably in time most stations will derive revenue from indirect advertising, as does station WEAJ of New York City. This station, which is classed as a commercial station, furnishes excellent entertainment, nearly all of which is paid for by indirect advertising; and the publicity given the various firms renting this station by the hour or by the evening has, so far, not proven objectionable.

No listener-in, for instance, objects to the announcer when he says: "You will now hear the Jones & Jones Department Store Band," or "The Male Quartette of the John Doe Garter Company will now broadcast a selection". In deriving a monetary benefit from the indirect advertising the broadcast station will be enabled to enlist better talent than those stations without this means of support. All in all, we feel certain that the radio industry is built upon a stable foundation, and that it will continue to grow rapidly.

We must now speak of the next set of doubters, those who dis-

courage their acquaintances from buying radio sets. The argument in this case is that the prospective radio fan should wait for a while, as the sets at present are not the best that can be had and will soon be superseded by better ones. Of course, this is a perfectly good argument, though foolish. Moreover, it is true that if the first motion picture attendants had been given this advice, we would not today have good pictures; and if we had not bought the first squeaky, unmanageable phonographs, we would not have good phonographs today; and if we had not patronized the makers of the first horseless carriages that puffed along the road and stopped more often than they ran, we would not be riding in limousines today.

With all our progress, we still have, practically every year, new model phonographs, new and better automobiles, as well as airplanes, and we will have them for many years to come. The same thing holds true of our present radio outfits. We will have new models every year for many years to come. The outfits we have today are tolerably good ones, and all those made by reputable manufacturers will be found to do the work as advertised. To be sure, we still have a good deal of poor merchandise with us, but no reputable dealer will carry it. Aside from all this, there are really excellent radio outfits on the market today which no one need be ashamed to own. All these sets perform well and give the entertainment for which they were designed. So why wait?

While speaking of next year's set or perhaps of the radio outfit of five years hence, the writer would like to put a thought into the minds of our designers.

There was a time when there were no complete radio outfits. We bought the different parts, such as a loose coupler, detector and condenser, and assembled them on a board. There was no such thing in those days as a graduated dial. Then someone conceived the idea of putting all the apparatus into a box. The apparatus was then controlled by means of knobs and graduated dials. We have stuck to this idea for a number of years, but the writer feels that this is not the ultimate radio outfit. *He believes that the dial and knob idea is entirely wrong.*

Recent experiments, which were made by the writer, have convinced him that future radio sets will have no dials whatsoever. Instead, we will have nothing but a panel on which will be a series of jacks, each labeled with the name of a station. If, for instance, we wish to listen to KYW, we will insert a plug into a jack labeled KYW. If we wish to listen to WDAP, we will insert a plug into that jack. The plugs will be constructed in such a way that a slight turning of one will bring the station in to full intensity. The plug, in other words, will act as a sort of vernier. When the outfit is first set up it will be tuned by the owner or by the firm installing it, in such a manner that all tuning elements are fixed, or rather locked. Each outfit will be equipped with a dozen or more jacks, so that a dozen or more stations may be listened to. The owner will first pick out the stations, local or long distance, which he desires to listen to, and he will then provide his jack-openings with inscribed tags, identifying each one. It will then be a simple matter for any member of the family to instantly operate the outfit.

Of course, the writer is well aware of the criticism which will now arise. What about other DX stations we may wish to get? The answer to this is: If you wish to play radio golf, there are a quantity of outfits with which that purpose can be accomplished. There is no reason why a man could not have two outfits, one for the family and one for his experimental work. But the argument for the dial-less, tuning-less radio outfit is a sound one. After all, the lady of the house has a right to have radio entertainment without requiring an expert to operate the set.

At the present time, the writer ventures to say that there are not 1,000 women in the United States who can operate the family radio outfit satisfactorily. Radio cannot become really great until this objection has been overcome. As a matter of fact, if the truth must be known, the average householder who wants a radio outfit does not wish to go hunting all over the Universe for broadcast stations.

Recent Novelties in Thermionic Tubes for Radio Work

By J. A. FLEMING, M.A., D.Sc., F.R.S.

PART I

Dr. J. A. Fleming was the pioneer inventor in connection with the electron tube or valve for radio reception. He has been for 38 years Professor of Electrical Engineering in University College, London, and is the author of 20 text books on electricity which have a worldwide circulation, and of nearly 100 scientific papers in the transactions of various learned societies. He is 74 years of age and has been closely and practically connected with the early work in three great inventions, viz., the telephone, electric lighting and radio telegraphy. He is regarded as an authority on the historical and scientific side of these important advances.



Dr. J. A. Fleming, F.R.S.

THE development of the electron tube, or thermionic valve, as it is called in Great Britain, is one of the fairy tales of science. It is an extraordinary testimony to the power of patient scientific investigation that inventors should have been able to harness the smallest thing in the physical universe, the electron, and through it make the transmission of speech, without wires, across the Atlantic Ocean almost an every day affair.

We are not yet nearly at the end of the wonders which this electron emission from various substances will enable us to achieve and the thermionic valve, even in its original two-electrode form, is destined to become an engineering appliance of the very greatest importance.

There are three ways in which the electron emission necessary for this purpose can be produced, viz., by the action of heat on refractory or infusible metals or carbon, by the action of light on certain metals called photo-sensitive and by the spontaneous breaking up of the atoms of certain elements called radio-active.

We now have reason to believe that the atoms of material substances—which we can handle and weigh—are structures built up solely of small indivisible particles of positive and negative electricity called protons and electrons. In fact, there is nothing but electricity in this ultra-atomic form in the physical universe. The physical atom comprises a nucleus which is a very robust structure built up of protons or atoms of positive electricity, and electrons or atoms of negative electricity, the former predominating in number. Around this nucleus a number of negative electrons called the

planetary electrons circulate in orbits and some of these are very easily flung off or detached.

APPEARANCE OF AN ATOM

We might picture to ourselves the appearance of an atom of matter say of copper or tungsten by imagining a bunch of grapes, the bunch being composed of white and black grapes intermingled. This may be considered to represent the nucleus of the atom. At distances varying from a few hundred yards to a mile or more, suppose single black grapes to be moving in various rings or orbits. These would represent the planetary electrons. The over-all bulk of the chemical atom is thus very large compared with the size of the single electron, in fact, it is about 100,000 times larger in diameter.

In metals which are good conductors of electricity and in those which are called the electropositive metals such as zinc, potassium, sodium, etc., planetary electrons easily become detached from atoms and hence in a wire of such metal we have free electrons intermingled with the atoms of the metal and these free electrons are flying hither and thither between the atoms with great speed.

When a wire—such as a Tungsten wire—is heated to a high temperature by passing an electric current through it, the free electrons are made to move all together in one direction. The resulting collisions of these wandering free electrons with the atoms increase their irregular motions, and thus cause the heat produced by the current.

If the irregular motion of the free electrons is increased beyond a certain limit, some of them may be flung out of the surface of the wire. This produces the electron or thermionic emission, so called because it is produced by heat.

OTHER METALS' EMISSIONS

On the other hand, there are other metals such as rubidium, potassium and sodium which emit electrons without heating and merely by allowing light, especially light at the violet end of the spectrum to fall upon them.

Finally there are other metals, notably radium, uranium, and thorium which emit electrons freely without being either heated or illuminated.

It has been found that if we form an alloy of some of these radio active materials with others which have a high melting point, the result is to give us a material which has very great power of thermionic emission. It has been found that an alloy formed of tungsten and thorium has very remarkable electron emission powers when heated in a vacuum. This alloy is prepared by mixing oxide of thorium or nitrate of thorium with the trioxide of tungsten before reduction by hydrogen to the metallic state. After this, it is drawn into wire through diamond dies. (See Fig. 1.) The wire is then subjected to a particular heat treatment wherein it is raised to a temperature between 2,200 and 2,300 degrees absolute temperature—that is, temperature measured from the absolute zero which is 273 degrees below zero Centigrade. The thorium then makes its way to the surface and forms a kind of skin of thorium atoms on the tungsten wire. Wires so prepared for filaments of thermionic valves or electron tubes are called thoriated filaments. A fundamental U. S. A. patent (No. 1,244,216) in connection with them was issued to Irving Langmuir. It was applied for July 15, 1914.

These thoriated filaments give off electrons very copiously at temperatures far below that at which pure tungsten gives an

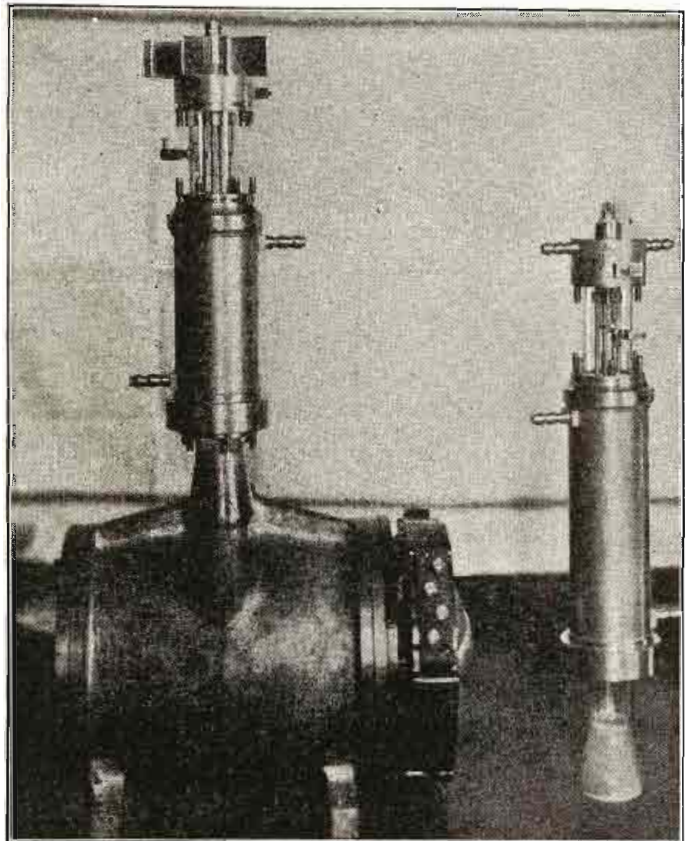
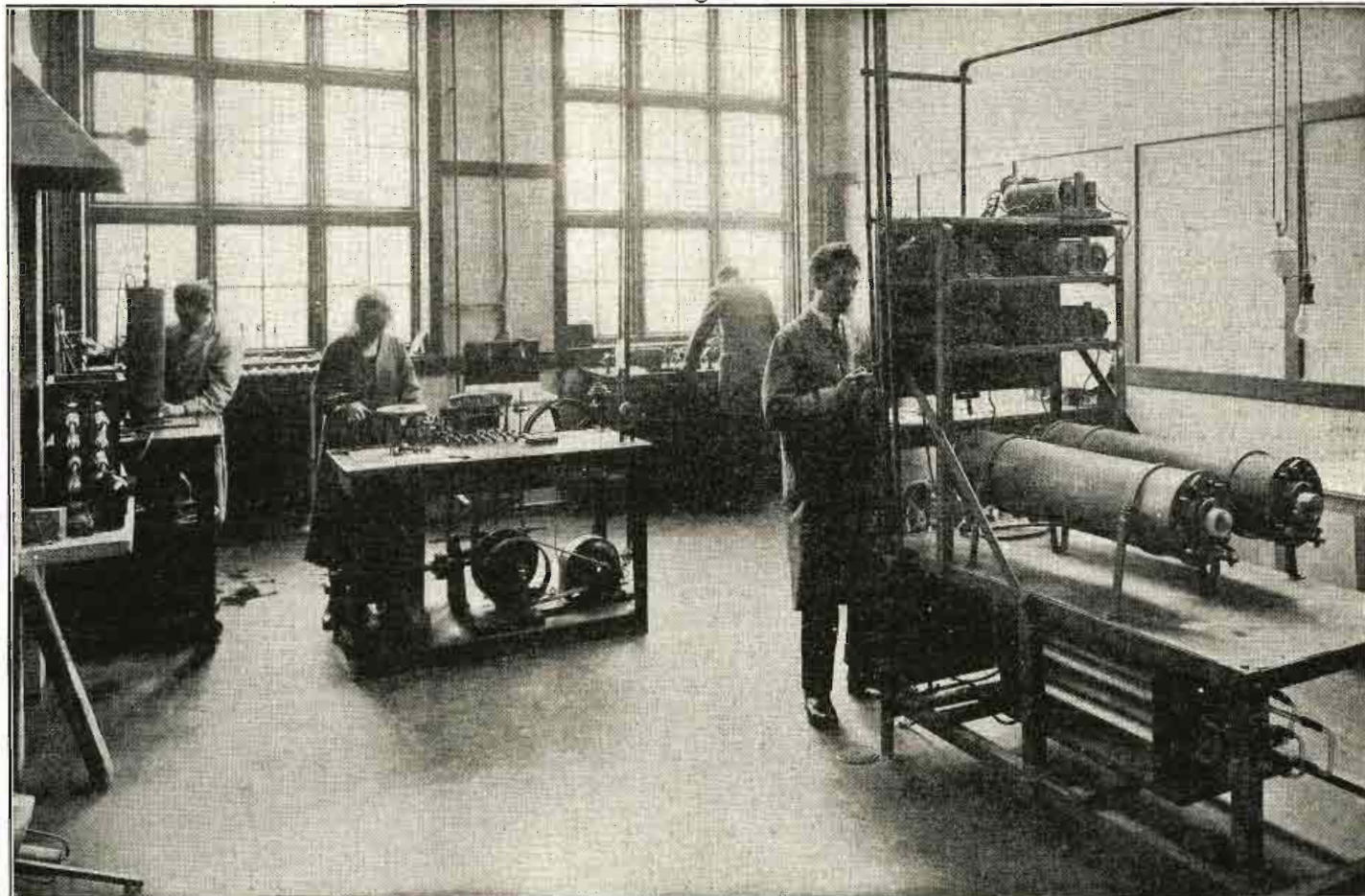

Fig. 6.—The new 10-K.W. "renewable filament" vacuum tube used in the Eiffel Tower transmitting station. It is mounted directly on top of a vacuum pump which operates continuously during transmission.



By courtesy of the General Electric Co., Ltd.
 Fig. 1—One of the research laboratories of the General Electric Company, Ltd., at Wembley. On the right is the apparatus for the preparation of metallic tungsten. The tungsten ingot, after hammering, is converted to wire by the wire-drawing apparatus seen in the center. Near the window is more delicate drawing equipment for reducing the wire to the very fine gauges required in filament construction. The wire is heated by means of an electric current as it passes through the diamond dies when being drawn.

equal emission reckoned in amperes per square centimeter of surface.

Worked at the same temperature, they give an enormously greater supply of electrons per sq. cm. per second.

It is well to remember that one ampere is equal to the emission of 6.28×10^{18} or nearly 6 million, million, million electrons per second.

THORIATED VALVE MORE ECONOMICAL

The thoriated filaments are, however, best worked at a temperature between 1,000 and 1,100 degrees C. or rather above a dull red heat. Hence electron tubes or valves made with such filaments are called in England "dull emitters" (D.E.). It is desirable not to work them at a higher temperature since in such a case the thorium "skin" is soon evaporated and the filament drops in power. The great advantage of these D.E. filaments in radio work is that they can be operated at a lower voltage and take much less current and power than an ordinary tungsten wire receiving valve. A very common type of receiving valve requires a filament voltage of 4 volts, takes .7 ampere to incandesce and absorbs 2.8 watts in power.

A thoriated or D.E. filament having the same dimensions as the tungsten one will give the same electron emission when operated with 1.6 volts and takes only .36 ampere and .58 watt in power. Hence, in place of a couple of storage cells or lead accumulators we can use a single large Leclanché primary cell such as is used for ringing electric bells.

These dull emitter valves are therefore, likely to be widely used in radio work in out-of-the way places where it is very difficult on account of lack of facilities to recharge storage batteries. The only disadvantage under which the dull emitter valve labors at present is that it costs just twice as much as the ordinary tungsten variety. But time and competition will, no doubt, remove this disadvantage.

The Marconi Osram Valve Company of Great Britain has recently brought out a dull emitter valve they call D.E.3 which has a filament that operates between 2.4 and 3 volts and requires only .06 ampere to heat. It can, therefore, be worked by two dry cells (Leclanché) in series and will give 800 hours' use on one battery. The plate voltage for this valve used as a high frequency amplifier is from 30 to 45. As a low frequency amplifier it uses 60 to 80 volts. The over all length of the valve is 75 mm. (3 inches),

its diameter 25 mm. (1 inch, see Fig. 2). It has a base with the standard British 4 p.m. collar to fit the ordinary valve socket; other British manufacturers now supply similar valves.

ANOTHER METHOD

Another method of obtaining a large electron emission from an incandescent filament not heated above a dull red heat is that developed by the Western Electric Company of U. S. A. and Great Britain, which has resulted lately in the production of a valve they call the "Wecovalve" which has an extremely small filament power consumption. (See Fig. 2.)

The Western Electric Company specialized years ago in the production of a type of valve filament based on Wehnelt's discovery of the electron emitting power of the oxides of the earthy metals. To prepare it, barium and strontium oxides are mixed with some combustible vehicle such as resin or paraffin wax and the material is painted on strips of platinum-iridium alloy. Between each coating the organic vehicle is burnt off. As many as 16 coatings are given and the result obtained is a metal wire covered with a dense closely adherent coat of oxides of barium and strontium. When this filament is mounted in a highly exhausted bulb with the usual grid and anode cylinder it gives a valve of remarkably low current consumption, *viz.*, .25 ampere at 0.8 to 1.1 volts for the filament and requires only 17 to 22 volts on the plate, as detector and 22 to 45 volts as an amplifier. It can, therefore, be worked with a single dry cell for several hundred hours.

In addition to remarkable improvements in receiving valves there have recently been equally great advances in the production of generating or transmitting valves. In the construction of large transmitting valves, lead glass has been used for making the bulb because it is easily worked and because platinum wires can be sealed air-tight in it. Glass, however, is very fragile and in the

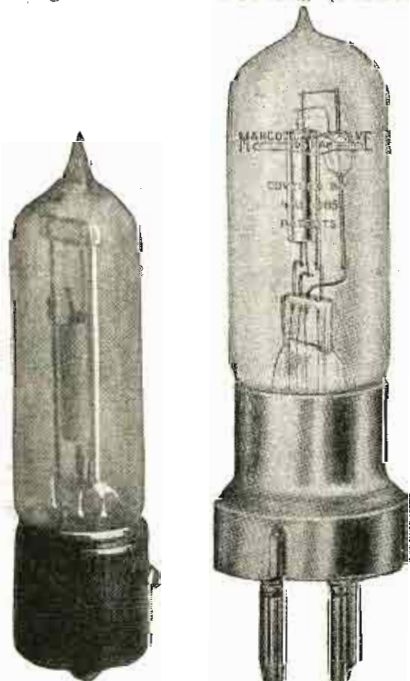

Fig. 2—Two recent types of receiving vacuum tubes. The one to the left has an oxide coated filament and the right-hand tube of English manufacture, has a thoriated filament. Both consume very little current.

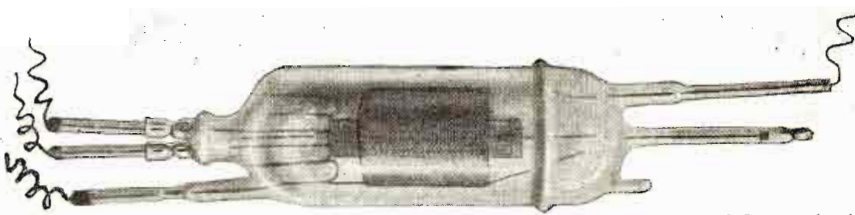

Fig. 4.—An English high power tube made of quartz; the filament may be renewed five or six times, the tube being sealed and exhausted again after each replacement.

case of large bulbs 8 or 10 inches in diameter the pressure of the external air amounts to a ton or more on the bulb. Also, glass, because of its large expansion by heat, is easily cracked.

SILICA BULBS

In England the bulbs for large power valves have been very successfully made of pure silica by the Mullard Radio-Valve Company, Ltd. (See Fig. 4.) Silica has a very small expansion with heat and a bulb of this material can be heated red hot and plunged into cold water without cracking. It has, however, a high melting point and can only be worked in an electric furnace or with an oxy-acetylene flame.

The difficulties of construction have, however, been overcome and a method of sealing the connecting wires into it has also been devised.

Platinum wire cannot be sealed through silica, but it is found that a molybdenum wire, which is a very refractory metal, can be sealed by means of metallic lead.

Such silica valves are now made for generating 5 to 10 kilowatts of high frequency power. A great advantage of the silica valve is that it can be cut open with a carbundum wheel, a broken or burned out filament replaced and the bulb sealed up and re-exhausted.

This cannot be done so easily with a glass bulb. Moreover, the silica bulb withstands cracking when the enclosed anode cylinder becomes hot.

As a large transmitting valve is an expensive article and as the filament in any case has only a limited life, the problem of

designing a tube which may be opened and the filament easily replaced, presented itself to radio engineers. Also the anode cylinder must form the outer casing so that it can be water cooled by a jacket.

Such a valve must, however, have its high vacuum continually maintained by a pump, otherwise an unavoidable leak at the joints will destroy the vacuum.

FRENCH DISMOUNTABLE VALVE

Such a dismountable valve has recently been constructed in France by M. Holweck and has been tested at the Eiffel Tower Radio Station in Paris.

He has also devised and constructed a special type of pump called a molecular pump of the type first made by Gaede in Germany. (See Fig. 5.)

If this molecular pump is jointed in series with a box pump or rotary oil pump to make a preliminary vacuum, the molecular pump can make and maintain a very high vacuum in the valve.

This valve contains a tungsten rod or thick wire as the filament surrounded by a grid or spiral of wire. The outer metal case forms the anode cylinder.

A valve of this type of 10-kilowatt size has been in operation at the Eiffel Tower station and has proven to be very efficient. (See Fig. 6.)

If the filament burns out, the valve can be dismounted, the filament renewed, and the valve put together again and re-exhausted.

This innovation renders it more than ever likely that in the near future the thermionic valve generator will replace both the

arc and the high frequency alternator as the prime generator of oscillations in the long-distance radio stations.

At the present time great attention is being given to the possible production of thermionic valves which will operate with cold cathodes.

As far back as 1909 the author of this paper described to the Physical Society of London (*Proc. Phys. Soc. Lond.*, Vol. 21, 1909) the production of a valve in which the cathode was composed of potassium-sodium alloy in atomic proportions. This substance is liquid at ordinary temperatures and in a high vacuum resembles mercury in appearance. It has the property of giving off electrons under the action of light. If some of the alloy is sealed in a glass tube in a high vacuum with a metal plate above the alloy a valve will result which rectifies high frequency alternating currents under the action of light. But the electron emission is much less copious than that of a heated tungsten filament. Moreover, the alloy is dangerous, as it is spontaneously inflammable and explodes when water is poured on it. Hence it is not a convenient substance to employ as a cold cathode.

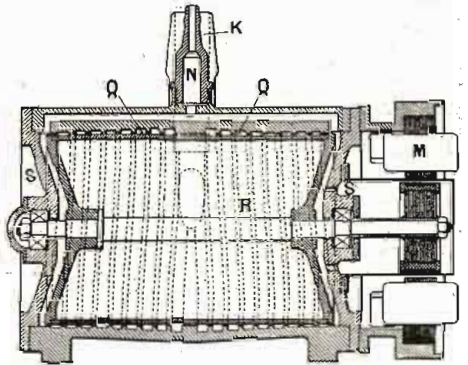

Fig. 5.—Sectional view of the Holweck molecular vacuum pump used with the new French high power transmitting tube.

Radio Waves Picked Up Eighty Feet Underground

EXPERIMENTS made recently in the south tube of the new Hudson River vehicular tunnel by radio and electrical experts proved that steel, iron, mud and water are no bars to radio waves. The tests, made at the suggestion of Morris M. Frohlich, secretary of the New York Tunnel Commission, was for the purpose of discovering whether it would be possible to use radio in communicating with men underground in time of accident or danger.

The experiment was under the direction of experts of the Westinghouse Electric and Manufacturing Company, who brought here from East Pittsburgh a new instrument to be used both in receiving and in broadcasting from unusual locations. Among those who took part in the experiment were G. Y. Allen and G. L. Beers, radio experts of the company; A. Hjort, electrical expert of Booth & Flinn, who are building the tunnel; M. L. Quinn, superintendent in charge of the work; Major Charles S. Gleim, the resident engineer; Dr. Edward Levy, consulting physician of the commission, and Mr. Frohlich.

EIGHTY FEET UNDER THE RIVER

The party descended to the tunnel through the land shaft at Canal and West Streets, and then walked through the tube to the pierhead line, where the great shield was busy boring its way toward the west. At this point they were 80 feet beneath the surface of the Hudson river. To reach the ears of the listeners the radio waves would have to enter either through the mouth of the tube in the neighborhood of Canal and Varick Streets and then, leaving the orifice through the earth, would have to travel about 1,000 feet under

the river, or they would have to pierce the water, travel through a heavy layer of mud, and then pass through the heavy iron walls of the tube.

When all was ready, Mr. Frohlich held

the loop antenna, while Mr. Beers operated the dials. Instantly came word that the party was in connection with WOR, Newark; then they got WEAF, WHN and WJZ, (Continued on page 1327.)

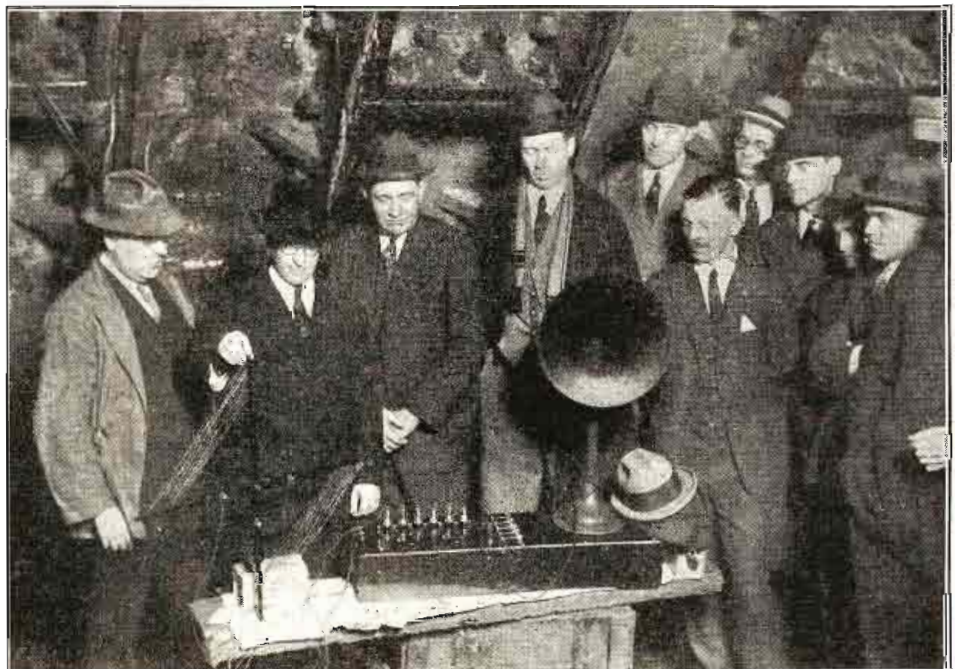
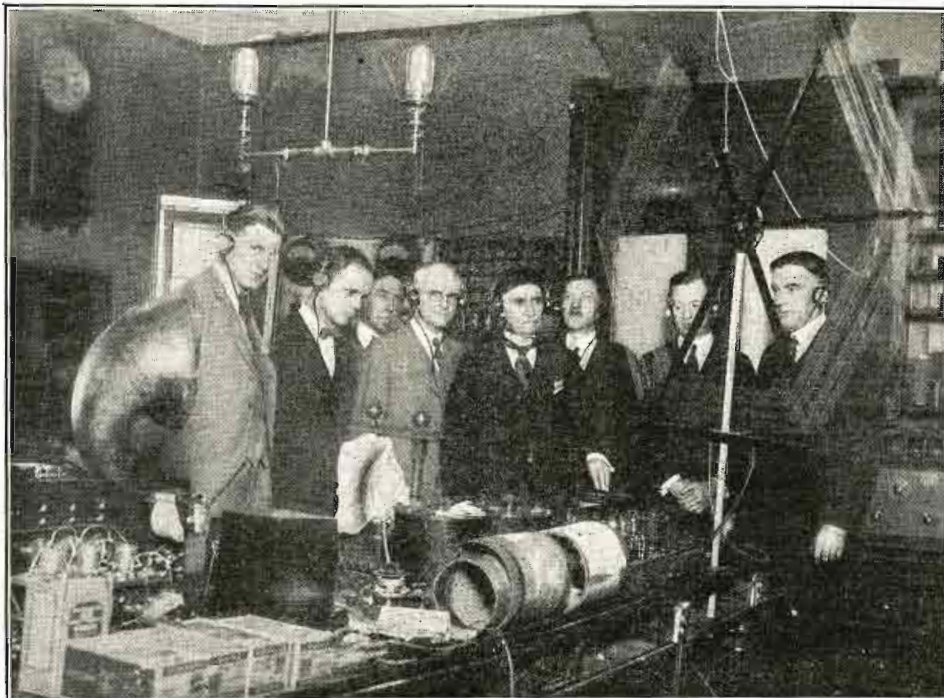

Photo of the assembly in the Hudson river tunnel during the test to determine the penetration of radio waves through the walls. A number of broadcast stations were successfully tuned in. © Photonevs, N. Y.

The Trans-Atlantic Broadcast Tests

By GEORGE E. OLIVER, A. M. I. R. E.

A very interesting account of the successful reception of English broadcasting stations at the laboratory of Dr. J. Harris Rogers in Washington, D. C. A very sensitive form of receiving set was employed, together with a specially constructed loop aerial, the latter being placed underground.



In the laboratory: From left to right are Geo. E. Oliver of Station WRC; W. L. Tesch, Engineer in Charge of WRC; Dr. T. E. Latimer; Dr. J. Harris Rogers; H. P. Flaharty, Arthur C. Doyle of the Radio Corporation of America, and D. H. Beatty, Safety Engineer of the Southern Railroad.

junction with Dr. Rogers' latest development, the "Coil Aerial Loop." The other set used was a receiver having three stages of untuned transformer coupled radio frequency, two audio and detector, specially constructed for the occasion. It may be of interest to the radio public to know that no outside antenna was used, as Dr. Rogers stated that static strays, and stray induction in all probability would interfere with the efficiency of reception. The "Coil Aerial Loop" was placed in a shielded underground well 20 feet deep, and to satisfy ourselves that this was efficient, in a preliminary test, an outdoor antenna was first tried. Then by means of a double pole, double throw switch, the set was switched to the underground loop, which increased the audibility from 25 to 50 per cent, and practically all external interference was eliminated. We then placed a compass on the table, and by means of this and a world chart, pointed our "Loop" at Carlisle, England, which, from our point of reception was the approximate central point of the British Isles. We then listened in, and by means of the many stations that were working within a seven and one half degree geographical radius of this central, we calibrated our receiver, jotting down the direction of the loop and our tuning condenser settings. These readings were valuable to us, since they afforded ready reference at all times during the test.

(Continued on page 1270)

THE reception of the English broadcast stations afforded an opportunity which tested the wares of combined English and American genius. As we know, radio stations in both countries heretofore have proved a very effective 500-mile range, although no one station in the world can state that at any time it has worked above this range consistently. However, it has been the desire of engineers on both sides of the Atlantic to ascertain whether it has been merely the fact that the listening public has availed itself of local programs, or the apparatus has not been designed correctly.

In former tests, England has heard several American stations, and in way of jest, has remarked that the "Yanks" know very little about receiver design but have a fair ability in the construction of good transmitters. This jest—to me—seems to be slightly exaggerated, as both nations have attained good design in radio science.

During the most recent test, the engineering staff of the Radio Corporation Station WRC in Washington, D. C., was invited to the home and laboratory of Dr. J. Harris Rogers, the well-known American scientist, to co-operate with him and his assistant H. B. Flaharty. On Sunday evening, November 24, our party, consisting of W. L. Tesch, engineer in charge of WRC, George E. Oliver, W.R.C., A. C. Doyle of the sales and service division of the Radio Corporation and D. H. Beatty, safety engineer of the Southern Railroad, arrived at Dr. Rogers' home about 9:30 o'clock. They were immediately escorted to the laboratory, as no time could be lost. Our set had to be calibrated by local broadcast stations in order that we might approximate the wavelengths of the English stations.

One set used was a stock model Radiola VII, which consists of a variable inductance, two stages of radio frequency, two of audio frequency and a detector, in con-

No outside aerial was used during the tests. Rather, a special type of coil aerial or loop was employed, this being of Dr. Rogers' design. It was placed at the bottom of a 20-foot underground well so as to be perfectly shielded.

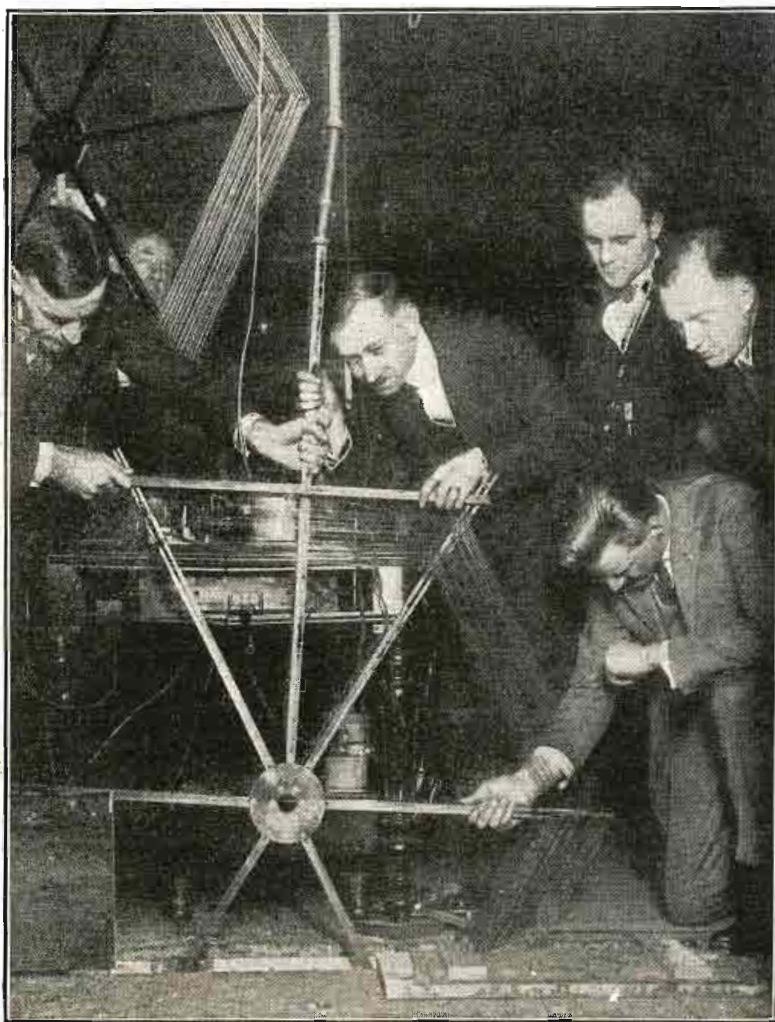

Radio Benefits Camp Veterans

By CARROL GEORGE LAKE

Convalescents, veterans of the World War, in the hospital at Camp Kearny, would spend many a weary hour if it were not for the radio that has been installed for their benefit. Although confined to their beds, these men find peace in listening to the outside world.



Each bed is equipped with a pair of head-phones, which are attached to a distributing line running from the radio receiver along the wall of the porch.

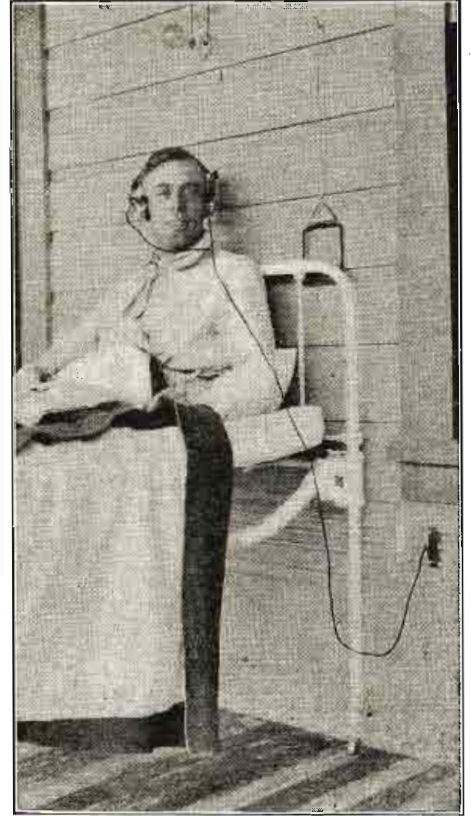

One of the Camp Kearny convalescents listening to a radio program picked up by the camp's central receiving set.

THE largest radio installation of its kind in the world—so far as it is possible to ascertain—was recently installed in the U. S. Veterans' Hospital at Camp Kearny, California. The funds for the radio set were raised by the citizens of San Diego and the accomplishment represents one of the biggest pieces of individual work that has been done for the veterans of the World War in any city in the country.

The hospital at Camp Kearny is filled entirely with veterans—men and nurses of the world war—who are suffering with tuberculosis. Some of them are hopeless cases. Others have a good chance of recovery and of a return to normal life. Still others have a chance—but only a fighting chance—and the most adequate remedy that the medical world knows today to assist this fight is rest. An American youth is a fighting man. He is a "Devil Dog" on the firing line. He fights for right and for his rights. And, when ill, he is apt to fight if an attempt is made to keep him in bed. Yet, when he has but a fighting chance for recovery, anything that will help to keep him peacefully in bed is of tremendous therapeutic value.

The idea of a high powered radio receiving set, centrally located and equipped to feed the ears of sick men in several wards at one time, was the inspiration of three employees of the U. S. Veterans' Bureau stationed at Camp Kearny. They believed that this radio installation would furnish diversion for the hopeless cases, help the fighters to regain their lost health, and would assist those who are soon to buck up against the world again to rebuild mental activity.

SET PURCHASED

A self-appointed committee, with the hearty approval and co-operation of Major Harry Cohn, Medical Officer in charge of the hospital, appealed to the Community Service of San Diego. Eventually, the citizens of that city and its environs arose in enthusiasm to raise the necessary money to give the patients at Camp Kearny everything that would in any way assist these sufferers to recover. Committees were ap-

pointed, business men gave their time, merchants opened their purses and musicians donated their services—all with unprecedented enthusiasm.

The medium chosen to raise the funds was the presentation of the Gilbert and Sullivan opera, "Iolanthe." Countess Wanda de Turczynowicz, renowned singer who is now making her home in La Jolla, personally directed the production. Vocalists of social and musical prominence in San Diego filled the cast. Chesley Mills gave his services and directed an orchestra of talent, each member of which gave his time without remuneration. The opera was produced on the evenings of September 19 and 20 at the Spreckels Theatre in San Diego and netted approximately \$3,700. This was more than twice the amount asked for, and made possible not only the procuring of the radio installation, but also the purchasing of other diversional equipment.

The Independent Electric Company of San Diego was the successful bidder for the radio installation, and while others said, "It can't be done," this company accepted and

fulfilled the guarantee demanded by the committee.

THE EQUIPMENT

The hospital wards are separate buildings—emergency construction—arranged in two rows of eight each. In the main quadrangle between the two rows of wards are the mess halls and the clinic building. Because of its central location, a small room in one end of the clinic building was chosen to house the receiving set. The master set has a one-stage radio frequency amplifier and is supplemented by a two-stage power amplifier.

(Continued on page 1322)

The radio receiving set and power amplifier at Camp Kearny, which furnish the convalescents with entertainment.

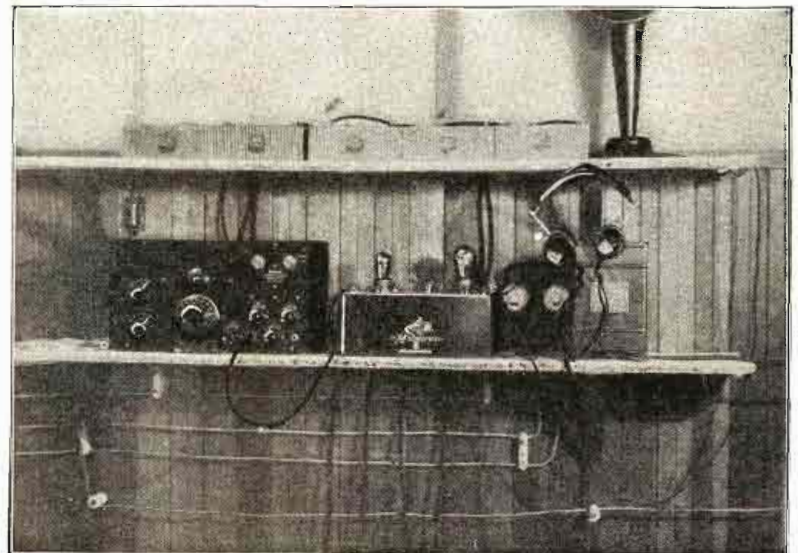

A Crystal Set Loud Speaker



This is the first successful type of loud speaker for crystal receivers that has appeared in the radio field. The system employed is ingenious and is quite practicable



THE impossible has been made possible and in a most striking manner. To be skeptical concerning the actual worth of a loud speaker supposed to amplify the energy from a crystal detector receiving set without the use of vacuum tube amplifiers is to be expected. The Frenophone was invented by S. G. Brown of the company of S. G. Brown, Ltd., of England. It actually does the trick and in a manner that is ingenious to say the least. Imagine a loud speaker that will operate satisfactorily, directly connected to a crystal set and without batteries of any description. Amplification is effected by mechanical means.

The instrument is shown on our front cover, and has more or less the appearance of an old type Edison phonograph. A close-up view of the working parts is given

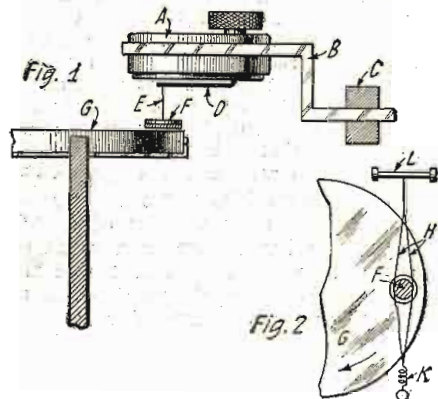

Diagrammatic sketch of the internal mechanism of the Frenophone, showing the revolving glass disc and special headphone.

in the diagram, at Fig. 1. Just how the Frenophone works can be understood by referring to the line sketch, Fig. 2. An

ordinary Brown telephone receiver, A, with adjustable magnets, is attached to a metal arm pivoted at B, and weighted at the end with counter-balance C. To the reed D and the receiver are attached the steel needle E to whose end is fastened a small disk F covered on the bottom with cork. This small disk is directly above a perfectly level glass plate G. The glass plate, in turn, is mounted on the shaft of a phonograph motor so that it may be slowly revolved. The disc F, as shown in Fig. 2, is suspended by threads H near the edge of the glass plate G. The two threads terminate at the center of the diaphragm L which is the diaphragm of the loud speaker.

In operation, the weight of the phone receiver brings the cork-faced steel disk into contact with the revolving glass plate. When the signals are picked up, the reed D vibrates in unison with the receiver diaphragm, thus creating an upward and downward motion of the disc F. The pressure of the needle on the disc can be finally adjusted by moving the counter-balance C. In operation, the motor is started, revolving the glass plate. Signals are tuned in causing the diaphragm reed and needle to vibrate. This produces a pressure between the disc and glass plate, and as the former is not rigidly fixed, it drags according to the pressure upon it. This is communicated to the diaphragm L, causing it to vibrate in unison producing sounds in the loud speaker horn. Cork and glass have a high friction coefficient and for this reason the action is greatly magnified. The application of some turpentine on the revolving glass disc will help to further increase the action.

The power for this instrument is, of course, furnished by the phonograph motor. The speed can be varied at will, but the results are about the same for speeds ranging from 12 to 70 revolutions per minute.



The Frenophone or crystal loudspeaker. The small phonograph motor and special headphone are situated in the casing in front of the horn.

Although this instrument requires very fine adjustment, it works satisfactorily and frequent adjustments are not necessary.

What Listeners-in Want

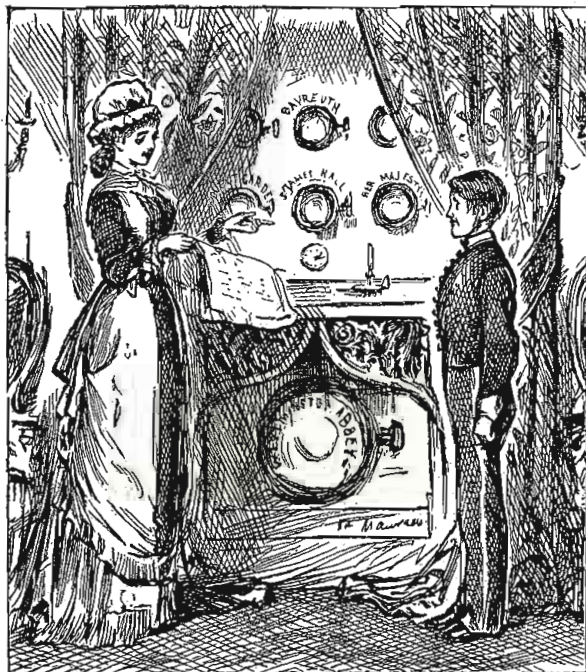

"Soundings" in Radioland recently made by three big Chicago broadcasting stations, reveal the fact that half of the fans want popular music and a

speeches or addresses of any sort, and male quartettes appear to be less popular than any other form of musical offerings, according to an analysis of 122,974 replies out of 263,410 received.

Musical Mistress of House ("on hospitable thoughts intent"): "Now, recollect, Robert, at a quarter to nine turn on 'Voi che Sapete' from Covent Garden; at ten let in the Stringed Quartette from St. James's Hall; and at eleven turn the last Quartette from 'Rigoletto' full on. But mind you, close one tap before opening the other."
Buttons: "Yes, Mum!"

This broadcasting prophecy appeared in "Punch," December 14th, 1877.

The vote polled by KYW, WDAP and WJAZ included no duplicates as far as could be ascertained. While less than half the votes have been classified, the results are thought to show the general desires of those who listen in, while, it is pointed out, every State in the Union, as well as Canada, Alaska, Mexico, Cuba, Central America, Bermuda and Hawaii was represented by communications received within 10 days' time.

little over a quarter desire more classical composition, a report from the Supervisor of the Ninth Radio District advises the Department of Commerce. Very few fans seem to care for

Popular music stood first on the list with a vote of 29 per cent. of the replies analyzed. Classical music was second with 24.7 per cent.; Jazz third, with 18.4 per cent. and old-time songs fourth, polling 5.7 per cent. of the votes. Other forms of entertainment received the following percentage of the votes: Dance music, 2.9; band music, 2.7; sacred music and vocal music, 2.1; grand opera, 1.7; and Hawaiian music, .1. Orchestral music, mixed quartettes, saxophones, symphony, religious, organ, Mexican, male solos, dramatic, quartette, instru-

(Continued on page 1337)

Fans of Yesterday

By ONE OF THEM



These reminiscences of early radio should be dear to the old timers, and should prove interesting to the new amateurs, who have not known the thrills of adjusting a coherer for days, just to hear a few dots and dashes. Just the same, with a loose coupler and a crystal detector we had lots of fun!

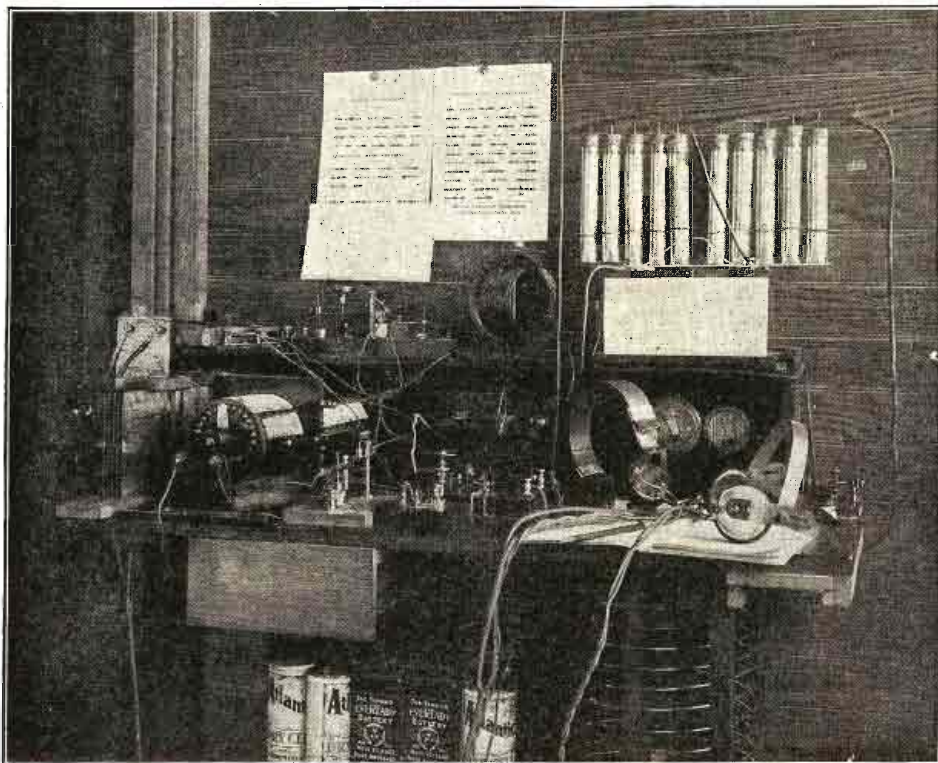

A typical amateur station of the 1912 type. Note the numerous detectors and the variable condenser on the extreme left. The glass tubes on the wall constituted the high tension sending condenser.

A FEW days ago I met one of my old friends who had been abroad for the past four years. Ten years ago this man was one of the best known amateurs in the United States, and naturally radio was one of the first things that came under discussion. I started to talk about reflex circuits, super-regeneration, neutrodynes and some of the later developments of the radio art. Much to my surprise, my friend did not respond with the usual line of latest dope that he used to spout in the days gone by. Rather, he appeared sort of amazed and dumbfounded and, after admitting that he had been entirely out of touch with radio during his sojourn abroad, I knew that what I was trying to tell him was all "Greek," and so I drifted back a few years to the days when amateur radio was in its swaddling clothes. The things we talked over should be of interest to fellows today who have super-heterodynes with so many controls that they have to ride up and down in front of them on a bicycle to tune them.

FIRST PHILADELPHIA HAM

This particular person at one time owned and operated the first radio receiver in the city of Philadelphia. And what a curiosity it was! A few wires stretched on the roof in those days marked a residence as the abiding place of some mysterious wizard who had mastered the fundamentals of a black art, comparable in a way with that practised by the old alchemists who searched for the Philosopher's Stone in the depths of their musty laboratories. This man was using a coherer when he started. What would happen if our present fans had to employ an electric bell to keep their detectors detecting? What would happen if their

detectors got clogged up and refused to function for hours at a time?

When the coherer reigned, there was not a great deal of stuff on the air to listen to. Messages were as scarce as the proverbial hen's teeth, and if one patiently sat up all night he might be rewarded with a sound, which, if heard in a pair of modern telephone receivers, would sound something like the scratching of a match on the cellar wall. But, the peculiar part of it was that the sound was not heard in telephone receivers. A buzzer or an electric bell was the indicating device used.

At the time my friend started his career in radio, there were probably not over 25 transmitters in the entire United States, and perhaps not over 100 in the world. The reception of a message was an event fit to celebrate in a most elaborate manner. And it was practically impossible to get your inquisitive neighbors (who always regarded you as somewhat of a peculiar nut) to actually believe that you had pulled something out of space. In those days they thought Marconi was the only man in the world who really knew how to receive messages.

BACK IN 1905

I do not know how many amateur experimenters there were in the country at that time (1905), but it is safe to say the number did not exceed 50. Wireless apparatus could not be purchased for the Marconi com-

pany, which then controlled everything from soup to nuts. They guarded their patents with every legal instrumentality available. If you wanted to make a coherer you had to go to the drug store and buy a medicine dropper, file up a couple of dimes and some nickels, and these, with a buzzer and relay and a few other odd pieces of junk made up the receiver. I dare say the average fan today would not recognize one of the old receivers as such, if it were brought to his attention. He might think that it was anything from a capillary electrometer to an electro-cardiograph.

EARLY PUBLIC ATTITUDE

Some idea of the public attitude toward radio at that time might be gained from the fact that the police investigated the business of the first man to retail radio apparatus in New York City back in the coherer days. When it became known that he was selling radio apparatus to the public, it was thought that he was some quack who was trying to make an illegitimate living, and the policemen who came went away half convinced that their original suspicions were still worth considering.

It was not until 1908 that amateur radio began to attract large numbers of experimenters. The boom came as a result of Pickard's discovery of the fact that the unilateral conductivity of crystals could be employed for the reception of radio telegraphic signals. This marked the second stage in the development of receiving apparatus—which stages divide themselves into five separate parts, as follows:

1. Marconi coherer.
2. Crystal.
3. Fleming Two-element valve.
4. DeForest Three-element valve.
5. Regenerative reception.



An early broadcasting station. In this picture Dr. DeForest is seen operating his arc Radiophone which could be heard in 1907 around New York; the lady is singing in the microphone.

The telephone receiver came into prominence in radio with the introduction of the crystal detector. At that time New England was the center of radio manufacturing. If I am not mistaken, there were three manufacturers up there turning out radio apparatus for amateurs. But, in those days the output was so small that any community that could sport three producers had to be regarded as the center of the industry.

DX WITH A CRYSTAL

It is surprising to know the distances the old timers used to get with their crystal outfits. The fan today thinks that 25 miles is about all that can be pulled out of a galena detector. I remember when 2,000 miles was a common accomplishment. I remember when ship operators would be fired if they could not work 1,500 miles under all conditions. Of course, we must remember that heavy spark transmitters with as much as a 15-kilowatt input were used by some of the commercial stations. Then, too, the fans of those days were slaves of circuits just as they are today. If they had been presented with one of the simple crystal receivers, as turned out by our manufacturers today, they would have looked upon it with contempt. Their circuits were elaborate and some of them had almost as many controls as a modern super-heterodyne. Coils! They had enough wire in them to string a telephone line from New York to Philadelphia. Of course, most of them were made for long wave reception and they usually had about 14 different circuits. There were instruments employed that the modern fan would not recognize as being part of a radio receiver. The writer well remembers the old "doughnut" tuners that were wound on a tube about the size of a beer keg, which incidentally is also extinct. Every fan had his pet circuit, which, quite naturally, was always better than the other fellow's—a further indication that this circuit business is some odd phenomenon of human nature.

TUNERS AND AERIALS

The single slide tuning coils that were built in those days were somewhat akin to



One of the old-time commercial stations that had apparatus built like a battleship, much better in fact than some of the present-day stuff. Note the two DeForest audions perched atop the left-hand receiving set. Also the large transmitting condensers in the rack by the window.

smoke-stacks, and if you did not live in a tower you had to cut them up into four or five parts to get them into a room. Aerials were elaborate systems of wire that would easily cover a city lot, and most of them had a natural period so great that reception from the present day broadcast stations would be impossible. Instead of looking for hard or soft tubes, the search was constantly on for good pieces of galena. The crystals were bought by the ton, so that one or two pet pieces might be selected.

It was between 1908 and 1910 that some wiseacre invented the electrolytic detector. Would some of our fans believe us today if we told them that we had to use a solution of sulphuric acid and water in a de-

tecting device? Yet that is exactly what happened. The old electrolytic detectors were far more sensitive than the silicon or galena, but they were as hard to keep in adjustment as a 1902 automobile. If one did not hold one's mouth just right, the thing failed to operate.

THE VACUUM TUBE

When Fleming's valve was introduced to the art, no great stir was created—in the amateur field at least—for the Fleming valves were very closely guarded and were not available for amateur use. In fact, I do not know of one of my friends who succeeded in obtaining one of these precious articles. It was not until DeForest made a real device out of it, that the vacuum tube was introduced generally. It was fortunate for amateurs that DeForest did this great piece of work and that it was kept out of the hands of those who would have cut off the amateur supply. DeForest had a place in his heart for the amateur, and he bent every effort to see that they were supplied with what was perhaps the outstanding invention of radio.

A DeForest tube in the old days was a thing to be protected with one's life. Although it looked like a huge dew drop hanging down on the front of the set, it was so far superior to the old silicon and galena detectors that there was no comparison. When the first tubes were brought out, little or nothing was known about amplification. Then someone insisted that tubes could be cascaded and it was a fine idea with the exception of the fact that there was no such thing as an amplifying transformer. If you wanted a transformer, you had to go out and buy a spark coil, dismantle it and use the coil and some of the wire to wind your own transformer. The first audio-frequency amplifying transformer that I had was about the size of some of the cabinets that now hold crystal receivers. It weighed about 7½ pounds—but it amplified, so everything was lovely. What would happen today if our fans had to go out and buy raw materials to make their transformers? What a sorry plight radio would be in. What if our present transformers were as large and heavy as the first ones? A modern set with several stages of audio frequency amplification would have to be moved from place to place on a truck.

I hope that these few sentences will help our present fans to realize that they're
(Continued on page 1320)

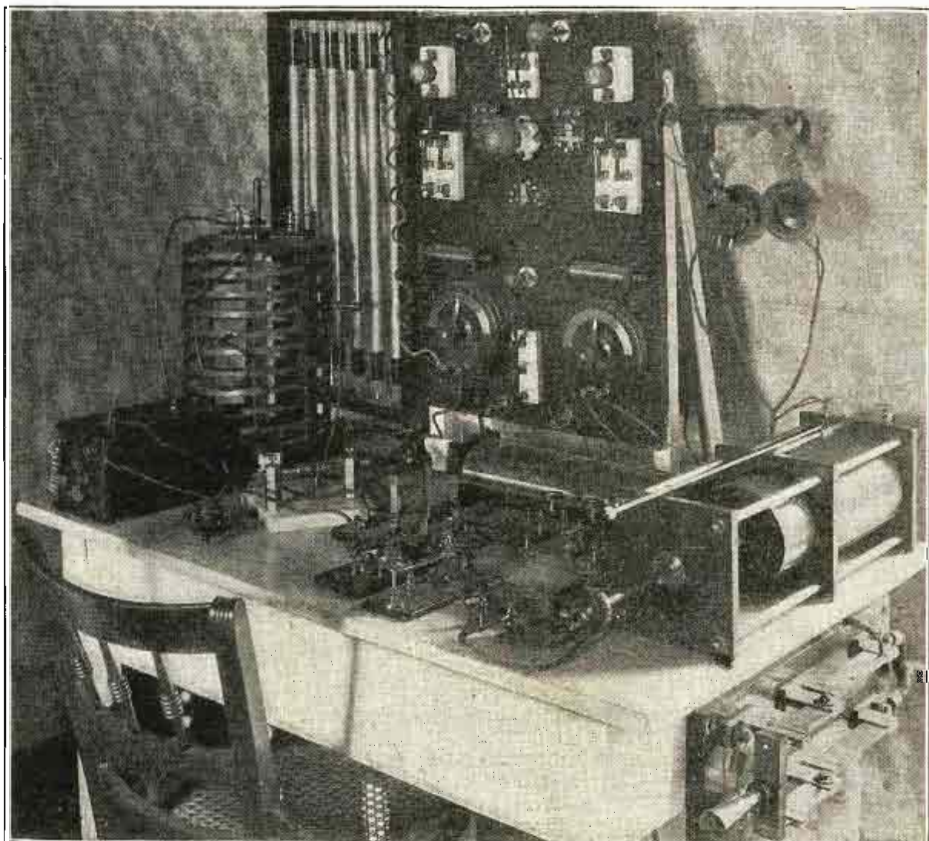

A real honest-to-goodness ham station of the pioneer days. No vacuum tubes here, but we venture to say that it was a star station in its day, judging from appearance. Note the tubular transmitting condenser and also the "power house" switch for breaking the "battery current!"

The Development of Wired Radio in Germany

By DR. KARL ROTTGARDT*

Although not new, wired radio has been used only a comparatively short time. It has proved most useful for telephonic communications over high tension lines and is now being used in every country. This article describes various arrangements which have proved very successful in Germany.

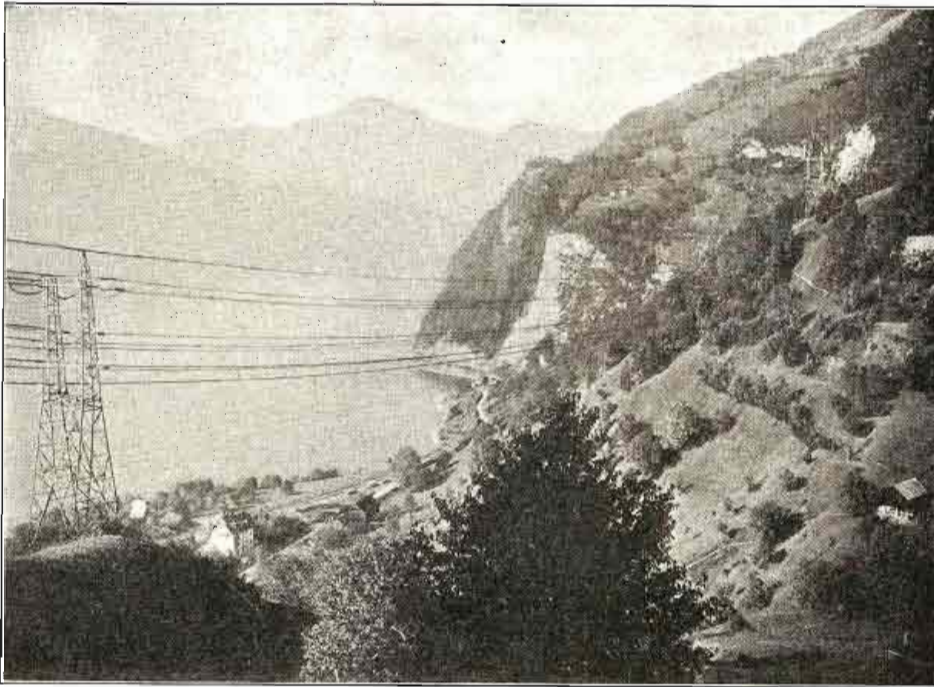

A 100,000-volt power line which is used, in the wired radio system, to guide the electromagnetic waves to the various sub-stations and permits instantaneous communication between any given stations.

It is a curious fact that radio has won the victory over wire communication. If a certain Marconi, after his first great achievement, had said that his electric waves would some day run in opposition to the telegraph and telephone, he would certainly have been laughed at. The electric waves, like everything else on our earth, are characterized by a natural laziness, and prefer to travel by an easy road, that is to say by wire, rather than through the free air, which, without doubt, offers great resistance to them.

We must certainly acknowledge our indebtedness to General Squier, U. S. A., for the first use of the electric waves on wire which he demonstrated in 1910. Today this system is used, more or less, in all the countries of the world. Within certain limits, at least in the immediate future, they will certainly win the lead.

The use of electric waves on the regular telegraph and telephone lines is today only for the purpose of giving simultaneously,

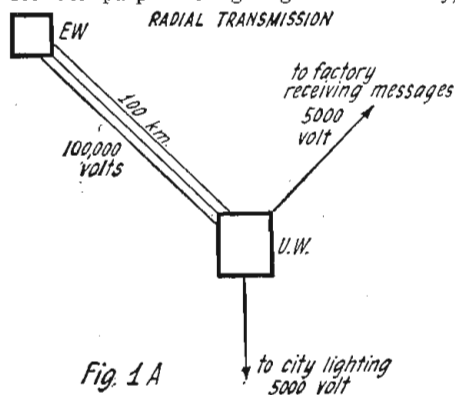

This diagram shows a wired radio circuit connecting the power house to sub-stations and factories. The guided radio waves travel over the high tension lines.

* Director of the Dr. Erich F. Huth Company, m.b.H.

on a single wire, a number of messages, either telegraphic or telephonic. This application has, accordingly, a great significance in the saving of copper. This is of special importance where it is necessary to use this raw material to the smallest possible amount, as in Germany. An even greater advantage is gained because, by employing vacuum tubes, we are able to use a conductor of much smaller cross-section than formerly.

EQUIPMENT SIMPLE

The sending of electric waves over regular telegraph and telephone lines is simple. The sending apparatus, producing the waves, and the receiving apparatus are directly connected to the wires. It operates very much as if the antennæ were connected by a wire.

Another great possibility for the use of wired radio is the high potential power lines as the conductor for the waves. This branch of service will not be interfered with so soon by everyday telephony.

More than this, wired radio will be used for communication from moving trains, for talking from train to train or from a moving train to a private telephone. Connection could also be made to the telephone system.

A further addition will indicate how the amateur can employ himself with the problem of telephony on other wire lines. Here is a field in which he can make real technical progress.

FAR-REACHING POSSIBILITIES

All countries of the world must devote their powers to saving coal. The more they develop the immense energy of their water power, so much greater is the significance of the quick telephonic communication between power installations, electric stations, transformer installations and the like. In Germany we are only beginning to make real use of our water power. In America you have gone much further in the utilization of the gigantic water power available. But it is certain that the full utilization of

this power is only possible when all the units of the system are in close touch with one another. Such intercommunication will serve to notify a plant not drawn on for its full capacity to supply power to a plant doing more than its share. In case of need, such as the breaking down of a high tension line, the system will be invaluable in averting a cutting off of the electric supply to plants and towns.

The connection of individual works by cable would be too expensive. Telephone or telegraph wires strung on the poles of high tension lines are inconvenient and in case of need are useless. If the power lines are broken down by frost, snow or storms, the much thinner telephone lines will be destroyed at the same time or earlier, so their utility would disappear in time of need. The use of the regular telegraph lines is out of the question because in the case of danger they cannot be relied upon. The radio transmission over wires will still work when the high tension lines are in part broken down, ruptured or out of order.

HOW IT WORKS

The diagrams 1A, 1B and 1C, give three simple examples of electric power plants, in which wired radio telephony is in use. An electric plant is located 60 miles from a transformer station which transforms the 100,000 volts received to a potential suited to the requirements of the consumer. From the transformers, lines go to large industries, towns with their street railroads, lighting systems, and wherever power is needed. The generating plant and the transformer station must be in constant communication with one another. They will be fitted out, therefore, with wired radio telephony. The connection is simple in the extreme.

A MORE COMPLICATED NET-WORK

There are two electric plants, EW₁ and EW₂, which are situated at some distance (12 miles and 30 miles) from a transformer station, to which they send their power (100,000 volts and 50,000 volts). A high tension line—60,000 volts—extends from it to a second transformer station UW₂, 25 miles

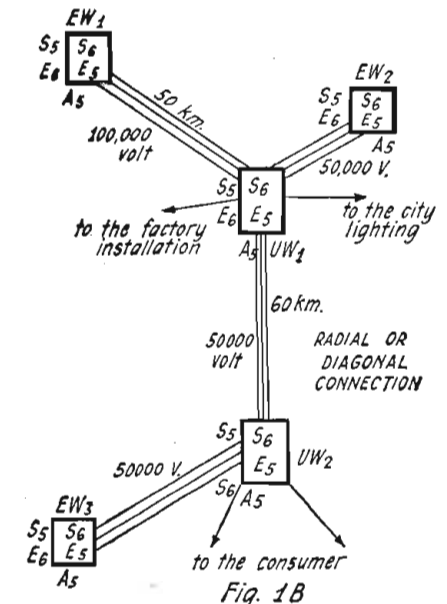

Another wired radio system permitting telephonic communications between numerous points connected with high tension lines.

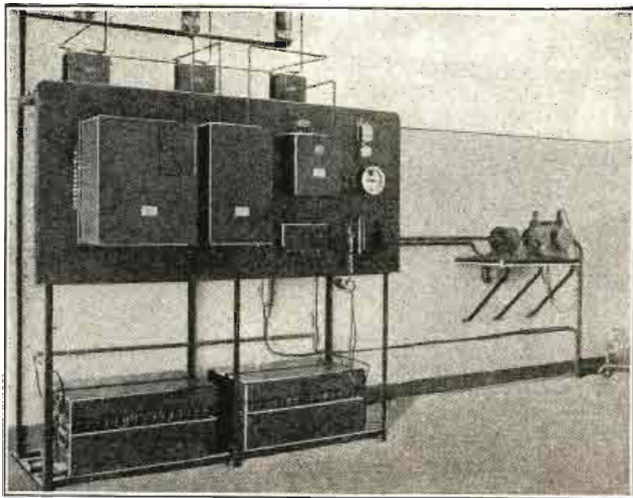

These two photographs show the type of apparatus used in central and sub-stations for wired Radio telephony. The transmitting and receiving apparatus is mounted on the panels and the batteries are on the ground.

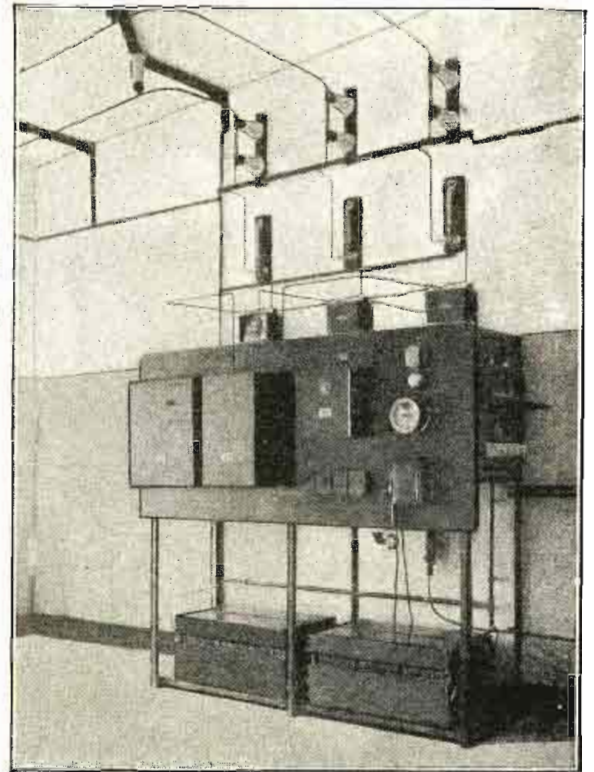

away. It has its own electric plant EW_3 . Each of the plants, shown in diagram 1B, must be able at will to talk to any other plant in the system.

1C SHOWS THE MOST COMPLICATED SYSTEM

Twenty-five miles from EW_1 , the general administration of the whole system is located. It is connected by the public telephone line with the manager of EW_1 , whose office is about one and a quarter miles from EW_1 . The manager of EW_2 has his office about the same distance from his plant. There is an erecting division between EW_2 and EW_3 , and this must be in touch with the two terminals at all times.

THE COMPLETE SYSTEM

Through this system it must be possible for the general director to speak to any plant and each plant must be able to speak to any other plant. Also in case the station called is busy the system must indicate it. The construction engineer through the system also must be able to talk with both terminals of his division, from any place and at any moment. All these imaginary conditions are solved by the high frequency technique. With it, it is quite immaterial whether the potential on the high tension lines is 5,000 or 150,000 volts, whether the line is "dead" or is carrying current, whether some wires are broken purposely or by accident.

The problems to be solved are briefly stated here:

1. The practical carrying of the waves over high tension lines, with the elimination of danger.
2. Talking in both directions as in ordinary telephony.
3. Insuring the telephone apparatus as well as the public lines against dangerous potentials.
4. Removing all noises induced in the receiver by the alternating current at high potential (25 to 60 cycles frequency) and from all switching noises.
5. An apparatus for giving a signal call.
6. The individual call, which calls up only the desired place, and gives the busy signal to other places.
7. The apparatus shall operate not only from its locality but at any distance.
8. That the conversation shall not go

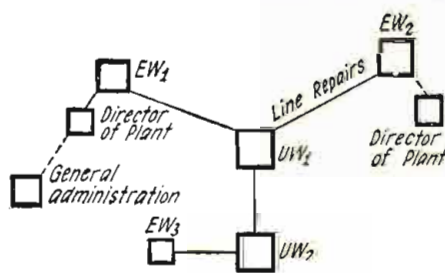

Fig. 1C

A more complicated network of wired Radio.

out on any lines from the place of telephoning, but that the transmission and receiving after connection shall go through any desired length of public lines.

THE HUTH-KUEHN CONNECTION

How the electric waves are produced, whether by alternator, by oscillating tube or by arc is quite immaterial, as it is immaterial in telephony by wire. All that is necessary is unceasing, undamped waves of sufficient constancy. The Dr. Erich F. Huth Company, of Berlin, uses their Huth-Kuehn connection, Fig. 2, which is without outer back coupling. It is distinguished by various advantages such as constancy of waves, absence of overtones, etc.

For the telephone connections the system devised in 1917, by Kuehn, is employed. It is to be found both here and in America, being the best modulated and strongest. Any other reliable telephone connection may be adopted.

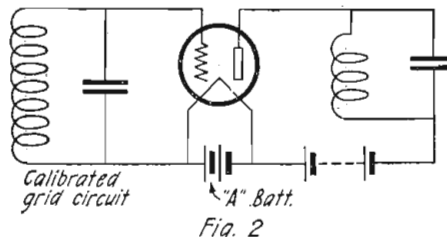

The type of oscillating circuit used in the transmitters for wired Radio.

The same applies to the receiving instrument. Any good receiving connection can be employed. Usually the audion without back coupling having one or two amplifying tubes, is used.

Inducing the waves upon the high tension wires is a characteristic feature of the Huth wired radio station. It uses the Schwartz star connection with the antenna (Diagram 3), which makes use of the air as the dielectric.

Parallel to each wire of a high tension line, a wire 325 to 800 feet long (according to the distance between poles) is strung. The suspension must be so made that if the main high tension leads break away, it will be impossible for the antenna to be disturbed. The antenna wires run at a distance of three to six feet from the high tension leads. The ends of the three antennae are taken to three coils, which are joined together at one point, forming a sort of star. This common point is grounded, thus providing protection for the apparatus against the high tension leads. The transmitting apparatus is connected to two coils, inductively coupled to the antenna coils, the receiving apparatus to one. The zero point of the star connection is not the mechanical zero, but is determined electrically. The

right selection is made when conversation can be carried on with the least interference between transmitter and receiver and when the alternating current of the power leads is no longer perceptible.

SYSTEM EXPLAINED

The system can be explained by an example (Diagram 1B). Near each plant are written two groups of figures, and around each plant is another group; S_6 and E_3 , which are sending waves of 6,000 meters and receiving waves of 5,000 meters the basic wave for intercourse for all stations. Besides this, each plant has 5,000-meter sending waves and 6,000-meter receiving waves (S_5 , E_6). One is then able at every station of the network to produce sending waves of 5,000 and 6,000 meters and to pick up with their receiving apparatus these same wave-lengths.

Besides all this, every plant has a very simple calling alarm, which is always tuned for 5,000 meters (A_5), and is always connected with one of the three antennae when the station is not receiving or sending. Suppose EW_2 wishes to speak to EW_3 . EW_2 pushes on his call button marked EW_3 . This puts his transmitter into action and 5,000-meter waves are sent out. It is diagonal transmission in question with exact periodicity of five seconds. So the only station in the network to receive the call will be the one to respond to a wave of 5,000 meters and for five seconds. The other receivers, that is to say, those which are set for 1, 2, 3, 4 and 6 seconds will not respond. The bell at EW_3 rings. The person in attendance goes to the instrument and takes up the receiver, thereby switching in his transmitter for the basic wave of

(Continued on page 1331)

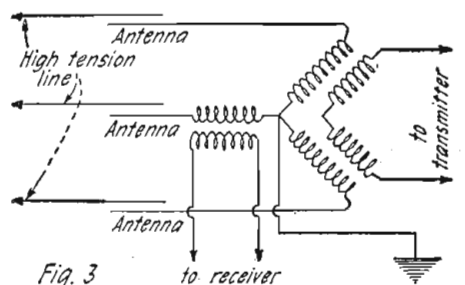

Fig. 3

Above is shown how the transmitter and receiver of each station are coupled to the lines.

Tuning and What It Means

By JOHN U. L. HOGAN

CONSULTING ENGINEER, PAST PRESIDENT AND FELLOW, INSTITUTE OF RADIO ENGINEERS; MEMBER, AMERICAN INSTITUTE OF ELECTRICAL ENGINEERS.



This article should prove of great interest to those who possess a Radio receiver but do not know how it works. The author has succeeded in giving a clear and concise explanation of the function of tuning apparatus without any technical terms or formulae.

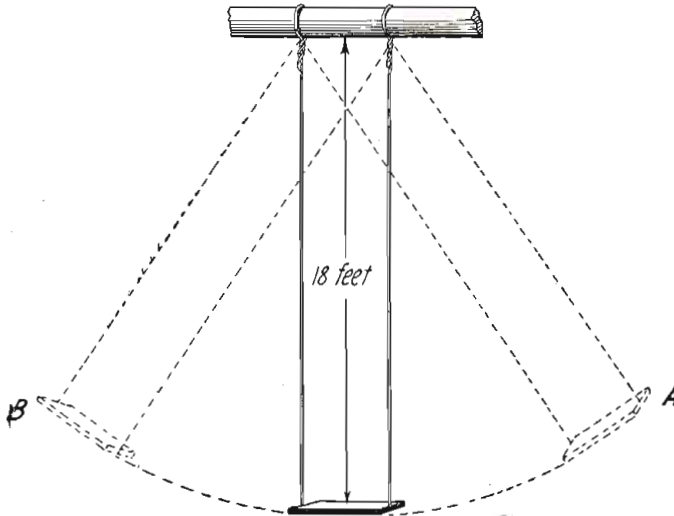

Fig. 1

Illustrating oscillations with a child's swing. If the length is 20 feet, it will take about five seconds to travel from A to B and back to A.

TUNING in radio circuits seems a mysterious process. There is nothing supernatural about the operation, and we can easily get a clear idea of it by comparing its principles and its effects with other occurrences in our daily lives. We are all more or less familiar with the tuning of musical instruments; we know that when a player tightens a string of his violin, that string produces a note higher in pitch than it did before it was tightened. We have noticed that the longer and heavier strings of a harp or piano give off the lower musical tones. If we wish to tune a string to make a certain sound, say that of middle C on the piano keyboard, we will usually begin by getting its length and weight about right and then adjust its tightness until we have *tuned* it to the exact pitch we desire.

THE MUSICAL SCALE

What is it that makes the notes of a piano have different pitches? What do we mean by high-pitched and low-pitched tones? The thing about a sound-wave which tells us its pitch is simply the *rapidity* at which it vibrates. If the sound vibration is very rapid, it will produce the sensation of a high-pitched tone; if it vibrates comparatively few times per second, the tone will be low in pitch or frequency. The range of frequencies ordinarily used in musical compositions extends upward from about 32 vibrations per second, which is the third C below middle C on the piano. The highest note commonly heard is the fourth C above middle C, which has a frequency of 4,096 vibrations per second.

If we wish to produce a note of any particular pitch, say that of middle C (which vibrates 256 times per second) we need only to set up a stretched string or some other vibrating body, so that it may oscillate at this particular rate.

SYMPATHETIC VIBRATION

Did you ever make the experiment of sitting before a piano, and, while holding down the "loud" pedal, singing or whistling some single note? Pressing the pedal lifts a

damper from the strings, and leaves them free to vibrate. Whatever note you sing, you will find that the corresponding string of the piano will take it up and continue to sound that particular tone for a moment after you stop singing. By uttering in quick succession two or three loud but short tones, you can get the piano to respond to a complete chord. What happens in this demonstration of sympathetic vibration is that your vocal cords produce air vibrations of the frequency corresponding with the note you sing. These air vibrations travel outward from your mouth as a sound-wave, which spreads in all directions through the room somewhat in the form of an imaginary but huge and ever-expanding soap bubble. The air-wave strikes against all the strings of the piano; one of those strings is tuned to the same pitch (the same frequency of vibration) as the sound wave. This particular string is the only one that can swing back and forth in unison with the sound-wave, and, as we shall see later, is the one which can most easily be made to move at that individual frequency or pitch. The sound-wave striking this string, and the successive impulses in the sound-wave coming along at just the right rate to hit the string exactly in step with its own vibrations, combine to make the string itself swing back and forth vigorously. When the sound-wave stops, because you stop singing, the string is going strongly; its oscillations cannot stop at once, and while they are dying away they produce new sound-waves of the original pitch which travel outward from the string and are heard by you as a reproduction of the tone you made.

THE NATURAL FREQUENCY

Let us see how some of these same effects occur in other vibrating systems. Instead of considering sound-waves, with their frequencies of from sixteen vibrations per second upward to thousands of oscillations

in one second, let us study the action of a child's swing hanging from the limb of a tree. If the swing, as shown in Fig. 1, is 20 feet long, it will travel from one high position to the other and back again in about five seconds. This time will be required to complete an entire double-swing from right to left and back, regardless of the distance through which the seat moves; if it is "swinging low" it will move comparatively slowly, and if "swinging high" it will automatically go fast enough to make each half-trip in two and one-half seconds.

The time required for any vibrating or swinging body to make a full or double swing is called its *time period*, or simply its *period*. The double-vibration itself is called a *cycle of oscillation*. The *frequency* of vibration is the number of cycles or complete vibrations that the system completes in one unit of time. In the case of sound-waves the vibrations are so rapid that we measure the number in one second, and speak of the frequency in *cycles per second*; for our swing which has a period of five seconds, it is more convenient to measure the frequency per minute.

Since there are 60 seconds in one minute and since the swing uses five seconds to make a complete swing or cycle, it is quite evident that the swing will describe 12 round-trips in one minute. Thus, its frequency is 12 cycles per minute. This is the frequency that the swing will take if started and left to itself, and consequently it is called the *free or natural frequency* of the swing. Of course, we can force the swing to vibrate at any other rate we desire if we will hold on to it and move it by main strength; in that way we can force it to move back and forth only five or six

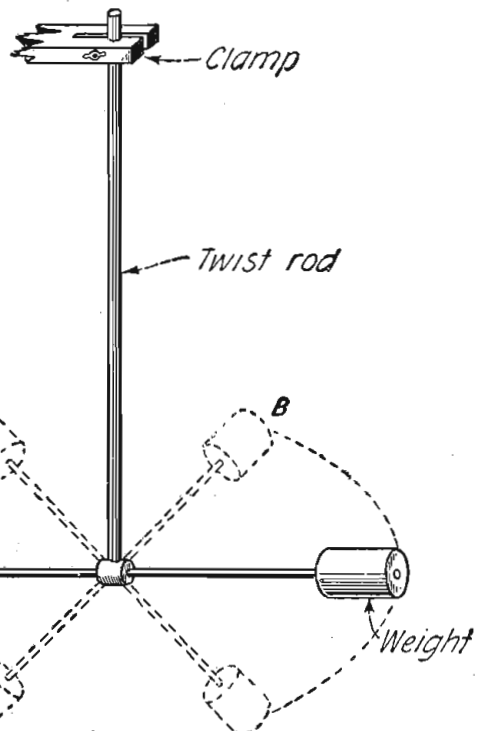

Fig. 2

A twisting dumb-bell or Torsion Pendulum; the weights swing back and forth between A and B, as indicated by the dotted lines.

times per minute, or we can speed it up to go even 20 times per minute. To do this, however, we will have to work hard and actually drive the swing at every point of its motion; for if we leave it alone for an instant it will begin to regain its natural frequency of 12 per minute.

On the other hand, we can keep the swing in motion at its natural frequency simply by pushing it slightly each time it passes us. Very little effort is required to keep it going at this rate, for we are taking advantage of its natural tendency to go back and forth at its own frequency. This natural frequency of vibration is the rate of swinging which is most easily attained by the system.

The middle C string of the piano has a natural frequency of 256 cycles per second. When an air-wave of this same frequency strikes the tuned string, the wave-impulses are able to set the string swinging back and forth strongly. It is a case very much like that of the swing, for when the driving impulses pushing the swing are timed to the rate of 12 per minute (which is the natural frequency of our swing), it is easy to make the seat move higher and higher with each oscillation.

CHANGING THE NATURAL FREQUENCY

We have seen that we can change the natural frequency of a musical string, or tune it, to give off any desired note, merely

A simple battery circuit; direct current flows through the wires in the direction indicated by the arrows.

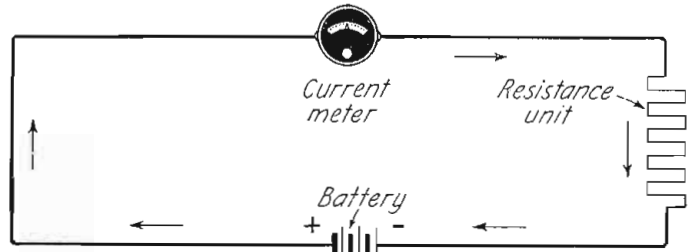

Fig. 3

time required for the weights to swing from one extreme position to the other and back again. This time is, of course, the period of the pendulum. The number of double swings or complete cycles that it makes in one second or in one minute is the natural frequency per second or per minute. A typical twisting dumb-bell of this sort will swing through a full cycle in one second; therefore its free or natural frequency is one per second or 60 per minute.

Suppose that we have such a torsion pendulum, with a natural frequency of 60 cycles per minute. If we take the twist rod between thumb and finger, about half-way down from the supporting clamp, and "roll" it slightly, we can move the swinging weights a short distance along their circular path. If, having

to oscillate at any other rate, we must either force it to do so by main strength (keeping hold of the swinging weights throughout their movements and not permitting them to oscillate freely) or we must change the natural frequency of the pendulum to the new value which we desire.

How can we change the natural frequency of such a twisting pendulum? What can we do to it that will correspond with changing the size or the tension of a piano string, and so change its rate of vibration?

It should be almost self-evident that if the twist rod is made more flexible, or more flimsy, it will not have so much spring or restoring force and consequently it will not be able to swing back the weights so fast when they are displaced from the position of rest by turning them in one direction. Therefore the time period may be lengthened, and the natural frequency correspondingly decreased, by increasing the flimsiness of the torsion rod. If the rod is left without change, but heavier weights are put on the swinging arms, the restoring force of the rod will be insufficient to move the larger weights as rapidly as before. Consequently, increasing the mass of the pendulum weights in a twisting dumb-bell system will also re-

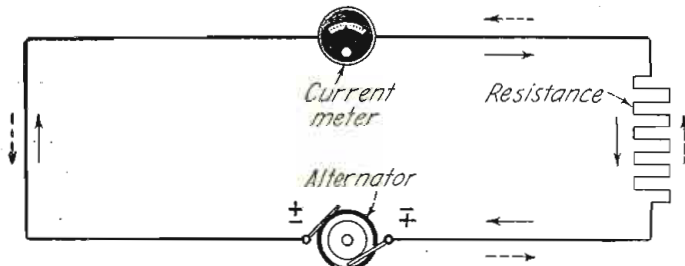

Fig. 4

Alternating current circuit; where the left-hand terminal of the alternator is positive, the current flows as indicated by the solid arrows, and by the dotted arrows when the right-hand terminal is positive.

by changing its size or its tightness. Let us now find out how the natural frequency of a mechanical system can be controlled.

The simplest slowly-oscillating mechanical arrangement which is capable of easy and flexible adjustment is probably the "twisting dumb-bell" or torsion pendulum shown in Fig. 2. This is nothing more than a vertical rod or stiff wire, clamped firmly at the upper end to prevent it from turning at that point, suspending a horizontal section which carries a weight at each end. The bottom part resembles a dumb-bell; for convenience in experiment it should be provided with interchangeable weights of several different sizes.

If we set up such a torsion pendulum with a rather thin vertical twist-rod and moderately heavy weights, it will have a fairly slow motion or low natural frequency. To set it going, you twist the dumb-bell around in a horizontal plane as far as it will move easily, and let go. The dumb-bell then swings back and forth, the weights moving in a horizontal circular path, first in one direction and then in the other, the motion gradually becoming less and less until the weighted arm finally comes to rest in its initial or undisturbed position. We may measure the

A condenser-coil or oscillatory circuit provided with charging battery and switch in addition to a discharging switch. Oscillations are produced in the inductance coil circuit shown in heavy lines.

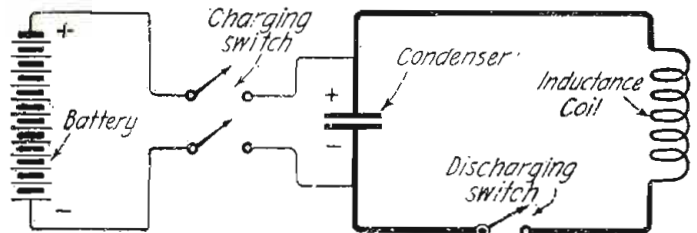

Fig. 5

given the pendulum such a feeble impulse, we allow the weights to swing back, their momentum will carry them past the position of rest and part way around in the opposite direction. The springiness of the twist-rod will soon arrest this motion, however, and the weights will once more swing in the direction in which we started them. We may now "roll" the rod between thumb and finger again, as before, and the second impulse will carry the weights a little farther away from the rest or natural position. By impulsing the system once in each swing we can build up an oscillation of considerable size, in which the weights swing with a good deal of motion. But to do this, the driving force must be applied at the right time in each oscillation; in other words, its frequency must agree with the natural frequency of the driven system. If we desire the dumb-bell

duce the frequency of natural oscillation. By a proper choice of flimsiness and mass we can make the natural frequency of the pendulum any value we desire within the practical limits of the structure. It is interesting to note that when we change the tension of a vibrating musical string we change the restoring force, and that alterations in the size of the wire change its mass for a given length; thus the control of the natural vibrating frequency of a piano wire is much like that of the torsion pendulum.

TUNING AND RESONANCE

We have seen that in order to drive a vibrating system most effectively, the frequency of the driving impulses must be practically the same as the natural frequency of the driven system. This was true of the musical string, the child's swing, and the twisting dumb-bell. It is equally true of all other systems, mechanical or electrical, which are capable of natural or free oscillations and which consequently have natural frequencies of vibration. The agreement or practical identity of the frequency of the applied force and the system which it is intended to operate is what we call resonance or *syntony*. When the vibrating system has its natural frequency adjusted to agree with the frequency of the driving force, it is said to be tuned to that frequency.

In this connection we must not overlook the fact that any oscillating system may be

(Continued on page 1270)

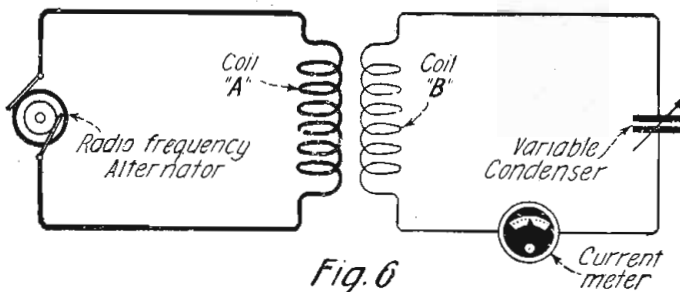

Fig. 6

How a high frequency dynamo may be arranged with a two-coil transformer to produce radio currents in a coupled condenser-coil circuit.

The Ultradyne Receiver

Part II

By **ROBERT E. LECAULT, A.M.I.R.E.**

In the last issue of this magazine, an improved Super-Heterodyne was described, with which no audio frequency amplification was used. In this article is described a two-step amplifier, especially designed to match the Ultradyne receiver and additional notes on the receiver itself are given.

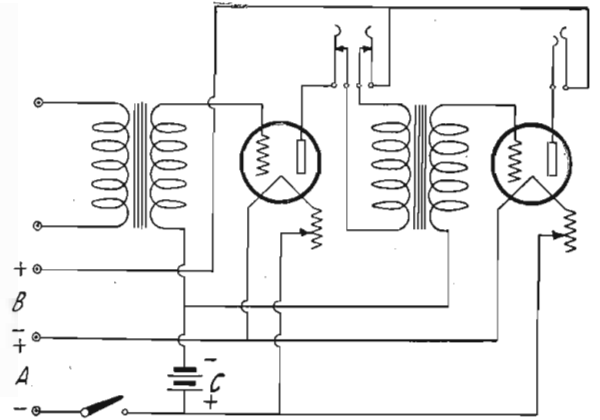
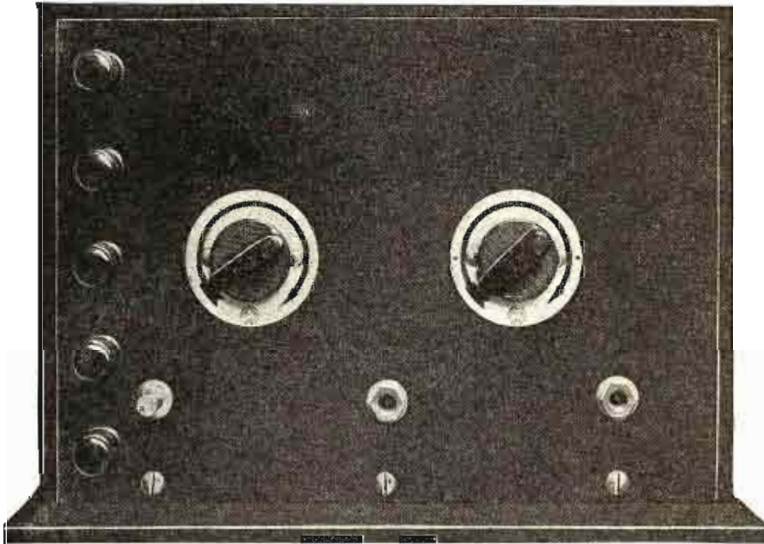

Fig. 6

On the left is a front view of the amplifier and on the right the diagram of connections, with the binding posts arranged in the same order as they are on the panel.

THE two-step audio frequency amplifier described in this article does not present any radical departure from the standard type, and although it is designed to match the Ultradyne receiver, it may be used with any kind of receiver, including crystal sets.

The complete amplifier is built in a cabinet 7x10x7 inches. The 7x10-inch panel is fixed to a wooden base, cut to fit inside of the cabinet, and upon this base are mounted the various parts comprising the amplifier. The parts necessary for the construction are: One panel 7x10 inches; one cabinet 7x10 inches; five binding posts; one battery switch; one double circuit jack; one single circuit jack; two rheostats; two sockets; two audio frequency transformers; one 4½-volt flashlight battery; a piece of sheet brass cut as shown in Fig. 5; screws for mounting the parts on the board; and bus-bar wire.

The audio frequency transformers to be used in this amplifier should be bought from a reliable manufacturer and have a ratio of not over 3:1 or 4:1 at the most in order to prevent distortion. A great many amateurs believe that a high ratio transformer should be used in the first stage. This is entirely wrong, as a high ratio transformer distorts speech and music and if the distortion is amplified in the first stage, it is much more marked in the second stage; therefore, the same low ratio transformer should be used in both stages.

The parts used in the construction of the amplifier should be of a good grade and all the following points should be observed when buying them. The rheostats should have the resistance element wound tightly so that the wire does not become loosened after being heated up by the current passing through it. The spring blade sliding over the wire should run smoothly and insure good contact. The screws should be long enough to permit a piece of bus-bar or heavy wire to be screwed tightly under. The sockets should be of substantial construction with enough material to prevent breakage of the part around the slot where the vacuum tube is inserted. The binding post or terminals should present enough surface to insure a good contact with the connections, and the spring blades pressing against the prongs of the tube should be made of spring brass or phosphor bronze which will not stay bent if once pressed down.

Figs. 1, 2 and 3 clearly show the arrangement of the various instruments on the board and the panel as well as the wiring, which in this particular unit was made with some No. 16 bare copper wire. The flashlight battery is used as a "C" battery to keep the grids of the vacuum tubes at a negative potential. Since this battery does not deliver any appreciable current, and is not changed often, it was found more practical to mount it inside the cabinet. This battery, if of good make, should last about a year and may be changed when necessary by removing the brass plate holding it in place and unsoldering the two leads connected to the blades of the battery. When connecting the battery, care should be taken that the negative pole is attached to the secondary windings of the transformers. The negative pole of the battery is the one soldered directly to the zinc case of one of

the extreme cells. The positive blade of the battery is generally imbedded in the sealing wax, while the negative is directly under the wrapping.

Fig. 4 shows the panel layout with the necessary dimensions for drilling the holes which are needed for mounting the binding posts, rheostats, switch and jacks. For the construction after the panel is drilled, one should proceed as follows:

ASSEMBLING THE AMPLIFIER

First mount on the panel the instruments mentioned above and fix the panel on the wooden base by means of three screws. Second, arrange on the wooden board the transformers, sockets and "C" battery so as to have as much room as possible around them, as this prevents capacity feed-back and makes the wiring easier. After the sockets, transformers and battery are tightly screwed down, the wiring may be done by

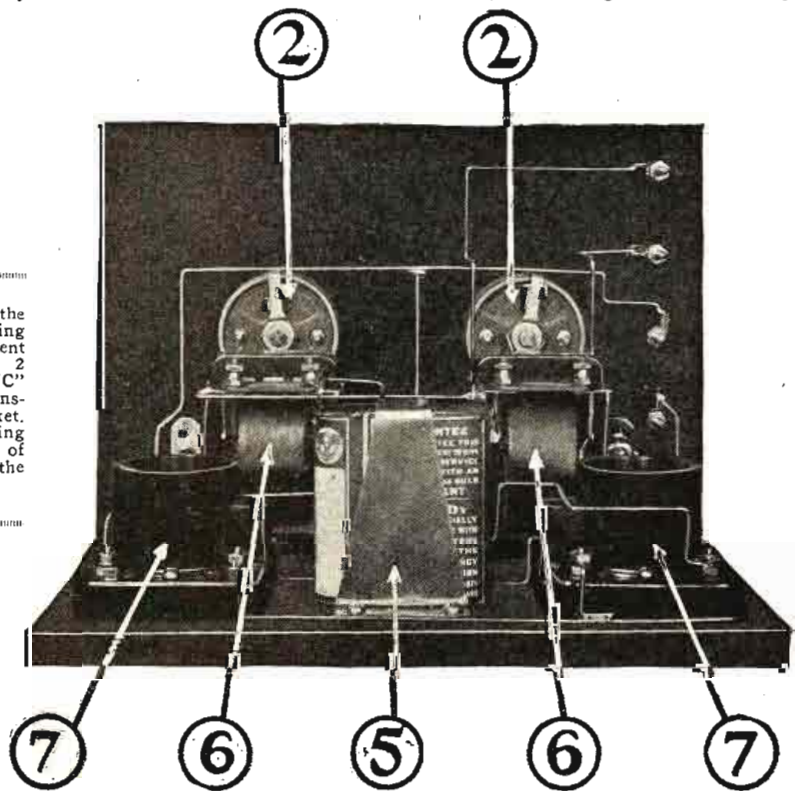

Back view of the amplifier showing the arrangement of parts: No. 2 rheostats, 5 "C" Battery, 6 transformer, 7 socket. Note the wiring and the strip of brass holding the "C" Battery.

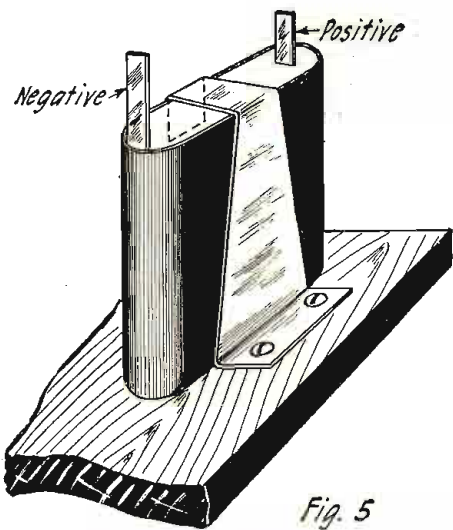

Fig. 5

This sketch shows how to mount the flashlight battery used as a "C" battery and the position of the poles on top of the battery.

means of the bus-bar or copper wire which should be bent at right angles, as shown in the photographs. The two upper binding posts are connected to the primary winding of the left transformer. Care should be taken that the binding post marked P on the transformer is connected to the binding post on the panel corresponding to the one connected to the plate of the detector tube in the Ultradyne receiver, as this permits the bridging of all binding posts by means of straight pieces of wire. The middle binding post to which the positive of the "B" battery is connected, connects the two upper blades of the jacks, while the lower ones are connected to the plate terminal on the sockets. The next binding post is the positive "A" battery and is connected directly to the two sockets, while the negative binding post, which is the lowest one, is connected to the battery switch. From the switch, a wire should run to the two rheostats, the other terminals of the rheostats being connected respectively to the two sockets. From the secondary windings of the transformers, leads go to the grid terminals on the sockets, while the other end of the secondary windings are connected together and also to the negative of the "C" battery. From the "C" battery positive, a wire is soldered to the negative of the "A" battery between the switch and the rheo-

A top view of the two-stage amplifier, showing all the instruments and their respective positions: No. 1, switch; 2, rheostats; 3, double circuit jack; 4, single circuit jack; 5, "C" battery; 6, transformers; 7, sockets.

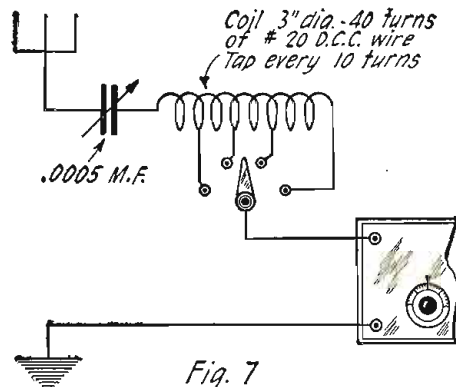
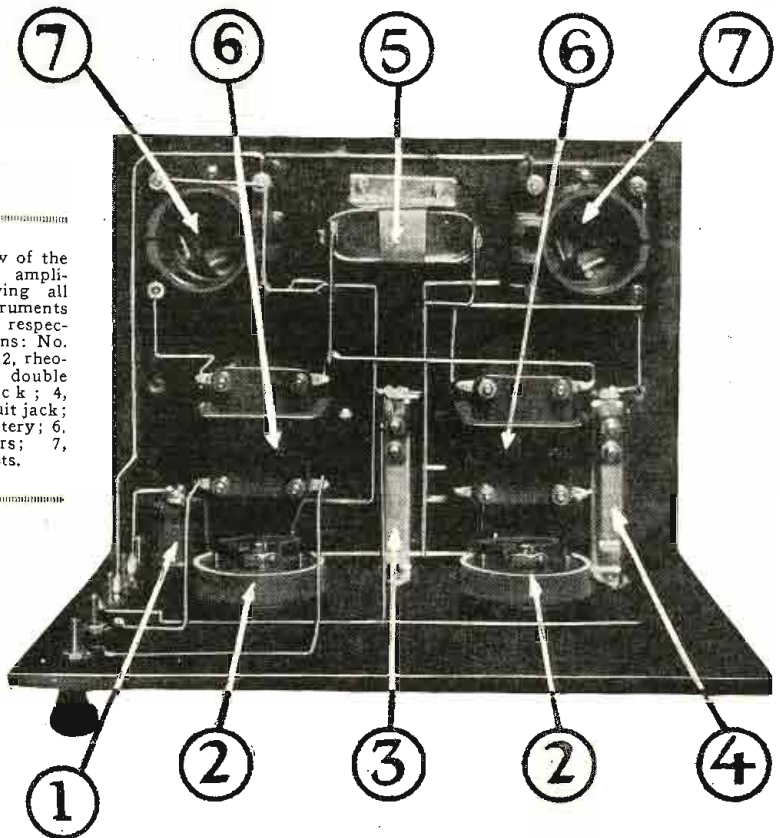

Fig. 7

When using various forms of aerials with the Ultradyne receiver it is sometimes advantageous to follow the above arrangement.

stats. The primary of the second transformer is connected to the two middle blades of the double circuit jacks, so that the terminal marked P is connected to the lower intermediate blade of the jack. Of course, all the jacks and joints of the wires should be carefully soldered.

As a precaution before mounting the sockets on the base board, the screws forming binding posts should be tightened with a screw-driver and pliers because it is extremely difficult to reach them once the socket is fixed, and very often a bad contact is formed between the screws and the blade, making contact with the tubes.

NOTES ON THE ULTRADYNE

We have found that a great many fixed condensers now on the market have not the capacity marked on the outside casing, and this may be a source of trouble when operating the receiver described in the last issue. We have tested about a dozen small mica condensers on a standard capacity bridge, and we have found that although the capacity marked was .00025 M.F., their true capacity varied from .0002 to as high as .00052 M.F.

As it is important to use the correct capacity across the first radio frequency transformer, we would advise those who do not obtain good results with the Ultradyne receiver they have built to try a variable condenser in place of the .00025 M.F. fixed condenser across the primary of RF-1, shown in Fig. 2, Part I of this article. If better results are obtained at a certain setting of the variable condenser, a fixed one, having the equivalent capacity, should be used.

USING AN OUTDOOR AERIAL

If it is desired to use an outdoor aerial with the Ultradyne receiver described in the last issue, it might help in some cases to connect a variable condenser in series with a tapped inductance between the aerial and the receiver, as shown in Fig. 7, for with some types of aerials the tuning may not be sharp enough.

When operating the receiver in congested districts, a great deal of interference may be avoided by using a loop aerial. This permits the reception of distant stations with a minimum of interference and static, a feature which is quite important for summer time reception.

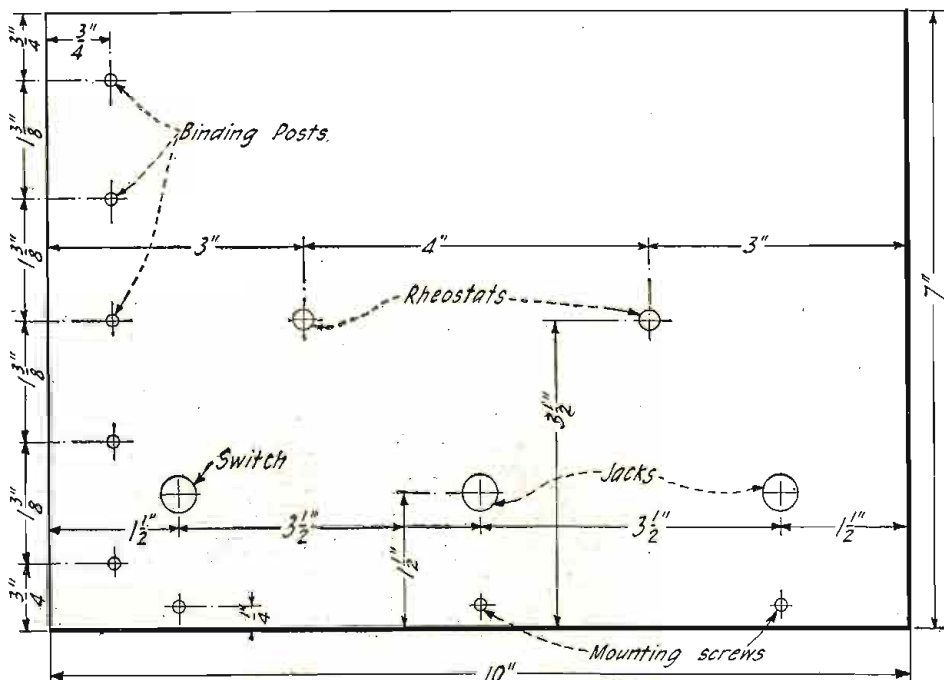

Fig. 4

The panel layout for the two-stage audio frequency amplifier. Only the center of each instrument is indicated as the mounting screws are differently spaced for each make of instrument.

Another Historic Event in Amateur Radio

By LAURENCE S. LEES



This, we believe, is one of the most interesting articles RADIO NEWS has ever had the opportunity to publish. Never before has amateur radio been crowned with such success. French 8AB is heard regularly on this side of the Atlantic by numerous amateurs and he is able to carry on consistent communication with 1XAM and IMO. What next!

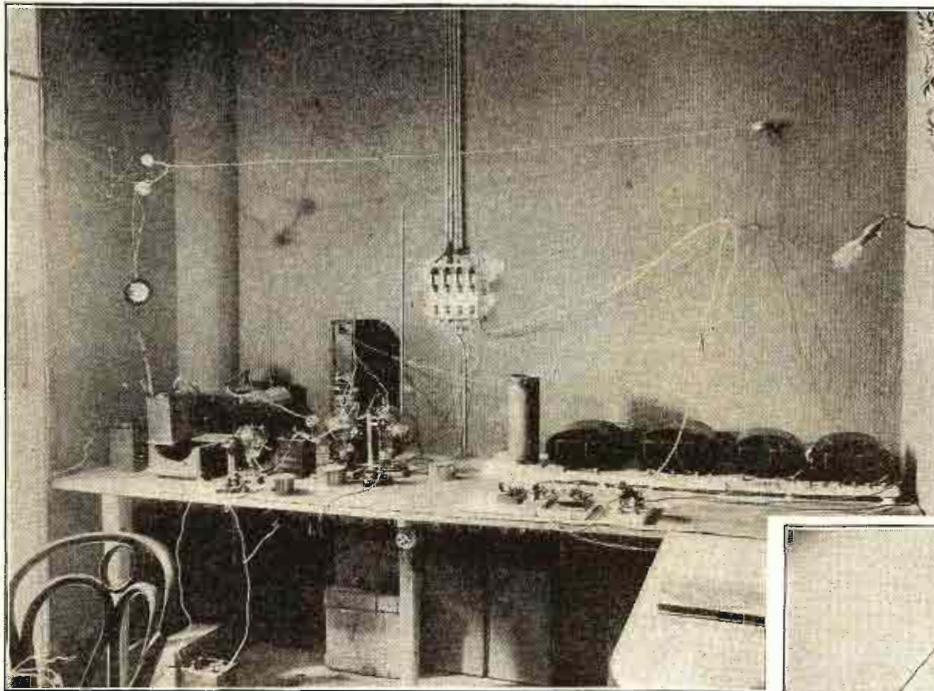

first journalist to get to him after his success in bridging the "herring pond" with a 100-meter wave.

Taking a pile of log books out of the bookcase in the neat study which adjoins his laboratory, he began telling me of his earliest efforts to catch the call signals of the American amateurs. He took part in the disastrous trans-Atlantic contest of February, 1921, and like all the other European amateurs, was not able to hear a single station call. He went without his share of sleep again for 10 nights in December of that year and had for his reward the word TEST for sure on the night of the 16th. But the call signal he was unable to catch.

It will be remembered that the famous American amateur, Mr. Godley, then in the British Isles, scored the most conspicuous success. Ten nights spent in bitter weather in an insufficiently heated tent on a Scottish moor shows of what heroic stuff amateur

I CALLED on M. Léon Deloy at his Nice home a few days after he had established bi-lateral communication between Europe and the United States. I found him talking by land line to a friend in Marseilles who had rung him up for details of his exploit. When he had finished, he pushed me into an enormous armchair, handed me a packet of cigarettes and in a very self deprecatory manner began to tell me of his feat.

Those readers of RADIO NEWS who met M. Deloy—you know him best probably as French 8AB—will remember his low voice and modest demeanor. He has a knack of making all whom he comes in contact with feel comfortable. He welcomed me as the

Three views of French 8AB located at Nice. The upper photo shows the transmitter employed in the tests. The Reinartz balanced C.W. circuit is used. The two receivers, a Grebe CR-13 and an eight-tube super-heterodyne are seen in the lower photo. To the right is shown a view of the special antenna system used for transmission on 100 meters.

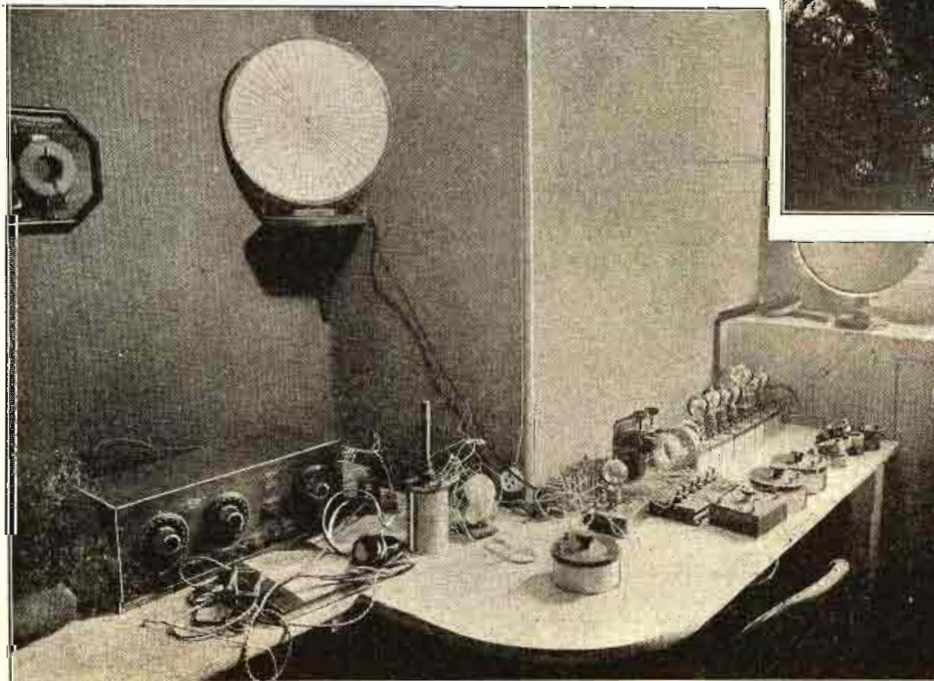
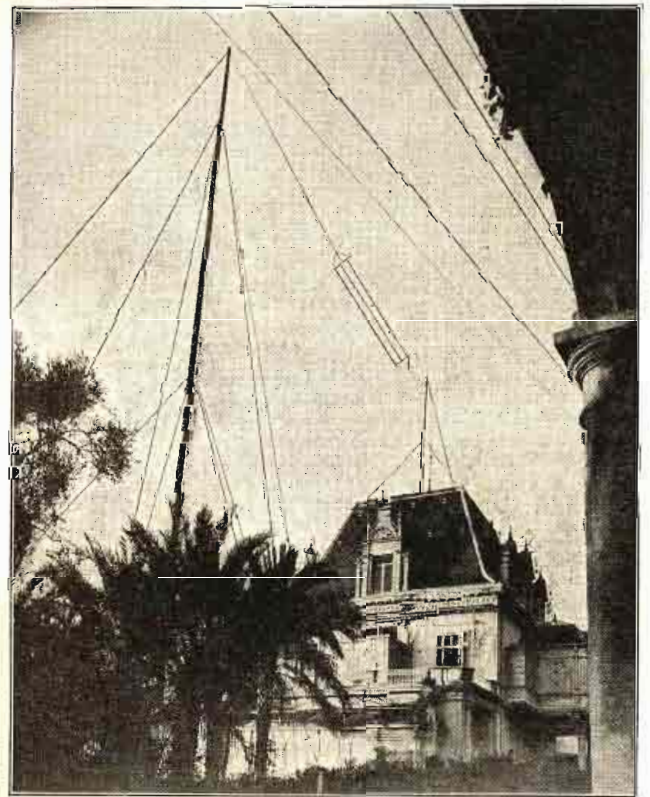

radio fans are made. M. Deloy was enthusiastic in his praise of Mr. Godley, but I really think that the success of the American put some "ginger" into the European amateurs, which has resulted in the unceasing efforts of the French and British amateurs to get across.

HIS FIRST ACHIEVEMENT

What disappointed M. Deloy very much in his own failure was the fact that he was able to pick up with ease the signals which, previous to the February essays, Chelsford sent on a 200-meter wave-length for experimenters to pick up. These signals were sent out on varying intensities, first, 1-kw., then 1/2- and finally 1/4-kw. M. Deloy was the most distant amateur to pick up the signals and his reception was marvelous. Marvelous is the only word to describe his performance at the time, because of his geographical posi-

(Continued on page 1290)

Radio Oddities



Above: Dr. H. G. Thompson, a Chicago dentist, has introduced the idea of soothing the pain that goes with having one's teeth attended to, by the use of a radio receiving set to which his patients can listen. It takes the "kick" out of the "pull", so they say. © Wide World Photos.

Right: If curiosity killed a cat, we can see where our little friend "Buddy" is in for a lot of trouble. Radio has a peculiar fascination for him, and he often climbs right into the loud speaker, to see just where all the sound comes from. © Photographs, N. Y.

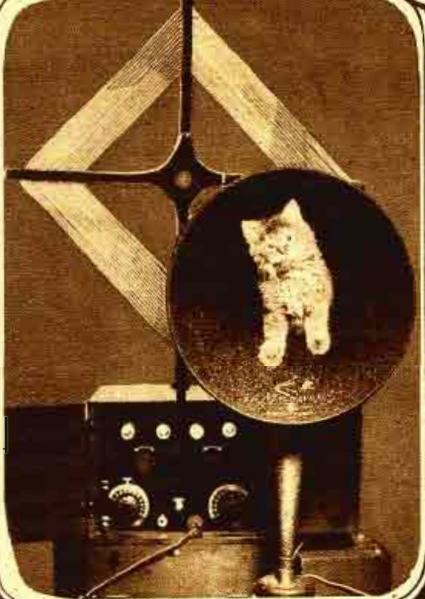

A Grecian vase serving as a loud speaker and a receiving set mounted conveniently in a writing desk are the latest in the way of radio in England. The vase, by the way, is built especially for this purpose; it is attractive and serviceable, to say the least. © Wide World Photos.



C. J. Waldron of Medusa, New York, faithfully listens in each day of the week for the noon-hour signal as transmitted from the Naval Station at Arlington, and re-broadcast through the General Electric Station at Schenectady. When the noon-hour signal has been heard, Mr. Waldron rings the bell in the village church and members of the community may set their watches at the correct time. © Wide World Photos.

Veteran Announcer Tells of His Experiences

BECAUSE of the fact that he holds the world's record for length of service as a radio announcer, H. W. Arlin, announcer at KDKA, the world's pioneer broadcast station, at East Pittsburgh, Pa., has probably had many experiences of interest to the BCL and amateur.

Mr. Arlin is one of KDKA's voices; the one with the most power. The voice that clips its words and sounds so business like. It is the one that has something of the twang of the Southwest in it.

February, 1921, saw the first of Arlin's announcing. Nearly 600 stations have been started since that time and the radio audience has increased a thousand fold and he has seen it all grow. The unusual things that he remembers are many but those recorded in the following are the ones that he remembers best.

Part of the audience uses the telephone

to get in touch with the station regarding announcements. One evening an excited man phoned in, asked for the announcer and then pleaded that news of the birth of twins to his wife be read by radio. The happy father was almost heartbroken when his request was refused. Another time, the phone rang and a newly wedded husband was nervously talking. The young man's request was quaint. He wanted KDKA to announce his wedding and then gave the knockout punch to his request. It was to the effect that because no publicity was wanted, the ceremony was kept from the newspapers. Yet he wanted his marriage announcement broadcast.

The most embarrassing event in Mr. Arlin's radio experience happened the first time Roger Babson, the famous statistician spoke from KDKA. It was in the early days when the system had not become the

fine thing it is now. Mr. Babson was nervously facing the microphone for the first time. Mr. Arlin was nervous because of efforts to assist the speaker. Finally the talk was started and then came the sad news after five minutes of an address. The transmitting set had not been turned on and the talk had to be given over again. It was quite embarrassing, according to Mr. Arlin, to explain this difficulty to a man of Mr. Babson's prominence, but it had to be done.

MOTHS VS. RADIO

In the spring of 1921 the KDKA transmitting room was located on the roof of a nine-story building. The microphone stood under a bright light and the windows of the studio were open at the top. It was a beautiful spring evening. Moths fluttered about the light thickly. A young tenor was singing into the microphone a throbbing,

(Continued on page 1320)

Radio Pictorial



The top photo shows a general view of the Monster Electrical and Radio Show, held in Paris for the first time. Many exhibitions, from America and other countries, of the latest radio developments were shown. © Kadel & Herbert. Below: George A. Wick, of station "WCAP," located at Washington, D. C., operated the amplifier control apparatus from the gallery of the house during President Coolidge's delivery of his first message to the 68th Congress, at which time thousands of people were listening in on their radio sets. This was the first time in the history of Congress that radio was used. © Kadel & Herbert.

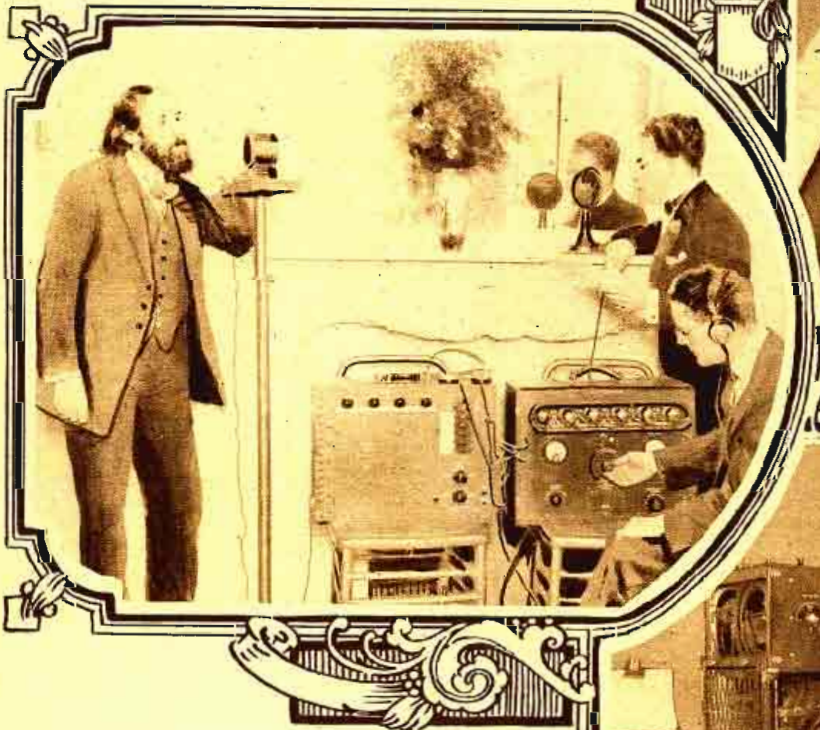
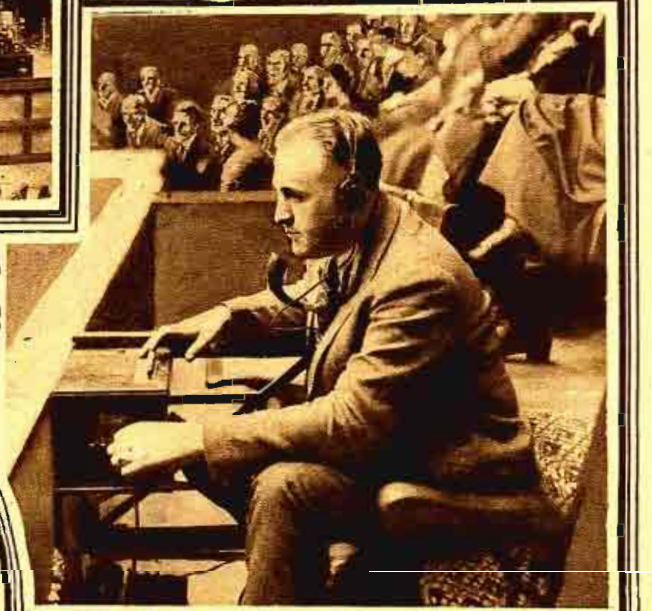

Above: Anton Lang, internationally known as the Christus of the Oberammergau Passion Play, who is now in America, sees something of the modern miracle, the radio, for the first time. Through the Radio Corporation station "WJZ", he delivered an address that reached more than a million people. The address was made from his own room in the Waldorf-Astoria Hotel, a special wire connecting him with the broadcasting station in Aeolian Hall. It was difficult to convince Anton Lang that he could talk "through the air", and directly from his hotel room to the outside world. The Passion Players had never even heard of such a thing as radio, and Anton Lang has rightly termed radio "The Modern Miracle". The photo shows, at the left, Anton Lang delivering his address over the radio, with Thomas A. Cowan, "WJZ" announcer, and H. V. Higgs, operator, on the right. Note the amplifying equipment it was necessary to bring to Anton Lang's room in the Waldorf to make this feat possible. © Kadel & Herbert.



Above is a view of the radio room on the new S.S. *Voltaire*, one of the liners which plys between New York and South American ports. The C. W. transmitter to the left has an output of 1½ K.W., which insures an ample transmitting radius. In front of the operator is a six-tube direction finder and next to it, the receiving set which employs a separate heterodyne for the reception of C.W. signals. © Keystone View Co.

Recent Radio Events

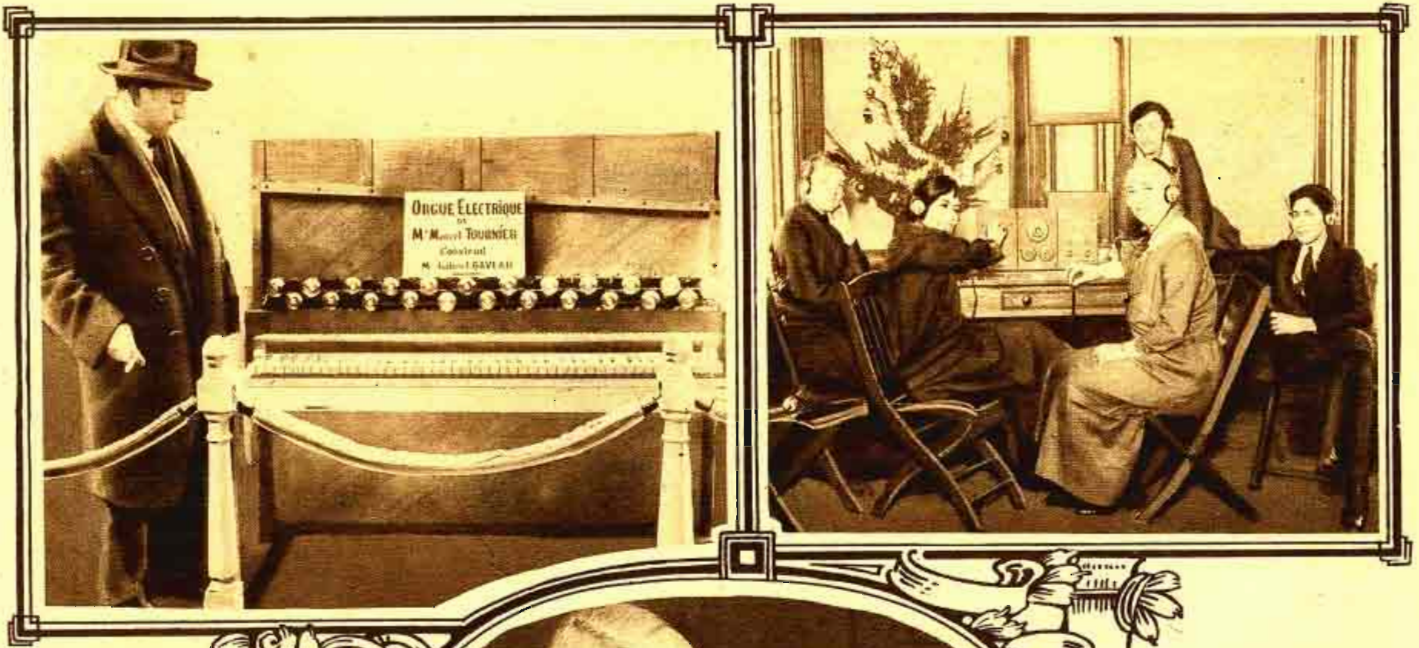

Above: One of the most interesting features of the Paris radio show was the exhibition of an electric organ employing the well-known and greatly used vacuum tube. One vacuum tube is used for each note of the organ and is adjusted so that when its key is depressed, it will oscillate at a definite frequency or period of vibration. The music from an organ of this type is said to be very beautiful. The inventor, Mr. Marcel Tournier, can be seen at the side of the "vacuum tube" organ. The piano part was constructed by the well-known firm of Gaveau. © Kadel & Herbert.

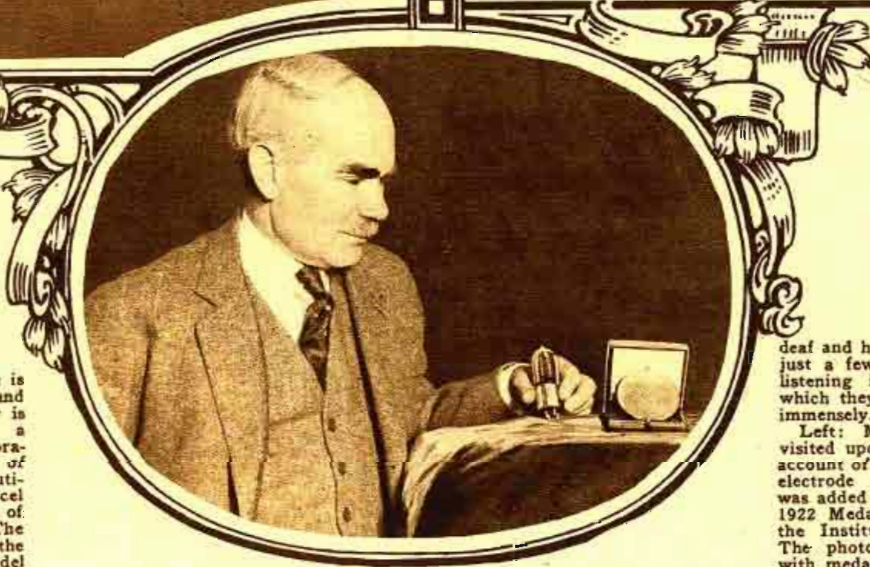

Above: The New York League for the hard-of-hearing lays claim to being the first New York institution of its kind to employ radio to aid the deaf and hard of hearing. Here are just a few members of the league listening in on a radio program which they are, no doubt, enjoying immensely. © Photonews, N. Y.
Left: Many honors have been visited upon Dr. Lee De Forest on account of his invention of the three electrode vacuum tube. Another was added by the presentation of the 1922 Medal of Honor, awarded by the Institute of Radio Engineers. The photo shows Dr. De Forest with medal and the tube that won it. © Kadel & Herbert.

Co-operation Necessary in Radio Traffic Problems

CONTROLLING radio traffic is something like handling vehicle traffic in a busy city where regulations exist and are observed by all.

Amateur radio operators and the broadcasters, it appears, no longer interfere with one another, but both are now complaining of the ship interference, Supervisors of the Department of Commerce point out. Needless to say, the ships must be permitted to communicate with the shore stations and each other. While some of them may still have the idea that the "air" belongs to them, as it did, virtually, for years, they now claim with some justice that there are not enough channels for their necessary communication.

Ship operators report—and supervisors agree—that the wave-lengths assigned to vessels are not all they should be. The 300-meter wave is not efficient; the 600-meter wave, used for calling and for distress signals, is always in use, and the 706-meter wave can't possibly serve all the vessels operating. So far as is known, it is understood that many foreign ships are not yet equipped to use 706 meters, which throws them on the 450- or 600-meter channel. Consequently the ships have to resort to the 450-meter wave assigned them. And this is squarely in the middle of the broadcast wave band. They are practically forced to use this wave-length for their

position reports transmitted between 7 and 11 p.m. daily.

TO ASK OPERATORS

In an effort to alleviate the interference, the Department of Commerce has asked Supervisors to take up the question with owners and operators. They are asked to transmit their position reports before 7 p.m. and after 11 p.m., which, it is believed, would relieve about 25 per cent. of the existing interference off the coasts in the neighborhood of broadcast stations.

Commenting on the interference situation recently, an official of the Department of Commerce said that the control of radio traffic was very similar to heavy automobile traffic in the street. Regulations have to be laid down and enforced in the air as well as on the public roads.

Automobiles have no special privileges as to right of way or speed. In other words, there is no class distinction shown. Regulations provide a speed, the right side of the road, stops at crossings, etc., for trucks, private, public and commercial cars. So the Department is trying to regulate the radio traffic in the air in the same way. Broadcasters, amateurs, commercial shore and ship stations must comply with traffic regulations, keeping in the channels assigned them. Through co-operation alone can the great air traffic be managed successfully.

FILE COMPLAINTS INTELLIGENTLY

Listeners-in who complain of interference waste their time and the time of the Department and its field force by complaining of interference in general; they must be specific, if aid is to be rendered, it was explained. Unless the call letters, or name of the offender, the time of interference and the nature of the matter sent is given to the Department, it is necessary to send a special investigator to the locality, where he has to listen-in for several days to find out who is causing the trouble. This entails a great amount of time and expense and the field force is small and inadequate to the demands.

Owners of receiving sets who think they hear interference in the silent amateur period must ascertain if it is an amateur or a ship. If they cannot read code, they should find an amateur neighbor who can, asking him to listen in and record what is being transmitted. His report can then be forwarded to the District Supervisor or the Department. Such complaints would aid the Department materially. Literally hundreds of valueless complaints are received in comparison to one reliable and accurate report of interference. Sometimes receiving sets are supersensitive, it was pointed out, and the interference may not actually be in the air but produced by other causes.

The Sad Story of AZZ

By ELLIS PARKER BUTLER

Author of "Pigs is Pigs"



Here he broke down and wept into a box of regenerative tubes on my counter. This took the static out of them and ruined them for life. When he raised his head his eyes were wet with tears. "Alas for that month!" he moaned. "It was during that month that my darling Mamie, down there in Virginia, let her cousin Amelia coax her to listen in to WPQX."

I SUPPOSE you know the recipe for making a genuine double-dyed radio fan. It begins with a "Take a —," just as all recipes do, and it goes something like this. "Take a man or woman who has declared he or she doesn't like radio and won't have a radio apparatus and hates radio like sin." Those are the people who get the radio bug in its severest form; after they have shrieked to the world that they detest radio and all its works, they generally get a \$5 crystal set and presently you find they own a super-complex back-flip monoduoodyne affair that cost \$800, and have given up eating and sleeping in order to spend all their time listening in.

From what this fellow, whom I call ex-AZZ, told me, I guess Mamie was a fan

of that sort. And I might say right here that you don't pronounce him as if he was spelled ex-azz, although he was an exasperated young man when he told me his story, which was one of the saddest in the world. No, you pronounce him ex-A-Z-Z. You've heard him often enough, when you have tuned in to WPQX, saying in the nicest voice in the world: "This is Station WPQX, A-Z-Z announcing." Maybe, if you are a husband, you have felt a little sore when you saw your wife open her eyes wider and draw a deep breath of bliss and heard her say, "Oh! That's that lovely A-Z-Z announcing!"

All right! Now you know who I am talking about and I can get down to his sad, sad story. And don't blame me if it

breaks your heart. I'm doing this for him, because he thinks that if Mamie sees it in print she may believe it. She won't believe him.

I started this little radio repair shop of mine, you understand, and I was going along doing a pretty good business. I had enough stock to replace anything that happened to break in my customers' sets, and I could show what was the matter with the home-made sets that did not work, and I was able to pay the rent and put a dollar in the bank now and then, and I gave credit to an ad for most of the business I got. I kept running in the papers the following: "If you have radio troubles bring them to me; I can fix them."

Well, on this evening I'm telling about, business was a little slack and I was sitting on the counter talking to M. K. Simmons. We were real interested in what we were saying and at the moment I did not pay much attention to the nice looking young fellow who came in and stood waiting for us to get through our chat. He did not seem to be in much of a hurry—just stood back and listened.

Simmons was telling me about his wife. He said that if his wife wasn't 52 years old and the mother of six children he would sure be jealous, because, what did I think? He had seen a post card on her desk addressed to this A-Z-Z, care of Station WPQX, New York, and the other side of the post card said, "I want to say how much I enjoy listening to AZZ'S announcing. Please tell him I am sorry he has a cold and hope he will be rid of it soon."

"Yes," I said, "my wife is the same way about that duck. She would rather hear that AZZ say, 'The next number on our program is—' than hear a Philharmonic symphony, or listen to Dempsey knock Firpo's block off. But I don't know that it's so queer, either. A lot of men get that way over some telephone girl's voice. I've heard men get so excited over the sweet voice of some girl that they have only heard say, 'One minute, please!' that they have invited her right then and there to go to dinner with them, and to a show after dinner. And, as like as not, if they ever did see her, she was at least 40 and looked like a withered lemon. Don't you worry about your wife, Simmons—there are a couple of million other ladies in love with that A-Z-Z voice, and I expect he gets two bushels of mash notes per day and doesn't think any more of them than if they were autumn leaves. They get used to it, those fellows, and it doesn't mean anything to them."

So M. K. Simmons said that was so, and bought a couple of dry cells, and went home. I turned to my big set and tuned in on WPQX, so the loud speaker would spout it out onto the sidewalk, and the first thing I heard was "This is Station WPQX, A-Z-Z announcing—" and then I turned to this young fellow and asked what I could do for him this evening. And when I got a sight of his face I saw the saddest face I ever saw in my life. It looked as if he had lost his last dollar and his relatives on both sides of the family and his pet dog and everything he had.

"I saw your advertisement," he said. "Yes, I've got one," I said. "What about it?"

"You say you can cure any kind of radio troubles," he said. "Can you?"

"I wouldn't advertise it if I couldn't, friend," I told him.

(Continued on page 1350)

A Radio Hotel

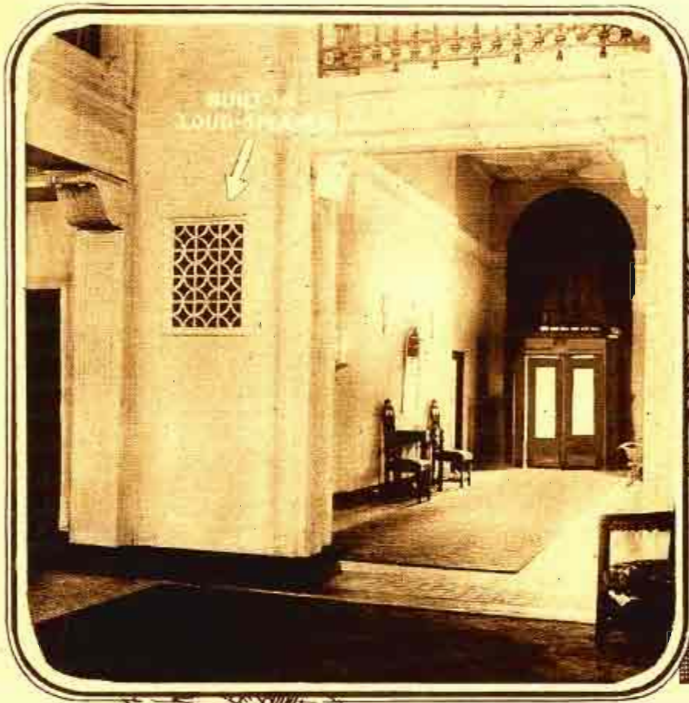

Above, a view of the foyer in the recently completed Pennsylvania Hotel in Philadelphia, shows one of the built-in loud speakers, many of which are situated at different parts of the hotel. These are all connected together and are operated from the same source.

These loud speakers are conveniently situated in waiting-room, foyer, lobby, and, in fact, in all parts of the hotel where people gather. Not only are they used for the reproduction of broadcast programs picked up by a special receiving set, but are employed for the purpose of paging and the reproduction of the music from the hotel orchestra.

NOT only has the Philadelphia public been bitten with the radio bug, but apparently the more prominent hotel and apartment house owners and engineers also have decided that radio benefits are to be a future added convenience to the comfort of their tenants.

The Pennsylvania Hotel, which is rapidly nearing completion, contains upward of 600 rooms; it is being equipped with one of the most modern radio systems in the world.

A special radio room has been built upon the roof; this will be equipped with a modern type of receiving apparatus connected to powerful amplifiers distributing the received radio features from local and distant stations to the main dining room, the lobby, the lounge, smoking room, banquet hall and grill, separately or to any or all of these locations simultaneously. The distributing apparatus consists of projectors—or, as they are commonly known, loud speakers

—of special design and giving a much better quality to the received energy than is present with the usual types of loud-speaker.

Another novel feature of this particular installation is the paging system that is to be interconnected with the radio equipment for the halls and lobbies. For example, the telephone operator sitting at her switchboard can, by plugging in a microphone, be heard on any one or all of the output stations, and make whatever announcements she may desire. In this manner the paging of the tenants and guests is accomplished and announcements of importance are made to various parts of the hotel.

No longer will it be necessary for diners to sit at their tables, after having eaten, to enjoy the orchestra music, for microphones are to be placed near the orchestra and music sent on wires to the lobbies and lounges throughout the hotel. Also, the transmission of lectures or speeches from

any one of these locations is to be retransmitted to all gathering places in the hotel.

At the present time the Ritz Apartment house at Newark, N. J., has telephone receivers in every room connected to a modern and powerful central receiving set and it is proving of very great satisfaction to the tenants.

The tendency of the enterprising builder and engineer is very rapidly approaching the inclusion of the most modern devices of this kind in their building plans. The installation of a mammoth radio equipment of proper design is naturally a problem which is different in each case and which must be solved by specialists in this newer type of engineering. The term "radio engineering" is hardly adequate to cover the problems that are involved, and, fortunately, the past experience of our telephone engineers in the amplification of sound has very materially assisted this new art.

Re-broadcasting, a New Era in Radio

It is gratifying to us to see that re-broadcasting has at last become a reality. This was first indicated in our editorial in the December, 1922, issue. In that issue, as will be remembered, we made mention that amateurs could re-broadcast broadcast concerts by very simple means. It will be seen from this article that the theory has now at last been translated into practise along lines as originally proposed in Mr. Gernsback's editorial. There is a strong probability that in the not too distant future there will be only one or two central broadcast stations which will furnish the whole country with entertainment. This entertainment will then be picked up by other stations which will re-broadcast it. The technical difficulties are, of course, as yet great, but they are surely and gradually being overcome.

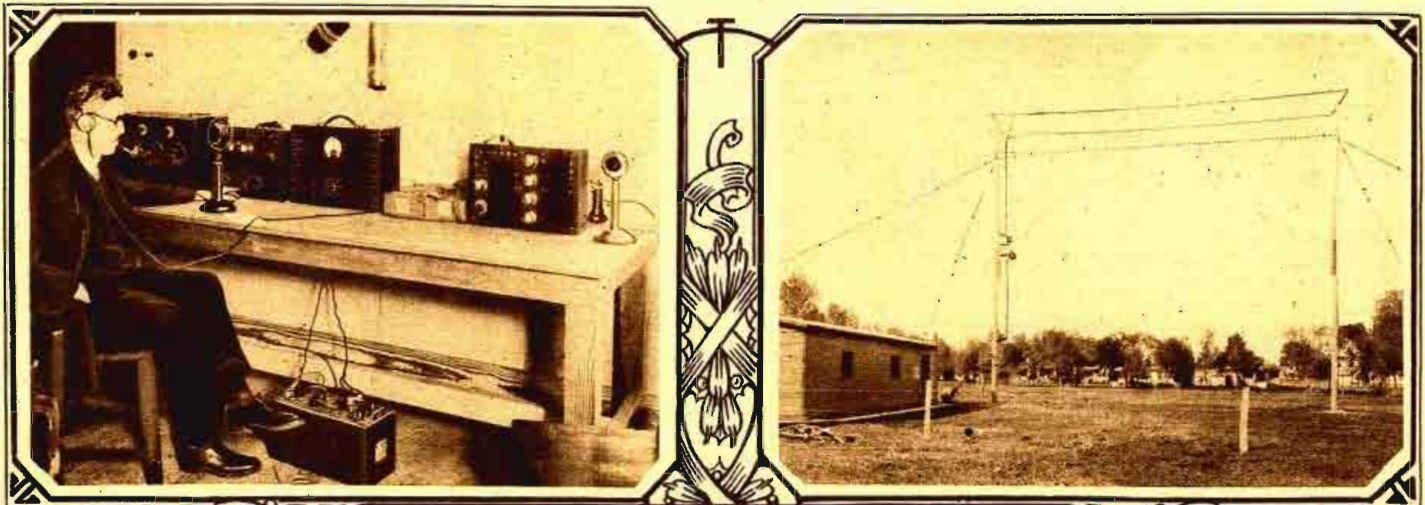

Above: Short wave or high frequency receiver at Hastings, Nebraska, used to receive the high frequency broadcasts from Westinghouse Station, KDKA, at East Pittsburgh, Pa. From there it is passed through a power amplifier, then into the transmitter and re-broadcast.

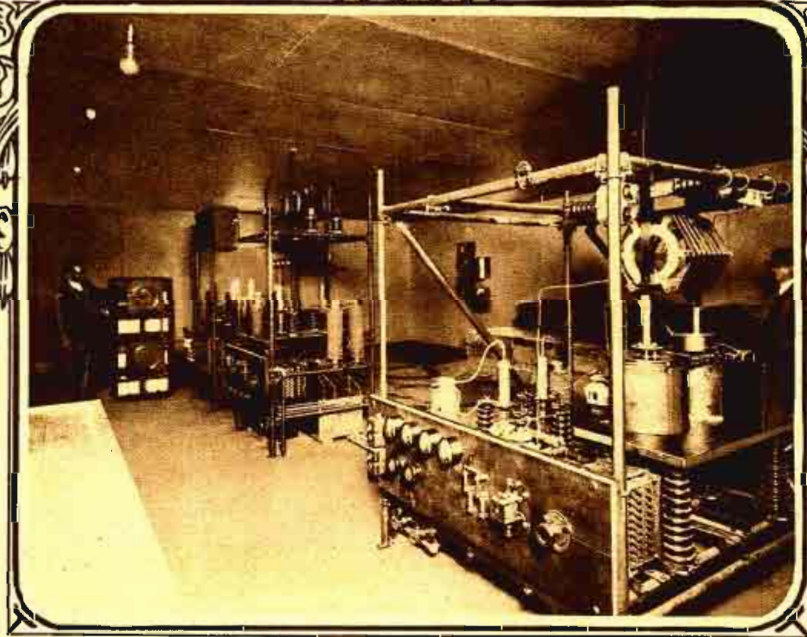

Above: View of the extremely short antenna used to receive the high frequency broadcasts at Westinghouse Station, KFKX, at Hastings, Nebraska. Left: View of transmitting apparatus at Westinghouse Station, KFKX, at Hastings, Nebraska, the first radio repeating station in the world.

"**R**ADIO broadcast repeating" is the newest phrase in the English language. It came into general use with the announced opening of Station KFKX at Hastings, Nebraska, November 21, 1923, which will be operated as a repeating station, giving no programs of its own.

Radio broadcast repeating is, however, more than a phrase, because it opens a new era in broadcasting.

Radio programs originating in important centers may now be received in isolated and far distant points with the same ease that they are received in the immediate vicinity of the station originating the program.

This is possible in the present instance in the case of KDKA of Pittsburgh, Pa., and KFKX at Hastings, Nebraska. KDKA broadcasts the original program, which is repeated with equal strength at KFKX, thus doubling the range in which the reception of the original program was possible.

The methods used by a radio repeating

station in broadcasting are much the same as those employed in the distribution of electric current from a central station. It is a well known fact that the central station, where the power originates, can transmit this power over long distances, and that at the receiving end it can be transformed in a way that makes it suitable for use at the receiving end.

It is practically the same thing with radio repeating. A central station broadcasts the original program. This is sent out on two frequencies—one frequency is such that radio receivers in general use may receive the broadcast; the other frequency is very much higher—so that radio receivers of the type now in use cannot receive it. This is a necessary and desirable feature, as the high frequency transmitting wave must be kept clear of extraneous noises such as are caused by the attempt to tune in with regenerative receiving sets.

This high frequency carries the program to the distant repeating station where it is received with special apparatus and re-

peated, either at the same high frequency for transmission to another repeating station, or it is re-broadcast at a lower frequency which will permit its reception on existing receiving sets. The repeated program serves an entirely new area, greatly increasing the number of listeners reached.

SPEED OF LIGHT

Owing to the speed at which radio waves travel, which is the speed of light, the repeated broadcast is simultaneous with the original broadcast and the listener is wholly unaware that he is hearing a repeated program.

Radio repeating was suggested and recommended by H. P. Davis, Vice-President of the Westinghouse Electric & Manufacturing Co., nearly a year and a half ago. He stated that the solution of the radio broadcasting problem lay in the introduction of a few centrally located broadcast stations which would serve many low-powered and non-interfering repeating stations, and so bring the best to the greatest number of listeners.

(Continued on page 1322)



Aaron Bush's Station 4FB

STATION 4FB is located at Athens, Ga., 70 miles northeast of Atlanta. Practically the entire equipment was designed and constructed by its owner and operator.

The four-wire inverted L antenna is swung between poles placed in two trees, and is 60 feet long. The free end is 75 feet high, while the lead-in end is 50 feet above the ground. Due to the unfavorable nature of the ground, a four-wire counterpoise system 95 feet long, directly under the aerial is used. Large composition insulators are used throughout.

The transmitter consists of two units. Unit "A" is the $\frac{1}{2}$ -K.W. spark set shown in photo. It consists of a Thordarson transformer, .0132 mfd. of Murdock moulded condenser, and a rebuilt Wilcox rotor on a variable speed motor. A split-primary OT is used. This is made up of one turn of 4-inch copper ribbon, 20 inches in diameter. The gap is efficiently muffled by a cover to permit operation during the early morning hours. When 8-inch coupling is used, the radiation is 3.0 amperes. The maximum working range of this set is 1,000 miles, although the signals were reported heard in England during the past T. A.'s.

With the advent of the summer season, and accompanying QRN, unit "B" was installed. This is not shown in the photo, as it obscures the remainder of the apparatus. It is a 10-watt C.W. using rectified A.C. A 24-jar chemical rectifier, with borax solution, smooths out the growl in the 60-cycle A.C. and 1,000 volts from a home-made transformer put the kick into the tubes. With 130 milliamperes on the plates, the radiation is 2.8 amps. During the five weeks in April and May in which the set was in operation, it was heard in 35 states. Stations 1,000 miles away were worked on several occasions, through bad QRN.

The receiver on the left is entirely home-made. It comprises a special short-wave variometer-variacoupler, three circuit tuner. Vernier variometers are used in grid and plate circuits, and are ideal for C.W. work through QRM. The wave-length range is 140 to 360 meters. Above the tuner is a panel in which are mounted three variable condensers and three D.P.D.T. switches. These condensers may be thrown across the variometers so as to reach the concert waves, or used in connection with the long-wave loose coupler on the extreme left. A detector and one-step amplifier adjacent to the tuner, complete the receiver. The wooden borax box, with Mazda light on top, contains an 80-volt acid-lead storage "3" battery. The storage battery in the foreground furnishes juice for the relay-key in spark unit.

The receiver has given very gratifying results indeed. Except for day-light work, most of the C.W. reception is accomplished without any aerial, to minimize QRM and QRN. Almost all the states have been logged, including quite a number of west coast stations. Two 10-watt phones at a distance of 800 miles came in very QSA.

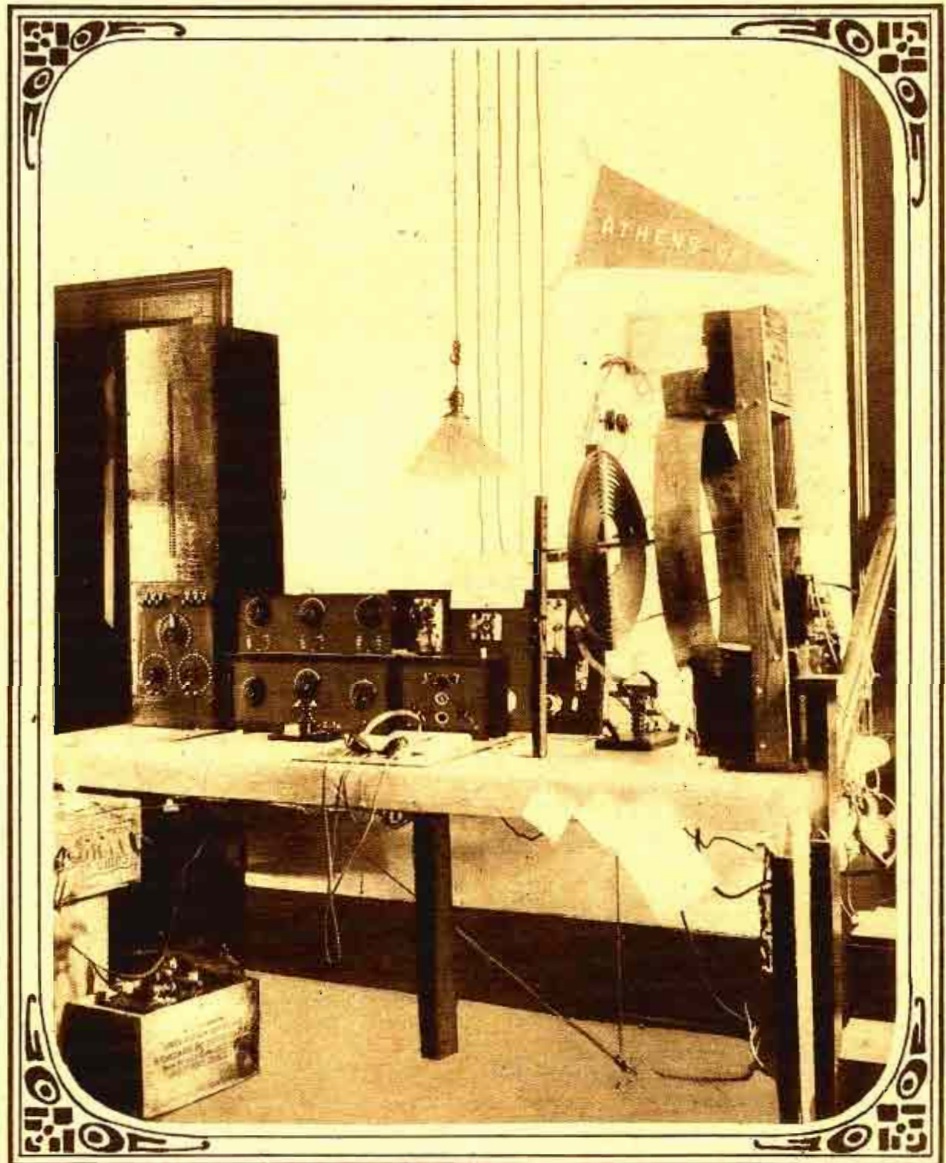

Mr. Bush still has his $\frac{1}{2}$ K.W. rock crusher in operation but prefers to use the 10-watt C.W. set. Note the husky O.T. to the right of the aerial change-over switch.

Due to college QRM, 4FB is on the air only during the spare time of its operator. However, an average of 200 A.R.R.L. messages per month have been handled during the past season.

AARON BUSH,
480 Meigs St., Athens, Ga.

Hamitorial

DISTANCE LENDS CHARM

WHY does the BCL sit up half the night to copy perhaps only the call letters of a distant station, the program having been so faint that it was agony to listen to it, in spite of the fact that a good station nearby

was on the air with a program worth listening to? He does it for the same reason that the Hams lost what little sleep they had been in the habit of getting when they tried for the 100-meter transmission to France. The same agony was in evidence at the end of the frantic call to France—a minute after F-8AB said go ahead CQ. On that memorable night—November 22, at 10:30 P. M.—of course chance had to have a hand in the game. It played to F. Schnell, IMO, Hartford. F-8AB heard him first. With a sinking of the entire world came a renewed determination to try again, and when IMO answered F-8AB, "yours truly" called again also. Imagine the suspense and then the extreme joy when F-8AB, after

calling IMO back, called IXAM saying OK but QSU after IMO. I didn't give a darn after that whether I burnt up the tubes or not. He had heard, that was enough. The poor wife woke up and wanted to know if I had gone crazy, but upon learning that F-8AB had heard me, there were two in the same state of mind, and it was some job to keep her quiet so that I could copy and keep track of the doings and so be able to take my turn in the game. It came when 8AB was trying to give IMO a message to Mix at WNP. IMO had trouble and could not copy, so I QSL'd to F-8AB for it, and he came back at me with greetings and appreciation for the achievement in perfecting the transmitting circuit that was in use in all three stations, advising me that it was responsible for the success of the tests. He then told me that his antenna current reading was 2.5 amps, and I replied that at this station the current reading was 1.5 amps, using a 100-watt set with a 400-watt input, at the same time sending him my greetings and expressing my joy over the fact that this was a fitting termination of our hopes, which were in evidence on the night of his visit to my home when I nearly talked him to death. When we said goodbye at 3 A. M., his final words were: "It will work."

I suppose we will go right along losing sleep, chasing after the future possibilities, being satisfied with the glory of achievement, and after all being a necessity in the world of progress, which alone would keep us on the job. The fact that distance is involved, helps by adding its charm, standing supreme. Ask the BCL.

JOHN L. REINARTZ.

NEW FRENCH REGULATIONS ENCOURAGE RADIO

French authorities have issued a set of regulations intended to encourage broadcasting and the use of radio equipment by amateurs throughout the country, according to advices received at the Department of Commerce from the American Commercial Attaché at Paris. It is provided that receiving sets may be possessed by any citizen of France who will sign a formal declaration, receivable at any post office, stating the kind of equipment used and agreeing that no part shall be taken in the transmission of private correspondence. Sets in the possession of foreigners, or used to receive private correspondence, require individual authorization.

The right to operate transmitting sets will be regulated by the Under-Secretary of the

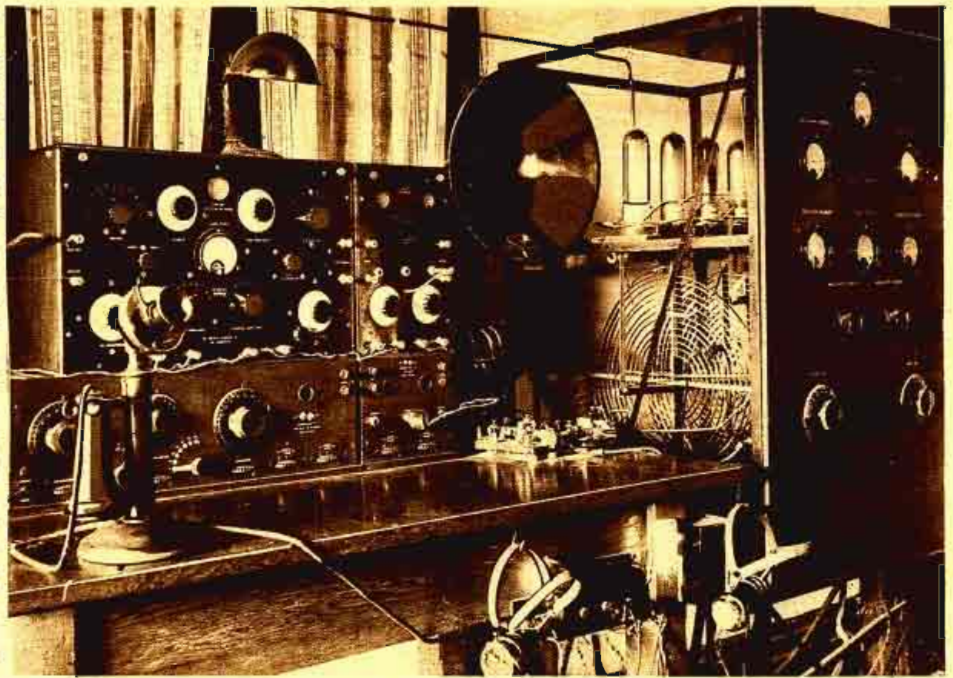

Station 6JX, 6BVW, 6ZU, owned and operated by Wilford Deming, Jr., 1404 Magnolia Ave., Los Angeles, Cal. The receiving sets are familiar. The transmitting antenna is a 4-wire T, 60 ft. long and 70 ft. from the ground. An 18-wire counterpoise fills the bill. The C.W. and I.C.W. transmitter uses four 50-watt bottles, the plates of which are supplied from a 1500-volt 600-watt Esco motor generator. The antenna current is 6.2 amps. on 100 watts.

French Postal Services, on the recommendation of a permanent commission upon which public service groups, manufacturers and amateurs will have representation. Transmitting sets are to be classified as follows: Those intended for establishing private communication; public broadcast sets; portable sets; sets used for technical experiments; and amateurs' sets.

Wave-length standards and other technical regulations will be set up for each class by public authority. The use of amateur and experimental sets will not involve the payment of any fees. Public broadcasting is made the subject of individual contract.

SPECTRUM ANALYSIS OF RADIO SIGNALS

When a radio sending station emits a signal consisting of successive trains of waves, the manner in which the vibrations are interrupted or die down has an important bearing on the amount of interference which this radiation will produce in receiving circuits tuned to frequencies other than the one on which this station

is supposed to be operating. In other words, the very suddenness or other peculiarity of the interruptions causes the station to send out, unintentionally, frequencies other than those it is supposed to be sending. A somewhat analogous case is that of the arc light, which in addition to the light it gives emits also certain invisible radiations. By examining this light with a spectroscope these invisible radiations have been found, and filters have been devised to screen them out. Similarly, a "spectroscopic" study of radio frequencies emitted by a station might help to find those frequencies which cause interference. Such a study could be made if it were possible to devise a series of receiving circuits, each of which would respond to one wave-length only and turn a deaf ear to all others; or if the signal were repeated indefinitely, a single circuit could be used and tuned successively to different frequencies. But as a matter of fact, all circuits will respond to a considerable range of frequencies, and the result of such a study gives a record which is apt to be confused by this overlapping of the effects of a number of frequencies. A mathematical study has, therefore, been made by the Bureau of Standards of the theory by which the actual frequency distribution in the radiation may be deduced from observations of the mean current induced in the receiving circuit when it is tuned to various frequencies. This theory affords a basis for spectroscopic study by which the interference producing quality of a station may be measured.

The theory is given in Scientific Paper No. 477 of the Bureau of Standards entitled "Spectroradiometric Analysis of Radio Signals." Copies may be obtained from the Superintendent of Documents, Government Printing Office, Washington, D. C. The price is 10 cents cash.

A SIMPLE RADIOPHONE TRANSMITTER

W. G. Garner (6ZAM) has sent us the circuit printed herewith and states that it is FB for short distance work. This circuit will work without any fooling around or critical adjustments. He has talked over a distance of five miles with this set, using the apparatus described, and reported very QSA. A number of such circuits have been published from time to time, but very few have

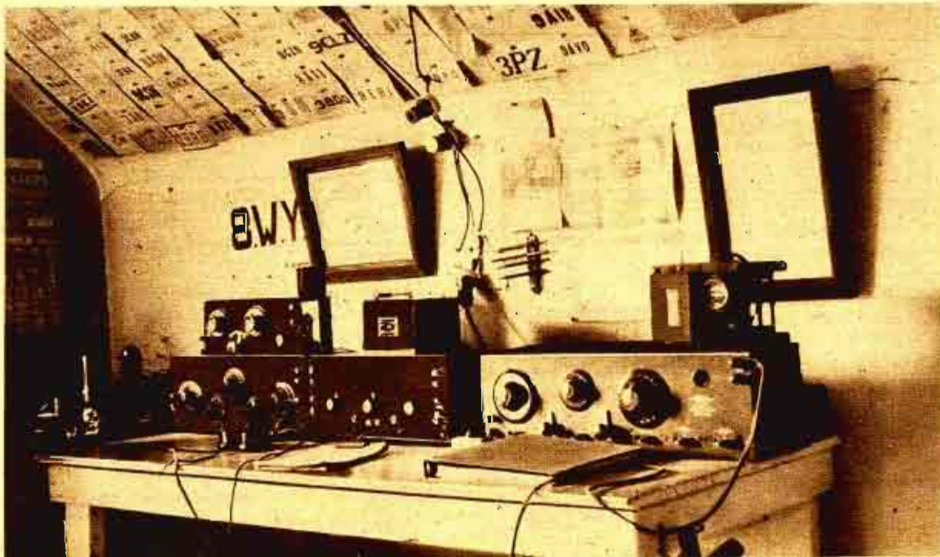

Station 8WY, owned and operated by S. W. Townsend, 79 Marvin Ave., Akron, Ohio. Antenna is a 5-wire inverted L, 45 ft. long and 35 and 45 ft. high, with a counterpoise, a duplicate of it, 8 ft. above ground. Two 50-watt bottles in a Hartley circuit with a 1500-volt transformer make up the C.W. transmitter. Antenna current on 100 watts is 5 T.C. amps. The receivers are: a home-made three circuit with two stages and a Grebe C.R.-8.

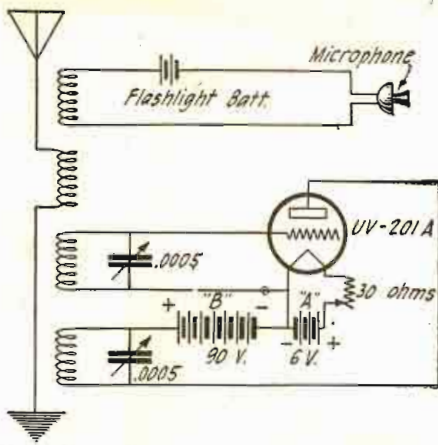

A simple radiophone transmitter employing a U.V.-201A for the oscillator and absorption modulation. This arrangement is easy to handle.

given any operating characteristics. If the specifications given herewith are followed, the set will work right off the bat.

All of the coils are wound on one tube with a diameter of four inches, using No. 18 D.C.C. wire throughout. Each coil consists of 10 turns and is separated from the next by $\frac{1}{8}$ inch. This is a modification of the well-known Meisner circuit and employs the loop absorption method of modulation. It will be found that neither the grid nor the plate condenser adjustment is critical. A UV-201A with about 90 volts on the plate will prove excellent for this purpose. Fair results can be obtained with 45 volts.

4PV

QRA-4PV; L. H. Leathers, 148 Avant Street, Spartanburg, S. C. Reports appreciated and QSL'd.

5SN

5SN, Curtis K. Smith, Box 7, Louann, Ark. Reports on my spk. sigs. appreciated.

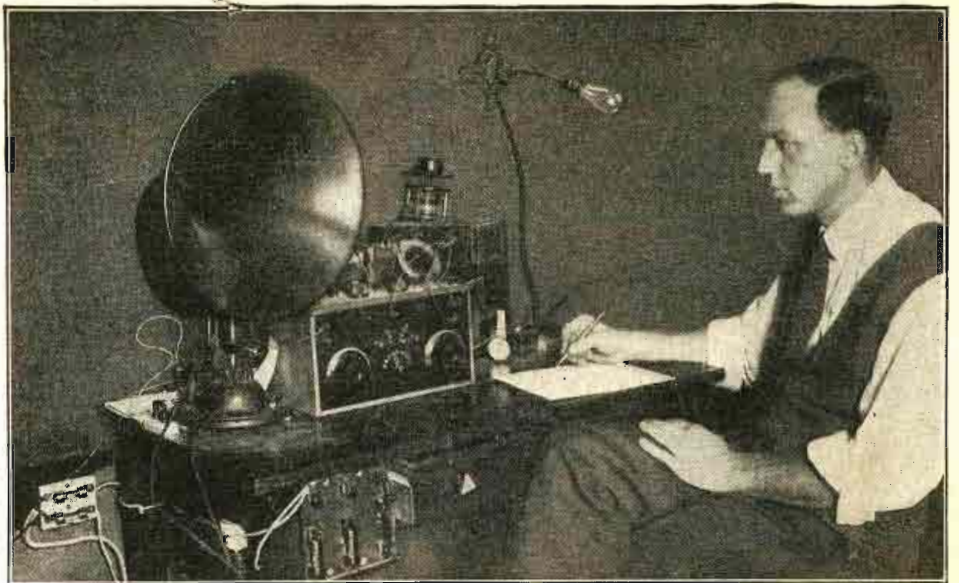

John L. Reinartz in his favorite corner waiting for the cameraman's powder to flash. If you look closely you will note that he is using a Reinartz receiver, for which we don't blame him.

2AAQ TO 6HQ

2AAQ (Robert E. Johnson), Fifth and Central Avenues, Ontario, Cal., will in the future be 6HQ, with 10-watt C. W. QSL's appreciated. All crds. answd.

5TW

QRA-5TW, R. E. Harris, 708 West Duke Street, Hugo, Okla. QSL's will be answered.

2BP

QRA-2BP; S. Bruno, 10215 Ninety-seventh Avenue, Woodhaven, New York. Pse. QSL.

9BBQ

The call 9BBQ has been issued to Frank C. Ahlgrim, 2239 Washburne Avenue, Chicago, Ill. A 10-watt C.W.

CAN. 4IC

The call 4IC has been issued to W. G. Stunden, 615 Ninth Avenue, N. W., Calgary, Can. All crds. answd.

9BCJ

9BCJ has ceased operation, permanently, at the former address in Webster Groves, Mo., and will probably join the ranks of the sixes in a short time. All communications will please be sent to Chas. C. Messman, General Delivery, Prescott, Ariz. (Continued on page 1327)

The Supremo-trol, Universal Wave-length, Ultra-sensitive Distance Destroyer

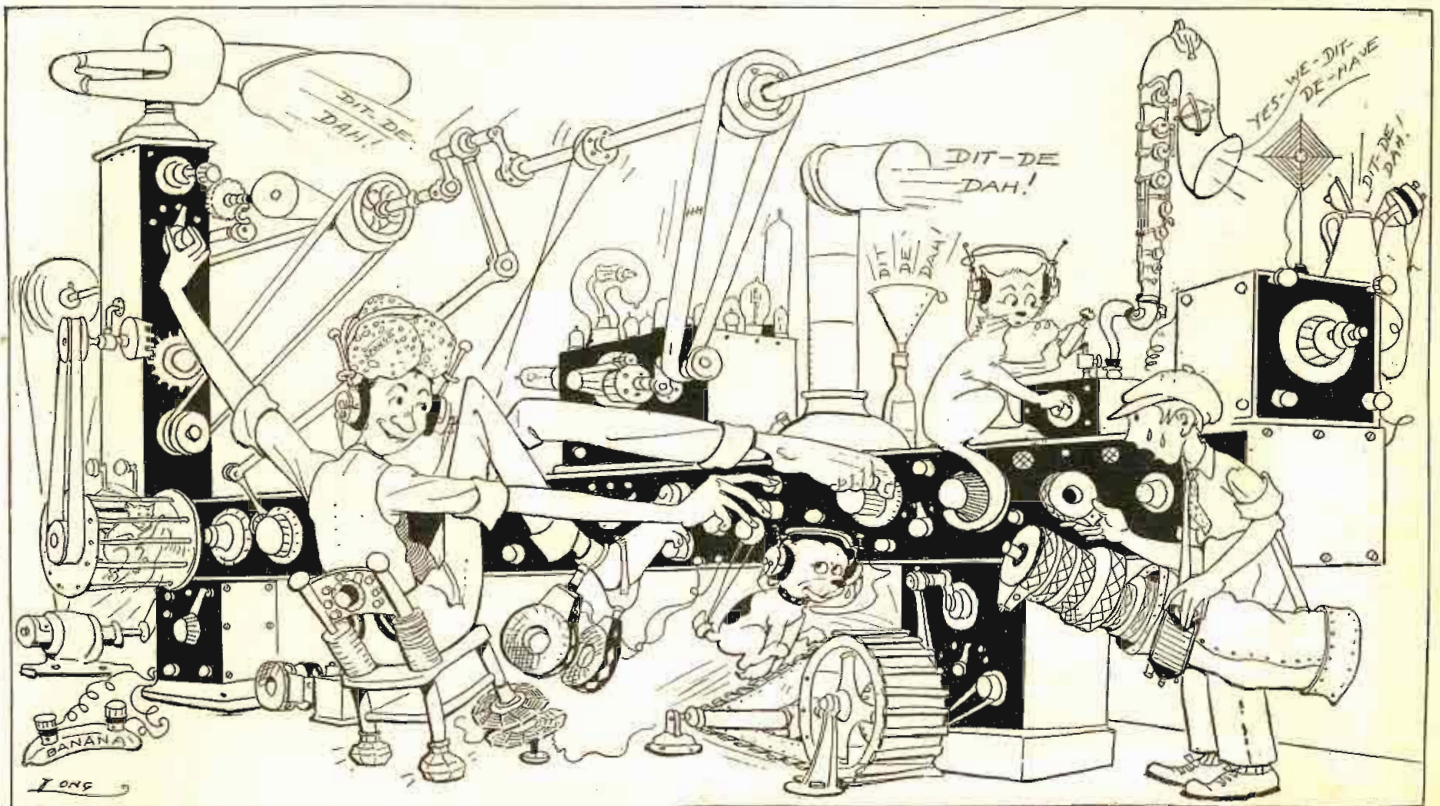

Here is the Ideal Baby receiver for simplicity of operation and delicacy of control. It's the "King of the Air" and "Four Aces" on DX. It will bring in London with one foot and WGY with the other, all at once! It's the safety set for radio nuts with the squirrels in a cage. The banana attachment is a marvelous tuner for the saxophone loud-speaker which shouts "yes, we have" as only bananas skin! It speaks for itself!

The Operation of Close Coupled Transformers

By W. P. POWERS

ASSISTANT PROFESSOR OF ELECTRICAL ENGINEERING, STEVENS INSTITUTE OF TECHNOLOGY.



By means of simple electrical analogies, the author explains the actions of various forms of transformers used in radio circuits. This article should prove quite helpful to the experimenters in understanding the operation of transformers.



THE transformer plays a most important part in radio, being involved in both transmitting and receiving circuits. Although frequently somewhat disguised and obscured by the circuit arrangement, a little study will usually disclose a transformer of some description. It is safe to say that almost every radio circuit has somewhere in its makeup a transformer.

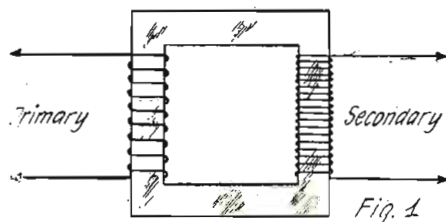

Diagrammatic representation of an Ideal transformer which is supposed to be used in the experiments described in this article.

The function of a transformer is to change the magnitude of the voltage or current. This is familiar to many, but the significance of the operation is not always fully appreciated. Because of the ability of a transformer to change either voltage or current, it may be said to transform constants of the circuit such as resistance, inductance and capacity and also reactance and impedance. It is the purpose of this article to point out the last named function of a transformer and to show a few examples of the application of the principle in practice.

The operation of a transformer can most easily be explained by considering the simple power transformer. Fig. 1 shows a simple transformer composed of an iron core and two windings. This is known as an "Ideal" transformer, because it is assumed to have no magnetic leakage, no resistance, and no iron loss. (These points can be substantially realized in practice.)

If we apply a certain A. C. voltage to the primary winding, there is an equal and opposite voltage at once set up in the same winding. This voltage is due entirely to the fact that the magnetic flux in the core (due to primary voltage or strictly magnetizing current) is cutting through the primary turns. If we wind a second coil (secondary coil) about the core, the core flux will cut through this winding as it does through the primary, setting up in it a voltage depending entirely upon the number of turns of wire in the coil. If the secondary winding has the same number of turns as the primary, the secondary voltage will be equal to the primary voltage. Such a transformer would be of no value except to insulate one circuit from another.

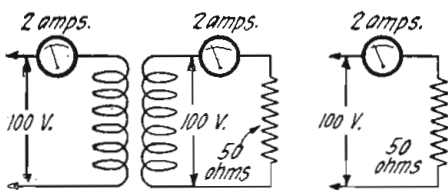

Fig. 2

A circuit containing a transformer with no step-up ratio, there being the same number of turns on the primary as on the secondary. The equivalent circuit is shown on the right.

Let us suppose, however, that the secondary winding has twice as many turns as the primary winding. (At this point it is well to call attention to the fact that this increase in voltage is obtained at the expense of the current. The transformer contributes no energy to the system, and therefore, can in no way amplify power. The term "amplifying" transformer, as we use it in radio should not imply that power is amplified in the transformer, but rather that it is merely transformed or transferred in proper form from tube to tube. The tube is the amplifying device, since it contributes additional energy to the system through the medium of the "B" battery.)

Fig. 3 shows the operation of a transformer having a step-up ratio of 1:2, operating on 100 volts, as in Fig 2, and loaded so as to draw the same power. It will be noticed that the secondary voltage is doubled (200 volts), and the secondary current is reduced from two to one ampere, maintaining the power relations correctly. The secondary load resistance, to satisfy this condition, is obviously 200 ohms, or four times the original value of Fig. 2.

Figs. 2 and 3, from the standpoint of the primary circuit (input side) are identical. These circuits operate on 100 volts; they each take 200 watts, and the primary cur-

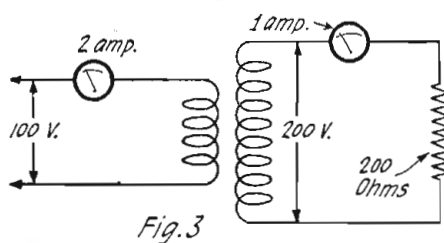

Fig. 3

A circuit containing a transformer with a step-up ratio of 1 to 2; the input does not vary, since the load is 200 ohms.

rents are the same. In fact, these circuits operate exactly like a simple resistance circuit of 50 ohms. The "equivalent" resistance of each circuit referred to the primary is, therefore, 50 ohms. However, the load resistance (secondary) in Fig. 2 is 50 ohms, while that of Fig. 3 is 200 ohms. Fig. 2 shows a transformation ratio of 1:1, while Fig. 3 shows a ratio of 1:2. It is apparent, therefore, that by the change in transformation ratio, we have reduced 200 ohms to what appears to be 50 ohms. If the transformation ratio had been 1:4, the situation would have been as shown in Fig. 4, where a load resistance of 800 ohms is reduced to 50 ohms in the primary circuit.

RELATION OF RESISTANCES

By inspection, it is apparent that the secondary resistance is to the primary equivalent resistance as the square of the secondary turns is to the square of the primary turns. In other words, the resistance ratio is proportional to the square of the transformation ratio.

For example, in Fig. 3; the secondary resistance is 200 ohms, the equivalent resistance referred to the primary circuit is 50 ohms. The ratio is four, which is equal to the square of the voltage ratio (2). Hence, the equivalent value for any secondary resistance referred to the primary circuit is equal to the actual secondary resistance, multiplied by

$$\left(\frac{N_1}{N_2}\right)^2$$

$$R_1 = R_2 \left(\frac{N_1}{N_2}\right)^2$$

For example, 1,000 ohms attached to the secondary winding of a step-up transformer, having a ratio of 10, will appear as 10 ohms in the primary circuit.

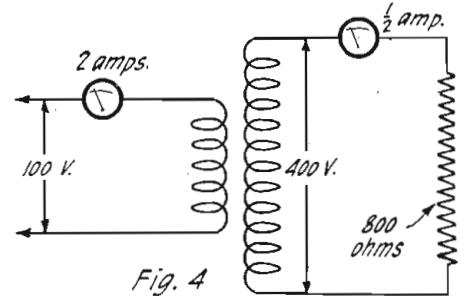

Fig. 4

The transformer in this circuit has a ratio of 1 to 4, but the load resistance being 800 ohms, the input energy remains the same.

$$R = 1,000 \times \left(\frac{1}{10}\right)^2 = 10$$

In general we have to do with circuits composed of resistance, inductance, or capacity, either separately or in combination.

INDUCTANCE

Inductance may be treated in the same manner as resistance. Inductive reactance as well, (because it is proportional to inductance), may also be treated as resistance. Inductive reactance is the term used to express the ohms developed in an inductance, L, when it is operating on an alternating supply voltage of frequency, f.

$$\text{Inductive resistance} = 2\pi f L \text{ ohms.}$$

For example, an inductance of four henrys attached to the secondary of a step-up transformer having a ratio of two, will appear as one henry in the primary circuit. In this case, the secondary reactance, if operating on 60 cycles, is 1,508 ohms; the reactance referred to the primary is 377 ohms.

Assuming 754 volts applied to the primary, the situation is as indicated in Fig. 5.

CAPACITY

Capacity is transferred from one circuit to another in proportion to the square of the inverse transformation ratio; that is, the higher number of turns is always associated with the lower value of capacity. Since the charge in a condenser is proportional to the applied voltage, it is quite apparent that raising the voltage would increase the charge, and would be equivalent to an increase of capacity at the original voltage. The work done in charging a condenser is, however, proportional to CE². This is unchanged by the transformer, hence C varies inversely as E².

(Continued on page 1324)

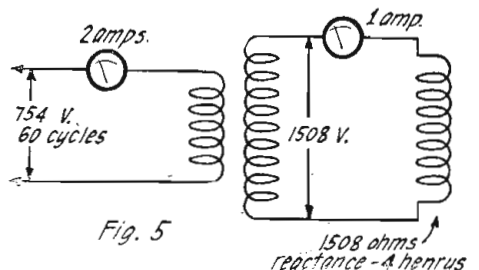

Fig. 5

When the proper inductance is used as load the effect upon the input is similar to the case where resistance is the load.

C. W. and Radiophone Transmitters

By L. R. FELDER

Part VI.



In his last article, Part V, Mr. Felder took up the subject of modulation systems. In this article he covers the subject of speech amplifiers, probably the most important consideration in radiophone practise. The information presented, although applying to radiophone transmitters, will be found of a nature quite serviceable in other phases of the radio field.

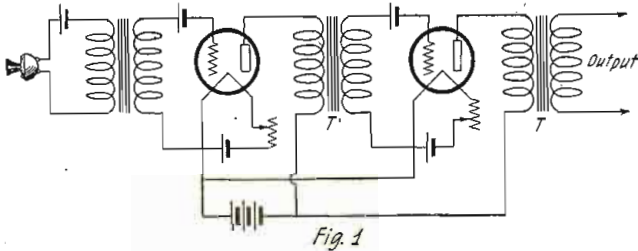
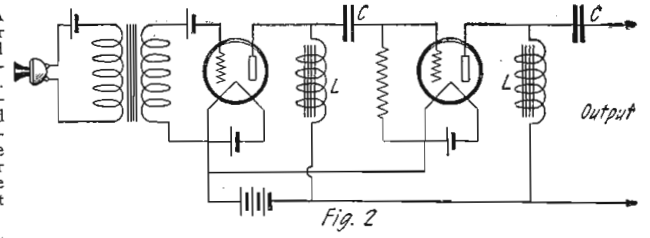

Fig. 1 - A transformer coupled speech amplifier, and Fig. 2 an inductance coupled speech amplifier. The transformer coupled type is the most widely used.



IN the foregoing articles of this series we have taken up the questions of the generation of radio frequency currents and their modulation. Also, the extent to which the degree of modulation influences the quality of sound reproduction. In this concluding article, the application of the foregoing will be given to one of the most recent developments of radiophone communication, namely, to radio broadcasting.

All broadcasting stations employ one of the standard types of radio frequency oscillation circuits. While there may be some variations in the circuits, they all accomplish, more or less efficiently, the same purpose: i.e., generate radio frequency currents which act as the carrier for the sound transmitted. Most stations employ the Heising Modulation System, since it is the most effective and efficient thus far developed.

frequencies in that range be equally and accurately reproduced. It is here that most broadcasting stations fail; they are able to reproduce with fair accuracy the band of frequencies between 250 or 300 cycles to 2,000 or 3,000 cycles. They do not reproduce well the sounds having frequencies above and below this range. As a result, distortions of a special nature are introduced. If the station fails to reproduce or transmit the higher frequencies (above 2,000 or 3,000 cycles) the speech and music will be intelligible, but not natural. Speech will sound muffled and drummy because the higher frequencies are absent; sopranos will sound like contraltos, tenors may sound like baritones and so on. On the other hand, if the lower frequencies are predominantly absent, speech will sound thin, empty and tinny. The low notes of drums will be absent, baritones will sound like tenors, etc.

timbre and nuance. A special type of microphone is employed in broadcasting studios. It is similar in principle and structure to the telephone transmitter, containing a diaphragm and carbon granule buttons. The broadcasting microphone differs, in this: It has two carbon granule buttons bearing on the diaphragm, where the ordinary telephone microphone has only one. This results in eliminating distortions which are present in the telephone transmitter.

ITS LOW OUTPUT

The output of such a high quality microphone is very low and, therefore, must be greatly amplified before it is impressed on the carrier wave in order to obtain the necessary degree of modulation. In the average amateur radiophone transmitter the output of the microphone is stepped up by a telephone transformer and then applied directly to the modulator tubes. This procedure is followed also by some low power broadcast stations. For the higher powered stations, such a system is not possible, because the output thus obtained would be entirely insufficient to modulate the radio frequency carrier wave. It is necessary, therefore, to employ one or several stages of speech amplification to increase the output to such a value that the necessary modulation is secured. These speech amplifiers are, in fact, nothing more than audio frequency amplifiers very carefully designed. It is a well-known fact that the average audio frequency amplifiers used in receiving sets are far from being distortionless. They either drop out low frequencies or high frequencies, and sometimes both. Harmonics are introduced on account of the presence of iron in transformers not properly designed. The speech amplifiers used in broadcast transmitters are designed to avoid these distortions. The type of speech amplifier used may vary, but there are three separate types which correspond to the different types of audio frequency amplifiers: 1—Transformer coupled; 2—inductance coupled; and 3—resistance coupled amplifiers, as shown in Figs. 1, 2 and 3 respectively. All of these types are very satisfactory and may be made practically distortionless if the circuits are designed properly. Of the three types the most distortionless amplifier is No. 3—resistance coupled. No matter what the resistance R is, the ampli-

(Continued on page 1337)

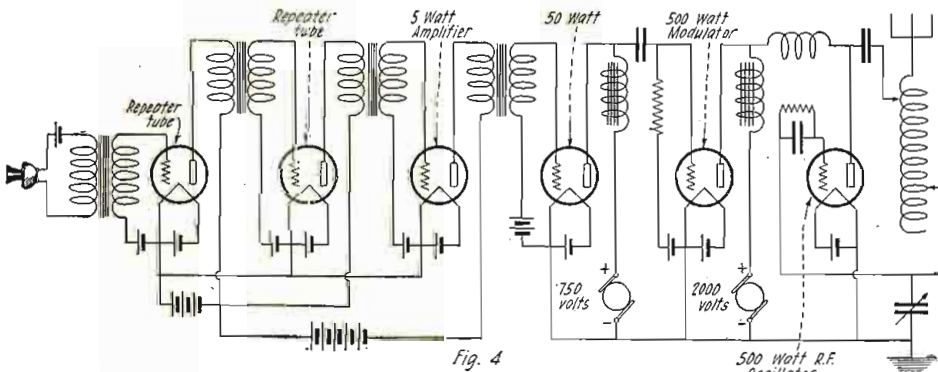

The circuit diagram of a complete broadcast transmitter including all requisites. This should prove helpful to the amateur contemplating the construction of a radiophone transmitter along similar lines.

This system was explained in full detail in the last article of this series. The important difference between a good broadcast station and a poor one lies in how faithfully the modulating system reproduces the sounds which are to be broadcast.

A broadcast station has a radio frequency system, and an audio frequency system. Faithful reproduction of sound is almost solely dependent upon the audio frequency circuit, and it is in this circuit that the chief differences exist. The equipment must meet certain conditions if it is to be distortionless, and produce the sound in the antenna exactly like it was delivered to the microphone.

THE PROBLEM

In radio telephony we are concerned with the transmission of speech, and in the special case of radio broadcasting, with the transmission of speech and music. The range of audio frequencies involved in speech sounds varies from about 100 cycles per second to about 5,000 cycles per second. In order that speech and music be faithfully reproduced it is essential that all these fre-

For natural reproduction of speech and music, therefore, it is obvious that all the frequencies between 100 and 5,000 cycles per second must be equally and faithfully transmitted.

The first precaution that is taken in broadcasting stations for equal transmission of all audio frequencies is the use of the best type of microphones. The usual type of microphone used in telephones does not reproduce all speech frequencies faithfully. It transmits a frequency range which makes speech in the ordinary tones intelligible, but it does not reproduce it with all the natural

A resistance coupled speech amplifier. So far as perfect reproduction is concerned, this is the best type, but it has the disadvantage of requiring a very high plate voltage; something that is not always readily obtainable.

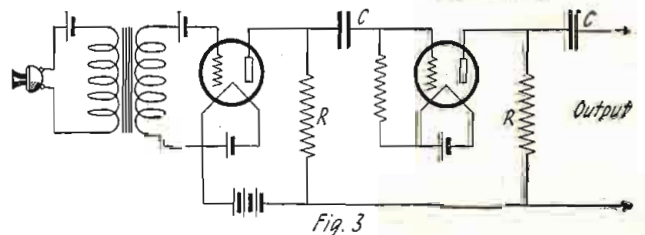

Fig. 3

A DX Receiver for Amateur Waves

By L. W. HATRY, 5XU



The form of circuit employed in this receiver is very sensitive to weak signals, as has been proven in the past. However, the design has much to do with the efficient operation of the set and the importance of adhering to every detail of construction regarding insulation and lack of shellac or dope in building such a set as this, cannot be overestimated.

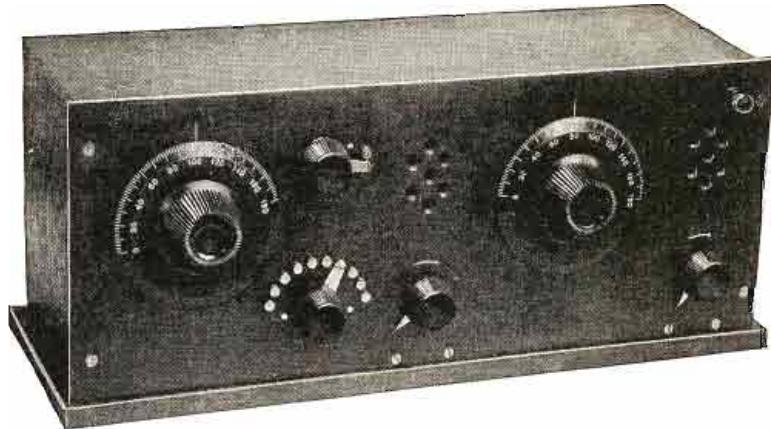

A front view of the short wave receiver. The two-point switch cuts in and out of the secondary load. Note the isolated aerial post in the upper right-hand corner of the panel.

the point as directly as possible; avoid paralleling wires if possible; build your A.F. amplifiers in a separate unit or else shield them; use a low capacity tube as a detector, such as the UV-199 or C-299, but don't use it with an adapter—better to remove its base and connect direct to the leads; don't shellac or varnish; and don't use bakelite tubing, but plain cardboard. Ground the positive of the filament and see that the rotary plates of the variable condenser go to the ground. See that the shaft of the variometer that is in the dial is also the end that is connected in the common filament return, which is grounded.

THE CIRCUIT

Look at the hook-up. The antenna is connected direct to a single turn of No. 14 D.C.C. wire wound on a 23-turn coil of No. 18 D.C.C. wire, which is L and is the secondary closely coupled to the plate variometer. Build your coil with No. 14 D.C.C. wire on a 4-inch diameter form and of 27 turns and

THERE have been any number of articles on building amateur receiving sets, so, to prove that this one is worth constructing, I am including a "Calls Heard" list.* Also, my best previous list has not had as many DX hams from all districts that represent DX for 5XU, as there are on this list. And my previous results were obtained by ear straining to hear three or four calls in a night, and those were usually a regular bunch who were heard by everyone. I don't know that Port Arthur is a dud location for reception, but I do know that I have used and tested several prominent makes of receivers and have not been able to better my results. I have preferred the single circuit, except for message handling, as it has not sufficient selectivity. Of course, radio frequency amplification gave better results, but I do not desire to add to my present collection of tubes, so I wanted a single-tube set.

Then I added a one-step to the receiver; that's consistency, hi!

see how the set is built. There are three views, so there is not much to be said about how the thing is built or assembled, for you will assemble yours your own way.

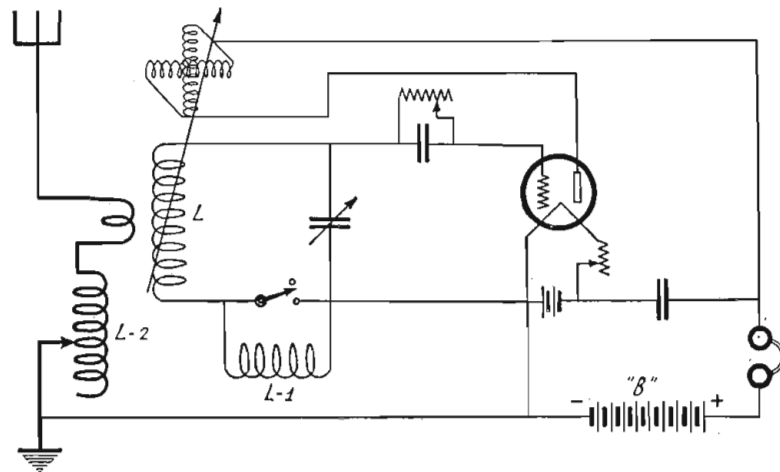

Circuit diagram of the tuner. Note the fact that the common filament lead is grounded. Audio frequency amplification may be added in the usual manner.

WHAT WAS WANTED

Having decided I wanted a satisfactory set, I aimed at the following:

1. Selectivity.
2. Wave range to go below 100 and above 300.
3. Simplicity of control.
4. Reception of DX consistently without straining.
5. No shield, and negligible capacity effect.
6. Possibility of calibration for QRH reading.

And having aimed, my score read something like this with a stymie at the sixth hole:

1. Nice and satisfactory.
2. From 80 to 370 meters and no losses.
3. Two tuning controls.
4. The old familiar signals quite often polarize the tube with too much charge. The old DXers pound in like on a one-step and the real DX is comfortably readable. Tested in comparison with a well known variometer regenerative and one-step, this receiver on one tube gives louder sigs.
5. Ground rotary plates of variable condenser, and mount coils a decent distance from the panel.
6. Nothing doing except at constant "B" battery voltage and ditto filament. Also, the same tube at all times. The antenna must detune from resonance for accuracy with any degree of constancy. Keeps calibration fairly good, if these things are observed. Notice the photographs. You will

A FEW PRELIMINARY DON'T'S

Here are a few "don'ts" that may save you grief:

Don't use pretty bus bar wiring, because it builds up capacity and reduces the size, in turns, of your coils; run your wires to

you will get better signals. Yes . . . I have tested. Tie the coils with white thread instead of shellacking. The plate variometer, in my case, is one of wood with untreated windings that left nothing but the cotton covering and the air between the two

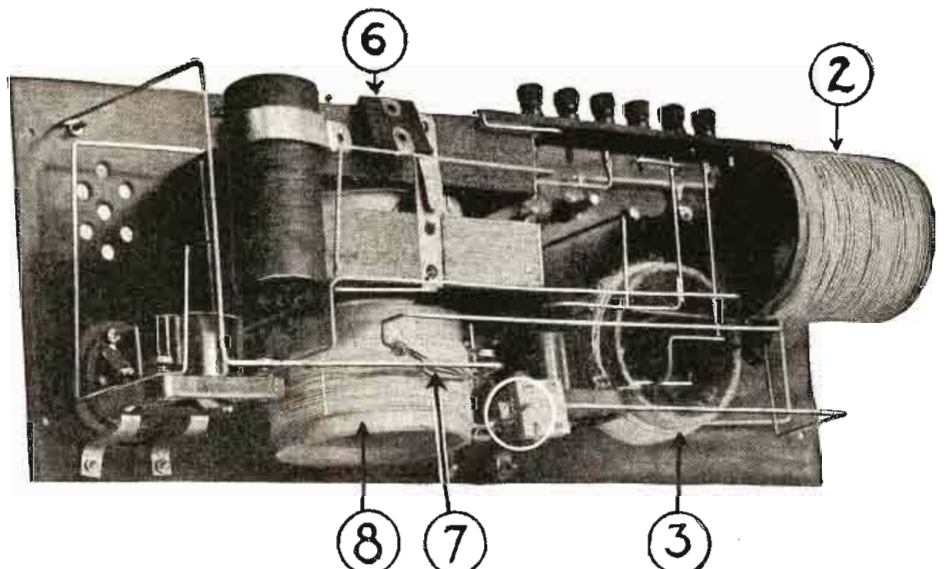

A rear view of the receiver showing (2) the secondary load, (3) the primary load, (6) the by-pass condenser, (7) the primary coupling coil, (8) the secondary coil. Note the short grid lead shown within the white circle.

*See "Calls Heard" columns.

windings of the variometer, which were parallel. The variometer has No. 19 D.C.C. wire for the windings. The grid condenser should be mica insulated and should be of as small a capacity as you can use without sacrificing strength on a weak signal. Mine is .0001 mfd. The tuning condenser, if insulated with hard rubber, will be satisfactory, or you can re-insulate some of your own. Where you must use a composition insulated condenser, see that there is plenty of distance between the terminals of the rotor and stator of the condenser and, if possible, drill a hole in the insulating material between any such terminals to reduce the body of solid dielectric in the field. There will be some losses not present in the rubber insulated condenser, if you use one insulated by one of the patent materials. The loading coil L-1 is a 35-turn coil on a 3½-inch diameter cardboard tube wound with No. 14 D.C.C. wire. It is shorted out when not in use and is at right angles to the other coils, which are also at right angles to each other; excepting, of course, the small grid coil and the plate variometer. The load coil represents no loss when not in use. L-2 is a bank wound coil and is made in that fashion on account of its compactness. I tested several coils, including spider-webs, and as the bank-wound seemed to sacrifice nothing, I used it. L-2 is the antenna loading coil and might represent some loss on the extra short waves, but this is doubtful when results are considered. The bank-wound coil is wound with No. 14 D.C.C. wire and will be found to stay in place well without the use of shellac. Finish by binding with thread in about three places to avoid the loosening through temperature variations. The antenna switch taps off the single turn in the antenna and then taps the coil at the first three and every two turns thereafter until nine taps are connected in. There are 10 taps with the tap at the single antenna turn. The antenna loading coil is wound on a 3½-inch form, but the size is not important. The tuning condenser is a 13-plate, .00025 mfd., and gives, with the grid coils, a low range of 80 to 230 meters, and a high range of 150 to 370 meters.

SERIES ANTENNA CONDENSER OF NO HELP

Separate the switch points as widely as convenient and use flush ones, if obtainable, to avoid the capacity between them. The single turn coupling coil is too small, in itself, without the loading coil, unless the antenna plus the coil is large enough to have the tuning point formed at the wave received, or above. In other words, a long receiving

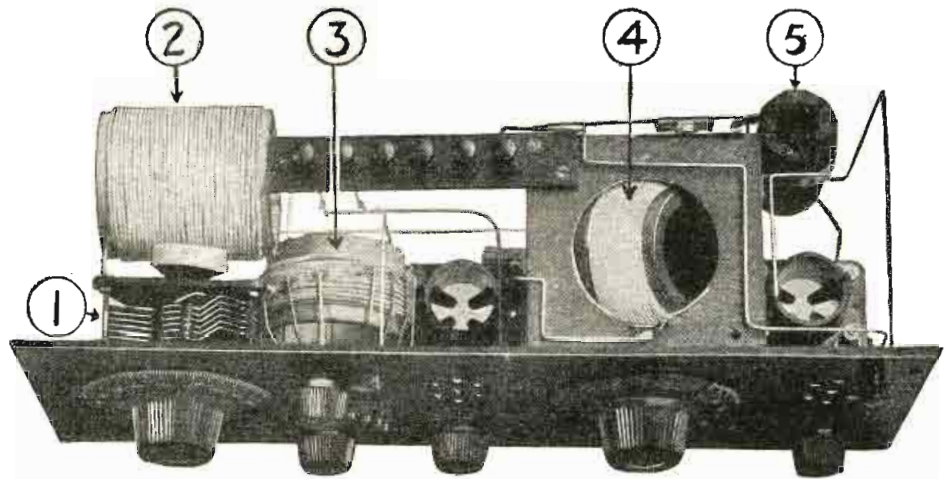

Another view of the receiver, clearly showing the relative positions of, (1) the variable condenser, (2) the secondary load, (3) the primary load, (4) the variometer and (5) the A. F. transformer.

antenna will get away from the switch, provided the fundamental of the antenna is above the maximum wave you wish to receive. It will do well on waves a fair distance above the antenna's fundamental period but not so well as with the loading coil. Of course, the set without the antenna loading coil is more efficient, and easier to operate. Don't bother about tuning the antenna exactly with a series variable as it is not necessary and produces no better results on this set than the switch approximately adjusted. The switch can usually be set for the whole range from 150 to 200 meters with satisfactory results. It never has to be exactly in tune and usually has to be a little above or below the wave received to avoid too much absorption from the grid and stoppage of oscillation or annoyance to someone nearby. Usually this set radiates considerably less than the usual standard regenerative.

WEAK AND STRONG SIGNALS

Another thing true about this set that speaks well for the elimination of losses is the fact that with weak signals no greater gain is experienced in signal strength when the loading coil is used in the secondary than when it is not. In other words, the capacity-inductance ratio does not seem to matter so much. On the stronger signals, however, signal strength is noticeably more with the loading coil than without it. This has also been tested with unit coils without the loading coil and the same thing held true. On weak signals it does not matter that the condenser

is at or near maximum and the coil of comparatively few turns, or the condenser near minimum and the coil of a greater number of turns, as the strength of the received signals seems the same. There is the increase on the loud signals though, often to the extent that they block the tube when tuned in with the loading coil in the circuit. This statement only holds true up to .00025 mfd., however. I tested on the signals of 1CMP, 2BQB, and other weak ones and on 9ZT, 8ZZ, and other loud ones.

It is not unusual to hear the regular QSA birds so loudly as to be readable with the phones on the table.

A FEW MORE HINTS

Separate the antenna lead well from the others. Also separate its terminal point. I lead my antenna to the lone binding post on the front of the panel which is well insulated from everything else. Nothing at a potential in the grid circuit is connected to the panel. I even drilled an oversize hole for the variable condenser shaft. A continuously variable grid leak will be almost indispensable with this set as will be found when trying to copy someone closely. Let the by-pass condenser be mica insulated and above .002 mfd.

When built, test it as assembled and in actual operation, too, as then you can keep track of wave-lengths. Please remember that I wired my set with the lovely bus wire and that is exactly why I tell you not to use the same.

Reminiscences of a Radio Inspector

By C. A. REBERGER

ASK anyone who has found it necessary to take the U. S. Government radio examinations—and failed—their general sentiment of the examining officer. It is quite needless to assert he would be branded as a cruel, inconsiderate, unjust, unfair, terrorizing individual who does nothing except sit in his office at the Navy Yard or Custom House, a cynical smile upon his face, nervously moving his hands as if anxiously awaiting the approach of the next victim.

Isn't this true? Don't the biggest number of those who flunk in most instances lay the blame on the poor radio inspector? They say he had the omnigraph shooting out 30 instead of the regulation 20; didn't give them a square deal in the theoretical end of the test, or probably that he scared them to death even before they actually started. During my experience with wireless I have had the opportunity to come in contact with scores of persons who took the examinations and

failed, and 85 per cent of them put the whole blame on the fellow who examined them, never taking themselves into consideration. It is very easy for anyone to encourage the idea that the radio inspector is unjust. But, after all, is he being treated justly? Are they acting fairly about it? Are they considering all sides of the question? Ninety-nine times out of a hundred we'll find they're not. It's always the other fellow who's the goat.

The work of this official, the radio inspector, is interesting. It is so because he deals with individuals of every conceivable type—both sexes. The opportunities for studying human nature are splendid, for it is surprising the great number of different types of people he deals with each month. Some are pleasant and congenial, some are snobbish and intrepid, while others are too nervous and scared to show their dispositions. But no matter what their characters may be, he shows no partiality; all are given

the same opportunities, and exactly the same chances because the tests are prepared by the Department of Commerce at Washington and not by the radio inspector. It is unfair, therefore, for us to condemn the man who examines us on the grounds that he gave us the most difficult set of questions. He is merely following instructions issued by his superiors. The whole trouble is, he is never given the opportunity to explain.

Mr. C. D. Guthrie is the Radio Supervisor for the United States Shipping Board. For some years he has acted as Radio Inspector for New York, thus making the acquaintance of hundreds of individuals interested in either amateur or commercial wireless. Because of his activities along these lines, he is well able to relate an interesting story of his experiences and at the same time to give many valuable hints to those who are contemplating taking the licensed radio operators' tests.

(Continued on page 1268)

Modern Radio Apparatus—Condensers

By JESSE MARSTEN



We have published articles on condensers from time to time, but we believe this to be the most complete. Mr. Marsten takes up every form of condenser employed in the radio field, describes it, gives the advantages and disadvantages of the type and furnishes numerous pointers. We are sure you will find this article of unusual interest.

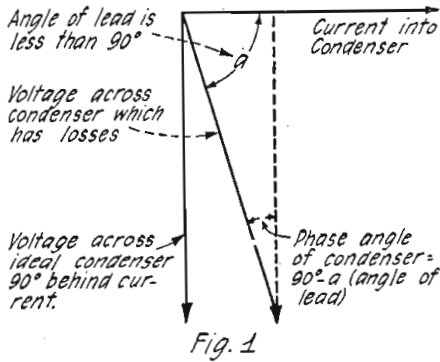

Fig. 1
This graph shows what is meant by phase angle. In an ideal condenser without losses the voltage should be exactly 90 degrees behind the current.

THE condenser constitutes one of the most important elements of the radio circuit. It is made in a number of different ways, each type having its own advantages, but regardless of where or how it is to be used a good condenser must meet certain requirements. These requirements will be considered here and the various types of condensers discussed.

GENERAL PRINCIPLES OF CONDENSER DESIGN

Phase Angle and Power Factor: If a figure of merit were to be assigned to a condenser, it would be its power factor or phase angle. The power factor or phase angle is a measure of the power loss occurring in the condenser. The smaller this figure, the smaller is the power loss. In an ideal condenser, energy is stored in electrostatic form only and in such case the current flowing into the condenser leads the applied voltage by 90 degrees. If, however, there is some resistance in the condenser there will be an absorption of power in this resistance. As a result all of the circuit energy will not be stored in electrostatic form, and the current into the condenser will not lead the applied voltage by 90 degrees. The power factor or phase angle is a measure of this absorbed energy and thus is a measure of the efficiency of a condenser.

Every condenser may be considered as a pure capacity in series with a resistance which absorbs energy. In such a case there is a simple relationship which exists between the capacity, resistance, power factor and phase angle of the condenser. The power factor and phase angle are both proportioned to the resistance of the condenser divided by its reactance. This relationship may be expressed as:

$$\text{Power Factor} = \frac{\text{Resistance}}{\text{Reactance}} = \text{Phase Angle}$$

It is seen that for low absorption of energy, i. e., low power factor and small phase angle, the resistance should be very small in comparison with the reactance of the condenser. The above expression for power factor and phase angle may be given in terms of the constants of the condenser as follows:

$$\text{Power Factor} = \text{Phase Angle} = \frac{2\pi f RC}{6.28 f RC}$$

in which R is the resistance and C the capacity of the condenser, and f is frequency. The power factor is usually ex-

pressed in terms of per cent., while the phase angle is expressed in degrees. Good condensers should have power factors of the order of 2 per cent. or better and phase angles of a few minutes or less.

It is of interest to note the difference between the phase angle of a condenser and the angle of lead, a difference which is not always clear to the amateur. The angle of lead is the angle by which the current flowing into the condenser leads the applied voltage, and is generally near 90 degrees in a good condenser. The phase angle, on the other hand, is the difference between 90 degrees and the above angle of lead, and is, therefore, very small. This difference is seen from an examination of Fig. 1.

The design of a condenser is a problem in reducing the power factor or phase angle of a condenser, or reducing the losses. The losses in a condenser are primarily due to the following:

(a) Ohmic Resistance in Series with the Condensers.—This resistance is largely due to the resistance of the plates of the condenser, the leads and the contacts. Condensers should be constructed with plates of high conductivity and with good contacts. This condition is a very simple one to meet and is generally adhered to in prac-

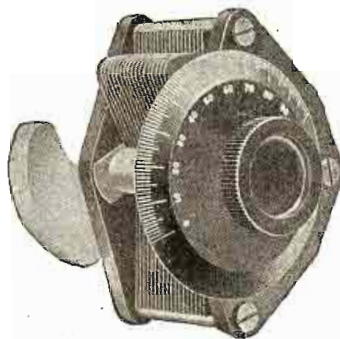

A typical air condenser with a counterweight to balance the movable plates.

tice, except in flagrant cases of poor and cheap construction.

(b) Leakage Through the Dielectric or Across It.—If the insulation resistance of the dielectric is low, there will be a leakage of current through the dielectric or across its surface, and this leakage represents a loss of energy. Only dielectric of the very highest surface and volume resistivity should be employed to reduce this source of energy loss.

(c) Dielectric Absorption.—This phenomenon is present to some extent in all solid dielectrics, and is practically absent in air. Apart from its electrical conductivity, a dielectric placed in a varying electric field absorbs energy. The amount of this absorption depends upon the nature of the dielectric employed. Thus paper has high absorption while mica and air have low absorption. The quality of different dielectrics, like condensers, may be measured by the phase angle of the dielectric. The smaller the phase angle, the less the absorption. Thus phenol resin has a larger phase angle than hard rubber, hence it makes a poorer dielectric. Another factor determining the amount of absorption is the amount of dielectric present in the con-

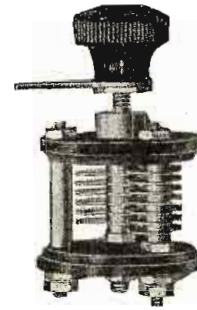

A small variable condenser used as a vernier for fine tuning.

denser. Condensers generally have other insulating material besides the dielectric between the plates, as for example end plates, insulating washers, supporting posts, etc. All this additional dielectric which in reality is no part of the condenser proper also absorbs energy, and so should be reduced to the smallest amount possible. Still another factor influencing the amount of dielectric absorption is the placing of this additional dielectric. The dielectric absorption is proportional to the strength of the electric field in which the dielectric is placed. The condenser should be designed so that insulating material, other than the condenser dielectric proper, is located where the intensity of the electric field is small.

(d) Brush or Corona Losses.—The losses discussed above occur in all types of condensers. The corona loss occurs only in condensers operated at high voltages. At very high voltages ionization of the air around the condenser takes place and leakage of currents occurs at points favorable to it, as for example where there are sharp points, edges, etc. At these sharp points the electric field is very intense, the voltage gradient is high and brushing occurs, which is evident by a visible bluish discharge. This is a loss of energy. To avoid this the condenser must be constructed so that there are no points where there is excessive electric field intensity, which means no sharp edges or points.

The above general considerations apply to all condensers especially to those which are used in circuits where the losses must be low. There are numerous other considerations of design such as mechanical ones which will be considered in the course of the article. However, condensers are designed for so many different purposes that many cases exist where the highest perfection in construction is not absolutely essential. Thus smoothing condensers in filter circuits need not necessarily have the low power factors necessary for radio con-

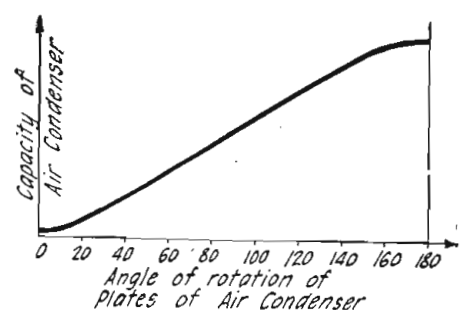

Fig. 3
Capacity curve of an air condenser with semi-circular plates.

condensers. What is here required is more the high capacity and insulation resistance. The special conditions which condensers must meet will be considered in the discussion of the different types of condensers which follows.

VARIABLE CONDENSERS

As compared with fixed condensers, variable condensers have a rather limited field of use. The principal use of variable condensers is in tuning radio circuits, whereas fixed condensers are used in almost every type of circuit, for example, as blocking condenser, filter and smoothing out condenser, protective condenser, by-pass condenser and so on. Variable condensers might, of course, be used for all these different purposes, but it would not be economical, and no advantage is gained in using a variable bulky unit where a compact fixed unit may be used.

There are three principle types of dielectrics used in variable condensers today. These are, air, oil, and mica. These have their different spheres of use. Thus air is used chiefly in receiving condensers, while oil is principally a transmitting condenser dielectric, and mica is used for both receiving and transmitting condensers. Apart from the losses in a dielectric, what de-

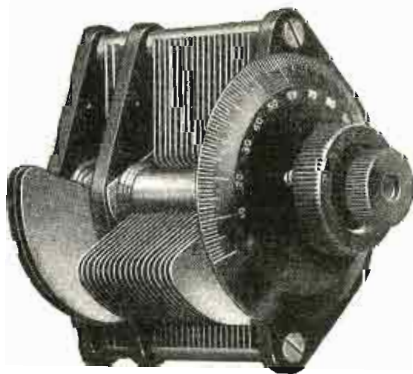

Fig. 6

A vernier may be composed of an extra plate operated by a separate knob, as shown above.

termines its use in a transmitting condenser is the dielectric strength, and to a lesser extent, the dielectric constant of the material. The dielectric strength determines the voltage which unit thickness of the dielectric can withstand without puncturing, while the dielectric constant determines the capacity of the condenser for given dimensions. Of the above three dielectrics, air has the lowest dielectric strength and is, therefore, least suitable for transmitting condensers. Of course the plates may be spaced widely and thus the condenser with air dielectric may be made to withstand high voltages, but this would necessitate a large number of plates to secure a given capacity because of the low dielectric constant of air. This is undesirable since the condenser is then made very bulky, and as a result variable air transmitting condensers are not generally used. There is a means whereby air may be used in a transmitter condenser without unduly large plate spacing, and this is to put air under high pressures. This has the effect of increasing the dielectric strength of air. This is an elaborate procedure and is, therefore, but seldom followed in practice, and then only in some high power work.

However, an ordinary variable air condenser, such as used in receiving work, may be converted into an efficient transmitting condenser at little cost by filling it with some good grade of oil. The oil has a high dielectric strength and so is suitable for high voltage work. When this is done, it should be noted, not only is the breakdown voltage increased, but the capacity is likewise increased, since the dielectric constant

of oil is much greater than that of air. These considerations apply only if the construction of the condenser is such that breakdown at lower potentials than the dielectric strength of the oil can not occur at other points of the condenser.

Mica has the advantage of having both very high dielectric constant and high dielectric strength. As a result, high capacity condensers may be made to occupy very small space and at the same time to withstand high voltages. It has practically displaced all other types of dielectrics for transmitting condensers and is gaining considerable vogue in receiving condensers. It is likewise being used in some types of precision condensers as its power factor is almost as low as that of air.

Variable condensers may be classified as continuously variable and stepwise variable. In the continuously variable condenser the capacity passes through all possible values between two limits, whereas in the stepwise variable condenser the capacity passes through a definite number of values, i.e., the capacity is varied in steps. The stepwise condenser, though variable, is really a special type of fixed condenser and will therefore be taken up under that heading.

VARIABLE AIR CONDENSERS

As usually constructed, variable air condensers are made of a group of stationary plates between which are interleaved a group of movable plates. These plates are generally semi-circular in shape. As more and more of the area of the movable plates interleaves with the fixed plates the capacity of the condenser increases. Such a simple variable condenser is illustrated in Fig. 2, in which the fixed and rotating plates are clearly visible. A graduated dial mounted on the same shaft as the rotating plates indicates what proportion of the rotating plates are interleaved with the fixed, and is thus a quantitative measure of the capacity. The dial might well be calibrated in actual capacity as some condensers are. This type of condenser gives a straight line variation of capacity; that is, the capacity of the condenser varies directly with the angle of rotation of the movable plates, as shown in Fig. 3.

This condenser illustrates a novel method of minimizing ohmic resistance in the condenser. All the stator plates and the rotor plates are each die-cast into one solid unit, thus insuring perfect contact between the plates in each group. Such a construction insures rigidity at the same time, resulting in constant spacing of plates, hence constant capacity and no possibility of motion of plates and short circuiting, which constitute the fault of a great many condensers. The weight at the end of the shaft is for balancing the rotating plates. It is obvious that unless some means is provided for balancing, the movable plates will not remain in any position in which they are set, but will fall back into a position of stable equilibrium. In order to avoid this, a weight equal to the total weight of the rotating plates is placed on the same shaft, but so

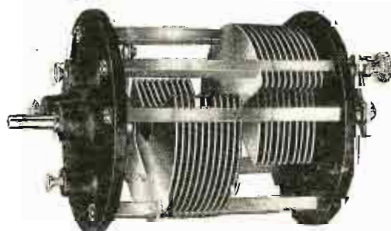

Fig. 4

To balance the movable plates half of them may be mounted opposite the other as shown in the picture above.

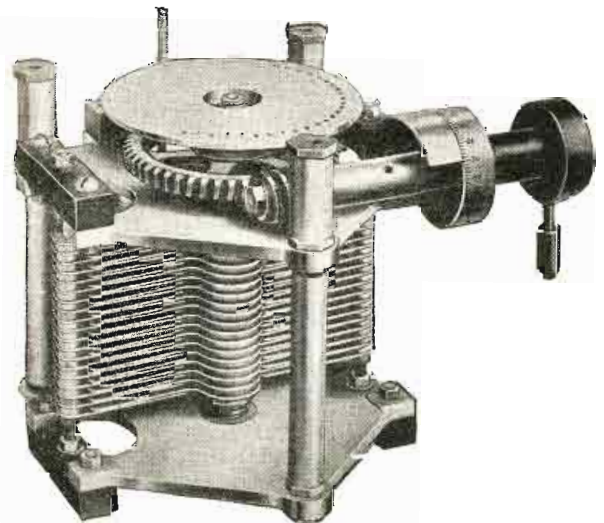

Fig. 8

A precision condenser equipped with a worm gear system to allow extremely precise adjustment.

disposed that the entire system is in equilibrium, no matter what the position of the plates.

Fig. 4 illustrates a variable condenser which employs a different means for balancing the rotor plates. Two sets of stator plates and rotor plates are employed placed on opposite sides of the shaft, so that when one set of rotors moves upwards, the other moves downwards. The weight is, therefore, uniformly distributed around the shaft and the system is always balanced. Such a condenser necessarily takes up more space than the one shown in Fig. 2, or other condensers which employ different means for balancing.

VERNIER CONDENSERS

The use of very selective circuits and the necessity for fine tuning have made it desirable to employ vernier condensers so that

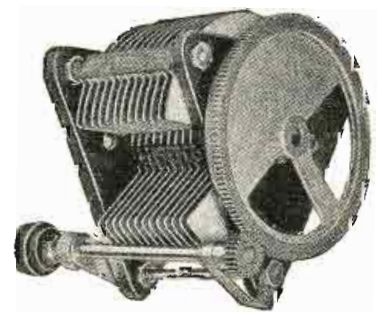

Fig. 7

A variable condenser equipped with a gear system to obtain a vernier action.

very small variations in capacity may be secured. This is not possible with the types of condensers described above, for a small motion of the dial produces a relatively large change in capacity. A number of different methods for securing a slow change in capacity are used. One of these is the use of a separate vernier condenser in parallel with the main condenser. Such a vernier is shown in Fig. 5. This condenser is of the ordinary construction, except that its parts are very small, hence, the maximum capacity is very small. Since the dial rotates the usual 180 degrees, it is evident that a minute change in capacity is secured with small motion of the dial.

Such a vernier, while generally satisfactory as far as operation goes, has two disadvantages: First, it requires two separate mountings for the main condenser and the vernier; second, as much dielectric loss may be introduced by the vernier condenser

(Continued on page 1339)

Building a Neutrodyne and Making It "Neut"

By LESTER D. CUSHMAN

The average person fails to realize the importance of systematic layout, neat wiring and soldered connections in a receiving set. These are very important considerations in the neutrodyne. Some neutrodyne owners have probably already found this out. At any rate, this article will give you a few worth-while pointers.



A front view of the Neutrodyne receiver built by Mr. Cushman. Note the positions of the jacks and rheostats.

IN the opinion of the writer nothing in radio can compare with building your own. DX work by Night Owls may hold the enthusiast's attention for a time, but the real enjoyment comes in the construction of a simple or intricate set and making it work.

In common with numerous other amateur constructors we were immediately struck with the possibilities of Professor Hazeltine's scheme for capacity neutralization in radio frequency amplifiers and after thoroughly digesting all the published accounts of the circuit, pestering both Professor Hazeltine and the builders licensed by him to manufacture commercially the set, with more or less relevant questions, we purchased some parts and went to it. Having had experience in building several reflex, regenerative and transformer coupled R. F. sets, we were plumb full of optimism. We soon discovered that nothing built to date requires the thought and care this circuit demands.

The parts were assembled on a shellacked black walnut panel 28 x 9 x 1/4 inches, with a tube shelf of the same material mounted on brass brackets, the A. F. transformers were mounted directly on the panel and the circuit used was the one published by one of the licensees with the single change of control for filaments of audio tubes by a rotary double pole, double throw switch in place of filament control type jacks.

The wiring was done in a more or less haphazard manner with bus wire and presented, when completed, anything but a neat and ship-shape appearance.

After testing, to make sure that 90 volts would not be impressed on the tube filaments, tubes were inserted and we proceeded to "neutralize."

We tried every conceivable combination of

buzzer and wave-meter under the sun, but were unable to balance out as per directions.

We hooked up to our antenna and listened with bated breath. Sure enough, she worked, but the dear familiar beat note greeted our ears. She "perked" but didn't "neut"; local stations came in no louder than those 500 miles distant. She was selective enough to tune out a 500-watt station

primary and secondary of the second neutroformer were bucking with an inverted connection. This was found by means of a pocket compass and a dry cell, testing the polarity of all the neutroformer coils. When corrected, the wiring looked more messy than ever. Careful examination showed that there were several delightful condenser leakage paths provided by the paralleling of high frequency lead wires.

SENSITIVE GRID LEAD

Then we accidentally discovered that the set "perked" beautifully if we touched the grid lead to the second neutrodon, thus providing a high resistance leak to ground, showing that it is possible to neutralize tube capacities by high resistance leaks. Being of a restless disposition, we were unwilling to tie our fingers to the set and thus provide a human leak, so we substituted two 5-meg. variable leaks in series. This worked, but the squeal was still with us. Being persistent, we determined to make the set work as per specifications or not at all.

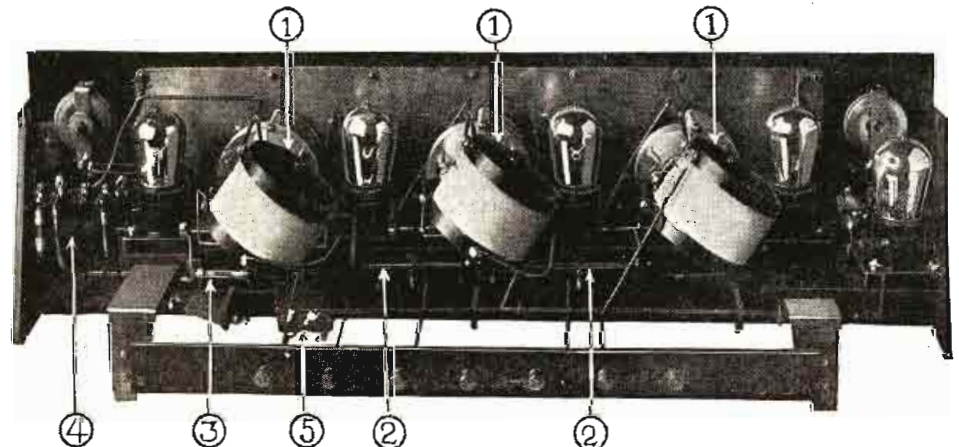

A rear view of the set clearly showing the relative positions of (1) the neutroformers, (2) the neutrodons, (3) the grid condenser and leak, (4) the first audio frequency transformer and (5) the by-pass condenser.

half a mile away, but she wasn't strong enough to work a loud speaker even on the locals.

Then began a careful examination and analysis for trouble, high frequency leaks, etc.

The set had been very hurriedly put together and wired; connections were made fast by soldering, but were made too fast for checking.

The first error discovered was that the

So starting all over again, our first thought was to thoroughly examine a factory built set and thus gather the fruits of their experience. One particular point struck us at once, namely, that the wiring was much more simple than our complicated maze.

With this in mind, we proceeded to make a picture of the set to scale, an elevation looking toward the back of the panel and two plans, one below and one above the tube shelf.

Some readers doubtless lack the skill to "put the thing on paper" that our years of drafting placed at our disposal, but even a rough sketch of the parts in their proper relative position drawn to scale is far better than no picture at all.

We then took our wiring diagram and sketched in the leads on our picture. A little study showed that certain of the parts were misplaced or in too inaccessible positions. This was corrected on the sketch and the leads from part to part shortened and placed where they could more readily be reached. Radio frequency leads were kept from too close parallelism to other like leads and to leads at or near ground potential.

A few hours spent in this way will amply repay the constructor when he actually starts to wire the set, for then each lead has its place and may be run direct, without awk-

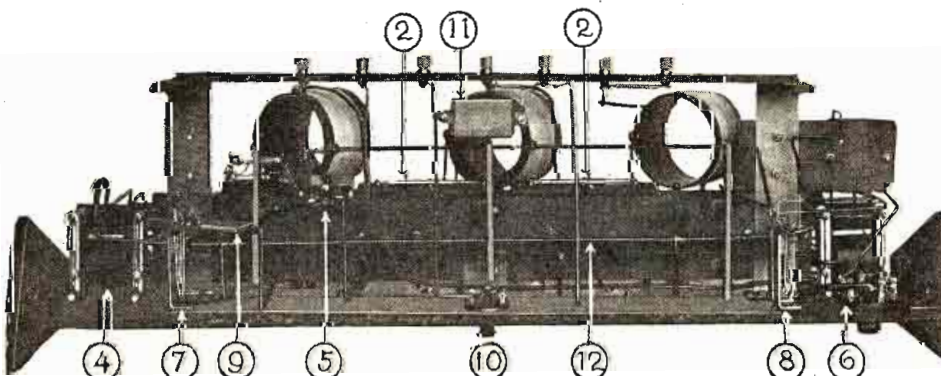

Under view showing (2) the neutrodons, (4) the first audio transformer, (5) the by-pass condenser, (6) the second audio transformer, (7) first amplifier jack, (8) second amplifier jack, (9) by-pass condenser; (10) filament switch, (11) by-pass condenser and (12) the shielded connection from the first to the second stage amplifier.

ward bends or kinks, and the completed wiring will have a neatness that will be a joy to the eye.

In sketching in the leads, try as much as possible to keep leads that do have to run parallel at least 2 1/4 or 3 inches apart, and where they cross make the crossing at right angles.

The sketch picture shows that absolute symmetry of appearance from the panel front was sacrificed for simplicity of wiring. This applies particularly to the disposition of jacks and control switches.

Let us caution the constructor on the absolute necessity of testing the wiring as the work progresses. A test set, consisting of a buzzer or miniature lamp, a dry cell and two flexible leads, is a great trouble saver.

Test each lead and circuit as completed. Cold soldered joints sometimes stick; test them with the buzzer and you will be sure of the contact. We also test every soldered joint for mechanical strength by a light tap or pull on the wire.

The test set has paid for itself several times over in keeping an unhealthy 90 volts off the tube filaments. Test every possible connection that might lead "B" battery current to the filaments before a tube goes into a socket. We also use a quarter ampere fuse on the positive leads to the "B" battery; this as an additional precaution in using 201-A tubes; other types of tubes should, of course, have proper size fuses.

We also want to caution the constructor to make haste slowly, check your diagram, check off each connection as made on both diagram and sketch. Use soldering paste sparingly and immediately wipe off joint

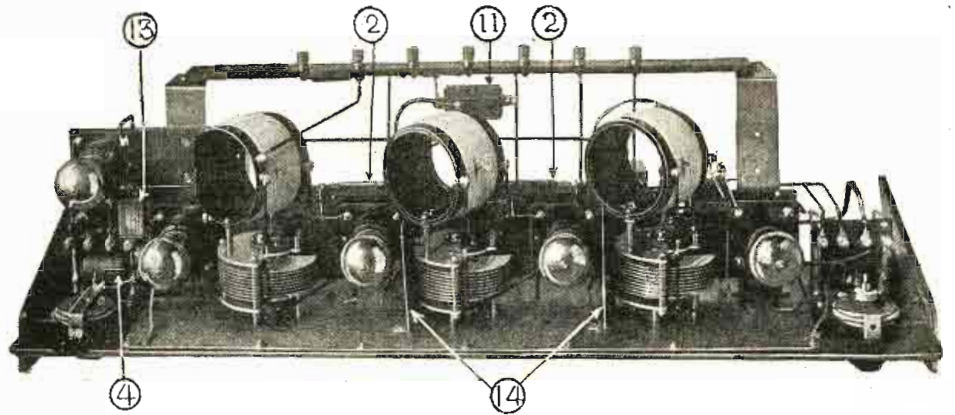

Top view showing (2) the Neurodons; (4) the first audio transformer; (11) by-pass condenser; (13) by-pass condenser; and (14) the extension shielding.

with a rag dampened with denatured alcohol.

We cover all our leads with spaghetti, more for appearance sake than anything else, but the covering is of some advantage where leads cross, in the prevention of accidental short circuits.

To summarize:

1. Study the relative apparatus positions before assembling on panel and wiring.
2. Be sure that neuroformers are hooked up with the relative polarity of primary and secondary correct.
3. Make all leads as short and direct as possible.
4. Keep radio frequency and "A" battery and audio leads separated as much as possible.

5. Check each lead as wired with diagram and sketch.

6. Test each lead as wired for contact and mechanical strength.

7. Clean each soldered joint as soon as cool.

8. Avoid screwed joints; solder every connection if possible.

9. Don't attempt to make your own neuroformers.

10. Don't hurry any of the work.

If the reader observes all the precautions noted in this story of our experience there is no reason why his neutrodyne should not "neut" and he will find that he has a set that is not only a delight to run, but a pleasure to show to his friends.

Make That Single Circuit Selective

By JOHN H. BOSTOCK

FOR the radio fans who have built single circuit sets, and I know that they are now wishing they had expended a little further and made the popular honeycomb or variometer set, this article is written.

As you have found out, the single circuit set, while giving louder signals, also brings in interference. The main reason you built your single circuit set was that it was inexpensive. Now I feel sure there are many fans who, like myself, have been trying to reduce interference. To these fans I offer the results of my experiments. You can alter your present single circuit receiver very easily by just substituting the new tuning arrangement. Looking at the diagram, you will notice that the circuit is almost identical with the usual honeycomb circuit; i. e. primary, secondary and tickler, and yet the whole thing is nothing more than a variocoupler.

A description at this time is therefore

not out of place. A tube of insulating compound or cardboard 4 inches in diameter (if the latter, it should be well shellacked) is obtained and some No. 24 D.S.C. wire. The tube will need to be about 7 inches long. Starting from one end, make a hole for a binding post 1/4-inch down and commence winding from the post. After winding 20 turns, make another hole for the binding post—this completes the primary; no taps are required. Leaving 3/4 of an inch, make another hole and start winding the secondary. Wind 60 turns and tap every 10th turn; this completes the secondary. The tickler is the usual wooden ball, and is wound with 36 turns of wire, 18 on each side. Now place the tickler in the tube. The ball should rotate between the primary and secondary turns and the small sketch will further make this understood. After the tickler is placed in the tube, make two more binding post holes in the tube between pri-

mary and secondary for tickler connections. This makes the whole tuning arrangement complete.

After drilling, you can commence the hook-up. Following a recent suggestion in RADIO NEWS, color each circuit as it is wired and

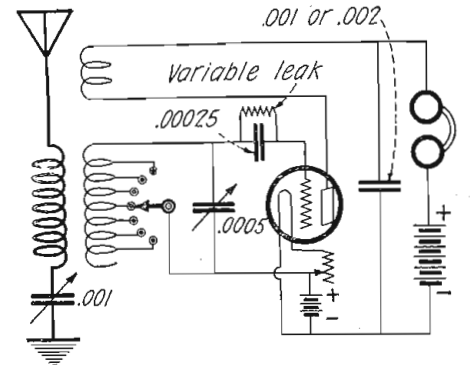

Circuit diagram for the tuning unit described in this article.

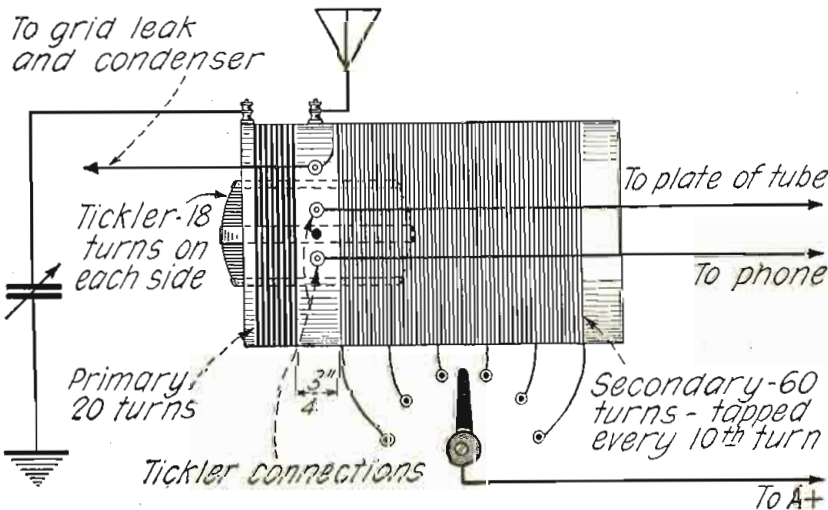

Details and connections of the tuning unit.

no mistakes will follow. I do not think I need explain further. If your skill has been sufficient to produce your single circuit, you will have no difficulty with this one.

Just a little word of caution. I have found that on most receivers the small .001 fixed condenser shunting phone or "B" battery is omitted. This circuit will positively not oscillate properly if this condenser is not included. The antenna I now have is about 120 feet long and I find the 20 turns on the primary quite sufficient for waves from 150 to about 800 meters. The primary condenser is in series with the ground and not shunted across the primary. This to me seems a little better than the usual shunt. I also find that the secondary condenser is very sharp in tuning and that the primary condenser acts as a vernier. I would advise the

(Continued on page 1318)



The Radio Constructor

The All-Purpose Receiver

By M. B. SLEEPER

Describing the radio frequency amplifier unit, a new design in which tuned and transformer types are combined to give greater signal strength and sharper tuning.

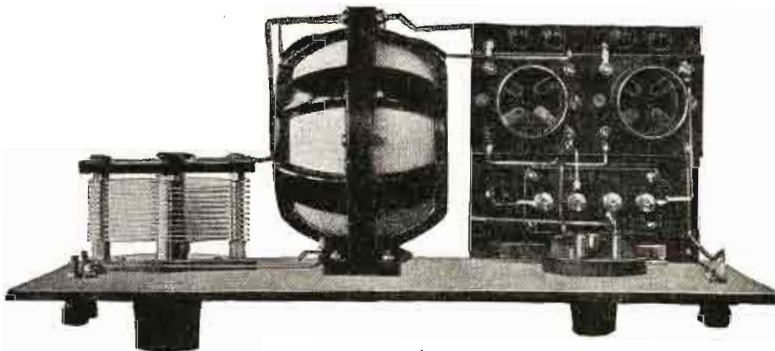

A top view of the two stage radio frequency amplifier unit designed for use with the All-Purpose Receiver.

insulating panel seven by fourteen inches, which carries at the rear a base panel measuring five by five inches. Remember, when you cut out the smaller panel, if you use an adjustable hack saw, to turn the blade 90 degrees. Then the frame will not interfere with the panel as you cut down. The locations of the holes are indicated in Figs. 6 and 7. In case your panel is not cut accurately, use the bottom as a working edge, and measure all vertical distances from it. For horizontal distances, draw a line across the center of the panel and measure from it to the left on to the right. Locate each hole with a punch mark, and check them all carefully before you start to drill. This is particularly important if you have done your layout work on the back of the panel, for it is easy to slip when transposing the positions from the front-of-panel drawing. In case you plan to have the drilling done at a machine shop, bear in mind that the

THE third unit of the All-Purpose Receiver* is the most interesting of all, for it introduces an entirely new system of radio frequency amplification. The instrument shown in the accompanying illustrations provides two steps of radio frequency amplification, the second of which is transformer coupled and the first, non-oscillating tuned transformer coupled. Perhaps you are looking for the second transformer. You won't find it, for it isn't there. In Fig. 1 you will see the circuit of this unit. Unlike the usual R.F. amplifier, this one is arranged to be connected directly with the antenna and ground as a tuning circuit. It is comprised of a fixed coupler and a .0005-mfd. variable condenser, and is connected to the first tube. When the R.F. unit is wired up with the tuning unit and detector, the tuning circuit in the latter instrument is not discarded, however, for it serves as the tuned transformer. Just the way this works out can be seen in Fig. 2, which shows the elementary wiring of the tuner.

So that there will be no confusion about the tuned transformer and the fixed coupler, it should be said that both instruments are identical in design. When the R.F. amplifier is not used, it is a fixed coupler, but with the R.F. amplifier hooked on, it be-

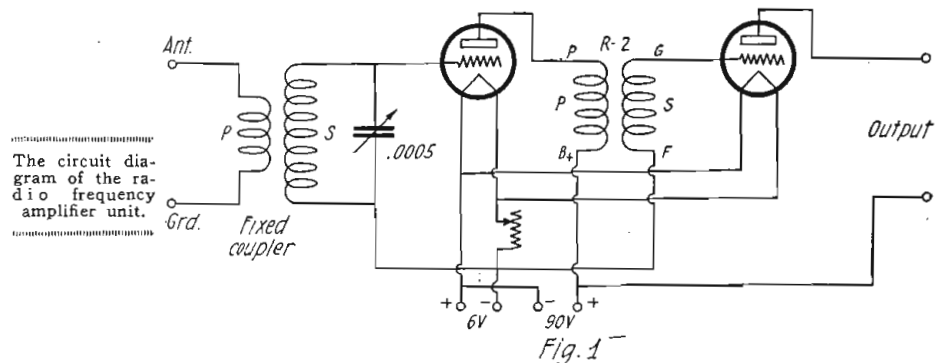

The circuit diagram of the radio frequency amplifier unit.

While the All-Purpose Receiver is designed for use with other types of R.F. amplifiers, this system opens up a number of interesting possibilities. In the first place, when used as in Fig. 2, or with the A. F. amplifier added, the combination makes a set not only very sensitive but very sharp in tuning. In fact, the fixed coupler in the receiver unit gives a considerable increase in selectivity over the tuning obtained with the use of an iron core transformer. And what is perhaps more important, it straightens out the curve of the iron core transformer so as to give very nearly uniform amplification over the entire wave-length range.

This set answers the question which is asked so often now-a-days—"How can I use radio frequency with a regenerative receiver?" As explained in the first article, the receiver unit can be made regenerative by putting a variometer in the plate circuit of the detector tube. There is no danger of feed-back action, because of the very low inductance of the tuned transformer primary.

comes a tuned R.F. transformer. The confusion of names is due to the fact that the device was brought out originally to replace the variocoupler. It was then found that the fixed coupler was equally useful as a tuned R.F. transformer.

CONSTRUCTION OF THE AMPLIFIER

Fig. 3 illustrates the R.F. unit in use with the other two. Figs. 4 and 5 show rear and side views. The parts are mounted on an

charges are much lower, and the chance of their making a mistake much less, if each hole is indicated with a center punch mark.

This is the only machine work necessary, as the parts are all standard, and can be obtained in any radio store. Corresponding parts can be substituted judiciously, although it may be better to use those specified because they fit the drilling. The 6-ohm rheostat is of the Fada type, the vari-

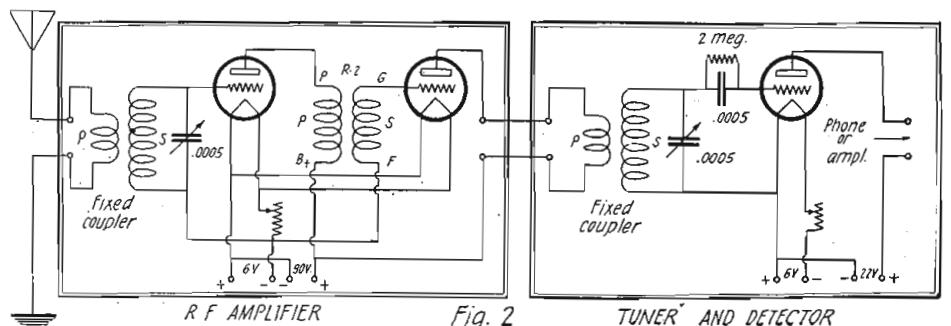

This clearly shows how the radio frequency amplifier unit, described in this article, is connected to the All-Purpose Receiver.

* The first unit, comprising the tuner and detector, was described in the September, 1923, issue of RADIO NEWS, and the second, a two-step audio frequency amplifier, in the October, 1923, issue.

unit by itself, connect the upper output binding post to the P terminal of an Acme R-3 transformer, and +B to the lower post. Run the G connection to one side of a crystal detector, the other to one telephone receiver tip, and the second tip to F on the transformer. While the tuning is not extremely sharp, it is all right for reception where the nearest broadcast station is 50 or 75 miles away. The volume, even on stations 1,000 miles away, is good for telephones, although insufficient for a loud speaker. To increase the strength for loud speaker operation, connect the G post of the R.F. transformer mentioned above to the upper input post of the A.F. amplifier, and the F post to the lower input terminal. Then you will have good volume with the purest quality.

There are dozens of combinations and experiments which can be tried out with these three instruments, for they are truly of all-purpose design. We shall be pleased to hear what you have done with them and of the results you have obtained.

This concludes the series of articles by Mr. Sleeper on the All-Purpose Receiver.

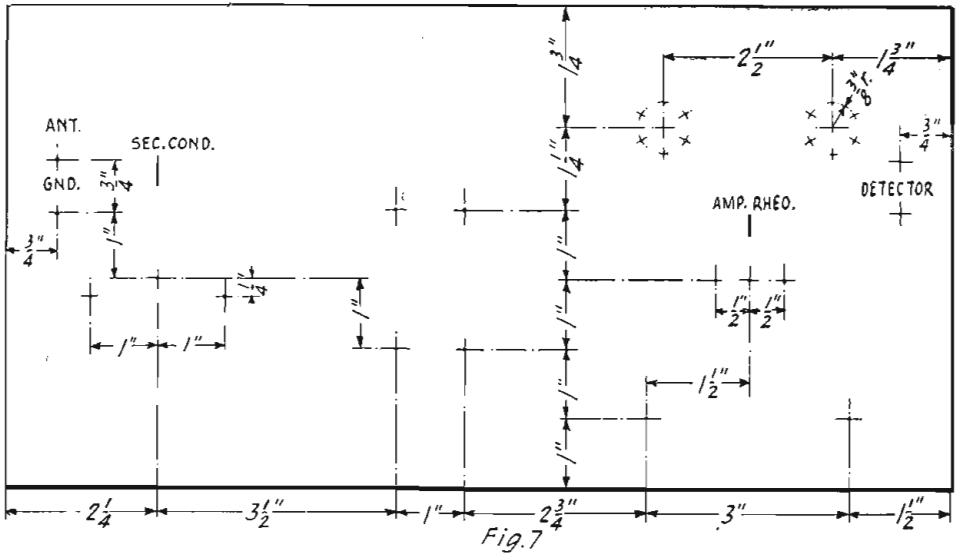

Specifications and layout of the main panel upon which the variable condenser, rheostat, etc., are mounted.

The Weagant Receiving Circuit

By Paul G. Watson

THE "Weagant" tuner mentioned in the writer's article entitled "Radio Station 4BY," appearing in the December, 1923, issue of RADIO NEWS, has been the subject of so many inquiries that it is impossible to answer them individually and give the desired technical information.

The basic circuit is not original with the writer, but is the invention of Mr. Roy Weagant, one time Chief Engineer of the Radio Corporation of America. This circuit is very simple in principle and in operation and has only one variable control when adjusted properly. By this is meant that the amateur band of wave-lengths (176 to 225 meters) can be covered efficiently by varying only one control, the secondary condenser. The same applies to the broadcast band of wave-lengths.

Fig. 1 shows the principle, or fundamental "Weagant" circuit, and the general relation of the components. The three coils are each of 50 turns and are preferably of the honeycomb or duo-lateral type which cover the broadcast band of wave-lengths. For amateurs, a special coil which will be described later is used for secondary and tickler, while a 25-turn coil serves as primary. The type of coils to be used in the receiver could be made the subject of a lengthy discussion, but it suffices to say here, that after some experimenting, the writer decided on the use of the above mentioned types.

THE EQUIPMENT

The secondary and tickler condensers are

of 23 plates, having a capacity of approximately .0005 mfd. The secondary condenser is equipped with a vernier adjustment. Body capacity can be eliminated from the tuner by connecting the movable elements of the tickler and secondary condensers, marked "M" in Fig. 1, together, and connecting them to the negative of the

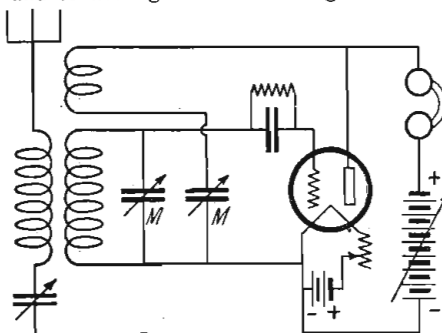

Fig. 1
Circuit diagram of the fundamental Weagant circuit. Advantage is taken of both inductive and capacitive feed-back.

"A" battery. The primary condenser is one of 43-plate having a capacity of .001 mfd. The grid condenser and leak are of the usual forms, the condenser being of .0005 mfd. capacity.

The superlative form of the Weagant circuit is shown in Fig. 2, which diagram shows the usual form of this tuner and in addition, one step of radio frequency and two steps of audio frequency amplification.

According to the writer's experience, after extensive experiments, this is one of the best amateur and broadcast tuners when used in this form. The three coils shown in the diagram, grouped together, are of the same size and should be mounted in the regular three-coil mounting for honeycomb coils. The fourth coil is out of inductive relation to the other three, and is tuned by the antenna series condenser. The resistance "R" is the resistance element of a 200-ohm potentiometer and is connected in shunt to the "A" battery. This resistance has a radio frequency by-pass condenser of .002 mfd. to the movable arm. A fixed condenser of .5 mfd. value is connected from the positive of the R.F. "B" battery to the moving arm of the potentiometer. In experimenting with this type of radio frequency amplification, an attempt was made to inductively couple it to the antenna circuit. From an experimental angle it was successful, but from a practical standpoint, the tuning was made too complex. It was necessary to add another condenser to tune the R.F., and the coupling between the antenna and the R.F., both of which had to be adjusted very closely, in addition to the usual tuning elements. By using it in the form presented here, it was found that the tuning was practically the same as it would be if the R.F. were to be eliminated, while the efficiency and sharpness were about the same as the more complex inductive coupled R.F. amplifier.

The type of radio frequency amplifier developed by these experiments is shown in Fig. 3. The general idea of this piece of apparatus was suggested to the writer by Mr. F. A. Hill, Radio 4GL, whose very efficient station has been heard in all parts of the globe. The circuit of the radio frequency amplifier, as shown in Fig. 3, can be applied to any tuner, while it is inductively coupled. The apparatus for this amplifier can be assembled on a small insulating panel, about six by nine inches, or can be incorporated in the tuner panel to which it is connected. No additional condensers need be installed when it is built in the receiver panel, as the usual short wave condenser can be rewired into the antenna tuning condenser for the radio frequency. The value of the radio frequency coil, when connected to various forms of tuners, will vary, but generally a 50-turn coil will be found satisfactory for broadcasting, while

(Continued on page 1326)

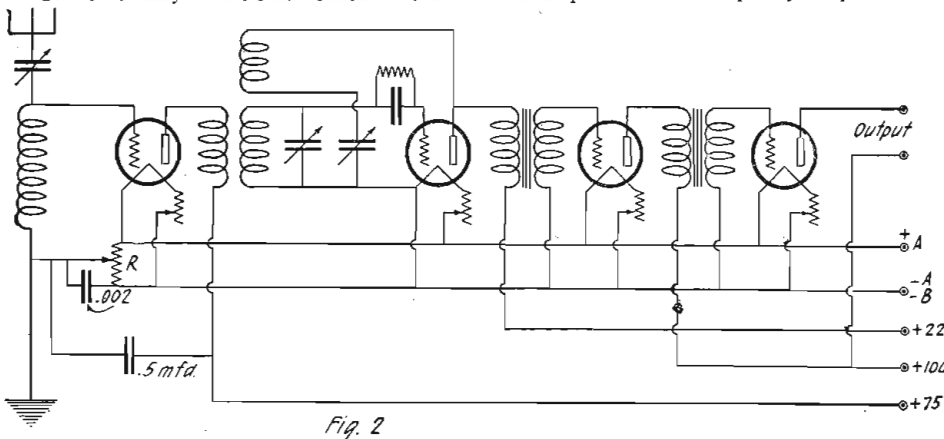

Fig. 2
The Weagant circuit used in conjunction with a tuned radio frequency amplifier and a two stage audio frequency amplifier. This is a very sensitive and selective circuit.

Lightning Protection for Antennae

By J. R. MCFARLIN*



It is the general idea among those with small knowledge of electricity that if an aerial is erected there is considerable danger of its being struck by lightning. This is not so, but it is necessary to protect aerials against the bad effects of induced currents. This article explains in a comprehensive manner the cause and effects of electrical charges and describes methods of protection.



THE various phenomena connected with the effect of lightning on radio antennae has received but scant comment in the literature devoted to the many aspects of radio. The average owner of a radio receiving set, or for that matter, the more advanced technician in the radio field, has seldom given more attention to this subject than to accept the ruling of The National Board of Fire Underwriters that an approved lightning arrester must be

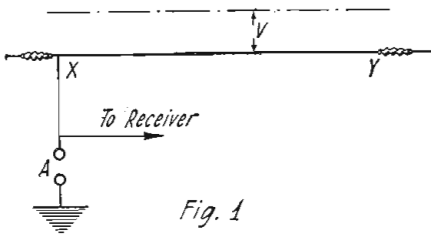

Fig. 1

If the static charge, represented by the broken line, becomes greater than the normal potential of the aerial X-Y, it will discharge to earth through the arrester A.

installed. This done, the matter has been forgotten.

The study of the theory underlying lightning disturbances and manifestations on radio antennae is of absorbing interest and in this article we shall review the subject in a more or less non-technical manner, contenting ourselves with statements of fact rather than with their sometimes involved and cumbersome analytical proof.

NATURE OF LIGHTNING

In past years the term "lightning" was taken as denoting electric discharges between cloud and cloud or between cloud and earth. As electricity came more into use, operating men found that during atmospheric disturbances, such as passing lightning storms, disturbances occurred on their circuits without lightning actually striking the line. Too, disturbances occurred when there was no lightning in the vicinity. The former disturbances were induced lightning disturbances and the latter generally static accumulations. They were all grouped in one class and called "lightning." With the advent of radio antenna many of the disturbances previously noted on electric circuits were manifested therein and these likewise were classified into one group and called "lightning."

So today, "lightning" as used in connection with lightning protection, is understood to mean protection against any abnormal phenomena of voltage (or current) occurring in an antenna system. Devices designed and installed for the purpose of affording protection to apparatus connected thereto from any and all the above phenomena are by standard usage called "lightning arresters."

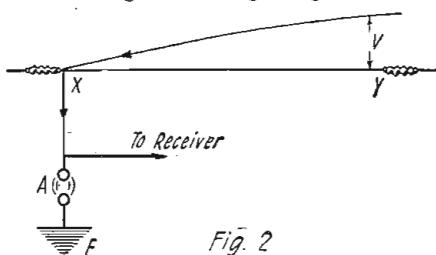

Fig. 2

Illustrating the case of Fig. 1; the charge flows to earth as indicated by the solid line and arrow heads.

WHAT A LIGHTNING ARRESTER IS Before discussing the various forms of lightning to which antennae are subject it will be helpful to explain generally what a lightning arrester is and how it operates.

Lightning phenomena on an antenna manifests itself as a rise in the normal voltage of the antennae with respect to ground. Consequently, if apparatus connected to the antenna is to be protected from such a rise the protective device employed should function as a "safety valve," opening up with the potential rise and dissipating it to the ground. This is exactly what a lightning arrester is—an electrical safety valve. The form which this electrical safety valve assumes is a gap in air, either at atmospheric or reduced pressure. Air possesses a certain dielectric strength and by a suitable gap provided between conducting electrodes, a "valve" may be made which will discharge all voltages above its critical breakdown value. After the dissipation of the charge its dielectric strength is restored and consequently the antenna is again at its normal potential. Usually the discharge of an antenna through a lightning arrester occurs in a few micro-seconds and the only knowledge that one ordinarily has of it is a slight click heard in the receivers.

Lightning as effecting radio antennae may for convenience be classified into four groups:

- a—Accumulated Static

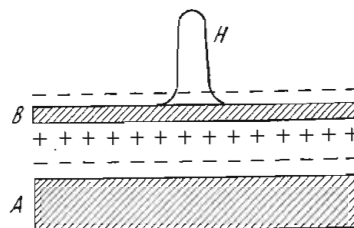

Fig. 3

An electrophorous, the surfaces of which have been charged with electricity by friction.

- b—Electrostatic Induction
- c—Electromagnetic Induction
- d—Direct Strokes

ACCUMULATED STATIC

Accumulated static is observed usually on antennae highly insulated from ground. Such antennae collect small electrical charges from rain, snow, fog, dust, hail, wind, etc., which, accumulating, increase the potential of the antenna until a point is reached at which the voltage arcs over the lightning arrester.

In Fig. 1, the antenna X-Y is assumed to have accumulated a static charge uniformly distributed, as shown by the broken line above it. (A charge is also carried by the antennae lead-in wire which is not shown, for the sake of simplicity.) This charge is V volts higher than the normal antenna potential. When this voltage becomes high enough to break over the lightning arrester A, it discharges to earth E, the charge flowing to ground much as indicated by the solid line in Fig. 2, on which arrow heads have been placed to indicate the direction of flow.

ELECTROSTATIC INDUCTION

The electrostatic induction form of lightning disturbance is produced on an antenna

by induction from charged clouds drifting overhead. The theory underlying this form will be made clearer by examining the *electrophorous*, a laboratory device. It consists of a plate A (see Fig. 3) of resin or hard rubber which has been electrified negatively by briskly rubbing it with a piece of flannel, and a metallic disc, B, provided

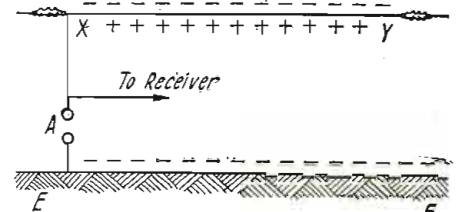
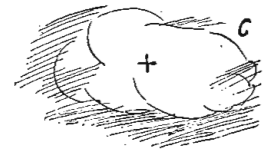

Fig. 4

As the cloud C, positively charged, floats over the aerial X-Y it induces a negative charge on the upper surface of the aerial and a positive charge on the lower surface as well as a negative charge in the earth.

with an insulated handle, H. When the metallic disc is brought near the negatively charged plate it becomes charged positively on the under surface and negatively on the upper surface. The two charges are of equal intensity. If now the plate is touched with the finger, the negative charge is dissipated and the plate is left with a charge of positive electricity. This charge remains on B as a free charge when B is removed from A, and may be dissipated by touching B with the finger, leaving the plate entirely uncharged. This process may be repeated so long as the exciting charge remains on A. The dissipation of either the positive or negative charge on plate B by contact with the finger is usually accompanied by a small cracking spark.

If now we may assume that a charged cloud corresponds to disc A, that plate B represents an antenna and that the breakdown of an arrester gap corresponds to touching B, it will be easy to understand the actual charging of an antenna through the influence of a charged cloud.

(Continued on page 1331)

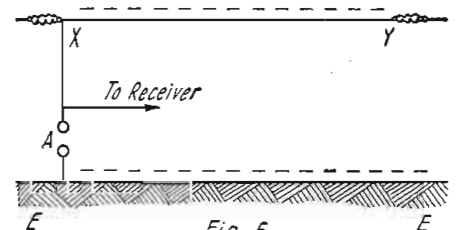
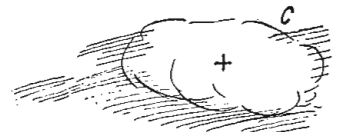

Fig. 5

After the positive charge has gone to earth the aerial and earth remain negatively charged.

*Electrical Engineer, Electric Service Supplies Co.

Awards of the \$50 Radio Wrinkle Contest

First Prize

A MERCURY VARIABLE CONDENSER

By F. L. PATTERSON

This unit combines the saving in space effected by the use of a mica condenser with the easy tuning of the well-known air dielectric condenser. It may be constructed very cheaply and every radio "bug" has the necessary tools. Parts 1, 3 and 4, in Fig.

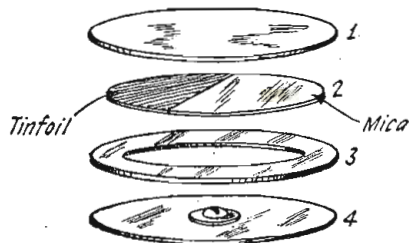

Fig. 1

The four principal sections of the mercury variable condenser in their correct positions for assembly.

1, are cut from some good grade of artist's cardboard. They should be about two and three-quarter inches in diameter and one-eighth inch thick. Part 3 has a hole about one and seven-eighth inches in the center. Piece 4 has an iron washer and machine screw in the center to form a contact for the mercury. Before putting another washer and a nut on the other side, the screw is sealed in the hole with a drop of sealing wax. Turn the nut down lightly on the wax. Apply heat to the screw un-

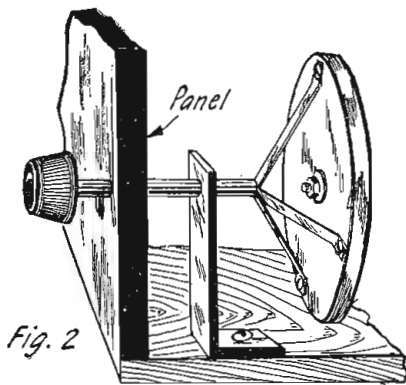

Fig. 2

Showing the manner in which the mercury variable condenser is mounted and supported.

til the wax begins to soften, then screw down with a wrench. Piece 3 is then glued to 4, making sure that the two pieces are joined well all around. This forms a shallow cup to hold the mercury. Procure some pure mercury. One dram should be sufficient. Pour it in the cardboard cup. Before gluing the mica (2) in position, place a piece of glass over the mercury, hold condenser in a vertical position, and see if the mercury level is about one-eighth inch below the machine screw. When this is adjusted, the mica sheet may be glued in position. This piece should be very thin and about 2 inches in diameter. Glue it on top of piece 3, taking the same precautions in making the joint tight, and also making sure the screw does not press the mica. Cut out a piece of tin foil, which will come within one-eighth inch from the machine screw when fastened to the mica, which may be done with glue or shellac. This forms the other plate of the condenser, which now looks like Fig. 3. Fasten a small

Prize Winners

FIRST PRIZE \$25

A Mercury Variable Condenser
By F. L. Patterson,
459 Princess Avenue,
London, Can.

SECOND PRIZE \$15

*From Single to Three-Circuit Tuner
With One Switch*
By Paul E. Duffield
5129 Knox Street,
Germantown, Philadelphia, Pa.

THIRD PRIZE \$10

*An Easily Constructed Honeycomb
Coil Mounting*
By David R. Inglis
1025 Baldwin Avenue,
Ann Arbor, Michigan

piece of brass inside of piece 1, to make contact with the tin foil; lead a wire from it through the cardboard, and glue the piece firmly on top of the mica. The condenser

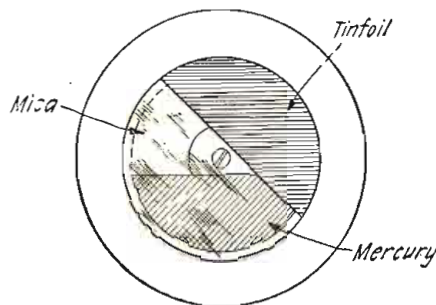

Fig. 3

Interior view of the completed mercury variable condenser.

is held vertically in operation and as it is turned, the mercury stays at the bottom. When the tin foil is also at the bottom, the full capacity is in effect, since the mercury is pressing close to the mica. Fig. 2 shows a good method of mounting. Three equally spaced holes are drilled close to the edge. Be sure that they do not go through the mercury chamber. Three strips of brass to form a tripod are attached thereto. It may be mounted directly on a panel, as shown, and flexible wire leads brought off from the contacts.

Second Prize

FROM SINGLE TO THREE-CIRCUIT TUNER WITH ONE SWITCH

By PAUL E. DUFFIELD

For ease of operation and volume of signals, the single circuit regenerative tuner stands supreme against the three circuit regenerative tuner. The latter, however, is more selective and will eliminate interference in cases where the single circuit tuner would be helpless. For consistent reception, it would be best to have both types, taking advantage of the single circuit set when the air is clear and switching over to the three circuit tuner when interference made clear reception in the single circuit set impossible.

It is not necessary, however, to have two sets. With the use of a four pole double throw anti-capacity switch connected with the required apparatus as shown in the accompanying wiring diagram, a rapid shift can be made from single to three circuit tuner, or vice versa. It is connected as a single circuit regenerative tuner when the switch is thrown to the left.

It is advised that No. 18 copper wire be used for connections and that all leads are kept as short as possible. Parallel wiring should be avoided. All of the apparatus employed in this arrangement is standard.

Third Prize

AN EASILY CONSTRUCTED HONEYCOMB COIL MOUNTING

By DAVID R. INGLIS

Although many new tuners have been invented, the honeycomb coil still proves itself very efficient, adaptable to many circuits, and, at the same time, practically the only efficient tuner of universal wave-length. One of the principal objections to its more widespread use has been the rather great initial cost of buying the mounting and the many plugs required for the numerous coils. But here is a successful mounting that costs almost nothing and is not difficult in construction, the parts being obtainable at a hardware store for a few cents.

A single mounting consists of two right-angle brass hooks fastened directly to the panel of the set, one inch apart and one above the other, as shown in the illustrations. Three such pairs of hooks can be

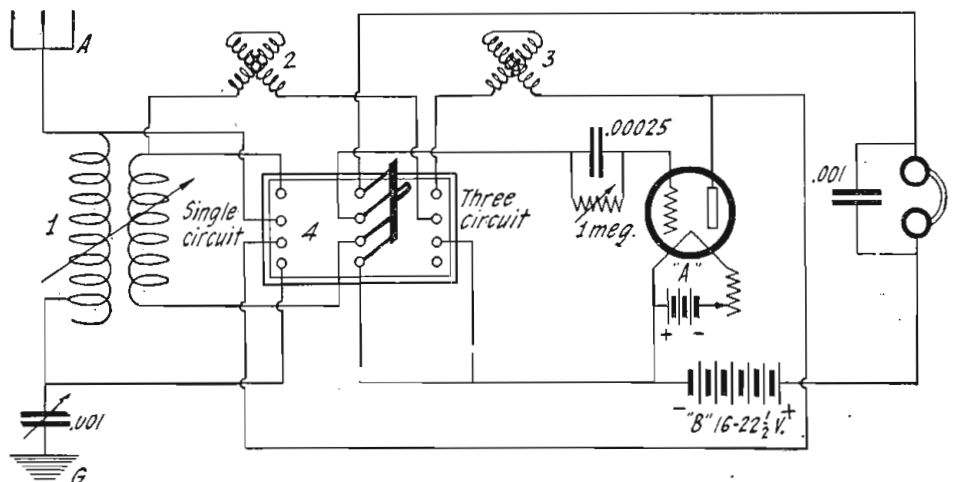

By means of a four-pole double throw anti-capacity switch connected in the circuit of a three-circuit regenerative tuner as shown, it becomes an easy matter to shift from a single circuit to a three-circuit connection at will.

placed side by side, an inch apart, to constitute a triple coil mounting.

The "plug" consists of two small screw eyes screwed into a small block of wood, with a separation of one inch. The screw eyes should be of such a size that they will fit rather snugly over the hooks of the mounting. The leads of the coil are soldered to the screw eyes, the wire coming around the coil and to the nearest eye, so that the polarity of the various coils will be the same.

Connections from the set are, of course, made to the hooks of the mounting. If the screw eyes fit snugly, there will be a positive connection, but if they are a bit loose, it will be necessary to solder to the horizon-

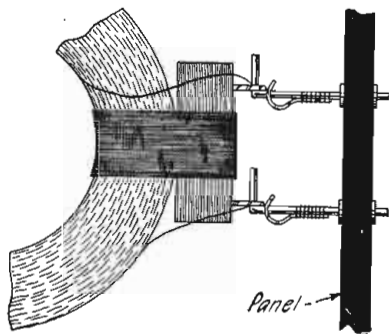

A very simple and practical mounting for honeycomb coils. The small springs fastened to the hooks insure good contact.

tal part of each of the hooks a piece of brass wire, bent in such a way as to bear against the screw eye when the plug is in place. This will insure a good connection to the coil.

The plug can be easily fastened to a honeycomb coil with ordinary friction tape. Such a mounting will support the largest honeycomb coil, it is also useful, however, for spider web coils, which are, perhaps, more satisfactory for short wave-lengths. Two small screws through the edge of a spider web coil and into the plug will fasten them securely.

Such a tuner, using home-made honeycomb and spider web coils in the ordinary regenerative circuit, has proved very satisfactory for amateur and broadcast reception and for the reception of the long wave commercials.

A FIT-ALL TUBE SOCKET

There are so many kinds of tubes now on the market, the bases of which are of different sizes, that it is necessary to connect up a new socket whenever it is desired to change tubes.

The drawing shows a socket which will hold any tube.

Simply insert the tube so that the pin fits in the little hole on the back part of the socket. Then tighten up the thumb nuts until

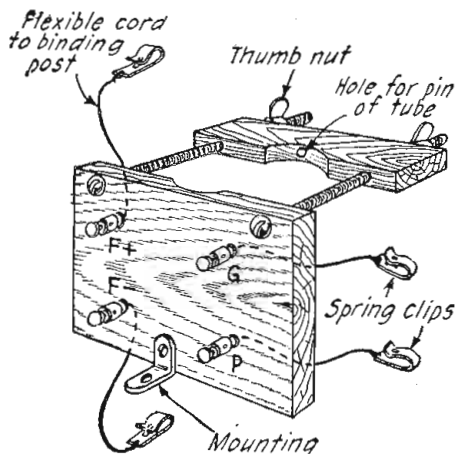

An ingenious form of vacuum tube socket particularly useful for experimental purposes. It will fit all tubes except the UV-199 and C-299.

the tube is secure. Connect the flexible cords with the small spring clips to their proper prongs on the tube, according to the marked binding posts on the front of the socket. The sketch shows how they are connected. Such a socket makes changing tubes easy.

Contributed by Carl Masson.

Speaking to Mars

over a light beam is Mr. H. Gernsback's latest idea of how we may communicate with Mars in a surprisingly simple manner. Mr. Gernsback suggests the use of the Bell Photo-Phone, which was really the first radio telephone. Read this fascinating article in the March issue of SCIENCE AND INVENTION; it will give you food for thought.

LIST OF RADIO ARTICLES APPEARING IN MARCH SCIENCE AND INVENTION:

Stop Your Receiver from Radiating. Circuits showing how to eliminate this nuisance. By A. P. Peck.

Radio Broadcasting Pierces Vehicular Tunnel.

How Modulation in Transmitters Is Rendered Visible.

Four Good One Tube Circuits—With Constructional Details.

How To Make a Cheap and Efficient Loud Speaker Horn. By Horace Porter.

A Highly Efficient Crystal Receiving Set. By Gilbert Billin.

Searchlight Causes Fading. By C. Doville Walker.

The Relationship Between Wave-length and Kilocycles.

Radio Control from Coast to Coast.

Radio Wrinkles—Hints to Constructors.

Radio Oracle—Question and Answer Box.

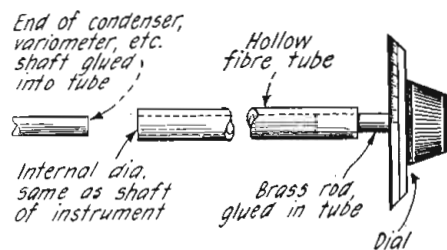

Hand capacity can be eliminated in a receiving set by insulating "live" shafts in the manner shown.

diameter equal to the outside diameter of the shaft so as to insure at least a tight fit. This tube extends through the panel to its surface, where the whole or a part of the removed piece of the instrument shaft is fitted into it, with enough left to take the knob and dial. It is, of course, much better to have the extension shaft made of insulating material. In either case, however, the connection is broken by the insulating tubing and no live part of the circuit extends past the shielding.

Contributed by A. J. Gmeiner.

AN EASILY MADE 25-OHM RHEOSTAT

The rheostat shown in the illustration can be made easily with a 25-ohm resistance unit and a switch arm, preferably one with a bushing. The blade is removed from the knob and is soldered to the collar. The pointer is made from a piece of sheet copper or aluminum and is fastened directly on the arm, from where the switch blade was removed. The resistance unit is mounted on the panel by a small bolt passed through the eyelet in the unit. This

Here is a good stunt for Magnavox owners. The storage battery is automatically disconnected from the field coil when the phone plug is pulled out of any of the jacks.

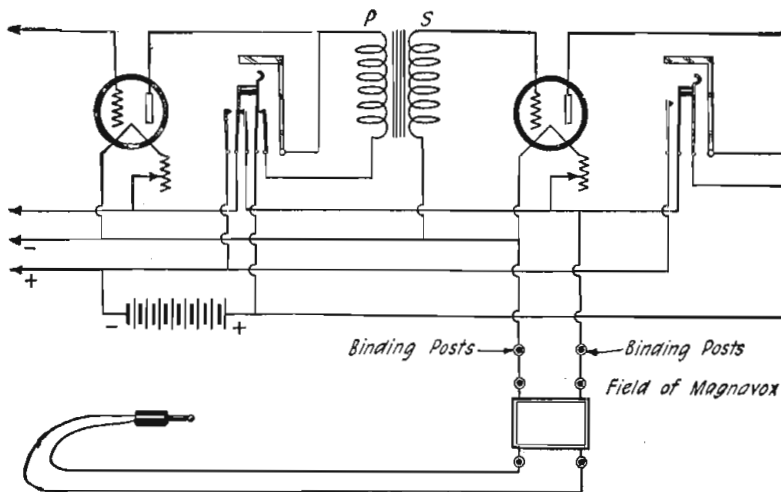

CURE FOR HAND CAPACITY

Hand capacity is not always eliminated by shielding the panel upon which the instruments are mounted, as many have found out. The reason for this lies in the fact that the usual variable condenser, variocoupler and variometer uses the shaft as the connection from the rotary element. In other words, the shafts of these instruments are a part of the circuit and therefore "alive."

Now, you shield your panel, drill the necessary holes for these shafts and thereby place live portions of the circuit out in front of the metal shield, thus in the usual case defeating the purpose for which the shield is there. Hand capacity is the result of the condenser effect created by the shaft, the knob and dial and the hand of the operator.

A cure for this is illustrated in the accompanying sketch. Enough of the shaft of the instrument is cut off so that the portion left will not extend beyond the shielding when the instrument is mounted. To this is glued, or otherwise attached, an insulating tube of fibre, having an inside

bolt serves as one connection of the rheostat. The position at which the bushing is mounted will depend upon the length of the switch lever used. The bushing serves as the other terminal of the rheostat.

Contributed by Clarence F. Book.

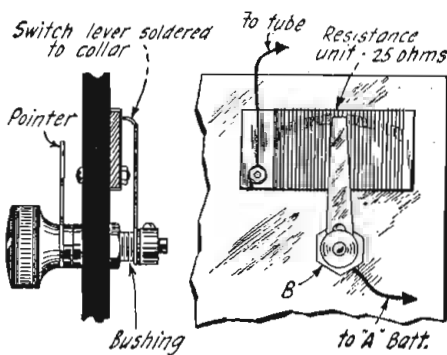

A very neat 25-ohm rheostat can be made with a 25-ohm resistance unit and a switch arm and knob.



RADIO NEWS LABORATORIES



RADIO manufacturers are invited to send to RADIO NEWS LABORATORIES, samples of their products for test. It does not matter whether or not they advertise in RADIO NEWS, the RADIO NEWS LABORATORIES being an independent organization, with the improvement of radio apparatus as its aim. If, after being tested, the instruments submitted prove to be built according to modern radio engineering practice, they will each be awarded a certificate of merit, and a "write-up" such as those given below will appear in this department of RADIO NEWS. If the apparatus does not pass the Laboratories tests, they are returned to the manufacturers with suggestions for improving them. No "write-ups" sent by manufacturers are published on these pages, and only apparatus which has been tested by the Laboratories and found to be of good mechanical and electrical construction is described. Inasmuch as the service of the RADIO NEWS LABORATORIES is free to all manufacturers whether they are advertisers or not, it is necessary that all goods to be tested must be forwarded prepaid, otherwise they cannot be accepted by the Laboratories. Address all communications and all parcels to RADIO NEWS LABORATORIES, 53 Park Place, New York City.

Apparatus Awarded Certificates

PENBERTHY INJECTOR HEAD SET

This head set, which is manufactured by the Penberthy Injector Co., Holden Avenue and Grand Trunk Ry., Detroit, Mich., differs from the usual construction in regard to the shape of the magnetic pole pieces. Two round poles, spaced 5/8 inch apart, each 5-32 inch in diameter,



actuate the receiver diaphragm. Two samples, each of 2,000 ohms, were submitted. Both were found very sensitive to weak signals and would also reproduce loud signals and concerts with a minimum of distortion.

Arrived in excellent packing. **AWARDED THE RADIO NEWS LABORATORIES CERTIFICATE OF MERIT NO. 197.**

RED DEVIL INSULATOR

The "Red Devil" insulator shown in the illustration is very convenient for use around a room or building for attaching wires such as antenna lead-ins or ground wires. The insulator may be fastened to a wall and a wire twisted around it. The wires stay in place due to the novel

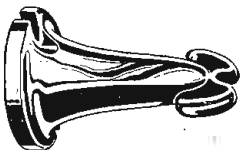

shape of the insulator. This insulator is of porcelain with a chocolate glazed finish. It is manufactured by J. Edgar Hires, Philadelphia, Pa., and is accompanied by illustrations showing the many ways in which wires may be attached to it.

Arrived in excellent packing. **AWARDED THE RADIO NEWS LABORATORIES CERTIFICATE OF MERIT NO. 271.**

ATLAS HEAD-SET

The Multiple Electric Products Co., Newark, New Jersey, has improved the construction of its head-set by adding an adjustable feature by which the distance between the diaphragm and the pole-tips may be varied. This is accomplished by means of a rubber washer placed between the diaphragm and the phone shell. Tightening the ear cap compresses the rubber washer and shortens the air gap between the diaphragm and the pole tips. The caps are knurled so that



a better grip may be obtained on them. This head-set has a resistance of 2,200 ohms and an impedance at 1,000 cycles of 33,000 ohms. It is very sensitive and reproduces with little distortion.

Arrived in excellent packing. **AWARDED THE RADIO NEWS LABORATORIES CERTIFICATE OF MERIT NO. 272.**

SUPERTRAN A. F. TRANSFORMER

A well constructed instrument that gives high voltage amplification

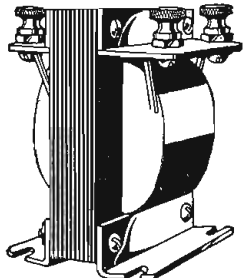

throughout a wide range of audio frequencies is manufactured by the Ford Mica Co., Inc., 14 Christopher St., New York City. The terminals are brought out through insulating pieces mounted at the top, as shown in the illustration, and are plainly marked to correspond with the vacuum tube connections.

Arrived in excellent packing. **AWARDED THE RADIO NEWS LABORATORIES CERTIFICATE OF MERIT NO. 297.**

ACCURATUNE CONTROL DIAL
The micrometer control dial manufactured by the Mydar Radio Co., 9-11-13 Campbell St., Newark, N. J., may be mounted on practically any instrument and will offer very

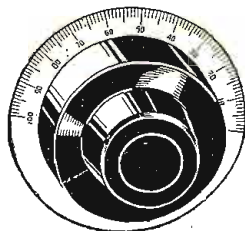

fine control. It is of the gear type. The large knob gives direct control while the smaller knob makes 40 turns to a 180-degree turn of the shaft. Both register directly on the same dial, which is silver plated and has plainly marked graduations. Friction against the panel effects the action.

Arrived in excellent packing. **AWARDED THE RADIO NEWS LABORATORIES CERTIFICATE OF MERIT NO. 298.**

ACCURATUNE RHEOSTAT CONTROL DIAL

The illustration shows this control dial in detail. The dial is silver plated to match the other dials

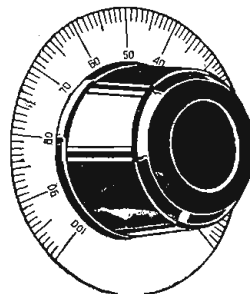

made by this company, and the graduations are plainly marked. It is of pleasing appearance and rugged mechanical construction. Manufactured by the Mydar Radio Co., Newark, N. J.

Arrived in excellent packing. **AWARDED THE RADIO NEWS LABORATORIES CERTIFICATE OF MERIT NO. 299.**

FIXED POST TAP SWITCH

This switch lever is also manufactured by the Mydar Radio Co., Newark, N. J. The shaft that

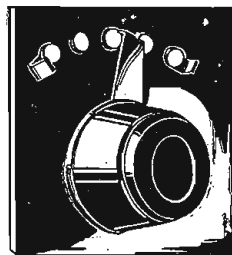

passes through the panel remains stationary. The knob and switch arm turn on the shaft. Thus there is no possibility of the switch coming loose from the panel and excellent electrical connection is always insured to the lever.

Arrived in excellent packing. **AWARDED THE RADIO NEWS LABORATORIES CERTIFICATE OF MERIT NO. 300.**

METRO HEAD PHONES

These phones are of the usual bi-polar construction, having metal-



lic shells and insulated ear caps. Although the resistance of the head-set is only 1,079 ohms, the impedance at 1,000 cycles is 17,000 ohms. The audibility is maximum from 300 to 3,000 cycles, which covers most of the notes of modern musical instruments. This headset is manufactured by the Metro Electrical Co., Inc., 67 Globc St., Newark, N. J.

Arrived in excellent packing. **AWARDED THE RADIO NEWS LABORATORIES CERTIFICATE OF MERIT NO. 306.**

ACE "B" BATTERIES

The Ace "B" batteries are manufactured by the Carbon Products Co., Lancaster, Ohio. Types 115 and 215 are of the standard 15-cell construction of the large and small sizes. As shown in the illustration, they are provided with taps for obtaining voltage from 1 1/2 to 22 1/2 volts. The binding posts are of the spring type and are very stable. The cells are securely sealed in place, which accounts for their long life.

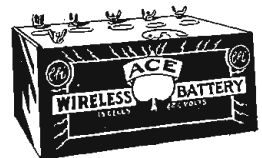

Arrived in excellent packing. **AWARDED THE RADIO NEWS LABORATORIES CERTIFICATES OF MERIT NOS. 340 and 341.**

ACE "A" BATTERIES

The Ace "A" batteries, No. 62 and 64, are made up of standard sized dry cells in two- and four-cell units. They are connected in parallel so that the voltage of the battery is 1 1/2, which is suitable for the 1 1/2-volt dry cell tubes. The illustration shows the four-cell type. These are manufactured by the Carbon Products Co., Lancaster, Ohio.

Arrived in excellent packing.



AWARDED THE RADIO NEWS LABORATORIES CERTIFICATES OF MERIT NOS. 342 and 343.

REMLER VARIOMETER

The new model type 500 Remler variometer is noted for its high inductance ratio. With an ordinary variocoupler, the wave-length range between 180 and 550 meters may be covered; this includes the entire broadcast range. The instrument runs very smoothly and is of neat appearance. The forms are of

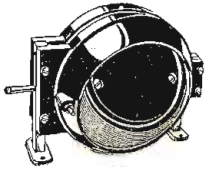

molded insulating material and the instrument is designed for both base and panel mounting. It is manufactured by the Remler Radio Manufacturing Co., 248 First Street, San Francisco, California.

Arrived in excellent packing. AWARDED THE RADIO NEWS LABORATORIES CERTIFICATE OF MERIT NO. 339.

REMLER LEVER SWITCH

The Remler No. 98 lever switch is of very rugged construction and insures positive contact with the switch points. The blade is of laminated construction, having three spring contact strips bent at an angle so that while sweeping over

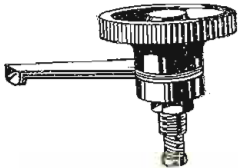

the switch points they maintain a clean contact without wearing ridges in the points. The switch point radius is 1 1/2 inches and the blade is highly polished, with a black insulating knob. Manufactured by the Remler Radio Manufacturing Co., 248 First Street, San Francisco, California.

Arrived in excellent packing. AWARDED THE RADIO NEWS LABORATORIES CERTIFICATE OF MERIT NO. 338.

PALL MALL 180-DEGREE VARIOCOUPLER

This variocoupler, which is manufactured by the Essex Mfg. Co., 117 Mulberry Street, Newark, N. J., is of very light and durable con-



struction. As the illustration shows, it is mounted on the panel at an angle so that a 180-degree turn of the dial varies the coupling from maximum to minimum. Provision is made for eight taps on the primary winding.

Arrived in excellent packing. AWARDED THE RADIO NEWS LABORATORIES CERTIFICATE OF MERIT NO. 337.

SELECT-A-WAVE TUNER

This tuner comprises primary, secondary and tickler windings. The primary and tickler windings are on the rotors inside and the secondary,



without taps, is on the outside of the tube. It is connected about the same as any standard three-circuit tuner, and is designed to cover the

entire broadcast range when used with a .0005 mfd. variable condenser shunted across the secondary winding. It is manufactured by the S. & R. Radio Co., 3786 Broadway, New York City.

Arrived in excellent packing. AWARDED THE RADIO NEWS LABORATORIES CERTIFICATE OF MERIT NO. 335.

THE DANIEL ADAPTOR

In order to place a UV-199 or a C-299 tube into a standard socket, some form of adaptor must be employed. The one shown in the illustration, which is manufactured by R. W. Daniel, 5234 Melrose Avenue, Los Angeles, Calif., is of excellent and simple construction. It is made of fibre and fits into a standard socket. The contact springs inside insure positive contact with the terminals of the smaller tube.

Arrived in excellent packing. AWARDED THE RADIO NEWS LABORATORIES CERTIFICATE OF MERIT NO. 336.

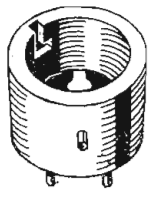

GLOBE RADIOPHONE BLOCK

When it is desired to connect several head sets to a receiving set, difficulty will be experienced in making connections unless some sort of connection block is employed. The one shown in the illustration, which is manufactured by the Globe Phone Mfg. Co., Reading, Mass., is of elaborate construction and is highly finished. It will accommodate from one to six headsets, which may be connected in the circuit by simply moving the slider along the rod. The binding posts which accommodate the cord tips are of an improved construction. The tips are clamped into them by tightening the screw. The base is of wood mounted on rubber feet.

Arrived in excellent packing.



AWARDED THE RADIO NEWS LABORATORIES CERTIFICATE OF MERIT NO. 323.

ANCHOR-ITE CRYSTALS

These detector crystals are securely mounted in a standard 1/2-inch metal base and were received well packed in tinfoil in small metal boxes. The samples submitted were very sensitive over practically their entire exposed surfaces. These crystals were submitted by the Anchor Co., 420 Wood Street, Pittsburgh, Pa.

Arrived in excellent packing. AWARDED THE RADIO NEWS LABORATORIES CERTIFICATE OF MERIT NO. 318.

LANGBEIN & KAUFMAN VARIOCOUPLER

This instrument, type CS72, is of accurate mechanical construction and is highly efficient electrically. The primary winding is on the outside, as shown, and the secondary winding on the rotor. The turns of the secondary winding are spaced with a cord, which is wound beside the wire. There are 17 taps on the primary winding. It is designed for

both base and panel mounting. It is manufactured by Langbein & Kaufman, 654 Grand Avenue, New Haven, Conn.

Arrived in excellent packing. AWARDED THE RADIO NEWS LABORATORIES CERTIFICATE OF MERIT NO. 334.



LANGBEIN & KAUFMAN VARIOMETER

This variometer, type V-140, is of similar construction to this company's variocoupler, except that the stator coil is wound inside of the form next to the rotor coil so as to give a high inductance ratio. The two instruments connected together to a vacuum tube detector cover a wave-length range of 120 to 450 meters.

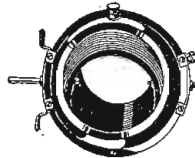

Arrived in excellent packing. AWARDED THE RADIO NEWS LABORATORIES CERTIFICATE OF MERIT NO. 333.

ACME RADIO FREQUENCY TRANSFORMER

The Acme Apparatus Co., 186 Massachusetts Avenue, Cambridge, Mass., submitted one each of its new type R-2, R-3 and R-4 radio frequency amplifying transformers. These instruments are designed for broadcast reception, using a different transformer for each stage of amplification. In this way maximum efficiency is obtained and the entire broadcast range is covered. The instruments are of neat appearance and are simple to install and connect.

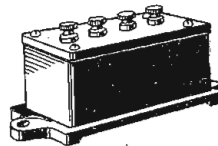

Arrived in excellent packing. AWARDED THE RADIO NEWS LABORATORIES CERTIFICATES OF MERIT NOS. 330, 331 and 332.

NULOID PANELS

The Nuloid Corporation, Kenilworth, New Jersey, submitted a sample Nuloid panel which was found to be very efficient as regards radio frequency losses and is especially recommended for use as radio panels and other insulating parts. It is highly polished on one side, very light in weight, easy to cut and drill and of pleasing appearance.

Arrived in excellent packing. AWARDED THE RADIO NEWS LABORATORIES CERTIFICATE OF MERIT NO. 273.

VARIABLE GRID LEAK

The New York Coil Co., 338 Pearl Street, New York City, submitted for test one of its variable grid leaks, which instrument is shown in the illustration. It is designed for base mounting, although it may be mounted on the front of a panel. A tapered resistance strip passes around the inside of the moulded form and a roller connected through a spring to the shaft makes contact with the resistance strip. A resist-

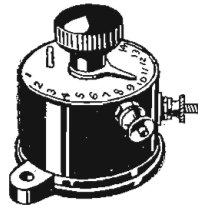

ance range of 32,000 ohms to 25 megohms was covered, although the instrument is only rated at 1/4 to 5 megohms.

Arrived in excellent packing. AWARDED THE RADIO NEWS LABORATORIES CERTIFICATE OF MERIT NO. 329.

FIXED CONDENSER

The fixed condenser, which is also manufactured by the New York Coil Co., is of the mica dielectric type and is noted for its accurate capacity rating. Rated at .002 mfd. a capacity of .0019 mfd. was obtained and the losses at 1,000 cycles are equivalent to a series resistance of 200 ohms. The condenser is

provided with two large holes and two small holes large enough to accommodate binding post screws.

Arrived in excellent packing. AWARDED THE RADIO NEWS LABORATORIES CERTIFICATE OF MERIT NO. 328.

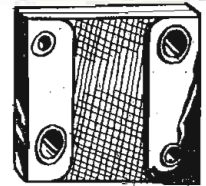

VERNIER CONDENSER

Although there are many mechanical vernier attachments that may be used with variable condensers, the vernier condenser shown in the illustration will probably give a greater degree of satisfaction as it is positive in operation and cannot get out of order. It is simply a miniature variable condenser of the tele-

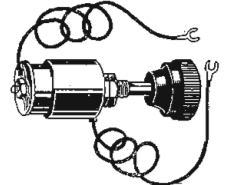

scopic type and has a capacity range of 5.49 to 21.3 mmf. To use, it is simply connected in parallel with the larger condenser. It is manufactured by the New York Coil Co., 338 Pearl Street, New York City.

Arrived in excellent packing. AWARDED THE RADIO NEWS LABORATORIES CERTIFICATE OF MERIT NO. 327.

TUNED R. F. TRANSFORMER

Although un-tuned radio frequency amplifying transformers give a fair degree of success, it is well known that the tuned type are much more efficient and offer greater selectivity. The one shown in the illustration is manufactured by the Radio Mfg. Co., 97 Dwight Street, Spring-

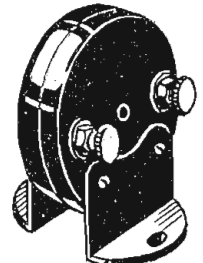

field, Mass., and is known as the "Style A" transformer. It has two windings enclosed in a metal case. The primary winding is to be shunted by a .0005 mfd. variable condenser in order to cover the broadcast wave-length range. The secondary winding is left untuned.

Arrived in excellent packing. AWARDED THE RADIO NEWS LABORATORIES CERTIFICATE OF MERIT NO. 326.

BROCKWAY VARIABLE CONDENSER

This condenser is of the mica dielectric type and is noted for its small size, neat appearance and high capacity. It is designed for mounting on the front of a panel and takes up very little more room than the ordinary 3 1/2-inch dial. The capacity range is covered by two turns of the dial. A range of 30.50 to 1078.08 mmf. is covered and the dielectric losses at 1,000 cycles are

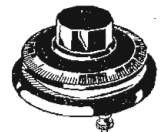

equivalent to a series resistance of 450 ohms, which is low for a mica dielectric condenser. This instrument is manufactured by the Brockway Laboratories Co., Toledo, Ohio.

Arrived in excellent packing. AWARDED THE RADIO NEWS LABORATORIES CERTIFICATE OF MERIT NO. 322.

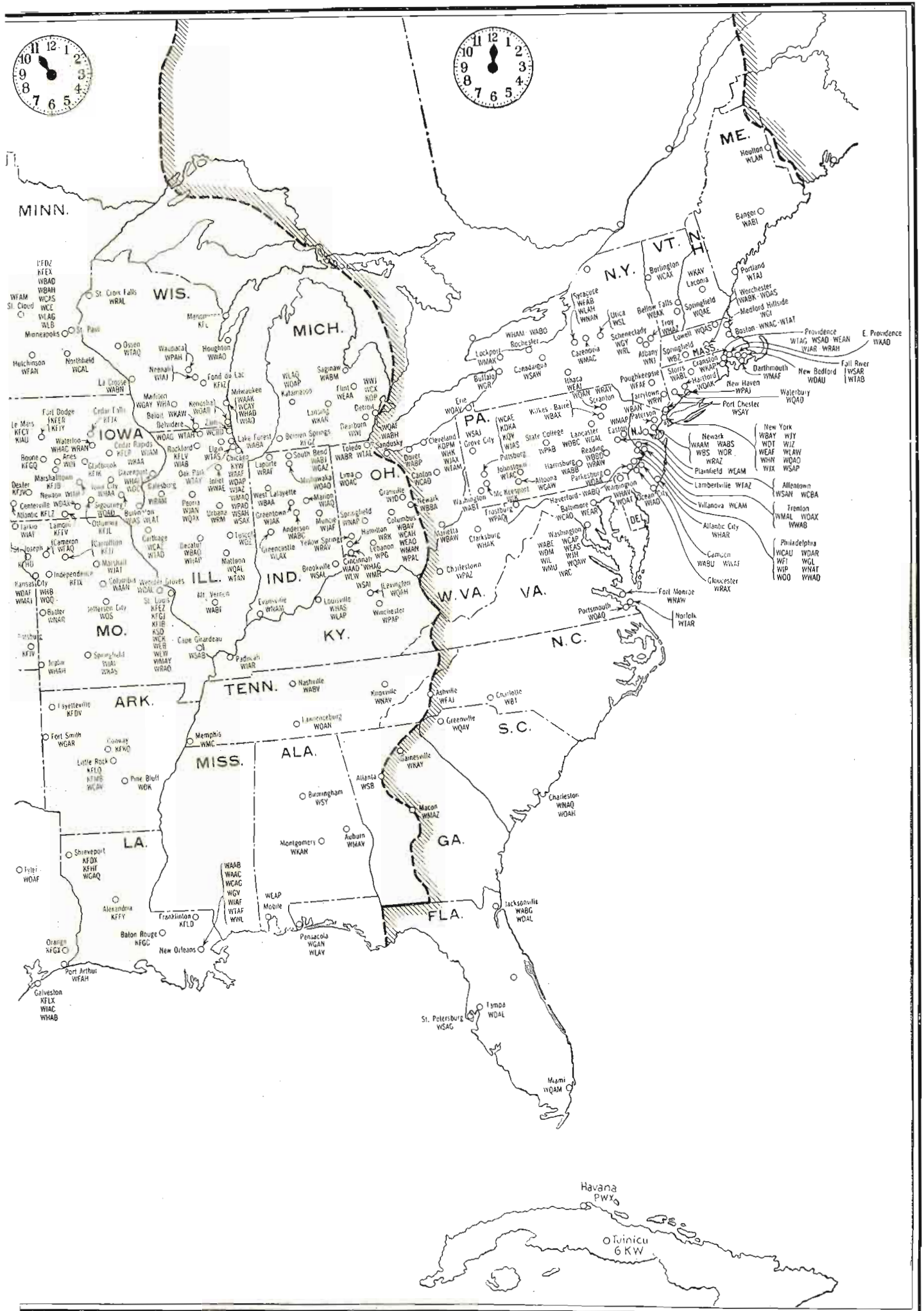

Correspondence from Readers

GOOD BROADCASTING AT ANY COST

Editor, RADIO NEWS:

Being a constant reader of RADIO NEWS and also the operator of a very efficient receiving station in my home, I was much interested in Mr. Yates' article on the Federal Radio Tax.

I have no way of knowing how the majority of broadcast listeners feel in this regard, but having numerous friends who are also enjoying radio and, like myself, have adopted it as a most fascinating hobby I know that all the fellows I have talked with would like such a method of maintaining a high standard for broadcasting programs. Could this not be handled by the Federal Radio Inspector's office issuing receiving station licenses good for one year at a minimum charge of say \$10 per year? This would, I am sure, enable the heads of the various radio districts to properly care for the broadcast stations.

Of course we should bear in mind at the same time that some of the broadcast stations are a tremendous advertisement for their owners and are, no doubt, looked upon as such and supported by an appropriation from the general advertising funds. I refer now to banks and department stores and I believe also that the newspapers now operating stations can all well afford to continue with programs of a very high order.

When radio is finally developed—as it is most certain to be—to the point where all receiving sets are more efficient, or even the equal of the famous neutrodyne circuit, which, so far as the writer is able to determine interferes very little, if at all, with neighboring listeners-in; when the squeaks and howls of some of the present circuits are eliminated, as they surely will be, we may look forward to the saturation point, but the consensus of opinion seems to be that it is still a long way off. I make this statement because I know of several people of very comfortable means who are not interested in radio for itself, but only as a means of pleasure, an entertainment. They will not spend the money necessary for an installation in their homes on account of the disagreeable interference of howling circuits, Naval telegraph stations, etc., which they have heard when friends have attempted to demonstrate.

However, if the radio tax is necessary to carry on good broadcasting, let it come. Could it not be collected by adding a certain per cent. to the purchase price of all radio apparatus? The Government could collect from the manufacturers, or retailers, and they in turn from the radio public, following along the lines of the war tax on luxuries, telephone and telegraph messages, etc.

The radio public does not want a decrease in either the quality or quantity of broadcasting. If it is vitally important to get their opinion, let all the broadcast stations in the country shut down for a period of two weeks!

J. M. LATHROP,
1824 East 79th St.,
Cleveland, Ohio.

FEDERAL CONTROL OF RECEIVERS

Editor, RADIO NEWS:

I have read with much interest your editorial in the January issue of RADIO NEWS "What Broadcasting Needs." You have touched on many points which, if put into effect, will undoubtedly improve reception, but what broadcasting needs most is "Federal Control of Reception," an elimination of the regenerative hound, who is, and always will be trying to stretch a receiver capable of reception from about 200 miles into one capable of receiving a 2,000-mile

station. This process results in nothing but squeals to the hound except under a freak condition, and does succeed in entirely destroying local reception for any listener within a mile of him. This pest has increased by the thousands during the past summer, due, I believe, to a great extent, to the distribution through department stores, of a particularly vicious receiver at a reduced price.

Broadcasting is a thankless job, it is true, but no matter how high the standard of the program, the fame of the artist, or how perfect the technical equipment of the station, the artist will not be appreciated or the station given credit, if the program comes through the receiver like a cat fight. This is unfortunate for the artist and the station, but most of us judge programs as we hear them, regardless of cause, and are then in no mood to write appreciative letters.

The Staccatone

A BRAND new musical instrument giving wierd and staccato like sounds. Anyone who has a loud-speaker, a vacuum tube and a few honeycomb coils, can make this remarkable instrument, recently developed by Mr. H. Gernsback. Read all about it in the March issue of PRACTICAL ELECTRICS.

SOME OF THE INTERESTING ARTICLES TO APPEAR IN MARCH ISSUE OF PRACTICAL ELECTRICS

Photo-Electric Telephony

By Dr. A. Gradenwitz, Berlin, Germany.
Solar Radiation Measurement

By H. H. Kimball and H. E. Hobbs,
U. S. Weather Bureau.

Television by Belin System
By Lucien Fournier, Paris, France.

Electric Clock Runs 1000 Years

Submarine Pilot Cable
By Dr. A. Neuburger, Berlin, Germany

World's Largest Electric Generator

Sam Graves' Gravity Nullifier
Story by George F. Stratton.

Simplified D'Arsonval Galvanometer

Automobile Ignition Coils
Voltmeter Multipliers

I would suggest that broadcast stations, at the time they ask for letters of appreciation, also ask for reports on any kind of interference with their program. The letters, I believe, would be a revelation and would result in a movement for Federal control of receivers. It seems the only relief can come from the elimination of the regenerative receiver and registration of all others—for which a fee should be charged and a license granted.

EDWARD H. SMITH,
564 W. 160th St.,
New York City.

REGENERATIVE SETS SHOULD BE TABOOED

Editor, RADIO NEWS:

I most heartily agree with your editorial entitled "What Broadcasting Needs," in the January number of RADIO NEWS. I think every one of your suggestions excellent. The trouble from ship traffic and other stations at from 450 to 550 meters is a great nuisance. I am using an 8-tube Heterodyne and when I am after very long distances I put it on a long outside antenna, and it certainly is annoying, just when one is going to pick up the announcer from the station that he has carefully tuned in, to have one of these spark transmitters crash into one's ears, to take one's head off.

Your complaint that announcers are prone to forget that DX fans would like to know, semi-occasionally at least, to whom they are listening, is well taken. I have listened, as you say you have, to series of some half dozen Jazz pieces, which I wasn't in the least interested in, before I could be certain where they were coming from. Then too, the far Western announcers seem to have much less vocal energy than the concerts they broadcast. It is very discouraging to be listening to some nice music, well tuned, and when the announcer comes in, to have his voice fade away so as to be almost indistinguishable.

Your suggestion that all broadcasting stations have some identifying sound to put on between numbers, as PWX has, or at least used to have, is fine. I should think a phonograph might be used to repeat the code letters of the station during intermissions. This could be beside the announcer, operated by a switch on his control board.

I am also heartily in favor of any means whereby all pay taxes or compensation of some sort, for what they are receiving now, gratis. I have already made a suggestion to WEAFF that I think there are a good many people in the country who would voluntarily contribute without being forced to. But if that sort of thing is done, care should be taken that the younger amateurs who cannot well afford to pay, should not be over-taxed, if they are taxed at all. It would be a shame in any way to discourage amateur experimentation in the radio field.

There is another point which you do not mention, and that is, gradual elimination by law, or by popular consent, of regenerative sets. Inasmuch as one can get equally good results with unregenerative hook-ups by using not more than one tube more than a regenerator, and with less whistling noises on his own set and no inconvenience to his neighbors, personally I think that the regenerative sets should be tabooed, or at least all but the very smallest.

HENRY B. NEWHALL,
1277 Woodland Ave.,
Plainfield, N. J.

RE WHAT BROADCASTING NEEDS

Editor, RADIO NEWS:

I was greatly interested in your editorial on "What Broadcasting Needs," because it stated the case so clearly. The *Saugus Herald* was perhaps the first weekly newspaper to run a radio column, it being started when WGI was the only broadcast station in New England and when only a few boys in the town of Saugus had radio receiving outfits.

Today the town is full of them, and tonight I was casting up in my mind the cost of some outfits I have seen and know something about. Of the 32 sets which I jotted down, none have cost their owners less than \$50, and some run as high as \$600. My own, with experimental apparatus, etc., stands me today a little more than \$200.

Yet tonight I sat down with my family to enjoy the Philharmonic concert from WEAFF, but it was impossible to do it. This wonderful concert came in loudly enough, but with it came code stations—everything from the tinkle-tinkle of a high-pitched set, to the grinding crash of the deeper toned code stations. It was impossible to get the concert. For weeks that has been our experience on any distant station or on any station with a wave-length above 400 meters.

You might say, "Well, why don't you enjoy the nearby stations? They have plenty of good concerts." Try and do it in any thickly populated district, if you have a good receiving outfit. When you get tired

(Continued on page 1296)



THIS Department is conducted for the benefit of our Radio Experimenter. We shall be glad to answer here questions for the benefit of all, but we can publish only such matter as is of sufficient interest to all.

1. This Department cannot answer more than three questions for each correspondent.
2. Only one side of the sheet should be written upon; all matter should be typewritten or else written in ink. No attention paid to penciled matter.
3. Sketches, diagrams, etc., must be on separate sheets. This Department does not answer questions by mail free of charge.
4. Our Editors will be glad to answer any letter, at the rate of 25c. for each question. If, however, questions entail considerable research work, intricate calculations, patent research, etc., a special charge will be made. Before we answer such questions, correspondents will be informed as to the price charge. You will do the Editor a personal favor if you will make your letter as brief as possible.

D.L. 1500 COILS

(852) Mr. Wilfred Murray, Edmonton, Alta, Can., requests:
 Q. 1. What kind of coil is the D.L. 1500 in Fig. 7, page 279, RADIO NEWS, for September?
 A. 1. The D.L. 1500 coils mentioned are dual-lateral wound coils of 1500 turns, otherwise known as honeycomb coils.

SUPER-HETERODYNE

(853) Mr. Rowland Cox, Fontana, Calif, asks:
 Q. 1. When using four stages of transformer coupled radio frequency in a Super-Heterodyne circuit, is it necessary to use more than one stabilizer to keep the grids at their proper potential?
 A. 1. One stabilizer controlling the four tubes is sufficient, but we would advise using separate rheostats for each tube.
 Q. 2. Is it necessary to completely encase each unit in a separate copper box?
 A. 2. If the instruments are properly arranged and the wiring done correctly, this will not be necessary.
 Q. 3. May one set of batteries be used for the entire set?
 A. 3. Yes, if the correct circuit is used.

CONDENSER IN GROUND

(854) Dr. A. L. Lundgren, Fort Dodge, Iowa, requests:
 Q. 1. Would a variable condenser in the ground circuits function as well or better than taps on a three-circuit receiver?
 A. 1. A condenser gives finer tuning than taps alone. It would be best to use both.
 Q. 2. What difference would it make if such a condenser were placed in the aerial instead of the ground circuit?
 A. 2. It would make no difference except in single circuit sets where the condenser should be placed in the ground circuit with the rotary plates on the ground side to eliminate hand capacity effects.

COUPLED CIRCUIT TUNER

(855) Mr. Charles E. Darworth, Jr., Bellefonte, Pa., asks:
 Q. 1. Kindly publish a hook-up that can be used with an Atwater-Kent coupled circuit tuner, a W.D.-11 tube and a .001 mfd. variable condenser.
 A. 1. A hook-up for this apparatus will be found in these columns. The condenser may be inserted in the ground circuit, as shown, to obtain finer tuning.

THE NEUTRODYNE RECEIVER

(856) Mr. G. F. Clark, Conway, Ark., writes:
 Q. 1. What wave-lengths is the Freed-Eisemann Neutrodyne receiver adapted to?
 A. 1. Approximately 200 to 600 meters.
 Q. 2. Is this receiver very selective?
 A. 2. As this receiver employs two stages of tuned radio frequency, it should prove very selective.
 Q. 3. What is the approximate cost of building one?
 A. 3. If good instruments are used, the cost of building this receiver would be approximately \$75 to \$85.

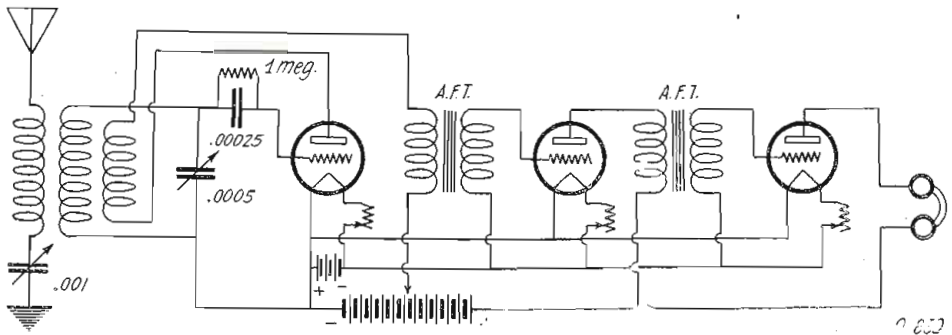

A circuit for the reception of long wave European stations, together with a two-stage amplifier to permit sufficient volume. Honeycomb coils are used for tuning and regeneration.

COCKADAY CIRCUIT

(857) Mr. R. F. Cool, St. Paul, Minn., writes:
 Q. 1. Kindly let me know where I can get a Cockaday hook-up.
 A. 1. A hook-up of this four-circuit tuner appeared in RADIO NEWS for October, 1923, on page 422 in answer to question No. 770.

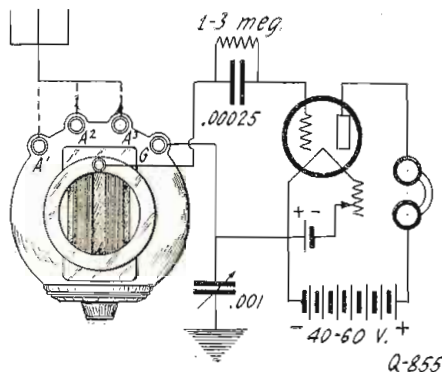

This shows how an Atwater-Kent coupled circuit tuner is connected up in a vacuum tube circuit.

TRANSMITTING LICENSE

(858) Mr. John A. Handford, New Bedford, Mass., asks:
 Q. 1. How may I secure a license to transmit?
 A. 1. To secure a license to transmit you must apply to the Radio Supervisor of your district for application blanks and then pass an examination on radio, and be able to receive code at 10 words or more per minute. You may address the Radio Supervisor, Custom House, Boston, Mass., for further particulars.

LONG WAVE RECEIVER

(859) Mr. C. J. Wafelbakker, Soerabaya, Java, writes:
 Q. 1. Please publish a diagram for a long wave receiver enabling me to pick up European stations.
 A. 1. You will find a diagram on these pages suitable for your purpose. Honeycomb coils are used in this circuit. The proper sizes may be selected by consulting the wave-length tables generally furnished by concerns manufacturing the coils.
 Q. 2. Could you tell me where I may buy radio frequency transformers for long waves?
 A. 2. Any reliable radio dealer should be able to furnish these transformers.

SQUEAL IN THIRD STEP

(860) Mr. Francis L. Wadsworth, Jr., Tuskegee, Okla., asks:
 Q. 1. How can I eliminate the continual squeal when I plug in on the third step of my amplifier?
 A. 1. We would suggest that you have a separate "B" battery for your third step. This should remedy the trouble. If this does not eliminate the squeal, your transformers are probably mounted too close together. A .0005 mfd. fixed mica condenser, connected across the secondary of the third transformer, will prove of help in this case.

STORAGE BATTERY USED WITH UV-199 TUBES

(861) Mr. H. W. Koelling, Elberton, Ga., would like to know:
 Q. 1. Can a six-volt storage battery be used with UV-199 tubes? How?
 A. 1. UV-199 tubes may be operated on a six-volt storage battery by using only two of the cells of the battery, thus obtaining four volts. If the full six volts are used, a 60-ohm rheostat must be employed.

MUSIC FADES

(862) Mr. Walter S. Bell, Jr., Castleton, N. Y., requests:
 Q. 1. Why is it that, when listening to a distant station, the music slowly fades away and after a short time grows distinct again?
 A. 1. This peculiar phenomenon, known as fading, is something that is not the fault of the receiving set. It seems to be due to the changing of atmospheric conditions. No remedy for it has been worked out as yet.

FEDERAL TYPE 59 RECEIVER

(863) Mr. Oreste Gregory, Pawtucket, R. I., writes:
 Q. 1. Will you please publish a hook-up of the Type 59 Federal receiver?
 A. 1. You will find the hook-up of this receiver on these pages. Jacks are shown after the detector, first and second steps.

DAYTIME RECEPTION

(864) Mr. Edward Radwill, Ronald, Wash., asks:
 Q. 1. I have a single tube regenerative receiver which works well at night, but I cannot hear anything during the day; why is this?

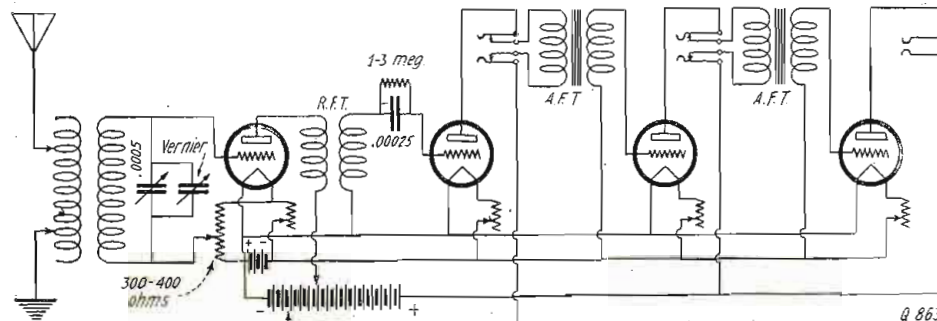

Circuit diagram of the Federal Type 59 receiver. This employs one stage of transformer coupled radio frequency amplification and two stages of audio frequency amplification.

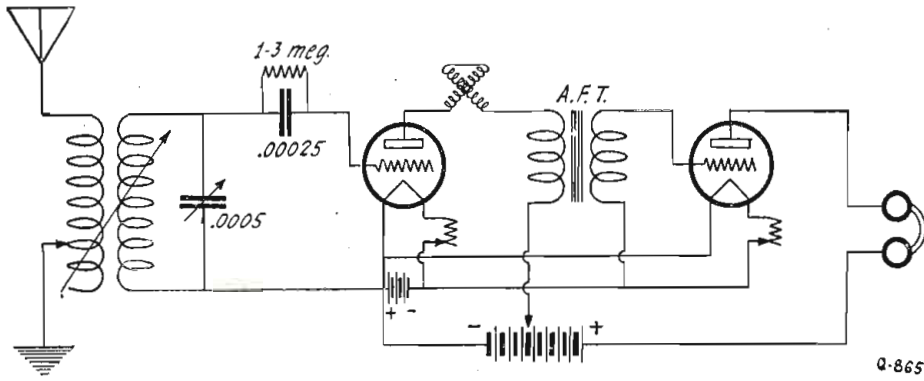

A very efficient type of regenerative circuit with a one-stage audio frequency amplifier, for the reception of broadcast stations. A variocoupler and a variable condenser are employed for tuning and a variometer for regeneration.

A. 1. Reception of broadcasting during the day is never as good as at night. One theory for this is that the sun absorbs a portion of the electromagnetic waves, thereby decreasing their strength which reduces the signal at the receiver. This condition may be somewhat counterbalanced by the addition of more tubes to the receiving set although a great difference will still be noted between day and night reception.

Q. 2. Where could I get a cabinet, size 7 x 24 inches?
A. 2. See the advertisements in this issue.

SIMPLE TWO-TUBE SET

(865) Mr. F. A. Stuart, Jackson, Miss., would like to know:

Q. 1. Please publish a circuit using the following apparatus: One variometer, one variocoupler, two jacks, one 23-plate condenser and two tubes.

A. 1. A hook-up employing these instruments will be found in these columns. The circuit is one using the tuned plate method of regeneration.

LOCATION OF AERIAL

(866) Mr. Ellis Vanderburg, Wichita, Kans., wants to know:

Q. 1. My aerial is at the side of a house and under a tree; will these conditions interfere with receiving?

A. 1. Yes, but to what extent it is hard to say. We suggest that you raise your aerial or change its location.

Q. 2. Which is the better tube, WD-12 or UV-199?
A. 2. The UV-199 seems to be the better all around tube.

Q. 3. Will the Murdock loud speaker work successfully on two stages of amplification?
A. 3. Yes.

RADIOLA IV

(867) Mr. Thomas E. Denton, East Orange, N. J., requests:

Q. 1. Please publish a hook-up of the Radiola IV three dry cell tube set.

A. 1. The Radiola IV hook-up appears in these columns. This set has the same tuner as the Aeriola Sr., described in the "I Want To Know Column" of the April, 1923, issue of RADIO NEWS. The switch and resistances across the secondary of the amplifying transformer are used to regulate the volume.

C-299 TUBE

(868) Mr. Raymond H. Haefler, Rockford, Iowa, writes:

Q. 1. Will a C-299 tube work in the circuit in Fig. 3, page 629, December RADIO NEWS?

A. 1. Yes, by merely placing three dry cells in place of the filament battery shown, and employing a rheostat of 30 ohms.

Q. 2. What capacity grid condenser and grid leak does the C-299 require?

A. 2. The grid condenser should be about .00025 mfd. The grid leak value is best found by experimentation, usually about three megohms.

Q. 3. Is a C-299 as good a detector as a C-300?
A. 3. A C-299 will give as good results as the C-300 tube when the proper grid leak is used.

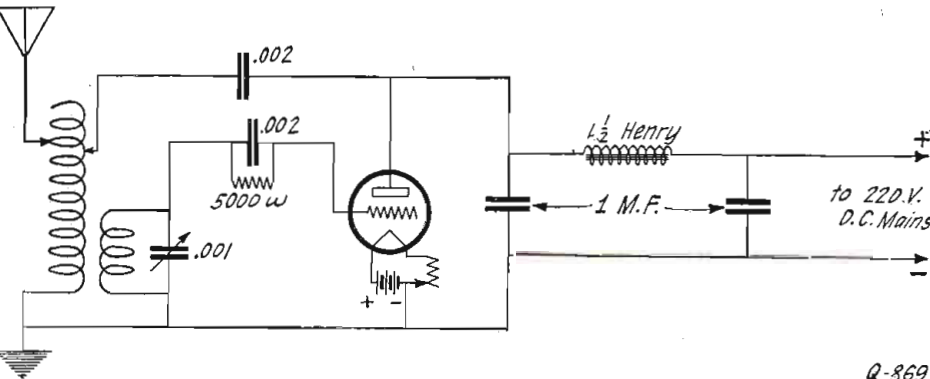

A five-watt C.W. transmitter circuit of the reversed feed back type employing 220 volts D.C. for the plate supply. A choke coil and two fixed condensers serve to smooth out the commutator ripple of the generator.

FIVE-WATT TRANSMITTER

(869) Mr. Robt. F. Gebbart, Edinburg, Ind., would like to know:

Q. 1. Please publish a circuit for a five-watt C.W. transmitter, showing how we can use 220-V D.C. light current for the plate.

A. 1. The diagram you request will be found on these pages. Care must be taken to get the polarity as shown, otherwise there will be a short

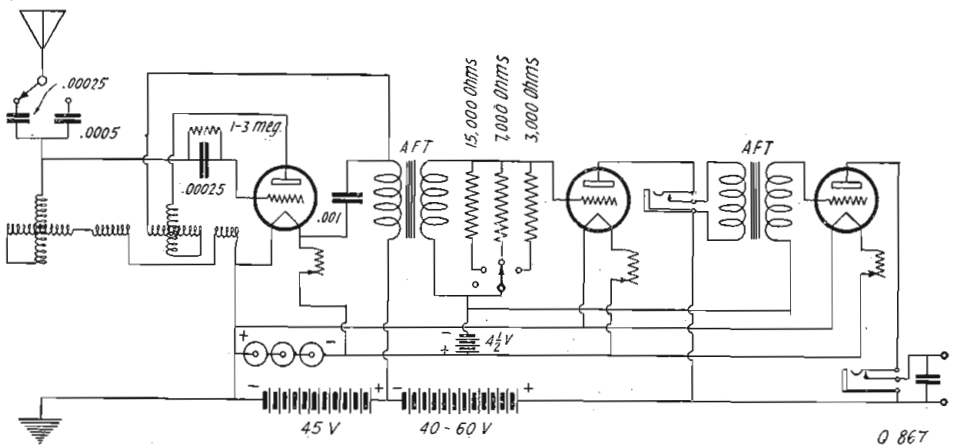

Circuit diagram of the Radiola IV. Three dry cell vacuum tubes are employed. The three resistance units connecting to the switch serve to control the volume of received signals. The basic circuit here is the same as that of the well known Aeriola Senior.

GREBE CR-12 RECEIVER

(870) Mr. H. R. Searing, Los Angeles, Calif., requests:

Q. 1. Please publish a circuit diagram of the Grebe CR-12 broadcast tuner.

A. 1. A hook-up of this tuner appeared in RADIO NEWS, November, 1923, on page 566.

VARIOMETER WINDINGS

(871) Mr. Jos. S. Lee, Pittsburgh, Pa., wants to know:

Q. 1. How many turns and size of wire must be used in stator and rotor of variometer to reach a 600 meter wave-length?

A. 1. The number of turns on a variometer will depend upon the size of the stator and rotor. If a standard size of about 3 3/4 inches for the stator is used it will require approximately 74 turns of No. 22 S.C.C. wire. The rotor, of course, should preferably be of the ball type and should have a very small clearance between it and the stator. This should also be wound with 74 turns of the same size wire.

Q. 2. If space does not permit, can the stator and rotor be bank wound, with good results from same?

A. 2. A variometer may be bank wound if

INTERFERENCE

(872) Mr. Peter Axell, Detroit, Michigan, writes:

Q. 1. When using my Atwater-Kent Radiodyne I experience interference, which sometimes sounds like clapping of hands, and there is always a crackling noise in the ear phones. Can you tell me what is wrong in this receiver?

A. 1. It would seem from your description that one of your "B" batteries is defective and delivers a fluctuating current to the plates of your tubes. It would be best in this case to try a new set of batteries in this position. It is also possible that you are using a poor grid leak. This would be especially the case if you are using a variable leak, as a good many of these instruments are poorly made and cause a frying sound in the receivers.

Q. 2. I do not seem to get any more distance than I did with a three-tube set. Would UV-201A tubes get more distance than the WD-12 tubes, which I am using?

A. 2. UV-201A tubes would undoubtedly give more volume and might prove better radio frequency amplifiers than the tubes you are now using. As a detector, however, this tube is no better than the WD-12. If the large tubes are used, it will be necessary to use a storage battery for beating the filaments.

NEUTRODYNE QUERIES

(873) Mr. N. Lawrence, Paterson, N. J., asks:

Q. 1. Why are all neutroformers used in Neutrodyne receivers wound with a ratio of approximately 4:1?

A. 1. The secondary of the neutroformer is wound with a certain number of turns, which when used with a condenser of a certain size will respond to all broadcast wave-lengths. As a rule, this will be approximately 60 turns of No. 22 S.C.C. wire. Use 15 turns of wire for the primary, as this has been found to give best results.

Q. 2. Is a set properly neutralized, if when the radio frequency tubes are turned on full, the set goes into a howl and oscillates?

A. 2. If the radio frequency tubes oscillate at any point, it shows that the set has been improperly neutralized. The object of the neutralizing capacities is to eliminate any chance of the tubes oscillating on any wave-length.

Q. 3. Would it be proper to use a "C" battery in the radio frequency part?

A. 3. A "C" battery may be used with advantage in a Neutrodyne receiver, if a high "B" voltage is used on the amplifier tubes.

RADIO FREQUENCY AMPLIFICATION

(874) W. R. Frick, Marcelui, Sask., Canada, wants to know:

Q. 1. Which of the following methods will give the greatest amplification per stage in radio frequency circuits, tuned impedance or the transformer coupled Neutrodyne method?

A. 1. When tuned impedance radio frequency amplification is employed, a potentiometer must usually be used in order to keep the tube from oscillating and as a potentiometer introduces losses in this circuit, it naturally follows that the Neutrodyne method of reception will prove superior. The capacity of the tubes are neutralized by special neutralizing capacities which allow these tubes to operate at full efficiency without danger of spilling over, or going into a state of oscillation on any wave-length.

Q. 2. Can a three stage radio frequency Neutrodyne receiver be used with success?

A. 2. A receiver of this kind would give great amplification, but as there would be four controls, each control to be turned at the same time, you can readily see that the tuning of a receiver of this type would be very difficult, if not impossible.

Get more Mileage out of your Radio Receiver



THE FILAMENT KONTROL

OF INFINITE ADJUSTMENT

With

FIL-KO-STAT

The Scientifically Correct Radio Rheostat

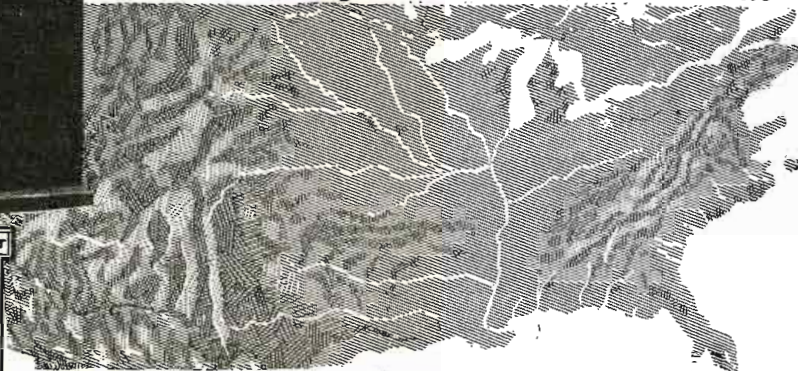

From RICHARD J. DAVIS
700 East Erie St., Painsville, Ohio.
"FIL-KO-STAT cannot be beat for fine adjustment and noiseless operation. The first night after installing it I got KDZA, Tuscon, Arizona (1500 miles), KYY, San Francisco (2500 miles) and WHA, Madison, Wis., (1000 miles)—all came in clear and loud *** without FIL-KO-STAT never have picked up these stations."

From LESLIE C. BILES
Maple and Burlington Aves., Delanco, N J
"After experiments with various filament controls, I have adopted FIL-KO-STAT as the finest instrument for ***controlling detector** In my humble opinion it is the greatest Radio Achievement of the year.***stations never heard before** (include) WAOA, WDAF, WCA, WOC, WSB, and WLAG on loud speaker On Oct. 28th, at 8 P M with powerful Philadelphia stations operating I tuned in with FIL-KO-STAT WKAQ, San Juan, Porto Rico **do not feel that I can say enough in praise of this little instrument** Many sets that are inclined to tune broadly can be improved with FIL-KO-STAT. It will positively separate stations on close wave lengths."

From H. R. HASLAM
249 W 126th St., New York, N Y
"***Three tube standard set**wire wound rheostats gave satisfaction on local stations, but on distant reception could not get point between owing to coarseness of adjustment. With FIL-KO-STAT change was wonderful, getting distant stations never received before, even Oklahoma City quite strong despite local interference."

From JACK WALSH
Independence, Colorado
"FIL-KO-STAT certainly a wonder Following stations received in nine days on one bulb WOA, WDAF, WFAA, WJAZ, WOC, WBAP, WHB, KFI, KHJ, KFEL, KFIX, WSB, WMC, KLZ, KFPO, WWAC, KZN, WDA, WLAG, WDAP, WGY, (2000 miles) CKCK, WOS, KOP, CFCN, WDAE, KSD, WJAD, WCB, KDYL, WHAS, KDKA, KGW, WAAW, KFKE, KGW, WEAY, WOI, KOB. I believe the FIL-KO-STAT is the secret of my success."

You, too, will be writing letters like these when you have tried a Fil-KO-Stat in your set

Radio News Laboratories say:

This filament rheostat (Fil-KO-Stat) is designed to control the filament current of practically all types of receiving tubes now on the market. It is noted for its exceptionally infinitesimal and uniform control of the current.

For instance, the critical adjustment of a one-ampere tube is spread out over a range of four turns of the knob, thus enabling a micrometer adjustment to be obtained.



RADIO STORES CORPORATION

Sole International Distributors
NEW YORK — CHICAGO — MINNEAPOLIS — LOS ANGELES — CLEVELAND — ST. LOUIS — OMAHA — SAN FRANCISCO
HOME OFFICE, Dept. R24, 230 West 34th Street, NEW YORK, N. Y.

YOU want more mileage out of your Radio Receiver. You can't properly tune in distant stations. You want to clear up those tube noises so exasperating when a DX announcer is telling you who he is and all you get is, "This is station brbrweeizgrump". Yes, you get many distant stations *but you never hear them*. They're on your antenna, weak little brothers waiting to be magnified into audibility. They're there with song and story, concert and dance. How you do wish you could hear them! Condensers and couplers are all on the job, properly adjusted, but all you get are whistles and disappointments, BECAUSE:

Unless your RHEOSTAT is a FIL-KO-STAT you can't adjust the most delicate, most critical tuning unit on your set—and that's your *vacuum tube*.

Wave length isn't everything. There's a finer control needed. You must be able to make most minute adjustment of your filament heat and so control the electronic flow in the tube. When you do this you will have perfect reception free of all tube noises and YOU WILL HEAR DX STATIONS YOU NEVER HEARD BEFORE!!!

Regardless of what set you have, it will pay you in added pleasure and satisfaction to replace your present rheostat with a FIL-KO-STAT. It's so easy to make the change. Or have your dealer do it. And if you are building a new set, Neutrodyne, Super Hetrodyne, Radio Frequency, Phusiform, Reflex, Regenerative, any type with any kind of tube—make sure of complete reception by using FIL-KO-STAT.

IMPORTANT!

FIL-KO-STAT is not a carbon powder rheostat. Nor has it disc, (which break and chip). Its resistance element is over 70 per cent metallic substances. Its full resistance is 30 ohms. And it is

UNCONDITIONALLY GUARANTEED TO GIVE SATISFACTION



Price \$2

The Fil-KO-Stat is suitable for any panel mounting. Rigid, nickel plated, drilled and tapped mountings for setting up Fil-KO-Stat on table, 15 cents additional.

In Canada—\$2.75



MURDOCK RADIO

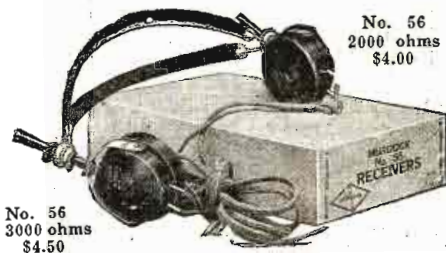

You can pay more
but you can't get
better value

FOR twenty years Murdock headphones have been the standard for efficient radio reception. Made with the precision of a delicately wrought instrument—they are unexcelled for sensitiveness, clarity and durability. The fact that over a million have been sold is proof of their superior service.

The Murdock embodies the finest, tested materials. Cases are made of solid moulded insulation, with parts firmly embedded—thus assuring firmness, strength and permanence of adjustment.

Why pay more?

THE great demand for Murdock 'phones has forced us to make them in large quantities, which means lowered cost to the consumer. Thus you can buy a Murdock for almost half what is asked for 'phones of equal value. Why pay more? Get a Murdock today and test it out. We guarantee complete satisfaction.

A higher price is a luxury — anything less is poor economy

Have you a new Murdock
Multiple Plug?

At all dealers

WM. J. MURDOCK CO.,
344 Washington Ave.,
Chelsea, Mass.

Sales Offices Chicago and San Francisco

STANDARD
APPARATUS
SINCE 1904

Reminiscences of a Radio Inspector

(Continued from page 1249)

"If you go to the Custom House or Navy Yard to take the radio examinations and fail, don't put all the blame on the examining officer," says Mr. Guthrie. "If you will but look at all sides of the question, you will discover that your nerves were all unstrung at the time, or else you were unprepared.

"Should you be planning to take the test,

know that?' An investigation showed he had taken a correspondence course in wireless. Imagine giving one who is unable to read signals a license which would enable him to go aboard some ship as radio officer. The funny part of it is, he became highly indignant when told to learn the code.

"At another date a prominent lawyer from Pennsylvania came to obtain a license. When in the middle of the code test he threw up his hands in disgust and informed me he was too upset to copy a single word. Another applicant did exactly the same thing, laying the blame to fast sending. I spoke softly to both, informed them it was simply because they were scared and urged them to try again. Both were successful on the second trial. Some days later I received a communication from the lawyer, in which he thanked me for the assistance and encouragement I gave him. A radio inspector is always willing to assist those who show they are really trying to do their best. The impression that he aims to scare them is nothing more than pure bunk.

"Knowing the code isn't all that is necessary; to obtain a commercial license the applicant must be acquainted with transmitting apparatus so that in case of a breakdown while at sea, he will be able to locate the trouble and make repairs. On the ocean there are no repair shops; therefore, it remains solely for the operator to see that the transmitter is always in working order. No one can foretell when disaster may overtake a liner. Should the radio be useless at

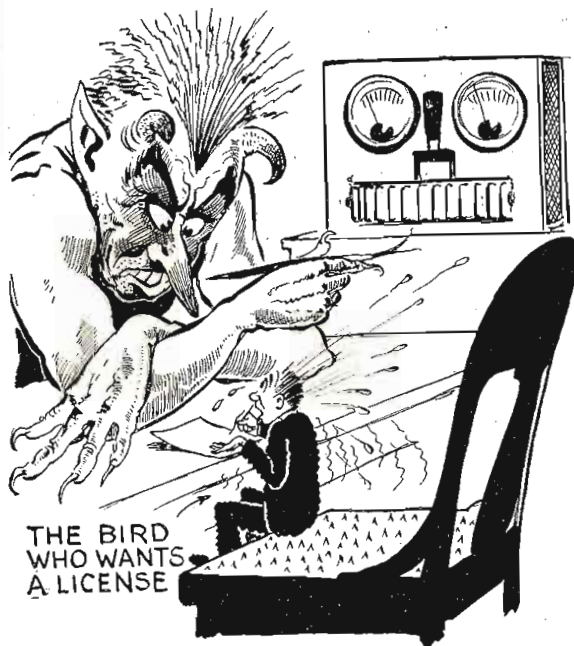

The radio supervisor as he appears to the poor soul taking an examination for a license . . .

be positive you are used to omnigraph sending. The code test is always given on this mechanical device. While some people have no difficulty in copying 30 words a minute, hand sending they are totally lost when it comes to copying 20 words transmitted by this instrument. The swing is vastly different, which is a big factor. It is a good plan to practice a bit with the omnigraph before taking the tests. When the time comes you will find it helped materially.

"Why is it that most persons dread the code tests? During the time I served as Radio Inspector I examined nearly 2,000 applicants and 80 per cent of them almost fainted while taking this end of the examination. Most of them are scared because they are afraid of the mechanical sending, while others think too much about the possibility of missing the one letter that will spell failure. If you are going to take such an attitude, it is foolish to even think of the test. The correct thing to do is to put your whole heart on the dots and dashes. Don't give the idea of failing a single thought, and when you enter the Custom House, come in with these words in mind—'I know I can succeed if I try. I'm going to pass the test. There is no such thing as failing.'

"Some years ago a girl and her brother entered my office. The young man was anxious to secure a commercial license, but when I asked him if he was ready to take the code test he simply looked at me in surprise and said: 'I didn't learn the code; is it necessary to

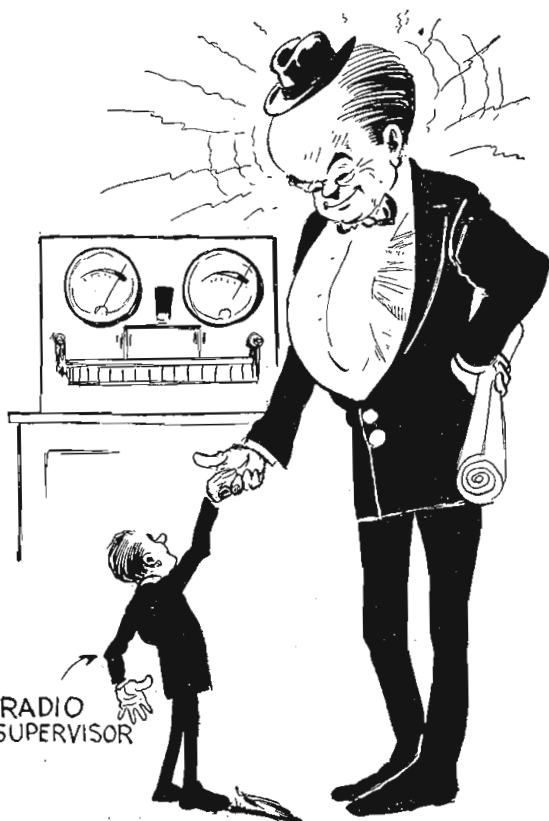

... and how the poor soul feels and the supervisor looks to him after he gets the license and is "all set,"

Complete RADIO Outfit!



This
Famous

TUSKA

Armstrong Regenerative Receiver and Two-Step Amplifier, Complete

only \$5 Down

Balance in Easy Monthly Payments

This great offer makes the finest of radio equipment available to every home. Why tinker with home made sets! Why confine your radio reception to the few local stations reached by a crystal set! For only \$5 down you can have a radio set that will reach out hundreds—even thousands of miles away and “bring in” your choice of all the wonderful programs broadcasted from the Atlantic to the Pacific. It has ample volume to operate a loud speaker on far distant stations. In the TUSKA we offer a set designed by Mr. C. D. Tuska—a famous radio engineer—and built complete under his personal supervision. In results—in appearance—in workmanship—it is the equal of outfits costing twice the price we ask. Send the coupon below for our Great Special Offer made for a limited time only.

No Accessories to Buy

The radio outfits we sell are absolutely complete. Most others make an offer on the bare set and leave you to buy all the extras like tubes, phones, etc., in addition. The outfit we offer you includes the Regenerative Receiver and 2-step Amplifier all enclosed in a solid mahogany case. Also the batteries, head-phones, tubes, aerial, lightning arrester, and full wiring installation equipment. You start operating without investing another single penny. Your \$5 payment brings it all.

UV 199 Tubes and Dry Cells Reduce Upkeep to Almost Nothing

Equipped with 3 of the latest type of dry battery UV 199 tubes. Use only .06 ampere current. Most perfect tube both for detecting and amplifying. Battery expense reduced to the absolute minimum.

Send Coupon for Great Special Offer

Just mail the coupon. Get all the details without any obligation. Don't think of buying an ordinary set without finding all about this new and better way. Very easy terms. Free Trial. The highest quality of radio equipment possible to have.

BABSON BROS., 2843 West 19th St., Chicago, Ill.

Dept. 59-43

LOOK!

Here Is What You Get

Tuska Regenerative Receiver and 2 step Amplifier; Handsome genuine mahogany cabinet; Genuine Bakelite Panel; 3 UV 199 Radiotrons (tubes); 3 adapters, permitting the use of UV 199 tubes in standard sockets; “B” battery, 45 volt capacity; 3 “A” dry batteries; set of lightweight, marvelously sensitive head-phones; 50 feet of lead-in wire; 100 ft. aerial wire; insulators for both ends of aerial and for turning corners; lightning arrester and all things necessary for complete installation.

BABSON BROS., Dept. 59-43
2843 West 19th St., Chicago, Ill.

Please send me your special offer on a Complete Tuska Radio Outfit on terms of \$5 down and monthly payments.

Name

Address

QUICK POSITIVE CONNECTIONS!

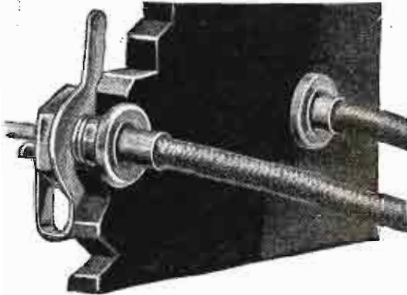

Union Radio Tip Jacks

(Patent Pending)

Price 25c

Just what you want when building your own set or experimenting with new hook-ups. Not only give positive electrical contact, they improve the appearance of your set.

Two sizes for all mountings. **Standard Type A** for panels up to $\frac{1}{4}$ inch thickness, **Special Type B** for panels, cabinet walls and partitions from $\frac{1}{8}$ to $\frac{1}{2}$ inch thickness. Will firmly grip all wires from No. 11 to 24 B & S gauge, and can be reamed to pass and hold antenna wire, battery leads, leading coils and vacuum tube lugs.

No parts to lose, chip or deteriorate. All parts heavily nicked. **Price, 25c.**

OTHER GUARANTEED UNION RADIO PARTS

Dial adjusters for minute variations in capacities of variable condensers. **Price, 60c.**

Tube sockets of molded condensite highly polished. Phosphor Bronze contact springs. Reinforced bayonet slot prevents breakage. Accommodates all standard tubes. **Price, 70c.**

Should your favorite Radio Store not carry Union Radio Tip Jacks and Guaranteed Parts send your order direct to us; also write for your copy of "The Union Radio Catalogue F."

RETAILERS AND WHOLESALERS

Samples of our guaranteed, reasonably priced "Quality Products" sent on request. Our terms and trade discounts are liberal. Write for our proposition.

UNION RADIO CORPORATION
200-MT. PLEASANT AVENUE, NEWARK, N.J.
NEW YORK OFFICE: 116-WEST-32ND-STREET

such a critical time, the results can easily be seen. Not so many months ago a young chap applied for a first grade license. When asked what types of apparatus he was familiar with, he replied: 'None, but I know I can operate most any kind. You see I had no practical experience with transmitters. I took a course from a school by mail and they used to send me pictures of sets together with an explanation as to their principles of operation.' Can you imagine that? Courses in wireless by mail may be all right, but if anyone ever expects to amount to anything in the radio world, I would advise him to go to a school where he can get practical experience.

"Many times during the period I served as Radio Inspector at New York, I was asked to express my views as to the prac-

ticability of having female radio operators aboard ships. This is a subject that has been discussed a great deal. To my mind, no respectable girl should work aboard ship. It would be all right if she could be assigned to some big passenger liner, where the stewardesses could look after her, but an operator must have a good deal of experience in commercial radio before he can get on such a ship. Therefore, it would be necessary for the girl to ship aboard a freight steamer to obtain the required experience, and this I would never advise.

"Girls make just as good operators as the boys. During the war I had the opportunity to examine many girls who secured licenses and I always found that they could take both the code and theoretical tests as easily as the men. Many of them were less afraid."

The Trans-Atlantic Broadcast Tests

(Continued from page 1225)

2LO BREAKS THROUGH

We then set our loop in the direction of 2LO (370 meters) and listened in on his wave. A great amount of interference was noted from local 360-meter stations, although, much to our surprise, at 10:05 Eastern Standard Time, a voice broke through in English dialect, repeating several times "L-O" (which we interpreted to mean 2LO), which gradually faded, and a few seconds later we heard the popular Nevins number, "The Rosary." The carrier of this station was very prominent, but the modulated wave was down to a very ragged quality and small intensity; the piano number ceased, and our energetic staff automatically became breathless with anxiety, straining ears for the next announcement, but without avail. He started speaking, when one of the local stations resumed transmission, which entirely abolished further reception on our still questionable 2LO, owing to very poor modulation.

We then attempted to do some work on the stations operating on wave-lengths in the neighborhood of 400 meters, and much to our surprise, we noted several good carriers which automatically ceased at 11:10 Eastern Standard Time, but this seemed to afford us an excellent opportunity of receiving a poorly modulated station which faded very consistently. Although we managed to bring this station to a fair degree of audibility, the enunciation was ragged, offering no means of identification. We worked on our apparatus until some bright person mentioned the presence of the famous Greek god "Morpheus." We then abandoned our experiment to take it up again the following Tuesday evening.

Tuesday evening, our experiment proved more fruitful. At 10:57 o'clock we heard strains of an opera and a few under-modulated words from the announcer (I may add that the listeners were breathless with anxiety), but our far-famed high-powered station at Arlington resumed operations and we were lost again, owing to a distinct harmonic in his transmission on our listening wave. However, only a few minutes had elapsed when Dr. Rogers' physician verified our astounding reception by quoting that he had heard the same music and besides had heard a few words of the announcer, which I shall quote: "Trans-Atlantic station! Trans-Atlantic station!" followed by "Our next effort will be Thursday when we will repeat this same program." These words convinced us that we had actually heard Europe.

Thursday night after a few amusing instances (being photographed, talking to newspaper men and refreshments), we again delved into our tests, starting promptly at 10 p. m. We succeeded in picking up a very weak carrier which was obliterated when a powerful station in Pittsburgh resumed operations. This left us again to our ever present resourcefulness, so we tuned in on a station, counting from one to ten for about two minutes. In signing off, he stated that it was then 6:30 p. m., our clock being 10:47 p. m., Eastern Standard Time.

The concise opinion of those who listened was that the stations in the British Isles were poorly modulated, and our suggestion to them is that in their next trans-Atlantic test, they try boosting their modulation, as they seem to have very good carriers, proving that they have transmitters of capable power for trans-Atlantic work.

Tuning and What It Means

(Continued from page 1233)

forced to vibrate at frequencies which are different from its natural or resonant rate. But, as in the case of the swing, such non-resonant vibrations must be maintained by the use of excessively large power (by main strength, as we said) since they do not take advantage of the tendency of the system to swing back and forth at its natural frequency. These non-resonant vibrations are called *forced* vibrations, to distinguish them from the natural or free vibrations of the system.

ELECTRICAL VIBRATIONS

One might well ask what the preceding discussion of music and pendulums has to do with electricity and particularly with radio. The answer is simple; in a word, everything. All the phenomena that we have considered from the mechanical viewpoint are reproduced in electrical circuits and are used in

radio communication. We have merely to work out the electrical counterparts of the various mechanical effects to understand the basis of tuning and resonance in radio circuits. Although the oscillations in an electric circuit are not visible, as they are in the case of a pendulum, they nevertheless occur in the same way and are subject to the same sort of control as to natural frequency, intensity of vibration, etc.

Let us first get a general idea of an electric circuit with electric current flowing in it. Suppose that the positive end of a battery is connected by a piece of wire with a current-indicating meter, that the meter is connected with one end of a resistance unit, and that the other terminal of the resistance is wired back to the negative side of the battery, as illustrated in Fig. 3. The battery is something like a pump for electric cur-

ATWATER KENT

Philadelphia

New Standards in Radio Reception

The clearness with which the ATWATER KENT Loud Speaker re-creates will give you a new conception of tonal fidelity.

IN the ATWATER KENT Model 10 Receiving Set and the ATWATER KENT Loud Speaker, new standards of excellence have been attained. No achievements in radio reception during the past year have created quite the same widespread interest and enthusiastic commendation.

The ATWATER KENT Model 10 Receiving Set is highly selective and easy to operate: —it gives exceptional volume and clearness on distant broadcasts. Its wide range and the ease with which a desired station can be tuned in is the delight of every owner.

Literature sent on request

ATWATER KENT MANUFACTURING Co.

4943 STENTON AVE., PHILA., PA.

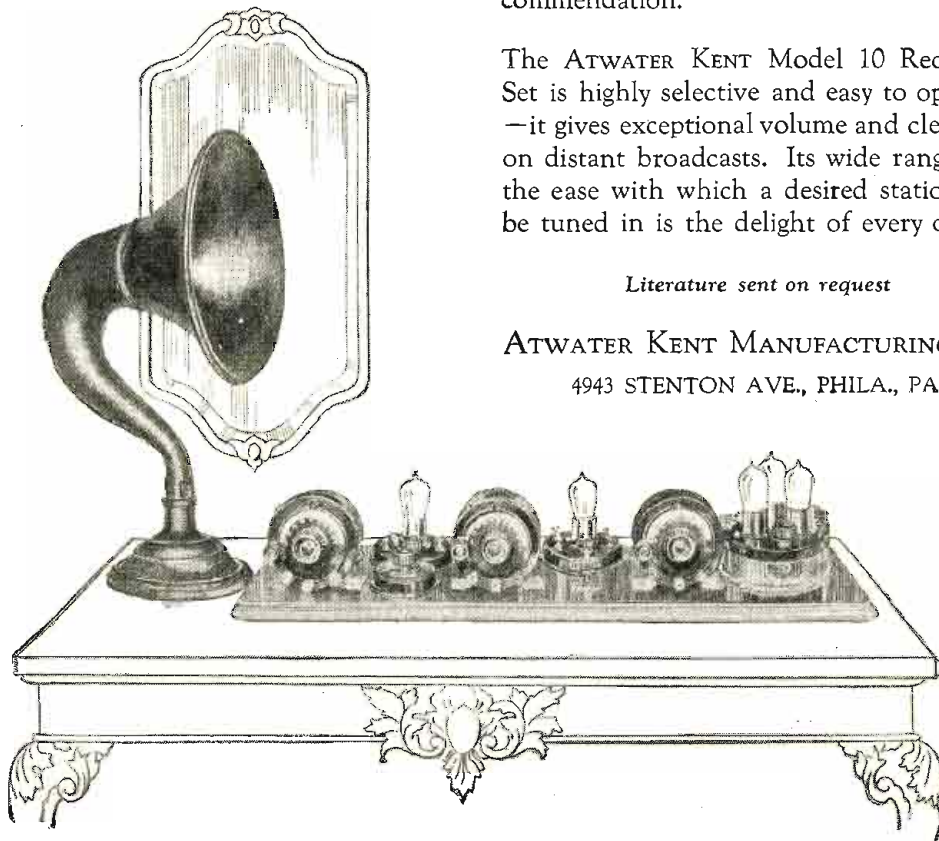

DUO-SPIRAL

The Leading Loop Aerial

With New Dial and Handle

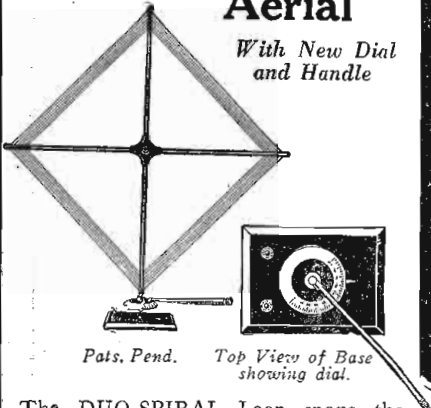

Pats. Pend. Top View of Base showing dial.

The DUO-SPIRAL Loop spans the continent on a loud speaker with many types of radio-frequency sets. Careful tests by leading manufacturers and radio engineers have proved its superiority. Used exclusively by the largest manufacturers of radio frequency sets. It is trim and neat in appearance and handsomely finished. It rotates freely on its base. Adjustment is made easy by handsome dial and a long handle which eliminates all body capacity effects. The green double silk covered wire is kept always taut by hidden springs. The DUO-SPIRAL loop completely replaces roof antenna and ground and practically eliminates static.

24-inch size. \$8.50
12-inch size. \$7.50

(These prices include new dial and handle)

TINY-TURN

A New and Superior Vernier Control

TINY-TURN makes possible an exactness in tuning never before attained. It has a 30 to 1 gear ratio instead of only 4 or 5 to 1 as in the ordinary vernier. No lost motion! The vernier turns in the same direction as dial. It can be instantly disengaged, leaving dial free. **INSTALLED ON ANY SET IN 3 MINUTES.** Handsome nickel and black finish. Packed in individual containers. We furnish counter display demonstrating boards.



Pats. Pend. Side View showing friction drive against dial. Price 75c

The above products (folders on request) are sold through dealers and jobbers. If your dealer cannot supply you, write us direct.

RADIO UNITS INC

1305 FIRST AVE. MAYWOOD, ILL.

rent; it produces between its terminals an electric pressure which tends to cause a flow of electric current when the terminals are connected by a wire or other conductor. The positive end of the battery, indicated by a plus sign, is the high-pressure end; the difference in electrical pressure or potential between the battery terminals is measured in volts, and the higher the voltage the higher the electrical pressure.

In the circuit that we have imagined, a path for current-flow from one end of the battery to the other is provided through the resistance unit and meter. The battery pressure will force a current to pass through the circuit; the amount of current will be registered in amperes, and will depend upon the pressure of the battery and the resistance of the circuit. The resistance is measured in ohms, which is merely that property of a wire which holds back electric current. In this circuit the current flows only in one direction, from high to low potential (or plus to minus ends of the battery, according to the conventional expression adopted many years ago); it is therefore called a unidirectional or direct current.

Suppose that the battery were connected into the circuit with its terminals reversed. The current would still flow from high potential or positive to low potential or negative, but its path through the wire would be in the reversed direction. If the battery in such a circuit were regularly and rapidly turned end for end, being connected with the wires each time, it is not hard to see that the current in the circuit would flow first in one direction and then in the other direction. In other words, the current would no longer be unidirectional or direct, but would change its direction or flow at regular intervals, going first one way and then the other. Such a regularly reversing flow is called an alternating current.

Alternating currents are not produced in practice by reversing the terminals of a battery, but instead by means of an alternating current dynamo or alternator. This dynamo machine automatically sets up electric potentials across its terminals, first in one direction and then in the other. The fluctuating potentials cause corresponding alternating currents in any electrical circuit connected from one of the alternator terminals to the other, such, for example, as that of Fig. 4.

It is not hard to see that electric currents which flow first in one direction and then in the other, that is, alternating currents which swing back and forth in a circuit, must have something in common with mechanical oscillations. They are evidently electrical vibrations, just as the swings of a pendulum are mechanical vibrations. The electrical swings, of course, require a definite length of time to complete one double-oscillation or cycle; this length of time, is, as before, called the period. The number of complete electrical cycles of alternating current in one second is, as in the mechanical case, the frequency in cycles per second.

Everyday electric alternating current used for house lighting has a frequency of 60 cycles per second, or a time period of 1/60 second. This is a much faster vibration than either the swing or the pendulum we have considered, but is right in the musical frequency range and corresponds to a tone about two octaves below middle C.

FREE ELECTRICAL OSCILLATIONS

The alternating currents we have just considered are not free or natural electrical vibrations, for their frequency of alternation is determined by the frequency of the voltages developed by the dynamo machine. The current that flows through the circuit connected to this alternator is forced to follow the voltage which sets it up, both as to direction and amount of flow, and hence as to frequency. It is, true enough, an electrical vibration, but it is a forced vibration. The

Morrison

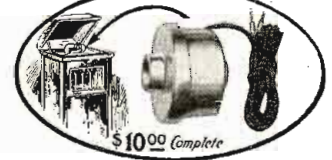

Loud Speaker

USE YOUR PHONOGRAPH FOR RADIO

To really enjoy radio you require a loud speaker that reproduces all broadcasting in full volume with rattle, vibration and distortion eliminated. Your phonograph has a sound-box that cannot be excelled. So attach a Morrison Loud Speaker to the tone-arm of your phonograph and you have a perfect combination—a scientifically developed loud speaking unit reproducing Radio's wonderful concerts through your phonograph's incomparable sound-box. It is the refinement of radio enjoyment.

A little dial on the Morrison enables you to adjust the tone, soft or loud, to suit your taste. Further than that, Morrison is fool-proof—requires no technical skill nor constant adjustment to operate.

This remarkable loud speaker complete with a 5-foot cord costs only

\$10.00

Nickel-Plated Model

Every Morrison Loud Speaker is sold on a satisfaction or money-back guarantee. Our 2 color catalogue describes Morrison fully—we would like to send you one free.

DEALERS

Our merchandising plan to help you sell Morrison Loud Speakers assures you a profitable business. Every sale you make brings many more. Let us tell you about this plan.

Morrison Laboratories Inc.

339 Jefferson Ave., E., Detroit, Mich.

It's Easy to Build Things

with a Junior Bench Saw



Does your ripping, mitering, grooving, rabbeting, tenoning, sanding, grinding and many other operations, with surprising ease and accuracy. Top 10"x13". Saws 1 1/2" stock. Dadoes 3/8"x5/8". Machine built entirely of metal. Driven by 1/4 or 1/3 h. p. motor. Portable. Attaches to any light socket. Extremely accurate. Descriptive circular tells many things of interest to workers in wood and soft metals.

W. & J. BOICE, 1730 Norwood Ave., Dept. 803, Toledo, O.

You can be quickly cured, if you

STAMMER

Send 10 cents for 288-page book on Stammering and Stuttering. "Its Cause and Cure." It tells how cured myself after stammering 20 yrs. B. N. Bogue, 896 Bogue Bldg., 1147 N. Ill. St., Indianapolis

SEE OUR GUARANTEE
HOOK-UPS and CATALOG FREE

REDUCED PRICES

ON STANDARD QUALITY PARTS

SERVICE AND QUALITY
BUILT THIS HOUSE

WE PAY TRANSPORTATION CHARGES IN THE UNITED STATES ONLY

PHONES THAT HAVE STOOD THE TEST

F161 Frost double set 2000 ohm \$3.35
F171 Frost double set 3000 ohm \$4.05
F162 Frost double set 2000 ohm \$4.05
F163 Frost double set 3000 ohm \$4.65
F172 Frost double set 3200 ohm \$5.15

166 Brandes Superior double set \$8.19
F167 Brandes Navy type double set \$6.75
F168 Genuine Type C Baldwin Phones double set \$10.50
F169 Genuine Type C Baldwin Unit with cord \$5.15

BALDWIN LOUD SPEAKER \$25.00

SPAGHETTI AND WIRE

F33 Per 4-ft. length 27c
F32 Tinned Copper No. 16 Wire Ft. 1c
F34 Wire with insulation similar to spaghetti on it. Wire is tinned for soldering. Price 10 feet 29c

ERLA R. F. TRANSFORMER
Specify 1st, 2nd or 3rd stage.
F1500 Erla Transformer \$3.40

ERLA REFLEX TRANSFORMER
F1650 Reflex Transformer \$4.40

TESTED CRYSTALS

F12 Galena, per pkg. \$0.10
F13 Silicon, per pkg. 10

JACKS AND PLUGS

Jacks are polished nickel, nickel-silver springs, pure silver contacts. Nickel washers for mounting on any panel $\frac{1}{8}$ to $\frac{1}{2}$ inch thick. Spread terminals make soldering easy.

F133 One spring (open circuit) \$0.32
F134 Two spring (closed circuit) 42
F131 Four spring (two closed circuits) 50
F135 Three spring (two open circuits, called "single filament control") 53
F136 Five spring (two open and two closed circuits, commonly called "two circuit filament control") 69
F139 Plug with threaded barrel instead of set screw. Takes cot tips 45

VARIABLE GRID LEAK

Panel mark type. Removable black enameled cap.
F50 Grid Leak 13c

GRID AND PHONE CONDENSERS

Mounting Holes spaced to fit screws of above Grid Leak. Mica insulation, wrapped with varnished cambric tape. Capacity, .00025 Mfd.

F55 Grid Condensers 6c
F59 Phone Condenser, .001 Mfd. 15c

C. R. L. ADJUSTABLE GRID LEAK AND CONDENSER

A turn of the polished black knob will enable you to get the one and only one potential that provides the maximum signal strength. Made for panel mounting.

F107 C. R. L. Adjustable Grid Leak and Grid Condenser \$1.49

FRESHMAN TESTED MICA CONDENSERS

F82 .00025 mfd. Condenser \$0.27
F83 .0005 mfd. Condenser \$0.27
F84 .001 mfd. Condenser 31
F85 .002 mfd. Condenser 31
F86 .0025 mfd. Condenser 41
F87 .005 mfd. Condenser 65
F88 .006 mfd. Condenser 65
F89 .01 mfd. Condenser 1.37

FRESHMAN VARIABLE GRID LEAK AND GRID CONDENSER

For unbroken range—zero to 5 megohms, clarifies signals, lowers filament current, increases battery life, eliminates hissing.

F80 Freshman Variable Grid Leak and Condenser \$0.85

AERIAL WIRE

F355 Copper 7 strand 100 ft. coil. \$0.77
F356 Single No. 14 Bare Solid Copper Wire 100 ft. Coils 55

SWITCH POINTS AND STOPS

Brass, polished nickel finish. Screw size, 6/32x $\frac{1}{2}$ ins. long, 2 nuts with each contact point and one with stops.

F158 Switch point $\frac{1}{4}$ " dia., $\frac{1}{8}$ " high Each 2c Dozen 18c Hundred \$1.05
F159 Switch Point diam. $\frac{1}{4}$ inch; height, Each Doz. dred 3-16 inch 2c 20c \$1.40
F150 Switch Stops 2c 20c 1.40

OUR GUARANTEE YOUR PROTECTION
Your satisfaction guaranteed. If for any reason you do not feel satisfied with your purchase, you may return it and we will refund your money. We will pay return transportation charges.

180° VARIOCOUPLER

The primary and secondary windings of this coupler are properly spaced. The center of the secondary is always in the center of the primary field. Black base, brown formica tube and nicked parts.

Panel or table mounting.
F1100 Coupler \$2.75

180° MOULDED ROTOR TYPE COUPLER

This 180° variocoupler has heavy black tube and moulded rotor. Wound with green silk wire and has 10 taps on the primary. Metal parts are brass nickel. Can be mounted on panel or table.

F1120 Variocoupler \$3.45

VARIABLE CONDENSERS

Condensers are made of heavy aluminum plates, evenly spaced with high grade bakelite ends.

F1443 43 plate .001 Mfd. without dial \$1.49
F1423 21 plates, .0005 Mfd. without dial 1.29
F1411 11 plates, .00025 Mfd. without dial 1.15
F1403 3 plates, .00005 Mfd. without dial98

VERNIER VARIABLE CONDENSERS

For fine tuning, neat appearance, this condenser is just the thing. Made of heavy aluminum plates and two high grade bakelite e n d s. These condensers are furnished with neat appearing knob and dial.

F1444 44 plates vernier .001 Mfd. with dial \$3.70
F1422 22 plates vernier .0005 Mfd. with dial \$2.73

ERLA AUDIO FREQ. TRANSFORMER
F1750 Erla Audio Transformer \$4.40

INDUCTANCE COIL MOUNTINGS

For base or panel mounting. Connecting leads furnished, coil settings are adjustable by means of knobs. Made entirely of bakelite and nickel metal parts. Coil mounting can be locked by knurled set screws.

F1673 Three circuit mounting \$3.75
F1692 Two coil mounting 2.70
F1691 Single coil mounting 37

INDUCTANCE COILS

Rigidly wound, nicely finished, low distributed capacity. All coils are equipped with standard mountings. We can supply any of these coils with or without mounting plugs. The wave lengths shown are range limits, based on variable condenser .001 mfd. capacity. Price un-price

No. turns	No. of Wave Lengths	mount- ed	mount- ed
1725	25	125-	250 \$0.34 \$0.78
1726	35	175-	450 .38 .91
1727	50	240-	720 .44 .97
1728	75	390-	910 .49 1.03
1729	100	500-	1,450 .53 1.08
1730	150	600-	2,000 .58 1.12
1731	200	900-	2,500 .67 1.21
1732	250	1,200-	3,500 .73 1.30
1733	300	1,500-	4,500 .77 1.31
1734	400	2,000-	3,000 .92 1.52
1735	500	2,800-	6,100 1.07 1.58
1736	600	4,000-	10,000 1.22 1.73
1737	750	5,000-	12,000 1.38 1.88
1738	1,000	7,000-	15,000 1.65 2.19
1739	1,250	9,750-	19,500 1.87 2.39
1740	1,500	14,500-	26,500 2.13 2.53

INSULATORS

These are very strong strain type insulators. Each Doz.

F360 Moulded Insulator shown \$0.10 \$1.10
F365 Porcelain insulators09 .95

VARIOMETERS

For efficiency, perfect inductive ratio, low capacity effect and neatness of design these variometers are unexcelled. Metal parts nicked. Stator and bail mahogany finish. Completely assembled.

F1200 Variometer \$2.65

The above variometers knocked-down stator wires cemented in the stators. Rotors are wound. All metal parts included.
F1205 Knocked-down Variometers \$1.85

MOULDED VARIOMETERS

F1220 Moulded Variometer \$3.95

DIALS

Genuine Bakelite Dial as pictured. Sharp engraved divisions and figures filled with a brilliant white. Set screws included.

F502 Dial, 2 inch, 3-16 in. shaft \$0.32
F500 Dial, 3 inch, 3-16 in. shaft35
F501 Dial, 3 inch, $\frac{1}{4}$ in. shaft35
F504 Dial, 4 inch, $\frac{1}{4}$ in. shaft67

Moulded composition dial as pictured. Has a luster that cannot be told from Bakelite. Set screws included. Each

F563 Dial, 2 inch, 3-16 in. shaft \$0.16
F550 Dial, 3-16 in. shaft22
F553 Dial, $\frac{1}{4}$ in. shaft22

AUDIO FREQUENCY AMPLIFYING TRANSFORMERS

Correctly designed for minimum distributed capacity and low core loss. Shielded beautifully finished in nickel and black enamel. Ratio 5 $\frac{1}{2}$ to 1.

F1506 Shielded Transformer \$2.95

THORNDARSON AUDIO FREQUENCY AMPLIFYING TRANSFORMERS

There is probably no better known transformer. Made by a company that specializes in transformers. Entirely encased in sheet aluminum shield. Heavy connecting straps to binding posts.

F1504 Thorndarson Transformer, 3 $\frac{1}{2}$ to 1 \$3.35
F1505 Thorndarson Transformer 6 to 1 3.75

"B" BATTERIES

Standard high grade radio "B" batteries. Never over five years old.

F230 22 $\frac{1}{2}$ volt Signal Corps type. Size 3 $\frac{1}{2}$ x2 x2 $\frac{1}{2}$ inches \$1.18
F240 22 $\frac{1}{2}$ volt large variable—5 positive taps. Size 6 $\frac{1}{2}$ x3 $\frac{1}{2}$ \$2.25
F245 45 volt large size binding posts. Size 7 $\frac{1}{2}$ x6 $\frac{1}{2}$ x3 \$4.50

INDUCTANCE SWITCH

For neat appearance and time saving, we suggest this inductance switch, as it needs but one hole in the panel to be mounted. Switch Points are mounted on this switch. 15 switch points, in all.

F1095 Inductance Switch \$1.22

MAGNET WIRE

Quality magnet wire. We carry three types in stock. Each spool is 8 oz.

Size	Price	Green silk	Price	Enameled	Price
F18	\$0.40	F20	\$0.76	F20	\$0.37
F20	.52	F22	.90	F22	.47
F22	.68	F24	1.05	F24	.51
F24	.78	F26	1.18	F26	.56
F26	.88	F30	1.70	F30	.62
F28	1.02	F32	2.00	F32	.66
F30	1.40	F36	2.70	F36	.85

SWITCH LEVERS

A high grade, polished nickel plated lever with solid moulded black composition knob. Complete with panel bushing.

Each

F151 1-in. Radius 14c
F155 1 $\frac{1}{2}$ -in. Radius 14c

VACUUM TUBES

Genuine Cunningham or Radiotron made by the General Electric Co. Every tube guaranteed new and in original package. We do not sell "bootleg" tubes. Will ship brand in stock unless specified.

F300 UV200 Detector \$4.37
F301A UV201A Amplifying 4.50
F11 WD11 1 $\frac{1}{2}$ volt. 4.50
F12 WD12 1 $\frac{1}{2}$ volt. 4.50
F299 UV199 3 volt. 4.50

QUALITY SOCKETS

For C200, C301A, C12 or WD12 tubes. Signal socket. Tube made of brass, nicked. Base is bakelite. Panel or base mount. Great Lakes nickel socket. Panel or base mount. Great Lakes bakelite socket. Panel or base mount only. All sockets have heavy spring contacts.

F1073 Signal Socket \$0.65
F1074 Belden Socket60
F1075 Great Lakes Nickel37
F1076 Great Lakes Bakelite, base mount only49
WD11 Bakelite Socket30
WD11 Adapter43
299 Bakelite Socket42
299 Adapter39

GREAT LAKES SUPREME RHEOSTATS AND POTENTIOMETERS

We guarantee these rheostats and potentiometers to be unexcelled. They give perfect satisfaction under constant use. Each turn of the resistance wire is in 2 groove which makes it impossible to have trouble when the contact slider runs over the resistance wire. Polished tapered knob base is $\frac{1}{2}$ inches and made of heat resisting material. A real value.

F90 C. L. Supreme Rheostats, 6 ohm \$3.99
F91 G. L. Supreme Rheostats, 25 ohm 4.42
F92 G. L. Supreme Rheostats, 40 ohm 4.45
F93 G. L. Potentiometer, 200 ohm 52
F94 G. L. Potentiometer, 400 ohm 56

HOWARD RHEOSTATS

F1064 Howard 6 ohm Plain \$0.98
F1065 Howard 6 ohm Vernier 1.35
F1066 Howard 25 ohm Plain98
F1067 Howard 25 ohm Vernier 1.35
F1068 Howard 40 ohm Plain 1.35
F1069 Howard 40 ohm Vernier 1.35
F1067 Howard 200 ohm Potentiometer 1.35
F1068 Howard 400 ohm Potentiometer 1.85

CUTLER-HAMMER RHEOSTATS

F1061 Cutler-Hammer Vernier \$1.35
F1062 Cutler-Hammer Plain90
F1063 Cutler-Hammer 30 ohm 1.35
F1064 C.-H. 30 ohm Resistance 1.35
F1063 C.-H. 200 ohm Potentiometer 1.22

BINDING POSTS

Complete with screw and washer. All brass finished in polished nickel or with black composition top as listed. Order by number. Each Doz.

F110 Large size, all nicked 70 75c
F112 Medium size, nicked, with top for phone tip or wire 30 30c
F112 Medium size, black composition top 4c 35c
F120 Large size, composition top 50 42c

WORKRITE NEUTRODYNE PARTS

Licensed under Hazeltine Pat. Consists of 3 variable condensers, 3 neutroformers and 2 neutroton condensers. Price for all above parts \$17.50

CABINETS

Here's a dandy new style cabinet with sliding top. Hand rubbed mahogany. A wonderful value. Panels not included. See panel prices.

F217 6x7x7 \$2.40
F219 7x9x7 2.70
F213 7x12x7 3.40
F228 7x18x7 3.75
F224 9x14x7 3.55
F221 7x21x7 3.95
F222 7x24x7 4.65

PANELS

Genuine Formica panels, to fit our cabinets.

F267 6x7x $\frac{1}{2}$ \$0.56
F269 7x9x $\frac{1}{2}$ 90
F263 7x12x $\frac{1}{2}$ 1.25
F268 7x18x3-16 2.16
F274 9x14x3-16 2.60
F267 7x21x3-16 2.95
F262 7x24x3-16 3.50
 $\frac{1}{2}$ inch Panel cut to size \$0.1 $\frac{1}{2}$ sq. in.
 $\frac{3}{16}$ in. Panel cut to size02 sq. in.

HOW TO ORDER
Order from this page. Please give number, description and price of the article you order to help us avoid mistakes. Total amount of your order and send Post Office money order, certified check or draft with your order. Be sure to give your name and street address on both letter and envelope. Do not include money for transportation. We pay it except on storage "A" batteries. See ads of previous months for other items.

For Transmission
or Reception!
"FRESHMAN SELECTIVE"
Mercury Variable Condenser

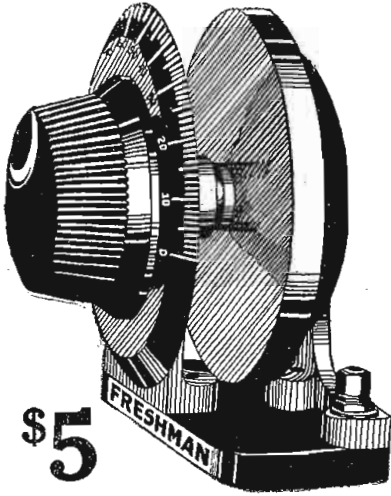

\$5

It has been conceded by the Foremost Radio Engineers that a Variable Condenser with Mercury plates is the most efficient for fine adjustment and selective tuning. Our engineers, after exhaustive experiments and research work, have developed a Variable Condenser with Mercury plates separated by heavy Mica dielectric. It is the ONLY VARIABLE CONDENSER the plates of which actually vary in area—AN ENGINEERING FEAT NEVER ACCOMPLISHED BEFORE.

- No Leakage
- Absolutely quiet
- No plate vibration
- Will stand 5,000 volts
- Compact and attractive
- Plates cannot collect dirt
- Cannot become short circuited

.0003 m. f. (equivalent to 17 plate)
.0005 m. f. (equivalent to 23 plate)
.001 m. f. (equivalent to 43 plate) ALL TYPES \$5

All Molded Parts and Dial of the
Finest Bakelite

At your dealer, otherwise send purchase price and you will be supplied postpaid

Chas. Freshman Co. Inc.
Radio Condenser Products

106 SEVENTH AVE. NEW YORK

EARN MONEY
AT HOME

YOU can make \$15 to \$60 weekly in your spare time writing show cards. No canvassing or soliciting. We instruct you by our new simple Directograph System, supply you with work and pay you cash each week. Write today for full particulars and free booklet.

WEST-ANGUS SHOW CARD SERVICE LIMITED
Authorized Capital \$1,250,000.00
154 Colborne Building, Toronto, Can.

dynamo voltage forces the current to flow in a given direction, and with a given intensity, by main strength.

There is another sort of alternating current generating system, however, in which the electrical oscillations are not forced. If we connect an electrical condenser in circuit with a coil of wire, which has the electrical property called inductance, we make a system which is capable of freely oscillating electrically. If such a circuit is provided with a battery and a charging switch, as shown in Fig. 5, as well as with a discharging switch, it may be used for the purpose of generating alternating currents. The working of such an arrangement, complicated as it may appear at first sight, is not hard to understand if one considers each portion of the system separately.

In the first place, let us look at the battery, the charging switch and the condenser. The electrical condenser is merely a pair of electrical conductors of somewhat large surface arranged so that their faces are close to, but not in contact with each other. Two sheets of tinfoil placed on opposite sides of a sheet of thin glass will make an excellent condenser for many purposes; two plates of copper each about two feet square, hung freely in the air about half an inch apart, give us another useful form. The glass in the first type and the air between the plates in the second arrangement, serve to keep the two plates electrically apart so that current cannot flow directly from one to the other. Yet the two comparatively large surfaces are allowed to act upon each other so as to develop the outstanding property of an electrical condenser, namely, capacitance.

This capacitance (formerly called capacity) measures the electrical size of a condenser, and shows the quantity of electricity which may be stored in a condenser at any given voltage or electrical pressure. A condenser is to electricity about what a toy balloon is to gas; one can charge a condenser with electricity just as one can blow up a rubber bag with gas. Electricity is stored in a charged condenser; gas is stored in an inflated balloon. If a gas-bag is filled from a pump producing some certain definite pressure, it will be possible to store a certain amount of gas in the balloon, and no more; the restoring force produced by the stretched walls of the bag will at some point be equal to the force of the pump, and no more gas will go into the balloon. The amount of gas that can be stored at some particular pressure will measure the size of the balloon for storage purposes. In the same way, if a condenser is charged at a definite electrical pressure or voltage, it will hold just so much electricity and no more; the restoring force developed in the condenser will prevent more electricity from entering as soon as the force becomes as great as the charging pressure. Thus, the quantity of electricity that a condenser will hold at some definite voltage will measure the size or capacitance of the condenser for storage purposes. In general, the capacitance is directly proportional to the size of the exposed surface and inversely proportional to the distance between them.

We should now be able to see that if the charging switch between the battery and the condenser in Fig. 5 is closed, a certain amount of electricity will flow into the condenser from the battery. This amount will be greater the larger the capacitance of the condenser and the higher the potential or voltage of the battery. For the condenser to charge in this way, however, the discharging switch also shown in Fig. 5 must be open, so that current cannot flow around the condenser through the wires leading to the inductance coil shown.

Having charged the condenser, we may open the charging switch. This leaves the condenser filled with electricity. The upper plate (Fig. 5), which was connected to the



The Saturn
"Above the Ordinary"
RADIO PRODUCTS

Automatic Plug

Nothing to solder or take apart. List Cord terminals inserted, instantly Price gripped a touch on the lever, instantly released. Each Saturn \$1 Plug sealed to protect you. Guaranteed.

Perfect Jack

Crowfoot offset and solder and flux on blades all ready for soldering. Best materials—Spring German silver blades, rounded corner brackets of nickel-plated brass, and sterling silver contact points. Quality throughout.

LIST PRICES

No. 1	Single Circuit, Open	50c.
No. 2	Single Circuit, Closed	55c.
No. 3	Double Circuit, Closed	70c.
No. 4	Single Filament control	75c.
No. 5	Double Filament control	80c.

Write for Folder

The SATURN Mfg. & Sales Co.

48 Beekman St.
New York, N. Y.

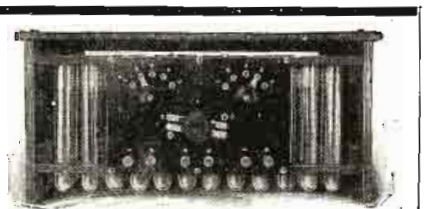

100 Volt Panel Type

"The most popular in this vicinity—"



We wish to commend your storage "B" battery," says the Southern Radio Sales Co., Newport News, Va. Such endorsements come to us unsolicited. KIC-O Batteries always make good. Alkaline type, won't sulphate or buck. Life unlimited. Not harmed by short-circuiting, overcharging, idleness. Panel switches five single cell variations. Recharge from any 110-volt A.C. line with small home rectifier. Charge lasts 3 to 6 months in detector plate circuit.

GUARANTEE
Your money back on any KIC-O Battery if not satisfied within 30 days. Write for full information on "A" and "B" Batteries.

KIMLEY ELECTRIC COMPANY, Inc.
2665 Main Street Buffalo, N. Y.

KIC-O Storage "B" Batteries
—long service, low cost

WOC--TRESKO

Licensed under Armstrong U. S. Patent No. 1,113,149
A long distance, 1000 mile, 600 meter range regenerative tuner for \$12.50

Add parcel post on 6 lbs. New circuit startling results. Cheaper than crystal set. Uses any aerial. Amplifiers to match set for your loud speakers. Circuits free—Full instructions.

TRESKO
Tri City Radio Elec. Supply Co.
BOX 148 DAVENPORT, IOWA

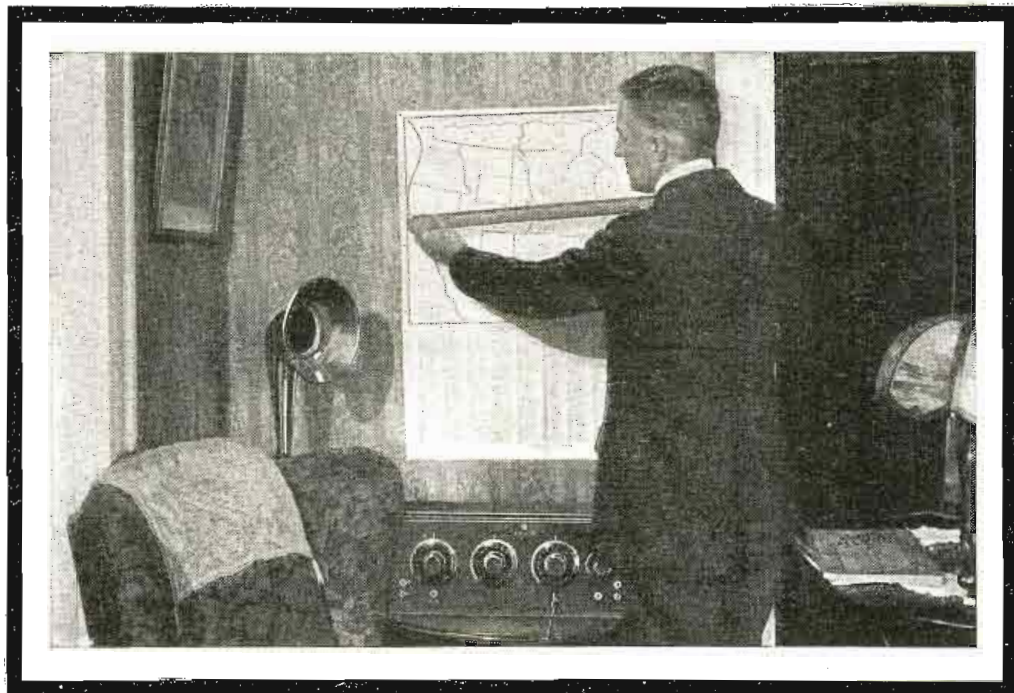

FADA "ONE SIXTY" WITH THE NEUTRODYNE CIRCUIT

Distance

The real thrill of radio is in listening to voice or music on the loud speaker from broadcasting stations located in cities a hundred or a thousand miles away.

To tune them in almost at will is a feature that has made hosts of enthusiastic friends for the FADA "ONE SIXTY" radio receiver. Here is a four-tube receiver combining the famous Neutrodyne circuit with the craftsmanship and experience that have made the name FADA synonymous with quality in radio. It is a receiver that is the equal of any five-tube set of any type or make.

Selectivity, volume, distance and clarity are outstanding features of the FADA "ONE SIXTY" radio receiver. Once the dial readings of any station are recorded that same station can always be tuned in again by returning to the same settings—and almost always, with loud-speaker volume. Price, \$120 at dealers. Extra for tubes, batteries and phones.

NOTE—For those who wish to build their own Neutrodyne receivers, FADA Neutrodyne parts are sold at \$25; the complete knock-down parts for four-tube set with book of instructions \$64; and the complete parts for five-tube receiver at \$65.60.

"How to Build It" book—the authority on the Neutrodyne circuit—sold by all dealers or direct for 50 cents per copy.

F. A. D. ANDREA, INCORPORATED
1581 Jerome Avenue, New York City

FADA RADIO



\$35.00

ACOUSTICOLA GRAND

Highest quality loud speaker made. CAST ALUMINUM vibrationless horn, extra large and sensitive unit. Adjustment lever tones down local stations and strengthens weak signals from distant stations just like focussing a camera.

ACOUSTICOLA Standard Model

Same wonderful unit, with same lever for instantly increasing or decreasing distance between poles and diaphragm. Fitted with non-metallic horn 21½ inches high with bell 10 inches wide.

Acousticola Phonograph Attachment

Same giant size unit with coupling to make a high grade loud speaker of any phonograph.

\$10.00

Trimm Headsets

Dependable **\$5.00**

Professional **\$7.65**

Lifetime guarantee with every Trimm product.

Write for folder.

TRIMM RADIO MFG. COMPANY
Dept. 64, 24 S. Clinton St., Chicago, Ill.



\$22.50

SEND FOR YOUR FREE COPY

TESTED HOOK-UPS

SUBMITTED BY USERS OF OUR



WONDERFUL TRANSMITTER

BUTTON FOR LOUD SPEAKERS

Price **\$1.00**

POSTPAID with instructions

AMPLIFICATION AND EXPERIMENTS

K. ELECTRIC CO.

15 PARK ROW

NEW YORK

positive terminal of the battery, is of high potential; the lower plate is of low potential; the potential difference of the two plates is the same as the voltage of the charging battery. In fact, this charged condenser is just like a battery provided with only a limited quantity of electricity; it can, by reason of its charged voltage, set up a current in any electrical circuit connected across its two plates or terminals, but the amount of current which will flow is limited by the amount of charge that the capacitance of the condenser permitted it to draw from the charging battery.

Suppose now that we close the discharging switch. This act provides a direct electrical circuit from one side of the condenser through the inductance coil to the other side, as shown in Fig. 5. The electricity stored in the condenser must discharge through this circuit as a current from the high potential plate to the low potential plate, passing through the inductance coil.

We come now to what is probably the most interesting thing about condenser-coil circuits of this sort. If the circuit is a good one, that is, if it has not such high resistance that electricity will not flow freely through it; the effect of the coil will cause the current to keep on going after the condenser is fully discharged. The current in passing through such a coil will gain a sort of momentum; it will not die away when the condenser voltage has fallen to zero, but will overshoot and pile up on the condenser plates in the opposite direction of charge. By reason of this peculiar action, the condenser will again become charged, but in the opposite sense; the upper plate will now be negative and the lower plate positive. However, some electricity will have been lost in passing through the circuit, and the new charge will be of somewhat smaller potential than was the initial charge. Otherwise the conditions will be as they were when the charging switch was opened and the discharging switch closed; the new reversed charge in the condenser will discharge through the coil in the opposite direction, and will again overshoot enough to charge the condenser a third time. Now the polarity will be as it was originally; the upper plate will be positive and the lower negative, but the amount of electricity in the condenser will, of course, be still less.

It is easy to see that the co-operative action of the coil and the condenser will cause, for a single initial charge, a long series of discharges which alternate in direction and which gradually die away in intensity. Thus there is produced in the condenser-coil circuit an oscillatory discharge, an alternating current which persists for many complete cycles but which finally dies away and which cannot thereafter be renewed until the condenser is again charged from the prime source (in this instance the battery). The number of complete oscillations produced by such a discharge may easily be several hundred, before the current falls off to small values.

What is it about an ordinary coil of wire that will cause a current through it to show a sort of inertia or momentum effect? Why does the condenser discharge current, passing through the coil, keep on going after the condenser voltage has become zero, so as to charge the condenser again in the opposite direction? The answer to both of these questions lies in the property of *inductance*, which is possessed by any conducting wire, but which appears in more concentrated or exaggerated form when the wire is coiled up into a spiral. This electrical property of inductance is analogous to the mechanical property of *mass*; it gives rise to inertia or the tendency to keep things as they are. Mass in a pendulum causes the weight to swing past the position of rest, so as to travel part way against the restoring force

ekko



Listen to radio through your phonograph

Ekko adapter connects your head phones with the tone arm of your phonograph and turns the sound box into a loud speaker. The best loud speaker you can use—utilizes the scientific design of the phonograph sound box, producing a pure mellow tone. (Not adapted to crystal sets without amplification.)

For Double Head Phones . . \$2.00 (Without Connectors)

For Single Head Phones . . . \$1.00 (Without Connectors)

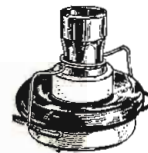

Ekko fits Victor, Silvertone, Sonora and other makes without connectors. Add 20c for connector for Pathé, Columbia, Vocalion; 25c for Edison; 30c for Brunswick. Or 75c for complete set.

Ekko Connectors at above prices also available separately to attach practically all loud speaker units to your phonograph.



The ekko Clamp

For ground wire and battery terminal contacts. The Ekko Clamp bites through rust or corrosion and assures positive contact on all electrical connections. Also used to tap 2 and 4-volt current from a 6-volt battery.

Ekko Clamp 25c. Pair (for battery terminals) 50c

Ekko Adapter and Ekko Clamp at your dealer's. Or order direct from us. Sent postpaid. Money back if not satisfied

The Ekko Company

111 West Monroe Street Chicago, Ill.

G. W. 5 Circuit Radio Plug

PATENT APPLIED FOR



PHONES LOUD SPEAKER SERIES PARALLEL SHUNT

Accommodates Head Set and Loud Speaker or Two Head Sets — permitting instant choice of Five Circuits without removing plug or changing tips.

Price \$1.50

At Your Dealer or Direct From Us

MADE OF GENUINE BAKELITE

Jobbers Write for Quantity Discounts

Manufactured by

G. E. WALKER CO., Inc.

1926 CHESTNUT ST. ST. LOUIS, MO.

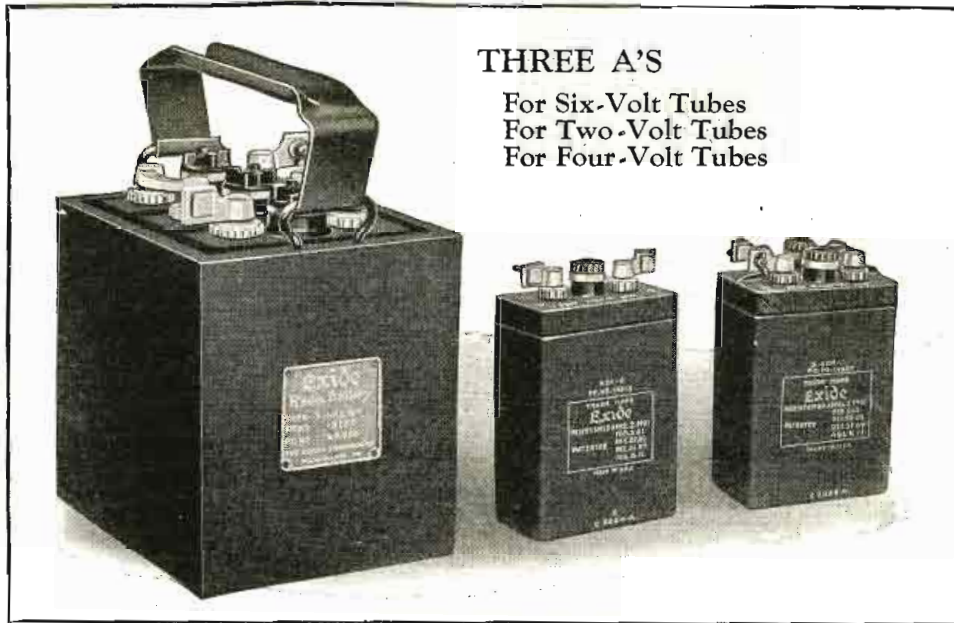

THREE A'S

For Six-Volt Tubes
For Two-Volt Tubes
For Four-Volt Tubes

If you take radio seriously

YOU want to tune in distant stations, but there is another thing you want just as keenly—to get what you get *clearly*.

No matter how far or how near the station is, for greatest clearness and for all-round satisfaction, you must use storage batteries. Once you hook up to Exide Radio Batteries you will never be satisfied with anything less. They give uniform current, smoothly, quietly, over a long period of discharge. Like good little boys, they are seen and not heard.

For low-voltage tubes

The two newest members of the Exide family are midgets in size but giants in power. These sturdy little A batteries weigh only five and six pounds each. They furnish in full measure that uniform and unflinching power so essential to clarity and distant reception.

They were specially designed for WD-11 and UV-199 vacuum tubes, but can be used with any low-voltage tube. The two-volt Exide A Battery consists of a single cell. It will heat the filament of a WD-11 or other quarter-ampere tube for approximately 96 hours. The four-volt A battery, having two cells, will light the filament of a UV-199 tube for 200 hours.

For six-volt tubes

Like all Exide Storage Batteries, the Exide A Battery for six-volt tubes is dependable and long-lasting. It is made in four sizes—of 25, 50, 100, and 150 ampere-hour capacities.

On land, at sea, in the air

It is the experience back of Exide Batteries that makes the Exide give such exceptional service in radio. There is an Exide Battery for every purpose. Exides run trucks, start and light automobiles, operate drawbridges, propel under the sea a majority of the world's submarines, send your voice over the wire every time you use the telephone.

A majority of all government and commercial radio plants both on land and at sea are equipped with Exide Batteries. The Leviathan is Exide-equipped. The giant dirigible Shenandoah carries Exide Batteries for ignition, lights, and radio.

It does not pay to get any but a known-to-be-reliable storage battery for radio. Exide Radio Batteries are sold by radio dealers and Exide Service Stations everywhere. Ask your dealer for booklets describing in detail the Exide Radio Batteries, or write us direct.

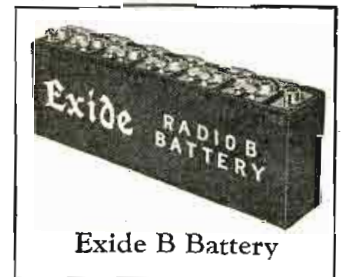

Exide B Battery

Exide

RADIO BATTERIES

THE ELECTRIC STORAGE BATTERY COMPANY, PHILADELPHIA

Manufactured in Canada by Exide Batteries of Canada, Limited, 133-157 Dufferin Street, Toronto

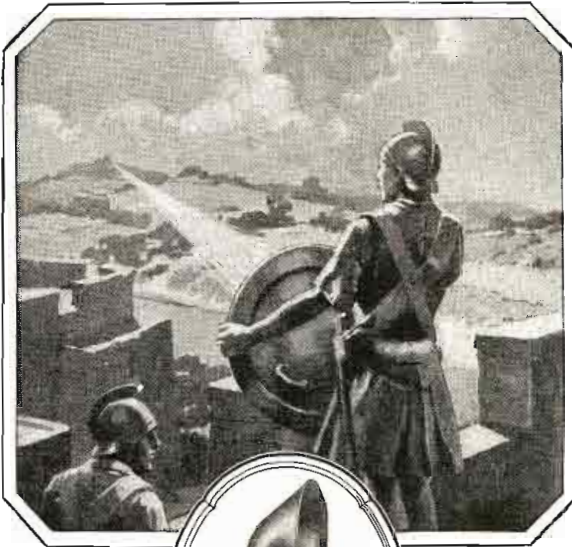

ANCIENT ROME

THE far-flung conquests of Caesar's legions brought vast territories under the sway of Rome but crude methods of conveying information weakened the structure, and the empire fell.

Today, due to Radio, the most remote settlement is in constant touch with the culture and events of the world. Geographical bar-

riers have disappeared, and man's horizon is unlimited. Sensitive instruments developed through painstaking care and years of experience have made this possible.

The Holtzer-Cabot Company, out of its twenty-five years' experience, has developed a family of superior receiving units. They bring the world to your home.

- | | |
|------------------------------------|---------|
| Holtzer-Cabot Loud Speaker | \$25.00 |
| Loud Speaker Phonograph Attachment | 10.00 |
| No. 2 Universal Headphones | 9.50 |
| No. 4 National Headphones | 6.00 |

Write for booklets explaining how the exclusive features of these instruments enable you to enjoy the wonders of Radio

THE HOLTZER-CABOT ELECTRIC CO.
125 Amory Street, Boston, Mass.
6161-65 South State Street, Chicago, Ill.
Dept. D.

Holtzer-Cabot
BUSINESS ESTABLISHED 1875

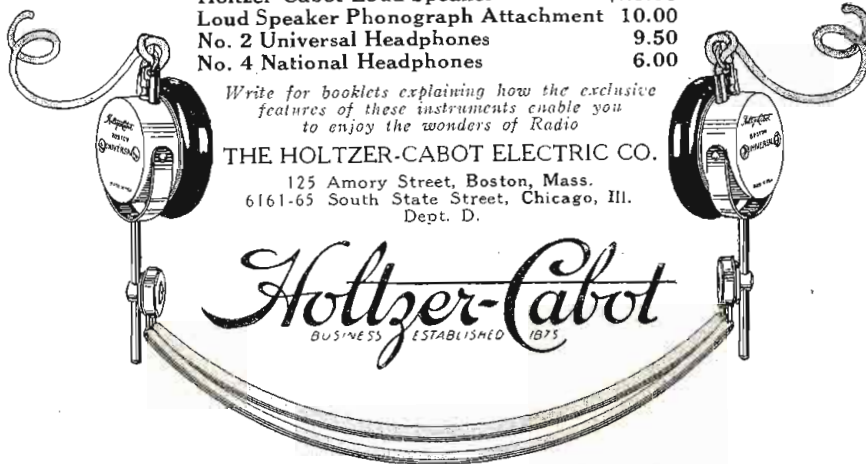

and prepare for the next swing. Inductance in an electrical circuit causes the current to persist beyond the condition of zero voltage. So as partly to charge the condenser for the succeeding discharge. Any coil of wire possesses inductance; the more turns, the closer the turns to each other, and the greater the area enclosed by each turn, the greater the inductance of the coil.

NATURAL ELECTRICAL FREQUENCY

When a condenser-coil circuit such as that shown in Fig. 5 produces electrical oscillations or alternating currents of gradually decreasing intensity, what governs the frequency of these oscillations? Reasoning that the inductance of the circuit corresponds with the mass of the torsion-pendulum weights, and that the capacitance of the electric example is comparable to the flimsiness of the spring in the mechanical case (since the condenser is what supplies the restoring force in the electric circuit), one might conclude that the frequency of vibration would depend upon the amounts of inductance and capacitance which are effective in the electric circuit. This conclusion would be exactly right; the analogy is close and complete. We may make the natural frequency of a condenser-coil circuit almost what we will, merely by changing the size of the condenser and of the coil. Since the natural electrical discharge of the condenser through the coil is always of the free frequency of the circuit, by changing the inductance and the capacity, or either of them, we may vary the frequency of the oscillations generated by such a circuit.

The arithmetical rule for finding the natural frequency is simply to multiply the inductance in henries (the practical unit) by the capacitance in farads, take the square root of the product, multiply this root by 6.28 and find the reciprocal of the new product. This reciprocal is the natural frequency of a circuit having the effective capacitance and inductance used for the calculation. The practical value of such a rule is that it enables us to find the natural frequency when we know the size of the coil and the condenser, and that it shows us that the frequency becomes higher and higher as the size of the coil and of the condenser are decreased.

Although it is easy to build vibrating electrical circuits having natural frequencies within the range of musical tones, those ordinarily used in radio signaling have much more rapid rates of vibration. Whereas the musical scale runs from about 16 to about 4,000 cycles per second, and while frequencies even lower and higher than these are audible and hence come within the range of so-called "audio frequencies," the radio frequencies are usually considered to begin at about 10,000 cycles per second and run on up to several millions per second. By proper choice of coils and condensers it is not difficult to set up oscillating electrical circuits with natural frequencies even as high as these. Thus we have found a way to produce free electrical oscillations with these enormously high frequencies that are used in radio.

THE RADIO FREQUENCY GENERATOR

The discharge of a condenser through a coil in an oscillatory or resonant circuit is not the only way we have to produce these radio frequency currents, however. In spite of the fact that the ordinary power alternator generates alternating current of only 25 or 60 cycles per second, it has been found practicable to increase the speed of special dynamos to the extent that they can directly produce alternating currents of 100,000 or even 200,000 cycles per second. Such high frequencies are entirely suitable for use in radio transmission. The electrical currents made by such generators are forced oscillations; they are constant in intensity and do not die away and require renewal charges ever so often. In addition to the alternator of radio frequency, which is due

Save 1/2 Cost of New Tube

GUARANTEED VACUUM TUBE REPAIRS AT POPULAR PRICES.

- We try to maintain 24-hour service.
- All repairs guaranteed.
- Tubes satisfactory or money refunded.
- Special discounts to dealers.
- Tubes returned P.P., C.O.D.

HARVARD RADIO LABORATORIES

200 OLD COLONY AVE. SO. BOSTON, MASS.

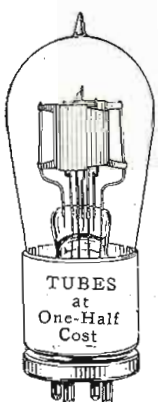

The Salesman's Favorite

for Economical Transportation



Utility Coupé \$640 *f. o. b. Flint, Michigan*

Daily more and more concerns are adopting automotive transportation for traveling salesmen for thorough economical coverage of territory. Those who buy equipment on the basis of careful investigation and consideration of all the factors are standardizing on Chevrolet Utility Coupé.

Why?

Because during its average life it supplies transportation at the lowest cost per mile of

any quality closed car, it delivers the salesman in good condition for transacting business, and its evident high quality reflects the equally high quality of the concern employing it.

If all salesmen were asked to vote on the best low priced car for their use, we are confident that all who are informed would select this car.

It pays to satisfy the salesman, especially when it costs no more to do so.

CHEVROLET MOTOR COMPANY, DETROIT, MICHIGAN

Division of General Motors Corporation

Prices f. o. b. Flint, Mich.

SUPERIOR Roadster	- - -	\$490
SUPERIOR Touring	- - -	495
SUPERIOR Utility Coupé	- - -	640
SUPERIOR Sedan	- - -	795
SUPERIOR Commercial Chassis	- - -	395
SUPERIOR Light Delivery	- - -	495
Utility Express Truck Chassis	- - -	550

Five United States manufacturing plants, seven assembly plants and two Canadian plants give us the largest production capacity in the world for high-grade cars and make possible our low prices.

Chevrolet Dealers and Service Stations everywhere. Applications will be considered from high-grade dealers only, for territory not adequately covered.

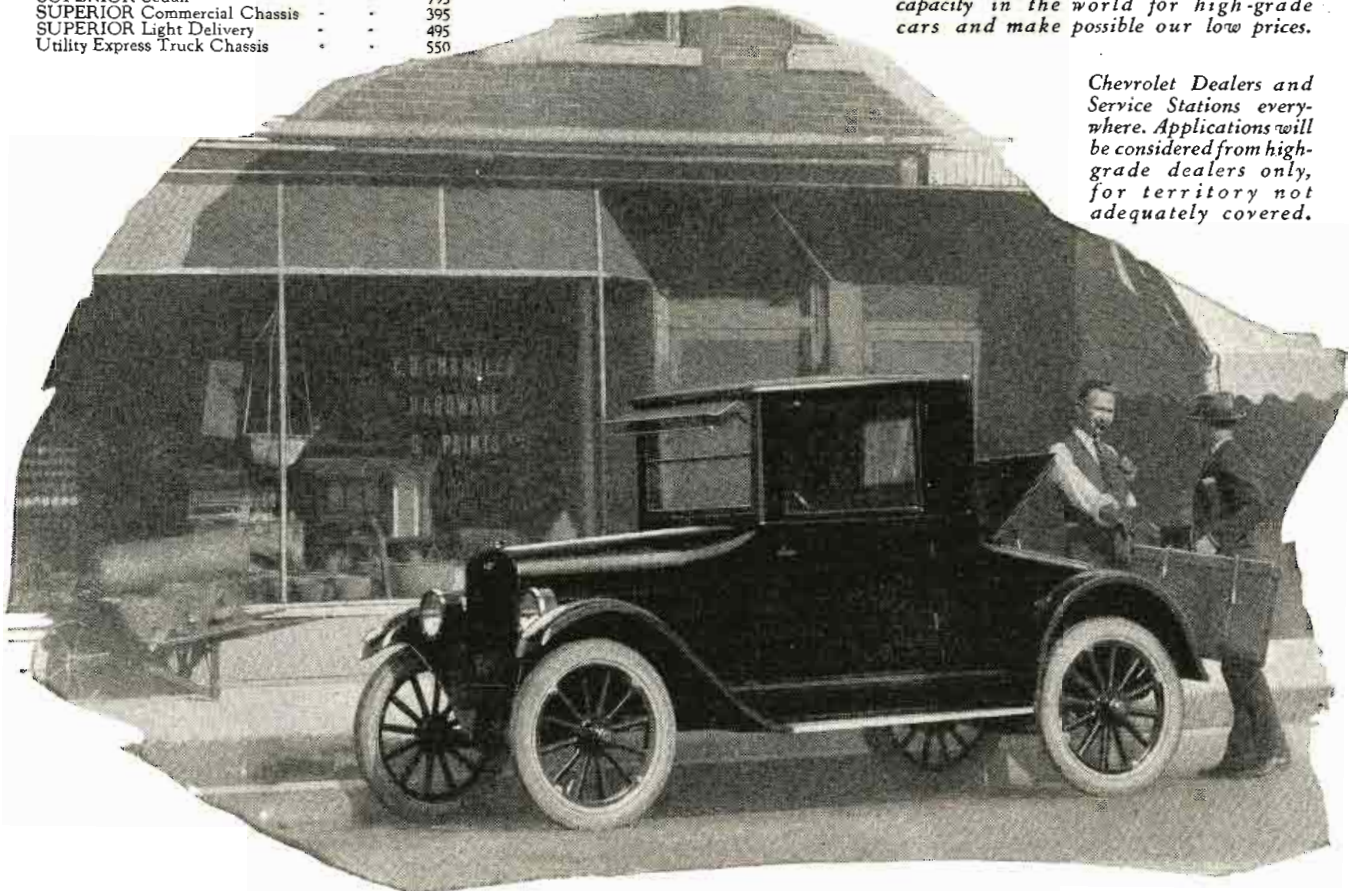

Build your own Radio Set!

—and save half the labor customarily involved.

The panels are completely drilled, and the parts are simply fastened with screws and nuts.

Any circuit desired may be employed. We have eight different types of panels.

The crystal black panel finish, together with the concave dials, lend a pleasing effect—the absence of knobs giving a clean, flush appearance.

You can build, or buy, a cabinet to suit your individual taste.

Illustrated catalog upon request

EISEMANN

EISEMANN MAGNETO CORPORATION
 William N. Shaw, President
 50 THIRTY-THIRD STREET, BROOKLYN, N.Y.

primarily to Professor R. A. Fessenden and in its present-day detail to E. F. W. Alexanderson and others, there have been discovered several ways to keep a condenser-coil circuit operating constantly and to prevent its oscillations from decreasing in intensity. Among these is the Poulsen arc which takes the place of the discharge switch in Fig. 5, and the Armstrong regenerative circuit for the vacuum tube which is well known by any experimenter. All of these generators produce in effect a smooth alternating current of controllable radio frequency. With the alternator, the frequency is changed by altering the speed of the machine; with the arc and vacuum tube, the frequency is controlled by varying the capacitance or inductance of the oscillating circuit.

COUPLED RADIO CIRCUITS

Let us now consider a circuit such as that shown in Fig. 6. Here a generator of radio frequency currents is shown at the left, connected to an inductance coil marked A. The alternating voltages produced by the generator will force alternating current of corresponding frequency through coil A. The magnetic field around this coil will induce voltages of the same frequency in coil B, which is connected in series with a current indicating meter and a condenser whose capacitance may be varied. What will happen in this second circuit, containing coil B and the condenser?

It should be evident that we have here an electrical case which may be compared with the torsion pendulum driven by rolling the twist-rod between the thumb and finger. The condenser-coil circuit at the right is an electrical system having its own natural frequency, which frequency we may control by changing the size of the condenser. This system is impinged periodically by the alternating voltages induced upon the coil B from the forced electrical vibrations or currents flowing from the generator through coil A. We should expect that it would be difficult to produce a current in the circuit of coil B unless its natural frequency agreed with the frequency of the driving or applied electrical forces, and this is exactly the case. The natural frequency of the coil B circuit may be varied by changing the capacitance of the condenser; as this frequency is brought more and more exactly into agreement or resonance with the frequency of the alternator, the current in the coil B circuit will increase to a maximum value.

Thus we see that to produce the greatest current in a second circuit associated with or coupled to another in which an alternating current is flowing, we must adjust the natural frequency of the second circuit to agree with the frequency of the driving current. This is called *tuning* the second circuit.

THE ANTENNA OR AERIAL CIRCUIT

So far we have considered only coil and condenser circuits, in connection with their natural frequencies. Nevertheless, what we have learned may be applied to any electrical circuit which possesses the properties of inductance and capacitance, whether or not it contains either coils or condensers. For instance, instead of the inductive effect being produced by a coil of several turns, it is possible to supply the requisite inductance by means of a single turn loop enclosing a considerable area. Instead of using a two-plate or multiple-plate condenser, the necessary capacitance may be found in a network of wires supported above the earth and connected to it through the circuit. Clearly, such an elevated group of wires will take the part of one condenser plate while the surface of the earth (which is a good electrical conductor) will act as the other plate of the condenser. The fact that wires are hung quite high above the ground will necessarily reduce the capacitance of the system but this will largely be compensated for by

Increase your Range

From 15 to 100 per cent

You can, with your present equipment, by using **SPRINGFIELD 16-STRAND BRAIDED ANTENNA**. Most wonderful wire for indoor loops. Its extra large surface—twice that of ordinary wire—enables you to get greater distance and clearness.

125 feet in your attic, in strands 3 feet apart, gives better results than 150 feet of ordinary wire outdoors. Write for free booklet.

At dealers—or send us \$2.50 for 100 feet.

Dealers and Jobbers—write for prices and terms.

SPRINGFIELD WIRE & TINSEL CO.
 67A Taylor St., Springfield, Mass.

Springfield 16 Strand Braided Antenna

Springfield Braided Wire: About 1/2 inch in circumference

Ordinary Antenna Wire: About 1/4 inch in circumference

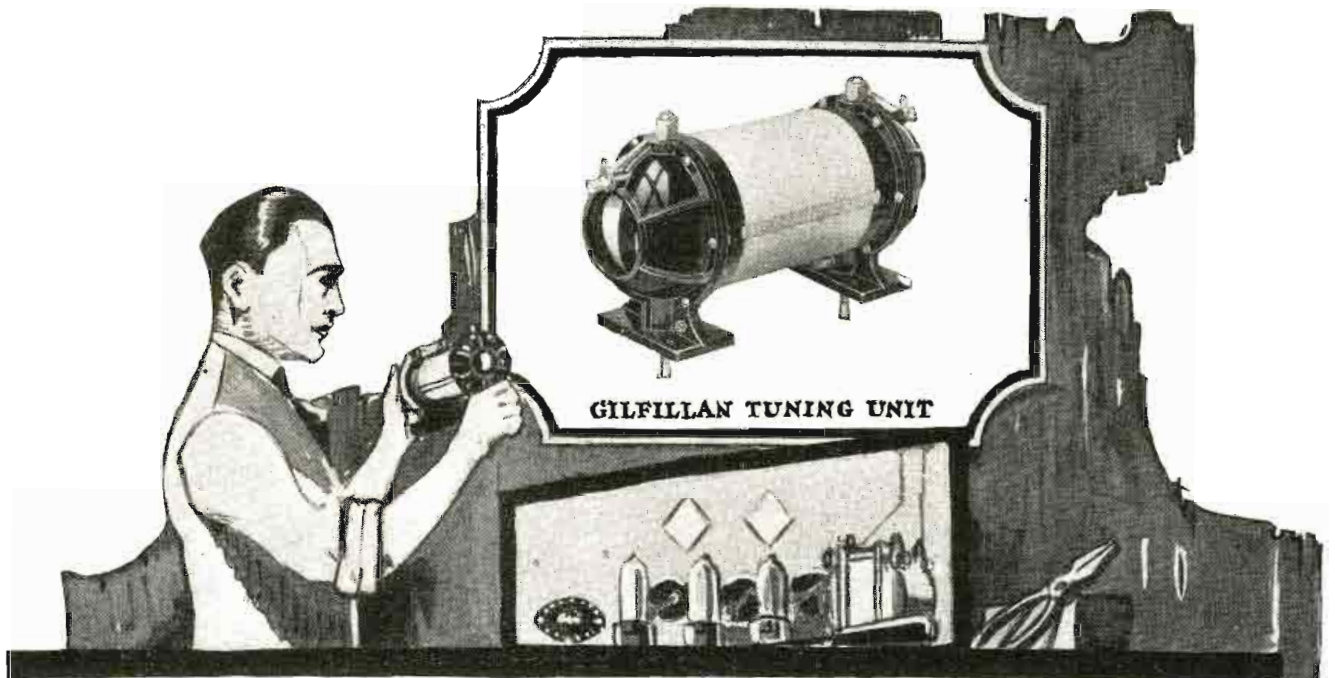

You must have sharper tuning with Distance!

WITH broadcasting stations operating within narrower wave-length limits, the problem of tuning out interference increases with the greater distance you aim to span. If you want to obtain maximum reception results from a sensitive detecting system, it must be matched with a highly *selective tuning unit*.

Q In brief—the more sensitive detectors and amplifiers are, the greater the necessity for higher selectivity in the tuning apparatus. Sharper tuning of any set—the complete elimination of interference is best accomplished by using the

Gilfillan Tuning Unit

Q Combines in one smaller, more compact, less costly piece of apparatus, the same duty and efficiency of two variometers and one variocoupler. Unexcelled in high selectivity and compactness.

Q Have your dealer show you this and other Gilfillan Quality Radio Parts. Build your own set throughout with these superior *synchronized* parts.

If your dealer can't supply you with Gilfillan Parts, send for name of nearest dealer and complete list of parts.

Gilfillan Transformer

AUDIO FREQUENCY TYPE—Laminations constructed of special high grade silicon steel of low watt loss character. Coil terminals moulded in solid strip of bakelite. Whole winding and core completely enclosed in pressed steel shell. Most effective in amplification duty—Ratio: 6 to 1.

GILFILLAN BROS. INC.

1925 McGee St.
Kansas City, Mo.

1815 W. 16th St.
Los Angeles, Cal.

225 W. 57th St.
New York, N. Y.

Licenseses General Bakelite Co.

Every genuine Gilfillan Radio Part carries this trade-mark



Look for it—it's your SEAL OF SERVICE

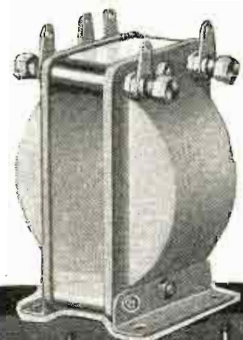

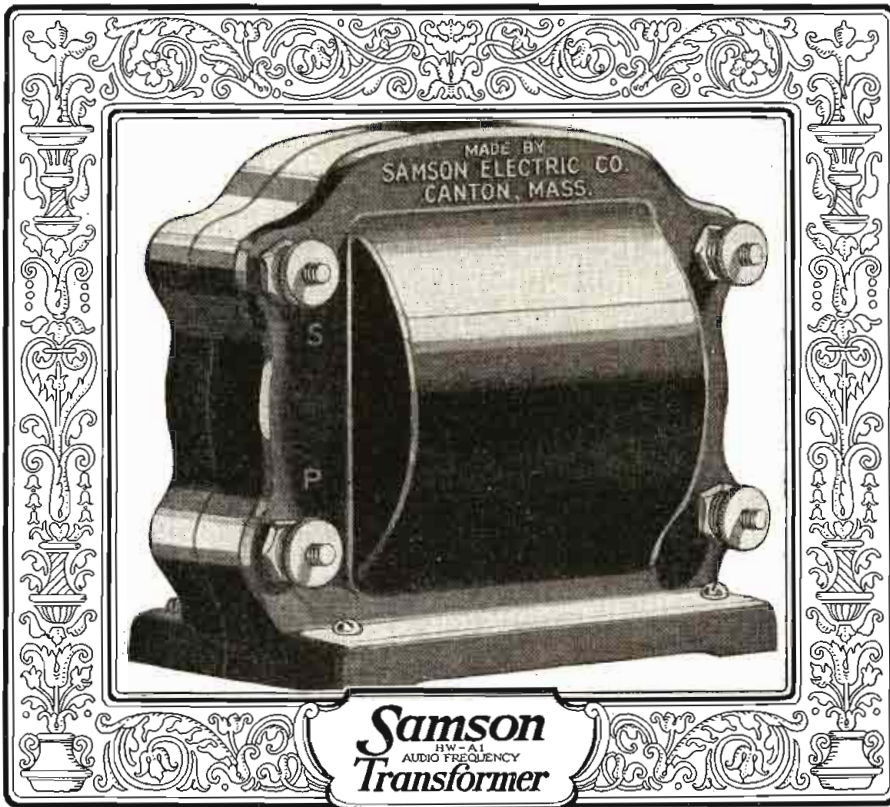

HOW TO IMPROVE YOUR SET



SAMSON HELICAL WINDING

All transformers except the Samson are wound spool fashion from end to end; the adjacent turns of wire are 500 to 1000 turns apart. The Samson is Helical Wound—wire in layers one on top of the other with the adjacent turns but forty turns apart. This method of winding, patented by and exclusive with the Samson Electric Co., reduces distributed capacity to an absolute minimum, accounts for greater amplification and the ability to transform the signals without distortion at any range.

HOOK a Samson HW-A1 Transformer to your set and notice the difference. You get 40% to 100% greater amplification—more volume from one tube than from two tubes with some transformers and more than from three tubes with others. You get practically no distortion at any range.

The Samson sells for \$7. It costs two or three times as much to make as any other transformer. The Helical Wound primary and secondary coils alone cost more than most transformers cost complete. But your \$7 gets the most satisfactory audio frequency transformer that the most experienced radio engineers have been able to design.

Insist on a Samson HW-A1 Audio Frequency Transformer. If your dealer hasn't it or won't get it for you, we'll send it prepaid on receipt of price. Ratio, 6 to 1.

Write for Results of Tests proving the superiority of the Samson. Ask for Chart No. 109.

SAMSON ELECTRIC CO.

Manufacturers Since 1882

Factory: Canton, Mass.

SALES OFFICES: Boston, New York, Chicago, Philadelphia, Pittsburgh, Buffalo, Cleveland, Detroit, Indianapolis, Minneapolis, St. Louis, San Francisco, Los Angeles, Seattle, Portland, Atlanta, Montreal and Toronto.

Bakelite Jack



The CICO Bakelite Jack is the finest article of its kind ever produced and the last word in scientific Radio construction. Moulded completely from Bakelite. No metal in frame construction. Wires connected to Nickel-Plated Brass Binding Posts. No soldering necessary. Special whitened phosphor Bronze Springs used throughout. Contact points of Sterling Silver. Four washers are supplied with each jack.

No. 30-Single circuit open .80
No. 31-Single circuit closed .85
No. 32-Double Circuit .90
No. 33-"A" Battery Switch .90

Consolidated Instrument Co.
of America, Inc.

41 East 42nd Street, New York

2-Way Plug

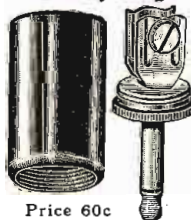

Price 60c

The CICO 2-Way Radio Plug has been a recognized leader for 2 years. Loud speaker and headphones or 2 sets of headphones can be connected simultaneously to the same plug by inserting 2 cord tips instead of one in each slot. Fits all standard jacks. Takes all types of tips, forked, straight and plain wire.

Every CICO PRODUCT is packed in a distinctive GREEN BOX and unqualifiedly guaranteed against all defects.

the great extent of the aerial wires (which may be several hundred feet in length) as compared with the size of ordinary condenser plates.

With this in mind, we may re-draw Fig. 6 in the form of Fig. 7, where the condenser connected to coil B has been replaced by an aerial and ground corresponding to the upper and lower plates of the condenser. Because of the capacitance of the aerial with respect to the ground, taken in connection with the inductance of the coil B, such a system will

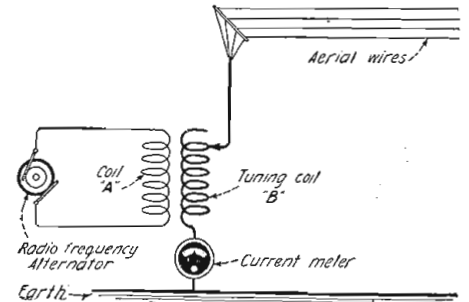

Fig. 7

As Shown here, an Elevated Antenna Wire System and Earth Connection May Be Substituted for the Condenser of a Resonant Circuit.

have a definite natural electrical frequency just as had the condenser-coil circuit. However, the capacitance is now fixed by the size of the particular aerial employed, and so in order to vary the natural frequency of the circuit it is necessary to make the inductance of the coil B adjustable. This is indicated by the arrow-tipped connection, which may be moved from turn to turn until the best value of inductance is found. When the inductance coil is made adjustable in this way, it is usually called a *tuning coil*. By changing the amount of inductance, the antenna circuit may be brought into resonance with the frequency of the driving alternator, as already explained in the case of the condenser circuit, so as to secure the greatest possible current flow at radio frequency between aerial and ground.

CREATING RADIO WAVES

Whenever rapidly-alternating or radio frequency currents flow in an aerial-and-ground system such as that shown in Fig. 7, they produce radio waves in space around the aerial. These waves shoot off in all directions from the aerial, and pass outward over the surface of the earth at the speed of 186,000 miles per second. The waves are electro-magnetic disturbances of the all-pervading medium of transmission that may be called the *ether* of space, and, except for their frequency, are similar to light and heat waves that travel through this same "ether." The frequency of the radio waves is exactly

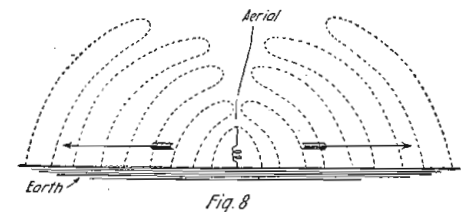

Fig. 8

This Illustration Shows How the Radio Waves Are Imagined to Pass Out Over the Earth's Surface from a Sending Aerial.

the frequency of the currents that produce them; if the radio frequency alternator of Fig. 7 is operating at 100,000 cycles per second, the currents in the antenna or aerial circuit will be of 100,000 cycles per second; the radiated waves will also be of this same radio frequency.

We imagine the radio waves to spread outward from the sending station in ever-increasing hemispheres, somewhat as indicated in Figs. 8 and 9. Fig. 8 shows roughly a side view of the antenna and the waves leaving

AMPLION

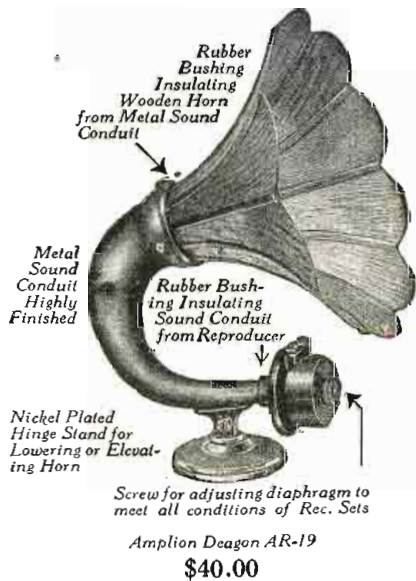

The "AMPLION" Pedigree

In 1887—Mr. Alfred Graham demonstrated the first practical Loud Speaker.

In 1893—GRAHAM Loud Speakers placed upon the market.

In 1894—First used in the British Navy. Transmitters applied to Phonographs for Loud Speaker reproduction. Demonstrations by Prof. McKendrick at the Royal Society.

In 1896—Naval Telephones developed and adopted by the British Admiralty.

In 1898—Watertight Loud Speakers patented. Fitted on board many warships and mercantile vessels throughout the world. Telephonic Submarine Signalling System devised.

In 1902—Complete Loud Speaker installations on central battery plan erected on warships as sole means of communication.

In 1906—The most extensive naval installation to date, including exchange system fitted to British warship "Dreadnought."

Onwards—Graham Loud Speakers applied to all sorts and conditions of service in England and many other countries, ashore and afloat.

In 1919—No less than 12,000 ship installations carried out.

In 1920—"AMPLION" Loud Speakers produced for Wireless by Alfred Graham & Co., and "AMPLION" Trade Mark registered.

In 1922—"AMPLION" standardized by leading manufacturers of radio apparatus in all parts of the world.

In 1923—Amplion introduced into the United States and Canada.

"That's the clearest reproduction I have ever heard"

This is what one of America's leading radio engineers said when he heard the Amplion at the New York Radio Show in October.

And added to this wonderful clearness is volume and tone quality as yet unequalled.

Simple to connect, no extra battery needed. Insist on an Amplion demonstration before you purchase a loud speaker.

Patentees: ALFRED GRAHAM & CO.
SIGNAL ELECTRIC MFG. COMPANY
Sole United States Distributors Menominee, Michigan
BURNDEPT OF CANADA, LTD.
Canadian Distributors—172 King Street W., Toronto

AMPLION

The World's Standard Loud Speaker

FROST FONES
(Registered U. S. Pat. Off.)

No. 161 Drawn Aluminum Shell Type, with composition caps. 2000 Ohm. \$4.00	No. 171 Drawn Aluminum Shell Type, with composition caps. 3000 Ohm. \$5.00	No. 162 Composition Shells and Caps, rein- forced V cord. 2000 Ohm. \$5.00	No. 172 Genuine Maroon Moulded Bakelite Shells and Caps. 3200 Ohm. \$6.00
-------------------------------------------------------------------------------------------	-------------------------------------------------------------------------------------------	-------------------------------------------------------------------------------------------	------------------------------------------------------------------------------------------

HERBERT H. FROST, Inc.
154 WEST LAKE STREET, CHICAGO, ILLINOIS.
550 Gates Bldg., Kansas City
30 Church Street, New York

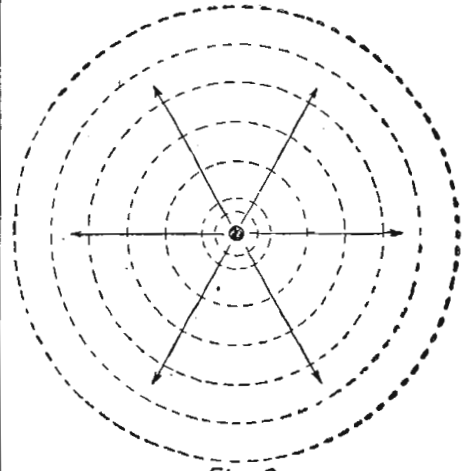

Fig. 9

Looking down from directly above a radio station. The waves are found to spread outward in all directions, as suggested by the arrows and ever-widening circles.

it in opposite directions, as indicated by the arrows. Fig. 9 is a plan representing the way in which the waves spread out in all directions from a radio station. At the tremendous speed with which they travel, radio waves will cover nearly 200 miles in 1/1000 of a second.

INTERCEPTING RADIO WAVE.

The radio wave traveling outward through space is a combined magnetic and electric disturbance that gradually grows weaker as it passes farther and farther from the sending station. So long as it retains enough strength to be recognizable, however, it will induce electric pressures or voltages in any conductor which it strikes. Just as a water wave will float a bit of wood up and down as it passes by, so will a radio wave set up electrical motions or currents in any circuit through which radio-frequency currents can readily flow. This is the property upon which we rely to receive radio messages. Antenna wires are thrust upward into the air and provided with ground connections; in them feeble currents are produced by the passing radio waves, and these currents are used to operate the radio receiving instruments. The aerial conductors may be of any form whatever; a single wire dropped from a flag-pole, a T-shaped group of wires, or an enlarged umbrella-like structure, will operate satisfactorily. Even a coil or loop of wire within a building, forming what is known as a loop aerial, will pick up enough power to operate modern radio receivers.

What can we do to get the greatest amount of current in our receiving aerial systems, so as to make their effects as large as possible? The answer to this follows from what has gone before. Once more we have an electrical circuit which is impulsed by a radio frequency electrical force, the force in this case being in the arriving wave. We have learned that to secure the greatest response to such an alternating force, we must tune the driven system. In our present problem, then, we must provide the receiving aerial system with capacitance and inductance in such proportion that its natural frequency will be the same as the frequency of the wave which we desire to receive. The receiving aerial already supplies us with the necessary capacitance; consequently we need only to insert the proper amount of inductance as a tuning coil between the aerial and the ground connection, as indicated in Fig. 10. By adjusting this coil, the aerial system may be tuned so that its natural frequency will be the same as the frequency of the arriving waves; under this condition we will secure the largest possible radio frequency current in the aerial for a given voltage induced by the waves. The receiving instru-

Comfort Cushion Your Ears!
The BATES Ear Cushion takes the headaches out of headphones. Improve the hearing qualities of your set 100 percent with
The BATES EAR CUSHION
Slips over any radio phone—instantly and easily. Cushion your ears and hear in comfort. Costs little—worth lots.
POSTPAID ANYWHERE IN U. S. for \$1.00 Per Pair
DEALERS: Write for special discounts. BATES Ear Cushions are fast sellers!
BATES & COMPANY
1516 Montana St. Chicago, Ill.

ON ONE TUBE
Broadcasting from Atlantic Coast, Mexico, Hawaii, Canada and Cuba heard in California by users of **CROSS COUNTRY CIRCUIT**. Range due to simplicity of set and only one tuning control. Easily and cheaply built by any novice. Dry cell tubes may be used. All instructions, blueprint panel layout, assembly photo, etc. Postpaid 25c. Stamps accepted.
VESCO RADIO SHOP, Bx. RN-117, Oakland, Cal.

Insure your copy reaching you each month. Subscribe to Radio News—\$2.50 a year. Experimenter Publishing Co., 53 Park Place, N. Y. C.

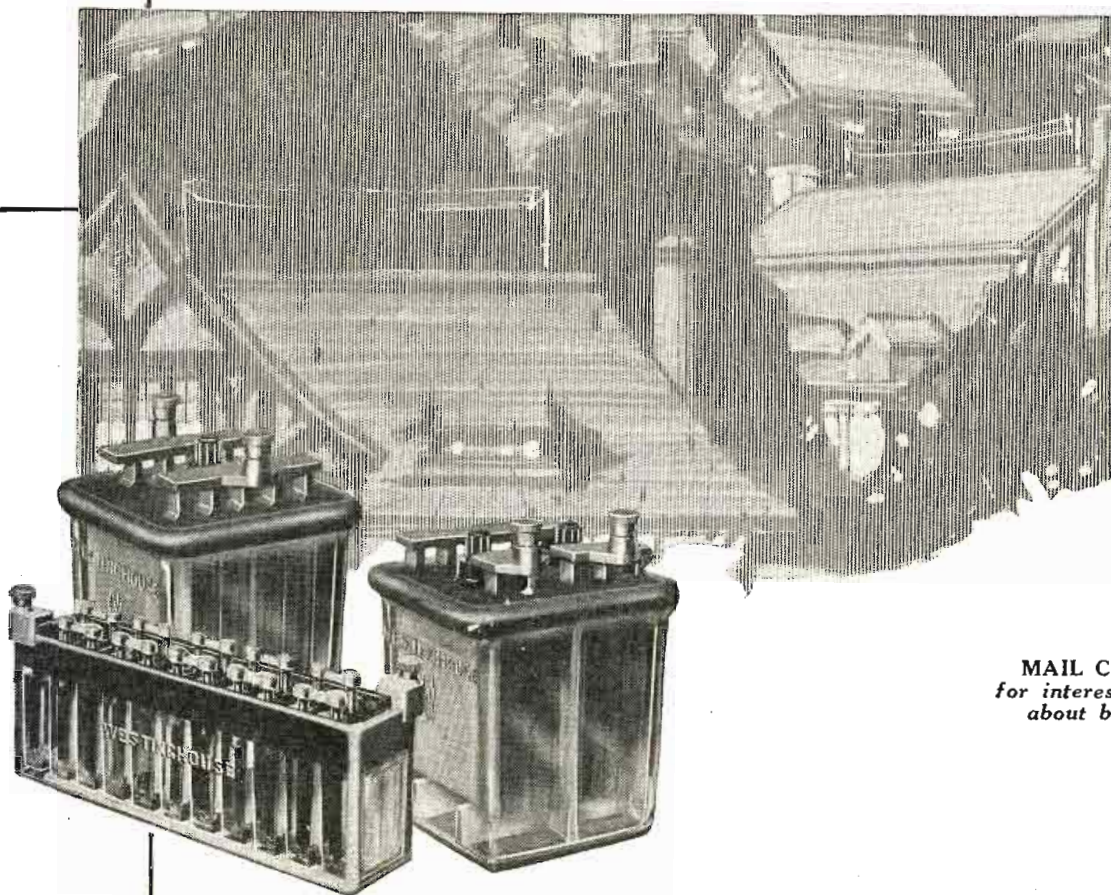

MAIL COUPON
for interesting facts
about batteries

FULL voltage battery current all the time! That's what you want. Westinghouse Radio Storage Batteries will give it to you. No more operating with run-down batteries! No more sudden drops in battery voltage! No more throwing away worn-out batteries! Westinghouse Batteries last. They hold their charge. They can be easily recharged. There's a size and type for every radio need. Built by Westinghouse, you *know* it's **RIGHT!**

Westinghouse **CRYSTAL CASE** Batteries have one-piece clear glass cases, with solid glass cell partitions and high plate rests (deep sediment spaces). Perfectly insulated against current leakage. "A" Batteries. 2 volts, for low-voltage tubes, such as WD-11 and WD-12. 4 volts, for tubes like UV-199. 6 volts, for tubes UV-201A or C-301A. Also rubber-case types. "B" Batteries. 22 volts. Regular and quadruple-capacity types. "C" Batteries in 6-volt units.

WESTINGHOUSE UNION BATTERY CO., Swissvale, Pa.

WESTINGHOUSE

RADIO "A," "B" and "C" BATTERIES

Westinghouse Union Battery Co.
Swissvale, Pa.
Send me Westinghouse Radio Battery Folder
A-3-A.

.....

.....

.....

Establishing a New Horizon for Radio!

MU-RAD RECEIVERS MA-15

JUST as the telescope widened our vision, so now the new long range receiver, MU-RAD MA-15, has opened up new territories, added to the pleasures of radio. Upon the foundation of Mu-RAD sensitivity, easy operation and selectivity, Mu-RAD engineers have achieved long range reception with loud speaker volume. Uses only a 2 foot loop aerial. Detector, three stages of radio and two stages of audio frequency amplification.

Guaranteed Reception with a 2 foot Loop Aerial—1000 Miles

Write for Literature TODAY!

MU-RAD LABORATORIES, INC.
801 FIFTH AVE. ASBURY PARK, NEW JERSEY

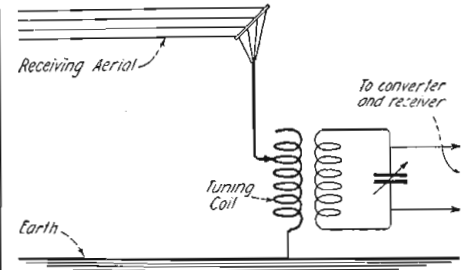

Fig. 10

A receiving system of this kind combines an aerial tuning coil with a closed resonant circuit so as to produce a highly selective arrangement.

ment used may be connected directly to this tuning coil, or, as suggested in Fig. 10, another tuned condenser-coil circuit may be coupled to it and the converter and receiver connected to that circuit.

INTERFERENCE

When the natural frequency of the receiver agrees with the frequency of the received wave, the greatest current is generated in the receiving system by that wave. Other waves from other transmitters, at different frequencies, will produce less than the greatest or maximum resonant current; hence their effects on the receiver will be lessened, and we have a simple means (in the tuning of radio circuits) to reduce "interference," as the unwanted signals heard from disturbing transmitters are called.

If we use a second tuned circuit coupled to the antenna circuit of our receivers, as in Fig. 10, we gain the selective power of two tuned adjustments in succession. In this way it is possible to secure sharp resonant effects, in which the desired or tuned incoming waves produce a relatively large current while interfering waves of slightly different frequency set up little or no current. Under these conditions the selectivity of the receiver is said to be high, or the tuning sharp. The less electrical resistance in any resonant radio circuit, the sharper will be its tuning; a two-circuit or coupled receiver permits control of the effective resistance conditions, and, although more difficult to adjust, is capable of greater selectivity or discrimination between desired and unwanted signals of slightly different frequency.

There is another kind of interference, however, which does not arise from other radio stations transmitting waves of definite frequencies differing from that which it is desired to receive. This is "atmospheric" or "static" interference, produced by electrical discharges in nature, by lightning storms, etc. Static interference does not appear to have a definite wave frequency, and hence it cannot be tuned out by simple resonant methods. Fortunately, these natural disturbances do not persist all year long nor at all times of day. Neither are they powerful enough to cause trouble in normal broadcast radio reception, except under extreme conditions or when the incoming signals are weak. There is less static interference, in Northern latitudes, in Winter than in Summer; frequently there is less in the early evening than during the day even in Summer. All of this favors broadcast radio-telephone operations.

RADIO FREQUENCY AND WAVELENGTH

In this article we have considered mainly the frequency of the radio waves, because that is the characteristic most closely associated with tuning effects. There is another term that has been much used in describing radio waves, however, *viz., wave-length*. The wave-length is simply the distance from crest to crest of the radio wave we imagine in space; it is usually measured in meters (one meter equals 39.37 inches) instead of in the more common English unit of feet. The wave-length is intimately connected with

SEND TODAY

Solid Rubber Box furnished either with strap or side handles,

6 Volts
80 Amperes

Latest, Most Effective Radio "A" Battery

SAHARA STORAGE BATTERY—IT'S DRY

Think of its advantages. There is no liquid acid to spill and ruin floors, rugs or creep up posts and ruin clothes—ideal for portable sets. Recharges quickly—easily—and cannot be harmed either by overcharging or drawing down too far. These exclusive features are what you want. We guarantee them. It is not a gelatin battery. It's dry and "chock full" of pep and life. Be the first in your town to have one of these remarkable batteries.

Order Today—Send No Money

We ship C.O.D. subject to your inspection, carrying charges to be paid by you. The price is \$35 if you order at once. Shipments made same day order is received. Remember there is no liquid—It's Dry. Orders are coming in fast. Get yours in today.

SAHARA DRY BATTERY CO.
Dept. C PAWTUCKET, R. I.

Dealers: There is a big business for you if you show this battery now. Send for discounts and get exclusive right in your territory.



*in Kennedy's new
furniture model sets*

Excerpt from a recent letter of the Colin B. Kennedy Corporation:

“WE MIGHT say that it is due in part to the beautiful finish that is obtained on the surface of the Formica panels that our new 410 receiving unit, incorporated in our various furniture model receivers, has such a beautiful appearance.”

Beautiful finish, and lasting finish. Perfect and permanent dielectric qualities. Easy working in production with a minimum of spoilage.

Those are the reasons why the radio engineers of the great independent radio manufacturers prefer and use Formica. There is no disagreement in their approval of this material, and a list of Formica's manufacturing customers reads like a directory of the industry.

Dealers and amateur set builders have the same feeling. That is why more Formica is sold for radio purposes than any other material of its kind.

Dealers: You can get Formica in sheets or in individual panels, enclosed in envelopes. It is the most widely advertised, and the best known radio insulating material.



THE FORMICA INSULATION COMPANY

4618 Spring Grove Avenue, Cincinnati, Ohio

Sales Offices

50 Church St., New York, N. Y.
422 First Ave., Pittsburgh, Pa.
1042 Granite Bldg., Rochester, N. Y.
415 Ohio Bldg., Toledo, Ohio

1210 Arch St., Philadelphia, Pa.
1819 Lyndale Ave., S. Minneapolis, Minn.
Sheldon Bldg., San Francisco, California
Whitney Central Bldg., New Orleans

516 Caxton Bldg., Cleveland, Ohio
9 S. Clinton St., Chicago, Ill.
313 Title Bldg., Baltimore, Md.
47 King St., Toronto, Ontario

FORMICA
Made from Anhydrous Bakelite Resins
SHEETS TUBES RODS

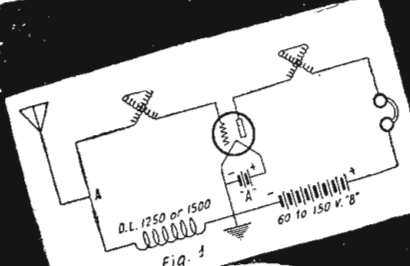

Pioneer Autoplex Variometers

The New Autoplex

The circuit that gives loud speaker reception with *one tube*.

Have you built the new Autoplex Circuit—? Here is super regeneration with all difficulties removed. Simple—inexpensive.

Send for our diagram hook-ups.

You must use the right Variometers — or you won't get results.

PIONEER-Autoplex Variometers

Built especially to fit the requirements of this circuit.

They have:

- High Ratio of Inductance Stator and Rotor Coils close together
- Stator Coil wound on inside of form.

Ask your dealer or write us.

Sales Agents in All Large Cities

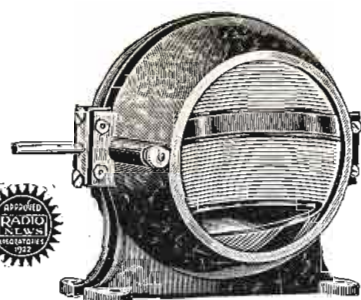

Pioneer Variometer Price \$650



PIONEER RADIO CORPORATION
101 Pioneer Ave. Galesburg, Illinois

the wave frequency; either constant of a radio wave may be found from the other by dividing into the wave velocity factor of 300,000,000 meters per second. A wave of 833,000 cycles per second frequency has a length of 360 meters. A 1,000-meter wave has a frequency of 300,000 cycles per second. Other corresponding values are given in the following table:

Wave Frequency	Corresponding Wave-length
10,000 cycles per second.....	30,000 meters
20,000 " " " "	15,000 "
30,000 " " " "	10,000 "
50,000 " " " "	6,000 "
100,000 " " " "	3,000 "
150,000 " " " "	2,000 "
200,000 " " " "	1,500 "
300,000 " " " "	1,000 "
400,000 " " " "	750 "
500,000 " " " "	600 "
600,000 " " " "	500 "
750,000 " " " "	400 "
833,000 " " " "	360 "
1,000,000 " " " "	300 "
1,500,000 " " " "	200 "
2,000,000 " " " "	150 "
3,000,000 " " " "	100 "

It is much more convenient to refer to these wave frequencies in kilocycles, or thousands of cycles, per second; thus, 20,000 cycles becomes 20 kilocycles, 150,000 is called 150 kilocycles, (abbreviated k.c.) etc.

There is, of course, a multitude of wave-lengths and frequencies between the limits of the above table, where only those in round figures are given. Each different wave frequency provides a channel for communication by radio, but even under ideal practical conditions, the closest adjacent frequencies cannot be used for simultaneous operation without setting up interference. With good modern apparatus, however, independent and non-interfering signaling can be carried on upon frequencies differing by 10,000 cycles (10 k.c.) or more, so long as the difference in intensity at the receiving station (where resonant selection must, of course, be accomplished) is not too great.

SURVEY OF THE TUNED SYSTEM

Tuning is evidently an essential throughout the entire radio sending and receiving system. At every point we are dealing with alternating electric forces, and always we desire to produce the maximum effects consistent with the voltage and power available. Consequently we tune the transmitting antenna to coincide in frequency with the generator, and we tune the receiving antenna to coincide with the wave frequency. From the beginning to the end of the radio circuits the working frequency remains the same in ordinary practice; if our generator delivers a frequency of 833 kilocycles per second, this also will be the frequency of the sending antenna current and of the radio waves it produces. The receiving aerial will be tuned to 833 kilocycles, and the currents flowing in it will have that frequency. If it were not for the principle of resonance, as exemplified by the timing of pushes to agree with the natural rate of the child's swing, radio in its modern forms would be a practical impossibility.

You have now seen how a stream of waves can be produced at a radio sending station, how the waves will spread outward for miles in every direction, and how their effects may be intercepted at any point within range of the transmitter. In order to understand how this system is used for the transmission of messages either by the dots and dashes of the Morse code (in wireless telegraphy) or by the spoken word (in radio telephony) you need only to grasp the idea of how the signals themselves are impressed upon and carried by the radio waves, and how, at the receiving station, they are first separated from the radio frequency currents which the waves produce and then applied to a responding instrument.

Unity Rheostats are the Best

Vernier and Non-Vernier

The Unity Vernier Rheostat

Recommended for the detector tube of Cockaday four circuit tuner

The highest type electrical instrument made for controlling resistance.

Price \$1.75
6 ohms, 25 ohms, 40 ohms

--- "Hear a set that uses Unity Rheostats" ---

The Unity Non-Vernier Rheostat

or the Cartridge Rheostat

Recommended for the "Long 45"

Resistances are interchangeable without removing the bracket from the panel

Unity Potentiometer Cartridges also fit the Unity Brackets

If your dealer cannot supply you, send your check or money-order to the factory with dealer's name.

UNITY MFG. CO., 228 North Halsted St., Chicago

Radio News Certificate of approval No. 281 and No. 282



6 ohms, 25 ohms, 40 ohms
Other resistances if desired
Complete Rheostats \$2.80
Brackets only .45
Cartridges, any resistance .35
Potentiometers, complete, 200 or 400 ohms 1.45
Potentiometer cartridges only .100

SUPER-HETERODYNE

The World's Best Radio Receiver

BY PERFORMANCE

ADVANTAGES NO OTHER RECEIVER CAN EQUAL

- 1. UNIFORM EFFICIENCY** over the entire wavelength range of 160 to 850 meters. This means that all stations, Radio-telephone Broadcasting, Amateur and Commercial within this wavelength range, will be received with maximum intensity. This very desirable feature is not obtainable by any other practical method using Radio Frequency amplification.
- 2. SELECTIVITY** by this system, greatly exceeds that obtained in all other methods of reception. Using the Model "C" with a loop in the Suburbs of New York, WOR 15 miles distance, operating on 405 meters, can be completely eliminated, and PWX 1300 miles distance operating on 400, can be received on a loud speaker. This holds true on an average cool night. There is no telegraphic interference from 200 meter amateur stations or 600 meter ship stations.
- 3. SIMPLICITY** to change from one station to another, there are only two dials to vary. The two dials can be calibrated for all the various stations, as there is only one best position for each station.
- 4. AMPLIFICATION** is much greater than obtainable in any other standard receiver. Total is as follows: 1st the Heterodyne Amplification in the 1st Detector; 2nd, the Regenerative Amplification in the 1st Detector; 3rd the 3 stages of Tuned Regenerative Radio Frequency Amplification; working at a low advantageous frequency; 4th, the second Detector action, and 5th, the two stages of low ratio distortionless audio frequency amplification.
- 5. RECEIVING RANGE** other factors correct, the receiving range is in proportion to the effective radio frequency amplification applied. As this receiver has much greater effective radio frequency amplification than all others, the range is proportionally greater.

Complete Constructional Blue Prints Consisting of Two Sheets 50x21" and Two Sheets 27x21", Our Numbers 30141-145. \$2.00 Postpaid.

Experimenters Information Service 531 West 46th Street :: **Designers of the Highest Class Radio Apparatus in the World** :: **New York City**



"THE ROLLS-ROYCE OF RECEPTION"



MODEL "C" SUPER-HETERODYNE

Wavelength Range 160 to 850 meters. Tubes. 2 Detectors. Oscillator. 3 Tuned Radio Freq. Amplifiers. 2 Audio Amplifiers.

The Super-Heterodyne is the most efficient method of short wave radio frequency amplification known. It is used extensively by the Commercial radio companies and various governments, when it is necessary to receive over extremely long distances, without interference from near-by stations. The remarkable results are due to the Super-Heterodyne action, which is briefly as follows: the incoming signal, which may be any wave from 160 to 850, is changed thru the use of a local oscillator, to a wavelength of 10,000 meters. At this wavelength an exact duplicate of the original signal is amplified at radio frequency with the very highest efficiency possible, rectified and amplified at audio frequency.

During this change a very high degree of selectivity is secured, due to the amplifier, which is designed to pass nothing but 10,000 meters. Accordingly while there may be ten or more signals in the loop, only one will be received at a time, the one that the oscillator heterodynes thru the amplifier.

HERE'S YOUR CHANCE TO LEARN NEWSPAPER WORK

Experienced Editor Will Teach You How to Become a Reporter. FASCINATING WORK—GOOD PAY—BIG OPPORTUNITIES

Only a Few Months' Work Required to Qualify You for a Better Position

Regular reporters earn from \$40 to \$125 a week. Good deskmen on a daily paper are paid from \$60 to \$100 a week. A "Star" Reporter can command his own salary. Hundreds of ambitious men and women enhance their income materially by corresponding for newspapers or writing for magazines in their spare time.

We Will Teach You at Home

We can develop your talent for writing and lead you into this well-paying profession. Our Practical Course in Journalism was personally prepared by Henry J. Brockmeyer, Assistant City Editor of the New York Evening Post. Mr. Brockmeyer has trained hundreds of men and women, many of whom have, under his guidance, developed into front rank reporters or feature writers.

Mr. Brockmeyer's course will teach you what it would take years of actual newspaper work to learn. The lessons are just brimful of everything a reporter must know. The following are only a few of the subjects covered:

Starting in Journalism. What is a Newspaper? What is News? Start and Finish of a News Story. Technical Terms. The Type Point System. Styles of Type, Proof Reading. Capitalization and Punctuation. A Late Fire Bulletin. Court Stories. Libel Laws, Copyright. Hints to Reporters. Personal Conduct. Re-Writing and Condensing Stories. Paragraphs and Short Items. Good and Bad Styles. Broadening the Vocabulary. Aids to Good Style. Special Stories. Suggestions for Stories. Rhetoric. Preparing Your Story. Don'ts for Writers. Office Organization. Syndicated Matter. Business Office. Mechanical Department. Hints for Headline Writers. The Make-Up. The Country Correspondent, etc., etc.

Write for Free Circular "R"

YOU SAVE 50% IF YOU USE COUPON AT ONCE

Special Limited Offer Gives You Opportunity of Learning at Half Price

The regular price for Mr. Brockmeyer's Practical Course in Journalism, including full consultation privileges, is \$10.00. To give more persons, both men and women, the opportunity of learning this profession, we have decided to offer the complete course to anyone who uses the coupon below before April 20 for \$5—exactly half price.

Anyone taking advantage of this special offer will be entitled to all the privileges of the course, exactly the same as though he had paid the full price. These privileges include a full consultation service, conducted by Mr. Brockmeyer personally, and cover any questions whatsoever in connection with journalistic work.

Five Days' Trial

In addition, we offer to send you the course on approval.

Just pin a check, money order or five dollar bill to the coupon below and mail. Then take five days after the course arrives to decide whether you want to keep it or not. If you are not fully satisfied return it at our expense and your money will be immediately refunded.

THIS COUPON EXPIRES APRIL 20, 1924.

THE PRESS GUILD, Inc.,
66-R—West Broadway, New York City

In accordance with your special offer enclosed please find \$5 for which you are to ship me at once, prepaid. Henry J. Brockmeyer's complete course in Practical Journalism with the distinct understanding that if I return the course in five days my money will be refunded in full and no questions asked.

(Name)

(Address)

(City) (State)

We repair the following RADIO TUBES and Guarantee Them

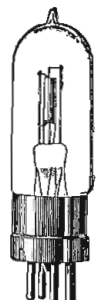

WD-11	\$3.50	DV-6	\$3.00	UV-201A	\$3.50
WD-12	3.50	DV-1	3.50	C-301A	3.50
UV-200	2.75	DV-2	3.50	UV-202	4.00
UV-201	3.00	DV-6A	3.50	C-302	4.00
C-300	2.75	UV-199	3.50	Marconi	3.00
C-301	3.00	C-299	3.50	Meorhead	3.00
6 v. Plate Amplifier	\$3.00	6 v. Plate Detector	\$2.75		

Mail Orders solicited and promptly attended to
Dealers and Agents write for Special Discount

H. & H. RADIC CO.

P. O. BOX 22-H

CLINTON HILL STA.

NEWARK, N. J.

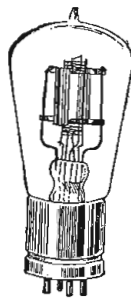

Another Historic Event in Amateur Radio

(Continued from page 1236)

tion. He lives at Nice, and the Alps run down to the sea all the length of that coast. When I visited him (in November) at his charming villa, the roses and carnations were flowering in his garden, but the mountains just at the back of Nice were capped with snow. A straight line drawn between French 8AB and London shows that about 200 miles of continuous mountain lies behind French 8AB, screening the 650-mile journey of the waves. Though the climatic surroundings are ideal, the same cannot be said of his condition for receiving as he is not much above sea level, just getting a bird's-eye view of Nice harbor. M. Deloy now accounts for his failure in the December, 1921, essays by the fact that he was using three stages of low frequency amplification with his Tuska hook-up. In the third trans-Atlantic contest held in December, 1922, he was more successful in reception, and this with the same hook-up but doing away with all but one stage of low frequency. It will be remembered that M. Deloy then managed to hear 17 American amateurs. What was much more epoch-making was the fact that M. Deloy was the only European amateur who was able to make himself heard in the States. You have all read how his signals were heard for an hour on 190 meters, with 1-kw. power. He was using four 250-watt tubes.

A very interesting thing he noted—and it is a thing which all amateurs will look out for in the next contest—was the fact that certain stations, picked up one night and their fine tuning noted, could not be heard on successive nights. Nevertheless those same stations were heard by other amateurs situated some distance away. M. Deloy had that experience and so, I believe, did the amateurs who got his signals in December, 1922. It was as if reception of the short wave-length was only good at successive points on the opposite continent, almost as if continuous connection existed, but only by a single wire which swung from one point to another like a pendulum. In his recent experiments with the 100-meter wave, M. Deloy has not had that trouble.

THE FIRST MESSAGES

In April, 1923, the French Military Radio started sending on a 45-meter wave for experimental purposes. The most bewildering circuits were published in the technical journals here, but laughing at them all, M. Deloy, with his old set, was able to hear them all. He also heard Poldhu working on 100 meters. By this time, M. Deloy was becoming very enthusiastic on the subject of short wave-lengths. When the English amateurs were working on 1,000 meters, he was unable to hear them, but when the authorities made them go to 360 he heard perfectly. Using the same wave-length he communicated with them and established for the first time bi-lateral communication between amateurs in France and in Great Britain. I ought to say something here about M. Deloy's license. He is the first amateur in France, not only because of his research work and his untiring championship of the cause of international amateur wireless, but also by right of seniority. He was granted a license by the French government which allows him to experiment on all wave-lengths from 1,000 meters down. No other amateur in France has such a license. The only other license to be granted before his (it was only granted a few hours before) was 8AA, and that was granted to what is really a semi-commercial concern.

On June 10, 1923, M. Deloy, three days before his departure for the States, decided to experiment with the 100-meter waves. His installation was hastily adjusted and some of the rudimentary coils and gadgets

Insure your copy reaching you each month. Subscribe to Radio News—\$2.50 a year. Experimenter Publishing Co., 53 Park Place, N. Y. C.



Why Buy Batteries More Than Once!

When you buy Willard Rechargeable B Batteries you're through going down into your pocket for B batteries every little while.

For unlike the ordinary battery which lasts only a few months, Willard Rechargeable B's are good for years—with average care at least five, and probably more.

Just figure up how much you'll save if you don't have to spend a cent for B batteries in the next five years.

The real value of Willard Rechargeable B Batteries, however, is to be measured not in dollars and cents but in improved results.

That's why they are not only the leading batteries for receiving, but also for broadcasting. They're used by 94 stations.

Your Willard Service Station or Radio Dealer will be glad to demonstrate the superiority of Willard B Batteries. Ask him, too, for the free booklet, "Better Results from Radio", or write direct to the Willard Storage Battery Company, Cleveland, Ohio.

Willard

Rechargeable Batteries for

Radio



Willard B Batteries

Willard Rechargeable B Batteries are made in 24 volt or 48 volt units, each type in two capacities, 2,500 and 4,500 m. a. h. Glass jars enable you to see the condition of your battery at all times and help prevent electrical leakage.



Willard A Batteries

Good A Batteries are as important as good B Batteries. There are several types of Willard A Batteries in a range of prices, including the Willard All-Rubber A Battery, with rubber case and Threaded Rubber Insulation. Five sizes, 20 to 125 a. h.

For Peanut Tubes



A leak-proof, storage battery that costs little, lasts for years and has many advantages over the ordinary peanut tube battery. See your Willard Dealer, or send for descriptive literature.

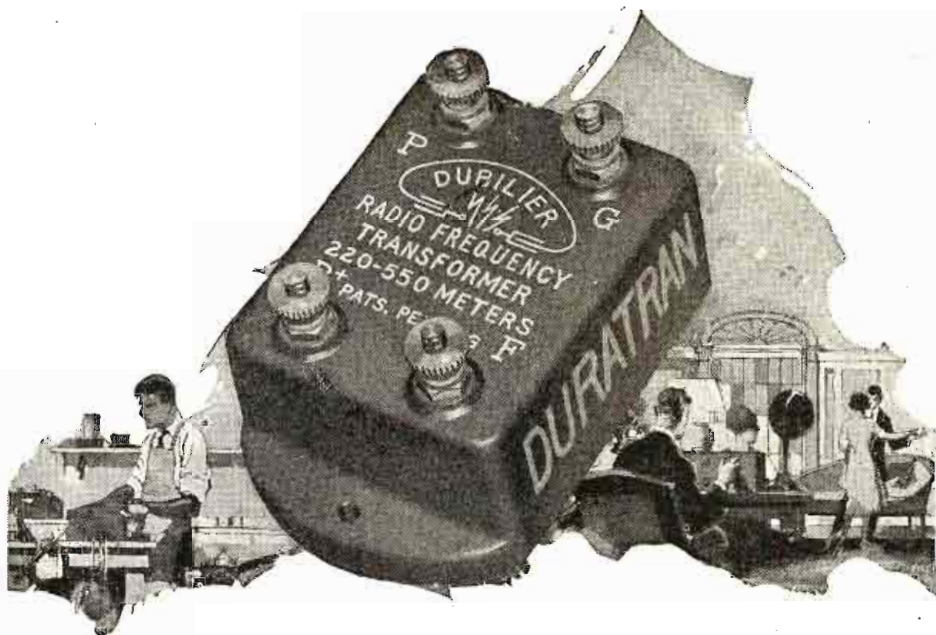

The DUBILIER *Duratran* Radio Amplification on all Wave Lengths

The Dubilier Duratran is the supreme radio-frequency transformer.

It amplifies powerfully and uniformly over all wave lengths now used by broadcasting stations.

Price, \$5.00. At all good dealers.

DUBILIER CONDENSER AND RADIO CORP.

40-46 West Fourth Street, New York City



Dubilier
Micadon
Fixed
Condenser



Dubilier
Ducon
Socket
Plug



Dubilier
Variadon
Variable
Grid
Control

DUBILIER DEVICES

TO THE RADIO DEALER

Let us explain how you can make the sale of our publications a worth while, well paying part of your business. Every one that enters your store is a prospective buyer of RADIO NEWS. RADIO NEWS will sell with little effort on your part.

You may sell our publications on a single copy basis with a fine margin of profit or on a subscription basis with a generous commission allowance.

Write now and prepare for Winter and Spring trade.

EXPERIMENTER PUBLISHING CO.

53 Park Place

New York

he used on that occasion he fished out of a cupboard for my benefit. To his very great pleasure and astonishment he was instantly successful, being heard by correspondents in Marseilles (100 miles as the crow flies) and at Orleans (400 miles). M. Deloy then went on to describe to me his visits to the United States, the fuss that was made over him, and the jolly people he met. In excellent English he told me that it was not his first visit, but that he had been to see Uncle Sam during the war while on an official mission.

COMPLETE SUCCESS

On his homeward trip, this indefatigable amateur experimented on board ship. He picked up KDKA's (Pittsburg) experimental broadcast on 100 meters, as well as Mr. Schnell, the Traffic Manager of the American Radio Relay League. This, coupled with his previous conviction of the great utility of the shorter wave-lengths, finally decided him to attempt communication on that wave-length with his American friends as soon as he returned. Before I speak of the actual exploit itself, it is interesting to note that the first two European amateurs he was able to pick up on the water were an Englishman, 6MI, and one hour later a Frenchman, 8BM. This occurred 900 miles west of Havre.

M. Deloy was back at his Nice home on October 28. He lost not a minute in preparing for the experiments he had in mind. The following day he had pulled down the great three-prism aerial he had been using and put up another. It was this which was used when he established two way communication with the States. He of course modified it during his preliminary experiments. The final form as it was used on the night of November 27-28, 1923, is shown in one of the accompanying photographs. It is a cage type. The highest point is about 80 feet from the ground. It is about 35 feet in length and is provided with a counterpoise exactly similar to it in shape. The spreaders at the lower end of the counterpoise can just be seen to the right of the lower leaves of the palm trees in the photographs. The upper end is fastened to the framework which can be seen jutting out on top of the upper corner windows.

THE TESTS

His transmitting and receiving sets he soon had working and started his experimental transmitting on 100 meters. In connection with his experiments (and he has all of them numbered for the sake of insuring accurate reports as to reception) M. Deloy keeps a pack of cards, on each one of them is written a letter of the alphabet. Just before sitting down to his key Mr. Deloy shuffles and cuts these cards and deals himself five. The five letters in the order they appear form part of his messages and the genuineness of the reception is gauged by whether these have been read. In his experiments M. Deloy is very grateful to the British amateurs who have been indefatigable in corresponding with him about his signals. His signals were heard in England when he was only using 1/2-kw., which was half the power decided on for the trans-Atlantic contest. An idea of his intensity may be formed from this extract from a letter sent him by Mr. E. J. Simmonds, an English amateur at Gerrards Cross, Bucks, whose call signal is 2OD. The extract refers to an experiment numbered 72, and is as follows: "Here is plain statement of your intensity which will interest you. Using super-heterodyne, five effective valves (excluding oscillator), your signals are readable on loud speaker downstairs—my cabin is on the first floor." The writer then goes on to state how he was able to receive French 8AB without an aerial. Another English amateur who had good reception of these signals was 2DX of Camberley.

Satisfied with his preliminaries, M. Deloy sent Mr. Schnell of the A.R.R.L. a cablegram asking him to listen in at a certain time. On this occasion, however, he was not

TUSKA RADIO

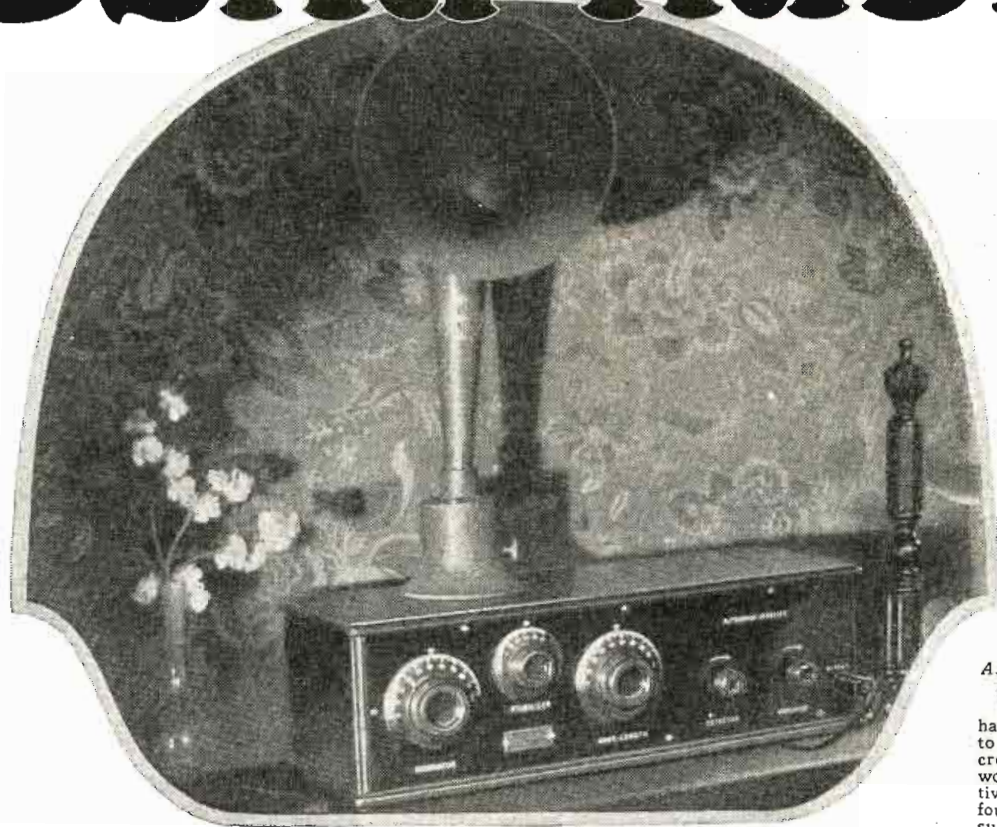

The Superdyne Radio
Frequency Receiver
Armstrong circuit, licensed
under patent 1,113,149

Radio enthusiasts who have had the opportunity to hear the new Tuska creation are amazed at its wonderful range, selectivity and volume. Uses four tubes, but equals or surpasses the performance of six-tube sets. Write for special folder 11-J

In the forefront of radio improvement

THE Superdyne, one of the most widely discussed successes of radio, exemplifies the constant creative work of Tuska radio engineers. For astonishing range, volume and clearness, especially on distant stations, the Superdyne is outstanding among the finest radio sets. It operates a loud speaker with a short indoor or any outdoor aerial. And being Tuska-built, it gives *lasting* satisfaction.

A radio with such splendid entertainment possibilities deserves the honor place in your home. So the Superdyne, like all Tuska Radios, is built with an eye to beauty as well as efficiency. In superb design, construction and finish, Tuska Radio establishes a high mark in radio manufacturing.

All Tuska models, ranging from \$35 to \$125, are built with scrupulous care, under the personal supervision of C. D. Tuska, noted radio pioneer, with thirteen years' experience in producing expertly made radio equipment. With an inborn love of finished workmanship, skilled New England craftsmen take pride in careful work on each Tuska Radio. Tuska Radio is sound in principle and perfect in workmanship. Your Tuska will give you years of uninterrupted radio pleasure.

Hears England on One Tube

"On a Tuska 220, one tube, I received bugle calls from England at 10.15 P. M. on Sunday, December 2nd. I wish to compliment you on the set you manufacture.

FRANK H. WOOD.
New York"



THE C. D. TUSKA COMPANY
Hartford, Conn.

After Extensive Tests and Comparisons

We Offer the

Branston - Quality - Guaranteed Audio Transformer

YOU can now get rid of noisy or otherwise unsatisfactory transformers and, with perfect confidence, replace them with this fully-tested-and-proved Branston Audio Frequency Transformer. The results will delight you and your "audiences."

You can now make up new sets, with the certainty that you have the maximum-possible amplification and best tone quality without distortion.

If your dealer has not yet secured his supply, send check or money order for as many as you need, at \$6.50 each, or order parcel post C.O.D. Mention your dealer's name, please.



Branston - Quality - Guaranteed Audio Frequency Transformer. Neat, compact, efficient. It gives the results you want. Each \$6.50

Use Branston "Broadcast Coils" for Closer Selectivity



Branston D.L. Honeycomb Coils and Back and Front Geared Mountings are "Standard of the World." Licensed under DeForest patents.

VERY fine adjustment, close selectivity and clearer reception for all wave lengths between 250 and 600 meters. Wound on Formica Tubes 5" diameter. Equipped with standard coil plugs. Fit any Honeycomb coil mounting. Furnished only in sets of three, Primary, Secondary, Tickler. In attractive carton, per set, at dealers or by mail, \$5.00

Protect Against Lightning and Static
Use Branston Vacuum Tube Protectors in place of the grounding switch.

APPROVED by Underwriters' Laboratories and Hydro-Electric Power Commission of Ontario.

Scientifically constructed. Always ready to carry away a lightning flash before it can enter the building. Drains static from the aerial, relieving interference. Signals are more audible.

It operates automatically. Requires no attention. Can be installed and forgotten. Designed for outdoor mounting. Petticoat insulator prevents leakage in wet weather. Vacuum tube entirely enclosed and protected from breakage, moisture, dirt, insects. Not affected by snow, sleet, or rain. Price, at dealers or by mail, \$3.00.

Send 2c Stamp for New Honeycomb Coil Hookups. Compiled by experts and includes five good Honeycomb Coil "Hookups" and complete catalog of famous Branston Radio Apparatus. Write today. Give us name of your radio dealer. If he cannot supply you, write

CHAS. A. BRANSTON, INC.

Manufacturers of Branston Violet Ray High Frequency Generators

817 MAIN STREET BUFFALO, N. Y.
In Canada Chas. A. Branston, Ltd. Toronto



R-51. Branston Approved Lightning Arrestor and Static Eliminator.

heard, as M. Schnell was trying to get him on 190 meters and of course F8AB was transmitting on 100. M. Deloy, therefore, sent another cable asking that vigil be kept for his signals beginning at 2 o'clock G.M.T. on November 26, at 100 meters.

Mr. Deloy repeated his signals continuously from 2 to 3 o'clock G. M. T. with only a five-minute pause at the end of the first half hour. When he awoke the next morning he found the following cable awaiting him:

HARTFORD, CONN. 25 NOV. 22.30 via UNION. COPIED SOLID, CONGRATULATIONS.

He was naturally overjoyed. Calculation of the difference in time between the two Continents showed that the cable had been dispatched as soon as he stopped for a five-minute silence at the end of the first half hour. The test was, therefore, a conclusive one. He determined, however, to hold one of another kind the following night. Sitting down at 2 o'clock G.M.T., he tapped out an 18-word message asking Mr. Schnell to cable agreement of a change of schedule. This message he only tapped out once. The following morning he found awaiting him the finest and tersest cable he has ever received. It consisted of only one word "AGREEMENT."

"TWENTY FEET FROM PHONES"

This cable from the States was followed on the same day by another asking him to listen in for IMO (Mr. Schnell) at 3:30 G.M.T. He did so and there resulted that exchange of telegrams between the two amateurs which made history. It was the night of November 27-28, and M. Deloy was able to converse with Messrs. Schnell and Warner for several hours. The only interruption which occurred was when M. Deloy, with his highly trained ear detected 1XAM (Mr. Reinartz) calling him while he was reading Mr. Schnell. He, therefore, interrupted his conversation with the latter, resuming it after he had conversed with his old friend. In the early part of that night M. Deloy asked how loud he was being heard. The answer came right back, "Twenty feet from phones." The conversation between the two amateurs as recorded in M. Deloy's log book makes most cheerful reading. The talk bristles with "Old man's" and at one moment Mr. Schnell is recorded as saying: "This is an historic night old man," and proceeded to recall how the two had speculated together five years before as to the possibility of amateurs ever conversing with each other over such enormous distances.

Their conversation, expressing as it did their great joy at having been able to forge this new link between the New and Old Worlds, demonstrates the great utility of amateur radio in spreading international amity.

M. Deloy illustrated his conversation with me throughout with his log books and with the famous cables. I felt some of the thrill he must have felt on receiving them.

That night Mr. Schnell transmitted the famous telegram of greeting from the American amateurs to General Ferrié head of the French Military Radio. In a short conversation I had with him on this subject he expressed himself as delighted with M. Deloy's success and with the kindly thought of the American amateurs. In his opinion the trans-Atlantic contests were by no means forestalled, but would become more interesting than ever.

FAILURE ON 200 METERS

What lent great excitement to all M. Deloy's experiments was his being able to hear the English amateurs trying in vain to call America on 190 and 200 meters. He wondered how long it would be before one of them would hit upon the happy plan of using the 100-meter wave-length.

When M. Deloy had finished telling me his story, we passed into the next room where his installation is fitted up. Turning



Look for this trademark card in your dealer's window or salesroom.

LEARN THE CODE AT HOME

"Just Listen—The Omnigraph will do the teaching"

with the

OMNIGRAPH

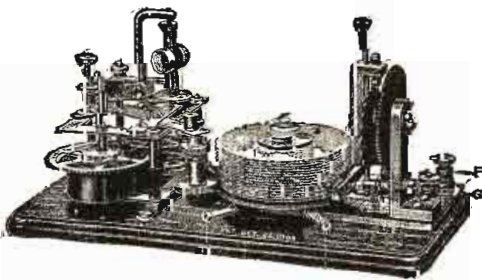

THE OMNIGRAPH Automatic Transmitter will teach you both the Wireless and Morse Codes—right in your own home—quickly, easily and inexpensively. Connected with Buzzer, Buzzer and Phone or to Sounder, it will send you unlimited messages, at any speed, from 5 to 50 words a minute.

THE OMNIGRAPH is not an experiment. For more than 15 years, it has been sold all over the world with a money back guarantee. The OMNIGRAPH is used by several Depts. of the U.S. Govt. all applicants applying for a Radio license. The

—in fact, the Dept. of Commerce uses the OMNIGRAPH to test all applicants applying for a Radio license. The OMNIGRAPH has been successfully adopted by the leading Universities, Colleges and Radio Schools.

Send for FREE Catalog describing three models, \$14 to \$30. DO IT TODAY.

The Omnigraph Mfg. Co., 20 Hudson St., New York City

If you own a Radio Phone set and don't know the code—you are missing most of the fun

Make it "REFLEX" with ACME

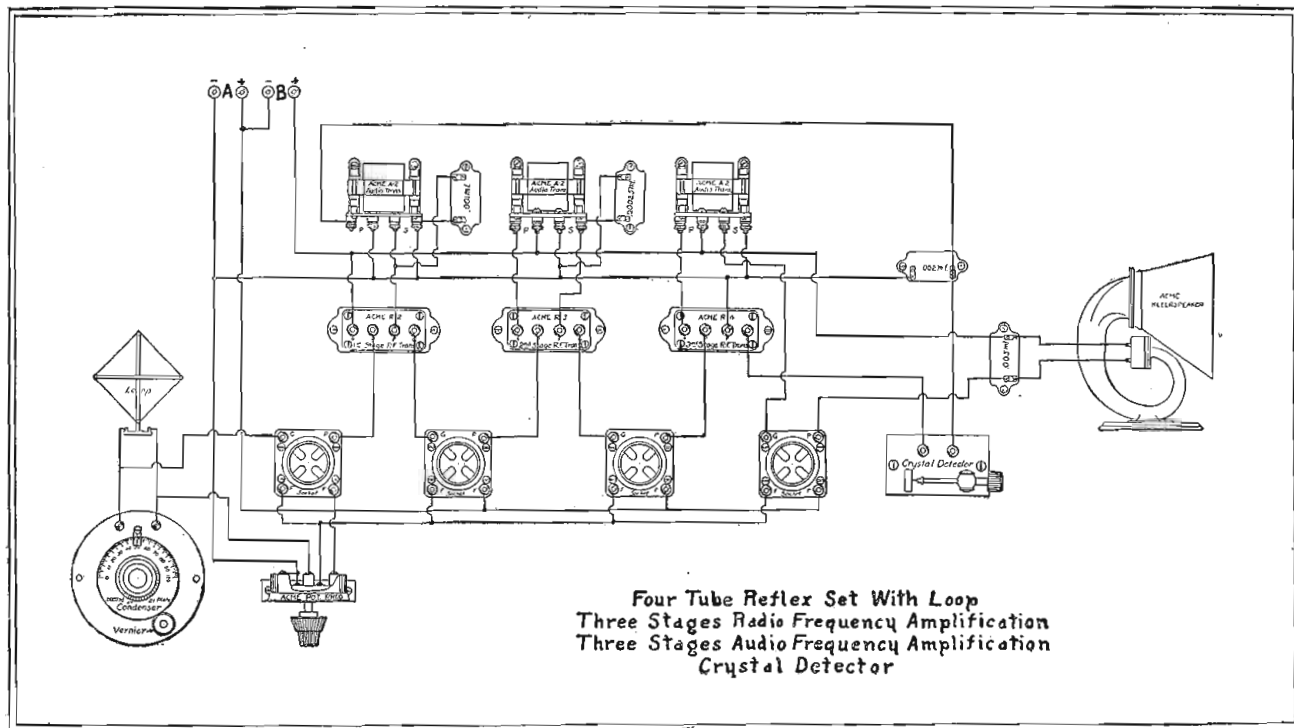

The Acme Pot Rheo

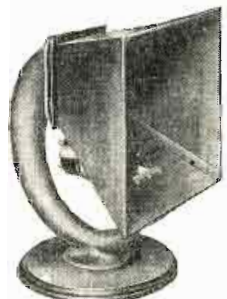

Acme Kleerspeaker

"... having tried almost every circuit on the market, I find that there is nothing that will compare with this hook-up in any way."

"MY list of call letters is too long to mention in this letter. . . . This circuit delivers such volume from points thousands of miles away . . . in fact, it brings in the distant stations just as loud as it does the local and without any distortion" . . . writes an enthusiastic builder of an Acme Reflex.

This Reflex circuit was perfected by our engineers after eighteen months of testing and experimenting. It gives the best consistent results for the least expenditure, the least construction and tuning effort and the least trouble. It brings in the distant station loud and clear and it won't annoy your neighbor.

FOR BEST RESULTS—Follow the diagram closely and use only the best apparatus. One Acme booster writes us: "Acme is so far ahead in every way that we would be foolish to attempt this hook-up with any other make of transformer." Write to us for "Amplification without Distortion"—a booklet containing wiring diagrams and helpful points on construction and operation. Use the coupon.

ACME APPARATUS COMPANY
Cambridge, Mass.



The Acme Radio Frequency Amplifying Transformer R-1, 2, 3, 4 for distance

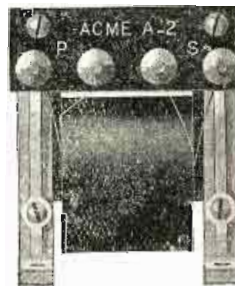

The Acme Audio Frequency Amplifying Transformer Type A-2

ACME

for amplification

ACME APPARATUS COMPANY,
Dept. 25, Cambridge, Mass.

I enclose 10 cents (U. S. stamps or coin) for copy of new edition of "Amplification without Distortion" containing complete instructions and wiring diagrams for making my set "Reflex."

Name

Street

City..... State.....

"What a whale of a difference
just a few cents make!"

— all the difference
between just an ordinary cigarette
and—FATIMA, the most skillful
blend in cigarette history.

Unbroken Reception

WITH a crystal detector, perfect reception is possible only when there is perfect control of tension on crystal. The DE-TEC-TONE gives you this—and more. It gives you a range of volume not possible with the ordinary detector.

The secret lies in the full micrometer adjustment that stays put with each adjustment. *No jar can change it.* Insures finer tuning, greater distance, unbroken reception.

Mounts in clips like a cartridge fuse, instantly adjustable, reloadable, detachable. Unequaled for reflex circuits.

Wherever a crystal is used, DE-TEC-TONE will give better results. If your dealer hasn't it, send \$1.50 to Pyramid Products Co., 117 No. Dearborn St., Chicago, Ill.

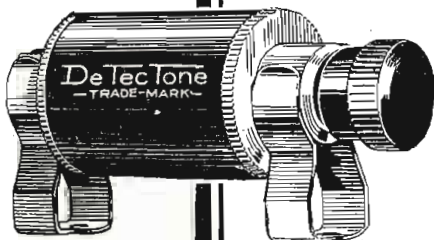

DE-TEC-TONE

CRYSTAL DETECTOR

to his super-heterodyne he told me the story of his struggles with that circuit. This one was the third he had built since 1921 and it was the most successful. With it he was able to hear Mr. Schnell's signals while standing 7 feet from the phones. He constructed it with very great rapidity, thanks to the invaluable Brunet Radio Blocks. His super-heterodyne can be seen on the right side of his bench in the photograph, while the cabinet on the left is his new type CR-13 two-tube short wave receiver. Turning to the other side of the room, M. Deloy showed me the set which transmitted the signals heard by the American amateurs. It is a single coil circuit using two 250-watt tubes with 25-cycle 4,000-volt plate supply. M. Deloy affectionately calls it his "QP hook-up" because the circuit originated with Mr. Reinartz, whose other call letters as the whole world knows are 1QP. His installation is, considering the short time which he had to fit it up and begin his experiments, necessarily rather sketchy and hasn't got that well polished look we have been advised to put into our laboratories, but it puts the goods across and it's the main thing in spite of the drill sergeant! From left to right can be seen the counterpoise condenser, the aerial ammeter and condenser, and behind that the inductance coil; next comes a 50-watt grid leak tube with its rheostat, and behind it is the grid condenser and filament ammeter, the stopping condensers and the two 250-watt tubes with their rheostat and filament voltmeter. On the right of these comes the plate milliammeter, the choke coil, the "Ferrix" 4,000-volt transformers. In the foreground of these are the keys.

The tubes used by M. Deloy were of the well-known French make "SIF." The first announcement of the establishing of two-way communication was made to the greater public by this firm at their stand at the big exhibition of Physics and Wireless, held at the Grand Palais, Paris, during the first fortnight in December. The first announcement to be made to the public was made to a small, special audience by Dr. Corret, the organizer in France of the trans-Atlantic essays, at a lecture he was giving at the Sorbonne under the auspices of the Radio Club of France. He read the telegrams of the American amateurs sent to General Ferrié and himself and provoked an enthusiastic demonstration in honor of that great French amateur Léon Deloy.

Correspondence from Readers

(Continued from page 1264)

of hearing code and want to hear the home stations you get squeals, cat-calls, howls and moans from regenerative set owners who either *cannot* or *will not* learn how to tune in. These noises are the death cries of radio unless something is done soon. There are three \$250 outfits within a mile of my home which are gathering dust because their owners have become disgusted trying to receive under present conditions.

It may be a year, perhaps two, before a decline will be noticeable, but it is coming unless the ether is cleared in some manner. Some dealers have told me that they will drop radio apparatus as a line as soon as the present season is over. They agree that the business is headed for a big slump unless something is done.

In every city and large town in the country will be found radio "experts" who are selling outfits from \$10 up, and nearly all of them are of the single circuit regenerative type, made up of ten-cent store parts, dollar "moonshine" tubes and dollar variometers and variocouplers. The condensers are paper and tinfoil—I have actually listened to faint music from a cheap fixed condenser

Good Bye! Variocoupler Enter Erla Selectoformer



Combines Improved Properties of Coupler and Wavetrap

Again Erla contributes notably to radio advancement. Erla Selectoformer, replacing alike variocoupler and wavetrap, greatly increases volume and selectivity in radio receivers, at the same time reducing cost.

Selectoformer, as the name implies, operates simultaneously as a selector and radio frequency transformer, picking off of the antenna the one wavelength desired and amplifying it to normal strength.

Thus is avoided the interference common to receivers that depend for selectivity upon tuning the coarse antenna system. Also, because of the amplification brought to bear, there is eliminated the loss of energy encountered in wavetraps of conventional type.

With Selectoformer, distant signals come in loud and clear, even with powerful local broadcasting in progress. Tone quality, likewise, is greatly improved, through reduction of static and other disturbances.

Control of the Selectoformer is effected through the 23-plate condenser already built into most receiving units. Installation is a matter of moments only.

For complete details regarding this and other Erla improvements, including latest reflex circuits, ask your dealer for Erla Bulletin No. 20, distributed gratis; or write, giving your dealer's name.

Electrical Research Laboratories
Dept. C. 2515 Michigan Avenue, Chicago

ERLA



Erla transformers eliminate distortion while increasing range and volume. Uniformly effective on 200-700 meters. Reflex and cascade types. \$5

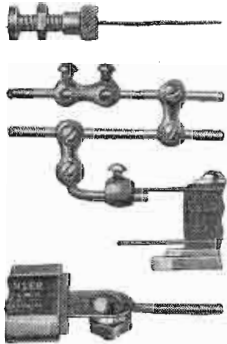

Assembly of radio apparatus is enormously simplified by Erla solderless connectors, made in sizes and styles for every purpose. List, 3c to 5c



Reliable and clear reception is assured through the Erla fixed crystal rectifier, requiring no adjustment and lasting indefinitely. List \$1



Erla condensers alone carry a certificate of accuracy on their labels. Look for the words "Tested Capacity" when buying. 35c to 75c ea.



Superior worth of Erla audio transformers, shown in their exclusive ability to amplify three stages without distortion, improves any set. \$5



Patented telescoping rim of Erla bezels fits any 1/4" to 3/4" panel, neatly screening openings required for tube ventilation. Nickel or enamel, 20c



Supreme beauty and strength are combined in Erla sockets, with heavy, nickeled shell cast into moulded Bakelite base. Many other advantages. \$1



Manufactured with jeweler's precision, Erla phone plugs offer maximum service and intrinsic value. Handle two sets of headphones. List 75c



Save 1/3 on Guaranteed Radio Equipment

Write us a post card—
Address Dept. 2-R

and we will send you free this 52 page catalogue of radio sets and parts. It also contains explanation of radio terms, map and list of broadcasting stations and much radio information, including an explanation of successful hook-ups and circuits.

You will be amazed at the low prices Ward's quote. A complete tube set having a range of 500 miles and more, including tube, head set, batteries, and antenna equipment, as low as \$23.50.

This catalogue contains everything for the expert and amateur. Complete sets and every improved part for building sets, all the most up-to-date devices—at the lowest possible prices.

Headquarters for Radio

Montgomery Ward & Co. is headquarters for Radio, selling everything direct by mail without the usual "Radio-profits." Why pay higher prices? Ward quality is the best and the prices will often save you one-third. Everything sold under our Fifty Year Old Guarantee—Your Money Back if You Are Not Satisfied. Write today for your copy of this complete 52-page Radio Book.

Write to our house nearest you
Address Dept. 2-R

Chicago Kansas City St. Paul
Portland, Ore. Ft. Worth Oakland, Cal.

This Radio Catalogue FREE

Montgomery Ward & Co.

Established 1872

The Oldest Mail Order House is Today the Most Progressive

2-LO, LONDON, ENGLAND

ON ONE TUBE

Another Record for the ELGIN SUPER-REINARTZ

Tuesday, November 27, during the test period between 9 and 9:30 P. M., Rev. E. A. Cole in the residence of J. A. McIver, of Roodhouse, Ill., while operating a set made of materials and in accordance with the hook-up furnished by the ELGIN RADIO SUPPLY CO., tuned in 2-LO, London, England, using receivers and but one tube. Later another tube was lighted and the loud speaker used, so that four people could hear the program and concluding announcement. The numbers, time, and the order in which they were played were

Officially Confirmed

by the St. Louis Post Dispatch in conjunction with the National Association of Broadcasters, who had charge of the tests. (See page 34, St. Louis Post Dispatch, Dec. 2, 1923.) This same hookup has been advertised extensively as the one which brings in stations 2,000 miles overland on a loud speaker and one tube; and this has been demonstrated so often as to need no repetition.

Send a two-cent stamp for circular giving one, two, and three-tube hookup, and price list of parts for this remarkable circuit. Address the

ELGIN RADIO SUPPLY CO.

209E CHICAGO ST.

ELGIN, ILL.

WHY NOT spend Spring, Summer and Fall gathering butterflies, insects? I buy hundreds of kinds for collections. Some worth \$1 to \$7 each. Simple outdoor work with my instructions, pictures, price-list. Send 10 cents (not stamps) for my Illustrated Prospectus before sending butterflies. Mr. Sinclair, Dealer in Insects, Dept. 37 Ocean Park, Calif.



Write for free catalog illustrating and describing our complete line of 1500 Good Tools
GOODELL-PRATT COMPANY
Toolsmiths
Greenfield, Mass., U. S. A.

with the headphones off. Two ten-cent stores in the nearby town of Lynn have employees who are selling complete sets, all made up of parts sold in these stores. One of these employees told me that he was booked up with orders for more than a month ahead; that he could make up two sets every evening, selling them with tube, headset and wire for aerial and ground for \$16.50, and another kind for \$12.50; still another for \$32.50, the last having audio frequency transformers at 90 cents each and two or three tubes.

There are four such sets in my immediate neighborhood. They do get the nearby concerts fairly well, but their owners want to compete with the four-tube, expensive and well-made set next door, so they try to get Hong Kong, Liverpool and Etah Harbor. By means of keeping their tubes oscillating for hours and a continuous twirling of dials, once in a week or so one of them will faintly hear a distant station. If they do not, they keep trying and say they do.

There are 20 such outfits to one decent one. At best they are bound to interfere, but placed in the hands of those who know absolutely nothing of how to handle them they do little except interfere with one another. If they get nothing, the rheostat is turned up higher; the more juice they use the more their owners think they have a chance of receiving something.

These salesmen, and the legitimate radio stores are exactly as bad. They give perfunctory advice as to how to run the set, collect the money and turn them loose. I ran across one man who had sat from 7 until 11 p. m. every night for nearly two weeks and hadn't been able to get a station. He was causing so much interference in the neighborhood that he was traced. His was a single-circuit, ten-cent store outfit with a dollar tube and a 150-foot aerial. He didn't get anything, but I'll tell the world he was transmitting something. We found he had a rheostat which was as effective as so much copper wire—the current was either on full power or not on at all. I gave him a Bradleystat out of pity and now we have comparative peace, as I fixed the Bradleystat so that he couldn't put all the current in the battery on the tube.

I want to see radio stay, but it is going out unless there is some regulation regarding regenerative sets and a whole lot more regarding code. Let any person listen in on WJZ or WEAJ in this section and hear more than one-half of the concert.

As for writing to broadcast stations, while I believe it should be done, I also believe that letters are going to be very few. In the first place, a great many persons hate to write a letter on any subject; many others do not know what to say. The novelty has worn off and concerts are being taken as a matter of course.

Radio receiving outfits are a luxury, and luxuries should be taxed and the money used to pay for concerts. The tax should carry with it a license to operate a receiving set and the ten-cent store kind should carry both a tax and a jail sentence.

The tin-pan loud talker did its best to kill radio, but the novelty and the idea of getting something for nothing carried it along. The novelty has worn off except with the new crop of buyers who are passing by the well-made outfits and purchasing stuff because it is cheap.

The radio sky-rocket has gone up with a flare; it is coming down now with nothing left but the noise. If the industry is to survive and grow, there must be regulation, not only of commercial code, but of broadcast listeners.

A. E. STARKEY,
281 Lincoln Ave., Saugus, Mass.

EXACTLY

Editor, RADIO NEWS:
Allow me to answer the questions put to me by Mr. Brakenridge in his letter printed in the January issue.

KELLOGG RADIO PARTS

Easy { **to Mount**
to Wire
to Solder
to Tune

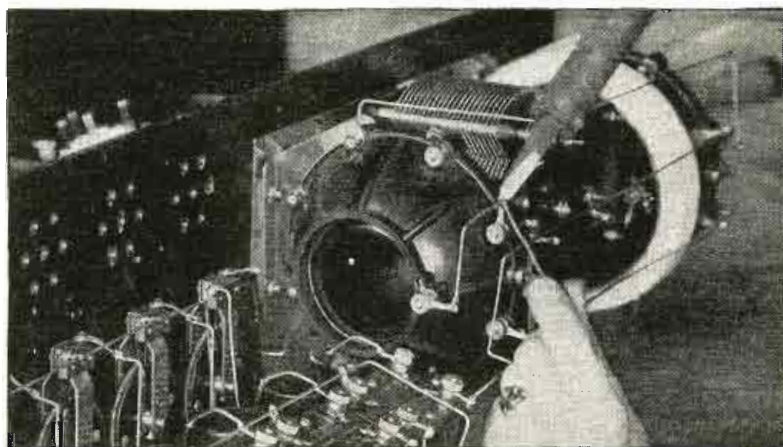

No Fussing or Re-drilling, Just Mount and Solder

They furnish every convenience for quick efficient assembly. And when connected—"O Boy!"

Did you ever hear such volume and still so clear and distinct!

That is the satisfaction of using Kellogg radio equipment—it puts the 'Ray' in Radio.

Join the group of "Happy Radio Fans." They are strong believers in quality, and Kellogg apparatus



USE—Is the Test



KELLOGG SWITCHBOARD & SUPPLY COMPANY

1066 West Adams Street, CHICAGO



Balanced! RADIO RECEIVER

Tube capacities, in balance as perfect as the balance of the gyroscope upon which the aviator's life depends. Clears reception of regeneration, reradiation and body capacity effects. Tuning, no longer a matter of guessing, but positively precise. Stations once located, always found at the same point on the dial. As simple to use as a phonograph. Each *Eagle Receiver* balanced—(tube capacities neutralized) individually, by foremost radio experts. Sponsored by a well-reputed manufacturer. Guaranteed without reservations.

Licensed by Independent Radio Manufacturers, Inc., under Hazeltine Patent No. 1,450,080. Dated March 27th, 1923, and other patents pending.

Write for Illustrated Leaflet



20 Boyden Place

BALANCED AS PERFECTLY AS THE GYROSCOPE BALANCES THE AEROPLANE



Keep your Customers satisfied

EVERYTHING IN RADIO



by aligning yourself with a dependable radio jobber

Progressive Radio Dealers in all parts of the country realize the importance of handling strictly high grade radio materials and apparatus. This organization wholesales exclusively,—they represent only the leading radio equipment manufacturers,—their products are guaranteed,—they are, therefore, a dependable source of supply, and the type of jobber you should tie up with for your requirements.

Hommel's Encyclopedia of Radio Apparatus 246-S Gives Complete Details.

Write for your copy.

LUDWIG HOMMEL & CO

530-534 FERNANDO ST. — ZZZ — PITTSBURGH, PENNA

I agree with him that the raw A.C.C.W. transmitter is "debutique," as I said before. Also, that on about double the wave it has a beautiful harmonic which is hard to get rid of if you live near the station. Well, how many hams have raw A.C.C.W. transmitters? Here's the way it goes: Suppose you and I live three blocks away from each other. We both want to get on the air as soon as possible, so we do it and use the least possible apparatus, just raw A.C. on the plates of our tubes from step up transformers. But we find that the QRM is terrible. This speeds us up, along with complaints from the Radio Supervisor. We stock in rectifiers. Then the QRM drops off considerably but still haunts us to the extent that something else must be done. We also note that for the same input we get a better output by using rectifiers, F.B.

Then one night we hear that station across the river whose A.C.C.W. was most annoying, and this time his note is a pure whistle. How cum? So you give him a call and say QSB, D.C.C.W. here, OM, when did you get the motor-generator? And he comes back: "Still using A.C. here OM, put new rect. and filter."

So you look up the filters and find they improve your set 100 per cent and you begin getting reported, QSB-D.C.C.W.-QSA-FB; that, in brief, is the evolution of every amateur station, and every C.W. you hear is in some stage of it. Tonight see if you can guess which stage each fellow is in, make a note of it, and next month try again and see what improvement each fellow has made. That's the way OM, you'll be doing it yourself soon, you bet!

Now, to get back to the QRM caused by harmonics: Did you ever stop to think about the QRM which lots of broadcast stations are causing to the Hams?

Around New York there are about four real good broadcast stations, but WEAJ is the only one which does not seriously QRM 200 meters. Tests have failed to disclose any harmonics from that station. But during the quiet hours when we listen for West Coast DX, the other stations are nuisances. Of course we can tune them out, but how do we know but what 6PL is hiding under WOR's harmonic? If both are on the same wave-length there's no hope. Did you ever stop to think about that side of the harmonic question? I address BCLs in general when I say that.

And now to settle the QRM question between us—BCLs are bothered by amateur transmitters only to a negligible extent—the Government settled that. Only those BCLs along the seaboard are bothered by commercial stations. Here's where the rub comes—It's your radiating tuners that are spoiling the game. Their owners will cause regenerative tuners on waves of about 220 meters to be taboo in this country if it continues. Wait and see, OM!

Why not below 220 meters? Just listen down there and see if you hear any squeals from receivers. Why none? I wonder! There ought to be a law that every prospective regenerative set owner would have to pass an examination and operate a single circuit receiver with an antenna radiation meter in the antenna lead as a test. The only flaw in that is—who would pay for the burnt out meters? Hi!

Now, here's a point you make that I must question. I quote your letter: "The average amateur C.W. wave is not as sharp as the good broadcast wave." Why compare average and good? That would throw it into an entirely different light. Wouldn't it? Reconsider.

You must realize that broadcasting stations are backed by capital. If something is positively necessary, such as good modulation, which the BCL public demands, then the B.C. station will buy it. For good modulation of high powers such as the broadcast stations require, the Heising sys-

ARE YOU SELF-CONSCIOUS

Embarrassed in company, lacking in self-control? Let me tell you how you can overcome these troubles. M. VERITAS, 1400 Broadway, New York City

LEICH ELECTRIC CO.,
Leich Headphones, Non Tune Rectifiers,
L'-Radio Jacks and Plugs
Write for complete Radio Bulletin 101-M.
Genoa, Illinois.

LARGEST SELLING TRANSFORMERS IN THE WORLD



Standard Equipment
on the better sets

ALL-AMERICAN Amplifying TRANSFORMERS

for Utmost Volume — Undistorted!

Use any good loud speaker and All-American Power Amplifiers

Months ago, the most severe receiving tests and laboratory comparisons possible to devise, repeatedly demonstrated that All-American Power Amplifiers were the most efficient, most thoroughly satisfactory transformers ever produced in the history of "push-pull" power amplification.

Now, from all over the continent, radio enthusiasts are writing in, further confirming this verdict.

"Results were astounding — both as to clarity of tone and clear volume. The 'All-American' people are certainly producers when it comes to transformers" — is the message which followed an All-American power amplification demonstration at the Duluth Chamber of Commerce. In the same

delighted vein, the other users are expressing themselves.

Accustomed as we have been, for years, to having the virtues of All-American Audio Frequency and Radio Frequency Transformers praised to the skies by radio "old-timers," we can only say that All-American Power Amplifying Transformers seem even more popular — if that is possible.

We Will Send You the latest All-American diagram and circular, describing Power Amplification; also the famous All-American book of Tested Hook-Ups — on receipt of 4c in stamps to cover mailing charges.

The consensus of opinion is that the addition of the popular "Push-Pull" form of power amplification to an audio frequency amplifier — by means of All-

American Power Amplifiers — results in amazing volume (wholly undistorted) with a roundness, richness, depth and purity of tone positively unequalled.

See your dealer promptly.

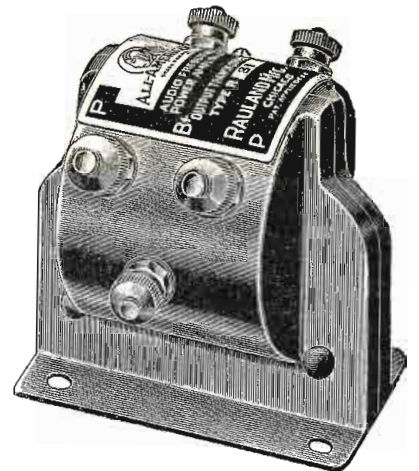

Power Amplifying Transformers for "Push-Pull" Circuits. (Input and Output Types.) Price each \$6.00.

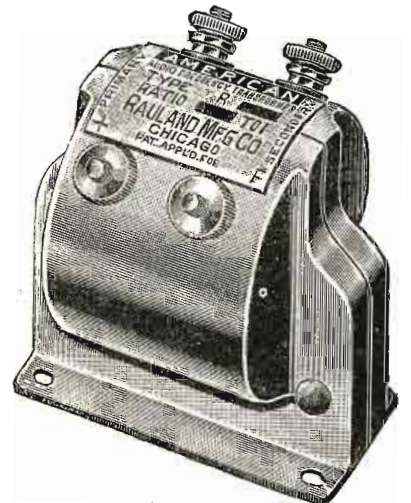

All-American Audio Frequency Transformers are available in three ratios: 3-1, 5-1, 10-1. Prices: \$1.50, \$4.75, \$4.75. All-Americans are best — no need to pay more.

RAULAND MFG. CO. 204 North Jefferson Street, Chicago
Pioneers in the Industry



All-American Socket
One-piece molded bakelite — for panel or base mounting. Finest socket money can buy. Only 75c.

Over half a million "All-Americans" in use

All the Better Dealers

Recommend

The "All-American"

"ESCO" MARK

Generators—Motors—Dynamotors—Motor-Generators
Stand Supreme in Wireless Field

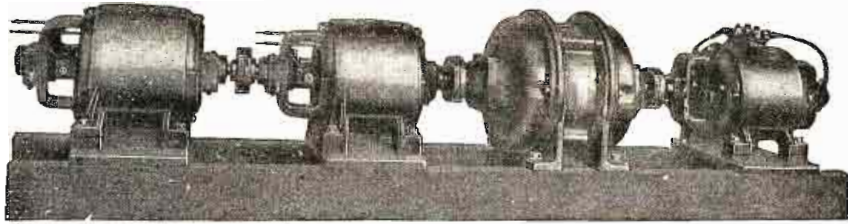

This Special 4-Unit Set made for Wis. Dept. of Markets—the largest Broadcasting Station in existence. A 10 H.P. Motor—two 1,000 V., 2,000 W. Generators to operate in series, producing 2,000 V. and 4,000 W. and one 12 V., 2,000 W. Filament Current Generator.

Send for Bulletin 237A listing over 200 combinations. We design and develop Special Apparatus for Special Purposes.

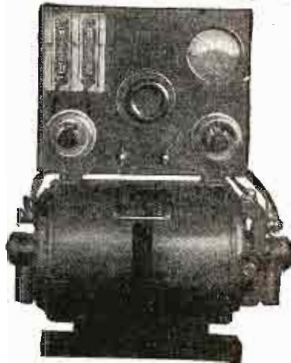

BATTERY CHARGER
Many Sizes—with or without Panels



DYNAMOTOR
Sizes to fit all requirements

SOLD BY PRINCIPAL DEALERS EVERYWHERE
ELECTRIC SPECIALTY COMPANY

211 SOUTH STREET STAMFORD, CONN., U.S.A.
Pioneers in developing High Voltage Apparatus

FLASH!

Another tube gone—"B" battery wires crossed for only an instant. RADECO Fuses would have saved it—they are saving thousands of tubes for satisfied radio fans. Read this letter

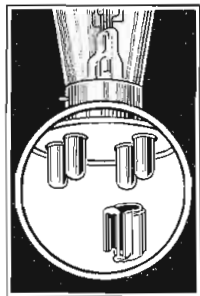

Radeco Safety Fuses

may be attached in an instant to any standard tube going in any standard socket.

In ordering, specify type of tube used

Price 50c each

At your dealer's or by mail postpaid



Radio Equipment Co.

Dept. 1 20 Stuart Street, Boston, Mass.
New England's Oldest Exclusive Radio House
DEALERS: Write for our proposition.

1358 Washington Street,
West Newton, Mass.

RADIO EQUIPMENT Co.
20 Stuart Street, Boston

GENTLEMEN:

I am writing to give you an experience which I recently had which may be of interest to you.

I am a Radio fan, and have experimented with many types of hook-up. I have also had the unfortunate experience of "blowing" several Radio tubes. Recently a friend of mine recommended your fuses, and I purchased three for my three-tube set which I am now using. Shortly after installing these fuses, in attempting to tighten a loose connection, my screw-driver accidentally touched the "B" battery lead. All three fuses were blown, and I realized that if it had not been for the Radeco Fuses I would have lost all the tubes in my set. I am inclosing herewith \$3.00 for which please send me six fuses for UV201A tubes, as I do not wish to be without them. You are at liberty to use this letter in any way.

Very truly yours,

FRANK J. BODAY

tem is best. Now, the Heising system demands a constant current input and it is of such nature that shunt capacity in the filter by-passes the modulations which consist of pulsating or alternating currents, and as such, they pass through the condensers shunted across the leads to the plate. Therefore, it is clear that the input must be pretty constant before it gets as far as the filter. So, you see, it is necessary to use a special motor generator or else batteries. Now both of these power sources are expensive, so Hams resort to rectified A.C. for the most part. Of course, the output of a tube fed by R.A.C. will not be as sharp as a motor-generator supply, unless it has a top notch filter. That explains it, I guess. It's like any competition where one competitor has the \$\$\$ OM, see?

Now you quote me wrong next. I do not question if any DX is done on single circuit tuners, OM, merely whether or not the majority of Hams use single circuits. I know that DX can be done on a single circuit—I used to use one. It's not a question of DX, nor one of volume; *selectivity* is the right button to push (the other will follow). Neither is it a question of circuit superiority. It's the way the set is made. Let that sink in.

Now a word about the results you quote. As to the results described in January, 1923, RADIO NEWS, page 1289; didn't you notice that 6ZY used a Beverage antenna? That's the point OM. Think it over, and read the Editor's note to the letter of Carlton J. Lake, page 727 of RADIO NEWS for December, 1923. That little note started quite a commotion. Hi!

What I just said applies to the DX record of 6ZY described in the February issue also.

Now about 5IM's station description in the July, 1923, issue. Why don't you tell the whole story? He says, "The receiver is of the single circuit type—it shows a remarkable degree of selectivity, comparing very favorably with the three-circuit sets! "Compares favorably," not better, nor as good! Get that?

Now don't say that the American amateur is behind on his receiving! Yes, the French and British hear us, but on what? Superhets, as you say, radio frequency Reflex; yes, but come right down to a compact, easily controlled set, and the American amateur with his set plus one step can't be beaten for a two-tube receiver.

Now don't knock Godley either; if he could receive American amateurs in England, why couldn't English amateurs do it too? They are doing it; certainly they're not dumb! That doesn't make Godley's accomplishment any smaller. Right?

And last, let me agree with you about regenerative receivers, also let me say that I agree with 1BAG entirely, and that I also agree with 7OZ in the December issue: why not give the three circuit receiver a fair trial? Use one for about three months and then go back to the single circuit. Thanks for your attention OM.

E. PEACOCK, 2ADH,
52 Radford Street,
Yonkers, New York.

FROM A DEALER

Editor, RADIO NEWS:

Regarding an item on "inferior" goods: The writer has been in the radio supply line for a considerable length of time and lately has done repairing, rewiring and building to order.

I have found that the reason for dealers offering cheap materials is that the radio fans demand them; we have handled only well known standard parts and tubes, and when we offered them at the advertised prices which afforded us only a small margin of legitimate profit, the answer came. "We can get a better price elsewhere." The result was usually that a cheap imitation was purchased.

A great many of the cut price stores ad-

UNITED ELECTRIC STORES CO.
East Pittsburgh, Pa. Next door to KDKA
Wholesale Radio Equipment
Same Day Shipments

VULCANIZED FIBRE
Be sure and specify "WILMINGTON FIBRE"
Sheets, Rods, Tubes, Washers, Etc., Specialties
Wilmington Fibre Specialty Co. Wilmington, Del.
Branch Offices "Everywhere"

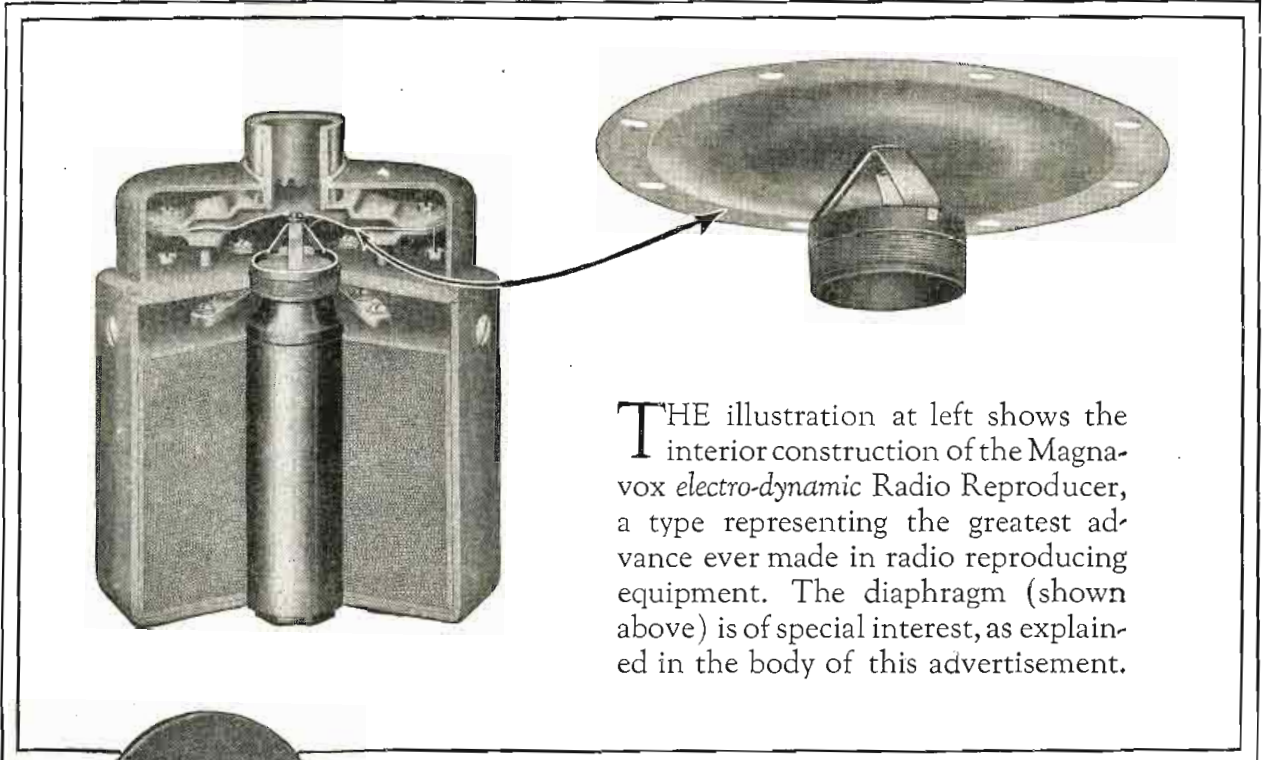

THE illustration at left shows the interior construction of the Magnavox *electro-dynamic* Radio Reproducer, a type representing the greatest advance ever made in radio reproducing equipment. The diaphragm (shown above) is of special interest, as explained in the body of this advertisement.



A1-R—\$59.00

This instrument (Magnavox Combination Set) consists of Magnavox *electro-dynamic* Reproducer combined with a Magnavox Power Amplifier in one unit. It is an important addition to Radio in the home.

MAGNAVOX—True Radio Reproducer

THE basis of the operation of a Magnavox Reproducer is its diaphragm, the importance of which can be seen from the fact that it is required to render an almost human service in recreating every tone and quality of instrumental music as well as speech.

This diaphragm (as illustrated) has been designed and constructed in accordance with entirely new principles. Its shape, size and special character make it capable of responding to the widest range of tones.

But even this highly efficient diaphragm might be handicapped by operating restrictions—every diaphragm must have a vibrating force applied to it, and the inherent ability of any diaphragm will be injured if it is affected by mechanical operation or other foreign influences.

The use of the *electro-dynamic* principle of operation (found only in Magnavox Reproducers) removes all objectionable influences. This principle, utilizing the famous “movable coil” permits the Magnavox diaphragm to respond in perfect unison to the original tone.

These exclusive features, fundamental to radio reproduction, account for the superiority of Magnavox Radio equipment.

There is a Magnavox for every receiving set: Type R for storage battery sets, and M1 for dry battery sets.

THE MAGNAVOX CO., Oakland, Calif.

New York Office: 370 SEVENTH AVENUE

PERKINS ELECTRIC LIMITED, Canadian Distributors Toronto, Montreal, Winnipeg

How You Can Know Latest Facts about RADIO

The very best way to know all Radio facts is to own a Lefax Perpetual Radio Handbook. When you buy it, you become a registered owner. That means complete facts as they are discovered, are mailed to you every month—printed, punched, ready to insert instantly in your Lefax Handbook. Lefax doesn't, cannot grow old. It keeps on giving you information, but you pay only once. There is no charge for the first twelve monthly mailings.

Here is a different, better book on Radio. It was written by Dr. J. H. Dellinger and L. E. Whittemore, Chiefs of the Radio Laboratory, U. S. Bureau of Standards, Washington, D. C. Ordinary books on Radio grow old and out-of-date almost as soon as printed. Changes occur rapidly. Lefax gives them all, as they happen. You get all the new ideas, in loose leaf form, pocket size, beautifully, accurately illustrated. And you get a complete list of broadcasting stations, with full information about each one.

The binding is flexible imitation Morocco leather—long, long wearing and very attractive. Pages are most readable and are indexed with linen tabs, plainly marked. There isn't anything else like Lefax, by any name or in any form. Look into it. Ask your Radio dealer, book store or stationer for

LEFAX Perpetual Radio Handbook

Published by

LEFAX, INCORPORATED

147 South Ninth Street

Philadelphia

vertise standard materials at prices cut below regular cost, but when you try to buy any, the last one was just sold a few minutes ago, and the buyer is handed the cheap imitation and he falls for it, because he was lured by the advertising of standard goods at cut prices. You will not find any legitimate well-established dealer offering anything but standard goods at standard prices. Why not patronize good dealers and pay a fair price, so that the dealer can make a profit? If this is done, the radio fan will not be cheated so many times.

CHARLES WINKLEHAUS,
84 John St.,
New York City.

DX IN THE HIGH SIERRAS

Editor, RADIO NEWS:

While making a trip to Return Mine, situated in Nye County, 12 miles from Ione, Nev., and accompanied by G. W. Pratt of San Francisco, Calif., President of the Return Mining Company, I decided to find out what results in radio reception could be accomplished at that elevation.

My receiving set consisted of a 4-tube Neutrodyne which I constructed. Tubes used were 201-A's for amplifiers, and a gas content tube for a detector. "B" battery, 22½ volts on the detector, 80 volts on the amplifiers. The "A" battery was a 6-volt ignition to begin with, but there is a sequel to that part of the story.

Arriving at the mine, a single copper wire was run from the hoist derrick to the cook house, a distance of 125 feet, with a 15-foot lead-in; the direction of the aerial was N. E. to S. W. The ground was 75 feet in length and was fastened to a crowbar driven through the ice into a pool of water.

With everything hooked up at 4 p. m. I put on the "cans" and began tuning. Everything was dead, not even static was audible. Thinking that some connection had become disconnected during transportation, I went over the wiring carefully, but found everything O. K. While sitting back in my chair gazing at the set and wondering if it would be better to drop it into the mine shaft or take it back with me for the spare parts it might contain, I suddenly heard faint music coming in, this was at exactly 5 p. m. Upon tuning in the station, I received the shock of my "radio life," for it was a New York broadcasting station. This fact was verified by Mr. Pratt and some of the miners present, and then the game of "Radio Golf" was on. For the next few hours I logged the entire area of the United States; and, give me credit, I also noted the dial settings of the stations as received. Here is a part of the record giving an idea of the area covered: New York City, Newark, N. J., four Canadian stations, including Vancouver, B.C., Lincoln, Neb., Mobile, Ala., Ft. Worth, Tex., Davenport, Iowa, Denver, Colo., Columbus, Ohio, Portland, Ore., San Francisco, Calif., Los Angeles, Calif., Salt Lake City, Utah, and stations in Montana and Wyoming.

The following day I constructed a loud speaker from a rusty piece of stove pipe, and using one phone element had Mr. Pratt, who knew nothing of tuning, take the dial log, and all the stations previously recorded were easily found by him, and came in clearly enough to be audible over a room 30 feet square.

Bedtime stories, lectures and music came to that group of wondering miners, for this was their first experience in listening to radio broadcast. Then suddenly everything faded out. I took a turn and found the "A" battery had become exhausted. This difficulty was met by my friend Pratt who brought his automobile into action, drove up close to the mess shack and connections were rapidly made to his auto battery. That was some battery, for I never had clearer reception. With new stations coming in as the earth's rotation brought them to their

DUTHO RECHARGEABLE STORAGE "B" BATTERIES

Fans and dealers alike are enthusiastic about Dutho "B" Batteries. Fans—for their unflinching performance and long life. Dealers—because of their unvarying satisfaction with their customers. Testimonial letters from dealers would indicate this was almost universal.

DUTHO "B" BATTERIES COST YOU LESS—LAST LONGER

They eliminate all battery noise and internal action. This prevents distortion. Heavy, individual glass tubes permit visibility at all times and make surface discharge impossible. You can see when and how to "keep them up." Condensing chamber in each cell overcomes fumes and prevents spilling.

DUTHO Batteries are sold DRY CHARGED, with solution in separate container. Once filled your battery is fully charged, ready for immediate use. Ordinary care in following directions will make DUTHO "B" Batteries last indefinitely. Thousands in use today.

Dealers: Write for attractive proposition.

Chemical Rectifier

\$1.95

DURKEE-THOMAS PRODUCTS COMPANY

1228 FOLSOM STREET

SAN FRANCISCO

\$5 6" x 2¼" x 2¼"
Weight 2½ lbs.

\$9 6" x 2¼" x 4¼"
Weight 4½ lbs.

\$17 6" x 2¼" x 9"
Weight 8½ lbs.

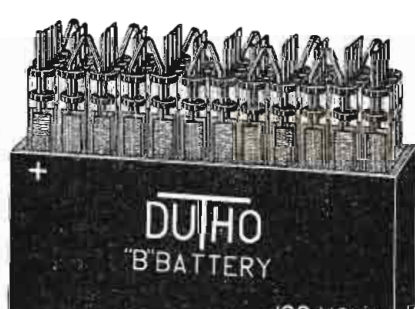
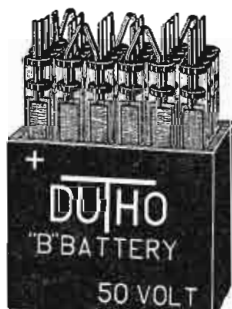

701

KENNEDY

The Royalty of Radio



See your dealer for demonstration of Kennedy receiving sets or write us for descriptive literature.
THE COLIN B. KENNEDY CO.

St. Louis

San Francisco

Jack Switch
\$1.00

To open and close circuits. Made in four styles. Complete with "On and Off" name plate, knob and pointer. Ask your dealer. Catalog free.

Carter Radio Co.

207 S. State St. CHICAGO



READY FOR YOU!
Our new 48-page catalog illustrates and describes 10 complete receivers and parts to build them. It contains over a thousand radio bargains which, because of our enormous buying power, have not, and cannot be duplicated elsewhere.
SEND A DIME FOR YOUR COPY TO-DAY.

Automatic Electric

LONGER
\$3.65



These headsets were formerly sold by the Automatic Electric Co., makers of telephone exchanges at \$10 each. We bought their entire stock—40,000 phones—paid spot cash and because of this buying power (unequaled elsewhere in the radio field) we are able to offer you a \$10 headset for \$3.65.
30 years of experience have produced the Automatic Headset. Coil is wound with about 6500 turns of No. 40 enamel coated copper wire. D.C. resistance 1600 ohms. Impedance at average music and voice frequency (800 cycles) 21,000 ohms. (Effective impedance rather than D.C. resistance is the big factor in a good headset.)

ERLA 1-TUBE REFLEX

Consisting of	Our Price
1 Variocoupler	\$3.45
23-Plate Variable Condenser	1.45
2 Erla Sockets	1.30
1 Erla Reflex No. 1 Transformer	4.45
1 Erla A. F. Transformer	4.85
1 Erla .002 Mica Condenser	.30
1 Erla .001 Mica Condenser	.30
1 Erla .0025 Mica Condenser	.25
1 Erla Fixed Crystal Detector	1.00
1 Howard Rheostat	1.00
2 Bakelite Dials	.50
8 Binding Posts	.40
1 Doz. Switch Points & 4 Stops	.30
2 Switch Levers	.50
1 6 1/2 x 14 1/2" Formica Panel	1.37

OUR PRICE \$20.90

REINARTZ DETECTOR and 2 STEP

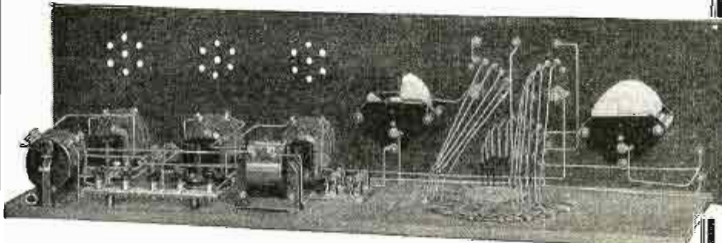

Reg. Price Each	Our Price Each
\$6.00	1 Panel 7x28x3/16 inch. \$3.92
2.50	1 Spider Web Coil. 1.95
6.00	1 23-P. Ver. Condenser. 3.45
5.00	1 11-P. Ver. Condenser. 2.95
1.50	1 Howard Vernier Rheostat 1.35
1.10	2 Howard Plain Rheostat. 1.00
.75	3 Firth Sockets. .35
2.00	1 Variable Grid Leak and Condenser (cartridge type) 1.40
4.75	2 Transformers (All American 10-1 and 3-1 or new type high and low ratio Thordarson) 3.95

DETECTOR ALONE \$11.45
(with plain condensers)

509 South State Street Chicago Ill. Dept. N-6



509 South State Street Chicago Ill. Dept. N-6

ONLY BRAND NEW MERCHANDISE !

By "Salvage" we DON'T mean something that has been used—we handle nothing but brand-new merchandise.

What we do mean is this: a manufacturer over-produces. He needs cash, so he sacrifices his stock. Our business is to buy—to "Salvage"—such stocks by paying spot cash for them. We bought 40,000 Automatic Head Sets in this way, 10,000 VT-2 Tubes, 5,000 Radiolas, etc.

But in order for us to keep on taking advantage of such offers, we must make a quick turnover. Therefore, we offer you the \$10.00 Automatic Head Set for \$3.65; the \$12.00 VT-2 Tube for \$7.45, etc.

"Salvage" to you means buying quality merchandise for less.

Complete Parts for AUTOPLEX

	Our Price
9 1/2 x 13 1/4 x 1/8" Formica Panel, drilled and machined	\$1.89
9 1/2 x 13 1/4 x 1/8" Mahogany Cabinet with hinged top	2.95
1 John Firth Socket	.35
1 Frost Plain Rheostat	1.00
2 Moulded Autoplex Variometers	7.30
2 3-inch Bakelite Dials	.50
6 Binding Posts	.30
1 Single Circuit Patent Jack	.35
1 1,250 or 1,500-Turn Honeycomb Coil	1.50
1 4x4 1/2" Formica sub base panel, drilled	.25
1 2 1/2 x 2 1/4 x 1/8" Formica Panel, Coil, clamp drilled	.07
1 Complete set of machine screws necessary for assembling the various parts	(no charge)
1 Hook-up for assembling and wiring	(No charge)
4 Lengths square bus bar wire for wiring	.10

OUR SPECIAL PRICE \$16.45

HAZELTINE NEUTRODYNE FREED-EISEMAN OR FADA LICENSED PARTS

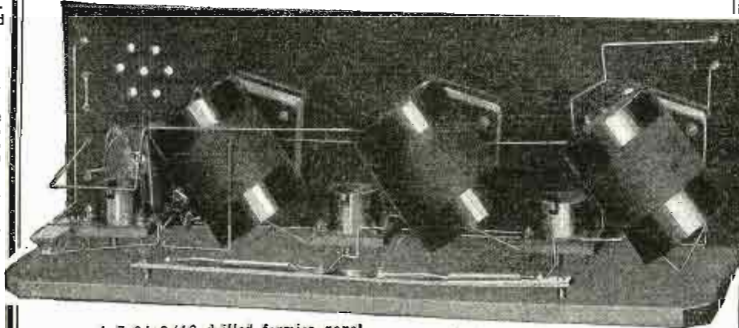

1 7x21x3/16 drilled formica panel
1 Howard Rheostat
3 4" Radion Dials
3 John Firth Bakelite Sockets

8 Binding Posts
3 23-Plate Variable Condensers
1 Wave Control Neutroformer
2 R. F. Amplifying Neutroformers
2 Grid Neutralizing Condensers
1 .0025 Micon Condenser
1 Marco Variabio Grid Leak
1 Base Board for mounting
25 feet tinned copper bus bar wire and complete instructions for assembling and wiring

\$28.60

4 tube set. \$44.65
5 tube set. \$46.25

SHORT WAVE RECEIVER

Regular Price	Our Price
\$10.00	2 Variometers \$3.90
5.00	1 Variocoupler 1.75
3.00	3 Bakelite Dials .75
1.00	1 John Firth Socket .45
1.10	1 Howard Rheostat 1.00
4.50	1 Mahogany Cabinet 2.95
2.25	1 Genuine Formica Panel 1.75
.80	8 Binding Posts .40
.50	1 Switch Lever .25
.40	12 Switch Points .20
1.00	1 Freshman Grid Leak and Condenser Combined .65
1.00	1 Complete Drawing for Assembly and Wiring .50

\$25.85 OUR VALUE PRICE \$13.45

Bradleystat or Bradleyleak Universal
NEW TYPE \$1.25 each

IMPORTANT !

Any individual part in any of the six outfits below may be purchased separately at the special reduced prices listed under column headed "Our Price."

COMPLETE INSTRUCTIONS

for assembling and blueprints for wiring are included with each outfit. Instructions written so everyone can understand them. No special skill or technical knowledge required—a few hours and you're ready to tune-in New York, Los Angeles—any of 'em!

PANELS DRILLED FREE

Specially drilled panels are included with each of the sets illustrated and described below. We give this free service only on panels included with complete sets.

COMPLETE PARTS FOR COCKADAY RECEIVER

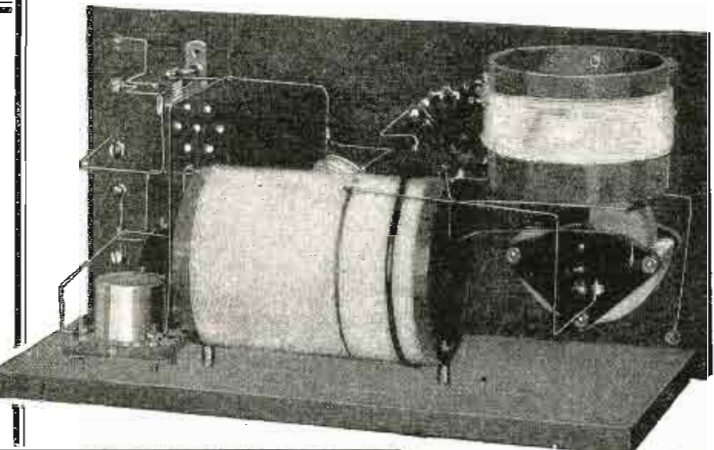

Regular Price	Our Price EACH
\$3.00	1 Cockaday Coil \$1.95
1.00	2 Bakelite Dials .25
1.00	1 John Firth Socket .45
1.00	1 Freshman Grid Leak and Condenser .65
1.50	1 Howard Vernier Rheostat 1.35
1.00	1 Patent Double Cir. Jack .50
.80	8 Binding Posts .05
.04	7 Switch Points .02
.50	1 Switch Lever .25
1	1 7x14 1/2" Formica Panel 1.44
1	1 Baseboard .25
3.30	2 23-Plate Condensers 1.45

OUR PRICE \$11.95

Western Electric



VT-2 TUBES CW 931

5 Watt "E" Tubes
\$7.45

About 1/3 of these 10,000 brand new, genuine Western Electric VT-2 Tubes that we bought from the U. S. Signal Corps have been sold. Radio men know that a genuine VT-2 Tube for \$7.45 is an unusual opportunity—a real "find"! These tubes may be used for RF and AF amplification and for CW, and phone transmitting. They have a higher amplification factor than any tube made! Not Navy defects—sold only as a surplus. Characteristics: Filament 6 volts, current consumption 1 amp., plate potential 22.5-350 volts.

Honeycomb Coils

1,500 Turns	\$1.50
1,250 Turns	1.50
1,000 Turns	1.25
750 Turns	1.00
250 Turns	.75
150 Turns	.60
100 Turns	.50
75 Turns	.40
50 Turns	.40
35 and 25 Turns	.40

Charge Your Radio or Auto Battery Overnight for a nickel

Why be bothered with the inconvenience and expense of taking your storage battery to a service station every time it requires recharging? The

**GOLD SEAL
HOMCHARGER**

*The World's Most Popular
Battery Charger*

charges any AUTO, RADIO or "B" storage battery in the *quickest, simplest and most efficient* manner possible. Connects to any lamp socket—operates silently—requires no watching. Fully automatic in operation—absolutely safe.

Beautifully finished in mahogany and gold. No danger from shock or fire—approved by Underwriters. **UNQUALIFIEDLY GUARANTEED.** Over 125,000 already in use.

Six-ampere size for all Radio, Auto and "B" storage batteries. Complete with ammeter—no extras to buy—\$18.50 (\$25.00 in Canada).

FREE. Ask your Dealer or write direct for free copy of Homcharger List of Broadcasting Stations, and Gold Seal Bulletin.

*Insist
on the GOLD SEAL*

LOOK FOR IT



which appears on Nameplate and Package. No other charger is just as good!

The Automatic Electrical Devices Co.
118 W. Third St., Cincinnati, Ohio, U. S. A.
*Largest Manufacturers Vibrating Rectifiers
in the World.*



broadcasting schedules, we could have continued late into the night, but we finally shut down when the Pacific Coast began broadcasting.

The next night, and the last one in which we used the set, the static was so bad that it was impossible to get clear reception; so reluctantly we packed the outfit up.

Taking the elevation at the mine and adding the 25-feet from the ground to aerial, I found that my antenna wire was 7895 feet above sea level.

The unusual factors encountered were as follows:

1. Absolutely no reception until 5 p.m., not even of the high power spark stations on the Pacific Coast.

2. Entire absence of static for two nights, followed by such a large amount on the third night that reception was impossible.

3. Height of aerial above sea level, distance covered, and the audibility obtained on the improvised loud speaker.

4. And last but not least, perhaps the most important, Mr. Pratt, recruited as another "Ham," is now enthusiastic over radio and is contemplating installing a phone outfit at the mine just as soon as his mine superintendent can master the code which we left with him, and pass the necessary examination. The last I heard from the superintendent as we left was "Dit dit dit, Dah dah dah, Dit dit dit."

J. R. MOUNT,
Major, Medical Corps, U. S. A.
Olympic Club,
San Francisco, Calif.

FERTILE FLORIDA

Editor, RADIO NEWS:

I was interested in the recent article in your magazine by Armstrong Perry entitled "Fertile Florida."

Being an inhabitant of that State, I feel that perhaps Mr. Perry—old-timer though he is—is not acquainted with all the conditions. I am not criticizing the article. What he says is all true enough, but being one of those restless and curious persons who have to pry into all things not exclusively someone else's business, the writer has been experimenting with radio reception for the past two years. Before last May the stations jammed each other. Since wave-lengths have been changed, I can't pass five degrees on my secondary dial without being jammed by spark transmitters. No, they are not amateurs. The amateurs are a decent outfit as a rule. I can drop down near the bottom of the dial and hear plenty of C.W. and mighty few sparks. Ship and shore stations on all wave-lengths from 400 to 600 meters literally tear up the air. Of course, I realize that most of the sparks do not reach very far, but they come in over half the dial on a three circuit receiver so you can see that we have no freedom from them. The majority of people who are prospective buyers of radio sets get disgusted with such conditions. I know, as I have friends who do not possess radio sets and who would have them if it were not for the fact that there are only a few stations that come in without spark interference. I have often counted six different spark transmitters working at once. Probably there were six or eight more without counting the ones that happened to be silent at the time. Why do they use rock-crushers? It seems that for the good of the radio business spark transmitters should be abolished by law. C.W. with less power will reach farther and not mess up the air to the extent of causing a lot of good receivers to be dusty and rusty because their owners are not technically inclined and care only for programs. For about eight months out of the year we have it badly. The remainder of the time we have it almost every night, but not so badly. One night, recently, it was really cool and almost frosty, but there was a constant bombardment of static. We have

Build a beautiful long distance set—for much less money!

There is no thrill like the thrill you get from a set of your own creation. No joints to solder, no tools required, when you use R P M Standardized Units. Merely connect binding posts. Each R P M Unit is complete in itself. Moulded Bakelite—extremely beautiful. R P M Units are efficient in performance, superior in quality and have absolutely no body capacity. You can pay more but you can't buy better units. Hook-up circuits in every package.



This is the No. 102 R P M Mounted Variometer. Bakelite panel. A great performer . . . \$8

R P M instruments—being standardized—permit changes in hook-ups enabling you to try different circuits by merely rearranging units. You can start with a few R P M's Units and add additional units as desired. Twenty years' manufacturing experience and latest machinery make possible these low prices. Ask your dealer—or write us. Unconditional guarantee.

RADIO PRODUCTS MFG. CO.
667 West Fourteenth St. Chicago



A UNIT FOR EVERY RECEIVING PURPOSE MOUNTED AND UNMOUNTED VARIOMETERS, VARIOCOUPERS, VARIABLE CONDENSERS, COUPLED CIRCUIT TUNERS—ALSO DETECTOR AND AMPLIFYING UNITS.

Ask Your Dealer For a
MONTROSE VERNIER CONDENSER
The condenser with genuine bakelite end pieces. Has positive contact between the vernier plate and main shaft. Will get the results where others fail, guaranteed to give entire satisfaction.
MONTROSE MANUFACTURING CO.
1200 Bedford Ave., Brooklyn, N. Y.

The **Sodion** Tube
CONNECTICUT TELEPHONE & ELECTRIC COMPANY
CONNECTICUT

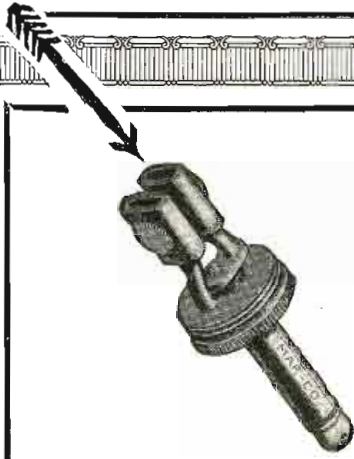

Oval binding posts enable you to connect one or two head sets, regardless of variations in size of terminal tips.

Investigate the MAR-CO DOUBLE Sta-Put PLUG

Most recent among MAR-CO improved radio devices, the DOUBLE Sta-Put PLUG offers a simple and satisfying solution to the problem of how to increase the audience for your set.

Requiring no tools, it's the simplest thing in the world to unscrew the protecting sleeve (not shown in the cut above), slip the 'phone terminals into the oval binding posts, and fasten them securely with the set screws, establishing perfect and permanent contact.

And the MAR-CO DOUBLE Sta-Put PLUG takes no more space than a plug holding only one set of terminals.

Nothing yet on the market equals the
MAR-CO DOUBLE Sta-Put PLUG

100% Efficient



Price 50c each



MAR-CO MULTI PLUG
Hard rubber casing. Metal parts nicked. Will take one pair of phones, two or four in parallel, two or three in series.....\$2.00



MAR-CO FORMICA JACK
These Jacks are highly nicked and insulated with formica. Contacts are sterling silver. Extra Washers allow wide range of panel adjustment. Electrical and mechanical construction makes short circuit impossible. Special easily connected terminals.

- No. 3 open circuit.....\$.60
- No. 4 closed circuit70
- No. 1 double circuit80
- No. 5 single filament85
- No. 6 double filament 1.00



MAR-CO STA-PUT JR. PLUG
No tools necessary to connect. Fits any tip. Metal parts nicked. This is the smallest practical plug on the market. 50c



MAR-CO SHUR-GRIP PLUG
Screw adjustment of chucks. Hard rubber insulation. Metal parts nicked. No tools necessary to fasten..... 75c



MAR-CO STA-PUT PLUG
Built to meet all requirements. Fits any tip. No tools necessary..... 40c

Ask your
Dealer for

RADIO MAR-CO PRODUCTS

MADE BY

MARTIN-COPELAND CO.

Providence, Rhode Island, U. S. A.

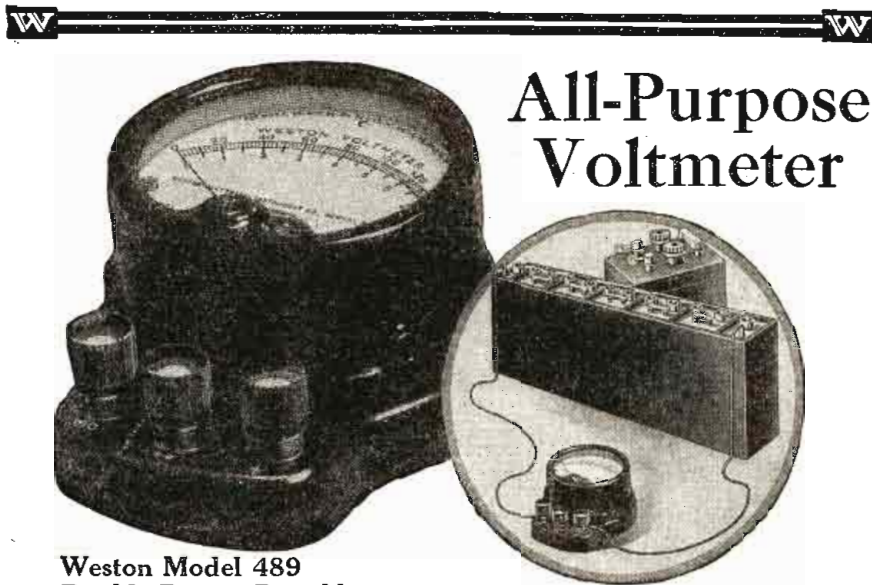

All-Purpose Voltmeter

**Weston Model 489
Double Range, Portable**

EVERY good set deserves one. A high resistance, double range, portable instrument for accurately measuring filament, plate and grid voltages. Locates trouble immediately. Eliminates guessing. Instantly indicates the state of batteries. Invaluable for accelerating exact tuning, lengthening tube life and eliminating noise. Ranges 150 and 7½ volts.

Write to-day for complete information. If your dealer cannot supply you, we will fill your order direct.

Weston Electrical Instrument Co., 173 Weston Avenue, Newark, N. J.
Branch Offices in All Principal Cities



every variety. Sometimes it sounds like a lazy surf. Sometimes like heavy artillery, sometimes like 150 machine guns just around the corner, sometimes like all of them together. When it gets like that, you couldn't hear Arlington's old spark set on the next block. Unfortunately we can't legislate static out of existence. Now, as we have no local stations to tune to, it is DX or nothing with us. We had a local station, but it quit working, so you can understand why radio is not a howling success in Florida. Here in Tampa we have a very bad power line noise, but we will find it some day and take steps to eliminate it. If we can get rid of spark interference, it will be a big boost for radio. If static can be overcome to permit year-round operation of sets, I will surely act on Mr. Perry's suggestions and clean up. Every set you sell that makes the buyer disappointed is a step farther away from the harvest Mr. Perry so optimistically describes. The fault is not with radio. It is merely that in Florida we have the worst possible conditions, particularly as all reception must be DX of necessity. My own set brings in WEAJ too loud for comfort. Also I can bring in WJAX on ground alone, clear but not loud. Also I can bring in Havana on a loop; not bad for a regenerative set. These are only stunts, but you can see what sparks will do to such a set on an aerial. There is no relief in sight.

H. SCHBAUGH,
304 E. Amelia Ave., Tampa, Fla.

SUGGESTIONS CONCERNING A RADIO TAX

Editor, RADIO NEWS:

I have just concluded Mr. Yates' article on "Shall We Have a Federal Radio Tax?" As he states that a monthly tax of 50 cents along with a small tax on manufacturers would amount to \$30,000,000 and said amount spent discreetly would pay for broadcast service, allow me to say that I will stand behind such a tax if the following addition to this plan is made:

As an example we will say that each station will get \$100. If each station were to get \$500, they could supply a better class of entertainment, could they not? Common sense answers, yes.

Now it is only necessary for a city to have one or two stations and not four or five. By eliminating these four or five stations, the \$100 received could be given to the two stations that can be picked by vote of the listeners of that town or city. In that way an excellent program is assured.

You will notice I suggest picking two stations: my reason being, one can broadcast a popular program such as jazz bands, singers of popular songs, etc.; the other station could broadcast opera, classic recitals, talks, lectures, etc., and the listener could take his or her choice. If the other stations wish to continue broadcasting, let them do so at their own expense.

To me, this is the ideal way, but no doubt others will think differently. I will watch the publishing of suggestions and see what others have to say.

H. C. TETLEY,
129 33rd St., Brooklyn, N. Y.

ADVERTISING BY RADIO

Editor, RADIO NEWS:

Upon receipt of the November issue of RADIO NEWS, I read the article "Advertising by Radio," by Chas. W. Eddy, Providence, R. I. I also read the article "Radio Public Impatient with Advertising Talks," in the September issue, by J. Strickland King, New York.

I wish to voice my sentiment on this subject. I heartily agree with Mr. Eddy's opinion. As Station WJAZ of Chicago put it recently, "It is the only thing we get for nothing." It seems to me to be a very sel-

Ackerman LOUD SPEAKER

Complete.
Ready for
Immediate
Use.

\$9.50

Delivered
Anywhere
in the
U. S. A.

**A marvelous speaker for
the price of a headset.**

Superior to many of the higher-priced amplifiers. Thousands of radio fans have welcomed this popular-priced quality speaker.

Standing 21" high, with 11" bell and made of heavy metal, eliminating vibration, together with its special loud speaking unit, this speaker reproduces voice and music far beyond expectations. Finished in plain black or brown; also special alligator grain in black and green.

If your local dealer is unable to supply you, send order direct to us and pay postman on delivery.

Sold on a Money-Back Guarantee

Ackerman Brothers Co., Inc.
301 West 4th St. Dept. ("R. N.") New York City



This speaker has been selected as the best value by the largest selling organization in the country.

Parts and Accessories
for makers of radio apparatus

GERACO
PROVED RADIO PRODUCTS

Details and Prices on request
GENERAL RADIO CORPORATION
Sole & Distributors of
First Quality Radio Equipment
including **MUSIC MASTER RADIO Reproducer**
10th and Cherry Streets Philadelphia



Atlas

TRADE MARK

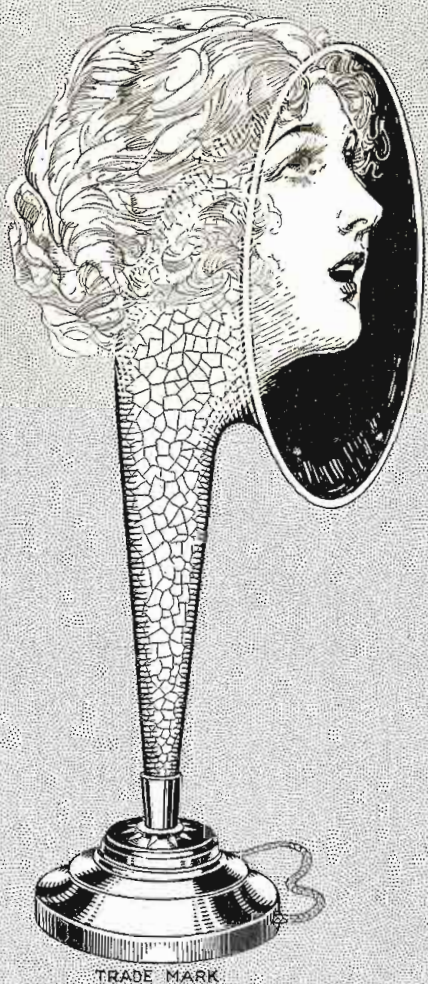

TRADE MARK

RADIO-REPRODUCTION LOUD SPEAKER

MUSIC AND SPEECH REBORN

EVERYWHERE
acclaimed the most
satisfactory radio repro-
ducer. Your own ears
will reveal this
superiority.



Write for Booklet "F"
AT ALL GOOD DEALERS
Complete \$25.00

Atlas Loud Speaker Unit

With Phonograph Attachment . . . \$13.50
Without Phonograph Attachment . . . \$12.50

Sole Canadian Distributors
MARCONI WIRELESS CO. OF CANADA, LTD.
Montreal, Canada

Multiple Electric Products Co. Inc.

2 Orange Street

Makers of Mono—TIME-LAG FUSES—Multiple

Newark, N. J.

DISTRICT OFFICES AT

Chicago, Baltimore, Philadelphia, Boston, Pittsburg, Atlanta, Detroit, Charleston, Kansas City, St. Louis, Louisville



CONTINENTAL

"New York's Leading Radio House"

Announcement—

As the constant and extensive growth of our wholesale business now requires the undivided attention of our entire organization we have discontinued all retail activities and closed our store at Six Warren Street on January first, 1924.

Our present main office at Fifteen Warren Street, New York, will be enlarged and made ready for the still greater demands that we expect will be put upon it by our intention to Serve the Dealer with all our energy and ability.

CONTINENTAL RADIO and ELECTRIC CORPN.
New York

CONTINENTAL RADIO and ELECTRIC CORPORATION
FIFTEEN WARREN STREET, NEW YORK, U. S. A.

BABY AUDIOPHONE

TRADE MARK
REG. U. S. PAT. OFFICE

The New Model

big in volume—big in value—but low in price. The Baby Audiophone offers a real high grade Loud Speaker at a popular price.

The same goose neck and horn used in the Senior Audiophone help to give the big volume and good quality in the smaller size Loud Speaker. The Audiophone line is now very complete with

- Senior Audiophone . . . Price \$32.50
- Junior Audiophone . . . Price 22.50
- Baby Audiophone . . . Price 12.50



Bristol One Stage Power Amplifier

No "C" batteries required. It provides the additional volume necessary to bring in far distant stations on the loud speaker. Price \$25.00

Ask for Bulletin 3012-S telling about the entire Audiophone Family.

THE BRISTOL COMPANY, Waterbury, Conn.

fish attitude to expect the broadcast stations to furnish us with the entertainment, which they give entirely at their own expense.

When I attend a picture show, I go on my own time; a time when I am at leisure, and go for diversion and rest. Should I, because of this fact, complain if a few advertisements are put on the screen? I have even more reason to complain because advertising is shown on the screen, than I have because advertising talks are made over the radio, for I pay for admittance to the picture show, and I pay nothing for the privilege of listening to radio programs.

However, I believe that only a minimum amount of advertising by radio should be carried on, as too much would be a detriment rather than a benefit to radio broadcasting. I am of the opinion that if advertising were carried on as outlined in Mr. Eddy's letter, radio broadcasting could become more self supporting, and thereby able to secure better talent and give more frequent programs than we now enjoy, at the "fabulous" cost to us BCLs of listening possibly five minutes to an advertising talk.

Before radio as an advertising medium is condemned, I believe the sentiment of the broadcast listeners should be obtained. I am not taking this stand because I have something to advertise, for I have not. I am merely a BCL, and one of the most enthusiastic of them. I am merely taking the stand that we should not be so utterly selfish as to expect something for nothing. A few minutes listening to an advertising talk over the radio I consider a very nominal price for the privilege of listening to radio broadcasting programs.

ELIHU G. WOODWARD,
Neame, La.

RESULTS WITH THE ST-100

Editor, RADIO NEWS:

It was with some diffidence, after reading Mr. Scott-Taggart's statement that the chief merit of the ST-100 Circuit lay in giving loud signals within 50 miles of a broadcast station, that I decided to give the hook-up a trial. The nearest broadcast stations to this point, Carruthers, Sask., are roughly 150 miles distant, and are not of the most powerful type.

The results were surprising. On the night of November 26, when American and Canadian stations were endeavoring to span the Atlantic, I heard about 20 stations, from Calgary to Pittsburgh. Stations within 1,000 miles were received with sufficient volume to operate a loud speaker. The more distant stations such as Dallas, Texas, were of comfortable volume. No capacity effects were found with the head-phones.

A few deviations from the original specifications, as set forth by the originator of the circuit, were tried. Instead of the D. L. coils, a variocoupler was used, also .001 M.F. variable condensers were used, both in the aerial lead, and across the secondary of the coupler. A resistance of one-tenth megohm was used, as recommended, although 50,000 ohms would probably improve matters. A crystal rectifier was found to function perfectly. A negative bias of 4½ volts was placed on the grids of the 201A tubes, using dry cells. This bias served to give greater amplification with clearer signals. A .001 M.F. condenser across the "B" battery proved of value in stabilizing the set.

As I write this, I am listening to WOAW at Omaha, Neb. The music is coming in clearly, and with sufficient volume for the average loud speaker. Clarity is exceptional. The filament control is not critical, and low frequency oscillations may be easily subdued, without sacrifice of volume.

It seems that any reliable make of equipment will function in this circuit, although care must be taken in the selection of the variocoupler, to see that there are sufficient turns in the secondary, at least 50. Separate rheostats are desirable, if not absolutely necessary. The R.F. lead on the crystal,

Buy Your Tubes Direct

SENT PREPAID IN 24 HOURS

- \$6.50 Frisco 1½ Volt WD-12 Type, Detector or Amplifier, Guaranteed \$4.50
- \$6.50 Frisco 6 Volt 200 Type, Detector, Guaranteed 4.95
- \$6.50 Frisco 6 Volt 201 A Type, Amplifier, Guaranteed 4.95

WESTERN RADIO HOUSE

2922 FULTON STREET BROOKLYN, N. Y.

☸ RADIO ☸

Complete Stock—Both Sets and Parts—
All Makes

ROSE RADIO SUPPLY

129 Camp Street New Orleans, La.
Send 10c for latest catalog

Brandes

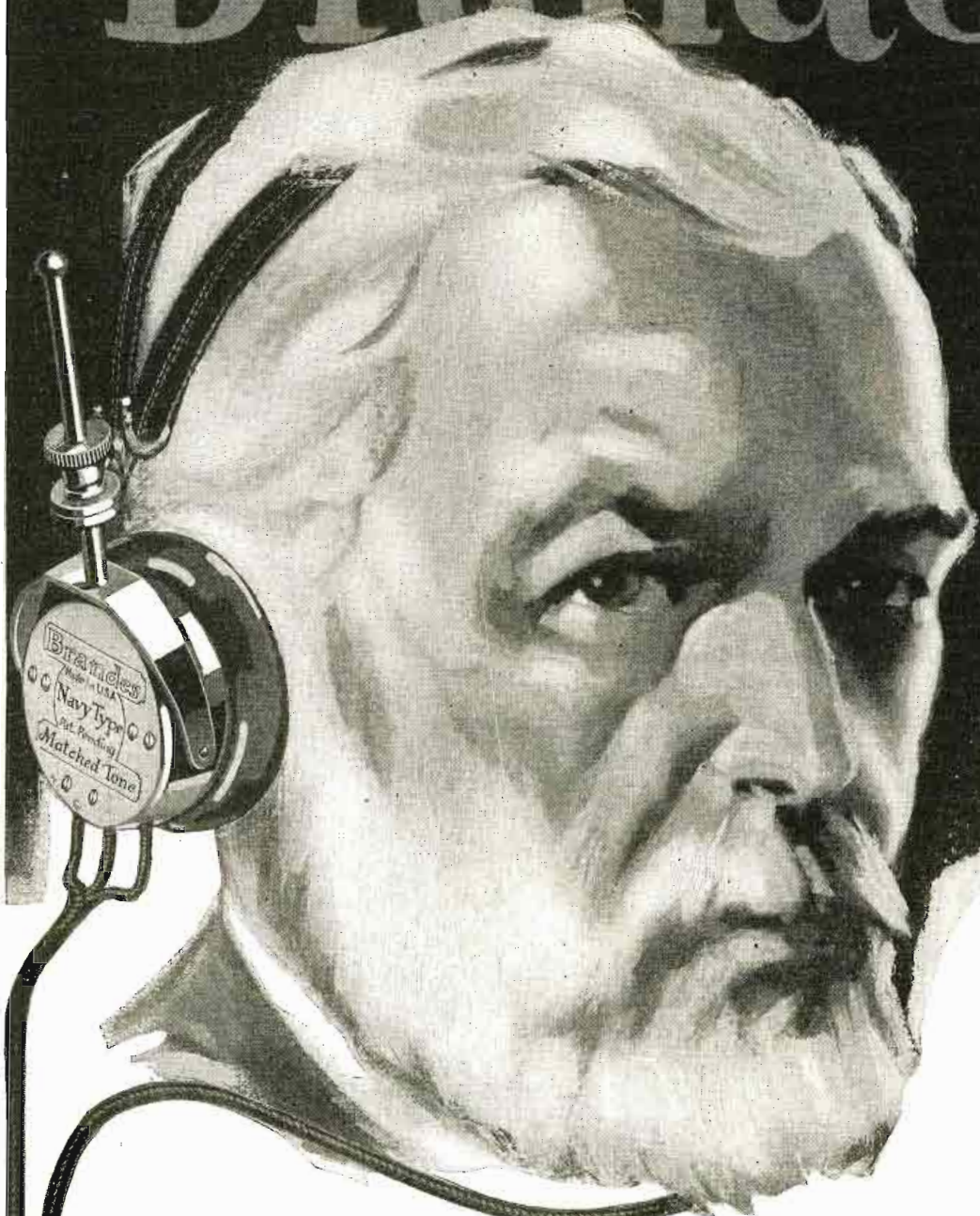

THE men who developed radio used the Navy Type headset for their delicate experiments. Its fine construction, *matched tone* and shielded cord caused them to single it out as the one headset for truly accurate work.

The shielded cord—an exclusive feature—eliminates “cord capacity howls.” The leads are encased in a metal braid that is continued to a third terminal—grounding all metal parts of the receivers and assuring purest tone.

Matched Tone

TRADE MARK. REG. U.S. PAT. OFF.

Radio Headsets

© C. Brandes, Inc., 1924



AMRAD

Basketball Variometer

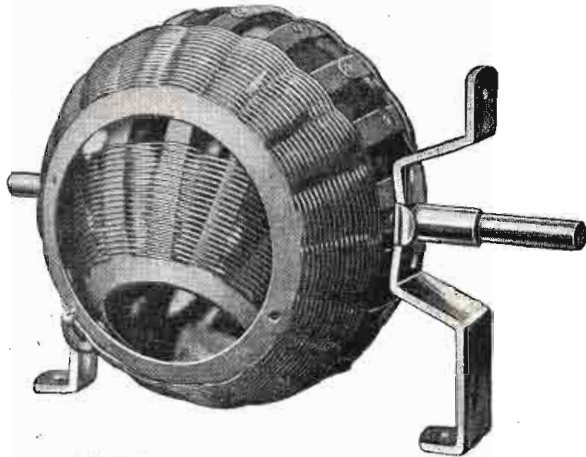

PRICE ONLY \$3.75

Improved Type 3650

Most Efficient

In an article describing eight types of Variometers, a leading technical editor said:—

"Variometer No. 4 (The AMRAD BASKETBALL) is probably the most efficient instrument of the lot on the market. One glance at its construction will show that the possibility of electrical losses has been practically eliminated. The semi-skeleton basketball winding has reduced the distributed capacity losses to a minimum. The sparing use of wax-impregnated fibre insulation has reduced the leakage losses

to practically zero . . . THIS VARIOMETER HAS BEEN SELECTED BY THE BUREAU OF STANDARDS FOR MOST OF THEIR EXPERIMENTS AND THIS ITSELF IS A VERY CONVINCING PROOF OF ITS ELECTRICAL EXCELLENCY."

How to Purchase

Order Basketballs from your dealer. If you can't get them, send us your nearest dealer's name or forward remittance direct to factory and we will ship promptly. Our money-back guarantee assures satisfaction.

Write now for new Bulletin V describing the Amrad Basketball (improved type). No stamps.

DEPT. N

AMERICAN RADIO AND RESEARCH CORPORATION MEDFORD HILLSIDE, MASS.

ONE THOUSAND AGENTS WANTED

WE want one thousand agents to sell subscriptions to RADIO NEWS, SCIENCE AND INVENTION and PRACTICAL ELECTRICS. We will pay a generous commission for this work and help you in every way. Our three publications are leaders in their fields, ready sellers and this is an offer well worth your while. A few spare hours a day will bring you a handsome return. Write regarding our proposition at once and be the first one to get started in your vicinity.

Experimenter Publishing Co.

HERBERT H. FOSTER, Sales Manager

53 Park Place

New York

as indicated by the manufacturers, should be connected to the plate.

In conclusion, I would say that, after trying many circuits, including reflexes, supers, and others, I have little hesitation in recommending the ST-100 to the fan who wishes a receiving set, with a maximum of volume, and dependable clarity, for a minimum of equipment.

J. A. YOUNG,
Carruthers, Sask., Canada.

IT MUST COME TO THIS

Editor, RADIO NEWS:

I have been a reader of your publication for a year or more and in the January number your editorial expressed exactly the broadcast situation as I have figured it out the past year. Feeling that neither myself nor many of my friends who are listeners-in were showing appreciation of the privileges we were enjoying, I had struck off a number of postals and distributed them among my friends and acquaintances who listen-in, with the instruction, "Use these freely." The trouble is that all of us broadcast listeners are getting something for nothing and—we are not caught at it. I am dilatory—I confess it—although I have sent a good many cards in appreciation. Reception is so easy, and while we have the best intentions about expressing our appreciation, we simply do not do it. There is no question but what you have hit the crux of the situation. May I offer a suggestion?

These appreciations would be sent more promptly and more surely if the material were at hand. By reason of your standing in the radio world why cannot you suggest to the National Broadcasters Association that it compose a standard card so that one form would apply to any section of the United States? Let the Association have a million printed and sent to all dealers and stations throughout the country for free distribution. If the cost of this is prohibitive, (in proportion to their own interests) the cards could be packed in envelopes in quantities of 15 to 25 and sold for 5 cents an envelope.

All the purchaser need do is buy an equal number of one-cent stamps and fill out the card when requested by the broadcast station or when he feels so inclined through his satisfaction with what he has heard. *If cards for this purpose are at hand, he will do it—otherwise, not.*

Mr. Yates' article regarding a Federal tax is analogous to the above and should be seriously considered by the listening-in public. If we all lean back and take the present broadcasting for granted—as our due, in fact—we may soon be looking at our receiving sets and sadly saying in apology, "Yes, we have nothing to listen to."

We, the public have been indifferent too long. Let's do something!!

CARLETON S. GIFFORD,
340 Commonwealth Ave.,
Boston 17, Massachusetts.

FROM A SEAGOING OPERATOR

Editor, RADIO NEWS:

May I use your magazine as a medium to express my feelings, as many another commercial operator would do?

The question of today, the way radio is taking leaps and strides in advancement and improvement, is: "Is the wireless operator at sea losing his place regarding officer's treatment and pay?" Now, my answer to that question is that he is, absolutely. I haven't been on many ships, but I've been in the amateur game and am now wearing out my second commercial ticket.

I have met operators who have told me how they are being treated on ships now-a-days, and in most cases a lot of these instances have a tendency to discourage a fellow. I've found that the crews of some ships have not the slightest respect for the

The New **KEYSTONE** RADIO \$1.50 LIGHTNING ARRESTERS

The new Keystone Arrester is made of genuine Bakelite with moulded-in binding posts and provides maximum protection against lightning and static charges. It is cheap insurance against damage to home and receiving set. Fully approved by Underwriters. Absolutely weather, dust and damp proof and has no vacuum to lose—it will operate for years. This pioneer arrester is backed by 31 years' experience in lightning arrester design. Sold in a red box by Dealers everywhere.

ELECTRIC SERVICE SUPPLIES CO.
17th & Cambria Streets,
PHILADELPHIA,
Monadnock Bldg Chicago,
50 Church St. New York.

PATENTS

To the Man with an Idea

I offer a comprehensive, experienced, efficient service for his prompt, legal protection and the development of his proposition. Send sketch, or model and description, for advice as to cost, search through prior United States patents, etc. Preliminary advice gladly furnished without charge. My experience and familiarity with various arts frequently enable me to accurately advise clients as to probable patentability before they go to any expense. *Booklet of valuable information and form for properly disclosing your idea free on request. Write today.*

RICHARD B. OWEN
PATENT LAWYER
2 Owen Building, Washington, D. C.
2276A Woolworth Bldg., N. Y. City

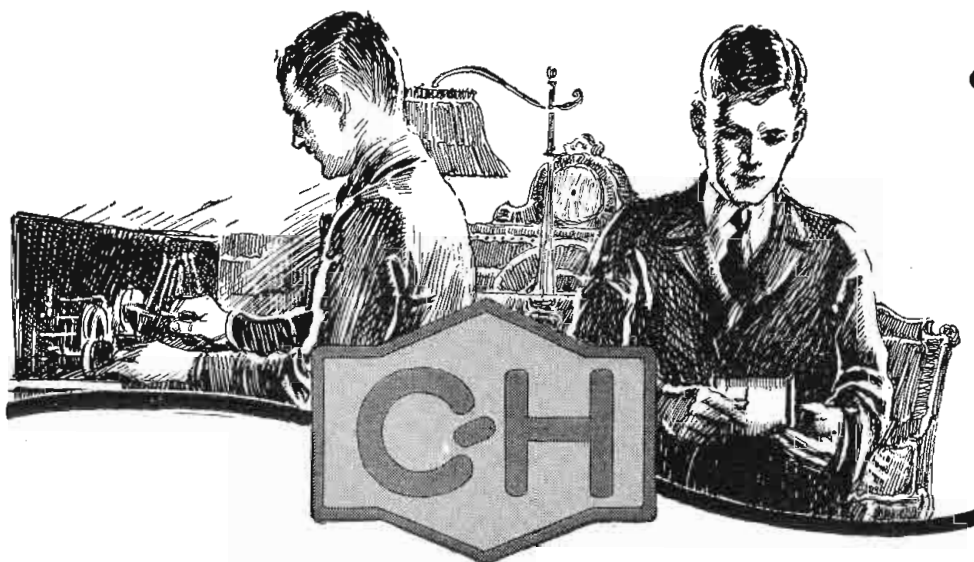

You Can Build With Confidence When You Demand This Trade Mark

Radio men of experience agree that more sets are ruined by careless buying than by careless construction. Most people take pains to see that diagrams are followed faithfully—that connections are tight—and instruments are properly placed. But this alone cannot assure results—the poor design of one single part can destroy the efficiency of the most elaborate set. Radio parts must be purchased with a knowledge of their maker—it is the only measure of their quality of which the average buyer can be certain.

A Complete Line of Radio Current Control Apparatus by the Most Famous Electrical Control Engineers

For more than a quarter of a century the name Cutler-Hammer has been demanded by engineers throughout the world in their specifications on current control. Gliding under the sea on the delicate apparatus of submarines; shooting skyward on the operator's handle of the modern office building elevator; keeping day and night watch over thousands of automatic industrial machines—in every branch of industry and in every country in the world you will find this famous trade mark justifying the confidence with which it was demanded. In radio it affords an easy way to be sure of quality in the parts you buy; demand it and build with satisfaction.

THE CUTLER-HAMMER MFG. CO.

Member Radio Section, Associated Manufacturers of Electrical Supplies
MILWAUKEE, WISCONSIN

"BUILT BY THE MASTER BUILDER"



Instruments of Guaranteed Quality Assure Success in Radio

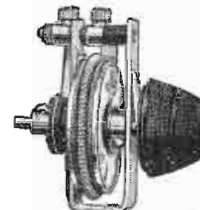

The C-H 4 Ohm Vernier Rheostat
Perfect detector tube control. Also furnished without vernier for amplifier tube control.

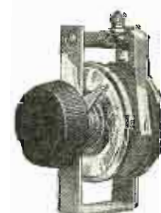

The C-H 30 Ohm Radio Rheostat
For control of the 1/4 ampere, "UV201A-C301A" type receiving tubes and the "UV199-C299" type.

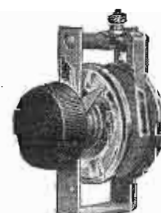

The C-H 125 Ohm Radio Rheostat
The rheostat that makes it possible to use a 6V storage cell with the UV199 or C299 tubes.

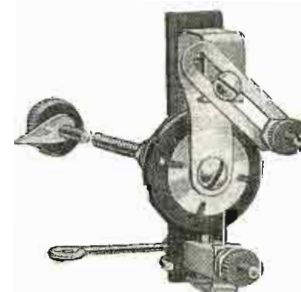

The C-H Variable Grid Leak
Mounted on the tube socket—panel controlled. Adjustable for all grid condensers.



The C-H Radio Potentiometer
The potentiometer with the resistance unit that does not wear and cannot be displaced under constant usage.

CUTLER-HAMMER





RADIO PLATE "B" BATTERIES

D-E-P-E-N-D-A-B-L-E

No. B-1, 22½ volts, \$3.00.
5 binding posts in steps of 1½ volts.

No. B-2, 45 volts, \$5.50.
5 positive taps.

No. B-16, 45 volts, \$4.50.
5 taps from 16½ to 22½ volts.

No. B-4, 22½ volts, \$1.75, for portable sets. 5 taps.

No. 3, Type C, 4½ volts, 70c. 3 taps.

WHEN you use **DIAMOND RADIO PLATE BATTERIES**, there's one place less you need to look for trouble. You **KNOW** they're good for endurance and power beyond other batteries you've had. Don't play tricks with your tubes. Give you more of your money's worth in uninterrupted radio entertainment. Get this better "B" battery **NOW**. Look for the **DIAMOND** trade mark. If your dealer has no **DIAMOND BATTERIES**, order direct, C. O. D.

DIAMOND ELECTRIC SPECIALTIES CORP.
103 SO. ORANGE AVE. NEWARK, N. J.
DEALERS—JOBBER, WRITE FOR PROPOSITION.

wireless man. The deck officers have now seemingly classed him as a "softy" and a hindrance to the ship and, in some cases, taunt him about his profession. In port the operator has time off, and why shouldn't he? He puts in his time at the radio equipment and that is all he is there for. They have even tried sticking the job of "checking cargo" on to him without extra pay, while they were figuring on giving him the "laugh" and then run ashore for a good time. It did not work out so well, and now they are peeved because of it.

There have always been arguments between the officers and the radio man regarding his position on board ship and my letter is to try and clear up the question. First of all, radio apparatus is installed on board vessels for the purpose of sending out distress signals in case of a serious accident and, also for handling the company's business between the vessels and the home office; on passenger vessels, also for use handling private traffic. The radio operator is put on board these vessels for the express purpose of handling the radio apparatus and nothing else; therefore, why should he check cargo and operate the "blinkers?" The latter is the job of the officer on watch. It does not state on his ticket that he must do any of these things.

The officers also joke him about his profession, but when it comes to the hearing of news and, in extreme cases, of sending the SOS, who do they look to? You see, in extreme cases they even show a little faith in the radio man after all. That's human nature for you. I have also found that the more news you strive to get, taking pains to write it up neatly, the less they appreciate it. They either say that the news is taken from newspapers or that you have made it up. Another case of human nature that makes a fellow certainly disgusted. You can give news every day for a year and they will never notice it, but just miss it once during that time and there is a terrible blow about it. Are we compelled to receive "news" for them? There is no law compelling us to do so, and it does not have to be done. It is done nevertheless, to make life on board ship a little pleasant for everyone. Can you explain this? I've been actually forced to wait my turn at the dining table (officers') just because the steward wanted to eat first. Is this right? I protested, but to no avail. This shows in a way that the radio man is gradually falling to a state where he will be dining in the sailor's mess and making his quarters in the forecabin. There is only one way of solving the present problem as regards the seagoing operator and, that is to have them all united under an organization once AGAIN, which will no doubt help toward retaining his old place on shipboard and give him decent pay. He is a licensed man and is entitled to officer's treatment. He is put on shipboard for a purpose, and for a radio purpose only.

A. J. CHARTERS,
Radio KUVB.

REAL STATIC

Editor, RADIO NEWS:

In the *Literary Digest* I noticed a quotation from another magazine with regard to static electricity which seemed to have its nest in the north-western mountainous section of Mexico and suggested that if somebody could answer "why," perhaps a solution could be found to the problem of controlling it.

It is a known fact that not only surrounding stations, but passing ships have traced such sections as the source of great static disturbances. I can't tell why such a condition exists, but if my little experience and knowledge will contribute in any way to the solution, I am glad to help.

It is known that electrical disturbances occur with more frequency where ore de-

A FAMOUS CLEARSTONE PRODUCT



New Goldcrest Model 60—\$60.00

SATISFACTORY SERVICE—EVERYWHERE

The new **GOLDCREST** model 60 is the famous old Clearstone model 60 with the wonderful reputation of combined efficiency in performance and simplicity of operation. The new **GOLDCREST** receiver is the final word in combined beauty and ruggedness of construction.

One stage of radio frequency amplification gives extreme range and the efficiency of the unit parts, all of which are manufactured in our own plant, means over all efficiency of the instrument which will operate a loud speaker with remarkable volume and clearness. It is the receiver for which you are looking for your home. Write for free circular describing our various models in detail.

DEALERS AND JOBBERS—Write for our interesting proposition

Model 60	\$ 60.00
Model 61	75.00
Model 62	120.00

THE CLEARSTONE RADIO COMPANY
CINCINNATI, OHIO

FREE

COMPLETE PRICE LIST

Aitken Radio Co.

504 Superior St. Toledo, Ohio

DELTA GOLD STRIPE

Radio Headphones

DELTA ELECTRIC CO.
Marion, Indiana



E·D·Elliott of Milford, N. Y. establishes a record

Think of getting Fairbanks, Alaska and La Palma, Panama, or London, England, when you live in New York! Yet this is the experience of Mr. Elliott, one of the thousands of enthusiastic users of MIRACO sets. With the inexpensive outfit shown here, priced at **only \$29.50** he received the following list of stations—*results that would do credit to a set costing three or four times as much.*

- | | | |
|--------------------------|-------------------------|------------------------|
| London, England | WCT Chicago | WTAM Cleveland, Ohio |
| WLAY Fairbanks, Alaska | WMC Memphis | WWJ Detroit, Mich. |
| NNW La Palma, Panama | WBAK Harrisburg | WJAZ Chicago, Ill. |
| PWY Havana, Cuba | WLAK Bellows Falls, Vt. | WDAP Chicago, Ill. |
| CPAC Calgary, Canada | WBAN Paterson, N. J. | WGY Schenectady, N. Y. |
| CJCY Calgary, Canada | WOC Davenport | WJZ New York City |
| KSFL San Francisco, Cal. | WPAP Winchester, Ky. | WEAF New York City |
| KPBC San Diego, Cal. | WMAM Beaumont, Texas | WOR Newark, N. J. |
| KJHQ Seattle, Wash. | WWZ New York | WHAS Louisville, Ky. |
| WJAR Providence, R. I. | WBAY New York | WEAB Dodge, La. |
| KFBU Lorine, Wyoming | WGL Philadelphia, Pa. | WKD Gainville, Ga. |
| WEV Houston, Texas | WMAF Dartmouth, Mass. | WUQ Washington, D. C. |
| WMAT Duluth, Minn. | WBAG Bridgeport | KMO Tacoma, Wash. |
| WPM Washington | WCAP Decatur | KOB New Mexico |
| WRAA Houston, Texas | WHN New York City | WDAR Philadelphia, Pa. |
| WHB Kansas, Neb. | WIAR Paducah | WPI Philadelphia, Pa. |
| KPHB Hood River, Ore. | WRP Camden, N. J. | WIP Philadelphia, Pa. |
| CFCA Toronto, Canada | WGAR Port Smith, Ark. | KDKA Pittsburg, Pa. |
| CKCE Toronto, Canada | WDAK Hartford, Conn. | WCAE Pittsburg, Pa. |
| CJCI St. John, Canada | WCAG New Orleans | KMN Butte, Mont. |
| WRP Dallas, Texas | WHAY Wilmington | KQP Hood River, Ore. |
| NGE Miami, Fla. | WOAY Scranton, Pa. | WHAZ Troy, N. Y. |
| KGA Oakland, Cal. | WGBY Birmingham | WGR Buffalo, N. Y. |
| KFEL Denver, Col. | WSB Atlanta, Ga. | WMAV Auburn, Ala. |
| WIAZ Miami, Fla. | WMU Washington | KFFE Boise, Idaho |
| WKY Oklahoma City | WCAT Rapid City | WNAL Omaha, Neb. |
| WDAE Tampa, Fla. | WRC Washington | WCAP Washington, D. C. |
| WEB St. Louis | KYY Chicago | WQAB Springfield, Mo. |
| WRK Hamilton | KFCB Phoenix | WFB St. Louis, Mo. |
| WHAB Galveston, Tex. | WWT Buffalo, N. Y. | WDR Detroit, Mich. |
| 6ZV Salt Lake City | WHAS Louisville, Ky. | WNAC Boston, Mass. |
| NAA Arlington, Va. | WCAY Milwaukee, Wis. | WBAZ Columbus, Ohio |
| WJAX Cleveland, Ohio | WLW Cincinnati, Ohio | CFZC Montreal, Que. |
| WBZ Springfield | WDAW Omaha, Neb. | WMAK Lockport, N. Y. |
| WOO Philadelphia, Pa. | WOQ Kansas City | WGF Des Moines, Ia. |
| WOS Jefferson City, Mo. | WPAW Wilmington | WHAM Rochester, N. Y. |
| WOK Pine Bluff, Ark. | WCE Minneapolis | WCAM Villa Nova, Pa. |
| WLAG Minneapolis | WCX Detroit, Mich. | WGAY Madison, Wis. |
| WEAZ Charleston | WLAZ Warren, Ohio | WWT Dearborn, Mich. |
| WJAB Lincoln Neb. | WAAS Decatur, Ga. | WGAN Orangeburg, S. C. |
| | | WWAJ Columbus, Ohio |



Radio's finest low-priced receivers

Here, in the improved MIRACOS, you'll find the same thrill of getting long distances, generally obtainable with only the most expensive and elaborate sets. To the whole family it will furnish entertainment, *unfailingly*, the whole year round—and at an initial price most every family can afford.

It isn't necessary, either, to be an expert at tuning in with the MIRACO. The operation is extremely simple. Scores of users everywhere tell us of the long-distance records they're making—Cincinnati hears 'Frisco, Denver hears Schenectady, New York hears Havana!

Such range as this is made possible through MIRACO'S many new refinements. Improved rheostats with multiple resistance windings enable you to use any type of tube, and a new aluminum shield prevents annoying body capacity effects. Shock absorbing pads prevent tube noises. Fully GUARANTEED against defects in material or workmanship. Price for 4-tube outfit shown above only \$54.50.

Other details of MIRACO receivers are explained more fully in our new bulletin. Write today for a copy.

The Midwest Radio Company

804 Main Street

Cincinnati, Ohio

The Improved MIRACO

MAIL COUPON TODAY

THE MIDWEST RADIO CO.,
804 Main St., Cincinnati, Ohio.

Gentlemen: Kindly send at once:

- Free bulletin.
- Agents' proposition.
- Dealers' proposition.
- Jobbers' proposition.

Name
Street address
City

HALLDORSON



4-Tube Sets
as low as
\$65.00

Radio Receivers

Beauty of design—clear and undistorted reception at long as well as close range—ease of control and selectivity—plus low price with the highest quality—has made the HALLDORSON RECEIVER the most popular set for the home. Beginners will appreciate the compact simplicity which enables them to secure maximum results. Write for our Descriptive Folder today.

Dealers and Jobbers:
Write immediately
for our attractive
proposition.

The HALLDORSON COMPANY

1772 Wilson Avenue

CHICAGO

posits are found, especially so where copper and iron abound. Such is the case around Arizona, New Mexico and the eastern part of California, but more especially so in the north-western part of Mexico, taking in the States of Chihuahua, Sonora, Sinaloa, Durango and Lower California, and heavier in Durango and Chihuahua.

This is the territory where static can be tasted and I say so from this experience. While going through the mountains in the State of Durango, on horseback, on a hot sunny day, I could constantly hear crackling like we hear through our receivers, but quite subdued and dry. Suddenly, without warning, a terrific peal of thunder sent my horse rearing, and simultaneously a bolt of lightning cut a tall tree in half from top to bottom killing three steers that were lying under it. These animals immediately began to puff up like inflated toy balloons and the next moment they burst with a "PUFF." Whether this started another disturbance I don't know but the next instant another bolt rent the atmosphere (rent is the right word, it did sound like tearing cloth and breaking sticks mixed in between). At the same instant my horse dropped like a piece of lead and I felt needles pricking my skin, a sensation which lasted for a half hour. My horse was dead and I was totally unhurt; why? I don't know. There was a taste of copper in my mouth for quite a while. I was with a party who had stayed behind a little and when they came up they said there was a peculiar smell in the air which I couldn't detect, probably because I had it in my mouth. They said it was like a soft fume of sulphuric or hydrochloric acid. During our travel through the mountains we observed other similar phenomena.

These electrical discharges also occur in the rest of the section previously mentioned, but heavier around a point which I would locate about 450 miles south of the International line and 150 miles from the California Gulf coast toward Mexico's main inland. This would bring the center of electric disturbances to the northern half of the State of Durango, Mexico. This is one of the most metallic spots on the face of the earth. There is one mountain near the City of Durango which is solid, virgin iron. This can be verified by consulting an encyclopedia, probably under "Durango." There is enough iron there to supply all the needs of the world for years to come.

"Metallic" localities may not be the cause of electricity in any form, but it probably attracts it and holds it as static, to become lively through the influence or pressure of atmospheric conditions. The crackling we hear through our receivers may be just a bolt or two killing a few cows in Mexico.

While I am on the subject of static I will give my experience in trying to invent an eliminator. I built a beautiful cage antenna and the drop or lead-in was also a cage of eight wires. The lead-in was of the same diameter as the horizontal, taken from the center and wire by wire. This drop tapered at the end and ended in a metallic ring at the hole where it should enter the building and from there it was grounded. Now the actual antenna I ran exactly in the middle of the cage and totally isolated from it, down the center of the drop cage, through the end ring without touching it and into the building to the receiver. The cage was made of No. 18 bare wire, and the antenna of No. 14 lighting wire, insulated. I was then ready for the great experiment; I had already figured my photo on the front page of RADIO NEWS and a picture of my antenna and own-make receiver, etc., etc. Everything was in readiness and working beautifully. I clamped on the headset, turned on the detector and two stages of A.F. and nearly had a fit. Then I switched around and connected my instrument to the cage and grounded the center wire. The results were as follows:
Using the center wire as antenna and the

The long-life tube!

Since their inception, radio vacuum tubes have been fragile. To knock or drop one incurred the expense of a new tube. But now there are

Myers Tubes

Practically Unbreakable

—so protected by their unique design that they have been dropped on the floor without injury.

But their sturdiness is only one feature. They are the most perfect detectors and amplifiers obtainable. Smaller capacity and no bunched leads mean less interference—more clarity and greater amplification. Actual tests, all over the world, have proved their supremacy.

Two types—Dry Battery and Universal (for storage battery). At your dealer's—or send price and be supplied postpaid. Write for free circuit diagrams.



(Actual Size)

\$5. EACH complete with clips ready to mount on your set; no sockets or extra equipment required.

E.B. Myers Co. Ltd.
Radio Vacuum Tubes
240 CRAIG STREET, W.
MONTREAL, CANADA

REMLER

Apparatus Radiates Quality
REMLER RADIO MFG. CO.

Home Office 182 Second St. San Francisco
154 W. Lake St. Chicago
30 Church St. New York

TUBES REPAIRED

Only Middle West Tube Service Station
8 Hour Service. No Extra Charge for Broken Glass.
WD-11, WD-12, C-11, C-12 \$3.00 Ea.
UV-200, C-300 2.75 Ea.
UV-201, C-301 3.00 Ea.
UV-201-A, C-301-A 3.25 Ea.
UV-199, C-299 3.25 Ea.
All Tubes GUARANTEED and Returned P.P. C.O.D.
DEY'S RADIO SERVICE
Dept. G. 235 Pine Ave. Chicago, Ill.

“GOLDEN-LEUTZ” “SUPER-PLIODYNE 9”

“The Perfect Broadcast Receiver”



Size 40 x 8 x 8

Weight 65 Lbs.

MANUFACTURED UNDER FARRAND LICENSE

A New Broadcast Receiver having 6 Stages of Tuned Neutralized Radio Frequency Amplification, Detector and 2 Stages of Audio Frequency Amplification

BUILT FOR PEOPLE THAT WANT THE BEST

Complete Illustrated Catalog and Instruction Book mailed on Request

GOLDEN-LEUTZ CORPORATION

476 BROADWAY

NEW YORK CITY



"Got twenty Stations I never heard before"

At our booth at the Chicago Radio Show, we heard from you countless expressions like this: "My set is now 100 per cent more selective and easier to tune," "I put three UNIVERNIERS on my neutrodyne set and last night got twenty stations I never heard before," "Your UNIVERNIER on a plain variable condenser makes a vernier condenser out of date." We were even asked repeatedly how to apply a UNIVERNIER to a vernier condenser. Such comments from people who know must have a logical foundation. Briefly, the facts are as follows:



Micrometrical control of the whole variable condenser, the variometer, the tickler, etc., is the only practical and theoretically sound method for obtaining efficient vernier control. The entire range of your set is thus under continuous vernier control, permitting reception of many signals which are passed by unknowingly with intermittent or no vernier control.

Made in two sizes:
No. 188 for 3-16" shafts
No. 251 for 1-4" shafts



The UNIVERNIER simply takes the place of the ordinary knob without altering your set. The simple mechanism contained within the knob gives you a twelve-to-one ratio and also direct control at will. The pointer always indicates the true position of the instrument, because it is rigidly attached to the shaft. The UNIVERNIER has the approval of leading radio engineers, and we submit it with confidence for yours.

You will find that the UNIVERNIER will dress up your panel, and give it a business-like, clean-cut appearance.

- The UNIVERNIER with black knob and silver dial . \$1.25
- The UNIVERNIER with mahogany knob and gold plated dial . \$1.50

At your dealer or postpaid on receipt of above amount.
Dealers and Jobbers: Write for Discounts.

THE WALBERT MANUFACTURING COMPANY
935 Wrightwood Ave. Chicago, Ill.

cage grounded, the static noises were so strong that they were deafening. Using the cage as antenna with the center wire grounded or not, the noises were greatly diminished or rather, were natural. I took the cage down and used my regular antenna and the static noises were as loud as when I used the cage.

Some experimenter might find this data helpful. Reversing the construction, whatever is the reverse, will eliminate static on outside antenna. Good luck to you.

A. CARDENAS,
101 Paloma Ave.,
Venice, Calif.

SAN JUAN STATION STILL ON THE AIR

Editor, RADIO NEWS:

In reading over the January, 1924 edition of RADIO NEWS, I noticed an article entitled, "San Juan's only broadcast station is now silent." The article goes on to say that the station has been silent for three months and that the radio fans sit idly at home brooding over their misfortune.

It is beyond my knowledge where you might have obtained this information, but I can assure you that it is incorrect, as I was in Porto Rico only three months ago and used to listen in on WKAQ's programs which were indeed very interesting. I might call to your attention the service this station rendered to the fans in Porto Rico and neighboring islands during the Dempsey-Firpo encounter. A special telephone line was installed between the French Cable office and the studio of WKAQ. When the results for each round were received they were immediately telephoned to the studio where the announcer informed the public in both Spanish and English, the time at which they were announced in Porto Rico and in the United States differing only by a few minutes.

Regular scheduled concerts are held on Tuesdays and Fridays from 9:00 to 10:30 Porto Rico time, which is equivalent to 8:00 to 9:30 E. S. T. Besides these two there is one on Wednesdays from 8:00 to 9:00 Porto Rico time, consisting of music broadcast from the Rialto theatre. At present there is the WKAQ orchestra composed of native talent which is doing its best to please the public.

The expenses of running the station are being met by the prominent radio dealers and by the Porto Rico Radio Club. Lack of co-operation on the part of some of the dealers was the reason this station was silent about six months ago, but at present it is on the air three nights a week besides giving out the weather report every night at 9:00 o'clock.

ARTHUR E. SALDANA,
132 College Ave.,
Ithaca, N. Y.

"TUNE IN" with Rosendal "B" Batteries

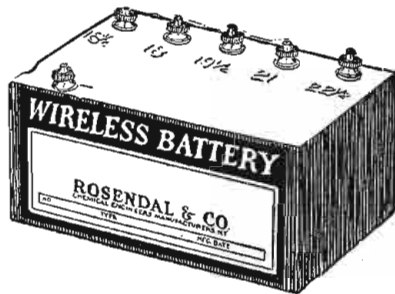

"TUNE IN" with a Rosendal and realize the full joy of Radio broadcasting. See how clearly your signals will come in—how delightful the reception.

It is not how much you pay for a battery that determines its service. It is how good a battery you can get for the money that you pay. Rosendal batteries provide a happy combination of the two.

It is first of all, a dandy battery made of finest materials to give extra service. Rosendal Batteries don't stand around on dealers' shelves. They come to you direct from the

manufacturer eliminating middleman's profit and that is the reason you pay so little for them. In addition to that every Rosendal battery is guaranteed. It must either please you or you are entitled to your money back.

Try a Rosendal once and you will be a steady user.

Send Money Order or Order C. O. D.

Shipment prepaid at the following direct to consumer prices.

ROSENDAL & CO.

Chemical and Radio Engineers

2 and 4 Stone Street New York

	Large	Medium	Small
22½ Volt Plain	\$1.66	\$1.33	\$0.93
22½ Volt Variable	1.84	1.50	1.00
45 Volt Plain	3.33	2.33	—
45 Volt Variable	3.66	2.66	—

Make that Single Circuit Selective

(Continued from page 1253)

use of a vernier condenser in the secondary, but for the primary it is not necessary.

With regard to selectivity, you will have to build it to appreciate its merits. I myself live only one air mile from WJZ and WOR, yet without any trouble I can get between the two and have pulled in WGY without interference.

Another feature of this set is that instead of the signals being reduced in strength they are louder than in the single circuit. I am not a code reader, but I know that if an amateur constructed this little set, he would be very pleased, as spark stations are very clear and sharp, one degree variation in the tickler coupling cutting out one and

"Lighting Fixtures" READY TO HANG

(Direct from Manufacturers)
Completely wired, including glassware. New designs. Send for catalogue No. 24. Send for DEALERS' proposition.
ERIE FIXTURE SUPPLY CO.
STA. R ERIE, PA.

MANUFACTURERS, ATTENTION!

Established Company of high reputation with electrical sales department will consider exclusive territory arrangement for Chicago district. Manufacturers of high grade Radio equipment desiring such connection, address:

RADIO NEWS, Box No. 155

Acme has perfected new "lowest loss" condenser

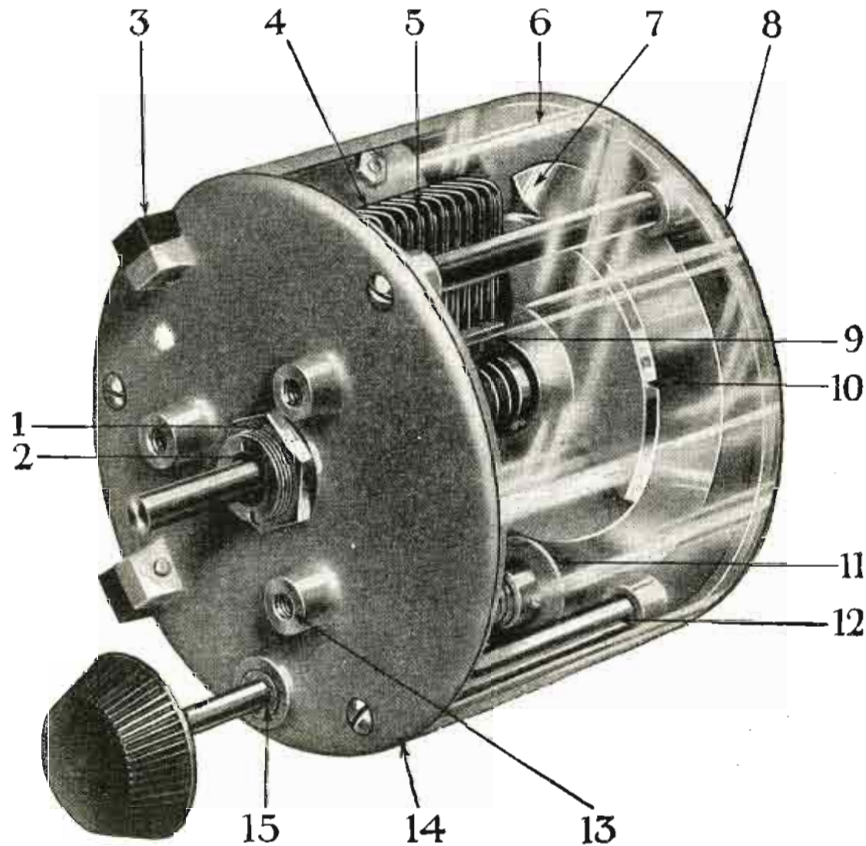

Because of low losses and sharp tuning of the Acme Condenser—practically all the currents on the antenna can now be used

IT REMAINED for Acme—manufacturers of the famous Acme transformers—to perfect the “lowest loss” Condenser. The Acme Engineers have been working for two years to bring out a condenser which would give to Radio experimenters sharp tuning and minimum losses. The new Acme Condenser has these fundamental advantages and also has many new improvements in structure and equipment. See the illustration with explanation, and, for more information, write to us for booklet—“Amplification without Distortion,” which contains many diagrams and helpful hints on how to build and get the most out of a set.

ACME APPARATUS COMPANY
Dept. 25. Cambridge, Mass.

- | | |
|-----------------------------------------------------------------------------------------------------------------|-----------------------------------------------------------------------------------------------------------------|
| 1. Steel brass cone bearings adjustable. | 9. Brass separator to which both rotary and stationary plates are soldered, making continuous circuit for each. |
| 2. Lock nut for bearing. | 10. Counterweight which balances rotary plates. |
| 3. Highest grade hard rubber Dielectric in that part of the field to prevent losses. | 11. Noiseless friction Vernier control seven to one ratio. |
| 4. Brass separator to which both rotary and stationary plates are soldered, making continuous circuit for each. | 12. Brass separators to prevent twisting and to take strain off Dielectric. |
| 5. Brass silver plated plates; rotary plates logalgebraic. | 13. Panel mounting holds for 120 degrees spacing. |
| 6. Dust proof covering. | 14. Metal heads. |
| 7. Stops at extreme end of movements. | 15. Steel bushing to prevent wear on Vernier shaft. |
| 8. Coiled connection between shaft and heads allowing lubrication of bearings. | |

ALL parts are of non-rusting metal, except steel bearing, which is covered with nickel-plated protective surface. End plate capacity is .000016 m. f., full capacity is .0005 m. f.

ACME ~for amplification

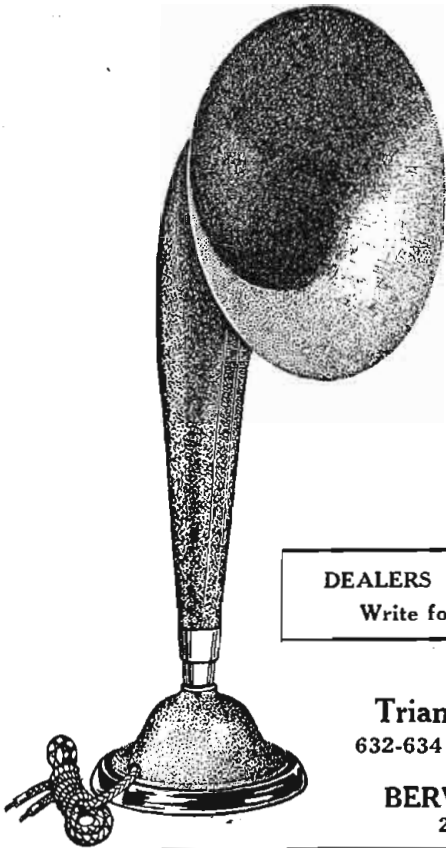

CLEAR AND LOUD

New Magnetic Unit
Sliding Lever Control

The BERWICK

Loud Speaker is Clear in Tone,
Rich in Volume, Adjustable, and

\$15.00 List.

No Batteries Required
HEARING IS BELIEVING

DEALERS AND JOBBERS:
Write for Proposition

Manufactured Exclusively by
Triangle Electro Trading Co., Inc.
632-634 BROADWAY NEW YORK
Also Manufacturers of
BERWICK SUPREME HEADSETS
2200 Ohm. 3000 Ohm.

INSIST ON BERWICK



Improve
your set
with an
AmerTran



Send for
Circular
No. 1005

STANDARD
of
EXCELLENCE
for audio amplification

With all tubes—In all stages



Its flat top, distortionless amplification curve assures faithful reproduction of speech and of music over the full musical scale.

In one stage audibility is increased 30 to 40 times in the flat part of the curve, depending on

the tube constant—the amplification is approximately 5 times the tube constant.

Type AF-6: turn ratio 5:1. Price, \$7. Ask your Electrical Dealer; or, sent carriage charges collect.

American Transformer Company, 177 Emmet St., Newark, N. J.

Designers and builders of radio transformers for over 22 years.



ERLA - REFLEX SETS BUILT AND REPAIRED

PANELS DRILLED
WAVE TRAP BUILT

R. WEISENMAYER
421 W. 65th Street
Chicago, Ill.

199 NECESSITIES

WIMCO 199 SOCKET \$.75
WIMCO 199 C SOCKET 1.00
WIMCO 199 ADAPTER75

Send for free literature.

Jobbers' Inquiries solicited.

THE WIRELESS MFG. CO., Canton, Ohio
MANUFACTURERS—DISTRIBUTORS

bringing in another. I might add that I am using a WD-11 tube.

Be sure to shield the panel, as the receiver is very sensitive to body capacity. While experimenting recently with WJZ on, I went to adjust the secondary, when the signals faded and I began to hear WGY as well as WJZ. Upon taking my hand away, back came WJZ. Of course I shielded the panel, pronto.

I will be pleased to hear from anyone building this set, and will also be glad to give any further information desired.

Fans of Yesterday

(Continued from page 1229)

skimming the cream off the experiences of thousands of predecessors, who, through the past 20 years, have perfected the art. The fellow who thinks he is clever today because he can go out and buy the parts and connect them up into a sensitive receiver should hark back to the time when 99 percent of the materials used had to be made. In those days the mere connecting up of a set was the easiest part. Today, if we connect up a set we have made it.

Veteran Announcer Tells of His Experiences

(Continued from page 1237)

pulsating rhythm. The young tenor sang a full high note, his mouth was opened wide to better enunciate the words of the song. Thus standing with his head thrown back, with his soul in the song, he almost burst his throat with the note. Then still standing thus, he sucked in a breath of air. Alas, for the artist; with this breath he also sucked in one of the white fluttering moths. Right into his throat the moth sailed and the young tenor's evening was completely spoiled. He uttered words and phrases which had no business going into the microphone. A radio evening almost ruined by a moth.

Another time, one of those things happened which are somewhat depressing at the time, though humorous to recall. A young singer, nervous at the start of her first radio recital, though happy at the thought of having her voice broadcast, brought one of her accompanists to play for her. She faced the microphone, after the announcement, prepared to sing and then the piano ran over the prelude. Alas for the singer, the piece the pianist was playing was in a different key from the one which the singer intended to use. The piece was pitched far too high for her and though she tried valiantly to follow the piano, she could make no progress and finally broke down. As the girl was young she cried. Later another song was tried with success.

LOVE THROUGH THE EYES

Has the expression, "Fell in love with his voice" ever been spoken in the reader's presence? It would seem that the radio announcer would receive his share of mash notes, but such is not a fact. There have been comparatively few, which leads Mr. Arlin to think that love comes through the eyes and not through the ears. For his voice goes to a bigger audience than does the face of any motion picture actor.

One of the public's pet fancies is that the radio announcers are big, strong men. Mr. Arlin states that everyone who meets him for the first time makes the remark to the effect that he expected to meet a much larger man. The voice, perhaps unconsciously, impresses the hearer as belonging to a certain type of man.

To Mr. Arlin there is romance in radio broadcasting; he enjoys immensely his con-



RADIO AT NEW YORK PRICES

Via Daily Parcel Post

The Prices Quoted Below Deliver Goods to Your Door

REFERENCES:
R. G. Duns, Bradstreet, Corn Exchange Bank, N. Y. City. No salvaged goods handled. Only standard brands in original packing, which bears our and the manufacturers' guarantee. Due to our tremendous output we can undersell any of our competitors. Send your order in today and insure prompt delivery.

HOW TO ORDER—Write your order plainly; state number, description and price of items wanted. Send Post Office or Express Money Order, personal check or bank draft.



VACUUM TUBES

Standard brand Radio Corp. tubes. Guaranteed brand new.

- 150 Detector, U.V. 200 ea. \$4.25
- 151 Amplifier, U.V. 201A ea. 5.75
- 152 1 1/2 volt W.D. 11 ea. 5.75
- 153 W.D. 12 ea. 5.75
- 154 U.V. 199 ea. 5.75
- 155 U.V. 193 Adapter for U.V. 199 tube fits any socket, ea. .50
- 156 W.D. 11 Adapter fits W.D. 11 tube and any standard socket, ea. \$0.50

AUDIO FREQUENCY TRANSFORMERS

The following transformers are guaranteed standard makes, and will produce very efficient results.

- J63 Dietzen 3 to 1 Ratio \$3.95
- J64 Dietzen 5 to 1 Ratio 3.95
- J65 Dietzen 10 to 1 Ratio 3.95
- J66 Acme Audio 3.95
- J67 Amertran 5.95
- J68 U.V. 712 R.C.A. 5.75
- J69 U.V. 714 R.C.A. 5.75

LOOP AERIAL

J76 Can be assembled by anyone in five minutes, all wood parts, wire and binding posts included, complete 89c

MOULDED BAKELITE VARIOMETER or VARIOCOUPLER

J79 Ea. \$4.95. List. \$7.00
A high grade instrument. Takes in the wave lengths from 250 meters to 800 meters. Table or Panel Mounting.

FRESHMAN VARIABLE GRID LEAK AND GRID CONDENSER

Lowest filament current increases battery life; eliminates howling; zero to 5 meg-ohms.

J102 Freshman Variable Grid Leak alone. \$0.65
J103 Freshman Variable Grid Leak and Condenser combined. 85c

FILAMENT CONTROLLED RHEOSTATS

Highest grade of material used, tapered knob.

- J104—6 ohm \$0.39
- J105—30 ohm 49c
- J106—200 ohm Potentiometer. 79c
- J107—400 ohm Potentiometer. 79c

HONEYCOMB COILS UNMOUNTED

Turns	Cat. No.	Price
25	J 200	\$0.40
35	J 201	.40
50	J 202	.45
75	J 203	.50
100	J 204	.55
150	J 205	.70
200	J 206	.80
250	J 207	.85
300	J 208	.95
400	J 209	1.05
500	J 210	1.15
600	J 211	1.35
750	J 212	1.50
1000	J 213	1.70
1250	J 214	1.95
1500	J 215	2.20

HONEYCOMB COIL MOUNTINGS

- J140 2-coil mounting. \$2.85
- J141 3-coil mounting. 3.79
- J142 Single coil mounting. 40c
- J143 Receptacle for single coil mounting. 50c

MISCELLANEOUS

- J163 Spaghetli Tubing per yd. . . \$0.09
- J164 Synthetic Crystal. 30c
- J165 Ground Clamps. 17c
- J166 Black Rubber Binding Posts. . . 05c
- J167 Nickel Plated Binding Posts for . . 05c
- J168 No. 18 Annunciated Wire half pound coil. 39c
- J169 6 ft. Phone Cord with tips. . . 70c
- J170 20 ft. Extension Cord with tips 1.95
- J171 Wall Insulators, Porcelain. . . 05c
- J172 Tubular Porcelain lead-in insulators. 6 in. 10c
- J173 Reinartz Coil. 1.45
- J174 Cockaday Coil. 2.45
- J175 2 in. Dial and knob. 25c
- J176 3 in. Dial and knob. 35c
- J177 Switch Arm—tapered knob. . . 19c

BUILD YOUR OWN SET

COCKADAY CIRCUIT COMPLETE

- Consisting of
- 1 Cockaday coil and 7 pigtail connections
 - 2 .0005 Variable Condensers
 - 1 Socket
 - 1 Panel 7x18
 - 2 Dials, 3 in.
 - 1 Grid Leak and Condenser
 - 1 Rheostat
 - 1 Switch Lever
 - 1 Base Board
 - 1 Ft. Bus Bar
 - 7 Switch Points
 - 7 Marked Binding Posts
 - 1 Jack
- Wiring Diagram and Instructions

J-178 - - Our Price \$12.65

DIETZEN SUPER HEAD SET

J181 2200 ohms \$2.95
Reg. Price \$5 per pair.
Since we are wholesale distributors for this wonderful headset we pass this bargain on to you. The Tone quality is of unusual volume. These phones can be used as a loud speaker unit. Sold with a money back guarantee if not satisfactory.

HARD RUBBER PANELS

The highest grade panel on the market. Highly polished finish; cut in the following sizes:

- J88—7x10 \$0.95
- J89—7x12 1.15
- J90—7x14 1.25
- J91—7x18 1.95
- J92—7x21 1.95
- J93—7x24 2.20

HIGH GRADE WOODEN VARIOMETERS

J97 Price. \$2.15
A real high grade job at extremely low price. Takes in all wave lengths.

AMPLITONE LOUD SPEAKERS

This speaker will give efficient results when used with any pair of Head Phones; highly nickel plated; 18 inches high.

J117 \$3.95

STANDARD BRAND HEAD PHONES

- J134 Brandes Superior \$5.25
- J135 Dictograph . . . 6.75
- J136 Baldwin Type "C" Double . . . 9.85
- J137 Baldwin Type "C" Single . . . 4.95
- J138 Western Electric 10.50
- J139 Dietzen Navy type 3000 ohms . . . 4.95

List price 8.00

BUILD YOUR OWN SET

REINARTZ CIRCUIT COMPLETE

- Consisting of
- 1 Reinartz Coil and 16 pigtail connections
 - 2 3 in. Dials
 - 1 .0005 Variable Condenser
 - 1 11-Plato Condenser
 - 1 Socket
 - 1 Vernier Rheostat
 - 3 Switch Levers
 - 1 7x14 Panel
 - 1 Base Board
 - 8 Marked Binding Posts
 - 12 Ft. Bus Bar
 - 1 Grid Condenser
 - 2 doz. Switch Points and stops
- Wiring Diagram and Instructions

J-179 - - Our Price \$10.85

DOUBLE PHONOGRAPH ATTACHMENT

This attachment fits all phonographs; will take any headset. It converts your phonograph into a loud speaker.

- J132 Double attachment. \$0.85
- J180 Single attachment fits any single phone unit to be used on phonograph. . 49c

1 1/2 VOLT DIETZEN TUBE

Two-element Fleming valve effect; operates on one dry cell with or without "B" Battery; wiring diagram free with each tube.

- J95 Dietzen Tube \$1.00
- J96 Socket for Dietzen Tube 40c

BAKELITE TUBE SOCKETS

Moulded of brown bakelite; Binding Post Connections.

- J99 Standard Type for 201A
- 301A, W.D. 12 39c
- J100 For U.V. 199, U.V. 209
- Socket 39c
- J101 For W.D. 11, C11 39c

RADIO SOLDERING IRON

Indispensable for the man who builds his own sets.

- J109 \$2.50
- J133 Soldering Paste Tube 25c

VARIABLE AIR CONDENSERS

These condensers are made of heavy aluminum plates, high grade bakelite ends.

- J110—21 Plate \$1.75
- J111—11 Plate 1.25
- J112—3 Plate \$0.95
- .00005 Mfd. 2.25
- J113—13 Plate .001 Mfd. 2.25

VERNIER VARIABLE CONDENSERS

Specifications the same as above.

- J114—14 Plate Vernier with knob and dial. \$2.95
- J115—26 Plate Vernier with knob and dial. 3.45
- J116—13 Plate Vernier with knob and dial. 3.95

MAGNET WIRE (8 oz.)

Double Cotton	Covered	Green Silk
J144 18 \$0.43	J145 18 \$0.73	
J146 2053	J147 2085	
J148 2268	J149 22 1.00	
J150 2478	J151 24 1.13	
J152 2688	J153 26 1.65	
J154 28 1.07	J155 28 1.95	
J156 30 1.58	J157 30 2.65	

WOOD CABINETS

Highest grade Mahogany Finish Cabinets. Hinged top. These cabinets are being sold at less than one-half regular value.

- J157 Wood Cabinet; panel size 7"x10" \$2.50
- J58 Wood Cabinet; panel size 7"x12" 2.75
- J59 Wood Cabinet; panel size 7"x14" 3.00
- J60 Wood Cabinet; panel size 7"x18" 3.50
- J61 Wood Cabinet; panel size 7"x21" 3.75
- J62 Wood Cabinet; panel size 7"x24" 4.00

RADIO FREQUENCY TRANSFORMERS

- J70 Tri-coil for 201A or 301A tubes \$1.95
- J71 For 199, 299 or W.D. 11 and 12 tubes. 1.95
- J72 Eria AB1 3.75
- J73 Eria AB2 3.75
- J74 Eria AB3 3.75
- J75 Eria Reflex 4.65

VARIOCOUPLER

J77 High grade 180 Degree Coupler made of Bakelite tubing wound with green silk wire. Special \$2.45
J78 Variometer same specifications. 2.45

PLATE CIRCUIT "B" BATTERIES

The highest grade of battery made at prices lower than they ever were sold before.

- J80—22 1/2 Volt Small \$1.15
- J81—22 1/2 Volt Medium 1.45
- J82—22 1/2 Volt Large 1.95
- J83—45 Volt Medium 1.95
- J84—45 Volt Large 2.50
- J85—45 Volt Extra Large 3.50
- J86—360 br. 1 1/2 Volt twin double duty "A" Battery. 75c

JACKS AND PLUGS

Jacks are polished nickel constructed with pure silver contacts.

- J118 One Spring open circuit. \$0.39
- J119 Two Spring closed circuit. 49c
- J120 Round plug as illustrated. 49c

AERIAL WIRE

- J121 100 ft. solid copperweld wire coil \$.49
- J122 7 strand 100 ft. 60c
- Ground Wire Rubber Covered No. 14
- J123 25 ft. coil. \$.49
- J124 50 ft. coil. 85c

INSULATORS

These are very strong strain type insulators.

- J158 Moulded insulator shown Ea. Doz. above \$0.10 \$1.10

LOUD SPEAKERS

J125—Dictogrand Loud Speaker. Reproduces the voice naturally. Formerly \$28.50. Now \$16.95.
J126 Magnavox new type. \$29.95
J127 Music Master 28.50
J128 Atlas Speaker 22.50
J129 Patha Speaker 21.95
J130 Dietzen Speaker 18.95
J131 Herald Loud Speaker New 30.00
The above prices delivered to your door.

Modell's 71 Cortlandt St.

ESTABLISHED 1825

New York, N. Y.

America's Greatest Radio Mail Order House

ELEVEN NEW YORK STORES

An Absolute Guarantee
with every instrument
made them famous!

SHAMROCK
FOR SELECTIVE TUNING

180°

Vario-Coupler
List price, \$3.50 each

DOUBLE DUTY PIG-TAIL Variometer

SHAMROCK MFG. CO.
318 Market St. Newark N.J.



The RāBAT
a Rechargeable
Wet 'B' Battery
at Only \$3.96



A rechargeable wet "B" Radio battery built on strict storage battery principles. Yet it costs only a trifle more than an ordinary dry cell.

The Ohio Rabat at the low price of \$3.96 has 12 cells with a total of 24 volts and ample capacity. It is noiseless, fool-proof, and compactly constructed. Built on a solid rubber base. Small, but neat and efficient. All elements visible—No internal discharge—More economical—Longer life—Higher and more continuous voltage—Easily recharged at home with aid of inexpensive Rabat Rectifier. If your dealer cannot supply you send direct. Price, South of Tennessee and West of Mississippi East of Rockies, \$4.25; West of Rockies, \$4.40.

Rabat Rectifier for recharging, 75c

THE RADIO RABAT COMPANY
RUSSELL BUILDING Playhouse Square CLEVELAND, OHIO

12 CELLS **The RāBAT** 24 VOLTS

SURE-FIRE
D-X
CRYSTAL

THE MARVEL OF ALL SYNTHETIC CRYSTALS

Extraordinarily supersensitive all over. Ideal on Reflex circuits. Tested, sealed, guaranteed. Indorsed by N. Y. Mail and Tribune.

50c. Mtd. at all dealers or sent postpaid.

Specialty Service Co., 9 Hanson Pl., Bklyn, N. Y.
Radio, Ltd., Montreal, Can. Canadian Distributors.



Send for DEALERS Catalog

HARRY ALTER'S "POCKETBOOK"
is a monthly net price catalog of Radio, Electrical and Lighting supplies. All good dealers should have a copy—get on our mailing list now. No obligation. Use your letterhead.



HARRY ALTER & CO.
WE SELL WHOLESALE ONLY
OGDEN BOUL. CARROLL AV. CHICAGO

tact with the artists; in fact, with the entire broadcast company. Mr. Arlin intends to be a broadcast announcer for a long time to come.

Radio Benefits Camp Veterans

(Continued from page 1226)

From the receiving set, wires were run, in series parallel, into four wards of the east group and into three wards of the west group, more than 9,000 feet of No. 14 rubber covered wire being used. Individual plug boxes were installed at each bedside, and 120 men were each furnished with a set of head-phones. Every feature of the entire installation is the latest in radio invention.

The camp electrician, with the Librarian and the Managing Editor of the "Optimist," the Camp Kearny weekly publication, were the original committee. Seated in the small room before the master set, these two ex-service men tune in and provide the bed-ridden men and women with concerts every evening. One of the first of the concerts included numbers from "Iolanthe" broadcast by members of the cast which made the Camp Kearny radio installation possible.

But—the bed patients are not the only ones fortunate enough to have radio close at hand. Many of the convalescent patients have their own sets, and, because of the abundance of the "radio fund," a smaller set especially adapted for code has been installed in the office of the "Optimist." This furnishes a medium through which late news may be learned and convalescent men given a chance to get "in touch" with the world. It also furnishes the possibility of code practise. (Recently two patients who have been practising at Camp Kearny and studying a correspondence course passed the examinations entitling them to operators' licenses.)

This set is being cared for by one of the telephone men (ex-service) who is an earnest student of radio. This man also has his own set in his room and from it has wired branches into other places in camp. One of these branches is in the telephone office and is so arranged that the receiver of the radio may be placed over the transmitter on the telephone switchboard. Thus, practically everybody in Camp Kearny—patient and personnel—has access to the benefits of radio at one time or another.

Re-broadcasting, a New Era in Radio

(Continued from page 1242)

The Westinghouse Company has followed this suggestion and the scheme seems to be the practical solution to the broadcasting problem, as evidenced by the reception given by the public to the new Hastings station.

This station repeats the broadcasts sent from the Westinghouse Station KDKA. After the first program which KFKX repeated from KDKA, letters were received from every part of the continent, telling of the wonderful results.

As Mr. Davis predicted, radio repeating may be the solution of the broadcasting problem. A few broadcast stations so located as to obtain the best program material would be able to supply the entire continent. These stations should have great power and be non-interfering. At distant points there should be repeating stations of great power available simply to repeat the original broadcast at the same high frequency.

COVER NATION

By this means a blanket of high frequency radiations will be made to cover the whole country. Then in each community it would be possible to locate a low powered and repeating station which could

"BUILD YOUR OWN" WITH "RASCO" PARTS!

Buy from the Oldest and Original Exclusive Radio Parts House in the United States

We pay all transportation charges in U. S. ALL GOODS SENT PREPAID IN 24 HOURS

Order direct from this page.

SPECIAL PRICES FOR THIS MONTH ONLY

Money refunded if goods do not satisfy

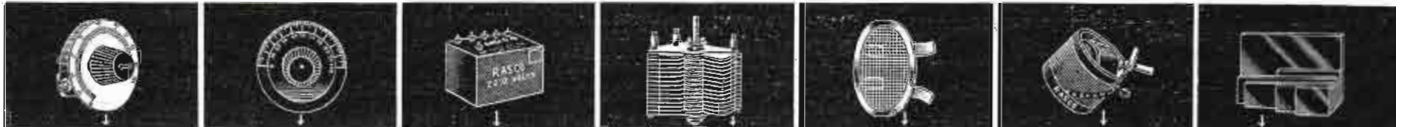

Rheostats and Potentiometers
Come with metal dials and composition knob. Excellent merchandise despite low price.
M4210 6 ohm Rheo. \$27
M4211 30 ohm Rheo. \$30
M4212 200 ohm Potentiometer .45

Molded Dials
Only very best grades handled. Bushings absolutely true. Dials cannot wobble. Letters inlaid in best white enamel. All dials for 1/4" shaft.
M3074 Dial 2" .20
M3075 Dial 3" .25
M3076 Dial 4" .40

Tapped "B" Batteries
We positively guarantee these batteries to be of long life. We carry only fresh stocks. We carry only fresh stocks.
M2250 Sm. 22 1/2 V. \$85
M2251 Medium Navy size, 22 1/2 volt. 1.20
M4500 Large size, 45 volt .230

Panel Mounting Condensers
Positively no better condenser on the market. Shafts 1/4" Save from 40 to 60% by assembling condenser yourself.
M1111 1 plate. \$1.10
M2121 21 plate. 1.22
M4343 43 plate. 1.33

"Rasco" Bezels
Finest Bezel on the market. Bezel comes entirely nickel plated. Can be used on 1/4" or 3-16" panel.
M1700 Rasco bezel. 1" \$1.15
M1701 Bezel, 1 1/2" diam. .20

Rasco 180° Varfocoupler
Silk wire wound on bakelite tubes. Six taps. Wave length 150 to 600 meters. For panel mounting 1/4" shaft. Your money refunded if it is not all we claim.
M3100 Varfocoupler prepaid . \$1.50

Diectryte Panels
Highest dielectric strength as per Bureau of Standards.
M7100 7x10x3-16" \$70
M7120 7x12x3-16" .95
M7140 7x14x3-16" .85
M7180 7x18x3-16" 1.25
M7210 7x21x3-16" 1.45
M7240 7x24x3-16" 1.65



Silicon Steel
Used practically in all audio-frequency transformers. Better than iron. Extremely soft. 3/8" wide and .007" thick.
M4900 Silicon steel, per foot \$1.08

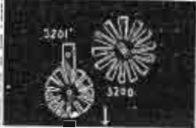

Spider Web Forms
Fine forms to wind your spider webs. Made from hard, well seasoned fibre, 1-16" thick, center and side holes for wiring. Both 3" diameter.
M3200 Spider form. \$25
M3201 Spider form. .25



M1375 Universal Bearing
to hold rotors. Length of bearing 2 3/4" shaft 1 1/4" thread 1 1/2" long, thread sleeve 3/4" long, each \$25
M1550 Sckettes. Four of these take one vacuum tube. Grasp tube firmly. Best by test. Set of 4 \$25



Brass Strip and Tubing
Brass strip 3/8" wide 1-16" thick; 6" long.
M1430 Per length. \$10
M1431 Brass tubing, dia. 1/4", 6" long; length \$15
Threaded Brass Rods Sold in 6" lengths only.
M8032 8-32" thread \$08
M6032 6-32" thread .06



Alcohol Blow Torches
Best made. Give intense hot flame. Great for fine work.
M8981 5" Torch. \$85
M8982 3" Torch. .50
M4104 Rosin Core Solder. A non-corrosive solder with flux inside.
18" length \$10



Monodyne Socket
This socket takes up 25% less room than any other. No outside connections. Nickel plated shell. Has fiber bottom with 4 socketlets. Socketlets hold socket to panel or board.
M6502 Socket . . . \$25



"Rasco" Switch Points
Nickel and polished.
M301, 1/4"x1/4", 6/32" doz. \$18
M304, 1/4" dia., 1/8" thick; 6/32" doz. .18
M305, 3/8" dia., 3/16" thick, 4/36", doz. .18
M375 Switch stop, 3/8" long, with nut, doz. .18



FREE
The big "Rasco" catalogue. Contains all Armstrong circuits. Every up-to-date vacuum tube hook-up. Greatest little book printed. Free upon receipt of postal.

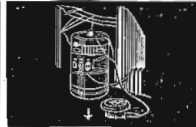

The Radiogem
The simplest radio outfit made. Includes all parts for tuning coil, tapped switch crystal catwhisker.
M5353 Radiogem, no aerial or phone. \$75
M5354 Radiogem, with 1000 ohm phone and 3 ft. cord \$3.75

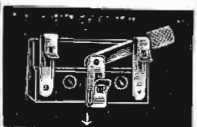

Throw Switches
Mounted on composition block. Small enough for all radio purposes.
M4100 Single pole. \$25
M4101 Double Throw Single Pole \$35



Bakelite 180° Coupler De Luxe Style
Tubes of natural color bakelite, wound with green s 1 1/2" Aluminum bracket, 1/4" shaft. Primary 13 taps. 180 to 550 meters.
M3150 Coupler. . . \$2.35



"Rico" (Adjustable) Loud Speaker Phone
Has rubber gasket underneath diaphragm, making phone fully adjustable. Gives amazing results as loud-talker on 1 and 2 stages of amplification.
M2525 Speaker with 5 ft. cord \$2.65

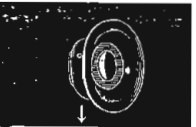

Soft Rubber Ear Cap
At last! Ear Caps that will relieve headaches, earaches, and undue pressure on the ears. Fit all receivers.
M3500 Ear caps; pair \$30



Series Parallel Switch
Quick change from one circuit to another. Black composition knob, nickel plated fittings. Blade radius 1 3/4".
M2950 Series parallel switch \$25



Melotone Loud Speaker
Best popular loud speaker. Fibre horn, heavy metal base, 5-ft. cord. Nickel goose neck. Greatest tuned (adjustable) talker. Horn length 11 1/2"; bell 6 5/8"; total height 9".
M255 Melotone Speaker \$4.80



Nickel Lugs
All lugs are nickelled.
M310 Brass Lugs for No. 8 screw, doz. \$10
M311 Copper Lugs for Nos. 6 and 8 screws, dozen 10
M309 Copper Lugs for Nos. 4, 6 and 8 screws, dozen . . . 10



Wood Cabinets
Highest grade mahogany cabinets made. Top is hinged. Made of 1/2" stock.
M714 Panel, 7x14" \$3.35
M718 Panel, 7x18" 3.80
M724 Panel, 7x24" 4.40
M710 Panel, 7x10" 2.60
M712 Panel, 7x12" 3.00
M721 Panel, 7x21" 3.90



Loop Aerial
Made entirely of well seasoned hard wood. Complete with all parts and base. Total height of loop 36". Can be put together by anyone in less than 5 minutes.
M2600 Two ft. loop aerial, complete. \$1.15

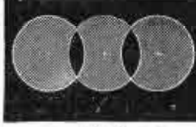

Mica Diaphragms
Made of special India mica in two sizes, 2 3/8" diameter and 1-13/16" diameter. Cement iron washer in center for real results on your phones.
M2550 Diaphragm, 2 3/8" \$20
M2551 Diaphragm 1-13/16" 15



Nickel Screws
Made of brass, nickel plated. Flat and round head style. Any thread up to 10/32".
Price, 1/4", 3/8", 1/2" long, dozen . . . \$15
Price, sizes 3/4" and 1" long, dozen 30



NEW! Push Pull Transformer NEW!!
Push Pull Transformer for many new circuits. See any radio magazine. Made of best materials. Coils impregnated. Silicon steel laminations. Save 50 per cent by assembling yourself. Simple instructions furnished.
M1150 Transformer. Ratio 6 1/2 to 1. \$4.00



Binding Posts
M030 Sm. size, 1/2" high, nickel finish, each \$04
M124 Initialed Binding Posts: Antenna; B. Bat. -; A. Bat. -; B. Bat. -; A. Bat. -; Ground; Phone; each . . . \$12
M45 Spring Posts, ea. .04
M44 Spring Posts, ea. .07

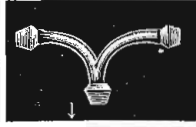

Double Phonodapter
Fits all phonographs and will take any standard double head set, thus making your phonograph a loud talker. Made of cast metal, nickel plated and highly polished.
M1320 Double Phonodapter \$65



Cardboard Tubing
Only seamless tubing made (I.—Inside Diameter. O.—Outside Diameter. L.—Length)
M6600, 3" L. 3 3/4" O. 7" L. \$30
M6601, 3 1/2" L. 3 3/4" O. 7" L. \$35
M6604, 4" L. 1 1/2" O. 5" L. \$35
M6605, 2 1/2" L. 1 1/2" O. 2 3/8" L. \$15



Radio Cement
Weather resisting. Used particularly for cementing covered wires. Coils covered with this cement require no form. Wires hold together solely with this cement.
M1750 Cement, 2-oz. bottle \$50



Bus Bar Wire
Square wire, 1/16" x 1/16", already tinned, making soldering easy. Sold in 2-foot lengths only.
M6400 Bus Bar, length \$05
Green Silk Cord Rubber Insulation, M4400 per foot. . . . \$02



Phonodapter
Will fit any phone. Make your phonograph a loud talker. Fits all phonographs. Made entirely of pure soft rubber with brass tube insert.
M1310 Phonodapter. \$38



Skinderviken Button
Famous Micro-Phone for Transmitters. Sold all over for \$1. This is the genuine article. No imitation. Smallest and most sensitive microphone made. Diameter 3/4".
M9595 Microphone. \$85

Short Wave Regenerative Receiver

- 1—M710 Mahogany Cabinet 7"x10" \$2.60
- 1—M7100 Diectryte Panel 7"x10" 70
- 1—M3150 DeLuxe Varfocoupler 2.45
- 1—M4343 43 Plate Cond. . . . 1.60
- 2—M3075 3" Dials 50
- 1—M200 Switch Lever 25
- 1—Doz. M305 Switch Points .18

Reinartz Circuit

- 1—M710 Mahogany Cabinet 7"x10" \$2.60
- 1—M7100 Diectryte Panel 7"x10"x3-16" 70
- 1—M2660 Reinartz induct. (225 to 600 met.) 1.90
- 1—M6500 Vac. Tube Socket .35
- 1—M4310 6 ohm Rheostat .45
- 2—M2121 21 Plate Variable Condensers 2.50
- 1—M5059 Grid-Leak Condenser 30
- 8—M201 Rasco Bind. Posts .80
- 2 Doz. M305 Switch Points .36

Total \$12.21

Our Price \$12.00

- 3—M200 Rasco Switch Levers .75
- 2—M3075 3" Dials 50
- 2—M1450 Vernier Attach. . . . 60
- 24 Ft. M6400 Bus Bar Wire .80
- 1—M1000 Double Cir. Jack .65
- 1—M1003 Rasco Plug 55
- 8—M6003 Bind. Post Name Plates 21
- 1—M1430 Brass Strip, 6"x1/2"x1-16" 10
- 1—Conrad Assembling Pattern & Blueprints .50

Total \$14.42

Our Price \$14.25

2 Stage Amplifier

- 1—M710 Mahogany Cabinet \$2.60
- 1—M7100 Diectryte Panel .70
- 2—M1100 A.F. Transformer 4.00
- 1—M1000 Double Cir. Jacks 1.30
- 1—M1003 Rasco Plug 55
- 2—M6500 Tube Sockets 70
- 2—M4310 6 ohm Rheostats .90
- 10—M6060 Post Name Plates .30
- 10—M201 Rasco Bind. Posts 1.00
- 30 Ft. M6400 Bus Bar Wire .75
- Blue Prints and directions . . 50

Total \$13.30

Our Price \$13.00

RADIO SPECIALTY CO., 98 Park Place, New York City
Factories: Brooklyn, N. Y. Elkridge, Md.

No More Leaks!

Loose, leaky connections cause troublesome balkiness in even the best-built radio sets.

Spare yourself such annoyances from the start by making every joint absolutely fast with the *HOME Electric Soldering Iron*.

It's the handiest solderer you can use. Turn a switch and the point gets hot enough to melt solder almost instantly. The current consumed is negligible.



Lasts a life-time. Pays for itself many times in convenience and utility.

Packed in a sturdy carton, with full instructions and a supply of flux and solder.

Costs only \$3.

If your dealer does not carry the *HOME Electric Soldering Iron*, send us your order and we will ship you one by return mail, either COD., parcel post or on receipt of cash or money order.

THE A. MECKY COMPANY
1705 Allegheny Ave., Philadelphia

HOME Electric Soldering Iron

be used to repeat the selected program for those living within its range.

The Hastings station is not a low powered repeater. On the contrary, it has the same power, or about the same power, as KDKA, but it was installed to demonstrate the principle of repeating, and can be used to repeat at a high frequency which is inaudible to the ordinary receiving set. Or it can re-transmit at a lower frequency, namely 1,050 kilocycles, or 286 meters, permitting it to be heard by the public.

In actual operation KDKA and KFKX operate in the following manner: KDKA has two transmitters, one of which broadcasts on a frequency of 960 kilocycles. These are the broadcasts which KDKA's audience has been hearing for the past three years. The other transmitter broadcasts the same concert simultaneously on a frequency of 3,200 kilocycles. This broadcast is the one received at KFKX. A special receiver is used which is connected by a telephone line to a transmitter which re-broadcasts the program on a 1,050-kilocycle frequency. There are three transmitters broadcasting simultaneously although the public hears only two of them. Thus is radio repeating actually accomplished.

There is no limit to the range of repeated concerts. KFKX could, just as easily as KDKA, repeat the concert to another repeater located in another section of the country. In fact, with enough repeating stations, one central broadcaster could give service to the entire world.

RADIO SE-AR-DE PRODUCTS

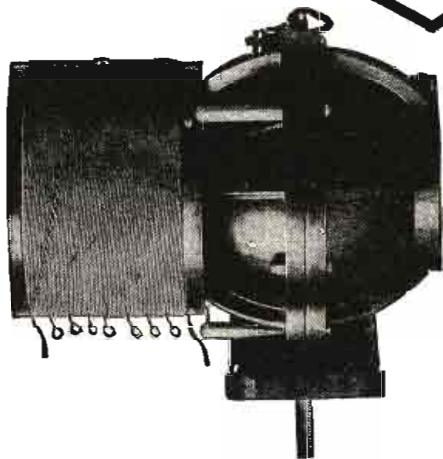

SE-AR-DE Molded RADIOMETER

Build Your Own Single Circuit Tuner

CATALOGUE No. 165

\$13.00

Range 180-3100M
" 300-3280M

R. MITCHELL & CO.

255 ATLANTIC AVENUE

BOSTON, MASS.

The Operation of Close Coupled Transformers

(Continued from page 1246)

The equivalent value for any secondary capacity referred to the primary circuit is equal to the actual secondary capacity times.

$$\left(\frac{N_2}{N_1}\right)^2$$

Capacity reactance, being inversely proportional to the capacity, is, however, treated like resistance or inductive reactance.

$$\text{Capacity reactance} = \frac{1}{2\pi fc} \text{ ohms.}$$

An example of capacity transfer is given in Fig. 6. Assuming a capacity of 100 mfd.

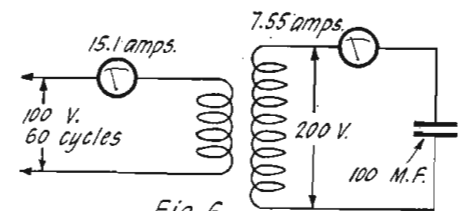

Fig. 6 A circuit illustrating the capacity transfer of energy from one circuit to another.

attached to the secondary of a step-up transformer having a ratio of two, the primary equivalent value is obviously 400 mfd., as shown in Fig. 6. In order to show the transfer of reactance and make the problem complete, voltages have been assumed, as was done in the previous examples. The following values are associated with the circuit shown in Fig. 6:

$$\text{Secondary capacity reactance} = \frac{1}{2\pi fc} = 26.5 \text{ ohms, (f=60 cycles per sec.)}$$

$$\text{secondary current} = \frac{200}{26.5} = 7.55 \text{ amp.};$$

$$\text{therefore primary amperes} = 15.10 \text{ amp.},$$

$$\text{primary capacity reactance} = \frac{100}{15.1} = 6.63$$

HYGRADE SPECIALS

- V.T. Sockets—Federal 85c—Paragon \$.85
- Fada 85c—Signal 75c—Na-Ald65
- Phone Plugs—Federal 69c—Fircro85
- Patent 45c—Weston 89c—Cico45
- 2 in 1 Variable Grid Control 1.75
- Bradleystat (new type) 1.59
- Filkostats (new type) 1.75
- Ambassador 3000 Ohm Head Set 3.25
- Brandes Matched Tone Head Set 4.98
- Nerco 2200 Ohm Head Sets 2.49
- Skindorvikin Transmitter Buttons85
- General Radio Loud Speaker Units 8.95
- Morrison Loud Speaker Units 8.95
- Acme R.F. Transformers Types R2, R3, R4 3.98
- Audio Frequency Transformers Thordarson 3.49
- Jefferson No. 41—\$3.49. Paragon 4.50
- Federal No. 226W—\$4.50. Federal No. 65 5.98
- No. 164A—Fada Neutrodon Condensers 1.10
- No. 163A—Fada Neutroformers 6.49
- No. 165A—Fada Hazeltine Parts 21.50
- Marko Storage Batteries \$8.75 up

All Orders Must Include Parcel Post Charges
Hygrade Electrical Novelty Co.,
41 WEST 125th STREET, NEW YORK, N. Y.

Reliable RADIO Goods

Results are Sure with RELIABLE Goods

And it's easy to get such goods—anything you want in radio equipment. Big, complete stock—everything guaranteed; quick service; right prices. And you're sure it's reliable when it comes from Andrae. Get our complete catalog—FREE.

Dealers

Buy reliable equipment from a house of established reputation. Send for catalog of tested and approved apparatus and our discount sheet.

JULIUS ANDRAE & SONS CO.
117 Michigan Street Milwaukee, Wis.

ANDRAE In Business Since 1867

1
ohms= $\frac{1}{2\pi fc}$, and equivalent primary capac-
ity= 400 mfd.

From the foregoing statements it is evi-
dent that an "ideal" transformer acts merely
as a means of transferring certain qualities
from one circuit to another.

Furthermore, resistance, inductance and
reactance (both inductive and capacitive)
are transferred in proportion to the square
of the transformation ratio. Impedance
(which is a combination of reactance and
resistance) follows the same rule. Capacity,
however, follows the *inverse* rule.

An interesting example of the application
of this principle to radio is shown in Fig. 7.
The "wave filter" or "wave trap," which is
widely used today employs this scheme. L
is a closely coupled air core transformer,
having a high ratio. When L C is tuned to
the undesired signal, there is established
in this circuit a very high resistance. This
resistance is transferred to the main circuit
and hence reduces the signal. The resist-
ance at resonance is so extremely high that
in spite of the step-down ratio, there is con-
siderable resistance transferred to the an-
tenna circuit. The inductive and capacitive
reactances are also transferred to this cir-
cuit for frequencies other than the undesired

signal but, due to the ratio of transforma-
tion, they are present to a rather small de-
gree, and so do not materially influence the
operation of the receiver. The wave filter
illustrated in Fig. 7 can be arranged by us-
ing 60 turns of No. 24 D.C.C. wire wound

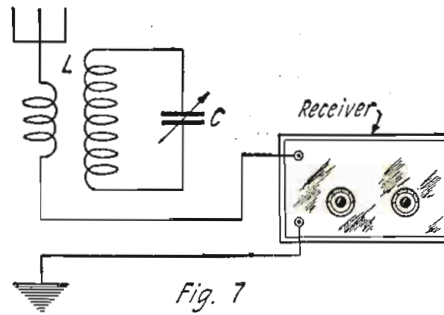

Fig. 7
A wave filter or "trap" used in conjunction
with a receiving set and acting as the trans-
former shown in Fig. 6.

on a cylinder 3 inches in diameter. The
transformation ratio should be 1:5, which
calls for 12 turns wound directly on the 60
turns, the 12 turns being inserted in the
antenna circuit. A condenser of .00025
mfd. across the 60-turn coil will suffice to
cover the broadcasting range.

AT LAST! YOU CAN



NO TAPS
200-650
METERS



2 ROTOR
DOUBLE
CIRCUIT
TUNER
TAKES PLACE
OF AND IS
MORE EFFI-
CIENT THAN
EITHER 3 HONEY-
COMB COILS
OR VARIO-
COUPLER AND
VARIOMETER

Tunes in Distant Stations Without Inter-
ference from Near-by Stations

Used with Double Circuit Regenerative Hook-up the
Select-a-Wave will give you

Maximum Volume, Coast-to-Coast
Range and Super-Selectivity

Not just a part but a Quality Tuner, highly recom-
mended by leading radio engineers. If your dealer
can't supply you send us \$8.00 and we will ship
postpaid with diagram and instructions.

Dealers Write for Proposition

S. & R. RADIO COMPANY

3786 BROADWAY NEW YORK CITY

K & C TUNED R. F. TRANSFORMERS

These Efficient Units Gaining Remarkable Success

These Radio Frequency Transformers are the result of considerable research work
by our Radio Engineers, and are remarkably flexible and efficient units. The wave
length of the transformer is controlled by the position of the rotor and can be set for
any given wave length between 150 and 600 meters. This range covers all broad-
casting and permits of maximum efficiency of the transformer. Previous efforts along
the lines of radio frequency amplification have been confined to the use of a Radio
Frequency Transformer, working efficiently only at one or two wave lengths. The
K & C Radio Frequency Transformer can be accurately tuned to any wave length
between the limits mentioned above.

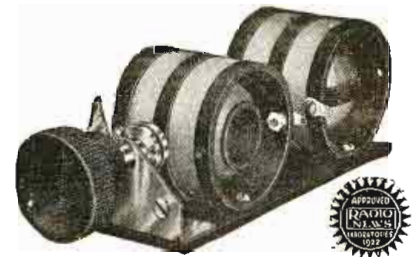

SPECIFICATIONS

Insulated shaft and disc type coupling. Each stage of amplification adjustable. Arranged for both panel and base mounting.

Pig-tail connections to rotating secondaries. Constructed of high grade bakelite.

CONTINUOUSLY VARIABLE RADIO
FREQUENCY AMPLIFYING
TRANSFORMER

Two Stage \$10.00
Single stage 5.50
Range 150-600 meters
Send 25c for blueprint giving details of highly
efficient Radio Audio-Frequency Circuit.



KC Your Guarantee



The Essence of Simplicity

K & C NEW "SERIES AUTOMATIC" PLUG A WINNER

Costs No More than Any Standard Plug
BUT

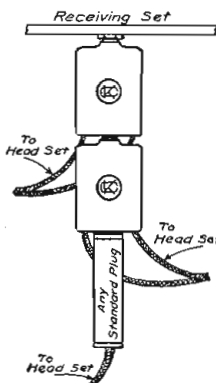

It enables you to add any number of headsets in the circuit *instantaneously*.
No multi-jacks or terminal blocks to fuss with.

Just "Plug plugs" into each other.

Any other make of standard plug can be used with the K & C "series auto-
matic" plug.

Moulded in pure bakelite.

K & C "Series Automatic" Plug \$1.25 each

KILBOURNE & CLARK MANUFACTURING CO.

Head Office and Works, Seattle

Portland, 305 Larrabee Street, Phone East 6156

San Francisco, 591 Mission Street, Phone Sutter 40

Los Angeles, 1103 West Tenth Street, Phone 581-002

New York City Reps., Steelman, Inc., 24 Murray St.
Tel. Barclay 7941-2

Radio Products of **K**uality & **C**haracter



*A Radio Part
with a Double Purpose—*
GREWOL VARI-GRID

Learn the secret of Grid Control thru the condenser. Varying the capacity of your tube is what gives results.

The Vari-Grid is a vernier .0005 condenser, 1 1/4" diameter, adapted for all condenser circuits. Lowest losses. Finest adjustment. Best results wherever used. Guaranteed by manufacturer.

Write for "Grid-Control," by Lefax editor. It's free.

If your dealer cannot supply you, order direct.

\$2.25

Randel Wireless Company

11 CENTRAL AVENUE

NEWARK, N. J.

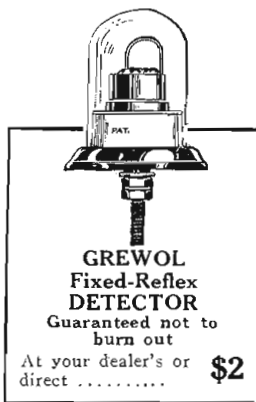

The Weagant Receiving Circuit

(Continued from page 1256)

a 25-turn coil will suffice for amateur waves. If the primary coil of the tuner is provided with an inductance switch, this should be varied for best results. When connecting the primary of the tuner, care should be exercised to completely eliminate the series condenser. The polarity of the primary coil is important, and will have to be found by experiment, because when it is connected in the wrong direction it will not pass signals.

A FEW DETAILS

A description of a "Weagant" circuit without a few construction and operating details would not be complete. The most satisfactory method of mounting the component parts is to arrange the three condensers to a row on a 12 by 18 inch insulating panel, the antenna condenser at the left, the secondary in the middle, and the tickler condenser at the right. The four rheostats and the potentiometer should be mounted in a row above and parallel with the row of condensers. A coil mounting of the conventional three-coil type should be placed in the upper left corner, with the knobs down. This last point is one that

Telmaco Radio Guide Book

Describes the Best
in Radio

Our new 64-page Catalog No. TER contains twenty of the most popular radio circuits printed in blue. These include the Hazeltine Neutrodyne, Grimes Inverted, Colpitts, Flewelling, Reinartz, Diode Electrad, Heterodyne, Super-Regenerative and many others. Each article used in circuit is attractively pictured instead of appearing in straight schematic form. Besides containing blue prints, the best in radio is also illustrated and described. Catalog sent postpaid for Ten Cents. Each circuit worth double.

Send for your copy today.

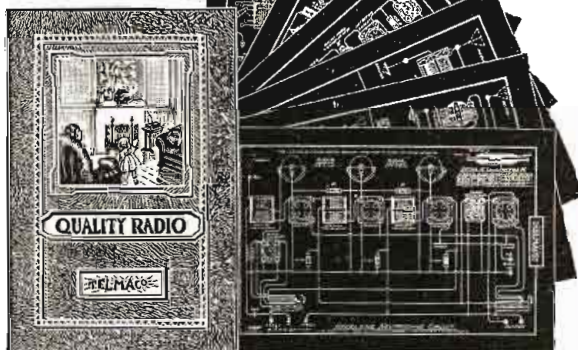

DEALERS! Our New Dealers' Catalog and Price List describes nearly all the better Standard Radio Lines. You should have it. Mailed FREE to all bonafide dealers making request on their business stationery.

TELMACO
Quality Radio Exclusively

Radio Division
TELEPHONE MAINTENANCE CO.
20 So. Wells St., Dept. B, Chicago, Ill.



**"AETNA"
Condensers**

High Grade Quality "AETNA" condensers are made of the best material, hard, pure Aluminum and Condensite Celoron end plates. WE guarantee every Condenser to prove to capacity. Mail Orders Filled Promptly.

Variable Condenser PRICES
No. 11 Plate...\$1.30
No. 17 Plate... 1.45
No. 23 Plate... 1.60
No. 43 Plate... 1.90

AETNA VARIABLE CONDENSER CO.
Phone: Lincoln 6052, 333-43 North Ave., Chicago, Ill.

Rainbow Multi-Plug & Cable



Put this type on your new set; it is small and may be mounted anywhere with cord and plug \$4.00 Type P. M.

Put this type on seven binding posts of your present set. With cord and plug \$5.00 Type B. P.



Put your Batteries on shelf in basement and run this 8-ft. cable through floor to set.

5A and B. Battery wires in cable. Antenna and ground are separate leads from cap. Guaranteed not to impair efficiency of set. For sale by all Jobbers and Dealers. Fully covered by patents applied for. Manufactured by **HOWARD B. JONES**
608 S. Canal St. Chicago, Ill.

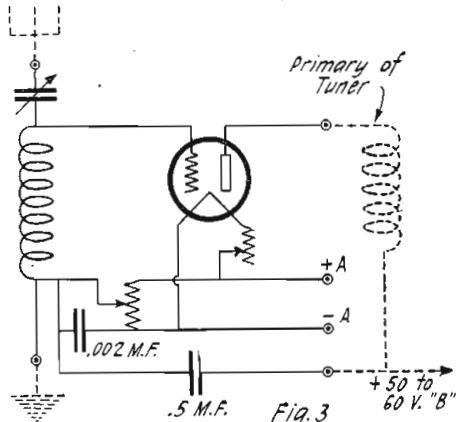

This form of radio frequency amplifier has been found the best for use with the Weagant circuit, shown in Fig. 1.

gives the operator much more comfort and eliminates much of the capacity between the hands and the coils. A wooden or insulating shelf should be arranged over the condensers to hold the vacuum tube sockets and transformers. The mounting for the R.F. coil should be placed on this shelf also. The R.F. coil should be kept as far as possible from the three-coil mounting and from the audio frequency transformers. The details of the amplifier (audio) have intentionally been eliminated, as there is no particular point to bring out in it.

TUNING THE SET

In tuning a "Weagant" receiver for amateur C.W. signals, the special coil mentioned above should be used. It consists of a secondary winding on a two-inch tube, having 30 turns of No. 22 D.C.C. wire, and a tickler winding of 36 turns wound on a form to fit tightly inside of the secondary tube. These two windings may be mounted on two coil plugs, and connected together mechanically in order that they may be conveniently handled in the honeycomb coil mounting. A 25-turn coil should be used in the R.F. amplifier and for a primary. To tune this apparatus for amateur signals, the tickler condenser should be used in just sufficient amount to allow the tuner to oscillate over the entire range of the secondary condenser. If properly balanced with the above coils, the tickler setting for such work will not be over 40 degrees. When the set is so adjusted, it will be found that all the tuning, except a possible readjust-

Insure your copy reaching you each month. Subscribe to Radio News—\$2.50 a year. Experimenter Publishing Co., 53 Park Place, N. Y. C.

ment of the antenna condenser, can be done with the secondary condenser. In this connection it should be kept in mind that the minimum value of a tickler condenser that will cause oscillation will give the best results on C.W. signals. However, the few extra degrees used to secure the "one knob" control will not materially deduct from the efficiency of the set.

In tuning for broadcast stations, the procedure for locating the carrier wave, or "squeal," is the same as for the amateur C.W. signals. When the desired station is heard, the amount of tickler condenser should be reduced until oscillation ceases. Then a slight readjustment of the secondary condenser made. Possibly a change will be necessary with the antenna condenser. The point where oscillation ceases is easily found, as it is the point where the carrier wave squeal ceases, and the voice or music comes in. It is quite important in tuning broadcast stations that a minimum of tickler condenser be used at all times, the one knob tuning not being recommended for wide changes, when the set is *not oscillating*.

In picking tubes for this circuit, it is recommended that a detector tube slightly "hard" be used, particularly for R.F. A UV-201A detector is being used by the writer with entire satisfaction, but same must be picked. It is not to be expected that any hard tube chosen at random will work.

The writer is using one of the R.F. tuners at present and does not hesitate to recommend it for its efficiency and flexibility to both amateur and broadcast listener. If properly constructed it will give excellent results.

I wish to take this opportunity to thank Mr. J. E. Hodge, Radio 4BY who introduced me to this circuit about one year ago and to Mr. F. A. Hill, Radio 4GL who assisted with the radio frequency amplifier.

Radio Waves Picked up Underground

(Continued from page 1224)

New York stations, and heard music and other bits of the day's programs. Mr. Frohlich, after expressing pleasure at the success of the experiment, said:

"We are working on a portable sending set for the use of those engaged in dangerous underground work. It is the hope of those engaged in such tests as this one that a device will be constructed that men can carry with them when they go to any work that is more than usually hazardous, and that will not prove cumbersome; something, for instance, that can be hung up, and used in case of danger to send out cries for help. It has now been proven that radio waves can enter anywhere and the only thing now needed is a portable transmitter."

With the Amateurs

(Continued from page 1245)

5RG

The call 5RG has been reassigned to Thomas R. Gentry, 4030 1/2 Travis Avenue, Dallas, Texas. A 5-watt A.C.C.W. All crds. QSL'd.

4PY

The call 4PY has been assigned to Merel Bivans and B. C. Fidler, Jr., ex 8ABE. Using a 50-watter.

1AHU

The call 1AHU has been re-issued to Joseph Chereskie, 19 West Street, Flor-

Safety
demands
the
BRACH
Vacuum
Radio
ARRESTER
made to protect
-not to meet a price.

Over 750,000 **BRACH**
Arresters installed on
Radio since 1913. Approved
by the National Board
of Fire Underwriters. Sold
by all leading radio dealers

L.S. BRACH M'FG. CO.
NEWARK, N.J. U.S.A.

Also Makers of the Famous

SOLDER ALL JOINTS WITH
SOLDERALL
The Best Way to Insure Clear Signals

25¢
A TUBE

A Real METAL
Solder
In Paste Form

Guaranteed Equal to Wire or Bar Solder

Clear as a Silver Bell

O-T SILVERTONE TUBES

(Registered)



will increase the signal strength of your set from 20 to 50 per cent—and even to a greater degree when used as a NEUTRODYNE detector.

Three Models

- O. T. 1A—2 to 4 volts, Battery Draw .15 amps. Price, \$6.00
- O. T. 9—2 to 4 volts, Battery Draw .06 amps. Price, \$6.50
- O. T. Power Tube—5 volts, Battery Draw .25 to .35 amps. Price, \$7.50

At your dealer or direct by mail. Write for complete literature.

Manufactured by DeForest Tel. & Tel. Co.

Exclusively for the

O. & T. Electric Corporation

1819 Broadway, New York
High class representatives wanted.

The O-T is the only genuine Silvertone Tube. Fully guaranteed. Beware of imitations.

TRIP-L-KOIL

VARIOMETER, VARIOCOUPLER AND VARIABLE CONDENSER IN ONE UNIT

OUR MONEY BACK GUARANTEE

If your dealer doesn't carry this tuner, send us your order direct. We will ship Parcel Post Collect at the \$9.00 price. If, after a fair test, you find the Trip-L-Koil does not meet with our claims, send it back—and your money will be returned instantly!

PLACE YOUR ORDER NOW!

If you contemplate building your own receiving set, or wish to improve on the one you now have, be sure and get a Trip-L-Koil—the new spider-web tuner. 200 to 600 meter range. Gives the selectivity of a two-circuit set to single-circuit hook-up. The Trip-L-Koil is positively the *sharpest tuning device* that can be installed in a single-circuit receiver.

AN AMAZING DEVICE!

The Trip-L-Koil *does away with* the variometer, variocoupler and variable condenser! Only two panel holes necessary for mounting. Beautifully and sturdily constructed. Complete wiring diagram with each tuner. Price \$9.00—no dials included.

ASK YOUR DEALER

Or Write Us Direct.

Wheeler-Green Electric Co.

ROCHESTER, N. Y.

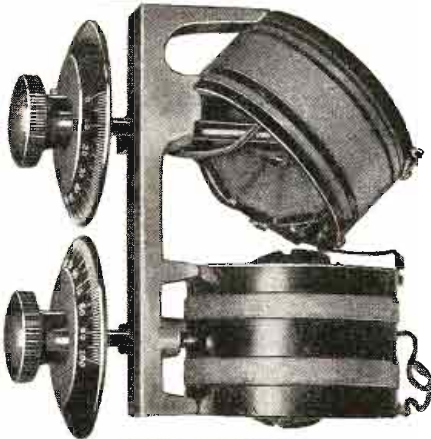

Patent Applied for

75C Will make All the Difference

Better reception—longer range—finer adjustments—clearer amplification. See your dealer for a Reliable Micro-Air Neutralizing Condenser today.

The Reliable Parts Mfg. Co. 2819 Prospect Ave., Cleveland, O.

RELIABLE



neutralizing condensers



TUBES REPAIRED

U.V.200, C.300, A. & P. Detector and Moorehead Detector.

- W.D.11 or W.D.12 \$3.50
- C.11 or C.12..... 3.50
- U.V.201 or C.301... 3.00
- U.V.201A or C.301A 3.50
- U.V.199 or C.299... 3.50
- U.V.202 or C.302..... 4.00
- A. & P. or Moorehead Amp. 3.00
- D.V.6.....\$3.00 D.V.6A..... 3.75

Broken glass shells replaced—No extra charge.

All tubes returned Parcel Post, C. O. D.

Radio Tube Repairing Co.

Hudson Terminal Bldg., 30 Church Street, Suite 327-E New York City, N. Y.



ence, Mass. 5-watt I.C.W. All reports QSL'd.

Calls Heard

This space is set aside each month for the listing of amateur calls heard. We invite you to send us a list of the stations you have heard, typewritten if possible, or at least sufficiently readable to prevent mistakes. Print the calls on a separate sheet of paper, using but one side. These should be arranged alphabetically for each district. To distinguish the stations that have been worked, they should be put in parentheses, and, according to the rules now in use, the C.W. stations should be mentioned in a separate list. The lists should reach us by the first of the month for publication in the following issue.

TRANS-PACIFIC TESTS

Stations heard by Station 2ZZ. Owned and operated by C. P. Smith, 83 Cabramalta Rd., Cremorne, Sydney, Australia.

Apparatus used. Home-made one-valve set. Marconi V-24 valve. Honeycombs were used as inductances. Aerial 40 feet high, 146 feet long, unbalance T-type single wire.

Will be pleased to hear from owners of the stations I have heard, and will answer all letters from same, giving times, strength, note, etc.

Oct. 25th, 6KA calling 3BM, Love, Aussie, (loudest of all stations heard). Oct. 28th, 6KA calling 3BM, Love, Aussie, (loudest of all stations heard); 6CKR calling (very faint tonight); 2RD calling—GZ (not sure): Oct. 31st, 2FT calling 6A. Nov. 1st, 6CKR calling CQ (very loud); 6KKR calling, Aussie; 8BAK calling; 4AOV or 1VHT calling CQ (time 0822); 6CKP calling; 9MC calling; 6CKP calling 9MC; 6RI calling 6KC; 1VC calling 3BM, Love, Aussie (not sure whether 1VC or 1VNN); 1NCO calling, Aussie, time 0718, not sure of call; 6KT calling; 7GD calling 3BM, Love, Melb.; 6VY calling; 6AVV calling; 6CKR calling 9MC and 9MC calling 6CRR, working together; 4MI calling 3BM, Love, Melb.; 6RI calling 6KC; 1VC calling 3BM, Love, Melb.; 6AV calling, 6CKP calling 9MC. Nov. 24th, 8GZ calling; Nov. 25th, 9ZT calling (both loud but fading badly).

6ALV ALAMEDA, CAL.

All C.W.—U. S. A.—3HG, 3VP, 4FG, 4KU, 5EB, 5FX, 5HT, 5KC, 5TJ, 5UO, 5AGJ, 5ADB, 5AKF, 5ZA, 5ZAV, 6CJU, 7MN, 8AA, 8AB, 8ER, (8GZ), 8TT, (8ABM), 8AJH, 8AME, 8BDA, 8BNH, 8COJ, 8AJH, 8ZZ, 9CE, 9EI, 9LZ, 9AHG, (9AHZ), 9APE, 9APF, (9APS), 9AVZ, 9AVU, 9BCH, 9BLY, 9BSP, 9BSO, (9BTT), 9BUH, 9BPV, 9BXC, (9BZI), 9CCO, 9CCR, 9CJC, 9CJY, 9CPI, 9DAW, (9DCH), 9DCW, 9DHD, (9DLF), 9DQU, 9DXN, 9DYY, 9EEA, 9EKY, 9ELV, (9YU), (9ZT).
Canada—5CN, 5GO, 9BX.

5BD, ARLINGTON, TEXAS (Det. Only)

1AOL, 1ARY, 1AW, 1BEP, 1BGC, 1BOQ, 1BWJ, 1CRI, 1ER, 1GS, 1GV, 1MY, 1OW, 1UJ, 1XM, 1YB, 2AAY, 2AGB, 2AM, 2AYV, 2BLM, 2BSI, 2BY, 2BYN, 2CEI, 2CSR, 2CSZ, 2CXG, 2CXL, 2FZ, 2KF, 2RB, 2TS, 2WB, 3ABJ, 3ACV, 3AHP, 3AJD, 3AS, 3BJJ, 3BNU, 3BOF, 3CFY, 3CHG, 3CJN, 3JJ, 3JY, 3LJ, 3ME, 3PL, 3SU, 3TR, 3UR, 3VO, 3XN, 4AF, 4AY, 4BG, 4BQ, 4CS, 4DB, 4DL, 4DO, 4EL, 4ER, 4FA, 4FS, 4FZ, 4GW, 4GX, 4IJ, 4IU, 4JH, 4MB, 4ME, 4MI, 4OA, 4ON, 4PB, 4PV, 4QW, 4AAM, 6ACM, 6AFO, 6AHT, 6ANB, 6AJH, 6AJJ, 6AOL, 6AOS, 6AOU, 6ARB, 6AUU, 6AWT, 6AZO, 6BBC, 6BCL, 6BCS, 6BDS, 6BEG, 6BH, 6BIC, 6BIO, 6BJC, 6BJO, 6BKS, 6BKX, 6BLM, 6BLW, 6BM, 6BMY, 6BNC, 6BPZ, 6BQR, 6BRF, 6BSX, 6BUA, 6BUH, 6BUI, 6BUO, 6BUR, 6BUY, 6BVE, 6BWE, 6CAW, 6CC, 6CDG, 6CEJ, 6CEK, 6CFY, 6CFZ, 6CGG, 6CGW, 6CHC, 6CHU, 6CID, 6CJJ, 6CJL, 6CKP, 6CKR, 6CMR, 6CNH, 6CNM, 6CSU, 6CU, 6ET, 6FP, 6FV, 6KM, 6LV, 6MG, 6MH, 6NB, 6NX, 6PL, 6VD, 6XC, 6ZAU, 6ZBA, 7ABY, 7ACI, 7ADR, 7ADS, 7AEL, 7AF, 7AFN, 7AGE, 7AGR, 7AGV, 7AK, 7AKH, 7DU, 7FY, 7HG, 7HW, 7IT, 7KR, 7KS, 7LH, 7LU, 7QD, 7QJ, 7RS, 7SC, 7SF, 7TO, 7WM, 7WS, 7YL, 7ZD, 7ZK, 7ZU, 8AAF, 8ACK, 8ADK, 8AEG, 8AFD, 8AGO, 8AHQ, 8ALW, 8AMM, 8ANL, 8ARD, 8ATL, 8AZH, 8BAU, 8BBJ, 8BCI, 8BDA, 8BDM, 8BDU, 8BEK, 8BFH, 8BFI, 8BKY, 8BNH, 8BNN, 8BOF, 8BPU, 8BVS, 8BVT, 8BVU, 8BVX, 8BVY, 8BWB, 8BXA, 8BXH, 8BXV, 8BXX, 8BZD, 8CDD, 8CDI, 8CEO, 8CKO, 8CNW, 8COW, 8CPM, 8CPY, 8COZ, 8CSE, 8CTP, 8CUX, 8CWL, 8CWU, 8CXW, 8DAC, 8DAT, 8DGP, 8DHO, 8DIS, 8DJF, 8DJF, 8DKM, 8DLE, 8DO, 8DP, 8DX, 8ES, 8FC, 8FI, 8FU, 8FN, 8GL, 8HK, 8JU, 8JY, 8KG, 8KU, 8MD, 8MT, 8PZ, 8SF, 8SO, 8TR, 8UE, 8XE.

Canadian—1AR, 2BG, 2BN, 2IC, 3ADJ, 3ADN, 3BA, 3OH, 3PG, 3TB, 3TF, 3XI, 3ZL, 3ZS, 4HF, 5GO, 9AL.

4DX, GREENVILLE, S. C.

(1ACU), (1ADN), (1AEG), 1AIY, 1AJP, 1AJT, (1ALJ), 1ALZ, 1BAH, 1BES, (1BBO), (1BWJ), 1CDM, 1CKP, 1CPO, 1COF, (1ER), 1FB, 1H, 1L, 1MY, (1ON), 1SN, 1ZE, (2AYV), (2BBX), (2BNZ), (2BQY), (2BZY), (2CEI), 2CIM, (2CJR), (2CLU), (2COZ), (2CRQ), (2CVU), 2FP, 2KE, (2KK), (2LE), 2OM, 2OR, (2RB), 2RM, (2WR), (3ACY), (3ADV), 3AHP, (3AJG), 3ATB, (3AWH), (3BBV), (3BDD), 3BFU, 3APR, (3BG1),

Get a Handy Binder for your RADIO NEWS. Holds and preserves six issues, each of which can be inserted or removed at will. Price 65c. Experimenter Pub. Co., Inc., Book Dept., 53 Park Place, New York.

(3BLC), (3BMN), 3BNU, (3BQP), (3BUY), 3BHV, (3BVA), 3BVR, (3CBL), (3CDK), (3CFV), 3FS, (3TW), 3JY, 3MO, 3OO, 3OO, (3TA), 3TJ, (3VO), (3ZO), 3ZS, 4AA, (4AF), (4AZ), (4BK), 4BY, (4CG), (4CS), (4CY), (4DB), (4DO), (4DT), (4EB), (4EL), (4EO), (4FA), (4FD), (4FE), (4FG), (4FO), (4FT), 4GX, (4H), 4HR, 4HS, (4HW), (4HZ), (4IT), (4JK), (4KU), (4LJ), 4LK, 4LP, 4MA, (4MB), 4ME, (4MI), 4MY, (4NA), (4NT), 4OD, 4OM, (4OT), 4PL, (4PV), 4QF, 4RR, 4XD, 4ZA, 4ZC, 5AAG, (5ABT), 5ACR, 5AGD, (5AGJ), 5AHD, (5AJP), (5AMH), 5ALV, (5DA), 5DD, 4DW, 5EN, 5FC, 5FY, 5GN, 5GP, (5HL), (5IN), (5K), 5KG, (5KR), (5LR), 5LV, 5MI, (5NJ), (5NS), (5PB), (5QF), (5QQ), (5RB), (5OK), (5OO), (5OP), (5VY), (5XU), (5ZAS), 5ZAV, 6TI, 6TV, 6WP, 7BJ, 7SC, 7AEB, 7IT, (8AAJ), (8ADA), (8ADK), (8ADO), (8AGL), 8AIO, (8AL), 8AMP, 8AMZ, 8ARO, (8ARQ), (8ATC), (8ATA), (8ATP), (8AWZ), 8AXN, (8AZO), (8BCI), (8BDA), 8BDH, 8BDU, (8BFH), 8BGL, (8BJS), (8BLX), (8BNA), (8BNO), (8BNZ), 8BOA, (8BRC), 8BSU, (8BUX), 8BWZ, (8BYO), (8CGE), 8CGX, 8PID, (8CJP), (8CKO), (8CKV), 8CNR, 8CNW, (8CQH), (8CTP), 8CUR, (8CVM), 8CNM, (8CYO), (8CYT), (8CYX), 8CZC, (8DC), 8DDW, (8DIF), 8GA, (8GZ), (8HV), (8JV), 8NB, (8OK), 8PL, (8PW), (8RG), 8RI, 8RO, (8TT), (8UN), 8VY, (8WY), (8YAE), 8ZAE, (8QC), (8ZW), (9AEP), (9ALM), (9ANY), 9AOG, 9AQQ, 9AOU, 9APS, 9APE, (9AUS), (9AWG), (9AWM), 9BCK, 9BAZ, 9BDS, (9BIK), (9BKD), (9BRK), 9BSH, (9BT), (9BUH), 9BYT, (9BZI), 9CAA, 9CAH, 9CCB, (9CCS), 9CCZ, 9CEE, (9CIP), 9CLK, (9CTV), 9CZS, (9DEK), (9DFW), (9DGW), 9BTL, (9DIS), 9DKM, (9DQA), (9DWK), 9DZY, 9EDO, (9EKY), (9ELB), (9EM), (9EP), 9IH, 9JG, 9MC, (9MF), (9MM), (9OT), (9OX), (9QI), (9UC), 9UZ, 9VM, 9VZ, 9YC, (9ZC), 9RA?, (9ZT), 1C.W.—1CKP, (4EQ), (5AGJ), (5HL), (5VQ), (9AAW).
 Phone—1AJP, (4JK), 4FT, (4FQ), (4IT), (4PV), (4KU), (5AMF), 5LL, (5HL both ways), 5KG.
 Spark—4IO, 4OT, (8RG), 8TH, 9AHO, 9DWK.
 Canada—3BP, 3HE, (3TA), 3TB, (3ZS), 4CL, 4DK.
 WKD on Phone—(2AYV), (3CFV), (4FE), (4FQ), (4PY), (5ABT), (5UO), (8GZ), (9MM).
 Please QSL ES QRK MI 30-watt C.W. 1C.W.

V. W. GILMORE, MILE SEVEN, ALASKA
 1ANA, 1BGC, 2KV, 2TS, 2NQ, 3ALN, 3CO, 3PB, 4AY, 4BQ, 4CN, 4CR, 4DQ, 4EQ, 4JK, 5ACF, 5AIU, 5AKN, 5AMA, 5CT, 5EB, 5EK, 5GA, 5GI, 5GN, 5AKY, 5AMN, 5IN, 5KC, 5LG, 5LR, 5MO, 5OO, 5QI, 5OW, 5UK, 5UP, 5WX, 5ZAV, 5ZB, 6ABX, 6AGE, 6AII, 6AK, 6ANB, 6AOI, 6AOS, 6ASX, 6AVV, 6BBW, 6BIC, 6BIH, 6BIQ, 6BJJ, 6BM, 6BNC, 6BQL, 6BRK, 6BUO, 6BVS, 6CC, 6CEU, 6CGD, 6CGM, 6CGW, 6CKP, 6CKR, 6CMU, 6CNH, 6CNW, 6FP, 6GR, 6JX, 6KM, 6KW, 6LV, 6MH, 6NX, 6PL, 6TS, 6VF, 6XAJ(Phone), 6ZAR, 6ZAV, 7AEA, 7AEL, 7ABB, 7ABF, 7ADR, 7AGF, 7AGN, 7AH, 7AII, 7AIM, 7BJ, 7FD, 7GE, 7JN, 7LH, 7NO, 7NN, 7PX, 7OB, 7QJ, 7QT, 7RC, 7SC, 7SF, 7SN, 7ZU, 8AFC, 8AGO, 8BDA, 8BZC, 8BQC, 8DDQ, 8CZ, 8GZ, 8KG, 8RJ, 9ADW, 9AHZ, 9AIM, 9AMB, 9APE, 9APP, 9AON, 9AOS, 9ASF, 9AUU, 9AWV, 9BAK, 9BAU, 9BEY, 9BII, 9BLY, 9BOF, 9BRI, 9BTO, 9CBJ, 9CGU, 9CGW, 9CVG, 9DIB, 9DNÜ, 9DSW, 9DXN, 9DZY, 9EAE, 9EKY, 9ELV, 9LV, 9TV, 9XI, 9YY, 9ZT.
 Canadian—4CR, 4DY, 5CN, 9CF, 9BX and WNP.

All the above listed stations are over one thousand miles distant and were received on a single circuit receiver with one and two steps of amplification. The approximate location of Mile Seven, Alaska, is Latitude 61 North and Longitude 145 West. Any station desiring to test for reception kindly mail card at least three weeks in advance of test. Can listen any time from six to twelve P.M. Pacific Coast Standard Time.

4PY. FORT LAUDERDALE, FLORIDA
 C.W.—1ACZ, 1ALJ, 1AOL, 1AQL, 1AQM, 1BGC, 1CAB, 1CMP, 1EE, 1FD, (1FM), 1HX, 1OA, 1SK, 1SN, (1YB), 2AGD, 2BPF, 2BSC, 2CEE, 2CPA, 2CQI, 2BE, 2BY, 2GK, 2RK, 2XNA, 3AB, 3IJ, 3LG, 3OV, 3AEK, 3AUV, 3BDO, 3BNU, 3BTA, 3BVA, 3CDN, 3CJT, (4BH), (4FT), (4FS), (4SB), (4IH), (4OB), 5AC, 5AD, 5FT, 5GN, 5HR, 5HT, 5KG, 5KN, 5LR, 5NK, 5NW, 5OT, 5OV, 5OI, 5OL, 5OY, (5RH), 5SD, 5VM, 5VV, 5XAP, 5ZA, 5ZU, (5ZG), 5ADH, 5AFS, 5AKN, 5AM, 5AXN, 6LV, 6ZL, 6ZI, 6ALK, 6AOI, 6CGW, 6XAD, 7KO, 7SC, 7ACM, 8AA, 8PL, 8PX, 8RJ, 8XE, 8ZC, 8ABM, 8AGO, 8APT, 8AQQ, 8AXC, 8BDU, 8BFM, 8BQI, 8BRM, 8COM, 8CPP, 8CVN, 8DHN, 8DKJ, 9EQ, 9JC, 9QR, 9VC, 9VM, 9WU, 9ZT, 9AAR, 9ACK, 9ADY, 9AEC, 9AIM, 9AMB, 9APP, 9APS, 9ASC, 9BAK, 9BCB, 9BEZ, 9BHX, 9BJI, 9BLY, 9BOZ, 9BRK, 9BRY, 9BNQ, 9CFY, 9CKP, 9CPK, 9CTE, 9CTU, 9DAY, 9DAW, 9DCR, 9DIS, 9DKB, 9DQU, 9DTT, 9EER, 9FEK, 9EGW, 9ELB.
 Canadian—1DD, 2BN.
 QSL to B. C. Fidler, Jr., ex 8ABE, 233 Brickell Ave.

GEORGE KRIVIZKY, SCOTTVILLE,
 MICH. (3-Foot Loop—1 Tube)
 C.W.—1AAJ, 1AFP, 1ALI, 1ALI, 1AOM, 1ASI, 1AUR, 1BVB, 1ER, 1RB, 1WO, 1YK, 2ACO, 2BM, 2BTE, 2BY, 2CEE, 2CGI, 2CQI, 2CRJ, 2CWO, 2CXD, 2CNL, 2CXV, 2DX, 2KF, 2SQ, 3AHP, 3AIC, 3BFX, 3BHM, 3BML, 3BZ,

Electrad Products

Their Quality Absolutely Guaranteed

YOU are safe when you buy Electrad Products. They are absolutely guaranteed, electrically and mechanically, to be of the finest materials and workmanship.

Most good dealers carry them because they are fairly priced, and give their customers good service.

Double Your Distance with an Electrad Variohm. 75c.



The latest invention in grid leaks. A simple turn of the knob and you can get any resistance from 1/2 to 30 megohms. Eliminates circuit noises, is moisture proof and non-microphonic. Absolutely guaranteed.

Electrad Lead-In. 40c.



Fits under closed window. Can be bent to any shape. Covered with fireproof insulation which prevents grounding on wet window sills. No holes in window frames and takes the place of unsightly porcelain tubes. Fitted with Fahnestock Clips.

Electrad Indorarial. \$1.50



Ideal for sharp tuning. Wonderful directional effects. Particularly effective where several local stations are broadcasting at once. Can be used also as ground. By using Indorarials for antenna and ground you can get any coupling you desire. Hang on wall, door or lay under rug.

Electrad Grid Leaks. 30c.



Absolutely uniform unvarying fixed resistance. A superior product of dependability, in all resistances from 1/4 to 10 megohms.

DEALERS: Write for samples and details on our special group assortment.

ELECTRAD Inc.

Dept. "H."

428 Broadway, New York City

The New WALNART INDUCTANCE SWITCH

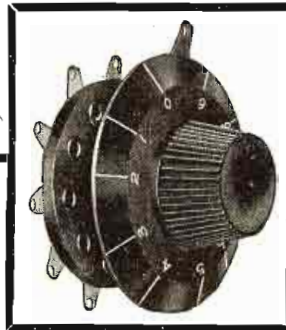

List Price **\$1.25**
Complete with Dial

Only with positive contacts can you get good reception. Switch points are unsightly and the contacts are poor. A Walnut Inductance Switch, 1-10 points, gives positive contact and better reception. Bakelite numbered dial shows exact position at all times.

Both instruments have CONDENSITE CELORON bases; the perfect dielectric insulation. (Made under Bakelite patents.)

WALNART Variable Grid Resistance

List Price **\$1.00**

Gets the best results from every tube. Eliminates hissing and brings in signals clear and strong. Nothing to wear out, lasts a life time.

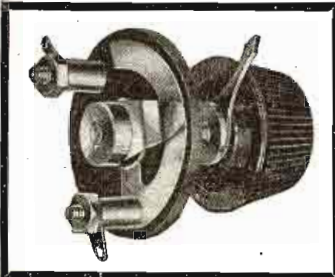

WALNART ELECTRIC MFG. CO.

1249 W. Van Buren St. Dept. 607 Chicago

3CDM, 3CHB, 3CHG, 3CIU, 3CXX, 3DB, 3FK, 3HS, 3IW, 3JY, 3KP, 3PL, 3TF, 4AI, 4AY, 4BS, 4BY, 4CS, 4DB, 4EB, 4EQ, 4FO, 4NA, 4QF, 4RH, 4SFO, 4AIU, 4BE, 4DH, 4FV, 4JJ, 4PY, 4SWS, 4YW, 4AGK, 4AKZ, 4APE, 4BM, 4BNC, 4BQ, 4BVE, 4CFZ, 4CGW, 4CMR, 4FP, 4JK, 4NX, 4PL, 4ZH, 4ADH, 4CO, 4DC, 4OB, 4QC, 4SC, 4TO, 4AA, 4AAF, 4ABA, 4ACM, 4ACV, 4ADA, 4AEX, 4AF, 4AFN, 4AGL, 4AIG, 4AGE, 4AJH, 4ANB, 4ANE, 4ANM, 4APV, 4AQO, 4ARS, 4ATG, 4ATL, 4ATP, 4AWL, 4BAG, 4BBT, 4BCF, 4BDA, 4BF, 4BFB, 4BFG, 4BGE, 4BHF, 4BJY, 4BKM, 4BMB, 4BML, 4BNH, 4BOA, 4BP, 4BPU, 4BQ, 4BQE, 4BQI, 4BQZ, 4BRJ, 4BSW, 4BTM, 4BUL, 4BUU, 4BVT, 4BVU, 4BVX, 4BYN, 4BZD, 4CC, 4COL, 4CDD, 4CDI, 4CED, 4CEF, 4CEJ, 4CFX, 4CG, 4CGI, 4CLK, 4CMU, 4CNO, 4COI, 4COM, 4CFM, 4CR, 4CRC, 4CRH, 4CXW, 4DAE, 4DBL, 4DBM, 4DCY, 4DDA, 4DDT, 4DFO, 4DGN, 4DGR, 4DHO, 4DJF, 4DJR, 4DJK, 4DLA, 4DP, 4DUU, 4DX, 4EF, 4ER, 4FC, 4GZ, 4JJ, 4NB, 4OA, 4PD, 4PL, 4SR, 4SV, 4UF, 4VY, 4WO, 4XAV, 4XK, 4YAL, 4YAR, 4YAU, 4YCT, 4YDC, 4YDP, 4YDV, 4YDY, 4YEM, 4YF, 4YFY, 4YGO, 4YGT, 4YHV, 4YIM, 4YML, 4YND, 4YOU, 4YPE, 4YPP, 4YVP, 4YQB, 4YRJ, 4YRK, 4YRP, 4YST, 4YAT, 4YATP, 4YUS, 4YVT, 4YWF, 4YWP, 4YXX, 4YAYE, 4YAX, 4YBAK, 4YBAV, 4YBJ, 4YCH, 4YCX, 4YBE, 4YBGH, 4YBHH, 4YBHI, 4YBHL, 4YBH, 4YBIJ, 4YBIS, 4YBJK, 4YBJR, 4YBKP, 4YBMX, 4YBOF, 4YBOZ, 4YBP, 4YBPV, 4YBPW, 4YBQC, 4YBQI, 4YBQU, 4YBRI, 4YBRK, 4YBRY, 4YBTH, 4YBTL, 4YBUH, 4YBUK, 4YBXO, 4YBYE, 4YBYJ, 4YCAH, 4YCCV, 4YCDO, 4YCFK, 4YCFZ, 4YCG, 4YCGN, 4YCIH, 4YCIJ, 4YCKF, 4YCKP, 4YCMC, 4YCNO, 4YCOG, 4YCPW, 4YCTE, 4YCTU, 4YCU, 4YCVI, 4YCVS, 4YCXU, 4YCYV, 4YDAP, 4YDAW, 4YDAY, 4YDCB, 4YDCR, 4YDD, 4YDDI, 4YDEK, 4YDEN, 4YDEQ, 4YDFH, 4YDFW, 4YDGE, 4YDGH, 4YHI, 4YDJI, 4YDKY, 4YDMI, 4YDMK, 4YDND, 4YDOE, 4YDON, 4YDOV, 4YDPE, 4YDPX, 4YDRC, 4YDRT, 4YDUI, 4YDVK, 4YDXN, 4YDXV, 4YDY, 4YDYV, 4YECN, 4YEDM, 4YEFZ, 4YEH, 4YEL, 4YELV, 4YEP, 4YEQ, 4YES, 4YKD, 4YLE, 4YLN, 4YMC, 4YMQ, 4YU, 4YV, 4YVK, 4YVM, 4YB, 4YCF, 4YY.

Spark—2BQZ, 2CTD, 3BBY, 3BDA, 3BOF, 3EHJ.

Canadian—C.W.—2BG, 2BN, 2BW, 2CG, 2IC, 3MS, 3PG, 3XI.

Read'em Binding Posts

ANT, FONES, GND, FONES, A Bat, A Bat, B Bat, 22 Volts, 45 Volts

The Marshall-Gerken Co. Toledo, O.

WANTED Complicated Hook-ups!

To simplify difficult hook-ups use "Read'em" Binding Posts. Tell at a glance whether it is Antennae, Ground, Fones, A or B battery, etc. Name neatly engraved for keeps on top of each post. (See illustration). The irremovable knobs save time, trouble and petty annoyances. "Read'em"s add to the appearance of any set. Don't be without them. Price 15c. each. Set of ten (as shown) \$1.50.

If your dealer can't supply you with "Read'em"s," order direct.

Look for the name "Read'em" on every post.

The Marshall-Gerken Co.

Dept. A 27 N. Ontario St. Toledo, Ohio

5XV, PORT ARTHUR, TEXAS

1ADN, 1ARE, 1BWJ, 1CGJ, 1CMP, 1CPN, 1ER, 1HX, 1IY, 1MY, 1RV, 1XAM, 1XM, 1YB, 2AAV, 2AL, 2BRB, 2BXW, 2BY, 2CEI, 2CJR, 2CKA, 2CPA, 2CQZ, 2CXD, 2CXX, 2KF, 2RK, 3AB, 3ALN, 3AMS, 3AS, 3ATB, 3BG, 3BGG, 3BGP, 3BHV, 3BKT, 3BNU, 3BOF, 3CO, 3HG, 3JJ, 3MO, 3NI, 3SU, 3TB, 3TR, 3UH, 3UR, 3VO, 4AG, 4EQ, 4FS, 4FT, 4FG, 4GA, 4GL, 4GW, 4MB, 4ME, 4NA, 4RR, 4SD, 4TG, 4AGE, 4AGJ, 4AHZ, 4AJF, 4AJJ, 4ANI, 4AOI, 4AR, 4ARB, 4AUP, 4AUV, 4AVV, 4AWT, 4BAH, 4BBH, 4BBW, 4BCL, 4BEQ, 4BFG, 4BHH, 4BIC, 4BIH, 4BJJ, 4BKX, 4BSG, 4BVE, 4CCG, 4CDG, 4CEK, 4CFY, 4CGW, 4CHU, 4CIX, 4CKF, 4CMR, 4CXP, 4CZ, 4FH, 4KM, 4MA, 4MH, 4MI, 4PL, 4OH, 4RM, 4TS, 4ZAF, 4ZAR, 4ZAU, 4ZAW, 4ZQ, 4ZV, 7ABB, 7ADR, 7AHS, 7ALN, 7APN, 7DC, 7GH, 7GS, 7HG, 7IH, 7LY, 7NN, 7OT, 7QC, 7QD, 7SC, 7SF, 7TX, 7YL, 7ZU, 8AGO, 8AIG, 8APN, 8ADA, 8AFN, 8ANB, 8AME, 8ACN, 8AXC, 8ATH, 8BAU, 8BCT, 8BDA, 8BF, 8BIK, 8BHN, 8BXX, 8CGJ, 8CJ, 8COJ, 8CUO, 8CWU, 8DAE, 8DDO, 8DGP, 8DKJ, 8DP, 8FS, 8PL, 8QO, 8TR, 8UF, 8YN, 8ZC, 8ZG, 8ZV, 9AAW, 9ACH, 9AEC, 9AJE, 9AHZ, 9AMB, 9AMK, 9ANO, 9ANY, 9AOM, 9AON, 9APP, 9ARU, 9AVC, 9SVU, 9AWF, 9BAK, 9BBW, 9BDE, 9BDR, 9BFF, 9BEH, 9BCC, 9BHD, 9BKI, 9BOF, 9BOP, 9BOY, 9BSH, 9BWV, 9CCS, 9CDE, 9CFI, 9CJY, 9CKD, 9CLO, 9CMN, 9CNB, 9CNH, 9CTE, 9CTG, 9CU, 9CYB, 9CYE, 9DAP, 4DAW, 9DAY, 9DDP, 9DHB, 9DHO, 9DJB, 9DJO, 9DPX, 9DPK, 9DRS, 9DSY, 9DXY, 9EAK, 9EER, 9EJT, 9EKY, 9ELW, 9EP, 9FM, 9HK, 9IH, 9IP, 9IV, 9LN, 9PE, 9PW, 9TA, 9YY, 9ZT.

Canadian—31A, 4CN.

WZV.

Vacuum Tubes Repaired

WD-11, WD-12, UV-201A, UV-199 and others for **\$3.00**

Quick service. All tubes repaired by us guaranteed to work as good as new.

Send your dead tubes. We prepay parcel post to you. All you pay is \$3.00 to postman. We give 48 hour service.

THOMAS BROWN CO.

511-517 Orange Street Newark, N. J.

\$3 Brings you a Genuine UNDERWOOD TYPEWRITER

10 DAYS FREE TRIAL. Your \$3.00 unconditionally returned if at end of 10 days you are not satisfied with this late model UNDERWOOD typewriter rebuilt by the famous Shipman Ward process.

GREAT PRICE SAVING Direct to you from the largest typewriter factory in the world by our money saving methods.

EASY MONTHLY PAYMENTS So small that you will not notice it while you enjoy the use of this wonderful machine.

FREE BOOK OF FACTS Explaining Shipman Ward's wonderful system of rebuilding typewriters and also valuable information about the typewriter industry both instructive and entertaining.

Act Today! Mail Coupon **5 Year Guarantee**

Please send me a copy of your free book of facts, explaining bargain offer.

Shipman Ward Mfg. Company
1953 Shipman Building
Montrose & Ravenswood
Aves., Chicago

Name.....
St. and No.....
City..... State.....

HEARD AT 5XV DURING APPROXIMATELY 12 DAYS IN OCTOBER.

1ADN, 1AJX, 1ALX, 1BEP, 1BKO, 1BWJ, 1CAB, 1CMP, 1ER, 1FB, 1IL, 1IV, 1KC, 1KW, 1PA, 1RV, 2ACV, 2AGB, 2ANA, 2BQB, 2BSC, 2BUM, 2BY, 2CCX, 2CQZ, 2CUA, 2CXL, 2CVZ, 2IG, 2WR, 2ZA, 3AAU, 3AB, 3AFS, 3ALN, 3ATS, 3BDO, 3BNU, 3BP, 3BVL, 3BOF, 3CH, 3HD, 3HS, 3JJ, 3JV, 3MO, 3TJ, 3TR, 3VO, 3ZO, 4AMH, 4BQ, 4EP, 4FT, 4GW, 4GX, 4HR, 4JK, 4KU, 4MB, 4OB, 4ON, 4PB, 4QF, 4QJ, 4RH, 4SB, 4XJ, 5ZA, 6AGJ, 6AMS, 6AOS, 6AUP, 6ARB, 6AWF, 6AWT, 6BEO, 6BBC, 6BIC, 6BIH, 6BKO, 6BMD, 6BM, 6BPZ, 6BRF, 6BUO, 6BVG, 6CFZ, 6CGW, 6CHL, 6CID, 6CTC, 6CU, 6ET, 6FLD, 6GGA, 6GCX, 6KA, 6QG, 6PL, 6OD, 6TS, 6XAD, 6ZA, 6ZAH, 7ABB, 7AHI, 7IG, 7LH, 7LU, 7LY, 7OH, 7WP, 7YA, 8AB, 8ADG, 8AGO, 8AGE, 8AIG, 8ATC, 8AP, 8BNH, 8BNM, 8BPM, 8BRM, 8CGJ, 8CNW, 8COH, 8CUX, 8CVG, 8CWK, 8CXI, 8DAT, 8DAW, 8DDJ, 8DAQ, 8DIG, 8DIL, 8DJF, 8DLS, 8GZ, 8HN, 8HWL, 8KC, 8KR, 8LX, 8MZ, 8OE, 8PA, 8WG, 8XE, 8XK, 100 meters; 8YY, 8ZZ, 9AAD, 9ACH, 9ACI, 9ACK, 9ACX, 9AGL, 9AGN, 9AIM, 9AOG, 9APF, 9AUC, 9AUW, 9AUV, 9AXX, 9AWP, 9AYN, 9BDS, 9BED, 9BEO, 9BEZ, 9BFB, 9BFI, 9BFP, 9BIK, 9BKK, 9BQO, 9BRK, 9BTT, 9BVN, 9BXO, 9BZI, 9CCV, 9CCX, 9CEH, 9CEJ,

9CFK, 9CHC, 9CHG, 9CK, 9CLZ, 9CNN, 9COL, 9CF, 9CTD, 9CTE, 9CTG, 9CTK, 9CTR, 9CZW, 9DAP, 9DEW, 9DKT, 9DKX, 9DMJ, 9DMT, 9DND, 9DSL, 9DXU, 9DYZ, 9DZY, 9EAR, 9EKF, 9ER, 9EKY, 9GC, 9MC, 9VC, 9VAJ, 9ZT.

Canadian—2CR, 3SI, 4HH, 4CN, 5CN.
KFKX on 100 meters.
Sumbody with codeword Boliq.
Too many to send cards to, but if you want one, write.
5XV answers all cards, you bet.
5s, too numerous to include in above list.
5ZA over 500 miles.

The Development of Wired Radio in Germany

(Continued from page 1231)

6,000 meters, for which the receiver at station EW₂ is automatically set by connecting the push button. EW₂ and EW₃ are now in connection with each other. While they remain so, the calling bells of the other stations EW₁, UW, and UW₂ are inactive, showing the "busy" signal and at the same time are cut off electrically. The communicating goes on just as simply as if it were a house telephone.

THE APPARATUS

However complicated the apparatus seems in the diagrams, it is perfectly simple in reality. The apparatus for two wavelengths, transmitting and receiving, includes a transmitting bulb of 10-watt maximum power (the range of certain audibility is 60 to 100 miles), a modulating bulb, a post-office transmission bulb, an audion tube, and two amplifier bulbs. The whole is only 20 inches wide, 8 inches deep and 20 inches high, including the calling accessories. As source of power, storage batteries and a small transformer are used. In order to be free from irregularities in the power on the leads of the network, the transformer runs 12 to 500 to 700 volts.

The photographs show a complete installation in a large electric plant in Germany, including storage batteries, transmitting and receiving apparatus, telephone, call bell, etc., and all safety devices.

When one goes from Lucerne down the Lake of the Four Cantons, celebrated through William Tell, one is surprised at the beauties of Switzerland. He sees passing over mountain and through valley a high power line with a dozen wires, which carry more than 100,000 volts. They extend to the Swiss United Railways at Amsteg under the St. Gothard, and supply these railways with their needed power. What the traveler does not see is that over these high tension lines there are carried many hours of intercourse by high frequency waves from Amsteg out to the various transformer stations.

The next installment of this paper will show how the amateur with the means at his command will be able to experiment with wired radio telegraphy and telephony.

Lightning Protection for Antennae

(Continued from page 1257)

Fig. 4 shows an antenna X-Y, with lightning arrester A connected and grounded and a cloud C. The cloud carries a positive charge. As it drifts over the antenna it induces a negative charge on the upper surface of the wire, a positive charge on the lower surface and a negative charge on the earth. There being a difference of potential between the antenna and earth, the positive charge on the antenna combines with the negative earth charge either by leaking to ground over poor insulation, or if the difference of potential is great enough, by arcing across the arrester.

KESTER SOLDER

Self-fluxing



"Requires Only Heat"

A Better Set is a Soldered Set



Kester Acid-Core
For Antennas and Heavy Work

KESTER Acid-Core SOLDER



1, 5 and 10 lb. Spools
One Pound Coils in Cartons

A safe solder for Radio—that's Kester Acid-Core Solder. Not only safe but simple and saving as well.

Kester Acid-Core Solder is saving because inside the hollow wire form of solder are tiny pockets full of scientific flux. This flows to the job bit by bit as the solder is used—saving the user's time and the material generally wasted by the old method.

Kester Solder is simple because it requires only heat—any form will do—a soldering iron, hot poker or nail, blow torch, gas flame, lamp, candle or even a match.

Kester Acid-Core Solder is safe because the scientific flux is non-corrosive (Underwriters' Laboratories Inspected). Use Kester, and make certain your finished job will last.

KESTER Rosin-Core SOLDER



1 5 and 10 lb. Spools One Pound Coils in Cartons
18 inch Sticks in Five Pound Boxes

This solder has the same desirable advantages of Kester Acid-Core Wire Solder, in being simple to use. It also requires only heat. Rosin as a flux, is preferred by some for the very delicate radio soldering. It is somewhat slower in its action and possibly requires a bit more skill in handling. This solder is obtainable in Standard size at most Radio, Electrical, Hardware and Auto Supply Shops, and is also made in the following sizes. Ask your Dealer.

- | | |
|------------------------|--------------------------------------------------------------------------------------------------|
| No. 1 is .240 in dia. | } Cut in 18 inch Sticks packed in 5 lb. Boxes. |
| No. 2 is .160 in dia. | |
| No. 3 is .123 in dia. | } Put up in 1 lb. Cartons and 1, 5 and 10 lb. Spools. Also 18 inch Sticks packed in 5 lb. Boxes. |
| No. 4 is .104 in dia. | |
| *No. 5 is .092 in dia. | |
| No. 6 is .081 in dia. | } Put up on 1, 5 and 10 lb. Spools. |
| No. 7 is .074 in dia. | |
| No. 8 is .068 in dia. | |
| No. 9 is .062 in dia. | |

*Standard

Manufactured by the
CHICAGO SOLDER COMPANY
4245 Wrightwood Avenue, Chicago

Direct Factory Representatives

DAVIES-ELY CO., 66 W. Broadway, New York City; 34 Portland St., Boston, Mass.
THE FAUCETTE-HUSTON CO., Chattanooga, Tenn.
LOUIS J. ZIESEL CO., 268 Market St., San Francisco, California

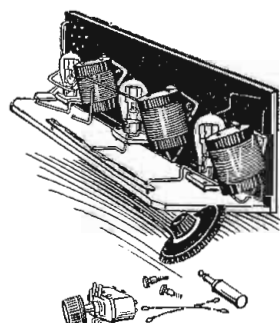

Kester Rosin-Core
For Very Delicate Work

The B-D Electric Soldering Outfit

\$2.00 RETAIL



Used by Housewife

The only complete Electric Soldering outfit on the market. Handy and ideal for home, factory, and radio work. The B-D Electric Soldering Iron is made of Copper from accurate dies, the heating element being contained in a unit of one-piece construction. It is of special construction, the highest grade Nichrome wire being used. Outfit contains electric soldering iron, cord, plug, soldering paste and solder, all contained in strong handsome box.



For Wire Connections



For Radio

The workmanship and heating element of the B-D Electric Soldering Iron is fully guaranteed for a period of one year.

GUARANTEE

Manufacturers
BLEADON-DUN CO.

Dept. B.D.3
213 S. Peoria Street Chicago



For Automobile

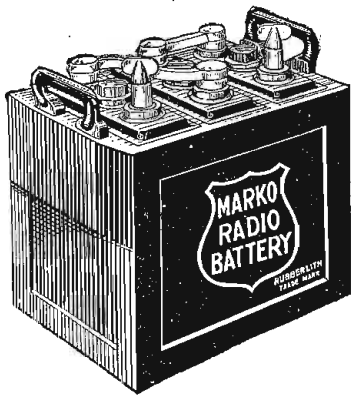

"A" MARKO BATTERY

90 and 120 AMP. HRS.

IN RUBBERLITH CASE
Ornamental As Well As Efficient

The Rubberlith case is a composition case with a high gloss giving the appearance of ebony. It is moulded in one piece, including handles and cells—no jars to break—and is practically indestructible. A worthy addition to your set.

All sizes, from 2 volt batteries up, carried in Mahogany Finish Cases.

DISTRIBUTED BY

- MARKO STORAGE BATTERY CO., 210 West 54th St., New York, N. Y.
- MARKO STORAGE BATTERY CO., 102 Jefferson Ave., Brooklyn, N. Y.
- RADIO DISTRIBUTING CO., 8 W. Park St., Newark, N. J.
- ALBANY RADIO CORPORATION, 356 Broadway, Albany, N. Y.
- TRUE & BLANCHARD CO., Inc., Newport, Vt.
- SCHIMMEL ELECTRIC SUPPLY CO., 526 Arch St., Philadelphia, Pa.
- CONSOLIDATED WIRE & MCHY CORP., Green & Congress Sts., Chicago, Ill.

Sold by Radio Supply Stores and all Marko Service Stations

MADE BY
MARKO STORAGE BATTERY CO.
1402 ATLANTIC AVENUE, BROOKLYN, N. Y.

RADIO TUBE EXCHANGE

We Repair All Standard Makes of Tubes Including

- W. D. 11 or W. D. 12\$3.50
- U. V. 200 or C. 300\$2.75
- U. V. 201 or C. 301\$3.00
- U. V. 201A or C. 301A\$3.50
- U. V. 199 or C. 299\$3.50
- U. V. 202 or C. 302\$3.50
- New 1½ Volt Tubes\$4.00



All tubes guaranteed to do the work.
RADIO TUBE EXCHANGE
200 BROADWAY NEW YORK CITY, N. Y.
All Mail Orders Given Prompt Attention
Orders sent Parcel Post C. O. D.

MARVEL SPECIALS

- FADA Neutrodyne Parts for 5 Tube Set.....\$50.15
- Set of 3 Neutrodyne Transformers with Neutrolising Condenser 14.70
- \$1.75 22½ V small B Batteries..... .75
- \$3.00 22½ V large B Batteries..... 1.45
- \$4.75 45 V medium B Batteries..... 2.00
- \$4.75 45 V medium B Batteries..... 2.00
- \$18.50 Homecharger "Gold Seal" A C Current..... 14.95
- \$18.00 Westinghouse Rectifier Charger..... 14.63
- \$7.00 Pioneer Bakelite Moulded Variocouplers. 4.95
- \$2.50 180 degree Coupler, 1200 meters..... 1.92
- \$6.50 Pioneer Bakelite Moulded Variometer... 4.95
- \$5.00 Acme Audio & Radio Transformers..... 3.95
- \$5.00 Globe High Ratio Transformers..... 3.45
- \$12.50 Per Pr. Como Push & Pull Transformers 10.50
- \$5.00 23 plate Vernier AMSCO Condensers.. 3.50
- \$5.50 43 plate Vernier AMSCO Condensers.. 4.00

Send for our free monthly Price List
Remittance Must Include Postage. Dept. RN
MARVEL RADIO SPECIALTY CO.
132 Nassau St., New York City

Fig. 5 shows this same antenna under the influence of the same cloud after the positive charge has gone to earth. Both antenna and earth are now negatively charged on account of the positively charged cloud.

ANOTHER DISCHARGE

Now suppose (see Fig. 6) that a negatively charged cloud D floats toward cloud C until close enough for a discharge to occur between them. This neutralizes the charges on both clouds. The negative charge on the earth, not being bound by any cloud, disappears and the negative charge on the antenna X-Y acts now as though it were a positive charge to the earth (the earth being at zero potential) and discharges to earth through the arrester.

Now suppose again, beginning with conditions as shown in Fig. 5, that cloud C drifts away from the antenna. The nega-

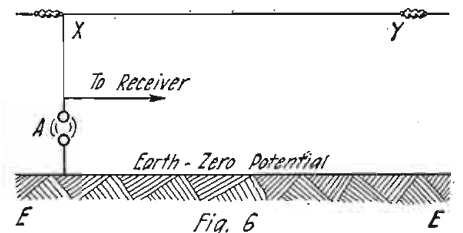
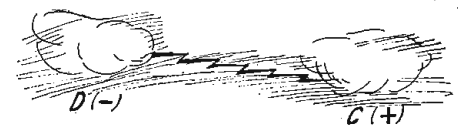

Fig. 6
A second cloud negatively charged will neutralize with cloud C and relieve the earth of its potential. The aerial charge then flows to earth.

tive charge on the earth drifts away with the cloud, and soon the earth in the immediate vicinity of the antenna is at zero potential. The negative charge on the antenna now acts just the same towards earth as though it were a positive charge and breaks over the arrester.

By electrostatic induction it is possible, therefore, to get discharges through a lightning arrester, first, when a charged cloud approaches an antenna; second, when this charged cloud discharges to another cloud or to earth; third, when the cloud drifts away without discharging either to another cloud or to earth.

ELECTROMAGNETIC INDUCTION

The electromagnetic induction type of disturbance on an antenna is caused directly by a lightning flash. A lightning discharge from cloud to cloud or from cloud to ground represents a transference of electrical energy from one body to another. The path of the flash carries a certain current (averaging approximately 10,000 amperes as estimated by the late Dr. Steinmetz). Around any conductor—in this case heated air—carrying current, a magnetic field is set up.

A flash of lightning occurs (Fig. 7) between two clouds D and C parallel to the antenna X-Y. The magnetic field set up

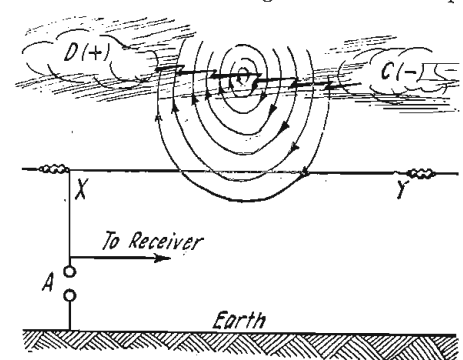

Fig. 7

An illustration of the magnetic field set up by a flash of lightning.

Get a Handy Binder for your RADIO NEWS. Holds and preserves six issues, each of which can be inserted or removed at will. Price 65c. Experimenter Pub. Co., Inc., Book Dept., 53 Park Place, N.Y.

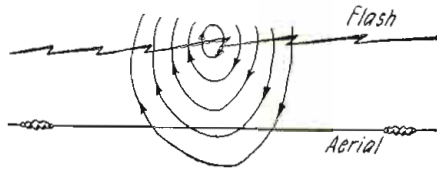

Fig. 8

The charge induced in the aerial is maximum when the lightning flash is parallel to it.

by this current flow spreads out at right angles to the flash, as shown by the circular lines. Many of these lines cut the antenna inducing an electromotive force in it. This induced voltage discharges to the ground through the arrester.

COMPARISON

Induced electromagnetic lightning charges are usually more violent and serious than induced electrostatic charges. They are a maximum when the flash parallels the antenna wire (see Fig. 8), because the lines of force cut the antenna at a right angle. There is no charge induced when a flash occurs vertically, as, for instance, from cloud to ground, for when it occurs at right angles to the antenna (see Fig. 9) the magnetic lines of force are parallel to the wire and do not cut it at all—they slide above and below the conductor. At any angle between the direction of the flash and the direction of the antenna conductor the intensity of the induced charge varies according to the cosine of the angle between them.

Both induced electrostatic and induced electromagnetic discharges may be single discharges. In many instances, however, two or more discharges follow at different intervals. Accumulated static discharges and charges from electrostatic induction occur on antennæ before, during and after storms. They may occur at any time, irrespective of storms or lightning flashes. Radio operators have observed discharges during periods of heavy "static" when using antenna without arrester since the discharges jump the plates of the series antenna condenser.

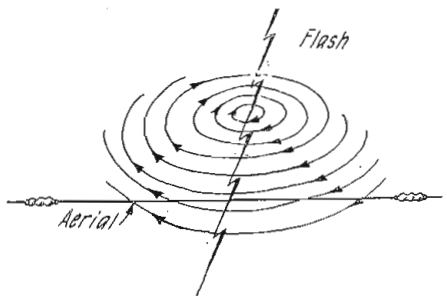

Fig. 9

There is no charge induced in the aerial when the lightning flash is at right angles to it.

If the primary circuit of the receiver were connected direct from antenna to ground through a tuning coil without a series condenser or arrester, no spark would be visible. Suddenly released charges, however, would be heard as loud clicks in the telephone receivers.

Electromagnetic disturbances occur usually during storms. They cannot occur unless there are lightning flashes.

DIRECT STROKES

Direct strokes of lightning to an antenna are the most violent forms of lightning disturbance. Fortunately they are the rarest form to which an antenna is subjected.

In order that an antenna may be struck, it must lie directly in the region of greatest strain. As the strain gradually increases between earth and cloud the antenna rapidly accumulates a heavy induced electrostatic charge which will go to ground over the arrester.



RADION

The Supreme Insulation

PANELS

They Do Not Chip
When Drilled

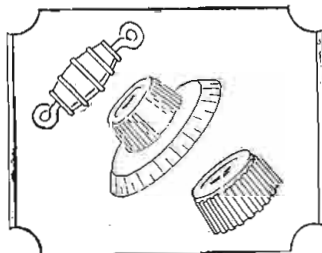

Drill, saw or engrave a Radion Panel. Use what tools you will, dull or sharp, this material will not chip or show ragged edges. Its proven electrical values make RADION the supreme insulation both from a scientific and a practical standpoint.

Made in the beautiful MAHOGANITE (mahogany grain) or polished black with Dials and Knobs to match.

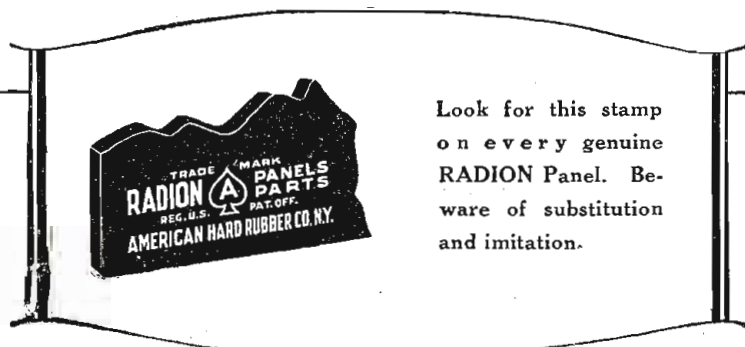

Look for this stamp on every genuine RADION Panel. Beware of substitution and imitation.

Sold at all good radio stores or write

AMERICAN HARD RUBBER CO.
11 Mercer Street New York

PANELYTE

RADIO PANELS

THE SUPERIOR RADIO INSULATION

Minimum Leakage
Highly Polished
Surface

PANELYTE PANELS
Drill Saw, Tap,
Engrave and Bevel — easily. Let
your boy tool it
at home.
Supplied in Con-
venient Carton



Use a PANELYTE
PANEL when you
build your next
set.
Each Panel is
Tested, Inspected,
Paeked and Sealed
at Factory.

Order from your
nearest dealer

Stocks carried in St. Louis, Chicago, Cleveland, Trenton
THE PANELYTE COMPANY

ORDERS PROMPTLY FILLED
Trenton, New Jersey

WEIGHS
ONLY
8 OZ



THE PHONE
IT
TOOK
A SOLID YEAR
TO DESIGN

A \$200,000.00 COMPANY
stands squarely back
of the guarantee on
every Scientific headset

SEND NO MONEY!

20,000 TURNS
EQUIVALENT TO
3,000 OHMS

Order TODAY
by Postcard
and Pay
Postman
on arrival

\$2.95

POST-PAID

LOUD
SPEAKER
UNIT \$1.95

We Guarantee The Scientific Headset to be the greatest value on the market. Try it for five days. If not satisfactory send it back and your money will be refunded immediately. Circular on request. Dealers wanted.

THE SCIENTIFIC ELECTRIC WORKS
98 Brookline Ave. DEPT. H. BOSTON, MASS.



RADIO ENTHUSIASTS

To those who want the best in radio equipment at moderate prices, this house has an especial appeal. Bulletin Number 7 has several very special hook-ups and lists new and dependable apparatus. It is free for the asking. Write.

RADIO INSTRUMENTS CO.
17 N. WABASH AVE., CHICAGO

AGENTS WANTED in Local Territory

Largest wholesale mail-order in the world is open for a few sales agents to take orders in small towns on

Sidbenel Storage B Batteries
Sidbenel Storage A Batteries
Sidbenel five tube dry batteries —and many other parts and accessories.

Prices and Catalog on application

Sidbenel Radio Equipment
Manufacturing Company
25 Mt. Eden Ave., New York City

If the cloud actually discharges to the antenna, there is little likelihood of any lightning arrester being able to afford protection to the apparatus connected to it on account of the tremendous amount of energy that must be carried off. An efficient arrester and a good arrester ground connection will minimize the danger. The inadequacy of such measures in affording full protection, however, from a direct discharge are apparent.

POWER OF STROKE

In connection with direct strokes of lightning, the following data calculated by Dr. Steinmetz are of interest:

Average potential gradient of discharge at moment of discharge is about 50,000 volts per foot.

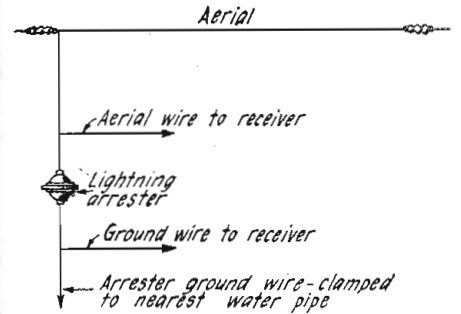

Fig. 10

How the lightning arrester is connected up to the aerial and ground.

Average potential difference between different points of cloud is about 50,000,000 volts.

Average current in discharge is about 10,000 amperes.

Average duration of discharge is about 1/500,000 of a second.

Average frequency of the discharge is 500,000 cycles per second.

Average energy of discharge is 10,000-kilowatt seconds or 7,000,000-foot pounds.

ANTENNA A PROTECTION

As stated before, a direct lightning stroke is one of the rarest forms of lightning that may affect an antenna. The chances that an antenna may be so struck are very, very slight; hence the phenomena accompanying a direct stroke have been described purely from the technical point of view and not with the idea of intimidating the user of outdoor antennae. As a matter of fact, the installation of a well made aerial over one's house offers a very high degree of protection to the house from a direct lightning stroke.

To secure adequate protection not only must the arrester itself be of highly efficient design, but it must also be properly and efficiently installed and grounded.

GOOD GROUND CONNECTION IMPORTANT

The general principles underlying the grounding of arresters are fundamentally no different from those underlying the grounding of arresters on lighting, power and other electrical circuits. Since an otherwise highly efficient arrester can be rendered practically worthless through a poor ground, it is very important that a good ground be provided. A lightning arrester cannot have too good a ground.

Fig. 10 shows one method of grounding. The lead-in wire from the antenna runs directly into line binding post of the arrester, while from the ground binding post of the arrester a wire leads to the nearest water pipe to which it is securely clamped. An approved ground clamp should be used for this purpose. A wire tapped onto this arrester ground wire runs, as shown, to the ground binding post of the receiver. The water pipe is a preferred form of ground connection owing to the fact that city water systems with their multiplicity of underground pipes afford an almost perfect earth connection. In case water piping is not available, connection may be made to the

grounded steel framework of a building or to some other grounded conductor.

DISADVANTAGES

While grounding arresters to the water system, as shown in Fig. 10, ordinarily results in an efficient installation, it may have at least two serious disadvantages:

(a) Many water pipes and other so-called "grounded" structures are only partially grounded, due to the use of insulating couplings, rusty joints, etc., and consequently offer only a more or less efficient ground.

(b) In all lightning protective installations it is desirable both from the standpoint of personal safety and fire risk to get the lightning discharge to the earth as quickly and as directly as possible. So it is desirable that connections should be as near perfect as possible. Rusty, insulated joints would be dangerous.

On account of the general use of insulating couplings in gas piping, lightning arresters should never be grounded to any portion of a gas system.

A GOOD GROUND

In order to secure the most highly efficient ground possible, it is recommended that, in all cases where one can do so, the above-mentioned clamped water pipe ground be supplemented by a driven pipe ground, as shown in Fig. 11. There are on the market brass pipe caps and malleable iron points that will greatly facilitate installation of such ground pipes. These are made for standard 1-inch iron pipe. While plain pipe may be employed, it is a decided advantage to use galvanized pipe on account of its greater durability in many soils.

To install such a pipe ground it is necessary to secure a pipe cap and point, as mentioned above, and a 6- or 8-foot section of 1-inch pipe threaded on both ends; it is also well to secure a standard 1-inch iron pipe cap. Screw the point securely on one end of the pipe and the iron cap on the other. Do not screw this iron cap "home," as it has to be removed later and the brass cap screwed on instead. Drive the pipe into the earth, leaving not more than three or four inches above ground; then attach the brass cap. Pour two or three buckets of water around the pipe to enable the earth to quickly and tightly close around it. The use of the iron cap for driving the pipe is recom-

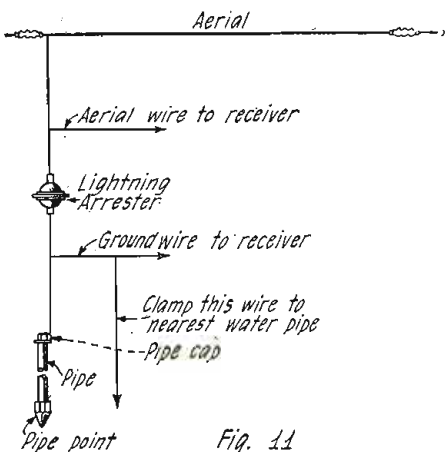

A pipe driven into the earth is superior to the water-pipe ground and should be employed where possible.

mended since the standard brass cap is apt to become quite battered.

The arrester ground wire should be run down to the cap, inserted in the wire lug provided and the clamping screw securely tightened. It is always preferable, as well, to solder the ground wire into the cap.

A ground made in accordance with Fig. 11 and as described above will be found particularly efficient both from the standpoint of instrument operation and lightning protection and will well repay for the trouble necessary to install it.

The Harkness Receiver

A Startling Achievement!

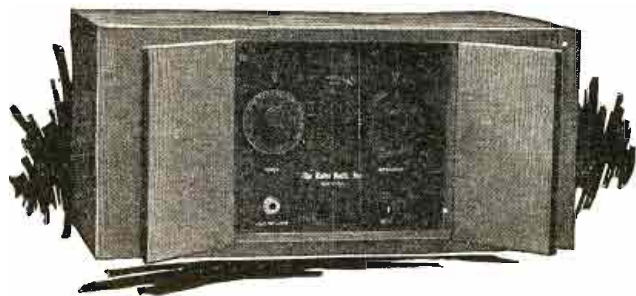

Only 1 tube-yet it operates a loud speaker!

THE new Harkness Receiver is a knock-out! Without any whistles, squeals, dial juggling, fuss or bother this inexpensive single-tube receiver actually does the work of a standard 2 or 3 tube set—actually performs like a receiver costing two or three times as much!

This FREE book tells how to build it

KENNETH HARKNESS, the Edison of Radio who developed this astonishing receiver, has just written a booklet telling how to build the 1 and 2 tube models of Harkness Receiver. *We will send you a copy of this book absolutely FREE.* Just mail the coupon below and we will send you a free copy by return mail.

Kenneth Harkness, originator of the Harkness Receiver, tells you *exactly* how to build his astounding new receiver in this free booklet. He leaves nothing to your imagination. With numerous drawings, diagrams and photographs he shows you each step in the construction of both the 1 and 2 tube models.

Remember—it took months of experimentation for Kenneth Harkness to develop this receiver. To perform properly it must be built *right*. It's easy, when you know how, and Kenneth Harkness will show you how in this free booklet. Construct *your* Harkness Receiver under the expert guidance of Kenneth Harkness himself.

You Must Act Quickly

Needless to say, our remarkable offer to send you a free copy of this booklet is only made for a very limited time. To get your free copy you must act quickly. Mail the coupon below immediately. Do it now.

**Mail this
Coupon for
FREE BOOK**

THE RADIO GUILD, Inc.,
256 West 34th Street, New York, N. Y.

Without obligation of any kind mail me postpaid and absolutely free of charge a copy of your booklet "How to Construct the Harkness Receiver, Models A and B" by Kenneth Harkness.

Name

Full Address.....
R.N., 3-24.



**DESIGNED ESPECIALLY FOR
RADIO RECEIVING**

We are Manufacturers of Fine Furniture and we sell direct to you with only a small factory profit.

A handsome hardwood hand-rubbed mahogany or golden oak finished Radio Table. Size of top 20x34 inches x 31 inches high.

Conceals A and B batteries. Small drawer holds tools and accessories.

PRICE, FREIGHT PAID, East of Mississippi River \$18.00
FREIGHT PAID to Rocky Mt. States 20.00
FREIGHT PAID to Pacific States 22.50

Cash with order. We have prepared a large stock and can ship tables and cabinets immediately.

CABINET PRICES REDUCED!

Hardwood, hand-rubbed mahogany finish. Hinged top.

Panel Size	Depth	Price
6 x 7 in.	7 in.	\$2.25
6 x 10½ in.	7 in.	2.50
6 x 14 in.	7 in.	3.00
6 x 21 in.	10 in.	3.75
7 x 18 in.	10 in.	3.50
9 x 14 in.	10 in.	3.50
12 x 14 in.	10 in.	4.00

POSTPAID, East of Mississippi River.
POSTPAID to Rocky Mt. states, add 25 cents.

POSTPAID to Pacific states, add 50 cents.

Cash with order.

Send for Free Catalogue of Radio Furniture

THE SOUTHERN TOY CO.
HICKORY, NORTH CAROLINA

NO DANGER TO SET

In the diagrams accompanying this article it will be noticed that in every instance the "Antenna Lead-In To Receiver" is connected to the antenna lead-in on the antenna side of the lightning arrester. The question may occur as to why a lightning discharge would not flow into the receiver rather than by way of the arrester air gap. Accumulated static and electrostatically induced charges on the antenna are steady high potentials and the maximum voltage to which they can build is determined by the air gap distance of the arrester. This gap for approved arresters is lower than the breakdown value of the insulation of the receiving apparatus.

Induced electromagnetic discharges, however, may be of any voltage, this being determined by the various factors. They are generally of very high frequency or steep wave front. Such discharges in attempting to enter the receiving set meet the tuning inductance which offers a tremendous resistance to their passage. A reflection of the incoming charges takes place and they are actually "kicked" back onto the antenna lead-in, whence they ground over the arrester. The tuning inductance of a receiving set acts in a manner identical with the "choke" or "kicking" coils employed in protecting standard electrical apparatus, such as generators, motors or transformers, from lightning. A turn or two of wire offers so much resistance to the passage of a high frequency lightning discharge that it jumps a very considerable air gap rather than flow through the wire winding.

THE LEADS

From this it will be evident that the lead from antenna to arrester and from arrester to ground should be as short and straight as possible and free from sharp bends and turns. Strict adherence to this rule will add measurably to the protection afforded by a lightning arrester installation.

It is recommended by the National Board of Fire Underwriters that lead wire from antenna to arrester must not be smaller than No. 14 B. & S. copper or not smaller than No. 17 B. & S. in case bronze or copper clad steel is employed. Ground wire from arrester to earth connection should be at least the same size as lead wire from antenna to arrester and should not in any case be smaller than No. 14 B. & S. in copper or No. 17 in bronze or copper clad steel. Where this wire runs for any distance it should be considerably heavier—the larger the better. In every case it should be protected from mechanical injury.

Antenna wire to instruments must enter the house through an insulating bushing or tube and should not be smaller than No. 14 B. & S. in copper or No. 17 B. & S. in bronze or copper clad steel. Ground wire to instruments and water pipe ground should likewise not be smaller. Where the arrester is installed outside, the ground wire entering the house need not be protected by an insulating tube.

In installing radio lightning arresters it is best practice to install them out of doors, as in this location they represent not only minimum fire risk, but they also make it possible to run antenna and ground conductors in a much straighter course, materially increasing the protection afforded by the installation.

**PRIVATE WIRELESS IN INDIA
AUTHORIZED**

Issuance of its first private radio transmitting and receiving license has been made by the Government of India to the Radio Club of Bengal. Under the terms of the license, weather reports, concert and student programs and non-political lectures, but no news items, can be transmitted to members of the Radio Club only. The broadcasting of programs is expected to begin within a short time under an arrangement with the Indian States and Eastern Agency.



CONNECTING THE A FILAMENT ACROSS A PROGRESSIVE B BATTERY

**Protect Your Tubes
GUARANTEED**

Progressive Safety "B" Battery

Guaranteed not to burn out your radio tube through crossed wires or wrong connections. The Progressive Radio Safety "B" Battery easily leads the battery field in long life and perfect action. It saves its users trouble and expense by its special protection of tube filaments against accidental crossing of wires or improper inserting of tubes.

22½ Volt-Standard Size \$3.50
45 Volt-Standard Size 6.00

If your dealer cannot supply you the battery will be shipped direct, C. O. D. or upon receipt of remittance.

Dealers - Write for our proposition.

Progressive Specialty Company
314 Sycamore St. Cincinnati, Ohio

KLAUS

Complete Stock of

Broadcast Receivers

Ready for shipment, KLAUS carries a complete stock of the latest and best broadcast receivers. All apparatus distributed by KLAUS is manufactured by the best manufacturers and bears the KLAUS GUARANTEE. Get our prices on amateur receiving and transmitting equipment.

KLAUS RADIO BULLETIN

for Dealers—Do You Get It?

Expert advice regarding radio problems, latest information about new equipment, and hints on radio merchandising which helps dealers make more money, is in every issue of the KLAUS RADIO BULLETIN. If you are not on our mailing list of dealers receiving the bulletin, send us your name and also receive our trade discount lists.

KLAUS RADIO & ELECTRIC CO.

Authorized Distributors

Dept. 200

EUREKA, ILL.

Operate your radio from your lamp socket with a

Gould Unipower Battery

For complete information address

GOULD STORAGE BATTERY CO.,
30 East 42nd Street New York

USE ONLY
AMPERITE
THE SELF ADJUSTING RHEOSTAT FOR AMPLIFYING TUBES
\$ 1.00 WITH MOUNTING

ELIMINATES HAND RHEOSTATS SAVES YOUR TUBES
ASK YOUR DEALER
GIVES LOUDER AND CLEARER MUSIC
SIMPLIFIES WIRING
GREATER DISTANCE

RADIALL CO. 320 WEST 42ND STREET
NEW YORK

What Listeners-In Want

(Continued from page 1227)

mental and male quartettes followed in popularity with fractions of one per cent. of the total vote analyzed. Reclassifying into three general groups gives popular selections 50.3 per cent. and classical music 27.3 per cent., the balance being miscellaneous. Analyzers of the returns believe that the heavy, popular dance and jazz music vote is due to the fact that the greater number of the voters were young people, and because nearly two-thirds of the letters were from men.

MANY FANS ARE TOO BLASE

That radio audiences are becoming frightfully blasé is pretty generally agreed; many do not take the trouble to send in either commendations or even criticisms of the programs heard, no matter how good or bad they believe them to be. When the Department of Commerce made an effort to learn the total number of receiving sets in the District of Columbia, only 1,351 fans took the trouble to reply up to December 1, out of a population of over 400,000, fully 20,000 of whom are believed to own sets. One element which may have prevented a large number of replies was the fear that the Government planned to levy a tax on receiving sets, as is done in many countries. The effort was made solely to get an idea of the number of local receiving-set owners, with a view to extending the census to cover the entire country. The results were discouraging, however, so that the project was abandoned.

C.W. and Radiophone Transmitters

(Continued from page 1247)

fication is practically uniform over the entire range of frequencies, because the resistance R does not vary with the frequency, at least not in the audio frequency range. To obtain the most amplification with such a system, it is necessary to make R several times greater than the tube resistance. Thus, if the tube resistance is 5,000 ohms, R should be at least 25,000 or 30,000 ohms. By employing resistance coupled amplifiers it is possible to secure distortionless amplification, and many broadcasting stations use this method.

AN INEFFICIENCY

The use of resistance coupled amplifiers means that large D.C. plate voltages must be used because the large coupling plate resistance R , Fig. 3, consumes most of the voltage drop, leaving only a small part of the voltage available for the tube. Suppose we have a tube whose resistance is 5,000 ohms and the plate resistance is 25,000 ohms. If the tube requires, for normal operation, 50 volts on the plate directly, it will be necessary to have 300 volts in the plate battery, because $5/6$ of the total voltage is consumed in the 25,000-ohm plate resistance, while only $1/6$, or 50 volts is consumed by the 5,000-ohm tube. Thus, while resistance coupling has the very great advantage of providing distortionless amplification, it has the disadvantage of being uneconomical as far as plate voltage is concerned.

This disadvantage is not present in inductance coupled and transformer coupled amplifiers. In both these types the resistance is low, but the inductance is high. Hence, there is only a small D.C. drop and practically all the voltage of the plate battery is applied to the tube. However, it is not as easy to secure distortionless amplification with these types of amplifiers as with the resistance coupled type.

PLATE IMPEDANCE

In order to secure distortionless amplifi-

PARAGON

Reg. U. S. Pat. Off.

RADIO PRODUCTS

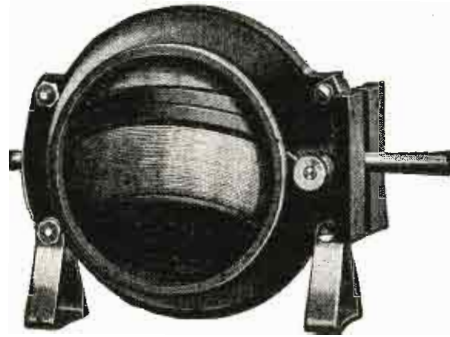

Keep Abreast of the Times

Use a Paragon Variometer in Your Receiving Set

Every man who owns a Radio Receiving Set naturally wants to get the best possible results that can be obtained with it. To do so he must keep abreast of the times and add parts where they will improve it.



Paragon Audio-Frequency Amplifier Transformer No. 81 Reduces tone distortion, \$5.00.



All PARAGON Parts are packed in distinctive Yellow and Purple Packages. They cannot be confused with any other packages on your dealer's shelves. Be sure you get the genuine.

Wavelength bands now in force involve radio currents of extremely high frequency. An inductance unit of exceptional electrical and mechanical excellence is needed to obtain the best results on these wavelengths. The PARAGON No. 60 Variometer, ribbed design, assures the greatest possible efficiency at high frequencies and makes it far easier to secure desired results on wavelengths of 150 to 200 meters.

The reduction of material in the support forms permits us to offer this essential radio part at an extremely popular price.

Add a PARAGON Variometer to your set. It will make it a better set and will increase your pleasure in listening in with it.

Illustrated Bulletins on Paragon Radio Products
are yours for the asking

ADAMS-MORGAN CO., 6 Alvin Avenue, Upper Montclair, N.J.

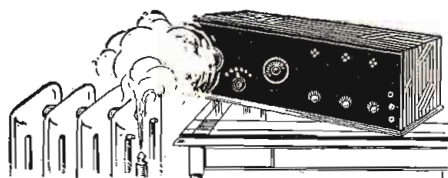

It stands all kinds of abuse

THIS incomparable radio panel material, never changes its shape or super-resistant qualities. It cannot warp, swell, melt, shrink or split. It is absolutely unaffected by water, oil, steam, heat, cold, solvents, high voltage ozone or any weather condition.

bakelite-dilecto

(A Laminated Phenolic Condensation Material)

Makers of the highest type radio apparatus are partial to panels of Bakelite-Dilecto. Builders of home-made sets, too, use this material to achieve surpassing results. Tremendously tough, yet not hard to machine. Dealers will show you how to get it cut and drilled.

The Continental Fibre Co. Factory: Newark, Delaware.

Service on Bakelite-Dilecto (also Continental-Bakelite, Conite, Conter and Vulcanized Fibre) from:

- New York, Woolworth Bldg.
- Pittsburgh, 301 Fifth Ave.
- Los Angeles, 307 So. Hill St.
- Chicago, Wrigley Bldg.
- San Francisco, 75 Fremont St.
- Seattle, 1041 Sixth Ave., So.

Offices and Agents Throughout the World

RUSONITE
RADIO CRYSTAL

Entire Surface Sensitive
The Recognized Standard Crystal Rectifier

Used all Over The World
Hundreds of Thousands of Satisfied Users.
Rusonite Has Revolutionized Crystal Radio Reception.

"THE PERFECT SYNTHETIC CRYSTAL"
Guaranteed
Price mounted 50c
RUSONITE CATWHISKER 14K. GOLD
Supersensitive; will not oxidize
Price 25c

Order from your dealer or direct from
Rusonite Products Corporation
15 Park Row, New York, N. Y.

ation it is a necessary condition that the impedance in the plate circuit should be several times that of the tube at all frequencies. The impedance of an inductance is directly proportional to the frequency, therefore, at high frequencies, the impedance is much greater than at the low ones. The amplification goes up as the plate impedance rises, so it is probable that greater amplification will be secured at high frequencies than at low frequencies with impedance or transformer coupled amplifiers. Thus these two types of amplifiers favor the higher frequencies. This type of distortion, namely favoring the higher frequencies, is not such a grave fault since practically all audio frequency amplifiers in receivers do not amplify the high frequencies sufficiently. The dropping out of high frequencies in receivers is partially compensated for by amplifying them more in the broadcast speech amplifier.

Of course, even an inductance and transformer coupled amplifier may be made practically distortionless as far as amplification is concerned by making the inductances so great that the reactance at all frequencies, even the lowest, is many times greater than the resistance of the tube. However, this would introduce another disadvantage. In order to make a very large inductance it is necessary to wind a great number of turns on an iron core. This means that the inductance would have a high distributed capacity, which would have the effect of short-circuiting the high frequencies. There are limitations on the size of impedances or high inductance transformers for amplifiers. In the case of transformer coupled amplifiers, another advantage might be mentioned, that is, the transformer itself offers additional amplification due to its step-up ratio.

All of the three methods are used, but it may safely be said that if plate battery is not a vital consideration the resistance coupled amplifier is the best and simplest one.

AMOUNT OF AMPLIFICATION

Whether one or more stages of speech amplification are to be used depends largely on the power of the transmitter and the type of tubes used for amplifiers. Generally, it is essential to use more than one stage of amplification because the output of the microphone is very low and insufficient to modulate after one step of amplification. It is best, and is the practise, to use a number of stages of progressively increased amplification, so as to stay within the limits of the capacity of the tube and to adapt the tube to the powers applied to it. To be specific, a 500-watt broadcast transmitter accomplishes its amplification approximately as follows: The output of the microphone, which is very low, is amplified by two transformer-coupled repeater tubes which have high amplifying powers but are of low power output. The output of these repeater tubes is then applied to another transformer coupled amplifier tube, which is a power tube capable of handling the larger voltages applied by the previous repeaters. This amplifier is of the order of three- to five-watt output. This output is next applied to a 50-watt tube, reactance coupled, which itself amplifies speech sufficiently to warrant applying it directly to the 250-watt modulator tubes. It will be noted that the power of the amplifier tubes increases progressively. This is extremely important and necessary if distortion is to be avoided. Thus it might be thought that three or four 5-watt tubes in succeeding stages would give the same amplification as the above system of two repeater tubes, a 5-watt tube and a 50-watt amplifier, especially considering the fact that a 5-watt tube has almost as high an amplification factor as a 50-watt tube. While this may be true, it is not possible to use 5-watt tubes in the latter stages, because the audio frequency voltages, due to the preceding stages of amplification, are so high that the tube becomes overloaded

The Better Class of Radio Equipment



HERE ARE SOME DEVICES THAT WILL KEEP YOUR SET IN GOOD CONDITION AND IMPROVE Its PERFORMANCE

Remember these two things for getting the best in radio: First, buy the better class of radio equipment such as Sterling parts; Second, keep your batteries in shape by charging them with a Sterling Rectifier and "know" your current conditions by aid of Sterling Pocket Meters.

Portable Rectifier
A type designed according to the latest specifications adopting the 5 amp. charging rate. Simplicity, ease of adjustment and taping charge, are features. 50 and 60 cycle, 6 and 12 volt \$16.00. Add \$1.00 west of Rocky Mountains.



"Right Resistance" Pocket Voltmeters
All types for testing of "A" and "B" Batteries; dry and storage. Draws just the right amount of current from battery while voltage is being read to make readings entirely accurate. New No. 45 volt-ammeter is used for testing the amperage of "A" Battery Cells and voltage of "B" Batteries. Price \$4.00. Other types \$1.00 up.



Audio & Radio Frequency Transformers
One of the original transformers of the radio field. The Audio type gives louder signal amplification, best tone qualities, and uniform amplifications. List price \$4.00. The Radio types are limited to the range of wave length over which they will operate successfully. Responds to range of 200-600 meters. Gives sharp tuning. Price \$4.00.



OTHER STERLING RADIO DEVICES:

12 Point Rotary Switch, Filament Meters, Rheostats, "B" Battery Charging Attachments.

THE STERLING MFG. COMPANY
2850 Prospect Ave. Cleveland, Ohio

FORD RUNS 57 MILES ON GALLON OF GASOLINE

A new automatic and self-regulating device has been invented by John A. Stransky, 2136 Fourth Street, Pukwana, South Dakota, with which automobiles have made from 40 to 57 miles on a gallon of gasoline. It removes all carbon and prevents spark plug trouble and overheating. It can be installed by anyone in five minutes. Mr. Stransky wants agents and is willing to send a sample at his own risk. Write him today.—*Adv.*

TELEGRAPHY

BOTH MORSE AND WIRELESS taught thoroughly. Big salaries; tremendous demand. Oldest, largest school. Endorsed by Telegraph, Railway, Wireless and Government officials. Expenses low—opportunities to earn large fortune. Catalog free. **DODGE'S INSTITUTE**, Mora Street, Valparaiso, Ind.

causing saturation and a grid current to flow, producing a bad distortion. In order to avoid this it is necessary to increase the power of the succeeding stages so that the tube can accommodate the powers applied to it without becoming overloaded.

After the speech is thus amplified, it is applied to the high power modulator tubes, and modulation results in the manner described in Part V of this series. Fig. 4 gives a complete diagrammatic sketch of a radiophone system built along broadcasting lines, and should prove of some value to amateurs contemplating building radiophone transmitters. It need not be followed in all details, but it would be well to use the general plan outlined. For a 50-watt amateur radiophone it would be well to employ a 5-watt speech amplifier before applying speech to the the 50-watt modulator tubes. For a 20-watt transmitter it might be advisable to use a 5-watt speech amplifier working at low outputs, or even perhaps a UV-201A or C-301A tube as speech amplifier. The lower output of the power tubes, the less amplification will be required before applying the speech voltages to the grids of the modulator tubes.

Modern Radio Apparatus —Condensers

(Continued from page 1251)

alone as by the main condenser, since each condenser has its own insulation material on it. Both these disadvantages are eliminated by means of the device employed on the condenser in Fig. 6. This condenser is similar to that shown in Fig. 2, but has a hollow shaft. Inside this shaft is another shaft at the end of which two plates are carried which rotate between two fixed plates. Each shaft has its separate knob by means of which it may be rotated. Thus the large or main capacity may be varied and then the two vernier plates may be varied so that fine adjustment of capacity is secured. It is seen that only one mounting is required as for any other simple type of condenser. An additional insulating end plate is incorporated in the condenser, however, which increases the dielectric loss. Such condensers may be, and are, built without this extra end plate, thereby avoiding any increased loss.

This type of vernier condenser is quite widely used. Its use involves, however, two adjustments, one for the main condenser and one for the vernier. The modern tendency is to reduce the number of controls and adjustments, thus making for simplicity of operation. As a result vernier condensers

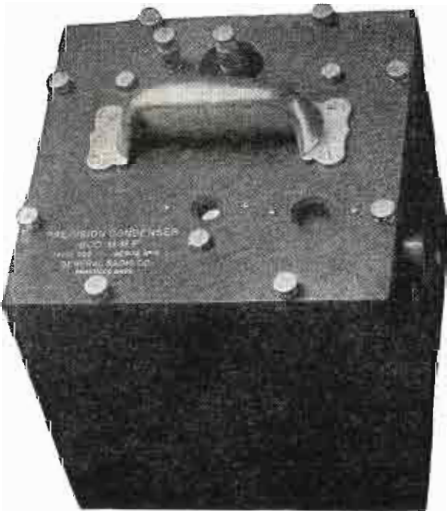

Fig. 9
The condenser shown in Fig. 8 mounted in its case. Note the control on the right.



Beginners, Experienced Amateurs and Experimenters turn to Coto for their Radio Parts

You can build from the very simplest radio set up to one with the latest refinements with Coto parts. And what is more fascinating than to try out the various circuits as they are published. And with Coto parts you know you will be getting the very best from these circuits. Learn the A. B. C. of radio—"Always Buy Coto."

Use All the Energy of Your Antenna

Don't waste it in the insulation losses of an inferior condenser. It's like pouring water in a sieve. The low losses of a Coto Condenser insure maximum signal strength. Use one and be convinced.

Coto Air Condenser with Vernier and Dial

There is just one bearing in this condenser and that is protected with hard rubber, the best known radio insulator. Plates are of SILVER PLATED copper, soldered rigidly in place for lasting efficiency. Type 3505, .0005 Mfd. \$5. Type 3510, .001 Mfd. \$6.

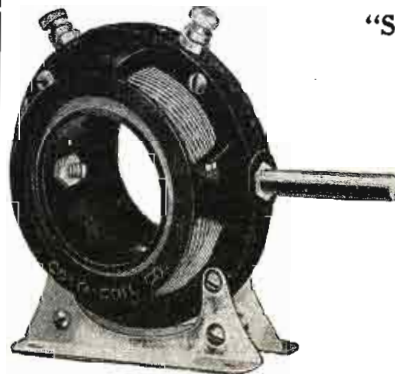

"So Much Better Than Your Advertising Claimed"

These are the words of a pleased user of Coto Compact Moulded Variometer. He was surprised because of its wonderfully compact size (3 1/4 x 1 3/4 x 3 3/4 in.) to find it splendidly efficient over the broadcasting wavelengths—200 to 600 meters. Price \$5. The Coto Moulded Variocoupler to match is just as fine. \$5.50.

GUARANTEE

Every piece of Coto Radio apparatus, (which also includes Cotogrip Tube Sockets, Honeycomb wound Coils, Tapped Radio Frequency Transformers, and Audio Frequency Transformers Type 4000 \$5) is Laboratory Tested before shipment. So we are perfectly safe in authorizing dealers and jobbers to guarantee you absolute satisfaction.

If your Dealer fails you, write us his name and your needs.



Type 4500

The 3 to 1 Ratio Transformer is Best for All Stages.

"Superior to any other
Regardless of Price."

COTO-COIL CO.

87 Willard Ave., Providence, R. I.

Pacific Coast Branch:
329 Union League Bldg., Los Angeles, Cal.

Northwestern Branch:
Geo. F. Darling, 705 Plymouth Bldg.,
Minneapolis, Minn.

Southeastern Branch:
C. P. Atkinson, Atlanta Trust Co., Bldg.,
Atlanta, Ga.

Canadian Distributors:
Perkins Electric Co., Ltd., Montreal,
Toronto, Winnipeg.

Mr. W. R. Reschke of Staten Island, New York, writes us:—"I am forced to write you this letter. I have been using your Coto Transformers in quite a number of sets and find them superior to any other transformer regardless of price. The results I get I cannot equal with other audio transformers, clear and plenty of amplification. Am using WD11, WD12 and U.V.201A tubes." Such experiences of users warrant us in recommending Coto Specials (\$2.50) as best for all stages!



Regal

Radio Apparatus

That Lives Up to Its Name

New "Regal" No. 162 Double Arm Inductance Switch



A 15 Point Switch complete in one unit. No more messy soldering. No more drilling of holes. No more chipped panels. Complete with hard rubber Knob and Dial

\$1.50

New "Regal" No. 120 Vernier Rheostat



For fine filament control of tubes and superfine tuning, the Regal Vernier stands alone. Nothing just like it on the market. Complete with Knob

6-Ohms. ... **\$1.25**
30-Ohms. ... **1.25**

New "Regal" No. 200 Audio Frequency Amplifying Transformer



For clearness of tone, amplification of voice and music from nearby and distant broadcasting stations, is unequalled by any transformer on the market

3 1/2 to 1 Ratio. **\$4.25**
5 to 1 Ratio. **4.50**

At all good dealers—otherwise write direct for complete descriptive folder No. 18, sending dealer's name

AMERICAN SPECIALTY CO.
Bridgeport Conn.



WARREN RADIO LOOP

Smallest Loop Antenna

All the well known advantages of the loop aerial are intensified in the *Warren Radio Loop*. So small you can slip it into a coat pocket, yet as sensitive as a much larger outside aerial with all its defects. Absolutely accident proof. Write for the name of the nearest Warren dealer and our Bulletin containing latest hook-ups, TODAY.

APPROVED RADIO NEWS MARCH 1924

Type A-737 (300-700 meters) 6 inches square—non-directional \$10
Type A-7236 (175-1000 meters) 6 inches square—non-directional \$12
Type B-2537 (300-700 meters) 18 inches square—directional \$20
Type BL-2520 (200-18,000 meters) with honey-comb coil mounting, 18 inches square—directional \$25

Send for Bulletin T-102

V-DE-CO RADIO MFG. CO.
Dept. N. Asbury Park, N. J.

LOOK—FANS—LOOK

Send card today for price list of radio parts. Many bargains. First class equipment. Knocked down sets. Detector tubes \$2.95, just sample of our savings.

RADIO PARTS MFG. CO.
Dept. "N." 1247 Marlboro Detroit, Mich.



Fig. 10
Outside appearance of the mica variable condenser shown in detail in Fig. 12.

ers are being built which require but one adjustment. One of the very best examples of this type of condenser is illustrated in Fig. 7, which shows the interior construction. This condenser is one of the most satisfactory for amateur and experimental use. Its plates are made of heavy brass and are well spaced and then soldered together, thus insuring a very low ohmic resistance. Soldering the plates gives also the same advantage as is secured with the moulded die-cast type of Fig. 2, namely it gives a rugged construction which prevents short-circuiting of plates, due to motion and maintains the capacity of the condenser always constant at every point. The figure shows the manner in which the vernier variation of capacity is secured. The movable plates are rotated by means of two interlocking gears with a large step-up tooth ratio. Thus a large angle of rotation of the knob produces a very small angle of rotation of the plates, hence a small capacity variation. This has but one knob for adjusting the capacity and, therefore, makes operation of the set more simple.

The condensers described and illustrated here are suitable for ordinary experimental and commercial use, but would not be suitable for precision work, as, for example, use as standard of capacity for measurement. For such purposes the condenser must be built to have minimum power factor, its dielectric loss must be the same regardless of the setting of the condenser, its capacity must be invariable and uninfluenced by external causes such as handling. Also the capacity must not be affected by external capacity effects such as the presence of the experimenter's body near the condenser. Fig. 8 illustrates a precision type of condenser designed to meet the above conditions. The plates of the condenser are made of heavy aluminium sufficiently widely spaced to prevent shorting between plates. The rotating plates are mounted on a steel shaft running in bronze cone bearings which are locked in position, thus avoiding end play. Accuracy of adjustment is secured by a worm gear arrangement for varying the capacity. As seen from Fig. 8, the gear is attached to the main shaft, as is also the main scale which is divided into 25 equal parts. The rotating handle is attached to the worm shaft which also carries a scale divided into



Fig. 11
Another type of compact mica variable condenser for receiving circuits.



Simple as ABC



Longer distance and clear signals are the pleasing results which you can be sure of when both the A & B batteries of your radio set are storage batteries. No other source of power for radio equals the storage battery. The Valley ABC Battery Charger is so simple and so easily operated that it makes storage batteries the most convenient and inexpensive source of power for radio. Enjoy radio at its best. Use storage batteries and charge them with the Valley ABC Battery Charger.

Charges 2-volt peanut tube batteries, 6-volt A Batteries, 6 and 12-volt automobile batteries, and 1 to 4 B Batteries. Bakelite panel, glass top. Harmonizes with any receiving set. At good radio shops.

VALLEY ELECTRIC CO.
3157 S. Kingshighway, St. Louis, Mo.

Valley Battery Charger



B-T

products are just as far ahead in

Design Quality and Workmanship

in 1924 as in 1921

B-T products are originals, not copies—not built just to sell—but to give satisfaction.

It is our aim to please you more with the product itself than by what we say about it.

Our latest booklet will help you. It is revised each month. Sent for 4c postage.

Better Tuning B-T
Price 10c

Bremer-Tully Mfg. Co.
Canal & Harrison Sts. Chicago, Ill.

Print YOUR OWN Stationery!

Letterhead, envelope, card, label, circular, Press \$18, Larger Press \$35, Job Press \$150. Save money. Print for others; big profit. All easy. Write factory for press catalog, TYPE, cards paper. **THE PRESS CO., D 72 Meriden, Conn.**

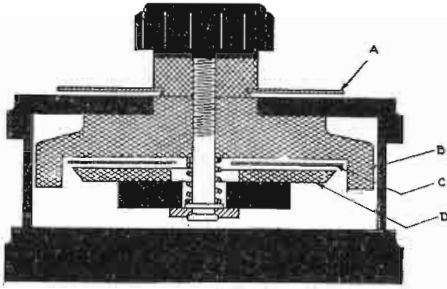

Fig. 12

A variable mica condenser, the capacity of which is varied by pressing the electrodes against each other. A—Dial. B—Upper Armature. C—Mica Dielectric. D—Lower Armature.

100 parts. The main scale has been so calibrated that one complete turn of the worm shaft rotates the main scale through one division, therefore each division may be read to 100th, since the worm is divided into 100 parts. In fact it is possible to read even closer, since the worm scale divisions are so large that fifths of the smallest division may be estimated. Only a very small amount of low loss dielectric is used and this is placed in a weak field so that the power factor is low. To minimize the effect of outside influences on the capacity of the condenser the case in which it is placed is lined with a copper shield which is grounded to the rotor plates. Fig. 9 illustrates the housing for the precision condenser. It is completely enclosed and dust proof, two glass windows being provided for reading both scales. The handle for rotating the plates is seen on the right side of the case.

The above type of air condenser is chiefly suitable for low voltage work, hence it is used in receiving sets and wavemeters, etc. To adapt this type of condenser for transmitting purposes, it would be necessary to space the plates considerably farther apart so that it could withstand high voltages. This makes the condenser bulky. The easiest way to adapt this type of variable condenser for transmitting purposes is to fill it with a good grade of oil as the insulating medium.

MICA VARIABLE CONDENSERS

Due to the fact that mica has a much higher dielectric constant than air, it is possible to obtain a

MINIMUM CAPACITY

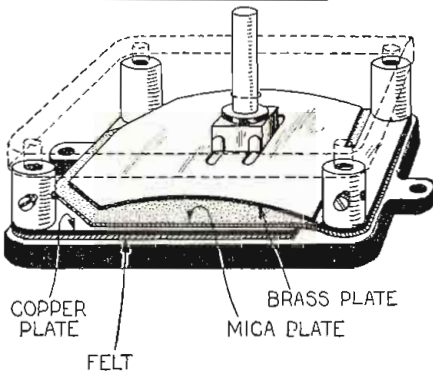

MAXIMUM CAPACITY

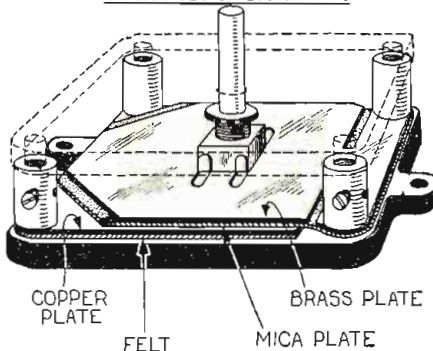
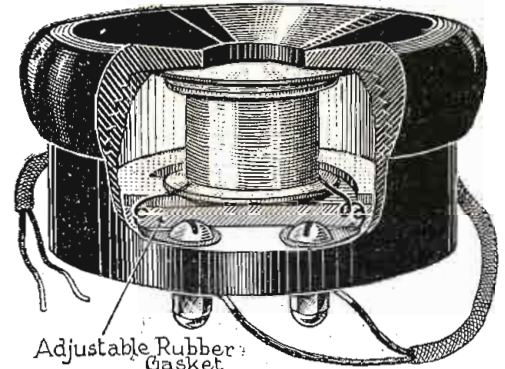

Fig. 14

A popular type of mica variable condenser having a very gradual increase of capacity on account of the special shape of the upper armature.

Announcing the "GEMPHONE"

the DOLLAR 1000 ohm ADJUSTABLE PHONE



Adjustable Rubber Gasket (Patent Pending)

\$1 with 3 ft. Cord \$1
Shipping Charges Prepaid to any point in the U. S.

Don't judge the "GEMPHONE" by its price. It is the cheapest radio phone on the market but its exclusive features place it in a class by itself. Its performance, the clarity and volume of sound reproduction, the faithfulness with which it reproduces radio broadcasting and code, the exquisite quality of tone together with a remarkably loud and clear volume, make it the equal to, and in many cases the superior of, phones at three and four times its price.

The "GEMPHONE" is of standard type and made of the very best grade of materials throughout. It is adjustable—one set screw enables you to adjust the phone to secure perfect reception under any condition.

The case is made of turned wood, an exclusive feature with the "GEMPHONE." This feature is responsible for its exceptionally rich and mellow tone.

The "GEMPHONE" is sold unassembled. The coil is wound to 1000 ohms—all you need to do is to place the parts into the case, tighten up the adjusting screw and connect the terminals and cord. Our instruction pamphlet shows how to assemble it in two minutes, using only a screw driver.

This Complete Radio Receiving Set

Consisting of Radiogem Gemphone and Aerial

\$250



This outfit is absolutely complete. It includes everything you need to hear the Broadcast Programs, market reports, time signals, ship calls or land station messages. Nothing more to buy—no batteries or tubes needed—no upkeep of any kind. The simplest radio outfit made—yet as practical as the most expensive. A crystal receiving set that you can operate and enjoy even though you know absolutely nothing about radio. You receive the RADIOGEM unassembled, together with a clearly written instruction book, which shows you how to quickly and easily construct the set, using only your hands and a scissors. The instruction book explains simply and completely the principles of radio and its graphic illustrations make the assembling of the RADIOGEM real fun.

Price of Radiogem without phone or aerial, \$1.00

Order Direct or From the Following Dealers:

- | | | | |
|--------------------------------------------|--------------------------------------------------|------------------------------------------------------|-------------------------------------------|
| Astoria, Ore.
Cook & Foster | Grand Rapids, Mich.
Specialty Sales Bureau | Medford, Ore.
Virgins Radio Service | Philadelphia, Pa.
Jos. J. Miller |
| Allanta, Ga.
Miller's Dollar Store | Hamilton, Ont., Canada
Radio Supply Co. | Media, Pa.
Media Elec. Co. | Phillipsburg, Pa.
A. C. Curtis |
| Brooklyn, N. Y.
Weber Talking Mach. Co. | Hartford, Conn.
Sage Allen Co. | Melbourne, Australia
Marks & Abrahams, Pty., Ltd. | Poughkeepsie, N. Y.
Chas. P. Raymond |
| Buffalo, N. Y.
Elec. Sup. & Equip. Co. | Hawera, New Zealand
H. H. Blake | Newark, N. J.
L. Bamberger & Co. | Pullman, Wash.
Electric Supply Store |
| Chicago, Ill.
Barawk Co. | Havana, Cuba
Compania Radiotelefonica de Cuba | New York City, N. Y.
Dixie Supply Co. | Saginaw, Mich.
J. A. Loubert & Co. |
| Home Supply Co.
Levitus & Fjansberg | M. Massana
Manuel Nodar, Jr. | Seattle, Wash.
Eastern Radio Corp. | Soatle, Wash.
Frank E. Wilson |
| Cleveland, Ohio
Service Publishing Co. | Radio Norelty
Hoboken, N. J. | Springfield, Mass.
Johnson's Book Store | Springfield, Ohio
Moore Sale's Service |
| Dallas, Texas.
Cullum & Boren Co. | C. R. Prieman Co.
Laurel Springs, N. I. | Syracuse, N. Y.
Syracuse Supply Co. | Washington, D. C.
Chas. Klaben Co. |
| Texas Furn. & Storage Co. | Stone & Kean
Los Angeles, Cal. | Oregon City, Ore.
Parsons Elec. Shop | |
| Gary, Indiana
Tribe of K. | Lester's Radio Shoppo | | |

THE RADIOGEM CORP., 66-R-West B'way, N. Y. City

DEALERS--Write for Prices and Circulars.



DUCK'S Big 256 pp. Combined Radio Catalog and Text Book—No. 16. Mailed for 25c in coin or money order. Not sent otherwise. Full of radio information and hook-ups. Prices extraordinarily attractive. Ever since 1909 Duck's catalogs have blazed the way with the best and most dependable radio products.

FREE Send postal for our special price list on all radio instruments in our catalog and countless new instruments and sets not in Catalog No. 16. Of special importance to those having catalog No. 16.

THE WILLIAM B. DUCK CO.

711-12 ADAMS STREET Dept. 3 TOLEDO, OHIO

IMPROVED!

50¢



Pat. Jan. 8, 1924
Other patents pending

**No. 40
PACENT
UNIVERSAL PLUG**

The first radio plug made was PACENT—and it has been steadily improved until now we can offer at a lower price a quality plug—with simplified type of connecting cord tips—all metal parts satin nickel finished and with polarity stamped on connection clips.

PACENT JACKS

There is an improved type of Pacent Jack for every modern circuit.

- | | | |
|----|--|-----------------------------------------------------|
| 61 | | 61—Single open circuit ... \$.60 |
| 62 | | 62—Single closed circuit70 |
| 63 | | 63—Double circuit80 |
| 64 | | 64—Heavy duty (loop) ... 1.00 |
| 65 | | 65—Three spring automatic... .85 |
| 66 | | 66—Five spring automatic.. 1.00 |
| 67 | | 67—Seven spring automatic.. 1.00 |
| 68 | | 68—Four spring automatic, Triple circuit 1.00 |
| 69 | | 69—Five spring special automatic .. 1.00 |
| 70 | | 70—Six spring automatic.. 1.00 |

Write for catalog N-3

Pacem Electric Co., Inc.
22 Park Place, New York, N. Y.

**Pacem
RADIO ESSENTIALS**

BATTERY CHARGER \$8.75

Charges at rate of four amperes per hour. Absolutely no noise. Cannot possibly overcharge. Electrolytic type. Nothing to get out of order. No contact points to stick—no bulbs to burn out. This home charger which comes in handsomely enameled metal housing, now sold direct to you from factory. Get one now, at this low price.

Western Rubber Mold Company
Radio Dept.
907-913 W. 19th St., Chicago

Code Instructions That Instruct Only \$2.00. Students now licensed mastered Code 15 Minutes. Ten word speed 3 Hours. Information free. Dodge Radio Shortcut, Dept. N, Mamaroneck, N. Y.

Learn **Electricity** by actual work in Great School of Coyne, on massive apparatus. Complete in 3-12 months. Enter a 911 m. B. S. Free. Special limited offer. Send for Big Free Catalog. Coyne Electrical School Dept. 59-43 1300-1310 W. Harrison St., Chicago, Ill.

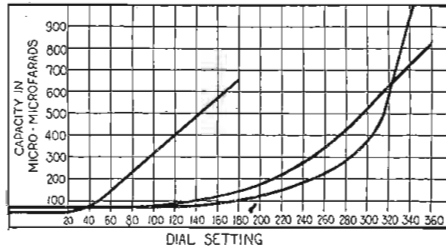

This chart shows the comparative capacity curves of two well known mica variable condensers compared to that of a variable air condenser.

sible to build mica condensers of a given capacity in much less space than air condensers. Furthermore, since mica has almost as low a power factor as air the efficiency of a mica condenser will be practically as great as that of an air condenser. As a result, there have appeared on the radio market variable mica condensers featuring the advantage of space economy. Figs. 10 and 11 illustrate two such types which are seen to be quite small in comparison with the air condensers previously described. The construction of the condenser shown in Fig. 10 is shown in Fig. 12; it is quite unique. This is a two-plate condenser, one fixed and one movable. B is the fixed plate which at the same time acts as the support for the entire assembly. D is the movable plate and between the two is the mica dielectric C. The movable plate is so mounted on the shaft that rotation of the shaft moves plate D up and down, thus bringing it closer to or farther from the fixed plate, in this way securing the capacity change. Complete capacity



Fig. 15

A compact receiving condenser of the cartridge type.

variation is secured with a 360-degree rotation of the dial as against 180 degrees, as in the air condensers. A comparison of the calibration of an air condenser and mica condenser is shown in Fig. 13, which illustrates this. Obviously finer capacity adjustment may be secured with the mica condenser over the lower range of capacity. It is questionable whether this is an advantage, since sufficiently fine adjustment may be secured with a vernier air condenser. The only advantage which the mica condenser can, therefore, claim is that of compactness. Such mica variable condensers are very suitable for some transmitter work at high voltages, due to the high dielectric strength of the mica.

FIXED CONDENSERS

Fixed condensers usually employ solid dielectrics, the chief ones being paper and mica. Glass was formerly used to the exclusion of all others, particularly for transmitting condensers, as the dielectric strength of glass is high. The Leyden jar is the famous example of the glass condenser. However, its losses were high and there was the additional disadvantage of fragility. As a result, it fell into disuse soon after the



Fig. 16

A small mica condenser used in the grid circuit of detector tubes. The terminals are formed by two springs between which a grid leak may be inserted.

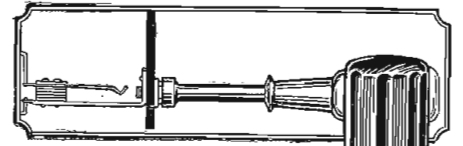

Spin All Nuts On—

IT'S so easy now—assemble any radio hook-up in half the time—make connections leakproof as soldering with Stevens SPINTITE Wrenches.

Fit all radio nuts. Hollow stem goes over projecting screws—hex socket gets full grip and protects nut—ebonized handle for comfortable leverage—cinch to reach difficult places. All sizes from 3/16 to 1/2 inch.

STEVENS & CO., 375 B'way, New York
Toolsmiths since 1899

Send \$1 for Set No. 71 (illustrated)

Sizes 7/16 and 1/2" for phone jacks 65c each.

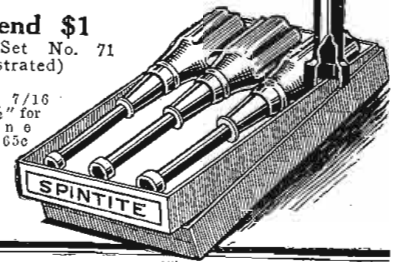

Stevens SPEED UP Tools

No Outside Wires Needed use the ANTENELLA

attached to any lighting socket—eliminating the inconveniences in Radio such as unsightly outdoor aerials, insulators, lightning arresters, lead-ins, etc.



Hundreds of unsolicited letters from satisfied users are on file in our office, showing that the Antenella is not only a real distance getter but also successfully overcomes static annoyances.

The complete—efficient and inexpensive aerial.

ANTENELLA

Price Only \$1.25

At your dealers—otherwise send purchase price and you will be supplied postpaid.

Chas. Freshman Co. Inc.
Radio Condenser Products
106 SEVENTH AVENUE, NEW YORK

HUGUENOT RADIO-PHONOGRAPH ATTACHMENT MAKES PHONOGRAPH A LOUD SPEAKER



Single, \$1.00 Bushing, \$.50 Double, \$3.00

Made of beautiful black polished hard rubber. It eliminates metal vibrations, leaks and loose connections. Quickly and easily attached.

McKENZIE ENGINEERING COMPANY
NEW ROCHELLE, N. Y.
Mail orders filled promptly on receipt of remittance. Specially made of phonograph and head-phones.

first application of mica to radio condensers.

Paper is not a very efficient dielectric, but it is very suitable for certain purposes. Where low loss and high efficiency are not the prime requisites, paper may very conveniently be used, otherwise mica is the only suitable dielectric. Thus condensers used for blocking direct current voltages, or for eliminating commutator hum may be made of paper, whereas antenna condensers, grid condensers and so on should be made of mica. However, paper is used quite extensively today in the cheaper type of condensers intended even for these latter uses.

Two sheets of paraffin paper and two sheets of tinfoil are interleaved and then folded over a stiff sheet of fibre, thus making a very simple and inexpensive condenser. The paper and tinfoil are firmly fastened to the fibre by means of eyelets, serving at the same time as the terminals. The conductors are used in the cheaper class of equipment and give



Figs. 17, 18, 19

These mica condensers can withstand high voltages and are used extensively in low power transmitters. The lowest one is variable in steps.

fairly satisfactory results. The capacity of these units is variable, due to the fact that the whole structure is not rigid, and any pressure on the unit varies the closeness with which the tinfoil and paper are packed. Hence it is not desirable in sensitive equipment to use such condensers, since variations in capacity will produce current variations which manifest themselves in noise.

Still another type of paper condenser as used in receiving sets is shown in Fig. 15. The construction of this is similar to that described above, except that it is assembled in cartridge shape which fits standard grid leak holders. These condensers are made in a variety of sizes and may be used as grid condensers, telephone condensers, and for other purposes where fixed condensers not subject to high potentials are required.

MICA CONDENSERS

The biggest advance in condenser design and construction was made when mica was introduced as a dielectric. The two chief advantages which mica possesses over other dielectrics are: (1) Low power factor, and (2) high dielectric strength. The phase angle of mica condensers ranges from 3
(Continued on page 1346)

Build Your Own

Neutrodyne Receiving Set

with a

WORKRITE NEUTRODYNE OUTFIT

(Licensed under Hazeltine Patent No. 1450080)



This is the outfit you have been looking for. All the parts for a Five Tube Neutrodyne Receiving Set put up in one outfit. No shopping around to get all the necessary parts; no doubts as to how they should be put together. A drilled panel and base board are included in this outfit as well as complete instructions and a mounting angle to assist you in mounting coils at the proper angle. The Outfit is packed in a neat box that you can use as a radio tool box. WorkRite Quality throughout. Order your Outfit today.

WorkRite Neutrodyne Outfit \$70.00

WorkRite Neutrodyne Kit

- DeLuxe Model contains:
- 3 WorkRite Neutroformers
- 2 WorkRite Neutrodons
- 3 WorkRite E-Z-Tune Dials
- Panel Layout, Mounting Angle and Complete Instructions

\$25.00



"WORKRITE RADIO PARTS WORKRITE"

Send for our complete catalog

THE WORKRITE MANUFACTURING CO.

1824 East 30th Street, Cleveland, Ohio

(Branch Office, 536 Lake Shore Dr., Chicago)

COAST TO COAST ON ONE TUBE

E. MacDonald of Bangor, Me., received Wenatchee, Wash., on 1 tube Royal Portable Broadcast Receiver. One dial control. Takes all wave lengths.

- Royal Portable 1 tube assembled complete with tube, phones, tube, batteries, aerial, etc. . . . \$18.75
- Autoplex Circuit works loud speaker on one tube.
- Complete Parts, tube Free 18.50
- Cockaday-Reinartz—Ultra-Audion circuits, 13.67
- panel, complete parts—Tube Free with each 13.67
- 5 Tube ROYAL Neutrodyne (mounted) unwired 49.47
- ROYALTRON tubes, guaranteed. Standard base.
- Types W.D.12, 201A and 200 3.95

Write for List. Dealers wanted.
ROYAL MFG. CO., Dept. 28, 296 B'way, N. Y.

TUBES \$5.43

- Genuine R. C. A. Radiotrons
- UV199, UV201 A, WD11, WD12
- Guaranteed Firsts in Original Packages
- BRANDES "SUPERIOR PHONES" \$4.86
- BRANDES "TABLE TALKER" 7.98
- BREMER TULLY VERNIER TUNER 3.97
- 3-AMP. TUNGAR TYPE BATTERY CHARGER 9.38
- ERLA REFLEX OR AUDIO TRANSFORMERS 3.96
- ALL AMERICAN TRANSFORMERS (All ratios) 3.82
- "PACENT" NEW STYLE PHONES 3.12
- COMO PUSH-PULL TRANSFORMERS (per pr.) 9.87
- 0 to 50 POCKET VOLT-METER 1.12
- "GOLD SEAL" HOMECHARGER 14.79
- ACME AUDIO TRANSFORMERS 3.96
- 23-PLT. VERNIER CONDENSER. Knob & Dial 2.13
- 23-PLT. VARIABLE CONDENSER 1.17

Cash or C.O.D.—Send for Complete List.
SIMPLEX RADIO SUPPLY CO.
1808 Lafayette Ave. St. Louis, Mo.

Get the Consrad Cloth Radio Map of the U. S.

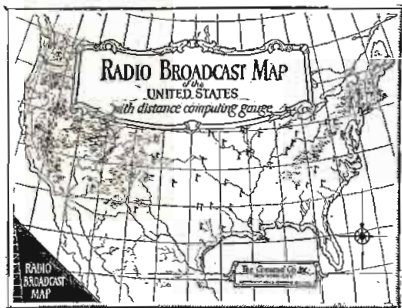

The Consrad Radio Map is different from all other maps in that it is printed on CLOTH and with proper care will last a lifetime.

The Map measures 17x22" and contains a special distance computing gauge of our own design which enables one to find any broad-casting station at a moment's glance.

A measuring rule is also furnished to help find the distance from any point in the United States to the station which is being received.

The broad-casting stations are contained on a separate sheet which can be fastened to the map by ordinary paper fasteners. The list is up to date and contains the new wave lengths.

The map is furnished in two colors and with the sheet of broad-casting stations, is enclosed in a two color heavy manilla envelope 9½x12".

50c.

Consrad Pattern No. 9. How to Make the ST100 Receiver

The S. T. 100 receiver employing a circuit devised by John Scott-Taggart of London, has proven to be one of the most efficient sets of reflex variety for broad-casting reception.

While only two tubes, a crystal detector are used, the energy amplified of incoming signals is powerful enough to operate any type of loud speaker without additional amplification.

The quality of reception will astonish those who are familiar with the performance of other circuits.

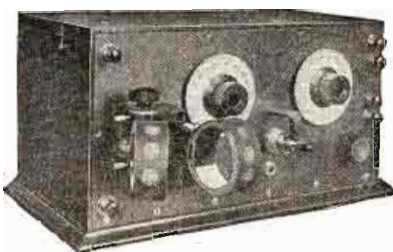

Another important feature is that the set tunes sharply, which is one of the utmost requisites of an ideal receiver.

The packet consists of blue prints for drilling the panel, wiring the apparatus, and a four-page instruction pamphlet giving complete details as to the parts required, tools needed, and even how to tune.

All these are contained in a two color heavy manilla envelope, 9½x12".

50c.

\$1.25 Here Is Your Chance to Learn All You Can About RADIO The \$10.00 Radio "Reading Course" Special at \$1.25

All the technical details and a thorough explanation of radio reception, written in easily understood, non-technical language by a foremost radio engineer and inventor. The five Lecture Books with over 100 graphic drawings give you the knowledge to intelligently buy, design, build, operate and maintain radio receiving apparatus. Tells you how to locate and correct troubles, how to make your

apparatus more efficient and gives you a thorough knowledge of radio science. This set of five handsome Lecture Books are a complete radio library. To own them is like having a trained engineer or instructor at your side, answering questions, pointing the way. No matter what your interest in radio, take advantage of this attractive special offer and be the owner of this fine set of books.

This set can be gotten at you dealer's or direct from us on receipt of \$1.25. If you prefer we will send it C.O.D. and you can pay the postman on receipt.



The Consrad "Making Your Own" series consists of plans for the construction of the most popular radio circuits and are gotten up so that anyone can construct a receiving set as easily as a woman can sew the simplest dress. Blue prints are furnished for drilling the panels and wiring the parts and a four-page pamphlet contains complete instruction even as to tuning. Each pattern is contained in a two colored heavy manilla envelope 9½x12" and sells at **50c.**



The Titles in this Series:

- No. 1 How to Make a Short Wave Regenerative Receiver 50c
- 2 How to Make Detector and Amplifier Units 50c
- 3 How to Make a Radiophone Crystal Set 50c
- 4 How to Make a Reinartz Receiver 50c
- 5 How to Make a Reflex Receiver 50c
- 6 How to Make a Cockaday Receiver 50c
- 7 How to Make a Neutrodyne Receiver 50c
- 8 How to Make an Autoplex Receiver 50c
- Packet B 20 Radiophone Diagrams with Supplements 50c
- C 14 Radio Formulae and Diagrams 50c
- D All About Aerials and Their Construction 50c

On Sale at All Reliable Radio Dealers or Direct from us.

The Consrad Co. Publishers and Sales Agents **233 Fulton St., N. Y. C.**



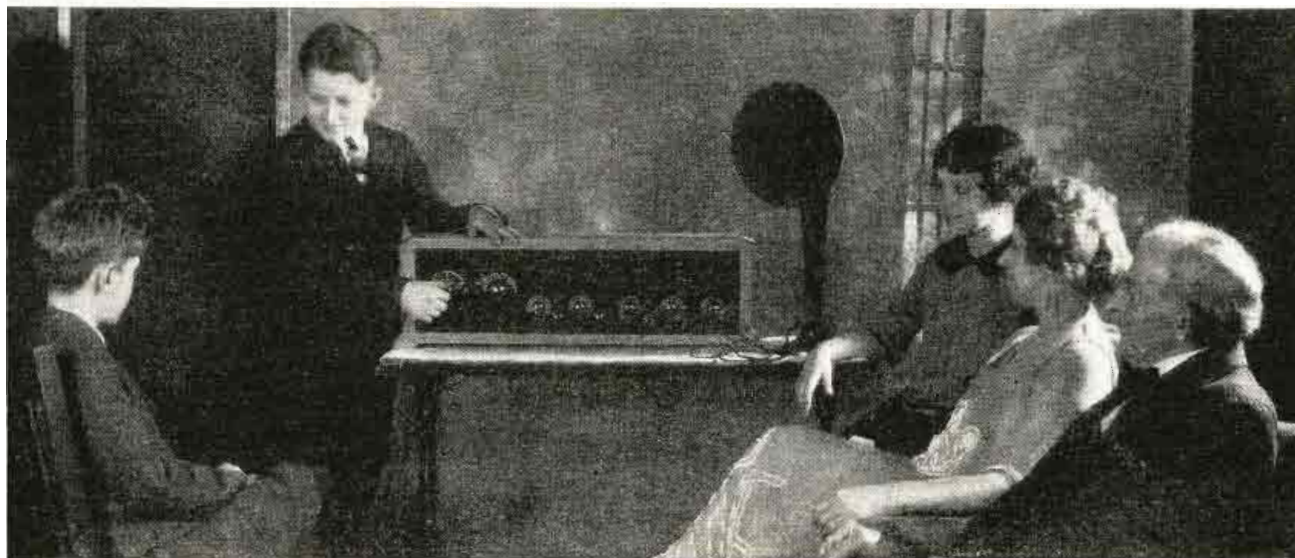

Day-Fan Unit Sets Bring Real Enjoyment to Young and Old

IT makes no difference what program you want to hear, the wonderful new Day-Fan Unit Sets will bring it to your home in tones that are clear, true and without distortion. They eliminate distance, minimize unfavorable conditions, and bring real enjoyment for every age.

They are built in either table or panel mountings. So

simple, and yet so complete, that even a child can get perfect results.

There are four types of units from which twenty-four different sets may be built. Each one is the highest development of its kind, and yet the price is surprisingly low. Your dealer has them in stock or can get them for you. See him before you buy.

The Dayton Fan & Motor Company, Dayton, Ohio

Established 1889



You NEED these
if you're building a set

50¢

The DIXIE JUNIOR SCREW ASSORTMENT contains the screws and nuts which you must have in assembling your radio sets. The DIXIE ENGRAVED BINDING POSTS are necessary to give your set that much-desired finished appearance.

Both the Dixie Junior Screw Assortment and the Dixie Engraved Binding Posts are essentials. They should head your list of parts to buy!

The price of the Dixie Junior Screw Assortment and of the Dixie Engraved Binding Posts is fifty cents per box. Order a box of each immediately!

The Dixie Junior Screw Assortment consists of 100 pieces, all solid brass, heavily nickel plated. The Dixie Engraved Binding Posts are a set of 8, each clearly marked for your set by superior engraving.

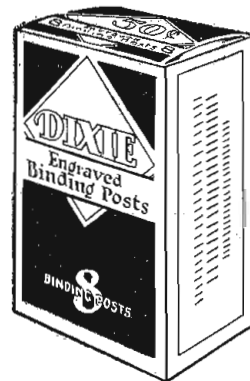

DEALERS~
Write immediately about these attractive display cartons and our liberal discounts



DIXIE SUPPLY COMPANY

91 Seventh Ave.

New York City

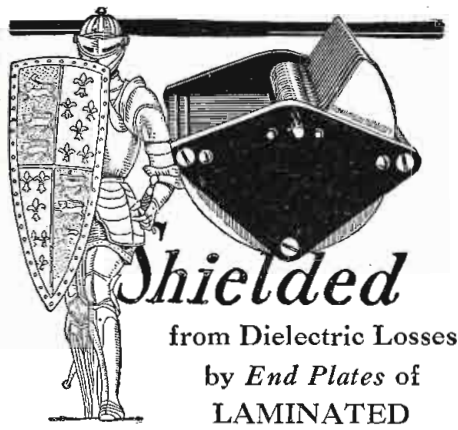

Shielded

from Dielectric Losses
by End Plates of
LAMINATED

CONDENSITE CELORON

U. S. TOOL Condensers

Infinitesimally small dielectric losses in *U. S. Tool Condensers* because they are perfectly insulated. The end plates of *Laminated Condensite-Celoron* cannot retain moisture even on the surface. Non-porous, proof against all capacity leaks and non-warping so that plates are permanently aligned. One of the details that make it well worth your while to insist upon *U. S. Tool Condensers*.

Write for Booklet.

U. S. TOOL COMPANY,
INCORPORATED
118 Mechanic Street, Newark, N. J.

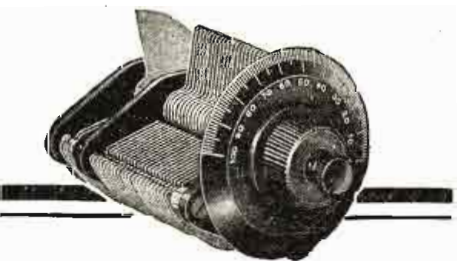

A RADIO POSITION FOR YOU

There are many good radio positions awaiting trained men today. Commercial Operating, Radio Repairing, Merchandising and other departments of the business constantly seeking the trained man.

Ours is a recognized school. In operation 14 years.

Y. M. C. A. RADIO SCHOOL

"Best Radio School in the East"

158 East 86th Street New York City

KILLOCH HEAD SET

2000 OHM \$3.25 POSTPAID IN U. S. A.
Baldwin Head Set \$8.75 Postpaid in U. S. A.
Send For Radio Catalogue
DAVID KILLOCH CO., 57 Murray St., N. Y. City

GOOD RADIO BOOKS. Radio Hook-Ups 25c. Design Data 25c. Construction of Radio Phone 25c. Ideas for the Experimenter's Laboratory 25c. Experimenter's Hand Book 25c. Henley's 222 Radio Circuits Designs \$1.00, just published. (Coin) Postpaid. Satisfaction or money back. Circular free of other good radio books. Order now. You can't lose. Ray Dobbins, 146 W. 27th St., Indianapolis, Ind.

feet to 5 feet, and mica condensers have been built to withstand voltages as high as 50,000 to 100,000 volts per condenser. In order to build high grade mica condensers having low power factor and high breakdown voltage, it is essential that only the best grade mica be used. Clear India mica has proved to be the best, and even this mica must be very carefully tested before being passed for use. It is difficult to tell by just looking at a sheet of mica whether it is good or not, consequently each sheet has to be subjected to an individual breakdown test by passing it between the two



Figs. 20-21-22

Three types of high tension mica condensers used in transmitting apparatus. The casing on each is of aluminum and constitutes one of the poles.

terminals of a high voltage spark coil. If the sheet of mica is good, a brush discharge or glow will take place over the entire surface as it passes between the two high voltage terminals. If there is any defect in the mica sheet, it will immediately be evidenced by the absence of this glow, since the high voltage will be short circuited at the defective point.

Mica condensers are generally built in several sections, each of which is composed of alternate layers of tinfoil and mica

Just a real Good Headset \$3.50

There's a way to prove the merit of a Camco Headset—use it. Write for facts—reasons why you'll gladly invest \$3.50 for a Camco Cannon Ball Headset or \$5 for a Camco Grand.

At your dealers or write

Cannon & Miller Sales Co. p.

47 W. Huron St., Buffalo, N. Y.

Factory: Springwater, N. Y.



WHY PAY MORE?

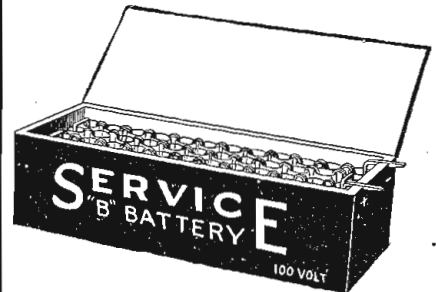

RECHARGEABLE			
50 Volts	\$5.50	100 Volts	\$10.00
75 Volts	\$7.75	125 Volts	\$12.50

Recharge from any 110 volt A.C. line with small home rectifier. Shipped fully charged and ready for use after adding acid. Will last for years with ordinary care.

SERVICE "A" BATTERY

RADIO SERVICE BATTERY	6 Volt	\$14.00
	80-100 Amps	
RADIO SERVICE BATTERY	6 Volts	\$16.00
	100-120 Amps	

2 YEAR GUARANTEE
INDESTRUCTIBLE
RUBBER CASE

SERVICE BATTERY CO.
704 East 102nd St., Cleveland, Ohio

LOUD SPEAKING CRYSTAL SET AT LAST

You can add a loud speaker to any crystal set by using the STEINMETZ Amplifier. Guaranteed to operate on any kind of crystal set regardless of what type it is, or we will refund your money. By using your crystal set with this amplifier music is brought in as clear as a bell and can be heard all over the room. Amplifier uses dry cell tube.

Write for our complete catalog and also information on a highly efficient detector and two-stage amplifier at \$22.50

STEINMETZ WIRELESS MFG. CO.

Manufacturers and Engineers

5705 PENN AVE. PITTSBURGH, PA.

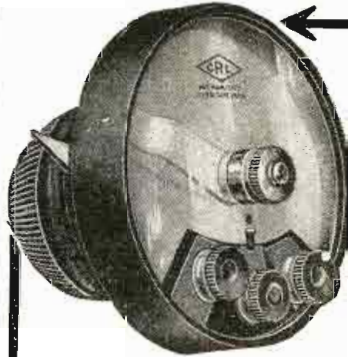

Fig. 23

A mica condenser of high capacity which is generally used in filter circuit.

sheets. The mica sheets are cut up into thicknesses of one mil and are then formed by a die to the size and shape required. Each section constitutes a condenser in itself. By constructing a condenser of a number of such sections in series, it is possible to subject it to very high voltages, and these voltages are then distributed over a number of condensers. By building the condenser of a number of such sections in parallel, large currents may pass through it without undue heating. By constructing the condenser of a number of such sections in series-parallel, the condenser may be made to have high voltage and high current capacity.

Each section of a mica condenser has the air and moisture which are in it eliminated by means of a pump, and a special insulating compound is forced through the section. The entire section is then subjected to very great pressure which presses the tinfoil almost into the mica and the insulating compound is forced into any empty spaces which may be present. The high pressure on the plates is maintained by means of a pressure plate so that the spacing is maintained constant, thus avoiding any capacity variations due to variable spacing. The



C R L POTENTIOMETERS

- No. 111 (400 ohms) . . . \$1.75
 - No. 111 (2000 ohms) . . . \$2.00
- By Parcel Post 10c. extra

You'll find these instruments everywhere—the most popular devices of their kind.

Every C R L instrument is carefully tested before it leaves the factory and is fully guaranteed.

How to Pick Out a C R L Non-Inductive Potentiometer

First, note the C R L trademark on the brass disc on which the contact shoe rides. Turn the knob and note that the shoe does not rub on the resistor but simply presses the disc down to make contact.

This arrangement gives noiseless adjustment through an infinite number of steps, and frees the resistor from all wear.

The resistor itself is a thin strip of graphite which is absolutely non-inductive. This permits the free passage of the delicate high frequency current of the received signal and so does not damp the regenerative oscillations as does a wire-wound potentiometer with its unavoidable inductance.

This instrument, together with a C R L Adjustable Grid Leak which has replaced thousands of the uncertain pencil mark types, gives you complete control over two of the most important elements in your set—the plate potential and the grid bias.

CENTRAL RADIO LABORATORIES

305-16th STREET

MILWAUKEE, WIS.

Mr. Dealer:

Your stock is not complete unless you have one of these cabinets on your counter. It contains 35 radio necessities which every customer needs. It will sell standard radio equipment for you at ever increasing rates.

It gives a splendid service to your customers—many customers coming to the store when they know that you handle these radio findings.

It is the small things that give you the biggest profits. But at the present what happens? You buy expensive little radio parts (findings) and stow them away in drawers and boxes. Your customer is never reminded that you carry these items. YOU BOTH LOSE. The "RASCO" way solves this problem. Customers now buy radio findings in unheard-of quantities because the "RASCO" cabinet on your counter commands attention.

Price of Cabinet
16.50

F. O. B.
New York
IMMEDIATE SHIPMENT

W A N T E D

Dealers and Jobbers to handle "RASCO" Radio Findings, "THE BIGGEST PROFIT MAKER IN THE WHOLE RADIO BUSINESS." Write or wire for particulars.



CONTENTS OF CABINET

- 900 Assorted Lugs
- 750 Assorted Name Plates
- 12 Bezels—small
- 12 Bezels—large
- 48 Cat's Whiskers
- 36 Switch Levers
- 36 Pointers
- 75 Phone Tips—standard
- 75 Phone Tips—separable
- 36 Adapter Bushings
- 48 Angle Plates
- 45 Assorted Cap Nuts
- 36 Lock Nuts
- 450 Assorted Lock Washers

2,559 TOTAL PIECES

Costs You

\$16.50

per Cabinet

You Get

\$55.19

or

234%

on Your Investment

ORDER YOUR

CABINET TO-DAY

SALESMEN WANTED to sell this cabinet. We still have a limited territory open. Write or wire for particulars.

RADIO SPECIALTY COMPANY, Inc.

Wholesale and Manufacturing Department

23 WEST BROADWAY, NEW YORK CITY

FACTORIES: ELKRIDGE, MD.

BROOKLYN, N. Y.

Two New E. I. Books for the Radio Fan

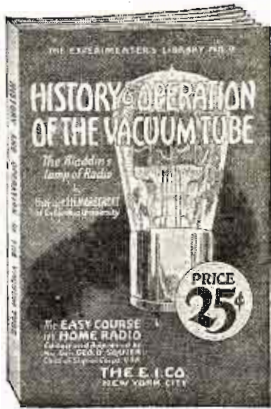

History and Operation of the Vacuum Tube

By PROF. J. H. MORECROFT

Associate Professor of Electrical Engineering, Columbia University

Edited and Approved by

MAJOR GENERAL GEO. O. SQUIER, Chief of the Signal Corps, U. S. A.

This book serves an interesting study of the fundamental principles, historical evolution, and practical application of the vacuum tube as used in radio apparatus of every description. Since the vacuum tube is one of the most important parts in the modern radio set, and has been largely responsible for making present-day radio entertainment possible, this book has been entirely devoted to the subject of that one particular instrument. It is written in simple everyday language with all technical terms thoroughly explained so as to make matters easily understood by everyone.

The book contains chapters on the phenomena of vacuum tubes in general; the operation of vacuum tubes as detectors and amplifiers; and the junction of the vacuum tube used in various transmitting and receiving circuits, etc., etc.

52 pages printed in legible type; 24 illustrations and diagrams; bound in two-color cover; size 5½ x 7½ inches; **Price, 25c.**

All About Radio Parts

By THOMAS W. BENSON

This book gives an extensive description of the various parts used in all types of receivers, especially explaining the features of certain apparatus and circuits. It also describes why the different parts are used and how they operate. There has been nothing overlooked.

To begin with, the book tells how radio waves are collected by means of an aerial, giving details of construction of different types and their advantages. Then detection is explained and various types of crystal and vacuum tube detectors described. Amplification, including regeneration, radio and audio frequency, is simply told.

This very instructive book will prove to be of great value in the hands of anyone interested in radio as it is very explicit and thorough.

Contains 52 pages, 36 illustrations and diagrams; bound in a two-color cover—size 5½ x 7½ inches. **Price, 25c.**

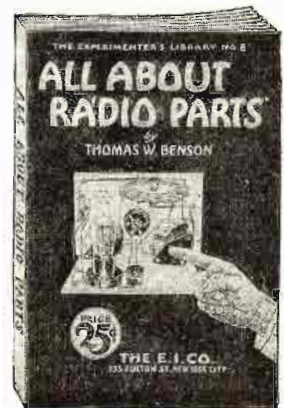

Other Books in the "Experimenters' Library"

No. 2—How to Make a Radiophone Receiving Set.....25c

No. 3—Radio Questions Answered.....25c

No. 4—Radio Frequency Amplifiers.....25c

No. 5—Loud Talkers and How to Build Them.....25c

No. 6—How to Tune Your Radio Set.....25c

No. 7—100 Radio Hook-Ups.....25c

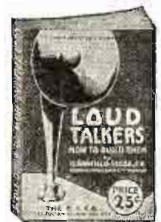

The "Experimenters' Library" is being increased at the rate of at least one new title each month. Every book is written by an authority and in language easily understood by everybody.

On Sale by All Reliable Radio Dealers

The E. I. Company (The Consrad Co., Selling Agents) **233 Fulton St., N. Y. C.**

various sections of the condenser are then placed in the holding case which is generally of metal and which forms one terminal of the condenser in the transmitting units. Receiving units are made in the same general way except that the housing may be different.

Fig. 16 illustrates the simplest type of mica receiving condenser which is made in a variety of sizes. These units are compact affairs generally used as grid or telephone condensers. Fig. 16 illustrates the model which has a standard grid leak holder incorporated in it for facilitating grid leak mounting. Fig. 17 illustrates a small condenser built to withstand moderate voltages up to about 1,000 which is suitable for small transmitting units as a grid or plate condenser.

Figs. 18 and 19 illustrate mica condensers which are used as antenna series condensers, and which are able to withstand voltages as high as 3,000 and will carry currents as high as 5 amperes. Both are in metallic containers, and terminals are brought out of the sides through insulating material such as

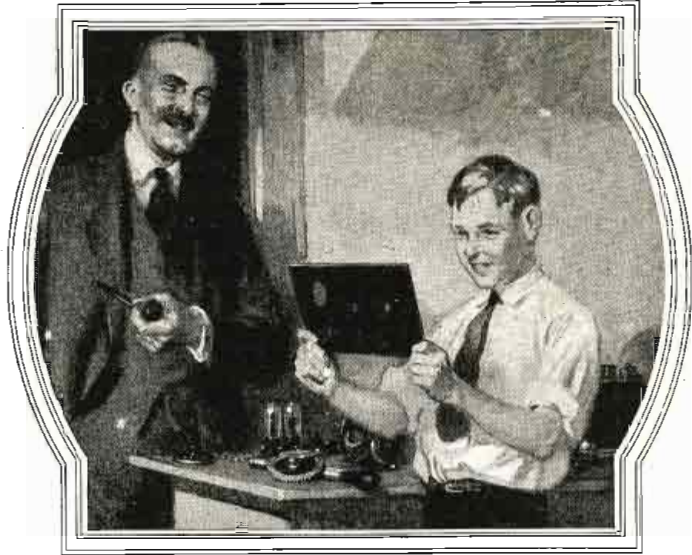

Fig. 24
This condenser built for the Navy Department to be used with a 30-K.W. arc transmitter can withstand 90,000 volts. It has a capacity of .002 MF. and is about 5 feet high.

mica. Fig. 19 illustrates the type of fixed condenser variable in steps. There is one common terminal, and three taps, enabling the use of three different capacities.

Figs. 20 and 21 illustrate the type of condenser used in radio frequency oscillating circuits. These come in various sizes from 0.002 to 0.004 microfarads generally. Fig. 20 represents the earlier type which utilizes a bakelite insulating top. This has been supplanted by the type shown in Fig. 21, in which the bakelite top has been replaced by a mica insulating bushing because of the fact that the losses in bakelite are much greater than in mica. In both types of condensers the containing metal case, usually aluminum casting, forms one terminal of the condenser.

Figs. 22 and 23 illustrate high capacity mica condensers which are used for such purposes as filtering, protection against kickbacks and so on. Fig. 22 represents a 1-microfarad condenser which is able to withstand 1,000 volts, hence may be used across 1,000-volt D.C. generators to weed out commutator ripples, prevent kickbacks by by-passing radio frequency currents, or may be used in high voltage rectifying circuits as filter condensers. Fig. 23 represents



Now for the hook-up

THE radio set builder's eyes shine with pride as he inspects his drilled Celoron panel. He has done a good job. The finely finished Celoron panel reflects his good workmanship. He is ready to mount his instruments and make the final connections.

A Celoron panel insures good looks to the radio set. Celoron panels are finished in black, oak and mahogany. Each Celoron panel is wrapped in a dust-proof glassine envelope to protect its lustrous surface. Grit cannot scratch it. Hands cannot fingerprint it. You are the first to unwrap it.

Celoron, a bakelite product, has high dielectric strength. It is approved by the U. S. Navy and the U. S. Signal Corps.

Special-sized Celoron panels are cut to order from sheet Celoron. Standard Celoron panels come cut and trimmed, ready to use, in these sizes:

- | | |
|-----------------|------------------|
| 1—6 x 7 x 1/8 | 5—7 x 18 x 3/16 |
| 2—7 x 9 x 1/8 | 6—7 x 21 x 3/16 |
| 3—7 x 12 x 1/8 | 7—7 x 24 x 3/16 |
| 4—7 x 14 x 3/16 | 8—12 x 18 x 3/16 |
| | 9—7 x 26 x 3/16 |

Write for our interesting booklet "Getting the Right Hook-Up." Sent free upon request.

To radio dealers: Send for special dealer price list showing standard assortments

Diamond State Fibre Company

BRIDGEPORT (near Philadelphia) PENNSYLVANIA
Toronto, Canada Branches in Principal Cities London, England

CONDENSITE CELORON STANDARD RADIO PANEL

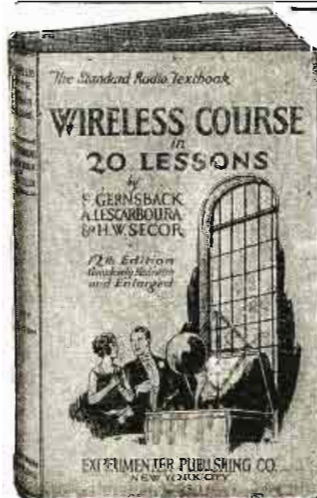

\$2.00 12th Edition \$2.00

WIRELESS COURSE IN 20 LESSONS

By S. GERNSBACK, A. LESCARBOURA
and H. W. SECOR

The Standard Radio Text Book

Size 6 x 9 inches. 264 pages. 500 Illustrations. Binding de Luxe. Semi-flexible Leatherette Cover. Genuine Gold Stamped, Round Corners, Red Edges.

Experimenter Publishing Co.

53 Park Place

New York, N. Y.

PROTECTION

FROM RAIN, WIND AND WEATHER, WITH DEPENDABLE INSULATION

Why trust to the ordinary unreliable type of insulators when your set can be made absolutely immune to rain or storm with these specially designed wall and lead-in insulators? Made of hard rubber with brass conductor through the center, the M & M LEAD-IN INSULATOR means specific protection to you.

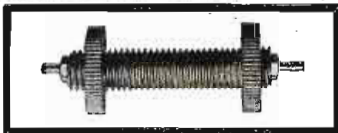
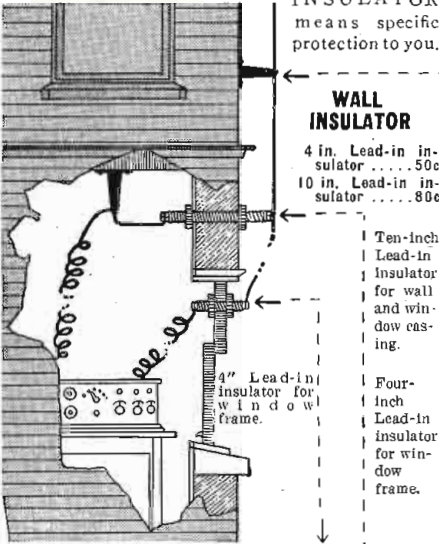

The M & M wall insulator has a steel base moulded into hard rubber column. Holds any sized wire from No. 14 to 4. Keeps wire 5" from wall, thus meeting underwriters' requirements.

Dealers and Jobbers: Write for our proposition.

THE M & M COMPANY

500 Prospect Avenue, Cleveland, Ohio

RADIO CABINETS

Direct from manufacturers, excellently finished in genuine mahogany and oak.

7 x 7 x 9.....\$2.85	7 x 7 x 21.....\$3.50
7 x 7 x 10.....2.95	7 x 7 x 24.....3.85
7 x 7 x 12.....3.05	7 x 7 x 26.....4.10
7 x 7 x 14.....3.25	7 x 7 x 28.....4.35
7 x 7 x 18.....3.40	

POSTPAID IN U. S.

Strongly constructed with grooves for panels. No fasteners or screws needed. Sizes denote panels required to fit in grooves of cabinet. Base Boards up to 18 inches 25c. extra; over 18 inches and up to 28 inches, 40c. extra.

D. SUMNER

237 South Market Street, Dept. 22, Chicago



Wonderful, new device, guides your hand; corrects your writing in few days. Big improvement in three hours. No failures. Complete outline FREE. Write C. J. Ozment, Dept. 44 St. Louis, Mo.

also a 1-microfarad condenser assembled in very much smaller space and hence not able to withstand such high voltages. These units come in sizes up to 4 microfarads and are very convenient for use in amplifier sets or as by-pass condensers where low voltages are present.

Fig. 24 is an extremely interesting illustration of the great possibilities of mica condenser construction. This is a 0.002-microfarad condenser built for the Navy for use in the oscillating circuit of a 30-K.W. arc transmitter. It is composed of a large number of sections in series-parallel similar to the sections employed in the condenser shown in Fig. 20. In fact this single condenser replaces 91 condenser units of the type shown in Fig. 20, and is able to withstand 90,000 volts maximum. The individual condenser sections are stacked in a metal case as shown, the case being one terminal as seen by the post at the bottom. The other condenser terminal is seen at the top on the corona shield. On the side of the condenser is seen an oil gauge.

Mica condensers are built in numerous other designs and for a great many other purposes, but the above covers the chief types in use in modern radio equipment.

Photos and illustrations by courtesy of Dubilier Condenser Co., Radio Corp. of America, Radio Industries Corporation, General Radio Co., Chelsea Radio Co., American Radio & Research Corp., Hartford Instrument Co.

The Sad Story of AZZ

(Continued from page 1240)

"Well, I've got one," he said, "and you're my last hope. I've tried everything else and nothing came of it."

"All right," I said. "Tell me about it. What sort of set have you?"

"It isn't trouble with a set," he said, giving a sigh that almost blew the roof off the shop; "it's a lady. Her name is Mamie. She is the dearest, loveliest, sweetest, most beautiful, fairest, most fascinating—"

"I'll take your word for the rest of it," I said. "Is she rich?"

"Yes," he said, "but I don't care anything about that. I love her for herself alone. I loved her the first time I saw her, before I knew her name. I set my eyes on her and loved her."

"Some do catch it that way," I said.

"And I think she loved me," he said. "In fact, I'm sure she did. Her eyes told me so."

"Yes, yes; go on!" I said.

"It was like this," he said. "It was on the subway, along about six o'clock and I was off duty and going home for dinner. The subway car was crowded and I was standing, holding on to a strap, and this beautiful girl was standing next to me holding on to a strap. She wasn't quite tall enough, so she was on her tip-toes. Well, the car gave a lurch and she lost her hold on the strap, and as she came down her ankle turned and she gave a cry and grasped my arm. I put out my hand to steady her, of course, and she clung to me and bent to rub her ankle and cried a little with the pain of it. So all the way uptown I held her steady and when we got off the car I told her I had better see her home, and she said that would be kind, and I did see her home."

"And you were in love with her by then, of course," I said.

"Yes," he said, "I was. And I am yet—more than ever. She's the only thing I live for. Without her I would rather be dead."

FAHNESTOCK'S LATEST RADIO HELP

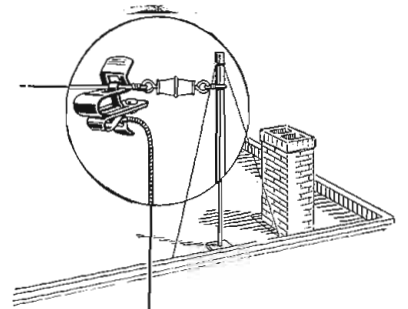

No. 31

THE

Antenna Connector

Price 10c

Snap larger connector over Antenna Wire; insert Lead-in Wire into smaller clip and a perfect connection is the result.

At Your Dealers

Fahnestock Elec. Co.
 LONG ISLAND CITY
 NEW YORK

YOU DON'T NEED TUBES

to hear concerts from distant Cities.

YOUR CRYSTAL SET

will bring them in if you follow my instructions. You may already have all the parts you need and merely have it hooked up wrong. People using my plans hear programs clearly from stations

400 TO 1000 MILES AWAY

No TUBES, BATTERIES, AMPLIFYING APPARATUS or SPECIAL CRYSTAL required. My COPY-RIGHTED instructions selling for \$1.00 are written so anyone can understand. They show you exactly how to fix the set you have or make one like mine. Satisfaction Guaranteed or money refunded. Picture of my set and further particulars FREE. Write me today.

LEON LAMBERT

595 So. Volusia St.

Wichita, Kansas

"COPPERWELD"
 THE IDEAL RADIO ANTENNA

COPPERWELD IS 50% STRONGER than Copper, can be strung taut, stays up when other wires stretch and break, and gives 100% electrical efficiency

COPPER CLAD STEEL COMPANY
 BRADDOCK P. O. HANKIN, PA.
 Directions for Antenna construction on reverse side of carton

So I asked her if I might call the next day, to learn how her ankle was, and she said I might. And I did."

He stopped then and tears came into his eyes, poor fellow.

"I did call," he went on, "and she was reposing on a couch in the parlor. She held out her dear little hand for me to shake, and I shook it. Then she said her ankle was getting along as well as could be expected and I sat down and we talked. And the first thing I knew she was talking about radio. Maybe I mentioned it and maybe she mentioned it, but, whoever mentioned it first, she was off in an instant, and the things she said about radio would have made a copper wire curl up and vanish in blue smoke. She said that radio was the meanest and most hideous thing that was ever invented and that she hoped I would never have anything to do with it, because, if I did, she was through with me then and there. She said it was a detestable thing and was ruining good music and wasting people's time and nobody but idiots and children cared anything about it. She said she liked me, but if I ever owned a radio set or had the least little thing to do with radio she was through with me forever, and that that was final and it might as well be understood."

"Some of them are that way," I said.

"She was, bless her dear little heart," he said. "And I learned why, later on. She had been engaged to a fine young fellow and he had been all a lover should be. He paid her every attention and was with her every moment of his spare time, and deluged her with candy and flowers and presents—until he got interested in radio. Then he stopped. He never could find time to spend a moment with her—he had to be remaking his set. He never had a cent to spend for candy or flowers—he had to buy new parts for the new set he was always making. And that was too much for her dear, loving little heart. She broke the engagement."

"Well, that was lucky for you, wasn't it?" I asked him.

He looked at me with a ghastly face.

"Do you know who I was?" he asked in a hollow voice. "Do you know what I was doing day after day and night after night?"

"No," I said, "how should I know? Tell me, if you want me to know."

"I was A-Z-Z," he said. "I was the announcer at WPQX."

"You what?" I exclaimed. "Why, man, I just heard A-Z-Z announcing from WPQX."

"I'm coming to that," he said sadly. "What I am telling you is the truth. I was A-Z-Z. It was my voice the ladies all fell in love with. It was to me they sent bushels of mash notes every day—hundreds and thousands of mash notes telling me how sweet and lovely my voice was. I got letters from Alaska and Florida. On Christmas I received 1,564,980 Christmas cards. We had to keep three girls at the studio to shoo off the ladies who came there to get just one glimpse of me. Yes, when I began my daily announcing over the ether waves each day, hundreds of thousands of ladies were listening, waiting to hear the sweet tones of my voice. I was A-Z-Z."

"Great Scott!" I exclaimed.

"You may well say so," he said dolefully. "And you can see what an awful thing it was for me. Just when I had met her and come to love her, my darling Mamie was swept away from me by her hatred of radio and my world-famous position in radio. I don't know how I managed to tear myself away from her that evening, but I did leave her."

"Well, what then?" I asked.

"For seven days I did not go near the studio again," he said, "and WPQX received over fourteen million letters and post cards asking where A-Z-Z was, and when he would

Special Notice

the new
1924

Pathé
REG. U.S. PAT. OFF. 

LOUD SPEAKER

MAHOGANY FINISH

Price Now \$17.50

(West of Mississippi \$19.00)

**Is Now
On Sale**

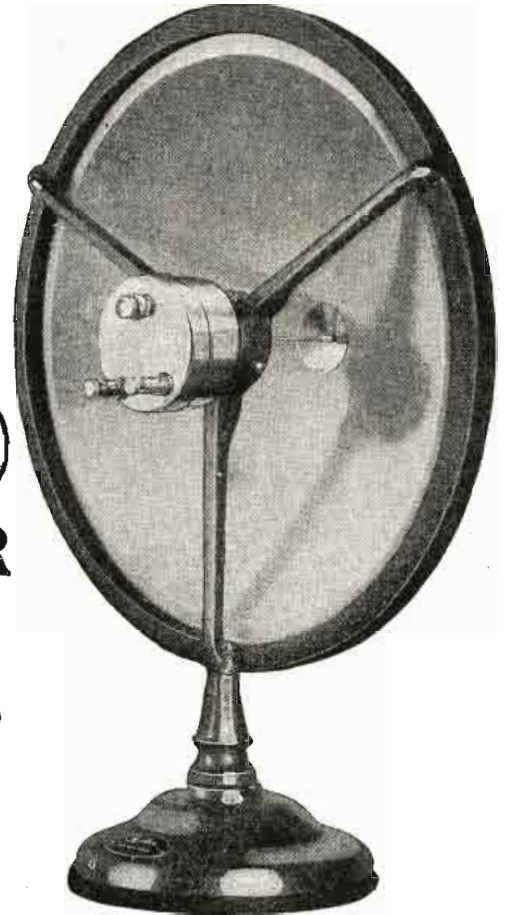

The new 1924 Pathé Loud Speaker is radically different in theory and construction design from any other loud speaker. It is scientifically perfect—the throaty voices of the horn have been finally done away with. The Pathé Loud Speaker actually *reproduces* distance signals clearly and without distortion.

It will add to your radio pleasure to find out the details of the new Pathé Loud Speaker. Step into your dealer's and see it, or write us today for free pamphlets and full particulars.

Pathé Phonograph & Radio Corp.

20 Grand Avenue

Brooklyn, N. Y.

Western Sales Office: 533 Wabash Ave.; Chicago, Ill.

SAVE ON RADIO

Stop paying exorbitant prices for radio apparatus. We can supply you any standard parts at greatly reduced prices.

WD11 TUBES, SPECIAL PRICE..... \$5.75
UV 201A AND C301 A TUBES..... \$5.75
BRANDES SUPERIOR PHONES..... \$4.95
22½ VOLT B BATTERY..... \$1.30

You can save money on the latest and best in radio at our rock-bottom prices. Orders shipped same day received, C. O. D., under absolute money-back guarantee.

We pay postage on orders accompanied by check. Write today for our Price-slashing FREE bargain list. STANDARD RADIO CO. 1233 Walnut St., Kansas City, Mo.

DEALERS

Send for new price list of parts & knocked down outfits. RADIO PARTS MANUFACTURING CO. 1245 Mariboro Detroit, Mich.

The Loud Speaker

FREE TO RADIO DEALERS

The very last word in radio. Dealers all over America are clamoring for it. Just off the press. Contains detailed drawings of latest hook-ups and sensational values in the best standard radio parts and supplies. Limited edition. Write for your free copy at once on your letterhead.

WESTERN RADIO MFG. COMPANY
138 WEST LAKE STREET
CHICAGO, ILL.

Look for the Gold Cover!

Send for
Free Sample
Copy

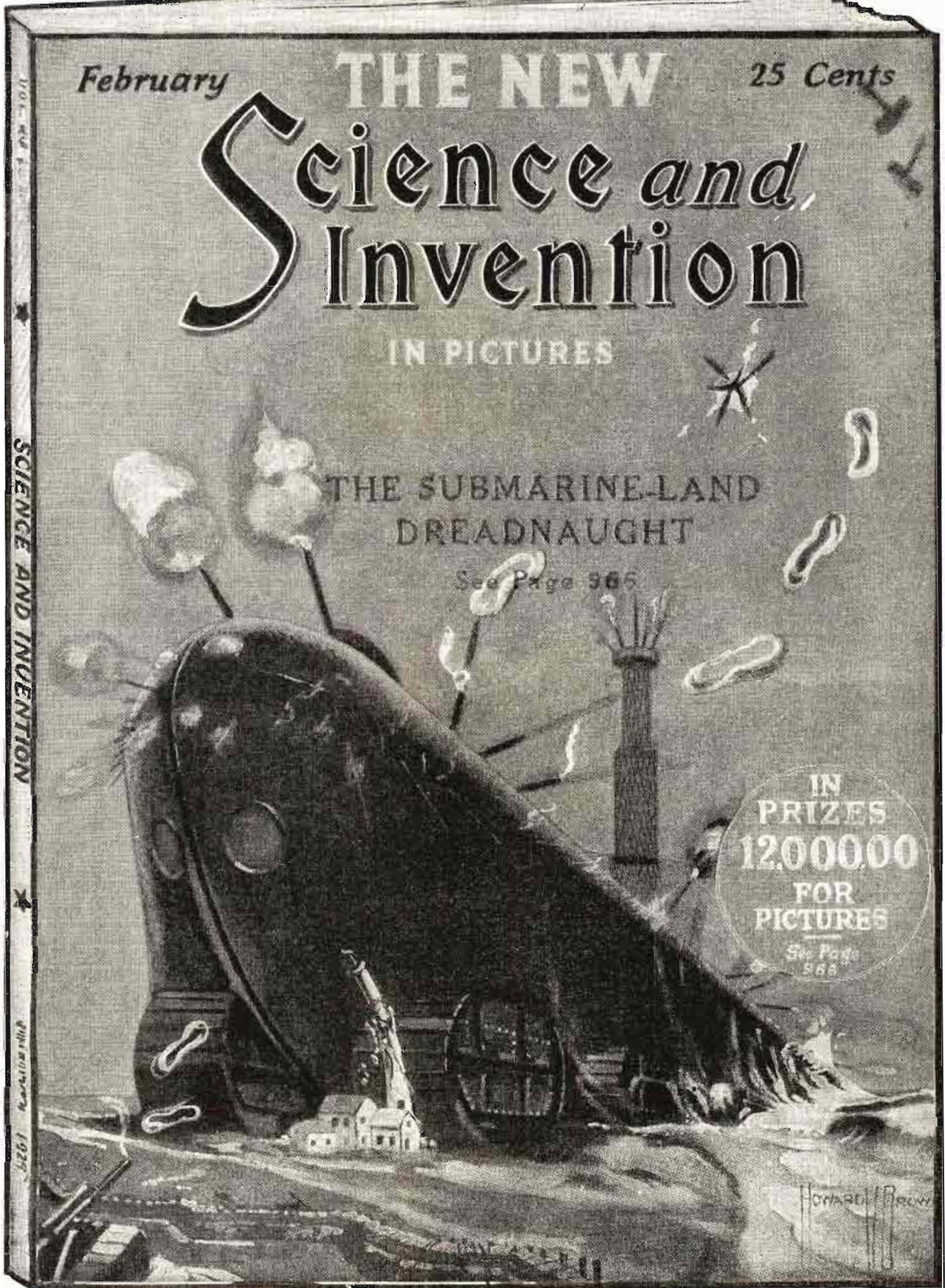

The *NEW* SCIENCE and INVENTION.

SOMETHING ENTIRELY NEW!

On All Newsstands January 20th

A scientific magazine without text—only illustrations and short captions. Every issue creates a sensation. This is the first scientific magazine ever printed with pictures and captions only. Order from your dealer now, otherwise you will surely be disappointed in not getting your copy. **LOOK FOR THE GOLD COVER!**

Over Twice As Much Radio As Ever Before

INCIDENTALLY, SCIENCE AND INVENTION appears in a new make-up which now makes its reading far more fascinating and interesting than it has ever been in the past.
EXPERIMENTER PUBLISHING CO.

25c A Copy - - - \$2.50 Per Year

53 PARK PLACE, NEW YORK

be back. On the eighth day I went to see Mamie again and I was told she had gone to Virginia for a two months' trip. I went back to the studio. There I told them plainly that I was through."

"Through?"

"Through with my career as an announcer. I told them that, for reasons of my own, I would never announce again—that I was never going to be connected with radio again in any way, shape or manner. You understand, my friend, that Mamie's love was more to me than my radio career. But they did not guess that at the studio. They said: 'We understand; a delicate soul like yours cannot stand all these mash notes. No doubt some of these ladies have hunted you down and are pestering you with their attentions. But if you go, we will be in an awful fix. Your voice is the most popular feature of the WPQX station. Stay with us a day or two until we can find another A-Z-Z.'"

"Another A-Z-Z?" I asked him, not understanding what he meant.

"Yes," he explained, "another man with a voice exactly like mine who could take my place as announcer in the studio! And that was only fair. If I was throwing them down in that way it was only right I should resign the title of A-Z-Z as well, and let another man have it. There was no reason why I should be a dog in the manger. So I swore them all never to reveal that I had ever been A-Z-Z, and I swore never to tell that I was or ever had been A-Z-Z. So for a month more I continued to announce from WPQX."

Here he broke down and wept into a box of regenerative tubes on my counter. This took the static out of them and ruined them for life. When he raised his head his eyes were wet with tears.

"Alas for that month!" he moaned. "It was during that month that my darling Mamie, down there in Virginia, let her cousin Amelia coax her to listen in to WPQX just once, and then and there she heard my radio voice for the first time, and like every lady who ever heard it she fell in love with it. Like all those who begin condemning radio most violently, she became very quickly the most intense sort of radio fan. They could not drag her away from the ear-phones. Day and night she sat listening for the voice of A-Z-Z, and when she heard it, a bright and happy smile would spread over her face. Then, and then only, she was happy. She telegraphed home to her folks to buy the finest and most perfect radio set they could find and to have it installed against her arrival home. When the time came for her to return to New York she bought a portable set and she kept the ear-phones on her ears in the cab on the way to the station, and on her ears as she lay in the berth of the sleeping car. She could not bear to miss one whisper of the voice of A-Z-Z."

"And it was about then," said the pitiable young man, "that I left the studio for the last time. I had arranged with a brokerage house to become a salesman of Second Preferred seven per cent Cumulative stock of the Imperial Picadilly Oil Company. Every day I telephoned to see if Mamie had arrived at her home again, and at last I heard the glad news that she had. I hurried to the house."

I did not venture to say anything when he paused; his grief was too great.

"Perhaps you can imagine how she received me, that darling of my heart?" he said. "She was friendly, but cold. She was honest with me, but she was frank. She said she had learned to appreciate radio and that she had learned more than that—she had learned that she could never truly love or think of marrying anyone but A-Z-Z. She said she knew he must have many admirers, but she would use any means to get to know him and make him love her. Then she bade me adieu, and walked to the door with me."

"That was tough," I said.

MICHIGAN MIDGET

The Sensation of Radio



No. 10 Detector

\$27



No. 11 Amplifier

\$30

NEVER before have such quality sets been offered at anything like the price of the Radio Midget (both Detector Unit and Amplifier Unit).

- Distance
- Clearness
- Selectivity

These three features stand out in the Michigan Midget and have truly made it "The Sensation of Radio." The quality of the materials and workmanship is the best and the engineering skill of design has made the Michigan Midget the long distance wonder.

Here is a set that tunes out local stations and brings in distant stations—clear and loud.

Go where you may—look over all the sets offered and then you will be more convinced than ever that there is nothing on the market to equal the Michigan Midget.

Send for catalog of other Michigan Quality Radio Products

MICHIGAN RADIO CORPORATION

GRAND RAPIDS, MICHIGAN

SUNSET REFLEX CRYSTALS

Tune in DX with your reflex circuit and Sunset Crystal. Greater sensitivity, longer life, more distance because of wood metal mounting. **50c** GUARANTEED!

Granular Galena in Bulk
Mrs., Dealers, Jobbers; Write for Proposition
U. S. MFG. & DIST. CO.
45 CLINTON ST., NEWARK, N. J.

R. G. ANDERSON

VARIABLE CONDENSERS

Made from pure hard aluminum with accurate machined brass spacers. All plates 20 B & S gage. Most rigid condenser made.

	Assembled Prices Ready to Mount	Complete Parts for Assembling
No. 3 Plate	57	40
No. 5 "	63	45
No. 13 "	98	70
No. 23 "	1.48	1.00
No. 41 "	1.98	1.40

R. G. ANDERSON
2035 Baxterly Avenue Lakewood, Ohio

JUST THE BOOK YOU WANTED

"RADIO NEWS" Amateurs' Handibook

Volume No. 1

Check full of radio constructive and instructive articles from cover to cover. Written by foremost radio authorities, in plain everyday language which everyone can understand. Sections include articles on Receiving Sets and Sundry Apparatus, Transmitters and Accessories, Radio Theory, Vacuum Tube Data, and Practical Hints for the Amateur. A book which also serves as a ready reference and should find a place in the library of every amateur. It contains 224 pages and over 375 illustrations, diagrams, and photographs, bound in a multi-colored heavy board.

On sale at all leading radio stores. If your dealer cannot supply you, pin a dollar bill to this ad and write your name and address in the margin below, and book will be forwarded to you postpaid. **PRICE, \$1.00.**

EXPERIMENTER PUBLISHING COMPANY, Inc. 53 Park Place, New York

Clear and Sweet

You've tried many expensive tricks to improve reception on that set of yours, but do you know that for the cost of one necktie you can get real results?

The ORIGINAL



AUTOMATIC BULL DOG GRIP PLUG

(Licensed Under Pat. Pend. Serial No. D 3010—No. 578540)

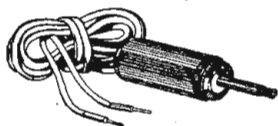

IS THE LAST LINK IN PERFECT RECEPTION

The COMSCO AUTOMATIC BULL DOG GRIP PLUG is very simple to operate. Connecting tips are inserted by a single touch, while with the flip of a small knob the tips slide out easily.

WE GUARANTEE THAT THIS PLUG saves you from short circuits and battery kicks. No more burned out phones or ruined transformers. No more broken finger nails.



For one pair phones \$1.00
For two pair phones \$1.50

FOR SALE AT YOUR DEALER

Otherwise send purchase price direct to us and you will be supplied.

GENERAL INSTRUMENT CORP.

123 LIBERTY STREET
NEW YORK CITY

"It was frightful," he said. "It was my voice with which she had fallen in love, and now another man's voice was taking its place as A-Z-Z. My voice had won her love, and now she was going to spend her life trying to make the other man marry her. And how sad was my position! I had sworn never to tell that I had been A-Z-Z. Those who could prove I had been A-Z-Z had sworn never to do so. What can I do about it? You advertise to correct all radio troubles—can you correct this of mine?"

Well, I don't mind saying I felt sorry for him, even if my wife was in love with his voice—or had been. Certainly I had never been asked to fix up a radio trouble like his.

"I think I might do something about it," I said after I had thought awhile. "There's only one thing I'd like you to explain first. You said you swore never to tell that you had been A-Z-Z, and you've told me. How do you get around that?"

"You're my doctor," he said. "A man has a right to tell his troubles to his doctor—even to his radio doctor."

"Well," I said, "I guess that must be so. Anyway, I don't know any kind of doctor that has as many troubles told to him as a radio man has. I'll see what I can do, anyway."

So I have written this story. It is written as fiction and it pretends to be fiction, because a doctor has no right to tell what a patient tells him. But it is fact. And I hope Mamie sees it and understands that it is fact. Then maybe she will understand that it is not the present A-Z-Z she is in love with, but the *ex-A-Z-Z*. And if Mamie reads this and wants to hear it from me direct, she can address me care of this magazine. I think the radio repair man ought to get one or two notes from the ladies, anyway; I don't see why the sweet voiced announcers should get them all.

Making Europe Part of U. S. Radio Audience

Experiments in short wave broadcasting by means of extremely high frequencies have reached a climax in the repeating of American broadcasts by British stations.

The feat whereby American broadcasts are repeated on these short waves and received and re-broadcast by English stations, thus reaching the peoples of Great Britain, France, Germany, Belgium and the Scandinavian countries, is the outcome of two years' experimenting and perfecting of high frequency apparatus by Frank Conrad, assistant chief engineer of the Westinghouse Electric & Manufacturing Company, who has probably done more in an engineering way to perfect radio than any other living man.

The interference problem, which became prominent about two years ago when so many broadcast stations had been started and were operating on frequencies very similar, first brought the idea to Mr. Conrad and his associates that extremely high frequencies held many possibilities for the perfecting of broadcasting. He started experimenting with his own station and from a short wave station installed on the roof where the transmitting apparatus of KDKA is located.

The first experiments with waves under 100 meters were made between the station at KDKA and amateurs living in the vicinity of Pittsburgh, Pa. Encouraged by the results of these tests, a receiving and re-broadcasting station was located in the Westinghouse building at Cleveland. The first of KDKA's broadcasts to be repeated were transmitted from the

Why JUNK YOUR SET?

The new **TWITCHELL AUXILIARY TUNER** connected to your present set will enable you to bring in the long and short wave stations which your present set cannot get. It also cuts out all local stations so you may bring in distance any time without local interference. Copyrighted diagram of this tuner 50c, or with all parts \$9.00. Complete instrument in Walnut cabinet, ready to use, \$15.00. Transportation prepaid.

MY HIGHLY IMPROVED REINARTZ brings in all important stations on this Continent loud, clear and without distortion. We dance to music from Atlanta and Los Angeles.

Build one of these wonderful 3 tube sets from my blueprint and specifications, price 50c, or with a complete and perfect double-wound spiderweb coil \$3.00 by mail. Picture of this set on a glass panel with every order. This copyrighted circuit is the most successful of any Reinartz modification yet produced, and is limited to the most. Thousands are in use.

A New and Wonderfully Efficient Coil of scientific design just perfected for the above circuit for \$1.50 extra. Coil alone \$4.00.

All goods prepaid. These instruments are easy to build, easy to operate. Everything clearly shown.

Send for bargain-list of parts.

S. A. TWITCHELL
1927 Western Avenue Minneapolis, Minn.

FREE!

Radio "Applause Cards"*

"— Station K-C-L-X signing off. If you have enjoyed the artists' program, won't you write in and tell them?"

By all means! Quickly and easily with "Applause Cards"*. They're handsomely printed mailing cards. All ready for you to fill in with your comments, sign, and drop in the mail box.

Keep a pack of them near your receiving set. You can use "Applause Cards"*. Liberally because they are **FREE AT YOUR RADIO DEALER'S**.

("Applause Cards" were originated by this Company, makers of the popular Dictograph Loud Speaker and the Aristocrat Dictograph Headset. The only "Applause Cards" are Dictograph Copyrighted "Applause Cards".)

A big **FREE** package of them awaits you at your dealer's. Or if he has not yet stocked, write us, giving his name and we'll ship you a generous supply of "Applause Cards" free, prepaid, direct. Dept. D-3.

D I C T O G R A P H
P R O D U C T S C O R P O R A T I O N
220 West 42nd Street New York City
* Reg. U. S. Pat. Off.

Watch Your Batteries



A run-down battery takes the joy out of your radio set. You lose volume, distance, and clear reception. The only way you can accurately know the strength of your battery is with the

PERFECTION HYDROMETER

A scientifically perfect instrument which can be used for any radio or automobile battery. Its ideal construction affords quick, easy reading, prevents breakage, and leakage of acid.

There are many imitations. Beware of them. If your radio or auto accessory dealer cannot supply you with the **PERFECTION HYDROMETER**, mail \$1 direct to us and we will send it to you postpaid, carefully packed.

BEMCO MANUFACTURING CO.
243 West 55th Street N. Y. City

The Peak of Radio Perfection



Type LR-170, 3 Stages Radio, Detector 3 Stage Audio Frequency Amplification

Uni-Tune

TRADE MARK

Receiver and the LOOP TUNER

TRADE MARK

Eliminates Aerial and Ground with Clearer Reception. **EXTREME SELECTIVITY** with easy manipulation. **FLEXIBILITY**—4 to 7 tubes may be used at will. **RANGE**—DX stations on the Loud Speaker. **SPECIAL WESTON VOLT-METER**—Showing A and B Battery voltages. Contains all batteries for dry cell operation. Write for Circular "R."

NASSAU RADIO CO., Inc.
60 COURT ST., BROOKLYN, N. Y., U. S. A.

station, whose call letters are KDPM. Then tests were made between East Pittsburgh and Springfield, Mass., which were also successful and finally short wave or high frequency receivers were installed in the homes of amateurs living in 20 cities or more, located so that they covered the country. All holders of these sets reported that reception on short waves was very favorable and that there were none of the drawbacks to broadcast reception on the higher wave-lengths.

These experiments covered a period of two years, nearly up to the time when KFKX, the first radio repeating station in the world, was started by the Westinghouse Company at Hastings, Nebraska, last October. This repeating station made use of the high frequency broadcasting and reception for the repeating of KDKA's East Pittsburgh, Pa., concerts and actually meant that KDKA's concerts were covering the entire country.

The KFKX station operated so successfully that negotiations were started with friendly concerns located in Great Britain to test the reception of high frequency waves. It was found the high frequency signals crossed the Atlantic with the same ease that they crossed the United States. The first test set in Great Britain was located in the plant of the Metropolitan-Vickers Co., at Manchester, England, which made very favorable reports upon the reception of the repeated concerts.

Recently the repeating took place with the British Broadcasting Co. which has a monopoly on broadcasting in Great Britain. Six or seven of this company's stations were tied together by means of telephone lines and the repeating of KDKA's concerts was started. The people living in Great Britain and Eastern Europe heard American concerts as plainly and with the same receiving sets with which they could hear their own station. It was the greatest triumph that radio had made in the past year and has actually changed the whole future of broadcasting.

The high frequency transmitter which does the repeating is located on the top of a nine-story building in the Westinghouse plant at East Pittsburgh, Pa. Because of the fact that high frequency sets are critical and can be thrown off their wave easily, the whole set is mounted on springs to guard against jars. To prevent the swinging of the antenna it is drawn taut between its uprights and the down leads are of copper tubing. The various inductances on the set are wound on rigid forms with copper tubing forming all leads. The transmitting set consists of three panels, as follows: The rectifier panel, the modulator panel and the oscillator panel. All the equipment represents the last word in transmitting apparatus with water-cooled tubes and special condensers.

The short wave transmitter is almost an exact duplicate of the big transmitting unit at KDKA with the changes necessary to efficiently work on the high frequencies.

One of the most striking things about the short wave transmitting set is the extremely short antenna used. The antenna at KDKA for use with the short wave receiver is slightly in excess of 35 feet in length. When the size of this antenna is compared to the 200-ft. lengths of the antenna used for regular broadcasts, the result is striking. That this small antenna will be sufficient to send broadcasts over the ocean is scarcely believed by many who see it.

LIEUT. WEBSTER APPOINTED

Lieut. E. M. Webster, Coast Guard, has been appointed to succeed Mr. L. J. Heath, of the Public Health Service as the representative of the Treasury Department on the Interdepartmental Radio Advisory Committee.

An Easy Way to Cut Out Interference

Add a Ferbend Wave Trap to Your Set

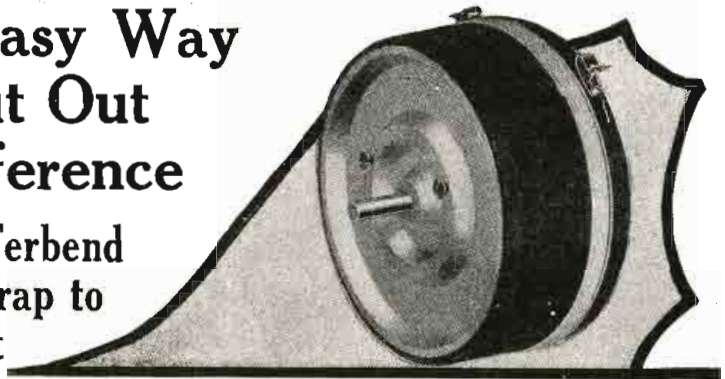

Enjoy your radio set. Get the station you want, *quickly*. Listen in on one thing at a time without annoying squawk-k-k-s or irritating whistles.

The Ferbend Wave Trap Makes Every Night Silent Night

New radio broadcasting stations are making receiving constantly more difficult. Many owners of long-distance sets are discovering powerful amplification is of little value so long as local stations are "all over the dial." Hundreds of users have solved the difficulty with the Ferbend Wave Trap—the missing link in Radio. A St. Louis user reports: "Heard Havana clearly with three St. Louis stations broadcasting. My receiver works like a new set. The 'Ferbend' is certainly a wonder!"

is sold with a positive guarantee that it will tune out your powerful local stations. Don't wait. Order now at our risk.

SEND NO MONEY

You need not send a penny. Pay Postman \$6.00 (plus postage). If you prefer, send \$6.00 with order and Wave Trap is mailed *postpaid* ready for panel mounting. Money back guarantee either way. You see you take no risk, so order TODAY.

YOU Can Obtain These Remarkable Results

You can obtain results as satisfactory as this St. Louis user. If you don't, it doesn't cost you a penny for the "Wave Trap"

FERBEND ELECTRIC CO.
25 E. South Water St., Chicago

Ferbend Electric Co.,
25 E. South Water Street, Chicago

Send me a Ferbend Wave Trap. I will pay Postman Special low price plus postage. I understand you guarantee Wave Trap to tune out interfering stations or refund money.

Check here for Ferbend Wave Trap unmounted at \$6.00.

Check here for Ferbend Trap mounted at \$8.50.

Either way the Ferbend comes to you completely guaranteed.

Name

Address

City State

FERBEND Wave Trap

TRADE MARK

PATENT APPLIED FOR

The Original Wave Filter

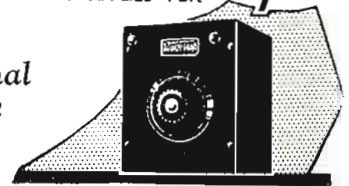

The Ferbend Wave Trap can also be supplied completely mounted ready for instant use on formica panel in mahogany finished cabinet, 6 x 5 x 6, \$8.50. Get full benefit of all the distance your set will give you. Order your Ferbend TODAY.

A J A X

(ST. LOUIS)

Quality Radio Parts

No. 18 Multi Plug for Jacks. List \$2.00.

No. 18-A Connector for Binding Posts. List \$1.75

One to Four Head Sets or Loud Speakers. Always in series giving full efficiency on each.

Patent Pending

AJAX
St. Louis
B.P.B.S.

Binding Posts for One or Two Terminals
List \$7.50 per 100
Write for Discounts on Complete Line

AJAX ELECTRIC SPECIALTY CO.
1926 Chestnut St., St. Louis, Mo.

Reduce Cost of Operating Your Radio Set

Pignolet Radio Voltmeter

is essential to satisfactory operation.

Portable Type

Write for booklet.

PIGNOLET INSTRUMENT CO., INC.
114 Liberty Street New York City



HEATH'S Radiant Condensers

Established as Standard

The Electrical Testing Laboratories of New York, after the most exacting tests possible, declared *Heath Radiant Condensers* the very peak of condenser efficiency—"negligible series resistance." The secret is in the Heath process of stamping and tempering plates so that they are PERMANENTLY FLAT.

UNIQUE VERNIER

Practically a separate vernier condenser. Separate geared adjustment reduces ordinary vernier tuning to infinite fineness.

Write for illustrated booklet and name of the nearest Radiant Dealer

LIST PRICES VERNIER TYPE

- 13 Plate including 2 7/8" dial and knob.....\$5.00
- 25 Plate including 2 7/8" dial and knob.....\$5.50
- 45 Plate including 2 7/8" dial and knob.....\$6.50

Jobbers and Dealers
Write Immediately for Proposition

Heath Radio & Electric Mfg. Co.
206 First Street Newark, N. J.

The GREBE Broadcast Receiver Type CR-12



DISTRIBUTORS
ALL STANDARD APPARATUS in STOCK
Dealers write to
SOUTHERN RADIO CORP. OF TEXAS
Individuals write ALAMO RADIO ELECTRIC CO., Inc., San Antonio, Texas

In England, the law prohibits large antennae, with the result that most antennae are under 40 feet. The result of this is that radio frequency receivers are the common apparatus used, so that the reception of the short wave signals is ideal on the continent.

The great difference in frequency between the short wave broadcasts (under 100 meters) and the common wave-length band, approximately 360 meters, can be noted by comparing the kilocycle frequency of two such waves. East Pittsburgh commonly transmits to England on a wave-length of 94 meters, which is a frequency of 3,200 kilocycles. At the same time KDKA is broadcasting to its regular audience on 326 meters, which is a frequency of 960 kilocycles. This difference in frequency tells much of the story of the short wave broadcasting.

Tests have proved that the high frequency broadcasts go farther with the same power input than the ordinary broadcast waves. It has also been proved that daylight has little effect, if any, on this carrying power. These two qualities of the short waves are what is going to affect the future of broadcasting and bring a new broadcast era in the New Year just started.

RADIO ESSENTIAL TO LIGHTHOUSE

Radio has come to form so vital a part in the work of the U. S. Lighthouse Service that the aid of a radio engineer has just been secured to apply the best means of radio communication and position finding in this coastwise service. John L. Preston, a radio engineer who has been active in the Radio Laboratory of the Bureau of Standards for the past five years, has been transferred to the Lighthouse Service where he will shortly take up his new duties.

Radio has been employed in the Lighthouse Service for several years. It has been handled by the engineers on duty with the co-operation of the Bureau of Standards. With the extension of the work in radio direction finding as well as communication, a specialist has been found necessary.

Of the vessels used in the coastwise safety service, 57 are now equipped for communication by radio. Of this number, 30 are steamers and 27 lightships anchored off the Atlantic and Pacific coasts. Ten radio beacons, or fog signal stations, are now in operation afloat and ashore. These stations, situated at dangerous or important points on the sea or lakes, transmit by automatic apparatus radio signals during fog or thick weather by which vessels provided with radio compasses may take definite bearings to guide them en route or toward harbors. Although invisible and perhaps 100 or more miles distant, these beacons become "visible" by virtue of distinctive radio signals. Five other beacons are now under construction and 32 more are proposed as soon as funds are available for their equipment.

The Lighthouse Service advocates the use of a radio compass aboard ships and not on the shore, as in the Navy Department system. Most of the vessels employed by the service are now equipped with radio compasses, by virtue of which they cannot only locate stations and beacons, but find the bearings of other vessels in need of aid.

ENGINEER MUST INVESTIGATE

Part of Mr. Preston's work will be to determine what type of apparatus now on the market is suitable for the service. He will investigate the four or five types of radio compasses, for example, and recommend a standard type for the ships in the service. All radio phenomena will be investigated, as well as all forms of trans-

USE A C H SHARP TUNER DIALS

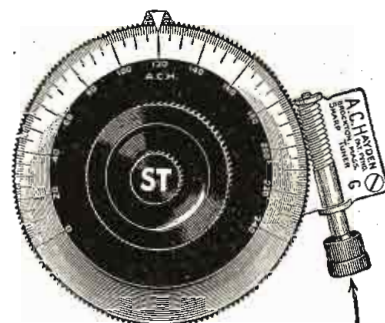

Why the A.C.H. is different
3 in. DIAL 156-10-1
4 in. DIAL 215-10-1

Rough tuning with dial or one thousandth of an inch in either direction.

Price ACH 3" Dial complete.....\$2.50
Price ACH 4" Dial complete..... 5.00
Regular fitting 5/16" hole, 1/4" and 3/16". Bushings, 5c. each extra. 10c for all.

ASK YOURSELF THIS:

Would W. S. Brooker, Alberta, Canada write and say "held Ft. Worth, Texas one hour steady, thanks to the ACH" and order another if he was not satisfied? To retain your good will you must be satisfied or money refunded. Ask for circular No. 6 on RV Loud Talker and Detector set. A wonderful set. All ready for you to put together.

A. C. HAYDEN RADIO & RESEARCH CO
Brockton, Mass., U. S. A.
Mail Orders Sent prepaid in U. S. A.



180° Straight Coupler No. 56

A Real FISCHER Instrument

Wave length 550 meters, 14 soldered leads, straight wound stator on genuine bakelite tubing, bakelite rotor, Fabnstock spring clip connections, white metal mounting base, non-conductive adhesive,—in short, a perfect coupler.

20 Diagrams \$2.75 Free with Each

For sale at your dealer's—or send the \$2.75 directly to the manufacturer and you will be supplied postpaid.

G. H. FISCHER & CO.
123 Liberty Street New York City

RADIO WALL MAP 10c.
Up to date, just off the press. Shows call letters, location, wave length, and kilocycles of all radio broadcasting stations; also American Relay divisions and radio districts. Complete with scale for measuring distances. Size 28x34 inches printed in three colors. Postpaid for a dime.
OZARKA, INC., 863 Washington Blvd., Chicago

OLD COINS, LARGE SPRING SELLING catalogue of coins for sale free. Catalogue quoting prices paid for coins, ten cents. William Hesslein, 101K Tremont Street, Boston, Mass.

mitting and receiving apparatus, suitable for offshore signaling. In a word, the duties of the new engineer will be to correlate the pure and applied science of radio.

Besides the purely official use of radio throughout the service, its application has been found very beneficial as a means of emergency communication and for entertainment. So much interest has developed among lighthouse personnel that a radio club with a periodic publication has been in existence some time. Transmitting and receiving sets, built by the keepers of lights where no standard equipment was installed, in many instances, have brought them into touch with the world, saved lives in emergencies and enabled the keepers to send or receive important information. All of this has added to the efficiency of the service.

RADIO VALUABLE

A case in point took place at Tree Point Light Station, off Alaska, where no regular transmitting station exists; the enterprise of the Second Assistant Keeper, however, in having built a home-made transmitting set, probably saved the life of his wife. When she was suddenly taken ill, he was able to call a neighboring radio station for aid. The tender *Fern*, coming from Ketchikan, Alaska, took his wife back to a hospital for treatment.

An emergency radio-telephone transmitter constructed from spare parts aboard the tender *Mandrono* by Operator George Owens, enabled the engineers to test out a radio-telephone set at the light station they were installing at St. George Reef, California, as soon as it was finished, saving time and expense. This set proved good, up to 12 miles from the new station.

Means of radio communication have enabled the service to replace extinguished lights in record time, warn vessels of dangerous positions, call for aid, in some cases to render aid to ships, and generally expedite the lifesaving work, as well as to furnish entertainment.

GERMAN RADIO MANUFACTURERS BOOSTING BROADCASTING

By means of propaganda, German radio manufacturers are endeavoring to encourage the public to protest against government restrictions on broadcasting. Official restrictions have impeded the popularizing of radio telephony in Germany, it is reported. The commercial development of radio communication in Germany is approaching a competitive character. At the Leipzig Fall Fair a program was broadcast from Berlin on a 2,500-meter wave-length and was successfully picked up in Leipzig, a distance of 93 miles. Receiving sets shown at the exposition were mostly of the four-tube type, using two stages of radio frequency and one of audio, or three stages of audio, when a loud speaker was employed. The one- and two-tube sets exhibited would not pick up the program sent out satisfactorily.

BROADCASTING IN GERMANY

Germany has a well developed, extensive commercial radio system. Nauen (POZ), Koenigswusterhausen and Eilvese are the three largest German stations handling considerable traffic directly with the United States, Central America, Egypt, Argentine, Bulgaria, Danzig, Esthonia, Great Britain, Italy, Netherlands, Russia, Sweden, Spain and Hungary. A large number of small coast and land stations handle weather, crop, market and stock exchange reports, which are generally broadcast from Koenigswusterhausen, which is a few miles from Berlin. Broadcasting is done with the 10-KW. tube transmitter on a 4,000-meter wave.

It is this commercial service, which is only accessible to subscribers, which is the real reason why amateur activities are so hampered in Germany and why the latest laws regulating broadcasting are so severe.

RADAK

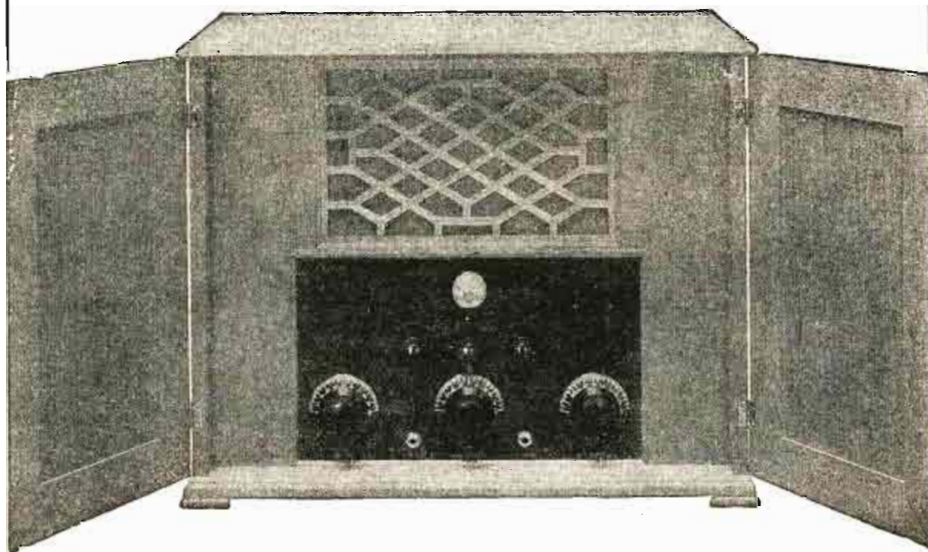

Model C64 Radak brings the voices of a continent to your home. Whether you crave the wonderful Symphony of a great city, the joy of Jazz, the wisdom of the speeches of the great, or the music of the plains, your wish will be gratified with this superlative receiver.

This five tube set is housed in a cabinet which will appeal to the artistic sense of the most critical judge. Three simple control knobs, equipped with remarkable vernier dials, may be mastered in a few hours by any one.

The set is complete, containing as it does a built-in Loud Speaker with wooden phonograph type horn, inside compartments for "B" batteries and "A" batteries if it is desired to use dry cell tubes. It provides two stages of tuned radio frequency amplification, tube detector and two stages of audio-frequency amplification. Licensed under Armstrong Regenerative Patent 1113149.

This set is the ultimate result of seventeen years continuous development by the oldest manufacturer of Radio in America.

Model C64 complete Receiver, without tubes or batteries.....\$225.00

From the R4 at \$25.00 to the C64 five tube radio frequency set at \$225.00 THE BASIS OF RADAK SUPREMACY lies in the fact that Radak sets are an engineered entity not a mere assembly of parts. Complete bulletin of all models sent on request.

Manufactured by

CLAPP-EASTHAM COMPANY

107 MAIN STREET, CAMBRIDGE, MASS.

New York, N. Y.
395 Broadway

Cleveland, Ohio
Caxton Bldg.

San Francisco, Cal.
709 Mission St.

BROWNLIE CRYSTAL

Guaranteed the Best **\$1.00**

"REFLEX SPECIAL" QUICK CONTACT RECTIFIER

Withstands Heavy Plate Voltage

The Acme Apparatus Co. says "prevent distortion and howling by using a BROWNLIE CRYSTAL in REFLEX SETS."

Order From Your Dealer or Direct

ROLAND BROWNLIE & CO.
22 Saunders Street Medford, Mass.

New York's Leading **RADIO EXPORTERS**

Connections wherever Radio is Known

Exclusive Export Distributors for 25 leading American Radio Manufacturers. Wholesalers and Manufacturers abroad write for catalogs.

NATIONAL INDUSTRIES, INC.
154 NASSAU ST., NEW YORK, N. Y., U. S. A.

WANTED—Back numbers of Radio News, Dec., 1921, Jan. and Feb., March and April-May, 1922. Experimenter Publishing Co., 53 Park Place, New York City.

NAZELEY'S

PORTENA

Folding Loop
Patent Pending

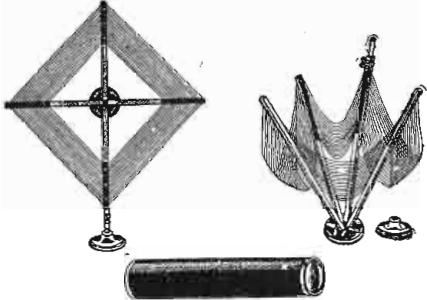

**Folds up like an umbrella—
Works like a charm**

Spread 28 inches

Genuine Bakelite Facings;
85 foot Green covered wire;
Rich mahogany finish;
In an individual morocco covered Tube.

List \$7 each
one dozen to a case

J. NAZELEY CO.
571 HUDSON STREET
NEW YORK CITY

SUPERTRAN

Audio Frequency Transformer
gives
REAL LONG DISTANCE

and preserves the natural tone of Broadcasting, both vocal and instrumental, exactly as sent through the Microphone



Price \$6.00

Can be used with any amplifying tube on the market with excellent results

At your dealer—or direct by mail on receipt of purchase price

FORD MICA CO., Inc.
14 Christopher St. New York

This commercial service is of course limited to large banks and business houses, for which it may be of vital importance to know every fluctuation of the Mark at foreign stock exchanges. They have to pay heavily for the installations.

The sets themselves are installed by the firm licensed for this purpose by the Post Office and are sealed, after the tuning elements have been set to the best position for the 4,000-meter wave. At certain fixed times of the day it is only necessary for the subscriber to lift the phones off a hook and listen to the commercial information.

This is the primary argument of the Government in limiting amateur activities as much as possible. The subscribers to the commercial broadcasting service must be protected at any price—because they pay heavily for the service.

Provisions have also been made to send urgent telegrams from one town to the other by radio making delivery over the phone. This is the second argument of the Government: The secrecy of telegrams would not be guaranteed if everybody were allowed to receive on any wave.

THE AMATEUR RADIO CLUB

In the spring of 1923, the first German amateur club was founded. It united all people interested in radio.

The difficulties were enormous. The former law, on which the Post Office based its authority and the severe actions taken against amateurs, was made at a time when radio was not even thought of by the general public. Old and out of date regulations were used against any activity in the wireless field. Manufacturers and amateurs suffered in the same way through the rigid control, which was practically exercised only to the advantage of three large trust firms.

The radio club spread information as best it could and after some time the Government announced its intention to satisfy the increasing demand for radio entertainment by creating a German broadcasting service exclusively devoted to spreading radio entertainment.

BROADCASTING COMPANY ORGANIZED

A company had been floated by the Post Office and some of the large firms called "Die Deutsche Stunde" (The German Hour). Experiments were started by this company to determine how the broadcasting service should be finally organized.

The results of this research work are the new laws which have now been put into force. It is claimed by the Government that the number of waves still available was hardly sufficient for even a limited broadcasting service and that the narrow band of waves still available made it all the more necessary to watch the amateurs very carefully. It was stated that the enormous traffic between all the surrounding countries, which was continually sweeping across Germany, would make even the limited service very doubtful. This statement of the Government can hardly be reconciled with the fact, however, that all commercial traffic is carried on on longer waves and that the question of interference was hardly worth while considering, as nearly all commercial stations in Europe are broadcasting with undamped waves of great sharpness.

INTRODUCING RADIO BROADCASTING

On October 15, the press was invited to attend a demonstration in the Telegraphic Technical Experimental Laboratory in Berlin. The laws were also published the same day.

The Post Office is going to issue broadcasting permits to private companies which will organize the programs on their own account. The transmitting stations, however, will remain the property of the Post Office.

Such a permit has, till now, only been issued to the "Deutsche Stunde," which has



No. 804
\$15.00
one of 5 styles

"Madera"
Die-cast WOOD

"CLEAR SPEAKERS"
In five high-art styles

This artificial wood, cast in steel dies under great pressure and heat, produces a Horn with wonderful acoustic properties, resembling a century-old violin.

Each Horn is equipped, complete with type C Baldwin Loud Speaker Unit. Works with any tube set, and with the more powerful crystal units.

If your Dealer cannot supply you, write for circulars, giving his name and address.

American Art Mache Co.
343 W. Austin Ave. Chicago

SHERMATRAN



One Stage Operates Loud Speaker with a ShermaTran

Audio Amplifying Transformer Type AS-5
LIST \$6.00

Gives Increased Selectivity as Well

As Regeneration. Maximum Amplification without Distortion. Similar Variable Audio Transformer gives a ratio from 2-1, to 15-1.....\$7.00

Dealers and Jobbers write for discounts

SHERMAN RADIO DISTRIBUTING CORP.
112-114 TRINITY PLACE NEW YORK CITY

TELEGRAPH INSTRUMENTS

DANDY MORSE LEARNER'S OUTFIT

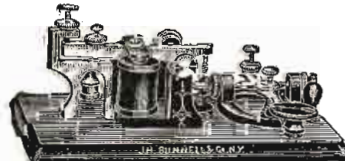

One dry cell is all that is required to operate this instrument.

Made by the best Telegraph Instrument Makers in the World.

Other types carried in stock.

Send stamp for Telegraph Manual No. 43R.

Instrument only...\$5.00 With dry battery...\$5.50

Special Price to Dealers

J. H. BUNNELL & CO. 32 Park Place, N. Y.

BECOME A PROFESSIONAL PHOTOGRAPHER

EARNING \$35 TO \$125 A WEEK

Three to six months' course Motion Picture, Commercial, Portraiture. Practical instruction. Modern equipment.

Ask for Catalog No. 56.

N. Y. INSTITUTE OF PHOTOGRAPHY
NEW YORK CHICAGO BROOKLYN
141 W. 36th St. 630 S. Wabash Ave. 505 State St.

begun broadcasting on a 400-meter wave from the VOX house in Berlin. This station is primarily intended to supply Berlin and the surrounding cities with radio entertainment. Similar stations are to be planned later for other large towns in Germany. Every station shall always serve only its immediate district. The stations will, therefore, necessarily not be very large, as only comparatively small districts will be covered.

Besides this more local broadcasting, the Government station Koenigswusterhauser near Berlin will later operate with more power on a 2,700-meter wave. This station will cover all Germany. The service is primarily intended for schools, hospitals and hotels—and not for amateurs, who will be allowed to receive only up to 700 meters.

These programs on the 2,700-meter wave will also be reproduced in lecture rooms and concert halls from time to time. These rooms will be rented for the evening and portable sets with sufficient amplification installed to reproduce the music with loud speakers. According to the Government's ideas, this will "popularize" radio, whereas, the probable effect will be just the opposite.

THE REGULATIONS FOR THE AMATEUR

The amateur must be a German subject. As an exception, such nations reciprocating in the issuing of licenses to German subjects will also be granted a license. The person applying for a license must be known at the Post Office, or he must prove his identity. If there is any reason for the Post Office to assume that he will misuse his set the license will be refused.

No licenses are issued to persons less than 21 years of age. The license is only issued after payment of the fees and is good for one year. After one year it must be renewed by payment of the same fee again.

The license holder must put up his own antenna with the permission of the property or house owners. If the antenna should disturb the public telephone or telegraph wires, it must be removed or put up in a different place at the expense of the amateur.

The Post Office does not assume any guarantee for broadcasting service, nor for the good quality of the service. The question of patent infringements is not interfered with by the Post Office.

The license may not be transferred. Only stamped sets, tubes and parts may be used. The antenna may have a maximum length of 50 meters. The set may only be used for listening-in to the German broadcasting service. It is prohibited to listen to news sent by other stations. If any such news should be heard, it may not be written down.

The amateur must see also that no one else misuses the set. Officials from the RTV (Reichstelegraphenverwaltung-Federal Telegraph Administration, the controlling body in the Post Office Department) are authorized to enter any rooms in which radio sets and accessories are stationed.

It is prohibited to make any changes in the sets, such as removing seals, hooking up with other parts, adding tuning elements, etc. It is prohibited to maintain a station or antenna after the license has expired. Any actions against the law are followed by cancelling the license.

The fee for the license is 25 Gold Marks. These regulations are rather stiff when compared to amateur regulations in the United States. The American amateur should be thankful that he has such liberties.

THE REGULATIONS FOR THE MANUFACTURER

Following regulations have been compiled by the Post Office and the Union of the German electrical industries and the Union of the Radio Industry. They are the rules applying to the production and sale of radio sets in Germany, with the exception of Bavaria.

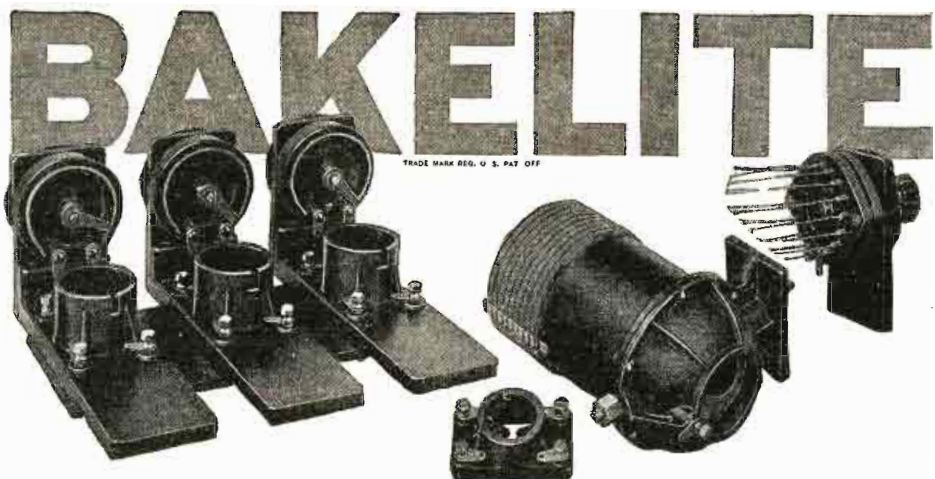

BAKELITE
Condensite
REDMANOL
 are the registered
 Trade Marks for the
 Phenol Resin Products
 manufactured under
 patents owned by
BAKELITE
CORPORATION

Gilfillan and Bakelite

All the molded insulation of these Gilfillan radio parts is 100% Bakelite.

In the words of the manufacturer, BAKELITE "insures positive insulation and absolute permanency." And that's the story in a nutshell.

Nothing else equals Bakelite in the combination of all its desirable properties such as insulation resistance, mechanical strength, permanence of color and indifference to all weather conditions.

The outstanding merit of Bakelite is its durability—its freedom from deterioration.

Every day, radio men are finding new applications for this "Material of a Thousand Uses," for parts made of molded or laminated Bakelite possess properties that successfully meet the most exacting demands of radio work.

Write for a copy of our Radio Booklet B.

Send for Our Radio Map

Enclose 10c. to cover mailing cost and we will send you a large Radio Map which lists the call letters, wave length, and location of every broadcasting station in the world.

BAKELITE CORPORATION

247 Park Avenue, New York, N. Y.
 Chicago Office: 636 West 22d Street

THE MATERIAL OF A THOUSAND USES

SUPER VALUES

NEW COCKADAY FOUR CIRCUIT RECEIVER

ALL PARTS—as specified by MR. COCKADAY in the January "POPULAR RADIO"...List Price \$75.00
 Solid Mahogany Cabinet \$7.50 extra.

Our **\$59.00**
 Price

FREE—Copy of January Issue "Popular Radio" with each order.
GET THE MOST OUT OF YOUR SET

The Maps will tell you—How Far—Who is Sending—Class of Station.
GRAM'S INTERNATIONAL RADIO ATLAS—UNITED STATES, CANADA, WORLD
 A compact 16-page Atlas of necessary maps and data. Large scale 2-page maps of the United States, Canada, The World. Red dots show towns with Radio Stations. Marginal indexes on maps show call numbers by states and towns. A map of North and South America for long range calls. A map of the U. S. on which you can mark stations you pick up. A map showing A. R. R. League districts. North America showing McMillan's Radio in The Arctic.
 Complete list of United States, Canadian and World Broadcasting and Leading Commercial Stations with Call Signal, Wave Length, Location, Ownership.

Price, 50c. Postpaid
OUR POLICY: 20% OFF LIST PRICES, ON ALL STANDARD RADIO APPARATUS
 Send Money Order, Including Postage

Size Open 23x14 1/2 in.
 Write for Our Catalogue D

The Radio Mail Order
 House Known for
 Our Low Prices



3 West 29th St.
 New York City

WANTED—Back numbers of Radio News, Dec., 1921, Jan. and Feb., March and April-May, 1922. Experimenter Publishing Co., 53 Park Place, New York City.

A Chemistry Laboratory for \$7.00

Think of it, fellows! Here is a *real* chemistry outfit with regular chemical apparatus that performs those fascinating, actual chemical experiments. This outfit is not a toy, put up merely to amuse, but a practical laboratory set, with all the chemicals, apparatus and reagents necessary to perform real work and to teach the beginner all the secrets of inorganic chemistry.

DESCRIPTION OF THE OUTFIT

The outfit consists of 44 Chemicals and Reagents all C. P. put up in appropriate wooden boxes, glass bottles, and hermetically closed jars. The acids are put up in glass bottles, with ground-in glass stoppers, and there is a sufficient quantity of chemicals supplied (mostly one to two ounces) to make dozens of experiments with each.

The apparatus furnished are all of the best obtainable make and of standard laboratory size and shape.

The Instruction Book is a real Chemistry Course for the Beginner. Some of the Contents are: Division of Matter; This is a Treatise on Elementary Chemistry and deals with the theory of the Elements, Molecules and Atoms, etc. Chemical Nomenclature; This explains in simple language the derivation of the chemical names of the elements and their compounds. There is a chapter on Laboratory Operations; Glass Working; First Aid; Fire Extinguishers; Experimenters' Aphorisms, etc.

A good part of the book is devoted to Weights and Measures. The Metric System, The English System and the U. S. System are fully explained.

The following tables are furnished: Symbols and Atomic weights of the Elements; Measures of Weights, Volume, Capacity and Length; per cent solutions; Conversion of Measure expressed in parts; poisons and their antidotes; technical and common name of chemical substances; formulas for cleaning various substances, etc., etc.

Among the 100 Experiments are:

How to make chemical tricks; How to make invisible and magic inks; How to test flour; How to test soil; How to make chlorine gas and smoke (German War Gas); How to bleach cloth and flowers. How to produce Oxygen and Hydrogen; How to make chemical colors; How to test Acids and Alkalies and hundreds of interesting hints and formulas.

Complete, \$7.00 Sh. Wght., 10 lbs. (Shipped by Express only)

(We guarantee shipment within 24 hours after your order is received)

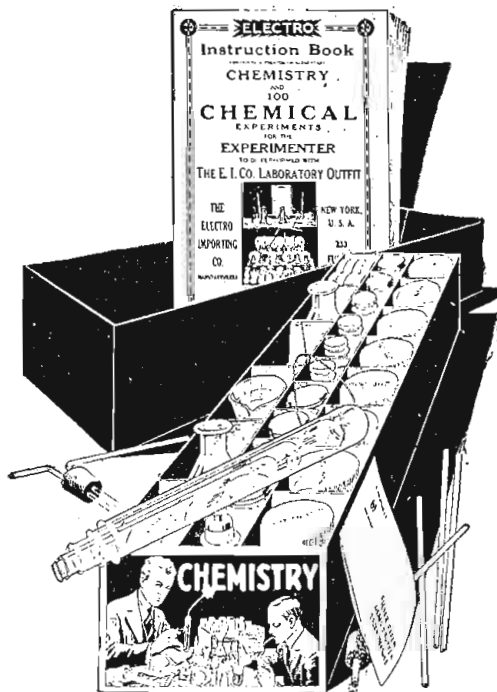

\$7.00

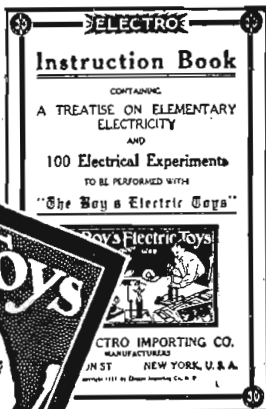

Every Fellow Wants the BOY'S ELECTRIC TOYS

The Boy's Electric Toy contains: Enough material to make and complete over twenty-five different electrical apparatus without any other tools except a screw-driver furnished with the outfit. Student's chromic plunge battery, compass-galvanometer, solenoid, telephone receiver, electric lamp, etc. Enough various parts, wire, etc., are furnished to make the following apparatus:

Electromagnet, electric cannon, magnetic pictures, dancing spiral, electric hammer, galvanometer, voltmeter, hook for telephone receiver, condenser sensitive microphone, short distance wireless telephone, test storage battery, shocking coil, complete telegraph set, electric riving machine, electric buzzer, dancing fishes, singing telephones, mysterious diving man, electric jumping jack, magnetic geometric figures, rheostat, erratic pendulum, electric butterfly, thermo-electric motor, visual telegraph, etc., etc.

With the instruction book we furnish one hundred experiments that can be made with this outfit, nearly all of these being illustrated with superb illustrations. No other materials, goods or supplies are necessary.

The outfit contains 114 separate pieces of material and 24 pieces of finished articles ready to use at once.

The size over all of the outfit is 14 x 9 x 2 3/4. Shipping weight, 8 pounds.

"The Boy's Electric Toys" outfit as described, \$7.00

Immediate shipment.

SEND NO MONEY

We have so much confidence in these sets that we desire to ship either one to you by express C.O.D. with the privilege of inspection. In other words, we ship on approval. It does not cost you one cent to take a good look at whichever outfit you want, and see if it comes up to your expectations. If it does, pay the express man \$7.00, plus express charges. If not, you need not accept it, and we will pay the return charges as well.

ELECTRO IMPORTING CO., 233 Fulton St., N. Y. City

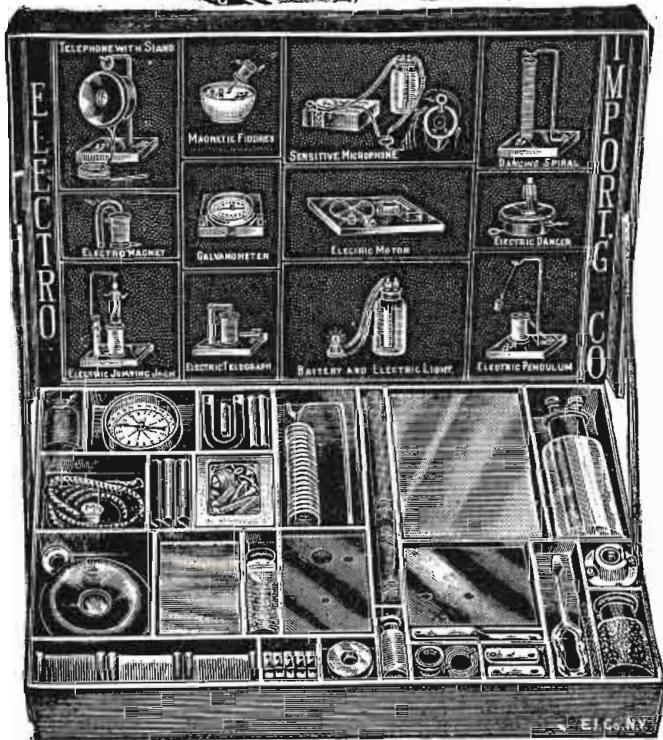

ELECTRO IMPORTING CO., 233 Fulton St., New York. Please send me by express THE CHEMICAL LABORATORY. If I don't like it I need not accept it. If I want it I only pay \$7.00 plus the few cents express charge.

ELECTRO IMPORTING CO., 233 Fulton St., New York. Please send me by express THE BOY'S ELECTRIC TOYS. If I don't like it I need not accept it. If I want it I only pay \$7.00 plus the few cents express charge.

The firm wishing to participate in the sale of radio sets for German broadcasting must pay 2,500 Gold Marks to the RTV (Federal Telegraph Administration). One thousand Marks are payable, cash down, the balance later.

Only complete sets may be sold, and spare parts, which are liable to wear. Certain technical requirements must be met by the sets. A sample of every line must, therefore, be deposited with the RTV.

Every complete set must be examined before leaving the factory to prove that it is exactly the same as the sample deposited. It is then examined by officials of the RTV, stamped and sealed. All spare parts must also be stamped by the RTV. Every set must bear a certain number of marks common to all sets of the same type. No changes, not even the slightest ones, are permitted without the authorization of the RTV. Every set must also receive a serial number. The RTV is not obliged to test or examine any sets within a given time. No claims for delays in testing or stamping will be considered.

A fee is taken for the stamping of every set according to the following schedule:

	Gold Marks
Crystal Detector sets	2.50
Tube sets without amplification.....	6.00
Tube sets with amplification.....	7.00
Tubes	0.50
For every added stage of amplification	1.00

Payment must be made within three days. If a firm is late, the stamping of further sets will be suspended.

The RTV takes no obligation for the quality of the sets. The RTV refuses any participation in the patent question.

Sets may only be sold to amateurs showing a license. The license must be indelibly stamped with the same number as the set. Against a license, where a number is already stamped, only spare parts liable to wear may be sold.

Dealers may only be supplied with sets if they can show the RTV license authorizing them to retail sets.

A manufacturing license is good for five years; it is not transferrable and may be canceled if the rules are infringed or for any other reason which may seem sufficient to the RTV.

The sets may have wave ranges of from 200 to 500 meters with the selectivity of an ordinary primary tuned receiver. The wave range may be raised to 700 meters if the set has the selectivity of an ordinary secondary tuned receiving set from 500 to 700 meters. The sets may not oscillate under any circumstances, even with increased voltages on filament and plate. They must be easily sealed and proof against the addition of further tuning elements.

The regulations for dealers are the same as for manufacturers, i. e., they may not sell sets without licenses and may not sell single parts. The fee for retailers' licenses is 10 Gold Marks.

All the controlling, license-issuing, examining and stamping of parts and sets must require such a cumbersome controlling organization that any real profits which might be expected from the fees and taxes will be completely swallowed. The whole controlling and stamping does not guarantee that the set will work properly, or that there will be a program broadcast for the benefit of its owner.

The fees are fairly high and, at present, beyond the means of the average amateur. Barring all persons under 21 from participating is another great mistake, for among younger students, school boys, etc., the most ardent amateurs are to be found.

The high fees prevent a quick popularization of radio in Germany. In the long run the enterprise of private capital will have to be called upon.

On the other hand, the so-called "guarded secrecy" of the telegraph means nothing.



RADIO FREQUENCY TRANSFORMERS

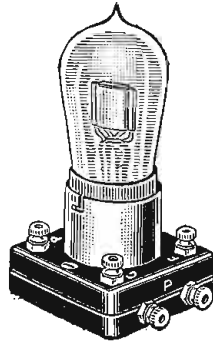

R. U. I. Radio Frequency Unit \$3.50

Radio Frequency Transformers to work and give good results must reduce capacity effect to the minimum.

United R. U. I. is a combined radio frequency transformer and tube socket. The Transformer is mounted in the socket. In this way the leads are extremely short and results are beyond expectations.

R. I. can be mounted in a socket. Here again long leads can be eliminated and better results obtained.

If you insist upon "UNITED" radio parts, we will gladly share the responsibility of your investment.

Our catalog of complete radio parts on request.

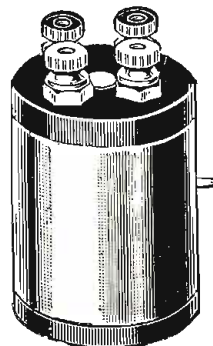

R. I. Radio Frequency Transformer \$2.50

UNITED MFG. & DIST. CO.

9701 Cottage Grove Avenue, Chicago

New York Office: 145 W. 45th St., New York, N. Y.

San Francisco Office: 709 Mission St., San Francisco, Calif.

Quality Radio Products

WE REPAIR

SAME AS NEW

W. D. 11 or W. D. 12.....	\$3.25
U. V. 200 or C. 300.....	2.75
U. V. 201 or C. 301.....	3.00
U. V. 201a or C. 301a.....	3.25
U. V. 199 or C. 299.....	3.25

Fill your order by return mail, and give you a

WRITTEN GUARANTEE

Mail us a burnt-out tube—Order any type repaired tube. Rebuilt Tubes for Sale.

25c EXTRA

Orders Sent Parcel Post C.O.D.

Radio Tube Laboratories
3570 Olive St., St. Louis, Mo.



Simplified Reinartz

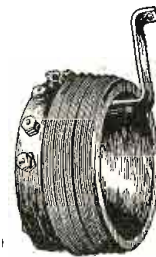

Improved circuit using pile banked inductance eliminates 4 controls. No switches, taps or soldering. EASIEST and CHEAPEST to build. Greater distance and volume by removing switch tap losses. Pile banked windings give extra sharp tuning and low distributed capacity. One control tunes 200 to 600 meters. Complete instructions, hookup, panel layout, etc. 25c. stamps accepted. TYPE "B" INDUCTANCE Vesco banked, with all circuit instructions, \$2.50 postpaid.

Vesco Radio Shop

BX RN 117

OAKLAND, CALIF.

Insure your copy reaching you each month. Subscribe to Radio News—\$2.50 a year. Experimenter Publishing Co., 53 Park Place, N. Y. C.

Salisbury Radio Table

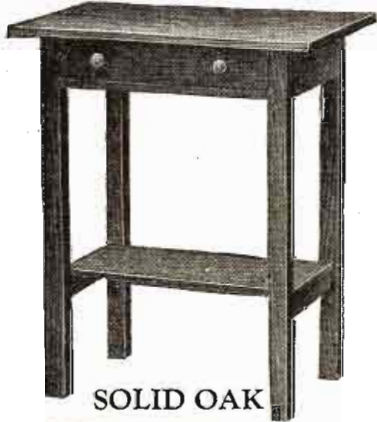

SOLID OAK

\$7

A REMARKABLY substantial, handsomely finished piece of furniture, particularly fashioned for holding Radio Sets. Choice of finish: Golden or Fumed Oak or Imitation Mahogany. The top is 18x24. There is one long drawer, and underneath is a

FROM THE FACTORY

Handy shelf for batteries

JUST check the finish you want in the Coupon below. Do not send money. Pay the expressman \$7, plus the small express charge, on delivery, and thus have the advantage of buying direct from the makers. Absolute satisfaction guaranteed. Salisbury Bros. Furniture Co. (The Randolph "Community" Workers), established 1863, Randolph, Vt.

SEND NO MONEY—Just mail this

SALISBURY BROS. FURNITURE CO.,
Dept. R01, Randolph, Vermont.
Send the Salisbury Solid Oak "Community" Radio Table, finished in (check) . . . Golden Oak, (check) . . . Fumed Oak, (check) . . . Imitation Mahogany. I will pay the expressman \$7 and expressage on delivery.
Name
Address
City

The New **METALECTRIC**
SOLDERING IRON
AN ALL-METAL QUALITY INSTRUMENT. OPERATES ON ANY CURRENT WITH THE SIMPLICITY OF A LEAD PENCIL. **\$5.50**
Ample heat capacity "Worth It!"
Cool Handle
Inter-changeable Tips.

—Accepted—
as the logical
Solution to
Radio Soldering Problems
"Guaranteed"
of your dealer or write
POST ELECTRIC CO. 34 E. 42nd St., New York

The crook can get a complete set with high amplification working on a loop and never be found out in the secrecy of his house. Anybody with knowledge of electricity will be able to alter the wave-length of even the best sealed receiving unit.

So the crook who wants to exploit commercial information without paying for it will be doing it even after the new law is in force. If the Government is fearful that its messages might not be secret enough, it should use high speed telegraphy and coding machines.

There are still enough ways and means of building sets of single parts. If the Government would issue licenses also for home built sets and allow experimenting, the returns to be expected would have been considerably greater.

However, under the present situation, every amateur with a non-licensed set is careful enough not to apply for a license and get himself on record.

It seems as if the Government is also realizing this situation, for a law is in preparation giving a final day of grace for the owners of non-licensed receiving sets to get licenses.

BEST BROADCASTERS WILL SURVIVE

The deletion of broadcast stations during the past six months has been quite rapid; the total reached 149, whereas only 107 opened, showing a loss of 42 stations. During the past month 33 stations fell by the wayside, so to speak, and only 15 new ones entered the field.

Apparently, as in many lines of endeavor, it is to be a "survival-of-the-fittest" race. On December 1 there were 549 broadcast stations still serving the public; 47 were the more powerful Class B stations; 281 were in Class A; 219 in Class C and two were listed as Class D, or development stations. Officials hope that the 219 Class C stations, all of which are operating on the single wave-length of 360 meters, will qualify as Class B stations, transfer to Class A, or quit, thus eliminating considerable existing interference chiefly among themselves. The result would be a group of about 100 big stations with distinctive wave-lengths, and approximately 350 smaller stations with exclusive district waves.

The broadcasting service in this country, which is of course privately owned and operated, leads the world in number of stations and is still holding public interest, the Department of Commerce believes. Moreover, its permanency is assured. Its real value, however, has not yet been fully realized, and will not be until there has been a wider distribution of receiving sets suitable for the reception of varied programs from several stations, permitting the listener to select at will the class of service of greatest interest and value.

The recent changes in wave-lengths grouped weaker stations between 220 and 280 meters and gave the more powerful stations the wave-lengths between 280 and 546 meters. In this class the longer waves usually are assigned to the more popular stations. It is only natural that the more powerful stations are the most popular since listeners-in naturally tune in on accustomed channels where they get the big stations with no interference. These stations all broadcast good programs and have a transmitting power which cannot be approached by Class A or C stations. When fans try for smaller stations on the lower wave-lengths, unless they have very selective receivers, they immediately get interference from the larger stations and the volume is appreciably less.

TALENT TO LARGER STATIONS

The weaker stations are "out of luck," so to speak, in another line; they find that the larger stations come into their territory if not their actual stations and get

World's Greatest BATTERY BARGAIN

FREE Written 2-Year Guarantee Your Proof of Performance
SAVE 50%
and Get a "B" Battery and Hydrometer Free

Thousands of Radio News readers will do just that through this amazing World Battery offer. They will buy the famous 2-year guaranteed World battery at the lowest price ever quoted and with it they will get free a hydrometer and a "B" battery.

COMPARE THESE PRICES

Special 2 Volt Storage Battery	\$5.00	For U.V.199 Tubes Same features as 2 Volt Tubes. Will run 200 hours on one charge. Rechargeable.	6 Volt, 60 Amps. \$8.50
Special 4 Volt Storage Battery	\$8.00	6 Volt, 100 Amps. 12.50	6 Volt, 120 Amps. 14.50
		6 Volt, 140 Amps. 16.00	

SEND NO MONEY
You need not send a penny. Just clip this ad, and mail with your name and address. The battery you specify will be shipped to you the day your order is received. When the battery arrives, inspect it—read our 2-year guarantee before you pay one penny. Convince yourself you are protected from every angle—that the World Battery saves you 50 per cent. Get the "B" Battery and hydrometer FREE. Clip the ad, and send your order today.

World Battery Co.
1219 So. Wabash Ave.
Dept. 10 R.N.
CHICAGO, ILL.
5 per cent discount for cash in full with order.

"B" Battery and Hydrometer

THE FRANSEN TUNER AND VARIOCOUPLER

Patent applied for
AT LAST THE PERFECT TUNER
for Broadcast Reception.

The most efficient and selective tuner made. For single circuit with tickler or variocoupler with loose coupled primary and secondary circuits.
Perfect and continuous variation of the inductance of the antenna circuit without SWITCHTAPS and without a VARIABLE CONDENSER in the antenna circuit.
Complete for panel mounting, postpaid, \$7.50.
RADIO RESEARCH LABORATORIES
ATASCADERO, CALIFORNIA

LISTEN-IN RADIO RECORD
REGISTERED U.S. PAT. OFF.
THE ONLY "LISTEN-IN" BOOK

KEEP A RECORD OF STATIONS HEARD, DIAL SETTINGS, RECEIVING CONDITIONS, ETC.

Flexible cloth binding. Gold stamping. 160 pages. Printed on Bond Paper. Contains introductory article "How to Receive Radio Broadcast," by Lloyd C. Greene, Radio editor Boston Globe. Many Radio Hints and Tips. Complete list of Broadcasting Stations and double page map of United States.

PRICE 75 cents
At Your Dealers or Sent Prepaid on Receipt of Price

LISTEN-IN PUBLISHING CO.
119 MAIN ST.
CAMBRIDGE, MASS.

the best talent, together with their following. The cost of maintenance is tremendous, besides the initial cost averaging about \$125,000. Few small operating companies can keep up the pace. The big electric manufacturing companies are exempt, of course, as well as some other interests which got off with an early start, expecting no return. These include some big department stores, large municipal daily papers, some national organizations and manufacturing companies, such as comprise the present 47 Class B stations. For the small concerns, the maintenance for good operation is a steady drain on their treasury which they cannot meet.

Students of the situation today declare there is no need for smaller broadcasters in cities where there are one or two large stations in constant service. The craze to broadcast, which was at first a popular fad, is now established on a positive operating basis, serving a practical need in almost every big community.

While some minor stations may continue in smaller districts where farmers are served, others, such as more prosperous newspapers, may function despite the cost, just for the good will, and some churches may operate to extend their scope.

WIRE BROADCASTING A REALITY

A new era in radio broadcasting, eliminating much apparatus, aerials and interference, is imminent, according to Secretary of Commerce Hoover and General Geo. O. Squier, Chief Signal Officer of the Army. Following an announcement by Secretary Hoover that electric lighting companies would soon be broadcasting news and entertainment over their wires for their subscribers, General Squier announced in an interview, that this was already being done on Staten Island, N. Y.

The new system, which is the practical application of General Squier's wired-wireless, is simply allowing the modulated carrier wave to travel over wire instead of through the air. The wires of the company, reaching to practically every home in the community, make it possible for each subscriber to plug in a simple radio receiving set and receive dependable news and entertainment in any room in the house without interference. A very nominal charge for the service, about half the charge for a telephone, will be made by the companies, it is understood. It is held that legally the companies can sue "wire tappers" for cutting in on the circuits.

Secretary Hoover sees in the innovation considerable relief in the radio interference now markedly present in the ether, while subscribers would be relieved from all interference, erecting aerials, establishing grounds, purchasing expensive sets, batteries and vacuum tubes. He further stated that this method would establish radio as a public service.

GENERAL SQUIER VISITS PLANT

General Squier recently returned to Washington from inspecting the first system to be established. It is operated on Staten Island by Wired Radio, Inc. General Squire said the operation was near perfect.

The need for radio operators, tuning, and much apparatus is eliminated. As there is no radiation, there is no interference. "Literally," he explained, "It is a one-way telephone service. But it does not do away with regular radio broadcasting in the ether, nor preclude those who desire to do so from purchasing receiving sets and tuning in on distant stations."

The model system in Staten Island has three phases to its programs. First, through the use of a regular radio receiving set, located in the plant, important broadcasts by pure radio can be picked up from the ether, automatically amplified and re-transmitted over the lighting circuits. Second, through arrangements made with a large news serv-

How turning this knob gets more stations

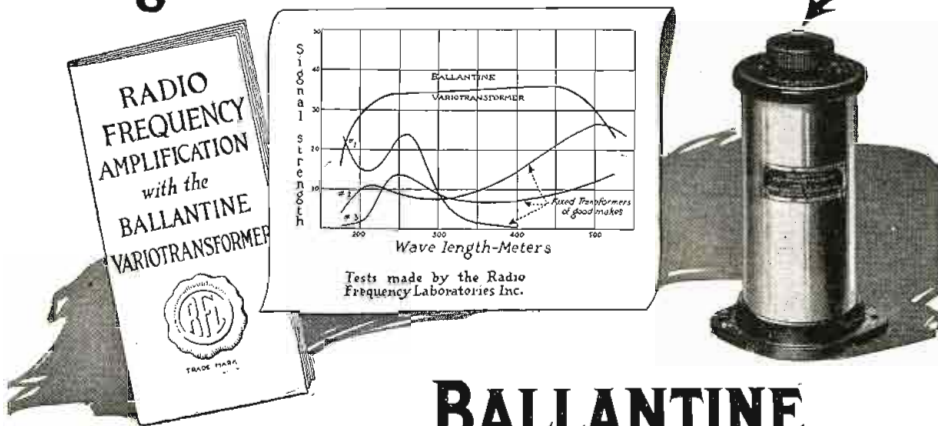

BALLANTINE VARIOTRANSFORMER

HERE'S evidence that the tuning dial of a Ballantine Variable R. F. Transformer gives superior results. The light line curves (plotted from careful experiment) show you that fixed transformers do not give satisfactory amplification for many of the important stations. Why? Because the *fixed* windings are out of tune.

With Ballantine instruments you can accurately tune everything from 200 to 600 meters—by merely turning the knob. This adjusts the windings to the wave length of the station wanted.

Get Stations You've Never Had

Perfect shielding and pig-tail connections assure clear tones. Then, by keeping amplification uniformly high throughout the broadcast range, you get all there is within reach of your set.

Send for This Booklet

"Radio Frequency Amplification with the Ballantine Variotransformer," 25 pages of practical interest. Mailed to Radio experimenters upon request.

Here's an assembly ready to hook into your present set—tube or crystal.

Complete radio frequency amplifier unit with socket and rheostat \$15.00

Transformer only \$9.60

At dealers or postpaid



BOONTON RUBBER MFG. CO.
Pioneers in Bakelite Moulding

624 Fanny Road, Boonton, N. J.

THE RADIO RECORD BOOK YOU NEED "WHERE I GO BY RADIO"

Handy Record Book. Every one interested in Radio will appreciate receiving as a Valentine, Easter or Birthday Gift.

Every line easily made, complete record of when, where, how and what you heard. Now being used by amateurs and professionals everywhere. Original, handy, useful. Avoid guessing about "tuning in." Records kept mean easy "listening in" again.

Popular Edition, each copy contains space for 300 complete records or stations "picked up," 2 copies \$1.00.

Holiday Edition, more attractive, space for 700 records only \$1.00.

Accurate list of Broadcasting Stations in United States on November 15, 1923. Also Canadian, Cuban, Hawaiian Stations and Call Letters of All Nations.

Send Your Order Today

Radio Dept. R, PROGRESS PRESS

Union, South Carolina, U.S.A.

RADIO SUPPLIES AT CUT PRICES

Brandes Headsets	\$4.95
Baldwin Headsets	8.75
Acme Audio or Radio Transformers	3.95
Jefferson Star Transformers	2.95
Federal Audio Transformers No. 65	5.75
22 1/2 Volt Variabio B Battery (Small)	.90
22 1/2 Volt Variable B Battery (Medium)	1.25
22 1/2 Volt Variable B Battery (Large)	1.75
45 Volt Variable B Battery (Medium)	2.25
45 Volt Variable B Battery (Large)	3.50
22 1/2 Volt Eveready B Battery No. 764	1.75
22 1/2 Volt Eveready B Battery No. 766	1.95
22 1/2 Volt Eveready B Battery No. 767	3.95
43 Plate Variabio Condensers Bakelite Ends	1.95
23 Plate Variable Condensers Bakelite Ends	1.50
3 Plate Vernier Condensers	.65
43 Plate Vernier Cond. with Knob & Dial	3.75
23 Plate Vernier Cond. with Knob & Dial	3.25

ALL ORDERS MUST INCLUDE POSTAGE

KENSINGTON RADIO SUPPLY CO.

4417 18th Avenue Brooklyn, N. Y.

Insure your copy reaching you each month. Subscribe to Radio News—\$2.50 a year. Experimenter Publishing Co., 53 Park Place, N. Y. C.

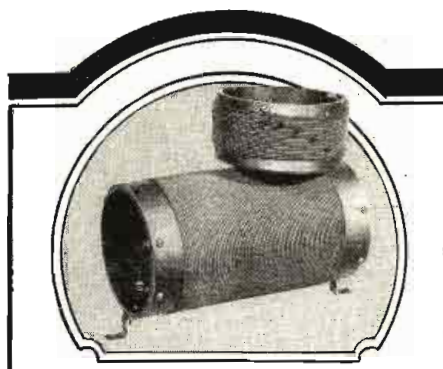

Authorized Cockaday Coil

Scientifically built of 1/8" hard rubber wound with double silk covered non-shellaced wire. Does not absorb moisture like ordinary coils. Gives low dielectric losses—low distributed capacity—low leakage losses—low conductor resistance. You get maximum selectivity, greater volume, sharper tuning, maximum sensitivity. Copper terminals, no loose ends. Built in strict accordance with specifications by L. M. Cockaday. Over twice as efficient as ordinary coils. Guaranteed. At your dealers, otherwise shipped to you postpaid.

Price \$5.00

Approved by

L. M. Cockaday

PRECISION COIL CO., Inc.

209-D Center Street

New York

ice, news bulletins are received over a leased wire and broadcast by voice between other numbers. Third, a local program of music or other entertainment is sent out from a studio in the plant, with any special features desired by the community. The news feature creates the first "radio news paper" direct to subscribers.

Radio advertising, voluntarily banned in the ether, is made possible and practical in wired-radio broadcasting, the General asserts. The operating company can assign waves for special use, general radio regulations not affecting wired-wireless systems. One wave-length could carry news, another advertising, a third information for the women and a fourth entertainment, the subscriber selecting the desired wave by turning a selector switch.

The simplest, crystal detector and phone will serve for plugging in on the light circuit, he says, but a loud speaker could be easily employed.

Several other electric companies are expected to start broadcasting in the near future under franchises from the North American Co., which, through Wired Radio, Inc., controls the patents.

BROADCASTERS AND SHIPPING INTERESTS TO CONFER ON WAVE-LENGTHS

A conference of commercial radio station owners and ship operating companies in New York has been called by the direction of the Government for January 11 to discuss ways and means of eliminating or minimizing radio interference from ships. The Supervisor of the Second Radio District has sent out the call at the suggestion of the Bureau of Navigation and under the urge of broadcasters and fans in and around New York, who claim the ships spoil the local programs.

The interference complained of is chiefly on the 450-meter wave between 7 and 11 P. M., when broadcasting is at its height, which is also the time when commercial ships make position reports, usually on 300 or 450 meters.

Officials of the Department of Commerce handling radio matters are very anxious to decrease the ship interference around New York and other ports, and are taking every means possible to aid. It must be realized, however, that when a wave-length or a channel is taken away from the ships, another must be provided, and that it is a difficult and serious matter to shift approximately 2,700 American ships to a new wave-length.

Efforts will be made at the forthcoming conference in New York to find out what can be done, but the department will probably present the suggestion that ships stay off the 300 and 450-meter waves between 7 and 11 P. M., recommending other channels for ship communication. The new channels suggested will probably include waves between the 600 and 800 meters used by the Government for marine and aircraft work, and in which there is one commercial ship channel on 706 meters. Another wave between 800 and 1,000 meters, now assigned for Marine radiophone communication, might be reallocated, as this medium is little used as yet, it was pointed out. The ships will, of course, keep the 600-meter calling and distress call wave-lengths, but it is hoped a new allocation beneficial to both broadcasters and shipping can be agreed upon.

SS. KROONLAND BREAKS RADIO RECORD

Rumors reached the offices of the Panama Pacific Steamship Co. recently, that their steamer *Kroonland*, bound from New York to Los Angeles and San Francisco, via the Panama Canal, was disabled. The vessel was then somewhere in the Pacific Ocean off the West Coast of Mexico. The usual procedure in such cases is to forward a

Guaranteed Head-Sets

"RED-HEADS" are guaranteed radiophones. You run no risk when you buy them. Money back if, after 7 days' trial, you're not satisfied that they're the best receivers on the market at the price. Why not act right now and get a pair? It'll mean getting the maximum from broadcasting from the day you put them into use.



RED-HEAD RADIO RECEIVERS

NOW READY

The new 1924 Model F Per Pair \$6.50 Complete | The new "Red-Head" Jr. Per Pair \$5.00 Complete

"Red-Heads" sent prepaid on receipt of price if you are unable to get them at your dealer's.

The NEWMAN-STERN COMPANY Dept. R.N. Newman-Stern Bldg. Cleveland



LATTICE COIL Specialties

Plain Coils Variocouplers Tapped Coils R.F. Transformers Variometers Micro-Mike Condensers

Make that New Circuit AUTO—MILO—or any other PLEX TALK right Out Loud by

Using Quality Apparatus as supplied under the ESTRU Trade Mark

Uni-Flex Parts Flexible Units Inter-changeable for all Kinds of Circuits.

Write for Literature



Dept. R-11 2905 W. MADISON ST.

SALESMEN

Largest radio publishing organization in the world, wants salesmen, either whole or side line, to sell an assortment of 20 books to the trade.

Liberal commission to hustlers. BOX 233, RADIO NEWS New York City.

PATENTS

Trade-Marks, Copyrights and Patent Litigation Write for advice and instructions how to proceed, costs, etc. Hand Book with illustrations of 100 Mechanical Movements sent free on request.

ALBERT E. DIETERICH Patent Lawyer and Solicitor

Successor to Fred G. Dieterich & Co. 690A O'rary Bldg., Washington, D. C.

Delivered to you Free

for 30 days trial on approval. Your choice of 44 Styles, colors and sizes of the famous Ranger Bicycles. Express prepaid. Low Factory-to-Rider Prices.

12 Months to Pay if desired. Many boys and girls easily save the small monthly payments.

Tires, wheels, lamps, and equipment at half usual prices. Write for remarkable factory prices and marvelous offers.

Mead Cycle Company Dept. F-116 Chicago



Write us today for free catalog

AND NOW!! Radio Agents Wanted

HERE IS YOUR CHANCE!

Become our "Owner Agent" in your community for

BLUE SEAL "GUARANTEED" RADIO

"Speaks for Itself"

Complete outfits. Wonderful Long-Distance reception over power Loud Speaker. Make your set pay for itself.

Save Money—Make Money

POSSIBILITIES UNLIMITED

Season now ripe. Time payment plan in Chicago. Work either part or full time.

A Real Radio Outfit—the one that's a year in advance

By our direct from manufacturer to consumer plan we are able to "save money for consumer" as well as pay "big commissions."

Men with executive ability and some money outside Chicago should write for territory and District Manager proposition.

Get on a live one by selling the latest craze of the age.

Write

BLUE SEAL MFG. CO.

1406-8 South Michigan Avenue Chicago

radiogram to the vessel via the nearest coast radio station for a speedy confirmation. On account of the present disturbances in the Mexican Republic, this was impossible. The messages were given to the Independent Wireless Telegraph Company's high power radio station at East Hampton, Long Island, and were forwarded direct to the vessel. The return reply was received within one hour, indicating that the *Kroonland* was 1,890 miles south of San Pedro, California, and that the rumors were unfounded. The service was much quicker than if the radiograms had been passed via the nearest coastal station.

Chief Operator M. J. Schaefer, of the *Kroonland*, and R. Venegas, of the station, WSA, deserve great credit for their remarkable handling of the transmission and reception, which was done, in this instance, without a break. Both operators received a letter of commendation.

This is considered a record for receiving an answer over a distance of 3,000 miles.

This vessel is of 22,500 tons displacement and has been fitted recently for special first-class service between New York, Havana, Panama Canal, Los Angeles and San Francisco. Special receiving apparatus has been installed on this vessel with a power speech amplifier so that the passengers may enjoy the radio broadcasts from the important cities in the United States during the entire voyage.

AIR IN IRELAND TO BE FREE

Early in 1924 it is expected that radio broadcasting will start in the Irish Free State. A £30,000 broadcasting company and the Radio Association of Ireland have recently been organized in Dublin, according to Consul Hathaway, who also reports that the government prohibition against the importation and use of foreign built radio apparatus will probably be moved.

Arrangements between the Irish postal authorities and the broadcasters were said to be nearing completion a month ago, awaiting the approval of the Dail. The broadcasting company composed of four co-operating groups will handle sales independently. Part of the expense of establishing a broadcast station will be paid for out of sales privileges, license fees and import taxes. Popular interest, first established last summer through the broadcasting of charitable fetes in Dublin, has been stimulated by the organization of the association devoted to developing the study of radio for amateurs. British radio manufacturers are said to be showing considerable interest in the radio development in the Free States, where German exporters are also active. American exporters can soon enter the field, it is believed, but should offer the cheaper grades of goods at first.

GOVERNMENT PLANS RADIO REGULATION

Radio, which for the first time carried to the continent at large, and perhaps Europe and Central America, the President's message, also carried his recommendations for remedial legislation on radio. Echoing Secretary Hoover's request that the laws affecting radio administration enacted in 1912 be revised, the President personally told Congress that new legislation regulating radio interference is needed. At present, Secretary Hoover is operating under a sort of "Gentlemen's Agreement" between commercial, governmental, private and amateur interests, reached last spring during the Second National Radio Conference.

Secretary Hoover stated recently that Representative White, who fathered the bill which bore his name last session, will introduce a simplified radio bill this session.

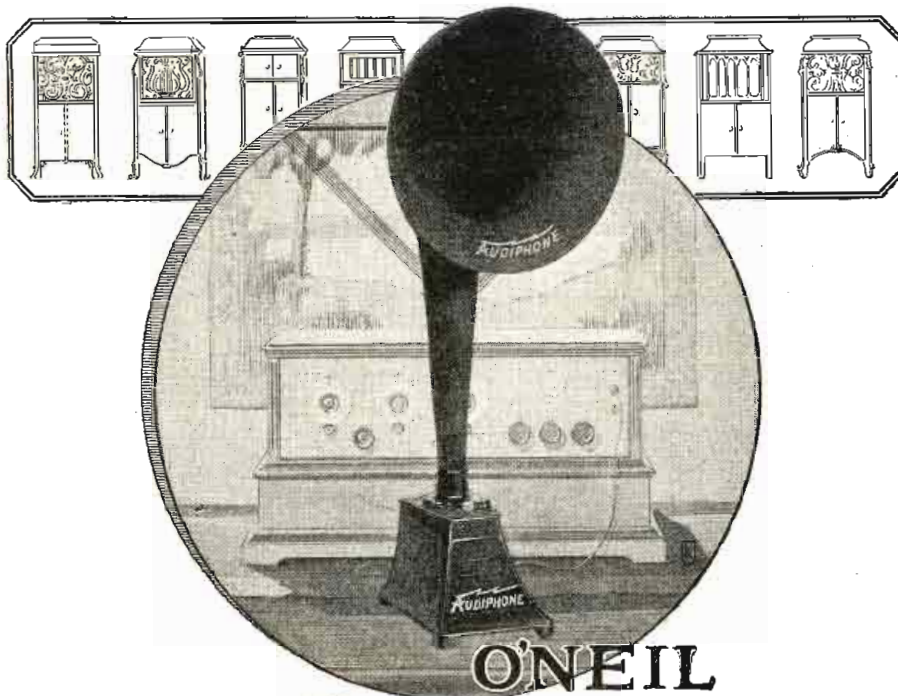

**O'NEIL
AUDIPHONE**

No extra batteries needed. Complete, with connecting cord.

\$25

\$30

Model in antique bronze
14 Inch Horn either model \$5 additional

THE absolutely natural tones of the phonograph now attained in radio reproduction through the O'NEIL AUDIPHONE. Phonograph craftsmen have made a perfect musical instrument and radio acoustic engineers have made it a flawless radio reproducer. Volume without blast. Exterior diaphragm adjustment. The "laminated voice core" makes the AUDIPHONE marvelously versatile.

Absolute satisfaction or your money promptly refunded. At your dealers or direct C.O.D., if you mention your dealer's name.

WRITE FOR LITERATURE.

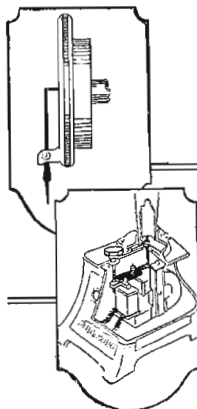

Note the similarity of construction between the phonograph reproducer (illustrated in the upper panel) and the reproducer of the O'Neil AUDIPHONE (below): both have a mica diaphragm set in a sound-box chamber and actuated by an elbow stylus bar—the principle of sound production is the same, resulting in perfect reproduction.

O'Neil Mfg. Co.

719 Palisade Ave., West New York, New Jersey

MAKE YOUR OWN PANELS

RADOPAINT withstands 4000 volts.
Resists Acid and all Climatic Conditions.
Makes a perfect panel from any kind of wood.

One quarter pint can post paid U.S.A. 50c
INSULATION PRODUCTS CO.
426 Plymouth Court CHICAGO, ILL.

CATALOG E19-0-10
PAGES FREE

EVERYTHING IN RADIO
One of the largest complete stocks in the world. 40 diagrams of latest Hookups.
DEALERS ALL OVER THE U.S.
Making big profits handling our supplies. 24-hour service. Goods shipped same day order received.



WHOLESALE RADIO DISTRIBUTORS
Dept. A. 6 W. 14th St. Kansas City, Mo.

Get a Handy Binder for your RADIO NEWS. Holds and preserves six issues, each of which can be inserted or removed at will. Price 65c. Experimenter Pub. Co., Inc., Book Dept., 53 Park Place, New York.



Cover the Continent—

If you're a radio enthusiast you're interested in long distance reception. And, no matter how loud and clear the nearby stations come in, the big thrill is realized only when you hear a station thousands of miles away.

Stromberg-Carlson

RADIO HEAD SETS

are built especially for long distance reception. They are equipped with Powerful Magnets which are necessary for sensitivity, sound volume and true tonal quality. Stromberg-Carlson Head Sets also have Layer Wound and Layer Insulated Coils,—a construction which will stand up under the highest plate voltages that a radio tube will stand.

Send for our booklet RN which will tell you more about these Head Sets.

Stromberg-Carlson Tel. Mfg. Co.
1060 University Avenue
Rochester, N. Y.



Have You Found a Really Good



Radio Frequency Set?

—a long range set that is easy to tune—only two controls—that brings in big volume yet can be sold at a popular price of \$70.00 for a four tube set in a mahogany cabinet.

To keep posted on what's new you owe it to yourself to write for descriptive literature on the Globe No. 320.

Manufactured by

GLOBE ELECTRIC CO.
MILWAUKEE

GLOBE
RADIO

The old bill, it is understood, has been reduced to lowest terms so as to permit proper interpretation with the development of the art and to give the Secretary of Commerce and his advisory committee liberal and more or less elastic authority over the control of national radio problems. A recent conference between representatives of the Government departments was successful in eliminating such points of disagreement as existed heretofore.

According to Secretary Hoover, the radio interference situation today is far better than it was at the time the original White Bill passed the House last year, due chiefly to the voluntary co-operation of the several interests. There is now little interference between the existing broadcast stations.

In general, the President also indorsed the enactment into law of the approved plan of the Joint Committee on the reorganization of the Government Departments, which places radio under the direction of an Assistant Secretary of Communications, who would have charge of telephones and telegraphs. The Post Office and the radio section of the Bureau of Navigation of the Department of Commerce would become a part of the Department of Communications, according to the present plan of the Joint Committee.

Before the reorganization is effected, however, all phases of the radio question will probably have been threshed out, and its administration may or may not be taken away from the Department of Commerce.

RADIO STUDIO LOCATED ONE HUNDRED MILES FROM STATION WBZ

A 100-mile broadcast line will tie up the new Boston studio of Station WBZ in Springfield and the *Boston Traveler Herald*, when completed.

This line, which will be the longest span connecting studio and station in the country, has been especially designed for broadcasting and will be used solely for that purpose. It will be built on the Boston and Albany Railroad right of way. To eliminate line noises, the wires will be transposed at frequent intervals, and every precaution will be taken to make it as good as similar lines connecting studios and stations only a few miles apart.

The Boston Studio will be located in the Brunswick Hotel, and will be specially built for broadcasting. It will be acoustically as well as artistically perfect. As Boston is the acknowledged center of culture, as well as one of the best musical communities in the country, the location is ideal. The line from Springfield to Boston will also connect with a number of places in that city. The pick-up system around Boston will be as elaborate as a telephone exchange. This will give Station WBZ the advantage of a very varied program.

Although Station WBZ has been heard in England, Cuba and on the Pacific Coast, changes in the transmission apparatus are contemplated which will increase the range of the station still more. All of these improvements will make of Station WBZ one of the best in the country and increase its utility and value a hundredfold.

GOVERNMENT BROADCASTS WANT ADS.

The Government is advertising by radio! But, although direct radio advertising is banned, there are few who will object, since the results achieved seem to indicate that the public is benefited. Every Wednesday night Mr. Morgau, of the Civil Service Commission, broadcasts from NAA, Arlington, openings in Government positions and announces examinations to be held for every kind of a job from that of an unskilled laborer to those requiring highly trained scientists, statisticians and execu-

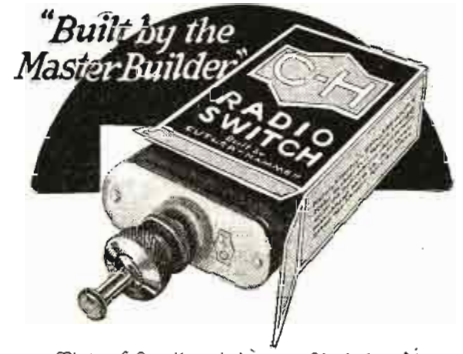

The perfect radio switch—correctly designed and skillfully constructed. Installed on any panel in five minutes to add hours of convenience, and protect both tubes and batteries. At dealers everywhere—insist on the genuine—in the orange and blue box. If your dealer has not been stocked send 60c plus 10c for packing and you will be supplied direct.

THE CUTLER-HAMMER MFG. CO.
Member Radio Section
Associated Manufacturers of Electrical Supplies
Milwaukee, Wisconsin

RADIO SWITCH

\$140 NEUTRODYNE
Set Only \$89.50



A \$140 Neutrodyne set while they last for \$89.50. High grade parts are used exclusively in the manufacture of this set. Wherever possible the connections and wires are underneath a bakelite panel, where they cannot be seen. The cabinet is genuine walnut with a mahogany panel gold engraved. Four rheostats insure finer tuning, the detector rheostat being a vernier. Stations over 1500 miles distance have been received in tests made. Each set is thoroughly tested before leaving the factory. This is your opportunity to buy a high grade Neutrodyne for a lower price than what the parts would cost you. We guarantee satisfaction. Send money order, draft or check. C.O.D. orders must be accompanied by \$20.00. Balance payable on delivery. Send in your order today before our limited supply is exhausted. Send for our radio Bulletin.

JACKSON RADIO COMPANY
Dept. 33, 639 W. North Avenue, Chicago, Illinois

PATENTS. WRITE FOR List of Patent Buyers, Three Guide Books and RECORD OF INVENTION BLANK before disclosing inventions. Send model or sketch and description of your invention for Examination and Instructions. Electrical cases a specialty. Highest references, reasonable terms, prompt attention.

No charge for the above information
VICTOR J. EVANS & CO.
919 NINTH ST. WASHINGTON, D. C.

PATENTS
DON'T LOSE YOUR RIGHTS Before disclosing your invention to anyone send for blank form "EVIDENCE OF CONCEPTION" to be signed and witnessed. Form and information concerning patents free.
LANCASTER & ALLWINE
270 Ouray Bldg., Washington, D. C.
Originators of the form "Evidence of Conception"

PATENTS C. L. PARKER Formerly Member Examining Corps, U. S. Patent Office. PATENT LAWYER McGill Bldg., Wash., D. C.
Patents, Trade Marks, Copyrights, Patent Litigation Handbook for Inventors, "Protecting, Exploiting and Selling Inventions," sent upon request.

PATENTS As one of the oldest patent firms in America we give inventors at lowest consistent charge, a service noted for results, evidenced by many well known Patents of extraordinary value. Book, Patent-Sense, Free. Lacey & Lacey, 631 F St., Wash., D. C. Estab. 1869.

tives. Some replies indicate direct results, but as not all applicants state how they learned of the openings, an exact check is impossible.

The recent call for apprentices for the Washington Navy Yard, however, brought several phone calls and mail enquiries from fathers and mothers interested in securing first-class training for mechanically inclined sons.

The openings annually announced over the radiophone cover as many as 1,000 different positions, Mr. Morgan states, and he is anxious for those seeking Government work to listen in Wednesday evenings at 7:25 and learn what is available. Some of the listeners-in, he says, proved to be only friends who called up the following day to talk with him, having recognized his voice.

RADIO NO INJURY TO MUSIC TRADE

Jazz has not killed musical appreciation or been detrimental to the trade in musical instruments, nor has the radio craze forced any solid firms out of business. This is the concerted feeling of officials of the Music Industries Chamber of Commerce. Alfred L. Smith, general manager, scouted the plaint to the contrary made recently by an insolvent piano house. He said:

"What would be a commonplace petition in bankruptcy has been made important by ascribing failure to an era of jazz and joys less subtle than those of music. This is an inaccurate impression of conditions in the music industry.

"The retail branch of the business is in a sound condition. Sales of musical instruments during the last summer have been far ahead of records for several years, while the demand for band and orchestral instruments has taxed manufacturing capacity. There were as many pianos shipped to retailers during October as in any month in the history of the industry. The failure of a piano dealer could not have been due to any combination of automobiles, movies and radio."

C. L. Dennis, manager of the trade service bureau of the chamber, said the claim that a consideration of motors and movies is influencing the music trade was as far fetched today as the well-known price of cheese, and that jazz and radio popularity, if anything, had stimulated the sale of certain interests and the liking for certain entertainment. He added:

"There is a surprising increase in the sales of harmonicas and saxophones. While there is no doubt that radio hit some of the unprogressive retailers and a few phonograph firms, for the most part it has been a matter for adaptation and constructive merchandising. Piano rolls and phonograph records have gone up by leaps and bounds since radio brought to so many homes the liking for pieces that could be heard only once unless bought for reproducing devices."

Data from 12 leading piano manufacturers and retail merchants obtained by Beach Bartlett, assistant manager of the organization, shows that orders for holiday delivery were 64 per cent. greater than last year, that manufacturing plans entail 78 per cent. greater production, shipments are 68 per cent. greater and unsold pianos are 38 per cent. less. He said:

"Manufacturers are generally optimistic. It is not true or rightly insignificant to say that radio has hurt the music trade. It is a new and considerable factor which requires adaptation and which may be regarded as an added stimulus."

RADIO TELEPHONE IN BRAZIL

Operating in the Federal District of Rio de Janeiro, Brazil, there are about 8,800 radio telephone receiving sets, according to Trade Commissioner Remer.

Broadcasting of music and entertainment is taking place regularly from the Govern-

Distance, Selectivity and Volume Combined.

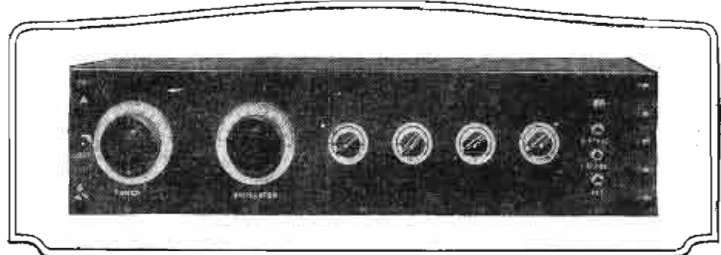

"The Standard of Comparison"



ULTRAFORMERS
Types "A" and "B"
Especially designed radio frequency transformers for use in the Ultradyne receiver. Type "B" may be successfully employed in any superheterodyne circuit as radio frequency transformers.

\$5.00



Send for thirty-two page illustrated book giving complete details on "How to Build and Operate the Ultradyne."

50c.

ULTRADYNE
The Improved
SUPER-HETERODYNE

The Ultradyne is a simplified and improved Super-Heterodyne. The Ultradyne employs the "Modulation System"—an entirely new principle in radio reception just developed by R. E. Lacault, A.M.I.R.E., who spent four years in research work in the Radio Division of the French Signal Corps.

This new principle is of such a nature as to increase the sensitiveness of the set over that of any known receiver—reduces to a minimum the controls employed, making the set easier to tune. Weakest signals are made to operate the loud speaker.

The Ultradyne, in addition to the "Modulation System," incorporates every good feature of the Super-Heterodyne.

SELECTIVITY—Completely cuts out all local stations at any time and receives distant ones clear and distinct.

SIMPLICITY—In tuning there are only two dials to adjust. These are vernier dials, which can be calibrated for all stations.

RANGE—Brings in distant stations that other receivers fail to get under the same conditions. Covers the whole broadcast wave length range. Truly a remarkable receiver of unusual merit.

Write for descriptive circular.

PHENIX RADIO CORPORATION
3-7 Beekman Street New York City

Copyright 1924 by Phenix Radio Corporation

INVENTORS PROTECT YOUR IDEAS

Send for our Guide Book, **HOW TO GET A PATENT**, and Evidence of Invention Blank, sent Free on request. Tells our terms, methods, etc. Send model or sketch and description of your invention and we will give our opinion as to its patentable nature.

RANDOLPH & CO.
Dept. 422, WASHINGTON, D. C.

Name

Street

City..... State.....

Insure your copy reaching you each month. Subscribe to Radio News—\$2.50 a year. Experimenter Publishing Co., 53 Park Place, N. Y. C.

\$200 Miniature Electric Prize Contest

THIS prize contest conducted by PRACTICAL ELECTRICS magazine, promises to be one of the most interesting that has been staged in recent years.

Here at last is something worth while. Not only can you win an attractive prize, but you will derive a tremendous amount of personal satisfaction from this contest. The illustration on this page shows the smallest electrical motor that has been built. Its dimensions are as follows: 11/64" high; 19/64" long. It weighs 5.5 grains.

This little motor is along the lines of our new contest except that we will not be quite so hard on the participants. We require miniature electric models, the largest dimensions of which must not be more than 3/4". Any electrical appliance, any electrical apparatus, any radio instrument that will be reproduced in a working condition in miniature, is eligible for entry in this contest.

World's Smallest Electric Motor

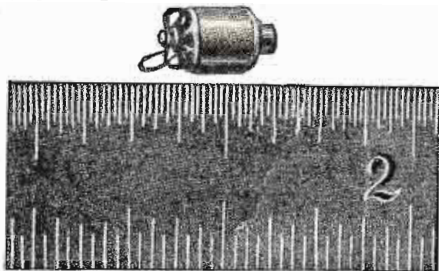

Total weight slightly above 5 grains. The tiny armature, .09" in diameter, has 4 pole pieces and is wound with No. 40 silk copper wire. Silver brushes are used. The over-all dimensions of the motor measure 19-64" long and 11-64" high. When connected to a small flash light battery, the motor runs at a very high speed.

The judges will welcome miniature models of the following: Electric bells, switches, all kinds of electric heating appliances, electric generators, telephones, microphones, telephone desk stands, telegraph instruments, any and all radio apparatus, static machines, electric lamps, batteries, rheostats, measuring instruments, fans, transformers, in fact any electrical apparatus or electrical appliance. One of the rules of the contest is that the miniature models must work. Dummies cannot be entered in this contest. The builders of these miniature models will come in for a goodly share of publicity as many newspapers and periodicals will feature these models.

There is still time to enter into this contest—it closes March 15th.

\$200 IN GOLD

First Prize	\$75
Second Prize	50
Third Prize	20
Fourth Prize	20
Fifth Prize	10
Sixth Prize	10
Seventh Prize	5
Eighth Prize	5
Ninth Prize	5

Full particulars, for entering the miniature models in this contest, closing date, rules and restrictions, etc., will be found in full in the March issue of PRACTICAL ELECTRICS.

The Electrical Magazine
for Everybody
Now Greatly Enlarged



One-third More Text and
Reading Matter than
Heretofore

This Magazine is Edited by

H. GERNSBACK

Also Editor of

Radio News

and

Science & Invention

100 Articles
Over 100 Illustrations
For Sale At All News Stands
25c. the Copy
\$2.50 a Year
Canada and Foreign
\$3.00 a Year

SEND FOR
FREE
SAMPLE COPY TODAY

See Coupon Below for
SPECIAL OFFER

PRACTICAL ELECTRICS is probably the most novel magazine of its kind ever conceived. It is personally edited by H. Gernsback, editor of SCIENCE & INVENTION and RADIO NEWS. Mr. Gernsback, who founded the old "Modern Electrics" as well as the "Electrical Experimenter," knows thoroughly what his readers want and have wanted for many years. PRACTICAL ELECTRICS, the 100% electrical magazine eclipses the best that was in "Modern Electrics" and "Electrical Experimenter."

Electricity covers such a tremendous field that the man who does not keep abreast with it does himself a great injustice. PRACTICAL ELECTRICS covers that field from every angle. It is written in plain every-day language that all can understand. It portrays the entire electrical development of the month faithfully in non-technical language. It caters to everyone interested in electricity, be he a layman, an experimenter, an electrician or an engineer—each will find in this magazine a department for himself and plenty more.

The March issue now on the news-stands contains 64 pages, over 100 different articles and over 150 illustrations, with an artistic cover in three colors. Professor T. O'Connor Sloane, Ph.D., is associate editor of the magazine.

INTERESTING ARTICLES TO APPEAR IN MARCH ISSUE OF "PRACTICAL ELECTRICS"
Photo-Electric Telephony By Dr. A. Gradenwitz, Berlin, Germany
Solar Radiation Measurement By H. H. Kimball and H. E. Hobbs. U. S. Weather Bureau
Television by Bell System By Lucien Fournier, Paris, France
Electric Clock Runs 1000 Years
Submarine Pilot Cable By Dr. A. Neuburger, Berlin, Germany
World's Largest Electric Generator
Sam Graves' Gravity Nullifier. Story by George F. Stratton
Simplified D'Arsonval Galvanometer
Automobile Ignition Coils
Voltmeter Multipliers

PRIZES

This magazine offers a number of prizes, as follows: Our \$50.00 Prize Contest for Junior Electricians and Electrical Experimenters includes as its elements simplicity, as great a degree of novelty as possible, and practicability. A new contest offering \$200 in prizes for best miniature working models of electrical apparatus. Also a new prize contest giving four prizes amounting to \$37.50 for the best account of an odd electrical experience. \$3.00 for the best article on Elec-Tricks, the new department. \$3.00 for the best "short-circuit," the semi-humorous department. In addition to this, the magazine pays high prices for all electrical experiments, electrical articles, etc. See current issue for full details.

This issue also contains articles by some of the greatest electrical writers, workers and students. The magazine will prove a revelation to any one interested in electricity.

Every issue besides its many other features contains the following departments:

- "New Things Electric"
- "Experimental Electrics"
- "Electrical Digest"
- "Junior Electrician"
- "Elec-Tricks"
- "Motor Electrics"
- "Short Circuits"
- "How and Why" (Questions and Answers.)

Make all checks payable to: "Practical Electric Co."

R.N. 3-24

SPECIAL OFFER

Gentlemen:
Although your regular price is \$2.50 per year, you will accept my subscription at \$2.00 per year (Canada and foreign \$2.50). I enclose the money herewith and I have written my name and address in margin below.

ment station at Praia Vermelha and the Radio Sociedade do Rio de Janeiro. A line is being put up to connect the former station with the Instituto de Musica to permit the broadcasting of concerts.

Few licenses have been issued outside the Federal District. The first radio receiving set to be installed in the interior of Brazil was set up recently by employees of the Araraquara railway. It is located at Araraquara, in the state of Sao Paulo, but picks up broadcasting from Rio de Janeiro and Buenos Aires.

NOW URUGUAY TAKES UP RADIO

Keen interest in radio is developing in Uruguay, according to Trade Commissioner George S. Brady, of Buenos Aires. An increasing demand for apparatus is expected by the end of the summer.

Amateur radio enthusiasm was retarded in Uruguay as in the Argentine and even up to the present time very little has been done. There are only five houses, Mr. Brady states, dealing in radio apparatus in Montevideo and two of them have just begun to handle radio goods. One of these concerns intends to erect a small broadcast station. The only station now broadcasting in Montevideo gives concerts very irregularly, making it necessary for the Uruguayan radio fan to depend very largely upon Buenos Aires. The other house actively dealing in radio apparatus has just hired a Belgian electrical engineer, who has been trained in radio in the United States to take charge of a new radio department, and the manager feels that his house is going to make a big success of radio apparatus. Both of these concerns intend to sell American sets only.

SALTZMAN SUCCEEDS SQUIER

Concerning the retirement of General Squier, Secretary Weeks recently stated: "General George O. Squier, Chief Signal Officer, is retiring at his own request and not resigning. He is greatly interested in technical questions, so doubtless finds his present duties irksome, and wishes to devote his whole time and energy to the work in which he has demonstrated brilliant ability."

The Secretary also announced that he would recommend Colonel Charles McK. Saltzman, the Senior Colonel of the Signal Corps, to succeed Major General Squier as Chief Signal Officer, upon the latter's retirement, after more than 40 years' service.

Colonel Saltzman was born in Iowa, October 18, 1871, and was graduated from the Military Academy in 1896. During the World War he was Brigadier-General of the Signal Corps, serving as Assistant to the Chief Signal Officer of the Army in Washington.

Colonel Saltzman has long been interested in radio and all methods of signaling. Among his many important assignments are the following: Chief Signal Officer of the Philippine Division, in charge of Electrical Division, Office Chief Signal Officer; delegate from the United States to the International Radio Conference in London, 1912; member of Interdepartmental Board on Radio Telegraphy in Washington, 1912-13; and member of Interdepartmental Committee on Radio Telegraphy in connection with the International Conference on Safety at Sea, 1913.

Colonel Saltzman is at present on duty as Chief Signal Officer, Second Corps Area, Governor's Island, New York.

GOOD NIGHT!

The little four-year-old daughter of a Missouri family is a radio enthusiast. One night, on concluding her prayers, she soberly said, "This is Marylyn Hepler signing off!"

Contributed by Mrs. G. B. Manion.



The **FANSTEEL**
Balkite
battery charger

PATENTS APPLIED FOR

has no vibrators, bulbs or moving parts and is entirely noiseless

FANSTEEL BALKITE

is a new metal developed for this charger. It acts as a valve, allowing current to flow into the battery but not out of it. It is the most efficient charger valve made, is practically indestructible, and does away with noisy, delicate vibrators and fragile bulbs.

The Gould Storage Battery Company is also marketing, under the Fansteel Balkite Patents, a complete battery and recharging unit known as the Gould Unipower, into which this charger, under the name, "The Fansteel Balkite Rectifier," has been incorporated.

The Fansteel Balkite Battery Charger for Radio "A" Batteries [6 volt] is an entirely new type of rectifier, based on the use of Fansteel Balkite, a new and rare metal developed for this purpose. It is entirely noiseless. It cannot deteriorate through use or disuse. It has nothing to replace, adjust, or get out of order. It cannot discharge or short circuit the battery, and requires no attention other than an occasional filling with distilled water. It will not overcharge, and cannot fail to operate when connected to the battery and line current. It is unaffected by temperature or fluctuations in line current. It is simple, efficient, and indestructible except through abuse.

The Fansteel Balkite Battery Charger will charge the ordinary 6 volt radio "A" or automobile storage battery at 3 amperes, from 110-120 AC, 60 cycle current. It comes complete and ready for use. Get it from your dealer, or use the coupon below.

Price, \$18
(\$18.50 West of the Rockies)

FANSTEEL PRODUCTS CO., Inc.

Dept. 11-A North Chicago, Illinois

Dealers and Jobbers: The Fansteel Balkite Battery Charger does away with complaints and replacement troubles. Write for literature and discounts.

Dept. 11-A

FANSTEEL PRODUCTS Co., Inc., No. Chicago, Ill.

Enclosed please find \$18. (\$18.50 west of the Rockies.) Send me the Fansteel Balkite Battery Charger for Radio 6 volt "A" Batteries. If I am not entirely satisfied I will return it and you will refund my money.

Name
Street
City State

RADIOLETTE
CRYSTAL RECEIVING SET
COMPACT AND COMPLETE



RADIOLETTES are beautiful in appearance, made of metal and are heavily plated in Nickel, and mounted on a polished base.

RADIOLETTES have the range and efficiency of any Crystal Set regardless of size or price.

They are equipped with our patented "Stay-put" detector, containing a super-sensitive Crystal.

Packed in individual boxes, twenty-four to the carton. All sets are unconditionally guaranteed.

PRICE \$4.00 EACH

BENSON MELODY CO., Distributors

2125 N. Halsted Street, Chicago, Ill.
Dealers: Write for discounts.

800 Miles with Roll-O Crystal on a Common Crystal Set

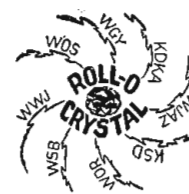

Every ROLL-O CRYSTAL is tested for loud and clear reception on stations from 300 to 800 miles away. Work perfectly on any ordinary set. No batteries or tubes needed. Sensitive throughout. S A T I S F A C T I O N GUARANTEED. Mail \$1.00 (stamps or coin) for

Three ROLL-O CRYSTALS. Sent postpaid.

ROLL-O CRYSTAL CO.

Desk 140, Mt. Washington, Cincinnati, Ohio

WANTED—Back numbers of Radio News, Dec., 1921, Jan. and Feb., March and April-May, 1922. Experimenter Publishing Co., 53 Park Place, New York City.

OPPORTUNITY AD-LETS

Follow these advertisements every month. Reliable advertisers from all over the country offer their most attractive specials in these columns.

Classified advertising rate fifteen cents a word for each insertion. Ten per cent discount for 6 issues, 20 per cent discount for 12 issues. Name and address must be included at the above rate. Cash should accompany all classified advertisements unless placed by an accredited advertising agency. No advertisement for less than 10 words accepted.

Objectionable or misleading advertisements not accepted. Advertisements for the May issue must not reach us later than March 1st.

THE Net Paid CIRCULATION OF RADIO NEWS IS OVER 200,000

EXPERIMENTER PUBLISHING CO., INC., 53 Park Place, New York, N. Y.

Agents Wanted

Agents Wanted in every city and town to sell standard radio apparatus. Attractive discounts given. If interested, write us at once stating age and radio experience. Wilmington Electrical Specialty Co., Inc., 405 Delaware Ave., Wilmington, Delaware.

General Agents—Service Men! Genuine Gold Letters for store windows easily applied. 20 percent cash commission on all orders from local agents appointed by you anywhere. 50 percent discount on your own orders. Free samples. Metallic Letter Co., 422 N. Clark St., Chicago.

Big Money and fast sales. Every owner buys gold initials for his auto. You charge \$1.50; make \$1.35. Ten orders daily easy. Write for particulars and free samples. American Monogram Co., Dept. 133, East Orange, N. J.

We want Salesmen and Agents, either whole or side line, to sell our low priced radio books to the trade. Excellent proposition for live wires. The E. I. Company, Publishers, 233 Fulton St., New York City.

You can make \$75.00 to \$100.00 a week selling our big line of 150 articles, used constantly in every home. Write us, we will send you our handsome \$15.00 Sample Case Outfit on trust. Federal Pure Food Co., Dept. T, Chicago.

Rug Salesmen—Get next to the biggest seller of the year. Loomrite Felt Rugs. Sell at sight at \$2.50, cost \$15 dozen. Big, complete Rug Catalog, Free. Malsley-Payne Mfg. Co., 104-N Hanover St., Boston, Mass.

New wonderful seller. Over 100 percent profit on every sale of Harper's Re-Use Set. Needed in every home. Washes and dries windows, sweeps, scrubs, mops, etc. Greatest year 'round seller. Write Harper Brush Works, 160 Second St., Fairfield, Iowa.

If you can Sell—You can make from \$75 to \$150 a week taking orders for our guaranteed all-wood tailored-to-measure suits all at one amazing low price. Tailoring experience not necessary. We teach you and supply you with finest selling outfit. We do all delivering. You just write orders and get your pay cash with order. Write at once, Address Dept. 794, Goodwear Chicago, Inc., 844 W. Adams St., Chicago.

Use our handsome Catalog; get orders from every home for Dr. Blair's famous home products. Liberal Pay. Dr. Blair Laboratories, Dept. 541, Lynchburg, Va.

Sells like Blazes! New, Instant Stain Remover. Fine Premium every sale. Big profits. Outfit free. Write quick. Christy, 32 Union, Newark, New York.

American Made Toys

Manufacturers on Large Scale, also homeworkers, wanted to manufacture Metal Toys and Novelties. Millions needed of Barking Dogs, Wag Tail Pups, Wild Animals, Automobiles, Indians, Cowboys, Baseball Players, Cannons, Toy Soldiers, Crowing Roosters, Statues of Liberty, Miniature castings of Capitol, Bathing Girl Souvenirs and others. Unlimited possibilities. Guaranteed Casting forms furnished manufacturers at cost price from \$5.00 up, with complete outfit. No experience or tools necessary. Thousands made complete per hour. We buy goods all year and pay high prices for finished goods. Cash on delivery. Contract orders placed with manufacturers. Catalog and information free. Correspondence invited only if you mean business. Metal Cast Products Co., 1696 Boston Road, New York.

Automobiles

Automobile owners, garagemen, mechanics, send for free copy of America's popular motor magazine. Contains helpful, money-saving articles on repairing, overhauling, ignition, carburetors, batteries, etc. Automobile Digest, 523 Butler Bldg., Cincinnati.

Build It Yourself—A real Automobile that any handy man or boy can build. A low-slung, speedy cycle car. Power supplied by famous 2 1/2 H. P. Shaw Motor. Send stamp today for Descriptive Circulars or send 25c for Complete Book of Easy-to-Follow Plans. Shaw Mfg. Co., Dept. R. N. 1, Galesburg, Kansas.

Business Opportunities

Make Big Money Out of Radio. Thousands of People want to buy a good Radio instrument. They have read that vast improvements have been made and they are ready to buy now if you show them the best. It is one thing to make a good radio instrument for your own amusement, but why not cash in now on your experience? Let us send you full particulars of the Ozarka Plan which shows you how to "Make \$120 Weekly" selling long distance Radio sets. The season is on right now. Let us tell you how to combine the clear signal of the crystal detector with the distance of the vacuum tube. Write today and don't fail to give the name of your county. Ozarka Incorporated, 813 Washington Blvd., Chicago.

For \$5 we'll write three catchy classified advertisements that will simply have to bring you business. We'll name the most profitable magazines, how to use them, etc. Martinek Company, 45 Humphrey St., Corona, N. Y.

Worth while opportunities for profits are constantly offered. Write for information. Dept. X, Paul Kaye, 149 Broadway, New York.

Sell us your spare time. Write Showcards for us. We instruct and supply work. No experience necessary. Wilson Methods, Limited, Dept. 51-C, Toronto, Canada.

Inch display 100 magazines, thrice \$8. Beck, 5453 Alaska, St. Louis.

Books

Experimental Electricity Course in 20 Lessons. By S. Gernsback and H. W. Secor, E.E. A course of the theory and practice of Electricity for the Experimenter. Every phase of experimental electricity is treated comprehensively in plain English. New experiments are described and explained and nearly every application of Electricity in modern life is given. 160 pages—400 illustrations. Flexible cloth cover, 75c. postpaid. Stiff cloth cover, \$1.25 postpaid. Experimenter Publishing Co., Book Dept., 53 Park Place, New York City.

The How and Why of Radio Apparatus, by H. W. Secor, E. E. This newest book on radio matters fills a distinct gap in wireless literature in that, while the treatment is made as understandable and as free from mathematics as possible, it at the same time incorporates a wealth of technique and instruction for the Radio Amateur—the Radio Operator—the Installation and Designing Expert—as well as teachers and students of the subject in general. A very broad field has been covered by the author, at the same time giving a great deal of information not found in other text books. If you are engaged in any branch of the Radio or allied arts at all you will surely need this latest contribution to radio literature, which is destined to be found on every radio man's book shelf before long. A glance at the following list of chapters gives but a very scant idea of the extensive and useful radio knowledge provided in its text: The Induction Coil; The Alternating Current Transformer; Radio Transmitting Condensers; The Spark Gaps; Radio-Transmitting Inductances; Radio Receiving Tuners; Radio Receiving Condensers; Detectors; Telephone Receivers; Radio Amplifiers; Construction of a Direct Reading Wavemeter and Measurement of Inductances; Appendix containing very useful tables, covering all subjects treated in this very unusual book. This newest of Radio Works, cloth bound in Vellum de Luxe, Gold Stamped and Hand Sewed, has 160 pages. Size of book 6 1/2 inches. The How and Why of Radio Apparatus. Postpaid, \$1.75. Experimenter Publishing Co., Book Dept., 53 Park Place, New York City.

Chemistry

Learn Chemistry at Home—Dr. T. O'Connor Sloane, noted educator and scientific authority, will teach you. Our home study correspondence course fits you to take a position as chemist. See our ad on page 1216 of this issue. Chemical Institute of New York, 66 West Broadway, New York City.

Correspondence Courses

Used correspondence courses of all schools sold, rented and exchanged. New 1924 catalogue free. (Courses bought). Lee Mountain, Pisgah, Alabama.

Correspondence Schools

Jazz-orchestra chording on tenor or regular banjo. Clay School, 1521 E. 86, Clevealand, Ohio.

Exchange

For Sale—Unused Radak H.R. Sets and H.Z. Amplifiers \$25.00 each; Anrad 2-stage R. F. Amplifier, \$25.00; \$35.00 Tuska Set, \$25.00; Western Electric Power Amplifier, without horn, \$35.00; Bristol Junior Horn, \$25.00; Kellogg Horn, \$10.00; King Amplifier Horns, \$8.00; Radiola Senior, \$30.00. All guaranteed. Write for bargain prices on new parts that you are interested in. H. B. Rogers, Colmsville, Missouri.

\$110.00 Six volt 150 ampere chrome nickel Edison Storage "A" Batteries at \$22.50 each. Also 6-volt 225 ampere at \$29.50, 200 ampere at \$35.50; 350 ampere at \$40.50. Every battery guaranteed perfect. A wonderful battery at an equally wonderful price. Edison (genuine) chrome nickel "B" storage battery plates (large size) at 4c per pair, 1/2c in lots under 100 pairs. Complete parts for making rechargeable storage "B" battery including genuine Edison chrome nickel plates, heavy glass vials, special wire, perforated rubber separators, chemical electrolyte and complete, simple instructions for assembling and charging. 100-volt unit of parts, \$9.35; 150-volt, \$13.90. Address B. R. Smith, Pioneer and largest dealer of above parts. 31 Washington Ave., Danbury, Conn.

For Men

Tobacco. Kentucky Home Spun-Mellow and Sweet. Five lbs. Best Grade Cheving, \$3.00; 10 lbs. Best Grade Cheving, \$3.75; 5 lbs. Best Grade Smoking, \$1.25; 10 lbs. Best Grade Smoking, \$2.00. Planter's Tobacco Union, Mayfield, Kentucky; Box 311.

For Investors

Inventors' Educator: 900 Meehan's Movements. 50 Perpetual Motions. How to procure and sell patents. Meehan's Movements greatly assist inventors, suggest new ideas. Explains how to select an attorney and avoid Patent Sharks. Price \$1.50. Postage Free. Albert E. Dieterich, 690 Ouray Building, Washington, D. C.

Instruction

Learn Chemistry at Home—Dr. T. O'Connor Sloane, noted educator and scientific authority, will teach you. Our home study correspondence course fits you to take a position as chemist. See our ad on page 1216 of this issue. Chemical Institute of New York, 66 West Broadway, New York City.

Help Wanted

We want Salesmen and Agents, either whole or side line, to sell our low priced radio books to the trade. Excellent proposition for live wires. The E. I. Company, Publishers, 233 Fulton St., New York City.

Earn \$25 Weekly, spare time, writing for newspapers, magazines. Experience unnecessary; details free. Press Syndicate, 5665 St. Louis, Mo.

Detectives Needed Everywhere. Work home or travel. Experience unnecessary. Write, American Detective System, 1968 Broadway, New York.

All Men, Women, Boys, Girls, 17 to 65 willing to accept Government Positions \$117-\$250 traveling or stationary; Write Mr. Ozment, 251, St. Louis, Mo., immediately.

Get posted—Good prices paid for butterflies, insects. See Sinclair display advertisement, page 1298.

We want high-class specialty salesmen now selling radio specialties to jobbing trade, to represent us west and south of Pennsylvania. We manufacture a high-class medium priced line of variable condensers and have a most interesting proposition for the right parties. State definitely in first letter line you are now selling, territory, age and experience. C. B. Fett, Bluffton, Ohio.

Improved Made Toys

Wanted—Manufacturers and Houseworkers to manufacture Metal Toys and Novelties. Wonderful opportunity. Millions needed. In Whistling Birds, Wild Animals, Wag Tail Pups, Crowing Roosters, Automobiles, Baseball Players, Statue of Liberty, Indians, Toy Soldiers, Barking Dogs and 50 others. No experience or tools necessary. Guaranteed casting forms with complete outfit, at cost. From \$3.50 up. We buy goods all year. Cash on delivery. Higher price for finished goods. Contract orders placed. Send for catalog and information free. The Improved Metal Casting Co., 342 E. 145th St., New York.

Insects Wanted

Get posted—Good prices paid for butterflies, insects. See Sinclair display advertisement, page 1298.

Languages

World-Romic System. Masterkey to All Languages. Primers, 23 languages. \$1.94 each language; English, French, German, Italian, Portuguese, Spanish. Pronunciation-Tables, 102 languages, 30c each language. Languages Publishing Company, 8 West 4th St., New York.

Miscellaneous

Get posted—Good prices paid for butterflies, insects. See Sinclair display advertisement, page 1298.

The Secret of renewing batteries. Save money. 25c (no stamps), Bornekey-RN, Lock Box 617, Burnham, Pa.

Distributing Agency Wanted. Old, established, reliable company, with ample Warehouse and Store facilities, high class Experienced Employees and Salesmen. Now handling Electrical and Auto-Motive Equipment; desires to act as Agent for Disbursement or Distribution of complete Radio Equipment for Kansas, Western Missouri and such other surrounding territory as required. Representing only one first class line of goods. Can furnish agents, if desired, on salary or commission covering City and Country Districts. Investigation Solicited. Triangle Service Company, Thirltick and Gillham, Kansas City, Mo.

French, English and German Stations read with a Single Bulb. Instructions, Blue Print and Transmitting schedule, sixty cents. C. H. Stoup, Valencia, Pa.

Make and Sell delicious Confectionery Pop Corn Balls, Crystallized or Cakes. Formula, \$1.00. Charles A. Lutz, York, Penna.

Super Crystal Receiver—With our famous Interlock Coil Crystal Circuit, hundreds are enjoying concerts from stations three hundred to one thousand miles distant. Cheap, simple to make, no tubes. Guaranteed instructions, \$1. Home Radio Shop, 736 N. St. Francis, Wichita, Kansas.

Super Sensitive Radio Crystals—Make them yourself for less than one cent each out of cheap plentiful material. Immense profits, guaranteed instructions only \$1. Home Radio Shop, 736 N. St. Francis, Wichita, Kansas.

Cabinets at Direct Factory Prices—Made in regular and special sizes. Dark oak or hand-rubbed mahogany finish, hinged top. Special prices on knock-down cabinets. Inquiries solicited from jobbers and manufacturers. Catalog Free. Corbett Cabinet Manufacturing Company, Box 262, St. Marys, Pa.

Key Check Stamping Outfit—Alphabet, Figures, Hammer, Gauges, Anvil, lots Key Tags, Name Plates; all in wooden case. Cost \$15.00, sell everything for \$3.50. Douglas, 683 Sixth Avenue, New York.

Motorcycles—Bicycles

Don't buy a Bicycle Motor Attachment until you get our catalog and prices. Shaw Mfg. Co., Dept. 6, Galesburg, Kansas.

News Correspondents

Earn \$25 Weekly Spare Time writing for newspapers, magazines. Experience unnecessary; details free. Press Syndicate, 566 St. Louis, Mo.

Patent Attorneys

Patents. Send drawing or model for examination and report as to patentability. Advice and booklet free. Highest references. Best results. Promptness assured. Watson E. Colman, Patent Lawyer, 624 F St., Washington, D. C.

H. F. Lowenstein, Registered Patent Attorney, Radio Expert, 825 McLachlen Building, Washington, D. C.

Patents—Send for form "Evidence of Conception" to be signed and witnessed. Form, fee schedule, information free. Lancaster & Allwine, 269 Ouray Bldg., Washington, D. C.

Patents—Inventors should write for Free Guido Books and Record of Invention Blank before disclosing invention. Send model or sketch of your invention for our Free opinion of its patentable nature. Radio, Electrical, Chemical, Mechanical and Trade-Mark experts. Victor J. Evans & Co., 922 Ninth, Washington, D. C.

Lacey Patent-Sense. See Page 1368.

Patents

Inventions Commercialized. Patented or unpatented. Write Adam Fisher Mfg. Co., 273, St. Louis, Mo.

Patents for Sale

Patent application blanks free. Patents for sale. Patent News-30, Washington, D. C.

Personal

Correspondence club—Many wealthy members everywhere. Fascinating particulars free. Smith, Box 1167Y, Denver, Colo.

Lonely Hoarts—Exchange letters; make interesting new friends in our jolly club. Eva Moore, Box 908, Jacksonville, Florida. Enclose stamp.

Exchange Cheery Letters with new friends. Write Betty Lee, Inc., 4254 Broadway, New York City. Stamp appreciated.

Lonesome—Join our club—make acquaintances everywhere. Big illustrated book with descriptions and photos, sent in plain wrapper for ten cents. Bonafide Co., Dept. 58, Kansas City, Mo.

Salesmen Wanted

Tailoring Salesman; Share \$100,000.00 Bonus and big advance commissions taking orders for snappiest Direct-To-Wearer line on earth; virgin wool custom tailored suits, \$28.00. Representatives are furnished a high-grade tailoring shop in one elaborate case. House of Campbell, State at Congress St., Chicago.

Lightning Strange Battery Compound. Charges discharged batteries instantly. Eliminates old method entirely. Galton free to agents. Lightning Co., St. Paul, Minn.

A salesman wanted in every town or city within 25 miles of a broadcasting station to sell Radiogem, the complete radio receiving set that retails for \$2.50. With Radiogem there is nothing else to buy—the outfit includes the Radiogem receiving apparatus, 1,000 ohm phone and aerial outfit. The cheapest radio outfit on the market—yet as practical as the most expensive. Big money to the right men. Send \$1.35 for sample outfit. The Radiogem Corp., 66R West Broadway, N. Y. City.

Salesman: A real, high class proposition selling new money-making specialties to all dealers. We guarantee minimum of \$40 weekly and traveling expenses against commissions. Live wires actually making \$5,000 to \$12,000 yearly. Big commissions. Splendid, workable selling plan. A square deal and your own business easily established. Write A. H. Main Co., Cedar Rapids, Iowa.

Scenery to Rent

Settings for Opera, Plays, Minstrels. Plush Drops. Address Anetia Grain, Philadelphia.

Song Poems Wanted

Poems Wanted—Sell your song-verses for cash. Submit Mss. at once, or write New Era Music Co., 152, St. Louis, Mo.

Song Writers

A \$500.00 Cash Prize is offered for the best second verse written for the song "Remember." Those wishing to compete may receive a free copy with rules by addressing Equitable Music Corporation, 430 State Theatre, N. Y.

Stammering

St-Stu-t-t-tering and Stammering cured at home. Instructive booklet free. Walter McDonnell, 121 Potomac Bank Bldg., Washington, D. C.

Stamps & Coins

Stamps—50 varieties, Brazil, Peru, Cuba, etc., 10c. 50 different U. S. 25c. 1,000 hinges, 10c. 1,000 mixed, 40c. List free. C. Stegman, 5936 Cote Brillant, St. Louis, Missouri.

California gold, Quarter size 27c; half-dollar size 53c; Half-dime and Catalogue 10c. Norman Shultz, Colorado Springs, Colo.

100 Different New Europe Free to approval applicants sending return postage. Anvelink, 2410 Prairie, Milwaukee, Wis.

Telegraphy

Telegraphy—Both Morse and Wireless taught thoroughly and quickly. Tremendous demand. Big salaries. Wonderful opportunities. Expenses low; chance to earn part. School established fifty years. Catalog free. Dodge's Institute, Cour St., Valparaiso, Ind.

Wanted to Buy

Full Value Paid for Old Gold, Jewelry, Watches, Diamonds, crowns, bridges, dental gold, silver platinum, gold silver ore, magnetite points, old false teeth. Packages needed if our offer is not satisfactory. United States Trading Works (The Old Reliable), 120 So. State St., 16, Chicago, Ill.

receiving set; must be cheap. Albert Gerlach, New La.

Wireless

Fifty assorted flathead solid brass machine screws, nuts, washers—copper lugs—50c. Eight initialed binding posts, set, 10c. Twelve nickelled binding posts—50c. All three items—\$1.50. Radio set for \$1.00. All prepaid. Stamps accepted. Kladag Radio Laboratories, Kent, Ohio.

Build your own electrolytic storage battery charger. Plates and complete instructions, \$1.00. Descriptive circular free. Peerless Electrical Parts Co., 105 Harris, Rochester, N. Y.

Magnavox R3 or M1. Latest nationally advertised reproducers. List \$35. Introductory \$25. The factory sealed carton is your guarantee. Radio Central, Dept. R, Abilene, Kansas.

Radio Panels. Cut exactly to size and a guaranteed 12 hour shipment. 1/4 in. thick, .01 1/2 per square inch; 3-16 in. thick, .01 1/4. Made of the highest grade black fibre. This material possesses electrical strength of 200 volts per mil, is inexpensive, unbreakable, easy to work and takes a fine finish. We pay postage. Radio Instrument & Panel Co., 564 W. Monroe St., Chicago, Illinois.

Immediate delivery. Tubes, Magnavox, Phones, Battery Chargers, Storage and "B" Batteries, Couplers, Vario meters, Condensers and all parts with Radio Corporation, DeForest and "Neutrodyne" Receiving Sets. R. B. Electric Co., Distributors, Galva, Ill.

Boys! Don't Overlook This. The "Rasco" Baby Detector. Greatest detector ever brought out with molded base. Fully adjustable. See former advertisements in this publication, or our catalog. Detector with Galena Crystal, complete, 50c, the same detector with Radiotele Crystal, 75c prepaid. Send for yours today. Radio Specialty Company, 96-98 Park Place, New York City.

Attention—50 Vacuum tube hook-ups. The greatest collection of vacuum tube circuits ever brought under two covers at such insignificant cost. These diagrams will be found in the great "Rasco" catalog, which contains raw materials and parts in a greater profusion than any other catalog. 15c in stamps, or coin, will bring the catalog to you. Radio Specialty Co., 96-98 Park Place, N. Y.

Edison Storage Batteries \$4.00. Cost \$40.00. 824 North Fifth, Philadelphia, Pa.

Fada Neutrodyne Parts \$58.50. UV201 A's, 199's \$5.45. Baldwin Phones \$8.95. All Post-paid. Prompt service. Everything in radio you require. Knowlton Radio, 414 W. 118th St., N. Y. C.

Radio Tubes Repaired. We repair UV201A or C301A at the price of \$3.50. No other types accepted. New Tube "Bell Toner" 6 volts, 1/2 ampere type, 201A amplifier and detector, \$3.75. All tubes guaranteed and shipped properly packed P. P. C. O. D. Dealers write for special discount. Mid-West Radio Tube Exchange, Dept. 3, 5120 Chene St., Detroit, Mich.

Neutrodyne—Complete parts for 5 tube set, licensed \$31.98. 1 Tube Reflex complete parts, \$14.98. Cockaday, complete parts, \$9.35; list of other specials. Pequot Specialty Co., New London, Conn.

Fix Your Own Radio—Avoid service charges and bungling "fixers"; Get "Trouble Shooter"—explains noises, dead circuits, weak signals, interference; gives simple tests that locate trouble quickly any type receiver; trouble key answers hundreds questions; stop that knock, howl, rattle, squeak, hiss, hum, whistle; limited number at 50 cents each. Radio Information Service, Galveston, Texas.

Selling Standard Radio Sets and parts on consignment—Big discounts—Pay me when you sell. Gilbert A. Swanson, Cambridge, Illinois.

Michigan Midget Receivers ready for immediate delivery. The features of this set are extreme long-distance, ease of control, small upkeep and reasonable initial expenditure. Thousands of satisfied owners. Without accessories \$27.00. The Capitol Radio Company, Box 522, Jefferson City, Missouri.

Build your own. The best hook-up I ever tried. Yours for a dollar. Any complaint your money back. E. F. Waits, Corinth, Miss.

The How and Why of Radio Apparatus, by H. W. Secor, E. E. This newest book on radio matters, fulfills a distinct gap in wireless literature in that while the treatment is made as understandable and as free from mathematics as possible, it at the same time incorporates a wealth of technique and instruction for the Radio Amateur—the Radio Operator—the Installation and Designing Expert—as well as teachers and students of the subject in general. A very broad field has been covered by the author, at the same time giving a great deal of information not found in other text books. If you are engaged in any branch of the Radio or allied arts at all you will surely need this latest contribution to radio literature, which is destined to be found on every radio man's book shelf before long. A glance at the following list of chapters gives but a very scant idea of the extensive and useful radio knowledge provided in its text. The Induction Coil; The Alternating Current Transformer; Radio Transmitting Condensers; The Spark Gaps; Radio-Transmitting Inductances; Radio Receiving Tuners; Radio Receiving Condensers; Detectors; Telephone Receivers; Radio Amplifiers; Construction of a Direct Reading Voltmeter and Decimeter; Antenna Construction; The Calculation and Measurement of Inductances; Appendix containing very useful tables, covering all subjects treated in this very unusual book. This newest of Radio Works, cloth bound in Yellow de Luxe, Gold Stamped and Hand Sewed, has 160 pages. Size of book, 6x9 inches. The How and Why of Radio Apparatus. Postpaid, \$1.75. Experimenter Publishing Co., Book Dept., 53 Park Place, New York City.

Experimental Electricity Course in 20 Lessons. By S. Gernsback and H. W. Secor, E. E. A course of the theory and practice of Electricity for the Experimenter. Every phase of experimental electricity is treated comprehensively in plain English. New experiments are described and explained and nearly every application of Electricity in modern life is given. 160 pages—400 illustrations. Flexible cloth cover, 75c. postpaid. Stiff cloth cover, \$1.35 postpaid. Experimenter Publishing Co., Book Dept., 53 Park Place, New York City.

How to Make Radio Frequency Amplifiers. This book is for the more advanced amateur, showing the construction of the Radio Frequency Amplifying Transformer and giving complete constructional data. It shows the application of Radio Frequency to amplifying units that the amateur may already possess and gives 15 hook-ups showing practically every use Radio Frequency Amplifying Transformers can be put to. 32 pages, 15 illustrations; bound in beautiful two-color cover, Prenalid 25c. The E. I. Company, 233 Fulton St., New York City.

**To Pay Less is Risky
To Pay More is Unnecessary**

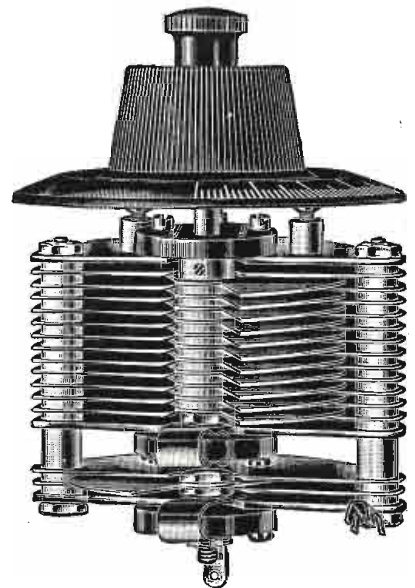

New York Variable Condenser with Vernier, 23 plate, price \$3.50.
New York Variable Condenser with Vernier, 43 plate, price \$4.50.
3 1/2" Dial and Knob included.

Without Vernier attachment:
43 plate \$3.00
23 plate \$2.00
11 plate \$1.50

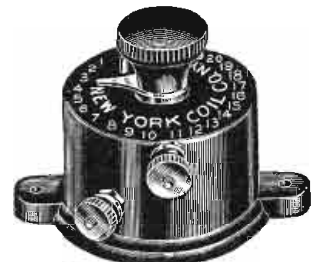

A Variable Grid Leak of quality and precision. Roller contact incomparably better.
Price \$1.50



Mica Fixed Condensers of tested and permanent capacity, ranging from .0001 to .006, 35 cents to 75 cents, of superior quality.

NEW YORK COIL CO.
338 Pearl St., New York City
Pacific Coast, 1240 S. Main Street, Los Angeles, Cal.

Boyd's Radio Lists
19-21 Beekman St., New York City

- 10,293 Radio & Wireless Equipment and Supply Dealers and Jobbers, price \$50.00
- 5,185 with estimated standing of \$5,000 or over, price 30.00
- 3,485 with estimated standing of \$50,000 or over, price 25.00
- 1,788 with estimated standing of \$100,000 or over, price 15.00
- 1,070 Radio & Wireless Apparatus Mfrs. & Assemblers, including Parts & Supply Mfrs. 7.50

The first mentioned list contains and indicates the restricted selections. Lists cover the United States Typewritten. With street addresses. Also supplied for local territory, certain states or cities, etc. Send for General Price List giving state figures on Electrical Supply Dealers, Retail Hardware, General Stores and other handlers of Radio Equipment. Names of any class for all parts of the world. Addressing. Mailing. Typewriting. Fac-simile Letters.

Use Graphite Disc Rheostat Says prominent radio expert

**RADIO FACTS FOR EVERYBODY;
NEWS AND THEORY OF WIRELESS**

While Nearly All Standard Tubes Will Give Good Results, Low Vacuum Type Is Best, Says Calcaterra.

LOW VACUUM TUBE IS BEST.
All standard tubes, however, will give good results.
BY JOSEPH CALCATERRA.
(Radio Engineer)

Another important consideration in getting maximum efficiency from a single tube is choice of the tube to use. While practically all the standard tubes now on the market will give good results, there is one tube which gives best results. That tube is the soft or low vacuum tube especially designed for detector use. UV-200 and C-300 tubes are of this type.

In tool making and high class instrument making best results are obtained only when the best tools are used. So also in radio receiving, exceptional results are obtained only when corresponding vacuum amplifier tubes are used. Care is taken. The hard or high vacuum tubes and their characteristics are such that a critical adjustment of grid, filament and plate currents are not required. With the soft tubes, however, best results are obtained only when these tubes are carefully adjusted.

Use Vernier Rheostat.
For adjustment of filament temperature to obtain the best operating point of the tube, a Vernier rheostat, preferably of the carbon pile resistance type, should be used. Care must be exercised in its use.

Conditions are finally made and the grid return from the secondary circuit to the filament should be made to the positive lead of the "A" battery.

The rheostat should be placed in the negative lead of the "A" battery, that is between the negative of the "A" battery and one of the filament terminals of the socket.

While a considerable change in the plate voltage applied in the plate circuit of a hard or amplifier tube when used as a detector will make very little difference in the operation of the tube, the soft detector tube is very responsive to slight changes in the plate voltage. The characteristics of different tubes of the same type vary to some extent, so that a fine variable adjustment must be provided to take care of the individual requirements of the tube used.

Can Vary Adjustment.
Usually the best point will vary from 18 volts to 22½ volts. The adjustment can be varied to a certain extent by trying the lead from the plate circuit to the positive end of the battery on the different taps provided on practically all "B" batteries. In most cases, however, a finer adjustment than the 1½ volt steps provided by the taps is required and this can be obtained by the use of a potentiometer.

One end (either end, may be used) of the resistance element of the potentiometer is connected with the positive lead of the "A" battery and the other end of the resistance element is connected with the negative lead of the "A" battery.

The negative lead of the filament circuit, as is done in most cases, is connected with the movable arm or contact of the potentiometer. The big variations in the plate voltage are obtained by moving the positive "B" battery lead to different taps of

Good for ALL tubes



Retail Price **\$1.85**
IN CANADA \$2.50
POSTAGE 10¢ EXTRA

Clipping from
Chicago Daily News
October 24, 1923

What Is Meant by a "Carbon Pile" Rheostat?

MORE than 20 years ago, the Allen-Bradley Co. developed a successful compression rheostat for big power circuits. It was made of flat carbon discs and the electric current flowing through the column was regulated by applying or removing pressure on the discs. The idea of the carbon pile was not new, even then, but successful commercial rheostats were unknown.

Graphite discs, however, soon replaced the carbon discs and to this day all Allen-Bradley rheostats are graphite disc rheostats, although many prominent engineers still speak of them as carbon piles.



THE Universal Bradleystat is sometimes called a carbon-pile rheostat. It is, however, a graphite disc rheostat. The discs are produced in an electric furnace under the most terrific temperatures known on earth. Carbon discs, carbon powder, metallic powder or other materials have long since been abandoned in favor of the reliable and noiseless graphite discs.

Your radio set needs a Universal Bradleystat for long-distance range, loud reception and noiseless control. By all means, avoid substitutes. Insist on the Universal Bradleystat.

The Bradleystat Won First Place in the Radio Broadcast long distance contest. The first prize winner used a Bradleystat and the greatest mileage record was made with a Bradleystat. More Bradleystats were used in this contest than the next four types combined. Bradleystat supremacy has become an actual fact through sheer force of superior performance.

Allen-Bradley Co.
Electric Controlling Apparatus
MILWAUKEE, WISCONSIN

287
Greenfield
Ave.



Milwaukee,
Wis.

Just Mail This Coupon!

Allen-Bradley Co.,
287 Greenfield Ave., Milwaukee, Wis.
Please send me your latest bulletin on the Universal Bradleystat and why it improves radio reception.
Name.....
Address.....
.....

"RICO" HEAD PHONES

Patented Dec. 25, 1923

"Rico" head sets are the original ones using the center pole pull on diaphragm. Well known for their sensitivity, loudness and absolutely tuned quality. Now made with superior tungsten steel magnets, better head band, a heavier and better quality cord, sherardized diaphragm, and a number of minor improvements. The higher priced phones are made with tuned (adjustable) diaphragms.

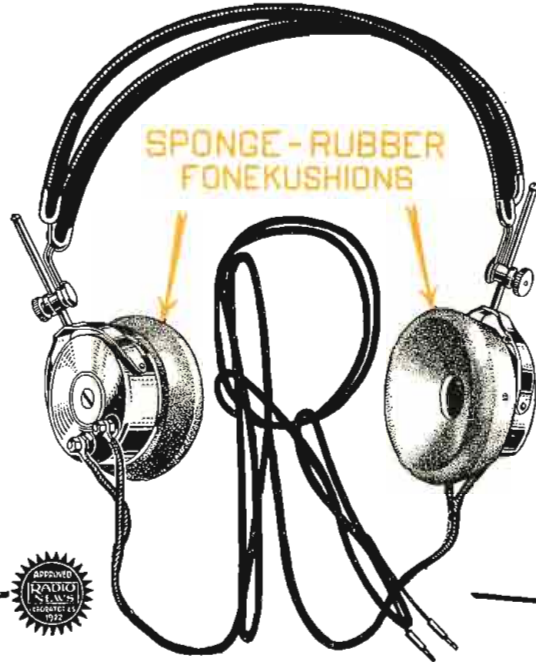

- PRICE LIST**
- No. 6. 2000 ohms (standard non-adjustable) ... **\$3.50**
 - No. 7. 3000 ohms (standard non-adjustable) ... **\$4.00**
 - No. 20. "Rico" De Luxe Tuned (adjustable) 2000 ohms **\$4.50**
Now equipped with sponge-rubber FONEKUSHIONS
 - No. 30. "Rico" De Luxe Tuned (adjustable) 3000 ohms **\$5.50**
Now equipped with sponge-rubber FONEKUSHIONS
 - No. 40. "Rico" De Luxe Tuned (adjustable) 4000 ohms **\$7.00**
Now equipped with sponge-rubber FONEKUSHIONS

All TUNED "Rico" Headsets now equipped with 2 "Rico" Sponge-Rubber Fonekushions. NOW the most comfortable phones in America.

THE "RICO" STRAIGHT LINE CONDENSER

This condenser marks a revolution in condenser building. It is the simplest and most practical type of condenser as yet developed for broadcast and amateur work. This condenser has been developed by our engineers after considerable research work and has been pronounced perfect by experts.

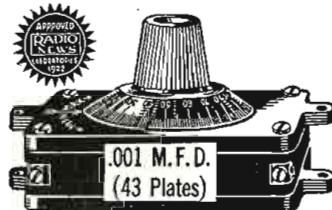

NEW TYPE

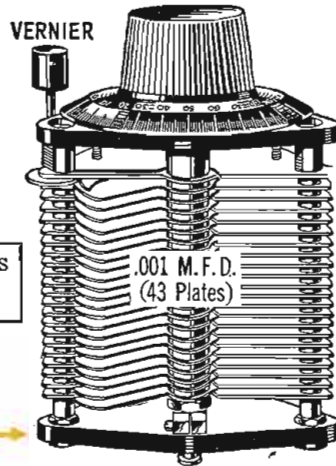

OLD TYPE

- Now manufactured in three types, to replace 43 plates, 23 plates and 11 plates.
- No. 450 "Rico" Condenser .001 mfd. (43 plate capacity) **\$1.75**
- No. 423 "Rico" Condenser .0005 mfd. (23 plate capacity) **\$1.75**
- No. 411 "Rico" Condenser .00025 mfd. (11 plate capacity) ... **\$1.75**
- All above types with out dial ... **\$1.50**

BOTH INSTRUMENTS ARE DRAWN TO SCALE

This Replaces This →

The "Rico" condenser weighs 6 oz. The old style weighs 15 oz. "Rico" vernier type has only one dial. Old type requires difficult mechanism.

Here are Some of the Outstanding Points:

- 1—Large capacity.
- 2—Replaces all standard condensers.
- 3—Uses a minimum of space size, 3½" x 2½" x 1¾".
- 4—For panel mounting or for table mounting—universal in its scope.
- 5—One complete revolution of dial adjusts condenser from minimum to maximum.
- 6—Vernier effect.
- 7—Absolute straight line curve.
- 8—Accumulates no dust between plates as is the case with air condensers.
- 9—Light weight. Condenser only weighs 3 oz.
- 10—Less than 1-10th amount of parts as used in old style mesh plate condenser.
- 11—Can never get out of order.
- 12—Impossible to short circuit.
- 13—Works in any position, vertical or horizontal. No counterweights needed.
- 14—Lowest in price for high class condenser.
- 15—Compactness. Size only 3½" x 2½" x 1¾" over all.

The "Rico" Straight Line Condenser must be seen to be appreciated. Made of the best materials that money can buy. Stands in a class by itself. All metal parts finished in nickel plate. We will refund your money if this condenser is not all we claim for it.

Dealers and Jobbers
Write or Wire for
Territory that is Still
Open for Proposition

RADIO INDUSTRIES CORPORATION

131 Duane Street, New York City

Cable Address: Ricotruda, New York

SEND NO MONEY

Radio Industries Corp., R.N. 3
131 Duane St., New York City.
Gentlemen:—Please send me by Parcel Post, ...
for which I will pay the postman the amount of ...
Name
Street
City State

A Radio Statement to the Public

The Meaning of Coordinated Scientific Research

KEEPING its pledge to the public, the Radio Corporation of America has concentrated its vast research and engineering forces upon the solution of certain fundamental problems facing the art—problems which have become more apparent as broadcasting stations and radio receivers multiply.

The phenomenal expansion of the radio industry, and the universal and ever-increasing appeal of radio, represent an outstanding development of the present century—for this industry has grown from infancy to maturity in a space of but two years.

♦ ♦ ♦

Briefly stated, there is today a necessity for

—*A radio receiver providing super-selectivity*—the ability to select the station you want—whether or not local stations operate. A selectivity which goes to the theoretical limits of the science.

—*Super-sensitiveness*—meaning volume from distant stations—along with selectivity.

—*Improved acoustics*—more faithful reproduction of broadcasted voice and music than has ever been possible before.

—*“Non-radiating” receivers*—a new development, a type of receiver which, no matter how handled, will not interfere with your neighbor’s enjoyment.

—*More simplified operation*—a super-receiver requiring no technical skill, thus making the greatest achievements of entertainment immediately available to all members of the family.

—*A receiver for the apartment house* and populated districts, requiring neither aerial nor ground connection.

—*Another type of improved receiver for the suburban districts*, equally capable to that above, for use where the erection of an aerial presents no problem.

♦ ♦ ♦

Painstaking search in quest of these ideals has led to new discoveries, setting new standards of excellence and performance—discoveries, which have established:

First—that improved acoustics are possible—a matter of scientific research and not of haphazard design—for truly melodious reception.

Second—that dry battery operated sets can be so designed as to give both *volume* and distance.

Third—that the regenerative receiver is susceptible to marked improvement providing selectivity, sensitiveness and simplicity of operation hitherto deemed impossible of accomplishment.

Fourth—that the Super-Heterodyne—the hitherto complicated device requiring engineering skill to operate—could be vastly improved—improved in sensitiveness and selectivity—and simplified so that the very novice and the layman could enter new regions of entertainment and delight.

Watch For Further Announcements

Radio Corporation of America

Sales Offices:

233 Broadway, N. Y. C.

10 So. LaSalle St., Chicago, Ill.

433 California St., San Francisco, Cal.

Radiola

REG. U. S. PAT. OFF.