

OVER 350,000 COPIES OF THIS ISSUE

1927

RADIO NEWS

REG. U.S. PAT. OFF.

MARCH
25 Cents

Over 200
Illustrations



Edited by HUGO GERNSBACK

ASLEEP AT THE SWITCH



RADIO'S GREATEST MAGAZINE

EXPERIMENTER PUBLISHING COMPANY, NEW YORK, PUBLISHERS OF
SCIENCE & INVENTION - RADIO LISTENERS' GUIDE - AMAZING STORIES - MONEY MAKING - RADIO INTERNACIONAL

Cunningham RADIO TUBES

Since 1915—
Standard for all Sets

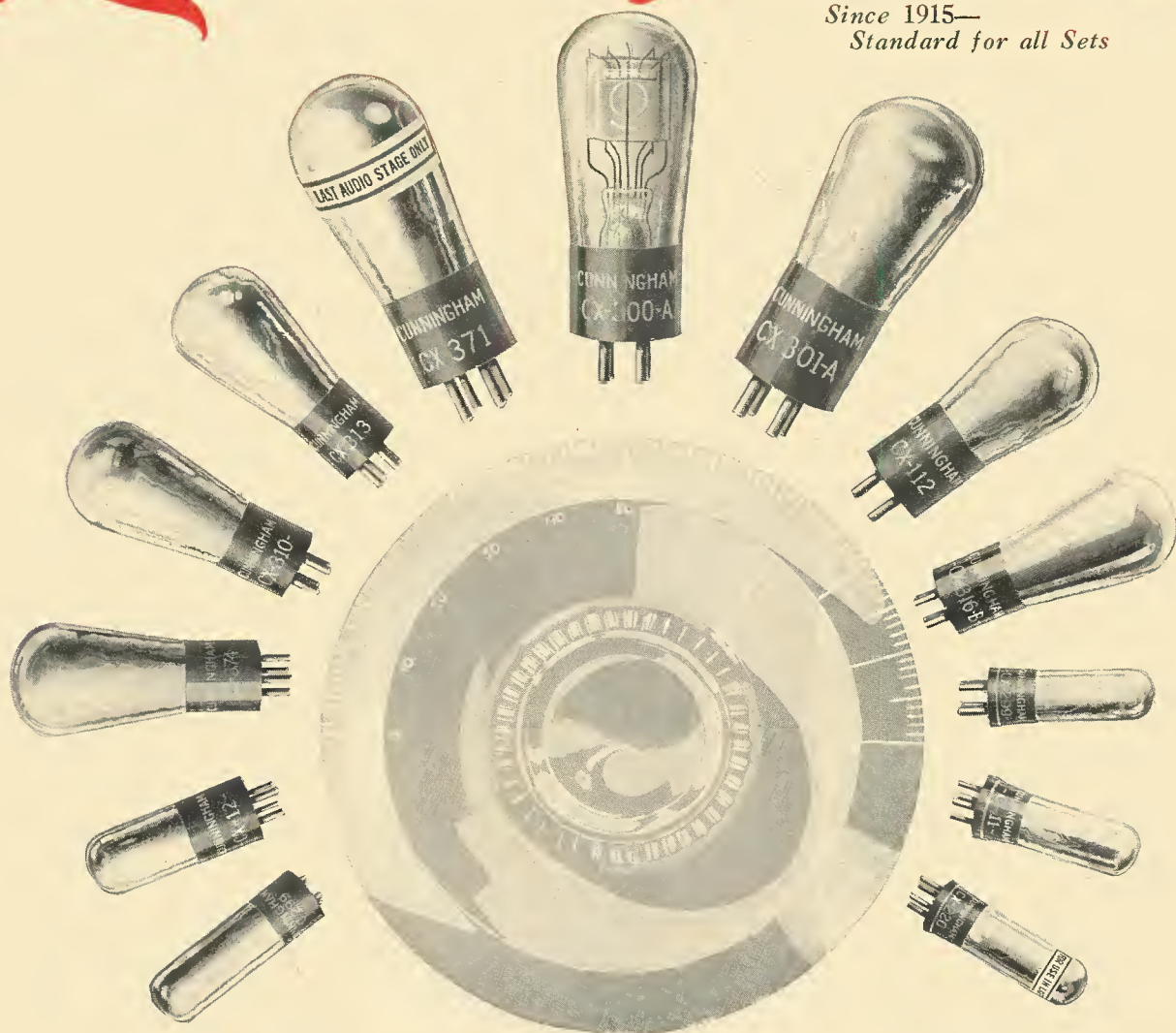

Every Time You Face The Dial

of your receiver, it is in anticipation of real radio enjoyment if Cunningham Radio Tubes are on duty behind the panel. Confidence in the product bearing the Cunningham name has become an habitual attitude of mind among radio-owners of discrimination.

Fifteen Types in the Orange and Blue Carton

E. T. CUNNINGHAM, Inc.,



CHICAGO



C-376

NEW YORK



C-377

SAN FRANCISCO

Manufactured and sold under rights, patents and inventions owned and/or controlled by Radio Corporation of America.

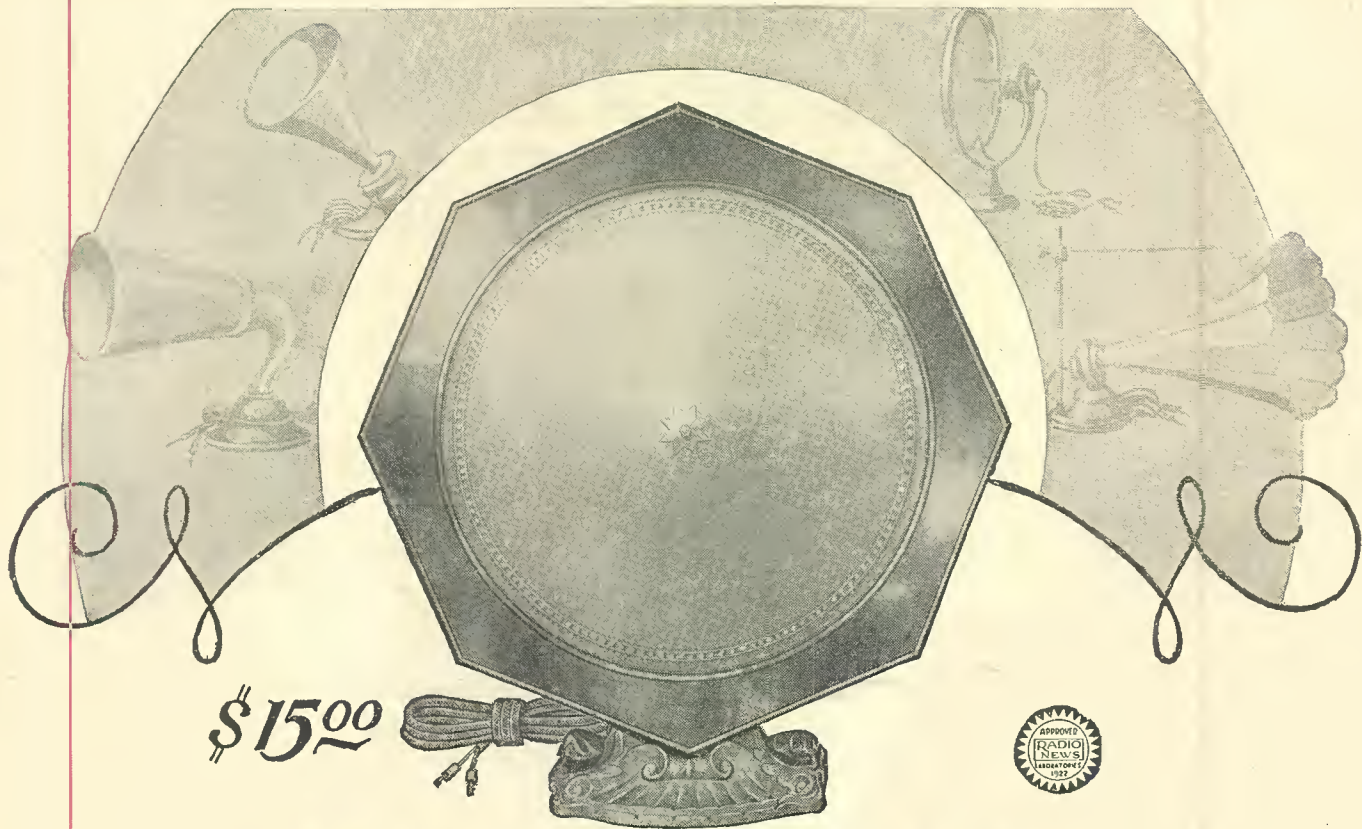

PROGRESS

REMEMBER the first loudspeakers? — they looked like megaphones and sounded worse. And remember the prices. Oh boy! Certainly, tremendous strides have been made in radio acoustics as well as in appearance. Yet most prices remain entirely too high — at least they did until Tower entered the field.

Now, you can buy a speaker of highest quality, such as the new Meistersinger, for only \$15. This cone may be used as a Wall or Table model, according to taste or space requirements. Its powerful direct-drive unit with *eight* connections to cone (*patented*) delivers a tone quality and volume usually associated only with speakers much higher in price. Other Speakers—each a leader in its class—from \$4.95 to \$9.50.

On Sale from Coast
to Coast

TOWER MFG. CORP.,
Boston, Mass.



RADIO NEWS

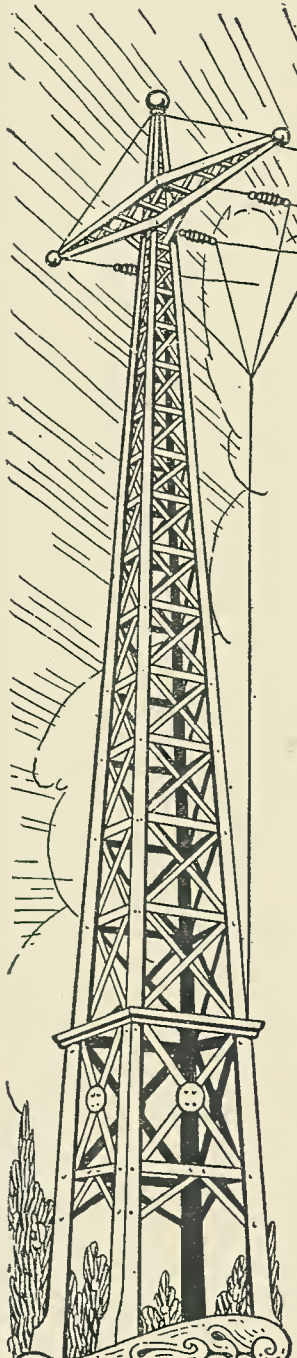

Published by EXPERIMENTER PUBLISHING COMPANY, Inc., Publishers of "Radio News," "Science and Invention," "Radio Internacional," "Radio Listeners' Guide," "Money Making" and "Amazing Stories."
 Editorial and General Offices: 53 Park Pl., New York City
 H. GERNSBACK, President. S. GERNSBACK, Treasurer. R. W. DEMOTT, Secretary.
 Member: Audit Bureau of Circulations Radio Magazine Publishers Association

VOLUME 8

MARCH, 1927

NUMBER 9

Contents of This Issue:

| | |
|---|--|
| What Radio Needs, By Hugo Gernsback 1085 | The Samson R. F. C. Receiver, By Alfred J. Poté 1110 |
| "Hello, London!" "Are You There, New York?" By G. C. B. Rowe 1086 | A Phasatrol-Balanced T. R. F. Receiver, By J. F. Rider 1115 |
| The Navy's Big New Transmitter, By S. R. Winters 1088 | Suggestions on Shielding, By William Le Roy Dunn, Jr. 1119 |
| First Link in English Radio Beam System, By A. Dinsdale 1090 | The Ultra-5 Receiver, By Theodore H. Nakken 1120 |
| A Single-Control Superheterodyne, 3,300 to 39 meters, By F. W. Dunmore 1092 | Wavemeter Calibration from Broadcast Harmonics, By A. Binneweg, Jr. 1125 |
| The Sun, Moon, and Radio Reception Conditions, 1094 | The Construction and Theory of Wave-traps, By James Wood, Jr. 1126 |
| Winners in the \$500 Title Prize Contest, 1095 | Easier Construction for the Experimenter, By C. A. Oldroyd 1128 |
| List of Broadcast Stations in the United States and Canada, 1096 | Progress in Radio, 1129 |
| What Makes "Good" Music Good—Harmony, By Charles D. Isaacson 1097 | Radio Wrinkles—Awards of the \$50 Prize Contest, 1130 |
| Radio News of the Month, 1098 | Correspondence from Readers, 1132 |
| New High Resistances for Radio Circuits, By Joseph Morgan 1099 | Radiotics, 1133 |
| What's New in Radio, 1100 | RADIO NEWS LABORATORIES, 1134 |
| Radio News of the Month Illustrated, By George Wall 1104 | With the Amateurs—"On Short Waves," By J. Bernsley 1136 |
| Horatio at the Bridge, By Robert Francis Smith 1105 | I Want to Know, By J. Bernsley 1137 |
| What Is the Best Loud Speaker, and Why? By H. Winfield Secor 1106 | New QRAs, 1171 |
| A German Portable Superheterodyne, By M. L. Muhleman 1108 | Radio and Fox Farming in Alaska, 1187 |
| A New Development in R. F. Amplifiers, By Robert H. Marriott 1109 | Book Reviews, By Robert Hertzberg 1189 |
| | Current Radio Articles, 1190 |

In Forthcoming Issues:

THE ELECTRIFIED HAMMARLUND-ROBERTS HI-Q RECEIVER

This A.C. receiver has three stages of R.F. and two of A.F. amplification, using 199 tubes throughout; except in the last stage of audio, where a 171-power tube is used.

THE NEW H.F.L. SUPERHETERODYNE RECEIVER

This set has simplified construction and there is a minimum amount of wiring necessary in its construction. Sensitivity is obtained from the four stages of I.F. amplification.

A NEW PUSH-PULL POWER AMPLIFIER

Three stages of power amplification with remarkable frequency-characteristics. This amplifier amplifies all fundamental frequencies without attendant harmonics.

RADIO NEWS is published on the 10th of each preceding month. There are 12 numbers per year. Subscription price is \$2.50 a year in U. S. and possessions. Canada and foreign countries, \$3.00 per year. U. S. Coin as well as U. S. Stamps accepted (no foreign coins or stamps). Single copies, 25 cents each. Checks and money orders should be drawn to order of EXPERIMENTER PUBLISHING CO., INC.

All communications and contributions to this journal should be addressed to Editor, RADIO NEWS, 53 Park Place, New York, N. Y. Unaccepted contributions cannot be returned unless full postage has been included. All accepted contributions are paid for on publication. A special rate is paid for novel experiments; good photographs accompanying them are highly desirable.

RADIO NEWS, Monthly. Entered as second class matter, July 12, 1924, at the Post Office at New York, N. Y., under the Act of March 3, 1879. Additional entry at Long Island City, N. Y., and San Francisco, Calif. Title registered U. S. Patent Office. Copyright, 1927, by The Experimenter Publishing Co., Inc., 53 Park Place, New York. The Contents of this magazine are copyrighted and must not be reproduced without giving full credit to the publication. Copyrighted in Germany. Reproduction of articles in Germany is reserved for Radio, Berlin 42. RADIO NEWS is for sale at all newsstands in the United States and Canada,

and at Brentano's, Ave. de L'Opera, Paris, France. European agents: S. J. Wise Et Cie, 40 Place Verte, Antwerp, Belgium.

HOW TO SUBSCRIBE FOR RADIO NEWS. Send your name, address and remittance to Experimenter Publishing Co., 53 Park Place, New York. Mention the name of the magazine you are ordering. We also publish SCIENCE AND INVENTION, RADIO INTERNACIONAL, RADIO LISTENERS' GUIDE, MONEY MAKING AND AMAZING STORIES. Write clearly.

RATES AND TERMS. The subscription rate for RADIO NEWS is \$2.50 per year. (12 numbers). When remitting do so by check, money order, or registered letter if cash is enclosed. Avoid sending cash through the mail if possible. Subscriptions for less than one year are not accepted. Subscription may be made in combination with SCIENCE & INVENTION, RADIO INTERNACIONAL, RADIO LISTENERS' GUIDE, MONEY MAKING AND AMAZING STORIES.

POSTAGE. We prepay postage in all parts of the United States, Mexico and island possessions. For foreign or Canadian subscriptions we require 50 cents in addition to the subscription price for additional postage charge.

CHANGE OF ADDRESS. Notify us as far in advance as possible. It requires several weeks to make an address change on our records. Always write clearly.

On expiration of your subscription we enclose a renewal blank in our last number to you; we stop our delivery to you on expiration.

General Advertising Dept., 53 Park Place, New York City.

ADVERTISING REPRESENTATIVES

FINUCAN & McCLURE, 720 Cass Street, Chicago, Ill.
 DAVIES, DILLON & KELLY, 15 West 10th St., Kansas City, Mo.
 T. F. MAGRANE, Park Square Bldg., Boston, Mass.

HARRY E. HYDE, 548 Drexel Building, Philadelphia, Pa.
 A. J. NORRIS HILL CO., 5 Third St., San Francisco, Calif.
 412 West 6th St., Los Angeles, Calif.

D. B. Wing
RADIO EXPERT O. D. Tucker, IV Co., Little Rock, Ark. "The Crosley 5-50 brings in twice as many stations as an ordinary set. And the ordinary set generally costs twice as much as the 5-50. Combines great selectivity—good volume and tone quality—with a very reasonable price. Accumulators permit more exact tuning of DX stations. Set is very easy to tune. 46 stations logged one evening, using 25-foot aerial."



L. G. Sawyer
RADIO EXPERT, Electric Parts Corp., Syracuse, N. Y. "37 stations logged with the Crosley 5-50 on an evening when one local (WPKL) was on the air and we are within a half mile of their antenna. The two Accumulators enable you to tune close. Very selective on all wave lengths and brings in low ones wonderfully. Crescendon builds up splendid volume on weak stations."



Harry A. Roberson
RADIO EXPERT, 940 Mass. Ave., Indianapolis, Ind. "Radio wholesaler asked me to help him in selecting a radio from several makes he had in stock. Bad receiving conditions around his home discouraged him. Nothing worked properly. I installed a Crosley 5-50. It was perfect, and I got an order for two more from a man who has a store full of radios at JOBBERS' cost. There's recommendation enough."



EXPERTS say ~ ~

These folks are radio experts—experienced in all its phases, "trouble shooters," service men, salesmen with engineering training, all keen individuals quick to determine true value in the kaleidoscope field of radio.

What they say comes from their actual experience with the leader of the Crosley Radio line—the 5 tube 5-50.

Their enthusiasm in a measure indicates the country wide success of this amazing radio—startling in its operation and its price, and as beautiful in its appearance as in its performance. Also made in exquisite console with genuine Crosley Musicone built in. 5 tube 5-75, \$75. 6 tube 6-85, \$85.

Other Crosley Radios from \$29 to \$98. Electrically operated Batteryless Radios, \$70 and \$95, with power unit at \$50.

New Ultra Musicone, \$9.75.

Super Musicone, \$14.75.

Crosley A. Power Unit, \$45.

Crosley Low Wave Receiver for 20 to 80 meter broadcasting, \$40.

THE CROSLY RADIO CORPORATION
CINCINNATI

Powel Crosley, Jr., Pres.

Crosley manufactures radio receiving sets, which are licensed under Armstrong U. S. Patent, No. 1,113,149, or under patent applications of Radio Frequency Laboratories, Inc., and other patents issued and pending.

CROSLY

- 5 FEATURES**
 Shielded Metal Chassis ~ ~ ~
 Single Drum Control Crescendon ~ ~
 Accumulators
 Power Tube
 Adaptability

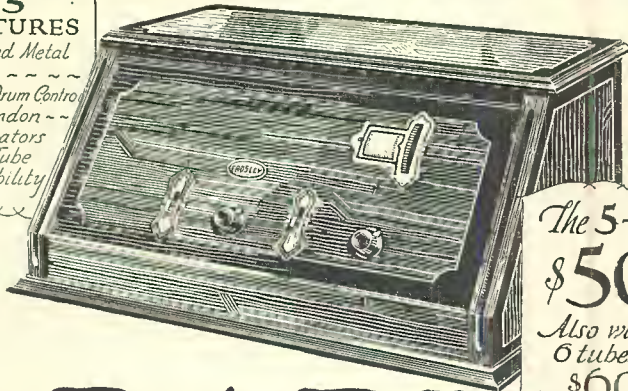

The 5-50
\$50
Also with
6 tubes at
\$60

RADIO

(Write Dept. 22 for illustrative literature)

Andrew J. Shirley
RADIO EXPERT, 510 Church St., Susquehanna, Pa. "I have operated Crosley radios under different conditions—clear and stormy weather, low and high altitudes, inside and outside of buildings and they have proven a wonderful piece of mechanism. In my opinion the present Crosley 5-50 one dial control is without a peer. The Crescendon for use on weak stations is certainly wonderful in bringing in the volume."



E. C. Amundson
RADIO EXPERT, The Radio Shop, New Auburn, Wis. "Never have I had in my six years of experience in radio so much in simplicity, selectivity, volume, distance and tone quality as the 5-50 revealed to me. I have tried out 25 makes of sets this season, but as yet have found none that will compare with the Crosley 5-50. Selectivity is surprising. More selective than three dial sets I have operated." (Sworn statement.)

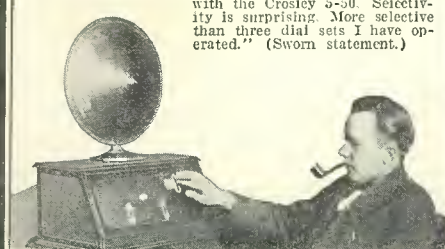

W. F. Gamble
RADIO EXPERT, Chattanooga Electric Co., Chatt., Tenn. "38 programs enjoyed from 9:00 to midnight is a regular evening's entertainment here. Those magic levers—the Accumulators—do their share in bringing to your fireside those stations which are reluctant to answer to the ordinary methods. Crescendon and Accumulators make tuning of large number of stations possible. Single dial makes tuning quick and easy."



Robert S. Adair
RADIO EXPERT, Southern Equip. Co., San Antonio, Texas. "Having an eight tube Super-heterodyne, I have no antenna or ground. I put my finger on the antenna post of the Crosley 5-50 and tuned. Imagine my surprise. I logged 21 stations in an hour and a half. This is a feat seldom equalled."

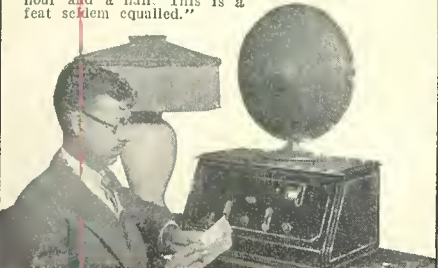

Oran C. Snyder
RADIO EXPERT, Snyder Radio Shop, 2593 New Magnolia Ave., Riverside, Calif. "Eastern range from Riverside exceeds Chicago stations. The 5-50 combined with the Musicone makes a wonderful outfit, and a very reasonable investment. 35 stations enjoyed and logged before 10 p.m. one evening."



O. W. Herb
RADIO EXPERT, Bradley-Duffee Electric Co., Norfolk, Va. "I have been operating radio receiving sets for upward of eight years and am skeptical. No set I have operated compares with your 5-50 in volume and ease of reception. 28 stations logged in one night, probably tops any list compiled by any make of set used in this locality. It is a marvel."



INDEX TO ADVERTISERS

INDEX TO ADVERTISERS

| | Page | | Page | | Page |
|---|------------|---------------------------------------|------------|---|------|
| A | | E | | K | |
| Acme Apparatus Co. | 1172 | Electrad, Inc. | 1150 | Karas Electric Co. | 1187 |
| Acme Electric & Mfg. Co., The | 1148 | Electrical Research Labs. | 1150 | Kellogg Switchboard & Supply Co. | 1179 |
| Acme Wire Company, The. | 1148 | Electric Specialty Company. | 1168 | Kelsay Company, The. | 1152 |
| Aero Products, Inc. | 1176 | Emerson Radval Corp. | 1084 | Keystone Products Co. | 1172 |
| Aerovox Wireless Corp. | 1158 | Engineers' Service Co. | 1187 | Kodel Radio Corp. | 1171 |
| Alden Mfg. Company, The. | 1172 | Erie Fixture Supply Co. | 1150 | Konite Corp., The. | 1157 |
| All-American Radio Corp. | 1064 | | | | |
| All Radio Company. | 1178 | F | | L | |
| Allen-Bradley Co. 1167, 1168, 1173, 1176, 1184 | | Fansteel Products Co., Inc. | 1141 | Lacault Radio Electric Labs., R. E. | 1175 |
| Allen-Rogers, Inc. | 1186 | Ferbend Electric Co. | 1169 | Lacey & Lacey. | 1177 |
| American Hard Rubber Co. | 1140 | Ferguson, Inc., J. B. | 1179 | Lancaster & Allwine. | 1158 |
| Amplion Corp. of America. | 1178 | Ferranti, Inc. | 1178 | Laurel House. | 1156 |
| Anrad Corporation. | 1147 | Fisher, C. C. | 1186 | Lignole Corp., The. | 1185 |
| Armo Radio Laboratories. | 1160 | Formica Insulation Co. | 1163 | Luden, Inc., Wm. H. | 1162 |
| | | Fort Shelby Hotel. | 1187 | Lynch, Inc., Arthur H. | 1150 |
| B | | Freshman Co., Inc, Chas. | 1182 | | |
| Barawik Company, The 1158, 1162, 1172, 1180 | | Frost, Inc., Herbert H. | 1185 | M | |
| Belden Mfg. Company. | 1161 | Furness Bermuda Line. | 1179 | M & H Sporting Goods Co. | 1178 |
| Bellaire Hotel. | 1184 | | | Martin-Copeland Co. | 1182 |
| Bogue, B. N. | 1148 | G | | Maxson, E. P. | 1187 |
| Box 64. | 1172 | Gardiner & Hepburn, Inc. | 1182 | Metro Electric Co. | 1151 |
| Brady, John B. | 1184 | Gearhart-Schleutner Radio Corp. | 1143 | Midwest Radio Corp. Inside Back Cover | |
| Bremer-Tully Mfg. Co. | Back Cover | General Electric Co. | 1173 | Monarch Mfg. Co. | 1185 |
| | | General Radio Co. | 1175 | | |
| C | | Golden-Leutz, Inc. | 1159 | N | |
| C. E. Mfg. Company. | 1170 | Gray & Danielson Mfg. Co. | 1144 | National Carbon Co., Inc. | 1145 |
| Carborundum Co., The. | 1157 | Grigsby-Grunow-Hinds Co. | 1177 | National Company. | 1168 |
| Carlton Mills, Inc. | 1162 | | | National Radio Institute. | 1083 |
| Carter Radio Company. | 1172, 1186 | H | | Naylor, Geo. W. | 1186 |
| Central Radio Labs. | 1184 | Hammarlund Mfg. Co. | 1174 | Newark Electric Co. | 1183 |
| Chemical Institute of N.Y., Inc. | 1155 | Hammarlund-Roberts, Inc. | 1148 | Norden-Hauck, Inc. | 1165 |
| Chicago Radio Apparatus Co. | 1173 | Hampton-Wright, Inc. | 1174 | | |
| Chicago Salvage Stock Stores. | 1166 | Harco Co., The. | 1164, 1178 | O | |
| Chicago Stock Gear Works. | 1160 | High Frequency Laboratories. | 1180 | Omnigraph Mfg. Co. | 1170 |
| Clark & Tilson, Inc. | 1184 | Hommel & Co., Ludwig. | 1162 | | |
| Clayton Radio Products Co. | 1183 | | | P | |
| Conrad Co., Inc., The 1166, 1189, 1190, 1193, 1195 | | I | | Palmer & Palmer. | 1176 |
| Cooper Corporation, The. | 1178 | International Resistance Co. | 1160 | Parker, C. L. | 1148 |
| Copper & Brass Research Ass'n | 1164 | | | Perryman, E. | 1181 |
| Cornish Wire Company. | 1184 | J | | Pilot Electric Mfg. Co. | 1179 |
| Coyne Electrical School. | 1154 | J-M-P Mfg. Co. | 1174 | Potter Mfg. Co. | 1179 |
| Crescent Radio Supply Co. | 1181 | Jefferson Electric Mfg. Co. | 1159 | Premier Electric Co. | 1152 |
| Crosley Radio Corporation, The | 1079 | Jewell Electrical Instrument Co. | 1154 | Press Guild, Inc. | 1146 |
| Culver-Stearns Mfg. Co. | 1177, 1182 | | | | |
| Cunningham, Inc., E. T. Inside Front Cover | | | | R | |
| | | | | Radiall Company. | 1162 |
| D | | | | Radio Association of America 1183, 1186 | |
| Deutschmann Co., Tobe. | 1182 | | | Radio Corporation of America. | 1130 |
| Dodge's Institute. | 1177 | | | Radio Institute of America. | 1156 |
| Donle-Bristol Corp., The. | 1180 | | | Radio News Ensemble. | 1177 |
| Dramatic Publishing Co. | 1187 | | | Radio Specialty Company. | 1153 |
| Dubilier Condenser Corp. | 1150 | | | Randolph Radio Corporation. | 1176 |
| | | | | Raytheon Mfg. Company. | 1178 |
| | | | | Roll-O Radio Corp., The. | 1176 |
| | | | | Rono Mfg. Co. | 1154 |
| | | | | S | |
| | | | | Samson Electric Co. | 1152 |
| | | | | Shure Radio Co. | 1171 |
| | | | | Silver-Marshall, Inc. | 1154 |
| | | | | Smith, B. Hawley. | 1158 |
| | | | | Southern Toy Co., Inc., The. | 1166 |
| | | | | Standard Radio Co. | 1155 |
| | | | | Starrett Mfg. Co. | 1181 |
| | | | | Steinite Laboratories. | 1170 |
| | | | | Sterling Mfg. Co. | 1146 |
| | | | | T | |
| | | | | Thordarson Electric Mfg. Co. | 1172 |
| | | | | Tower Mfg. Co. | 1077 |
| | | | | Townsend Labs. | 1181 |
| | | | | V | |
| | | | | Valley Electric Co. | 1184 |
| | | | | Vinco Mfg. Co., Inc. | 1187 |
| | | | | Vitalitone Radio Corp. | 1186 |
| | | | | W | |
| | | | | Walker Co., The Geo. W. | 1164 |
| | | | | Warren Electric Co. | 1160 |
| | | | | Webster Co., The. | 1171 |
| | | | | Western Radio Mfg. Co. | 1152 |
| | | | | Westingale Electric Co. | 1174 |
| | | | | Windsor Furniture Co. | 1149 |
| | | | | Wireless Specialty Apparatus Co. | 1142 |
| | | | | Wolf, J. W. & W. J. | 1183 |
| | | | | World Battery Co. 1152, 1174, 1178, 1184 | |
| | | | | XYZ | |
| | | | | X-L Radio Labs. | 1180 |
| | | | | X-L Radio Sales. | 1164 |
| | | | | Yahr-Lange, Inc. | 1182 |
| | | | | Yale Specialty Supply Co. | 1168 |
| | | | | Yaxley Mfg. Co. | 1180 |

The New

MULTIVALVE

From the
New York Herald Tribune

—The New MULTI-
VALVE may well
revolutionize the
manufacture and
use of Radio Ap-
paratus.

Dec. 19, 1926

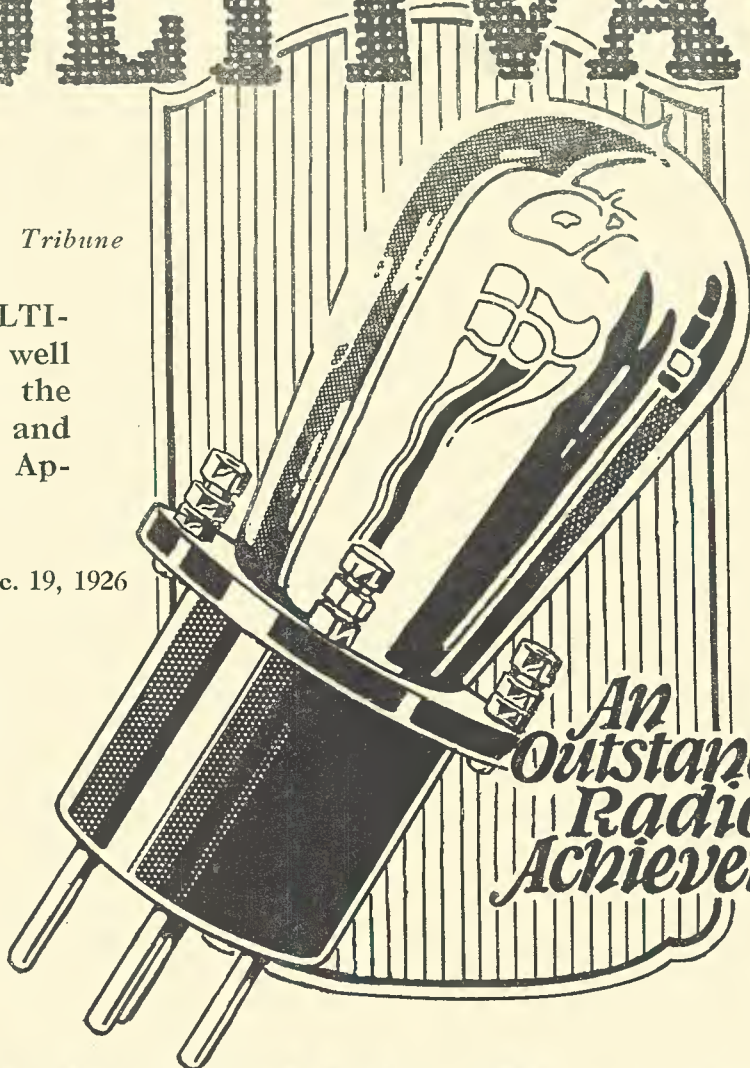

An
Outstanding
Radio
Achievement

Gives
Power, Distance
Quality, Clarity
of Tone, Max-
imum Volume,
Distant Recep-
tion All on the
Loud Speaker

ONE MULTIVALVE—Many tube performance

PRICE
\$6⁵⁰

Emerson Multivalve

Operates on 5 volts ¼ ampere
Dry Cells or Wet Storage Batteries
Tube Can Be Used With Any
Standard Circuits.

Economical in Upkeep
Use Any Standard Socket
The incomparable radio tube that
operates on loud speaker.

In MULTIVALVE we have de-
tector, radio frequency, and audio
—all in one.

Trouble free—No tube noises or
adjusting of various tubes.

One Multivalve will do the work of several tubes in a Radio Set. The radio public has had nothing new in sets or tubes for almost two years. The EMERSON MULTIVALVE has astonished and surprised the radio engineering world. They were skeptical until they heard it. Now they believe in it.

It is a distinctly new achievement—that of incorporating into one tube the necessary elements that will perform the work of many tubes.

With one Multivalve you can build any number of highly efficient circuits in half the space formally needed. This new tube has been rigidly tested by Radio's finest laboratories. A certificate of approval has been awarded on the tube by the RADIO NEWS laboratories.

This tube has opened a new era in Radio—It is the greatest and perhaps the most startling engineering achievement since the original single Vacuum tube. Save space, time and money in building your new Receiver by using the New Multivalve.

If your local dealer cannot supply you, write to us direct.

DEALERS! JOBBERS! Write for Valuable Proposition!

THE EMERSON MULTIVALVE

Patents Pending

EXCLUSIVE LICENSEE and MANUFACTURER

EMERSON RADVAL CORPORATION

25 WEST 43d STREET

NEW YORK, N. Y.

RADIO NEWS READERS' BUREAU

Time and Postage Saver

IN every issue of RADIO NEWS you undoubtedly see numerous articles advertised about which you would like to have further information. To sit down and write an individual letter to each of these respective concerns, regarding the article on which you desire information, would be quite a task.

As a special service to our readers, we will write the letters for you, thus saving your time and money.

Just write the names of the products about which you want information, and to avoid error the addresses of the manufacturers, on the coupon below and mail it to us.

If the advertiser requires any money or stamps to be sent to pay the mailing charges on his catalogue or descriptive literature, please be sure to enclose the correct amount with the coupon.

We will transmit to the various advertisers your request for information on their products.

This service will appear regularly every month on this same page in RADIO NEWS.

If there is any Manufacturer not advertising in this month's issue of RADIO NEWS, from whom you would like to receive literature, write his name, address and the product in the special section of the coupon below.

TEAR ALONG THIS LINE

TO: READERS' SERVICE BUREAU,
 Experimenter Publishing Co., Inc., 53 Park Place, New York, N. Y.

RN-3-27

FROM WRITE YOUR NAME and ADDRESS HERE:
 NAME
 ADDRESS CITY, STATE.....

Gentlemen: Please advise the firms listed below that I would like to receive detailed information on their product as advertised in the.....issue of RADIO NEWS.

DO NOT USE THIS COUPON FOR TECHNICAL QUESTIONS

| NAME | ADDRESS (Street — City — State) | List here specific article on which you wish literature. | If Catalogue of complete line is wanted, check in this column |
|-------|------------------------------------|--|---|
| | | | |
| | | | |
| | | | |
| | | | |
| | | | |
| | | | |
| | | | |
| | | | |
| | | | |
| | | | |

Check here if you are a dealer

Your Dealer's Name

Address

FREE!



"MEN! Here's the 'dope' you've been looking for"

HOW TO GET INTO THE RADIO BUSINESS

J.E.S.

Many Earn
\$50 to \$250 a Week
in Work That is
Almost Romance

If you're earning a penny less than \$50 a week, clip coupon now for FREE BOOK! New Book, profusely illustrated, tells all about the Radio profession, thousands of opportunities—in work that is almost romance! YOU can learn quickly and easily at home, through our tested, improved methods, to take advantage of these great opportunities! Why go along at \$25 or \$35 or \$45 a week, when you can pleasantly and in a short time learn to be a Radio Expert, capable of holding the big pay jobs.

Clip Coupon for Free Book

Don't envy the other fellow who's pulling down the big cash! Our proven home-study training methods make it possible for you, too, to get ready for a better job, to earn enough money so you can enjoy all the good things of life. Most amazing book ever written on Radio tells how—thousands of interesting facts about this great field, and how we can prepare you, quickly and easily in your spare time at home, to step into a big-pay Radio job. You can do what thousands of others have done through our training. GET THIS NEW FREE BOOK. SEND COUPON TODAY.

J. E. SMITH, President
NATIONAL RADIO INSTITUTE
Dept. CB-9 WASHINGTON, D. C.

These Instruments FREE of Extra Cost

All instruments shown here and others—SIX BIG OUTFITS—sent to all our students free of extra cost. Clip coupon now—find out all about this big unequalled offer while you still have time to take advantage of it. Our training is intensely practical—these instruments help you learn to do the practical work. Receiving sets, from simplest kind to thousand-mile receiver. Many other big features.



J. E. SMITH
President

My Radio Training Is the Famous "Course That Pays for Itself"

Spare time earnings are easy in Radio when you know it the way we teach you. Increase your income almost from the start of your course thru practical knowledge we give you. We show you how to hold the job, then our big Free Employment Department helps you get one. Free book "Rich Rewards in Radio" tells how.

Howard B. Luce of Friedens, Pa., made \$320 in 7 weeks during his spare time. D. H. Suitt of Newport, Ark., writes, "While taking the course I earned in spare time work approximately \$900." Earl Wright of Omaha, reports making \$400 in a short time while taking his course—working at Radio in his spare time only! Sylvester Senso, 207 Elm Street, Kaukauna, Wis., made \$500.

And when your training is completed you're ready to step into a real big Radio job like C. C. Gielow, Chief Operator of the Great Lakes Radio Telegraph Company; E. W. Novy, Chief Operator of Station WRNY; Edward Sanko; Chief Operator of Station WGR; and hundreds of other N. R. I. Trained men. The National Radio Institute, originators of Radio Home-Study Training, established 1914, today offers you the same opportunity these men had, under a contract that pledges you full satisfaction or money refunded on completing our training. It's your big chance to get into Radio—mail coupon for FREE Book and proof.

NOW!
Special
Spare Time
Offer
6
BIG
OUTFITS

Radio
Needs
Trained
Men

National
Radio Institute
Dept. CB-9
Washington, D. C.

Dear Mr. Smith:
Without obligating me in any way, send me your big FREE BOOK, "Rich Rewards in Radio," and all information about your practical, home-study, Radio Course.

Name.....

Address.....

Town State.....

SEND THIS COUPON TODAY

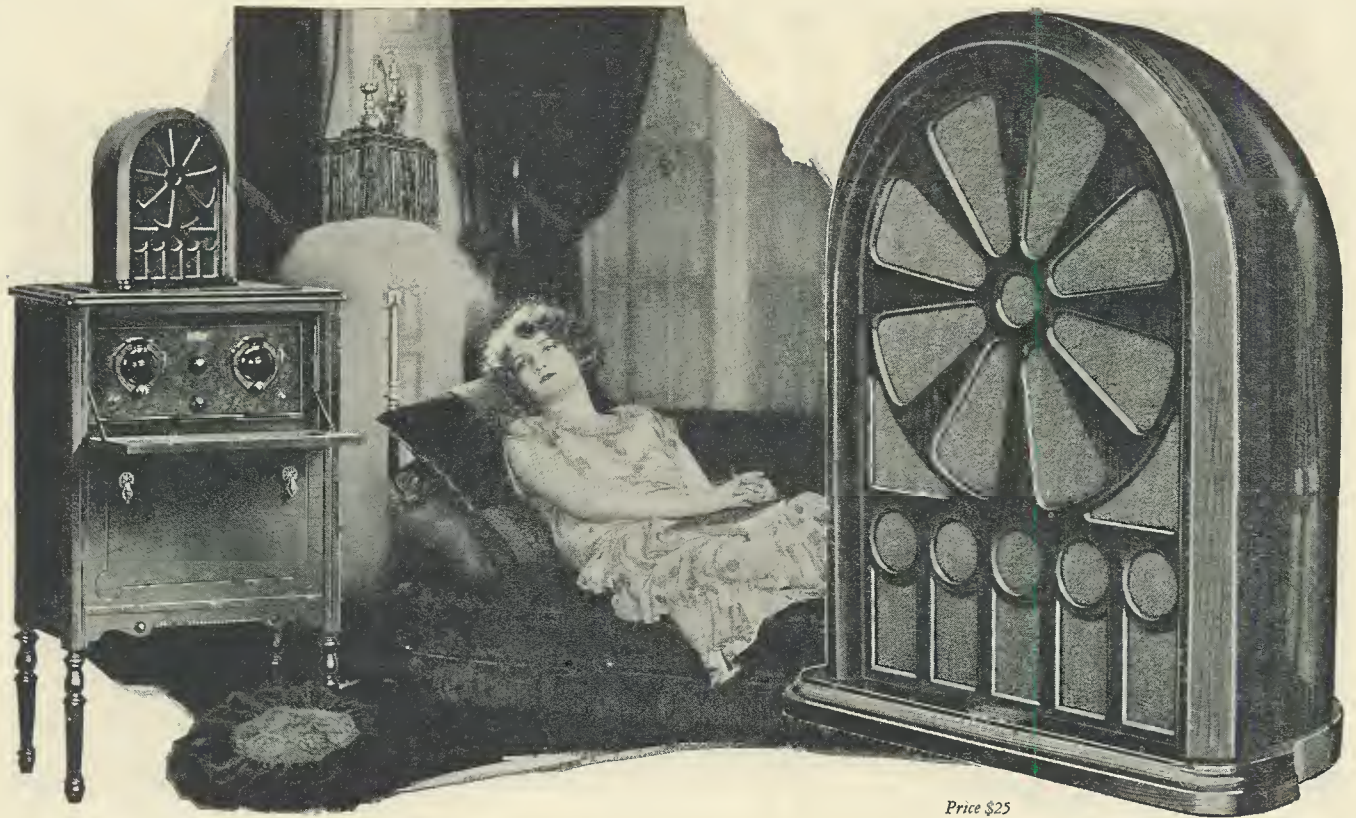

The set illustrated is All-American Hiboy. Priced at \$115.00

Price \$25

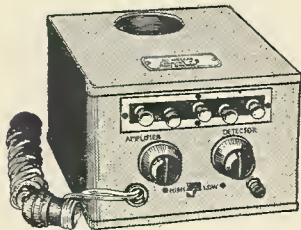

ALL-AMERICAN
Battery Eliminator

For that steady output of unvarying plate current, so essential to fine tone, All-American Battery Eliminator has no superior. It is absolutely noiseless, due to the fine quality of its units. Easy to adjust. Five output taps, the amplifier and detector controls, and the high-low switch, make it easy to obtain any required voltage.

Price \$37.50

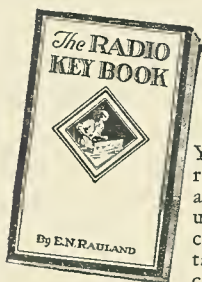

New 1927
Radio
Key Book

You'll find this book worth reading—an interesting analysis of radio, in simple understandable form, and complete constructional details of leading types of circuits. Send 10c (coin or stamps) to cover postage and mailing.



ALL-AMERICAN
REPRODUCER

For more enjoyment, more real satisfaction from your receiving set, use an All-American Reproducer. It has all the best features of cone-type reproducers, with the added advantage of a sounding chamber. It reproduces every tone faithfully; highest treble and lowest bass; without distortion, through the entire amplifying range.

The All-American Reproducer is highly sensitive—preserves the delicate overtones and harmonics so essential to tone-sweetness and quality. It is equally efficient for both voice and instruments.

ALL-AMERICAN RADIO CORPORATION

4209 Belmont Avenue, Chicago, U. S. A.

All-American Radio, Ltd., Toronto, Canada

OWNING AND OPERATING STATION WENR 266 METERS



RADIO NEWS

HUGO GERNSBACK,
Editor and Publisher

EDITORIAL AND GENERAL OFFICES, 53 PARK PLACE, NEW YORK

Vol. 8

MARCH, 1927

No. 9

WHAT RADIO NEEDS

By HUGO GERNSBACK

THESE are still a number of good people in this country and elsewhere who refuse to buy radio sets because, so they argue, receiving sets as a whole are not yet perfected. I have often said this is an incontrovertible fact, and that, indeed, radio sets have not been perfected. I have also said that the same holds true of practically everything that one can think of.

The man who refuses to buy a radio receiver because he claims it is not as yet perfected blithely goes and buys a new automobile, knowing full well that the automobile has by no means been perfected. The tires still blow out; the carburetor is still unperfected; spark plugs, in spite of all claims to the contrary, still foul; carbon still collects in the cylinders and must be removed periodically,—but why go on with the list? What is true of the automobile just mentioned is true of radio, and of the human machine as well. Although human beings have been “manufactured” for millions of years, they have not as yet been perfected, and probably they never will be. In the meanwhile we do admit, and do insist, that radio has made far greater progress in the short time since its inception than have the automobile, phonograph, and many other mechanical and electrical utilities.

In the meanwhile, no sane person will find it logical to condemn a radio set or even look upon it with suspicion, simply because it has not been perfected. If radio survives for the next 10,000 years, there will always be some new improvements made; but even then the radio will not have been perfected 100 per cent. Perfection is humanly impossible.

In the quest of improvements in radio there are, however, a number of stages which, during the next few years, no doubt, will be attained. Not that these will revolutionize radio science in any way, but they will make for better radio.

The following are just a few random thoughts that occur to me about details wherein radio can be improved and most likely will be improved during the next decade.

In practically all of our receiving sets today we have coils (inductances) and tuning condensers. It is admitted by most engineers that the condenser itself serves no indispensable purpose, in the last analysis, that is, for the purpose for which we utilize condensers today. The condensers are used to change the wavelength of the coil, but the same result can be obtained by using a coil without a condenser. The variometer is such an instrument and was used quite extensively, but its range was not sufficient. It could not be made to tune sharply enough.

There is still another way of tuning a coil, namely by making a sort of harmonica of the coil; that is, by opening and closing the convolutions of the coil—in other words, by pulling the coil out and letting it go back again. Excellent tuning can be done in this manner, but, so far, it has not been found practical. There may be some other ways of arriving at the same thing, and sooner or later, in my opinion, the condenser will not be used at all for tuning purposes. It is worth while to give some consideration to this problem. It is thought that the condenserless receiver will have less losses and will give far greater efficiency than the sets we now use.

The next great important step is the cold vacuum tube. There is no new thought here, either, because our physicists and research engineers have busied themselves for years along these lines; but I predict that the cold vacuum tube will be with us during the next ten years. At the present time we require expensive “A” batteries or “A” eliminators for only one purpose, and that is heating the filament of our tubes. We heat the filaments for one reason only, and that is to get an *electronic flow* to bridge the empty space, otherwise called vacuum, which surrounds the essential tube electrodes. The electronic stream is necessary for the operation of a radio

tube and, in order to get such a stream of electrons, which may, in popular parlance, be termed “conductive particles,” the “A” battery is required.

We know that it is possible to effect an electronic stream without the use of a glowing filament. For instance, radium will supply such a stream. But radium is too expensive to use practically. DeForest suggested and patented its use in a tube many years ago, but so far it has not been used, for economical reasons. There are, however, other materials and combinations that are able to give out an electronic stream, without using an “A” battery, and relying only upon the “B” battery or 110-volt-lighting current to do the trick. Such tubes will be made practical and will be used during the next decade. They will not revolutionize radio by any means, but will better our reception, do away with tube noises, and eliminate one of the greatest bugaboos with which radio has to contend. I speak of burnt-out tubes.

The greatest immediate need that faces the radio set-building industry is, no doubt, the sharp-tuning set. During the past few months new stations have been added to the list at an astonishing rate; and it is not likely that, even with the enactment of radio legislation, these new stations will be compelled to close up.

Even if there is a rearrangement of wavelengths, there will still be tremendous congestion in the ether; and, the more sensitive receiving sets become, the worse the conditions logically must be. Unless such sets are of great selectivity, it will be impossible to tune in any one station without receiving one or more in the background on the loud speaker. The crying need, therefore, is for sharper and sharper sets, particularly in our larger cities, where dozens of stations operate simultaneously. I predict that this will be the greatest problem of this season's radio-set builders; because people will refuse to buy sets this year unless

the prospective customer can be shown that he can get the stations which he wants without having three or four which are not wanted thrown in, at the same time, for good measure.

There are, of course, several such sets on the market even today, but the majority of sets do not tune so sharply. The sooner the manufacturers realize the urgency of this popular demand, the greater will be their sales. I have stated before that I am in favor of loop sets for congested districts. They seem to be the only real solution at the present time; because, with the loop set, it is possible to tune out the unwanted interference, by simply shifting the loop itself, and thus get rid of most of the interference. This seems to be the best solution today for the problem of obtaining sharp-tuning sets, and more and more manufacturers are coming to realize just this.

Many years ago I maintained that the outdoor aerial was doomed, and each year sees the fulfillment of this thought. Outdoor aerials today have no purpose in a great city; they defeat their own purpose by their numbers. When you see some of the apartment buildings garnished with as many as fifty aerials, a schoolboy could figure out that the efficiency of each one cannot remain very high. But the public at large has as yet not been educated to the use of a loop, although the time is at hand when such education must proceed rapidly. This condition does not, however, prevail throughout the country. In rural districts the aerial is still the best bet, because in such situations the ability of the set to obtain distance is really imperative and, fortunately, the aerial is far more efficient in the country than in the city. The reason for this is, of course, simple. In the first place, the absence of tall steel buildings, which absorb a great deal of energy, makes for better reception in the country. Furthermore, on the country home there is only one aerial; consequently no interference from others nearby, which is the case with most aerials in the city.

... In which the Editor again cheerfully acknowledges that Radio has not reached its full perfection—and points out that nothing else has—he predicts a few improvements which may be expected—such as more efficient tuning methods and “cold” vacuum tubes—why the set of the future necessarily will be more selective than any we now have—why the city dweller must rely more and more on the use of the loop to pick up signals—and why rural fans still require aerials. . . .

Mr. Hugo Gernsback speaks every Monday night at 9 P. M. from station WRNY on various radio and scientific subjects.

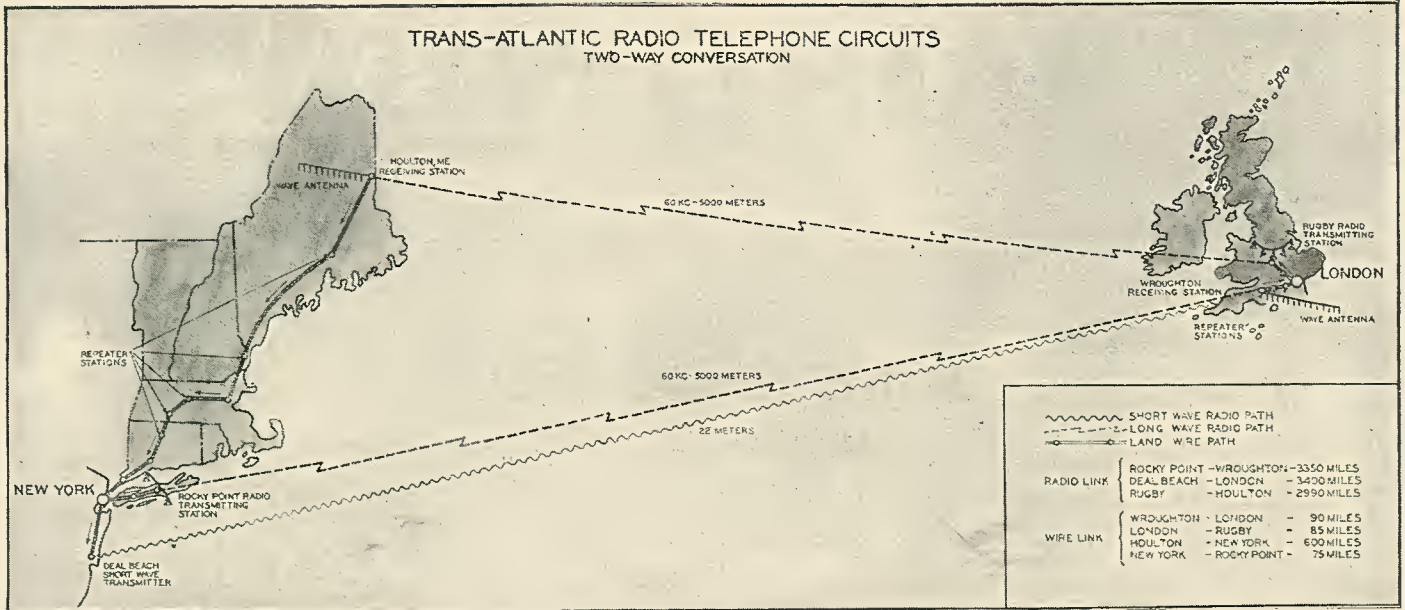

Transoceanic radiotelephony follows the paths indicated in the map. The distances between the points are given in the accompanying table.

“Hello, London!” “Are You There, New York?”

Describing the Transatlantic Radiotelephone System and Apparatus

By G. C. B. ROWE

ON Friday, the seventh of January, 1927, in New York and London, simultaneously, the first commercial transatlantic radiotelephone service was made available to the public. At 8:30 a. m., President Walter Gifford, of the American Telephone and Telegraph Co., spoke the words, “Hello, London!” into a telephone transmitter in the offices of the company on lower Broadway, New York. Almost instantaneously came back the reply of Sir Evelyn P. Murray, the secretary of the British post office. From then until late in the afternoon, messages of all kinds were flashing back and forth between the two greatest cities of the world.

Apparently the toll of \$25 a minute was low enough, for the operators at both ends of the line were besieged with applications for connections; and in order to accommodate even the major portion of the calls, it was necessary to extend the time of communication beyond the intended closing hour of 1:30 A. M., New York time.

IN the December, 1925, issue of RADIO NEWS, there appeared an article entitled, “Transatlantic Radio Telephony,” and under the title were these words, “Transatlantic telephony by radio will probably be opened to the public within the next twelvemonth, if present plans do not go awry.” These plans have not gone awry; and today it is possible for a man to put in a call from his desk in New York City and, within a relatively few minutes, talk with someone in London by Radio.

Radio has made another giant stride forward and it does not seem unreasonable to predict that, within a short time, we shall be able to talk from any point in the United States to any point in western Europe, utilizing, of course, the radiotelephone, with practically no changes from the form in which it is used today. —EDITOR.

SINGLE-SIDE-BAND TRANSMISSION

The principle of the system of radiotelephony employed in the transatlantic service is that described in the December, 1925, issue of RADIO NEWS, and differs considerably from that employed in ordinary broadcast transmission and reception. The latter is effected through the medium of a “carrier wave,” the modulation of which creates two attendant “side-bands.” This is common knowledge to most radio fans. In order to conserve power, and for other reasons which will be explained, the transatlantic service employs but one side-band; the other, as well as the carrier wave itself, being suppressed by a suitable system of filters.

An important factor in the transatlantic transmission is the use of the piezo-electric crystal, such as governs standard-frequency broadcasts. This keeps the oscillator of the transmitter exactly on its fundamental wavelength, a most desirable precaution where speech is so costly; for even a slight variation in the frequency would make the speaker difficult to understand at the receiving end.

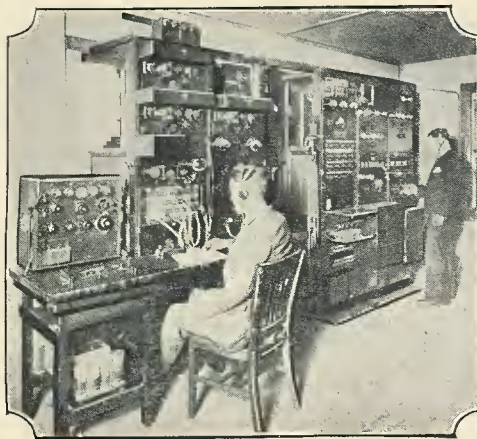

The radio receiving station at Houlton, Maine, which is connected by land-line with the New York exchange.

© International Newsreel.



A part of the 7250-foot antenna at Rocky Point, L. I., where the telephone messages are put “on the air.”

© International Newsreel.

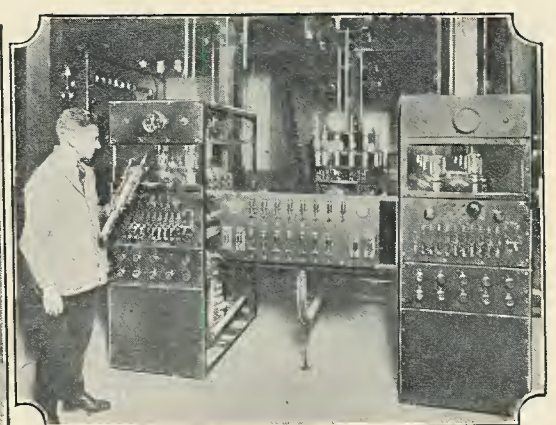

A few of the giant vacuum tubes, used in transmitting telephone messages from New York to London, seen in the amplifiers at Rocky Point.

© Wide World.

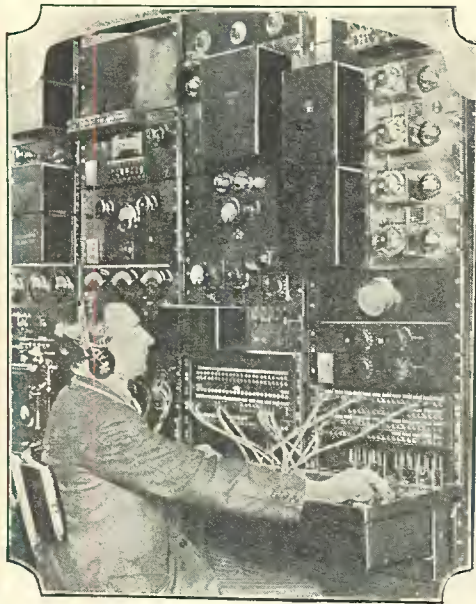

At the left is the English end of the trans-Atlantic telephone system. The operator is seated before the control panel with the various lines going to the London exchanges. At the right is shown a circular bank of fifteen 10-K.W. water-cooled vacuum tubes used in the final stage of amplification.

© Wide World.

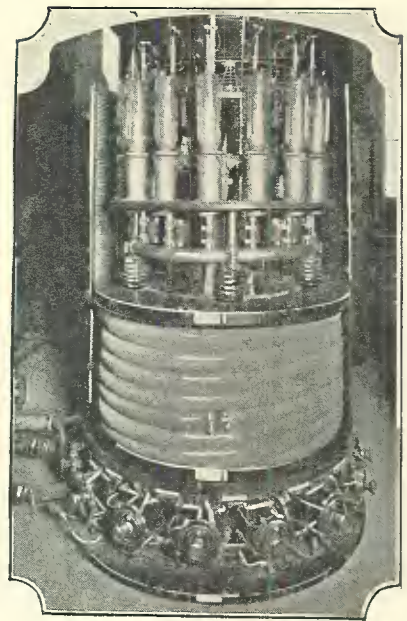

Below is the main power panel at Rocky Point for all circuits except the high-voltage. About fifty signal lights at the operator's left indicate failure in any of the circuits.

Photo by courtesy of Amer. Tel. & Tel. Co.

Below is the final stage of the high-power amplifier at the Rugby station. In the background are the banks of the 10-kw. tubes and in the foreground the instrument and signal panel.

Photo courtesy of Amer. Tel. & Tel. Co.

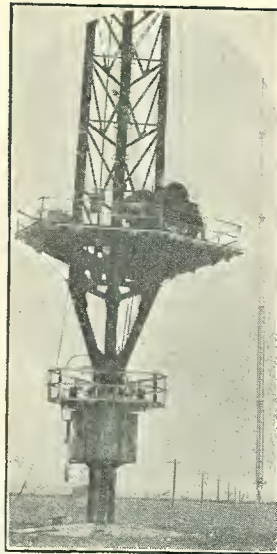

Above is part of the antenna system at Rugby, England. These masts are 820 feet in height.

© Herbert Photos, Inc.

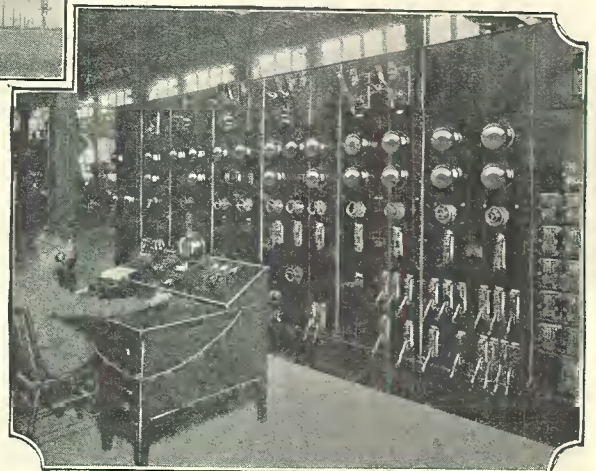
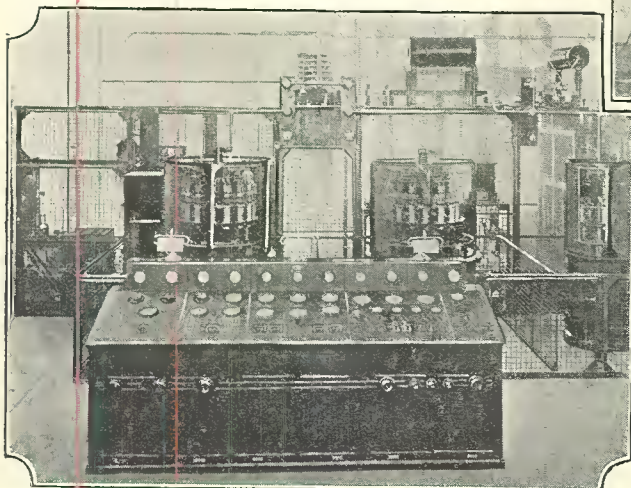

NEW YORK SPEAKING

Let us trace the progress of a call from a telephone subscriber in New York to an Englishman with whom he desires to speak. The former calls the long-distance operator in New York and informs her that he wishes to speak with Mr. Londoner at Mayfair 4321. "Long Distance" communicates with the transatlantic operator, at the American transmitting station, Rocky Point, seventy-five miles out on Long Island. This operator, who must be a man skilled in technical radiotelephony and telegraphy, operates a buzzer working on 1,500 cycles, and places with the corresponding operator at Wroughton, in England, a call which is automatically registered on a tape, thus obviating mistakes in the understanding of numbers and names.

The Wroughton operator, who is at the English receiving station, then communicates through the trunk-wire (English long-distance) operator the call for Mayfair 4321 in London. When the necessary connection to the Englishman's phone has been completed, the London operator informs the New York operator (by voice) that all is ready, and the connection is made to the phone where the New Yorker is awaiting his call.

These operations will normally take but a few minutes, and the telephone subscribers can communicate with each other as readily

as in the ordinary long-distance conversation over land-lines. At the conclusion of the call the replacement of the receivers on their hooks indicates, by the customary flashing of lights, to the station operators that the exchanges have been disconnected automatically from the radio station, and that another call may be put through.

All this sounds more or less easy and expeditious; but in order to make it so and span the Atlantic Ocean with the human voice, it has been necessary to design and construct stations and apparatus costing \$5,000,000. All of this equipment is in use for a single conversation, as no "duplexing" methods are yet in use.

STEPPING UP THE SPEECH CURRENTS

Let us first consider the amplifiers. From the time the American subscriber speaks into the transmitter of his telephone in New York, until the signal has reached the Rocky Point station, the signals are carried at the ordinary low telephone voltage, as they would be to Philadelphia, for instance. At the transmitting station, however, the audio-frequency currents produced by the voice are led into a speech amplifier, and used to modify a carrier wave of 30 kilocycles (30,000 cycles = 10,000-meter wavelength).

Now, in order to make more clear the ex-

planation of the method of eliminating the carrier wave and one side band, it may be noted that the ordinary frequencies used in sound reproduction over the telephone range from 200 to 5,000 cycles. It is not necessary to take into consideration the higher and the lower frequencies required to give an exact reproduction of some musical instruments. For the sake of clearness in describing procedure, we will assume that the band of voice frequencies is just 5,000 cycles in width. This band of frequencies, originating at the telephone in New York, has been transmitted unchanged to the station at Rocky Point, where it is amplified 2,000,000 times. Representing 250 watts of power (a third of a horsepower) it is then used to modulate the first, or 30-kilocycle carrier wave.

HETERODYNING THE CARRIERS

Now, when this carrier wave is heterodyned by the voice-frequency band, there are created two sets of beat notes, one ranging from 25 to 30 kilocycles and the other from 30 to 35 kilocycles. In other words, we have a "sum" and a "difference" band, one above and the other below the 30-kc. carrier. By means of proper filters any band of frequencies can be eliminated from a circuit; and in

(Continued on page 1184)



The Navy's Big New Transmitter

Initiating A Policy of Tube Transmitters In Place of Arc Sets

By S. R. WINTERS



THE huge radio sending apparatus illustrated on this page has just been installed in the naval station at San Diego, Calif., for the purpose of direct communication with land stations and naval vessels in the area of the North Pacific ocean, as well as with the naval station at Annapolis, Md. It is stated to be the most powerful vacuum-tube transmitter at present in service for telegraphic communication, anywhere in the world; and has four times the power of the biggest one of similar type previously used by the navy.

This Goliath is capable of radiating 80 kilowatts of electric energy, or 60% more than the highest-powered broadcast station; but it will not be used for telephone or broadcast work, and owing to its very long wave (approximately 10,500 meters) will not be picked up by broadcast listeners. Its transmissions will be all in the "Continental code," familiar to amateurs.

In installing the transmitter, the radio division of the Bureau of Engineering, U. S. Navy, has inaugurated a policy which may bring about, in a few years, the complete elimination of the arc transmitters now in use in its high-power stations. The first transmitters used in the navy's stations were of the spark type, which radiated a discontinuous or "damped" wave. These were replaced by arc transmitters of the present type, which were a great improvement and increased efficiency in communication, because they radiated a continuous or "undamped" wave. The tube transmitters, however, are now displacing the arc transmitters because, among other reasons, of their higher

efficiency and lower operating cost, according to claims.

REDUCTION OF INTERFERENCE

In adopting the tube transmitter the Navy officials were influenced by a desire to lessen the interference from which broadcast listeners have often suffered. The arc transmitters have always been a source of trouble in this respect, because they produce arc "mush" and harmonics. Because of the rapid growth of broadcasting, this is being felt more and more; and the navy is now co-operating with the Department of Commerce to clear the air of interference for the benefit of broadcast listeners. Thus NSS, the

On the right are the units in which are mounted the transmitting vacuum tubes and the water system for cooling them.

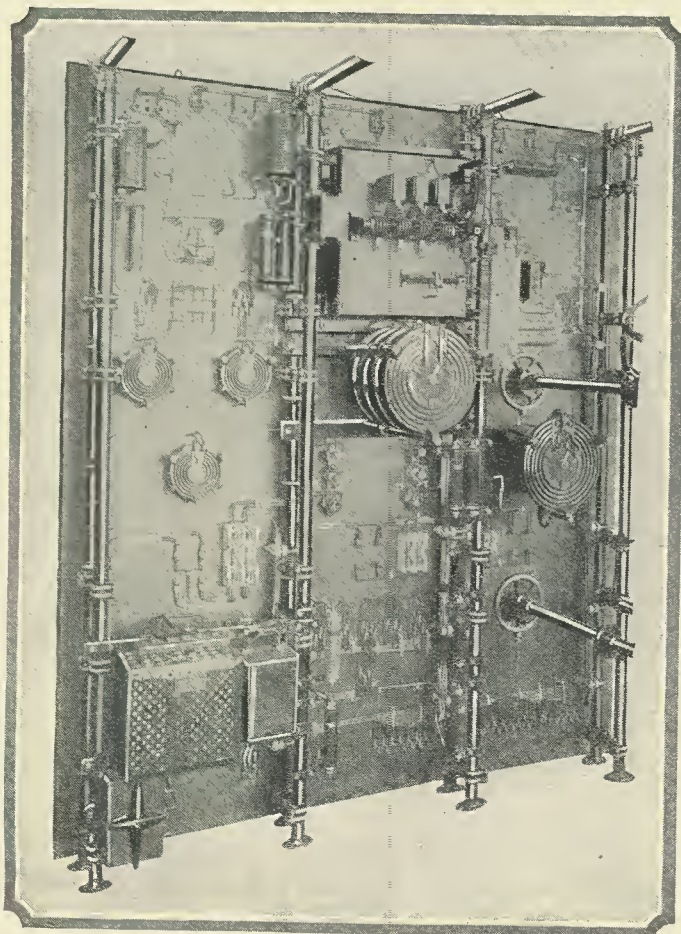
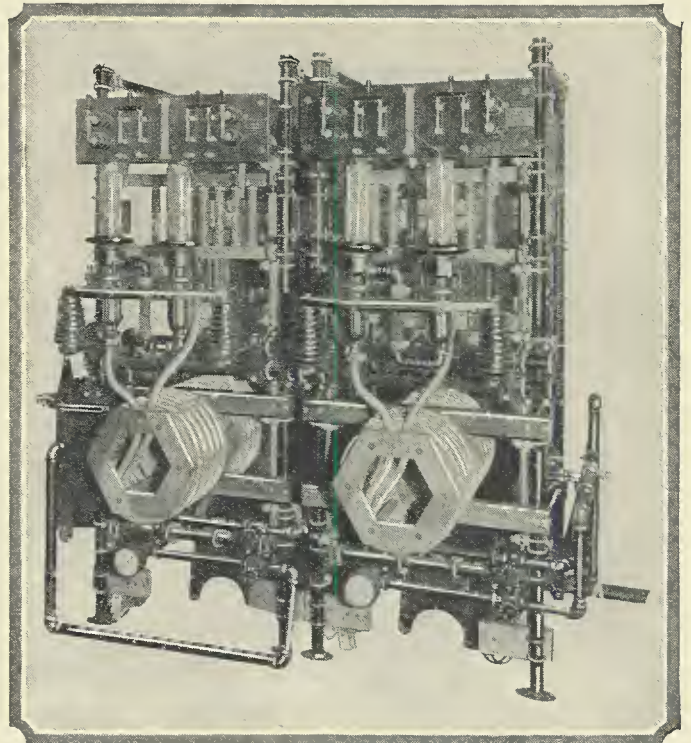

highest-power Government station, located at Annapolis, only a few miles from Washington and Baltimore, is shut down two hours every evening—from eight to ten o'clock—in order that local set owners may enjoy programs from nearby studios. The Annapolis station has two arc transmitters, each rated at about 300 kilowatts; and except for the daily silent period, it is in nearly continuous operation, communicating with various European and South American countries as well as the Navy's Pacific Coast stations. With a tube transmitter of equal range installed, the station could be operated twenty-four hours per day, due to the freedom of the tube transmissions from "mush," and harmonics.

GREATER ECONOMY OBTAINED

Before bids on the new transmitter were solicited, a comparison was made, between the Annapolis installation and the proposed tube transmitter, which re-

A view of the rear of the control panel for the rectifier and motor-generators.

Photos by courtesy of General Elec. Co.

vealed some rather startling information.

For instance, it was found that the 80-kilowatt tube set would deliver more current to the antenna and have a greater communication effectiveness than the 300-kilowatt arc has at present. It was found that, even after the cost of the vacuum tubes was deducted as an operating charge, the tube set would pay for itself through the saving in power bills alone in less than four years. This is brought about by the fact that the tube transmitter, due to its higher efficiency, draws only (approximately) 150 kilowatts when the sending key is depressed and only a small fraction of this when the key is up, which is estimated to be about two-thirds of the time. This is in marked contrast to the arc transmitter, which requires about 300 kilowatts, or twice as much power; this amount is consumed all of the time the arc is in operation, regardless of whether the key is up or down. The only energy consumed by the tube transmitter, when the key is up, is that required to light the filaments of the vacuum tubes.

Other points in favor of the tube transmitter are its simplicity and the ease and quietness of its operation. The arc must be manually started. It is generally operated continuously for considerable periods, because it is impracticable to shut it down for a few minutes at a time. It requires cooling water at about thirty to thirty-five pounds pressure; whereas the tube transmitter needs only about one-fifth as much water and at only five pounds pressure.

The arc transmitter has approximately sixty relays, all of which operate simultaneously. These must be maintained in good condition. If the adjustment of the contacts is not perfect, a ragged signal is the result. The relays are very noisy in operation. It is very different with the tube transmitter, which has only one very small high-speed relay, carrying practically no current and having no sparking at the contacts to destroy them quickly. The tube

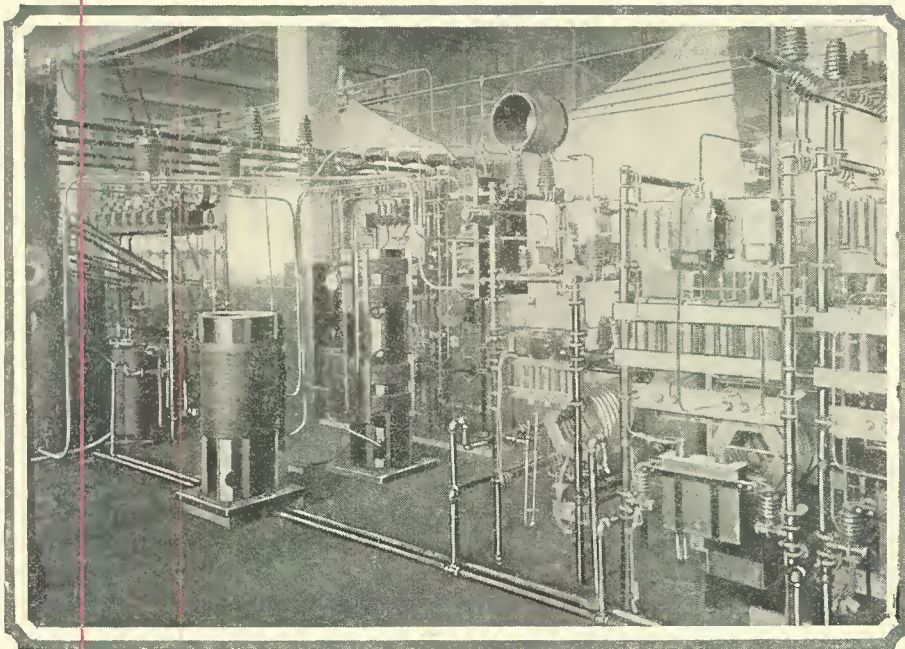

An idea of the wiring of the 80-kw. transmitter may be had from this illustration. Note that tubing is used, for the most part, instead of busbar.

transmitter is quiet in operation, the only noise being the running of a small motor-generator set which is used to light the filaments. The tube transmitter may be easily arranged for remote control, not only of the keying, but also of starting and stopping. This means that the operator in the Navy Department's radio central in Washington could have complete control of the transmitter at Annapolis, some thirty miles away.

The present arc transmitter of the Annapolis station has a compensating wave in addition to its "fundamental," and thus utilizes two communication channels. The "keying" of the transmitter is effected through short-circuiting a portion of the antenna loading inductance, this action changing the wavelength a few meters. The wavelength has one value when the key is down and another when the key is up, but the transmitter is radiating energy all the time. The tube transmitter utilizes only one communication channel and radiates only when the key is depressed. With the present congestion in the ether and the limited number of available communication channels, this becomes an important feature.

MULTIPLE-TUBE INSTALLATION

The 80-kilowatt tube transmitter at San Diego is of the latest type, using a 6-phase vacuum-tube rectifier to furnish direct current at 15,000 volts to the plates of the oscillator and amplifier tubes, which draw 7.5 amperes of current. The rectifier operates from ordinary commercial 60-cycle, 3-phase power. This alternating current is first stepped up to a high voltage by means of a transformer and then, passing through six keneiron tubes, is converted to direct-current power. A suitable filter, consisting of condensers and choke coils, is used to smooth out the ripple in the rectified current.

For the transmitter proper, the master oscillator-power-amplifier circuit is used in conjunction with a "tank" circuit to insure the elimination of harmonics from the radiated output. The master oscillator uses a single tube which generates the radio-frequency oscillations. These are then fed into the power amplifier, which comprises several pairs of "push-pull" units operating in parallel, on exactly the same principle as the smaller units now popularly used in a number of radio receivers and power am-

plifiers for loud-speaker work. The only difference is that their output is several thousand times that of the receiving instruments. The power output is controlled through regulation of the plate voltage or of the number of "push-pull" amplifier units in operation. Either way keeps the efficiency at a high point.

The tubes used are of the 20-kilowatt metal type, water-cooled, known as model UV-207.

JAPAN ORDERS BIGGEST TRANSMITTER

In order to obtain direct telegraphic communication with Western Europe, the Japanese Wireless Telegraph Co. has recently placed an order in Germany for a 600-kilowatt transmitter, which it is hoped to put in operation by the middle of 1928. A part of the work, it is officially explained, will be done on reparation accounts.

The new Japanese station, which, it is asserted, will be the most powerful in the world when installed, will have eight towers, 820 feet high, with $1\frac{1}{2}$ -inch guy "wires," and sixteen antenna wires with an effective radiating height of 640 feet. The R.F. energy will be generated by two transformers of 900-kv.-amp. size, and the antenna output will be 150,000 meter-amperes. The receiving station will be equipped with four double-loop receivers, picking up waves between 2,400 and 24,000 meters in length.

MONSTER BROADCASTER PROPOSED

Even this gigantic structure is to be surpassed, if the ambitious plans of the "Radio Peredacha," or Russian official radio authority, as reported from Moscow, are to be carried out. In addition to the seventy-five new transmitters called for, ranging from 500 watts to a super-power fifty-kilowatt at Taschkent, all of which it is hoped to erect this year, the scheme is to link all the enormous area of Russia to its central authority by building a 1,000-kilowatt broadcast station near Moscow. By this gigantic energy emission, it is hoped to make reception of the station possible with a simple crystal set, anywhere in Russia.

Another high-power broadcasting station for which contracts have been let is to be erected by the government of Finland out of the proceeds of a recent loan. It is to be of 25-kw. power and cost eight million marks (\$267,00).

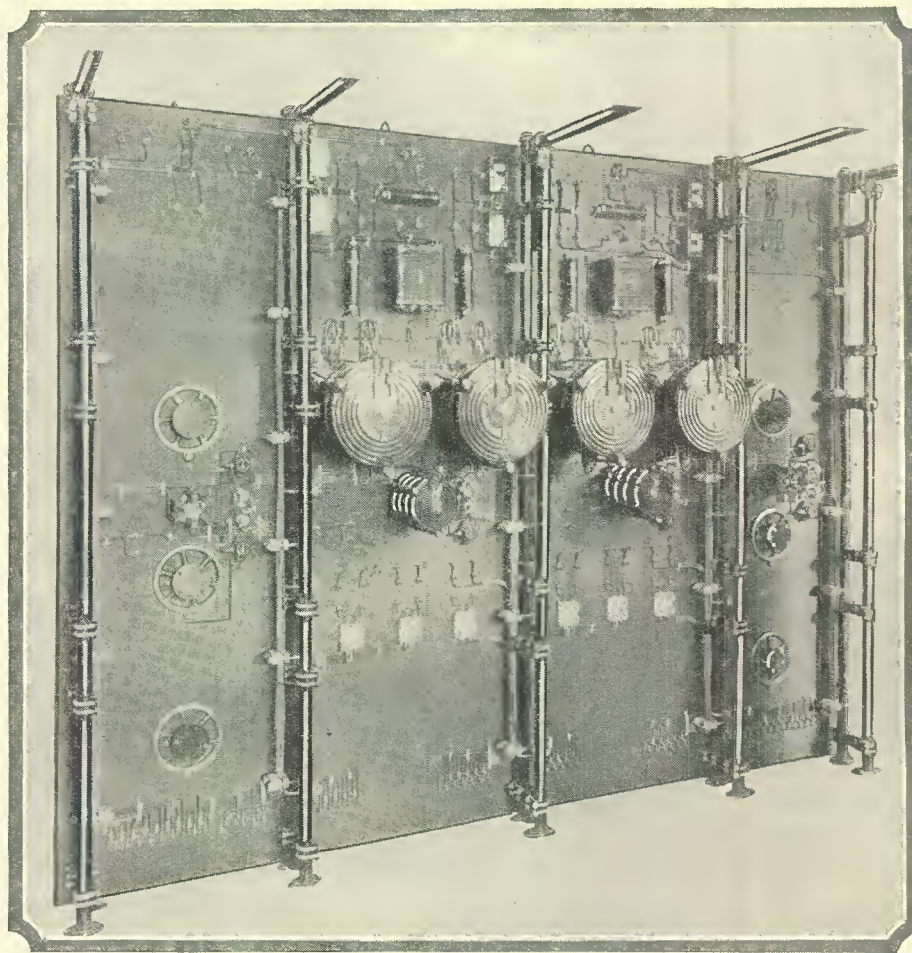

Above is shown the rear of the power-amplifier control panels.



Photos © Photopress.

The Marconi Transatlantic Short-Wave Service Now In Operation

By A. DINSDALE*

IT is now about sixteen years since the British government first conceived the idea of building a chain of high-power radio stations throughout the British Empire, to enable Britain's far-flung colonies to keep in close touch with the mother country.

Many difficulties, legislative and technical, impeded progress to such an extent that, by the time the war broke out, communication had been established only with Canada and Egypt; and it was only in 1923, after several years of discussion, that the British government definitely decided to proceed with the

erection of radio stations to communicate with each of the dominions. The dominions had been pressing for such a service for some years and immediately took arrangements in hand for the erection of corresponding stations to form a complete imperial radio service.

While negotiations were proceeding with the Marconi Company for the erection of high-power long-wave tube stations to carry out these services, Senatore Marconi became convinced, as a result of his experiments, that a new system of radiotelegraphy could be developed which would enable these Im-

perial services to be carried out much more efficiently and at much lower cost.

MARCONI'S SHORT-WAVE PLAN

His plan was to use short radio waves—of 100 meters or less—which, contrary to the generally accepted theory at the time, he had proved to be quite reliable for communicating over great distances. He proposed to increase the strength of signals and the speed and efficiency of working, by employing reflectors to concentrate into a narrow beam the radiated energy at the transmitting station. Similarly, at the receiving station, reflectors were to be used to converge a greater amount of energy upon the receiving aerial.

The idea of using reflectors was not new; it had frequently been suggested in connection with the longer-wave stations, but the length of the waves employed, and the enormous size of the reflectors which would be required, made the idea totally impracticable. Marconi himself had used reflectors during the course of his original experiments, which, of course, were made upon wavelengths of but a few meters only. Since those original experiments, and until recently, progress has steadily been made in the direction of using longer and longer wavelengths for long-distance radio communication.

To change suddenly from high power and long waves to low power and short waves required, as Senatore Marconi has said, a considerable amount of courage. He had no uncertainty, however, and neither had the company of which he is president, so the proposal was put before the British government.

So convincing were the arguments in favor of the new system that the whole technical policy of imperial radio communication was revised and the government entered into a contract with the Marconi Company to build short-wave beam stations in England to communicate with Canada, South Africa, Australia and India. The governments and



At the lower right are shown the feeder lines for the antenna, with a junction box; on the left an antenna coupling box, and the antenna balance weight system in the background.

© Herbert Photos, Inc.

*Member, Radio Soc. of Gt. Britain.

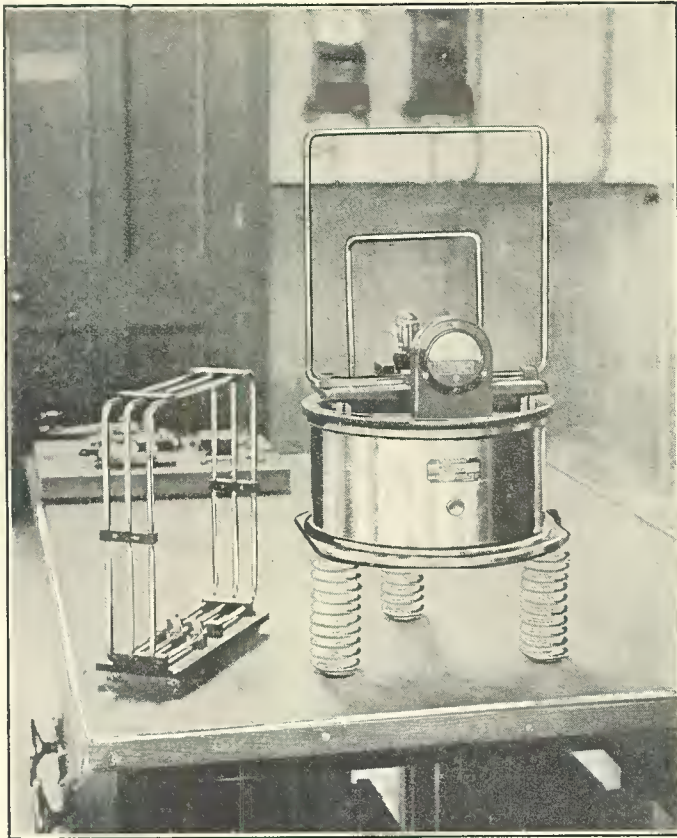

The wave-meter of the short-wave station at Bodmin, for checking the accuracy of the transmitter's wave. The coil of a radio compass, used with the meter, is shown at the left.
© Herbert Photos, Inc.

radio companies in each of these dominions were equally impressed by the value of the beam system, and contracted with the Marconi Company to build corresponding stations to communicate with those being erected in England.

The building of the stations was started in April, 1925. They have been under construction longer than was at first anticipated, but this has been due to the fact that research work has been carried on simultaneously with constructional work, and many valuable improvements on the original designs have been made as the work progressed.

Power tubes have had to be specially designed, to deal with the extra-high frequencies of short-wave working. It is claimed that the new oil-cooled transmitting tubes now in use at the transmitting stations are the most efficient of their class in the world.

ENORMOUS SIGNALLING SPEEDS

The contract between the Marconi Company and the British post office laid down that the stations for the Canadian service should be capable of communication at a speed of 100 words per minute (counting five letters to a word) each way during a daily average of 18 hours, and that a demonstration fulfilling this condition should be given by actual working for seven consecutive days.

This demonstration took place between October 7 and 14 last, and the guarantees (which were regarded by everyone as extremely stringent) were fulfilled. During these, and the preliminary tests carried out by the contractors, speeds of 250 words per minute in each direction, equal to 500 words per minute over the complete circuit, were worked for many hours on end.

Counting every hour of the seven days' test, the average speed of signalling was about 600 letters per minute in each direction. This result abundantly justifies the claims made for the beam system, and indicates that the stations will be capable of handling all the traffic that is likely to be available between England and Canada for some years to come.

As in broadcasting, it has been found that the establishment of a station in virgin ter-

ritory will create a large circle of new listeners, so in commercial radiotelegraphy it has been found that new traffic is created by the provision of new and more rapid means of communication. This has been demonstrated particularly in the case of the high-speed radiotelegraph services, opened a few years back between London and Paris and other continental cities.

It can therefore be confidently anticipated that the establishment of the beam services, which enable large volumes of traffic to be dealt with in the

and the corresponding beam stations are being built at Melbourne.

The site occupied by the British beam stations for communication with Canada are also utilized for the stations which will communicate with South Africa. The South African stations are now practically complete.

Similar stations are being built on the east coast of England for communication with Australia and India, and in the dominions near Cape Town (South Africa), Melbourne (Australia) and Bombay (India). All these are in an advanced stage of construction and to be opened probably within the next few months. This will complete the present imperial scheme.

Outside of this, however, the Marconi Company is already engaged on a considerable development of commercial radiotelegraph services on the beam principle. The company has been licensed by the British postmaster general to conduct services with certain European countries and with all other foreign countries outside Europe. In addition to the long-wave radio stations it has been operating on these services for some years, it has nearly completed a beam station at Dorchester for communication directly with South America. A corresponding station is also in process of erection at Rio de Janeiro.

Another important development in which beam stations are included, and are already under construction, is the Portuguese scheme for linking up Portugal with her colonies and establishing communication between these centers and other parts of the world. These stations are now being built at Lisbon, the Cape Verde Islands, the Azores, and in East and West Africa. When they are completed radio services will be established to England and the principal continental countries and to South America. The beam stations in this scheme are being erected at Lisbon, Loanda and Mozambique.

Thus the net of beam stations is rapidly being extended to encompass a world-wide communication system.

ADVANTAGES OF THE BEAM SYSTEM

The capital expenditure is considerably less; the system is more economical to run and maintain; it is by far the most rapid method of communication yet devised; and

(Continued on page 1180)

shortest possible time, will create new business and so bestow a great benefit on the commerce of the countries thus linked up.

EXTENDING THE NET

The beam transmitting station in Canada is situated at Drummondville, 30 miles east of Montreal, and the receiving station is at Yamachiche, 25 miles north of Drummondville. These stations are linked up by land line, to the central office of the Canadian Marconi Company in Montreal, in the same way that the English stations are linked to the general post office in London. Beam stations are being erected in Canada for direct communication with Australia, also,

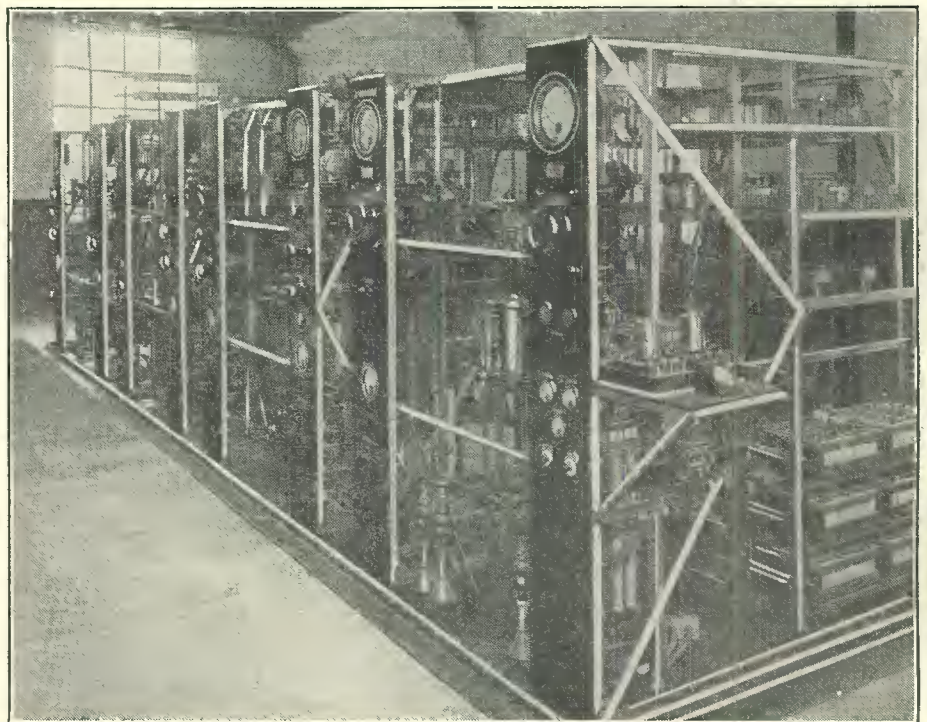

Four amplifier panels in the Bodmin station for transmitting by the radio beam system.
© Herbert Photos, Inc.

A Single-Control Superheterodyne for 3300 to 39 Meters

How It Finds Use in a Portable Radio Direction Finder

By F. W. DUNMORE*

MANY radio receiving sets of the single-control type, designed to operate over the broadcast band of frequencies, made their appearance in the past year. A type of single control for superheterodyne receiving sets, which has recently been developed by the author, makes possible unicontrol operation over a frequency band or wavelength range about eight times that of the present-day broadcast receiving set. This receiving set has been incorporated in a portable radio direction-finder, and the following description covers this combination.

The portable direction finder, with its one-control receiving set is shown, set up in position in Fig. 1, and dismantled in Fig. 2. Everything but the direction-finder coil is housed in the aluminum box. The wide frequency or tuning range is made possible by a set of seven interchangeable plug-in direction-finder coils, each with a corresponding heterodyne generator coil and a cam (to be described later) for operating the auxiliary tuning condenser.

THE RECEIVER

The receiving set is a superheterodyne which employs a standard Signal Corps amplifier. The tuning controls have been reduced to one by mounting the main tuning condenser and the heterodyne-generator tuning condenser on the same shaft. This shaft

carries also a cam operating an auxiliary variable condenser, which maintains a constant frequency-difference of 66.7 kilocycles between the heterodyne frequency and the incoming frequency. The receiving set is shown in Figs. 3 and 4. Fig. 5 gives the circuit diagram.

In this diagram G is the amplifier. The coils I and condensers B, C, and D constitute the high-frequency heterodyne generator circuit. H is the low-frequency heterodyne generator for C.W. reception. The tuning-condenser, A, of the direction-finder coil, has a maximum capacity of .0005-mf. It is mounted on the same shaft with the high-frequency heterodyne-generator condenser, B, which has a maximum capacity of .00025-mf. A similar condenser, C, with a maximum capacity of approximately .0002-mf., is connected in parallel with B. Condenser C is operated by means of a cam, which is so shaped that for a given direction-finder coil, J, and heterodyne-generator coil, I, the heterodyne frequency beating with the incoming frequency gives the predetermined intermediate frequency of 66.7 kilocycles. The cam is made from a bakelite disc 1/8 inch thick, cut to the desired shape.

The cam-operated condenser carries a gear wheel (Fig. 4), insulated from the shaft. A second gear wheel (on a shaft terminating in a knob on the panel), when meshed with the first gear, provides a means whereby condenser C may be operated by hand. This provision for the hand operation of condenser C is necessary for the determination of the cam shape; but it is not used thereafter, unless it becomes necessary to make a new cam. The method of designing the cam is explained below.

The balancing condenser, F, has connected in parallel with it a 3-plate compensating condenser, E, this latter condenser being operated by cam No. 2 on the shaft of the balancing condenser. The purpose of E is to compensate for the detuning effect of the balancing condenser, F, on condenser A.

BALANCING CONNECTIONS

D is a two-plate condenser used to check the work of determining the shape of the cam. Switch S, as shown in Fig. 5, controls the current supply to the tube filaments. It will be noted from the circuit diagram that the mid-

point of the direction finder coil is grounded, as is also the filament circuit.

The direction-finder-coil tuning-condenser, A, is connected across the terminals of the direction-finder coil. The input or grid side of the first detector tube is connected to one

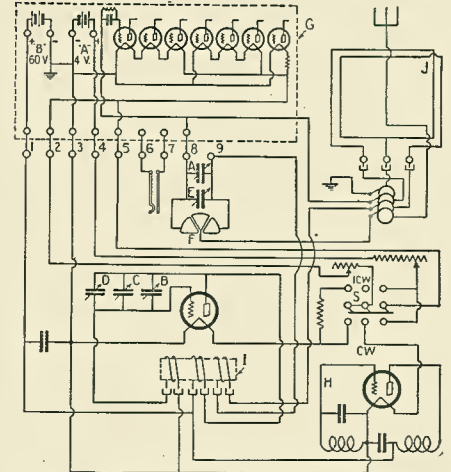

Fig. 5. Above is shown the schematic wiring diagram of the single-control superheterodyne direction finder.

side of this condenser. The other side of the condenser is connected to one of the sets of fixed plates of the balancing condenser, F, and to one of the plates of the automatic retuning condenser, E. This connection gives greater stability to the circuits, requires a balancing condenser of less capacity (because of the greater symmetry of this circuit), and increases somewhat the frequency range of a given direction-finder coil and tuning condenser at the higher frequencies, on account of the removal of the tube capacity from across the terminal of the direction-finder coil.

The movable plates of the balancing condenser, F, are connected to an antenna, which is an integral part of each direction-finder coil and rotates with it. This antenna consists of a brass rod, the height of the coil, passing through the center of the latter. Into the first is telescoped another rod, which, when extended, doubles the height of the antenna. Such an antenna on each coil was found to give sufficient antenna effect for good balancing. The connection of this small antenna to the movable plates of the balancing condenser is much more effective than grounding them.

HETERODYNE-GENERATOR COILS

To cover the frequency range given above, seven heterodyne generator coils are required. This necessitates seven cams, each of different shape; these, with their respective heterodyne-generator coils and corresponding direction-finder-coil antennae, cover the frequency range. Five of the seven direction-finder-coil antennae are shown in Fig. 2. The cams, heterodyne-generator coils, and tuning dials are shown in Fig. 6.

These coils are of the plug-in type, having six terminal plugs apiece; four constitute the terminals of the plate and grid coils, the other two being the terminals of the coupling coil, which is in series with the direction-finder coil. The turns on this coupling coil vary for each frequency band. The coils are wound on tubes 2 3/4 inches outside diameter and 2 1/4 inches long. Each is protected by a layer of varnished cambric and by two



Fig. 1. The portable superheterodyne erected on its tripod with the loop in position for receiving.

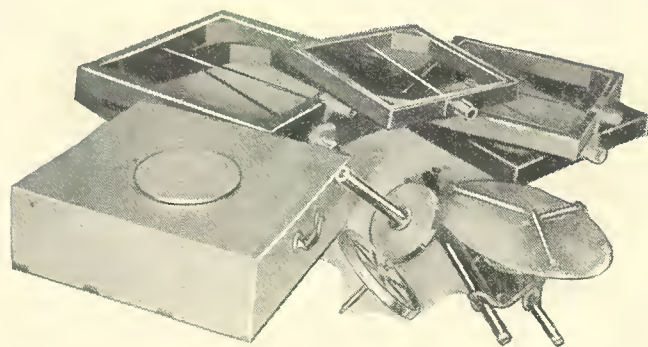

Fig. 2. Here the portable superheterodyne receiver is shown in its knocked-down condition. Loop antennae of different sizes are employed with this set in order to cover the wide range of wavelengths efficiently. With these different cams, generator coils and dial discs calibrated in kilocycles. See Fig. 6.

bakelite discs, one over each end of the coil. A socket is provided to receive them, in which the wires of the receiving set terminate. Heterodyne-generator coil C is shown in position in this socket in Fig. 4. In each of these generator coils the plate winding is on the lower half of the form, with the outer end of the coil connected to the plate. The grid winding is on the upper half of the form, with the outer end connected to the grid. The grid and plate coils are wound with the same size wire and have the same spacing between turns.

THE I.F. FREQUENCY AMPLIFIER

The intermediate-frequency amplifier (G, Fig. 5), is one designed by the Signal Corps and known as Type BC-116. It contains seven Western Electric type 215A tubes and is operated from a 4-volt storage or dry battery. It consists of a first detector, three stages of 66.7-kilocycle (4,500-meter) intermediate-frequency amplification, second detector and two stages of audio-frequency amplification. This amplifier is contained in the wooden box in the rear left corner of the aluminum box. See Fig. 3.

LOW-FREQUENCY GENERATOR

In order to make possible C.W. reception, there is provided a second generator, which is designed to give an audible-beat frequency by interaction with the intermediate frequency. This second heterodyne circuit, with tube, may be seen at the right in Fig. 4 and at H in Fig. 5. The filament current to this tube is controlled by means of a switch on the panel; so that when the switch, S, is in the C.W. (continuous-wave) position the filament current is on, and when the switch is in the I.C.W. (interrupted-continuous-wave) position the filament current is off, and a suitable resistance is automatically thrown into the circuit to compensate for the change in load. This switch is automatically thrown to the "OFF" position when the box containing the receiving set is closed.

The complete receiving set operates from a 4-volt storage battery or from three No. 6 dry cells. Three 22½-volt batteries are used for the plate battery.

BALANCING AND RETUNING CONDENSERS

In order to obtain a sharp minimum, a balancing or compensating condenser is used. This condenser consists of three movable plates and two sets of two fixed plates each. The two sets of fixed plates are connected through the slip rings and brushes to the two terminals of the direction-finder coil. The movable plates are connected to a small antenna; which is a telescoping brass rod permanently supported in the center of each direction-finder coil, and may be seen in Fig. 1. It makes connection (through a fourth brush and slip ring) to the movable plates of the balancing condenser when the direction-finder coil is plugged into position. This antenna, though small, is sufficient, when extended to its full length, to produce the required balancing effect at the point of minimum signal when a bearing is being taken.

At the higher frequencies it was noted that the balancing condenser had a marked detuning effect. This would necessitate returning the set each time the balancing condenser

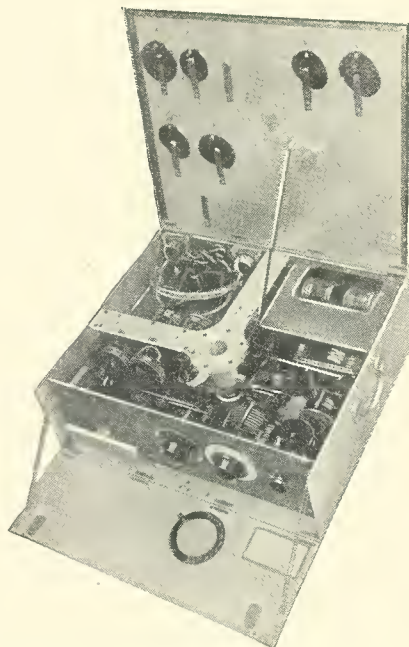

Fig. 3. The receiving apparatus of the uni-control direction finder with the lid of the metal cabinet raised.

is operated. To overcome this, a small variable 3-plate condenser, E, Fig. 5, was connected across the direction-finder-coil tuning-condenser. This small compensating conden-

ser is operated by means of cam No. 2 on the balancing condenser shaft, the cam being so shaped that the compensating condenser changes its capacity in an amount equal and opposite to the change in capacity caused by the operation of the balancing condenser. This simplifies the operation of the direction finder at the higher frequencies.

DIRECTION-FINDER COILS

The direction-finder coils, seven in number (one for each of the heterodyne-generator coils and corresponding cams and dial discs), vary in size from 12¼ inches to 24½ inches square. They are shown in Fig. 2, and are lettered from A to G, with the frequency range marked on each. Each of these coils is provided with a socket, containing four terminal plugs, two connected to the end of the coil, one to the center of the coil, and the fourth to the brass-rod antenna. In this way the direction-finder coils may be quickly plugged upon the upper end of the shaft, making electrical connection to the receiving set at the same time. The coils are enclosed, being wound on box frames made of wood.

MISCELLANEOUS FIXTURES

The shaft is made of insulating tubing, in two sections, one of which is removable. The fixed section, shown in Fig. 3, contains the slip rings, plug terminals for making connection to the removable section, and a socket in its lower end for receiving the handwheel. The removable section, shown in Fig. 7, has in each end four socket connections for connecting the slip rings to the terminals and center of the direction-finder coil and to the antenna on the direction-finder coil. The illustration shows only three sockets; the fourth was added after the picture was taken.

The aluminum scale and handwheel are both detachable. The scale is engraved from 0 to 360 degrees.

The magnetic compass is arranged to plug into the opening, which receives the movable shaft section, before this section is put into position. It is shown in this position in Fig. 7. The index mark on the large aluminum box is aligned with the compass needle and locked in position, after which the magnetic compass is removed. Radio bearings are then read on the scale, with the index mark as a north (zero) reference.

The aluminum panel, shown in Figs. 3 and 4, contains the filament-control switch, the balancing-condenser dial, the main tuning or unicontrol dial and two knobs. One knob operates condenser D and is for the purpose of determining whether the cams are shaped properly.

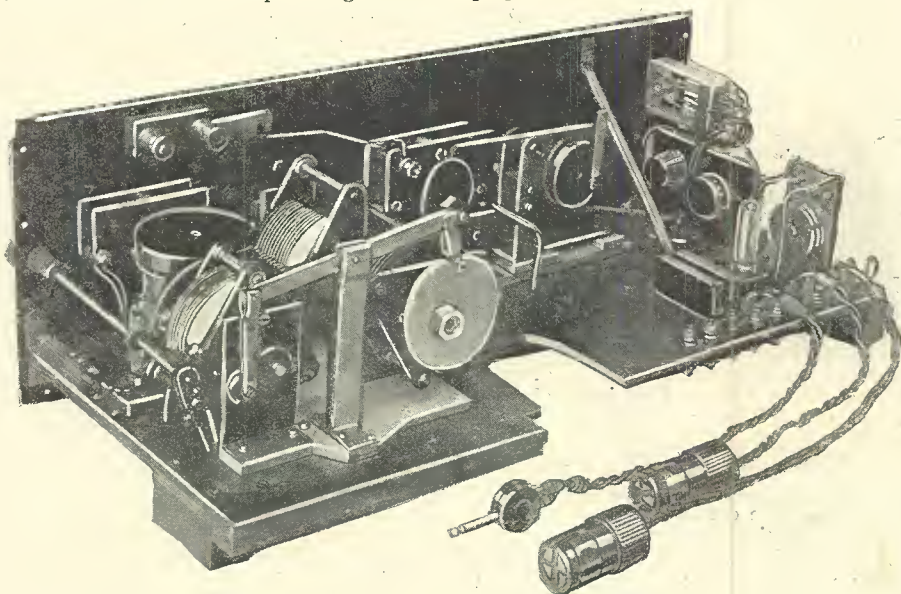

Fig. 4. At the rear of the set may be seen a cam and a lever system which operate the variable condensers.

The second knob is used only when the cams are being shaped. The unicontrol dial with one of the scales in position is shown in Fig. 7. These scales, shown in Fig. 6, are provided with thumb tabs engraved with letters A to G, each scale being calibrated in kilocycles so that if it is used with its respective direction-finder coil and heterodyne coil and cam, the receiving set may be adjusted to receive any desired frequency within its range.

DETERMINING THE CAM SHAPE

Cam No. 1 for operating condenser, C, is cut from a 4-inch bakelite disc and is made as follows: a circular bakelite disc (Fig. 8, No. 1) with keyway is slipped on a bushing on the rear end of the common shaft carrying the two condensers, and is locked in such a position that the disc is thrown in front of the rocker arm carrying the roller which is to ride on the periphery of the cam after it has been made. The roller shaft is pointed and just clears the disc. The control knob on the panel is pushed in, meshing the two sets of gears, and thus making the heterodyne-generator condenser, C, hand-operated.

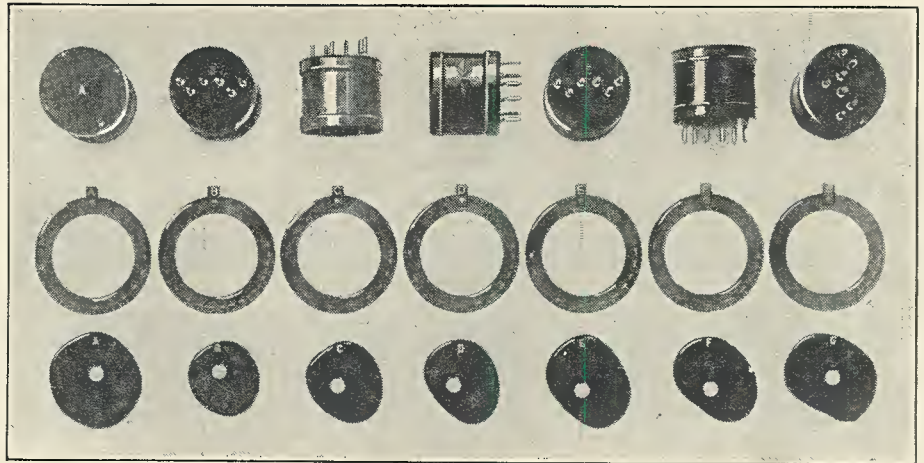

Fig. 6. At the top are the heterodyne generator coils; then the discs calibrated in kilocycles and at the bottom the condenser cams.

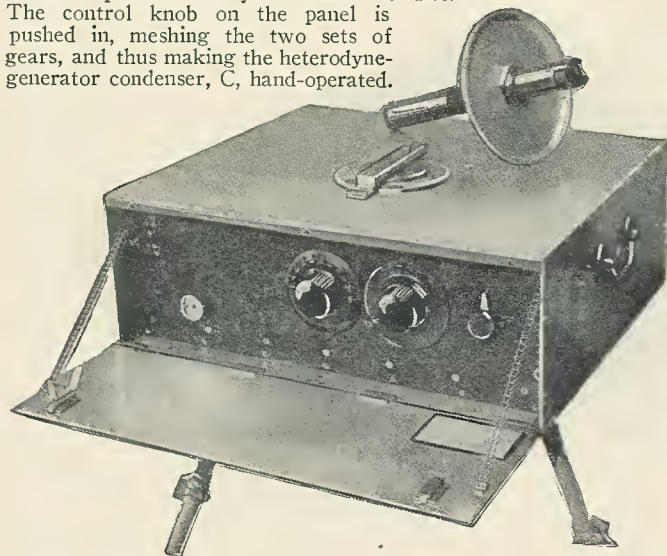

Fig. 7. In order to set the index of the direction finder on the true north use is made of a magnetic compass, here shown in place of the loop antenna.

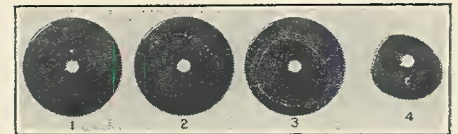

Fig. 8. A condenser cam in the four stages of its construction.

the rocker arm to dent the cam as shown in Fig. 8, at 2. Circles of the diameter of the roller are drawn about each dent, as shown at 3, Fig. 8, and the cam is cut out along the tangent line; the resulting cam is shown at 4. To use the cam, it is replaced with a washer in front of it; this causes the rocker-arm roller to ride on its periphery, thus operating condenser C in accordance with the cam shape.

METHOD OF USING.

When the direction finder is being set up in the field, the tripod is first placed in a convenient location as free as possible from surrounding objects, and the legs are adjusted to make the table level. The protecting covers over the holes in the top and bottom of the aluminum box are removed, the box is placed in position on the tripod, and

A signal is tuned in at every five division points on the scale of the main tuning dial with the two controls (the main tuning dial and the knob operating condenser C) as with an ordinary superheterodyne receiving set; and the plunger on top of the aluminum box is tapped at each tuning position. This plunger hits the rocker-arm roller, thus causing the pointed shaft through the roller on

oriented so that the panel faces approximately due north. The scale is placed in position on the shaft and the desired dial and superheterodyne-generator coil is plugged in position, along with its respective cam. The top cover is closed and the magnetic compass placed in its socket, over the hole into which the direction-finder shaft is later plugged. This compass is allowed to assume its north and south position and the case is rotated until the index mark on the compass box is directly in line with the needle. The index mark on the large aluminum box is then rotated until it coincides with the index mark on the magnetic compass case. The lock nut is then tightened and the magnetic compass removed.

The shaft is plugged into position, and the proper direction-finder coil is mounted on the end of it. The handwheel is next inserted underneath the aluminum box and screwed into position. The aluminum case is connected to ground, and the headphones are plugged in. The direction-finder is then ready for use.

The Sun, the Moon, and Radio Reception Conditions

SUN, OR MOON?

“ONE who has carefully studied the static and the fading, and the so-called earth currents in transatlantic cables, cannot help imagining that these phenomena are electrical messages sent us by the activities of our sun,” said Professor Michael I. Pupin, addressing the American Association for the Advancement of Science.

His words, as popularly reported, caused some misapprehension by those who thought they portended that inhabitants of the sun are trying to send us radiograms collect. They point to a subject which is now receiving diligent study by the use of every known method of registering impulses of radiant energy, including radio receivers.

The use of the latter, and the results of study of signal strength compared with solar phenomena, were detailed at length recently before the Institute of Radio Engineers by Dr. Greenleaf W. Pickard. This excerpt will be of interest to those who have been collating reception records with the calendar of the moon's phases.

“There is no question but that sunspots, magnetic character of days, and reception are related. The period so strongly shown here is 27 days. This is a solar and not a lunar period (“solar day” or rotation of the sun on its axis—*Editor*) and is in fact due to the recurrent earthward presentation of sunspot or otherwise active areas.

“More than one casual observer has noted a coincidence between, say, the full of the moon and depressed reception; lunar and solar periods are so nearly alike that, once started, such coincidences will run through several cycles. But eventually the lunar period will get out of step with reception, and then it will be obvious that there is no real relation. In August and September the full moon came at or near minimum reception, it came near periods of maximum reception in March, April and May, while in June and July it approximately coincided with normal reception!”

THE SOLAR BOMBARDMENT

It is of interest to note that Professor

Pupin's statement regarding the origin of static and fading in solar activity is based on a principle which was pointed out by Mr. Hugo Gernsback in his editorial in *RADIO NEWS* six years ago, in the December, 1920, issue, from which the following is a verbatim transcript:

“What, then, is the real cause of freak messages? It certainly can not be attributed to the ionization of the atmosphere, nor to ordinary meteorological conditions. The writer takes the view that all freak messages take place only during magnetic disturbances of the earth. Such magnetic disturbances which have their origin in the sun, and which are not very well understood today, occur very frequently. It is the writer's opinion that if these magnetic disturbances occur, lying in the same direction with that of the message, the freak condition will occur by reason of the fact that the electromagnetic waves follow the path of least resistance, and flow easily with such electromagnetic disturbances.”

Winners in the \$500 Title Prize Contest

Our Readers Describe the Troubles of Fond Papa and Little Dicky

"WHAT do you call this?" yelled Fond Papa at Dicky. It was what the grammarians call a rhetorical question, and no satisfactory reply could be expected from the young hopeful; but the readers of RADIO NEWS endeavored to supply the deficiency and sent in over sixty thousand titles to relieve the editor of the task of writing one. (That task might have been easier, after all, than selecting from so great a heap of good ones.)

You remember the story (which appeared in RADIO NEWS for November, 1926), how Fond Papa boasted proudly of Dicky's accomplishments with the radio receiver, and of his horror when he found that the little fellow had taken advantage of a little time alone with the set to break the tubes and tear out the coils. A veil was discreetly drawn over the events of the next few minutes; but if all the vengeance suggested by our readers had been heaped on the head, etc., of Dicky, the entire staff of the S. P. C. C. would have work cut out for them for the next year. One "ham" queried "Wouff-Hong or Audio Choke, Which?" (hi).

We told the story, partly as an object lesson to parents of promising youngsters, and partly as an explanation of our cover illustration. For the best titles of ten words or less, describing the scene, here reproduced, we offered a total of \$500 in ten prizes. The response was the most widespread that any of our prize contests have elicited, and included more separate replies.

MANY COINCIDENCES

The more than sixty thousand slips received were not sixty thousand different answers; for the same answer would occur to hundreds of entrants. About six hundred different readers suggested simply "Local Interference," each of course with a notion that he or she was original in the idea. At the close of this article we give about four hundred of the favorite answers, which, with slight changes, make up the bulk of the huge pile of small slips and cards shown in the illustration.

Some years ago Mark Twain wrote an essay arguing the prevalence of telepathy, and instanced in favor of his theory the simultaneous occurrence of the same idea to people in widely-separated localities. Most of the phenomena he described may be ascribed to pure coincidence and to the similarity in the processes of all human minds working from the same data toward the same end; but in this contest some of the coincidences seemed rather striking. The same answers would run in bunches in one day's mail, and drop off in the next. For in-

stance, "A' Eliminator" was much more of a favorite at the beginning than at the end of the contest. Some interesting experiments might some day be carried out along this line.

INDUSTRY IN COMPETITION

However, returning to the subject of the entries in our contest, we should say that there were not 60,000 separate contestants; some of our readers sent in many entries.



One envelope contained 118 slips, and some of the contributors wrote in several times, as new suggestions occurred to them. On the other hand, many were content with one entry—and among these were some of the best. In many cases it was evident that a family had combined efforts, each member contributing one or more answers, and that the ladies were not the least interested.

In physical appearance, owing to the rules of the contest, there was not the variety to be found in previous competitions. A few were attractively hand-lettered; but in general only plain cards or slips of paper were sent in. Full attention was given to the wording of each, regardless of its neatness; although it is found in a contest of this kind that anyone who has taken the trouble to think up a good reply has taken care also to make it as attractive as his facilities permit. A great many replies had been set up in type and printed on a press, and one telegram was received at the close of the contest.

DX RECEPTION

The geographical distribution of the contestants covered the civilized world. Liberal time had been given for the return of replies, and they came from Australia, New Zealand, India and China—one envelope from a ship on the Yangtze patrol. Another was from Melilla, in Spanish Africa, and several from Johannesburg, South Africa, were noted. Among the Canadian replies was a letter from White Horse, far up on the Yukon. As usual, all western Europe, Latin America and Japan were well represented; there were replies in Spanish, Portuguese, French and German. A few were in the "Continental" code of dots and dashes used in radio, which is international. Some of our entrants attempted to express by exclamation points and other graphic explosions the pent-up energy of Fond Papa—and a few, we regret to say, endeavored to describe it in words hardly suitable for a magazine admitted into the family circle.

ODDITIES IN REPLIES

While many entries were quite inapt, so far as the pictured subject was concerned, others were very ingenious plays on words. A great deal of ingenuity was displayed by a hundred or so contributors in making up acrostics on RADIO NEWS and WRNY, by sentences with words beginning with these letters in their order. Though some of these were very good, a straining after effect was too often noticeable.

Many replies, it is true, were just a little too elaborate, as others were a little too brief. Two others caught the same idea which won for Dr. Fish the first prize, but failed to bring out its full possibilities as he did.

Endeavors were made to fit to the situation the name and trademark of almost
(Continued on page 1148)

PRIZE WINNERS

- First Prize\$300.00
"AN OLD DETECTOR AND A NEW CUNNING HAM"
 By Dr. Hermon J. H. Fish, 688 Oak St., San Francisco, Cal.
- Second Prize\$100.00
"WOW—WODA—WRECK" (Wow! What a Wreck!)
 (Stations WOW, Omaha, Neb.; WODA, Paterson, N. J.; WRECK, Whitehaven, Tenn.)
 By Roy H. Cawood, 8324 Vineyard Ave., S. E. Cleveland, Ohio.
- Third Prize\$50.00
"THE 'BABE' TRIES TO PULL SOME INSIDE STUFF"
 By Frank G. Davis, P. O. Box 428, Springfield, Ohio
- Fourth Prize\$15.00
"THE 'HOUSE' OBJECTING TO THINGS BEING DONE IN THE 'CABINET'"
 By Charles E. Riley, Charlestown, Indiana
- Fifth Prize\$10.00
"AN UNSHIELDED RECEIVER, FINELY FINISHED"
 By George A. Hartnett, 1033 Penn Ave., Des Moines, Iowa
- Sixth Prize\$5.00
"THE SONATA (SON AT A RECEIVER)"
 By F. P. Gilbert, 407 Lake Ave., Lyndhurst, N. J.
- Seventh Prize\$5.00
"A NEUTRO-DYIN"
 By W. H. Mayfield, Box 100, Miami, Ariz.
- Eighth Prize\$5.00
"EVERYTHING CAME OUT ALL RIGHT"
 By Phil Philippson, Phil's Buffet, 513 Mulberry, Des Moines, Iowa
- Ninth Prize\$5.00
"AN ELIMINATOR THAT IS GOING TO SQUEAL"
 By H. H. Wigglesworth, 234 W. Mt. Pleasant Ave., Mt. Airy, Pa.
- Tenth Prize\$5.00
"ENTERING THE CABINET WITHOUT PROPER DIPLOMATIC TRAINING"
 By Mrs. F. L. Robinson, Drayton, S. C.



Several myriads of entries in the Title Contest being read and graded in the office of RADIO NEWS. There are here bushels of slips of paper, each hardly larger than a visiting card. Each slip had to be carefully examined for its legend.

What Makes "Good" Music Good—Harmony

By CHARLES D. ISAACSON*

On this page we have illustrated many of the artists and celebrities who have entertained you through WRNY.

ERCOLE CARTOTTO, who spoke on the principles of art and its development in the youthful mind, is a fellow-townsmen of President Coolidge, whose portrait he has been commissioned to paint.



THIS month I am going to discuss the differences between so-called "good" music and "popular" music. Many an intelligent person says, "Classical music is not for me; I prefer the popular sort."

Now, if "classical" were used in its literal sense, I might understand the attitude of the speaker. But "classical" is employed to describe everything which is not of the "jazz" variety. It would seem that what the speaker intends to convey is something like this: "I can get a kick out of ballads, dance music and syncopated rhythms, and that is all I want to hear."

But wait! The great concert violinist plays Dvorak's "Humoresque" and Drdla's "Serenade" and an arrangement of "Annie Laurie." These are melodies which belong out of the "classical" side; the singer has "Believe Me If All Those Endearing Young Charms," "The Last Rose of Summer" and the like. These are good and arc pretty. And here, on the other hand, we find the dance orchestra playing an arrangement of an opera or so-called classical jazz. Thus the points of demarcation are not so easy to indicate!

As a matter of fact, outside of the very "modernistic," almost every symphony, opera, oratorio, concert of chamber music (small ensemble) or individual solo program contains innumerable strains which are as "pretty" and "catchy" as any scraps of vaudeville numbers or straightaway popular songs.

(Continued on page 1178)

HELEN KELLER That wonderfully inspiring personage, who has overcome to such a degree the handicaps of blindness and deafness, is holding the microphone to guide her as she speaks into it.



DEVAH HART, Pianist, who is a regular at WRNY.

CHARLIE MACK, of the Vanities, is the funniest ever.



BETH CHALLIS, Singer of character songs, above. Below, that fine lyric tenor, **CRAIG CAMPBELL**.



LUCILLE CALLETTE, famous French violinist, is shown above.



At left, one of WNY'S latest, a splendid soprano, **BETSY SPOGEN**.



ODETTE MYRTIL, above, playing into the "mike" from a perilous perch. At left, **JACK WHEATON'S ORCHESTRA**, also high up in the French Building. Right, another novelty, "SWIMMING ON THE AIR."

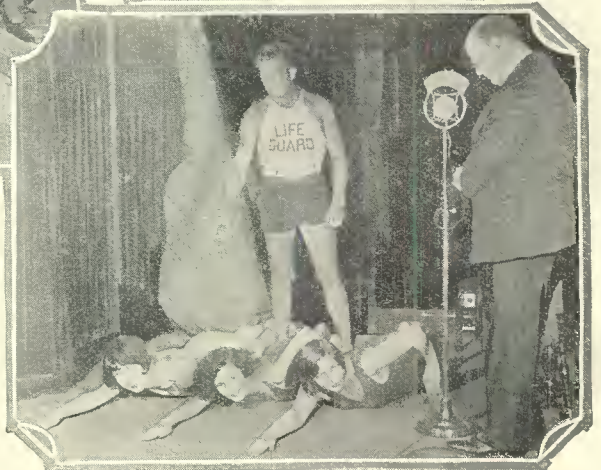

* Program Director, WRNY.

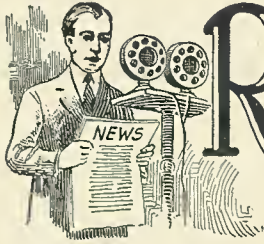

Radio News of the Month



BEAM SYSTEM SENDS TALK ACROSS SEA

AT the same time that the transatlantic telephone service between the United States and England was put in operation, it was announced that conversations had also been carried on between the Marconi beam stations at Bridgewater, England, and Drummondville, Quebec, with extensions by land line to Ottawa. The Marconi stations, as explained elsewhere in this issue, were built for ultra-rapid communication by code on short waves, and it does not appear that there is any present purpose to initiate a regular phone service over them. The directional beam system employs less power than the long-wave transmitters, messages from which are reported to have been heard in South Africa.

BRAIN-WAVE RADIATIONS

THE endeavor to find a parallel between nervous and electrical activity has continued since the first discovery of galvanic electricity. In late years the idea that the brain might be a source of magnetic waves has been a theme for many investigations. Prof. Fernando Cazzamalli, of the University of Milan, Italy, has made public experimental tests with a wavemeter in a shielded room, leading him to the conclusion that the mental wavelength is between 4 and 100 meters. This will be read skeptically by most "amateurs."

A GERMAN RADIO COLLEGE

UNDER the auspices of the German ministry of education, a "radio school" has been established at Jena, in connection with the university. It will broadcast systematic instruction in mathematics, chemistry, physics, and modern languages.—C. L. Vydra.

BELGIUM'S RADIO SCHOOL

THE first national school of radiotelegraphy in Europe has been established by the Belgian government for the purpose of training technicians and operators for the civil service, both in Europe and in the Congo, as well as officers and non-commissioned officers of the army, and aviators. It was authorized by a law recently passed; and is to be administered under the joint control of all the ministries whose work is affected; railroads, marine, posts and telegraphs, aviation, and national defense.

FREE LICENSES FOR THE BLIND

GREAT BRITAIN now grants licenses for radio receivers free of charge to those who are blind. It is necessary for the applicant to register with his or her local council, which issues a certificate. On presenting this at the local post office, a listener's license is issued free of the usual ten-shilling (\$2.44) tax.

STOPS OUR STATESMEN

NO respecter of persons indeed is the SOS call, that bearer of fearful tidings from the sea. While President Coolidge was receiving the greetings of the city of Trenton on the 150th anniversary of Washington's victory, the broadcast of the proceedings was suddenly stopped by a signal of distress from a ship out in the Atlantic.

BROADCASTERS AND COPYRIGHTS

IN a recent decision of Judge T. D. Thacher, in a federal court, the principle was laid down that a broadcaster is responsible for an infringement of musical copyright, even though "it does not participate in the rendition except by affording others

OVER 800 BROADCAST STATIONS MAY BE LISTED

ON the first day of this year 671 broadcast stations were in licensed operation, and reports to the Department of Commerce from district inspectors showed 132 transmitting plants under construction. About seven more broadcasters had been added to the list for every one who had withdrawn, since licenses could be had for the asking. In addition to this, 134 had increased their power; so that there are now over a hundred stations of more than 500 watts power, though four-fifths of the new stations have less than this wattage. As this issue of RADIO NEWS goes to press, new licenses are still being issued at the rate of one a day or so.

UNCLE SAM'S RADIO BILL

BUDGET estimates for the coming fiscal year, as presented to Congress, include items of \$7,830,000 to be devoted to radio apparatus and work. Of this sum, about \$5,000,000 is for the navy, and \$2,225,552 for the army, signal corps, this, however, including wire and cable work. For naval research, \$200,000 is asked, and for the radio work of the bureau of standards, only \$50,000. The department of commerce undertakes to enforce the radio laws for \$230,000—provided they are not amended to require additional work.



This chilly scene shows the antennae of an Alaskan farm, which keeps in touch daily with civilization by radio, as told on page 1187.

the opportunity to hear it." In other words, radio is not "merely leaving open a window;" it is a deliberate and controlled process of reproduction. By analogy, the duty of the broadcaster, legally and morally, to censor programs would appear to be unavoidable.

SOUTHERNMOST BROADCAST STATION

CHRISTCHURCH, New Zealand, has a new broadcast station, farther south than any other in the world. It is in a southern latitude corresponding roughly to that of Milwaukee in the northern hemisphere. However, additional stations will be built at Wellington and Dunedin, and the latter is considerably south of Christchurch.

SET BACK FOR "WIRED RADIO"

IT is announced that a check to the transmission of radio programs over leased telephone wires has been experienced in St. Paul, where this system has been made available to a thousand subscribers (as illustrated in last month's RADIO NEWS). A protest was filed by (Continued on page 1187)

RADIO FIRE BRIGADE

THE fire department of Prague (Czechoslovakia) is being equipped with radio receiving sets and portable transmitters. These will be carried by the apparatus and make possible communication with headquarters while detachments are in attendance at a fire.—C. L. Vydra.

"CLOTURE" BY RADIO

RADIO has, it is reported, accomplished the formerly impossible feat of stopping a parliamentary orator in full swing. The speeches in the diet of Finland are broadcast for the popular benefit; and one long-winded orator who was "talking for Buncombe" reached his mark. He was suddenly interrupted by a long-distance telephone call from indignant constituents with a warning that he was wearing out his popularity by his lack of terminal facilities. The astonished statesman at once yielded the floor.

New High Resistances for Radio Circuits

A Description of the Method of Manufacturing Coated-Filament Resistances

By JOSEPH MORGAN*

NO product used in radio reception has required more painstaking research than the high-resistance unit. Although these units are usually quite inconspicuous, and little thought is given to them by the radio amateur, there is no part of a radio apparatus which is capable of giving more trouble if not properly designed and constructed.

Such units have many uses; amongst these may be listed grid leaks, resistance-coupling units, sound-volume control potentiometers, "lossers," and current-limiting resistors for "B" battery eliminators. A satisfactory resistance unit must have the following qualities:

It must have a sufficient current-carrying capacity, so it will not break down or change unduly in resistance when in use.

It must be non-inductive and non-capacitative.

It must be noiseless, compact and durable.

The evolution of the high-resistance unit is an interesting one. The first units were exceedingly crude. Probably the earliest type of high-resistance unit was a coil of resistance wire. Needless to say, such a device had numerous limitations. The units were bulky and were unable to pass heavy currents without generating excessive heat. They had too high an inductance and too low a current-carrying capacity. They were very expensive.

EARLY CRUDE TYPES

Some of these disadvantages were overcome by a unit which consisted of two metal rods immersed in ink. The value of the resistance was determined by the space between the two electrodes and to a certain extent by the dilution of the ink. It is true that such a resistance unit was inexpensive, but it was neither practicable nor compact, and needless to say, it had no permanence.

In 1922, high-resistance units made of paper, dipped in Indian ink and fastened between two metal contacts became very popular. These units were frequently mounted, as grid leaks, together with a grid condenser. Inexpensiveness and compactness were the only virtues possessed by this type of unit. They were rarely within twenty per cent. of rated value, and were unable to dissipate more than one-fiftieth of a watt without overheating. In 1924 some of the better manufacturing companies introduced a modification of this type of unit in which the inked paper was sealed in a glass tube. While this protection was an improvement, the units were still exceedingly undependable in every respect.

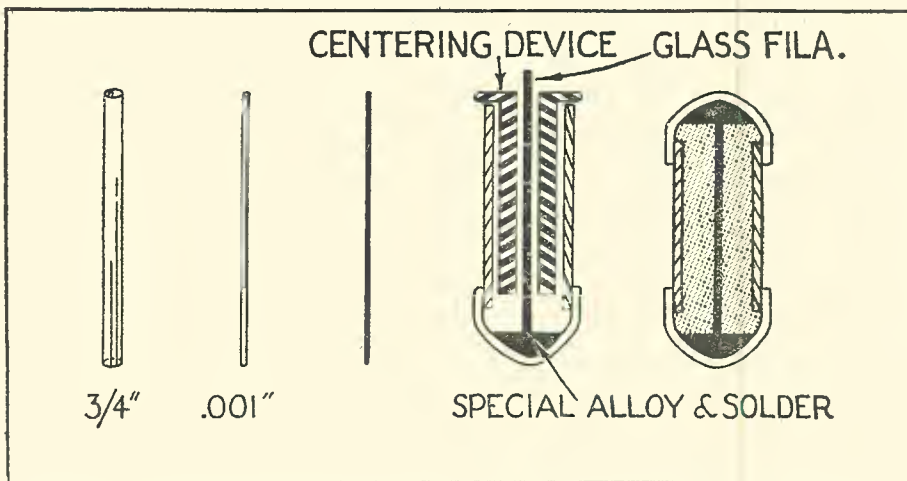

Stages in the manufacture of high resistance units. First a 3/4-inch glass rod is drawn out to a thickness of .001 inch in diameter. This filament is coated with the resistance material. The coated filament is put into a device which centers it in the cap and the outer glass tube and there soldered. The centering device is then withdrawn and the other cap soldered on.

It was fully realized at this time that if resistors were to keep pace with units employed in radio circuits, extensive research would have to be conducted in connection with high-resistance materials and the methods of employing them for use in compact units.

THE METALLIC RESISTOR

Engineers had already begun a series of elaborate experiments with a view to producing a strictly scientific and practicable product. All of the old methods were tried and found wanting. At last a method was discovered for coating the internal surface of small glass tubes with a thin layer of metal. These glass tubes were provided with metal caps which made an electrical contact with the internal coating. This type of unit was a great improvement over anything that had been made previously; but the metal coating was necessarily so very thin that it was impossible to make a satisfactory contact between it and the metal caps. Moreover, the heat developed when large currents were carried produced permanent changes in the resistance of these almost infinitesimally thin metallic films. The curious part of

this type of resistor was that it frequently showed splendid characteristics immediately after manufacture; but, in several months of use, the units deteriorated excessively because of the crystallization of the very thin conducting films.

It is safe to say that hundreds of substances were tried on many different kinds of glass in these experiments. Also at least fifty different types of alloys for hermetical sealing were tried and tested from every possible point of view. In the performance of these experiments the numbers of test units ran into the thousands. If it had not been for the definite lack of permanence, these units would have been satisfactory; but it is easy to see that, when a film of highly-conductive metal is spread on the inside of a glass tube thin enough to produce a high resistance, such a coating must necessarily be very fragile and impermanent.

LATEST PRODUCTION METHODS

Finally the laboratory work produced the modern type of metallized resistor, in which the conducting coating is placed on a glass filament within a protecting tube. These units fulfilled the most exacting specifications which could be written for a high-resistance unit. The filament used in these units is spun on a specially-constructed machine in lengths of five hundred feet. The glass

(Continued on page 1163)

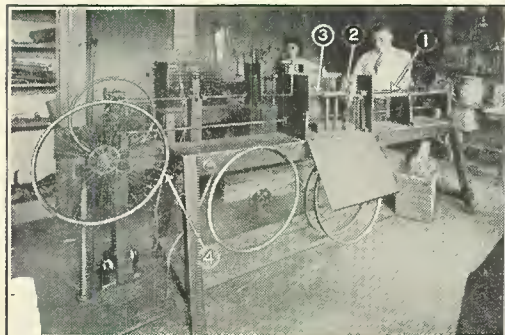

No. 1 indicates the 3/4-inch glass rod; 2, the gas oven where the glass rod is melted; 3, the glass filament, .001-inch in diameter, and 4, the wheel on which the glass filament is wound.



Here an operator is shown holding the cap and tube in a special pair of pliers and soldering the coated filament in place.

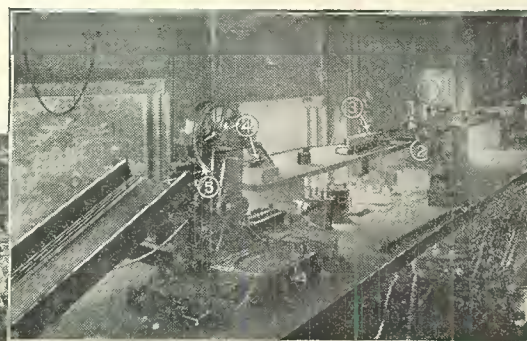

No. 1 is a gas furnace in which the coating is sealed on the glass filament; 2, liquid is here applied as an insulator against atmospheric changes; 3, drying device; 4, device for measuring resistance of a unit length of filament; 5, filament cut into two-foot lengths.

*Engineering Department, International Resistance Co.

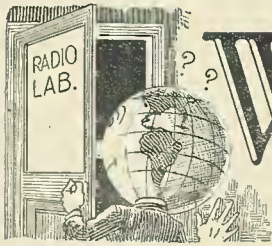

What's New in Radio



NEW R. F. COILS SHIELDED BY ROUND COPPER CANS

AMATEUR constructors who desire to experiment with shielded radio-frequency transformers, without resorting to the work of preparing copper or aluminum sheets, will find very convenient the new individually-shielded coils shown in the illustration. These units are small solenoid inductances, placed inside spun-copper cans, and fitted with four-prong bases which fit in ordinary tube sockets. They are especially handy for experimental work, for they can be kept out of the way while the sockets alone are being wired in a set.

Each unit is made in two pieces, one comprising the coil itself, fastened to a shallow cover and to a four-prong plug, and the other a copper can alone. The com-

plete unit is $3\frac{1}{4}$ inches in diameter and $3\frac{3}{4}$ inches high. The R.F. transformer proper is a straight bakelite solenoid, $2\frac{1}{8}$ inches long and $1\frac{7}{8}$ inches in diameter, and wound with green silk-covered wire. Inside this coil, which is the secondary, is a fixed primary, wound on a separate little tube $1\frac{1}{4}$ inches in diameter and $1\frac{1}{4}$ inches long, fixed at the lower (plug) end of the inductance.

These shielded coils are supplied in kits of three, with sockets. They are adaptable to the usual forms of R.F. amplifier circuits as well as to special arrangements of the experimenter's own design. The coils are grounded through the filament-return leg of the coil secondaries.

In the illustration, the letter C indicates the R.F. transformer proper; P, the plug at the end of the can, and S, the tube sockets into which the coils fit.

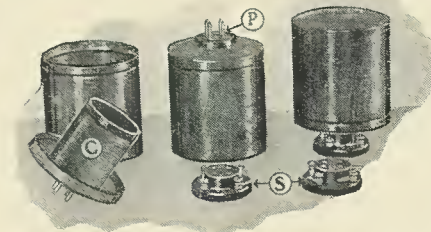

A group of three individually-shielded R. F. transformers. The can of the left-hand unit has been removed to show how the coil C fits against the shallow cover.

Photo courtesy Wm. A. Welby & Co.

These shielded coils are supplied in kits of three, with sockets. They are adaptable to the usual forms of R.F. amplifier circuits as well as to special arrangements of the experimenter's own design. The coils are grounded through the filament-return leg of the coil secondaries.

In the illustration, the letter C indicates the R.F. transformer proper; P, the plug at the end of the can, and S, the tube sockets into which the coils fit.

RADIO SET ON POSTCARD IS GERMAN NOVELTY

AN enterprising German stationer with a scientific mind is making a novelty in the form of a "radio postcard," the back of which is reproduced herewith. The front takes the usual postcard form, with one-half

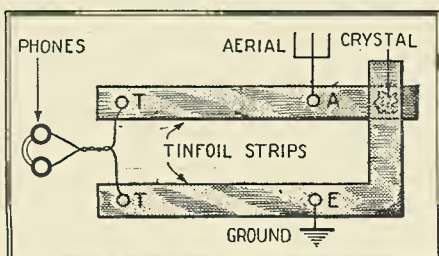

Hook-up of the "radio postcard."



*Ich hab mein Herz
in Berlin verloren.....*

Reproduction of the back of the "radio postcard." The ditty which the washerwoman is wailing in such lugubrious fashion is "I Have Lost My Heart in Berlin."

Courtesy Martin Kolischak, Berlin.

RADIO BATTERIES CONNECTED THROUGH WALL PLATE

BY installing the "A" and "B" batteries (or their equivalents) in some nearby closet, or in the cellar of the house, and connecting them by concealed wires to the wall plate of a new connector cable-wall plate combination, the owner of a radio set can remove the power units entirely from the living room, and thus keep their unsightly wires hidden. The radio set then obtains its current through a single flexible cable, equipped with a plug that fits into the wall-plate socket.

The wall-plate is of standard electrical-fixture size, and will fit over a regular

switch-box cover of the type used in the wiring of homes for electricity. In the illustration it is at the left, marked W.P.

The plug is fitted with seven contact points, which are sufficient to accommodate practically all modern receivers. The ends of the wires in the cable, which connect to the set, are identified by the colors of the insulation sleeves, the pins on the wall-plate receptacle being marked correspondingly.

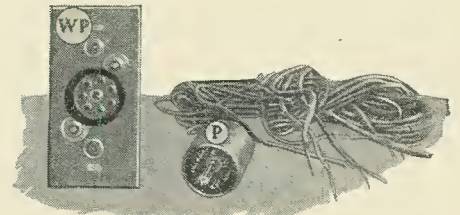

The two units of the wall-plate and battery-cable combination. WP is the plate, P the plug which fits into it.

Photo courtesy Howard B. Jones.

The plug can be inserted in only one position, so that it is almost impossible to cause an accidental short-circuit.

SCREWDRIVER ADJUSTS NEW VARIABLE RESISTORS

THE filament adjustment of the tubes in many radio circuits is not critical, and therefore it is not necessary to provide continuously-adjustable rheostats for them. The settings of potentiometers, connected across tube filaments supplied with alternating current, likewise are not subject to frequent change. Once the proper values of such variable resistors have been found, the instruments can be disregarded.

Two new resistors for service of this kind have been recently brought out. They are ordinary rheostats and potentiometers, except that, instead of being equipped with knobs, the ends of their shafts are cut off short against the mounting studs and slotted to accommodate a screwdriver blade. They are intended to be mounted on a sub-panel or elsewhere in the back of a receiver. The constructor adjusts them with a screwdriver to suit the conditions in his own set, and then simply leaves them alone.

The rheostat is available in all the standard resistance sizes, ranging from $\frac{1}{4}$ ohm to 1,000 ohms; the potentiometer is made in the usual values, 200 to 400 ohms. Mechanically, the instruments are very small, being only $1\frac{3}{8}$ inches in diameter and about $\frac{3}{4}$ inch deep overall. They are fitted with mounting-

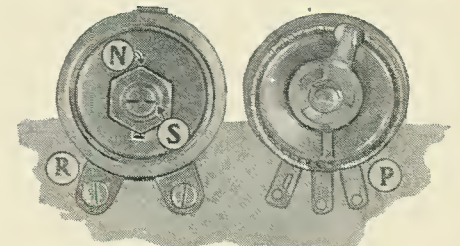

The knobless rheostat R, is shown at the left, and the potentiometer P, at the right. N is the mounting nut and S the slotted shaft.

Photo courtesy Carter Radio Co.

studs requiring only single holes in the set panel.

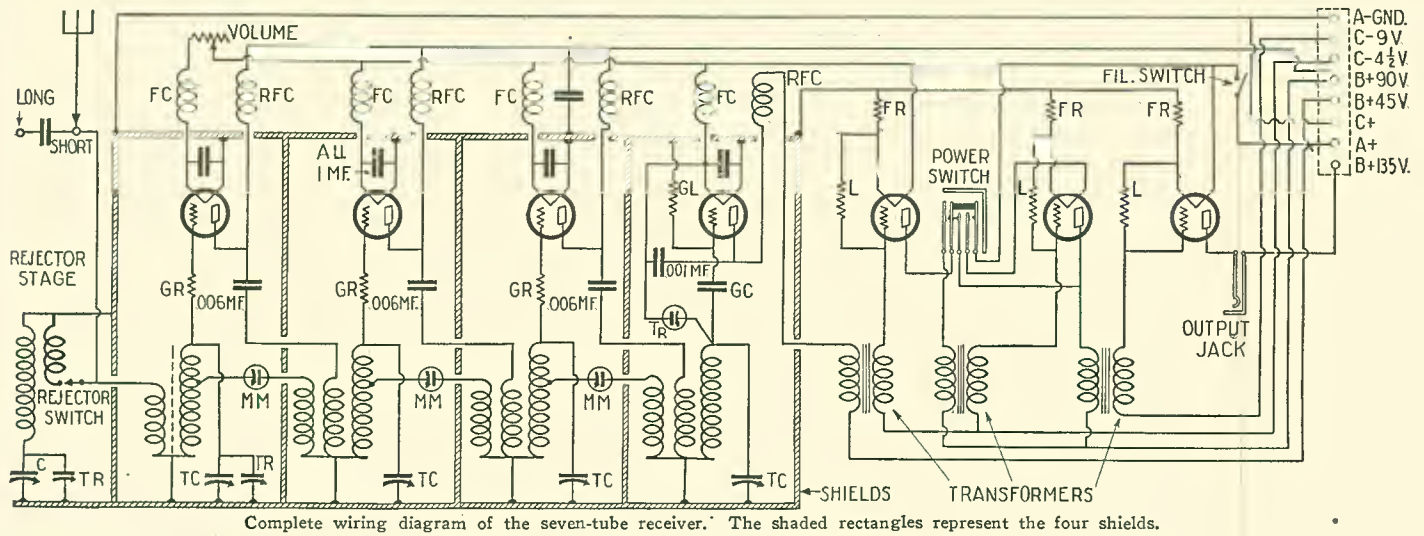

Complete wiring diagram of the seven-tube receiver. The shaded rectangles represent the four shields.

REJECTOR STAGE ENHANCES SELECTIVITY OF SET

A HIGH degree of selectivity is obtained, in a recently-announced seven-tube receiver, by the use of a rejector stage which is a permanent part of the outfit. The variable condenser which tunes the rejector (wave-trap) circuit is coupled to the same

represent the following: K, main tuning knob (condenser control); V, volume adjustment (filament rheostat on first R.F. tube); F, filament switch; P, power switch (allows use of either two or three stages of A.F.); R.S., rejector-stage switch; T.R., trimming condensers (one for rejector stage, other for first R.F. tuning stage).

The complete circuit of the receiver is

place at the extreme left end of the set chassis. (In the top view of the latter, C and S are the condenser and coil, respectively.) In the circuit diagram the designating letters are as follows: T.C., tuning condensers, all on one shaft; T.R., trimming condensers; M.M., "mikro-mikes," (balancing condensers); G.R., fixed resistances; G.C., grid condenser, and G.L., grid leak, of detector tube; L, resistances to prevent A.F. oscillation; F.R., automatic-filament-control resistors; F.C., filament chokes; R.F.C., radio-frequency chokes. The fixed condensers across the R.F. tube filaments are by-passes.

The two-winding transformer in the first (left-hand) shield is a regular antenna coupler, with untuned primary and condenser-tuned secondary. The coils in the other copper cans have three windings apiece; from left to right they are, respectively, neutralizing winding, primary, secondary.

In the accompanying top view of the set chassis proper, the first two R.F. stages are shown with their copper cans (and also a bottom copper plate to complete the shielding) removed. The other stages are shown with the cans (S.H.) in place. Each can is equipped with a round cover (S.C.) at one end, through which the tube can be inserted. The inter-stage couplers (R.F.) are of the solenoid type, and stand upright. The little box B.P. is the by-pass condenser for the second stage. The three sockets for the audio amplifier (A.F.) are placed alongside the extreme right-hand shield. The other letters in this illustration correspond to those marked on the half-tone front view of the receiver.

All the instruments are mounted on a cast

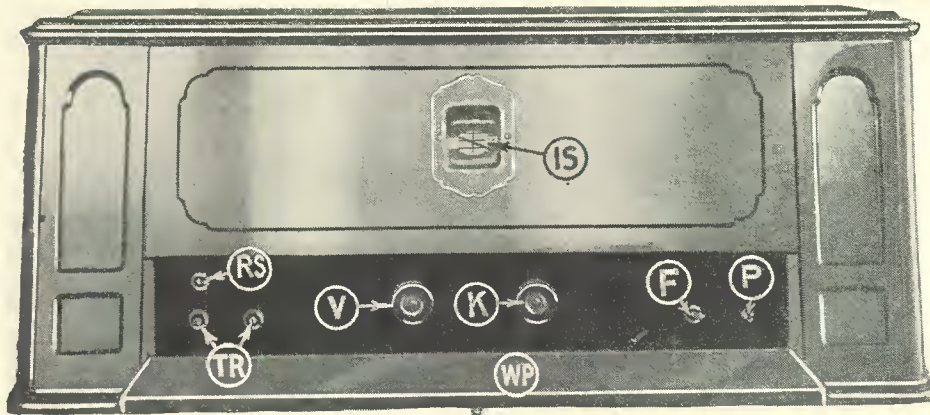

Front view of the complete seven-tube receiver, showing indicating scale and control knobs. Illustrations courtesy Bremer-Tully Mfg. Co.

shaft that drives the four tuning condensers of the R.F. and detector stages of the set; so that the single tuning knob which controls the latter adjusts the rejector at the same time. The use of the rejector feature is optional, a simple single-pole, single-throw snap switch on the front panel permitting the owner of the receiver to throw it in or out, as interference conditions require.

The set as a whole embodies some unusual features in construction. Installed in its cabinet, its overall dimensions are: length, 29 inches; height, 12 3/4 inches; depth at bottom, 16 inches; depth at top, 14 inches. The difference in depth between the top and bottom is due to the fact that the front of the cabinet is sloping.

The indicating scale, graduated directly in meters, is viewed through a decorative bronze-framed window in the center of the upper panel. (See front view of receiver). The control knobs and switches, however, are placed on a narrow sub-panel, 21 inches long and 3 3/4 inches wide, which occupies part of the lower section of the cabinet. This panel is set in a recess, and is protected by a narrow hinged wood panel (WP). After a station has been tuned in, the wood panel is closed in place, thus completely hiding the knobs and leaving only the indicating scale to identify the finely-finished cabinet as a radio receiver.

In the front view, the letters in circles

given herewith. It needs little explanation, as the arrangement of the R.F. and A.F. portions is more or less obvious. The four shaded rectangles represent copper shields, each 10 3/4 x 4 3/8 x 3 3/4 inches, and covering a complete R.F. stage. The rejector stage components are not shielded, being fixed in

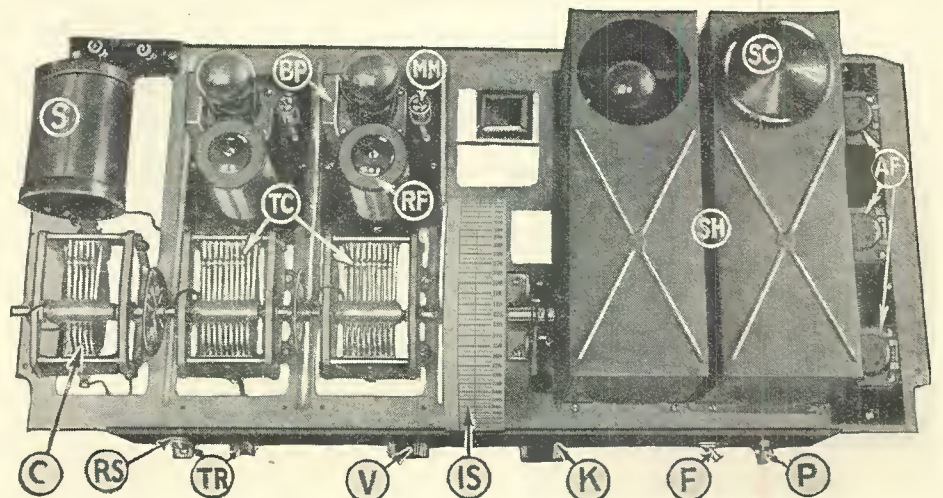

Top view of the receiver chassis. The copper shields of the first two R. F. stages have been removed to expose the instruments.

aluminum frame, which gives the set strength and rigidity. The various choke coils are mounted along the back edge of this frame, and are not visible in the photographs.

The necessary "A" and "B" batteries are connected to the receiver by means of a flexible cable extending out from the rear of the cabinet. The "C" battery is placed on the aluminum frame in the space just behind the indicating scale. The output jack for the loud speaker is also in the rear, being mounted on the wood back of the cabinet.

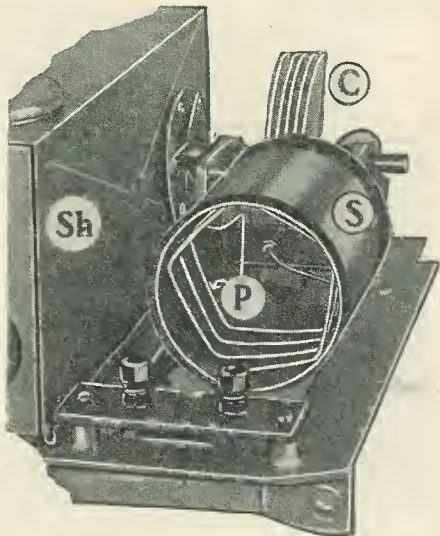

Close-up of the rejector stage instruments.

A close-up of the rejector stage is shown. The tuning coil consists of a secondary, S, of bare copper wire wound on a tube of insulating material, and a primary, P, of four turns of heavy bare copper wire, spaced as shown inside the secondary. The rejector condenser is C, the shield of the first R.F. tube is S.H. The two binding posts in the foreground are for the aerial (see wiring diagram).

The set in question was tested out in RADIO NEWS Laboratories, as well as in Station WRNY, and excellent results were obtained. The selectivity, due to the rejector stage, is remarkable. It is possible, with this set, to tune out a broadcast station less than one mile distant, and bring in another station only 20 kilocycles removed in the waveband. This is quite unusual, and, as a rule, can be accomplished only by means of a super-heterodyne using a loop.

LIBRARY LOUD SPEAKER HAS SPACE FOR BOOKS

A NEW loud speaker, intended for use in the library, has accommodations for several books. It is made entirely of wood, and makes a desirable addition to the furniture in this room.

The loud-speaking section proper consists of a speaker unit fastened to the neck of

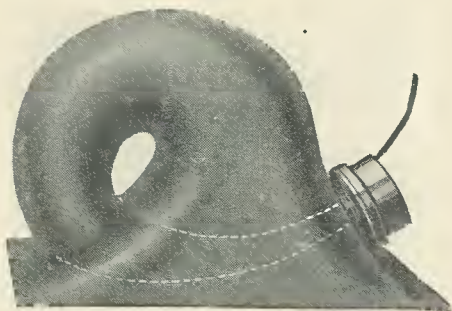

The loud-speaker unit proper. This shows how the horn curls up inside itself.
Photos courtesy Premier Electric Company

a curled-up horn, which is set upright in the wood tone-chamber. This chamber is the box set in the center of the speaker base,

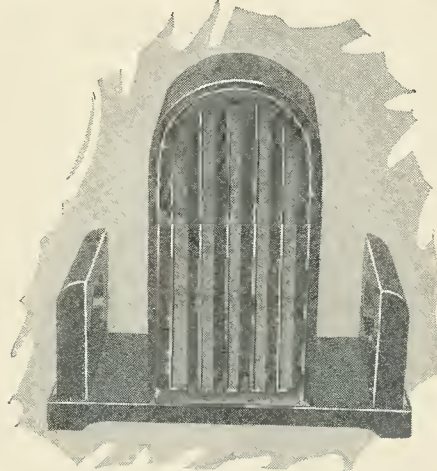

The library loud speaker. Two or three books may be placed in the rack on either side of the center tone chamber.

and is covered by a grill work which permits the sound to emanate, but prevents the entrance of dust, dirt, etc. The actual shape of the horn unit is shown in an accompanying illustration. The great effective length of the horn gives the speaker a high quality of reproduction, covering both high and low notes alike.

The instrument is finished in walnut. It is 17½ inches high, 18 inches wide, and 9 inches deep.

"DIRECTION FINDER" FITS LOOP RECEIVER

A "DIRECTION finder" attachment for the loop aeriels of broadcaster receivers is a new novelty for set-constructors. It consists of a small illuminated map of the United States, on which is mounted an arrow indicator. The instrument may be obtained with the arrow in different places on the map, so that it will read correctly when used in different cities. The "finder" is attached to the loop in such a manner that

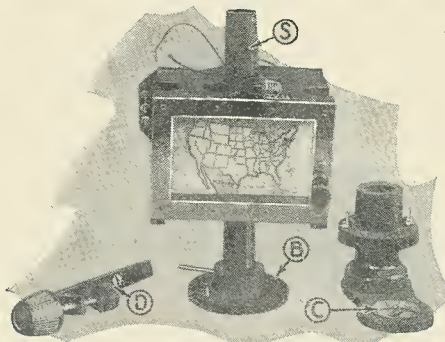

Component parts of the "direction finder" attachment for loop aeriels.

the arrow rotates when the loop is turned, and indicates the direction from which a station is being received. The glass frame is set in the front of the receiver panel, and becomes an integral part of the outfit.

The "direction finder" consists of three parts: a driving knob and wheel, D (see illustration); a base and supporting shaft for the loop, and also the map frame, S and B; and a receptacle for the loop which also includes a magnetic compass, C.

A complete assembly of the apparatus in a receiver is shown in the other illustration. The loop is set in the top of the cabinet, resting in the compass frame and in the shaft S of the map-frame unit. The driving unit, D, the knob of which is on the panel directly below the map, operates as a friction gear against the base B, and allows

close adjustment of the loop's position. The pointer P is actuated by a simple rubber-band coupling between a little pulley attached to its shaft and the loop shaft proper, S. The owner of the receiver must calibrate the pointer by first turning the loop in the direction of some known station and then turning the needle (by means of an auxiliary knob on the map frame), until it points in the proper direction.

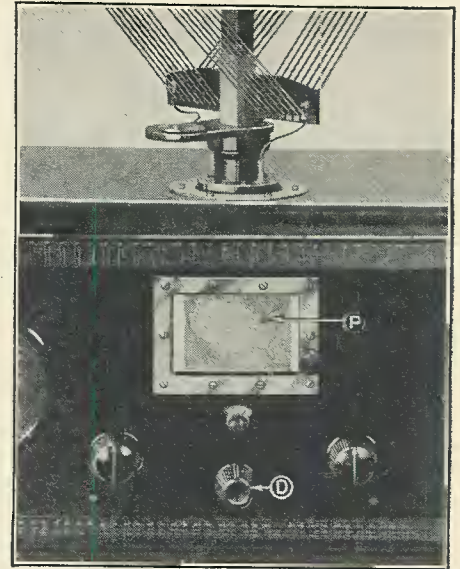

Close-up of a typical loop receiver, showing the "direction finder" attachment completely installed. The loop is turned by means of the knob D. P is the pointer on the map.

Photos courtesy Howe Mfg. Co.

The reading of the loop is not extremely accurate, but it gives the set operator a fairly good idea of the direction of a received station.

Since this "direction finder" involves the fitting of the loop shank to it, and the cutting of an opening in the set panel, it cannot usually be worked into an existing receiver, but it makes an interesting addition to one under construction. Several other models are available for attachment to loops that are separated from the receivers themselves.

FREE-EDGE CONE SUPPORTED BY DRIVING UNIT

A SHALLOW metal cone, attached to the driving pin of the speaker unit, supports the paper cone of a new loud speaker of the "free-edge" cone type. The paper is simply placed against the metal cone (C in the illustration), where it is held in place by means of a hexagon cap-nut.

Although the construction of the supporting mechanism is strong and rigid, the paper cone is vibrated quite vigorously by the speaker unit, and gives loud response to signals of moderate intensity. The instrument



The paper cone has been removed from the stand, in this view, to show the position of the driving cone C, to which the paper is fastened by a single nut.

Photos courtesy Utah Radio Products Co.

is adaptable to all sets designed for loud-speaker operation.

The paper cone is 16 inches in diameter, the instrument standing 20 inches high over all. The paper is edged with gold paint, the rest of its surface being decorated with fancy designs.

INDIVIDUAL "VERNIERS" ON THREE-GANG CONDENSER

SEPARATE little trimming or "vernier" condensers are provided on each section of a new three-gang variable condenser designed for use in two-stage R.F. receivers of the single-control type. These enable the constructor to compensate each tuning stage for the different capacity effects caused by the different lengths of connecting wires in the set, and thereby make real single control possible, without the necessity of additional trimming condensers on the front panel of the set.

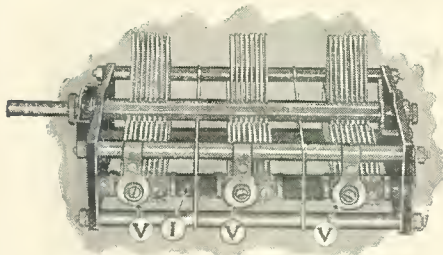

General view of the gang-condenser, showing the positions of the three trimming or "vernier" condensers, V. The bars of insulation between the sections are indicated by I.

The details of the construction are shown in the two accompanying illustrations. It can be seen that the "verniers" are simply little flexible leaves supported between the tie rod (R) that holds one side of the condenser together and the right-hand sides of the stator plate assemblies, S.P. Each flexible leaf faces a fixed one (connected to each stator), a thin disc of mica being placed between them. A short screw passes through holes in all three discs, and turns into a threaded hole in the rod to which the stator plates are fastened. The holes are larger than the diameter of the screw, and the head of the screw rests against an insulating

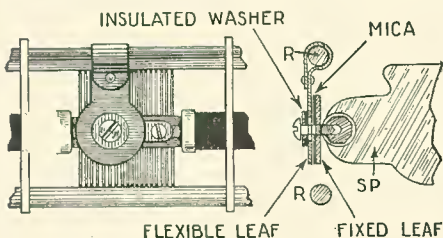

Detailed drawing of the "vernier" condenser mechanism.

Illustrations courtesy Amsco Products Co.

washer, so that it does not short-circuit the condenser, as one might think at first. The capacity of each "trimmer" is adjusted simply by means of this screw.

The condenser is of the straight-line-frequency variety, each section having a maximum capacity of .00035 mf. The plates are of brass, the insulation hard-rubber. The instrument is 5 1/4 inches deep behind its mounting stud, 6 1/2 inches long over all, and 3 1/2 inches wide.

LOUD SPEAKER USES PLASTER TONE-CHAMBER

EXTERNALLY this loud speaker resembles a conch, but actually the reproduction of voice and music is afforded by an unusual tone chamber of curved shape. This is so constructed that the tone-response characteristics of the instrument cover a wide range of frequencies, taking in both the low

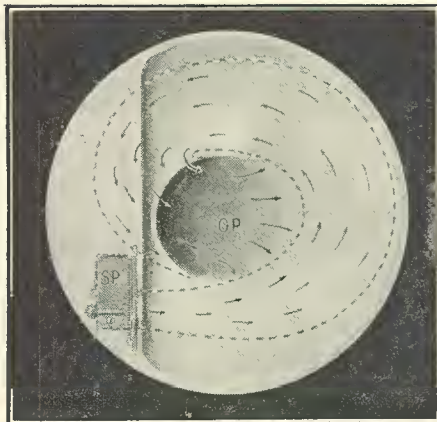

Phantom view of the operating section of the loud speaking, showing the loud-speaking unit, SP, and the opening, OP, through which the signals emerge. The arrows indicate the direction of the sound.

Photos courtesy Nathaniel Baldwin, Inc.

and the high notes transmitted by broadcast stations.

The operating unit of the speaker is a heavy, white plaster cylinder, 11 inches in diameter and 8 inches deep, with an opening in the center. As can be seen in the "phantom" drawing, the reproducing unit proper, S.P., is fastened to the side of a recess in the plaster cylinder, its diaphragm facing the end of the hollow chamber formed when the plaster is molded. The dotted lines indicate how the chamber curls inside the plaster cast and enlarges gradually into the opening, O.P. The arrows show the direction of the sound through the chamber.

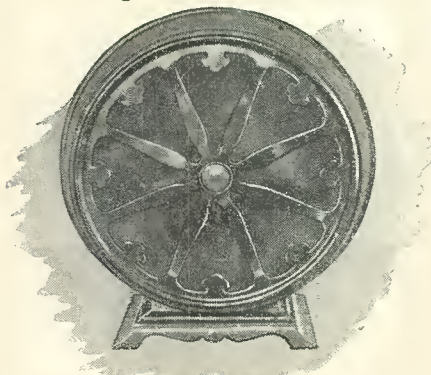

View of loud speaker.

The instrument is enclosed in a decorative metal case which is equipped with a heavy base. It may be used with any standard receiving set and furnishes clear signals of good volume.

TUNER-AMPLIFIER COMBINATION

A CHICAGO manufacturer has conceived the novel idea of separating the R.F. and detector section of the usual radio receiver from the audio amplifying and loud-speaker circuit, and of building the former into a small cabinet connected by wire to the amplifier section. Because of its uncommonly small size, the tuner may be placed on a narrow book-stand or similar stand next to an easy chair or lounge, and may be operated easily and comfortably by a person sitting or reclining beside it.

The master cabinet, marked T in the photograph, is covered with sharkskin fabricoid and trimmed with cast bronze ends. It contains a two-stage radio-frequency amplifier and a detector, with a one-hand-control tuning mechanism and two volume adjusting knobs. A hidden cable, A, connects this unit to the amplifier cabinet, AC, and also carries "A" and "B" power from the latter to the R.F. and detector tubes. The cabinet

holds a special power reproducer, the audio amplifying components, and a supply system that runs the whole outfit on 110-volt A.C. A flexible cord fitted with a lamp-socket plug (B) is provided for easy connection of the power unit to the house lines.

The speaker cabinet is tall and graceful, and readily harmonizes with other pieces of furniture in the most luxuriously furnished homes.



How the radio tuner and detector is connected to the audio amplifier and loud speaker.

Photo courtesy Richard T. Davis Mfg. Co.

PEDESTAL LOUD SPEAKER

ALTHOUGH this speaker consists essentially of a reproducing unit fitted to the end of a horn, it is entirely non-directional; that is, unlike ordinary horn models, it distributes sound equally in all directions. The construction which gives it this characteristic is shown in the illustration.

The unit, U, is concealed in the round base of the speaker, being fitted to the end of the upright horn, H. The mouth of the latter, facing straight up, is partially covered by a wooden cone, the apex of which points downward, so that the sound rising from the horn strikes the smooth surface of the cone and spreads outward in all directions with equal intensity.

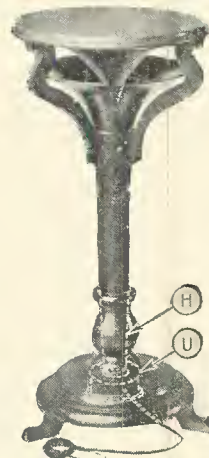

This shows the position of the horn in the upright loud speaker. U is the speaker unit, H the horn.

Photo courtesy Aristocrat Studios.

The speaker is made of wood, and is available in two styles of finish, walnut and mahogany. The bell of the horn is 12 inches in diameter, while the top is 15 1/2 inches across. Over all, the instrument is 32 inches high. The flat top makes a fine support for a flower pot, vase, or other decoration.

Radio News of the Month Illustrated

By GEORGE WALL

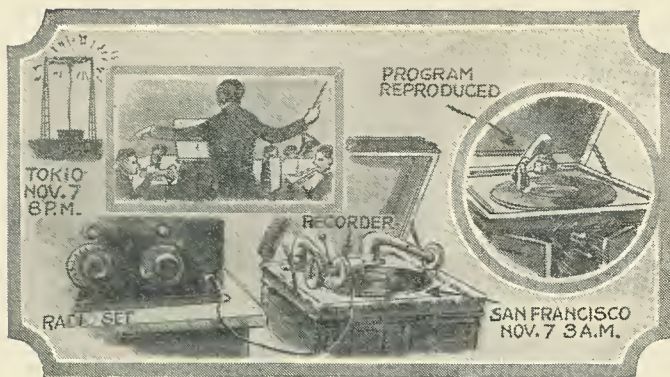

A San Francisco man, Oliver J. Williams, took down radio songs in a foreign tongue by placing his loud speaker in front of the recording device which he had attached to his phonograph. They were so well recorded that Japanese gentlemen were able to recognize from them, when replayed, the words and the announcement of the Tokio broadcast station. Incidentally, because of the International Date Line, the reception is dated seventeen hours earlier than the broadcast.



Pussy's appearance before the microphone at Los Angeles is said to have been the first radio recognition of "Us Cats."

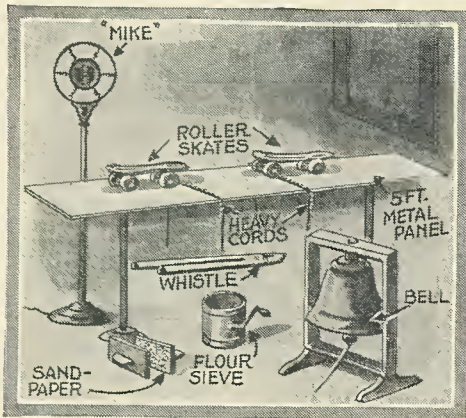

Even a radio studio requires "scenery"; but its scenery must be of the type appealing to the ear, not to the eye. The old-time playgoer may remember "The Heart of Chicago," with its express train coming on the stage. Above is the material with which the program director endeavors to produce a similar effect upon the ear of the broadcast listener.



The law is most conservative; but after churches have followed the example of the public hall and the theatre in equipping themselves with amplification apparatus the courts have followed suit. Judge Ullman, of the superior court of Baltimore, has caused a microphone to be installed at the witness stand. The witness can speak in a natural tone of voice, and avoid the mental confusion caused by the endeavor to talk loudly, yet be clearly heard by judge and jury alike.



The radio doctor is a newcomer on the program of a Western broadcast station. Once a week he takes his place before the microphone and reads off the week's contents of his "question box," giving advice and hints on hygiene and diet, etc., to the listening audience. The feature is said to be highly appreciated by rural families.



Horatio at the Bridge

By ROBERT FRANCIS SMITH*



IT'S been a big hop between drinks, and my little inverted dust mop slings me a look full of coal dust.

"Well!" she snaps. "What was wrong with Cousin Mary, that you hadda make a fox pass and get her so mad she left in a huff?"

"That was fortunate," I replies, easily. "Most of 'em leave in a cab."

Doris glowers a coupla wavelengths higher. "Can the sauce!" she demands; "what's a idea of criticising her table manners? You ain't got enough of your own to soil the fly-leaf of the book of etiquette!"

"Harsh, my dear," I chokes. "But I couldn't stand her. She's one of these radic meal hounds."

"Radio meal hounds?" echoes the total loss.

"Yeh," I replies. "She ate soup with nine stages of audio frequency."

"Put it in the act," advises Doris sourly. "You could'a shown at least a little courtesy—a little merery."

I glanced at the ceiling. "The quality of mercy is not strained," I quotes.

Doris slips in her five watts. "Maybe that's what's wrong with it," she tallies.

Now you've gotta sample of my home life.

In case we ain't svum the channel together, I'm Joe Hammerstein, chief mainstay of the shoemakers' guild as a tap dancer on the stage. Doris is the feminine relief, theatrically, and the salary splitter on the street. She splits exceedingly fine. As it happens, we're passing the season in the *Inanities of 1927* on Broadway, Land of the Midnight Bun, commuting home to Brightmere-on-the-Deep, Long Island, where the pretty waves lap the shore and the ether waves tap the aerials.

The moment at hand is a Sunday noon, and a distant relative of the housewife has clinched the rattler for the big town as the

upshot of my cracking that she had the mouth and hoof disease—eat and run. I admit I was wrong, in part. She couldn't run. She was so fat that every time she stood up she threw a total eclipse over three acres. But it worries me not, as Kipling—or maybe it was Lew Cody—remarked, saying. "A woman is only a woman, but a nickel cigar is a joke."

However, the day's sunny, though cold, and I puts on my coat with the firm intention of doing a few cartwheels across lots to chin with The Master. Doris, eagle-eyed and acid-tongued, puts in her exit line.

"Where to?"

"Over to Jerry's."

I'll bet you wish it was Tom and Jerry" she opines. Being a morsel of truth, I lets it lay.

Jerry Lawson—dubbed The Master by a troupe of butlers—is our scientific friend. He specializes in radio. Tall, dark, twenty-four and as serious as an operation for a wallet on a Scotchman, he'll never be content with this life until he's designed four-wheel brakes for static. He's just moved in to a brand new laboratory building, two stories high and packed with his junk, accumulated from years of search, research and return engagements. I steps into his library and greets him cordial.

"Well, what's the racket today?"

"Oh, hello, Joe," replies Jerry, casual. "I'm just finishing a little solitaire."

True, he's got the cards out in front of him, evidently stuek. I don't ever recall having seen The Master play solitaire before, but it's possible enough, so I don't

emit any crack over it. But Jerry opens the show.

"Play cards much, Joe?" he asks.

"Not solitaire," I replies. "Poker, whist, pinochle, craps with the stage hands and, when Doris ambushes me, I get rung into bridge. Why?"

"Do you play bridge with sufficient proficiency to assist me in a little vital experimental work?" he asks.

"Vital?" I echoes. "Are you gonna croak somebody?"

The Master shakes his head, smiling that faint smile of his that he uses as a mask for the fact that he doesn't actually get the point.

"You'll help me?" he repeats.

"Sure," I replies. "But what's the connection between bridge and radio?"

"At present, merely an idea about to be executed; later, perhaps some new form of amusement to rank with the movies, golf and what-not."

"Especially what-not," I adds. He passes it up—or rather over—so I sits down in the presence of a nice new theory that hasn't walked yet.

"Elucidate," I commands. I learned that word from an interviewer in Boston.

Jerry reclines in his decrepit Morris chair. With all his jack—he owns a coupla railroads, a steamer or two, and about two-thirds of the real estate in Florida that's above water—it'd seem like he'd sorta renew the upholstery, but no. He claims he can't do good thinking in any other chair. Consider-

(Continued on page 1156)

"He points to what looks like a gyp hotel for indigent sparrows. The Master with his mind for detail explains, and I listens."

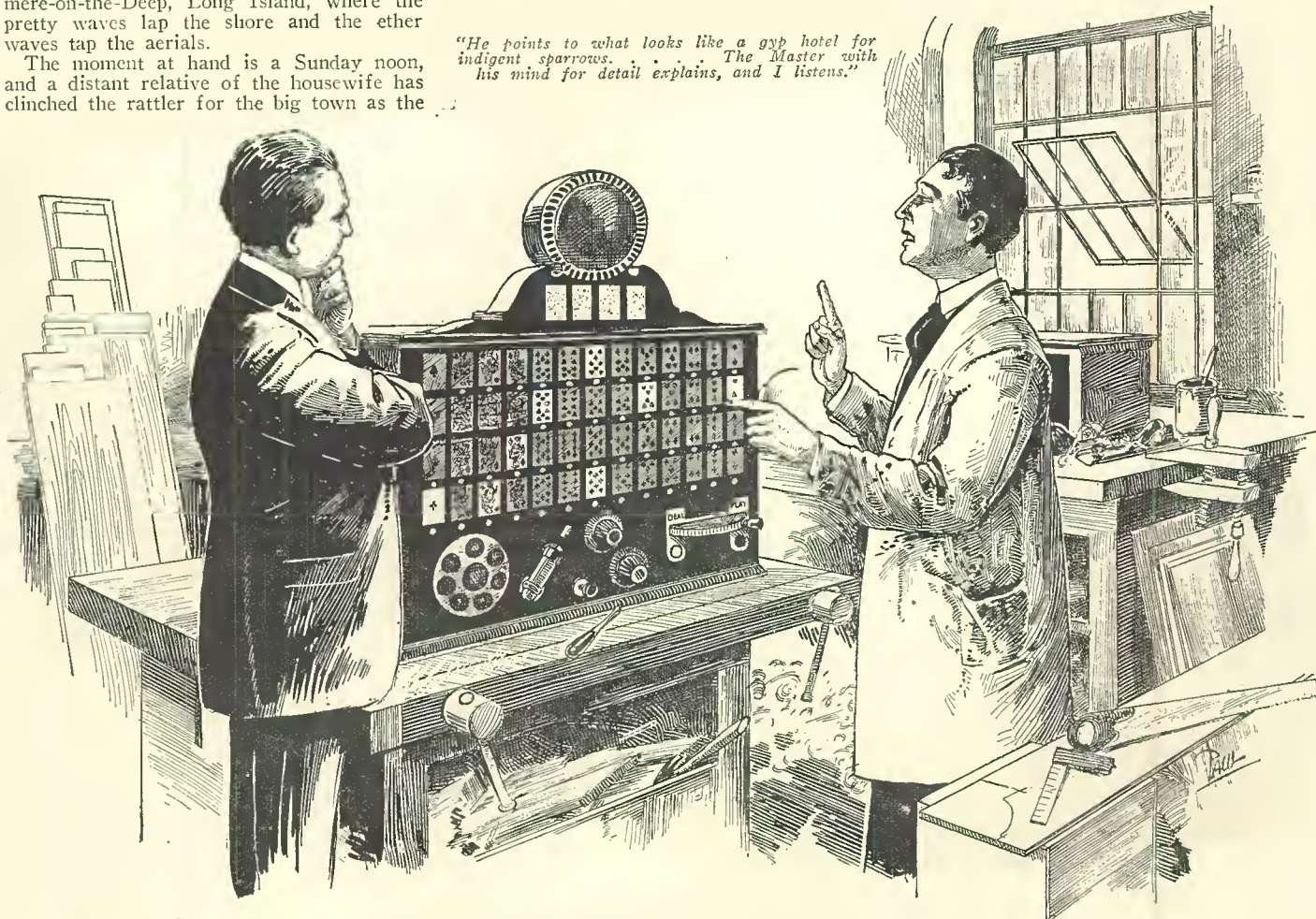

* Copyright, 1926, by Robert Francis Smith.

What Is the Best Loud Speaker, and Why?

By H. WINFIELD SECOR



A good horn-type loud speaker is desirable for use with most cone speakers. The horn-type speaker shown in the accompanying cut is one recommended by the author, because of its large, well-designed-horn, which has a thick non-metallic wall.

Photo courtesy The Reichmann Company

THE task of designing and building a satisfactory loud speaker for use in radio receiving sets, has hidden within it a vast amount of science and laboratory research. This is not realized by the average person; he may, perhaps, buy a loud-speaker unit and fit it to a talking-machine or other horn, and ask proudly, "What's the matter with that?"

It has taken most of us quite a long time to become educated to the fact that the average loud speaker, whether of the cone or the horn type, left much to be desired. We thought that we were hearing good music from even the first loud speakers, in many instances; but since the cone speakers came to the front so strongly, during the past year, we have begun to realize that the real backbone, of a great portion of the musical renditions by orchestras and bands, is represented by the bass and baritone notes, which are the tones in the lower part of the musical scale. All who have a true musical ear, and who are used to listening to quartettes and other vocal and instrumental groups, are aware of the importance of the bass and baritone.

DOUBLE-SPEAKER EQUIPMENT

At least one of the well-known American radio manufacturers (the Zenith Company of Chicago) has for several years supplied in every one of its cabinet sets, two loud speakers; one to take care of the higher audio frequencies, and the other to care for the lower and intermediate vocal

frequencies. At the present time this idea has been gaining favor with the radio public very rapidly; and during the past few months, several radio set builders have announced that their cabinets are being fitted with the very happy combination of a cone speaker and a horn speaker. The merit of this lies in the fact that the cone gives us a very fine reproduction of the extremely valuable bass and baritone notes, while the horn helps tremendously, on all vocal selections especially, by doing its part to bring out the higher intermediate and treble notes.

If we refer to the graphic chart (Fig. 1) we find the whole story of this loud-speaker problem pretty well exemplified by the

A great deal of the science required in the design of a satisfactory loud speaker, whether of the horn or cone type, is made evident by means of the accompanying graphic diagram. If we want to listen to an exact reproduction of a musical selection being rendered by an orchestra, we actually need a horn 35-feet long, as the wavelength of the lowest note given out by the bass viol is 35 feet in air. As the dotted outlines of various sizes of horns indicate, the smaller horns are able to give us an imitation of a bass note only by vibrating at one of its harmonics.

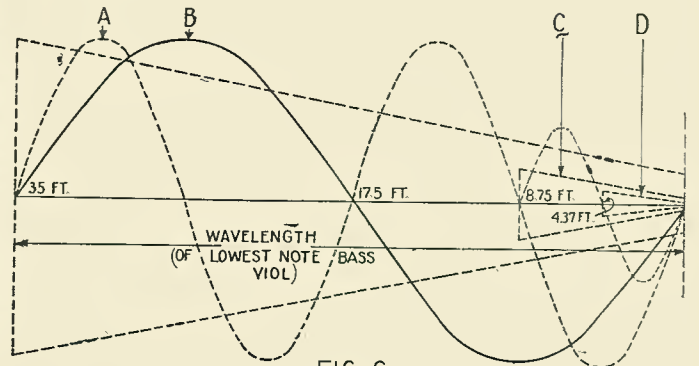

FIG. 6

horizontal graph lines which indicate clearly the range of the various human voices, such as soprano, alto, bass and baritone; and also we learn the position of the lowest, medium and highest instrumental notes—those of the bass viol, violin and piccolo. From these graphs, it is clear why the average cone or horn speaker, with the range of frequencies shown, does not cover all of the audio frequencies that are so necessary in faithful musical and vocal reproduction.

REMARKABLE NEW HORN

The new orthophonic horn, whose design has been worked out by the engineers of the Western Electric Company and the A. T. and T. Company, and which is now supplied on a well-known line of talk-

This is a semi-sectional view of the new orthophonic horn used in one of the leading talking machines. This orthophonic horn is curved or folded so that its great length is capable of being contained in a small space. It makes a very fine radio loud speaker.

Photo courtesy Victor Talking Machine Co.

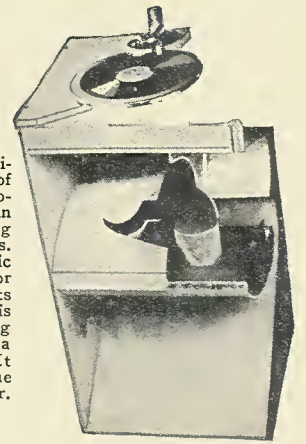

ing machines, is a most remarkable product of the scientist's laboratory. The range of notes to which the orthophonic horn, in the 72-inch size, will respond or resonate, is shown graphically and clearly in Fig. 1.

Therefore, it would seem to indicate to us that the solution of the loud-speaker problem may eventually resolve itself into the utilization of a horn of this type fitted with a good loud-speaker unit. In a \$1000 model talking machine, fitted with the orthophonic horn and connected to a superheterodyne radio set, for instance, its owner has a most wonderful sound-reproducer; and those who have heard this instrument have stated repeatedly that it gives the finest reproduction of the human voice or musical instruments that they have ever heard.

In this case, it is well to remember that the orthophonic horn does most of the work; it is not necessary to fit it with an elaborate loud-speaker unit, though a good unit should be used. In the case of the talking machine referred to, the makers have designed what they call an "orthophonic-speaker" unit which has a special duralumin diaphragm, with a special suspension, which gives a very fine quality of reproduction in itself. The point, however, which the writer wishes to emphasize is

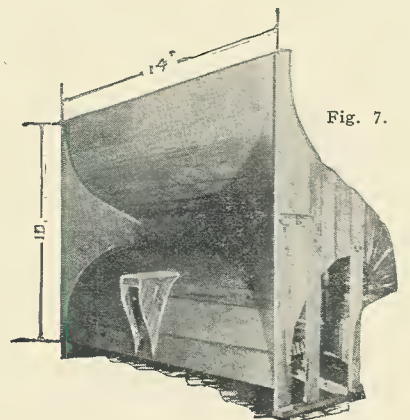

Fig. 7.



The picture at the left shows a talking machine, containing a large 20-foot orthophonic horn, installed in a hotel. This horn gives tremendous volume and very faithful reproduction of bass, baritone, and treble notes from an ordinary phonograph record. Radio music and voice can be reproduced through this horn when desired.

Photo courtesy Victor Talking Machine Co.

The picture at the right shows dimensions and appearance of an experimental 40-foot orthophonic horn. Photo courtesy Victor Talking Machine Co.

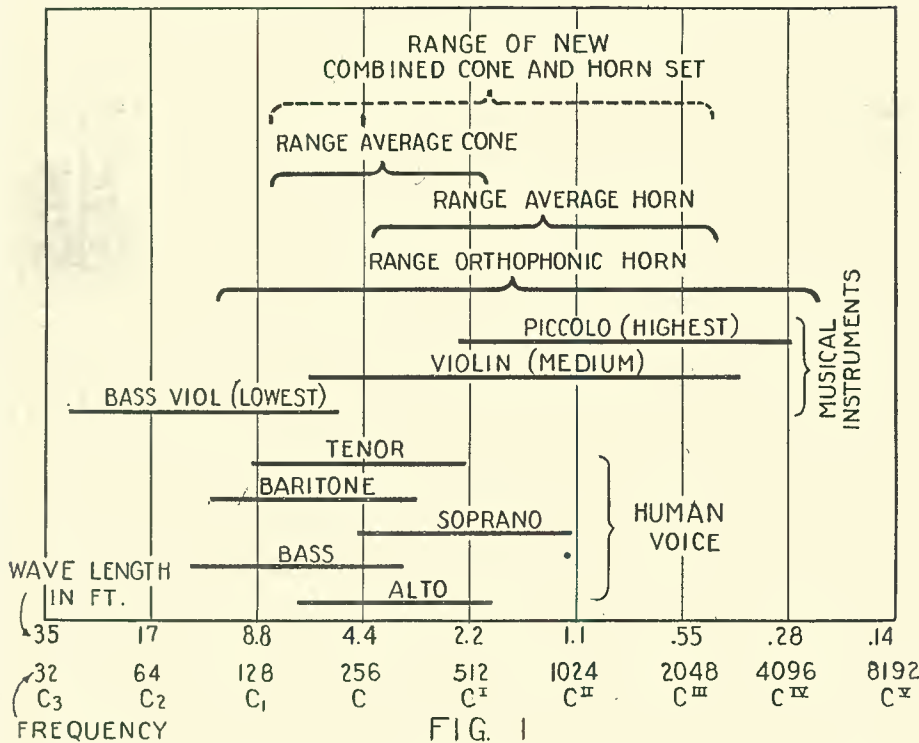

FIG. 1

This diagram, prepared with the aid of data given in a recent scientific paper by S. T. Williams, chief engineer of the Victor Talking Machine Company, makes it very clear why the average horn or cone speaker is not entirely satisfactory. The orthophonic horn in the 72-inch size, however has a range from 100 to 5,000 vibrations per second, covering practically all musical notes. To approximate this, anyone can improve his radio quality a great deal by using a horn together with a cone speaker, connected in series or parallel, as trial may dictate.

that this orthophonic-loud-speaker unit is practically as helpless as any other speaker unit, if it is fitted to an ordinary horn. Many of the writer's friends, after reading about some of the features of the orthophonic horn (particularly the fact that in the larger talking machines there is incorporated a six-foot length of horn cleverly folded up, or concentrated in the cabinet of the machine), have asked the question, whether they could not obtain similar results by using a straight six-foot horn? The answer is, yes, if the horn is properly designed, so that it increases in size in a certain mathematical ratio.

In any event, as Prof. Dayton C. Miller pointed out quite a few years ago to the writer, the long horn, anywhere from 4½ to 7 feet in length, will far surpass anything that a small horn can do. It is interesting to note in passing that Prof. Miller at that time about ten years ago, mentioned that he had obtained very wonderful results with a 7-foot horn made of concrete 4 inches thick, as well as with wooden horns of the same length. The orthophonic horn is 6 feet or 72 inches in length, and larger sizes of this orthophonic type of horn have been experimented with, up to 40 feet in length. The 20-foot horn of this folded type, curved to the mathematicians' taste, as dictated by the inventors, has become a standard unit, for use in large hotel dining rooms and other locations, where an ordinary phonograph record and electrical pick-up arm are used to send forth sonorous tones of tremendous volume and power.

It would seem to a present-day observer, after carefully reviewing all that has been done by the various loud-speaker manufacturers in the past few years, that the old-fashioned horn (having an average axial length of about 1½ feet) can never be made to do any more than it does at present, as shown in the graph (Fig. 1). This means that, unless the small horn is supplemented by a cone, to take care of the lower notes, such as the bass and baritone, radio broadcast listeners simply cannot hear a vocal or instrumental selection reproduced in their home just as it is sung or played in the studio or concert hall.

The next step in the development of our future loud speakers would seem to be toward something on the order of the orthophonic horn; or else direct adoption of this device, fitting the horn with a good loud-speaker unit. Another alternative appears in the development of a new type of cone, the advance models of which have recently been put on the market. Fig. 2 shows a new

model receiving set, fitted with both cone and horn speakers.

Figs. 3 and 4 illustrate and explain one of the latest developments in cone speakers, which the writer has been testing for some time. This cone and one or two others represent the newest advance in cone-speaker design: i.e., they are constructed with two vibrating members or sections, one of which reproduces the bass and low intermediate notes, such as baritone, while the high-pitched part of the cone reproduces the high intermediate and treble notes, such as tenor and soprano. The writer feels free to express an opinion to which many of his colleagues agree, that the average single-cone speaker is liable to lower the register of the tenor and soprano voices, as well as that of the high-pitched musical instruments. In fact, this usually occurs unless special care is taken to adjust the unit very carefully and also see to it that the cone is operated with a suitable set and in the proper manner. Cones are best connected to the output of a radio receiver by means of a choke-coil and condenser, in order to eliminate the "B" battery current from the speaker.

The most obvious remedy for the high-note deficiency in the musical reproduction of the average cone is to use two speakers, as previously mentioned: while the ultimate solution, hard to carry out just now, as orthophonic horns are not being sold separately from the talking machine, is to adopt the orthophonic horn in connection with a good speaker unit. There is now on the market a high-priced power cone, used in the Panatropie talking machine, which has a vocal frequency range from the bass notes up to highest soprano; but the price is beyond the reach of many people. This cone works differently from all others, and is thus able to reach up the scale.

Referring to Fig. 4, the action of the new cone having two vibrating sections for the low and the high notes, is clearly shown. As will be seen, the annular section (outer ring) of the diaphragm, repro-

(Continued on page 1165)

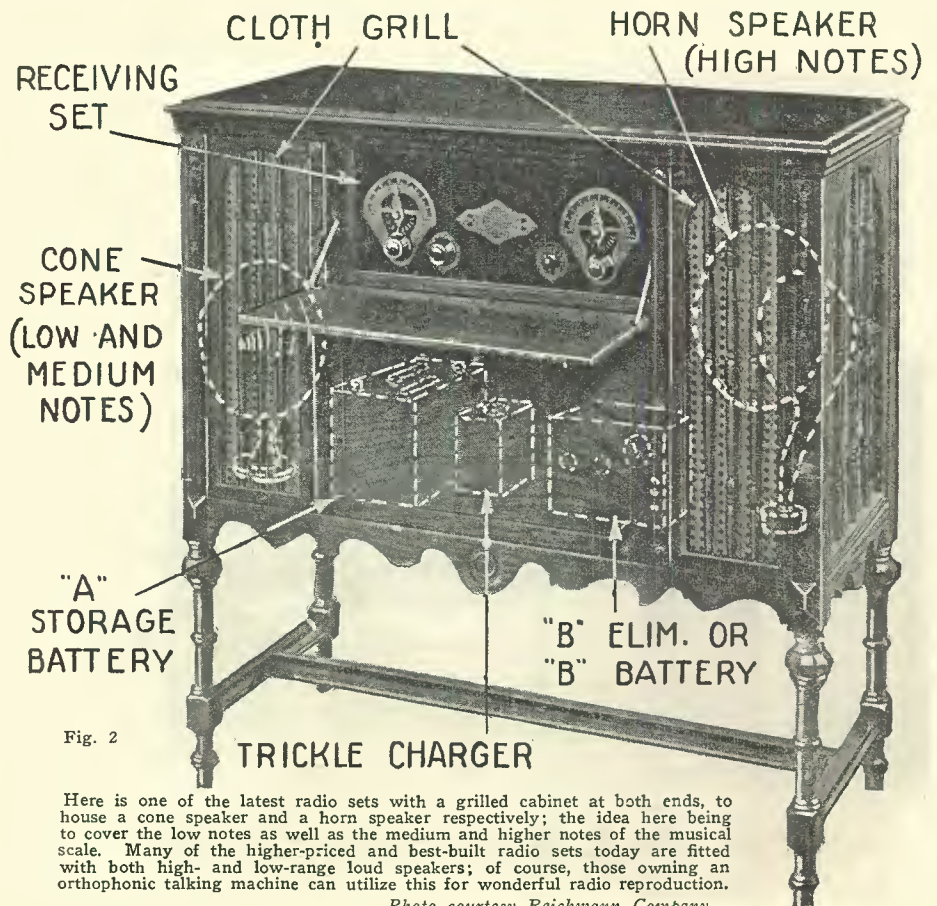

Fig. 2

Here is one of the latest radio sets with a grided cabinet at both ends, to house a cone speaker and a horn speaker respectively; the idea here being to cover the low notes as well as the medium and higher notes of the musical scale. Many of the higher-priced and best-built radio sets today are fitted with both high- and low-range loud speakers; of course, those owning an orthophonic talking machine can utilize this for wonderful radio reproduction.

Photo courtesy Reichmann Company

A German Portable Superheterodyne

A Set Covering the Wave-Band from 200 to 2000 Meters

By M. L. MUHLEMAN

THE desire for long-distance reception, and the best of that, by European radio fans is evidenced by the fact that manufacturers have placed superheterodyne receivers at their disposal. It is just a case of supplying a growing demand for a set a bit more powerful than previously available.

A German manufacturer now presents a portable superheterodyne receiver, which, without a doubt, is of considerable merit. It is, in some respects, surprisingly similar in design to American standards.

CONVENIENT "LOGGING" DEVICE

A front view of this receiver is shown in Fig. 1. Being a portable set, it is designed

Fig. 1. The left knob (large) of this portable superheterodyne controls the wavelength (aerial-tuning) and the other the oscillator condenser. The other two knobs adjust the rheostats. This receiver is designed especially for loop reception. Photos by courtesy of Dr. Eric F. Huth, G.m.b.H., Berlin.

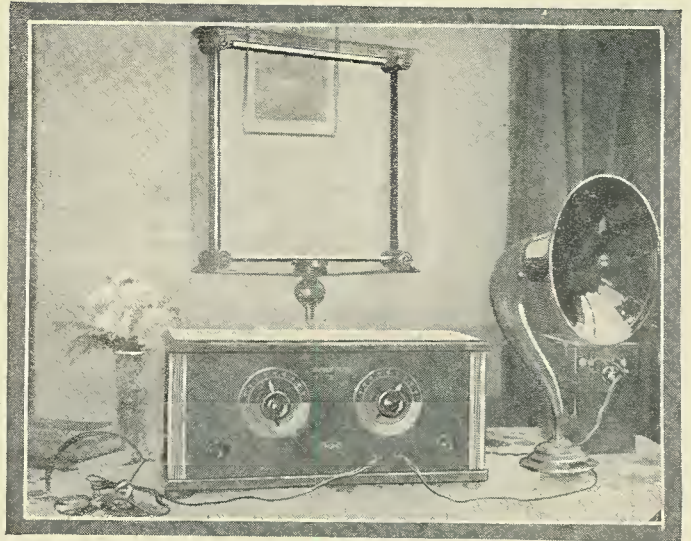

surfaces, upon which station calls or wavelength settings can be written, and the set thus calibrated. The left knob operates the aerial tuning condenser, the right knob the oscillator condenser. The settings of both are practically the same for any one station. The knobs at the extreme left and extreme right of the lower part of the panel

Seven tubes of the 1½-volt type are employed in this set. There is an oscillator, first and second detector, three intermediate-frequency amplifiers and one audio-frequency amplifier.

The two-volt "A" battery and the 90-volt "B" battery are placed in a compartment in the rear of the cabinet, as shown in Fig. 4.



Fig. 2. The schematic diagram of the seven-tube German portable superheterodyne. Two jacks are provided, one for a headset and the other, after the A.F. stage, for a loud speaker.

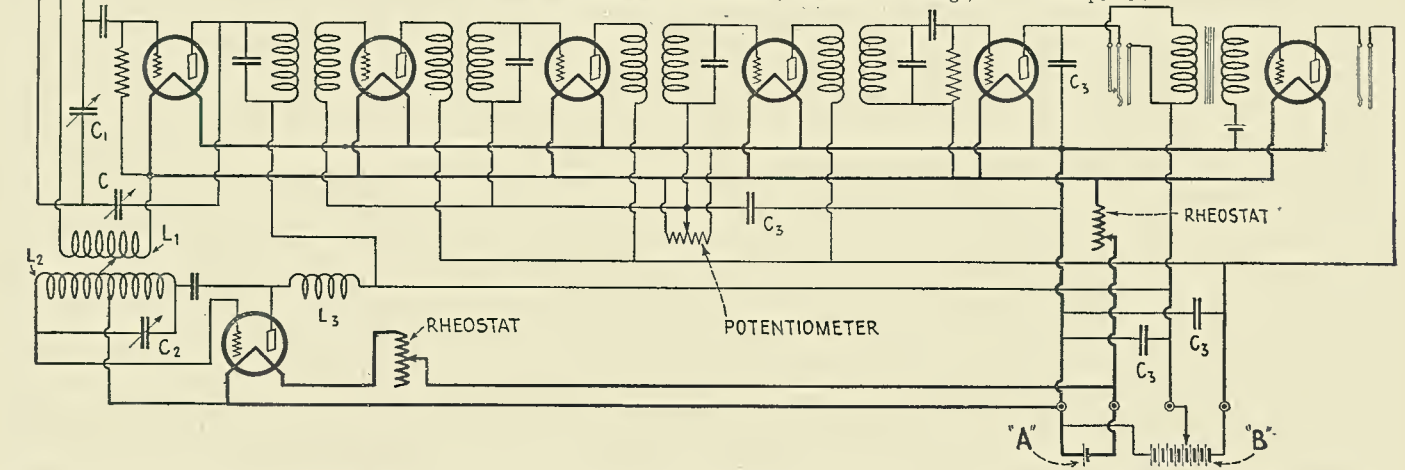

to operate from a loop aerial, which is also shown. All tuning is accomplished by the manipulation of the two large knobs, the pointers of which traverse conventional scales, marked in degrees. Secondary pointers below the knobs move over frosted glass

control rheostats. One allows a fine adjustment of the current through the filament of the oscillator tube, the other controls the current to the rest of the tubes. Two jacks are provided, one for phone reception and the other for the loud-speaker.

WIDE RANGE FOR EUROPEAN BROADCASTS

This receiver has a double wavelength range, controlled by a switch inside the cabinet. With the switch in one position the receiver covers the range between 200 to 600 meters. Changing the position of the switch shifts the wavelength range; and stations operating within the band from 600 to 2000 meters can be received.

The intermediate-frequency amplifying transformers are adjusted to peak at 68 kilocycles and matched to this frequency at the factory. Each transformer is enclosed in a metal casing, which acts as a shield and prevents any possible interaction of the circuits. The two variable condensers are also shielded from each other, as will be noted from Fig. 3, and the oscillator tube together with the oscillator coupler are placed within this space. To carry the protection still further, the inside of the cabinet is lined with copper sheeting; so that in effect the only energy that can possibly set the circuits to functioning is that picked up by the loop aerial.

One might imagine that with the lining of copper on the inside of the cabinet it would be unnecessary to employ any sort of shielding between the various components within. This however, is not true; as one of the

(Continued on page 1164)

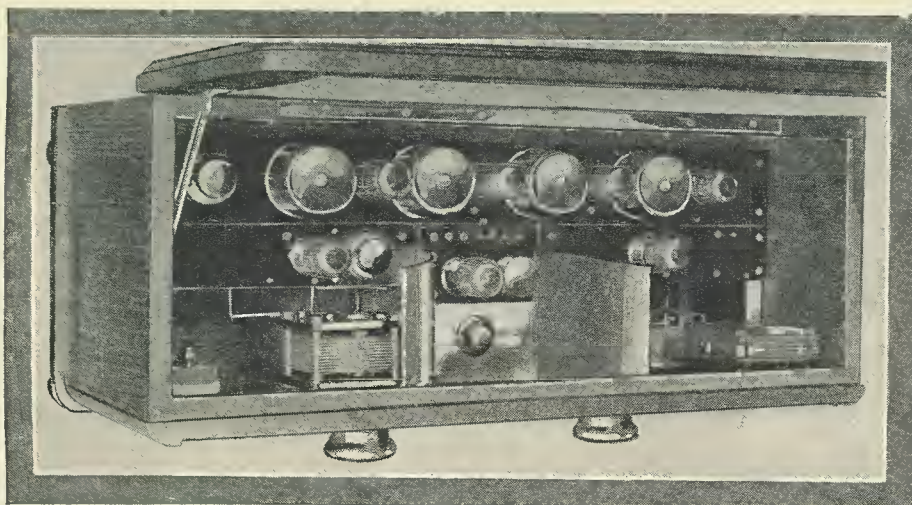

Fig. 3. Notice the type of shielding employed about the two variable condensers, the oscillatory circuit being placed between them.

A New Development in R.F. Amplifiers

Description of the Loftin-White Constant-Coupling System

By ROBERT H. MARRIOTT*

WHAT bids fair to become the outstanding circuit of 1927 is the Loftin-White Circuit, the theory of which is described in this article the first of a series in RADIO NEWS. The new circuit is remarkable in that it gives constant amplification over the entire broadcast range, without the usual artifices and without the usual "crutches" which have been employed for several years in trying to accomplish this end. The second article, describing how to build the set, will be published in an early issue.

—EDITOR.

DURING the past year I became very much interested in a new circuit, because it seemed to me to be the first real improvement in radio-frequency-amplifier circuits since broadcasting began to be the principal use for radio. The theory of the circuit interested me at first; since then my interest has been increased by the practical results that have been obtained from the circuit in actual use.

Broadcasting began its very rapid development in 1921. However, the better radio-frequency amplifier circuits which we have used, since 1921, date back before that time. For example, in several law-suits, Hartley, Rice and Hazeltine have all carried their dates back before 1919. Hartley, for example, goes back to 1915, and Hazeltine to 1918, with Rice between those two years.

Radio-frequency amplifiers were in some demand before the radio broadcasting era. They were fairly practical at long wavelengths, but for comparatively shorter waves, such as we use now in broadcasting, their performance was handicapped by an excessive feed-back, which took place through the inherent capacity between the grid end and the plate end, respectively, of the grid and plate circuits. This feed-back produced undesired oscillation in the grid circuit, and subsequent signal distortion. Hartley, then Rice, and then Hazeltine (apparently not knowing of Rice), set out to kill the effect of the feed-back by introducing into the grid circuit an opposing feed-back from the plate circuit. In a sense, they did what you may have done if you have had to fight a prairie

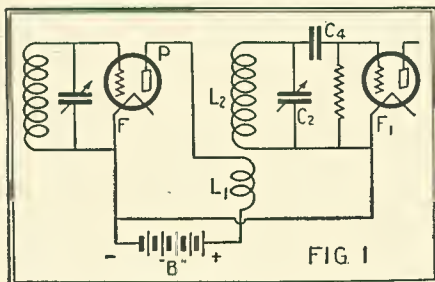

The common form of tuned-radio-frequency circuit coupled to the detector, as employed in most present-day receivers. Compare this with the circuit of Fig. 2.

or forest fire; that is, they produced a back fire. They used varied connection arrangements to produce the back fire; but all three employed the one principle of having two opposing feed-backs from the plate circuit. The use of this principle makes an improvement; but the improvement is not uniformly

effective for all broadcast wavelengths. Also, this likeness in principle has produced another controversial patent situation, involving Hartley, Rice, Hazeltine and others.

A DIFFERENT SOLUTION

This new circuit does not operate on the principle of having two opposing feed-back currents from the plate circuit. It operates on the principle of making the feed-back harmless before it starts back to the grid. In other words, the new circuit takes the teeth out of the feed-back. Also, it is uniformly efficient for all wavelengths. And because its principle is different, it is not involved in any controversial patent situation.

The new circuit is not the product of the wealth of a large corporation, rich in money, laboratory facilities and picked men from our higher educational institutions. On the contrary, it is the product of two independent inventors.

The circuit was produced partly by Edward H. Loftin, who has been in close contact with the practical, theoretical and patent aspects of such circuits for a number of years; first as officer in charge of the radio patent and research section of the United States Navy, and later as a consulting engineer, in private practice. His co-worker,

quite different. Fig. 1 has one plate circuit while Fig. 2 has two. Fig. 1 has one coupling, while Fig. 2 has two couplings between the plate circuit and the grid circuit of the detector tube. Fig. 1 has no condensers in the plate circuit, while Fig. 2 has two condensers in one of its plate circuits. Also, Fig. 3 indicates that the feed-back voltages

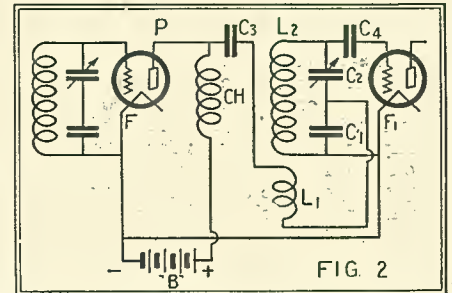

A circuit embodying the Loftin-White principle. It is non-reactive and provides constant electrical coupling at all broadcast frequencies. Note that the primary L_1 is "floating."

and resulting voltages in Figs. 1 and 2 are quite different.

TWO PLATE CIRCUITS

In Fig. 1 both the radio circuit and the direct-current circuit of the "B" battery are through F to P, L_1 , the "B" battery and back to F; while in Fig. 2, the "B" battery circuit is from F to P, through the choke coil, Ch, through the "B" battery and back to F, because C_3 and C_4 will not pass the direct current from the "B" battery. The radio-frequency circuit in Fig. 2 is through F to P, C_3 , L_1 , C_4 , and back to F, because the choke coil, Ch, will not pass much radio frequency current.

The plate circuit in Fig. 1 is coupled to the grid circuit of the detector tube only by the inductive relation of the primary, L_1 , to the secondary, L_2 ; or, we can say, by the mutual inductance of L_1 and L_2 .

The plate circuit in Fig. 2 is coupled to the grid circuit of the detector tube, not only by the mutual inductance of L_1 and L_2 , but in a second and additional way by the mutual capacity, C_4 .

Mutual inductance is less effective for transferring energy at the higher wavelengths than at the shorter ones. Mutual capacity behaves in an opposite manner; that is, it is more effective for the long-wave broadcasts than it is for the shorter. Also, as the tuning condenser, C_2 , is increased in capacity for tuning to the long waves, it automatically changes the relative coupling value of C_4 , making the latter still more effective for the transfer of long-wave signals. In Fig. 2, the coupling abilities of the mutual inductance and the mutual capacity are adjusted so that they combine to produce the same signal transfer for all wavelengths. This is the needed improvement over Fig. 1; because the latter depends on inductive coupling only, and, therefore, does not transfer all frequencies equally well.

PHASE-SHIFTING CONDENSER

In Fig. 2, the condenser, C_3 , is provided to shift the phase of the radio-frequency alternating current in the plate circuit; so that any feed-back that may occur from the plate, P, to the grid circuit of that tube, will be out of phase with the same frequency in that grid circuit. When sufficiently out of phase, it will not add itself to the grid fre-

(Continued on page 1175)

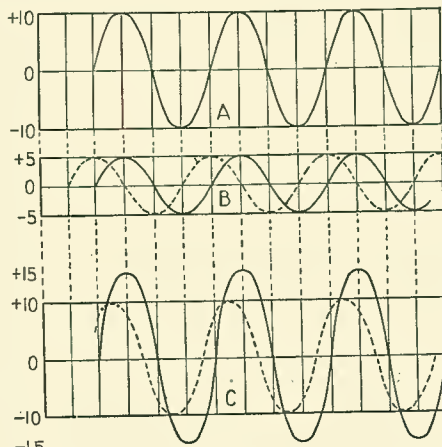

FIG. 3

A graphical comparison of the grid voltages and feed-back voltages developed in the circuits of Figs. 1 and 2.

Mr. S. Young White, has been interested in the practical application of radio theories for about fifteen years and, during recent years, in the tedious work of producing practical improvements in broadcast receivers.

The two-fold functioning of this circuit involves two theories, one being the explanation of why the feed-back does not produce regeneration, and the other the explanation of why the coupling scheme utilized transfers all broadcast frequencies onward equally well; the second is responsible for the description "constant-coupled, non-reactive plate circuit" given the system by its inventors. Those explanations can perhaps be made plainer by referring to circuit diagrams and graphs.

Fig. 1 shows one stage of a radio-frequency-amplifier system, the first tube being an amplifier and the second tube a detector. Fig. 2 shows the corresponding Loftin-White circuit, applied between the amplifier tube and the detector tube. Fig. 3 contains graphs of the grid voltage of the first tube and the feed-back voltages in circuits like Figs. 1 and 2.

A glance tells us that the two circuits are

* First President of the Institute of Radio Engineers.



The Samson R.F.C. Receiver*

Tuned R.F.-and-Impedance Amplifier Provides Equal Amplification

By ALFRED J. POTÉ



WE are pleased to offer to our readers the details of a receiver which employs a radio-frequency amplifier system of distinct merit, since it provides equal amplification at all broadcast frequencies. This has been brought about by the judicious use of a single stage of tuned-radio-frequency amplification and two stages of impedance or choke-coil-coupled radio-frequency amplification. The first is extremely efficient on the short waves; the latter, though not as efficient basically as the former, is far more efficient on the longer waves. Since the impedance amplifier acts somewhat as a blocking circuit, and prevents undue coupling between the tuned R.F. stage and the detector, it has been found possible to employ regeneration in the detector circuit without affecting the functioning of the R.F. amplifier in any way.

The set as a whole is extremely sensitive to distant signals, has a high degree of selectivity and an audio amplifier of the dual-impedance type which can be relied upon to give excellent reproduction. —Editor.

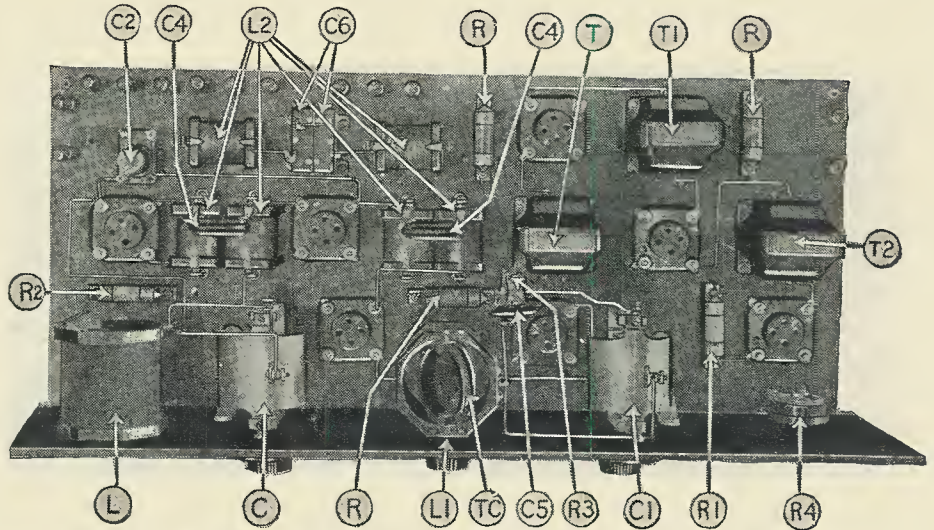

A top view of the Samson R.F.C. receiver. L2 are the radio-frequency chokes used in the two impedance-coupled R.F. stages. C4 are the blocking condensers; L1 comprises three coils, a variable primary, a secondary and a variable tickler coil. The latter can be seen at the top. C2 is the one and only neutralizing condenser.

THE home builder, who has for the past several months successfully directed his major efforts towards obtaining a good audio-frequency amplifier, is again turning his attention to the radio-frequency end of his receiver, in order to utilize his beautiful reproduction on some of the distant stations.

Even in view of the extent of our chain broadcasts today, the desirability of a substantial amount of radio-frequency amplification is unquestioned. In general, it may be said that there have been no improvements of major importance in this field dur-

ing the past year; and we are now confronted with the task of obtaining a radio-frequency amplifier which will be free from not only the many shortcomings which were apparent a year ago, but many more, not then apparent, but which we now recognize with our changed conditions of broadcasting and reproducing.

THE PROBLEM IS ELECTRICAL

It may be well to ask at the start, just what is wrong with home-built radio-frequency amplifiers? The question might be answered by discussing the theoretical shortcomings of the multitudinous amplifying systems; but we must not overlook the fact that one of the chief difficulties is that, inherently, radio-frequency networks are such that the *mechanical* arrangement of parts

and wires affects circuit conditions tremendously; so that extremely variable results may be obtained with any given circuit in the field. Another difficulty has been caused by the attempts to improve radio-frequency amplifiers by performing mechanical tricks with the circuit elements rather than by resorting to fundamental electrical design.

For instance, assuming all other things the same, no amplifier is made *electrically* better by using a variable capacitance of the straight-line-frequency, rather than the straight-line-capacity type. Now, of course, an egg-shaped coil, let us say, used instead of a solenoid, would affect an amplifier electrically; but unless the builder is made aware of what he is paying in efficiency for more

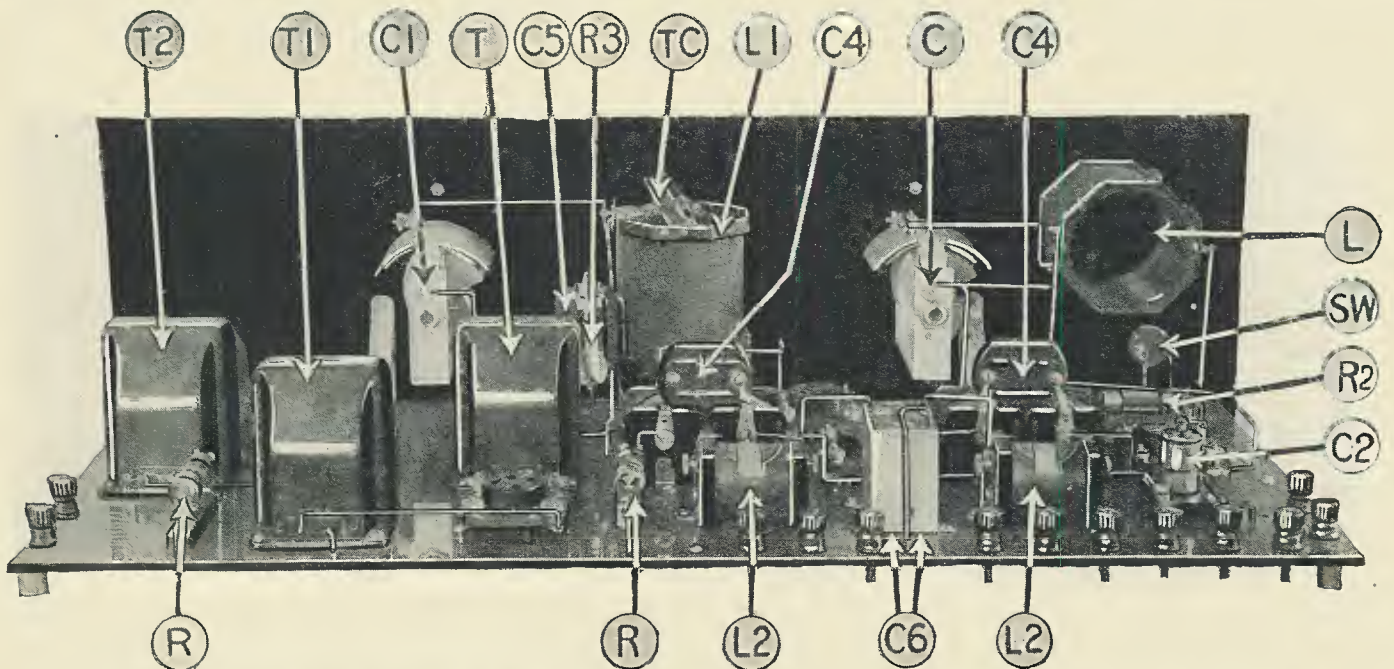

A rear view of the Samson R.F.C. receiver. The parts are: L, antenna coupler; TC, tickler coil; L1, R.F. transformer; L2, R.F. chokes; C, C1, tuning condensers; C2, neutralizing condenser; C4, coupling condensers; C5, grid condenser; C6, by-pass condensers; R, R2, automatic filament controls; R3, grid leak; T, A.F. Transformer; T1, T2, dual impedances and SW, filament switch.

* Radio News Blueprint Article No. 11.

easily obtaining some desired effect, the improvement expected may become zero or a negative quantity in his estimation. This phase of the problem would bear further discussion, but the point we are trying to make may be more clearly brought out by what follows.

PROBLEMS OF AMPLIFICATION

Most of the radio-frequency amplifiers which we have today are open to criticism on one or more of the following counts; difficulty of control, multiplicity of controls, difficulty of construction, non-uniform frequency characteristic (which means that much more amplification is obtained at some part of the wave band than at others), instability, and "trick" adjustments which vary with variable conditions in the power sources.

Now, considering first the question of multiplicity of controls, we may say, in general, that in order to obtain selectivity without depending too much on regeneration we must have two or more tuned circuits. If we try to get away from a plurality of control dials, we encounter mechanical difficulties in the construction of a "gang" control. If, on the other hand, we obtain selectivity with one tuned circuit sufficiently "soaked up" with regeneration, we again encounter difficulties of manipulation, since the regeneration control would require a comparatively delicate adjustment with each new position of the tuning dial.

Of all the troubles mentioned above, perhaps the most serious, and certainly the one most generally known, is the variation in the amplification factor of R.F. amplifiers over the broadcast-frequency band. A variation of fifty per cent. in a single stage of tuned-R.F. amplification is not uncommon; and where two or more such stages are worked in cascade, the resulting variation is very serious indeed. This defect is most apparent in tuned transformer-coupled amplifiers, and in the past attempts to correct this difficulty have been most generally methods of loss equalization. A tuned stage which had an amplification of 7.5, let us say, at 550 meters against 15 at 200 meters, was so "doctored" that the amplification remained sensibly the same at the long waves, but was reduced to a comparable value at the short; say 7.3 at 550 meters, 9 at 400 meters, and 6.5 at 200 meters.

More uniform amplification was unquestionably obtained, but unless the home-builder was willing to compensate for the loss at the low end by adding another stage, the equalization resulted only in giving no more sensitivity at the long waves, and less than before at the short. In commercial receivers this method permitted an improvement; since, if the criterion of stability was the maximum over-all amplification, loss-

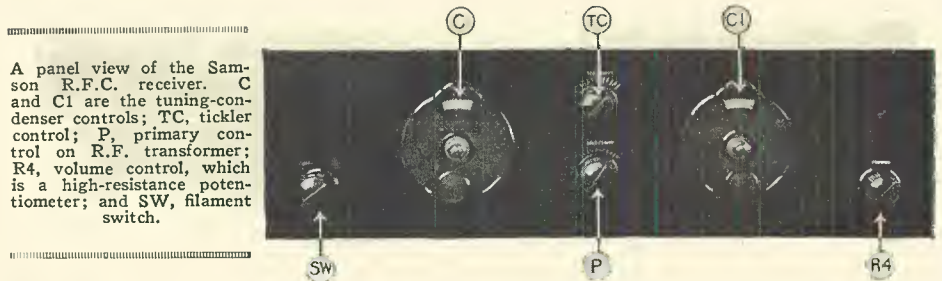

A panel view of the Samson R.F.C. receiver. C and C1 are the tuning-condenser controls; TC, tickler control; P, primary control on R.F. transformer; R4, volume control, which is a high-resistance potentiometer; and SW, filament switch.

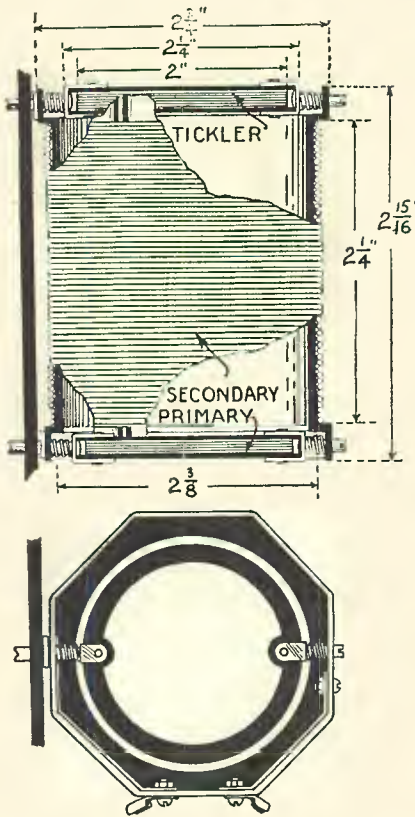

PRIMARY 40 TURNS No 28 D.C.C. WIRE
SECONDARY 54 TURNS No 26 D.C.C. WIRE
TICKLER 16 TURNS No 28 D.C.C. WIRE

Constructional details of the radio-frequency transformer. The coils can be wound on ordinary insulating tubing. Note that both primary and tickler coils are variable. The aerial coupler has the same physical dimensions, but has a continuous winding of 60 turns of No. 26 wire with a tap at the sixth turn for the aerial connection.

equalization would allow the use of another stage, which would otherwise be impossible, and thus the amplification level might be maintained throughout the range at nearly the previous maximum value.

VARIABLE-COUPPLING SYSTEMS

Straight-line characteristics in the radio-frequency amplifiers have also been obtained by using mechanically-variable coupling; but in a home-built receiver this method is hardly a feasible one without the use of manufactured parts, which accomplish a coupling variation when the secondary is tuned.

By combining two different kinds of coupling, one of which has a drooping and one a rising frequency characteristic, a favorable frequency curve may be obtained; but the peculiarities of such a circuit are many, and the relative electrical magnitudes of the circuit elements are important, so that unless exact data are available for home-building, this very ingenious method may prove a disappointment.

In view of the foregoing, it might be said that the design of an R.F. amplifier which accomplished a frequency equalization, and at the same time gave a gain in amplification at every position of the frequency band, which entailed no extra controls, which was inherently stable, and which required for successful construction only the ability to place parts so that high-potential leads were reasonably short—would be a long stride in the right direction. There, briefly, are some of the characteristics of the amplifier here described.

The amplifier proper is simply impedance-coupled. A tuned circuit is coupled to the antenna and works into the first tube; there follow two impedance-coupled stages, and then another tuned regenerative circuit feeding into the detector.

A SPECIAL IMPEDANCE REQUIRED

Now, in order to realize a gain which is some reasonable fraction of the "mu" of the tube, the coupling impedance should attain a value which is 150%, or more, of the internal filament-plate resistance of the tube. To attain this high impedance with

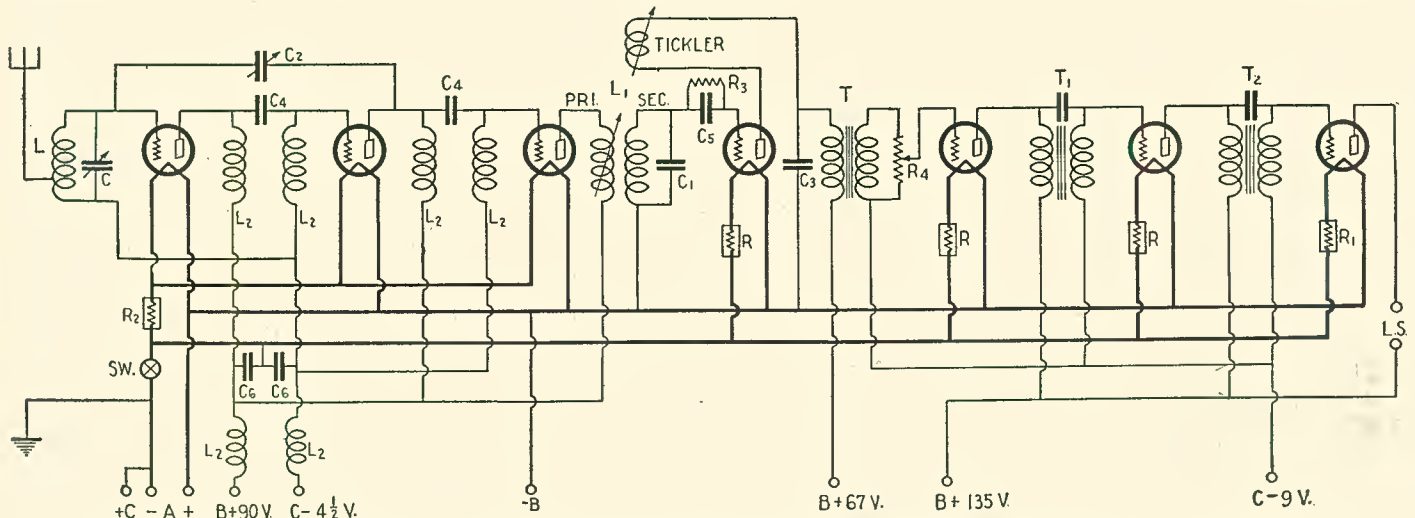

The schematic wiring diagram of the Samson R.F.C. receiver. Note the manner in which the neutralizing condenser C₂ is connected in the circuit. Two R.F. chokes (L₂) are used in series with the "B" 90-volt lead and the "C" 4½-volt lead to keep the radio-frequency currents out of the batteries. The chokes are by-passed by condensers C₄. The filament switch and automatic filament controls can be placed in either the plus or the minus "A" battery lead, whichever is the most convenient; but it is recommended that the layout wiring diagram be followed.

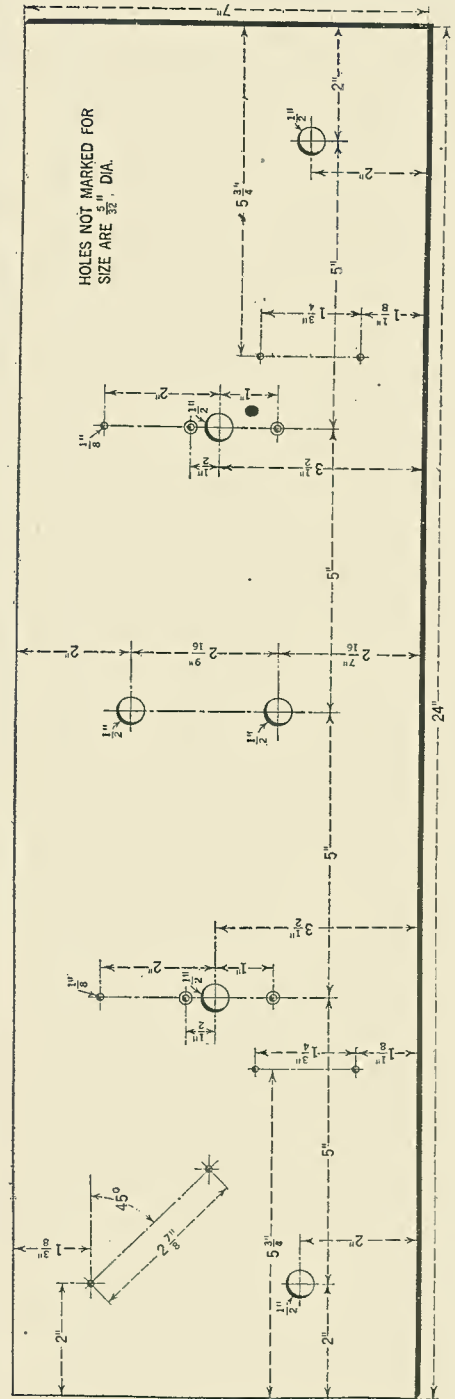
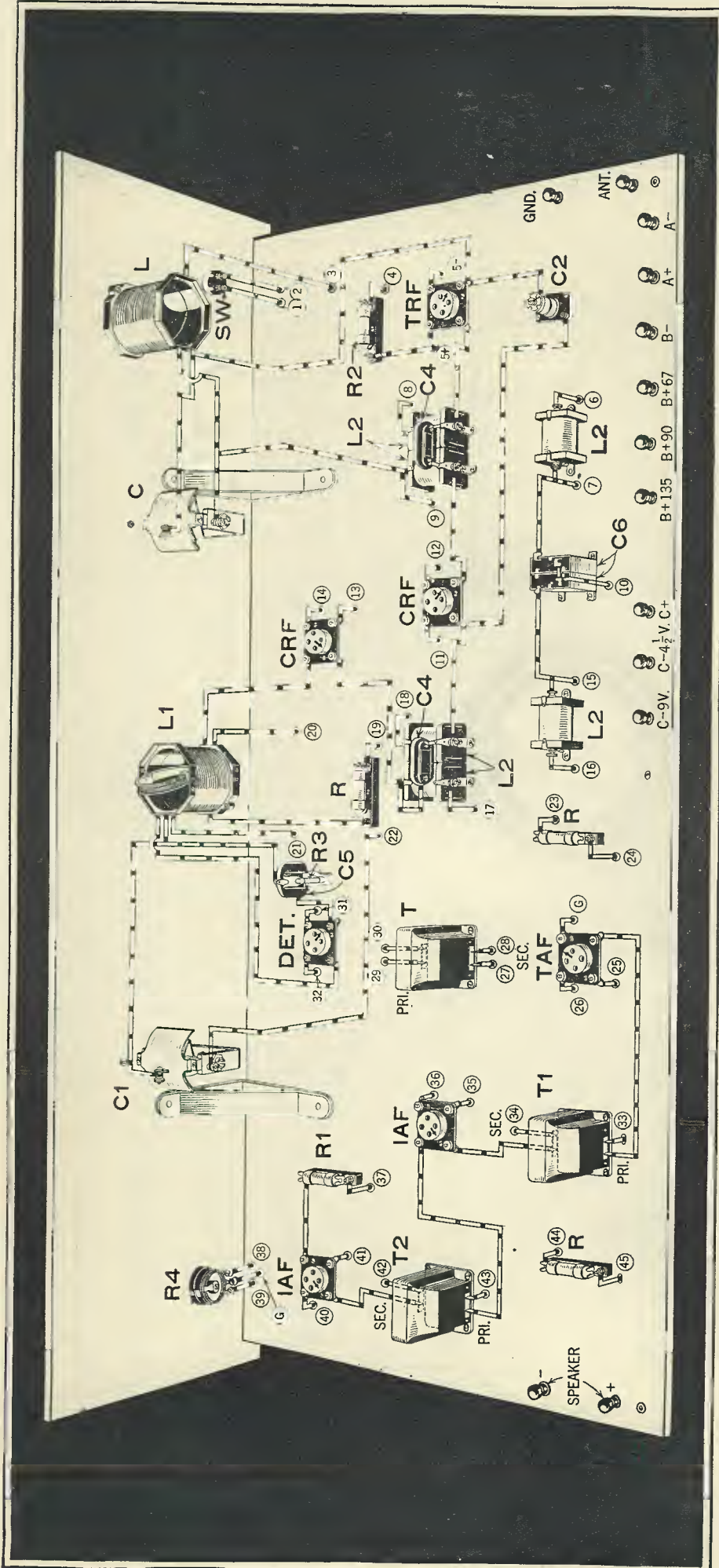

Left: The layout and wiring of the main portion of the Samson R.F.C. receiver. The majority of the wiring connections are made underneath the sub-base. It will be noted that most of these wire holes carries the same number or letter on both sides of the sub-base; so that it is an easy matter to run each lead to its proper terminal. The panel drilling layout is shown above. If other apparatus than that specified is used, all but the shaft holes and bracket holes should be disregarded.

a pure inductance at signal frequencies would be a very simple matter; but the unfortunate fact is that any choke we may attempt to use for coupling will act as a capacitance at these frequencies, hence the impedance we may obtain is that of a condenser equalling the distributed capacity of the coil plus the equivalent shunt-tube capacitance. It is immediately apparent, then, that for a successful amplifier of this type, we must have a coupling choke with extremely low distributed capacitance. By means of a patented helical winding it has been possible to make such a choke, its ca-

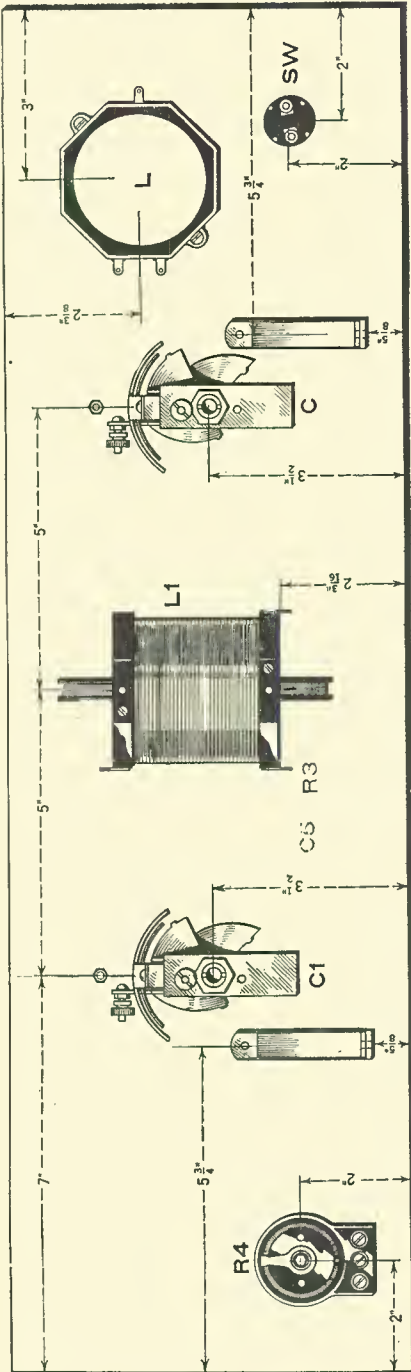

Above: Layout of apparatus on the panel. All the necessary dimensions are given. Special care should be exercised in mounting the two supporting brackets so that the panel will fit evenly upon the sub-base. Right: The wiring on the underside of the sub-base. This plan should be used in conjunction with that on the opposite page. The lead that passes over hole 27 makes connection at this point with another wire which comes through the sub-panel.

capacitance being of the order of 2 or 3 micro-microfarads at broadcast frequencies.

It is this capacitive plate load which gives the amplifier its interesting characteristics. Since the reactance of a condenser is an *inverse* function of frequency, the external plate impedance (hence the amplification) increases with increasing wavelength, and the greater gain occurs where it is most to be desired.

Also, with a capacitive plate load the feed-back through the inter-electrode capacitance of the vacuum tube is of such phase as to cause anti-regeneration, making the amplifier inherently stable. However, if we make use of the phase reversal through the

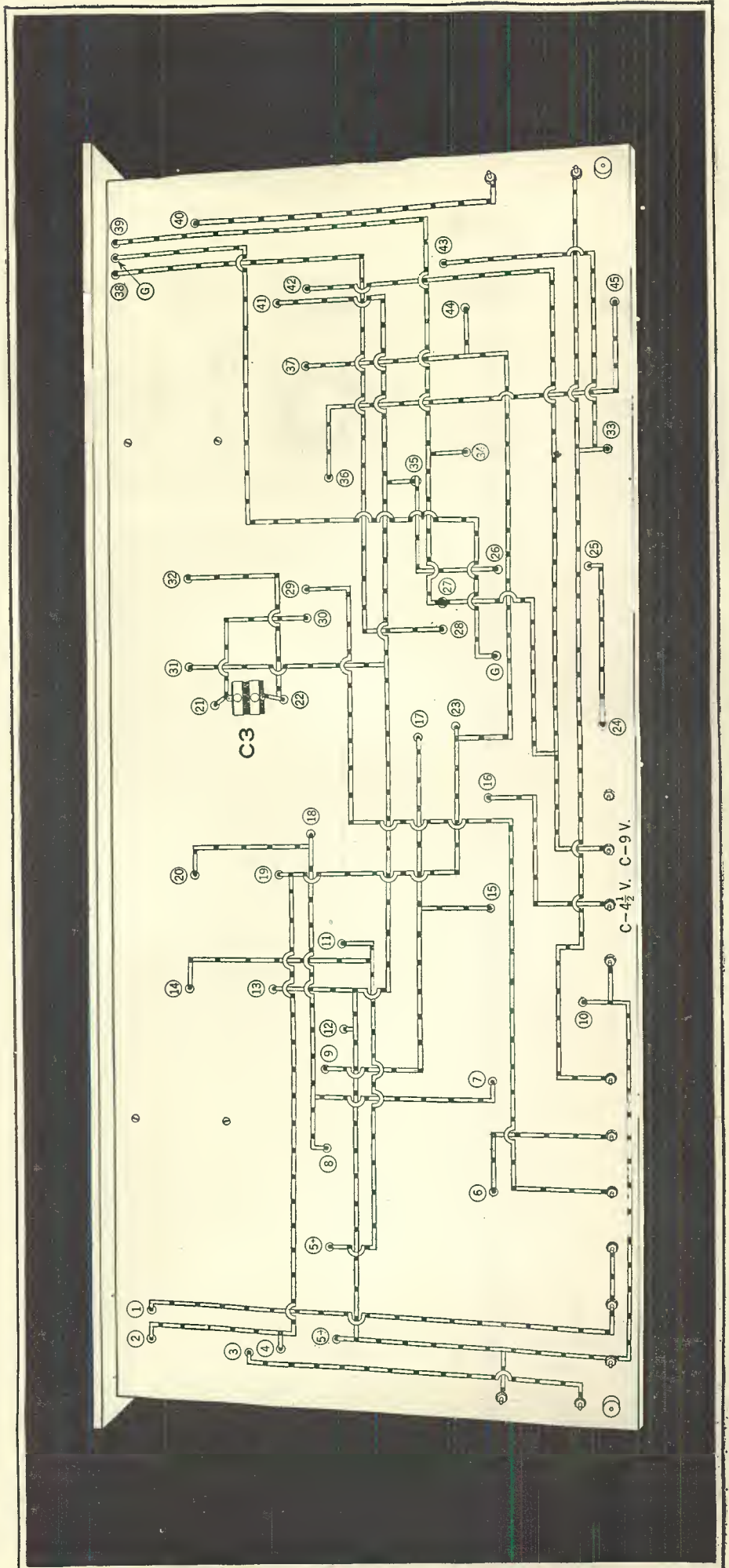

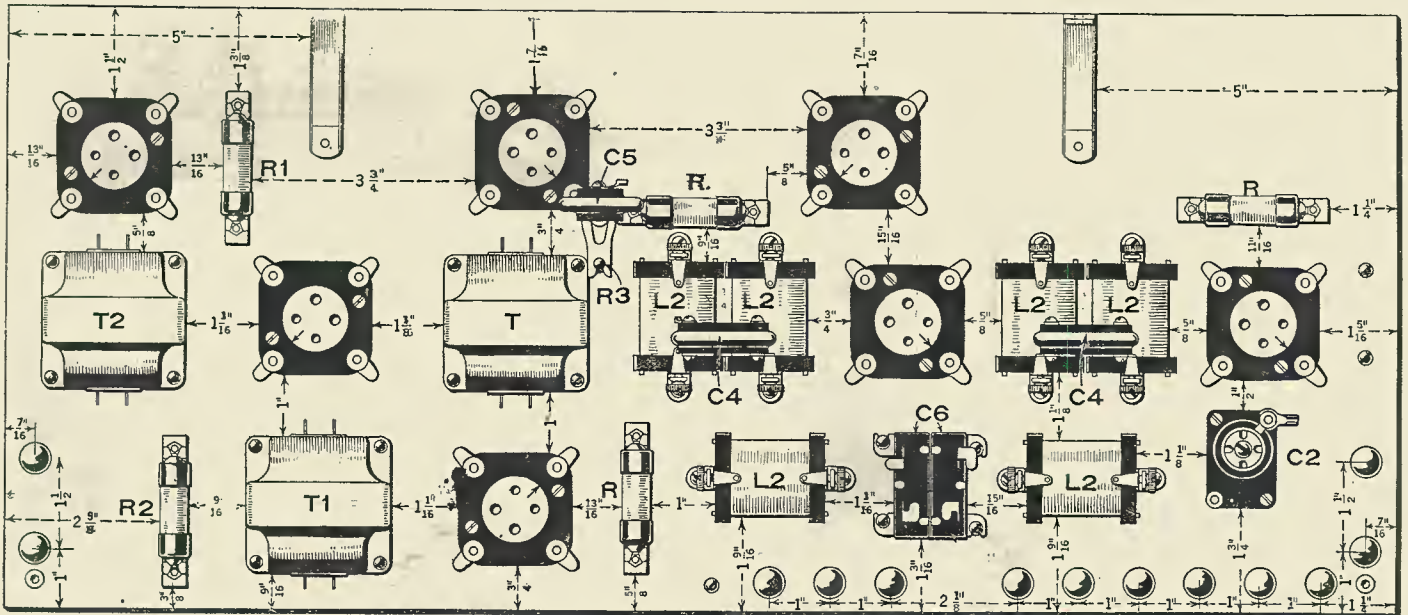

Layout of the apparatus on the sub-base. The measurements between the different pieces of apparatus are given for those who wish to lay out the holes by the use of a center punch rather than resort to the drilling layout shown below. The correct position for the supporting brackets is again indicated. The lettering on all the apparatus corresponds to the lettering in the other illustrations and on the specification table containing the list of parts.

coupling system and tube, and connect the plate of the second tube through a small neutralizing condenser to the grid of the first tube, it is possible to neutralize this feed-back; or, by overneutralizing, to introduce regeneration into the first tuned circuit. In the latter case the adjustment is set at the long waves and will then require no further adjustments.

The grids of the R.F. amplifier tubes should be properly biased, and it should be stressed at this time that the "B" and "C" power sources must be thoroughly isolated from the amplifier, by means of chokes and condensers.

THE R.F.C. RECEIVER

The receiver to be described embodies all of the features previously outlined. The antenna system feeds into a single stage of tuned-radio-frequency amplification of conventional design. This is followed by two

stages of choke-coil or impedance-coupled, radio-frequency amplification. The detector, which follows the choke coil amplifier, is regenerative. Variable coupling is provided for both the tickler coil, through which regeneration is obtained, and the primary coil of the R.F. transformer coupled to the input of the detector. The detector is followed by a single stage of transformer-coupled A.F. and two stages of dual-impedance A.F. amplification. A semi-power amplifier tube is used in the last stage, to prevent overloading.

The radio-frequency amplifier portion of this receiver is more stable in operation than the conventional type but, having many of the characteristics of conventional types, it is quite capable of oscillating under certain conditions. Consequently a small variable neutralizing condenser (C2) is employed for the purpose of stabilization. It will be noted

from the circuit diagram that this neutralizing condenser is not connected in the usual manner. One side is connected to the grid terminal of the first tube in the tuned R.F. amplifier, and the other side to the plate terminal of the first choke-coil-coupled R.F. amplifier tube. This is a most satisfactory arrangement and provides a perfect control, which cannot be said of most neutralizing schemes. Unfortunately, the arrangement cannot be applied to the usual type of tuned-radio-frequency circuit.

The use of straight-line-frequency variable condensers makes the tuning characteristics of the receiver satisfactory from the standpoint of the operator; for no crowding of stations is experienced, as usually is the case with the old type straight-line-capacity condensers. This is a long step towards freedom from interference.

(Continued on page 1144)

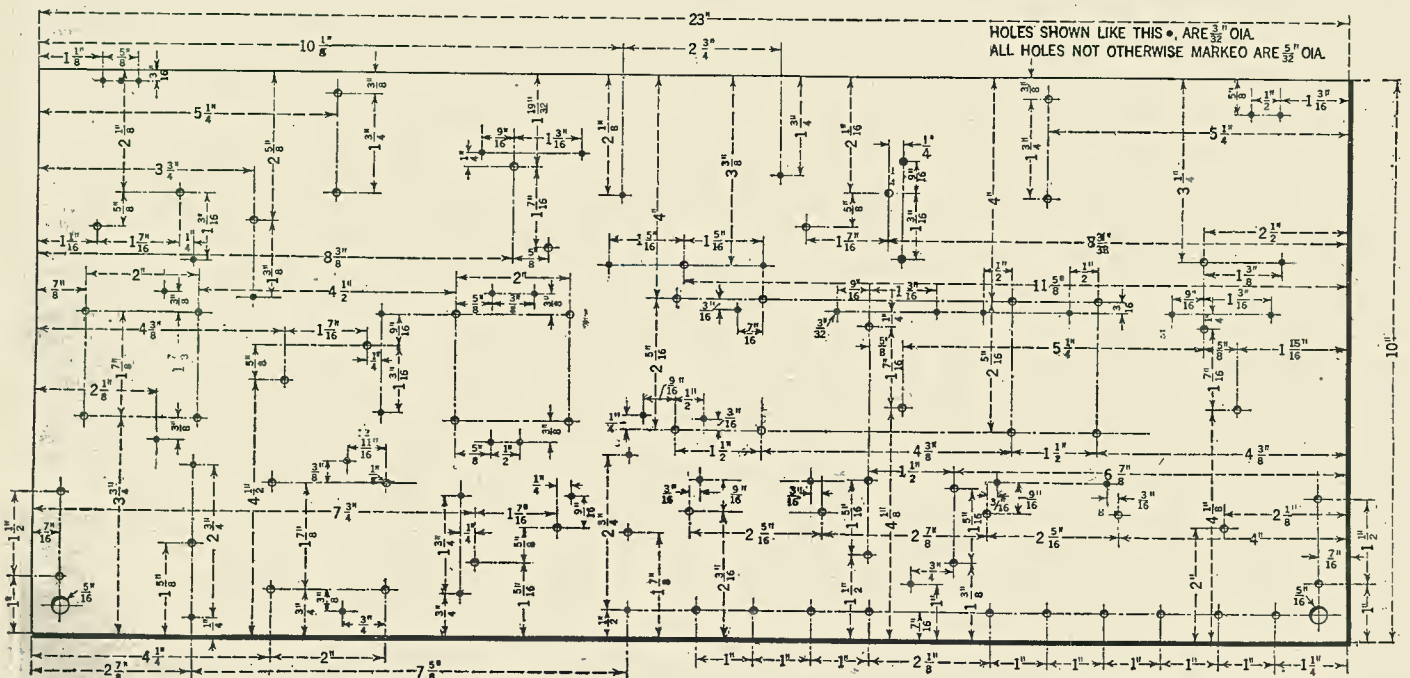

Drilling layout for the sub-base. All holes in full black are wire holes, used in wiring up the set. All the necessary data are included in this drawing.

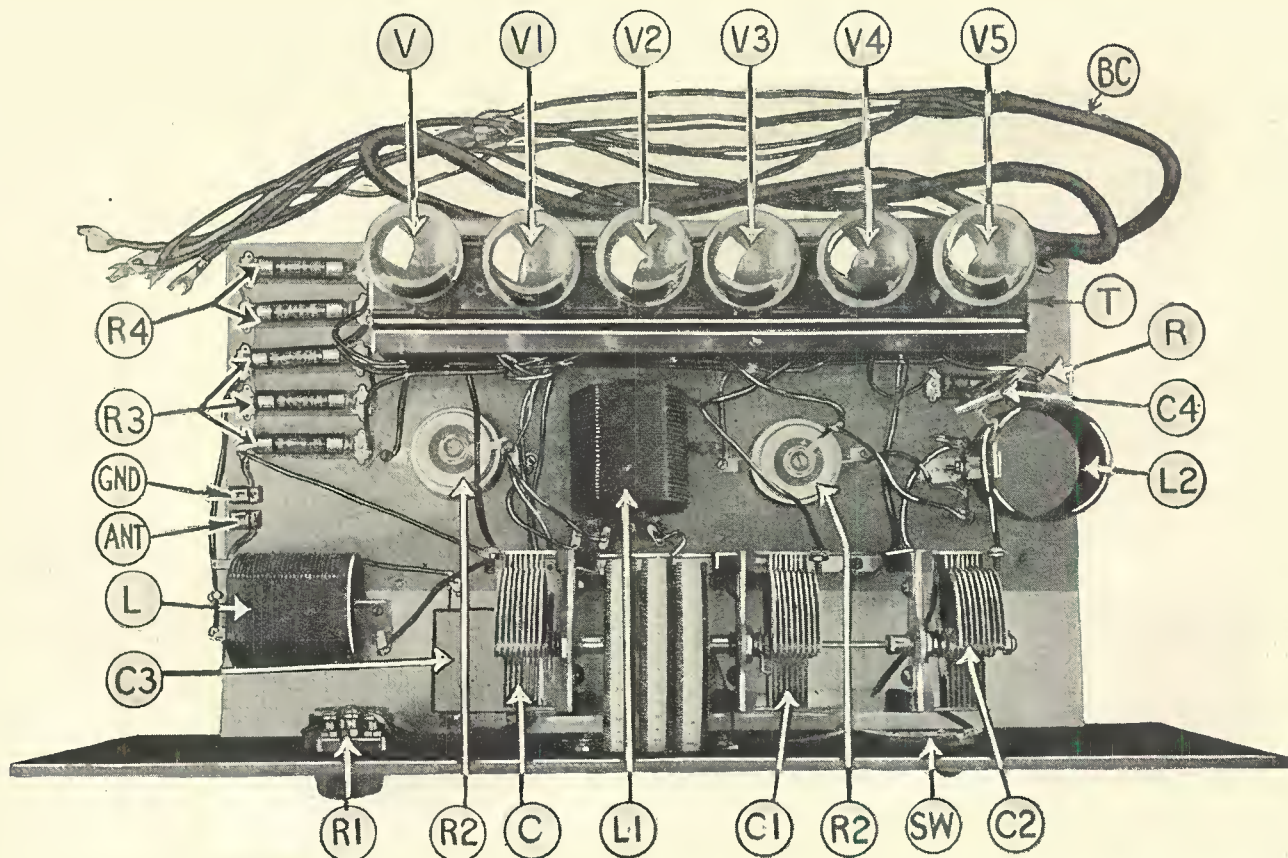

A top view of the Phasatrol-Balanced Receiver. The parts are: L, antenna coupler; L1, L2, R.F. transformers; C, C1, C2, tuning condensers; C3, by-pass condenser; C4, grid condenser; R, grid leak; R1, volume control; R2, Phasatrols; R3, R4, automatic filament controls; SW, filament switch; BC, battery cable. V is the 1st R.F. tube; V1 is the 3rd A.F.; V2 is 2nd A.F.; V3 is 1st A.F., and V5 is the special detector tube. V1 should be a power tube.

A Phasatrol-Balanced T.R.F. Receiver*

A New Phase-Shifting Device Employed for Stabilization

By J. F. RIDER

HERE is a set which employs an entirely new type of stabilizer for the radio-frequency stages. It is a phase-shifting device, free from the usual "griefs" common to most type of neutralizers. Its use does not introduce heavy losses into the radio-frequency circuits but, rather, takes advantage of a well-known principle heretofore given little notice. Since its effect is not altered by a change of frequency, there is no necessity of continual adjustment and the efficiency gain is constant on all broadcast wavelengths. Greater sensitivity is thus obtained from the two stages of tuned-radio-frequency amplification employed. The A.F. amplifier is of the dual-impedance type and is capable of handling the excessive energy delivered by the R.F. amplifier and providing an undistorted output to the loud speaker.

—Editor.

of sensitivity. The times have changed however, and it is necessary now for the designer of a radio receiver, intended for home construction, to consider every demand of the radio fan. If all are not fulfilled, the receiver is unsatisfactory. Simply to make the assertion that a receiver is "good" and that it will provide "satisfaction" is not sufficient. Albeit the real test is the actual operation, detailed discussion of the design will bring to light the relative points of merit and deficiency. The six-tube receiver described in this article is a successful effort to fulfill the six requirements mentioned in the opening paragraph.

CHARACTERISTICS OF THE SET

The selectivity is obtained through the use of two stages of tuned-radio-frequency amplification (capacitatively tuned) with a fairly high ratio of inductance to capacity, which in conjunction with efficient inductances afford a high factor of selectivity. In view of the fact that the frequency operating characteristics of the R.F. circuits manifest a great effect upon the A.F. signal

which is passed from the detector tube to the audio amplifiers, the R.F. stages are balanced against oscillation by means of a new device called the Phasatrol. By balancing against oscillation, the side-band characteristics of the R.F. amplifiers are very much improved over those obtained when the R.F. stages are not balanced.

The balance, however, is not obtained in the usual manner. The usual negative bias is applied to the grids; the grid circuits are free of series resistances and the full 90 volts is applied to the plates of the radio-frequency amplifiers. The unit used is a combination of resistance and capacity which shifts the phase of the alternating voltages in the plate circuits of the R.F. amplifying tubes, so that over a certain waveband, tube oscillation and excessive regeneration are eliminated.

When the Phasatrol is connected in the plate circuit of an R.F. tube in the manner shown in the schematic diagram, the fixed condenser in the Phasatrol unit changes the time factor of the feed-back impulses so that, instead of meeting the signal impulses in

THE design of radio receivers has reached the stage where certain definite requirements must be complied with. Sensitivity, selectivity, stability, ease of operation, ample amplification and quality reproduction must be available.

In days of old, and not so long ago at that, the musical palate of the average radio fan was very easily satisfied. The prime interest was reception, with a fair degree

Front panel view of the Phasatrol-Balanced receiver. R1 is the volume control, SW the filament switch and C, C1 and C2 the tuning condensers. Note that condenser C2 (shown in the view at top of page) is controlled by the center drum.



*RADIO NEWS Blueprint Article No. 12.

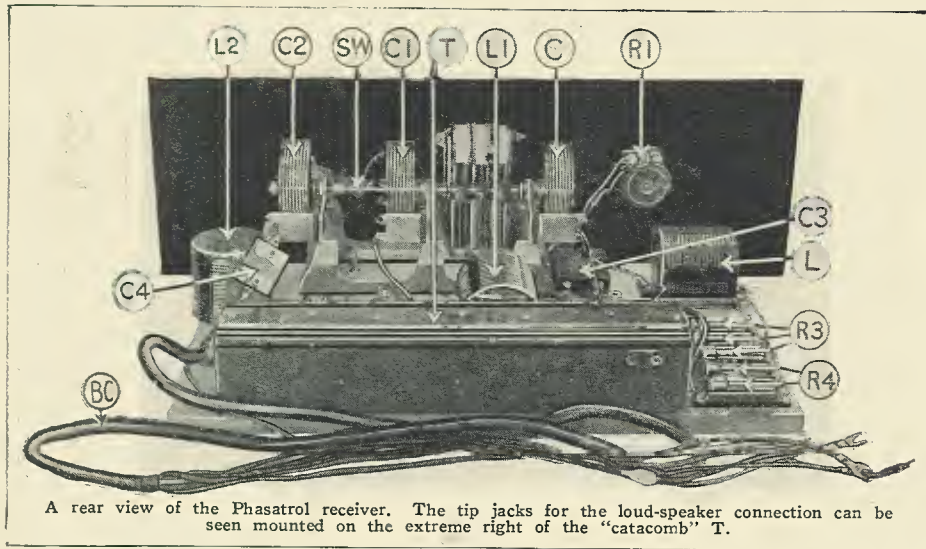

A rear view of the Phasatrol receiver. The tip jacks for the loud-speaker connection can be seen mounted on the extreme right of the "catacomb" T.

phase and building them up, they travel through the grid-to-plate capacity of the tube and arrive on the grid just after the signal oscillations have gone. Hence, there is no re-enforcing action, and no excessive regeneration to cause undesired oscillation. Theoretically the phase difference is never absolutely complete. Some regeneration takes place but this is entirely acceptable.

The variable resistance in the Phasatrol, being both non-inductive and non-capacitive, has no effect on the phase displacement, but serves principally to feed the direct current of the "B" battery to the plate of the tube.

By eliminating positive biases from the grids and series damping resistances from the grid circuits of the R.F. amplifiers, the proper degree of selectivity is obtained with correct side-band characteristics. There takes place a certain amount of side-band suppression (which cannot be avoided because the shape of the resonance curve of a satisfactorily tuned circuit) but this is fully compensated for in the A.F. stages.

To preserve side-band characteristics at the highest possible level, the detector tube is nonregenerative. The method of tuning the R.F. stages has been selected to permit tuning with one hand and still retaining individual tuning. This is possible with the three-gang drum type of condenser shown.

AUDIO-FREQUENCY STAGES

The A.F. amplifier consists of a three-tube combination, the development of the inventor of the Sodian tube, Mr. H. P. Donle. It has a rising characteristic, with correct

curve to operate very excellently with all receivers whose R.F. amplifiers are of correct design. Operating in conjunction with the R.F. amplifying system used in this re-

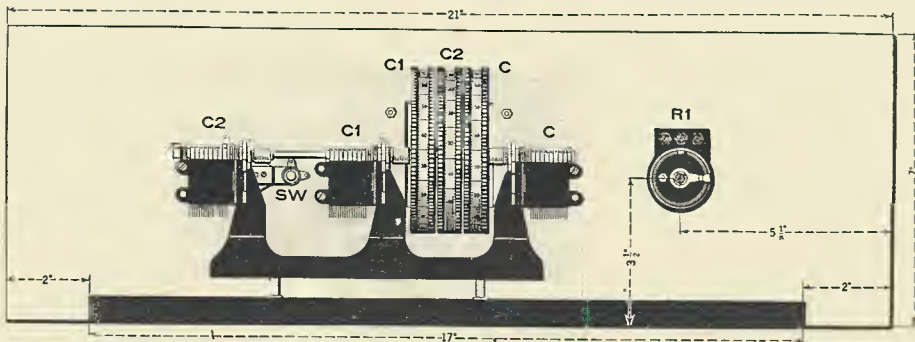

Rear-of-panel constructional layout view of the receiver. Note that the gang condenser unit is actually mounted on the baseboard. All necessary dimensions are given.

ceiver, it produces a remarkable quality of amplification. In addition, the design of the unit is such that it will carry a much greater input without overloading, than is obtained with the average audio amplifier, without a sacrifice in quality. In view of this fact the R.F. amplifier can be operated "wide open" and the full benefits of the powerful amplification of the audio amplifier realized.

The output circuit consists of a choke-condenser combination, providing a filter for the loud speaker, and also additional protection against demagnetization of the speaker magnets and burn-out of the speaker

winding. Through the use of this output unit, high voltages can be applied to the plate of the output tube, with perfect impunity; as the breakdown voltage of the condenser is far greater than any voltage which will be applied to the output tube, and developed across the condenser in normal practice.

ARRANGEMENT OF RECEIVER

The selection of the individual parts was a serious consideration from the viewpoints of beauty of appearance, ease of assembly and ease of wiring. Take for example, the front-panel view. As an item of beauty the panel shown cannot be equaled. The face of the panel is two-toned and the inlay of beautiful satinwood marquetry. To give some technical figures pertaining to this panel, the dielectric constant is 4 and the power factor was found to be .025, which is a very good figure. The drums for the localized-control unit are shown in the center of the panel. The left drum controls the input circuit to the first R.F. tube; the right drum, the input to the second R.F. tube; and the center drum, the input to the detector tube. The pilot-light switch is mounted at the right, and the volume control device is mounted to the left, of the drum control.

The use of the "catacomb" assembly of all sockets, together with the complete audio amplifier and output unit, very greatly simplifies the assembly. Ordinarily it would be necessary to mount six individual sockets, the three audio coupling units, and the output unit. This work is entirely eliminated with the "catacomb" assembly. All the sockets necessary for the complete receiver constitute an integral part of the assembly, which comprises also the audio coupling units and the output unit. With this unit, the construction is divided into four groups. The first comprises the panel and the local-

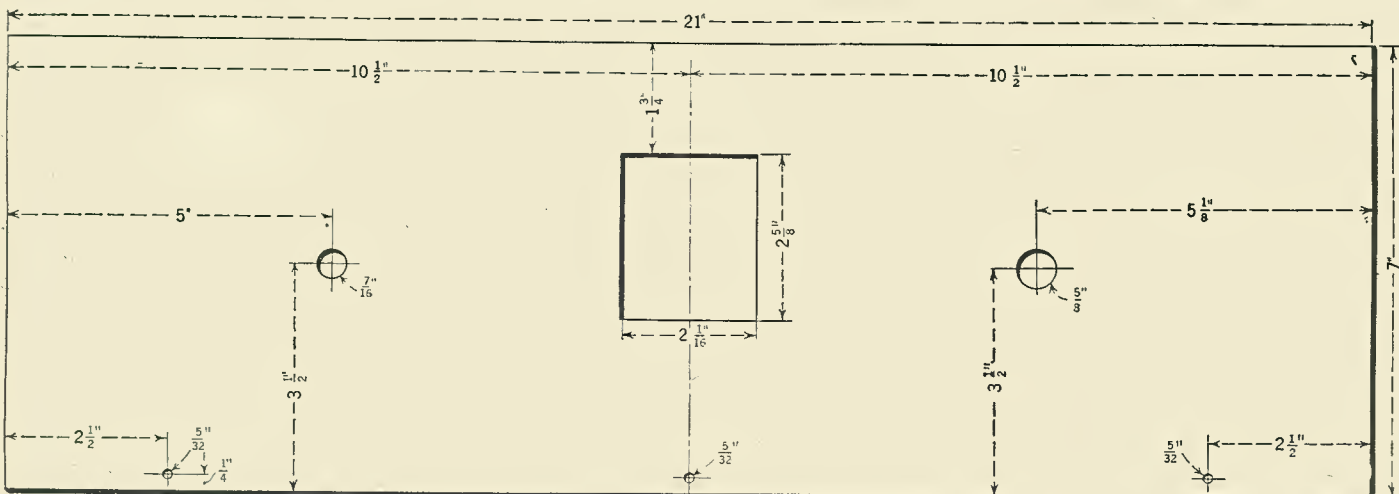

Details for the panel drilling. There are very few holes, as the gang condenser unit is mounted on the wooden baseboard. Actually, the only instruments mounted on the panel are the volume control and the filament switch.

ized condensers; the second, the R.F. coils and balancers; the third is the catacomb assembly, and the fourth, the assembly of the automatic-filament-control units. The view, looking down upon the receiver, shows these parts very clearly.

The construction of the receiver progresses in like manner. The panel dimensions are 7 x 21 inches and the baseboard dimensions, 10 x 17 x 1/2 inches. The three mounting holes (panel to baseboard) are laid out and drilled. When drilling the panel, drill from the front to the rear. The localized-condenser unit is then placed in the position shown in the picture, and a space for the drums cut out of the center of the panel. Then the light switch and the volume-control units are mounted in their respective positions. The volume-control unit is a 100,000-to-500,000-ohm variable resistance, connected as shown in the wiring diagram.

The R.F. coils and the balancing units are then placed in position. The positions of these items can be gleaned best from the constructional sketches. The catacomb assembly is then temporarily placed in position, without any permanent connections or fastening to the baseboard. This step is followed by the mounting of the five automatic-filament-control devices. When proper spacing has been obtained, the initial wiring can be carried out. This consists of the grid and filament connections between the secondaries of the R.F. transformers and their respective tuning condensers. All of the filament connections of the tuned circuits are grounded, being connected to the metal frame of the condensers. This will necessitate the use of a grid-filament connection of the grid leak; instructions for this connection will follow later.

THE SOCKET-AND-A.F. AMPLIFIER UNIT

Now, for the wiring of the "catacomb" assembly. First remove all the screws fastening the cover of the assembly to the case. This step will result in both a cover and a separate socket strip becoming evident. An examination of the socket strip carrying the contacts will show that a series of connections between some of the filament terminals has been made by the manufacturer. This is the common filament lead and will later connect to the "A+" lead. An inspection of the paper on the container will bring to light a number of designating numerals and a flexible lead associated with each numeral. Each of these leads connects with a part of the coupling units within the case. A study of the drawing of these leads will show a dotted outline surrounding each set of numerals. This outline is supposed to represent the unit within the case. Reading from left to right, we see three connections within the first enclosure; this is the output unit. Then we see three more connections within

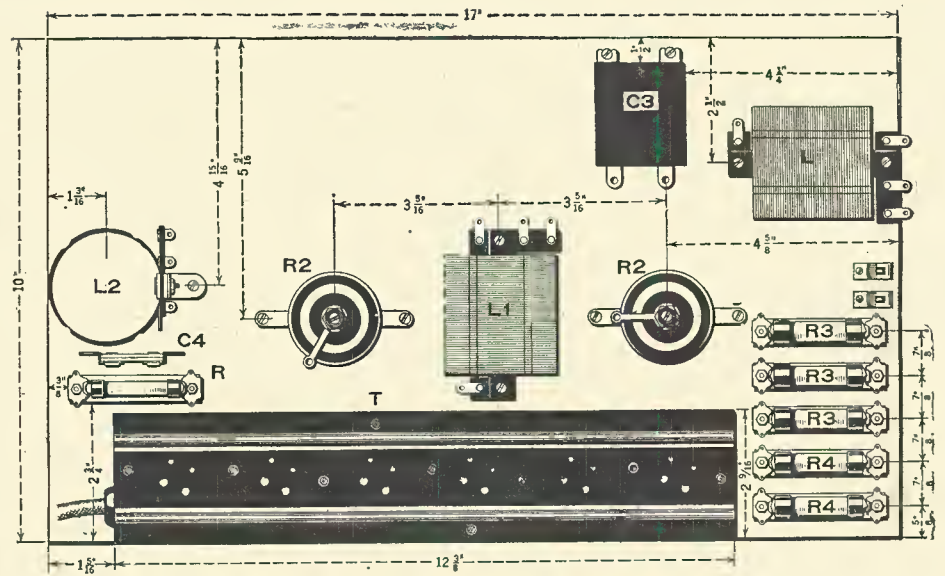

Baseboard layout of the apparatus. All the necessary dimensions are given.

the second enclosure; this is the coupling unit connecting the second and third audio stages. The third enclosure from the left has four connections; this is the coupling unit connecting the first and second audio stages. The enclosure following towards the right has five connections; this is the

sockets. With the socket strip held in the normal position (that is, as it was originally mounted on the case) examine the drawing showing the socket strip. You will see that, reading from left to right (this arrangement affords greatest ease of wiring), the first socket is for the first R.F. tube. The second socket houses the third audio or output tube, then following towards the right, we find 2nd audio, 2nd radio, 1st audio and finally the detector.

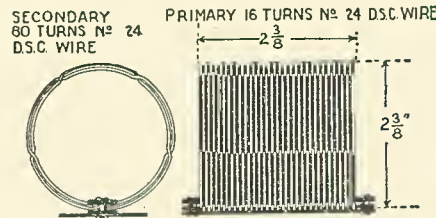

Constructional details of the antenna coupler and R.F. transformers, all of which are identical. The coils can be wound on ordinary insulating tubing.

FIRST WIRING PROCEDURE

Now examine the printing on the cover of the case. The recommendation is made to connect D1 with 2 in tuned-radio-frequency receivers. Do so, by connecting the D1 lead to a portion of the lead designated as 2; but leave sufficient wire for 2, so that connection to the socket strip will be possible. Then connect D3 to the can, by scraping the paint from the can and soldering the wire to the can. This connection places the by-pass condenser in the detector-plate circuit across the proper terminals, when the receiver is finished. No external bypass is now required. Now connect F1 and F2 together and solder to the can at the most convenient point. Do not connect F3 and F1 together; F3 will be connected later. The F1 and F2 connection places the negative bias on the first audio amplifier. Then connect the tip jacks to the wires shown.

unit connecting the detector and the first A.F. tube. The enclosure at the extreme right has two connections. This is a .002-mf. by-pass condenser. Another condenser is shown between the second and third large enclosures. This is a by-pass condenser of .15-mf., and all connections thereto are made inside the case.

Apparently we have a maze of wires and terminals, perhaps very confusing at the outset. The simplicity of the unit will evidence itself as soon as the actual wiring will begin. The next step is the arrangement of the

The next step is to fasten the socket strip to the can. This is effected by means of a screw at each end of the strip, fastened to the flanges available for this purpose. There

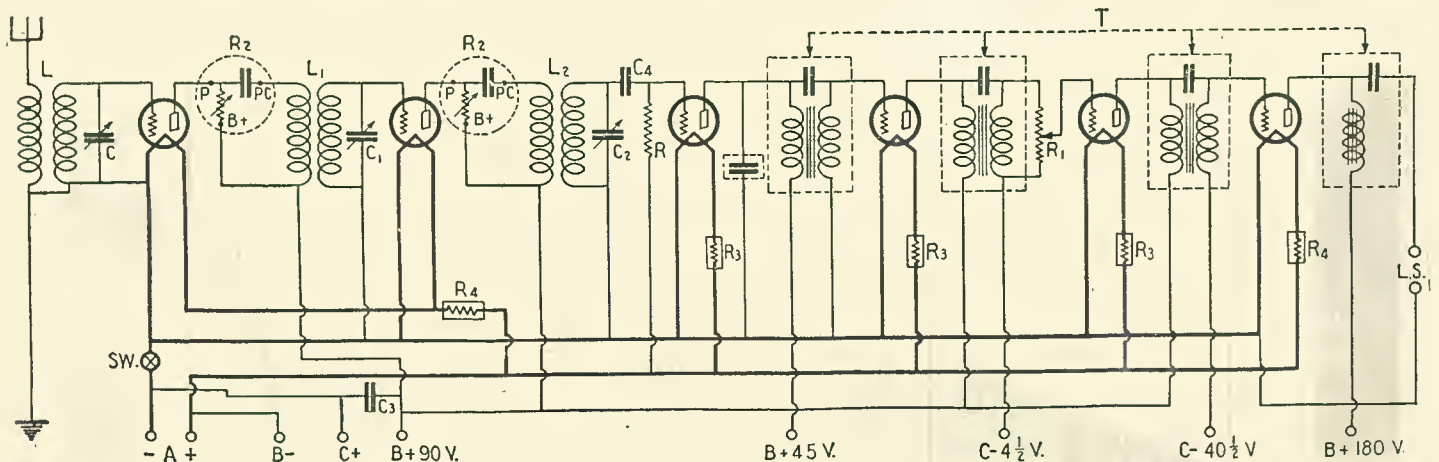

The schematic circuit diagram of the Phasatrol-Balanced Receiver. R₂ indicates the Phasatrols; it will be seen that each consists of a fixed capacity and a variable resistance. The three dual impedances and the output filter, indicated by T, are all mounted in the catacomb.

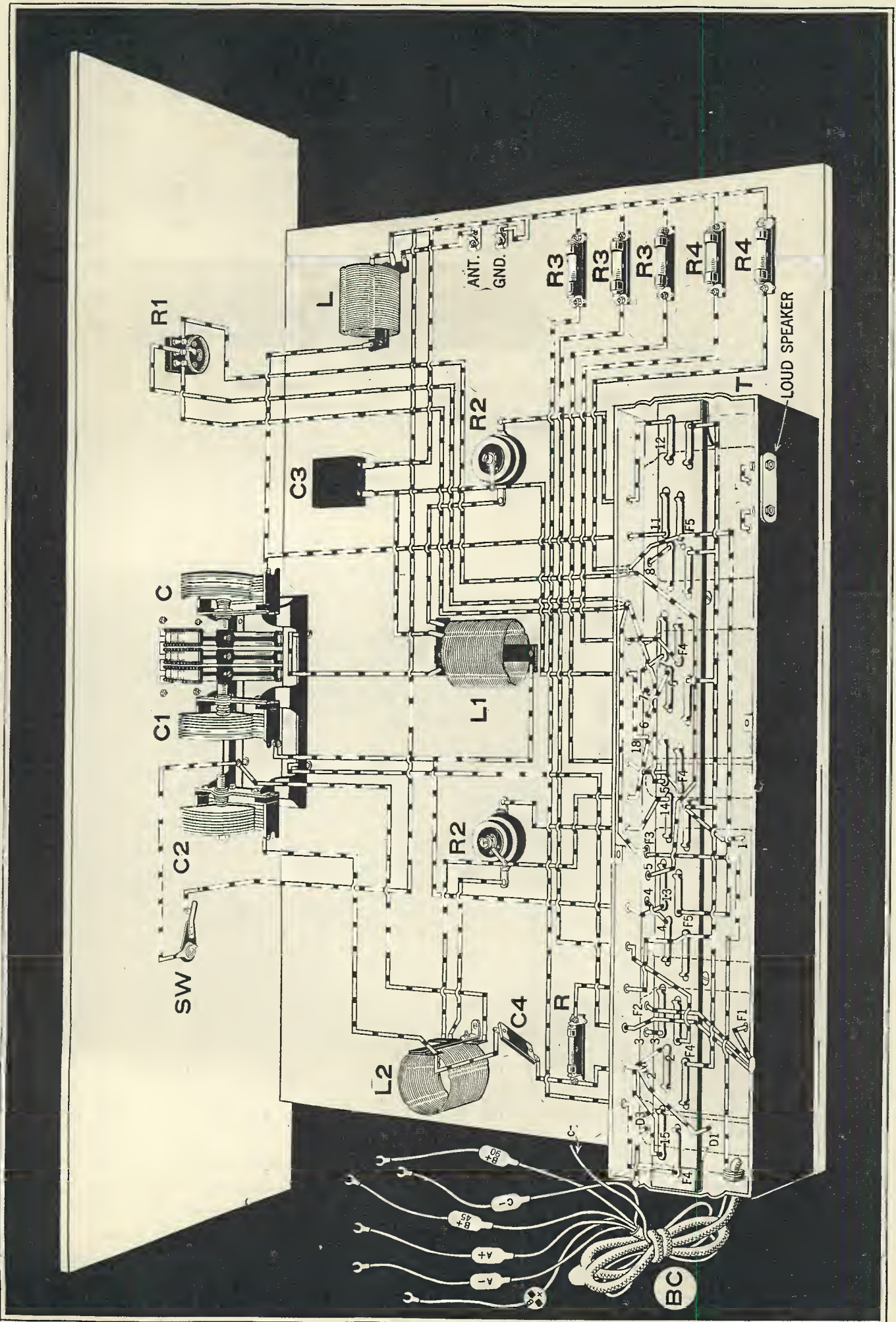

The layout and wiring of the Phasatrol-Balanced Receiver. This is shown with the cover removed from the catacomb, in order to reveal the wiring underneath.

| SYMBOL | Quantity | NAME OF PART | VALUE OF PART | REMARKS | MANUFACTURER ★ |
|-----------|----------|---------------------|---------------|----------------------------------|------------------------|
| L | 1 | Ant. Coupler | | | 1 9,11,12,13,28 |
| L1, L2 | 2 | R.F. Trans. | | | 1 9,11,12,13,28 |
| C, C1, C2 | 1 | Var. Cond. | .00035 mf. | 3 Tandem Cond. | 2 10 |
| C3 | 1 | Fixed Cond. | 2 mf. | Bypass | 3 14,15,16,17,18,33,37 |
| C4 | 1 | Fixed Cond. | .00025 mf. | Grid Condenser | 3 14,15,16,17,18,37 |
| R | 1 | Grid Leak | 3 meg. | With Mounting | 19 3,14,15,16,17,30 |
| R1 | 1 | Potentiometer | 0-50000ohm | Volume Control | 2 5,21,22 |
| R2 | 2 | Stabilizers | | Phase Shifting Device | 3 |
| R3 | 3 | Auto. Fil. Controls | 5v. 1/2 Amp. | | 4 |
| R4 | 2 | Auto. Fil. Controls | 5v. 1/2 Amp. | For RF tubes and semi-power tube | 4 |
| T | 1 | Amplifier Unit | | Including R.F. & detector socket | 2 |
| Sw | 1 | Fil. Switch | | | 5 10,17,30,22 |
| | 1 | Panel | | 7"x21"x3/16" | 6 23,24,25,31 |
| | 1 | Base Board | | Hard Wood (10"x17") | |
| | 4 | Vac. Tubes | 5v. 1/2 Amp. | 2 R.F. and 2 A.F. Amplifier | 7 26,27,34,36 |
| | 1 | Vac. Tube | 5v. 1/2 Amp. | Special Detector | 7 26,27,34,36 |
| | 1 | Vac. Tube | 5v. 1/2 Amp. | Semi-Power Amplifier | 7 26,27,34,36 |
| | 2 | Connector Clips | | Or Binding Posts | 8 29,32,35 |

NUMBERS IN LAST COLUMN REFER TO CODE NUMBERS BELOW.

| | | |
|------------------------------|--------------------------------------|--|
| 1 Benjamin Elec. Mfg. Co. | 17 Leelle F. Muter Co. | 33 Precision Coil Co. |
| 2 Alden Mfg. Co. | 18 Sengamo Elec. Co. | 34 Perryman Elec. Co. |
| 3 Electrad, Inc. (Phasatrol) | 19 Int. Resis. Co. (Durham) | 35 Magnavox Co. |
| 4 Rediall Co. (Amperite) | 20 Yexley Mfg. Co. | 36 Van Horne Co. |
| 5 Carter Radio Co. | 21 Central Radio Labs. | 37 Wireless Spec. Appar. Co. (Faradon) |
| 6 L'ignole Corp. | 22 H. H. Frost, Inc. | |
| 7 C. F. Mfg. Co. (Ceco) | 23 Formica Ins. Co. | |
| 8 Palmestock Elec. Co. | 24 American H. Rubber Co (Radion) | |
| 9 Silver-Marshall, Inc. | 25 Diamond State Fibre Co. (Celoron) | |
| 10 Bruno Radio Corp. | 26 Radio Corp. of America | |
| 11 Hammarlund Mfg. Co. | 27 E. T. Cunningham Co. | |
| 12 Sodine Elec. Co. | 28 Bremer-Tully Mfg. Co. | |
| 13 All American Radio Corp. | 29 H. H. Eby Mfg. Co. | |
| 14 Aerovox Wireless Corp. | 30 A. H. Lynch, Inc. | |
| 15 Polynet Mfg. Corp. | 31 Ins. Co. of America (Insuline) | |
| 16 Tobe Deutschmann Co. | 32 K-L Radio Labs. | |

If you use alternate parts instead of those listed in the first column of manufacturers, be careful to allow for any possible difference in size from those originally used in laying out and drilling the panel and sub-base.

FORM COPYRIGHT 1927 EX. PUB. CO.

★ THE FIGURES IN THE FIRST COLUMN OF MANUFACTURERS INDICATE THE MAKERS OF THE PARTS USED IN THE ORIGINAL EQUIPMENT DESCRIBED HERE.

appears on the socket strip a number of numerals, which correspond with those on the fiber cover in the case, and for a definite purpose. One filament terminal for each socket is unconnected. Connect the free filament terminals of the two R.F. tubes together and then carry a wire through the holes on the side of the case to the automatic-filament-control device, which is to control these tubes. Then follow by bringing out separate filament leads for all of the other tubes. The positions of these control units are shown in the illustration and the wiring diagram. This wiring is greatly facilitated by using the celatsite wire, because it is insulated and tinned and solders easily.

OTHER SOCKET TERMINALS

Now connect the lead designated as 1, on the fiber top, to any one of the common filament terminals. Remember that the common filaments were wired at the factory by the manufacturer. With the socket strip in place, connect the wire designed 7 to the terminal marked 7. This is followed by 8 to 8; 6 to 6; 4 to 4; 3 to 3 and 2 to 2. Make these leads as short as possible. Socket terminals, reading from left to right, 15, 13, 14, 5, 11 and 12 are unconnected. These are respectively, the detector grid, the second R.F. grid, the second R.F. plate, the second A.F. grid, the first R.F. grid and the first R.F. plate. Having connected the radio-frequency coils and the tuning con-

denzers, make the connection between the grid lead of the first stage of radio frequency and terminal 11. Follow this by connecting the grid lead of the second radio frequency stage with terminal 13; and follow by connecting the grid lead, of the stage connecting to the detector via a .00025-mf. condenser, to terminal 15. This condenser need not have grid-leak mounting clips, since the connection of the grid leak is effected later, and the leak has its own mounting clip and base.

Three socket terminals remain unconnected. They are 14, 12 and 5. Also four leads from the case remain unconnected. They are 18, 5, and D2 and F3. The next step is to connect the socket terminal 5, the lead 5 and the lead F3. These three are, respectively, the grid terminal of the second audio and the grid and filament terminals of the choke coil connecting to the second audio grid. It is across this choke that we connect the volume-control unit, as shown in the diagram. F3 is connected to one of the outside posts of the volume-control unit. The lead 5 is connected to the other outside terminal of the volume control unit; and the socket terminal 5 is connected to the center post. This connects the volume control as shown in the wiring diagram. A separate "C" battery lead is then connected to the F3 connection. This is the "C" battery lead for the second audio tube. The "C" battery lead for the output tube is contained in the cable. The D2 lead is left unconnected. The grid leak is now connected into the circuit between the grid terminal of the detector tube and the positive filament (which is the common filament lead) on the socket strip. By means of this arrangement, all the tuning condensers are grounded and a positive bias is applied to the grid.

The next items of interest are the primaries of the R.F. units, the plate connections of the R.F. tubes and the balancing units. The balancing units have three terminals, marked P, PC and B+. Connect the plate lead of the primary of the first R.F. transformer (not the aerial coil) to the PC connection of the balancing unit and the "B+" battery lead of the coil primary to the "B+" terminal of the "phasatrol." Repeat with the other primary and its associated balancing unit. Now connect socket

(Continued on page 1140)

Suggestions On Shielding

By WILLIAM LE ROY DUNN, Jr.

SHIELDING, intelligently used, is a tremendous asset. If, on the other hand, it is used in a slipshod, careless manner—that is without paying proper attention to losses which may be created—it is worse than nothing at all.

One often is advised to shield each stage of tuned-radio-frequency amplification. In a poor set, that is, one which is not properly designed, which tends to go into oscillation at the most embarrassing moment, this is advice indeed well worth taking. The oscillating condition will disappear—along with much of the selectivity and a good many miles of range. Far better advice would be to consign the offending receiver to the nearest ash-can, or to redesign the set.

SHIELDING EFFECTS

Whenever metal or conducting material of any kind is placed in the field of a coil, the resistance of that coil rises. This is due to the fact that eddy currents are set up in the conductor. These eddy currents are in such a direction that they produce a field exactly opposing that of the coil. The effective self-inductance of the circuit is thereby

reduced. It is therefore necessary to have a larger coil when shielding is used than would otherwise be employed. This coil, of course, has more wire and thus a higher resistance. The field, due to the eddy cur-

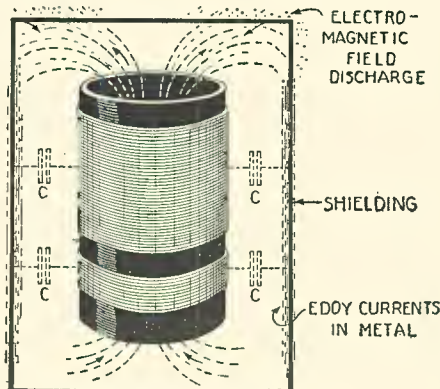

The dotted condenser symbols, C, indicate the capacity effect between the turns of the coil and the shielding, as shown by the field discharge.

rents, has an electromagnetic shielding effect, because its field tends to neutralize the field of the coil at every point. Where shielding is employed for electrostatic purposes, its deleterious effect on the effective resistance may be greatly decreased by cutting radial slots in the shielding in the plane vertical to the axis and parallel to the ends of the coil. This reduces the eddy currents by placing a greater resistance in their path, and also greatly reduces the electromagnetic shielding effect.

The logical purpose of radio-frequency shielding is to serve as a shield for electrostatic fields; that is, to prevent the capacitive coupling of one stage to another. This is largely caused by the stray fields from the variable condensers, the tube, and the electrostatic field of the coil. In this particular case, shielding may be of great benefit, but in order that this benefit may not be neutralized by causing increased resistance in the coils, the coils should have no external fields. Toroidal inductances have a low radio-frequency resistance, are easily obtained on the open market and have prac-

(Continued on page 1140)

The Ultra-5 Receiver*

A Midget Regenerative Superheterodyne with a High Degree of Selectivity and Sensitivity

By THEODORE H. NAKKEN

THE principal feature of the set described in this article is its ability to unscramble the mess of interference in congested districts. The set is also very sensitive; consequently DX reception is possible while local stations are still on the air.

The circuit comprises a "modulator" tube, an oscillator and a regenerative detector. It is actually a "midget" superheterodyne, except that the regenerative detector takes the place of the usual intermediate stages. Because regeneration takes place at a different wavelength from that to which the input circuit is tuned, there is very little chance of oscillation difficulties.

The set, as a whole, is as selective as a standard superheterodyne and as sensitive as a five-tube tuned-radio-frequency receiver.—Editor.

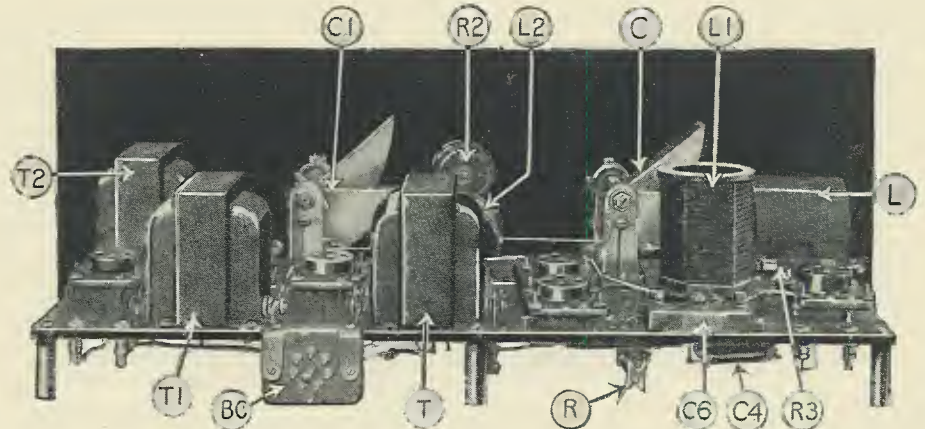

A rear view of the Ultra-5 receiver. The parts are: L, antenna coupler; LI, long wave R.F. transformer; L2, oscillator coupler; C, tuning condenser; C1, oscillator condenser; C4, by-pass condenser; C6, coupling condenser; R, grid leak; R2, volume control; R3, automatic filament control; T, T1, A.F. transformers; T2, output choke, and BC, the battery cable receptacle.

IN the design of broadcast receivers it is becoming more and more important that the selectivity be as great as possible without sacrificing the quality of the received program. This necessity rises above all others in the congested city districts, where it has become more and more difficult to separate the high-powered stations from one another.

One of the receivers that have been capable at all times of just this exacting separation is the superheterodyne; but the superheterodyne circuit can be successfully built into a set by only experienced constructors. This is the reason why, in general, the home-built superheterodyne does not deliver as good results as might be expected from such an efficient circuit.

One of the main reasons for the failure of home-built superheterodynes to function properly is the lack of properly matched intermediate transformers. Many transformers are constructed with too broad a tuning characteristic and thus are responsible for heterodyning of different stations in the intermediate frequency amplifier.

Another drawback of the general run of superheterodynes is the fact that it is necessary, in order to stabilize the intermediate amplifying tubes, to control the intermediate amplifier by means of a variable potential on the grids of these tubes. This invariably

results in a loss of quality of reception and high "B" battery consumption.

Again, another difficulty in the operation of the average superheterodyne is that the first detector tube has a tendency to oscillate. It also stands to reason that the presence of two different detectors introduces the possibility of detector distortion, not only once,

THE SUPERHETERODYNE CIRCUIT

In all standard superheterodynes there are two detectors, which serve two distinct purposes. The second detector is used primarily to separate the audio-frequency component, constituting the signal, from the carrier wave, or rather, in the super, from the intermediate wave. The first detector, how-

Panel view of the Ultra-5 receiver. C is the tuning control, C1 the oscillator control which is a tuning factor also, R2 the volume control and SW the filament switch.

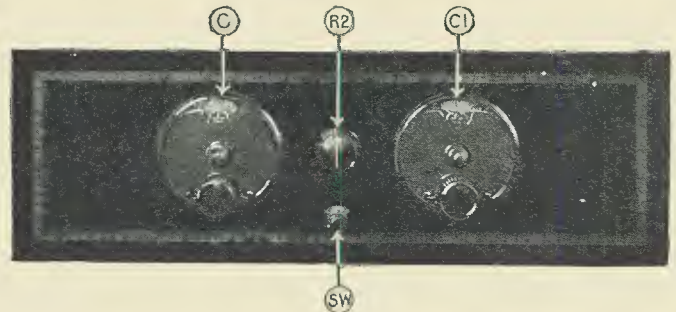

but twice. This last objection against the superheterodyne was overcome a few years ago in the creation of the Ultradyne circuit by Mr. R. E. Lacault, whose modification of the first detector circuit did away with the troubles that might be laid to the use of the first detector. This so-called "modulation" system of Lacault is one of the most interesting systems ever devised for superheterodynes, and therefore merits description in detail.

ever, has a distinctly different function. Its purpose is to create a radio-frequency current of predetermined wavelength which is called the intermediate wavelength, and which is then amplified to a great extent by the intermediate amplifier. The latter, being tuned to a definite wavelength, requires no further manipulation, once it has been adjusted properly.

The last feature above has made the superheterodyne deservedly popular, for the amplifying system, being tuned, gives the receiver a high degree of selectivity, yet involves no extraordinary manual dexterity on the part of the operator who is anxious for the best possible results.

The creation of an intermediate wavelength or frequency is accomplished by the so-called "beat method." It is a well known fact that, if two different frequencies are introduced simultaneously into a given circuit, there is created in that circuit a complex waveform, due to the interaction of the two original waves.

The two waves do not mix completely, but if we subject them to the detecting process (which is the accumulation into single impulses of the total, of either the positive or negative radio-frequency impulses upon the grid of a vacuum tube), we find that the detected current has a frequency equal to the arithmetical difference between the two original frequencies. There is also created another frequency, equal to the sum of the

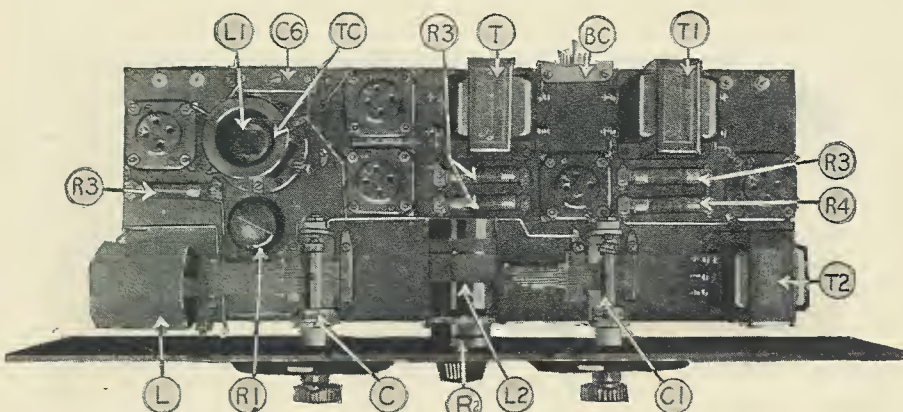

A top view of the completed Ultra-5 receiver. Note the tickler coil TC in the long wave inductance LI. The tickler is set once and thereafter regeneration is controlled by R1 should any further adjustments be found necessary. The adjustable condenser C6 is instrumental in eliminating local interference from harmonics.

*RADIO NEWS Blueprint Article No. 13.

The layout and wiring diagram of the Ultra-5 receiver as seen from the upper side of the sub-base. A good many of the connections are made underneath the sub-base and the wires are passed down through holes; each of which, in the diagrams, is numbered so that any one wire can be traced from the upper to the under side.

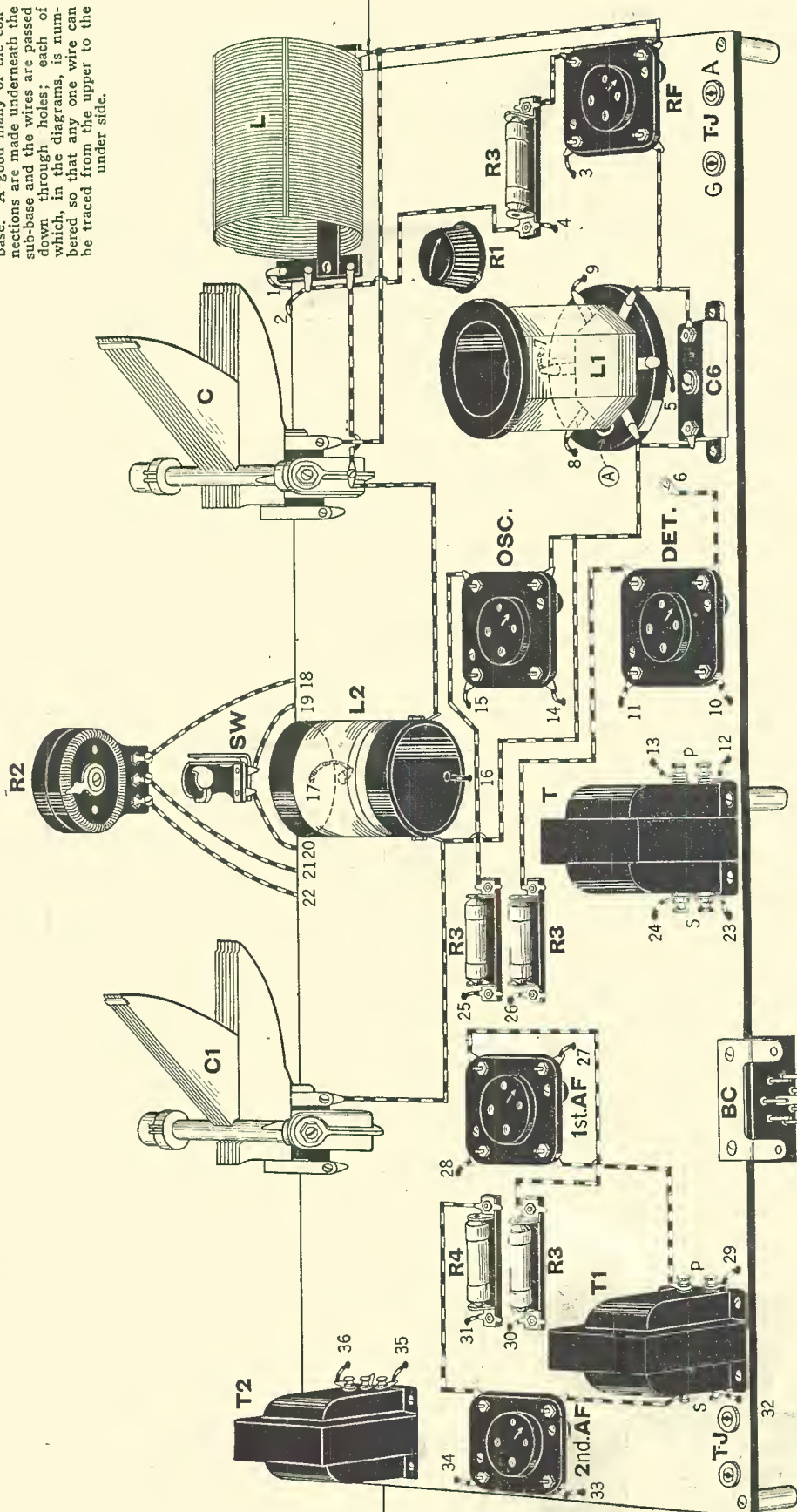

original ones, but this is utilized in only a single system, of reception, the Sargent Infradyne.

THE INTERMEDIATE AMPLIFIER

In most superheterodynes the intermediate frequency is created by the following process: the first detector is tuned to the desired signal, and into its grid circuit we introduce impulses from an oscillator which can be tuned to any desired frequency. As soon as the difference between the signal and the oscillator frequencies reaches the frequency to which the intermediate amplifier is tuned, the resulting beat-frequency will be further amplified and carried to the second or audio-frequency detector.

This system has two drawbacks: The first is that the first detector often tends to oscillate on its own account; the second, and more serious one, is that the local oscillator is coupled to the input circuit. This means that the input circuit of the receiver really serves also as the output circuit of the local oscillator, so that if the superheterodyne is used on an outdoor antenna, it will radiate and may spoil radio reception of others for miles around.

In the Ultradyne this evil is completely avoided. The first detector has no constant plate potential, and, in fact, does not act as an ordinary detector at all. The oscillator output is not connected to its grid circuit, so that the danger of radiation is practically obviated.

A plate current can flow only when the plate of a vacuum tube is made positive. If we apply an alternating potential to the plate of this first detector, the tube will function only at the moments when its plate is positive, and not at all when its plate is zero or negative.

Lacault accomplished this in a very simple way. He connected the plate of the first detector, through its intermediate primary, to the grid of the oscillator tube. This grid varies in potential from a maximum negative to a maximum positive value. This varying potential is thus applied to the plate of the first detector, so that the latter tube functions more or less intermittently. Through this peculiar action, the detector works as a true mixing tube. The signal is detected by it, and reduced to a frequency which is exactly equal to the difference in the two frequencies of the incoming signal and the local oscillator.

It is this intermediate-frequency signal which, in our Ultra-Five, is fed directly to the regenerative audio-frequency detector.

I believe that as far as sensitivity is concerned, there has not yet been developed a circuit which, even with a plurality of radio-frequency amplifying tubes, can surpass a regenerative detector. In a superheterodyne receiver there is no barrier against the use of a detector in a pure regenerative circuit. With such a circuit, we can do away with the difficulty of finding an adequate set of intermediate amplifying transformers and we can eliminate several tubes.

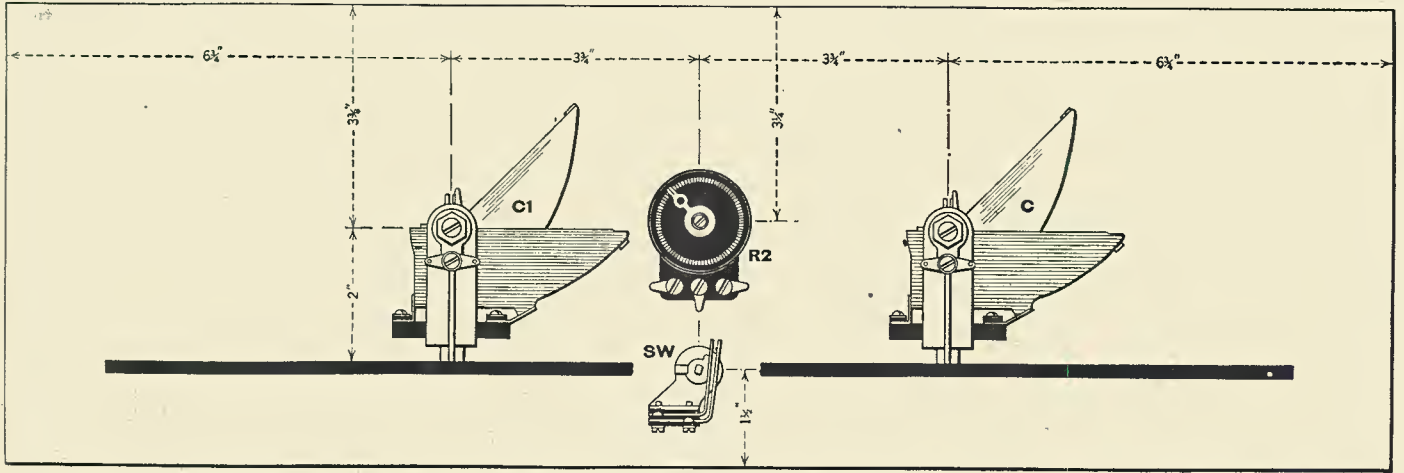

Layout and drilling sketches (above and below respectively) for the front panel of the Ultra-5 receiver. All the necessary dimensions are given.

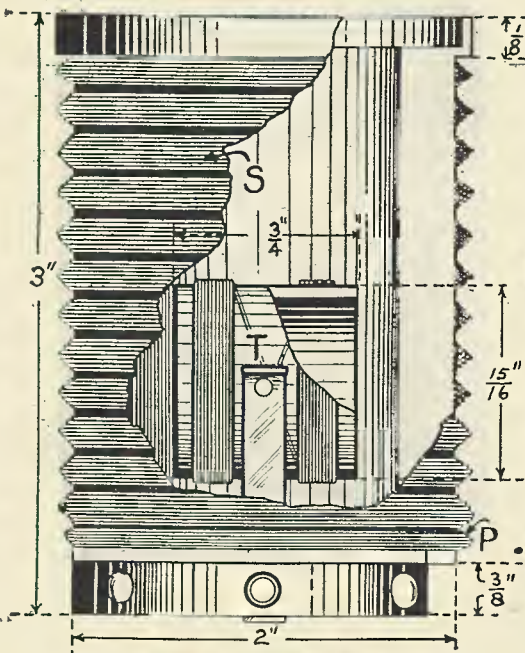
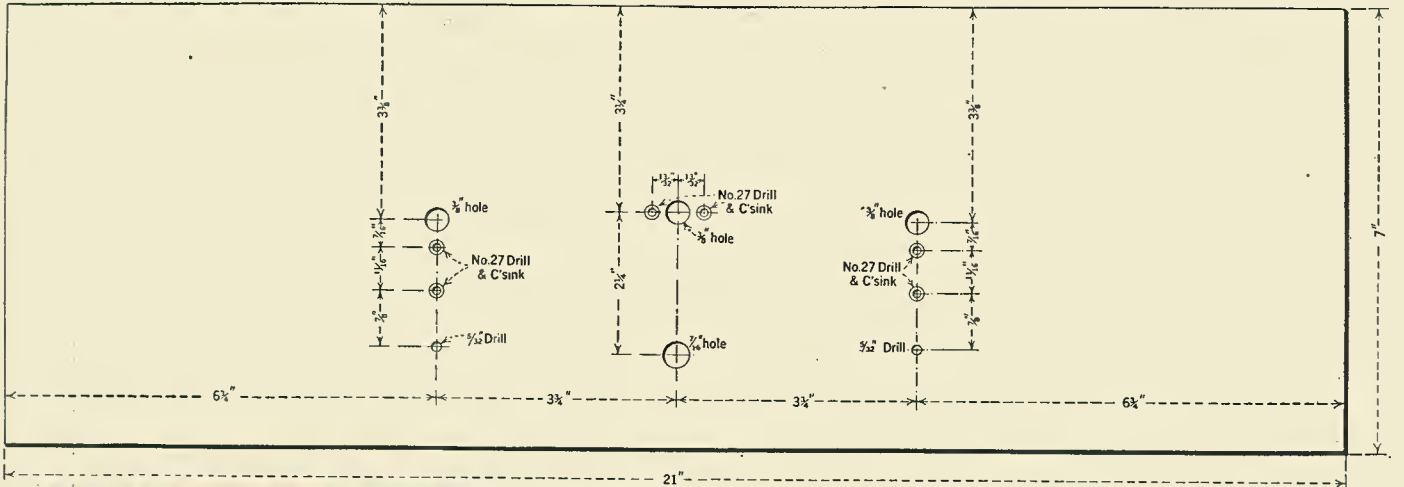

**PRIMARY (P) 100 TURNS
No 38 D.S.C. WIRE LAYER WOUND**
**SECONDARY (S) 260 TURNS
No 24 D.S.C. WIRE LAYER WOUND**
**TICKLER (T) 52 TURNS No 38
WIRE LAYER WOUND**

At left: Constructional details of the long-wave R.F. transformer. The secondary coil is layer-wound. The small sketches below show the manner in which the wire is wound. To make it clear, each turn is numbered. The tickler coil is also layer-wound but there are only two layers on this coil. Ordinary insulating tubing can be used as the form if desired.

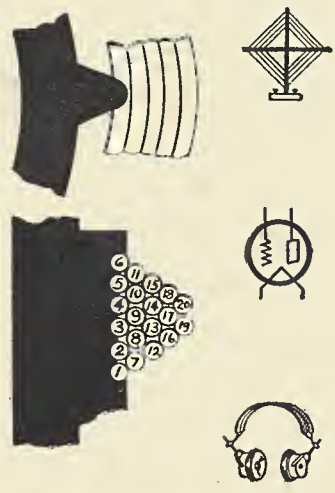

A circuit of this kind enables the average constructor to build himself a receiver in which all doubtful parts (the intermediate-frequency transformers with their potentiometer control and the first detector) are eliminated. A receiver with most of the good qualities of the superheterodyne will be the result, with the added advantage that its use will not disturb the reception of programs by neighboring set-owners.

ARRANGEMENT OF THE FIRST STAGES

In looking over the schematic wiring diagram which is given in Fig. 1, we see that an ordinary antenna coupling coil is employed, so that the receiver can be hooked

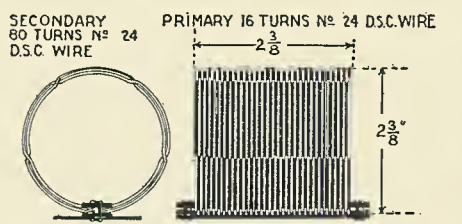

Constructional details of the antenna coupler. This may be wound on ordinary insulating tubing if desired.

to either an indoor or an outdoor aerial, or to a lamp-socket antenna. A variable condenser serves to tune the receiver to the desired signal.

It will be observed that no grid condenser or grid leak is attached to the first or mixing tube; but that the antenna is coupled directly to the grid. Neither is necessary, because the plate of this mixing tube is not connected to any positive point of the general "B" battery, but is connected through the primary of the intermediate-coupling coil to the grid of the oscillator tube. When this is done it follows that the plate potential of the mixing tube will be alternating positive

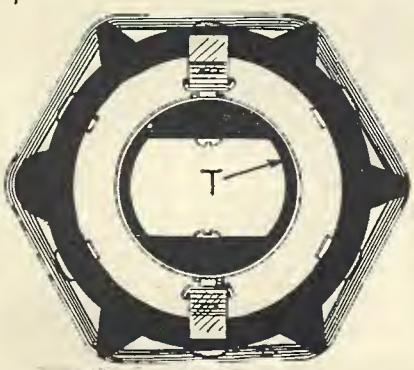

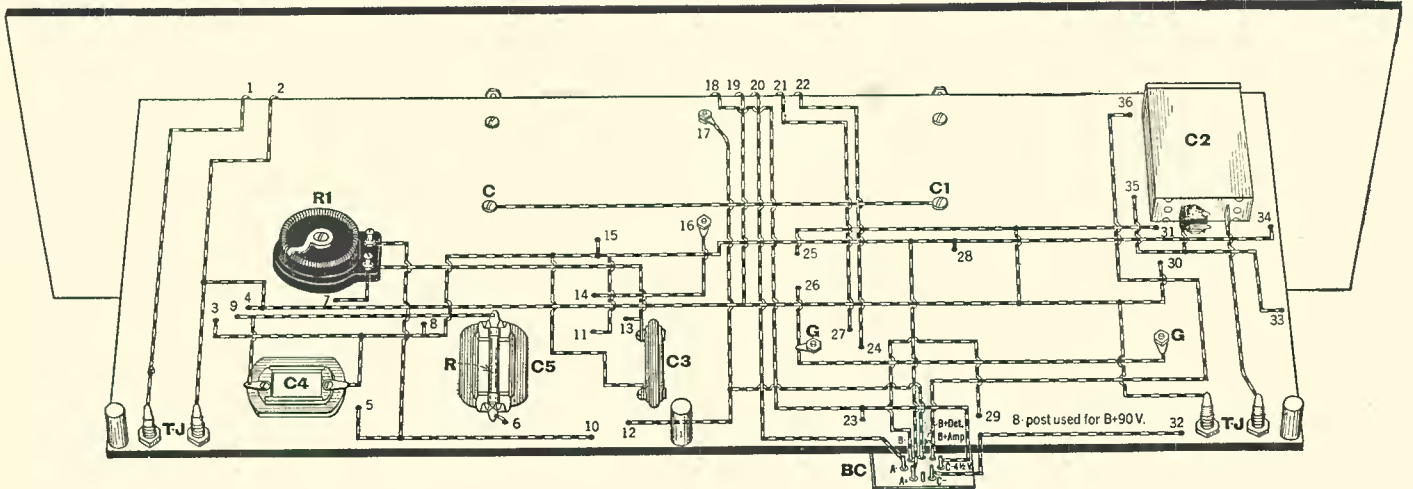

The layout and wiring of the underside of the sub-base. Take note of the fact that the "B—" prong on the battery cable receptacle is to be used as the "B+" 90-volt lead. Connect the "B—" to the "A+" on the outside of the set.

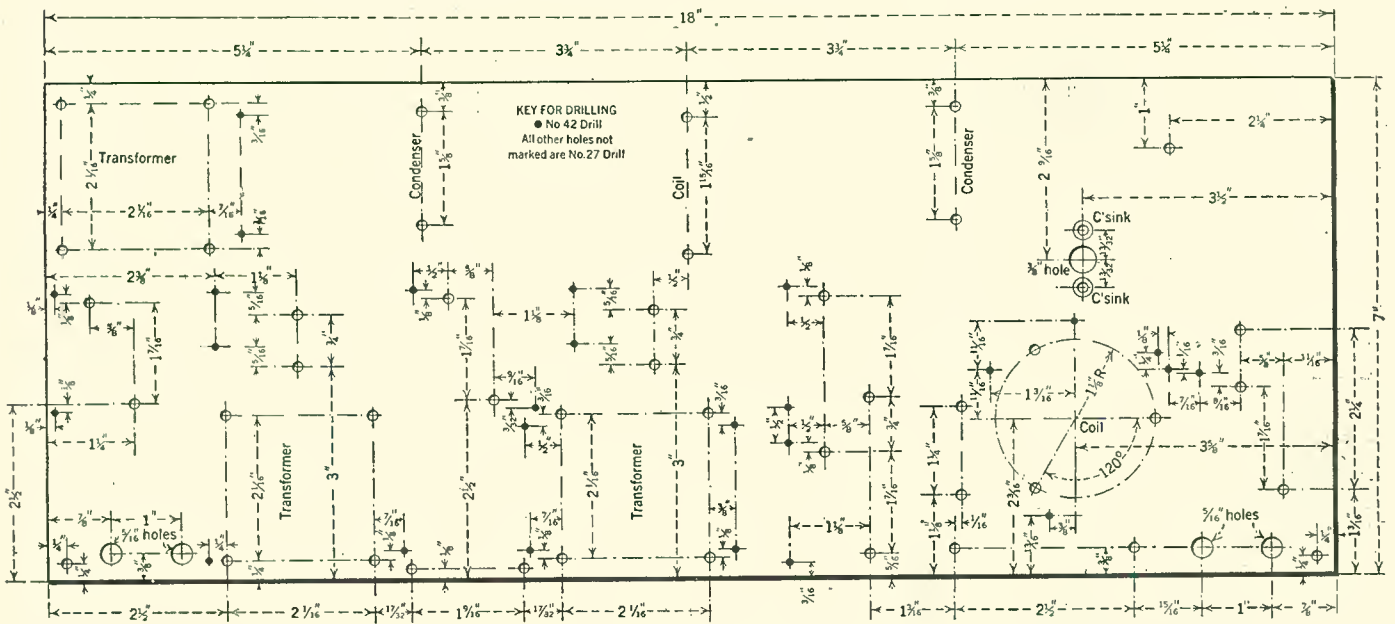

Details of the drilling for the sub-base. All holes in full black are for passing connecting wires through the sub-base.

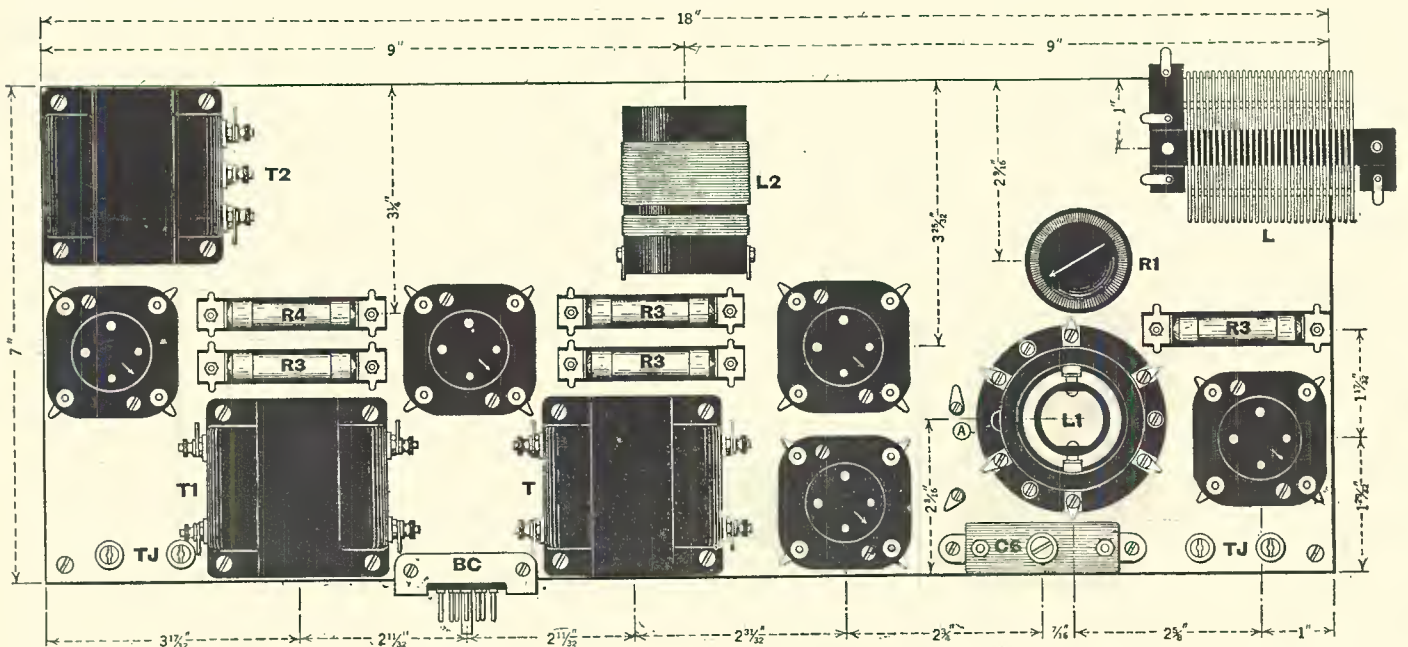

Constructional layout of the apparatus on the sub-base. Be sure to mount the base of the R.F. transformer L1 so that the depression, indicated by A, is pointing towards the left as shown.

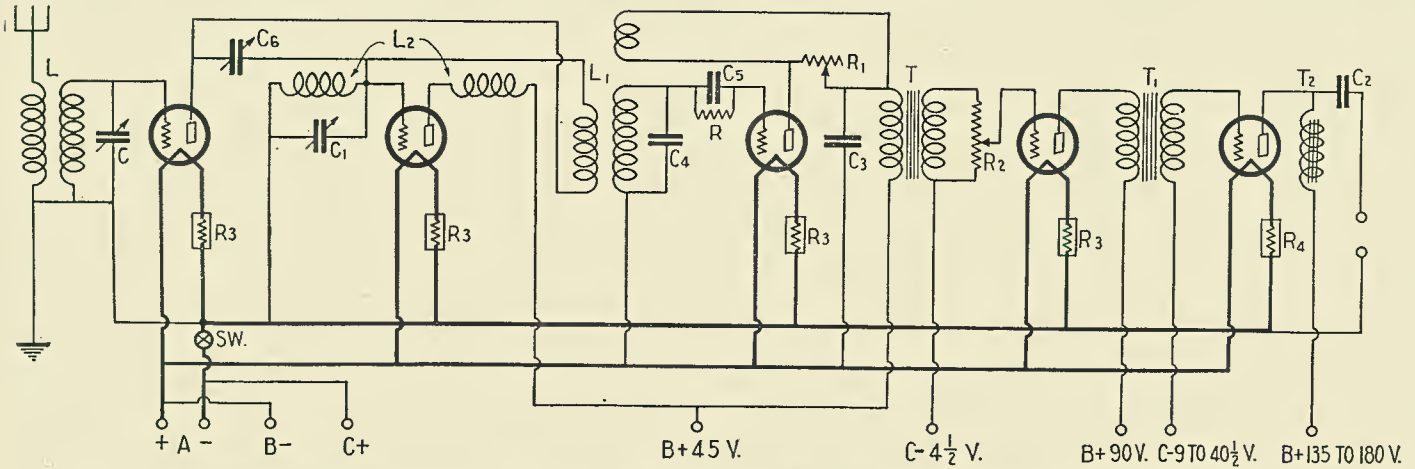

Fig. 1. The schematic circuit diagram of the Ultra-5 receiver. It is suggested that a power or semi-power tube be used in the last audio stage. The correct "B" and "C" voltages to use depend on the tube. Consequently two voltage values are given in each case in the diagram above.

and negative; because it swings up and down in unison with the potential of the oscillator grid. Thus, plate current flows only intermittently in this tube, and the frequency of the application of a positive potential to the plate can be regulated completely by the tuning of the grid circuit of the oscillator tube.

In this way the incoming signal is caused to beat with the intermittent surges of current through the mixing tube; and the result is that the plate current flowing through this tube is modulated by the incoming signal, at any beat-frequency that may be desired.

The intermediate transformers of the ordinary superheterodyne or Ultradyne receiver have been replaced by a coil unit consisting of a primary, a secondary and a tickler coil, and having six terminals.

In order to make the construction of the receiver as simple as possible, a plug-in coil (L₁) with a six-terminal base has been chosen; this is available in almost every radio store. It is tuned by means of an ad-

PRIMARY (P) 15 TURNS No 26 D.S.C. WIRE
SECONDARY (S) 42 TURNS No 26 D.S.C. WIRE

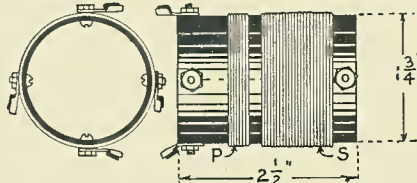

Constructional details of the oscillator coupler. The two coils are wound on a section of insulating tubing.

justable condenser (C₆) across the primary and a fixed condenser across the secondary. The regeneration in this system is controlled by means of a non-inductive variable resistance (R₁) across the tickler coil which is placed in the immediate vicinity of this plug-in coil inside of the receiver, because it need be adjusted only once for every particular detector tube used. The regeneration control, therefore, need not be placed on the front panel of the receiver.

OTHER FEATURES

As a volume control, a 500,000-ohm potentiometer (R₂) is placed across the secondary of the first audio-frequency transformer, so that the volume of the receiver may be adjusted at will.

To permit the use of different kinds of power tubes in the last audio stage, a proper output device, comprising a 30-henry choke and 2.0-mf. condenser (T₂, C₂), has been incorporated in the receiver. In case "B" batteries are used, an 112-type tube can be successfully employed; but when a good "B" battery eliminator with sufficiently high

voltage is employed, a 171-type power tube can be inserted without any changes in the wiring of the receiver.

In order to eliminate as many controls from the front panel as possible, all the tube filaments are controlled by means of automatic filament controls. The use of these insures the proper operating current to each tube, so that distortion, which often results

from the improper use of hand-operated rheostats, is prevented. At the same time, it is possible, by changing the automatic filament controls, to operate the receiver with any kind of tubes fitted with UX bases.

CONSTRUCTIONAL DETAILS

The panel measures 7 x 21 inches and the
(Continued on page 1181)

| SYMBOL | Quantity | NAME OF PART | VALUE OF PART | REMARKS | MANUFACTURER ★ |
|---------------------------------|-----------|------------------|--------------------------|-----------------------------------|----------------------|
| L | 1 | Ant. Coupler | | | 1 2,3,16,17,41 |
| L1 | 1 | R.F. Coil & Base | | Long Wave Plug-in Type with Tick. | 2 |
| L2 | 1 | Osc. Coupler | | Special | |
| C | 1 | Var. Cond. | .00035 mf. | | 3 1,2,16,17,18,29,46 |
| C1 | 1 | Var. Cond. | .00025 mf. | | 3 1,16,17,18,29,46 |
| C2 | 1 | Fixed Cond. | 2 Mf. | For Output Filter | 4 5,20,21,22,23,28 |
| C3 | 1 | Fixed Cond. | .002 Mf. | Bypass | 5 4,19,20,21,23 |
| C4 | 1 | Fixed Cond. | .0005 Mf. | Bypass | 5 4,19,20,21,23 |
| C5 | 1 | Grid Cond. | .00025 Mf. | With Grid Leak Clips | 5 4,19,20,21,23 |
| C6 | 1 | Adj. Cond. | Max..001Mf. | Neutralizing | 9 |
| R | 1 | Grid Leak | 2 meg. | | 6 4,20,21,23,24 |
| R1 | 1 | Var. Resistance | 0-2000ohms | Regeneration Control | 4 23,25,26,27 |
| R2 | 1 | Potentiometer | 0-500,000ohm | Volume Control | 4 23,25,26,27 |
| R3 | 4 | Auto.Fil.Control | 5v. 1/2 Amp. | | 7 |
| R4 | 1 | Auto.Fil.Control | 5v. 1/2 Amp. | For Power Tube | 7 |
| T ₁ , T ₂ | 2 | A.F. Trans. | | | 8 2,16,17,18,42,45 |
| T2 | 1 | Choke | | For Output Filter | 8 2,16,28 |
| | 5 | Sockets | | UX Type | 1 2,15,23,46 |
| SW | 1 | Fil. Switch | | | 10 23,25 |
| TJ | 4 | Tip Jacks | | For Aerial, Cnd., & Loud Speaker | 10 25,26,30 |
| BC | 1 | Battery Cable | 7 Wires | | 10 31 |
| | 1 | Insulating Tube | 2 1/4" long, 1 1/2" dia. | For osc. coupler | 11 32,33 |
| | 1 1/2 lb. | Copper Wire | #26 Double Covered Silk | | 12 13,34 |
| | 50 ft. | Hook-up Wire | Spaghetti Covered | | 13 12,34 |
| | 1 | Panel | 7"X21"X3/16" | | 14 11,32,33,47 |
| | 1 | Sub-Base | 7"X18", 3/16" | | 14 11,32,33,47 |
| | 2 | Dials | Vernier | | 15 2,16,17,35,43 |
| | 4 | Tubes | 5v. 1/2 Amp. | | 36 37,38,39,40,44,48 |
| | 1 | Tube | 5v. 1/2 Amp. | Semi-Power Amplifier | 38 36,39,43,44,48 |

If you use alternate parts instead of those listed in the first column of manufacturers, be careful to allow for any possible difference in size from those originally used in laying out and drilling the panel and sub-base.

NUMBERS IN LAST COLUMN REFER TO CODE NUMBERS BELOW.

| | | |
|--------------------------------|----------------------------------|-------------------------------------|
| 1 Benjamin Elec. Mfg. Co. | 17 All American Radio Corp. | 33 Diamond State Fibre Co. (Celero) |
| 2 Silver-Marehall, Inc. | 18 Bremer-Tully Mfg. Co. | 34 Belden Mfg. Co. |
| 3 Hamarlund Mfg. Co., Inc. | 19 Wireless Specialty Appar. Co. | 35 Martin-Copeland Co. (Narco) |
| 4 Electrad, Inc. | 20 Aerovox Wireless Corp. | 36 Perrymen Elec. Co. |
| 5 Sangamo Elec. Co. | 21 Polymet Mfg. Corp. | 37 Moulded Products, Inc. |
| 6 Int. Reals. Co. (Durham) | 22 Tobe Deutschmann | 38 Radio Corp. of America |
| 7 Radiall Co. (Amparite) | 23 Leslie F. Muter Co. | 39 C. T. Cunningham, Inc. |
| 8 Thordarson Elec. Mfg. Co. | 24 A. H. Lynch, Inc. | 40 E. Mfg. Co. |
| 9 H. L. Radio Labs. | 25 Carter Radio Co. | 41 Sodine Elec. Co. |
| 10 Tuxley Mfg. Co. | 26 H. H. Frost, Inc. | 42 American Trans. Co. (Amertran) |
| 11 American H. Rubber (Radion) | 27 Central Radio Labs. | 43 Cornell Elec. Co. |
| 12 Cornish Wire Co. | 28 Precision Coil Co. | 44 Magnavox Co. |
| 13 Acme Wire Corp. | 29 National Co. Inc. | 45 Acme Apparatus Co. |
| 14 Lignole Corp. | 30 Brooklyn Metal Stamping Co. | 46 Alden Mfg. Co. |
| 15 H. H. Eby Mfg. Co. | 31 Howard B. Jones | 47 Inc. Co. of Amer. (Ineuline) |
| 16 Sangon Elec. Co. | 32 Forisica Insulation Co. | 48 Van Horne Co. |

FORM COPYRIGHT 1927 EX. PUB. CO.

★ THE FIGURES IN THE FIRST COLUMN OF MANUFACTURERS INDICATE THE MAKERS OF THE PARTS USED IN THE ORIGINAL EQUIPMENT DESCRIBED HERE.

Wavemeter Calibration from Broadcast Harmonics

How to Utilize Standard-Frequency Transmissions for this Purpose

By A. BINNEWEG, Jr.

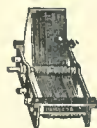

THE ever watchful Bureau of Standards has been checking up on broadcast frequencies and has found, over a long period of time, that there is practically no deviation in the frequencies of the carrier-waves radiated by the better known broadcasting plants. There is no reason, then, why these stations cannot be used to calibrate wavemeters, the accuracy of which will depend only upon the care used in this work. The writer here describes a simple means of wavemeter calibration, using these reliable frequency standards, and yet requiring no apparatus not found in any radio listener's home.

For the experimenter, a simple wavemeter that will give fairly accurate wavelength checks is a great convenience. Even if greater accuracy may be desired than that given by a wavemeter of this type, such a wavemeter is often a necessity in locating dial-settings when tuning-in standard-wave signals and the like. An accuracy of 2% or better may be secured with a little care. Waiting for certain stations to sign off, is often troublesome; a simple wavemeter often saves much of this trouble.

The large number of broadcast stations on the air in almost every locality offers a very convenient means of wavemeter calibration. Not only may the main wave be used, but harmonics of the main wave may also be utilized for this purpose, provided certain precautions are taken to determine the correct harmonics.

DESIGN OF THE WAVEMETER

The circuit for such a wavemeter is shown in Fig. 1. The condenser should be .00035 mfd. for ordinary use. The coils necessary to cover any range down to 15 meters with such a condenser are as follows:

| | Turns |
|----------------|-------|
| 260—560 meters | 50 |
| 180—280 meters | 33 |
| 90—230 meters | 17 |
| 45—130 meters | 9 |
| 15—50 meters | 3 |

The above values overlap, that is, wavelengths at the top settings with a smaller coil may also be obtained from the lower dial-settings with a larger coil, hence a continuous calibration may be had.

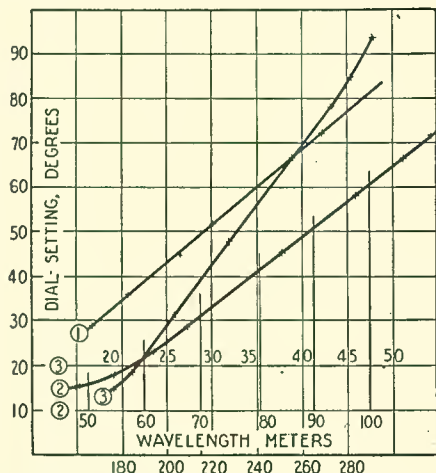

FIG. 2 - TYPICAL SLC CURVES

Some examples of a set of calibration curves for a wavemeter, using a different coil for each curve.

This is the simplest wavemeter that can be constructed. It requires a minimum of apparatus and is as simple as any to calibrate. The condenser should be mechanically rigid and should be mounted in a small case. The dial should be securely set in place and the condenser leads should be rigid and heavy. The leads may be brought out of the case at any convenient spot; it is quite an advantage to provide a honey-comb mounting, besides the binding posts, originally. This facilitates determining the correct number of turns for the coils, sometimes, and has other advantages.

The coils are wound with a fair-sized wire (any convenient size will do), on pieces of 2-inch bakelite tubing of the proper length. The wire should be securely held in place by some "dope," such as collodion; glue will not do, for it cracks off in a

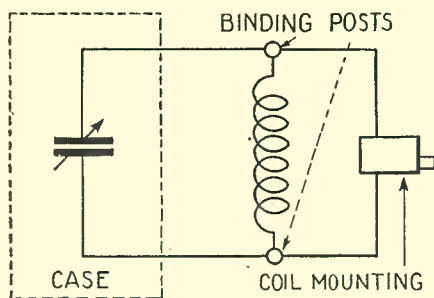

FIG. 1

With a .00035-mfd. variable condenser in parallel with an inductance (which is interchangeable) an effective wavemeter can be made, as diagramed above.

short time. When necessary, the coils may be wound in two layers.

There is some advantage in using the proper condenser in the wavemeter, hence an explanation of the curves shown in Fig. 3 will be of value.

TYPES OF CONDENSERS

Curve No. 1 represents the distribution of wavelengths on the wavemeter dial using an S.L.C. condenser. This "curve" is practically a straight line from 25 to 85 on the dial. An S.L.C. condenser offers an easy means of calibration between these two values, if wavelength vs. dial-setting is desired.

Curve No. 2 of the same figure shows the distribution of kilocycles on the dial of an S.L.C. condenser. It was plotted by calculating the corresponding kilocycles for each wavelength. Such a curve would be more difficult to determine; hence an S.L.C. condenser should not be used for kilocycles vs. dial-setting; there is much "cramping" at extreme dial-settings.

Curve No. 3 shows the distribution of wavelengths on a S.L.F. condenser in the receiver used; it is more difficult to determine than the straight line, also.

Curve 4 is a straight line showing how the kilocycles would be distributed on a theoretical S.L.F. condenser; and Curve 5, differing but slightly from a straight line, shows the actual kilocycle distribution on the condenser used.

The kilocycles were calculated from the relation: $V = KW$ where V is the velocity (or 299,820 kilometers per sec.). K is the frequency in kilocycles, and W is the wavelength in meters. The frequencies may also be obtained from lists giving wavelengths, power, etc., of all stations.

Theoretically, the S.L.F. condenser is the one to use, since the stations are allotted wavelengths 10 kilocycles apart. The curves may then be plotted, using kilocycles vs. dial-settings, and opposite the Kc. the corresponding wavelengths may be written for convenience. However, an S.L.W. condenser or an S.L.C. condenser may be used, as herein described.

At the present time it is customary to deal with wavelengths, hence it is all right to use an S.L.C. condenser; since it gives a straight-line relation between 25 and 85 on a 100-degree dial, as shown by the curves; ordinarily the experimenter has more of these condensers at his disposal.

NECESSARY OPERATIONS

The process of calibrating a wavemeter using the click-method and a regenerative receiver is as follows:

The station is tuned-in, with the receiver just above the point of oscillation. A carrier "hump" will be noticed on each side of the correct setting; tune the receiver between the two. Then bring up the wavemeter and couple it rather loosely to the secondary of the receiver and vary the dial of the wavemeter until a click is heard in the phones of the receiver, or until it stops oscillating. It may then be necessary to move the wavemeter farther away, so that the indication will not be so broad. With a little experimentation, the correct position may be determined within half a degree. Lay off the dial-settings and wavelengths on a piece of graph paper, and plot each point from the two values; that is, the dial-setting and its corresponding wavelength. These wavelengths are known and are regularly published in many radio publications.

After the broadcast waveband has been covered, the wavemeter range may be extended downward by listening for broadcast harmonics. A 50-turn, space-wound coil in the receiver covers the broadcast range quite well with a .00035-mfd. condenser; to extend the range down to 90 meters use a 40-turn coil in the receiver. Such a coil allows tuning-in the short-wave broadcast stations at the top of the dial and these are used as starting points on the curves. Nearby stations, that is, stations within 20 miles, give many audible harmonics and harmonics of quite distant stations are often heard.

(Continued on page 1183)

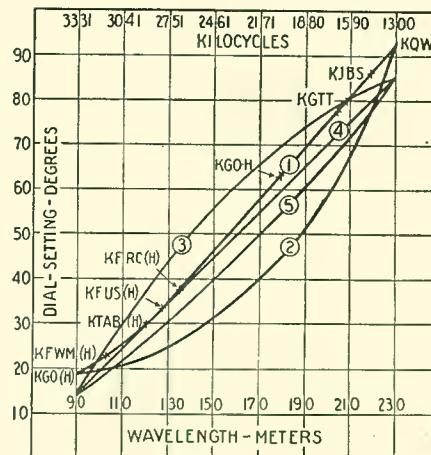

FIG. 3

Experimental and theoretical calibration curves, obtained from condensers of different types in the wavemeter.

The Construction and Theory of Wavetraps

How the Set Owner May Eliminate Station Interference

By JAMES WOOD, Jr.



Fig. 15. A front view of the wavetraps, the circuit of which is shown in Fig. 4-A. Note that there are two aerial and two ground posts.
Photo courtesy of X-L Radio Laboratories

THE wavetraps is more or less familiar to every radio fan. How it works, and when it will work, are facts that are not, however, as well known. We will, therefore, consider the wavetraps from both the practical and the theoretical sides.

There are several ways in which a wavetraps may be electrically connected to a radio receiver. Fig. 1 shows the commonest and probably best-known method of connection. Fig. 2 is much the same, except that the trap circuit T is connected directly in the antenna lead, instead of being coupled by means of a small coil a, as it is in Fig. 1. The tuning of the receiver is not appreciably affected in either of the connections when the trap circuit is varied. While for a given filter, Fig. 1 shows the more selective connection as regards the elimination of in-

terference, Fig. 2 shows a connection which affords more complete elimination of interference. This is due simply to the fact that in Fig. 2 the trap circuit is more closely coupled to the antenna circuit than in Fig. 1. Which circuit should be employed depends upon the conditions under which the wavetraps is to be used.

SELECTIVITY VS. SENSITIVITY

For example, suppose we wish to receive KDKA on 309 meters, but we are located in New York City a short distance from WGBS, operating on 316 meters. We have a fairly selective receiver, but some interference from WGBS is experienced. To eliminate the latter station, and still retain KDKA, we would have to use the connection in Fig. 1. That in Fig. 2 would eliminate WGBS, but KDKA would be reduced in intensity considerably.

Now, suppose again we wish to receive KDKA, but we have an unselective receiver, and WMCA on 340 meters interferes. If the interference were strong, Fig. 2 would be the better connection, otherwise we could use Fig. 1. In general, then, we may say that Fig. 1 will give the desired results in all but exceptional cases, and is, therefore, to be preferred. Fig. 3 shows a third method which on paper, appears to be very good. Practically, however, it has one very serious fault, that the tuning of the receiver is very materially affected when the trap circuit T is adjusted. This makes the arrangement unsatisfactory for use. The same may be said of Fig. 4, which it will be seen, shows a tuned antenna circuit to which the wavetraps is coupled by means of a small coil. The arrangement shown in Fig. 4a, however, is satisfactory.

BUILDING A WAVETRAPS

We come now to the construction of a wavetraps suitable for use in the broadcast band of wavelengths. Such a trap is shown in the illustration (Fig. 10). The condenser has a maximum capacity of about .00045 mf. The inductance is made up of two coils arranged "binocular" fashion, and consisting of 45 turns each of No. 18 bell wire. Over each coil are wound 10 turns of No. 24 D.C.C. wire. The method of connection is shown in Fig. 5. The binocular arrangement helps to reduce the external field of the coils, and thus minimizes the possibility of undesired coupling between the trap circuit and other circuits in the vicinity.

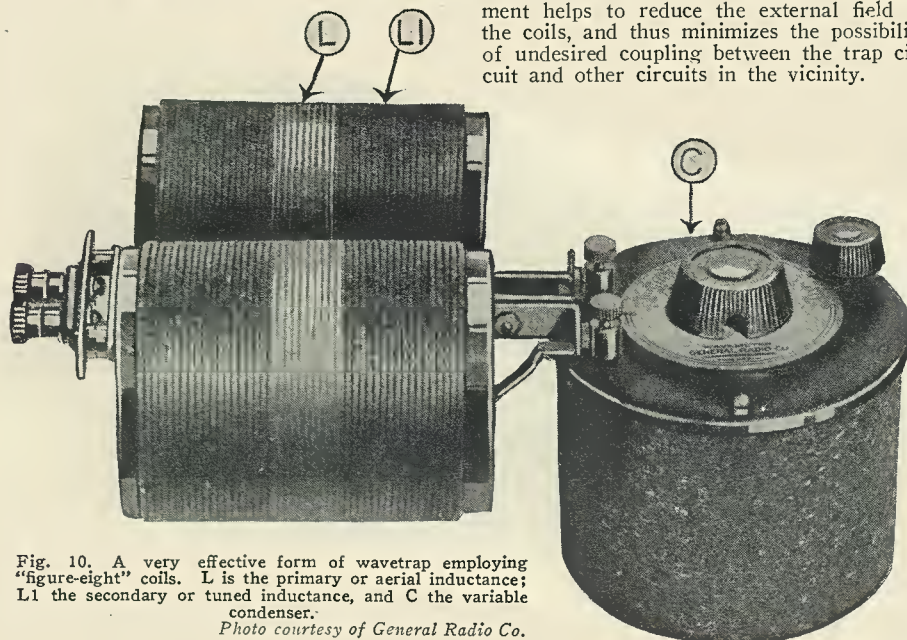
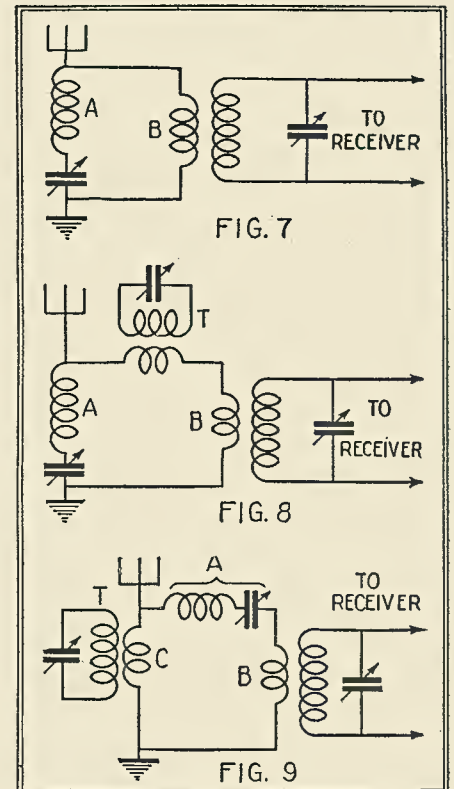

Fig. 10. A very effective form of wavetraps employing "figure-eight" coils. L is the primary or aerial inductance; LI the secondary or tuned inductance, and C the variable condenser.
Photo courtesy of General Radio Co.

Sometimes, in order to insure a minimum of undesired coupling, the coils and condenser of the wavetraps are shielded. Sheet copper is, everything considered, the best material for the purpose. It need not be particularly heavy, No. 30 B. & S. gauge being sufficiently thick to reduce the disturbing electric and magnetic fields to about 1/50 of their value at 300 meters. This is usually sufficient for wavetraps work. The figure given does not, of course, hold for any



Three distinctive types of wavetraps circuits, which can be employed in connection with any receiver for the elimination of interference.

other metal. For example, if brass were used instead of copper, the shield would have to be considerably heavier for the same shielding effect. With brass of high zinc content (66% copper and 34% zinc) it would be necessary to use No. 22 B. & S. gauge to obtain the same shielding effect as can be obtained with No. 30 copper.

Whatever material is used, it is very important that the shield be as completely closed as possible. There must be no edges left unsoldered, as a very narrow slit of any appreciable length will reduce the shielding effect very considerably. In general, shielding need not be resorted to in the broadcast band. Occasionally, however, when a powerful broadcast station is close enough to cause interference due to the pickup of the coils themselves, shielding of both the receiver and wavetraps may be necessary. Another form of wavetraps, employing the circuit of Fig. 4a, is illustrated in Figs. 15 and 16. The coil L consists of 8 turns of No. 18 D.C.C. wire. Coil LI has 60 turns of No. 22 D.C.C. wire. The adjustable condenser C has a capacity range from .0003 to .001 mf. C1 has a maximum capacity of .00035 mf.

MULTIPLE WAVETRAPS

Suppose now we have a more difficult interference problem to solve. Suppose as be-

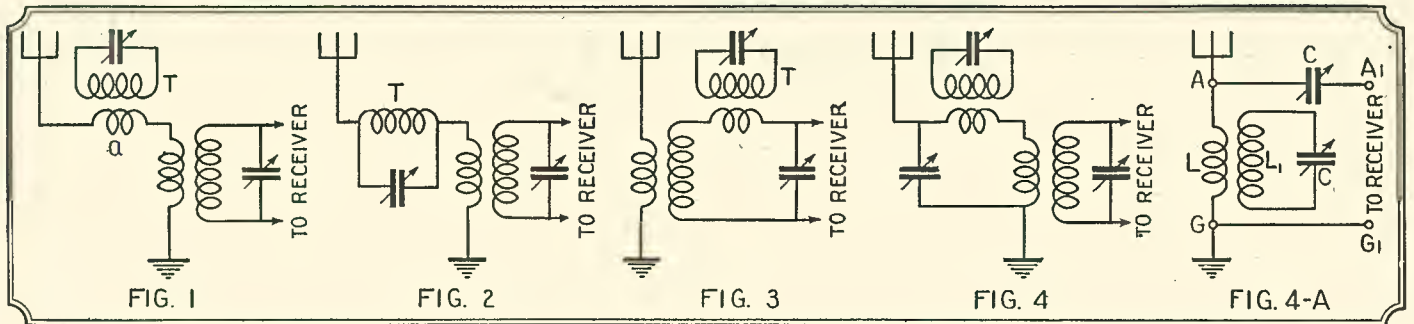

A group of both series and parallel wave-trap circuits that can be used for eliminating unwanted stations in any number of manners, as described in the text.

fore that we wish to receive KDKA on 309 meters, and that the interfering stations are WLWL on 288 meters, WGBS on 316 meters, and WMCA on 340 meters. Fig. 6 shows a method for eliminating the three

sion by pointing out several precautions that must be taken for successful operation of wave-trap systems in general:

(1). Use only low-loss coils and condensers.

be sure, all filters do absorb a little energy from the circuits to which they are coupled, because of the I^2R loss. The filter action, however, is hindered rather than helped by this absorption.

Suppose (Fig. 2) that T is tuned to the undesired signal. Suppose further that the resistance of the circuit is zero, and that a voltage E is impressed across the filter circuit. This is shown diagrammatically in Fig. 11a. It will be seen that the inductive current I_L lags 90° behind E, and the capacitive current I_C leads E by 90° . The resultant current is, therefore, zero (the two currents being equal and opposite), and the interfering signal would not be heard.

Practically, this state of affairs could never be realized because both the inductance and the condenser must have some resistance. The practical case is shown in Fig. 11b. Here there is a resultant current I, because I_L and I_C are not 180° out of phase. Since there is a resultant current in the antenna, the interfering signal is not entirely eliminated. It is thus evident that, for the best results, the resistance of the trap circuit should be as low as possible.

The operation of the circuit shown in Fig. 1 is much the same, but a little more complicated. It is analyzed in detail in Fig.

(Continued on page 1168)

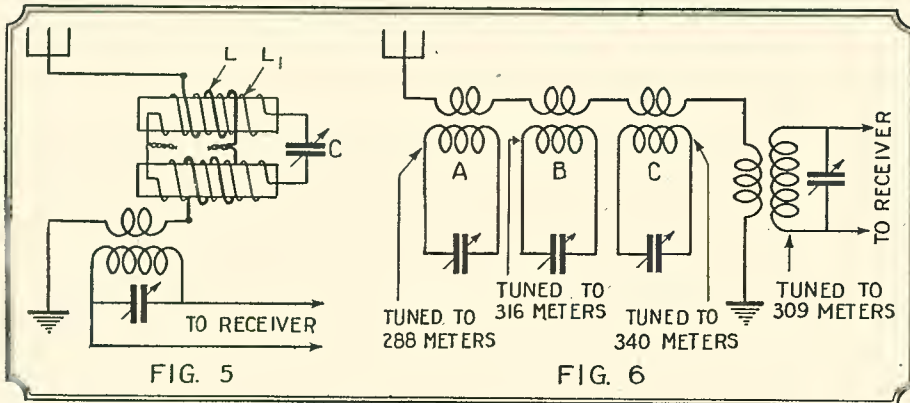

Left: The circuit diagram of the wave trap illustrated in Fig. 10. Right: A circuit containing a series of wave traps for eliminating the signals from three stations at one time. This is a good arrangement to employ where there are a number of local stations creating interference.

undesired stations and retaining the desired station.

The order of tuning shown in the figure need not, of course, be followed. For example, we might tune A to 340 meters, B to 288 meters, and C to 316 meters. In order for the circuit as a whole to work successfully, however, it is necessary that A, B, and C be all of low-loss construction. This is even more important here than in a circuit employing only one trap. Incidentally, if one of the interfering stations happens to be a "spark" station, it cannot be eliminated by means of a wavetrap. The reason for this will be given presently in discussing the theory.

OTHER TYPES OF CIRCUITS

So far we have been discussing only the so-called series-resonance filter. There is also a parallel-resonance filter circuit, illustrated in Fig. 7. Branch A is tuned to resonance with the interfering station. Under these circumstances the branch offers a very low impedance to the interfering signal and hence the latter does not pass through branch B to any extent. The desired signal, on the other hand, does not pass as readily through A. The tendency is, therefore, to eliminate the undesired station, and to retain the station being received. A modification of Fig. 7 is shown in Fig. 8. Here the small portion of the interfering signal that tends to pass through branch B is prevented from so doing by the trap circuit T.

Fig. 9 shows a circuit similar to Fig. 8, except that the positions of the parallel- and series-resonance circuits are reversed, and the two trap circuits are tuned to the desired signal, not the interfering signal. Fig. 9 will, as a rule, give better results than Fig. 2.

Before discussing the theory it may be well to conclude this rather general discus-

(2). Never mount the condenser inside the coil.

(3). Be sure that there is as little coupling as possible between the wavetrap and the receiver, and between the separate wavetraps, if more than one is being used.

(4). Tune the wavetrap carefully, so that when the undesired station has been eliminated the desired station has not been reduced in intensity.

(5). If shielding must be resorted to in order to make the wavetrap function properly, be sure to allow at least 2 inches between the metal and any part of the wavetrap inside. When the shield is in place there must be as nearly as possible a continuous metal surface around the coils and condenser. Binding-post holes should be the only openings present.

THEORY OF WAVETRAPS

We come now to the theoretical discussion. Consider Fig. 2. This is a rejection circuit and is not, as it is very often referred to, an absorption circuit. The undesired frequencies are rejected or prevented from flowing in the antenna circuit, but they are not absorbed. The ideal filter (that is, one without resistance, which would be the best obtainable) would have zero I^2R loss. To

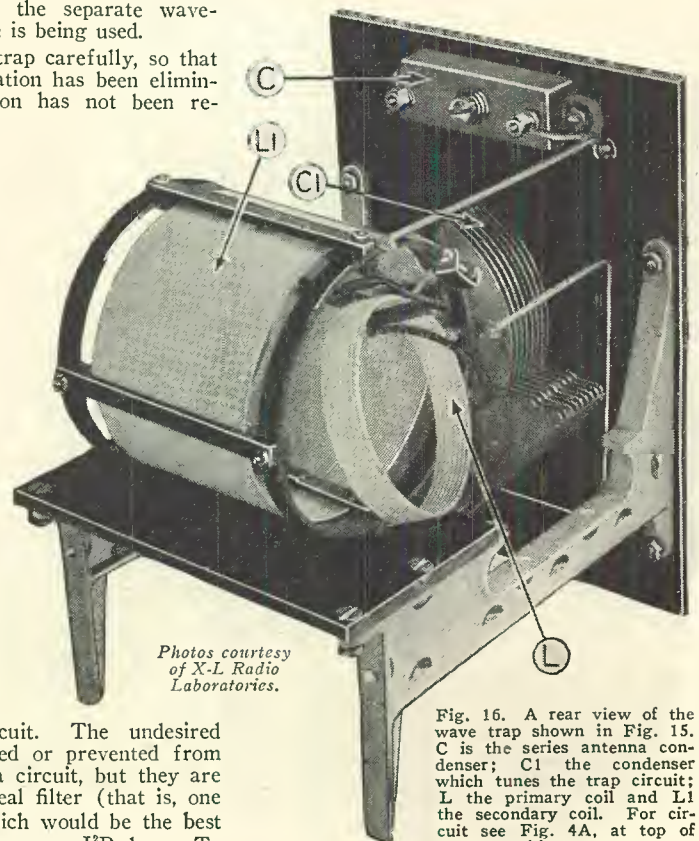

Photos courtesy of X-L Radio Laboratories.

Fig. 16. A rear view of the wave trap shown in Fig. 15. C is the series antenna condenser; C1 the condenser which tunes the trap circuit; L the primary coil and L1 the secondary coil. For circuit see Fig. 4A, at top of this page.

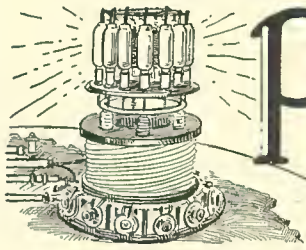

Progress in Radio

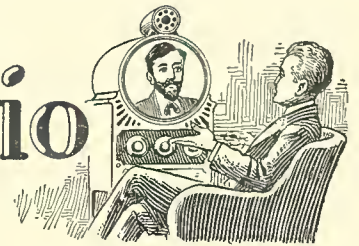

A RESISTANCE-BATTERY-COUPLED A.F. AMPLIFIER

A resistance-coupled amplifier obviating the use of coupling or blocking condensers is described by S. B. Smith in a recent British patent specification. It will be noticed that the amplifier shown in the illustration utilizes a potentiometer form of coupling to the grids of the various tubes; the positive potential which would otherwise be communicated to the grids from the plates of the preceding tubes being counteracted by an opposite negative potential from a high voltage "C" battery common to all grids. The amplifier can, therefore, be used for amplifying the effect of direct current potentials applied between the grid and the filament of the first tube. The action of the amplifier can be easily understood by referring to the illustration. The input of the first tube V_1 comprises a resistance R_1 , across which the potentials to be amplified are introduced. The lower end of the resistance R_1 is taken to a tapping on the battery B_2 , in order to give the grid of the first tube a suitable negative bias. The plate circuit of the tube V_1 contains a plate resis-

tickler coil into the wave trap instead of into the normal antenna tuning circuit. Referring to the accompanying illustration, it will be seen that a tuned circuit $L_1 C_1$, which is connected to an aerial and ground system through a series condenser C_2 , forms the input circuit of the tube. Loosely coupled to the inductance L_1 , is another tuned cir-

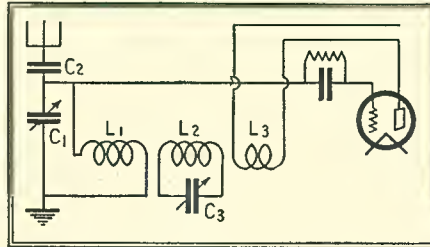

A simple regenerative hookup, employing a tuned absorption circuit $L_2 C_3$ as regeneration control.

cuit $L_2 C_3$, which forms the trap circuit. Regeneration is obtained by including an inductance L_2 in the plate circuit of the tube, which is then coupled to the trap circuit $L_2 C_3$. The regenerative effect is brought about, of course, by the fact that the circuit $L_2 C_3$ is coupled to the grid circuit of the tube through the ordinary antenna tuning circuit. It should be noted that the intermediate circuit $L_2 C_3$ is electrically disconnected from the other components of the circuit.

The arrangement provides a non-critical regeneration control.—*Wireless World*.

A DUAL-AMPLIFICATION SCHEME

A rather peculiar form of dual amplification circuit is claimed by J. Sieger in a British patent. The circuit appears to be of the type in which incoming oscillations are rectified by a crystal, the audio-frequency potentials being passed on by a transformer to the grid circuit of a tube which further amplifies them. The tube is also used to introduce a regenerative effect into the tuned circuit, which is connected to the grid circuit of the tube. Thus, the invention should be quite clear from the accompanying diagram.

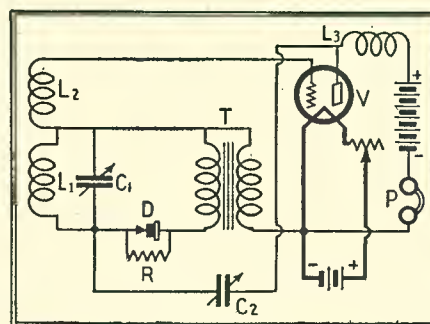

A new form of simple reflex circuit, employing a crystal detector for rectification. The tube amplifies at both radio and audio frequencies.

Here it will be seen that an inductance L_1 , such as a loop aerial, is tuned by a condenser C_1 . Potentials across this tuned circuit are rectified by the crystal detector D , the rectified potentials being passed on by an A. F. transformer T to the grid circuit of the tube V , through another inductance L_2 , which is coupled to the loop aerial or inductance L_1 .

The plate circuit of the tube contains a radio-frequency choke L_3 and the usual "B" battery and headphones. A regeneration or throttle condenser C_2 is included between the plate and one side of the inductance L_1 . If the circuit is carefully followed out it will be seen that the two inductances are connected respectively in the grid and plate circuits of the tube, capacity regeneration being obtained by means of the condenser C_2 . A further feature of the invention is the inclusion of a resistance R , which is connected across the detector D . The object of this resistance is to stabilize the set and prevent it from breaking into oscillation too readily when the crystal contact is altered or affected by vibration.—*Wireless World*.

A VARIABLE INDUCTANCE WITH LOADING COIL

This invention, which relates to variable inductances of the shielded or "spade-tuned" type, is the production of Newsom Henry Clough, of Chelmsford, Essex, who has been granted a British patent thereon. Briefly the

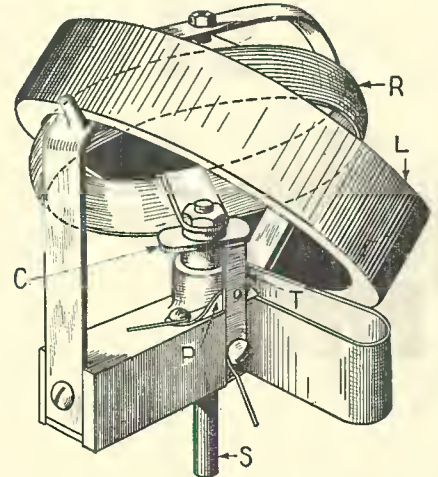

A variable inductance employing a metal ring as the principal control factor. The coil L is also tapped, so that it can cover wide inductance ranges.

design is as follows: a variable tuning and loading device comprises a variable inductance of the "spade-tuned" type, provided with a switch, or switches, adapted automatically to include or exclude a loading device or devices in the circuit of the tuning device.

One form of construction is shown in which L is a coil, the inductance of which can be varied by the rotation of a copper ring, R , mounted within the coil upon a spindle, S . Also mounted upon the spindle is an insulated cam, C , so shaped that through 180 degrees of rotation of the ring, R , it presses the switch tongue, T , away from a contact upon the plate, P ; while during the other 180 degrees of rotation it permits the tongue, T , to make contact. The switch, T, P , serves in its closed position to short-circuit an additional external inductance, connected in series with the coil, L .—*Wireless Trader*

NEW VARIABLE INDUCTANCES

Under patent granted to L. Bonnet, Perpignan, France, the inductance of transformer windings and inductance coils used in tuning radio receiving sets is varied by means of

(Continued on page 1168)

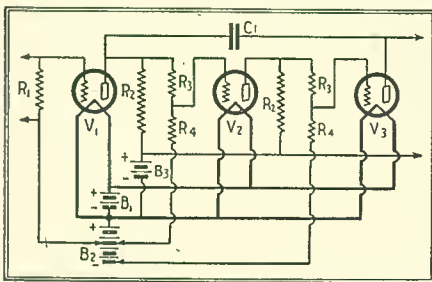

A resistance-battery-coupled A.F. amplifier wherein a common "C" or "bucking" battery (B_2) is employed for maintaining the grids of all three tubes at a constant negative potential.

tance R_2 , which is connected to the positive side of the "B" battery B_1 . The plate A of the tube V_1 is coupled to the grid of the tube V_2 through one section of a potentiometer comprising two resistances R_3 and R_4 . The ohmic value of these resistances is considerably greater than that of the plate resistance R_2 . The other half of the potentiometer, R_5 , is taken to a negative tapping on the "C" battery B_2 ; this negative bias being suitably adjusted to more than counteract the positive potential which would otherwise be conveyed to the grid from the plate of the plate V_1 , the grid potential, of course, becoming negative with respect to the filament. The tube V_2 , is coupled to the tube V_3 in a similar manner. In order to overcome any regenerative effect which may occur in the amplifier, thus giving rise to audio-frequency oscillation, a stabilizing condenser C_1 may be connected between the plate of the tube V_1 and the plate of the tube V_3 , acting, of course, in the manner of an ordinary neutralizing condenser.—*Wireless World*.

SELECTIVE REGENERATIVE CIRCUIT

A rather interesting form of selective receiving circuit is described by A. G. Benstead and Rotax (Motor Accessories), Limited. The invention really consists in coupling a tuned filter circuit or wave trap to the aerial inductance and coupling the



First Prize

AN INTERCHANGEABLE PLUG-IN COIL

By ROBERT N. AUBLE.

The self-confining characteristics of the so-called "lemniscate" coil make it a highly desirable accessory in the experimenter's laboratory. The coils heretofore described in the various radio journals have been so difficult to construct that but few of us have had opportunity to learn their advantages. And, too, the factory-built coils have been so bulky as to discourage their use in some receiving sets where compactness is a prime consideration.

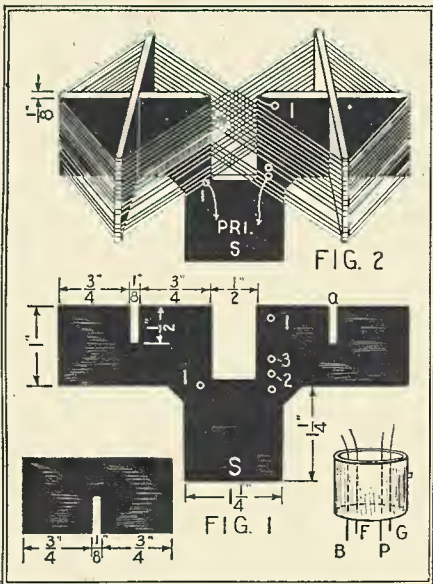

Fig. 1 shows the main supporting strip and the cross pieces on which the wires are wound, in the manner shown in Fig. 2 above. The leads for the coils are brought out through the holes as indicated.

The coil illustrated in the accompanying sketches is not only easy to construct, but is also very compact. At the same time it has the additional advantages of a "low-loss" form.

The form upon which the coil is wound is sawed from a piece of bakelite, formica, or other suitable material. If several coils are to be constructed, several strips of material may be clamped together in a vise and all of them sawed at the same time. For each main supporting strip (S, Fig. 1) two cross strips should be cut. The depth of the slot in the cross strip and of the corresponding slot in the supporting strip should be one-half the vertical height, so that when the two are fitted together the joint at the top and bottom will be even. The center slot in the main supporting strip should be of such width that the wire will not touch the insulation when carried straight across. The projecting parts at the bottom should be of such width and length as to fit snugly into the shell of a discarded vacuum tube. Small holes for wire (indicated in Fig. 1) should be bored in the supporting strip. The four ends of the primary and secondary coils are threaded through these holes before they

Prize Winners

First Prize \$25

AN INTERCHANGEABLE PLUG-IN COIL

By ROBERT N. AUBLE
1121 Tecumseh St., Indianapolis, Ind.

Second Prize \$15

BRASS COTTER PINS AS TERMINALS

By G. A. LUERS
130 E. Capitol St., Washington, D. C.

Third Prize \$10

SIMPLE TAPPING CLIP

By C. A. OLDROYD
127 Abbey Rd., Barrow-in-Furness, Lancs., England.

All published Wrinkles, not winning prizes, will be paid for at the rate of two dollars each.

The next list of prize winners will be published in the May issue.

are soldered into the prongs of the tube shell.

The dimensions given in the sketches are optional with the constructor, since the size of form to be used will depend upon the space into which the coil is to be placed, upon the size of wire used, and upon the number of turns of wire. A form one inch high will accommodate 72 turns of No. 26 D.S.C. wire.

In the winding of a coil, the wire is first threaded through hole number 1, four or five inches being left for convenience in soldering in the tube shell. The wire is carried around one-half of the form in a clockwise direction; thence through the center slot, and counter-clockwise about the other half of the form. The other end of the primary coil should be brought out at the same side of the form as the first end, while the two ends of the secondary are to be carried to the opposite side. When completed, the two ends of the primary are soldered to the plate and positive filament terminals of the shell, and those of the secondary to the grid and negative filament terminals. After the wires have been soldered, the shell is filled with sealing wax to render the coil rigid.

The coil illustrated has seven double turns on the primary and 64 double turns on the secondary, and is suitable for use with a .00035-mf. condenser for the broadcast band of wavelengths.

Second Prize

BRASS COTTER PINS AS TERMINALS

By G. A. LUERS

The radio owner or electrical worker, in need of a plug-in type of terminal for detachable parts of the wiring, will find in the means shown in the attached sketch a simple, positive and effective terminal.

Brass cotter pins, of the most appropriate size, are soldered to the ends of the wires. The ends of these terminals can be squeezed together with the fingers, inserted into any

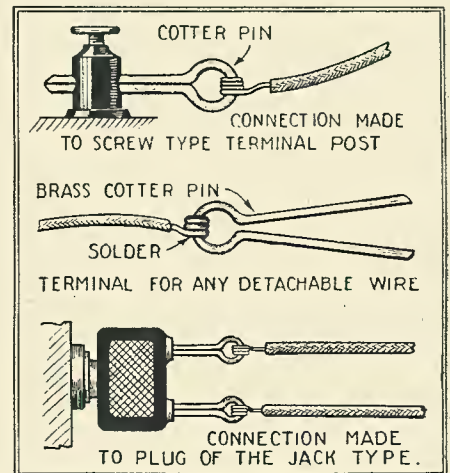

A convenient use for cotter pins in radio construction is shown in the above illustrations, as excellent substitutes for wire terminals.

screw or a plug-in type of connection. They will give good contact and offer a fair resistance to being pulled out. This resistance to removal will be increased if the ends of the cotter pin are spread outward.

Third Prize

SIMPLE TAPPING CLIP

By C. A. OLDROYD

A very simple and useful tapping clip or connector, for tapping coil turns and busbar leads, can be readily made from a stiff brass or steel wire spring having a diameter

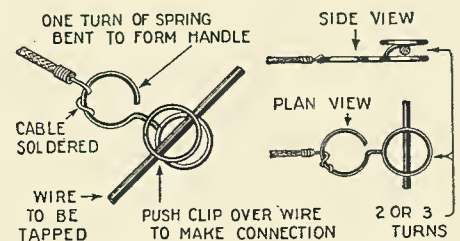

It is handy, in experiments, to have terminals on the leads, which can be quickly connected to different taps or connecting wires. A portion of a spring soldered to a lead, as indicated above, will prove satisfactory.

of from 1/4 to 3/8 inch. Three or four turns are cut from the spring and one turn is bent outwards, away from the others. This forms a convenient handle, to which the end of the flexible connecting lead is soldered.

At the right the clip connector is shown in plan. The position of the wire which is to be tapped can be seen above. The clip is gripped by the loop handle and pushed over the bared wire; on account of its elasticity the clip will hold the wire securely.

A dozen or more clips can be made in as many minutes if cut from the same spring. These clips will prove very handy for test

work, since they grip both round wire and square busbar equally well.

MAKING BATTERY TESTS EASIER

Most hydrometer floats have a tendency to stick to the sides of the glass tube when a reading is being taken; and the instrument must be shaken before an accurate reading is possible. To remedy this, take off the bulb and remove the float. Next, take a piece of No. 28 bare copper wire and twist four prongs on it, as shown in the sketch.

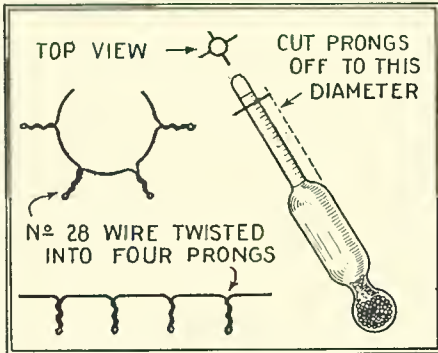

To keep the float of a hydrometer free from the sides of the tube, a wire twisted as shown above will be a great aid.

Then wrap it around the small end of the float and twist the two ends together, thus making a fifth prong.

When it is fairly tight, cut off the prongs to a uniform length, a little less than the diameter of the lower end of the float. The points, hitting the sides of the tube, will prevent the float from sticking. The little extra weight of the wire will not materially affect the reading.

Contributed by John H. Wack.

CLIP FOR END OF WIRE

Every year, miles of new wire are wasted by fans when they secure the free end of a wire by a loop around the storage spool. At least two turns of wire are kinked and twisted in this fashion; and, before a new coil can be started, six to eight inches of damaged wire must be cut off.

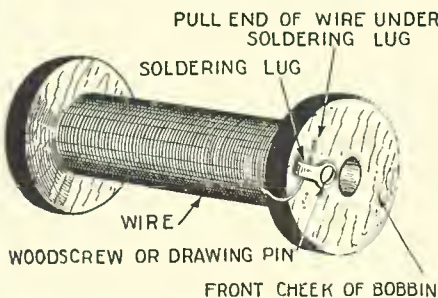

When it is necessary to store spools of wire; instead of twisting the wire in order to keep it on the spool, fasten a soldering lug on the spool's end and it will keep the wire in its proper place.

This waste can be avoided if the end of the wire is secured under a small spring clip fixed to the bobbin cheek, as shown. The wire is simply pulled under the clip in one motion.

The clip can be made from a short piece of stiff, thin brass strip; a soldering lug affords a simple solution. It is just the right size and already has a hole for the fixing screw. The tip of the lug is bent up slightly, to guide the wire under the clip. A short wood-screw can be used to fix the clip to the bobbin cheek. A large drawing pin often serves the purpose quite as well, particularly if the bobbin happens to be a small one.

Contributed by C. A. Oldroyd.

AN INEXPENSIVE TELLTALE LAMP

Has it ever been your misfortune to forget to switch off the eliminator some evening, after you have finished listening-in with your set, then fail to discover the fact until the next night? Although the current consumption of the majority of eliminators is relatively low, it is senseless to run up the electric-light bill any more than necessary. The suggestion has been made that an ordinary electric lamp be used as a telltale indicator in a twin-socket along with the eliminator plug, but this means that just so much more current will be consumed.

In the accompanying sketch is shown an arrangement originated by Hugo Gernsback, Editor of RADIO NEWS, whereby a telltale indicator is provided; its maintenance cost is almost negligible. It consists of a small "wattless" neon lamp of such a size that the ordinary electric lamp base-plug, will give good service as a "telltale" light to show when eliminators are in operation.

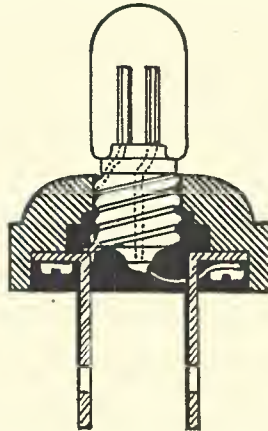

A "wattless" neon miniature lamp, soldered in the cap of an ordinary base-plug, will give good service as a "telltale" light to show when eliminators are in operation.

and these wires soldered in turn to the two terminal screws in the cap.

This little device can be placed in a twin socket with the connecting wires for the eliminator running from the other side. The lamp will, therefore, be lighted while the eliminator is operating, and its pinkish-orange glow will act as a telltale.

HOMEMADE WIRE GAUGE

The simplicity of making an accurate wire gauge is shown in the illustrations. The graph was plotted from the finished gauge and some wire of known gauges. Two straight wood or metal rulers placed edge to edge and separated at the six-inch mark about 3/16th of an inch and fastened in contact with each other at the left ends are used. Short lengths of brass strips bolted at each end will hold them apart. This forms a tapering slot between the two edges.

At the right is shown the curve for determining the size of wires in connection with the gauge shown above. This curve may be obtained by placing known sizes of wire in the gauge and then drawing a curve through the points found. If the curve is carefully drawn and the readings closely made, this should prove to be a fairly accurate gauge.

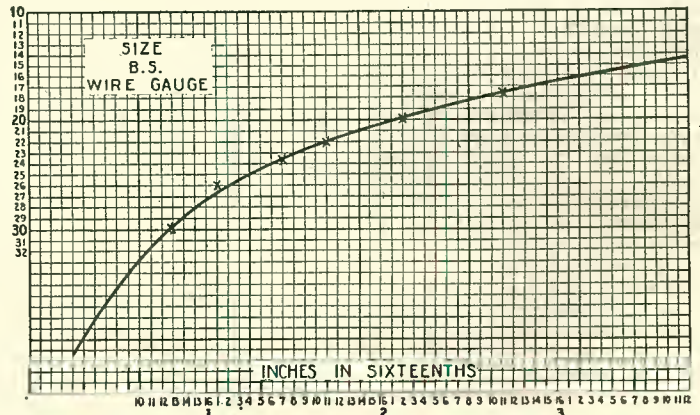

To use the gauge simply place the bare wire to be measured into the slot and move it to the left until it fits snugly. The lower rule is then read to the nearest 16th of an inch and the reading recorded. By consult-



By fastening two pieces of ruler together, so they are separated about 3/16 of an inch at the 6-inch mark, an excellent wire gauge can be made.

ing the chart, which you can easily make, the size of the wire can be determined. For example, in the reproduced photograph the scale reading shown is 2 and 2/16th inches. From the calibrated graph we find that the size of the wire is No. 20 B. & S.

Contributed by Raymond B. Wailes.

DOUBLE-THROW SWITCH FOR DETECTORS

The advantage of mounting two crystals, so that either may be used in a reflex or any crystal set, is evident, especially when the loss of time incident to shifting them is to be avoided.

A simple mounting, which has dual connections and double crystals, is shown in the

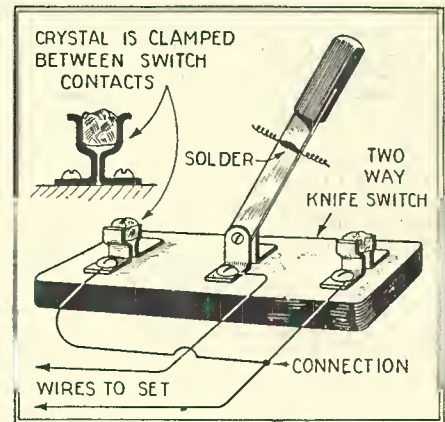

After soldering a catwhisker on each side of a S.P.D.T. knife switch, two samples of crystals can be compared by merely throwing the blade from one side to the other.

attached sketch. It consists of a two-way knife-switch, with pieces of crystals inserted in the contacts and catwhisker wires attached to the blade section.

Contributed by G. A. Luers.



Correspondence from Readers



A LISTENER'S PLEA

Editor, RADIO NEWS:

A certain Eastern station is broadcasting a special program. Frequently, the announcer makes a statement, "That his station will be very pleased to hear from those listening-in, especially from distant points."

Radio fans eager to log this station, of course, acknowledge the reception, giving out the desired information as to the reception, etc. What is the result from many stations? Speaking for thousands of radio fans along the Pacific coast, I wish to say that in a great number of cases their letters remain unanswered.

What effect does this have? Well, it tends to create a bad feeling toward this station in particular. Instead of the writers boosting, sad to state, they knock.

At the present writing I have sent at least ten unanswered letters to different Eastern stations. Desiring their letters as a verification that I had listened to their program, which would allow me to log officially their station, I have nothing to prove that I had picked up their program. Seeing is believing; and this is what counts in a log.

Many of the Eastern studio managers are very prompt in granting a reply, which tends to create a psychological effect, and in turn makes their stations popular. The studio manager who remains indifferent to such correspondence displays only a lack of good business qualifications. He had better "snap" out of his lethargy, pronto, if he desires to retain the good-will of the many thousands of radio enthusiasts throughout the United States and Canada.

A word to the wise should suffice. Let me voice also the Californians' plea to all Eastern announcers; please be liberal with your station call. Let us hear it often.

HOMER G. GOSNEY,
406 So. Catalina Ave.,
Redondo Beach, Calif.

(Our sympathies are, of course, always with the DX listener. Rather than decreasing in numbers, we know that the tribe is increasing steadily by leaps and bounds. The editors are in receipt of thousands of letters during the week, showing that the DX listener is rather on the incline than decline, as some writers have rashly asserted.)

The quest is always for distance, and nine out of ten letters coming to RADIO NEWS emphasize that the builder of a new set wishes to get distance before anything else.

Just the same, we do not believe that it is up to the broadcast station to answer each and every letter, for these reasons: A broadcast station furnishes you with entertainment, and gives you the wherewithal to obtain satisfaction. It does not cost you a penny, the broadcast station bearing all expense. Is it, therefore, quite fair to expect that the station will answer all the mail? A large station receives anywhere from 500 letters up each and every day, and this does not include the "fan" mail. To answer such mail would require the services of a special staff, which would mean only one thing, namely, decrease in the station's quality, because the cost has to be met somehow, and the more you burden the station with unnecessary expense, the less you will get from it.

On the other hand, how is the station to

know that a reply is wanted? Nine out of ten letters which we see addressed to the various stations simply say, "Received such-and-such a program, at such-and-such a time, FINE!", or words to this effect. On the other hand, if an answer is really wanted, the best and only way is to send a return postcard attached, which costs very little, and practically forces the broadcaster to answer such communication. If such a reply postcard is used, we wager that every one of them will be answered in due time.

Most broadcast stations also issue the Ekko stamps, which can be had by addressing the station, and sending 10c for postage and clerical work. Practically all the large stations issue these stamps for verification purposes.—EDITOR.)

ACCURACY OF HOME-BUILT APPARATUS

Editor, RADIO NEWS:

A number of articles have appeared in the radio press in which it is stated that a high-resistance voltmeter may be made by connecting in series a low-reading milliammeter and a high resistance of the proper value. For instance, a milliammeter, reading one milliampere full scale, used in conjunction with a 0.2-megohm resistance, will make a legitimate voltmeter, reading 200 volts full scale.

It is, however, very difficult to obtain on the open market a high resistance of the proper accuracy and made of the proper material for such a purpose. The average man will go to a radio store and purchase a grid leak or other high resistance which is entirely unsuitable for the work at hand. That is, a 0.2-megohm grid leak rarely has a resistance of 0.2 megohms. Grid leaks are usually adjusted by the large manufacturers to come within 10%, and many on the market are far from being this accurate. The voltage readings will be no better than the accuracy of the grid leak.

Further, every grid leak has an important "temperature-coefficient," those of carbon or inked paper having a negative coefficient and some other types being positive. They will vary as much as 0.5% per degree Fahrenheit. Even though compensation be made for room temperature, the current through the grid leak will usually heat it so that its temperature is considerably above that of the room and more errors result. It should be understood of course, that for their purpose, grid leaks are entirely satisfactory, since a variation of 10%, in the value of the grid leak or high resistance in a receiving set or resistance-coupled amplifier, makes a very small difference. Such an error in the reading of a voltmeter is, however, a different matter.

High-resistance voltmeters are expensive, because their resistance is made of wire properly insulated and of the proper alloy to have a zero change of resistance with temperature. Being made of such material, they will read accurately under all ordinary conditions. Such wire-wound resistances for several hundred volts usually contain, several

thousand feet of wire, and are consequently expensive to make.

In view of these facts, a voltmeter made with a commercial resistance can rarely be relied on to be accurate within 10%. In many cases the error will be greater. If such a combination is used, it should at least be done with a knowledge of the possible errors, and not with the expectation of securing a high-grade and accurate high-resistance voltmeter.

JOHN H. MILLER,
Electrical Engineer, Jewell Electrical Instrument Company, Chicago, Ill.

(Our correspondent puts the matter so clearly that there is hardly need for comment. While many pieces of apparatus can be built at home and serve perfectly for all purposes, the construction of precision apparatus calls for special testing equipment as well as suitable materials.—EDITOR.)

RADIO SALESMANSHIP AND SERVICE

Editor, RADIO NEWS:

I have read your remarks concerning Mr. Edison and his attitude toward the radio industry with great interest, and agree with you that he has either made his statement without investigating the actual facts, or else with some motive in view, possibly the increase of sales of his new records. Be that as it may, there was one statement you made that struck home with me, and that was about the radio dealer servicing his sales. You state that "in the last analysis, radio will probably be handled by radio or electrical stores, whose staff understand the mechanism."

Honestly, the most amusing thing extant, to my mind, is to go into a first-class music store, with the rooms full of pianos, cases full of all kinds of expensive musical instruments, floors covered with phonographs, and over in one corner an interesting display of radios. You are approached by a suave salesman (who could no doubt display a \$600 piano or \$300 phonograph, or \$125 saxophone, without the least qualm) and you state you saw the radio set in the window, and wonder whether it is a 5-tube tuned-radio-frequency type, or is it a six-tube with resistance-coupled audio. He stammers and turns desperately around, and says that "just a moment, our radio man, Mr. Blank, will wait on you." And further, "Won't you look at the set?" So you go over, and he says that it is \$130. Well, you ask concerning the distance that it usually gets under local conditions, and he is very hazy. You ask how many 45-volt "B" batteries it takes, and he again drops back on Mr. Blank. All that he is certain, absolutely certain of, is that it is \$130, and that it is a beautiful set. And pretty soon Mr. Blank comes in, and here he is, a young peppy kid, usually about 20 years old, who you know has grown up with a radio from the crystal set. Well, with him around, then you can find out something.

But the ridiculous thing is that so many of these so-called salesmen in music stores, and department stores, haven't the brains, or the ambition, to get hold of a few radio magazines, and post themselves up enough to talk intelligently on the stuff they have. I think this has more than anything to do with the feeling that a specialty store should

(Continued on page 1142)

(Expressions of readers' opinions are their own, and may differ from the editorial belief. It is desired to permit here fair arguments on either side of a radio controversy.—EDITOR.)

Radiotics

EVER TRY THIS?



Rubbery item from the *Tulsa (Okla.) World* of December 19: "Young was tampering with his radio and WINDING A SET in efforts to make a three-tube outfit." Our guess is that he had a whole mob of spare parts hanging around and, instead of placing them as usual, he just wound the works on some sort of a form.

Contributed by Karl White.

NEED ANY OF THESE?

Important radio event announced in the *N. Y. American* of Dec. 20: "Sale of Battery chargers, UNITS, Crystals, tubes, AMPERES, Wiring, Condensers, Cabinets, SIGNALS, etc." We are sending Mike down for a pound of resistance units, a bucket of amperes and a dozen packages of signals.



Contributed by Otto Follonder.

EXPENSIVE FUEL

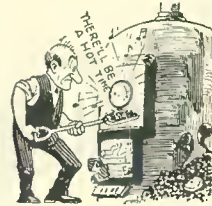

In the *Joplin (Mo.) Globe* of Dec. 21, we have this "hot" one: "\$40 coal heater like new. Burns LOUD SPEAKER. Call 1472." We know that coal is rather an expensive item just now, but loud speakers are not our ideal fuel. Even if nowadays coal has to be heated, does it have to

be entertained, too?

Contributed by Frank W. Roth.

JUST LIKE A FAIRY!

Aesthetic touch from the *Philadelphia Inquirer* of Dec. 19: "The sub-panel FLITS across the ends of the shelf brackets . . ." Well, well, so this 'dress dancing has at last reached the intelligence of the radio set! Next thing we know the loud speaker will be jazzing around the table to its own music.



Contributed by John H. Roberts.

ADVANCE IN TRANSFORMER DESIGN



Easy way to use up old string is related in *Popular Radio Magazine*, November issue: " . . . is one of the few transformers built with CORD and windings . . ." Now if you think something is wrong with your audio circuit, just go out in the kitchen, grab a lot of old twine and a little wire, wind 'em up; presto, New Transformer!

Contributed by J. Walter Briggs.

METER MANUFACTURERS, NOTICE

Manufacturing item in the *Baravik 1927 Buyers' Guide*, as follows: "'B' units which fail to deliver the required voltage when the current consumption is around 50 to 60 MILLIAMMETERS defeat the purpose of power tubes." We sincerely trust that there are not many gadgets like this running around loose; for one would soon eat up the stock of the meter men.



Contributed by A. F. Pearce.

THE LATEST IN LOUD SPEAKERS



This advertisement is from the Nov. 7 issue of the *Detroit Sunday News*: "A real Beautiful Jewett C A N E speaker, sweet and clear tone. Only \$5." Well now, all things considered, that's pretty cheap when you think what you get for five bucks. You can entertain your girl with music as you stroll along.

Contributed by Wm. G. Mortimer.

RATHER HARD ON THE LADY

On Nov. 25 the *Sioux City (Iowa) Tribune* had this gem: "The game will be broadcast by WJAZ using 10,000 watts on a Sioux City woman, charged with . . ." We never heard the outcome of this; but we hope the poor lady escaped and suffered no great injury from having 10,000 watts used on her.

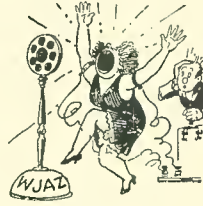

Contributed by Arthur Anderson.

SEND YOUR OWN TRUCK

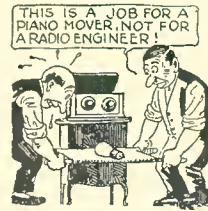

Heavy stuff from the Dec. 10 issue of the *St. Louis Post-Dispatch*: "New UX-112 POUND tube—\$1.45." We sent for one of these heavy-weights right away and found that it contained a cast-iron grid and a lead plate. Need you ask, gentle reader, if the output of such a tube is heavy? It certainly is.

Contributed by E. B. Hurd.

IF you happen to see any humorous misprints in the press we shall be glad to have you clip them out and send to us. No RADIOTIC will be accepted unless the printed original giving the name of the newspaper or magazine is submitted with date and page on which it appeared. We will pay \$1.00 for each RADIOTIC accepted and printed here. A few humorous lines from each correspondent should accompany each RADIOTIC. The most humorous ones will be printed. Address all RADIOTICS to

Editor RADIOTIC DEPARTMENT, c/o Radio News.

HOW DOES THIS WORK?



In the catalog of the *Standard Radio Company* we have discovered a queer type of variable condenser, as it has a "single POLE mounting." We have not seen this condenser mounted ready for use, but we assume that there is required some sort of a pole upon which the condenser balances itself. This right?

Contributed by A. L. Henriksen.

IT'S THE OLD ARMY GAME

Athletic question from the *Pittsburgh Chronicle-Telegraph* of Nov. 30: "Would it be possible to use PUSH BALL transformers in a 5-tube R.F. set?" As we remember the size of the pushballs that were used back in 1918, we would advise against the use of any such article in a radio set. Agree with us?

Contributed by Howard S. Seifert.



UNIQUE, TO SAY THE LEAST



A giant stride forward, as narrated in the *Cleveland News* of Nov. 5: "A completely self-contained, electric light line OPERATED BY RADIO receiver." At last the prophecies have been fulfilled. Power by radio. No more worries about the line breaking in the winter, glorious thing, though?

Contributed by L. E. Baker.

SORT'A SLOW!

In the *Providence Sunday Journal* of Nov. 14 we have this important notice: "Radio amateurs in more than 50 countries are now actively engaged in effecting TWO-DAY international private communication." There must be something out in the middle of some ocean that slows the waves up. Can you offer any solution?



Contributed by Ben R. Moon.

NEW TYPE PLUMBING



On Dec. 12 the *San Francisco Examiner* ran an article on connection of ground wires with a head as follows: "About Soldering to Cold WEATHER Pipes." However, we read the article through carefully, but we could find no reference to any fur-lined pipes or anything

of that sort. Got any dope on this?

Contributed by E. F. McDaniel.

RED HOT MAMA!

On Dec. 19 in the *Boston Sunday Advertiser* there appeared this news item: "Bradley was stringing a radio aerial when a wire he had in his hand came in contact with an electric light WIFE." It does not say whether the lady was lit up or not, but it does relate that the



gent was more or less shocked.

Contributed by Mrs. Irene Pierce.

ALMOST HUMAN

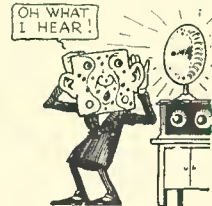

An interesting advertisement from the *New York Sun*, Dec. 19: "'B' eliminator condensers, guaranteed SELF-HEARING if punctured." Think of that! It makes no difference how much you punch the poor condensers they will hear themselves. What they say is, of course, a matter of conjecture.

Contributed by Steve Johnson.

IT'S A CROOL WOILD

Sad gesture from *Radio Doings* of Dec. 4: "The 5-tube Crosley at \$42 is WEEPING America in its price-class." We made immediate inquiries to find out what caused the weeps, and ascertained that someone had bumped into the set and had cracked a tube in the amplifier. Tough, ain't it?



Contributed by Herman Osswald.

APPROVED RADIO NEWS LABORATORIES 1922

RADIO NEWS LABORATORIES



RADIO manufacturers are invited to send to RADIO NEWS LABORATORIES, samples of their products for test. It does not matter whether or not they advertise in RADIO NEWS, the RADIO NEWS LABORATORIES being an independent organization, with the improvement of radio apparatus as its aim. If, after being tested, the instruments submitted prove to be built according to modern radio engineering practice, they will each be awarded a certificate of merit, and a "write-up" such as those given below will appear in this department of RADIO NEWS. If the apparatus does not pass the Laboratory tests, it will be returned to the manufacturer with suggestions for improvements. No "write-ups" sent by manufacturers are published on these pages, and only apparatus which has been tested by the Laboratories and found to be of good mechanical and electrical construction is described. Inasmuch as the service of the RADIO NEWS LABORATORIES is free to all manufacturers whether they are advertisers or not, it is necessary that all goods to be tested be forwarded prepaid, otherwise they cannot be accepted by the Laboratories. Apparatus ready for the market or already on the market will be tested for manufacturers, as heretofore, free of charge. Apparatus in process of development will be tested at a charge of \$2.00 per hour required to do the work. Address all communications and all parcels to RADIO NEWS LABORATORIES, 53 Park Place, New York City.

"B" BATTERY ELIMINATOR

The "Velvetone Super B" shown, submitted by the Velvetone Co., 3729 Avalon Blvd., Los Angeles, Calif., has an electrolytic rectifier and is designed to operate on either 50- or 60-cycle, 110- to 125-volt A.C.

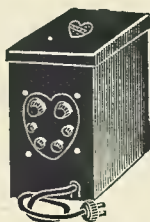

house-lighting current. The highest delivered voltage is somewhere above 135 volts, and the current output is sufficient to operate satisfactorily most radio receivers.

AWARDED THE RADIO NEWS LABORATORIES CERTIFICATE OF MERIT NO. 1738.

RESISTOR MOUNTING

The grid-leak or resistor mounting shown, submitted by the Aerovox Wireless Corp., 489-493 Broome St., New York City, N. Y., is of molded



bakelite. It is strong and neat, and its springs provide a sure contact for the resistance unit.

AWARDED THE RADIO NEWS LABORATORIES CERTIFICATE OF MERIT NO. 1767.

HYDROMETER

The "Ala B" hydrometer shown, submitted by the Ala Mfg. Co., 401-419 So. Sangamon St., Chicago, Ill., has a thin hard-rubber nozzle and



is of great use in taking care of storage "B" batteries, as it can be easily used with very small cells.

AWARDED THE RADIO NEWS LABORATORIES CERTIFICATE OF MERIT NO. 1771.

CONE SPEAKER

The "Trimm" cone speaker shown, submitted by the Trimm Radio Mfg. Co., 24 So. Clinton St., Chicago, Ill.,

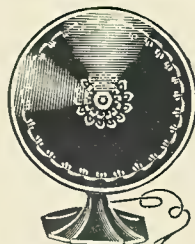

is of the free-edge type. A metallic ring protects the edge of the cone from injury. The main feature of the unit is that the iron armature in front of the electromagnets is attached to a small aluminum cone,

which in turn is fastened to the housing unit by means of six screws. The reproduction is clear and of good volume.

AWARDED THE RADIO NEWS LABORATORIES CERTIFICATE OF MERIT NO. 1785.

VACUUM TUBE

The "Excello-Tron" tube, model 201A shown, was submitted by F. C. Mitchell, Jr., 4198 Dumaine Street, New Orleans, La. Its characteristics are similar to those of a good 201A-type tube, and it operates satisfactorily as an amplifier and detector. It has a UX base.



AWARDED THE RADIO NEWS LABORATORIES CERTIFICATE OF MERIT NO. 1790.

RADIO RECEIVER

The "Buckingham Junior" chassis shown, submitted by the Buckingham Radio Corp., 17 East Austin Ave., Chicago, Ill., is a six-tube radio receiver having three tuned radio stages, a tuned detector and two stages of audio frequency. The set is controlled by two dials, as the



condensers are mounted in pairs. The four tuning coils are completely shielded. The reception of the set was found to be satisfactory.

AWARDED THE RADIO NEWS LABORATORIES CERTIFICATE OF MERIT NO. 1806.

VARIABLE CONDENSER

The "S L S Straight Line" variable condenser shown, submitted by the Wireless Radio Corp., Varick



Avenue and Harrison Place, Brooklyn, N. Y., is of very good construction. Its plates are of such shape that the condenser is a combination of the straight-line-wavelength and the straight-line-frequency types.

AWARDED THE RADIO NEWS LABORATORIES CERTIFICATE OF MERIT NO. 1807.

RADIO RECEIVER

The "Bush and Lane" radio receiver shown, submitted by Bush & Lane, Holland, Mich., is a one-control six-tube type, and incorporates two stages of tuned radio frequency,

tuned detector and a three-stage audio-frequency amplifier. An interesting feature is the luminescent



tuning scale. The set was found to be selective and the reception was satisfactory with regard to quality and volume.

AWARDED THE RADIO NEWS LABORATORIES CERTIFICATE OF MERIT NO. 1811.

VARIABLE CONDENSER

The "S & S Low Loss" variable condenser shown submitted by Stern and Stern A. B., Regeringsgatan 9, Stockholm, Sweden, is of the

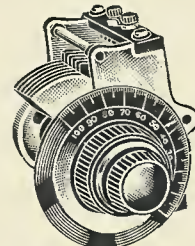

straight-line-wavelength type, and is very finely built. Its main feature is the vernier arrangement, which is attached to the rear of the condenser in a small housing. By unscrewing, or tightening, the cap of the housing the vernier ratio can be varied gradually between 1:50 and 1:500.

AWARDED THE RADIO NEWS LABORATORIES CERTIFICATE OF MERIT NO. 1815.

VACUUM-TUBE BASE

The "Duplex Base" shown, submitted by Havekost and Simonds, 154 Nassau St., New York City, N. Y., enables a power tube to be used in any stage of a radio receiver, if, instead of having an ordinary base, the tube is equipped with a duplex base. The correct "B" and "C" voltages for the tube can be easily provided, by connecting the additional batteries to the corresponding binding posts on the rim of the socket.

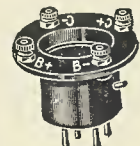

AWARDED THE RADIO NEWS LABORATORIES CERTIFICATE OF MERIT NO. 1818.

GROUND CLAMP

The ground clamp shown submitted by Leslie F. Muter Co., 76th St. and Greenwood Ave., Chicago, Ill., is made of soft tinned copper. It has an underwriter's retaining



washer, a brass lug nut and an adjustable screw. It can be easily fitted to a pipe, with which it makes a good contact.

AWARDED THE RADIO NEWS LABORATORIES CERTIFICATE OF MERIT NO. 1819.

STORAGE BATTERY

The "National" "A" storage battery shown, submitted by the Na-



tional Lead Battery Co., 1704-26 Roblyn Ave., St. Paul, Minn., is a six-volt lead-plate type, assembled in a one-piece acid-proof rubber container with a bail handle. The battery is of excellent quality, and available in five different sizes.

AWARDED THE RADIO NEWS LABORATORIES CERTIFICATE OF MERIT NO. 1823.

POWER UNITS

The "Home Power Unit" shown, submitted by the National Lead Bat-

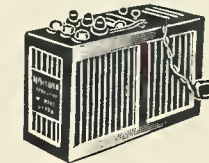

tery Co., 1704-26 Roblyn Ave., St. Paul, Minn., is a combination in one rubber case of a medium-size 6-volt lead-plate storage battery and a trickle charger. The H.P. unit, Type 1, uses a two-ampere tungar bulb as rectifier; while the Type 2 embodies an electrolytic system of charging. The construction is of

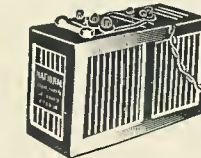

good quality and the operation has been found satisfactory.

AWARDED THE RADIO NEWS LABORATORIES CERTIFICATE OF MERIT NOS. 1824 & 1825.

RHEOSTAT AND SWITCH

The "Yaxley" rheostat and switch shown, submitted by Yaxley Approved Radio Products, 9 So. Clin-

ton St., Chicago, Ill., is a regular air-cooled rheostat having an additional insulated spring. The contact between this spring and the movable arm is controlled by a small attachment to the latter.



AWARDED THE RADIO NEWS LABORATORIES CERTIFICATE OF MERIT NO. 1827.

RADIO RECEIVER

The "King Cole" radio receiver shown, was submitted by the Anylite Electric Co., Fort Wayne, Ind., and incorporates one stage of tuned R.F., a tuned detector, two stages of transformer-coupled and two stages of resistance-coupled audio. The coupling

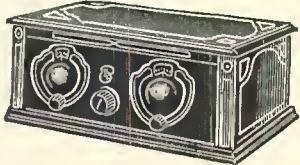

between the primary and the secondary of each coil is variable; one part of the winding of the primary is wound on the tickler inside of the secondary. The tickler is fixed on the same shaft as the rotor of the tuning condenser and participates in each motion. The reception is fair with regard to quality and volume.

AWARDED THE RADIO NEWS LABORATORIES CERTIFICATE OF MERIT NO. 1830.

POWER-CONTROL DEVICE

The "Brach Controlit" shown, submitted by the L. S. Brach Mfg. Co., Newark, N. J., consists of a relay whose armature is provided with two pairs of insulated contact springs. The windings of the relay are in series with the "A" battery and the receiver. When the switch of the receiver is open the relay is released and the armature connects the trickle charger to the house



lighting. When the switch closes the filament circuit, the total current passing through the winding operates the relay. The trickle charger is thus disconnected and two other contact springs connect the "B" battery eliminator to the house-lighting line. The device operates satisfactorily and does not affect the operation of the receiver.

AWARDED THE RADIO NEWS LABORATORIES CERTIFICATE OF MERIT NO. 1835.

A.F. TRANSFORMER

The "KIR" audio-frequency transformer shown, submitted by J. Wise & Co., St. Antoine Buildings, 40 Place Verte, Antwerp, Belgium, af-

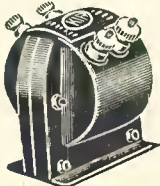

fords very good reproduction when incorporated in an amplifier. It is ruggedly built and is encased in metal.

AWARDED THE RADIO NEWS LABORATORIES CERTIFICATE OF MERIT NO. 1836.

BATTERY ELIMINATOR

The "Super Power" "B" battery eliminator shown, submitted by the Greene-Brown Mfg. Co., 2600 No. Western Ave., Chicago, Ill., operates on 110-volt A.C. house-lighting cur-

rent and uses a full-wave QRS rectifier tube. The voltage and the current are sufficient for almost any existing radio receiver. The operation is very quiet and no hum has been heard.



AWARDED THE RADIO NEWS LABORATORIES CERTIFICATE OF MERIT NO. 1838.

VACUUM TUBE

The "Q R S Redtop Full-Wave" rectifier tube shown, submitted by



The Q R S Music Co., Chicago, Ill., is a filamentless double-wave gas-type rectifier tube, and has a high current-carrying capacity. Very good results were obtained when it was tested in conjunction with a "Brown" "B" eliminator and some others.

AWARDED THE RADIO NEWS LABORATORIES CERTIFICATE OF MERIT NO. 1839.

RADIO RECEIVER

The receiver shown, submitted by



Chas. E. Chapin Co., 227 Fulton St., New York City, N. Y., is a five-tube set having two stages of tuned radio frequency, a tuned detector, and two stages of audio frequency. The receiver is neatly wired and operates satisfactorily.

AWARDED THE RADIO NEWS LABORATORIES CERTIFICATE OF MERIT NO. 1843.

CRYSTALS

The Crystals shown, submitted by Palmer & Palmer, 404 W. Utica St.,



Buffalo, N. Y., are of silicon, galena and pyrite and are mounted single, double and triple. They were found to be sensitive and may be used successfully in any crystal receiver set.

AWARDED THE RADIO NEWS LABORATORIES CERTIFICATE OF MERIT NO. 1844.

"A" ELIMINATOR

The "Radi" "A" eliminator shown, submitted by the Briggs and Stratton Corp., 1047 Louis Ave., Milwaukee, Wis., is a combination in one case of a tube rectifying device, delivering current under six volts, and using a two-ampere tungar bulb with a small six-volt floating lead-plate storage battery. Beside this there is incorporated in the same case a relay, which connects the "A" and "B" battery eliminator to the line when the receiver's filament switch is turned on. The operation of this eliminator is satisfactory and almost no hum is heard.

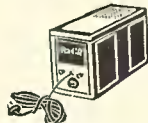

AWARDED THE RADIO NEWS LABORATORIES CERTIFICATE OF MERIT NO. 1846.

RESISTANCE-COUPLED AMPLIFIER

The "Kelford" resistance-coupled amplifier, No. 184 shown, submitted by The American Specialty Co., Bridgeport, Conn., is of excellent construction. The housing is of



molded bakelite and has a very neat appearance. This amplifier, used in conjunction with any good detector unit, is capable of unusually high quality amplification.

AWARDED THE RADIO NEWS LABORATORIES CERTIFICATE OF MERIT NO. 1849.

CRYSTAL RECEIVER

The "Pandora" crystal receiver shown submitted by the Brooklyn Metal Stamping Corp., 718-728 Atlantic Ave., Brooklyn, N. Y., is a multi-control crystal set. The tuning is effected by a slider. It gives fair reception for local stations and covers a great part of the broadcasting wave-range. Binding posts are provided for antenna, ground and phones.

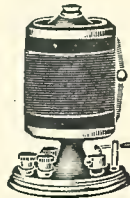

AWARDED THE RADIO NEWS LABORATORIES CERTIFICATE OF MERIT NO. 1851.

RHEOSTAT

The "Mar-Co Air-Cooled" rheostat shown, submitted by the Martin-Copeland Co., Providence, R. I., is of the one-hole-mounting type. The resistance unit is almost completely exposed, the molded bakelite base coming in contact with it at only a few points. The movable contact arm has a pigtail connection and its contact with the resistance wire is

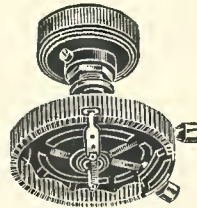

controlled by a special spring. The rheostat is of extremely neat appearance.

AWARDED THE RADIO NEWS LABORATORIES CERTIFICATE OF MERIT NO. 1854.

RESISTANCE

The "Carter" Resistance shown, submitted by the Carter Radio Co.,

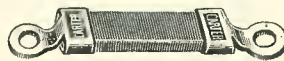

300 So. Racine St., Chicago, Ill., consists of a small bakelite strip around which is wound a resistance wire. The unit is provided with lugs and is available in different sizes.

AWARDED THE RADIO NEWS LABORATORIES CERTIFICATE OF MERIT NO. 1855.

CONE SPEAKER

The "Amplion" cone speaker

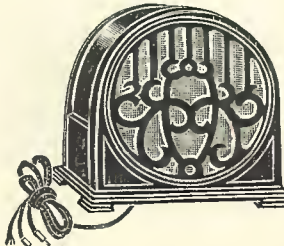

shown, submitted by The Amplion Corporation of America, 280 Madison Ave., New York City, N. Y., is of the free-edge cone type. The cone is made of impregnated cloth and attached directly to the diaphragm of the unit, which is provided with an adjustment screw. The whole is mounted in an attractive wooden housing. The reproduction by this instrument of music and speech is very fine and of good volume.

AWARDED THE RADIO NEWS LABORATORIES CERTIFICATE OF MERIT NO. 1856.

RHEOSTAT

The air-cooled rheostat shown, submitted by the Wireless Radio Corp., Varick Ave. and Harrison Place,

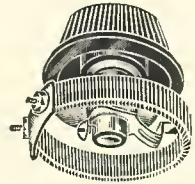

Brooklyn, N. Y., is of the one-hole-mounting type. The resistance unit is so mounted that it is completely exposed on all sides and can therefore stand relatively high current, as its cooling is rapid. The contact between the movable arm and the resistance wire is good in all positions of the former.

AWARDED THE RADIO NEWS LABORATORIES CERTIFICATE OF MERIT NO. 1857.

JACKS

The "Duo" jack shown, submitted by the Wireless Radio Corp., Varick Ave. and Harrison Place, Brooklyn,



N. Y., makes it possible to use either the phone plug or the phone tips or both at the same time.

AWARDED THE RADIO NEWS LABORATORIES CERTIFICATE OF MERIT NO. 1858.

The single jack shown was submitted by the Wireless Radio Corp., Varick Ave. and Harrison Place, Brooklyn, N. Y. The metal parts

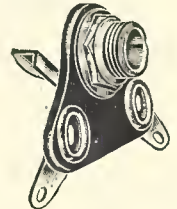

are of nickel-plated brass and the insulation is of good quality. The instrument provides very good contact.

AWARDED THE RADIO NEWS LABORATORIES CERTIFICATE OF MERIT NO. 1859.

PILOT LIGHT AND SWITCH

The combination pilot light and switch shown, submitted by the Wireless Radio Corp., Varick Ave. and Harrison Place, Brooklyn, N. Y., operates as a filament switch

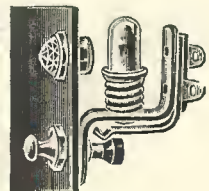

and at the same time lights up and turns off a pilot light in the back of the red cut crystal.

AWARDED THE RADIO NEWS LABORATORIES CERTIFICATE OF MERIT NO. 1860.

(Continued on page 1172)



With the Amateurs

“On Short Waves”

Dealing with the Design and Operation of a Short-Wave Transmitter

By J. BERNSLEY

MOST amateurs and “would-be” amateurs now realize that short-wave transmission and reception (below 100 meters) is “the thing.” There is no need to quote many long-distance records to prove this fact, as a few hours of listening on a short-wave receiver will furnish all the proof that is required.

However, because short waves are short waves, there are numerous difficulties and precautions which the constructor must consider when he is building apparatus for either the reception or transmission of signals within this band. We hear so much from amateurs who have constructed short-wave apparatus and who complain that their transmitters do not oscillate properly; or that they cannot get the results they expect from their short-wave receivers.

Very few ham beginners seem to realize that they encounter in short-wave work conditions entirely different from those usually experienced in ordinary broadcast receiver work. Radio energy at the high frequencies used by amateurs is very difficult to handle, and it is most essential that only parts of correct value be employed in short-wave transmitters or receivers. We will point out a few of the most noteworthy differences between short- and broadcast-wave receivers, which will help drive this point home.

We know that in the conventional broadcast set the tuning coils may be wound with wire of practically any gauge and in almost any fashion. In the design of short-wave coils, however, the turns must be space-wound. Heavy-gauge wire will be found to be most practical, and as little supporting material as possible should be used. The grid condenser in the 200-600 meter set is almost invariably of .00025-mf. size. In a 20-200 meter set a .0001-mf. is all that is required. In broadcast work an aerial about

100 feet in length is usually recommended. When a short-wave set is connected to the same aerial, the best results are obtained if a .0001-mf. or .00025-mf. fixed condenser is inserted in series with the aerial lead.

Very high-frequency currents are rather capricious, this characteristic making it necessary for the amateur to exercise particular pains when building short-wave apparatus. In the old days we used any conglomeration of junk; but today a consistent range of 2,000 miles and more is possible only through the use of low-loss inductances and condensers and improved vacuum tubes.

REDUCING INTERNAL CAPACITY

In short-wave work, the conventional type of transmitting tube with its metal base and inside-wire connections suffers from what we term excessive “internal capacity,” which plays havoc in a transmitter designed for operation below 100 meters. To offset this disadvantage the amateur, not so long ago, would remove the base from the tube and separate the four connections to reduce the capacity; thereby obtaining more stable tube operation and a dependable R.F. output. Yet the wires from the plate, grid, and filament

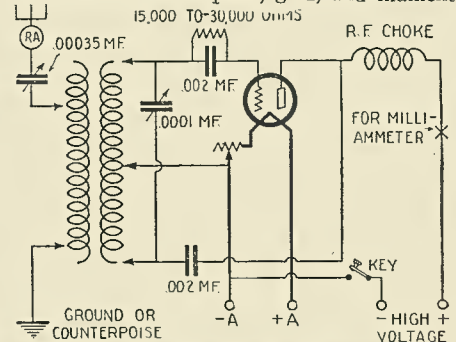

Fig. 2. The schematic circuit diagram of a short-wave transmitter employing a single vacuum tube. This is known as the Hartley circuit.

are all brought through the same end of the standard transmitting tube and, because of their proximity, an appreciable tube capacity exists even when the base is removed.

A tube we believe to be ideal for short-wave transmission, because of its construction, is shown in Fig. 1. Note how the leads are separated, each one being brought through a different part of the glass; grid-to-plate and grid-to-filament capacity are thus reduced to a minimum. (Of course, there is always some internal tube capacity, due to the juxtaposition of the elements). The characteristics of this tube are very favorable for short-wave work. No fixed plate voltage is required, the minimum required to produce an R.F. output being about 500 volts. The maximum plate voltage specified by the manufacturer is 3,000 volts. The filament consumption of the tube is 2.35 amperes at 10 volts. The plate current is usually between 40 and 50 milliamperes. Its R.F. output is about 30 watts under average conditions; although much more can be

obtained when the tube is placed in an efficient oscillating circuit, with correct constants, and supplied with more than 2,000 volts on the plate.

CONSTRUCTION OF A TRANSMITTER

Of the numerous existing oscillator circuits, the Hartley is most commonly used among radio amateurs. The transmitting circuit shown in Fig. 2 is of this type, and employs an inductively-coupled antenna circuit, in compliance with present legal re-

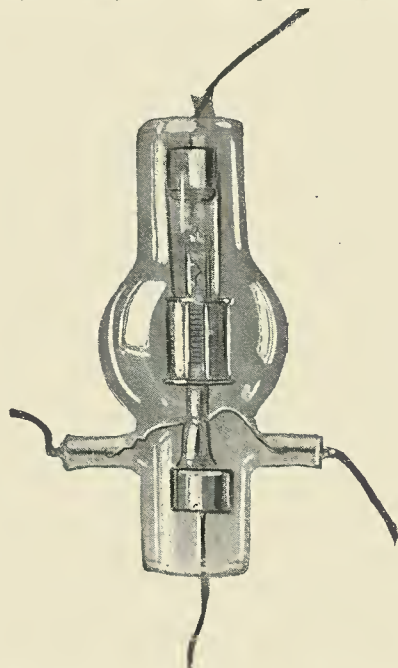

Fig. 1. A transmitting tube designed for short-wave work. The internal capacity of the tube is greatly reduced by the use, instead of the usual base, of widely-separated leads from the tube elements.

Photo courtesy of De Forest Radio Co.

quirements. Its operating range is variable between 15 and approximately 75 meters. The antenna inductance consists of 8 turns of flat copper ribbon about 1/4 of an inch in width, each turn spaced about half an inch away from the preceding one. The first turn should form a circle about 3 1/2 inches in diameter. The primary inductance (grid inductance) has the same dimensions. The grid leak required, for stable operation, should have a value in the vicinity of 30,000 ohms. The grid condenser should be of the transmitter type, and of .02-mf. capacity. The condenser connected across the primary inductance is a .0001-mf. double-spaced instrument (14 plates total, double-spaced). The condenser connected in series with the antenna, to reduce the operating wave below the latter's fundamental, is .00035-mf. size.

If an ordinary 5- or 7 1/2-watt tube is employed in the transmitter, then approximately 500 volts will be sufficient for the plate.

(Continued on page 1171)

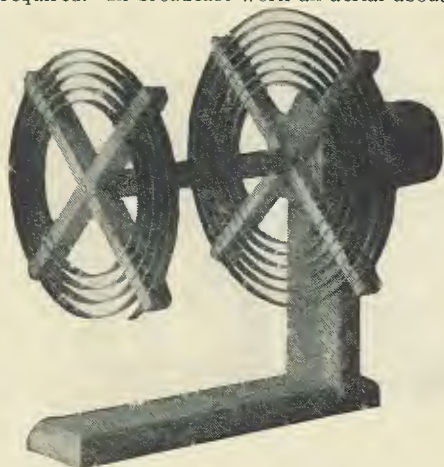

Fig. 3. An oscillating transformer, or antenna coupling inductance, designed for short-wave work. The coils are wound with heavy copper ribbon.

Photo courtesy Amateur Radio Specialty Co.



Conducted by Joseph Bernsley

THIS Department is conducted for the benefit of our Radio Experimenters. We shall be glad to answer here questions for the benefit of all, but we can publish only such matter as is of sufficient interest to all.

1. This Department cannot answer more than three questions for each correspondent. Please make these questions brief.
2. Only one side of the sheet should be written upon; all matter should be typewritten or else written in ink. No attention paid to penciled matter.
3. Sketches, diagrams, etc., must be on separate sheets. This Department does not answer questions by mail free of charge.
4. Our Editors will be glad to answer any letter, at the rate of 25c. for each question. If, however, questions entail considerable research work, intricate calculations, patent research, etc., a special charge will be made. Before we answer such questions, correspondents will be informed as to the price charge.

Mr. Bernsley answers radio questions from WRNY every Thursday at 8:15 P. M.

HENRY-LYFORD RECEIVER
(Q. 2203) Mr. T. J. Dolan, Connerville, Indiana, asks as follows:

Q. 1. I would like to obtain the schematic wiring diagram of the Henry-Lyford receiver, and whatever constructional information you can furnish as regards the various coil units employed in its construction. Please show the adaptation of a power tube in the last audio stage with its proper B and C voltages.

A. 1. The schematic wiring diagram of the Henry-Lyford receiver is shown in Fig. Q. 2203. The set comprises one neutralized tuned-R.F. stage, one untuned stage, and a tuned detector stage. Two stages of transformer-coupled A.F. amplification are used, the last stage employing a power tube, and the first stage a variable resistance for controlling the volume. The following are the items necessary for the construction of this receiver:

- 2 Variable condensers, .00035-mf.;
- 1 Fixed condenser, .001-mf.;
- 1 Fixed condenser, .002-mf.;
- 2 A.F. transformers, low ratio;
- 1 Midget balancing condenser, 55-mmf. maximum;
- 3 Automatic filament controls, 1/2-amp. each;
- 1 Filament-control jack, single-circuit;
- 1 Single jack, closed-circuit;
- 1 Radio frequency transformer, untuned type, (see below);
- 1 Variable resistance, 500,000-ohm;
- 5 Sockets (UX spring-cushion type preferred);
- 1 Panel, 7 x 20 inches;
- 1 Baseboard, 7 x 20 inches;
- 5 By-pass condensers, 1-mf. each;
- 10 Binding posts;
- 1 Filament switch.

Construction of the Coils

L₁ is somewhat similar to an ordinary three-circuit tuner, with the exception that the rotor is only semi-variable. Winding R is simply adjusted by hand until maximum efficiency and selectivity is obtained, and also when in the position that permits neutralizing oscillations by means of the small midget variable condenser (BC). The secondary winding, S, is 3 inches in diameter and consists of 60 turns of No. 22 D.C.C. wire, space wound. The wire is imbedded in a celluloid form, which is accomplished by means of acetone, a solvent for celluloid. The primary winding, P, is wound on a 2 3/4 x 1/2-inch celluloid form (also imbedded), and consists of 15 turns of No. 24 or 26 D.C.C. wire. R consists of 18 turns of No. 22 D.C.C. wire, on a 2 3/4-inch celluloid form. The construction and assembly of this entire unit is shown in Fig. Q. 2203-B.

Inductance L₂ is practically an ordinary T.R.F. transformer, of the low-loss type. The secondary winding, S, consists of 65 turns of No. 22 D.C.C. wire, space-wound on a 3-inch celluloid form. The primary winding, P, is wound on a 2 3/4-inch celluloid form, and consists of 15 turns of No. 24 or 26 D.C.C. wire, and is also space-wound. This complete construction and assembly is somewhat similar to that of L₁ except that the third or rotor winding is omitted. Note that these two coils have plug-in mountings, so that coils of other dimensions for various wavebands may be substituted. The untuned-radio-frequency transformer, R.F.T., should preferably be of the manufactured type, since it is somewhat difficult for the amateur to construct this type of instrument.

Adjustment and Operation

In the adjustment of the receiver, to obtain proper results, all that is necessary is to obtain a combination adjustment of the position of coil R in its relation to winding S and the balancing condenser, which is simply set at various positions until both .00035-mf. variable condensers can be rotated to any desired frequency, without obtaining the usual regeneration or oscillations heard with regenerative receivers. The three automatic-filament-controls are amply able to regulate the filament temperatures of the various tubes, which feature reduces the number of controls. The 1-mf. condensers are placed in various portions of the receiver, to by-pass any stray R.F. current that may exist in the battery and audio amplifier circuits. A filament-control jack is used in the last or final output stage; so that when using only

one stage of audio-frequency amplification, the filament of the fifth tube is automatically disconnected, thus preventing any unnecessary waste of filament current.

For this receiver there are two other sets of plug-in coils which have smaller dimensions, so

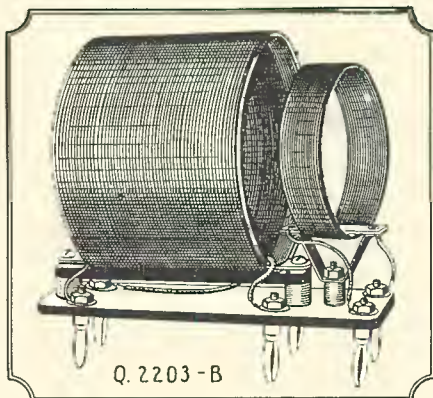

The appearance when completed of the coil L₁, which is used in the Henry-Lyford receiver. L₂ is very similar in construction, except that the third or semi-variable winding at right is omitted. Plug-in mountings are used so that coils of various inductances may be employed.

that with one a wavelength range of from 25 to 135 meters is covered, and with the other 75 to 225-meter reception may be obtained. The coils for which constructional data has been given above cover the entire broadcast range.

If an intermediate volume is desired between the outputs of the first and second stages, the resistance R₂ is increased until the desired volume is obtained. The dial readings for two variable tuning condensers correspond very closely; and the readings may be jotted down with the assurance that should the station be desired again, it will be obtained at their respective positions.

COUNTERPHASE POWER SIX RECEIVER

(Q. 2204) M. E. Thomas, Milwaukee, Wis., asks as follows:

Q. 1. Please furnish me with a description of the Counterphase Power Six-Tube Receiver, including those details which are necessary to obtain satisfactory reception with the receiver.

A. 1. The schematic wiring diagram for the Counterphase Power Six Receiver is shown in Fig. 2204. It incorporates three stages of tuned-radio-frequency amplification, a special neutralizing sys-

tem for overcoming oscillations in each R.F. stage, a detector and a two-stage transformer-coupled audio-frequency amplifier, in whose final stage a power tube is employed.

No constructional data for the special toroidal coils can be furnished as it is exceedingly difficult to construct a coil of this type without adequate facilities. Two tandem condensers with compensating verniers attached to each unit are employed for tuning. The following is the list of parts necessary for the construction of this receiver:

- 4 Torostyle transformers, 1 type TA, 3 type TC;
- 3 Non-inductive resistances, 1500-ohm;
- 2 Twin condensers, type LD-17;
- 1 Variable resistance, 500,000-ohm;
- 1 Fixed condenser, .001-mf.;
- 3 R.F. chokes;
- 3 Neutralizing condensers;
- 1 Grid condenser, .00025-mf.;
- 3 Fixed condensers, .006-mf.;
- 2 A.F. transformers;
- 2 Vernier dials;
- 2 By-pass condensers, 1.0-mf.;
- 1 Grid leak, 2-megohm;
- 6 Binding posts (or battery cable);
- 1 Double-circuit jack;
- 1 Single-circuit jack;
- 1 Filament switch;
- 1 Rheostat, 3-ohm;
- 2 "C" batteries, 4 1/2-volt;
- 6 Cushioned sockets;
- 1 Panel, 7 x 24 x 3 1/8 inches;
- 1 Baseboard, 9 3/4 x 23 1/2 x 1/2 inches.

Adjustment

After the receiver is completed, the following process of adjustment should be used. Adjust all neutralizing condensers so that the movable plate is halfway down. Tune in a station of moderate power on a low wavelength (200 to 300 meters) to exact resonance on both dials, using the small trimmer condensers to obtain fine adjustment. Adjust the 500,000-ohm volume control to give the greatest volume without oscillation or squealing in the loud speaker; which means to point where no whistling will be heard when the dials are rotated back and forth across the signal. Place a small piece of paper over the "F-1" contact spring of the third R.F. tube socket, so that the tube filament does not light. The signal will, no doubt, still be heard; and the neutralizing condenser should now be adjusted back and forth with a small screwdriver, until the signal becomes weaker, or disappears altogether. Now return the right-hand dial for the loudest signal, and again adjust the neutralizing condenser for minimum signal. If it can be tuned out entirely the correct adjustment of the condenser has been obtained.

Now remove the piece of paper from the filament spring and repeat the operation with the second R.F. tube. Retune both tuning dials before making the final adjustment of the neutralizing condenser, and make sure that the signals remain weak, or entirely disappear, over a band of one or more turns of the neutralizing condenser, before finishing the adjustment.

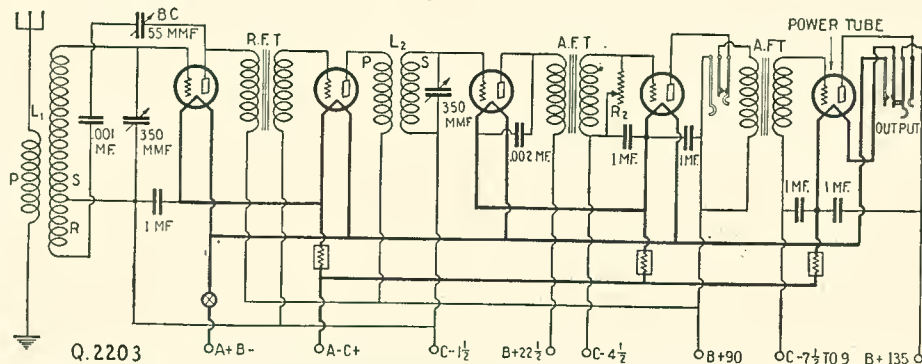

The circuit diagram employed in the wiring of the Henry-Lyford receiver. A stage of neutralized T.R.F. is used in conjunction with an untuned stage, detector, and two stages of A.F. amplification. A power tube is recommended in the last audio stage.

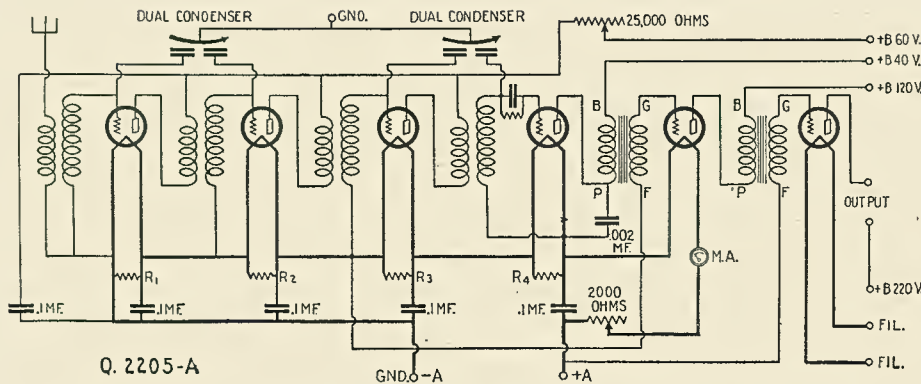

Hook-up of the Varion, which is designed for use with an "A, B & C" battery eliminator, such as that shown in Fig. 2205-B. The filaments of all tubes are wired in series to keep down their current consumption. Ballast resistances are placed across each tube. Only 199-type tubes may be employed in the first five stages of the receiver.

Replace the filament connection, and repeat the performance with the first R.F. tube; being very careful in adjusting the neutralizing condenser, as the band of silence in this stage is very small, and may be passed over. As soon as the position of reduced volume is heard, replace the tube, and note whether the amplifier can be made to oscillate when the 500,000-ohm resistance is entirely cut out of the circuit, with the tuning controls set around 350 meters. If the receiver has been carefully wired, it may be possible to secure slight oscillation at this wave length; but this is desirable for greatest sensitivity. If no oscillations occur, turn the volume control on full, and rotate the neutralizing condenser of the third R.F. tube by half turns until oscillations occur at 350 meters, and the position of greatest sensitivity is thus obtained.

THE VARION A.C. RECEIVER

Q. 2205) Mr. E. F. Palm, Flint, Mich., writes: Q. 1. Since your description of the Varion D.C. eliminator unit, there has appeared somewhere the description of a Varion A.C. receiver, which is a 6-tube affair and obtains all power from the light socket (A.C. source). Can you furnish me with any information and circuit diagram employed, battery eliminator system, etc.?

A. 1. The Varion A.C. Receiver has been described in the current RADIO LISTENERS' GUIDE & CALL BOOK, AND RADIO REVIEW by Bert E. Smith. However, the essentials, such as circuit diagram and list of parts needed, are herewith given. The circuit diagram for the receiver is shown in Fig. Q. 2205-A; that for the eliminator device in Fig. Q. 2205-B.

The following are excerpts from Mr. Smith's description in RADIO LISTENERS' GUIDE, which we believe will be helpful to the constructor: "A" battery elimination in the Varion is accomplished by means of a special circuit in the eliminator and receiver. The problem of "A" elimination depends entirely upon the quantity of current to be passed through the filter system. Referring to the diagram of the receiver, it will be seen that five 199 tubes are employed before the final or output tube. These five tubes require approximately sixty milliamperes of current each, at three volts, to operate the filaments. If these five tubes were placed in a circuit with their filaments in parallel, a total of three hundred milliamperes current would be required and this would be more than an efficient filter could easily handle. However, if we were to place these tubes in series, it would then be necessary to have only sixty milliamperes of current available, but the voltage

across the filament series terminals would have jumped to fifteen.

"Obviously, since we have up to two hundred and fifty or more volts at our disposal with the Varion, and there are eighty-five milliamperes of current, it is only necessary to find some way to apply some of this excess current and voltage to the tube filaments. Glancing at the eliminator diagram, we find a resistance has been placed in shunt

receiver to operate in that manner. In the first place, the plate current of the tubes, including that of the power tube in the Varion circuit, will be added to the filament supply; and this must be compensated for by raising the value of the shunt resistance, so that the total of the two currents does not exceed sixty milliamperes. We also have the factor of line-voltage fluctuation. This is easily taken care of by making all values in the eliminator proper for a minimum line-voltage, and then absorbing the excess current by means of an additional shunt resistance. The manner in which this is done is shown very clearly in the various receiver diagrams.

"The 'C' bias voltage on the power tube is supplied by the voltage drop across the 2,250-ohm resistance. We still have, though, the problem of bias voltages for the balance of the tubes in the receiver. As we have already placed the tube filaments in series, we may readily utilize the fact that there is a three-volt drop across the filament of each tube in the circuit. By properly positioning the various tubes we have the detector operating at a positive bias of one and one-half volts, the three radio-frequency tubes at a negative bias of three volts, and the first audio tube at a negative bias of nine volts. These values, in respect to the particular plate voltage under which each of these various tubes operates, are exactly those called for by the tube manufacturers.

Correcting the Filament Current

"There is one point about the receiver circuit which many of you have probably noticed. That is the presence of resistances placed across all of the tubes in the series connection except the first tube. These resistances are placed at these points to compensate for the addition of the plate current to the filament supply by each tube in the connec-

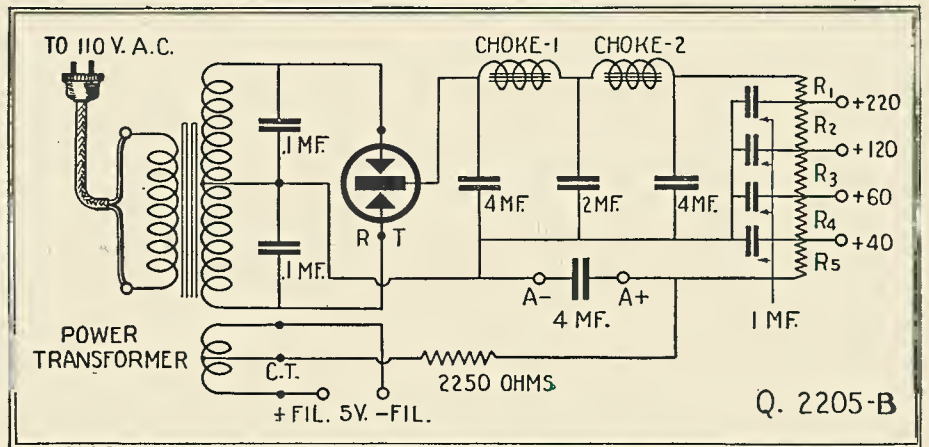

The schematic wiring diagram of an efficient "A, B & C" battery eliminator. This power unit may be used in conjunction with any type of receiver constructed along similar lines to those of the Varion A.C. set diagramed above. A rectifying tube with a current output of 80 milliamperes should be used.

across the total output of the unit. Current will flow through this resistance, varying in quantity with the resistance across the circuit. Now, if we break the "B" line and insert our filament series connection, we shall have, assuming that the value of the shunt resistance is correct, the right amount of current flowing through each tube; and in doing this we have lost but fifteen volts from the maximum of our plate voltage supply. This, in effect, is what is done in the Varion.

"There are a number of other points to take into consideration, however, before actually building a

tion. If this extra filament current were not taken care of in some manner, the last tube in the line would be getting approximately ten milliamperes more current than the first tube.

"Reference to the circuit diagram of the eliminator, as shown herewith, will disclose that it is very similar to the standard Raytheon circuit. There are several refinements, however, which have not been heretofore included in eliminators; for example, experienced constructors will appreciate the fact that successful design and operation of the

(Continued on page 1146)

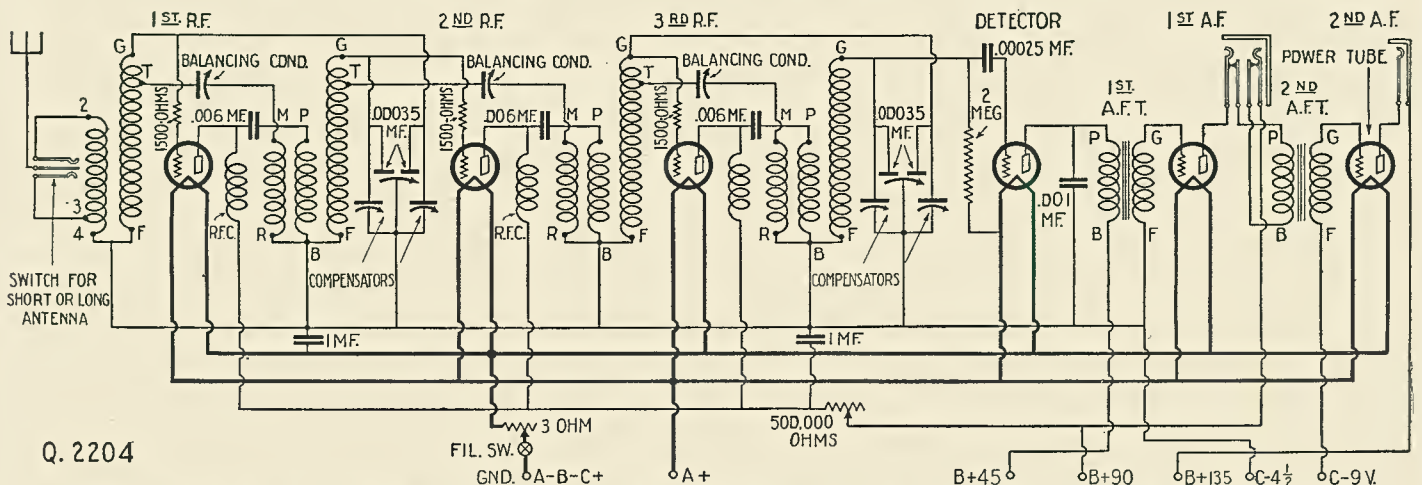

The efficiency of the counterphase six-tube receiver is considered by most radio experts to be unsurpassed. However, the above diagram incorporates several new features, due to recent developments which serve to enhance the sensitivity and quality factors. A power tube is employed in the last stage, the 112 type being almost invariably used. The 171 type can be used if the power tube plate voltage is increased to 180 volts, and 40 1/2 volts "C" battery is used.

SEEING
M O R E
THAN THE
MICROSCOPE

Electrons, which are very important in radio, are too small for any microscope to make visible. Yet our eyes can watch their paths—study their habits.

In the laboratories where Radiotrons are studied there are instruments which make all these things possible—and more. Knowing how many electrons leap across from the filament to the plate of a vacuum tube is in its way as abstruse a study as the measurement of distant stars by astronomers. Yet this abstruse research has a definite application in the RCA Radiotron in your radio set. That is why the laboratories back of RCA spend millions in scientific research that is far too much like "pure science" for an ordinary manufacturer.

Radiotrons are improved and new ones are developed, to make radio better. Because this research shows in *results*, Radiotron users keep five great factories busy!

Watch your tubes, always, for the RCA mark. You will find it on Radiotrons for every purpose.



clear up the tone

Do you get a blast when you turn the volume up a bit? Do you get sweet, clear tone at low volume, but noise when it's louder? The trouble's probably right in one tube—the tube in the last audio stage. The Radiotron laboratories discovered that no ordinary tube can let big volume through clearly. Change one tube to an RCA power Radiotron. *Then* turn up the volume . . . and it comes through *clear!*

Bring your storage battery set up-to-date with
a power RADIOTRON UX-171 or UX-112
a detector RADIOTRON UX-200-A
and RADIOTRONS UX-201-A for all-round quality.

Bring your dry battery set up-to-date with
a power RADIOTRON UX-120
and RADIOTRONS UX-199 for all-round quality.

RADIO CORPORATION OF AMERICA - NEW YORK - CHICAGO - SAN FRANCISCO

RCA Radiotron

MADE BY THE MAKERS OF THE RADIOLA

Build the R.F.C. Receiver

or any other set and reception will depend primarily on the integrity of the manufacturers who make the parts. That is why so many discriminating set-builders insist on genuine

RADION

The Supreme Insulation



You know that insulation is important, that tiny electrical impulses must be passed along through the circuit without possibility of leaks and losses.

RADION PANELS are made of a hard rubber compound especially developed for radio use. It is the most efficient panel insulation known. Electrical tests establish RADION as having the lowest angle phase difference, lowest dielectric constant, highest resistivity (megohms-cm), lowest power loss factor and lowest moisture absorption.

RADION PANELS are beautifully finished and produce an unmatched result in any cabinet. They are easy to cut, drill or engrave with simple home tools.

RADION PANELS*

are made in these stock sizes:

| | | | |
|--------|--------|--------|--------|
| 7 x 10 | 7 x 14 | 7 x 21 | 7 x 26 |
| 7 x 12 | 7 x 18 | 7 x 24 | 7 x 30 |

New Ace Quality
Hard Rubber Panel with
Crackle Surface*

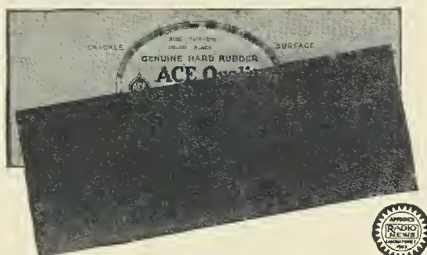

At popular prices. Ask your dealer. Made in the same sizes as RADION PANELS. Will not show small scratches or finger prints. If your dealer does not have RADION or ACE PANELS write us stating size you want. Do not accept substitutes. Write to

AMERICAN
HARD RUBBER COMPANY
11 Mercer St., New York, U. S. A.

Makers of RADION and ACE
PANELS, DIALS, SOCKETS, BRACKETS
TUBES, COIL FORMS

A Phasatrol Balanced T.R.F. Receiver

(Continued from page 1119)

terminal 12 with the P terminal of the balancing unit connected to the first R.F. transformer, which would have been normally connected to the tube plate. Then connect socket terminal 14 with the post P on the other balancing unit. Follow this by interconnecting the two "B+" terminals of the balancing units and connect this lead to the lead 18 on the fiber top of the catacomb case. Now ground the frame of the condenser and also one side of the pilot light, both on the catacomb case. Connect the other connection of the pilot switch to the common connection of the automatic-filament-control units. Connect the aerial and ground as shown and the set is wired. Now mount the socket-strip cover.

COILS AND TUBES

Before proceeding with the discussion of the operation, it might prove advantageous to give the specifications of the R.F. transformers and the aerial coil, all of which are alike. The primary consists of 16 turns of No. 24 D.S.C. wire on a 2¼-inch form. The secondary coil consists of 80 turns of the same size wire. The primary is wound adjacent to the secondary coil, with last and first turns touching.

The tubes recommended for the receiver are 201A types for the radio frequency, detector and first audio stages. The second audio can utilize to good advantage a 112, although a 201A will work satisfactorily. The output tube should preferably be a 171.

OPERATION

With the tubes in place, the first step is the balancing of the receiver. The receiver is set into operation, and the drum manipulated until a low-wave station is tuned in. The balancing units are then adjusted by turning the setscrew of the first phasatrol, slowly backwards in a counter-clockwise direction until the maximum signal strength without oscillation is obtained. The same procedure is followed with the other balancing unit.

Once the correct adjustment has been obtained further manipulation will not be necessary, when the receiver is being operated. The adjustment should be such that the tube is operated at maximum regeneration without oscillation. The receiver will be found selective, stable in operation, sensitive and affording perfect quality amplification and reproduction.

The volume output is adjusted by means of the volume-control unit, located on the panel. To enter into a lengthy discussion of what the receiver has done and will do in the line of distant reception, should be unnecessary. Let it suffice to say that the receiver in operation has proved satisfactory to both those fans who are continually clamoring for DX and to those fans who are entirely disinterested in DX reception, but demand perfect local reception with the required selectivity and faithful reproduction.

RADIO INTEREST AND THE LIGHTING BILL

THE New York Edison Company, said Arthur Williams, vice-president of the corporation, at an official hearing, attributes to radio \$1,000,000 of its annual business; both from battery chargers and power units, and from the increased consumption of lights by listeners who stay at home instead of going out or earlier to bed at night. Mr. Williams vindicated the policy of the company in advertising by broadcasting musical and other programs, in addition to the use of space in local newspapers and other publications.

Suggestions on Shielding

(Continued from page 1119)

tically no stray electromagnetic field. The use of toroids in tuned-radio-frequency amplifiers is never bad design.

SHIELDING DESIGN

Shielding must be complete, that is each radio-frequency stage should be in a metal compartment completely inclosing it on all sides. The toroid should be as far away from the walls of the container as possible. This is to prevent an abnormal increase in the distributed capacity and to prevent a shift of the wavelength band of the receiver to a higher level. It is a good idea to run all wires in a shielded cable with the exception of the grid wire, which should never be shielded. All battery leads, plate leads and grid return leads may and should be run in the same cable.

AUDIO-FREQUENCY CIRCUITS

The above few instructions are adequate for the radio-frequency end of the set. Shielding audio-frequency circuits, however, is a horse of another color. There is no necessity of using shields here, unless more than two stages of impedance- or transformer-coupled amplification are used. With modern low-ratio transformers there is not even any necessity of shielding as many as three or four stages. However, in large speech amplifiers, where many stages are used in order to build up the intensity to a point where it will feed power tubes, shielding is important. In this case it should be of soft iron, for here we are concerned only with the electromagnetic field. It should be as complete in this case as it was in the case of the electrostatic field.

The writer is well aware of the fact that the above simple instructions are wholly inadequate for an understanding of the reasons behind all this. The real significance of shielding is only obtained by a thorough knowledge of classical works on electricity and magnetism. The reader is referred to Starling's "Electricity and Magnetism", or Poynting and Thompson's "A Text Book of Physics", Vol. IV. A simpler treatment may be obtained from any elementary college text book on physics.

If the suggestions given in this article are kept in mind quieter, more selective, better receivers will result. In shielding, as in everything else, it is necessary to think before you act.

PRO BONO PUBLICO

Prayer and warning unite in this boldly displayed address to its readers on the front cover of the *South African Wireless Weekly* of Cape Town: "PLEASE don't oscillate. Don't forget to earth (ground) your aerial." Let us hope that Akrikanders and Uitlanders alike have taken the hint.

REPORTS INVITED ON 2RN

Editor, RADIO NEWS:

Some months ago you were kind enough to insert a notice in your columns requesting your readers to send me reports on reception of the Dublin broadcasting station, 2RN, and much useful information was obtained as a result of this notice.

As you know, the Dublin station now works on a wavelength of 319.1 meters; and I would be much obliged if you would insert a notice in your columns to the effect that reports on the 2RN transmissions using the new wavelength will be welcome at the following address.

JAMES KITCHEN,
Editor, *Irish Radio and Musical Review*,
179 Great Brunswick St., Dublin, Ireland.



Add the new Balkite Combination



U. S. PATENT, OCT. 12, 1926

to your radio set now
with your "A" battery it supplies
all radio power automatically from
the light socket

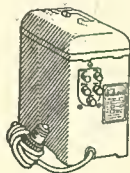

Three New Balkite "B"s

Balkite "B" eliminates "B" batteries and supplies "B" current from the light socket. Three models. Balkite "B"-W at \$27.50 for sets of 5 tubes or less requiring 67 to 90 volts. Balkite "B"-X (illustrated) for sets of 8 tubes or less; capacity 30 milliamperes at 135 volts—\$42. Balkite "B"-Y for any radio set; capacity 40 milliamperes at 150 volts—\$69. (In Canada: "B"-W \$39; "B"-X \$59.50; "B"-Y \$96.)



The New Balkite Trickle and High Rate Charger

Has a low trickle charge rate and a high rate for rapid charging. Can thus be used either as a trickle or as a high rate charger. Noiseless. Rates: with 6-volt battery, 2.5 and .5 amperes; with 4-volt battery, .8 and .2 ampere. Price \$19.50. (West of Rockies \$20. In Canada \$27.50.)



Balkite Trickle Charger, \$10

For those who require a charger of limited capacity only. Can be left on continuous charge thus automatically keeping the battery at full power. Over 300,000 in use. Rate .5 ampere. Price \$10. West of Rockies \$10.50. (In Canada \$15.)

All Balkite Units operate from 110-120 volt, 50-60 cycle AC, except the Balkite Charger which is also made in 25-40 cycle model.

Now you can operate your radio set from the light socket, merely by adding the new Balkite Combination Radio Power Unit. Once connected to your "A" battery and set and plugged into the light socket, it *supplies automatic power to both circuits.* You need not even turn it off and on for it is controlled by the filament switch already on your set. Whenever you turn on your set you will find Balkite Combination always ready to operate with full even silent power. It will give a constant quality of reception that cannot be secured in any other way.

Balkite Combination can be installed in a few minutes.

Like all Balkite Radio Power Units it has no tubes, nothing to replace or renew, and is a permanent piece of equipment that will serve you not only this year, but for years to come. It is noiseless in operation. It serves any set now using either 4 or 6-volt "A" batteries and requiring up to 30 milliamperes at 135 volts of "B" current—any set of 8 tubes or less, including power tubes.

Add Balkite Combination to your radio set and know the pleasure and convenience of owning a set always ready to operate at full power. Price \$59.50. [\$83 in Canada.] Ask your dealer. Fansteel Products Co., Inc., North Chicago, Ill.

WALTER DAMROSCH
and the
NEW YORK SYMPHONY
on the air

Every other Saturday night a symphony concert. On alternate Saturdays one of Mr. Damrosch's famous piano recitals. Over stations: WEAJ, WBEI, WGR, WFI, WCAE, WSAI, WTAM, WWJ, WGN, WCCO, KSD, WDAF, WOC, WCAP.

Balkite Hour
SATURDAY EVENINGS
9 P.M. Eastern (8 P.M. Central) Standard Time

FANSTEEL Balkite Radio Power Units



from Franklin to Faradon

Compare Franklin's crude Leyden Jar with the compact, efficient Faradon Capacitor of modern radio.

The Wireless Specialty Apparatus Company, established in 1907, manufacturers of Faradon, specializes in electrostatic condensers for all purposes.



Model T
All Metal Mica
Condenser
(Showing Type 1
Terminals)

For dependability
insist upon Faradon equipment for your radio set and battery eliminator.

Approved for the RFC Receiver; Ultra 5; and Phasatrol Balanced TRF Set.

WIRELESS SPECIALTY APPARATUS COMPANY

Jamaica Plain, U. S. A.
Boston, Mass.



Model WS By-Pass Unit Made in 1/2 MFD, 1 MFD and 2 MFD Units



PRICE \$10.50

Model WS-3750 "Universal" Filter Capacitor Block. Other models in blocks or individual units with any desired capacities and voltage ratings.

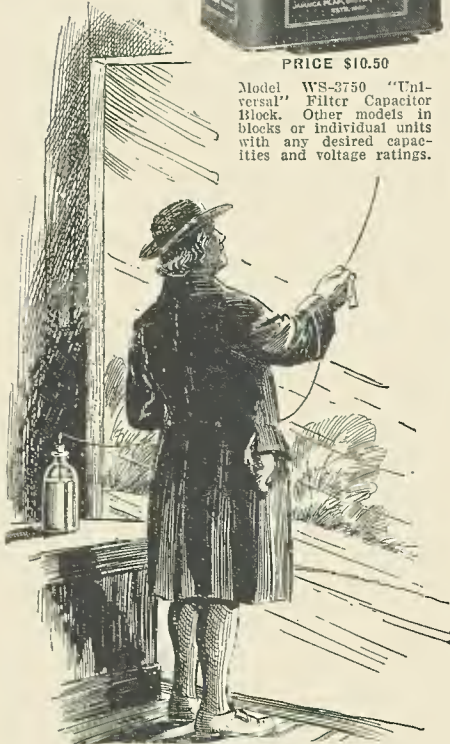

Faradon By-Pass and Filter Capacitors

Correspondence from Readers

(Continued from page 1132)

handle radio—the attitude of the salesman, and their refusal to use their brains and try to grasp something new.

Another thing, and that is the disinclination, almost refusal, of a store to say that a set will do anything definite. You have advised readers to try out a number of loud speakers, suggesting that they have them tried out in their homes. Well, on approaching a department store here on this subject, they say emphatically they will not send out a speaker on approval. Of course, they qualify by stating that it may be applied as credit on another one, but the inference is made that they are not in the business of giving you any choice in the matter. You hear them at the store and buy them, when any sensible man knows that a store room, with vibrant strings all around you, and everything imaginable to build up the sound, is not typical of the average man's house and living room. Of course, some of the dealers in radio have the speakers on a shelf, with a switch whereby you can listen to one after the other in turn.

Another thing, the leading department stores have been selling well-advertised sets, at cut prices, and have placed them in all parts of this city, but yet it is impossible to get a definite statement out of them as to what a set will do. I would think it would be good business to put out several sets in various parts of town, on average antennas, and then be able to make statements based on the experiences therefrom. There is too much of this "you pays your money and takes your choice (or rather your medicine)." The radio dealers should take a leaf from the auto business, and remember that in 1920 and 1921, a man paid down his deposit for a car, and then was told that as soon as they got a shipment, which would probably be four or five weeks, maybe longer, he would get his car. Now,—good night!—it is as much as your peace of mind is worth to let it be known that you are thinking of buying a car.

Just the other day I learned of the sale of a set, where the local music store agreed to service it for two years. Now, this is getting down to brass tacks, and it seems to me, as you state in your editorial, that this is the policy that must be followed by all stores selling radios. You can't sell a radio like a wheelbarrow or a rake or a dish. It must be sold with the understanding that it is a piece of mechanism that must be treated right to get certain results.

However, I think the set makers are simplifying them too much. They are overdoing the control idea, and getting them to the point where, with one dial, and amperites, etc., the controls are reduced to practically nil; and, in addition, the possibility of making a slight minor adjustment that might make the difference between a good working set and a poor one, has been removed from the power of the purchaser. That is, this one-control idea and the example of putting the coils, and all other connections under the metal chassis, where the owner can't get at them (as Crosley has done in his late sets), is making it imperative for the dealer and manufacturer to service them.

STEWART F. LAMB,
Portland, Oregon.

A RADIO CORRESPONDENCE LEAGUE

Editor, RADIO NEWS:

I am a high school graduate, eighteen years of age, and interested in radio. No

greater pleasure is mine than to tinker away with some piece of so-called "radio junk" in the hope of obtaining something new. One time I obtained a mercury detector, another time a new kind of crystal detector. Many times I have been awake all through the night working on some new appliance. On one of these "stay-awake trips" I found a way to use a lead coil and tungsten filament for a trickle charger. Who knows but these innocent experiments might some day prove a treasure trove?

I would like fellows of my age, living in the United States or foreign countries, to correspond with me at intervals, with relation to radio and scientific developments in their localities, and I will do the same. Thus we can form a world-wide correspondence league, the only cost of which would be the postage.

HYMAN BUSHLOWITZ,
1632 So. Fifth St., Philadelphia, Pa.

(A great proportion of the young radio enthusiasts of this type are already "Homs" and using the much swifter means of short-wave radio to carry on their international discussions; but it may be there are many who would like to use their pens and typewriters to strike up interesting radio acquaintances of the type suggested. Those who do may well address Mr. Bushlowitz direct.—EDITOR.)

INTERFERENCE BY THE AURORA

Editor, RADIO NEWS:

As a confirmed radio fan, I have never noticed the effect of the aurora on radio reception; but as wire chief in the telegraph department of the Santa Fe Railway Co., Chicago, I have, on several occasions, noted the interruptions caused by these "earth currents," as we term them.

This is especially noticeable on our duplex and quadruplex circuits, where a rather fine electrical, capacity and magnetic balance is required for satisfactory operation.

The induced current of the aurora seems to be the result of a difference in potential between distant points of surface of the earth, which we tap for a return conductor in most of our systems of Morse telegraphy.

This potential difference in the earth seeks to equalize itself through the medium of the various wires connected thereto, and in doing so destroys our balance to a point where duplex operation is practically impossible.

In some cases single wires are so affected by this slow alternation that it is quite difficult to maintain a working adjustment of even the simple equipment involved. This is especially true of the longer wires.

On our duplex circuits this interruption first favors the signal, then opposes it. If any effort is made to adjust therefore, you find that you have more trouble for your pains; owing to the fact that when the reversal takes place, some minutes later, you are in a worse condition than if you had left your balance alone.

As evidence that this is strictly an "earth current" I point out that metallic circuits, (wires with no ground connection) usually work through it without difficulty.

In ordinary Morse telegraphy we use voltages of from 160 to 320 volts, at about 50 to 100 milliamperes. This gives us an idea of the probable voltage difference induced by the aurora, inasmuch as it frequently is strong enough to neutralize such power. However, a mathematical calculation of the power of the original source of the phenomenon is a bit more than I care to attempt.

I may add that the "Northern Lights" interference is easily distinguished from other earth disturbances, because of its slow alternations and the presence of both voltage and current in easily measurable volume.

L. C. WEBB,
1100 Railway Exchange, Chicago, Ill.



"The new Quadraformer VI is the best set we have ever built, ever handled, or ever seen. It separates stations on 1/2 meter! We have built sets for the last four years but never heard its equal" —

*Swenson Bros., radio dealers of Headville, Kansas

THE MORNING AFTER each great battle with the ether, Mr. Quadraformer Radio Fan is as jubilant as a two year old. He'll "tell the world" how those elusive stations came pounding in like a ton of brick.

And, strange as it may seem, he makes good on every boast.

His skeptical friends drop in on him unexpectedly of an evening, and stay to marvel at the tonal richness and clarity of each re-creation, as he goes from station to station as easily as turning the pages of a book.

For he owns a Quadraformer.

Don't you want radio results like that? Install the new shielded Quadraformers in *any* tuned radio frequency receiver—it's just a few minutes' interesting work—and you, too, will get results you never before thought possible.

Remember, we *guarantee* that you'll be just as pleased as Mr. Swenson is or you get your money back. That's fair, isn't it? Then take me up on my offer in the little coupon in the corner.

THE ESSENTIAL KIT

Contains everything necessary to change over any existing two stage tuned radio frequency receiver using .00037 mfd. or .0005 mfd. variable condensers to a Quadraformer, or with the kit and a few other standard parts easily purchased anywhere you can build the remarkable QUADRAFORMER VI exactly as described in the February RADIO NEWS.

The Essential Kit contains the three new shielded double-range QUADRAFORMERS, a specially designed SELECTIVITY CONTROL that enables you to cut thru the locals in the most congested districts, and the AMPLITROL—the latest invention of Gearhart-Schlueter—which makes the receiving set equally efficient on all wavelengths.

There is also included a very complete, step-by-step instruction book, containing many illustrations and full page drawings, fully covering the assembly, wiring, testing, operation and trouble-shooting of Quadraformer sets.

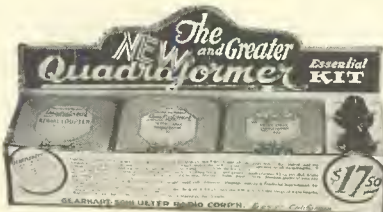

GEARHART-SCHLUETER RADIO CORP'N
1719-21 VanNess Ave., Fresno, California

Oakland, Calif.
I have installed your new Essential Kit in my old five tube set and I am more than pleased with the wonderful improvement.
I am getting many stations that I could not get before. The selectivity is all that one could ask for, critical to a degree. The tone quality, and quietness of operation perfect.
Many thanks, and every success to you, which you most surely deserve for one of the greatest sets so far put on the market. I'm a "Quad" booster at all times.
GEO. H. AMES.

Waterloo, Ontario.
I was never so surprised in my life! When I had the new Quad VI all connected up I set the dials and turned the switch—and I had Florida right off the bat! And just a few minutes before I had listened to another six tube set and it was so noisy I had decided that it was not much of a night; and then the Quadraformer brought them in clear and noiseless.
Your Quadraformer VI is the best receiver I have built yet for both tone, quality, and quietness of operation.
WM. BORNE.

Sausalito, Calif.
My but I was surprised! The tone is wonderful. I have built all kinds of sets, but the new Quad VI is the best, and I have at last the set I have wanted.
FRED LUHMAN.

Inside Facts on the New Quadraformer Coils

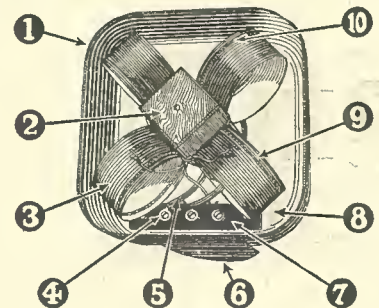

1. A scientifically designed shield against impact reception and electrostatic coupling. Heavy drawn copper, handsomely finished in natural copper lacquer, trimmed in gold.
2. The Quadraformer coil sections are self-supporting, being mounted on a single central insulating block. This gives the lowest possible dielectric losses and the least insulating material in the field. It is the elimination of just such losses in the new Quadraformer coils that keep the high frequency resistance at a minimum, securing increased selectivity, volume and natural tone quality.
3. This shows one of the four windings making up the complete secondary. Special triple insulated heavy copper (No. 28) magnet wire is now used in both primaries and secondaries. The extra heavy insulation separates the turns more than is usual and reduces the inter-turn capacity greatly. The resulting complete transformer has the highest inductance combined with the lowest distributed capacity of any closed magnetic field coil.
4. All connections between the windings and the terminal binding posts are first securely fastened mechanically and then firmly soldered, using rosin flux, for permanency.
5. All primary leads, which carry the B battery voltage, are protected by genuine Italian flame-proof varnished insulating tubing—the highest grade "spaghetti" that can be bought.
6. The mounting bracket is of sturdy construction and holds the completed transformer firmly in place on baseboard or sub-panel.
7. The binding post terminal strips are genuine Celoron.
8. An accurate laboratory determined air-space separates the Quadraformer windings at all points from the shield. All interstage Transformers are accurately matched on a master oscillator and packed in matched pairs for most efficient operation with dual condensers.
9. The primaries are now wound with the same heavy wire used in the secondaries. The primary windings will stand a load of 3 amperes without heating, and are **POSITIVELY GUARANTEED NOT TO BURN OUT.**
10. A heavy insulating string separates each primary winding from its associated secondary winding, eliminating the bad effects (broad tuning, for one) of the capacity coupling between primary and secondary present in most transformers. It is also a further guaranty against burn-outs.

Order From Your Dealer or Direct FROM US

Quadraformer parts are carried in stock by reliable dealers in most cities. If your dealer happens to be out of stock you may order direct from us by using the coupon to the right. Send no money. Just pay the postman the price of the parts plus a few cents postage.

GEARHART-SCHLUETER RADIO CORP'N
1719-21 Van Ness Ave., Fresno, California.

Please send me the new Quadraformer Essential Kit, containing the three shielded Quadraformers; the Selectivity Control; the Amplitrol; and complete Instruction Book, for which I will deposit with the postman \$17.50, plus postage, upon delivery. It is understood that if I am not MORE than pleased with this purchase that I have the privilege of returning this kit in salable condition within 30 days and you will refund my money.

NAME.....
ADDRESS.....
CITY..... STATE.....
(Send cash with order and we will ship prepaid)

The Quadraformer "6" Receiver

AC ACCURACY



The Difference between the Outer edge of a station and the absolute center

New

Straight Line Frequency

REMLER

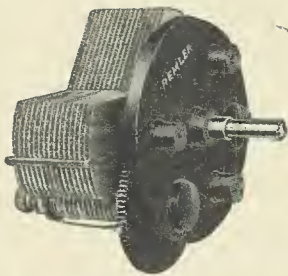

Twin-Rotor Condenser

Why discard your present receiver when all it actually needs is a set of these new condensers? Then you will have a wide separation of stations over the entire broadcast range, due to the 360° dial movement.

All the tried and proven Remler features are incorporated in this new Straight Line Frequency type.

A special adjustment permits variation of the condenser capacity at zero dial setting. In consequence the condenser can be adapted to the particular coil used. Body capacity is completely eliminated and electrical losses are reduced to a minimum.

Straight Line Frequency:

- No. 648—.00035 max. less dial ... \$4.50
- No. 649—.0005 max. less dial ... 4.50
- No. 659—.0001 max. less dial ... 4.50

Straight Line Wave-Length:

- No. 630—.00035, with dial \$5.00
- No. 638—.00035, less dial 4.50
- No. 631—.0005, with dial 5.00
- No. 639—.0005, less dial 4.50
- Dial complete75

Write for two color descriptive circular.

REMLER

Division of
Gray & Danielson Mfg. Company
260 FIRST STREET
Chicago • SAN FRANCISCO • New York

The Samson R. F. C. Receiver

(Continued from page 1114)

ISOLATING THE BATTERIES

A study of the circuit diagram and the illustrations will show that there are two extra radio-frequency chokes. These have a very important function. One is connected in series with the common grid-return lead from the two choke-coil R.F. amplifiers, and the other in the common plate lead from the same tubes. In this position the extra chokes prevent any of the radio-frequency currents from passing into the "B" and "C" battery circuits and affecting the operation of the other tubes. The R.F. currents in each case are by-passed direct to the common "A—" connection through the two large fixed by-pass condensers, C6. Practically all intercoupling of tubes through the common "B" and "C" batteries employed is eliminated in this way.

One excellent feature of the A.F. amplifier is that it requires no "toning." This is due principally to the fact that dual-impedance amplification is employed for the last two stages. A dual-impedance amplifier should not be confused with the regular type of impedance-coupled amplifier. The latter can be easily overloaded and, unless precautions are taken, distortion will result. The dual-impedance amplifier, on the other hand, is very hard to overload and will give excellent reproduction even in cases when the volume of sound is excessive; or, putting it another way, when the input energy to the amplifier is high. Notwithstanding this, a volume control (R4) is incorporated in the set; but its purpose is to control volume only and not to "tone" the amplifier.

With the numerous precautions taken in the design of this receiver to prevent coupling through the common "B" and "C" batteries, and to eliminate chance of the radio-frequency circuits oscillating, and with the provision of variable coupling both for regeneration and between the primary and secondary coils of the output R.F. transformer, it has been found perfectly practical to employ automatic filament controls on all tubes. The use of these ballasts is an insurance that the voltage at the filament terminals will never exceed 5 volts, the correct operating potential.

CONSTRUCTION OF RECEIVER

Though the R.F.C. is a large set, it is not as difficult to build as one might suspect upon first examination. No mechanical "tricks" have to be resorted to in assembling. After the panel and the sub-base have been drilled in accordance with the layouts accompanying this article, the apparatus can be mounted. First mount the R.F. transformers, the variable condensers, the filament switch and the volume control on the panel. The two supporting brackets should also be fastened to the panel at this time. Proceed by mounting the rest of the apparatus, as listed in the specification sheet, on the sub-base. It will be noted that, with the exception of one small fixed condenser, all of the apparatus is mounted on the upper side of the sub-base.

The next step is the wiring of the apparatus on the sub-base. Take plenty of time to do it and follow carefully the accompanying wiring layouts. Naturally, there is a maze of wires on the under side of the sub-base, but the actual wiring up of the parts is not at all difficult. You will note that each hole through which a wire passes carries a number. All the numbers are duplicated on the under-side of the sub-base. Thus, it is a very simple thing to carry each wire along to its final terminal. As each

| SYMBOL | Quantity | NAME OF PART | VALUE OF PART | REMARKS | MANUFACTURER * |
|--------|----------|------------------|---------------|------------------------|----------------------|
| L | 1 | Fixed Coupler | | | 1 |
| L1 | 1 | R. F. Trans. | | Var. Primary & Tickler | 1 |
| L2 | 6 | R.F. Chokes | 250 H.H. | For Impedance R. F. | 1 |
| C, C1 | 2 | Var. Cond. | .0005 mf. | | 1 2,7,11,13,14,18,30 |
| C2 | 1 | Var. Cond. | 4 to 25mf. | Neutralizing | 2 18,29 |
| C3 | 1 | Fixed Cond. | .001 mf. | Bypass | 3 4,20,21,22,34,40 |
| C4 | 2 | Fixed Cond. | .0025 mf. | Blocking Condensers | 4 20,21,22,34,40 |
| C5 | 1 | Fixed Cond. | .0005 mf. | With Grid Leak Clips | 4 20,21,22,34,40 |
| C6 | 2 | Fixed Cond. | 1 mf. | Bypass | 5 3,4,20,21,22,33,34 |
| R | 3 | Auto.Fil.Control | 5v. 1/2 Amp. | | 6 24,25,26 |
| R1 | 1 | Auto.Fil.Control | 5v. 1/2 Amp. | For Semi-power tube | 6 24,25,26 |
| R2 | 1 | Auto.Fil.Control | 5v. 1/2 Amp. | For Grouped R.F. tubes | 6 24,25,26 |
| R3 | 1 | Grid Leak | 4 meg. | | 5 3,20,21,22,23,24 |
| R4 | 1 | Var. Resistance | 500,000ohm | Volume Control | 3 22,27,41 |
| T | 1 | A. F. Trans. | 2 to 1 | | 1 2,30 |
| T1,T2 | 2 | Dual Impedances | | | 1 11,14,17,30 |
| Sw | 1 | Fil. Switch | | | 8 16,20,22,28 |
| | 2 | Brackete | | | 1 |
| | 13 | Binding Posts | | | 9 29,30,31 |
| | 1 | Panel | | 24" X 7" X 3/16" | 10 12,31,32 |
| | 1 | Sub-base | | 23" X 10" X 3/16" | 10 12,31,32 |
| | 2 | Dials | | Vernier | 1 2,9,14,15,35 |
| | 6 | Vacuum Tubes | 5v. 1/2 Amp. | | 36 37,38,39 |
| | 1 | Vacuum Tube | 5v. 1/2 Amp. | (Semi-Power) | 26 37,38,39 |
| | 7 | Sockete | | UX Type | 7 2,9,11,13,30 |

NUMBERS IN LAST COLUMN REFER TO CODE NUMBERS BELOW.

| | | |
|--------------------------------------|---------------------------------------|--|
| 1 Samson Elec. Co. | 17 Ford Radio & Mica Co. | 33 Precision Coil Co. |
| 2 Bremer-Tully Mfg. Co. | 18 Hammarlund Mfg. Co. | 34 Dubilier Radio & Cond. Co. |
| 3 Elcstrad, Inc. | 19 Bodine Elec. Mfg. Co. | 35 National Co. Inc. |
| 4 Sangamo Elec. Co. | 20 Polymet Mfg. Corp. | 36 Perryman Elec. Co. |
| 5 Tobe-Deutschmann Co. | 21 Aerovox Wireless Corp. | 37 C. E. Mfg. Co. (Ceco) |
| 6 L. S. Braoh Mfg. Co. | 22 Leslie F. Muter Co. | 38 Magnavox Co. |
| 7 Benjamin Elec. Mfg. Co. | 23 A. H. Lynch, Inc. | 39 Van Horne Co. |
| 8 Carter Radio Co. | 24 Int. Resis. Co. (Durham) | 40 Wireless Spec. Appar. Co. (Paradon) |
| 9 H. H. Eby Mfg. Co. | 25 Langbein-Kaufmann (Silkay) | 41 Amer. Mech. Labs. (Clarostat) |
| 10 Formica Ins. Co. | 26 Daven Radio Corp. | |
| 11 Alden Mfg. Co. | 27 Central Radio Labs. | |
| 12 Diamond State Fibre Co. (Celoron) | 28 Taxley Mfg. Co. | |
| 13 Silver-Marshall, Inc. | 29 X-L Radio Labs. | |
| 14 All-American Radio Corp. | 30 General Radio Co. | |
| 15 Martin-Copeland Co. | 31 Insulating Co. of Amer. (Insuline) | |
| 16 H. H. Frost, Inc. | 32 Amer. H. Rubber Co. (Redion) | |

If you use alternate parts instead of those listed in the first column of manufacturers, be careful to allow for any possible difference in size from those originally used in laying out end drilling the panel and sub-base.

FOR COPYRIGHT 1927 EX. PUB. CO.

* THE FIGURES IN THE FIRST COLUMN OF MANUFACTURERS INDICATE THE MAKERS OF THE PARTS USED IN THE ORIGINAL EQUIPMENT DESCRIBED HERE.

NEW!

Eveready Layerbilt "B" Battery No. 486, the Heavy-Duty battery that should be specified for all loud-speaker sets.

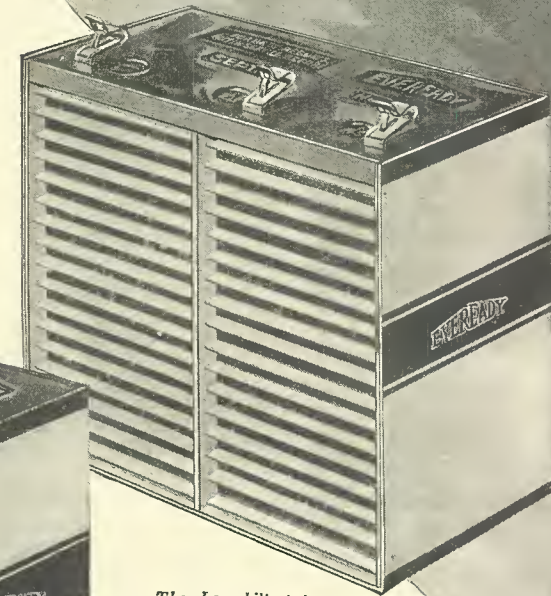

The Layerbilt patented construction revealed. Each layer is an electrical cell, making automatic contact with its neighbors, and filling all available space inside the battery case.

DIFFERENT!

For greatest economy all loud speaker sets require the new Eveready Layerbilt "B" Batteries

IT WILL pay you, in convenience and reliability as well as in dollars and cents saved, to use this remarkable battery.

The reason for the Eveready Layerbilt's surprising performance lies in its exclusive, patented construction. No other battery is like it. It is built in flat layers of current-producing elements, making practically a solid block. The layers make connection with each other automatically, and occupy all available space inside the battery case. Layer-building packs more active materials in a given area, and makes those materials produce more electricity.

Every loud-speaker set should use Heavy-Duty batteries, for they alone offer economy on modern receivers. When you buy new "B" batteries, be sure to get the Heavy-Duty size, and remember that the Eveready Layerbilt has proved to be the longest lasting, most economical of all Heavy-Duty batteries.

Our laboratories are continually testing batteries, and in all our tests we have yet to find a battery that is equal to the new improved and radically different Eveready Layerbilt "B" Battery No. 486. The development and perfecting of this remarkable

battery is an outstanding battery-building achievement. It is the result of many years' experience plus the facilities and resources of the pioneer manufacturers of all dry cell batteries.

NATIONAL CARBON CO., Inc.
New York San Francisco
Unit of Union Carbide and Carbon Corporation

Tuesday night is Eveready Hour Night
—9 P. M., Eastern Standard Time, through the following stations:

- | | |
|------------------|--------------------|
| WEAF—New York | WTAM—Cleveland |
| WJAR—Providence | WWJ—Detroit |
| WEEI—Boston | WGN—Chicago |
| WTAG—Worcester | WOC—Davenport |
| WFI—Philadelphia | WCCO { Minneapolis |
| WGR—Buffalo | { St. Paul |
| WCAE—Pittsburgh | KSD—St. Louis |
| WSAI—Cincinnati | WRC—Washington |
| | WGY—Schenectady |

"B" Power that exactly suits your set

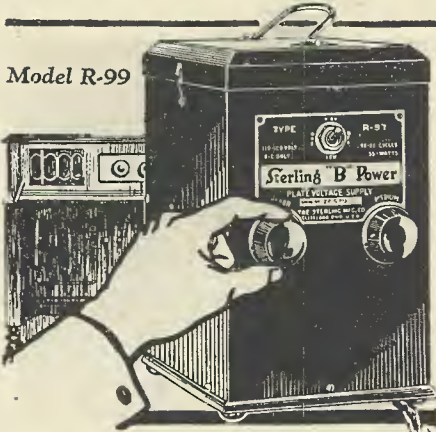

Model R-99

Sterling "B" Eliminators in 3 models— Suit any Set

FOR multi-tube sets using F power tubes, the Sterling R-97 Raytheon Tube type gives 180 volts at 50 mils. and 40 volts "C" Power—all voltages being adjustable. Price . . . \$55.00 The Sterling R-99 has all the advantages of the R-97 but is without "C" voltage terminals. Price . . . \$45.00

For sets of not more than 5 large tubes the Sterling RT-41 is the season's outstanding value—gives 130 volts at 20 mils. has adjustable voltages, four terminals, is no larger than one dry battery and sells complete at the remarkably low price of \$28.00

Sterling Features that Insure the Greatest Satisfaction

Quality of parts are the finest that money can buy. No stinted manufacturing operations, no rushed inspection—built carefully and guaranteed right. And most important—proof of performance and stability by thousands of owners.

Choose a

Sterling

"B" ELIMINATOR for your radio

Send for the Sterling booklet "M" showing complete line of radio equipment and useful data on radio care.
THE STERLING MFG. CO.
2831 Prospect Ave. • Cleveland, Ohio

wire is connected in, it should be marked with colored crayon on the wiring layout. This method saves much confusion.

After all of the apparatus on the sub-base has been completely wired, the sub-base and panel should be fastened together by means of the two supporting brackets. The wiring job can then be completed.

OPERATION

The R.F.C. receiver is comparatively simple in operation, as there are only two main tuning controls. There are a number of points which should be kept in mind, however. The first is that the detector tube can be made to oscillate very easily if the coupling of the tickler coil (which is controlled by the top center knob) is advanced too far. It is best to keep the coupling loose at all times, except when DX stations are being received. A bit of experiment will determine the best position for the tickler coil for normal reception.

Second, the selectivity of the set can be increased or decreased at will by varying the coupling between the primary and secondary coils of the output R.F. transformer L1. This is accomplished by turning the lower center knob. It is advisable to employ loose coupling in congested districts, particularly so if you are after DX reception. The best positions for this knob can be determined by trial only. It is of considerable advantage to have such an arrangement, whereby the selectivity can be altered to suit local requirements.

Third, the set must be properly neutralized, by adjusting the condenser C2, before it will operate at maximum efficiency. This is a simple task. Merely adjust the condenser C2 so that both dials can be turned from zero to maximum without the set going into oscillation. The most satisfactory way to accomplish this is to work backwards; that is, adjust condenser C2 so that the set oscillates and heterodyne whistles can be picked up. Then increase its capacity, step by step, until the set is at a point just below oscillation at all broadcast wavelengths. Before making this adjustment be sure that the detector tube is not oscillating because of advanced tickler coupling.

I Want to Know

(Continued from page 1138)

receiver is largely dependent upon the quality and design of the apparatus used throughout. In selecting parts for the Varion receiver, apparatus of the highest grade was used and in several cases where present apparatus was not satisfactory, special instruments have been designed and manufactured especially for the Varion.

The plate voltages supplied are sixty-seven for the radio frequency tubes, forty-five for the detector, and one hundred and thirty-five to one hundred and eighty for the power amplifier. Independent of the type of power tube used the 2250-ohm resistance in series with the centre tap of the filament winding will give it a correct negative bias. The "C" bias voltage is obtained by the drop across this resistance. The heavier the current drawn through this resistance, the greater the voltage drop will be and, corresponding to the heavier current drawn by the UX-171, the grid bias will increase correspondingly over its value when a 112 is used.

The parts necessary for the construction of the receiver and eliminator are as follows:

Parts For Receiver

- 2 Double condensers (.0003-mf. each unit);
- 1 Panel (radion or bakelite), 17x3/16x28 inches;
- 1 Sub-panel (radion or bakelite) 7x3/16x26 in.;
- 6 Sockets;
- 2 Illuminated controls;
- 1 Variable resistance, 2,000-ohm;
- 1 Variable resistance, 25,000-ohm;
- 1 Milliammeter, 2 inch, 0-100 milliamperes;
- 3 Brackets;
- 3 Aluminum shields;
- 4 T.R.F. coils;
- 3 Binding posts;
- 1 Condenser, .001-mf.;
- 1 Condenser, .00025-mf.;
- 5 Condensers, 0.1-mf.;
- 1 R.F. choke;
- 1 First-stage transformer;
- 1 Second-stage transformer;
- 4 Filament resistors;

Thousands Use These Ingenious TRANSMITTER UNITS



Here's a marvel of Engineering design—a practical miniature transmitter, used by thousands of radio fans and experimenters for amplification purposes. It is a most novel unit, having hundreds of uses. Every amateur should have two or three of these amplifiers in his laboratory.

A FEW USES FOR THESE UNITS

| | |
|--|--|
| | |
| | |
| | |
| | |
| | |

With each unit is mailed an eight-page instruction pamphlet containing suggestions for innumerable uses. Our supply is limited; avoid disappointment by ordering today. The coupon below is for your special convenience.

SPECIALLY PRICED
While they last— **95c**
(or Two for \$1.75) per unit

THE PRESS GUILD,
66-R West Broadway, New York, N. Y.
Enclosed find 95c/\$1.75 for which send me postpaid one/two amplifier units as advertised.
Name
Address
City, State

The MERSHON Condensers

smooth out tone through B eliminators as a plane smooths the rough surface of a board

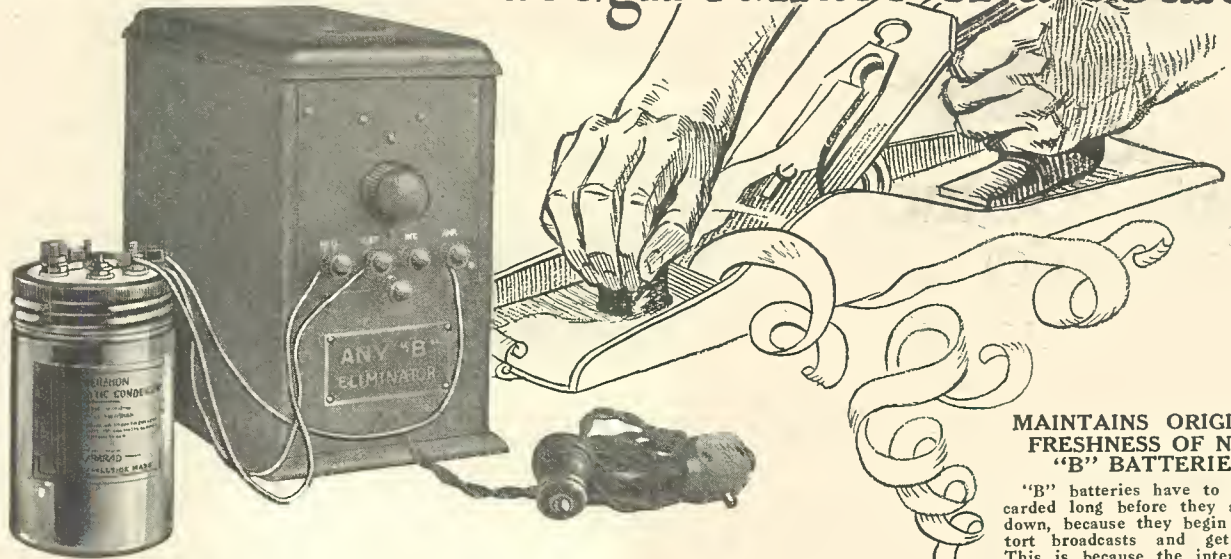

MAINTAINS ORIGINAL FRESHNESS OF NEW "B" BATTERIES

"B" batteries have to be discarded long before they are run down, because they begin to distort broadcasts and get noisy. This is because the internal resistance of the batteries increases as they age. Connecting a Mershon across your "B" batteries (with a disconnecting switch) overcomes this high internal resistance and so greatly prolongs the useful life of dry cell batteries. The Mershon itself does not wear out or run down. It may be used continuously with endless sets of "B" batteries.

Makes old "B" eliminators ever fresh like brand NEW "B" batteries

Connecting a Mershon condenser to your "B" eliminator vastly improves the tone quality from your receiving set. The famous Mershon's action is two-fold. First, it assists in more perfect filtering (straining) of the uneven current supplied by the Lamp Socket. Second, it acts as a reservoir to store a large amount of energy which is fed to the Receiver in a continuous smooth flow as called for by incoming broadcasts. This action may be considered the same as the results of using a plane for a rough board. Most "B" eliminators use a good filter, which can be noted by the lack of any A. C. hum. But for perfect results and tone quality comparable to that which is obtained from the use of the new "B" batteries, it is essential that a sufficient amount of energy be stored directly back of the receiving set. This energy must be on tap to instantaneously supply current for loud or long sustained musical notes. The famous Mershon enables this storage of energy to be accomplished electrically rather than chemically. The result is a great improvement in tone quality. It is particularly noticeable on low notes which require a large amount of current for proper reproduction.

To connect a Mershon is as simple as connecting a battery to your Receiver. Three lead wires are provided attached to the Mershon, the positives being colored red and the negative black.

CAUTION: Of course it must be realized that a Mershon added to a "B" eliminator will not improve tone quality; or the use of any other tone improvement device; if the design of a receiving set or loud speaker is such that the tubes or loud speaker are overloaded.

There are many other uses for Mershon condensers. Write Dept. 1C7 for descriptive folder.

AMRAD CORPORATION
Medford Hillside, Mass. Harold J. Power, Pres.

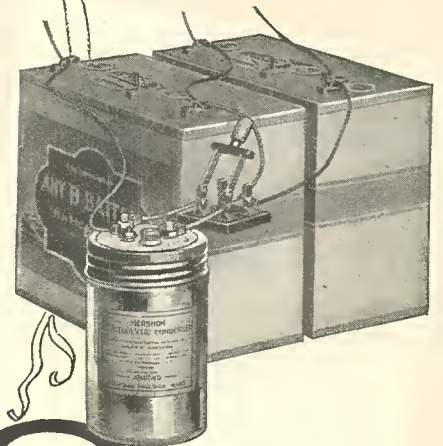

\$ 8.

AMRAD



The Fullest Value in Radio

—plus the joy of building it yourself—

WONDERFUL as the Hammarlund-Roberts Receiver was in 1926, when over 70,000 were built at home, this year finds the New HI-Q* Set incorporating many features which make it even finer value than ever before!

One interesting advance is complete shielding which prevents coupling between stages and eliminates oscillation. Another is Automatic Variable Coupling—a new feature which gives maximum and equal amplification over the entire tuning range. Its circuit is a marvel of efficiency and all parts are matched.

The result is a quality of TONE—a degree of VOLUME—and a keenness of SELECTIVITY which are a distinct radio achievement.

Anyone can build the New Hi-Q* Set at home and save money. Follow simple instructions in the "How to Build" book and in a few hours have a radio equal to \$150 to \$200 factory-made units of similar efficiency.

Parts Complete (Less cabinet) **\$63.05**

The most complete radio instruction book ever written



Get a copy from your dealer to-day or send 25 cents direct



*High ratio of reactance to resistance. High ratio—Great selectivity—Loud Signals

Hammarlund-Roberts, Inc. 1182-C Broadway New York City

- 1 Grid leak, 3-megohms;
 - 1 Six-conductor cable;
 - 1 Two-conductor cable;
 - 25 feet No. 18 flexible wire, etc.
- Parts For Eliminator
- 1 Metal box 10 x 12 x 24 inches;
 - 1 UX socket;
 - 1 Condenser block;
 - 1 Transformer;
 - 8 Binding posts;
 - 2 Transformer brackets;
 - 1 Cord and plug;
 - 2 Socket bushings, 1/8 inch;
 - 1 Strip insulating paper;
 - 1 Resistor, 2250-ohm;
 - 1 Rectifying tube;
 - 1 Condenser, 2.0-mf.;
 - 1 Resistance (Ward-Leonard ABC);
 - 2 Choke coils 30-henry;
 - 1 Binding-post strip, drilled;
 - 8 feet No. 18 flexible wire, etc.
 - Nuts, bolts, lugs, etc.

\$500 Prize Contest Winners

(Continued from page 1095)

every known radio receiver and piece of apparatus. Bartlett was apparently ransacked for "Familiar Quotations," and Dicky was heard searching in the cabinet for every feature that has been broadcast since KDKA was of his age. Equally thorough seemed to be the searches through the broadcast station list for appropriate letters.

Other punsters trifled with the name of our juvenile hero and made it variously "Jack," "Bob," "Henry," "Mike," etc.; while the use of "son" for "sun," "heir" for "air" and "home" for "ohm" became at last somewhat trite. A physician, sticking to his scalpel, suggested "The Autopsy."

Various emotions were expressed by readers putting themselves in Fond Papa's place; some baseball fans thought first of the World Series, then coming on. One cynic consolingly pointed out the possibility of escaping a soprano concert on that disastrous evening; and an unsympathetic Washingtonian whose home seems to be surrounded by "bloopers" expressed a hearty wish that "there were about a dozen Fond Papis and Dickies right around my neighborhood."

SOME INGENIOUS ANSWERS

After carefully selecting from the replies received, day by day, the most ingenious and original, several further winnowings were necessary. From the final group of best ones the ten given in the box on the first page of this article were chosen. Many others displayed much merit, and we here quote a few deserving of honorable mention:

- "A Belated 'Refrain,'" by Leola L. Markus, Virginia, Minn.
- "A Disciple of Edmund Flewelling," by F. H. Read, Kavanagh, Canada.
- "A Junior Dissociating M. I. R. E.," by S. Grunzler, Montreal, Canada.
- "A Sure Way to Get DX (Daddy Cross)," by H. A. Kirkwood, West New Brighton, N. Y.
- "A Radio That's Like An Airplane—No Earthly Good," by L. A. Wachlin, Sayville, N. Y.
- "A Table of Contents," by the same contributor.
- "About Time for Dicky to Get Distance," by Robert T. Gidley, Melrose, Mass.
- "Accessories After the Fact," by Norman Wilson, Toronto, Canada.
- "An Infant Industry That'll Soon Be in the Hands of a Receiver," by H. H. Daniel, St. Louis, Mo.
- "As Pepys Would Remark, 'And So to Bed,'" by Edgar Williams, Halifax, England.
- "Averting the Saturation Point in Radio," by J. Mack Gamble, Hannibal, Ohio.
- "Baby Twister Causes Great Damage; Fear Some Parts Total Loss," by Roy H. Cawood, Cleveland, Ohio.
- "Both to the Woodshed," by John H. Ellison, Milwaukee, Wis.
- "Bringing Out Powerful Bass Notes," by F. H. West, Richmond Beach, Wash.
- "Dad Reverses the 1924 Model and Uses a Switch"—Unsigned.
- "Dad Swears Himself In," by L. A. Wachlin, Sayville, N. Y.
- "Debut of Young Operator as 'Ariel' in 'The Tempest,'" by Riley M. Fletcher Berry, Sanford, Fla.
- "Er Liebt Zerstreung (He Loves 'Dispersion')," by Antony Stern, Prague, Czechoslovakia.
- "\$50 to \$250 a Week as a Radio Expert!" by James Edmonds, Erie, Pa.
- "Five Seconds Left to Play," by U. G. Johnson, Delafield, Wis.
- "Frantic Father Finds Son by Radio," by Mrs. Albert Lundstrom, Eugene, Oregon.

ACME CELATSITE WIRE



—a tinned, copper bus bar wire with non-inflammable "spaghetto" covering, for hook-ups. 5 colors; 30-inch lengths. We also offer the highest grade of "spaghetto" tubing for Nos. 10 to 18 wires. 5 colors; 30-inch length.

Flexible Celatsite

Flexible, stranded wire for point-to-point and sub-panel wiring. Non-inflammable "spaghetto" covering. In black, yellow, green, red and brown; a color for each circuit. Put up in 25-foot coils.



Celatsite Battery Cable

—a silk-covered cable of varicolored Flexible Celatsite wires, for connecting batteries to set. Prevents "blowing" of tubes; gives your set an orderly appearance.

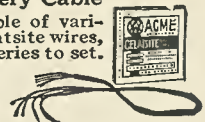

Stranded Enameled Antenna

Best outdoor antenna you can buy. 7 strands of enameled copper wire; maximum surface for reception. Prevents corrosion and consequent weak signals.



Send for folder

THE ACME WIRE CO., DEPT. D NEW HAVEN, CONN.

ACME WIRE MAKES BETTER RADIO



RADIO PRODUCTS are of National Repute

"B" POWER SUPPLY UNITS

- 30 milliamperes @ 135 volts
- 25 Milliamperes @ 150 volts
- 15 Milliamperes @ 180 volts

\$35 complete with guaranteed Tube Automatic Control Switch

No. 1—for 6 V Tubes; No. 2—for 4 V Tubes. Neat, efficient, positive action.

\$5.00 Complete

Trickle Chargers

No. AT-1—delivers 1/2 to 3/4 amperes. Price complete with cord, bulb—\$10
No. AT-2 with switch to charge 3/4 amperes or 1 1/2 amperes—complete with bulb, etc., \$15

Write also for information on our

Universal A & B Chargers

Prices quoted are for East of the Rockies

THE ACME ELECTRIC & MFG. CO. 1412 Hamilton Ave., Cleveland, O.

Manufacturing for 10 years.

C. L. PARKER

Ex-Examiner U. S. Patent Office
Attorney-at-Law and Solicitor of Patents
McGill Building, Washington, D. C.
Patent, Trade Mark and Copyright Law

You can be quickly cured if you

STAMMER

Send 10 cents for 288-page book on Stammering and Stuttering. "Its Cause and Cure." It tells how I cured myself after stammering 20 yrs. B. N. Bogue, 6965 Bogue Bldg., 1147 N. III. St., Indianapolis

**Windsor Wall or Table
Type Cone Speaker
Amazes Radio World**

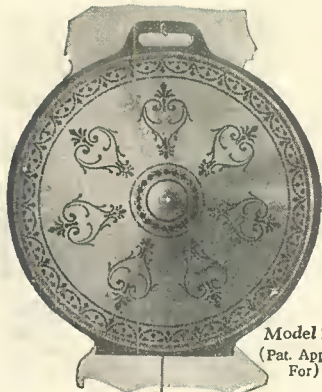

Model 210
(Pat. Applied For)

The latest model Windsor Cone Loudspeaker has astonished the world of radio. In convenience, quality of reception, and extremely low price, it far surpasses anything yet offered. The cone is 22 inches in diameter and is supported by an easel back. It can be hung up on the wall, as in the picture above, or stood upon any flat surface as shown in the picture below. It contains the famous Windsor loudspeaker unit noted for its extreme clarity and fidelity of reproduction.



Model 210
22-inch Cone Loudspeaker
with easel back

\$15⁰⁰

(West of Rockies \$18)
(Pat. Applied For)

Model 302 (Shown below)
With Moulded Composition Horn Loudspeaker and 18-inch Cone Loudspeaker.

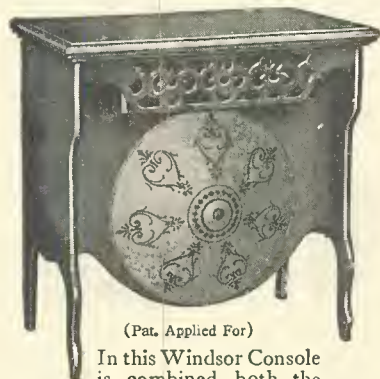

(Pat. Applied For)

In this Windsor Console is combined both the Windsor Moulded Composition Horn Loudspeaker and the 18-in. Windsor Cone Loudspeaker. The top is 30 in. x 17 in. and stands 29 in. high. Plenty of battery and equipment space is provided by large shelf in rear. Price, finished in Mahogany or Walnut **\$48⁰⁰**
(West of Rockies, \$55)

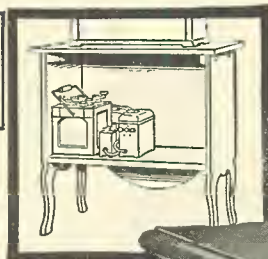

Rear view at left shows large compartment with ample space for batteries, battery charger, or battery eliminator, which are entirely concealed from view. Back is open for ventilation of batteries.

At right is shown the Cone Loudspeaker, with its panel, which is quickly and easily removable, allowing instant access to all batteries, battery charger, battery eliminator or other equipment and wiring.



(Pat. Applied For)

Model 200—with 22-inch Cone Loudspeaker

This Windsor Cone Loudspeaker Console is equipped with a 22-inch Windsor Cone Loudspeaker. Its top is 30" x 17" and is 29" high. The battery shelf provides ample space for batteries, charger, battery eliminator and other equipment. Beautifully finished in either Mahogany or Walnut.

Model 200

\$29

Console
with Cone
Loudspeaker
Ready for
Set and
Batteries
(West of
Rockies, \$35)

**This is the Fastest Selling Line of
Loudspeakers and Loudspeaker
Consoles in the Radio World Today**

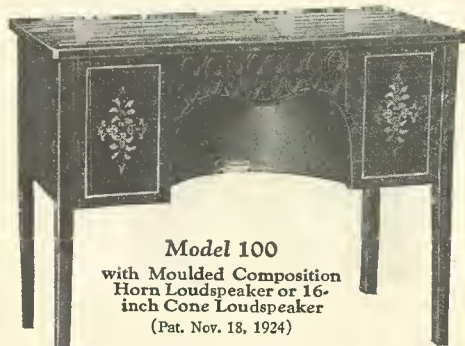

Model 100
with Moulded Composition
Horn Loudspeaker or 16-
inch Cone Loudspeaker
(Pat. Nov. 18, 1924)

Above is shown a beautiful Windsor Loudspeaker Console, finished in either Walnut or Mahogany, which provides ample space on top for any radio set. The battery shelf beneath will accommodate all necessary equipment. Equipped with either Moulded Composition Horn or 16-inch Cone Loudspeaker. Size: 38 in. x 18 in., and 29 in. high. Price **\$40⁰⁰**
(West of Rockies, \$42.50)

To the right is shown the newest Windsor Loudspeaker Console. It is equipped with a 22-inch Cone Loudspeaker and cabinet suitable for 7-inch radio panels up to 26 inches in length. Battery shelf provides ample space for all equipment. Beautifully finished in either Walnut or Mahogany. Price (without receiving set) **\$44⁰⁰**
(West of Rockies, \$52.00)

Note to Dealers: Write or wire today for details of the highly profitable Windsor line.

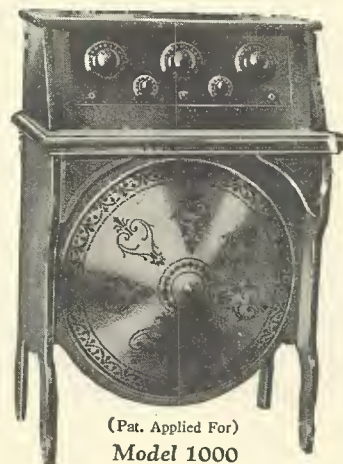

(Pat. Applied For)

Model 1000
with 22-inch Cone
Loudspeaker

Electrical Department

WINDSOR FURNITURE COMPANY

1410 Carroll Avenue • CHICAGO, ILLINOIS

Los Angeles Branch—917 Maple Avenue

New 32-Page Booklet Giving Information Usually Known Only to Expert Set Builders



Just off the press

Every radio set contains from one to a dozen fixed condensers. Do you know what they are for? Do you know how to test them to see whether they are working properly? Do you know that there is a way of changing the range of your tuning condensers? — of getting greater selectivity—of improving the tone? All through simple application of fixed condensers.

The Dubilier Condenser Corporation is now supplying radio fans with a complete and authoritative explanation of the correct use of fixed condensers.

You have often envied the man who could look over your set and by inserting a small fixed condenser somewhere, greatly improve its tone and operation. Do this yourself. Perhaps some defect in reception that you have always thought could not be helped is due to an imperfect condenser.

This new booklet will also give you the most recent information on power amplifiers, filters and battery eliminators. Send 10 cents in stamps or coin for your copy.

Dubilier

CONDENSER CORPORATION

4377 Bronx Boulevard, New York, N. Y.

"Hope First Prize Is Mine; I Need Another Neutrodyne," by Albert M. Bonawitz, Millersburg, Pa. (Too bad—Editor)

"If Critical, Remove a Few Turns of the Primary," by Leonard J. Cooper, Springville, N. Y.

"Input First Step of Detector," by Robert J. Higgins, Philadelphia, Pa.

"Interfering with the Child Labor Act," by Edward H. Biedermann, San Francisco.

"Little Wrecks He," by L. A. Wachlin, Sayville, N. Y.

"Limitations of Remote Control," by E. S. French, Washington, D. C.

"Lucky Horn," by Rolland Martin, Fulton, Ind.

"No Connection," by D. H. King, Norfolk, Va.

"Of Secondary Consequence," by L. B. Barrett, Bangor, Maine.

"Pacific Time! How Son Wishes It Were!" by Mrs. Jennie Lind, Richmond, Cal.

"Radio Experimental Station 2YR," by R. F. Hoover, Bethlehem, Pa.

"Radio Parts Distributed by Male," by Sydney Smith, St. Davids, Canada.

"Resistance Is Useless," by Kate M. Buhl, Youngstown, Ohio.

"Richard and Dad In One Night Effluent With Stasis" (acrostic), by Howard M. Byron, Conshohocken, Pa.

"Scene Prior to the Quenching of a Destructive Little Spark," by George Gibb, Vancouver, Canada.

"SON Will Be Relayed to BED by DAD," by R. Easingwood, Clinton, N. Y.

"Sorry OM," by Winfield Miller, Mansfield, Mass. (The amateurs will get this.)

"The Losser," by T. S. Armstrong, New Liskeard, Canada.

"The One-Kilotot Broadcaster," by W. L. Puckett, Cave City, Ky.

"The Radio is Still in the Grasp of Infancy," by B. A. Oshorn, Buffalo, N. Y.

"There, That Ought to Fix Their Doggone Bed-time Stories," by W. F. Manthorne, Hampton Roads, Va.

"2L8 Coming In," by Richard S. Foelkes, Yonkers, N. Y.

"Unusual Interference Phenomenon Affecting Two Generations," by Harry Lucas, Berlin, Germany.

"When Radio Needs You," by D. A. Cozad, Dayton, Ohio.

"When the Tubes Went Out, Fond Papa Pawed the 'Heir'," by E. B. Coots, Charlestown, Indiana.

"Wire Less the W=IRE," by Meyer Parmet, New York City.

FROM THE TWO-YEAR-OLDS

We are indebted to the parents of several equally promising youngsters for their reactions to a like situation. "This is the



Master Clarence Leininger is seen tuning his own radio set. His parents have prudently supplied him with this, so that he may not be tempted to follow Dicky's bad example.

actual soliloquy of a two-year-old caught in a similar act," writes Merle J. Wightman of Seattle, Washington:

"Poor daddy's radio; poor papa's radio."

In contradiction to the advice unfeelingly tendered by so many elders, S. J. Parkes of Vancouver, Canada, enters the suggestion of his own two-year-old granddaughter:

"Don't spank him!"

"Fixing the Radio" is the diagnosis of another two-year-old, Eleanor Lyons of Dayton, Ohio; and Master Clarence C. Leininger, of Chicago, whose picture as a budding radio expert appears here, is of the opinion that "Baby Broke Daddy's Radio; Daddy says 'Get Out of There!'" would cover the situation.

And the grandparents' side of it is shown in a letter from J. Harry Thompson of



Pat'd. 5-2-'16 7-27-'26

Licensed by Rider Radio Corporation

APPROVED RADIO NEWS LABORATORY 1927

R. F.

Oscillation Conquerer

"Phasatrol"

A true balancing device for radio frequency amplifiers.

If your set squeals or oscillates you need PHASATROLS.

If you are building a new set, and want the last word in electrical efficiency—equip it with PHASATROLS.

PHASATROL is the latest development in the field of radio frequency amplification. As a balancing device, it is far superior to any other methods heretofore in use for suppressing oscillations in the radio frequency amplifier circuit. It is being used and endorsed by leading radio authorities.

At your dealers or write direct. Write for Hook-up Circular.

Price, \$2.75

175 Varick St, Dept. 27 New York, N. Y.

ELECTRAD

LYNCH

METALLIZED

FIXED RESISTORS

ARE WARRANTED—

Absolutely Noiseless
Permanently Accurate
Dependable!

Write us!

ARTHUR H. LYNCH, Inc.
Manufacturers of Radio Devices
Fisk Bldg., Broadway & 57th Street
New York, N. Y.

MEMBER RMA

"Lighting Fixtures"

READY TO HANG
(Direct from Manufacturer)
Completely wired including glassware
Send for new Catalogue No. 27
(Just reduced prices)
Special Proposition to Dealers
ERIE FIXTURE SUPPLY CO.
STATION R ERIE, PA.



ERLA

Erla Crystals still reign supreme for use in any circuit employing a crystal detector. Super-sensitive, permanently adjusted, assuring full volume at all times. Ideal for reflex sets. Buy this better crystal at your dealers. If he cannot supply you we will send it prepaid to any city in the U.S. for \$1. Electrical Research Laboratories, 2500 Cottage Grove, Chicago, Ill.

Insure your copy reaching you each month. Subscribe to RADIO NEWS — \$2.50 a year. Experimenter Publishing Co., 53 Park Pl, N.Y.C.

**30
DAYS
FREE
TRIAL**

7 Tube Set Single Dial Radio



The Metrodyne

ONLY ONE DIAL TO TUNE

Retail Price

\$75

Completely Assembled

**Big Discounts
to Agents and Dealers**

Wonderful offer direct from the factory! The world's greatest radio. A perfect working, single dial control, 7 tube receiver. And just to prove our claims, we will ship it to your home for **30 days' free trial**. Test it under all conditions. Test it for distance, volume and tonal quality — and if you are not convinced that it is the best single dial set you ever heard, return it to the factory. We don't want your money unless you are completely satisfied.

**BIG PROFITS
TO AGENTS AND DEALERS**
Our Agents and Dealers make big money selling Metrodyne Sets. You can work all or part time. Demonstrate the superiority of Metrodynes right in your home. Metrodyne Radios have no competition. Lowest wholesale prices. Demonstrating set on 30 days' free trial. Greatest money-making opportunity. Send coupon below—or a letter—for our agent's proposition.

Metrodyne Super-Seven Radio

A single dial control, 7 tube, tuned radio frequency set. Approved by America's leading radio engineers. Designed and built by radio experts. Only the highest quality low loss parts are used. Magnificent, two-tone walnut cabinet. Artistically gilded genuine Bakelite panel, nickered piano hinge and cover support. All exposed metal parts are beautifully finished in 24-k gold.

Easiest set to operate. Only one small knob tunes in all stations. The dial is electrically lighted so that you can log stations in the dark. The volume control regulates the reception from a faint whisper to thunderous volume, 1,000 to 3,000 miles on loud speaker! The Metrodyne Super-Seven is a beautiful and efficient receiver, and we are so sure that you will be delighted with it, that we make this liberal **30 days' free trial offer**. You to be the judge.

Mail COUPON Below!

**Let us send you proof of
Metrodyne quality**

F. L. Warnock, Greentown, Ind., writes: "I received the Metrodyne in good shape and am more than pleased with it. Got stations 2,000 miles away."

C. J. Walker, Mariposa, Calif., writes: "Received my Metrodyne Single Dial set O. K. I believe that these one-dial sets are going to be excellent sellers. I had no trouble in tuning in stations enough to satisfy anyone, so you will please send me another set."

Roy Bloch, San Francisco, Calif., writes: "Very often we travel from New York to the Hawaiian Islands quickly—from station to station—by means of the little tuning-knob which operates the electrically-lighted dial. The Metrodyne Single Dial Set is much easier to operate than any radio set I've ever seen."

We will send you hundreds of similar letters from owners who acclaim the Metrodyne as the greatest radio set in the world. A postal, letter or the coupon brings complete information, testimonials, wholesale prices, and our liberal **30 days' free trial offer**.

METRO ELECTRIC COMPANY
2161-71 N. California Ave., Dept. 103
Chicago, Illinois

Gentlemen:

Send me full particulars about Metrodyne 6 tube and 7 tube sets and your **30 days' free trial offer**

Name.....

Address.....

If you are interested in AGENT'S proposition, place an "X" in the square



**30
Days' FREE Trial**

Metrodyne Super-Six

Another triumph in radio. Here's the new 1927 model Metrodyne 6 tube long distance tuned radio frequency receiving set. Approved by leading radio engineers of America. Highest grade low loss parts, completely assembled in a beautiful walnut cabinet. Easy to operate. Dials easily logged. Tune in your favorite station instantly on same dial readings every time. No guessing.

Mr. Howard, of Chicago, said: "While five Chicago broadcasting stations were on the air I tuned in seventeen out-of-town stations, including New York and San Francisco, on my loud speaker horn, very loud and clear, as though they were all in Chicago."

We are one of the pioneers of radio. The success of Metrodyne sets is due to our liberal **30 days' free trial offer**, which gives you the opportunity of trying before buying.

METRO ELECTRIC COMPANY

2161-71 N. California Ave. • Dept. 103 • Chicago, Illinois

**6
Tube Set
\$48.50**
RETAIL PRICE
Completely
Assembled

MAIL THIS COUPON
or send a postal or letter. Get our proposition before buying a radio. Deal direct with manufacturer—**Save Money.**



R. F. CHOKE



For Majestic Music Samson Chokes must be used

"All sense of listening ceases—you are in the great artist's presence."

say the musically critical who have simply added

Samson Chokes

to their radio receiving sets to eliminate howling, "motorboating" and other disturbing noises—for at all times these chokes keep radio and audio frequency currents where they belong.

For this purpose Samson Chokes cannot be approached because their patented helical winding prevents the choke acting as a by-pass condenser at certain frequencies and reduces distributed capacitance effect to a negligible minimum. These chokes have no pronounced self resonant points. Special bulletins on the uses of these chokes are available.

- No. 85 Samson R.F. Choke (85 millihenries)\$2.00
- No. 125 Samson R.F. Choke (250 millihenries)\$2.25
- No. 3 Samson A.F. Choke (3½ henrys)\$3.25

Our book—"Audio Amplification"—already accepted as a manual of audio design by many radio engineers—contains much original information of greatest practical value to those interested in bettering the quality of their reproduction. Sent upon receipt of 25c.

SAMSON ELECTRIC COMPANY



MAIN OFFICE: Manufacturers CANTON, MASS. Since 1882
Factories at Canton and Watertown, Mass.

Euclid, Pa.: "In the long winter evenings out here on the farm, Mother and I must depend on the radio, RADIO NEWS and the daily paper for all our pleasure, information and education. But how we long for the old days, even if 'Daddy's little radio transformer' did make a 'degenerative set.' This is youth's way of learning and you must give the kid credit for thorough and patient persistence in his insatiable thirst for radio information—which may be the nucleus of a great inventor. Who knows?"

OFF-TOLD TALES

The rules of this contest were so simplified that the great majority of entries adhered to these more closely than ever before. Many, however, used one-cent postal cards as stationery in envelopes, instead of putting them to the purpose for which they were intended, or using plain paper instead. This was unnecessary.

We have derived a great deal of pleasure from the study of the replies, as we are sure our readers have done, from the diversion of working out the many clever ones submitted. Below we give several hundred different replies which were merely descriptive, with slight variations. This excludes many sentences which were merely descriptive, such as "Fond Papa Discovers Dicky Destroying Radio," and lack the wit to be found in most of the following examples:

About to Oscillate; About to Take the Hair; "Aggravating Papa"; "A" Eliminator; Aladdin Radio; All-American Transformer; Amateur Interference/Night; All Unstrung; Apparent (A Parent) Interference; Approaching Storm; "Ask Dad, He Knows"; Assault and Battery. "B" Eliminator; Baby Eliminator/Transformer; Beat Notes Imminent; Beat Reception with Howling; Before the Bowl; Bed Time Story; Binding Posts Needed; Blasting; Blooping; Blue Prints with His Next Set; Breaking Into Radio; Boy's Best Friend Is His Mother; Broadcasting/A Receiver/Without a License; Breakdown Test; Boy Eliminator; Broken, The Third Commandment; Bringing Up Father; Broadcasting Must Be Regulated.

Cause of Sound Waves/Beat Notes/Howling/Backlash; Can You Beat Him?; Caught in the Act; Censored; Children's Hour; Charging the Eliminator; Changing the Hook-Up/Wavelength; Circuit Breaker; Chip of the Old Block; Change of Program; Calm Before the Storm; Child to Be Reared; Close-Coupled; Coils Hook-Up; Contentment; Curiosity Killed a Cat/the Set; Consternation; Costly Entertainment; "Curfew Shall Not Ring Tonight."

Dad Will Supply the Switch; DAD Coming on the Hair; Daddy's Pets—Both Spoiled; Dad Tunes in on KID; "DAD Coming in Strong"; "Daddy, I'm Fixing It"; Daddy's Little Helper; Destroying His Rival; Detector in the Last Stage; Delving Into the Mysteries; Dicky Will Broadcast Next; Dicky Tunes in on WHIP, etc.; Doomed/An Investigation; "Degenerative Receiver"; Dicky About to Receive SPANK/etc.; Dicky Demonstrates; Dickydyne; Detector and a Loud Speaker; Detection Followed by Amplification; "Dicky Sure Knows How to Work the Radio"; Distortion; DX/Reception/Pan; Discord in a Flat; D—! X—!

Early Start; Effects of the Son on Reception; Efficiency Expert; Eliminator Causes Howling; End of a Perfect Day/Set; Elimination; Eventually, Why Not Now?; Everything Going Out, etc.; Experimenter; Ex-Statics; Exploring Parts Unknown; Extracting Radio Information; Expensive Toy.

Frequency Changer; Family Receiver; Father, Forgive Him, etc.; Father as a Loud Speaker; Finishing a Receiver/Touches; First-Hand Knowledge; First Lesson in Radio; Future DeForest/Expert, etc.; Free Radio Service; Fresh Kid's Masterpiece, etc.; Forecast; Warmer in Southern Portions, Showers and Squalls.

Government Regulation Needed; Getting His Hand In/Goat/Inside Dope; Getting the Most Out of Radio, etc.; Getting to the Bottom of Things; Getting "H—!"; Grasping the First Stages of Radio/for Words.

Hand Capacity Effects; "Ham" in the Making; Hearing Glasgow; Heavy Interference; He'll Get Halifax; "Henry" Choke; High Losses; High-Frequency Circuit; His First Experience; His Father's Son; His Master's Voice; Home Charger/Made Rectifier; Howling Detector/Success; Howling Caused by Interference/Misplaced Parts/Defective Tube and Loose Wiring; Hunting for the Cat Whisker/etc.

Impedance; Interference; Interference and Static/Howls and Squeals; Inside Interference/Information; Infantile Paralysis of the Radio; Infancy of Radio; Infant Industry; "I Want to Know"; Innocent Mischief; In Bad; Inquisitiveness; Inductive Interference; Interference from Static/POP/etc.; Infandytne; Inexperience; Interference and a Loud Speaker; Inside Out/Stuff; The Ins and Outs of Radio; Interference Eliminated/Coming in Strong; In-the-Hands of a Receiver; Insula-

DESIGNED to OUTLAST World Storage A Battery

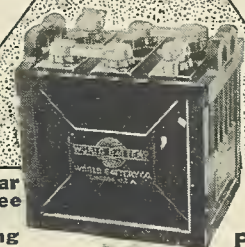

Two-Year Guarantee Bond in Writing

NEW LOW PRICES

Famous the world over for reliable, enduring performance. Solid Rubber Case lasting protection against acid or leakage.

Approved and Listed as Standard by Leading Authorities

including Radio News Laboratories, Poplar Sci. Inst. Standards, Pop. Radio Laboratories, Radio Broadcast Laboratories, Radio in the Home and Lefax, Inc.

Send No Money

Just state number wanted and we will ship same day order is received, by express C.O.D. Pay expressman after examining batteries. 6% discount for cash with order. Remember, you save 50% on World Batteries—so send your order today.

WORLD BATTERY COMPANY Dept. 10 1219 S. Wabash Ave., Chicago, Ill.

- Solid Rubber Case Radio Batteries
- 6-Volt, 100-Amperes \$10.00
- 6-Volt, 120-Amperes \$12.00
- 6-Volt, 140-Amperes \$13.00
- Solid Rubber Case Auto Batteries
- 6-Volt, 11-Plate \$10.00
- 6-Volt, 13-Plate \$12.00
- 12-Volt, 7-Plate \$14.50

Set your radio dial at 228.3 meters for the World Storage Battery Station WSBG. Variety—new talent—always interesting. Jerry Sullivan, Dir. and Announcer. "Chl-CAW-go"



Make Money Sell Radios Save Money

We will pay you \$25 to \$60 cash for every order you take as our Neighborhood Agent. Just demonstrate the glorious tone, amazing distance, and volume of Premier Radios in your own home or place of business. Quote our low F.A.C. TOKY price, and orders come EASY! Only two or three orders pays for your own CONSOLE.

Special Price on Demonstrator \$24.50
5 TUBE Tuned Radio Frequency Hook-up Licensed by U.S. Navy Dept. Walnut finish cabinet. You sell for \$50.00.

FREE TRIAL
Premier Radio Receivers sell themselves, because of our unusual FREE TRIAL OFFER! You'll find there is nothing on the market equal to Premier quality at Premier's low price because we manufacture every part.

Trade-in Old Sets
Yes, Sir! Our Agents can take the old "Squealers" in trade, and that alone opens up hundreds of opportunities to take orders and make profits, in every neighborhood.
Write for Sensational Offer to Neighborhood Agents
PREMIER ELECTRIC CO. Dept. 299 Grace Street at Ravenswood Ave., CHICAGO

RADIO CATALOG

Dealers! Send for our new 1927 Catalog. Contains nationally advertised high quality sets, kits and parts.

Use your letterhead.
Western Radio Co. 134-136 W. Lake St. Chicago, Ill.

Print Your Own
Cards, Stationery, Circulars, Paper, etc. Save money. Print for others, big profit. Complete outfits \$3.85. Job press \$11. \$23, Rotary \$149. All easy, rules sent. Write for catalog presses type etc. THE KELSEY CO., P-72, Miden, Conn.

Largest variety of Radio Parts!

1926
EDITION
No. 16

300
Illustrations

8-Page
log book of
all U. S.
Broadcast
Stations



**THIS
68 PAGE
RADIO
CATALOGUE
FREE**

75 HOOKUPS

BUY FROM RADIO'S OLDEST MAIL ORDER HOUSE

WE are the oldest established, exclusive radio mail order house in the country. Our motto is "Quick Shipment." All orders are shipped within 24 hours. Quick, prompt, courteous service. We carry a larger variety of radio parts and findings than any other radio house in the country.

"RASCO HAS IT"

If you are in need of certain small radio parts that other radio and mail order houses do not bother to carry, get the Rasco parts catalog, and you will find them there, anything from a screw to copper ribbon and telephone diaphragms, as well as thousands of other small radio findings. Just to mention a few:

Lugs, nuts, dials, vernier dial, jacks, plugs, every kind of knob, cords, panels, screws, sliders, washers, selenium, tinfoil, switches, crystals, cap nuts, Litz wire, cord tips, brass rods, resistances, name plates, spring binding posts, switch parts, metal ribbon, carbon balls, binding posts, all types, switch points, switch levers, lock washers, carbon grains, ground clamps, metal pointers, insulated tubing, low melting metal, antenna connectors, bus bar wire, as well as thousands of other articles.

We carry the Largest Variety of Small Radio Parts in the World.



THE NEW RASCO CATALOG No. 16

Contains the Following Hookups:
All Armstrong Circuits: These important circuits are explained clearly, all values having been given. Just to name a few of the Vacuum Tube circuits: The V.T. as a detector and one-step amplifier; Super Regenerator; one-step radio frequency amplifier and detector; three-stage audio frequency amplifier; short wave regenerative circuits; 4-stage radio frequency amplifier; radio and audio frequency amplifier; inductively coupled amplifier; all Reflex Circuits. This catalog is crammed full of small parts and radio findings, literally thousands of them. In addition there is much useful information contained herein.

If you will paste this coupon on a post card and mail today, we will be pleased to send you our new Catalog at once.

| | | | |
|---|--|-------------|--|
| RADIO SPECIALTY CO., | | RN-3-'27 | |
| 98 Park Place, New York | | | |
| You may end me, without charge or obligation, your NEW CATALOG No. 16. (Write on margin if you desire.) | | | |
| Name | | | |
| Street | | | |
| P. O. | | State | |

RADIO SPECIALTY CO.

98 Park Place

New York, N. Y.

SM

Look—
You'll Find 'em



220 Audio & 221 Output Transformers - \$6.00

That's the S-M sales story—just that you'll find S-M parts in more and better circuits than any others.

The designers—the men you look to for guidance—have used S-M parts in more than half of this year's circuits.

Would they stake their reputations on anything less than parts they KNEW would satisfy you?

S-M audio transformers, output transformers, coils or power units have been selected for the following circuits—and in many form the basis of design. In this list are included the most popular recent designs.

- Infradyne Shielded Six
- Silver-Cochaday
- Best's A.C. Browning Drake
- Best's A.C. Diamond of the Air
- Radio News Batteryless Receiver
- Radio Broadcast Super
- Radio Age Super
- Radio Broadcast Local
- LC-27 Junior Power Pack
- Citizens Call Book Monotone Receiver
- Call Book Power Pack
- Callies Super
- Radio Mechanics "A", "B" and "C" Eliminator
- Radio Engineering "A", "B" and "C" Eliminator
- Radio Mechanics Man-O-War Super
- Lincoln Super

- Best's Short Wave Set
- Hush-Hush II Short Wave Set
- Popular Mechanics Super
- Christian Science Monitor 6 tube Browning-Drake
- Radio Engineering Short Wave Set
- New York Sun "B" and "C" Eliminator for Resistance Amplifier
- Chicago American Short Wave Set
- Chicago Post Power Amplifier
- Best's new Super
- Radio News Power Amplifier
- Loftin-White
- Popular Radio Town and Country Receiver
- Radio News Super
- Nakken's Ultra-Five
- Cochaday's Pre-Selector
- Chicago News Short Wave Adapter

SILVER-MARSHALL, Inc.

848 W. Jackson Blvd.

Chicago, U. S. A.



A-B Relay

The Jewell A-B Relay is an automatic switch for connecting and disconnecting both the trickle charger and B-Eliminator, of a radio set, in their proper order and at the right time by merely snapping the filament switch.

When the B-Eliminator is operating the trickle charger is disconnected, eliminating any hum from that source. When the set is turned off only the trickle charger is connected to the lighting circuit.

An A-B Relay is very handy as it does away with bothersome hand switching and eliminates the dangerous chance of leaving the B-Eliminator on after the set has been turned off. It does not consume any additional current, other than that used by the tube filaments.

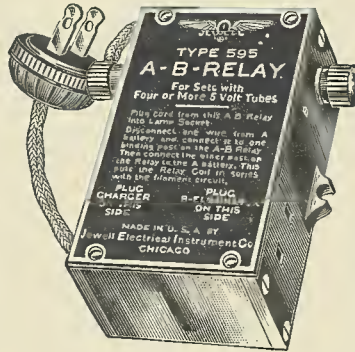

A-B Relay

The A-B Relay is essentially an efficient low resistance magnet connected in series with the A-Battery and the tube filaments, and actuating special silver carbon contacts.

Write for special form No. 1023 which describes the A-B in detail.

Jewell Electrical Instrument Co.

1650 Walnut Street,

Chicago, Ill.

"26 Years Making Good Instruments"



tion Needed; "It Is Better to Give," etc.; It Won't Be Long Now; I Think the Grid Leaks. Junior Radio Man/Works the Radio/Radiotriician; Just Like Daddy; "Just a Moment, Please"; Jack in the Box; Knockdown Kit; Knocked-Out Set.

"Laff That Off!"; Last Stage of Radio; Last Thing Out; Lack of Shielding; Learning the Radio Business from the Ground Up; Like Father, Like Son; Little Learning, etc.; Little Radio Expert, etc.; Little Mr. Fixit/Buster; Lightning Arrester; Local Interference; Low Losses/Becoming Total Losses; Looking for the Facts in the Case; /Money in the Honeycomb/Bedtime Story/Announcer/WRNY/Santa Claus/Uncle Wiggily, etc.; Loose Coupling/Connections; Love's Labor Lost; Lost Chord; Last Number Before Signing Off.

Mama's Darling; Making a Set Wireless; "Mad-Lad-Sad-Bad"; "Me Fix It"; Man-Made Interference; Marconi, Jr.; Minor Interference; Minute That Seems a Year; Midget Condenser/Transformer; Music Master; Music Hath Charms, etc.; "My Radio! Oh, Oh, Oh!"

Neutralized; New Radio Inspector; New Hook-Up/In Sight; New "A" and "B" Eliminator; New Radio Needed; Noiseless Radio; 1927 Model; No More Blooming/Static; No-Wave Receiver; "Nize Baby"; Neutralizing a Set; Not on the Program; Not a Console Model; No Accessories Needed; No Previous Experience Required; "Next Number Will Be a Duet."

Off the Air/Heir; Outside Interference; Out-Balanced Receiver; Operating Without a License; Old Man Interference; Operating Table; Ohm, Sweet Ohm; Oh, —; Only One Installment Paid!/Left!

Papa Super-Het; "Pied" Radio; Pandora's Box; "Parasites" (from Europeans); Peck's Bad Boy; Papa's Pets; Pa's Turn at the Switch; Papa Will Tune in on Dicky; Poor DX (Dick's) Reception; Push-Pull Stage; Process of Elimination; Pulling Out the Stations; Prodigal Son; Program Censored; Powerful Loud Speaker; Pride Before a Fall.

Quiet Set; QRM/QRN. Remote Control; Receivers Past and Future; Reducing the R.F./Wavelength; Rectifier Needed; Remedy for Static; Real Ham; Radiotimist; Radio Adios; Radio Insurance a Necessity; Radio Should Be Foolproof; Ra(i)dio; RADIO NEWS; Radio/Boycott (Boy Caught) Radio Bug/Broadcast/Coupler/Dissembler; Radio Dealer's Friend/Doctor; Radio Pirate/Fiend/Destroyer; Radio Interference/Trouble/Tragedy; Radio for Old and Young/

Radio At His Finger Tips/In Its First Stages/Trouble Finder/Losses/Transformer/ Parts and Loud Speaker/At Its Worst/Without Tubes and Coils/Set For Sale/In the Home/Radio Review/Beginner/Amateur/Expert / Wreckspert / Wireless Reactivation.

Radiotics; Radioactive/activity; Raid on the Radio; Remedy for Static; Radio Frequency Trouble; Radio-dyin'; Receiver in Bankruptcy.

Separation of All Wavelengths; Servicing a Set; Set a Baby Can Handle; Seeking RADIO NEWS/etc.

Shielding Needed/for Hand Capacity; Shock Excited; Single Control; Signing Off; Situation Well in hand; Sick-tube Set; Silent Night/Knight; "smatter, Pop?"; Simplifying Radio Construction.

Son Affects Reception/S. O. S. Stops Broadcasting; S. O. S. Your Old Man; Sore's Your Old Man; S. O. S.—Save Our Set; Socket; Solving the Mysteries of Radio; SON Broadcasting the Parts; Spanking Receiver; Spare the Rod, etc.; Spirit of '26/The Age.

Stand By One Moment; Static-tician; Stage of Audio Frequency; Stabilizing a Set; Starting Early in the Radio Business; Sun Spots on the Radio; Station WOW Ready to Broadcast; Static/Eliminated.

Station SON Ready to Receive; Switch Needed/Will Connect, etc.; Switching Hour; Surprising Infant Industry; Station MAD, etc.; Super-Wreckodyne.

Tempest, Sunshine/and the Radio; Taking After Dad; "Then the Fun Began"; Taking the "Ra" out of Radio/Wire out of Wireless, etc.

Time to Rewire/Recoil; Tomorrow's Radio Engineer; Too Much Regeneration; Total-Loss Receiver; Two Experts/Loudspeakers; Two Down, One to Go; Treasure Chest;

Trying Out the New Hook-Up; Trouble Shooter/Finder, etc.; Transformer About to Receive; Tuning In/Station WRNY/IRE, etc.; "Tube or not tu-be"; Tube and Coil Eliminator; Tuning Out; "There's a Long, Long Coil Unwind-ing"; Tuning in Daddy's Wave Length.

Unauthorized Change of Wavelength; Unraveling Radio Mysteries; Unshielded Receiver; Unscientific Experimenter; Untuned R.F. Set; Unstrung.

Variocoupler; Vivisection. "Weather Forecast; storm approaching, heavy static"; Where's the Music?/Peter Rabbit?/etc.; "What's In It?/Makes It Go?"; What Are the Wild Waves Saying?; Where is My Wandering Boy Tonight?; Why Radios Need Shielding; Will Hear Wales (Wails); Will the Detector Socket?;

Why Fathers Get Gray; Where Ignorance Is Bliss, etc.; Will Get at the Seat of the Trouble; "What the —?"; When a Feller Needs a Friend; Wire Pulling; Wild Over Radio; Why Locks Were Invented; Wreck of the Neutrodyne/etc.; Wreckodyne; Wrecktrifer/Wrecktrifier; Worst Is Yet to Come.

"Yes, Sir, That's My Baby!"; Young Expert/Radio Mechanic/America; Younger (Re) regeneration/Too Much.

Learn **Electricity** IN GREAT SHOPS OF COYNE—complete in 12 weeks on actual electrical machinery. Earn \$200 to \$600 a Month Earn while you learn. Free railroad fare to Chicago. Send for big free book—today. H. C. LEWIS, Pres., Coyne Electrical School Dept. 37-77 1300-10 W. Harrison St., Chicago, Ill

Rono REPLACES JACKS and BATTERY SWITCH **\$2.50** MULTI-STAGE JACK FILAMENT SWITCH SAVES TIME, MONEY AND MINIMIZES LOSSES CAUSED BY OLD STYLE JACKS If your dealer cannot supply you order direct enclosing remittance or we will ship C.O.D. Rono Mfg. Co., 428 S. Clinton St., Chicago

Chemistry paves the road to Success!

Some people measure success in terms of money and others in degree of knowledge and culture. Chemistry is the one uncrowded profession today that offers both. America, always a land of amazing opportunities, is especially so now in the field of applied Chemistry. Industries have developed within eight years more rapidly than the output of trained men to conduct them. Every big industry needs chemists and there is a real demand for them immediately.

Earn a Bigger Salary from now on—

Good Chemists Command High Salaries; you can make yourself independent for life by unearthing one of Chemistry's Undiscovered Secrets!

Do you remember how the tales of pirate gold used to fire your imagination and make you want to sail the uncharted seas in search of treasure and adventure? And then you would regret that such things were no longer done. But that is a mistake. They *are* done—today and everyday—not on desert islands, but in the chemical laboratories throughout your own country. Quietly, systematically, the chemist works. His work is difficult, but more adventurous than the blood-curdling deeds of the Spanish Main. Instead of meeting an early and violent death on some forgotten shore, he gathers wealth and honor through his invaluable contributions to humanity. Alfred Nobel, the Swedish chemist who invented dynamite, made so many millions that the income alone from his bequests provides five \$40,000 prizes every year for the advancement of science and peace. Herman Frasch, who showed how to extract sulphur built up a huge fortune. C. M. Hall, the chemist who discovered how to manufacture aluminum made millions through this discovery. F. G. Cottrell, who devised a valuable process for recovering the waste from flue gases, James Gayley, who showed how to save enormous losses in steel manufacture, L. H. Baekeland, who invented Bakelite—these are only a few of the men to whom fortunes have come through their chemical achievements.

NOW IS THE TIME TO STUDY CHEMISTRY

Not only are there boundless opportunities for amassing wealth in Chemistry, but the profession affords congenial employment at good salaries to hundreds of thousands who merely follow out its present applications. These applications are innumerable, touching intimately every business and every product in the world. The work of the chemist can hardly be called work at all. It is the keenest and most enjoyable kind of pleasure. The days in a chemical laboratory are filled with thrilling and delightful experimentation, with the alluring prospect of a discovery that may spell Fortune always at hand to spur your enthusiasm.

YOU CAN LEARN AT HOME

To qualify for this remarkable calling requires elaborate specialized training. Formerly it was necessary to attend a university for several years to acquire that training, but thanks to our highly perfected and thorough system of instruction, you can now stay at home, keep your position, and let us educate you in Chemistry during your spare time. Even with only common schooling you can take our course and equip yourself for immediate practical work in a chemical laboratory.

EASY MONTHLY PAYMENTS

You don't have to have even the small price of the course to start. You can pay for it in small monthly amounts—so small that you won't feel them. The cost of our course is very low, and includes everything, even the chemistry outfit—there are no extras to buy with our course. Our plan of monthly payments places a chemical education within the reach of everyone.

SPECIAL 30 DAY OFFER

Besides furnishing the student with his Experimental Equipment, we are making an additional special offer for a short while only. You owe it to yourself to find out about it. Write today for full information and free book "Opportunities for Chemists." Send the coupon right now while it is fresh in your mind. Or just write your name and address on a postal and mail it to us. But whatever you do, act today before this offer is withdrawn.

DON'T WAIT—MAIL COUPON NOW!

CHEMICAL INSTITUTE OF NEW YORK, Inc.

Home Extension Division 3

66-R West Broadway

New York City



LETTERS

From Students Who Have Taken This Course

You will probably be pleased to learn one of the lessons gave me an idea to turn my chemical knowledge to profitable account. I am now making a varnish and paint which undersells the other type products by \$2.60 a gallon, in some cases more. Have been receiving gallon orders from painters during past week which has netted me a profit of \$12.50 for my "spare-time chemical industry." Many thanks for your training thus far.

J. J. KELLY.

I am but half way through your course and am certain that I have saved my Company many times the cost of the course and raised myself in the Share Holders estimation. The knowledge obtained has its immediate practical application and I do not hesitate in saying your course and the personal attention you give is invaluable to the practical man in any business where chemistry plays a part. You may use this letter and my name and address to the furtherance of your good work.

JOHN WALTER.

I have not written since I received the big set. I can still say that it far exceeded my anticipations. Since I have been studying with your school I have been appointed chemist for the Scranton Coal Co., testing all the coal and ash by proximate analysis. The lessons are helping me wonderfully, and the interesting way in which they are written makes me wait patiently for each lesson.

MORLAIS COUZENS.



T. O'CONNOR SLOANE, A.B., A.M., LL.D., Ph.D.

Noted Instructor, Lecturer and Author. Formerly Treasurer American Chemical Society and a practical chemist with many well known achievements to his credit. Not only has Dr. Sloane taught chemistry for years but he was for many years engaged, in commercial chemistry work.

EXPERIMENTAL EQUIPMENT FURNISHED TO EVERY STUDENT

We give to every student without additional charge this chemical equipment, including forty-nine pieces of laboratory apparatus and supplies, and forty different chemicals and reagents. These comprise the apparatus and chemicals used for the experimental work of the course. The fitted heavy wooden box serves not only as a case for the outfit but also as a useful laboratory accessory for performing countless experiments.

CHEMICAL INSTITUTE OF NEW YORK

Home Extension Division 3

66-R West Broadway, New York City

Please send me at once, without any obligation on my part, your free Book "Opportunities for Chemists," and full particulars about the Experimental Equipment given to every student. Also please tell me about your plan of payment and your special 30 day offer.

NAME

ADDRESS

CITY STATE.....

R. N. Mch., 1927.

Double your pay

If you are earning the average young man's salary, a Radio Institute of America Home Study Course in radio operating can double your pay. R. I. A. has more than 7,500 satisfied graduates. The courses of study are the finest obtainable at any price. They qualify you to pass the U.S. Government Commercial or Amateur License examination.

[Send four cents in stamps for our big catalog]

CUT HERE

RADIO INSTITUTE OF AMERICA
324 Broadway, New York City
Please send me full information about your Home Study Course of Radio Instruction.

- I am interested in the complete course which qualifies for the U. S. Gov't Commercial or Amateur Radio License.
- I am interested in the technical course for radio dealers, jobbers, salesmen and technicians.

Name.....

Address.....

RADIO INSTITUTE OF AMERICA
Formerly Marconi Institute Established in 1909
324 Broadway New York City

Horatio At the Bridge

(Continued from page 1105)

ing some of the things he has thought of—well, never mind.

"You know old Horatio Martelle?" he begins. I nods. Everyone knows him, the town's leading banker. Leading by a mortgage.

"Also, of course, Tom D. Sloan, the retired miller?"

I admits the acquaintance.

"And Rufus Phillips, the broker?"

"Bandit, you mean," I corrects, "The margin hound."

The Master smiles. "And Harrison Edwards, the steamship owner?"

Again I agrees. "The Four Simple Honors?" I grins.

"Precisely," says Jerry. "You know well that for several years these four have been playing bridge almost nightly?"

"Sure," I admits, "The whole town knows that."

"Even so," states The Master, "it must cease to be."

"Oh, woe!" I wails, "And why?"

Jerry sits up and taps the bench with a ruler. "Sloan is called to Minneapolis to resume active charge of his mills," he informs me. "He'll be gone several years, it seems."

"Breaking up the party, and you want me to pinch hit?" I steps in.

The Master shakes his head. "No, no, Joe. For Edwards must leave for New Orleans to save his Southern Steamship Company from disastrous competition."

"You and me pinch hit?" I inquires hopefully.

"Worse than all that," continues Jerry. "Phillips' doctor has ordered him to Arizona indefinitely, to ward off tuberculosis."

"And where's Martelle going?" I asks.

"The North Pole?"

"Martelle stays here," says Jerry, musing.

Silence for a moment.

"Well, what's the opus?"

"Doctor Maxwell has examined all four men, and reached a rather startling conclusion."

I perks up. "That being—?"

"These men have been playing bridge, every evening, for so many years, with such an avidity, an expertness, and an intense inner jealousy that if they were to cut it out immediately the doctor fears for their sanity."

"Crazy over bridge?"

"It might mean that. They are all well past fifty, which is not exceptionally old, but none the less too old to change habits. It's been nearly ten years that the four have been playing, and a sudden curtailment would work serious injury on them. Routine, you know, sets deeply."

"True," I concedes.

"So, being aware of the doctor's verdict—though denying it on the surface, I can see that they are worried—they came to me, to see if I couldn't devise some means whereby I could have them play by radio. This happened about three weeks ago."

"But can't they find others to play with?" I inquires.

The Master shakes his head vaguely.

"These men, warm friends in every other line, become equivalent of savage beasts at bridge. Oh, I know it sounds funny, but it's the truth. Oddy, they do not play for money; they seek merely the greatest number of points. When they first began to play, in the past, the question arose as to which was the best player. After nearly a decade, the problem is still unsettled. Their rivalry will never die until one of them is proven champion."

"So they asked me to fix it for them. Frankly, they seem to think that I possess occult powers. At first I suggested that they

VISIT
LAKEWOOD
NEW JERSEY
AND
THE LOVELY
LAUREL HOUSE

MIDWINTER GOLF
WINTER SPORTS
CONCERTS-DANCING

A PERFECT HOTEL
WITH REMARKABLY
LOW RATES

UNDER
RENOWNED
SALTZMAN
MANAGEMENT

RADIO BOOK FREE

64 pages full of opportunity. Your guide to what's right and standard in Radio; full explanation of liberal offer paying agents \$60 to \$100 a week and how to get latest radio goods at wholesale.

Big Money In Radio

We want live dealer and agents in every locality. Lifetime opportunity. This Book more than a catalog—shows big profit way to get into world's newest and richest field—make big money—turn full or spare time into cash. **Accept This Offer!** Write for FREE book. Lowest prices—make 40 to 60% every sale.

5-tube Coast to Coast Receiver \$39.50 Retail. Sells on sight. Hundreds of such money makers. Write for special agent's wholesale prices. Newest sets, parts and accessories—tremendous savings and profit. Write for FREE book and amazing offers.

Standard Radio Company, 1410 Walnut St. Kansas City, Mo.

5 Tube Set
only \$39.50 RETAIL

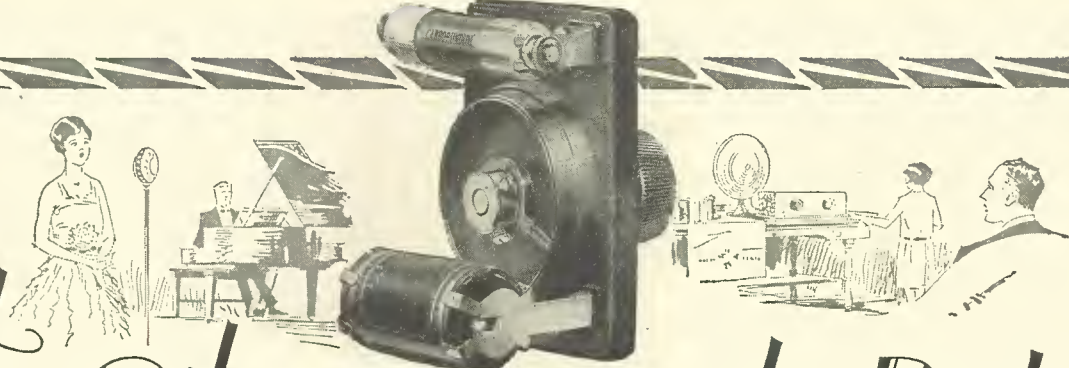

"The Other Night on the Radio"

HUNDREDS of letters from delighted listeners-in are telling us of their experiences of "the other night on the radio." Owners of the Carborundum Crystal Set Hook-up who are reaching out to stations 50, 70, even 200 miles away and getting perfect reception. Users of reflex sets getting better results than ever before—owners of super-hets telling us of the crystal clear tones, the sharper tuning and the increased volume they are enjoying. But above all they are telling us of the clear, true quality of tone—undistorted, crystal clear tones that come to them because of the installation of

The Carborundum Stabilizing Detector Unit

Reg. U. S. Pat. Off.

THE CARBORUNDUM COMPANY, NIAGARA FALLS, N. Y.
CANADIAN CARBORUNDUM CO., LTD., NIAGARA FALLS, ONT.

SALES OFFICES AND WAREHOUSES IN New York, Chicago, Boston, Philadelphia, Cleveland, Detroit, Cincinnati, Pittsburgh, Milwaukee, Grand Rapids
The Carborundum Co., Ltd., Manchester, Eng.

\$3.50
IN U. S. A.
WITHOUT
DRY CELL

The
Carborundum
Company
Niagara Falls, N. Y.

Please send free
Hook-up Book D-1

Name _____
Street _____
City _____
State _____

— KONITE PRODUCTS —

No-Hum "B" Eliminator

\$12⁰⁰

COMPLETE
NO TUBES
NO ACIDS
TO BUY

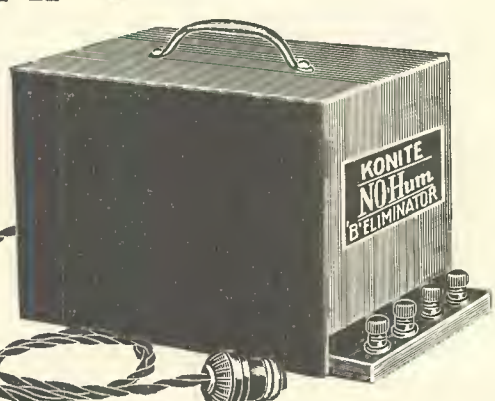

\$10.50
UNASSEMBLED

Don't Apologize for Poor Reception

How many times have guests come to the house and you offered apologies for poor reception because your "B" batteries were "down and out"? You can always depend upon the electric light company to furnish electricity and by just plugging into the light socket, you will always have a "B" battery supply for your radio set by using the KONITE "NO-HUM" B ELIMINATOR.

The voltage will never vary. If you use 22½ or 45 volts for your detector and 90 volts on your amplifier, the KONITE "NO-HUM" B ELIMINATOR will always deliver the specified amount of voltage. To get good volume from your set, you must supply the full amount of voltage required.

4 Taps B—; 22½ V.; 45 V.; 90 Volts.
The operating expense of current used is less than \$1.00 per year dependent upon the rate of your local light company.

Works on 110 Volts A.C., 60 or 25 cycles—operates all sets from 1 to 9 tubes.
DEALERS—We have an excellent proposition for those who desire to handle our line. Write or wire for territory.

Konite Recti-Trickler

\$4⁷⁵

COMPLETE

CHARGES BOTH
"A" and "B"
BATTERIES

—:—

LOWEST
PRICED CHARGER
MADE

—:—

ELECTROLYTIC
PRINCIPLE

—:—



Absolutely Noiseless Charging

The RECTI-TRICKLER has been designed after an exhaustive series of tests to provide a self-contained unit at an extremely low cost, a unit that is practical and requires no attention.

It is a combination Rectifier and trickle charger all in one—Charges both A & B batteries (wet) from the house lighting cut—Works on DC or AC Current; all you need to do is to connect it to any house light socket, clip the two leads to your battery and it starts to operate.

No tubes, no acid necessary. The simplest unit of its kind—uses the electrolytic principle. No noise. The RECTI-TRICKLER is guaranteed against defects for six months.

DEALERS—Exclusive territories and liberal proposition is ready for you—write for particulars.

If your dealer does not stock them, THESE UNITS will be shipped C. O. D. to you if desired
KONITE CORPORATION, 25-27 WEST BROADWAY, NEW YORK, N. Y.

90 VOLT "B" POWER UNIT \$12.75

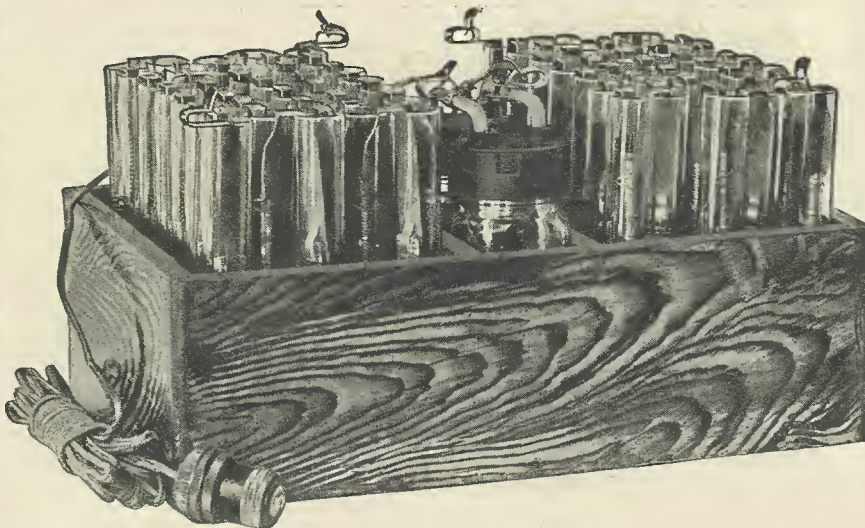

RUMOR has had it this NEW HAWLEY ADVANCED POWER UNIT was coming—and here it is. Hawley Storage "B" batteries have been standard for over 5 years and the same quality—the same standard of workmanship comprise this unit with its new ingenious hook-up and built-in-charger giving the utmost in B-Elminator simplicity. Positively guaranteed not to give the slightest kind or trace of a hum or line noises. Simply plug into your electric socket and forget it. Any inexperienced person can hook it up in 2 minutes as all voltages including those for any kind of detector are all plainly marked. Operates any 1- to 10-tube set. Does not contain any acid. It's so good—such true smashing value—that my 5-year-old 30-day trial offer refund applies. You've got to see it—hear its operation to fully appreciate this statement.

The prices—only slightly more than ordinary dry cells, 90 volts, \$12.75; 112½ volts, \$15.25; 135 volts, \$17.50. For 105 to 120 volts, 25- to 130-cycle alternating current only. Special sizes to order of any voltage. Knockdown kits at still greater savings. All complete as above—nothing to purchase extra. Further covered in my regular 2-year guarantee. Ample stocks—all packed—same day shipments and your order is all I need to speed it on its way to you. Simply say: ship C.O.D.—pay expressman its cost plus small transportation charges—and you'll thank me later—or write for my free literature, testimonials, etc.

B. HAWLEY SMITH, 321 Washington Ave, Danbury, Conn., U.S.A.

Mfr. of "A" Power Units, "B" Power Units, "A" Storage Batteries, "B" Storage Batteries and A & B Chargers including Tricklers

Two Times Two!

"Built Better"—this always has been, and is the policy of AEROVOX.

One year ago the demand for high grade Fixed Mica Condensers, Filter Condensers, Power Supply Condenser Blocks, and Lavite Resistances forced us to double our floor space and equipment.

Today, even though we are now operating on a 24 hour schedule, we are again compelled to double our facilities. With our present plant in full swing—without costing our customers one single production day—we are moving to new quarters at 60-72 Washington St., Brooklyn, N. Y.

"Two times two"—this is our growth for the year just passing. Does the "Built Better" policy pay? AEROVOX thinks so. More than 200 radio manufacturers and thousands of you fans evidently think so, too.

Wherefore, we thank you!



FREE RADIO GUIDE

Gives special hook-ups with illustrations. Shows the latest sets, the newest developments in radio at startlingly low prices. Get the set you want here and save up to 50%. Everything in parts, kits, complete factory-built sets and supplies. Orders filled same day received. Write for free 164-page copy NOW; also please send names of one or more radio fans.

RARAWIK CO., 540-557 Monroe St., Chicago, U. S. A.



PATENTS

DON'T LOSE YOUR RIGHTS
Before disclosing your invention to anyone send for free blank form "EVIDENCE OF CONCEPTION" to be signed and witnessed

LANCASTER & ALLWINE
Reg. Pat. Attys. in U. S. and Canada
270 Ouray Bldg., Washington, D. C.
Originators of the form, "Evidence of Conception"

Insure your copy reaching you each month. Subscribe to Radio News—\$2.50 a year
Experimenter Publishing Co., 53 Park Place, N. Y. C.

select someone to deal cards for them, and radio to each his hand and then play it out by wireless. This did not meet with their approval, the suggestion being brought forth that each player might tune in on the other fellows' hands. So that was out. Now, I have devised an automatic game, which I intend to demonstrate to them before they leave. Tonight, in fact."

"Yes?"
"Oh, yes indeed. Come into the carpenter shop and I'll show you the sets. No, here's the original, which will do for demonstrative purposes."

He points to what looks like a gyp hotel for indigent sparrows. It's a box three feet long by two feet high, a foot or so deep, looking very suspicious and proving more so. The Master, with his mind for detail, explains, and I listen.

"On the front panel of the set you observe four tiers of windows, each the size of a playing card. On each of these glasses is painted a card, each tier containing, in order, the cards of a suit, ace to deuce. The top row being spades, and the rest hearts, diamonds and clubs, respectively. A white light behind each card illuminates it."

"Sure," I says, having nothing else to crack. But The Master is in his element when explaining, and I've learned to listen, being wed these several years.

"We now come to the 'dealer'," continues Jerry. "Take, for example, the ace of spades. Behind this—and every other 'card'—is a separate vertical shaft, with a commutator horizontal to the top of the cabinet. The commutator is made of hard wood, and has but one point of contact, that being of copper. However, there are four brushes making contact with each commutator, so arranged that when the latter is spun and allowed to coast down to a stop, it must stop on any one of the four brushes. A ratchet prevents stopping between brushes. Numbering the brush next to the front panel Number One—that in each instance connecting to the panel of the individual set—the others are, respectively, Number Two, Minneapolis, Number Three, New Orleans, and Number Four, Arizona. This set is for Mr. Martelle, here. If the commutator stops on the front brush, it lights the ace of spades on this set. If on another brush, the ace is lit up on one of the three other sets. Is it clear so far?"

"Perfectly," I replies, accidentally sensing the point. "But just how do you do all this cross-country dealing?"

"By special dispensation from the government, I am permitted to work on very long wavelengths, five thousand and over, so as not to interfere with broadcasting. If the commutator had stopped on Brush Number Two—Minneapolis—an impulse of 5,000 meters would have been sent out, lighting the ace for Mr. Sloan, but no place else. Brush Number Two, at 5,020 meters, for New Orleans, and Brush Number Three, 5,030 meters, for Arizona. I allow a gap of ten meters to avoid possible interference. Clear?"

"Three transmitters for one card?" I begins. "And there's 52 cards—"

"Making an ostensible total of 52 times 3 or 156 separate transmitters," finishes Jerry, smiling faintly. "A practical impossibility. I have constructed a multiplex transmitter which is tapped at various wavelengths. That part was comparatively easy. However, there's more."

I gasps. "Do tell!"

"Certainly," obliges The Master, very serious. "Above the four tiers of cards you will note four card spaces, each filled with a sheet of ground glass. Focused on each of these as a screen is a small stereopticon, using frames of motion picture film as slides. I'll show you."

Jerry lifts up the top, and I takes a squint. To describe it accurately, each projector has a wheel with fifty-two spaces, into each of

which is inserted a frame of film picturing a card. By controlling the wheels, any card can be made to appear in any space.

"Clever," I admits. "How's it played?"

"I'll demonstrate," offers The Master. "Here, on the right, is a double-throw switch, one contact being 'deal' and the other 'play'. To start the game, throw the switch on 'deal' and press the large red button below it."

He does so, and the fifty-two commutators whirl, and the cards flashes.

"Now, I release it, and they gradually slow down and stop," he states. They does.

"A special clutch arrangement prohibits more than thirteen commutators stopping on any one set," he explains. "As it happens, we are dealt the ace of spades, the jack, ten, four and five of clubs, the ten, queen and six of hearts and the queen, jack, eight, seven and four of diamonds."

It was so, for a fact.

"All conversation, scoring and bidding, of course, is carried on by ordinary radio. Through a special arrangement I have effected a system which makes it unnecessary to shift a switch from transmitting to receiving. They simply talk as they would were they all in one room."

"Yeh?" I mutters. It's as hard to get a word in with The Master as it is with Doris, only I don't mind Jerry—he always says something.

"Below each card in the 'hand' lines is a button. Shifting the double-throw switch from 'deal' to 'play', the one leading presses the button below the card he wishes to play. This causes that card to flash in one of the ground-glass images on all four sets. Thus fifty-two more transmitters are necessary, making so far 208 taps on the large transmitter, with all receivers tapped to match."

"How about the dummy?" I asks.

"I was coming to that," states Jerry.

Keep tubes full of 'pep' (without removing them from set)

TUBES weaken with use, cut down the sensitivity and power of your set, and consume more current. To enjoy top-notch programs every night, keep your tubes always like new. Once a month, for ten minutes, attach a Jefferson Tube Charger to your set. The improved reception—plus longer life of tubes and batteries—are worth many times the small price of \$5. Also rejuvenates run-down or paralyzed tubes. Guaranteed, patented, and made ONLY by Jefferson. Get one today—from your dealer.

JEFFERSON ELECTRIC MFG. CO.
Largest manufacturers of small transformers
541 So. Green Street, Chicago
(PATENTED)

Jefferson
No. 275 Tube Charger

Easy! Just connect Jefferson Tube Charger to the two 'A' battery terminals for 10 minutes, once a month, as per directions for large or sma tubes.



UNIVERSAL TRANSOCEANIC "PHANTOM"

LOOK AT THE INSIDE!

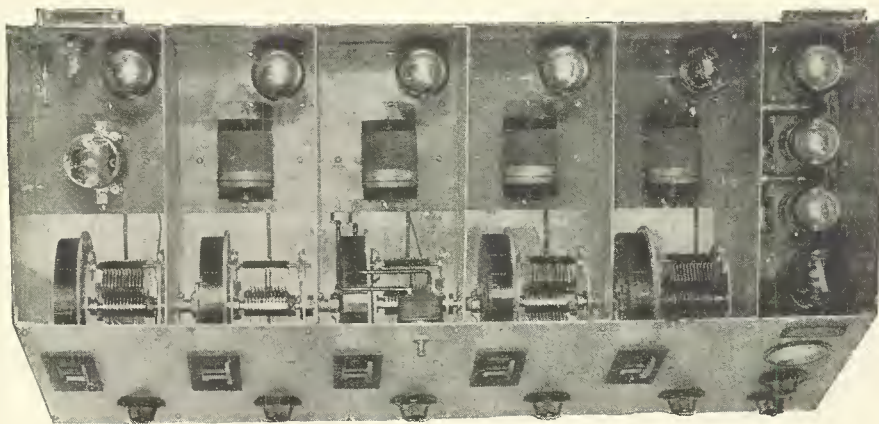

GOLDEN-LEUTZ UNIVERSAL TRANSOCEANIC PHANTOM TOP VIEW

A few of the outstanding features—1. Single Gang Control or Individual Tuning. 2. Wavelength Range 35 meters to 3600 meters. 3. 100% Shielded. 4. Eight reading Voltmeter reading up to 560 volts. 5. Power Audio Amplifier built-in. 6. Receiving range only limited by static level. 7. Maximum selectivity, sensitivity and a new standard of musical reproduction. 8. Design by Charles R. Leutz. 9. Price of kit \$220.00. Price of set completely constructed and laboratory tested \$250.00 without accessories.

A NEW CATALOG ON THE PHANTOM NOW READY FOR YOUR REQUEST.

GOLDEN-LEUTZ, Inc.,

Cables "Experinfo"

SIXTH and WASHINGTON AVES.

LONG ISLAND CITY, NEW YORK



ONLY
\$24.75
COMPLETE

150 Volts

**NOTE
THESE
POINTS**

150, 90, 67½ 45 and 22½ volt taps give correct voltage with no variable, troublesome resistance. Full wave rectification. Delivers 150 volts at 50 Milliamperes. Gives constant, unvarying power to any set up to 10 tubes using resistance, transformer or impedance coupling. Works with power tube sets. No expensive tubes to burn out. No dangerous acids. Costs less than \$1 a year to use. Easy to hook up. Cannot blow out receiver tubes on short circuit. Needs little attention. Simple, compact, absolutely free from hum.

**HERE IS
The "B" Eliminator
you've been waiting for**

Just think, \$24.75 puts an end to your "B" Battery troubles. The Warren 150 Volt Outfit does the work of others costing twice as much. Guaranteed to do all that is claimed for it or money refunded. Approved by leading Radio Magazines.

**WARREN
"B" Eliminator**

Enclose your check for \$24.75 with order and we'll pay the express charges to your address—or—we'll ship C.O.D. and you pay the express costs. Send in your order NOW—you'll never regret it. The Warren is not only very attractive in appearance, but it is made from the finest materials and assembled and tested by experienced workers. Just try the Warren—you'll find that it makes your set work far better and that it will give you more genuine radio satisfaction than you thought possible. ORDER NOW.

Warren Electric Company -- (DEPT. RN) -- Peoria, Ill.

HERE IT IS — Entirely New!

SLF — SLWL ARMO CONDENSER

WITH MICROMETER ADJUSTMENT

PRICE
\$3.75

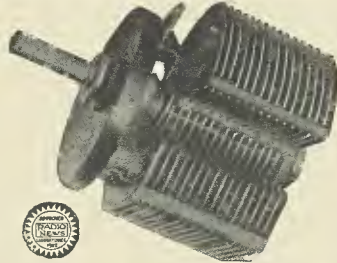

Capacities
.00015
.00025
.00035
.0005

Will fit all sets new or old, will separate stations no matter how close

No other manufactured condenser allows accurate matching of capacities and inductances with out the aid of balancing condensers or compensating devices. ARMO, on the contrary, uses a micrometer adjustment allowing a change in capacity of 30%, thereby eliminating the use of precision instruments or special equipment to balance coils. This is done by a simple adjustment on the rotor shaft. Adjustment will not change the curvature; that is, it will be perfect for each wave length. This must not be misunderstood for adjustable stationary capacity. Another feature—The plates are soldered, not assembled, thereby offering a free electrical service reducing resistance very materially. Being an unusually small condenser for its capacity, it has a very concentrated field. This, along with its small amount of insulation, well out of the way of the field, gives improved selectivity.

We also make a special short wave condenser covering the entire short wave band. Price \$2.05, parcel post paid.

We are equipped to manufacture transmitting, balancing and oscillating condensers in single lots at quantity price. State capacity desired. Write us direct, giving the name of your dealer.

ARMO RADIO LABORATORIES, 1666 Tarleton St., Los Angeles, California

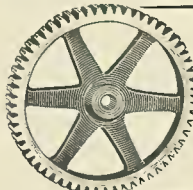

**GEARS
All Kinds—Small**

The most accurate made and prices reasonable. We carry a complete line of gears in stock for immediate shipment. Can also quote on special gears of all kinds. Send us your inquiries.

Write for Catalogue 40
Chicago Stock Gear Works
105 South Jefferson St., Chicago



"This large white button, when pressed by the user of any one set, causes his cards to appear on the panels of the other three sets as well as his own. To avoid confusion, the dummy cards use red illumination. This requires fifty-two more taps, bringing the total to 260."

"Any tricks?"

"The dummy's cards are, as it occurs, capable of being played from any of the sets, though I could prevent that by adding 156 more taps. This would make it entirely too cumbersome, so I am relying on their honor. For that matter, should some one press a dummy card who was not entitled to do so, the player having the contract could call him down over the radio. There's little cause for concern there. But as to tricks—when four cards have been played, whoever wins the hand presses the third large button—blue—and this wipes all the cards from all the ground-glass screens. Then another card is led, and so on. To avoid errors, the players will also call out each card as it is played, providing a double check. The 'wiper' requires one transmitter, bringing the grand total to 261."

I heaves a long breath. "And does it work?"

"I am holding a demonstration for the gentlemen tonight," he replied, a bit wearily. "I'm almost a wreck. I've been finishing these up for the past two weeks or so. The original idea came to me two years ago, but I did nothing further than build the cabinets."

I smiles. "How'll you work it?"

The Master loves to answer questions—being single. "Well, I'm using the ballroom in the house for the purpose. At each end I'm placing a set, and one on each side, panels facing the walls so that they'll not be visible to any player save the one operating. The radios are all ready—I'm dispensing with the speaking radio, since that is an assured fact—and the gentlemen promise to be here at seven-thirty."

"Want me?"

"Assuredly," replies The Master. "If you've time to spare, we'll practice a bit, so you'll be able to give pointers to the players."

I snickers. "First time I ever will be able to hand out any advice on bridge to those babies," I remarks. "All I know about that game is that it's bad form to trump your partner's ace when she or he isn't looking."

I fusses around all afternoon, helping Jerry carry the sets into the house, line them up and get ready for the evening. We tries them out, and they seems to percolate.

Immediately after dinner—I escapes having to help wash the dishes because Doris has company and don't dare bawl me out—I treads over to The Master's. By seven-thirty, on the dot, the four shows up, all suspicious. It's two-thirty when they calls it an evening. In all my hectic existence I never sees so much enthusiasm in so much old age. They mastered the things in a few moments and spent the entire time playing.

"Marvellous!" exclaims Sloan. "Why, it beats the cards all ways."

Phillips coughs a wheeze or two. "Excellent! I can imagine no happier times than our future radio games will be!"

Edwards also vents approval; of the lot, only Martelle evidences even the vaguest suspicion as to the practicability.

"Are you sure, Jerry, that this thing can't be tampered with?" he asks.

"Naturally not," replies The Master. "A set could be destroyed, of course. But I have arranged everything in an ultra-substantial manner. You need fear no concern that you would not feel for ordinary radio receiving—even less, in fact. The sets will be expensive to operate, but it was necessary in order that I could be fairly sure of surmounting all but the worst possible weather conditions. The tubes, which may require changing, are of course easily accessible. The rest is locked securely, and I shall retain the keys. Surcly, the set can

be altered; but the process would be a long, tedious, and—I have it!"

"Honestly?" I queries.

"It never occurred to me before, but the surest sign of honesty is regular playing—every night if possible. I thoroughly guarantee you that anyone attempting to effectively tamper with a set would require many days to achieve results. The wiring took me almost two weeks of steady labor, and is extremely intricate. Without a blueprint, it is practically impossible to correctly trace it. However, if you play every evening, there most certainly will be small opportunity for anyone of you to obtain illegitimate tricks—in short, to cheat. Further, I believe I can guarantee that you are even safer from cheating with this outfit than you are playing at a table."

"Agreed," and the four men shake hands.

I'll skip a few days and save time. Jerry went and personally rigged up each set; it's two-months later, and the four have been playing for a fortnight with great success—at least, we've listened in on their talk, and satisfaction seems beyond question. It's a Sunday night, and Jerry and I are busy decorating his ballroom for a Christmas party, when the third assistant butler, somewhat less than his normally adamant self, announces that we have callers. The callers immediately enter, proving to be Sloan, Edwards and Phillips, and I'm putting it mild, sweet child, when I say that if they'd been hooked to a hot-wire meter they'd have run up 100 amperes.

"Gypped!" is Phillips' first word.

The rest of the conversation is too warm to publish, but it all simmers down to this: Martelle, for the last six days, has won steadily, and with hardly more than a breathing spell has raked in the points. Averaged up, they find he's slammed for one hundred per cent, making him the champion. Also, it seems that Martelle and his family sailed this morning on the *Leviathan* for a winter on the Riviera.

"Is his home closed?" inquires The Master, worried.

"Caretaker's there," grunts Sloan. "We can get in, I guess."

Which we does, immediately examining Martelle's set. One glance proves that it hasn't been tampered with on the outside. The Master unlocks the case, and finds the insides according to Hoyle. Nothing seems to have been accomplished, and the three are forced to concede Martelle's superior prowess as King of the Grand Slam. They drops us off again at Jerry's, and we takes a flip upstairs into the library of his joint.

"Well, what do you make of it?" I asks, as we enters the room.

"Clever, I must say," gurgles The Master, and I can see he wants to laugh but ain't used to controlling his muscles beyond a smile. "It's damn clever!"

When Jerry swears it's so.

"Tell me?"

The Master slumps down into his "thinking chair." A short spell of silence ensues. Then Jerry speaks up.

"Martelle used to be an electrician, years ago," he smiles, that faint, haunting smile of his getting wider and wider, despite himself. "Joe, do you recall the exact position of the set in his library?"

"On a table—why?"

"On a table, yes. Also on the table directly behind the set, was a long Chinese chest. Remember that?"

I reflects a second. "Why, yes, come to think of it, there was a chest there. Rather unusual place for that type of ornament, too. What's the scandal?"

The Master laughs, intensely amused. "I wondered why Martelle was so insistent upon having the first set I showed you. He dropped in one day and said that the color just matched his library table, and made me promise to give him that particular one. I never thought further on it until tonight."



Get Your Money's Worth
of
local and distant
programs

Use a
Beldenamel Aerial
with your new set



DISTANCE! That is
the real test of your
new set.

But don't forget that you cannot get the finest results unless you have a good aerial. Many good sets are permanently crippled because set owners mistakenly believe that corroded, soot-covered aerials are "good enough."



Ask your nearest radio dealer
for a Beldenamel Aerial

A corroded aerial reduces the volume and distance of even the finest radio set. That is why a Beldenamel Aerial should always be used. Each strand of a Beldenamel Aerial is coated with weather-proof, fume-proof baked enamel. Even after years of service, a Beldenamel Aerial is still as good as new. It cannot corrode. It always assures maximum distance and greatest volume.

Belden
Manufacturing Company
2314A South Western Avenue,
Chicago, Illinois



HOMMEL NEVER GOLDBRICKED A DEALER

Simply because Hommel does not buy goldbricked merchandise that requires a lot of misrepresentation to sell.

Hommel handles only the best selling merchandise—the kind that assures every Hommel Dealer a quick turnover.

Hommel's many years of merchandising experience has given him a keen discernment of good and bad selling lines—a good judgement that has built a national reputation for standard and reliable dealer's supplies.

Send for the Hommel Catalogue No. 27-S today—and tie up with Hommel—the wholesaler who never retails.

WHOLESALE

EXCLUSIVELY

LUDWIG HOMMEL & CO

929 PENN AVENUE

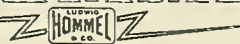

PITTSBURGH, PA.

IMPORTANT
-as
the
TUBE
Itself

The Watch Do of your Tube

Amperite alone can supply automatically, the self-adjusting filament control your tubes require for perfect rheostat regulation under all varying conditions. Insist upon Amperite, and accept nothing else. Simplifies wiring. Eliminates hand rheostats. Specified by leading engineers in every popular circuit. Types for all tubes. Price \$1.10 mounted (in U.S.A.) At all dealers.

Radiall Company
50 FRANKLIN ST., NEW YORK

FREE Write for Hook-ups to Dept. R.N. 3

AMPERITE
REG. U.S. PAT. OFF.

The "SELF-ADJUSTING" Rheostat

FREE RADIO GUIDE

Gives special hook-ups with illustrations. Shows the latest wrinkles and newest developments. Get what you need here at a big reduction. Everything in parts, kits, complete factory-built sets and supplies. Learn how to make your set up to date. Quick service. Write for free 164-page copy NOW; send names of other radio fans.

BARAWIK CO., 540-542 Monroe St., Chicago, U. S. A.

Whenever your voice gets tired—and your throat is husky and dry take a **LU DEN'S** —millions do

Throats, vocal organs, breathing apparatuses—they all work hard to keep up with the times. Sales talks, radio talks, lectures, sermons, singing, acting — then there is the weather, the dust, the fumes of traffic—and smoking too much — no wonder throats get husky, voices hoarse and coughs develop. That's why millions of throats are grateful for Luden's Menthol Cough Drops. The exclusive menthol compound brings such prompt relief.

In the yellow package **5¢** everywhere

\$100 a week Selling Shirts

Fred Frankel, III., writes: "I earned \$110 first week selling Carlton Shirts direct to consumer." You can too. No capital or experience required. We pay 25 per cent. cash commissions daily and big extra bonuses.

WRITE FOR FREE SAMPLES
CARLTON MILLS, Inc., Shirt Mfrs.
114 Fifth Ave., Dpt. 169C, New York

"Keep on thinking," I requests, eager. "Oh, it matched, all right. Many things, too. Martelle was up there the day I fitted the wooden commutators onto the shafts. I had cut the commutators on a lathe, all at one time, as a long rod, and later split them into fifty-two wooden rings. When assembling the set I found that, after the copper contact had been added, a slight deficiency in cutting the wood had caused the commutators to be a bit out of balance. To offset this I drilled a hole in each commutator, directly opposite the copper contact, and placed in this hole a short steel bar, an inch long by a quarter of an inch in diameter."

"Uh-huh?" "And Martelle, having seen that, resorted to his electrical knowledge. In his Chinese chest he constructed four shelves, each shelf being on a level with a row of commutators. Then, behind each commutator that he wished to control he simply placed a very large electromagnet! While the commutators were spinning, he gradually turned on the current in the electromagnets, so that when the commutators ceased revolving, the iron bar would be drawn towards the magnets, and the copper contact rest on the brush controlling his own card! He stacked the cards!"

I plumps down on a box. "Well, chase me, if I ain't a fairy!" I yelps. "He cold-decked them!"

Silence again. Then I speaks. "Why didn't you tell those three about it?" "It wouldn't have done any good; they didn't lose any money or valuable articles. Nothing is gone except their self-esteem. And that is very much for the better. For now they can cease playing bridge and devote themselves to more profitable pursuits."

I grunts. "Still, Martelle was a crook." "By necessity," states The Master. "For years Martelle's family have been after him to take them to Europe for the winter. His games interfered with the process. I heard that his wife threatened to divorce him if he didn't take the trip. He was literally forced to either desert his pals and thus admit defeat, or else lose his wife. His position was trying."

All of which proves that people who live in glass houses should never read Elinor Glyn.

FINIS

AMAZING STORES IN OUR MARCH ISSUE:

THE GREEN SPLOTCHES, by T. S. Stribling. A perfect story for our pages according to the editor's viewpoint must be really amazing and must be scientific. This story is, without a question, a classic of scientific fiction, and furthermore, one of the most amazing tales it has ever been our good fortune to read.

UNDER THE KNIFE, by H. G. Wells. Here is an extraordinary imaginative story by the great author, a story of such audacity that you will read it breathlessly from start to finish.

THE PEOPLE OF THE PIT, by A. Merritt. Here is an exceedingly clever story by this well known author; a story about intelligences — absolutely incomprehensible to us — intelligences — with almost invisible bodies, floating through the air, yet possessing strange powers.

THE HAMMERING MAN, by Edwin Balmer and William B. MacHarg. In this story, the psychological detective (by this time well known to our readers as Luther Trant) with the help of his sphygmograph, lays bare a crime a generation old, thus solving many weird and mysterious problems and putting many minds at rest.

THE LAND THAT TIME FORGOT, by Edgar Rice Burroughs (Part II). If you think it is impossible to maintain a high pitch of exciting interest in telling of thrilling episodes and adventures, read the second instalment of this story.

New Resistances for Radio Circuits

(Continued from page 1099)

fiber, which is extremely uniform in diameter, is then passed through the conducting solution and into a high-temperature furnace, where it is baked in an atmosphere of gas. This method of producing the conducting element results in an extremely homogeneous conducting surface, thoroughly hardened upon an excellent insulating base.

The coated filament is in many ways more convenient to the internally-coated glass tube. First, it is possible to have a thick coating of conducting material, because of the extremely small area of the filament. Second, it is very easy to put a layer of protecting material over the conducting substance on such a fiber; whereas it is difficult to coat such a layer on the inside surface of a glass tube, particularly if the bore of the tube is small.

One of the most important advantages of the fiber over the internally-coated tube is that it makes readily possible the measurement of conductivity of the coated fiber as the latter is fed out of the coating machine. Naturally, such measurements insure a uniform product. Further, after many experiments and many months of research, engineers have found that it is a simple matter to obtain a good contact between the coated fiber and the metal caps.

The coated fiber, after leaving the baking furnace, is next protected with a thick film of refractory insulating material which in turn is baked until it is hard. Such a coating completely protects the conducting surface against climatic changes.

The conducting material used in "metalized" resistors is unlike the usual metallic conducting materials, which show a tendency to crystallize. It is of a colloidal nature, and, after it has passed through the high-temperature baking furnace, it is absolutely uniform and homogenous, and shows no tendency to crystallize even after many months of use.

It cannot be too strongly stressed that the coated-glass filament, in all its stages of manufacture, has its resistance per unit length *continuously* measured. There is no single piece of this conducting fiber in use which has not been measured several times before leaving the factory.

The filament, after it comes out of the insulating machine, is automatically cut into two-foot lengths. It is stored in tubes until required for the assembly of finished units. At such a time it is cut into lengths of approximately $1\frac{3}{4}$ inches and mounted in glass tubes with metal caps at each end.

HIGH-CURRENT UNITS

The situation with regard to resistance units intended for the dissipation of much energy, that is from one-half watt up, is very similar today to the problem of the grid leak as it was four or five years ago. There are on the market numerous "power resistors" which have the same lack of stability under heavy currents as the old grid leaks and coupling resistors used to have under light loads.

Engineers have been working several years on "power resistors"; but, until recently, they had found nothing which reached the high standards established by the filament type of high-resistance unit. They have at the present time a new power unit which meets every desirable quality. As this unit has many novel features, it will be described in a later paper, in detail. At present it is sufficient to say that they can be made to dissipate three watts and upwards, depending on the particular condition for which the resistance is designed; and are obtainable in all values.

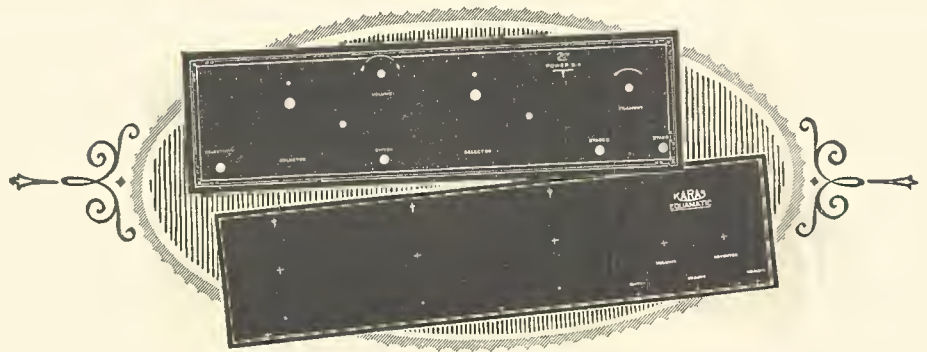

POWER SIX, KARAS, H. F. L.

ADDED to the list of handsomely Veri Chromed Formica kit panels are now the Bremer Tully Power Six, Karas Equamatic front and sub panels, H. F. L. Nine in Line Superheterodyne with sub panel, Victoreen Universal single dial control. There are also Infradyne 7 x 28, and 7 x 30, Aerodyne, St. James 8 tube, Bremer Tully Counterphase, Browning Drake National, Madison Moore Superheterodyne, Camfield Duoformer. They are sold by leading jobbers and dealers.

Special panels cut to size and Formica tubing are also available for Amateurs.

THREADED TUBING FOR MANUFACTURERS

Single dial control is making evenly balanced inductances necessary. Formica threaded tubing permits turns of the same diameter evenly spaced apart. A large equipment for threading tubing is now in operation at the Formica plant, giving manufacturing customers prompt service on their requirements.



The FORMICA INSULATION COMPANY
4618 SPRING GROVE AVENUE

CINCINNATI, OHIO

Hear the FORMICA
Orchestra Tuesday
9 to 10
over WLW

FORMICA

Formica has a
Complete Service on
Insulating Material for
Radio Manufacturers

VICTOREEN

**In Super Sets Means
Volume Selectivity and
Satisfaction**



VICTOREEN RHEOSTAT
Zero temperature coefficient. Increased number of turns of wire. Third terminal to simplify wiring. Five resistances—2, 6, 10, 20, 30 ohms—\$1.20 ea. Victoreen Potentiometers—200, 400 ohms—\$1.50 each.



Victoreen R-F Transformers
Tuned to a precision within one-third of one per cent—made by a pioneer radio manufacturer. Two types—No. 170 for use with regular tubes; No. 171 for dry cell tubes. Price \$7.00.



Audio Control Unit
Permits minimum number of panel controls and consists of 3 rheostats of proper ohmage mounted on the bakelite base. Controls the second detector and audio tubes. Use Type 3-R for 201 A tubes. Use Type 3-R-1 for power tube. Price—\$4.50 each.



MASTER CONTROL UNIT
This one dial unit has been so constructed that by means of compensator controlling the antenna condenser, adjustment is permitted up to a 20 degree variance in capacity, with a 360 degree vernier motion. Used in circuits employing two or more condensers of the same capacity. Easy to mount—no change in wiring necessary. Two condenser type Price \$19.50 Each additional condenser Price \$4.5

The George W. Walker Co.
6528 Carnegie Avenue Cleveland, Ohio
Merchandisers of Victoreen Radio Products

A German Portable Superheterodyne

(Continued from page 1108)

greatest difficulties experienced with a superheterodyne is the *harmonic* interference, due in most cases to interaction between the oscillator and the intermediate-frequency circuits. The protection offered these circuits is seen then to be of the utmost importance.

Another notable feature is the antenna coupling adjuster. This is a variable condenser connected in the loop aerial circuit (C in Fig. 2) which allows an increase or a decrease in the effective damping, thus providing an excessively sharp-tuning set when it is desired. This condenser is mounted on the rear sub-base inside the set, as it is not instrumental in the tuning operations. It need not be touched after having been once adjusted to suit local requirements.

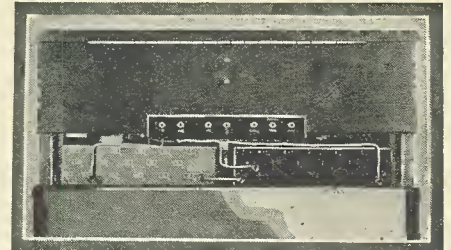

Fig. 4. The rear of the cabinet, showing the two-volt "A" battery and the 90-volt "B" battery.

The whole circuit is so well stabilized that setting the potentiometer, which is employed for varying the voltage on the grids of the radio frequency tubes, also becomes an inconstant operation. Therefore, like the coupling condenser, it is mounted inside the set.

The radiation of energy from this set is negligible; so that there is no possibility of interfering with the operation of neighboring receiving sets. In the first place, energy can radiate from the loop aerial only, the set being shielded; and, in the second place, whatever energy might leave the aerial is always at least 7½% out of tune with the received wave.

The circuit diagram of the receiver is given in Fig. 2. It is of a conventional type, with the possible exception of the oscillator circuit, which is of a type that has only recently come into use in this country in connection with superheterodynes. The coil L3 is a radio-frequency choke.

A THREE-TUBE SET COVERING A WIDE RANGE

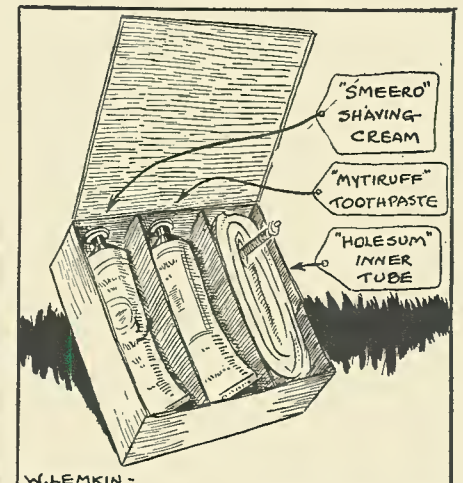

Copper Shielding

Gives better reception
— closer selectivity and
finer tone quality.

Sheet copper combines
higher conductivity with
easy working qualities.

**COPPER & BRASS
RESEARCH ASSOCIATION**
25 Broadway — New York

NEW INFRADYNE KIT
ALL GENUINE PARTS IN STOCK NOW!
FREE WHOLESAL CATALOG
Listing thousands of new radio parts, kits, furniture, accessories and complete radio sets, at prices that save you money. Write for your copy now, it's free.
THE HARCO CO., 1253 S. Wabash Ave., Chicago, Ill.

FIRST CLASS TRICKLE CHARGER \$250
IN U.S.A.
When Cash Accompanies Order. Complete parts & 1 ft. extension cord—nothing else to buy. Simple instructions, screwdriver, pliers and 30 min. work. Guaranteed to work on any A.C. socket.
X-L RADIO SALES, Dept. RN
2424 Lincoln Ave., Chicago, Ill.

What Is the Best Loud Speaker and Why?

(Continued from page 1107)

duces the bass and low baritone notes, while the conical (pointed center) portion reproduces the upper baritone and soprano notes. The writer was certainly very much surprised when he first tried this cone and especially when he heard the voice reproduction. Almost any cone speaker will sound fine, as long as a violin or bass viol is playing; but an uncanny effect is produced when the announcer starts to talk.

As I have mentioned before, it is of course frequently the case that the cone is being operated with a poorly-designed set, or perhaps it is not getting enough power, or else it needs the introduction of a choke coil and condenser into the circuit feeding the cone from the last stage jack. The diagram for this connection of the cone speaker has been published so many times that it needs no repetition here, and

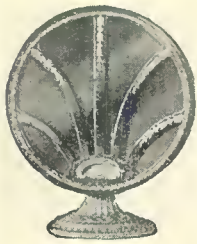

Fig. 3

There are dozens of cone speakers on the market, each of which seems to have some little advantage or merit of its own; but the one here shown, and recommended by the author from among several which he has tested, not only possesses the unusual faculty of bringing out and emphasizing the bass and baritone notes, but it is so designed that the smaller section of the cone emphasizes the high notes. Photo courtesy Reichmann Company

the experts in the radio stores will tell you all about it. Figs. 8 and 9 illustrate two output transformers or filters which the writer has found to improve the quality of reproduction a great deal.

The first picture shows a very fine model of horn speaker which the writer has been using in his experiments for over a year in connection with various cones. One of the good points about this speaker is the fact that the horn is non-metallic. It is made of molded bakelite, about 1/4-inch thick, and has a considerable axial length, sufficient to give a fairly good reproduction of the baritone and bass notes of the musical scale. As Prof. Miller and others pointed out long ago, the horn itself must not vibrate; only the air column within it. This speaker has also a controlled mica diaphragm; the design of the talking unit being such that a push-pull action on the diaphragm is obtained. This speaker is the best the writer has ever tried out for use

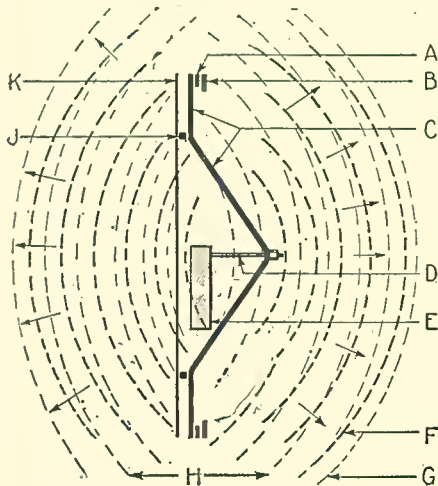
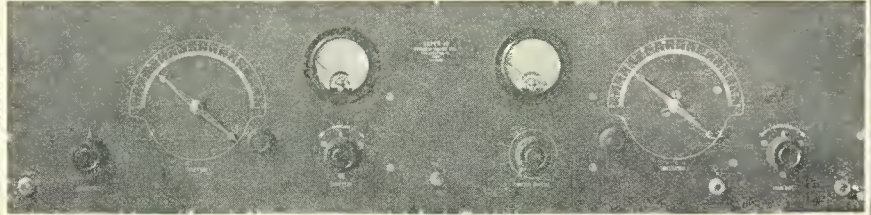

FIG. 4

Diagram above shows how both bass and treble sound waves are created and brought out by the large and the small vibrating sections of the dual-type cone speaker pictured above.

Norden-Hauck Super-10 AROUND THE WORLD WITH THE U. S. NAVY



Panel size, 36"x9"x1/4" Super 10-tube Standard Admiralty Model

Weight: 55 lbs.

A SUPER-10 has been installed on board the "U. S. S. Wright," now sailing for Asiatic waters with the U. S. Aircraft squadrons. This receiver will also be used for entertaining civilian representatives at various ports of call.

A New and Advanced Model Highest Class Receiver in the World

THE NORDEN-HAUCK SUPER-10 is an entirely new and advanced design of Receiver, representing what we believe to be the finest expression of Modern Radio Research Engineering. It is the product of years of experience devoted exclusively to the attainment of an ideal Broadcast Receiver—regardless of cost.

Results obtained in every respect will upset all your previous ideas of good radio reception. The unusually large number of unsolicited testimonials constantly being received from users—concerns and individuals of international repute—indicates the absolute superiority of the NORDEN-HAUCK SUPER-10.

You, too, may enjoy the advantages of this wonderful receiver at a surprisingly moderate cost. Here are only a few of the host of features that place the NORDEN-HAUCK SUPER-10 far in advance of competition.

- 10 tubes employed to give perfect reproduction with unlimited range and volume power.
- Simple to operate, having only two major tuning controls.
- No Harmonics. Signals are received only at one Point.
- Super selectivity on all wave lengths.
- Special Power Audio Amplifier, operating any loudspeaker and eliminates necessity of external amplifier.
- Built to Navy Standards.
- Can be operated directly from house current with socket power devices.
- Wide wave length range without change of coils, 200-550 meters full. (Adaptable 35 meters to 3600 meters if desired.)
- Thoroughly shielded at all necessary points.
- Use Loop or Antenna.

Complete Price List for Socket Power Operation

| | |
|---|----------|
| 1 Norden-Hauck SUPER-10, completely constructed and laboratory tested | \$307.00 |
| *1 Heavy-Duty 200 V. "B" Eliminator and Tube, 50/60 cycle A/C 110 V. | 42.50 |
| 1 Automatic "A" Power Supply, complete | 29.50 |
| 10 Tested Tubes, including Power Tube | 22.50 |
| 1 Western Electric Cone Speaker, 540AW or Farrand Sr., and Plug, | 32.60 |
| 1 Set Antenna Equipment, complete | 5.00 |
| 2 "C" Batteries | 2.00 |

TOTAL COST OF ALL ITEMS—NOTHING ELSE REQUIRED...\$441.10

* 25/30 cycle A/C current, \$47.50.

PROMPT EXPRESS SHIPMENTS NOW BEING MADE.

Tear off and mail today

Upon Request complete literature attractively illustrated, will be gladly mailed without charge, or full size constructional blue prints, showing all electrical and mechanical data, will be promptly mailed postpaid upon receipt of \$2.00.

Write, Telegraph or Cable Direct to

NORDEN-HAUCK
Incorporated
ENGINEERS
MARINE BUILDING
Philadelphia, U. S. A.

NORDEN-HAUCK, Inc.
Philadelphia, U. S. A.

Gentlemen:—

Please send me without cost or obligation on my part, attractive illustrated literature describing the new Norden-Hauck Super-10.

I enclose \$2.00 for which please send me, postpaid, complete full size constructional drawings, and all data for building the Super-10.

Name.....

Address.....



FREE

RADIO CATALOG

100,000 RADIO STOCK

OUR NEW 1927

RADIO CATALOG

100 PAGES OF RADIO BARGAINS

BEFORE you build or buy a radio be sure to consult our new 100 page catalog—sent to you free. All the latest kits, accessories, and parts—a million dollar radio stock to choose from.

We Save You Money

We handle only brand new apparatus—standard makes that are fully guaranteed. QUANTITY sale of QUALITY parts explains our low prices. Compare with others and see why thousands of fans look to us as radio headquarters. Write for your copy of this new catalog today.

CHICAGO SALVAGE STOCK STORES
 509 S. STATE ST. Dept. RN CHICAGO, U. S. A.

WE NOW SELL RADIO PANELS

We guarantee these panels to be perfect, factory-cut and edges true and smooth. There are many kinds of panels but old-timers know that nothing equals FORMICA.

| | |
|--|--|
| 7"x18"x3/16"—\$2.50 Black, Mahog. or Walnut color. | 7"x26"x3/16"—\$3.65 Black, Mahog. or Walnut color. |
| 7"x21"x3/16"— 2.75 Black, Mahog. or Walnut color. | 7"x28"x3/16"— 3.85 Black, Mahog. or Walnut color. |
| 7"x24"x3/16"— 3.15 Black, Mahog. or Walnut color. | 7"x30"x3/16"— 4.00 Black, Mahog. or Walnut color. |

Shipped POSTPAID anywhere in U. S. If you order both a Panel and Cabinet from us deduct 25 cents from above prices, as we will ship both together by Express collect.

We now make a beautiful Radio Table with genuine mahogany or walnut top rubbed to a piano finish. Has turned legs, battery compartments, etc.

Of course you know that we make the Iveyline, Piedmont and Carolina Radio Cabinets.

SEND FOR OUR FREE CATALOGUE.

The SOUTHERN TOY COMPANY, Inc., Hickory, North Carolina

RADIO NEWS

BLUE-PRINTS!

You can obtain a complete set of Blueprints for these Receivers Direct from RADIO NEWS

| | |
|--|--------|
| THE ULTRA-5 RECEIVER Radio News Blueprint Article No. 13..... | \$2.25 |
| THE SAMSON R.F.C. RECEIVER Radio News Blueprint Article No. 11..... | \$2.00 |
| THE PHASATROL-BALANCED T.R.F. RECEIVER Radio News Blueprint Article No. 12..... | \$1.50 |

Order direct from RADIO NEWS
 53 Park Place, New York, N. Y.

Mention Name of Receiver and Article Number

on small dry-cell sets, using three or four tubes of the UX-199 type; as it gives surprising volume with a very slight amount of current variation.

Of course there are plenty of good horn speakers on the market, and also many fine cone speakers. You should go to your radio dealer and hear a number of speakers before you decide to buy one; and when you do so, you should pay particular attention to a horn speaker, to see that it reproduces the bass notes fairly well. On the other hand, when buying a cone speaker, note particularly how it reproduces the higher musical notes, such as upper baritone and tenor voices.

Another graphic chart is shown (Fig. 6) which will help to make clear just why it is quite impossible, for a speaker with a short horn or of small diameter, if of the common cone type, to reproduce bass and baritone notes with any degree of fidelity. Looking at this graph in Fig. 6, we see a wavelength of 35 feet represented graphically, this corresponding to the lowest note from the bass viol, as shown by the frequency chart (Fig. 1). Theoretically and also practically, if you care to reproduce this lowest bass viol note with full intensity, you will require a horn 35 feet or more in length. The Victor people, in their experiments with the orthophonic horn, have actually built a folded horn of this type, with an axial length of 40 feet, a photograph of which is reproduced in Fig. 7.

EXPONENTIAL SUPER-HORNS

Some of the questions that arise in the average person's mind, when he thinks of a 40-foot horn being used to sound this low bass note, are: How about the higher notes up in the tenor and soprano ranges? How does such a horn manage to resonate

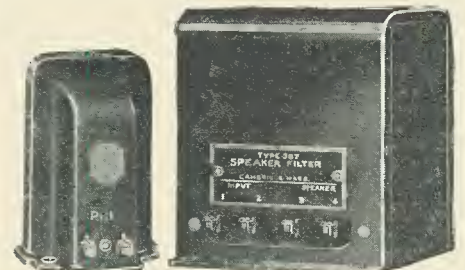

Fig. 8 Above are shown junior and senior models of loud-speaker filters. These filters keep the battery current out of the loud-speaker circuit, and prevent blasting and "hard" music.

Photos courtesy General Radio Co.

such a high-frequency, short-wave note? It might seem off-hand, perhaps, that such a horn could not handle a high soprano note, such as high C; but strange to relate, when the horn is mathematically worked out as to its curves and progressive "exponential" increase in size (such as we find in the case of the orthophonic horn), all of the notes are resonated or sounded equally well. It is hard to realize that one horn six or even fifteen feet long can reproduce all these different frequencies with equal efficiency and quality; but as the old saying goes, "the proof of the pudding is in the eating." If you have never heard a talking machine fitted with an orthophonic horn, you owe yourself a great musical treat; and the first time you have an opportunity, you should certainly visit some local phonograph dealer and have one demonstrated. Only then will you be able to realize what you have been missing with the ordinary phonograph.

Incidentally, it is interesting to note from a scientific point of view that when the orthophonic horn, six feet or more in length, is used with an ordinary needle soundbox to pick up the voice from the new electrically recorded disks, a greater volume than was ever heard from an ordinary phonograph of the old type is at once

realized. This means a great deal in the future development of radio loud speakers; for we at once see that, if we ever reach the point where orthophonic horns or their equivalent become available to the radio manufacturer, he will have only to add a small loud-speaker unit of good design, such as the orthophonic unit or its equivalent. Then the music will roll forth in sonorous volume and with a quality that has never been realized until the present day, except by those who have sat in the presence of a symphony orchestra.

THE OCTAVES IMITATE THE FUNDAMENTAL

The question has often been asked the writer, how can a small horn ever possibly reproduce a bass note, or even make an attempt at it? Fig. 6 will help to show how this is possible. Practically all musical sounds are rich in harmonics: i.e., they are built up of a number of different frequencies, which are multiples of the one pronounced or predominant frequency, which is called the fundamental. It is this fundamental frequency, or tone, which we hear most strongly, in the case illustrated in Fig. 6; but, as we look at this diagram, we see that the second harmonic is of a different frequency (it is exactly an octave above the fundamental). This is where the small horn gets its chance to give forth a sound (or, specifically speaking, a partial sound) taking on the nature of the true fundamental-tone frequency. Suppose the bass viol sends forth a note with a wavelength of 35 feet and that you have only an 8 3/4-foot horn to reproduce it; this horn will have to resonate this note on the fourth harmonic (second octave) which has a wavelength of 8.75 feet in air, as Fig. 6 shows. Suppose again you have only a short horn with an axial length of 4.37 feet; if the bass viol's lowest note, about 35-foot wavelength, is sounded, this little horn, 4 1/2 feet in length, will attempt to give you a sound something like the fundamental, by resonating at the partial frequency or eighth harmonic (third octave).

It is a case, as one can see, of "the tail wagging the dog." If you want to realize all the beauty of the great bass and baritone notes, which form the real background of practically all musical renditions, whether vocal or instrumental, you will have to do it in some other way than by using simply a single reproducing instrument, fitted with a small horn a foot or two in length.

From the above considerations, it is obvious why some of the principal cone-speaker makers have developed and are marketing large cones three to four feet in diameter. In the laboratories of one of these cone manufacturers, cones as large as ten feet in diameter have been successfully used; they give the tones of the voice very faithfully, not to mention the most wonderful musical reproductions. These huge cones, remarkable as it may seem, are effectively actuated by a small electro-magnetic unit, such as that employed in the small table cones with which we are all familiar. (An explanation of the "exponential" horn will be found in RADIO NEWS for April, 1926, page 1422—"The Passing of 'Canned Music,'" by Major J. S. Hatcher; and one of the nature of sound-wave propagation and its effects on the ear in RADIO NEWS for June, 1926, page 1662, "Audio - Frequency - Amplifier Transformers," by Sylvan Harris).

SNOBBISH!

"Make your set more select" is the headline of a "Wireless Corner" of one of the provincial papers. How is it done?—"Wireless," London.

PROLONGED ENJOYMENT

"Radiodilettanti" is the formidable term for Italian BCL's. Their sets are "radiori-civitori."

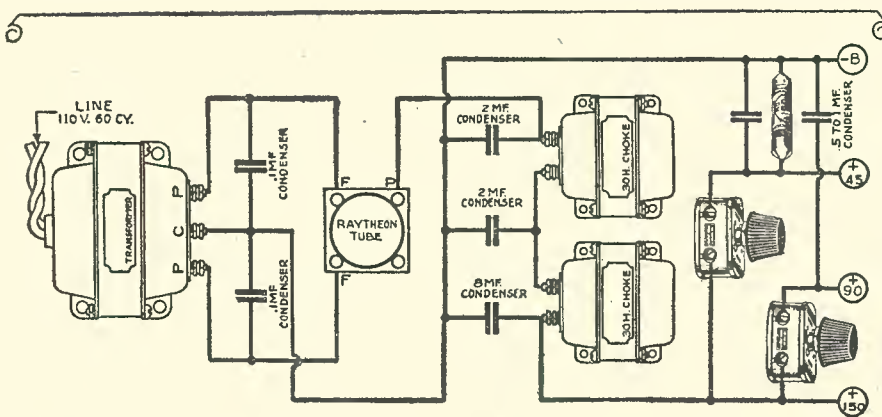

Improve Your B-Eliminator with Allen-Bradley Resistors

WHEN you build a B-Eliminator, be sure that your kit contains Bradleyohm-E for plate voltage control and Bradleyunit-A for the fixed resistors. Then you will be assured of perfect plate voltage control.

Bradleyunit-A

PERFECT FIXED RESISTOR

This solid, molded fixed resistor has no glass or hermetic sealing in its construction. It is a solid unit, molded and heat-treated under high pressure, that is not affected by temperature, moisture and age. The end caps are silver-plated, and can be soldered without affecting the accuracy of the Bradleyunit. By all means, use Bradleyunit-A when you need a fixed resistor in your radio hookup.



Bradleyohm-E

PERFECT VARIABLE RESISTOR

This oversize variable resistor is used as standard equipment for accurate plate voltage control by leading B-Eliminator manufacturers. The scientifically treated discs in Bradleyohm-E provide stepless, noiseless, plate voltage control, and the setting will be maintained indefinitely. Ask for Bradleyohm-E.



Always insist that Bradleyohm-E and Bradleyunit-A are included with your B-Eliminator kit. You then will be assured of perfect voltage control.

ALLEN-BRADLEY COMPANY
287 Greenfield Ave. :: Milwaukee, Wis.

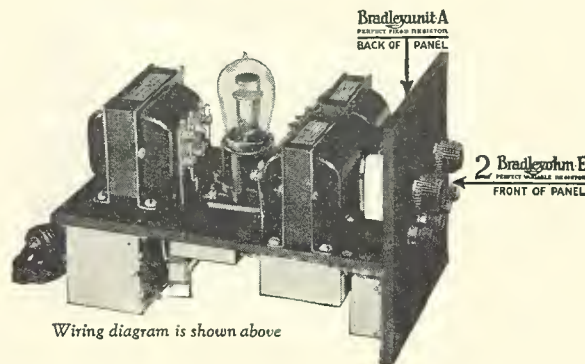

Write for Folder Giving Seven B-Eliminator Hookups.

Use Allen-Bradley Perfect Radio Devices

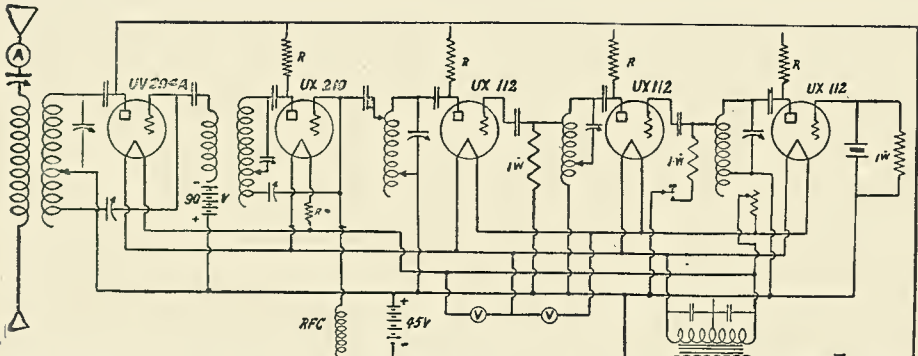

THIS Crystal Oscillator in this diagram is a UX112, controlled by a 320 meter crystal for 80 meter operation, or a 160 meter crystal for 40 meter operation. Assuming a 320 meter the first UX112 oscillates at 320 meters: The second UX112 at 160 meters. It also amplifies at this wave-length. The third UX112 oscillates at 80 meters. The UX210 acts as an amplifier. This last tube also acts as a driver for the 204A, which is tuned to the wave-length of the UX210. The plate supply comes from an "ESCO" Item No. 26.

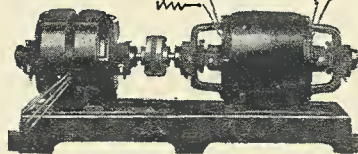

ELECTRIC SPECIALTY COMPANY

Mark "ESCO" Trade

211 South Street

Stamford, Conn., U. S. A.

Manufacturers of Motors, Generators, Motor-Generators
Dynamotors and Rotary Converters, for Radio and Other Purposes

Progress in Radio

(Continued from page 1129)

two or more electrically-connected concentric metal tubes, slidably mounted in relation to the windings so that the latter may be enclosed or shielded to a variable extent. In Fig. 1 is shown a single coil, 4, which may be used for tuning the aerial circuit or for filtering out undesired signals by means of

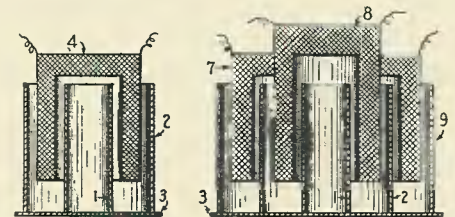

Tuned R.F. transformers, the inductance of which is varied by sliding the coils along the surfaces of metal tubes.

the slidable metal tubes, 1, 2, connected by a metal plate, 3. Fig. 2 shows a transformer coupling comprising coils 7 and 8 placed between the slidable metal tubes, 1, 2, 9, mounted on a plate, 3. In a modification, a coil open at both ends is provided with slidable shielding tubes at each end.—Wireless World



NATIONAL POWER AMPLIFIER

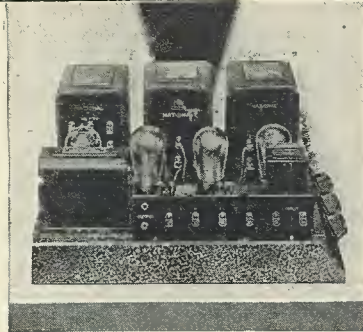

Gives any radio set true quality and fidelity of tone, with as great volume as desired. In addition, it supplies all B-current for the set and C bias for the power tube. Uses either Raytheon BH or Rectron full-wave rectifying tube.

Designed on sound engineering principles in collaboration with Arthur H. Lynch and James Millen. NATIONAL COMPANY, CAMBRIDGE, MASS., W. A. Ready, Pres., makes also B-Eliminators,

the famous NATIONAL Tuning Units with BROWNING-DRAKE Coils and Transformers, Impedafomers, Velvet-Vernier Dials, and Variable Condensers.

Send for bulletin 116-N3

The Construction and Theory of Wavetraps

(Continued from page 1127)

12a. We are again assuming the resistance to be zero. E_1 is the voltage impressed by the signal across L_1 , the small coupling coil. The current I_1 through this coil lags 90° behind E_1 , and is so shown in the vector diagram. The flux set up by L_1 is, of course, in phase with I_1 . The voltage E_2 , or $I_1 \omega M$, induced in L_2 , lags the flux by 90° as shown. The trap circuit current I_2 is in phase with E_2 , since circuit 2 is resonant to the interfering frequency. The voltage induced in circuit No. 1 due to I_2 is 90° behind I_2 , and is indicated by $I_2 \omega M$ on the diagram. This voltage is 180° behind I_1 , and hence is an IR reaction. The presence of circuit No. 2 thus not only reduces the amplitude of the resultant current flowing in

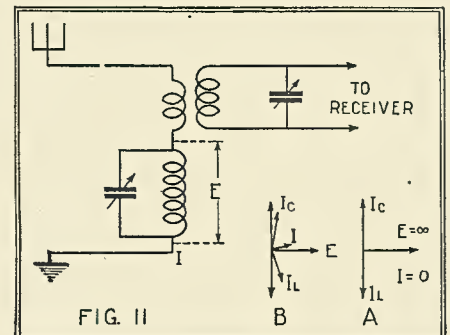

A diagrammatic illustration of the functioning of the type of wavetraps shown in Fig. 2.

circuit No. 1, but also changes its phase with respect to E_1 as shown in Fig. 12b. Notice that the resultant current is very small in comparison with the current that would flow if no filter were present. The current is not, however, zero; because the coupling between the trap and antenna circuits is not 100%. The case where the resistances of the circuits are not zero is reasoned out in much the same way, and will not be discussed.

Bradleyometer

THE PERFECT POTENTIOMETER

Uses graphite disc resistors which are noiseless and not affected by atmospheric conditions. Metal parts are nickel plated. One hole mounting. Finish and knob match Bradleystat. Made in 200 and 400 ohm ratings.

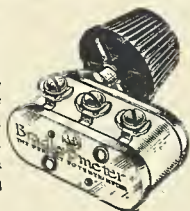

Allen-Bradley Co.

Electric Controlling Apparatus

287 Greenfield Avenue Milwaukee, Wis.

Yale GROUND HOG INCREASES POWER AND DISTANCE

Marvelous newly-invented ground gives incredibly improved reception. Doubles power and distance users say. Reduces leakage. Stops jangling even in midsummer. Results never before equalled. Satisfaction guaranteed or money back at once. Proven absolutely essential to clear, powerful distance reception. Draws and holds moisture indefinitely. Highly sensitive to radio energy.

HIGHEST APPROVAL
Approved by Radio News exhaustive laboratory test and endorsed by other high scientific radio authorities.
SEND NO MONEY—To introduce, we offer to those who act at once, regular \$5.00 size for only \$2.00. Send name today and pay \$2.00 plus 17c postage on delivery. Or send only \$2.00 with order and save postage. **FREE**—Full description of Ground Hog and details of amazing special low priced battery offer on request—write today. Yale Specialty Supply Co. 125 W. 5th St. Kan. City



THE FREQUENCY FACTOR

We will consider Fig. 9 next. The vector diagram for branch C is the same as Fig. 12a, with the exception that the branch is tuned to the desired signal instead of the interfering signal. The vector diagram for branch A is shown in Fig. 13, the resistance of the circuit again being considered zero. Diagram 13a shows the condi-

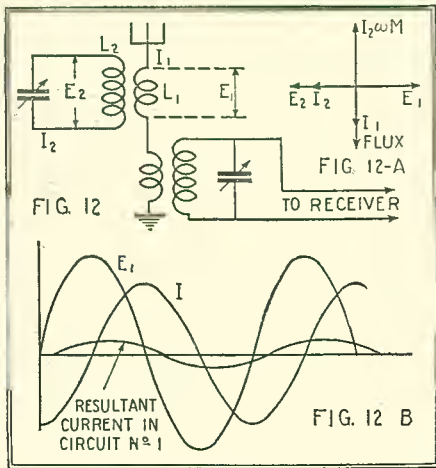

Illustrating the operation of the wavetrap circuit shown in Fig. 1.

tions for the desired frequency. Notice that the impedance of A for the desired frequency is zero. Now consider 13b where we have an interfering frequency greater than the desired frequency. There is now an appreciable impedance because the inductive reactance is greater than the capacitive reactance. The current, therefore, is smaller in amplitude than in 13a. Diagram 13c illustrates the same conditions for a frequency lower than the desired frequency.

SPARK INTERFERENCE

It was mentioned above that a wavetrap would not eliminate spark interference. Before this can be explained, it will be necessary to touch briefly upon the phase relations of currents and voltages in A.C. circuits. The two so-called "states" that exist in A.C. circuits are *transient* and *steady*.

The transient state, as a rule, exists only for a short time after the voltage is applied to the circuit. This is, however, not always true. Assuming an emf. of constant maximum amplitude and constant frequency, the relationship between the current and voltage that is established after a short interval of time is known as the steady state. Fig. 14b depicts this state for the circuit shown in 14a, assuming the switch S to be closed. Notice that Fig. 14a shows resistance in both the inductive and capacitive branches. This causes the inductive current

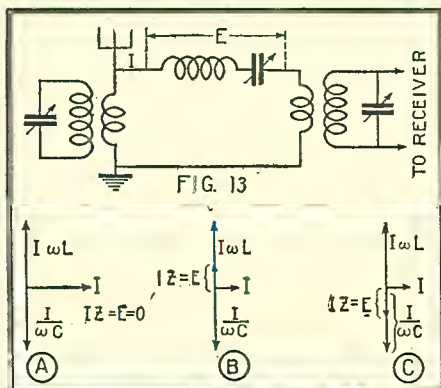

Indicating the electrical characteristics of the wavetrap circuit shown in Fig. 9.

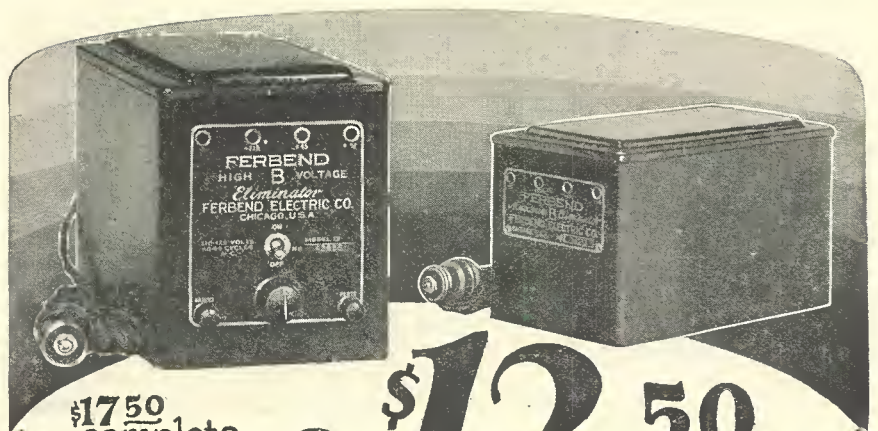

\$17.50 complete



\$12.50 complete

The Lowest Priced Quality "B" Eliminator

Livermore Falls, Maine. Have been using your Eliminator for a year and well satisfied with it as it gives good results and is free from any hum.
ELMER A. RIGGS.

Duluth, Minn. Your Eliminator has given me wonderful continuous service for the past year.
F. A. LOHMER.

St. Louis, Mo. Your Eliminator is wonderful. I am recommending it to all my patients as I think it a wonderful value.
DR. A. C. BURIAN.

Columbus, Ohio. Your Eliminator has been in service for a year and I am very well satisfied with it.
LEO C. SPRAGUE.

San Jose, Calif. Have had your Eliminator for a year and it has given perfect satisfaction.
W. S. SAWDEY.

Cleveland, Ohio. After nineteen months of service my Ferbend Eliminator is still giving excellent results and has stood up against much higher priced outfits.
R. ST. BARHOFF.

Beaver, Penn. I have been using your Eliminator for a year now and have wonderful results with it.
R. L. McCULLOUGH.

Corseana, Texas. One year ago I bought one of your Eliminators and have been very well pleased with it.
DR. HUBERT B. LOVE.

Aledo, Ill. The Eliminator I bought from you a year ago works fine.
WILLARD RUSE.

The moment you see the good Ferbend "B" Eliminator you understand why during its first two years of successful service it has made nearly 50,000 friends. "Singular Value" is written all over this fine instrument.

Outstanding Quality, however, is confirmed only through proof of lasting good performance—so we ask you to read the interesting endorsements reproduced here. They are only a few out of thousands—but actually your best means of verifying the information we give you.

How can we produce a Quality Instrument at a price so spectacular? Because we are pioneer specialists in the manufacture of "B" Eliminators—because every component part is designed, made and assembled under one roof—because our overhead is many times lower.

The Original Ferbend "B" Eliminator operates direct from your Electric Light Socket on 110-120 volt A. C. Lighting Circuit. Delivers up to 100 volts. Price \$12.50. The electrolytic method combined with full wave rectification gives results far superior to those obtained by any other method.

The New Ferbend High Voltage Model for extremely large sets and all sets using power tubes. Delivers up to 180 volts. One Control adjusts voltages on all taps. Price \$17.50.

Equal to the Best—at a cost less than half! Sooner or later you will purchase a "B" Eliminator. Why pay more?

Money-Back Guarantee

See Your Dealer—or Send Direct

Shipment made direct on receipt of price, or C.O.D. if preferred. Use for 10 days to convince yourself—if unsatisfactory write us within that time and purchase price will be refunded. Send Coupon TODAY.

FERBEND ELECTRIC COMPANY

425 West Superior Street

Chicago, Illinois

FERBEND "B" ELIMINATOR

FERBEND ELECTRIC CO.
425 W. Superior St., Chicago, Ill.

- Send \$12.50 model.
- Send \$17.50 model.
- Send at once. Payment enclosed.
- Send C. O. D. Send Literature.

Makers of the original and genuine



Name

Address

City..... State.....

Approved and passed by the rigid Laboratory Tests of the two foremost Radio Laboratories in America—Radio News and Popular Radio.

CeCo Tubes specified by John F. Rider for his Six Tube T.R.F. Set described in Radio News

“Hard” and “Soft” Detector Tubes

A Comparison of Their Characteristics and Respective Merit

By ROGER WILLIAMS*

A NEW HARD DETECTOR

There is a tube which not only is free from the above-mentioned disadvantages, which are inherent in the soft tubes, but also possesses distinct improvements over the regular all-purpose type of hard tube; namely, a special internal construction to prevent mechanical vibration of the elements, and a mutual conductance 25% greater.

In this tube we have a special detector built for its task, with the following features: non-microphonic, high input impedance, non-critical, sharp-tuning, quiet background, high mutual conductance, perfect stability, and maximum sensitivity consistent with these requirements.

This special tube may be substituted

The article featured in January Radio News, page 815-B, under the above title referred to—



Type “H” Special Detector

Reprints of this important article—and complete data of this new detector sent FREE on request. Address

C. E. MFG. CO., INC.,

Providence, R. I.

to lag somewhat less than 90° behind the applied voltage, and the capacitive current to lead the applied voltage by somewhat less than 90°. Due to the fact that the inductive and capacitive currents are not 180° out of phase, a resultant current flows in the circuit. This is, however, small as a rule, or more specifically when the values of R_1 and R_c are small.

The resultant current in this particular diagram is in phase with the applied voltage because the angle of lag of I_1 is equal to the angle of lead I_c . This, of course, might not be the case. In radio circuits I_1 would nearly always have the smaller phase difference, because R_1 is nearly always greater than R_c .

Now consider the circuit with switch S open. Suppose we close the switch at any particular time, and suppose the value of E at this time happened to be D, as shown in Fig. 14b. It is clear from the diagram that the steady-state values of I_1 and I_c for this value of emf. would be respectively F and G. When the switch is closed neither of the branch currents will have their steady-state

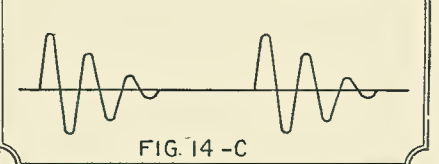
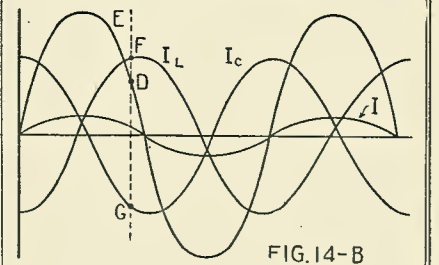
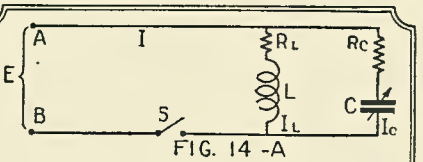

Illustrating Fig. 14-B the transient and steady electrical states of the trap circuit of Fig. 14-A, shown above, and the effect of spark interference, Fig. 14-C.

values. The inductive current must start from zero because of the electrical inertia of the inductance. The inductance tends to oppose a sudden inrush of current. The condenser current, on the other hand, will instantly rise to some finite value, and the direction of current flow will be such that the current wave is on the same side of the zero line as the emf. wave.

It will generally take several cycles for the branch currents to assume their proper amplitude and phase relations with regard to the applied voltage. During these several cycles the current passed by the circuit as a whole is large, much larger than I in Fig. 14b.

Now spark signals consist of a series of short-wave trains as shown in Fig. 14c. These wave trains are so short that the current in the trap circuit never has a chance to assume a steady-state value; hence the trap circuit always allows a large portion of the current to pass. This means, of course, that the interfering spark station is not eliminated.

RADIO IN A NUTSHELL

Mrs. Suburbia, displaying the new receiving set to admiring visitors. “It works like this, my dear. The aerial picks up the radio music, and it comes down inside the set, where some funny little things keep on condensing it and condensing it until the noise is small enough to work the loud speaker.—*News of the World, London.*”



Fred W. Stein.

Steinite

Greatest \$1 Value in Radio Today

INTERFERENCE ELIMINATOR

NO RADIO SET COMPLETE WITHOUT IT

Select stations at will. Especially necessary for 1 and 2 dial controlled sets. Under present conditions the average set fails to bring in the desired stations properly. The Steinite Interference Eliminator shuts out local and other interference. You get one station at a time, the one you want, and tune in loud and clear. Operates on any set—attach to aerial wire and to set—no changes—no extra tubes or batteries.

Over 400,000 Sold

New 1927 Model

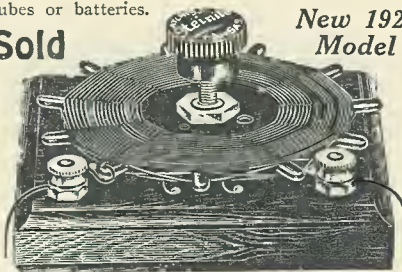

\$1 Postpaid If you are not delighted with results you get your dollar back

Improved Results with Tube or Crystal
Try entirely at my risk the wonderful improvement this inexpensive little device will make in the reception of your set. Improves results on both crystal and tube sets that use any kind of aerial except loop antenna. Clears up reception wonderfully, increases volume and partially absorbs static. Money-Back Guarantee.

MONEY BACK GUARANTEE Put this interference eliminator on your set and note amazing improvement. No tools needed—install in a moment's time. Connect with set and follow simple instructions. Money back promptly if not delighted. \$1 postpaid when cash with order. **ORDER TODAY**—a dollar bill will do. References: Exchange National Bank; Atchison Savings Bank.

The New Steinite 7-Tube Radio uses no batteries of any kind—only \$125. Loud Speaker Built in. Complete with tubes \$151 with nothing to buy. Operates from light socket 1e an hour. Write for descriptive literature before buying an expensive Battery Set. Also Steinite Long Distance Crystal Set \$6—6-Tube Battery Set \$45. **WRITE TODAY.**

STEINITE LABORATORIES, 402 Radio Bldg., Atchison, Kansas

LEARN THE CODE AT HOME

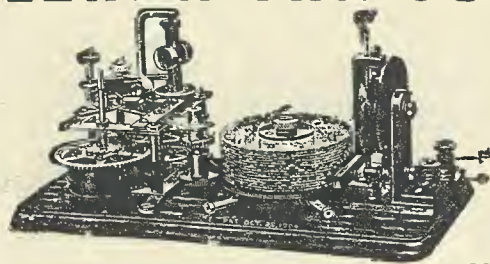

WITH THE OMNIGRAPH

THE OMNIGRAPH Automatic Transmitter will teach you both the Wireless and Morse Codes—right in your own home—quickly, easily and inexpensively. Connected with Buzzer, Buzzer and Phone or to Sounder, it will send you unlimited messages at any speed, from 5 to 50 words a minute.

THE OMNIGRAPH is not an experiment. For more than 15 years, it has been sold all over the world with a money back guarantee. The OMNIGRAPH is used by several Depts. of the U.S. Govt.—in fact, the Dept. of Commerce uses the OMNIGRAPH to test all applicants applying for a Radio license. The OMNIGRAPH has been successfully adopted by the leading Universities, Colleges and Radio Schools.

Send 6c for Catalog **DO IT TODAY.**
THE OMNIGRAPH MFG. CO., 15 HUDSON STREET, NEW YORK CITY
If you own a Radio Phone set and don't know the code—you are missing most of the fun

"On Short Waves"

(Continued from page 1136)

With the transmitting tube mentioned in the preceding paragraphs, however, a plate voltage of at least 1,000 volts will be required.

The construction of the R.F. choke coil is as follows: wind on a tube approximately 1 to 1½ inches in diameter, and approximately 6 inches in length, 150 turns of No. 28 D.S.C. wire. Fasten the two ends of the winding to two terminals, which should be rigidly clamped or bolted to the form. The tube or form should be of either bakelite or hard rubber.

The plate voltage employed with this type of transmitter should preferably be D.C., so that a pure C.W. note may be obtained. If only A.C. is available, then employ some efficient means of rectification, such as a full-wave kenotron system or a bridge-system chemical rectifier, with a suitable transformer to step-up the 110-volt A.C. to the required or desired plate voltage. Straight or raw A.C. may be used, the transmitted note corresponding to the frequency of the current impressed on the plate of the transmitting tube. The various methods of rectifying alternating current will be taken up in a future article; the efficiency, cost and other features of each system will be discussed in detail.

Meanwhile, those who have not as yet constructed a transmitter, or desire to rebuild their present one for effective short-wave operation, would do well to employ an arrangement similar to that shown in this article. The adjustment is extremely simple; the two variable condensers are simply turned until a resonance point is reached. This will be indicated by a sharp drop in the plate-milliammeter reading, and by a movement or increase in the radiation-ammeter reading. (The radiation ammeter should preferably be of the thermocouple type). If the wave emitted is higher than desired (say 50 meters instead of 40), simply rotate the condensers toward their minimum settings, or reduce the number of turns employed in the grid coil.

Inquiries about this transmitter or the apparatus employed in its construction, or concerning any other short-wave problem, should be addressed to the Editor, Amateur Section, RADIO NEWS, 53 Park Place, New York.

NEW QRA's

4JO—FRANK E. ORCUTT, x-8DDU, 2045 W. Church St., Orlando, Fla. QRK mi cw sigs on 40 es 80. Psc. OSL, crd 4 crd.

5ZAV—LE ROY MOFFETT, Jr., 223 East Fourth St., Oklahoma City, Okla. (incorrect in call book). Again on air with master oscillator (50 watts). Glad to QSO es QSR. Hw?

Five new 80-meter stations, all in Shreveport, La., as follows:

5FX—R. TRIMBLE, 618 Herndon Ave., 7½ watts.

5KH—DAVE EASTON, 214 Dalzell St., 5 watts.

5KZ—MALCOLM CLACK, 1535 Cresswell St., 5 watts.

5LF—BYRD HIGH SCHOOL, Line Ave., 7½ watts.

5WF—FRANK WATTS, 1716 Park Ave., 10 watts.

A DIAL READING



A B C
Light Socket Radio Power

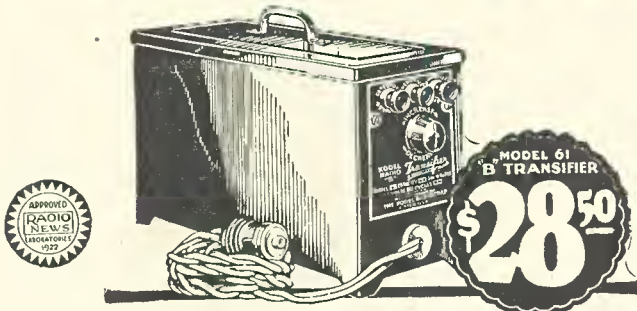

Kodol Transifiers

Operate any radio receiver direct from the light socket. Replaces all batteries. Absolutely no hum or noise—gives increased volume, a purer, richer tone. Will last indefinitely. See Kodol Transifiers at your nearest radio dealer or write direct for full information.

Five Efficient Models to Serve Any Set!

You may purchase exactly the Transifier to fit your needs. Models for all sets and all currents

- Model 15 "A & B"—4 or 6 volts "A" current, 22½ to 180 volts "B" current..... \$65.00
- Model 10 "A"—4 or 6 volts "A" current for sets up to 8 tubes..... 42.50
- Model 61 "B"—Radio's most popular eliminator for 5 and 6 tube sets 22½ to 180 volts..... 28.50
- Model 10 "B"—22½ to 180 volts "B" current; 4 to 12 volts "C" current—for any size set..... 42.50
- Model 63 "B"—for use on 110 or 220 volt direct current circuits—for any size set..... 25.00

Prices Do Not Include Tubes

The Kodol Radio Corporation,
CINCINNATI ~ OHIO

Complete Parts For Radio News
NAKKEN ULTRA-5
As Described in Radio News
ALSO
FREE New 1927 Catalog FREE
Shows photographs and hook-ups of all latest kits, complete line of cabinets and consoles, accessories and parts. We are headquarters for all nationally advertised lines. Dealers and professional set builders write today for your copy of this big FREE CATALOG. Use your letter head.
SHURE RADIO CO.,
19K-21 S. Wells St., Chicago

WEBSTER
"LITTLE GIANT B-C"
All A.C. Models Raytheon Equipped
Both B and C Current from the light socket. Marvelous results. Greater distance and volume. Improved reception. Ample power for the largest set. Five variable voltages..... \$50.00
Webster "Super B" three variable voltages. Price \$39.00
Webster Popular "B" Open type..... \$35.00
Direct Current Model 25.00
Write for free booklet "Improving Your Radio"
THE WEBSTER CO.
866 Blackhawk St., Chicago

Insure your copy reaching you each month. Subscribe to Radio News—\$2.50 a year
Experimenter Publishing Co., 53 Park Place, N. Y. C.

Supreme in
MUSICAL PERFORMANCE!

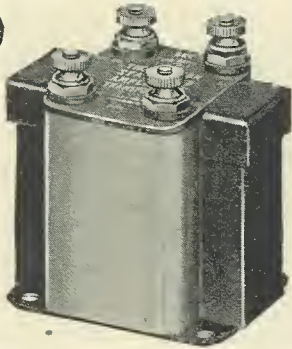

THORDARSON

Thordarson transformers are famous for their great tonal purity and are standard equipment on the majority of quality receivers. Unusually faithful reproductive powers. Ideally adapted for use with cone type speakers.

THORDARSON POWER COMPACT



The complete power amplifier foundation unit. Contains (1) a power supply transformer, (2) a center tapped filament supply for the power tube, (3) two 30 henry filter chokes, (4) two buffer condensers of 0.1 Mfd. each, — all in one compound filled case. Greatly simplifies wiring of complete power amplifier and B eliminator.

Type R-171 for Raytheon rectifier and UX 171 power tube, \$15.00. Type R-210 for UX 216-B rectifier and UX 210 power tube, \$20.00.

SEND FOR THIS FREE BOOKLET
POWER from the LIGHT SOCKET

THORDARSON ELECTRIC MFG., CO.
500 W. Huron St., Chicago, Ill.

Gentlemen: Please send me your booklet "Power from the Light Socket" describing power amplifiers using your new power compacts.

Name

Address3448-A

HEAR the wonderful
New Acme Speaker
at your dealer's.

ACME
for amplification



FREE RADIO GUIDE

Gives special hook-ups with illustrations. Shows the latest wrinkles and newest developments. Get what you need here at a big reduction. Everything in parts, kits, complete factory-built sets and supplies. Learn how to make your set up to date. Quick service. Write for free 164-page copy NOW; send names of other radio fans.

BARAWIK CO., 540-542 Monroe St., Chicago, U. S. A.

Insure your copy reaching you each month. Subscribe to RADIO NEWS — \$2.50 a year. Experimenter Publishing Co., 53 Park Pl., N.Y.C.

Radio News Laboratory

(Continued from page 1135)

VERNIER DIAL

The illuminated vernier "Glo-Dial" shown, submitted by the Wireless Radio Corp., Varick Ave. and Harrison Place, Brooklyn, N. Y., is of the back-panel mounting type and has a translucent dial, behind which is a small low-current electric bulb.



This is operated from the receiver's "A" battery and controlled by a special switch. A small attractive knob in front of the panel controls the operation of the dial, which can be used with practically any type of radio receiver; as provision is made for attaching it to almost any standard condenser.

AWARDED THE RADIO NEWS LABORATORIES CERTIFICATE OF MERIT NO. 1861.

POWER UNIT

The "B" and "C" power unit shown, submitted by The Sterling Mfg. Co., 2839-53 Prospect Ave., Cleveland, Ohio, operates from 110-volt A.C. house-lighting current and uses a "Raytheon B H" tube as rectifier. The apparatus supplies the necessary

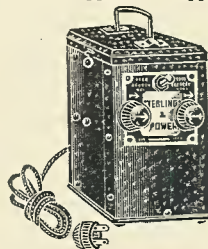

voltages for the plates and grids. Four terminals are provided for the "B" and two for the "C" leads. An interesting feature of this eliminator is that not only are the voltages for the detector and medium "B" adjustable, but also those for the two "C" taps. The current output is satisfactory and the operation is good.

AWARDED THE RADIO NEWS LABORATORIES CERTIFICATE OF MERIT NO. 1862.

PLUG

The plug shown, submitted by the Brooklyn Metal Stamping Corp., 718-728 Atlantic Ave.,



Brooklyn, N. Y., was found to be satisfactory both electrically and mechanically.

AWARDED THE RADIO NEWS LABORATORIES CERTIFICATE OF MERIT NO. 1863.

DIAL

The vernier dial shown, submitted by the Brooklyn Metal Stamping Corp., 718-728 Atlantic Ave., Brooklyn, N. Y., is of the vernier type. It has a



very neat molded frame and can be easily mounted on the panel of almost any receiver. The dial itself is provided with clockwise and counter-clockwise readings.

AWARDED THE RADIO NEWS LABORATORIES CERTIFICATE OF MERIT NO. 1864.

CONDENSER

The "Precision" filter condenser shown, submitted



by the Precision Coil Co., 209 Centre St., New

CARTER

"Midget" Rheostat
with
Filament Switch



\$1

Furnished in 11 different resistances

The Two P's

One is the Pioneer, the originator, the man with the vision, who dares, who risks, that his fellowmen may be richer for his efforts. The other, the Pirate who steals the brain child of the Pioneer and offers his infamous copy, as something "just as good" pleading as his excuse a lower price—but the copy is never the original and is dear at any cost. Ask for Carter products by name—there are no better values.

Any dealer can supply

In Canada: Carter Radio Co., Limited, Toronto.

CARTER RADIO CO.
CHICAGO

NION FIXED-RIGID DETECTORS



Have built over 50 sets including 3-4 tube Grimes and used NION without a single failure. On straight Regenerative and R. F., I omit Grid Leak and connect 22:1-2 volts tap to crystal improving tone 100 per cent without affecting volume or distance. I have found no other so dependable. Sincerely, H. Peigh, 647 N. Lawndale, Chicago.



TOP NOTCH

RECEPTION AT
EVERY POINT
GUARANTEED

50c At Your Dealers
or by Post

KEYSTONE PRODUCTS CO.
304 Gardenia Ave., ROYAL OAK, MICH.

Manufacturers'
Representatives
wanted everywhere

Box 64

RADIO NEWS
53 Park Place, N. Y. City



UX POWER TUBES installed in any set without rewiring by Na-Ald Adapters and Connectorals. For full information write Alden Manufacturing Co., Dept. K-26, Springfield, Mass.

York City, N. Y., is designed for use in audio filters in connection with "B" battery eliminators, and will stand relatively high voltages. Different sizes are available.

AWARDED THE RADIO NEWS LABORATORIES CERTIFICATE OF MERIT NO. 1865.

RHEOSTAT

The "Kelford" air-cooled rheostat shown, submitted by the American Specialty Co., Bridgeport,



Conn., is of the one-hole-mounting type; and its bakelite base is gear-shaped, so that it comes in contact with the resistance unit over only a very small surface, thus causing efficient cooling. The arm makes a good contact in any position.

AWARDED THE RADIO NEWS LABORATORIES CERTIFICATE OF MERIT NO. 1866.

MIDGET CONDENSER

The midget condenser shown, submitted by the

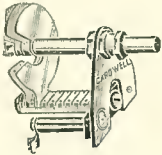

Allen D. Cardwell Mfg. Corp., 81 Prospect St., Brooklyn, N. Y., is sturdy and compact. It has a maximum capacity of approximately 20 mmf. and extremely low minimum.

AWARDED THE RADIO NEWS LABORATORIES CERTIFICATE OF MERIT NO. 1868.

HOOK-UP WIRE

The "Alpha Colored Rubber" flexible hook-up wire shown, submitted by the Alpha Radio Supply Co., 621 Broadway, New York City, is rubber-



insulated, flexible, stranded, tinned-copper wire. The rubber insulation, which is available in different colors, does not stick to the copper, thus enabling easy soldering.

AWARDED THE RADIO NEWS LABORATORIES CERTIFICATE OF MERIT NO. 1873.

FIXED CONDENSER

The "Tinytobe" Condenser shown, submitted by the Tobe Deutschmann Co., 11 Windsor St., Cambridge, Mass., is a small fixed condenser, 1 1/8 x 3/4 x 3/16 inches in size, which can stand a relatively



high voltage and is available in capacities from .0001 to .02-mf. It is so light that it can be soldered directly in the circuit without any other support.

AWARDED THE RADIO NEWS LABORATORIES CERTIFICATE OF MERIT NO. 1874.

AERIAL

The "G C"-aerial shown, submitted by the Gilcrest Co., 2052 Market St., San Francisco, Calif.,

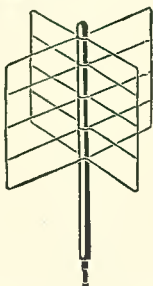

consists of two 24-inch square frames, made of No. 4 copper wire. Three horizontal wires, equally spaced, are soldered to the vertical sides of the

The 2 ampere Tungar will Trickle Charge, too!

Trickle charge a 6 volt battery from one post. Give it a full charge from another. The 2 ampere Tungar charges ALL radio "A" and "B" storage batteries—and auto batteries also. It's a simple matter of connection. Just look at this diagram.

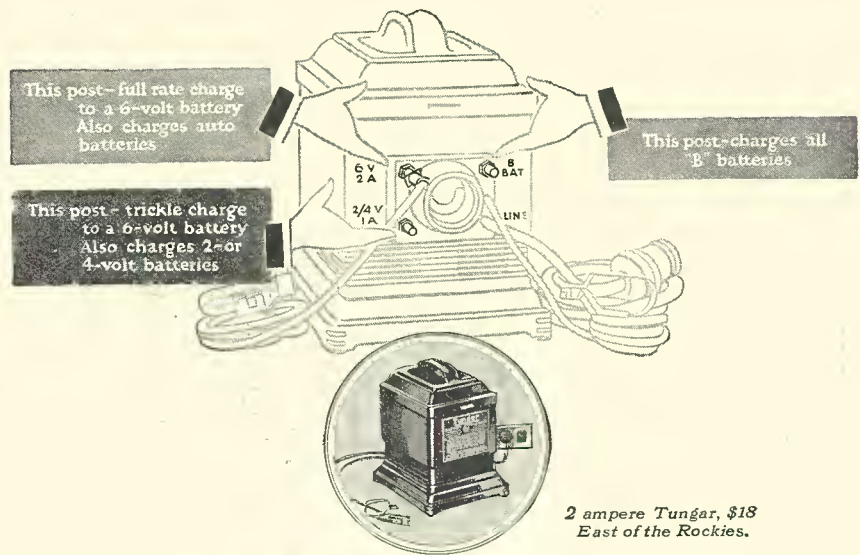

Merchandise Department
General Electric Company
Bridgeport, Connecticut

Tungar—a registered trademark—is found only on the genuine. Look for it on the name plate.

GENERAL ELECTRIC

Dealers!
Set Builders!

Write for

CHI - RAD'S

FREE RADIO CATALOG

Lowest Market Prices
Standard Advertised Lines
Complete Stock Quick Service

Be Sure to Use Business Letterhead
When Answering

CHICAGO RADIO APPARATUS CO.,
415 S. Dearborn St., Dept. RN., Chicago

Bradley-Amplifier Resistance-Coupled PERFECT AUDIO AMPLIFIER

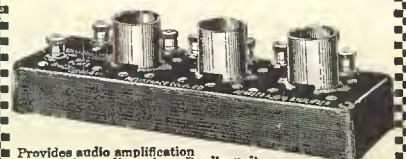

Provides audio amplification with minimum distortion. Bradleyunit molded resistors used in the Bradley-Amplifier do not vary with age and are not affected by atmospheric conditions. Can be used to replace transformer amplifiers in standard radio sets with decided increase in tone quality.

Allen-Bradley Co.

Electric Controlling Apparatus
287 Greenfield Avenue Milwaukee, Wis.

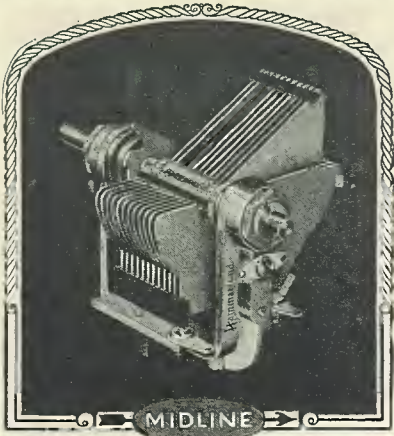

**Chosen by Experts
Throughout the World**

Hammarlund Condensers and Coils embody distinctive features which make for supreme efficiency.

Twenty-eight leading designers have officially specified Hammarlund Precision Products for use in their newest circuits.

**HAMMARLUND PRODUCTS
Are Used in These
1927 Receivers**

- Haynes "DX2 Multi-valve"; La-cault "LRA";
- Cockaday "LC27"; Browning-Drake;
- Sargent "Infradyne"; Morrison "Varion";
- Pacent "Ultimax"; St. James Super;
- Victoreen Super; New Harkness; Henry-Lyford; Carborundum Super;
- Loftin & White; Hammarlund-Roberts "Hi-O";
- Popular Science Monthly "Powerful"; "World's Record" Super.

We shall be pleased to refer to the proper authorities any inquiries regarding the above circuits.

HAMMARLUND MFG. CO.
424-438 W. 33rd Street, New York City

**For Better Radio
Hammarlund
PRECISION
PRODUCTS**

6 Volt

**STORAGE
RADIO
"A" BATTERY**

\$5.00
C. O. D
Send No Money

Most amazing battery value ever offered! A genuine World-volt Radio "A" Battery with 25 ampere capacity for only \$5! It is just the thing for Trickle charger. Famous World Quality assured. Equipped with

Solid Rubber Case

An assurance against acid and leakage. Order shipped same day—subject to your examination on arrival. Extra offer: 5% discount for cash in full with order. **ACT TODAY!**



World Battery Company
1219 S. Wabash Ave. Dept. 110 Chicago, Ill.

square. The two frames are fixed to the wooden supporting rod by means of U-shaped washers and wing nuts. The antenna is provided with a Fahnestock clip for the lead-in wire. Tested with a relatively short lead-in wire, the antenna has been found to be satisfactory, especially with regard to sharp tuning and separating stations in the metropolitan area.

AWARDED THE RADIO NEWS LABORATORIES CERTIFICATE OF MERIT NO. 1320.

LEAD-IN CONNECTOR

The lead-in connector shown, submitted by Leslie F. Muter Co., 76th and Greenwood Ave., Chicago, Ill., is made of a 15-inch soft copper strip covered



with insulating tape and impregnated with paraffin. AWARDED THE RADIO NEWS LABORATORIES CERTIFICATE OF MERIT NO. 1820.

AUTOMATIC FILAMENT CONTROL

The "Muter Fixed Rheostat" shown, submitted by Leslie F. Muter Co., 76th and Greenwood Ave., Chicago, Ill., is constructed with a resistance wire



which is sealed in a glass tube. It is designed to work in series with the filaments of the radio tubes to insure the proper amount of current.

AWARDED THE RADIO NEWS LABORATORIES CERTIFICATE OF MERIT NO. 1821.

AERIAL KIT

The "Aero Complete Aerial Kit" shown, submitted by Swan-Haverstick, Inc., Trenton, N. J.,



comprises 100 feet of antenna wire, fifty feet of lead-in wire, a lightning arrester, some insulators and the other miscellaneous articles necessary for putting up an antenna.

AWARDED THE RADIO NEWS LABORATORIES CERTIFICATE OF MERIT NO. 1826.

JACK

The "BMS" jack shown, submitted by the Brooklyn Metal Stamping Corp., 718-728 Atlantic Ave.,



Brooklyn, N. Y., is sturdy and provides very good contact between the springs and plug. The insulation is of high quality.

AWARDED THE RADIO NEWS LABORATORIES CERTIFICATE OF MERIT NO. 1832.



"Your house is on fire!"
"Oh, no! The wife has just tuned in Pittsburgh, that's all."



**30 Days
FREE TRIAL**

New One Dial Radio

NOW! Westingale offers the last word in Radio. One Dial control—lowest factory prices—30 Days' Trial—Money Back Guarantee. Why not have the NEWEST Radio? Why pay high prices? Why take chances when you can put a New 1927 WESTINGALE in your home for 30 Days' Trial on the absolute guarantee that if you don't find it the biggest and best value you have ever seen—You Don't Have to Keep It.

Westingale 5 tube sets—One or Two-Dial Models are most beautiful and powerful sets made—and easiest to operate. Music, Sports—market reports from Coast to Coast on loud speaker. Newest two-tone period style cabinets with Renaissance design on front panel embossed in dull gold.

5 Tube—2 Dial \$47.00
5 Tube—1 Dial 57.00

Agents—Dealers
Your own Radio Free. Get demonstrator set and make \$100 a week easy. Full or spare time. Big discount on first set placed in each locality. Be first—write today for dealers' discount and full particulars.

Unbeatable for appearance, performance or price. Don't buy any radio until you send for our FREE 1927 Catalog which pictures and describes these two last minute models, and get our liberal 30 Days' Trial Offer.

Westingale Electric Co.,
Dept. 179
1751 Belmont Ave., Chicago

**Changes Your Set Into
a Low Wave Receiver**



Sent postpaid upon receipt of \$15 M. O.—or C. O. D. plus postage. State name of set and type of tubes you use.

SUBMARINER



Converts any set, regardless of make or number of tubes used, into a high class low wave tuner, with which you may experience the thrill of listening to voices from all parts of the world on low wave lengths. No changes necessary to your present set.

**EVERYWHERE
A SENSATION**

No jumble of stations on low waves—no disagreeable noises—practically no static. Learn code by listening to amateurs from all parts of the world. Comes ready to attach; no extras needed. Just plug in and you have command of the low wave lengths. Operates as a wave changer in superheterodynes. Connected and disconnected instantly. Order today.

ORDER TODAY

WE GUARANTEE TO REFUND YOUR MONEY IF THE "SUBMARINER" FAILS TO OPERATE.

J-M-P MANUFACTURING COMPANY
Dept. 115X MILWAUKEE, WISCONSIN

**OUR SPRING CATALOG IS
READY FOR FANS AND
SET BUILDERS**

Radio's newest developments are listed in this great book—even greater than in the Fall issue. Send today for your free copy. You'll find new radio joys.

Specify Catalog B-8

HAMPTON-WRIGHT

P. O. Box 181 Indianapolis

Insure your copy reaching you each month. Subscribe to **RADIO NEWS**—\$2.50 a year. Experimenter Publishing Co., 53 Park Pl., N.Y.C.

The New Loftin-White Constant-Coupling Circuit

(Continued from page 1109)

quency to build up an amplitude out of proportion to the other broadcast frequencies in the grid circuit. Such adding-up does occur in receivers employing circuits like Fig. 1, producing serious signal distortion. Too much feed-back causes the grid circuit components to oscillate of their own accord; and oscillation in a tuned R.F. receiver is ruinous, as it produces distortion and uncontrollable squealing when stations are tuned in. Condenser C_2 prevents both the distortion and squealing.

In Fig. 3 the graph, A, is intended to represent the alternating voltage in the grid circuit at the frequency with which the grid circuit of the first tube in Fig. 1 is in tune. Now the conclusion to which Loftin and White came, in their study of regenerative and oscillating tube circuits, was that, in tuning the grid circuit of the second tube, the normal tuning adjustment over-shoots the mark; to the extent of increasing the inductive reactance of the first tube's plate circuit to such a point that the voltage feed-back from the plate circuit is shifted forward to the position of the solid graph, B. That solid graph, B, is in phase with the graph A and adds to A to make the solid graph C. For example, +5 adds to +10 and -5 adds to -10, in combining these graphs.

This adding up of the energy represented by A and the solid graph B produces distortion. That is, A has been made to grow from its normal size to the size represented by the solid graph, C; while the other different frequencies which go to make up broadcast signals are not built up in proportion (if we follow out the Loftin-White theory) because they do not bear the same relation to the frequencies to which the grid circuits of the first and second tubes are tuned. If the feed-back represented by the solid graph B is large enough, then the solid graph C will become larger, and excessive feed-back or oscillation, will result.

Loftin and White, working on this theory that oscillations are produced by the inductive reactance of the plate circuit in shifting the voltage forward in phase, placed capacity reactance in the plate circuit to shift the voltage backwards.

The dotted graph, B, represents the feed-back shifted backwards in phase, so that when the dotted graph B is added to graph A, the resulting dotted graph C is no larger in amplitude than the original graph A. For example, the dotted graph B is at about 0 when A is at 10, therefore, nothing is added to A.

Were the relations, as shown in Fig. 3, maintained between the dotted graph B and the graph, A, the result must be a shifting process rather than a building-up process. That is an interesting theory for the experimenter to speculate on, and may be a field for other inventions. If we had an oscillograph that operated as plainly on a million cycles as the ordinary oscillographs operate on sixty cycles, we might be able to see what goes on under those circumstances. Perhaps a tube with an added capacity between the grid and plate, and other elements suitably chosen, could be used at ordinary oscillograph frequencies to indicate what goes on at broadcast frequencies. This, of course, is of more interest to mathematically-inclined experimenters and those who have access to oscillographs and other laboratory equipment.

CORRECTION FOR STRAY COUPLINGS

In all receivers there are both inductive and capacity couplings which are not wanted, but are there because parts must be placed fairly close together and connected by wires.

A NEW AMPLIFIER UNIT

that provides for Extremely Faithful Reproduction

SCHEMATIC DIAGRAM FOR COMBINATION 2 STAGE DOUBLE IMPEDANCE COUPLED AND 1 STAGE TRANSFORMER COUPLED AMPLIFIER WITH SPEAKER FILTER

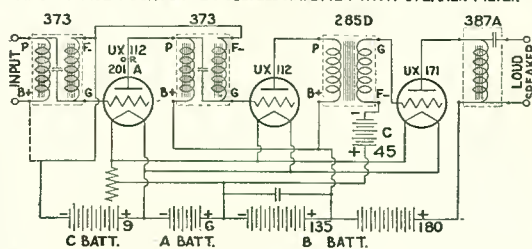

While the use of double impedances is not new in principle the General Radio Type 373 Double Impedance Coupler is unique in design and performance. To facilitate installation the complete unit, consisting of two impedances and a fixed condenser, is contained within a metal shell. It is connected in precisely the same manner in an audio amplifier circuit as a transformer.



The extent of its range of even amplification is from appreciably below 100 cycles to over 10,000 cycles, with a gradual downward deviation of slightly less than 7% between 100 and 400 cycles. This deviation in an otherwise perfect amplification curve is so slight as to be practically negligible, because the ear of the average individual can not detect a variation of intensity of much less than 25%.

The amplification curve, in fact, compares favorably with that generally obtained with resistance coupled systems which have the disadvantage of large sacrifices of plate voltages.

The General Radio Double Impedance Couplers have the further advantage that when connected as shown in the above diagram, with one transformer coupled stage, they may be used with a properly designed Plate Supply Unit.

Type 373 Double Impedance Coupler\$6.50

The following parts are used in the General Radio Laboratory Amplifier:

- 2—Type 373 Double Impedance Couplers\$13.00
- 1—Type 285-D Audio Transformer 6.00
- 1—Type 387-A Speaker Filter 6.00
- 3—Type 349 UX or CX Sockets 1.50
- 1—Type 410 or 301 Rheostat, 6 ohms 1.25
- Complete cost of amplifier parts\$27.75

If your dealer is unable to supply you with any of the above items, we shall be glad to send them to you prepaid upon receipt of list price.

GENERAL RADIO CO., Cambridge, Mass.

GENERAL RADIO

PARTS and ACCESSORIES

"Behind the Panels of Better Built Sets."

Super Heterodyne Construction and Operation

By R. E. LACAULT, E.E., I.R.E.

is a book full of practical information for the owners and builders of super heterodyne sets. This is written so that anyone can understand it and should prove particularly useful to those who do not obtain the expected results from their home made sets, as the trouble shooting chapters are very complete.

Other chapters include—

- The how and why of each part. Trouble shooting chart.
- How to check and match your tubes. How to build a power amplifier, etc.

and COMPLETE CONSTRUCTIONAL DETAILS ON THE

LR 4 -- Price \$1.97

Set of four full size drawings for the assembling, construction and wiring of the LR4—\$1.00.

R. E. LACAULT RADIO ELECTRIC LABORATORIES, 1931 BROADWAY, NEW YORK CITY, Dept. 1A

Manufacturers of the MAGNIPOWER and ANODYNE

High power amplifiers and plate supply.

Write for literature describing these REL products.

USE THESE COILS and IMPROVE ANY RADIO RECEIVER!

with
AERO COIL
SUPER-SENSITIVE
INDUCTANCE UNITS



TUNED RADIO FREQUENCY RECEIVER
\$12.00

The Aero Coil Tuned Radio Frequency Kit illustrated above will positively improve the performance of any receiver. Patented Aero Coil construction eliminates radio frequency losses and brings tremendous improvement in volume, tone and selectivity. Kit consists of three matched units. The antenna coupler has variable primary. Uses .00035 condenser. 8 page color circuit, layout and instruction sheet for building the supersensitive 5 tube Aero-Dyne receiver packed FREE with each kit. Extra copies, 75c each. Instructions include insert showing how to wire up for a power tube if desired.

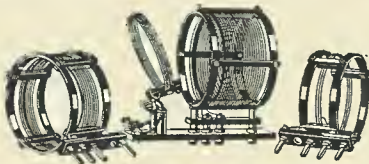

LOW WAVE TUNER KIT
\$12.50

Completely interchangeable. Adapted by experts and amateurs. Range 15 to 130 meters. Includes three coils and base mounting, covering U. S. bands, 20, 40 and 80 meters. You can increase the range of this short wave tuner by securing coils No. 4 and 5. Combined range of 15 to 550 meters. Both interchangeable coils fit same base supplied with short wave kit and use the same condensers. Coil No. 4 price \$4.00; Coil No. 5, price \$4.00.

Get these coils from your nearest dealer. If he should be out of stock, order direct from the factory.

Aero Products, Inc.

Dept. 105

1772 Wilson Ave. Chicago, Ill.

LEBNITE
THE POWERFUL NEW
MULTIPOINT FIXT DETECTOR



75c Post Paid
The Super-Power Crystal
Double Volume Double Distance
Perfect for Reflex — Great for Crystal Sets
From your dealer or direct. Dealers write for discounts

PALMER & PALMER
404 W. Utica St. Buffalo, N. Y.
Makers of the Famous
MULTIPOINT LINE

Kennedy & Kennedy, 1442 Yonge St., Toronto, Ont., Excl. Can. Dist.

These parts and wires couple, inductively and capacitatively, with others or each other. Because the Loftin-White circuit contains both inductive and capacity couplings and the phase-shifting reactance, as shown in Fig. 2, it contains three elements that may be adjusted to offset undesired inductive and capacity couplings and stray feed-back. This works out so that little shielding and sometimes none at all, is required, where it would be reasonable to expect that shielding would be necessary.

AT ALL WAVELENGTHS

Interesting comparisons can be made between a receiver with a circuit like Fig. 1 and a receiver with a circuit like Fig. 2. With the Fig. 1 arrangement and suitable "B" battery, the receiver will squeal probably for every broadcast station from 200 to 250 meters. For some stations above 250 meters, it will noticeably distort the voice or music. Stations higher up the scale will not be distorted, but will be weaker than they should be.

With C_3 removed (short-circuited), the circuit of Fig. 2 will also squeal for every broadcast station from 200 meters up to 250, but it will not stop there; it will squeal for every station in the broadcast band.

Then, if we reduce the filament current or the "B" battery voltage so that the tube is not amplifying as it should, we can just stop the squealing and get distorted signals from all stations. In other words, the circuit treats the stations all alike from one end of the scale to the other. If C_3 is put back where it belongs, and the filament current and "B" battery voltage are raised to their proper values, the circuit will be restored to condition, and will not distort or squeal. It will resume its ability to handle all broadcast wavelengths alike.

ACCURATE PARTS REQUIRED

Of course, C_3 , L_1 , L_2 , C_1 , C_2 and C_h must be properly proportioned and related to each other, and to other parts in the set, to produce these desirable results. In fact, if the elements are not properly proportioned and related, some strange circuit actions will result. For example, if L_1 is connected backwards, the set may not pick up any broadcasts at all in the middle of the scale. If C_3 is too large and C_1 , C_2 and L_2 are not properly related, the set may squeal at one place or another; or with a different arrangement, it might squeal at two places.

Owing to the necessity for making the parts for the Loftin-White circuit accurately and for locating them accurately relative to each other and relative to the wiring and other components of the receiver, it is difficult to build such a receiver correctly from the theoretical description. However, a receiver may be built easily if the parts of a receiver now in successful operation are duplicated.

Manufacturers of parts concentrate their ability on the building of a few parts, instead of on all the parts and assembly arrangement of a complete receiver. The result is there are available some excellent parts for the making of a model receiver. To get the most suitable parts for such a set, it is usually necessary to select from the products of several manufacturers. These firms may be competing on some parts, but they have found through experience that it is best to cooperate in supplying the instruments a designer of a model receiver may select.

The radio constructor knows how important it is to have the correct parts, which nearly always are the heart of his receiver. A complete set, describing the constructional details of the receiver, with the parts that have proven to be most successful, will be described in an early issue of RADIO NEWS. This will enable the reader to become thoroughly familiar with, and to take advantage of, the merits of the Loftin-White Circuit, which we believe to be the outstanding one of the year.

FREE!
This
84 PAGE
RADIO
BOOK
OVER 2000 ITEMS

The World's Largest Exclusive Radio Mail Order House
will send you—**FREE**—this wonder catalog of radio bargains containing over 2000 items of everything in **RADIO**, including all the latest Sets, Kits, and Parts, at rockbottom prices that Save you 1/2 to 1/3.
5-TUBE SETS AS LOW AS \$24.90
LATEST 1927 MODELS
Table and Console models with built-in loud speakers. Beautiful, genuine mahogany and walnut cabinets. All sets at amazingly low prices.
SEND FOR BOOK TODAY
We cannot begin to tell all about this wonderful Radio Book. Simply send letter or postal, and this bargain radio catalog will come to you absolutely free. Write Today.
RANDOLPH RADIO CORP.
180 N. Union Ave., Dept. 224 Chicago, Ill.

"B" BATTERY ELIMINATOR

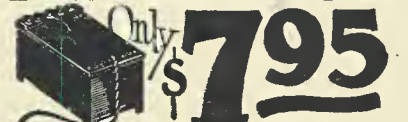

Only \$7.95
MONEY-BACK GUARANTEE
No more worry with "B" Batteries! Hook up a Roll-O "B" Battery Eliminator and forget battery troubles forever. This wonderful new invention means better reception, sharper tuning. Gives you more real pleasure from your set.
Completely Equipped—No "Extras" to Buy
Operates perfectly on direct or alternating current, giving up to 90 volts current, and using the full wave of the power supply. Simple directions enclosed—anyone can plug it in to any kind of set up to six tubes. Constant voltage gives set more power. Costs no more than set of good "B" Batteries. Solidly built in beautifully finished metal case, with genuine Bakelite top.
SEND YOUR ORDER NOW
Don't blame your set because run down "B" Batteries won't let it work right. Order your Eliminator NOW. Write name and address on a piece of paper, pin a dollar bill to it, and mail it TODAY. Pay postman balance (\$6.95 plus a few cents postage) when he delivers your Eliminator. Use it ten days. If not more than satisfied, return it and get your money back.
THE ROLL-O RADIO CO.
Dept. T-6 3d & Sycamore, Cincinnati, O.

Bradleystat
PERFECT FILAMENT CONTROL



Provides complete noiseless filament control for all radio tubes without change of connections. Metal parts are nickel plated. One hole mounting. Self contained switch opens battery circuit when desired.

Allen-Bradley Co.

Electric Controlling Apparatus
287 Greenfield Avenue Milwaukee, Wis.

Insure your copy reaching you each month. Subscribe to RADIO NEWS — \$2.50 a year. Experimenter Publishing Co., 53 Park Pl., N.Y.C.

Easier Construction for the Experimenter

(Continued from page 1128)

pencil is run around the various parts, and notes made regarding the position of tube socket terminals, and so on. Even the more important leads can be sketched in with colored pencils.

When the experimental set is dismantled, the sheet of paper will be found to contain a detailed layout, and it can be used to mark off the holes in the baseboard of the final set. (Fig. 1.) This simple kink saves a great deal of time and trouble, and enables one to duplicate the first set in every detail.

The various parts shown in the illustration are of English manufacture, apart from the coil units. The variable condensers shown are perhaps the best make on the British market, and their unconventional design may be of interest to American fans. A condenser of this type is shown by itself in Fig. 2.

The spindle carrying the rotary plates is vertical, instead of horizontal as in nearly all American makes. In consequence, the condenser takes up very little room, and hand capacity is entirely absent. The latter feature is particularly marked with short-wave sets.

A TENFOLD DIAL READING

The upper part of the spindle carries a bakelite fitting into which a worm is cut, the horizontal spindle carrying the dial ending

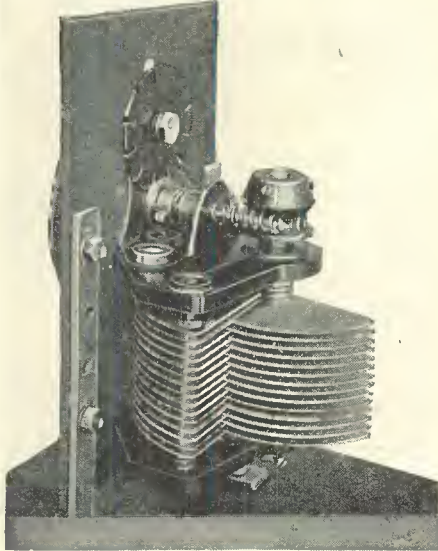

FIG. 2

Close-up view of the new multi-gear condenser.

Photos © C. A. Oldroyd.

also in a worm gear. The total reduction is twenty to one; ten complete revolutions move the rotary plates through an angle of 180 degrees. Very fine adjustment is therefore possible, and the gearing is really "silky," there being no back-lash of any kind.

But perhaps the most important part of this design is that each station can be located to a vernier point. The dial makes one complete revolution for one-tenth of the total travel of the plates; in addition, a counter wheel, fitted above the spindle and shown close to the panel, indicates the revolutions. Behind a little window cut in the panel appear the numbers 1 to 10 as the dial is turned. After each complete revolution the counter dial moves from one number to the next. The construction of the counter mechanism resembles the maltese cross used in movie projectors; a pin fixed to a collar on the horizontal spindle engaging in a slot of the counter dial and actuating it every time the spindle completes one revolution.

The dial reads from 1 to 100, the counter

Better Reception

Majestic "B" Current Supply

delivers pure direct current from your light socket

| | | |
|---|---|--|
| <p>Majestic Standard-B Capacity seven tubes or six plus 1 power tube. 45 milliamperes at 135 volts.</p> <p style="text-align: center;">\$26.50</p> <p>West of Rocky Mts., \$29.00</p> | <p>Majestic Super-B Capacity one to twelve tubes, including the use of power tubes. 45 mills at 150 volts.</p> <p style="text-align: center;">\$29.00</p> <p>(AS ILLUSTRATED) West of Rocky Mts., \$31.50</p> | <p>Majestic Master-B Positive control of all output voltage taps. For sets having high current draw or heavy biasing batteries. 60 mills at 150 volts.</p> <p style="text-align: center;">\$31.50</p> <p>West of Rocky Mts., \$34.00</p> |
|---|---|--|

Raytheon Tube \$6.00 extra. No acid or liquid. No filament to burn out.

DEPENDABLE. ECONOMICAL. Will positively give you Better Reception.

See your dealer today. Insist on a demonstration on YOUR set immediately
(Can be purchased on deferred payments)

GRIGSBY - GRUNOW - HINDS - CO. 4572 ARMITAGE AVE. CHICAGO-ILL

Listen!

Every Monday 9:15 P.M.

to the "RADIO NEWS ENSEMBLE"
the high class concert feature under the direction of
Millicent Frances,
Lillian Tonge, coloratura; Stuart Arles, tenor;
Rose Rubenstein, dramatic soprano; Warren McGoldrick, basso.

"ALWAYS GOOD SINGING"

For Concert engagements, inquiries and copies of souvenir book, address
RADIO NEWS ENSEMBLE WRNY
The Roosevelt, New York

PATENTS As one of the oldest patent firms in America we give inventors at lowest consistent charge, a service noted for results, evidenced by many well known Patents of extraordinary value. Book, Patent Sense, free.
Lacey & Lacey, 631 F St., Wash., D. C. Established 1869

Rubber Covered Insulators

Actual Size

Neat and efficient. For antenna, ground and for lead in wires. Small screw starts readily and makes finished job. Great improvement over ordinary large, unsightly insulators. They keep the wires in place and out of the way. Packed 10 in a box, 25c at your dealers or direct from us.

CULVER-STEARN'S MFG. CO.
Worcester, Mass., U. S. A.

TELEGRAPHY
(Morse and Wireless) and RAILWAY ACCOUNTING taught thoroughly. Big salaries; great opportunities. Oldest, largest school. Endorsed by Telegraph, Railway, Radio, and Government officials. Expenses low—opportunities to earn large portion. Catalog free.
DODGE'S INSTITUTE, Swan Street, Valparaiso, Ind.

M&H
Radio's largest
kit supply house
ESTABLISHED 30 YEARS

BUILD THE

ULTRA "5"

With An Original, Authentic Kit
from Radio's Largest Kit House
"The Superhet"
Simplified. Price **\$49.75**

READY FOR RADIO FANS!
COMPLETE KIT
For the 6-Tube PHASATROL BAL-
ANCED RECEIVER. Price **\$49.50**

If You Prefer Distance, and selectiv-
ity, Build the

R. F. C. RECEIVERS

Special R. F. Choke KIT
Amplification. Price **\$63.50**

The Only Power Amplifier That
Really Does the Work

AMERTRAN

BUILD IT YOURSELF
Write For FREE Circuit Diagram and
Our Prices On These Parts

The ONLY SUPER without a
Harmonic

MADISON-MOORE

WRITE FOR OUR PRICES
ON THIS KIT.

OUR CIRCULAR
IS NOW READY
It Will Pay Set Builders to Send
for This.

M. & H. SPORTING GOODS CO.
512 Market St., Phila., Pa.

NEW AERO COIL KIT

ALL GENUINE PARTS IN STOCK NOW!
WHOLESALE CATALOG

FREE

Listing thousands of new radio
parts, kits, furniture, accessories,
and complete radio sets, at
prices that save you money.
Write for your copy now. It's
free.

THE HARCO CO., 1253 S. Wabash Ave., Chicago, Ill.

Cooper "A" Eliminator

Not a Power Unit
Employs No Trickle Charger
Operates direct from the
Light Socket. See Your Dealer

EVERYTHING IN RADIO

AT ATTRACTIVE PRICES. SETS OR PARTS.
Orders shipped exactly as ordered. Prompt Service.
Write for Prices. Mail Order Only. Write for Catalogue.
ALL RADIO COMPANY, 417 North Clark St., Chicago

dial numbers from 1 to 10; so that each station can be definitely logged, for instance, 5-65; that is the counter dial reads 5, the large dial 65. DX work is really a pleasure with this type of condenser, whose advantages become more marked the closer the set tunes.

What Makes Good Music Good?

(Continued from page 1097)

THREE STAGES OF MUSIC

Perhaps this will simplify the matter for you. Music has three parts: rhythm, melody and harmony.

Perhaps the reason jazz is so popular is that it is so rhythmic. The earliest music of the savages was merely rhythm and nothing else—the beating of a bone on a rude drum.

Melody is the line of the notes you can whistle. Harmony is the structure of thought and decoration.

Popular music, in its ordinary garb, rarely goes beyond bare rhythm and melody, while "good" music uses the rhythm and melody only as a means to harmony.

To the developed music lover, the lack of harmony is as noticeable as the lack of an entree or roast in a dinner which claims to be such and has only cocktail and dessert. To the undeveloped music lover, the need to digest the seemingly heavy foods of harmony seems irksome—until you know, and then!—The old scare is gone.

This may be said, in summarizing these brief thoughts on a great subject: all the elemental pleasures of the popular variety of music are in the permanent works, plus other charms and values, which are endearing and nourishing to mentality and soul.

CURRENT ACTIVITIES

Now for a quick glance over two months of exciting broadcasting through WRNY. I see the range of subjects from the broadcast of the "Vagabond King" to the "Black Bottom" contest.

We had the remarkable opportunity of "picking up" an entire performance of the former, that brilliant musical success of the François Villon legend, direct from the theater. The comedy, the conversation and the plot—all were easy to follow, and of course the choral singing and orchestral effects were well broadcast.

At the other end of the scale was the "Black Bottom" contest at the wild and woolly Club Circus, in Greenwich Village, where one enters a tent (as it seems) and, amid the imaginary surroundings of an old-fashioned one-ring circus, even to the "hot dogs," there is an unforgettable atmosphere of gayety and joy. Many girls tried for the prizes, which finally were won by a group headed by the little star, Mildred Wallick.

Speaking of jazzy effects, WRNY is now very proud of its exclusive rights to Phil Napoleon and his orchestra. Phil is very properly called "The Emperor of the Air." He has no Waterloo, and there is no napping, for it is always "giddyap Napoleon"; and in the case of the sentimental love airs, it is just as Napoleon told it to Josephine. Napoleon, with the Original Indiana Five alternating, is heard three times a week from the Rosemont Ballroom, New York City.

Of the patriotic and national gatherings, I think our celebration of the Wright brothers' first airplane flight was noteworthy, with army, navy, post office and department of commerce officials on hand, with Harry Guggenheim, president of the great Guggenheim Foundation for aviation education, aces, world flyers, arctic flyers and others to eulogize the brothers. Orville and Wilbur. Imagine! England, France, Switzerland, Italy, Japan, Germany and other governments sent official messages of

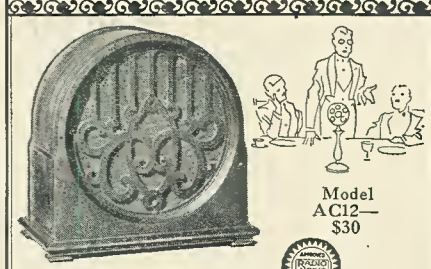

Model
AC12—
\$30

The AMPLION CONE

ably stands the severest test you can give

—clear reproduction of speech.

YOU will enjoy the many speeches and talks that will be broadcast this winter much more if you attach an Amplion Cone to your radio set.

The secret of its fine performance lies in the matchless Amplion unit which is assembled with the Cone in a handsome mahogany cabinet, 14" x 14" x 9".

Amplions from \$12 to \$50
Ask your dealer for a demonstration
THE AMPLION CORPORATION
OF AMERICA
Suite S, 280 Madison Ave., New York

AMPLION

Choose with Confidence



World Radio Storage "B" Battery

12 Cell—24 Volt

Proved value. Thousands of users find reception almost magical. Clear, true power—instantly and unendingly. Wise economy. Sturdy construction—Solid Rubber Case protection. Recharged for almost nothing. Endorsed and listed as standard by famous Radio institutions including Pop. Radio Laboratories, Pop. Sci. Inst. Standards, Radio News Lab., Lefax, Inc., and other Radio authorities. What more need be said? *Extra Offer: 4 Batteries in series (96 volts) \$10.50.*

Send No Money Just state number wanted and we will ship same day order is received, by express C. O. D. Pay expressman after examining batteries. 5% discount for cash with order. Remember—you save 50% on World Batteries.

WORLD BATTERY COMPANY

1219 So. Wabash Ave. Dept. 75 Chicago, Ill.
Makers of the Famous World Radio "A" Storage Battery
Prices: 6-volt, 200 Amp. \$10.00; 120 Amp. \$12.00; 140 Amp. \$15.00.
All equipped with Solid Rubber Case.

Set your radio dials at 283.3 meters for the World Storage Battery Station W3BC. Variety—New Talent—Always Interesting.
JERRY SULLIVAN—Director and Announcer—121st C.A.W. go!

For Perfect Amplification— FERRANTI

Audio Frequency Transformers
Amplify faithfully every note in the scale—each transformer tested ten times—your set needs one for perfect reproduction. Model A.F. 3—\$12.00. Model A.F. 4—\$8.50.

FERRANTI, INC.
130 West 42nd St., New York, N. Y.

Raytheon

LONG LIFE RECTIFYING TUBE

congratulation to the station and its listeners.

NOVELTIES

One night we went to the top of the unfinished French Building, Fifth Avenue and 45th Street, New York, amid riveting, sawing, hammering and the like, where Julia Hoyt, Magda de Bries and Odette Myrtil took their lives in their hands, and Jack Wheaton's orchestra played jazz tunes, to the astonishment of Fifth Avenue pedestrians, who looked up and blocked traffic.

WRNY was the first station to solicit funds directly over the air, and report them as they arrived. It was for the *New York American's* Christmas Fund, and didn't the money pour in! We also assisted the *New York Evening Post's* Fund for Old Couples, with the assistance of O. P. Heggie and Genevieve Tobin.

And, since we mention theatre folks, we've had an array of celebrities you'd never forget: Marjorie Rambeau, Charles Gilpin, Charles Coburn, Margot Kelley, S. Jay Kaufman, Leonore Taylor, Carroll MacComas, and on and on. Maria Liszt, grand-niece of Franz Liszt, played her immortal uncles' works; George Liebling, the youngest pupil of Liszt, had a great artist recital. A new and stunning singer of Vienna, Rose Mortl, made her debut on the air. Moran and Mack were positively the funniest things you ever heard on the radio—they were a hundred times funnier than Will Rogers, it seemed to me.

The "21 Adventurous Nights" series of the Edison hour is going along in wonderful style. As many as 5,000 letters a week have come in, commending the idea and the individual programs. I think Craig Campbell was one of the greatest of the soloists. Minna, Mischea Elman's sister, sang, and we had the Tuxedo Musical Club, the Carrollers' Male Quartette, Redferne Hollinshead, and Norman Jolliffe. We've been to the Realm of Happiness, Tragedy, In the Nursery, Picking the Chestnuts and so on. Have you your copy of the book? It is sent upon request.

Perhaps the most important feature on WRNY is the Industrial Huntington Hour, which is the message of Huntington, West Virginia, and the Ohio Valley. It is telling the rest of the country about one great section of the United States. Governor Howard M. Gore was on one night. The Huntingtonians, the West Virginians and the Ohio Valley Girl all perform weekly, on Fridays at eight o'clock. Have you received your souvenir from Huntington?

So much, so much! Walt Kuhn giving painting lessons over the air, the Delta Upsilon Glee Club, the Delta Kappa Epsilon banquet with Mary Mellish and Senator Albert J. Beveridge, and the Prospect Lodge entertainment, which was so successful.

**Station
WRNY**
NEW YORK
373.8 Meters - 802 kilocycles
*is owned and operated by the
publishers of this magazine
Our Editors will talk to you
several times every week—
See your Newspaper
for details*
**TUNE IN ON
WRNY**

PILOT

Again Leads the Way to BETTER RADIO with—



**The
PILOT
ART-DIAL
DE LUXE MODEL**



**PILOT-LITE
ILLUMINATED DIAL**

The illuminated window makes tuning accurate. Drilling template supplied makes assembly easy. Enhances appearance of any radio set.

Velvet-vernier tuning control—a triumph of modern Science and classic Art. White and black figures in combination give clockwise and anti-clockwise readings. Made the substantial Pilot way to easily carry "gang" condensers without slippage or backlash. Genuine Bakelite **95c**

A Vernier Dial lit by a tiny Mazda bulb operated by your "A" Battery. Friction drive, no backlash. Simplified drilling Template, Bezel and Mazda Bulb included in this price made possible only by the Pilot manufacturing policy. Complete **\$1.50**



PILOT
ELECTRIC M'FG. CO., INC.
323 BERRY ST., BROOKLYN, N.Y.

BRAZIL
Samuel Meyer
41 Rua Buenos Ayres, Rio Janeiro

ARGENTINE
Samuel Meyer
367 Bartolome Mitre, Buenos Aires

ENGLAND
R. A. Rothermel, Ltd.
24 & 26 Maddox Street
Regent St., London, W.1.

AUSTRALIA
United Distributors, Ltd.
72 Clarence St., Sydney

Get parts shown here at S. S. Kresge Radio Depts., or through local dealer.

BERMUDA

Just Pack Up and Go
It's like taking a train—Bermuda is only 48 hours from New York. Average temperature 60° to 70°. Two sailings weekly on luxurious transatlantic liners:

S.S. Fort Victoria
S.S. Fort St. George

For booklets and reservations write

FURNESS

BERMUDA LINE.
34 Whitehall St. New York City
or any local tourist agent

Potter Condensers

Potter condensers, American made of highest quality materials to full capacity, build the best Socket Power Devices, Power Amplifiers, Impedance Amplifiers. And they are best for Filter Uses, Rectifiers, By Pass, and Blocking D.C. All types and sizes.

POTTER MANUFACTURING CO.
North Chicago, Illinois

KELLOGG Radio
Flawless Reproduction

For Absolute Tone Fidelity hear a FERGUSON RECEIVER. Ask the nearest Authorized Ferguson Dealer or write us. J. B. FERGUSON, Inc., 225 West 57th St., New York, N. Y.

CHOSEN AGAIN!

YAXLEY

Approved for

**NAKKEN "ULTRA 5"
R. F. C. RECEIVER**

and

Phasatrol Balanced T.R.F. Set

Yaxley Approved Radio Products were again chosen for the two latest radio receivers. Chosen now, as they were in the past, for the careful workmanship embodied and true to life reproduction that naturally results with products backed by years of manufacturing experience.

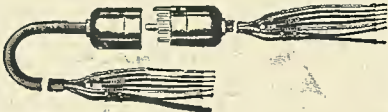

Cable Connector Plug for Binding Post

No mounting is necessary—simply connect ends of Cable Connector wires to binding posts and battery terminals as marked and it is ready for use. Plug has seven 15-inch wires which connect to binding posts. Receptacle has a 5-foot, seven strand cable for connecting to batteries.

- No. 670—Cable Connector with Cable\$4.00
- No. 10—Midget Battery Switch for filament control. Positive action .50
- No. 416—Pup Jack for phone tips, etc.15

At your dealer's. If he cannot supply you, send his name with your order to

YAXLEY MFG. CO.

Dept. N 9 So. Clinton St. Chicago, Ill.

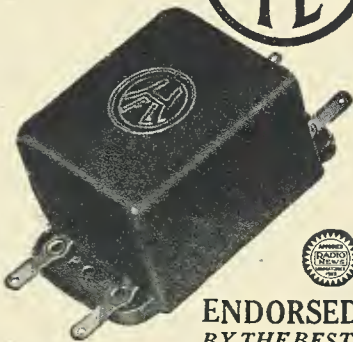

PRAISED By every leading Radio Editor, By Engineers and by thousands of fans, who have used H. F. L. Units, and appreciate their extreme excellence. Every H. F. L. Unit is unconditionally guaranteed. Write for circulars describing these remarkable instruments in detail. See H. F. L. Units at your dealers.

- H-210.....\$8.00 F-320.....\$8.00
- H-215..... 8.00 L425 & 430 ea. 5.50

HIGH FREQUENCY LABORATORIES
129 N. Wells Street Chicago, Illinois

FREE RADIO GUIDE

Gives special hook-ups with illustrations. Shows the latest wrinkles and newest developments. Get what you need here at a big reduction. Everything in parts, kits, complete factory-built sets and supplies. Learn how to make your set up to date. Quick service. Write for free 164-page copy NOW; send names of other radio fans.
BARAWIK CO., 540-542 Monroe St., Chicago, U. S. A.

**First Link in English
Radio Beam System**

(Continued from page 1091)

a far greater measure of secrecy is assured, for only receiving stations situated nearly on a direct line between the transmitting and receiving stations can pick up the signals.

The speed of working is at present limited only by the mechanical limitations of the transmitting and recording instruments, and when suitable land-line recording apparatus has been developed, capable of working at higher speeds than that now available, the over-all speed of working of the beam stations will be capable of corresponding increase.

Tests between England and Canada have shown that the use of beam antennae at both transmitting and receiving stations has resulted in a strength of signal some hundred times greater than that obtainable with non-directional transmitting and receiving aerials at each end of the circuit, utilizing the same power. It has enabled the service to be carried on under conditions when signals obtainable by means of non-directional aerials were hardly discernible. A further advantage is a very large degree of freedom from static.

DESCRIPTION OF THE STATIONS

The design of the masts and aerials for the beam stations differs entirely from anything previously used for commercial radio stations or broadcast stations. At each transmitter there are five latticed steel masts, erected in a straight line at right angles to the "great-circle bearing" of the distant receiving station. The beam is therefore projected accurately in the direction of the stations with which communication is being maintained.

The masts are 277 feet high, with cross-arms at the top measuring 90 feet from end to end and giving an additional 10 feet to the height.

The aerial and reflector systems consist of a number of vertical wires, forming, as it were, a wire curtain, suspended from steel cables attached to the cross arms and running along each side of the row of masts. The aerial system is on one side of the masts, facing the distant station, and the reflector system is on the opposite side.

The British transmitter for communicating with Canada, rated at only 20 kilowatts,

**40 Non-Technical
Radio Articles**

every month for the beginner, the layman and those who like radio from the non-technical side.

SCIENCE & INVENTION, which can be bought at any newsstand, contains the largest and most interesting section of radio articles of any non-radio magazine in existence.

Plenty of "How To Make It" radio articles and plenty of simplified hook-ups for the layman and experimenter. The radio section of **SCIENCE & INVENTION** is so good that many **RADIO NEWS** readers buy it solely for this feature.

**Radio Articles Appearing
in March Science &
Invention**

- The Radio Telephone Circuit to Europe.
- Construction Article on a New Six-Tube R.F. Set.
- An "A, B and C" Battery Eliminator, By A. P. Peck.
- "B" Eliminator and Power Amplifier, By Herbert Hayden.
- New Skip-Wave Radio Transmission.
- Radio Oracle—Question and Answer Box.
- Radio Wrinkles.

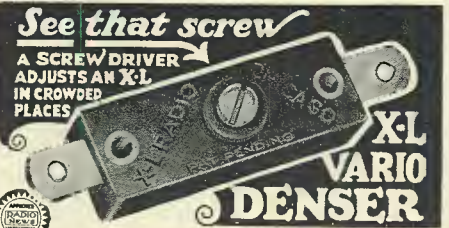

RESULTS in easier tuning, more distance, volume and clarity—greater stability. Indorsed by leading authorities.

MOEL "N"—A slight turn obtains correct tube oscillation on all tuned radio frequency circuits. Neutrodyne, Robert's two tube, Browning-Drake, McMurdo Silver's Knockout, etc. Capacity range 1.8 to 20 micro-microfarads. **PRICE \$1.00**

MOEL "G"—with grid clips obtains the proper grid capacity on Cockaday circuits, filter and intermediate frequency tuning in heterodyne and positive grid bias in all sets.

CAPACITY RANGE

- Model G-1—.0002 to .0001 MFD
- Model G-5—.0001 to .0005 MFD
- Model G-10—.0003 to .001 MFD

PRICE \$1.50

X-L PUSH POST—Push it down with your thumb, insert wire, remove pressure and wire is firmly held, releases instantly. **PRICE 15c**

PUSH POST PANEL—permanently marked in white on black insulating panel. In box including soldering lugs, raising bushings and screws for mounting, etc. **PRICE \$1.50**



X-L Radio Laboratories, 2426 LINCOLN AVE., CHICAGO, ILL.

**THE
B-6 Tube Circuit**

can be built with a minimum of effort using Kit No. 1 (illustrated) **\$7.50**

or Kit No. 2, including these coils plus a special double tuning condenser and



Three **DONLE-TRUPHONIC** audio units\$30.50

B-6 Supersensitive detector ..\$5.00

Complete file of literature on request.

THE DONLE-BRISTOL CORP.
Cambridge Street
MERIDEN - CONNECTICUT

"READY NOW!"

New Spring Edition

Radio Listeners' Guide

**LATEST RADIO STATION LIST
NEW CIRCUITS, ETC.**

50c On All Newsstands

is operated direct from the central radio office at the general post office in London. The interconnecting land line is led in to a relay attached to the first panel of the set. By this means the operator in London is in full control of the transmitter, and a moment after he presses his key (or feeds his signalling tape into the high-speed Wheatstone transmitter) the signals he is sending are recorded in the telegraph office in Montreal, which is connected in a similar manner to the Canadian wireless receiving station.

In the same way the messages put on the transmitter in the telegraph office in Montreal are recorded in London, after traversing the Atlantic and passing through the English beam receiving station.

All the other imperial services will be operated in a similar manner from London, as soon as they are completed.

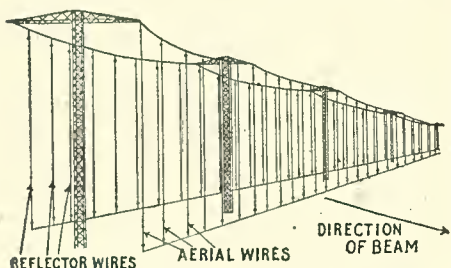

A diagram of the antenna system for radio beam transmission, as employed by Marconi.

Now that the Canadian station has been completed and put into service, the preliminary tests will at once be made in the case of communication between England and South Africa. On the completion of these tests, those with Australia and India will follow, the construction of beam stations for all these services now being nearly completed.

As the home of Marconi's first long-distance radio experiments; Great Britain was the pioneer country in commercial radio telegraphy. Today, with the modern high-power tube transmitting station at Rugby for all-round communication with any part of the world and with her ships, and the new beam stations for direct communication with each of the dominions, she possesses the most complete, up-to-date and efficient radio service in the world.

The Ultra-5 Receiver

(Continued from page 1124)

distance between the shafts of the condensers is $7\frac{1}{2}$ inches. The sub-panel is 7×18 inches. The variable condensers are of the straight-line-frequency type. These are provided with drilled L-shaped frames, which are used to support the sub-panel. It is not necessary, therefore, to employ additional brackets. The dials completely cover the screws used for fastening the condensers and the volume-control resistor. The sub-panel is laid out in accordance with the accompanying sketch.

When building this receiver, it is advisable first to mount carefully the sockets, the transformers and choke, and the automatic filament controls, by means of small screws and nuts held by lock-nut washers. The last parts to be mounted and wired are the coils, because these might otherwise be damaged in the handling of the receiver, while the circuit is being wired.

The "B+" terminal of the second amplifying transformer is connected directly to the "B—" point on the cable jack which is fastened between the two amplifying transformers. We have selected the "B—" lead for this function because the first amplifying

HERE IT IS

Marvelous Townsend

"B" ELIMINATOR

(Complete)

only \$4.95

\$1.00 Down Balance C.O.D.

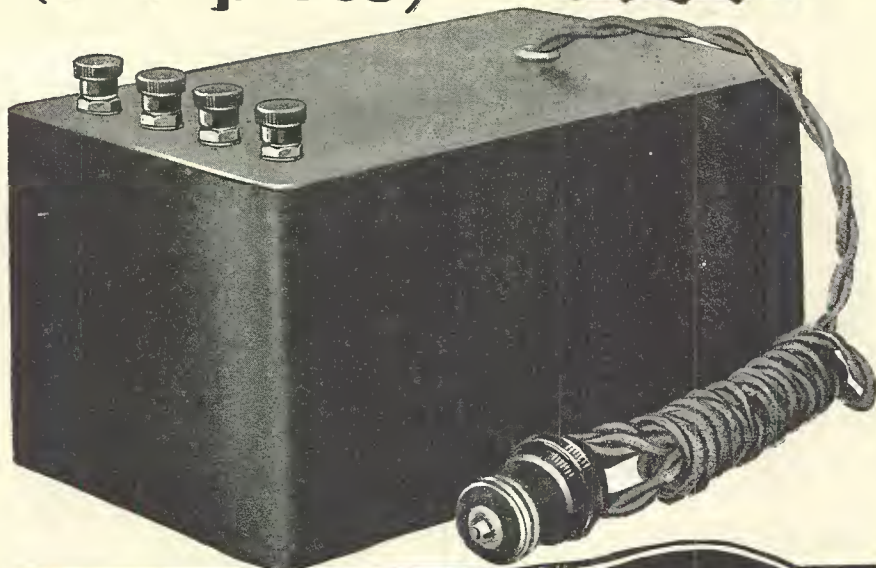

Direct from Factory at lowest price on record

Here is great news! For half the price of a set of "B" batteries you can now enjoy greatly improved reception and be done forever with the nuisance of recharging and renewing unreliable "B" batteries. We make every part that goes in the Townsend "B" Eliminator in our own factory. That's the reason we can give it to you at such a remarkably low price—give you a high quality instrument backed by a real guarantee. Users report splendid results. A fine "B" Eliminator at the lowest price on record. Our 10 days Free Trial proves it.

MONEY BACK if not amazed and delighted

You alone are the judge. We could not afford to make this guarantee if we were not sure of the Townsend "B" Eliminator's splendid performance. Just plug into your electric light socket and in a moment you will realize what good reception means. Delivers up to 100 volts on any set up to six tubes, on direct or alternating current—any cycle. Gives full wave rectification. Full tone, clarity and volume—uninterrupted by screeches of fading batteries.

Rush Order Today

Simply fill out the coupon and slip it into an envelope with only \$1.00. Get it into the mail at once. Your "B" Eliminator will be sent you promptly by return mail. Deposit \$3.95 only with the postman. Try out the Eliminator for ten days—then if not astonished and thrilled by improvement in operation, return it to us and purchase price will be refunded in full. You don't need to put up with battery nuisance another day when it is possible to own a "B" Eliminator at this startlingly low price. Send for it today.

TOWNSEND LABORATORIES
713 Townsend Street, Dept. 25 CHICAGO, ILL.

10 Days FREE TRIAL
You are the Judge!

Attach only \$1.00 to this coupon!

TOWNSEND LABORATORIES
713 Townsend St., Dept. 25, Chicago, Ill.
Gentlemen: Attached find \$1.00. Kindly send at once Townsend "B" Eliminator, C. O. D. for \$3.95, plus postage, on guaranteed 10-day free trial.

Name.....
Address.....
City..... State.....

A Laboratory Product

CRESCENT LAVITE RESISTANCES

Used in 50 big broadcasting stations
12,000, 48,000, 50,000 and 3,000 ohms.
For distortionless simplification. Order a Crescent today at \$1.50. Special sizes made to order. Discounts to dealers.

Crescent Radio Supply Co., 1-5 Liberty St., Jamaica, N. Y.

RADIO SETS AT 50% DISCOUNT!

Big Discounts On All Accessories
Local representatives wanted. Sell direct to user at big discounts; money back guarantee. Liberal commissions. We cooperate with you in local newspaper and direct mail advertising. Write for details today.
E. PERRYMAN, Sales Manager
P. O. Box 1142 Chicago

DEALERS!

Complete stock of nationally known parts and accessories. Send for illustrated catalog and discount sheet.
Radio Exclusively Since 1921
CLARK & TILSON, Inc.
122 CHAMBERS ST. New York
The Nationally Known House

RADIO PANELS OF GENUINE BAKELITE

Cut, drilled and engraved to order. Send rough sketch for estimate. Our New Catalog on Panels, Tubes and Rods—all of genuine Bakelite—mailed on request.
STARRETT MFG. CO.
520 S. GREEN ST. CHICAGO

Insure your copy reaching you each month. Subscribe to RADIO NEWS—\$2.50 a year. Experimenter Publishing Co., 53 Park Place, N. Y. C.

FRESHMAN AUTOMATIC CHARGER

Connects Right to Your Light Socket

\$15



NO MORE "A" BATTERY TROUBLES

Sold by Authorized Freshman
Dealers Only

Write for new literature

CHAS. FRESHMAN CO., INC.
New York—Chicago

tube is provided in this particular receiver with 90 volts, and the last tube should be adaptable to any plate voltage, required by type 112 or 171 tubes. This necessitates the use of two different "B" and "C" battery voltages for the amplifying tubes and if we did not use the "B—" lead for this purpose we would be one lead short in the cable.

The six-terminal coil base is fastened in such a way that the lug on the coil form points to the left of the finished receiver. This coil requires three mounting screws, which we can utilize to additional advantage for the support of the three fixed condensers, which are tapped for No. 6 screws. The sketch of the various parts mounted on the sub-panel shows exactly how these condensers are located. We may now install the various coils in the R.F. end; specifications for all these are given in the diagrams.

After the receiver has been thoroughly checked, the cable is inserted and a single tube is placed in one of the sockets. This tube should light if the "A" is turned on. The various connections can be checked further by means of a voltmeter connected between the various points where voltage differences should exist. When you have made sure that no short circuits are present in the receiver, insert all the tubes. The antenna and ground leads being provided with phone-tip plugs, these are inserted in the antenna and ground jacks (TJ), at the left of the baseboard, while the speaker tips are inserted in the output jacks, TJ. The receiver should then be turned to a nearby station; and, as soon as the broadcasting is heard, the resistance, R., controlling the regeneration, should be adjusted to give good volume. Once this regeneration has been adjusted, it can be left alone until another detector tube is inserted.

TUNING

The receiver tunes extremely sharp; the right-hand dial, which controls the oscillator, is particularly sensitive. Tuning should be done carefully, because if the dials are turned too fast, it is possible to pass right by even the very strong local broadcasting stations.

Depending on the location of the receiver, the regeneration should be adjusted in such a way that the best quality of reproduction is obtained. If the Ultra-5 is used in a large town, for which purpose it is specifically recommended, the regeneration does not have to be advanced to the highest point; but out in the country regeneration, of course, is desirable to the utmost extent. This, however, is entirely up to the individual user.

It is advisable to compile a tuning chart of the receiver, because the tuning is so sharp that no indication of the presence of a station is given except when the tuning is exactly right.

Many people experience trouble with superheterodyne receivers, due to excessive whistling on some stations. When we remember how the superheterodyne functions, it will come to mind that there are three distinct frequencies involved in its operation; the signal wave, the oscillator wave and the intermediate wave. The latter is created deliberately, as explained.

If, however, the receiver is located in a crowded district, where several powerful stations are broadcasting at the same time, there is a possibility that two or even three waves from different broadcasters will be impressed on the detector circuit. These different frequencies may intermingle freely, and combine individually or jointly, perhaps, with the oscillator frequency. In this manner they may, therefore, give rise to serious interference, squeals and undesirable noises. Of course, in order to be capable of doing this, the beat notes resulting from such stray waves must have a frequency equal to that to which the intermediate amplifier is tuned. If, therefore, we have a means of tuning

CONTINENTAL S. L. F. W.

(Straight Line Frequency Wavelength)
CONDENSER

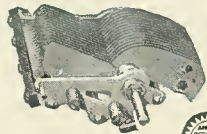

Used in
**DAVEN BASS
NOTE RECEIVER**

**SARGEANT'S
INFRADYNE
CIRCUIT**

PRICE

(All Capacities)
Single - - \$2.50
Double - - 5.00
Triple .0035 for In-
fradyne Circuit 9.50

Popular Radio
LC-27
and other circuits
in Radio News

If Your Dealer Cannot Supply You, Sent
Direct, Postpaid, from Condenser
Headquarters

GARDINER & HEPBURN, Inc.,
611 Widener Bldg. Philadelphia, Pa.

Mar-Co Dials

TOBE

Radio Interference Filter No. 1

is made for attachment to household motors and appliances, up to 1/4 H. P., such as oil burners, refrigerators, sewing machines, vibrators, etc. Its design incorporates means for prevention of damage to commutators, which may occur when condensers only are used.

Provided with five leads so that no extra wiring is required for attachment. A simple wiring diagram is printed on the label.

PRICE \$15.00

Write for special descriptive pamphlet N-3.
TOBE DEUTSCHMANN CO.
Engineers and Manufacturers
Cambridge Mass.

"Super Ball" Antenna

EASY TO INSTALL
Efficient on all circuits—non-directional—more stations logged.

LASTS A LIFE TIME
No sagging wires—no corrosion—always in service.

AMAZING RESULTS WITH YOUR PRESENT SET

You will actually be amazed at the fine results you get using the "Super-Ball" ANTENNA. Your set will be more selective—tone clearer—static reduced to the minimum.

30 Day Unqualified Guarantee by the Manufacturer

See your dealer today. An army of satisfied users in America and Europe.

YAHRLANGE

MILWAUKEE, WIS. INCORPORATED DETROIT, MICH.

A NEW RADIO PLUG

Simple to use, gives perfect electrical contact with any style tip.

Simply push cord tip through plug, loop cord and push tip back into plug.

Sent postpaid
on receipt of 50c

CULVER-STEARN'S MFG. CO
Worcester, Mass.

the intermediate stage or stages to a different frequency, when we find such interference occurring, we possess a means of preventing this nuisance.

In ordinary superheterodynes this is almost an impossibility, because the intermediate stages are previously tuned by the manufacturer of the intermediate transformers. In the Ultra-5, however, we have but one intermediate stage, and we therefore need not hesitate to change its intermediate frequency; because no other circuits will be put out of resonance by this move. It is for this reason that the primary of the long-wave coil L_1 , is shunted by the adjustable condenser, C_6 . We could as well have applied this variable condenser across the secondary; in fact, its place is optional.

After we have attached the receiver to the antenna and it is functioning properly, we will wander slowly over its entire scale. If no squeals at all develop, so much the better. If squeals are encountered at any point, we vary the capacity of the condenser C_6 slightly by means of a screwdriver. This variation affects the wavelength of the coil combination, and thus it is impossible for the particular interference to occur again.

In this way it is quite easy to find, for any locality, a setting of the condenser C_6 where interference between local broadcasters is prevented or reduced to a minimum.

A second advantage of the use of this adjustable condenser is that it enables the builder to bring the primary and the secondary of the intermediate transformer in close resonance. In this condition the transfer of energy from primary to secondary will be at a maximum, and the signal will be passed on to the detector with the greatest possible efficiency.

A CORRECTION

TWO slips of the pen were reproduced in the article, "Some Facts About Condensers," in the January issue of RADIO NEWS, and were not detected until the issue was off the press.

A microfarad is, of course, the millionth part of a farad, instead of the thousandth, as stated; and a micromicrofarad, the millionth part of a microfarad.

In addition to this, the capacity of a condenser varies inversely as the thickness of the dielectric, not as the square of the thickness.

This is published as a notice to such only of our readers as have not yet called the matter to our attention.

Wavemeter Calibration from Broadcast Harmonics

(Continued from page 1125)

Prepare a table of the stations in the locality, tabulating the main waves and the harmonics; the 2nd harmonic being half the main wavelength; the 3rd one-third, etc. A table that was actually used for some of the curves is shown below.

| Station | Main Wave | 2nd. Harm. | 3rd Harm. |
|---------|-----------|------------|-----------|
| KFWM | 206.8 | 103.4 | 68.9 |
| KJBS | 220.4 | 110.2 | 73.5 |
| KQW | 230.6 | 115.3 | 76.9 |
| KZM | 239.9 | 120.0 | 80.0 |
| KFRC | 267.7 | 133.9 | 89.0 |
| KGO | 361.2 | 180.6 | 120.4 |
| KPO | 428.3 | 214.2 | 142.8 |
| KLX | 508.2 | 254.1 | 169.4 |

Using the stations at the top of the dial, note a few points at the top of the dial; then draw a line on the calibration curve in the direction in which the final curve will probably go. Read, from this temporary curve, where one of the harmonics will come near 25 on the dial; and then adjust the receiver at this wavelength with the wavemeter. When the station is on that gives this har-

\$75.00 A WEEK BUILDING RADIO SETS —in your spare time

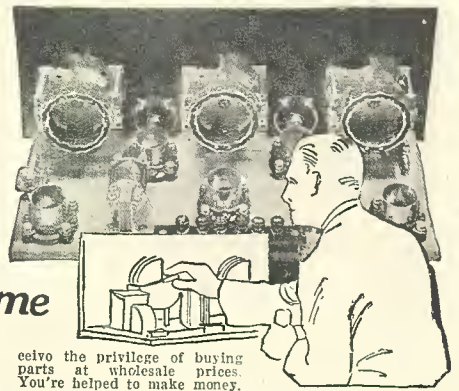

Join the Radio Association of America. Learn how to build and repair radio sets. The Association will train you—start you out in business if you wish. Be the radio "doctor" of your community. \$3 an hour upwards easily made. Radio offers you a big money-making opportunity right now.

EARN \$500 IN SPARE HOURS

"I have at last found myself," writes Lyle Follick, Lansing, Michigan, "I have already made over \$500 building radio sets after working hours." Werner Eichler, Rochester, N. Y., writes, "I have made over \$50 a week in my spare time."

Our members are starting radio stores, increasing their salaries, securing better positions, passing radio operator examinations, earning big money for the most enjoyable kind of spare-time work.

WHAT A MEMBERSHIP MEANS

A membership in the radio Association of America gives you the most up-to-date and thorough training in the Science of Radio.

You're taught how to build and repair all kinds of sets. You're given the training you need in preparing for a Licensed Radio Operator's examination. You re-

ceive the privilege of buying parts at wholesale prices. You're helped to make money.

JOIN THE ASSOCIATION NOW

If you're interested in Radio for either pleasure or profit, join the Association without delay, because we have a plan whereby your membership may not—need not—cost you a cent. Only a limited number of these memberships are acceptable. Write now for details. Write before it's too late.

This Association has prepared a beautiful book that gives figure-facts regarding the profit possibilities of the Radio Industry, the purpose of the Association, and the details of the Special Membership Plan.

MAIL THIS COUPON

RADIO ASSOCIATION OF AMERICA
Dept. RN-3—4513 Ravenswood Ave., Chicago.

Send me your book and details of your Special Membership Plan.

Name

Address

City State.....

Do away with Battery trouble and expense. Install a **Clayton "B" Eliminator**

Operates direct from light socket. New battery pep every day in the year. Works on any set, new or old.



Will last for years.

Ruggedly built, of quality material throughout. Steel cabinet, size 6x6x12 inches, black crystalline finish.

MORE VOLUME—SWEET TONE

\$11.75 -- COMPLETE
Nothing else to buy

This is our improved model at the old price. This Eliminator has been giving satisfaction throughout the country, as many letters of testimonial sent to us by users prove. They are being used on practically every make of receiver successfully.

Be sure to get our literature before purchasing an Eliminator.

Operates any set up to eight tubes. Costs less than 50c a year to operate.

UNwise to pay less. necessary to pay more. **No** Acid Hum Noise Attention

Sold With a Ten-Day Money Back Guarantee

Clayton Radio Products Co.
3539 BROADVIEW RD. CLEVELAND, OHIO

USE THIS ORDER COUPON NOW.

CLAYTON RADIO PRODUCTS CO.
3539 Broadview Rd. - Cleveland, Ohio

Name

Address

Send literature.....

Money enclosed..... Send C. O. D.....

→ NAKKEN ULTRA FIVE ←

AERODYNE CARBORUNDUM 8-TUBE SHIELDED RECEIVER ST. JAMES SHORT WAVE SAMSON T. C.

NINE IN LINE MELO-HEALD ELEVEN VICTOREEN INFRADYNE WORLD'S RECORD SUPER 8 RADIO FREQUENCY CHOKE

PHASATROL SIX

Dealers writing us specify just what hookup you are especially interested in.

NEWARK ELECTRIC Co.

"Nothing but Radio"

226 WEST MADISON STREET

CHICAGO, ILL.



Now! World "A" POWER UNIT

Complete-Automatic-Unvarying

"A" Current From Your Light Socket

at a price anyone can afford

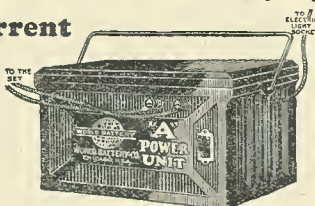

Provides even, unchanging "A" current from the moment you throw on your set switch. Finer reception, uninterrupted by "fade-outs" and "screeches" from run-down batteries or uneven power. No bothersome recharging. No expensive and fragile tubes to burn out. World "A" Power Unit assures full tone quality and wider DX range.

\$14.75

Built for Long Life

by the same trained experts who for years have made World Batteries famous for supreme quality, tested and approved by leading authorities, including Radio News Laboratories, Popular Sci. Inst. Standards, Pop. Radio Laboratories, Radio Broadcast Laboratories, Radio in the Home, Lefax, Inc. A marvelous improvement at less than half the cost of any similar equipment.

Shipped complete—subject to inspection—on receipt of price, \$14.75. 5 per cent discount if cash in full accompanies order. Sent C.O.D. if you wish. Write today.

WORLD BATTERY COMPANY
1219 So. Wabash Ave., Dept. 150-X, Chicago, Ill.

Set your radio dials at 283.3 meters for the World Storage Battery Station WSBG. Variety—New Talent—Always Interesting. JERRY SULLIVAN—Director and Announcer—7-Ni-CA-W-go.

Heavy-Duty RADIOHM



for Simple Control of B-Battery Eliminator

A single turn of the knob gives full resistance variation to control eliminator's output voltages. Permanent resistance as adjusted. Insulated for 1,500 volts. Approved by Raytheon Laboratories. Outlasts eliminator, giving full efficiency from it. \$2 at dealer's, or from us.

Central Radio Laboratories

19 Keefe Ave., Milwaukee, Wis.
Australian Representative—United Distributors, Ltd., Sydney.
Canadian Representative—Irving W. Levine, Montreal.
Great Britain Representative—R. A. Rothermel Ltd., London.
69 standard set makers use Centralab variable resistances.



CORWICO

Radio's Best Wire

"FROM THE GROUND UP"

Amateurs and experts have proved through experience that for all around efficient service and for building a neat job Corwico radio wire has no equal. Use it in your next set.

Ask Your Dealer for Corwico Wire

Write for interesting booklet on radio wires and their uses.

Dealers and Jobbers—Write for the "Corwico" wire proposition.

CORNISH WIRE COMPANY
30 Church Street New York City

monic, it will probably be found very near the estimated position. Tune in and plot this point on the curve. Work back on the new curve drawn to this point and find other points in the same way. Sometimes a point is found that does not fit the curve; disregard it, it is probably wrong. Mistakes can easily be made, as will be seen from the table; some of the harmonics are quite close together. However, if a nearby station is used, one can be quite sure of the harmonic, and the other points will serve as checks. Another satisfactory way of being sure is to listen on the main wave just when a station is about to sign off. Then shift to the harmonic and listen to see whether it disappears.

In securing data for the curves, as may be readily seen from the curves here, it is unnecessary to take a large number of points; when using an S.L.C. condenser take two or three values at the higher settings of the wavemeter, one at the center and two or three at the lower settings; these determine the curve quite nicely.

Broadcast harmonics have been heard as low as 30 meters and have been tuned in and identified; but ordinarily 50 meters is the lower limit when this method is used. With this method there is usually less chance for error in selecting harmonics than with the "driver-receiver" method (in which the harmonics become complicated sometimes), and no extra equipment is necessary. This work may be greatly simplified by using two stages of audio amplification.

The short-wave stations are usually much easier to calibrate from for the indication of the long-wave stations is sometimes quite broad. On nearby stations, the coupling should be reduced to a minimum; and in some regenerative receivers the tickler must be of the correct value.

The receiver dial itself may also be calibrated by using a curve; but different antennae and various adjustments of the receiver may change results.

For special ranges of the wavemeter, remember that to have a particular wavelength come in lower on the dial it is necessary to increase the inductance.

The wavemeter will only be as accurate as the calibration-curve; therefore use graph paper of sufficient size for the desired accuracy. The curves for the different ranges may be plotted on the same sheet for convenience; different "base-lines" for the different ranges will be necessary, as shown in Fig. 2.

Such a simple wavemeter is very convenient in determining the location of short-wave broadcast stations and, with calibrations for a few different coils, will have many uses; it will repay one many times over for the time spent in its construction. No owner of a modern receiver should be without one.

"Hello, London! Are You There, New York?"

(Continued from page 1087)

this case the carrier wave of 30-kc. and the "sum" band, reaching up to 35-kc., are suppressed. This leaves us a band of frequencies from 25 to 30 kc. (See Fig. 1).

This difference band is then heterodyned with a second carrier wave, this being of 90 kilocycles (3,331 meters—See Fig 1A). As before, there are set up sum and difference bands; they now range from 60 to 65 and from 115 to 120 kilocycles. Again the carrier wave and the sum band are eliminated; and we have a band of audio-modulated frequencies, ranging from 60 to 65 kilocycles, which are transmitted by radio across the Atlantic.

This 60-ke. band is selected because it is the designated one (5,000-meter wavelength)

BELLELAIRE HOTEL

420 Diversey Parkway, CHICAGO

\$2.50 to \$5 a day for a large, beautifully furnished room, with private bath attached, in this new hotel located at the north end of Lincoln Park where Sheridan Road begins. Food and service of great excellence at reasonable prices in the famous restaurant.

Take any north bound motor coach—fare 10c—or any surface car routed in North Clark Street. Illustrated literature upon request.



Bradley Leak

THE PERFECT GRID LEAK



Provides a noiseless range of grid leak resistance from 1/4 to 10 megohms. Assures most effective grid leak resistance value for all tubes. Small grid condenser (0.00025) is separate. Metal parts nickel plated. One hole mounting.

Allen-Bradley Co.

Electric Controlling Apparatus
287 Greenfield Avenue Milwaukee, Wis.

Special Library of Information

RADIO PATENTS and TRADE MARKS

JOHN B. BRADY

Patent Lawyer

Ouray Building Washington, D. C.

Cable address: RADIOPAT

Telephone: Main 4806

Valley Chargers

Manufactured by VALLEY ELECTRIC CO., ST. LOUIS, MO.



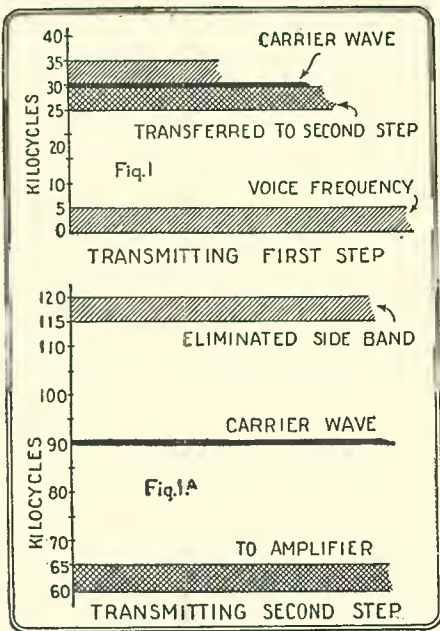

This diagram illustrates the carrier waves and the two side-bands, and the way in which the carrier and one side-band are eliminated in transatlantic radiotelephony.

for transatlantic telephone communication. It is also much easier to separate by filters frequencies as far apart as 60, 90 and 120 kilocycles than those closer together, as in the 25- to 35-kc. band with which we started.

TRANSMISSION AND DETECTION

Further amplification is then carried out, first with a 10-kilowatt water-cooled tube, then with a stage of two such tubes, and finally with a third stage of twenty tubes. The voice impulse has now been magnified in volume more than two billion times. The power radiated into space from the antenna is about 70 kw., or about a hundred horsepower.

At the receiving end of the system in Wroughton, England, the incoming signals in the frequency band of 60 to 65 kc., are caused to beat with a locally-generated frequency of 60 kilocycles, thus resupplying the suppressed carrier wave. The difference-frequency thus created, 0 to 5 kilocycles, reproduces the original voice frequencies and causes an audible signal in the telephone circuit, as indicated in Fig. 2.

The same steps are carried out in the same order when the speech of the Londoner is being transmitted to America, except that the American receiving station at Houlton, Maine, reduces the receiving signal to audibility in two steps, by 90 and 30 kilocycle modulation, instead of by a single reconstituted carrier wave, as used at Wroughton.

AUTOMATIC VOICE RELAY

It has been discovered that, when talking by telephone over long distances, such as between New York and Chicago, where a certain type of cable is employed, all the energy produced by the transmitter, when energized, does not stop in the receiver. Some of it is reflected back over the line and is heard again in the first receiver. This "reflection" has been eliminated by an ingenious little "electrical valve," which permits the electrical energy to go in one direction only and therefore stops reflection.

Something of the same sort was experienced in the preliminary tests of the transatlantic radiotelephone. Whenever anyone spoke at the New York end he would hear a howl in his receiver. After due experimenting it was discovered that this was caused by similar reflection. By referring to the sketch showing the telephone lines used in this system, it will be seen that there is a line from the receiver at Houlton, Me., to New York and on the English side, one from

LIGNOLE

Chosen by—T. H. NAKKEN for the "NAKKEN ULTRA-5"
Chosen by—JOHN F. RIDER for the "6-TUBE PHASATROL BALANCED RECEIVER."



PANEL AS SPECIFIED by T. H. NAKKEN
Drilled and Lettered.....List \$7.50

PANEL AS SPECIFIED by JOHN F. RIDER
Drilled and Lettered.....List \$7.50

THE LIGNOLE CORPORATION
508 So. Dearborn St., - - - Chicago, Ill.



If unable to obtain from local dealer write us direct, mentioning his name.



An interesting report on LIGNOLE by Prof. GUY M. WILCOX, Sr., Prof. of Physics, Armour Institute of Technology. Yours for the asking.



OPERATE YOUR RADIO FROM LIGHT SOCKET for 6³⁹

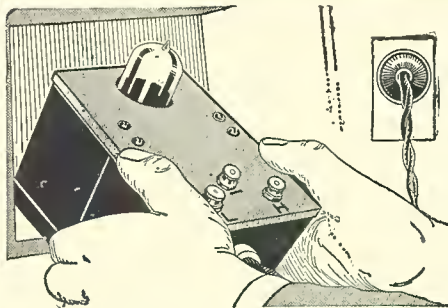

Used with storage "A" battery furnishes "A" power for your set from the light socket. After connecting you are ready to enjoy real radio pleasure. Uses only a few cents worth of current per week.

Operates Large and Small Sets
Has separate taps so that it is equally effective for large and small sets; handles up to 12 tube radios. May be used also as a Trickle Charger. Has two rates: .4 and .6 amps per hour.

Completely Equipped—Nothing to Buy
Includes a genuine General Electric Tungar Trickle Charger Bulb, worth \$4.00, FREE Fully Guaranteed. YOUR MONEY BACK IF NOT SATISFIED.

MAIL THIS COUPON TODAY

MONARCH MFG. CO., 4554 Maiden St., Chicago, Ill., Dept. RN.
 Ship at once, post paid, (check enclosed) West of Rockies \$6.99.
 Ship at once C.O.D. for \$8.39, plus postage.
 Name
 Address
 City State

MONARCH MFG. CO.,
Dept. RN. 4554 Maiden St., Chicago, Ill.

HAVE YOU SEEN "THE NEW BALDWIN 99"

Here is Baldwin's latest contribution to radio—THE BALDWIN "99" a greatly improved new type speaker, the development of the most famous of all units—THE BALDWIN—built into the new "99" "99" WORKS WITH OR WITHOUT HIGH VOLTAGE

Loudspeaker tone is judged by the quality of its unit; 15 years ago Nathaniel Baldwin designed units that were recognized for their fine tonal quality and today Baldwin is still the standard by which others are judged, comparable to the sensitive mechanism of a fine watch.

A SIMPLE PLUG-IN SPEAKER THAT OPERATES ON ANY SET WITHOUT CHANGE

If you appreciate true tone fidelity, hear and see the NEW BALDWIN "99" at your dealers—15 years of unit building experience is the vital factor in its excellence. THERE IS NO SUBSTITUTE FOR A BALDWIN.

At all good Dealers \$28.50
Folder Sent On Request.
J. W. & W. J. WOOLF, Baldwin Distributors, 229 Fulton St., New York

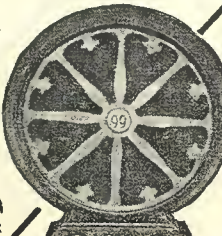

FROST-RADIO VARIABLE HIGH RESISTANCE UNITS

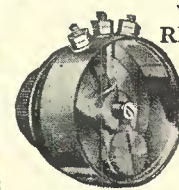

For fine control of tone and volume you should install FROST-RADIO Super-Variable High Resistance Units as indicated in our free booklet. Far superior to wire wound type. Operation is smooth and noiseless because of the exclusive roller contact arm. Nickel-plated brass case. Single hole mounting. Supplied in a variety of resistances from 400 to 500,000 ohms. List \$1.25.

BAKELITE and METAL FRAME RHEOSTATS

The neatest, most compact and most serviceable rheostats made. Have smooth-working contact, bakelite pointer knob, single hole mounting. Finest nichrome or chrome A wire; wide resistance strip keeps rheostat cool under heaviest load. A type to suit every requirement from 25 to 75 ohms. Bakelite type, list 25c. Metal Frame Type, list 50c. Your dealer has them.

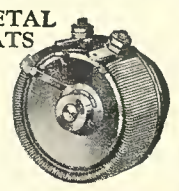

HERBERT H. FROST, Inc.

160 N. La Salle St. CHICAGO
MEMBER R.M.A. New York Los Angeles

FROST-RADIO FROST-RADIO FROST-RADIO FROST-RADIO
FROST-RADIO FROST-RADIO FROST-RADIO FROST-RADIO

\$75 A WEEK BUILDING RADIO SETS

In Your Spare Time

Join the Radio Association of America. Learn how to build and repair sets. The Association will train you—start you out in business, if you wish. Be the radio "doctor" of your community. \$3 an hour upwards easily made.

Earns \$500 in Spare Time

"I have at last found myself", writes Lyle Follick, Lansing, Mich. "I have already made over \$500." Werner Eichler, Rochester, N.Y., "... have made over \$50 a week in my spare time." Our members are starting radio stores, increasing their salaries, securing better positions, passing radio operator examinations, earning big money in spare time.

Join Association Now

Are you interested in Radio for pleasure or profit? Join now because we have a Special Plan whereby your membership need not cost you a cent. Only limited number of these memberships acceptable. Write now for details—before it is too late.

Mail this Coupon—

Radio Association of America,
Dept. RNA-3, 4513 Ravenswood Ave., Chicago

Send me details of your special Radio Association Membership Plan.

Name

Address

City..... State.....

Lowest Wholesale Prices

LR-4 KITS NOW READY FOR DELIVERY

Madison Multi-Chokes, Cockaday LC-27, Hammarlund-Roberts, Alden Truphonic, AmerIran Power Packs, Ultimax, Inftradyn, Benjamin Controlladene Kits in stock.

JOBBERS-DEALERS PROFESSIONAL SET BUILDERS

Before buying, get our quotations on our **GUARANTEED KITS. 3-Hour Shipping Service.**

1927 BUYING GUIDE

A few copies left for Dealers and Professional Set Builders. Send for yours today. It's free!

ADDRESS DEPT. RN

We are the Exclusive Direct Representatives of the Committee of 21 Manufacturers

Allen-Rogers

Incorporated

Kit Headquarters

110 East 24th St. New York, N.Y.

Amazing New 5-Tube Radio At Very Small Cost Improves Reception 100%

New York City, N. Y., Feb. 10.—Lieut. Sterling G. Sears of the U. S. Naval Reserves has perfected a marvelous new 5-tube Radio that improves average home reception about 100%. Due to special features, this Radio is extraordinarily selective and powerful, easy to operate, very economical on Battery consumption—and costs only about one-third of the usual price of 5-tube machines. Perfect satisfaction absolutely guaranteed, and a 10-day Free Trial offered to all who wish to try it. Full information together with reports of tests made by experts will be sent FREE to all who write at once to Geo. W. Naylor, Jr., Dept. 314N, 161 Chambers St., New York City. Write today—no obligation!—adv.

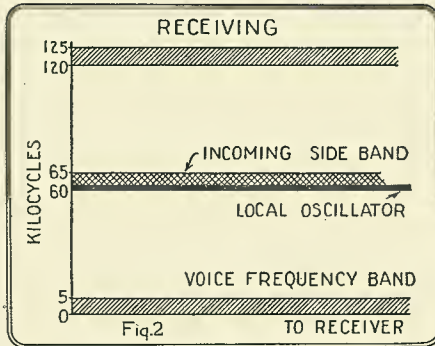

The "beating" of the incoming side band with a locally-generated wave of 60 kc. reduces the frequency to audibility.

Wroughton to London. These lines are, in their normal state, open; that is, ready for use.

Now it was discovered that, when one spoke into the microphone in New York and the signals were put on the air at Rocky Point, a portion of them went up to the receiving antenna at Houlton. They were detected there and carried down to the telephone in New York by the land line connecting these points, thus producing the howl. Therefore, in order to overcome this difficulty, a relay was placed in this line between Houlton and New York, which short-circuits it automatically when the microphone is energized in Manhattan. This short-circuiting device is a vacuum tube which operates an ordinary telephone relay. The same type of shorting is employed in the land line between Wroughton and London. Thus, when one person is speaking in New York the line between there and Houlton is shorted, while the London-Wroughton line is open; the opposite being the case when the man in London is talking.

The same type of relay is used also in the transmitting lines between New York and Rocky Point and in the line between London and Rugby, where the English transmitter is located. Therefore, when New York is talking the receiving line is shorted and the transmitter open, the reverse being true at the English side.

One of the first experiments with two-way radiotelephone conversation was undertaken at Catalina Island, California, several years ago, between the island and the mainland. This, however, was abandoned when a cable was laid between these two points. However, it would be possible for anyone to talk from Catalina to another, in Paris or Berlin, for instance, because there is a telephone cable between the Continent and England. So one might talk by air from Catalina to the mainland, by land line to Rocky Point, by air to London, and then by cable and land line to whatever point in Europe he desired. This is in the not-distant future, and surely the picture presented is not overdrawn.

One other development which the telephone engineers have yet to master, is that of secrecy in the air links between Rocky Point and Wroughton, Rugby and Houlton. Anyone who so desires may tune in with a receiving set on 5,000 meters and hear the conversation, providing he supplies the necessary local oscillations, which are needed to reduce the single side-band of approximately 60,000 cycles down to the audio-frequency range. The engineers say it is a relatively simple matter to counteract this, for the signals can be "scrambled" in such a manner at the transmitting end, that they will be unintelligible to anyone who has not the correct method of "unscrambling." This latter process is just as simple at the English end as the scrambling at the American side, and will doubtless be introduced in the near future.

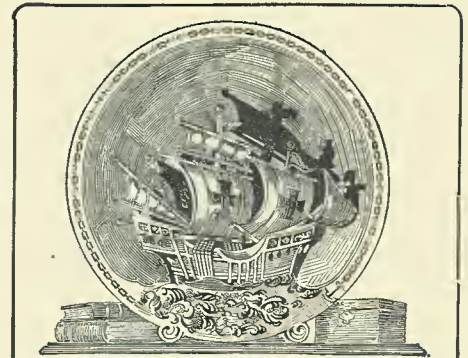

New Vitalitone Cone LOUD SPEAKER

A beautiful, real model of a ship, executed in statuary relief, and colored; Antique Polichrome.

Powerful vitalitone adjustable unit, will not rattle or buzz—unqualified guarantee.

Price Only \$12.50 F.O.B. N.Y.

Send For Literature

MANUFACTURED BY VITALITONE RADIO CORPORATION

88 University Place, N. Y.

Licensed Pat. No. 1593106

CARTER

Volume Controls
Jacks
Potentiometers
Switches
Rheostats

MAKE THE

NAKKEN Ultra-5

WORK BETTER

Carter parts are original Carter designs, and there is nothing to take their place for superiority of performance. Each part is built for a specific purpose—original—not an adaptation.

In Canada: Carter Radio Co., Limited, Toronto

CARTER RADIO CO.

CHICAGO

FIVE TUBE RADIO

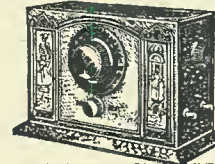

\$25.00

AGENTS WANTED BIG COMMISSION

Demonstrating agent wanted; every county. Exclusive to right man. Sell what public wants—five tube, long distance, loud speaker radio with single dial control. Price within reach of all. \$25.00 retail; liberal discount to agents. Sell in spare time—evenings. No selling or radio experience necessary. Territory going fast. 100 page Radio Book FREE. Write today—don't delay. CC FISCHER, 122 W. Austin Ave., Chicago

Three Foot Cone OR Roll Type Speaker

MAKE YOUR OWN AND SAVE EIGHTY PER CENT OF COST WITH THE FAMOUS ENSCO KIT. ONLY \$10.00.

MAKE YOUR OWN THREE FOOT CONE OR ROLL SPEAKER IN LESS THAN AN HOUR. Complete parts furnished in kit form. We guarantee this speaker the equal of any manufactured cone speaker at any price.

With this THREE FOOT CONE SPEAKER you hear *all* the tones. It brings out the true depth and beauty of orchestral and instrumental music. Can be operated softly for Living Room Music or Full Volume for dancing, and without trace of distortion.

Kit includes famous "ENSCO" cone unit, the only direct-drive, distortionless unit for large cones; Alliambra Phonotex for big cone, with brass apex, two Sepia Prints showing cabinet or simple stand construction. All necessary instructions.

Buy this wonderful speaker under our absolute guarantee. Your money back if you are not convinced that it is the finest reproducing medium obtainable at any price. It works on any set, with ordinary Tubes or with Power Output.

SEND NO MONEY

ENGINEERS' SERVICE CO.,
25 Church St., (Oesk N) New York City

Write your name plainly as indicated below, then mail and complete kit will be forwarded to you. Just pay postman \$10.00 upon delivery.

NAME
ADDRESS

Wonderful New RADIO LIGHT

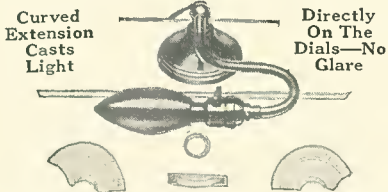

DESIGNED especially for radio use. Adjustable shade permits light to be directed exactly where wanted. Extra long silk cord has standard socket plug. Finished in beautiful soft bronze over all. Base weighted to prevent tipping.

If dealer cannot supply, send check or money order, amount \$1.00. All charges covered. Money-back guarantee.

VIMCO MFG. COMPANY, INC.,
721-C Ellicott Square Buffalo, N. Y.

VIMCO RADIO LIGHT

HOTEL FORT SHELBY

Lafayette Blvd. at First St.
DETROIT

Less than 5 minutes' walk from wholesale, retail, financial and theatrical centers. Quiet, comfortable rooms at reasonable prices. Restaurant and coffee shop. An especially pleasant room with private bath \$3.50 a day and up; others \$2.50 up. Servidor Service. Fort Shelby Garage close by.



W. G. McKay, Ass't Sec'y
Seth E. Frymire, Mgr.

RADIO NEWS OF THE MONTH

(Continued from page 1098)

the broadcasting company, with a station which had permitted its facilities to be used, on the ground that the programs "should not be used for profit, either by tapping wires or picking up the broadcast." It is reported, however, that programs from independent stations will be substituted.

"IMPERIAL" SYSTEM EXTENDED
CLOSE upon the installation of commercial beam radiotelegraph service between Great Britain and Canada, the completion of the Australia-England link was announced, and during the present month, the South Africa-England and Canada-Australia lines are to be put in operation, according to schedule.

RADIO AND FOX FARMING IN ALASKA

Radio is taking the place of tedious mail communications in the fox-farming business at Kusilof, a lonely settlement on the Cook Inlet side of the Kenai Peninsula in Alaska. F. W. Williamson, proprietor of one of the largest fur ranches in the territory, has installed there what is perhaps the only wireless station owned and operated by a fox farm in the United States.

Two aerials have been rigged, one of them for the commercial station, as will be seen in the accompanying photo. The other is a double endless wire, 150 feet long, and fully insulated. It is up about 60 feet in the air, with one end attached to the house and the other end to the mast. A five-tube Grebe Synchrophase set is used for receiving. When the set is in use all of the electricity on the farm is switched off, local interference thus being done away with.

On winter evenings the Williamsons have their dinner at 4 o'clock. This corresponds with concerts commencing at 6 p. m. at the Palace Hotel in San Francisco or the Olympic in Seattle. The loud speaker reproduces these clearly and the meals are as enjoyable as though the jazz artists were right in the room.

The snow may be several feet deep out of doors, the Kusilof River and Cook Inlet are covered by solid sheets of ice, but the family are snug at home, in touch with the latest in entertainment; although it is 90 miles to Anchorage, the nearest town of any size.

A licensed operator lives at the fox farm and handles the transmitter, which is operated two hours a week. In winter the mail is delivered only once a month by dog sled, sometimes not that often. Nevertheless, Mr. Williamson always knows what is going on in his business in the States. He gets the fur reports from the New York auctions and handles other commercial messages. Again, the radio serves its purpose in emergencies. This spring it brought a cannery doctor into the wilderness to attend the arrival of a new baby at one of the fox farmer's homes. If an engine should break down at Kusilof, there is no machine shop nearer than Anchorage. In the summer Mr. Williamson can wire to the States for new parts and have them in fifteen days, instead of the forty that would otherwise be required.

Lucile F. Saunders, Cordova, Alaska.

KEITH J. UPTON

If Mr. Upton sees this notice, will he be good enough to get in touch with the editor of this magazine, as soon as possible, in connection with certain radio information desired by the Editor?

EXPERTS TURN TO EQUAMATIC

Professional Radio Set Builders Find This Remarkable Receiver Delights Every Customer

HUNDREDS of professional set builders who have been turning out sets ever since the days when radio was a "craze" have found in the Karas EQUAMATIC 5-Tube Receiver the set they want for their customers. Each expert who has built one of these remarkable receivers has found that the one who bought it was more than delighted with his purchase—he was amazed with the results the EQUAMATIC delivered.

These experts tell us that the EQUAMATIC gives their customers exactly what they want—Matchless tone quality—a high degree of selectivity—long range when it comes to DX work—and a world of volume—with simplicity in tuning that is unsurpassed.

The Equamatic Receiver is easily and quickly built by anyone, whether familiar with receiver assembly or not. To the expert its construction is both a joy and a simple job, so carefully have all constructional details been worked out by our engineering department. Dealers everywhere can supply you with the necessary Karas and other parts used in the Equamatic. Get in touch with your dealer today and

Mail Coupon for Circular And Record of Performance

The coupon below, if filled out and returned to us, will bring our fully descriptive circular and a complete and interesting record of the performance of the Equamatic Receiver. We want every professional radio set builder to have complete data on this great receiver. MAIL THE COUPON TODAY. Address

KARAS ELECTRIC CO.,
1123 Association Building Chicago

Karas Electric Co.,
1123 Association Building, Chicago.

Please send me FREE your circular fully describing the Karas Equamatic Receiver, and a complete record of its performance in the hands of other expert set builders like myself.

Name
Address
City..... State.....



The F.P.M. saw cuts wood, iron and bakelite at any angle. Recommended by Radio Engineers and Set Builders. Unequaled for sturdy, lasting construction and fine workmanship. Blades of finest tempered steel. Get the F.P.M. Saw at your dealers or any hardware store or order direct.

1 F.P.M. Saw and 7 Blades sent prepaid \$1.00

DEALERS Write for Discounts JOBBERS
F. P. MAXSON, 1031 Newport Ave., Chicago

Acting Plays for Amateurs;

Monologs, Recitations
Drills, Minstrel and Vaudeville Jokes and sketches; ideas for entertainment. Send for free catalog.
Dramatic Publishing Co., 542 S. Dearborn St., Chicago

OPPORTUNITY AD-LETS

Follow these advertisements every month. Reliable advertisers from all over the country offer their most attractive specials in these columns.

Classified advertising rate twenty-two cents a word for each insertion. Ten per cent discount for 6 issues, 20 per cent discount for 12 issues. Name and address must be included at the above rate. Cash should accompany all classified advertisements unless placed by an accredited advertising agency. No advertisement for less than 10 words accepted.

Objectionable or misleading advertisements not accepted. Advertisements for the May issue must reach us not later than March 1st.

CIRCULATION LARGER THAN THAT OF ANY OTHER RADIO PUBLICATION

EXPERIMENTER PUBLISHING CO., INC., 53 Park Place, New York, N. Y.

Agents Wanted

Big Money and fast sales. Every owner buys gold initials for his auto. You charge \$1.50; make \$1.35. Ten orders daily easy. Write for particulars and free samples. American Monogram Co., Dept. 133, East Orange, N. J.

Guaranteed Genuine Gold Leaf Letters anyone can put on store windows. Large profits, enormous demand. Free samples. Metallic Letter Co., 422 N. Clark, Chicago.

Tired of Working for other people? Without experience, training or capital I'll show you how you can become financially independent. Easy, pleasant work. \$100 profit every week. Free automobile. Write today for particulars. Albert Mills, Mgr., 9029 Monmouth, Cincinnati, O.

Aquatic Devices

Self-Inflating Life Belt—pocket size. Wonder of the age. Miniature-hollow-ribbed lifeboat distendable around body instantly. Sustains wearer in deep, rough water. Most practical safeguard for sea-travelers and non-swimmers. Boon to aquatic sports. Get free illustrated booklet. Self-Acting Life Belt Co., 55 E. 8th St., New York.

Business Opportunities

Free Book. Start little Mail Order Business, Pier Company, 72AF Cortland Street, N. Y.

Stocks—Bonds, Domestic—Foreign, bought—sold. Dealers in all marketable securities. Frank Y. Everett & Co., 20 Broad St., New York.

Manufacture Crystals—Big profits, particulars Free. Box 313, Wichita, Kansas.

Co-operative EIA membership is establishing one honest and industrious man of each county in his own successful industry. Young married men preferred. Write confidentially about yourself. Equitable Industries Association, 154-R Nassau St., New York.

Chemistry

Learn Chemistry at Home. Dr. T. O'Connor Sloane, noted educator and scientific authority, will teach you. Our home study correspondence course fits you to take a position as chemist. See our full page ad on page 1153 of this issue. Chemical Institute of New York, 66 W. Broadway, New York City.

Correspondence Courses

Used correspondence school courses sold on repurchase basis. Also rented and exchanged. Money-back guarantee. Catalog free. (Courses bought). Leo Mountain, Pisgah, Alabama.

Help Wanted

Detectives Needed Everywhere. Travel. Experience unnecessary. Write, George Wagner, former Government Detective, 1968 Broadway, N. Y.

Earn \$25 weekly, spare time, writing for newspapers, magazines. Experience unnecessary. Details FREE. Press Syndicate, 973, St. Louis, Mo.

Become a Landscape Architect. Uncrowded profession of wonderful opportunity for money-making. Easily mastered by mail. Earn while you learn. Write for book. American Landscape School, 11 Newark, N. Y.

Set Builders! We furnish jobs for you. (No fee.) Competent men needed today in every community to build LC-27 and Hammarlund-Roberts Sets. Big money for you if you can qualify. Register NOW, giving particulars, experience, references. Allen-Rogers, Inc., 118 E. 28th St., New York City.

Instruction

Radio Announcing as a profession or for the politician, business man or any radio speaker—taught in ten lessons. Send for prospectus. Pioneer Radio Broadcasting School, Inc., 843 Little Bldg., Boston.

Miscellaneous

Inventors: Use our special service for presenting your invention or patent to manufacturers. Adam Fisher Mfg. Co., 278-A Enright, St. Louis, Mo.

Y. M. C. A. Radio Institute, 154 East 86th Street, New York. Hundreds of successful graduates. Home Study and School courses. Radio operating or Mechanics. Send for Free Booklet.

Forms to Cast Lead Soldiers, Indians, Marines, Trappers, Animals, 151 kinds. Send 10c for illustrated Catalogue. H. C. Schiereke, 1031 72nd St., Brooklyn, N. Y.

Motorcycles, Bicycles

Don't Buy a Bicycle Motor Attachment until you get our catalog and prices. Shaw Mfg. Co., Dept. 6, Galesburg, Kansas.

Old Money Wanted

\$2 to \$500 each paid for hundreds of Old or Odd Coins. Keep all old money, it may be very valuable. Send 10c for New Illustrated Coin Value Book, 4x6. Guaranteed prices. Get posted. We pay Cash. Clarke Coin Company, 14 Street, LeRoy, N. Y.

Old Money Wanted. Do you know that Coin Collectors pay up to \$100.00 for certain U. S. Cents? And high premiums for all rare coins? We buy all kinds. Send 4c for large Coin Folder. May mean much profit to you. Numismatic Co., Dept. 112, Ft. Worth, Tex.

Patent Attorneys

Inventors—Should write for our Free Guide Books and "Record of Invention Blank" before disclosing inventions. Send model or sketch of your invention for our Free Inspection and Instructions. Radio, Electrical, Chemical, Mechanical and Trademark experts. Terms reasonable. Victor J. Evans & Co., 923 Ninth, Washington, D. C.

Patents—Send for form "Evidence of Conception" to be signed and witnessed. Form, fee schedule, information free. Lancaster and Allwine, Registered Patent Attorneys in United States and Canada, 269 Ouray Bldg., Washington, D. C.

Patents. Send drawing or model for examination and report as to patentability. Advice and booklet free. Highest references. Best results. Promptness assured. Watson E. Coleman, Patent Lawyer, 721 9th Street, N.W., Washington, D. C.

Patents

Inventions Commercialized. Patented or unpatented. Write Adam Fisher Mfg. Co., 278 Enright, St. Louis, Mo.

Patent Sense valuable book free. See Lacey's ad page 1177. Lacey & Lacey, 631 F St., N.W., Washington, D. C.

Photoplays Wanted

\$55 for Ideas. Photoplay Plots revised, criticized, copyrighted, marketed. We are right on the ground in daily touch with studios. We know the market. Send for free booklet. Universal Scenario Company, 218 Security Bldg., Santa Monica & Western Ave., Hollywood, Calif.

Postage Stamps

Stamp Collectors—Phillips Monthly Bulletin (illustrated) offers over 2000 special bargains, sets, packets, single stamps etc. each issue. Free. Phillips, Box 1012, Hartford, Conn.

Printing

Neagravure Process Printed Stationery—Distinctive—Different. Samples. Soliday, Knox, Indiana.

Radio

Boys! Don't Overlook This. The "Rasco" Baby Detector. Greatest detector ever brought out with moulded base. Fully adjustable. See former advertisements in this publication, or our catalog. Detector with Galena Crystal, complete 50c, the same detector with Radiocite Crystal, 75c prepaid. Send for yours today. Radio Specialty Company, 96-98 Park Place, New York City.

Attention!—50 Vacuum tube hook-ups. The greatest collection of vacuum tube circuits ever brought under two covers at such insignificant cost. These diagrams will be found in the great "Rasco" catalog, which contains raw materials and parts in a greater profusion than any other catalog. 15c in stamps, or coin, will bring the catalog to you. Radio Specialty Co., 96-98 Park Place, New York City.

Power transformers, chokes and parts. Write for lists. Radio Parts Sales Co., Box 24, Orange, N. J.

Wireless from Mars! Startling! Thrilling! Hand it to your Friends to read and then watch them drop it with surprise! Barrel of Laughs! Price—15c. Mars Novelty, 1914 Crystal St., Chicago.

Resistance Coupled Amplification gets great distance with excellent quality by means of improved method of connecting amplifier to detector circuit. Blue-print showing necessary changes sent on receipt of \$1.00. W. Moses, 9235 Edmunds Ave., Cleveland, Ohio.

Radio trouble finder, log, dictionary. A new illustrated 64-page book. Pocket size. Sent postpaid for 25c, coin or stamps. Patrick-Mahoney Co., P. O. Box 931, Schenectady, N. Y.

Tested Galena Crystals per pound, 75c, prepaid. Buskett, Joplin, Mo.

"Alkabatts" 22½-volt Alkaline Storage B, \$1.95. AB charger, \$1.95. B eliminators, catalog. Science Specialties, 620 Fayette, Indianapolis, Ind.

Free Sample Ivory Radio Panel the new radio panel now in great demand. Its handsome grained and polished surface, insulating qualities, workability, and permanent finish, will make the most beautiful and efficient set of all. Also Ivory dials and knobs. Ivorylite Radio Panel Co., 3121 Avenue G, Fort Worth, Texas.

Radio Stamps

Wanted—Radio Station Stamp Collectors, everywhere. Write Chas. A. Philidius, 510 East 120th St., New York, N. Y.

Scenery for Rent

World's Most Beautiful Settings for operas, plays, minstrels. Amelia Grain, Philadelphia.

Song Writers

Songwriters Substantial Advance Royalty payment essential to publication contract. Expert advice furnished beginners upon receiving poems requiring music and copyrighting for free examination. Send today. Walter Newcomer, 1674 Broadway, N. Y.

Stammering

St-tut-t-tering and stammering cured at home. Instructive booklet free. Walter McDonnell, 121 Arcade, 1126 Granville Avenue, Chicago, Ill.

Telegraphy

Telegraphy—Both Morse and Wireless taught thoroughly. Big salaries. Wonderful opportunities. Expenses low, chance to earn part. School established fifty years. Catalog free. Dodge's Institute, Cour St., Valparaiso, Ind.

Wanted to Buy

Full Value Paid for Old Gold, Jewelry, Watches, Diamonds, crowns, bridges, dental gold, silver, platinum, gold or silver ore; magnet points, old false teeth. Packages returned if our offer is not satisfactory. United States Smelting Works (The Old Reliable) 39 So. State St., Dept. 16, Chicago, Ill.

BOOK REVIEW

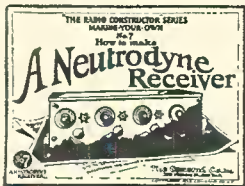

THE NEUTRODYNE

for those who want to ENJOY Radio

If you've never had a "Neutrodyne," you don't know what quiet, clear, steady, Reception is.

Why have Neutrodyne receivers been sold in the hundreds of thousands—Why are they being sold today in even greater quantities?—Because the Neutrodyne gives you quietness, freedom from internal squeals and howls with which no circuit can compare.

Tuning a Neutrodyne is a pleasure—Distance, volume, clarity—are all achieved.

If you want the pleasure of a fine Radio Receiver, build the Neutrodyne with a Consrads Pattern.

Full size blueprints furnished on Panel and Wiring—16-page instruction pamphlet. All in handsome folder.

50c
ON ALL NEWSSTANDS

If your dealer cannot supply you write direct

The Consrads Co., Inc.
53 Park Place,
New York, N. Y.

Consrads

BY ROBERT HERTZBERG

THEORY OF VIBRATING SYSTEMS AND SOUND, by Irving B. Crandall, Ph.D. D. Van Nostrand Company, New York City. 6 x 9 inches, 272 pages, cloth, illustrated. Price \$5.00.

Quality of reproduction being the aim of all radio set builders, it is a wonder that radio people do not study the actual mechanics of sound reproduction as much as they read and talk about the electrical amplifiers which they connect to sound-reproducers. Many qualified radio engineers, who can design amplifiers just about perfect in themselves, trust their instruments to the none-too-tender mercies of loud speakers that are makeshift in comparison; and of course they can do nothing about the results.

The "Theory of Vibrating Systems and Sound" is a book calculated to remedy this situation, in part at least. Its purpose is to give, in modern terms, a treatment of the basic theory of vibrating systems and sound, and to show how it has been applied to modern problems.

It is not particularly an elementary work, but is intended for students of physics who desire a knowledge of the theory of sound. It is mathematical, but contains many passages that can be read with understanding by beginners.

SUPER-HETERODYNE CONSTRUCTION AND OPERATION, by Robert E. Lacault, E.E. Radio Electric Laboratories, New York, N. Y. 5 x 8 inches, 103 pp. cloth. Price, \$1.97.

Undeniably the most complicated, the most versatile and the most sensitive radio receiving scheme, and therefore the most interesting one, the superheterodyne has long enjoyed the favor and attention of advanced radio experimenters. Because of its complexity, it has always been something of a terror for beginners, who regard it as the ultimate goal of their ambition as radio set constructors; but it is gradually losing its impressive aspect because of the wealth of technical information on it now available.

The latest contribution to superheterodyne data is made by Robert E. Lacault, designer of the well-known Ultradyne and former managing editor of RADIO NEWS. In this handy little book, entitled *Super-heterodyne Construction and Operation*, he has written a comprehensive resumé of superheterodyne theory, followed by practical advice on electrical design and mechanical construction. In the introduction the author says: "I have answered a great many questions regarding this type of set and found that the same ones are generally asked, regarding certain characteristics of this method of reception. I have, therefore, endeavored in this work to cover all these points and many others, and to make clear the operation of the superheterodyne. In order to make it understandable by the most uninitiated, technical descriptions have been avoided and everything is explained as clearly as possible. The troubleshooting chapter should prove useful to those who do not obtain the expected results from sets they have built."

The book starts with a short review of alternating-current theory, tuning, and the actions of coils and condensers. This section, in the opinion of this reviewer, is a waste of space, for it is much too brief to be of any value at all. Furthermore, the old shop-worn hydraulic analogies are used in the explanation of condenser operation; these are all right for beginners who as yet can hardly recognize a condenser when they see one, but they are something of an insult to the fan who knows enough about radio to attempt the construction of an outfit as advanced as the superheterodyne. A person who must resort to the water-pump-and-tank diagram for an idea of how condensers work has no business reading a treatise on the superheterodyne; he should be dabbling with a two-tube R.F. set.

The chapters on vacuum tube characteristics and how telephones and loud speakers work are likewise unnecessary. Perhaps it is the author's intention to refresh his readers' memory on these elementary subjects, but he could have done much

This Book and Magazine section will appear in each issue of RADIO NEWS, and contain reviews of the new publications of interest to radio students, from the beginner to the most advanced. It will be found a useful guide to intelligent purchasing. For the benefit of our readers, contemporary periodical offerings, both American and foreign, will also be briefly listed.

THEN

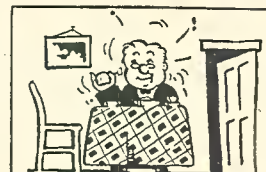

7 P.M.—Rushes supper to tune in big DX.

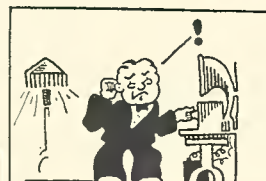

7:30—Discovers set wont work.



9 P.M.—Still trying to locate trouble.



12 P.M.—Gives up in disgust!

Don't hire an expert! Repair your Radio set yourself—it's easy

No matter how much or how little you know of your radio receiver, this new "Radio Trouble Finder" book is going to be a big help.

It explains the common and special faults of all the standard receivers of today; tells how to recognize instantly, by various methods, where the trouble lies and also gives special simple tests by which you can determine what is wrong with your receiver. Then for each particular fault there is explained the proper procedure for correcting it.

Book Contains 64 Pages
Size 6x9, Illustrated,
Handsome 2 Color Cover

he bought



ONLY 25c On All Newsstands

BUY YOUR COPY TODAY

If you cannot secure a copy from your dealer, order direct.

THE CONSRAD COMPANY, Inc.
53 Park Place, New York, N. Y.

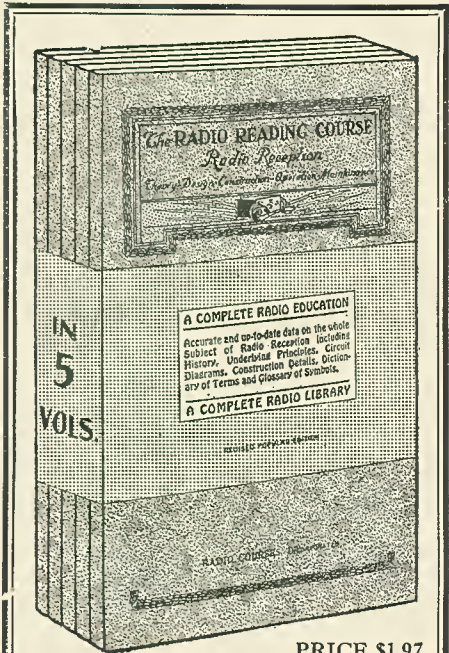

PRICE \$1.97

A RADIO EDUCATION

IN 5 VOLUMES

Theory, Design, Construction
Operation and Maintenance

LEARN AT HOME

These five component parts of a complete Radio Instruction Course are outlined in five volumes that contain not merely the essentials as so many books do, but more, they contain all that any modern up-to-the-minute textbook on any subject would cover. They are in themselves a COMPLETE radio education teaching every possible portion of Radio science.

Size of each book 6 by 9 inches, handsomely bound and illustrated with charts, diagrams, descriptions of equipment, etc.

SEND NO MONEY for these books. Just forward your name and address. We send you the books at once. On receipt of same you pay the postman \$1.97 plus a few cents postage and then they are yours.

Distributed by

The Consrad Company,
Incorporated
53 Park Place, New York, N. Y.

better by simply referring them to standard and more explicit handbooks, or at least to particular passages in such books having some direct bearing on his own specialized subject. Hydraulic analogies are highly incongruous in a superheterodyne manual, to say the least.

However, once the discussion of superheterodyne principles starts, the book becomes well worth reading; in fact, it is worthy of the closest study. Each individual unit of the typical "super" is closely analyzed, its function explained, and its trouble-making proclivities classified. The last two chapters of the theoretical section of the book deal with the matching of tubes in the intermediate amplifier, and the matter of shielding. A quotation from the former chapter may be of interest to experimenters who are undecided about the value of matched tubes in a "super". Mr. Lacault writes:

"In sets where the amplifying tubes are controlled by a single potentiometer, they (the tubes) should be matched so that when the voltage applied on the grids is varied, they all start to oscillate at the same point. If one of the tubes oscillates before the others, the potentiometer cannot be turned beyond the point at which this tube oscillates, and the other tubes are not amplifying the signals as much as they should."

The last quarter of the book is devoted to a detailed description of the LR4, a nine-tube set of the author's own design. This is the same receiver described in RADIO NEWS for January, 1927.

RADIO ENCYCLOPEDIA, by Sidney Gernsback, New York, N. Y., publisher. 8½ x 11¼ inches, 168 pp. cloth. Price, \$2.00.

The 1927 edition of S. Gernsback's *Radio Encyclopedia* is beautifully printed and bound. It makes a highly useful, as well as decorative, addition to any radio fan's book-shelf.

The text has been revised to a considerable extent, and has been brought right up to date. There are, likewise, dozens of new illustrations, of the most modern instruments, and scores of explanatory diagrams and drawings.

About 1,200 different radio words, terms and expressions are defined and explained in clear and understandable language. The definitions are short, but accurate and directly to the point. Any radio experimenter who is hazy about the meaning of the words or expressions he encounters in the pursuit of his hobby can add greatly to his knowledge and to his general understanding of the art by keeping a copy of the *Radio Encyclopedia* within easy reach and by referring to it freely and frequently.

The compiler of the encyclopedia has been very thoughtful in including among the numerous technical explanations short biographies of the men who have been most prominent in the development of radio telegraphy and telephony. Many radio amateurs know very little about men like Henry, Goldschmidt, Fleming, Meissner, and dozens of others; these are merely names to them, not real people. Mr. S. Gernsback gives short histories of some sixty-six inventors, whose various efforts are responsible for radio as it exists to-day.

THE OUTLINE OF RADIO, by John V. L. Hogan. Little, Brown, and Company, Boston, Mass. 5 x 7½ inches, 268 pp. cloth. Price, \$2.00.

When a man who has been a professional radio engineer for more than twenty years sits down to write an explanatory book on radio for people who do not know the difference between a microfarad and a micrometer, the worst must be expected. However, when that same engineer turns out a volume that is absolutely devoid of technical terms, and couched in lucidly clear language which the layman can really understand, he deserves loud cheers of commendation.

The man and his book are John V. L. Hogan and *The Outline of Radio*, respectively. He wrote the first edition a few years ago, and earned immediate recognition for it. He revised the work recently, and has issued a second edition, embodying explanations of the latest developments in broadcasting.

Mr. Hogan, in his foreword, offers the following wise advice: "If you are using a radio instrument, but are not quite sure how it works, study the science of radio. If you would like to put a receiver into your home, first find out what to expect of it. If you are merely curious about this new topic of conversation, read a little concerning it. But now for a word of warning: Don't expect any one book, or any five books, to tell you all there is to know about radio. Begin with an outline of what radio has done; and next, find out how to-day's radio accomplishes its surprising results. Then you will be ready to think about special applications and subdivisions of the science and the art; you may go into details of construction or operation, concentrating upon problems of generation, modulation, application, or what-not. But, primarily, get in mind the groundwork that forms the solid foundation of the whole of radio."

Current Radio Articles

RADIO BROADCAST, January, 1927.

A number of excellent receivers are described in this number of *Radio Broadcast*. One is a six-tube superheterodyne, designed by Kendall Clough. It is of comparatively simple and compact construction, using only two stages of intermediate-frequency amplification and one of audio amplification. The first detector and oscillator



68 Pages of
Radio's most
popular circuits
only 25c

This 68-page book of the Consrad Company is the latest compilation of Hookups in Radio. The Hookups are those that have been tried, tested and perfected by time and by thousands of Radio Listeners.

This priceless book contains: 18 Crystal Detector circuits, 39 Regenerative, 21 Reflex, 23 Radio Frequency, 10 Super Regenerative, 10 Amplifier and Oscillator, 5 Super-Heterodyne and other valuable Hookups.

All circuits are shown by simplified drawings and each is explained in detail.

The book is 6x9 inches in size, illustrated, and is contained in a special attractive 2 color cover.

**SOLD ON ALL
NEWSSTANDS**

If your dealer cannot supply clip this handy coupon and mail today.

**The Consrad Co., Inc.,
53 Park Place, N. Y. City**

Gentlemen—I enclose 25c for 1 Copy of your 68-page book, "150 Radio Hookups."

Name

Address

City, State

Second call to this wonderful Magazine offer

Free

You save \$1.00 and get 100 page books free



WE GIVE YOU THIS VALUABLE BOOK

It tells you how to make furniture, home appliances, tools, sport devices, hundreds of things that cost hundreds of dollars otherwise. It is full of drawings—pictures—constructional plans. Everything is explained fully—ready for you. Regular Price of this Book is \$.50. We are giving it free with every subscription to—

SCIENCE & INVENTION

To tell you how tremendously and intensely interesting is this great magazine is to tell you that exactly 30,405 men, from every country in this wide world of ours, are regular listed reporters of SCIENCE & INVENTION. The world is combed for big and small events in this marvelous scientific era—

Radio, Electricity, Chemistry, Mechanics—

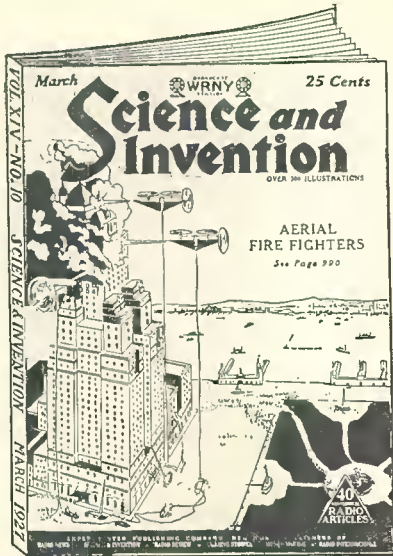

All Scientific fields of endeavor are covered fully.

Here is a list of some of the major articles in the brand new March issue just out—

Solving the City Traffic Problem by H. Gernsback.

Aerial Fire Fighters. Seeing Over a Wire.

Fill out the coupon below — Enclose \$2.50—and you get SCIENCE & INVENTION for 12 consecutive months—and absolutely Free, one copy of "How to Make It".

ACT NOW—This offer may never be repeated.

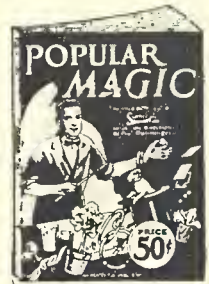

IT COSTS NOTHING TO OWN THIS BOOK

POPULAR MAGIC is a book for you, for everybody, young and old. But especially for those who want popularity, those who want to realize how much the admiration of friends help toward making life worth more. POPULAR MAGIC contains thousands of simple, entertaining parlor tricks, as many puzzling magical stunts and a whole book full of mystic spirit novelties. A new set of tricks for every day in the year. You get this book absolutely FREE by subscribing now

AMAZING STORIES

A new kind of magazine. Scientifiction by world-famed writers. Marvelous, Amazing Stories by great men such as Jules Verne, H. G. Wells, etc., appear in this new magazine AMAZING STORIES every month.

Stories of flying into space at dazzling speed on a comet; Mesmerizing the dead; remarkable situations of all kinds. Tremendously interesting—yet instructive.

Keeps you in touch with the writings of the men of the greatest imaginations in the world. A magazine for young and old.

Some of the big feature stories of the March issue just out are:

The Green Splotches by T. S. Stribling.

Under the Knife by H. G. Wells.

The Land That Time Forgot by Edgar Rice Burroughs.

Price \$2.50 the Year. Think of it for only \$2.50 you get one copy free of POPULAR MAGIC and AMAZING STORIES for 12 consecutive months delivered to your door. Fill out and mail the coupon now.



Experimenter Publishing Company, Inc.

53 Park Place
New York, N. Y.

EXPERIMENTER PUBLISHING CO., Inc.,
53 Park Place, New York, N. Y.

Gentlemen: I enclose \$.....for one year's subscription to....., you are also to send me free one copy of.....

Name

Address

City..... State.....

Experimenter Publishing Company, Inc.

53 Park Place
New York, N. Y.

Now it's complete ~ ~ ~ Ready for your radio bookshelf

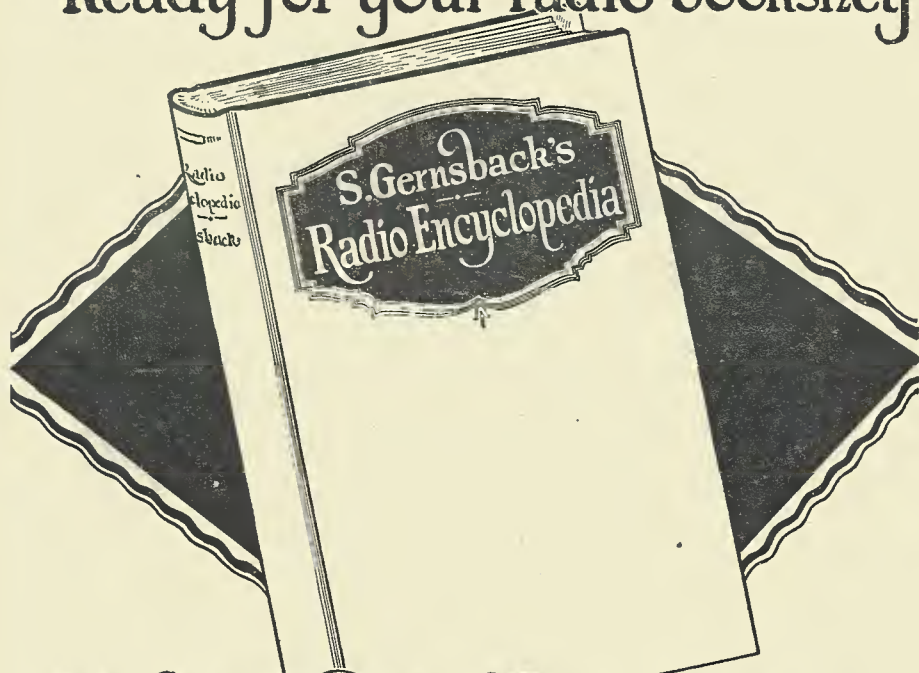

The First Radio Encyclopedia ~ Ever Published ~

Edited by **SIDNEY GERNSBACK**, Editor of "Radio Listener's Guide and Call Book (Radio Review)." Editor of "Money Making." Author of "Wireless Course in Twenty Lessons"—"One Thousand and One Formulas"—"Practical Electricity Course"—etc.

S. GERNSBACK'S RADIO ENCYCLOPEDIA is the only standard work ever published in America attempting to classify alphabetically the countless words used in the highly specialized science of RADIO.

The **ENCYCLOPEDIA** is written in plain English so that everybody can understand the definitions and descriptions.

This is not a Dictionary, but a real Encyclopedia of Radio.

The book contains as a supplement a classified cross-index designed to bring together radio references under one heading having relations in common.

All circuits new and old are described by word and picture and every part and apparatus used in Radio is explained and made understandable by means of photographs and drawings.

The work contains 1,930 definitions, 549 photographs, drawings and diagrams. Size of book is 9 x 12 inches, nearly an inch thick, 168 pages printed on strong heavy paper, specially made for books of this kind. It is bound in stiff Keratol covers, hand sewed and gold stamped.

PRICE **\$2.00** Postage Paid

SEND ALL ORDERS DIRECT TO THE EDITOR

SIDNEY GERNSBACK

53 PARK PLACE

NEW YORK CITY

S. GERNSBACK,
53 Park Place, New York, N. Y.

R. N. 3

I enclose \$2.00 for one copy of your new "RADIO ENCYCLOPEDIA" as advertised above.

NAME

ADDRESS

CITY, STATE

components are shielded in individual cans, in order to insure operating stability. The set is designed for operation with a short indoor aerial, instead of on the customary loop. The six tubes, of the 201A type, show a plate-circuit drain of 30 milliamperes.

In another article David Grimes, the well-known exponent of the "reflex" idea, describes his new "inverse duplex" system, whereby two stages of tuned radio-frequency amplification, detector, two stages of transformer-coupled and one stage of resistance-capacity-coupled audio amplification are employed with only four tubes. Some of the outstanding features claimed for the scheme are as follows: excellent R.F. selectivity on all wavelengths; substantially equal R.F. amplification on all wavelengths; special arrangements to secure real tone quality in the audio circuit; means for preventing detector tube overloading; elimination of direct current from loud-speaker windings; straight-line volume control; long tube life, because of negative bias on all amplifying tubes; small "B" battery drain; unique audio grid arrangement on first audio tube to overcome "hand hum"; use of 171 power tube and 200A detector; determination of audio phases for reduced radio-frequency modulating effect on excessive signal strengths.

Leslie Biles gives constructional data on the "Hi-Q" Receiver. This set is already well known to the readers of RADIO NEWS, having been completely described in the December, 1926, number of this magazine.

James Millen describes a combined amplifier and A.C. operated power-supply unit, the parts for which were recently put on the market by a large New England firm. This unit comprises a "B" eliminator feeding the plates of a three-stage amplifier, consisting of one stage of impedance coupling and two stages of resistance-capacity. The combination is a very good one, furnishing loud signals of perfect quality.

Other articles include "The Hundred-Billion-Dollar Vacuum Tube", by James Stokley, and "Piezo-Crystals", by M. Thornton Dow.

POPULAR RADIO, January, 1927.

Kenneth Harkness has designed a new receiver, called the KH-27, which he describes in detail. It employs six tubes in all, in a circuit involving two stages of tuned R.F., a non-regenerative detector, and three stages of impedance-coupled A.F. The R.F. portion of the set uses an adaptation of the Rice system of neutralization, while the A.F. uses new twin-impedance units, which, it is claimed, provide remarkably clear reproduction. In both the plate and grid circuits of the amplifier tubes choke coils are used, their presence in the grids being particularly stressed.

This is the main constructional story. Other articles are: "Who Will Pay the Man Who Pays the Broadcaster?" by Orrin E. Dunlap, Jr.; "Radio's Contribution to Our Language", by Charles Magee Adams; "KFP"—a Miniature Broadcasting Station That Directed a Battle", by Lloyd Jaquet; "The Quack Doctors of Radio", by E. E. Free; "What Happens When You Tune Your Set", by Sir Oliver Lodge; and "How to Build the LC-Junior Power Pack", by L. M. Cockaday.

QST, January, 1927.

The amateur interested in transmitting will find in this number of QST a description of two low-power, crystal-controlled outfits which are simpler in construction than many receivers. They are ideal sets with which to enter the fascinating transmitting "game", for they are positive and dependable in action, and also quite inexpensive; the complete parts can be purchased for slightly more than thirty dollars. Constructional plans for two models are given: one for operation entirely on alternating current, and the other for use with a direct-current plate supply.

David Grimes, in an article entitled "Developments in Tuned Inverse Duplex", describes the very same circuit he discusses at some length in the January number of "Radio Broadcast."

This is very unusual editorial duplication, and the author will probably be called to account for it. Other excellent technical articles include "A Direct Radio-Control Relay", by Robert S. Kruse, and "How Our Tube Circuits Work", by the same writer.

QST Française, Paris, France. December, 1926. 84 pages, two-color cover.

The French QST is a large and healthy magazine filled with technical and popular material in abundance, with the technical articles predominating. There are stories on wave propagation, the theory of the three-element vacuum tubes, the radio compass of F. W. Dunmore (of our own Bureau of Standards), the use of the double-grid tube, the effect of negative grid bias, and on kindred subjects of interest to radio enthusiasts. If the numerous mathematical formulæ found in the magazine are any indication, the average French radio fan's technical ability and training are somewhat superior to the average American's.

The magazine evidently believes in encouraging its readers to build radio sets, for its publishers include with each copy of the December issue a two-foot-square blue-print, showing, in full scale, the details of a low-power transmitter using three tubes.

RADIO UMSCHAU, Frankfurt am Main, Germany. December 19, 1926. 48 pages. Characteristic green cover.

This magazine is a weekly, two-thirds of its pages being devoted to the programs of the German, French, British, Spanish, Swiss and Nor-

START IN BUSINESS FOR YOURSELF TODAY

"SPARETIME MONEY"

A book, not a Magazine

Is a complete 100 page book that gives you 52 approved plans in detail for establishing your own Spare time Business!

52 plans—completely outlined with a procedure for establishing yourself in those most successful and most lucrative Spare Time businesses in the United States.

Each plan consists: First—of a definite workable item that can be retailed by people of limited means and have only a few spare minutes a day to utilize. Second—the best method of production is outlined carefully with suggestions as to what to avoid. Third—Avenues of distribution or selling are given—such methods of selling by mail as are applicable and all similar details are discussed, and Fourth—information of importance in carrying on to reap large, generous profits are discussed.

Altogether you have before you 52 complete, accurate Spare Time businesses that have returned hundreds of dollars to others.

Sparetime Money, contains 100 Pages, of the large magazine size, 9 x 12 inches—with handsome colored covers, over 100 illustrations.

PRICE 50c --- Sold On All Newsstands

If Your Dealer Cannot Supply You Order Direct

The Consrad Company

53 PARK PLACE

NEW YORK, N. Y.



Now! The Big Second Edition Is Ready!

The world's latest book on Modern Magic prepared under the direction of the Master Magician Dunninger is now printed in its Second Edition

**HUNDREDS OF THE LATEST MAGIC TRICKS
BIGGER AND BETTER THAN THE 1st EDITION**

Be the popular man in your circle of friends. You can entertain them and hold their attention with a thousand surprises and novelties.

POPULAR MAGIC is a book for you, for everybody, young or old. But especially for those who want popularity, those who want to realize how much the admiration of friends helps toward making life worth more.

POPULAR MAGIC contains hundreds of simple, entertaining parlor tricks, as many puzzling magical stunts and a whole book full of mystic spirit novelties. A new set of tricks for every day of the year. Entirely new magic tricks all the way through.

300 ILLUSTRATIONS

SIZE 9 x 12 INCHES

PRICE 50^c

SOLD ON ALL NEWSSTANDS

If Your Dealer Can Not Supply You Write Direct

Copies of the First Edition Can Be Procured By Writing Direct

Experimenter Publishing Company, Inc.

53 PARK PLACE

NEW YORK, N. Y.





An Amazing Romance of the Year 2660

By HUGO GERNSBACK, editor of *Amazing Stories*, *Radio News*, *Science & Invention*. Against an amazing background of mechanical electrical and chemically altered life of mankind there is set a brilliant and colorful romance in the life of the greatest living scientist of that age.

Ralph's love for the beautiful stranger, his conquest of his rival and the worsening of the great saturnine Martian, culminating in a running fight in space with tragedy and terror conquered by almost unbelievable and incredible weapons, make one of the most interesting and gripping stories ever told.

PRICE—\$2.15 Prepaid

Experimenter Publishing Co., Inc.
53 Park Place New York, N. Y.

Does Your Lodge or Club Need Money

WE have arranged a program whereby we will give "Treasury Funds" to live organizations.

If your organization can use extra money—fill out the coupon below and mail to our Mr. Murray. He will tell you about a pleasant plan that requires no investment.

TEAR OFF HERE—AND MAIL

EXPERIMENTER PUB. CO., INC.
M. B. MURRAY, 53 Park Place, New York City, New York. Tell me "How"—Please.

Name
Address
Organization
City..... State.....
No. of Members
Needs \$..... For.....

wegian broadcasting stations. A perusal of these pages gives one the impression that European radio-set owners certainly have a wide variety of programs, in a half-dozen different languages, to select from.

There is comparatively little technical material in the magazine. The one item that attracted the eye of this reviewer was a hook-up of a "B" eliminator, an instrument whose possibilities Europeans seem slow in appreciating.

DER DEUTSCHE RUNDFUNK, Berlin, Germany. December 19, 1926. 84 pages. Three-color cover.

This weekly is edited primarily for the broadcast fan interested only in radio programs and the performers who fill them. It contains the daily programs of the most prominent European stations, personality stories about microphone artists, and only two constructional articles. Of the latter, one deals with a home-made "B" eliminator and the other with a simple two-tube regenerative receiver.

FUNK, Berlin, Germany. December 10, 1926. 48 pages. Characteristic black and yellow cover.

This third German radio weekly is like its contemporaries in that it features the broadcast programs. However, its technical section is much heavier than the others, filling about half of the magazine. There are articles on loud-speaker theory and operation, and on the construction of two receivers. One set uses three tubes, operating, respectively, as R.F. amplifier, detector, A.F. amplifier. The detector is regenerative, but the tickler coil feeds into the secondary of the antenna coupler, instead of into the secondary of the transformer coupling the R.F. and detector circuits. The other outfit uses a double-grid tube in a regenerative-detector one-stage A.F. arrangement.

MODERN WIRELESS, London, England. December, 1926. 144 pages. Two-color cover.

Crammed full of constructional and technical articles from cover to cover, *Modern Wireless* is a magazine the experimenter will literally eat up whole. No less than ten different receivers, from a humble crystal outfit to an aristocratic superheterodyne, are described; detailed photographs, wiring diagrams and illustrations are given, enabling the constructor to make any one of the sets without trouble. An occasional explanatory article breaks up the procession of the how-to-make-it stories.

Some of the non-constructional articles are entitled: "Direction Finding at Sea"; "What Distorts Distant Reception"; "What Are the Limits of H.F. Amplification?" (for the benefit of American fans, it might be explained that "H.F." means high frequency, and corresponds to our "R.F."); "Alternating-Current Measuring Instruments"; and "The Effects of Capacity in H.F. Circuits."

WIRELESS MAGAZINE, London, England. January, 1927. 104 pages. Three-color cover.

The January, 1927, number of *The Wireless Magazine* might be called an American number, because so much of the contents deals with American apparatus, American broadcasting stations, and American progress. The feature article, in fact, is entitled "The America Seven," and is a description of a rather novel outfit, tuning from 15 to 600 meters. On the regular broadcast band between 200 and 600 meters it is a five-tube neutrodyne, functioning in normal fashion. For the short-waves, the three dials of the neutrodyne portion are left tuned in one position, and two extra tubes, one an oscillator and the other a detector, are thrown into the circuit. The short waves are heterodyned with the local oscillator current so that the resultant beat note is of the same frequency as that to which the neutrodyne is tuned. The system now acts exactly like a superheterodyne, with the neutrodyne performing as the intermediate-frequency amplifier.

Other articles bearing an American angle are: "A Hint for American Amateurs"; "How They Do It in America"; "A Picture of American Broadcasting"; "A Chat About American Sets"; "Below the American Broadcast Belt"; "American Amateurs' Transmitting Licenses"; "Jottings on American Progress"; and "Some American Stations."

THE WIRELESS WORLD AND RADIO REVIEW, London, England. December 22, 1926. 48 pages. Characteristic light blue cover.

A mixture of constructional, technical and popular articles gives this magazine a wide appeal. The leading article is entitled "Increasing the Range of the Nucleus Receiver", the expedient being a single stage of tuned R.F. amplification made up in unit form. It is intended for connection to a set employing a detector tube which is normally fed by an antenna coupler.

In another article Marconi recounts his now familiar pioneer experiments in trans-Atlantic radio communication, his reminiscences being particularly interesting at this time because of the recent opening of the Canadian Beam System.

"RADIO FOR ALL"

HUGO GERNSBACK'S
GREAT BOOK FOR RADIO
BEGINNERS AND
AMATEURS ALIKE

What the beginner in radio needs is a book in which he can get all the information necessary for him to understand radio to make or buy a receiving set suitable to his means, to know how to operate his set, and, after he has an understanding of the radio art, information that will enable him to advance and get the most out of his outfit. All this must ordinarily be dug out of textbooks and pamphlets, but the aim of this book is to have all the data and information that the beginner will need from the time that he takes up radio. It is a permanent, comprehensive reference book for the dyed-in-the-wool dabbler in Radio.

PRICE \$2.00 POSTPAID

EXPERIMENTER PUB. CO., Inc.
53 Park Place New York, N. Y.

\$MONEY\$ Real Money

May be earned during your spare time taking subscriptions to—

RADIO NEWS
SCIENCE & INVENTION
AMAZING STORIES
MONEY MAKING

Selling these magazines is easy—just a few minutes a day—after school—after work—or after household duties will net you BIG PROFITS and a STEADY INCOME.

Hundreds of others are receiving large sums of money weekly through our plan.

LIBERAL COMMISSIONS

Write today for Application
Blank and full particulars

M. B. MURRAY
Experimenter Publishing Company
53 Park Place, New York, N. Y.

Start today to earn a **SECOND INCOME** "MONEY MAKING"

- Tells You How to Start Your Own "Business"
- Tells You How to Operate a Big Profit "Side Line"
- Tells You How to Make a Substantial "Spare Time" Income

The people who really enjoy the little luxuries that have become so important in today's home are those who do not have to sacrifice essentials to do so. A second income, no matter how small, solves this problem.

Why not start today? There are hundreds of ways to develop a steady additional income that will bring to your home the many little things that make life more enjoyable.

MONEY MAKING tells you how, each issue takes various ways and means and explains them in such a way that you can immediately apply them to your own benefit. Some plans require no initial outlay while others, for a small first cost, return many dollars a year to your pocket.

Begin now—Let today be the starting point for you into a bigger income and a thorough enjoyment of the luxuries of this life.

Copies 25c -- On All Newsstands

Subscriptions \$2.50 the Year—if your newsdealer cannot supply you use coupon below.

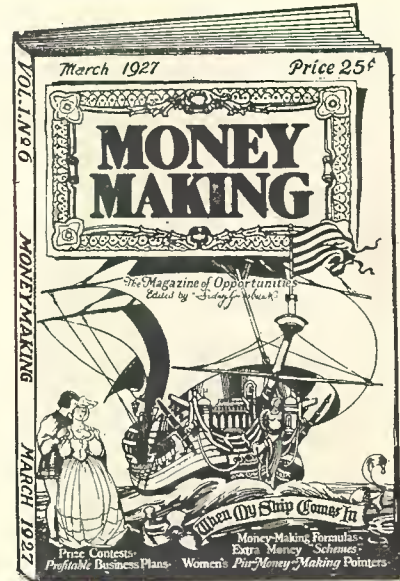

The Big New Spring Edition Is Here Latest List of Broadcast Stations

New Circuits—Data—Information



192 Pages
Size: 9x12 Inches
Illustrated

More Radio data, information and constructional articles than ever before—Radio's greatest array of valuable data ever published in any quarterly.

Full to the brim with page after page of illustrated articles.

Spring Edition contains latest list of Broadcast Stations, several complete latest circuits with full constructional data—also many illustrated general Radio articles.

See your newsdealer to-day or write direct.

Copies 50c -- Sold Everywhere

Subscriptions \$2.00 the Year—if your dealer cannot supply you use the coupon below.

USE THIS COUPON

Conrad Co., Inc.

53 Park Place, New York City

CONRAD CO., INC.,
53 Park Place, New York, N. Y.

R.N.-3

Gentlemen: I enclose \$.....for one year's
 subscription to

Name

Address

City State

"NOVELTIES"

How to Make Them

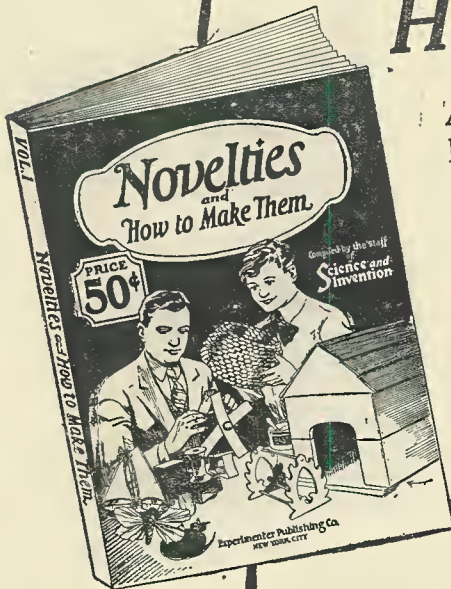

Almost every home has an old clock around—Do you know that a great many surprising, fun making, and useful novelties can be made just from the old springs, the gears, etc.

NOVELTIES, the new book, compiled by the staff of SCIENCE & INVENTION shows you how to make hundreds of wonderful Novelties, mostly out of old scrap things laying around the house. 116 Pages, in this book, show pictures, diagrams and explanations of remarkable, interesting things to make in your spare time.

Every page has a big, wonderful surprise for you. There is no end to the simple, magical things you can make at home.

It is sold on all newsstands. Buy your copy now. If your dealer cannot supply you use the special coupon below.

PRICE
50
CENTS

NOVELTIES, contains 116 Pages, hundreds of illustrations and is published in the big magazine size 9x12 inches

PER COPY



MAKE HUNDREDS OF USEFUL THINGS AT HOME WITH "HOW TO MAKE IT"

Building your own home furniture, cameras, radio cabinets, sport devices, etc., is easy if you know what materials you need, and have an illustrated explanation on how to proceed. Then, too, you can save a good deal of money by making these valuable things yourself.

"How to make it" a big book compiled from the great magazine "Science and Invention," is full to the brim with hundreds of up-to-date things to make at home. Things that can be made by any man with only a few simple tools.

Contains 116 Pages, 300 Illustrations. Large Size 9x12 Inches. PRICE 50c

SURPRISE YOUR FRIENDS' MASTER MYSTERY Read "POPULAR MAGIC"

POPULAR MAGIC contains thousands of simple, entertaining parlor tricks, as many puzzling magical stunts and a whole book full of mystic spirit novelties. A new set of tricks for every day of the year. Compiled from the great magazine "Science and Invention."

GET THIS GREAT BOOK TODAY. Chock full of Tricks, Novelties, Mystic performances, Master sleights-of-hands, Gags, Disappearing acts. All kinds of fun. Buy a copy or order direct. PRICE 50c.

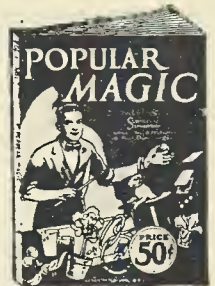

Contains 116 Pages of Tricks, Hundreds of Illustrations, Size 9x12 Inches

EXPERIMENTER PUB. CO., Inc.,
53 PARK PLACE, NEW YORK

Gentlemen: I am enclosing \$.....for one copy of NOVELTIES; HOW TO MAKE IT; POPULAR MAGIC

NAME

ADDRESS

CITY, STATE

(Check Books Desired)

SOLD ON ALL NEWSSTANDS

IF YOUR DEALER CANNOT SUPPLY YOU USE COUPON

Experimenter Publishing Co., Inc.
53 Park Place New York, N. Y.

COMPARE WITH ANY 6^{to} 8 TUBE SETS

30 DAYS FREE IN YOUR HOME

Retail \$
LIST Price **49⁷⁵**
GET SPECIAL OFFER
one year
GUARANTEE

You Don't Send a Penny
Mail Coupon for
Amazing Special
Offer!

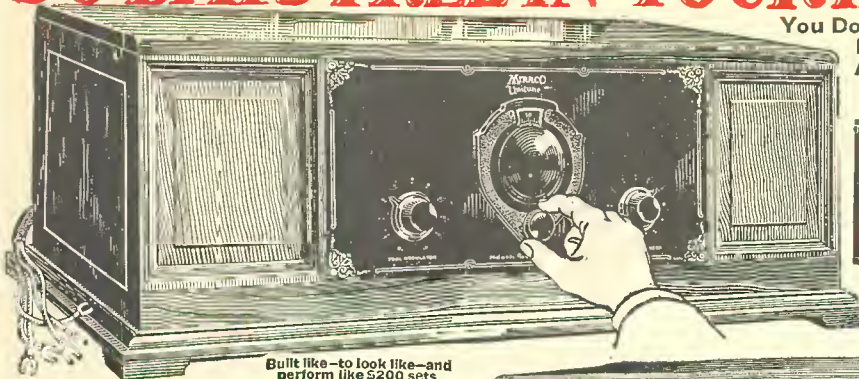

Built like—to look like—and perform like \$200 sets

Real Single Dial Control!

Magnificent Big Powerful Miraco "Unitune" Get Special Offer Amazing Low Price!
The celebrated Miraco Ultra—U.S. Navy type circuit, has also been adapted to Single Dial Tuning—without sacrifice of selectivity, volume, clearness, power, tone, or distance getting qualities! In the magnificent big Miraco Unitune—above shown, you turn one vernier knob for stations every where. Beautiful hand-rubbed, piano hinged, solid walnut cabinet, 28 in. long, 15 in. deep, 10 in. high. Sloping Bakelite panel is walnut finished to match. Also offered on 30 days free trial!

Coast to Coast and Foreign Reception Certified

MIRACO RADIO GETS 'EM COAST to COAST

by Miraco users
Notice! Enormous sales of the celebrated Miraco big fine Receivers (results from delighted users so highly endorsing them to friends) again enable us to add hosts of costly new features, latest refinements and up-to-the-minute improvements such as you might expect to find only on much higher priced sets. Miraco's this year are still better—more beautiful—more selective—more powerful for less money than ever before.

USER-AGENTS WANTED . . . WRITE!
Reports from users everywhere leave little for us to add. These are only a few of the many in our files and which we receive daily. Send coupon for plenty of additional proof and testimony of nearby users.

Coast to Coast With One Dial First Evening
I set up the Miraco Unitune about 5 P.M. and heard 35 stations, New York to California, the first evening. The fifth station I heard was Schenectady, N.Y., about 2,000 miles from here. The eighth was Pittsburgh. Heard other stations in Illinois, Nebraska, Missouri, Oklahoma, Colorado, Iowa, Texas, Kansas, California, Catalina Island, Utah. C. D. KRAKEL, Sterling, Colo.

Has Tried 50 Makes—Finds Miracos Best
Having owned and operated over 50 radio receivers, some of the most expensive, well-known makes, including superheterodyne, I believe I know what standards a radio must meet to be absolutely satisfactory. In my estimation the Miraco Ultra and Unitune are the most beautiful, efficient and selective receivers I have ever used. They are as good as the best and better than most at any price. H. P. AEBERLI, Orchlee St., N. S., Pittsburgh, Pa.

Cuts Thru Chicago Locals—Gets Coast to Coast on Single Dial

I live in a part of Chicago surrounded by powerful broadcasting stations, where costliest sets have failed to prevent interference. With my single dial Miraco Unitune, however, I have repeatedly astonished neighbors and friends by cutting through all the 17 or 18 Chicago stations and pulling in programs from Florida to California and up to Canada, clear and loud on the speaker. Every night is "silent night" for us so far as getting coast to coast. KFI, Los Angeles, and other California stations come in so loud I have to turn down the counterbalancer. I also separate the many Chicago locals. The Unitune is the most selective set I have ever heard of, and the tone quality is marvellous. And so big, handsome and easy to work—we just turn one dial and sweep the continent for programs. S. E. GUNTER, Addison St., Chicago.

Tunes Out Nearby Local With One Dial

Unitune One Dial set highly satisfactory. Find no difficulty in picking up and separating stations from 226 to 526 meters. Logged about 40 in ten days. I successfully tune out WCWS, Bridgeport—only 4 miles from my home—in 2½ points on the single dial. EDGAR R. THOMAS, Stratford, Conn.

Gets Distance Easy With 1 Dial

Unitune sure brings in far distant stations and is easy to tune. It is a marvelous set. LOUIS ULLSPERGER, Sterling, Neb.

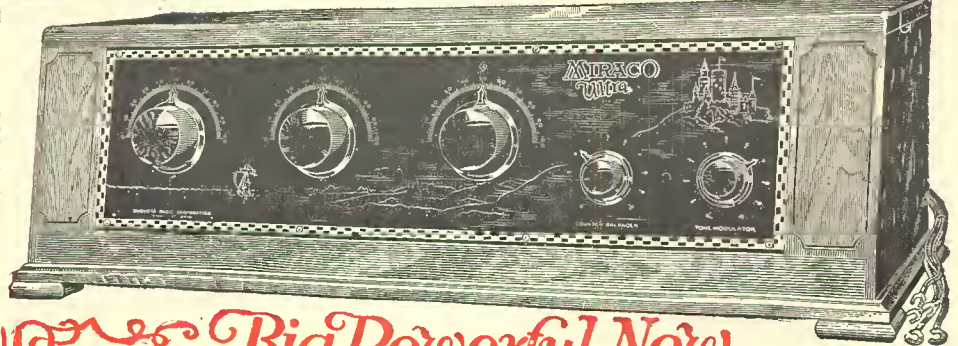

27 in. Long
Fine Walnut Cabinet

Big Powerful New MIRACO

TRADE MARK REGISTERED

ULTRA-SELECTIVE LONG DISTANCE RECEIVERS—EASY ON CURRENT
Guaranteed UNBEATABLE Among the Big, Fine Multi-Tube Sets

UNLESS 30 DAYS of actual enjoyment, use and comparison in your home proves your Miraco the most selective, clearest toned and most powerful distance getter among ANY sets using up to 8 tubes—don't buy it! Be thoroughly convinced entirely at our risk. Your verdict final—absolutely no strings to OUR offer. Satisfaction UNCONDITIONALLY guaranteed by America's big, old, reliable makers of FINE sets—Midwest Radio Corporation—7th successful year. Many, many thousands of enthusiastic users throughout U. S. A. and Canada. Get their testimony. Get the amazing new low wholesale prices and Special Offer! Mail coupon or postal.

Operate From Light Socket or Batteries
Miracos are latest, up-to-minute, models with newest features. Unsurpassed for quiet, low-cost operation with A and B light socket power supply units or batteries. Power tubes and more than 90 volts of "B" can be used, although the amazing power built INTO a Miraco makes this unnecessary. Coupon brings full information, users' testimony. Amazing Special Offer!

Reduced Factory Prices—Save! Lots of \$\$\$
Tremendously greater sales this season have made possible BIG reductions on our sets and accessories. Save MORE THAN EVER by dealing direct with Midwest. Or make big profits selling your friends. Get User-Agents' AMAZING Special Offer on Free Demonstrating Outfit (no re-tape, no contract to sign). Our offer will ASTONISH you. Clip coupon NOW.

7th Anniversary Special!

Only \$19.95 net—an unheard-of price for a high-grade, fully guaranteed 5-tube radio! It's the new \$30 (retail list) Miraco Compact—14" wide, finished in brown mahogany. Can't be equalled anywhere near the price in quality of construction, selectivity, distance-getting power, tone, ease and economy of operation—let 30 days' trial prove this! Complete with high-grade accessories—nothing else to buy—only \$49.85 net. Act quick—supply limited. Get Special Offer

FREE!
30 DAY TRIAL



Another bargain, direct from factory, Coast to Coast range. Powerful, selective; clear, sweet tone.

All the Proof you want is waiting for You!

Coupon or postal brings reports from hosts of users in your vicinity and elsewhere proving that Miraco sets at rock-bottom money-saving factory prices, outperform sets costing up to four times as much. You can also buy speakers, tubes, batteries, etc., at big savings from us!

Get our proposition before spending money elsewhere.

MIDWEST RADIO CORPORATION
Pioneer Builders of Sets

404-X Miraco Building
Without obligation, send free literature, testimony of users, AMAZING SPECIAL OFFER and full particulars of your big money-saving factory-price proposition on Guaranteed Miraco sets and all radio supplies. () User () Dealer () Agent

NAME
ADDRESS

\$19⁹⁵

This Coupon is NOT an Order

Send coupon for Amazing Special Offer!

RADIO VALUES EASILY UNDERSTOOD *if you will* INVESTIGATE



Maximum capacity 150 volts at 60 mils. Price complete with Raytheon tube \$49.50. (Slightly higher on West coast.) If your dealer cannot supply you we will ship prepaid, fully guaranteed, on receipt of list price.

No one questions The Bremer-Tully Mfg. Co. record for producing successful radio products. Ask any fan who has followed radio. He knows the wisdom and economy of B-T products from experience. Many have written us that our advertising claims are not strong enough,--*but quality is always recognized eventually.* It has taken the public longer to recognize the difference in B-Eliminators than in many other radio products,--but the superiority of the B-T B-Power Unit is now being understood. Every incoming mail proves it.

We believe this Unit offers greater value, greater convenience and greater assurance of satisfaction for either present or future. The Unit is a very definite radio necessity for proper operation of multi-tube sets or those using a power tube. It means better reception and freedom from battery troubles. It furnishes enough volt-

age to operate the power tube properly and delivers the correct voltage without guess work. *There are no knobs to turn--no variable resistances.* You simply "plug in" according to the number and kind of tubes in the set. The correct voltage is automatically delivered. Here is a "light-socket" unit that's safe to use.

INVESTIGATE IT WILL SAVE YOU MONEY

"Better Tuning" is a booklet published to tell our readers many things about radio they won't find elsewhere. The 11th Edition fully discusses B-Eliminators, Counterphase Receivers, the Power-Six Kit for set builders and new B-T parts and their uses. Contains valuable information for set builders and those interested in factory sets. Use the coupon.



COUNTERPHASE—EIGHT

Acclaimed by seasoned radio fans the greatest set ever built. Unexcelled performance and contains more features, (many exclusively B-T) than any set regardless of price. This model \$225.00.

Please send a copy of the 11th Edition "Better Tuning." I am interested in Counterphase Receivers, B-Power Units, Power-Six Kit, parts.

(Please print name and address)



COUNTERPHASE—SIX

Similar to the "Eight" but with four tuned stages instead of five. The greatest value ever offered in a radio set at the low price of \$155.00.

BREMER-TULLY MFG CO., 520 So. Canal St., Chicago, Ill.