

RADIO NEWS

Editor: THE WHOLE RADIO TRADE
 MANAGING EDITOR: HUGO GERNSBACH

DEALERS
 PERSONAL
 EDITION

PRICE, WATERHOUSE & CO.,

56 PINK STREET

NEW YORK

February 23, 1928

Mr. S. Gernsbach,
 Vice President and Treasurer,
 Experimenter Publishing Company, Inc.,
 230 Fifth Avenue,
 New York, N. Y.

Dear Sir:

RADIO NEWS: DEALERS PERSONAL EDITION

In accordance with your instructions, we have made an audit of the circulation sales of the above magazine for the January and February issues.

We have verified the following figures:

	<u>January</u>	<u>February</u>	<u>Together</u>
Copies printed	24,000	20,000	44,000
Average weight per copy	14 ozs.	13 ozs.	
Bulk mailed by weight to dealers, subscribers and advertisers	18,029 lbs.	14,008 lbs.	
Equivalent to copies	20,604	17,240	37,844
Other copies mailed	1,080	1,080	2,160
Delivered to agents	500	500	1,000
Used by solicitors	125	125	250
Total copies published	22,309	18,945	41,254
<u>Less returns to date</u>	<u>1,302</u>	<u>663</u>	<u>1,965</u>
	21,007	18,282	39,289

Yours very truly,



Cunningham RADIO TUBES

*The AC way
is the modern
way*



**For better reception
with any AC set, use**

**CUNNINGHAM
AC Tubes CX 326 and C 327**

These tubes eliminate batteries—
just plug into your house lighting
circuit and enjoy modern radio re-
ception. It is just that simple.

E. T. CUNNINGHAM, Inc.
New York Chicago San Francisco

The radi : leadership of 1928

**NOW
\$90**

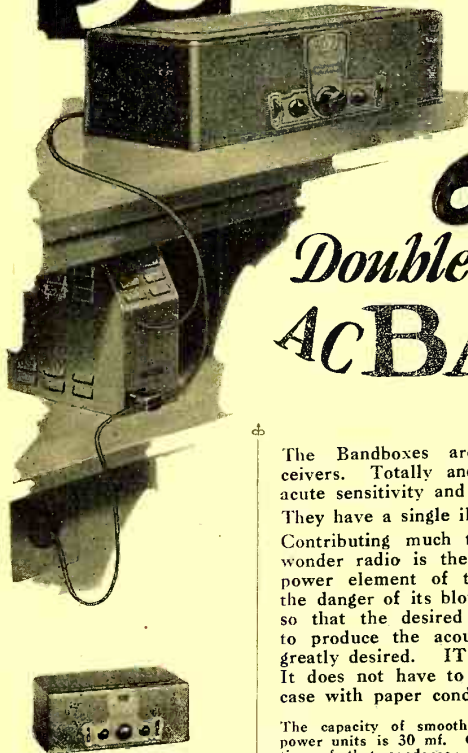

180 volts on the output tube plate/
Gigantic *UNDISTORTED* volume from the Bandbox!

Power! Power! POWER! A feature of the Crosley AC Bandbox that lifts it head and shoulders above competition! 170 to 185 volts on the plate of the power output tube! Comparative checkings of competitive radios show interesting figures. Under identical testing conditions the Bandbox shows a full 170 to 185 volts on the plate of the 171 power output tube. Other radios show from 100 to 110 and 130 to 140 volts on the plate of output tube. The 171 power tube should have around 180 volts. This better than 40% superiority in one case and 25% in another is the difference between today's radio and yesterday's.



MUSICONE
Type-D
\$15

Crosley Musicones are famous for their value. This new style is no exception. Its low price of \$15 is in keeping with Crosley traditions. It instantly demonstrated its soundness by immediate and enormous sales.

602 Double Unit AC BANDBOX Single Unit 704

The Bandboxes are genuine Neutrodyne receivers. Totally and completely shielded, their acute sensitivity and sharp selectivity is amazing. They have a single illuminated dial.

Contributing much to the success of this 1928 wonder radio is the Mershon Condenser in the power element of the set. Not being paper, the danger of its blowing out is entirely removed so that the desired *heavy voltage* can be used to produce the acoustic and volume results so greatly desired. **IT IS SELF HEALING.** It does not have to be replaced as is the case with paper condensers.

The capacity of smoothing condensers in Crosley power units is 30 mf. Other sets use only a fraction of that condenser capacity. Undersize condensers, transformers, etc., are used in order to build down to a price. Crosley builds up to a standard.

The AC Bandbox is purposely made in two models—the 602 in a double unit—the 704 self contained. This is to provide maximum adaptability in all sorts of surroundings and uses.

The 602 double unit provides console cabinet installation in ALL kinds of consoles.

The 704 is for those who want the entire set in one cabinet. The two sets are identical in elements, design and performance. The physical difference is solely to meet the human differences of taste, necessity and price! The size of the 704 is 17¼ inches long by 12¾ inches wide and 7½ inches high.

Battery Type Bandbox \$55

This celebrated model needs no picture for in appearance it is identical to the 602 receiver pictured above. Its amazing performance has won the radio world this season and its value is as outstanding NOW as the day it was first presented!



**SELF CONTAINED
\$95**

Approved Console Cabinets manufactured by Showers Brothers Co., of Bloomington, Ind. and Wolf Mfg. Industries, Kokomo, Ind., are sold to Crosley dealers by H. T. Roberts Co., 1340 S. Michigan Ave., Chicago, Sales Representatives.



Crosley is licensed only for Radio Amateur, Experimental and Broadcast Reception
THE CROSLEY RADIO CORPORATION
Powel Crosley, Jr., Pres. Cincinnati, Ohio
Montana, Wyoming, Colorado, New Mexico and West, prices slightly higher
Write Dept. 1 for descriptive literature

New
401 Dry Cell Type
**BANDBOX
JUNIOR
\$35**

A new dry cell receiver with all the features of the Bandbox — selectivity, sensitivity, volume and appearance. For places where AC current or storage battery service is not available or desired.

"You're there with a Crosley"

CROSLEY RADIO

Editor:
THE WHOLE RADIO TRADE

Managing Editor:
HUGO GERNSBACK



Associate Editors:
O. D. WILLIAMS
C. P. MASON

EDITORIAL AND GENERAL OFFICES: 230 FIFTH AVENUE, NEW YORK

VOLUME 9

MARCH, 1928

NUMBER 9

Table of Contents

The Month's Best Editorial—\$100 Prize Winner <i>By Kenneth E. Hughes</i>	3
Mr. Hughes is one of those who know what they want. More ideas are always in demand for this page.	
Sell Radio Under Home Conditions <i>By Pearl Holloway</i>	4
A tip which should be of value to many dealers; the set builders have already made a good deal out of a similar idea.	
The Radio Dealer Must Keep Well Posted <i>By Joseph Fairhall, Jr.</i>	5
The radio dealer, especially, is selling something which is of little use without brains to use it. He must be "the guide, philosopher and friend" of his clients.	
No Rest for The Wicked—or The Service Man <i>By M. G. Goldberg</i>	6
If genius is an infinite capacity for taking pains, it requires genius to succeed in the radio trade.	
How We Personalize a Chain of Neighborhood Stores <i>By J. Mukasie</i>	7
The writer tells us how he successfully practices "This Small Town Stuff" in the biggest city in America.	
Dealers Should Make Their Qualifications Known <i>By Edward D. MacClaren</i>	9
It is not enough to be as wise as Solomon; you have to convince your neighbors of the fact.	
Shadows of the Radio Business <i>By H. D. Hatfield</i>	10
Facts and figures on the recent flurry caused by the incursions of the A. C. set into the trade.	
Interesting Young People in Radio <i>By E. H. Bragg</i>	11
A large share of your future customers are now behind a school desk. You have an excellent chance to meet them now.	
Looking Into Radio Trade Problems <i>By Radio Dealers</i>	12
A symposium of brief, but timely articles, written straight from the shoulder.	
Dealer Plans That Have Been Successful	15
We have opened this series in a spirit of optimism. We hope that our editors will make it a regular monthly feature.	
How We Sell Radio to Tourists <i>By J. C. and Ethel Wilder</i>	16
A couple of enterprising Floridians tell how the state's best crop is capitalized by them.	
Replacement Troubles Must Be Lessened by Educating the Public <i>By George Coby</i>	17
A manufacturer expresses his viewpoint on a problem which keenly concerns dealers and distributors as well.	
Dealers' Service Sheets—No. 1	20
The DEALERS PERSONAL EDITION endorses Mr. Hughes' editorial by spending money to carry it into effect. Your suggestions will be welcomed.	
The Latest Merchandise	23
Instituting another feature—not an advertising one—which we plan to extend to the fullest possible service to readers. If you don't see what you want, ask for it.	
Safeguarding Radio Credits <i>By Archie Oboler</i>	24
The use of an "assignment of wages" to protect installment sales has been successful for a Chicago firm.	

The Next Boom

ANY letters reach us continuously from the radio trade inquiring about the progress of television. Personally, we feel highly enthusiastic and very bullish about television in general. Television is just around the corner; and before the end of this year television attachments will be sold for use with present radio sets, while many broadcast stations will be broadcasting television impulses.

It is important to understand that television, as we define it, is the ultimate goal in the visual transmission of events. *Do not confuse television with picture transmission.* At the present time, several stations, notably WEAJ and WOR of New York, have been broadcasting pictures. These, however, are only still photographs and it takes more than a minute to transmit each picture. We believe this is not all that the public wants; it is an interesting experiment, but we do not believe that, so far as the radio public is concerned, it has a future. What the public does want is *instantaneous vision*; so that, when a prize-fight is held in New York, it can be viewed in Chicago as it is taking place, and the artists who appear at the broadcast stations can be seen by millions at the same time that they are heard. That will be true television.

That there will be another boom, incomparably greater than the broadcast boom, as soon as we get started and get going in television, is a foregone conclusion. Fortunes will be made, not only by television parts manufacturers, but by television set manufacturers; and, as usual, those with foresight and those who get in on the ground floor, will reap the benefit.

And let no one believe that television is far off in the future. Indeed, as we go to press, telegraph dispatches reach us that the great department store of Selfridge's has placed on sale in London a television kit retailing at \$32.50. The report has not yet been confirmed, but it is an indication of the speed at which events are moving in this direction.

At the present time, Captain O. G. Hutchinson, general manager of the English Television, Limited, Corporation is in this country, and transmission apparatus of the Baird type is even now being constructed to broadcast television impulses over a well-known New York station. The Baird people will have a few dozen television receiving sets scattered around New York City and the demonstration is to take place some time in March or early April.

My recommendation to the radio trade is that you watch television closely. Events in this field from now on will follow rapidly.

HUGO GERNSBACK, *Managing Editor.*

\$100⁰⁰ Prize Winner

THE MONTH'S BEST EDITORIAL

WHY is it some one of the radio magazines does not publish, as a regular monthly feature, *radio service sheets*, for the dealer and service man exclusively? Such a sheet, each month, would soon provide a file that would be of great value, to both the dealer and the set manufacturer.

A few magazines attempt such information; some by printing a resumé of a circuit in the text, others by showing photographs, diagrams and part lists. These are all right as far as they go; but they are a mere scratch on the surface.

Radio Servicing is the all-important feature of radio sales. A well-trained and competent sales force, nation-wide advertising, good-will programs, a good product, mean nothing to those who handle a sale, from manufacturer to consumer, when a set sold to the public develops unavoidable ailments and is serviced incompetently.

To quote a current magazine, "To give the radio-buying public skilled service in the installation and operation of its sets, to provide the dealer with trained service men . . . is one of the large problems of the radio industry . . ." In the same article is information that the R.M.A. is initiating a movement to co-operate with various sources of radio training. This is a step in the right direction and should receive the support of all who might benefit from such a move.

Who will disagree, though, when the writer says a radio training of *itself* is insufficient in the radio servicing field? The bone of this contention will be obvious presently.

It is perhaps true that the fundamental principle of radio is the same, and that four or five types of circuits cover all makes. It is true, also, that each manufactured set has its pet "gadgets," its "latest features," sealed catacombs, etc. Then, to argue, it is true that, with the modern set testers, the good service man can quickly arrive at any seat of trouble and rectify it with suitable dispatch and dignity. A good service man with years of experience and the finances behind him to furnish the



By KENNETH E. HUGHES

1917 TWENTY-SECOND STREET,
GALVESTON, TEXAS

required and expensive apparatus, can do this, maybe.

The dealer or service department with not so much capital, and not so many years of experience, encounters many seemingly freakish sets, of which little is known or can be learned. The factory-made set is not featured in the trade publications as are the kit-sets. Consequently the service man is in the dark when he meets a set new to him.

If the service man has had good training and has learned as he went along, he will fall back on his knowledge and make a test to the best of his ability, or, perhaps he may decline to render service. If he is not so conscientious, however, he will tackle the set as if it were an ordinary T.R.F. receiver. The results need no guessing; among other things, the manufacturer may have to his credit a dissatisfied user of his product and a very prolific source of detrimental advertising.

Another source of trouble in the smaller cities is the fact that many responsible firms handling radio as a side line will hire young men (whose sole claim to radio knowledge is the fact that they got a crystal set for a few newspaper subscriptions and have since built a superheterodyne, but who have never given radio, as a study, any thought) to do their servicing; rather than pay more than \$18.00 or \$20.00 a week for

a man who knows radio as it should be known to render intelligent service.

For the very reasons mentioned above, the writer has encountered users of standard, nationally-advertised sets, sold by highly reputable dealers, who would not call the service department where they bought their outfit. One, especially, remarked he would prefer paying the expense of getting a service man from Houston, 50 miles away, to having a certain dealer work on his set, if no other service was available. Fortunately this case is rare, rather than the rule.

Granting that an authorized dealer has all the service information he needs on the lines he handles, or could get the information by writing the factories, he is nevertheless called upon to service many sets which his service men are not as fully familiar with as they should be to render quick, dependable service. No matter what receiver, how many, or how few, a dealer may handle, he can render efficient service on *any* set if he has a file of Service Sheets prepared for his use and covering the standard factory sets and technical accessories. Then, if he uses the trade magazines as he should—files them for reference—he has at his finger tips instant information on any factory set, last-minute kit, circuit or part. He can render profitable service, for he loses no profit by prolonged guess-testing. The service man learns about another set from a reliable source. The manufacturer holds the good-will of the user of his product. The set-owner learns to have the necessary confidence in the dealer, to step more than occasionally into the store, usually making a purchase—and, thereby, helping the industry.

It would be appropriate that this two-in-one publication, the DEALERS PERSONAL EDITION, should inaugurate this real dealer service. No other feature could do so much good to the entire radio field. Even the broadcaster and the artist will benefit; because if a good set is maintained properly, the B. C. L. will better appreciate the good programs and be more inclined to let those responsible know it.

(Continued on page 8)

The article chosen each month as the most helpful of those received from our Editors (The Whole Radio Trade), will appear on this page, and its author will receive the prize of \$100.00. This is awarded on the basis of the best ideas—not the best literary effort—and their practical and useful features.—MANAGING EDITOR.



SELL RADIO

under Home Conditions

By PEARL HOLLOWAY
L.F. Holloway Hardware Co.
Fremont, Neb.

Time: Any hour.

Place: Any store selling radio.

Characters: The usual group of Dial Twirlers. Enter an Honest-to-Goodness Prospect.

Problem: To give him the kind of program he wants without arousing the ill will of other customers who want to manage the radio.

WHO has not been confronted with such a problem? Of course, many Dial Twirlers are genuine prospects, but all too frequently they want entertainment and are not in any immediate danger of placing an order for a machine. As a rule, too, they want the lighter programs and are not at all willing to hear one concert through, preferring to tune in on something different constantly. Some times, too, the sales force in the store have this dial-twirling mania to such a degree that the real value of the program from any station is lost in a jumble of sounds and snatches of songs. This Honest-to-Goodness Prospect may be one of those people who say, "I'd buy a radio if I knew I could get a real program, one full of genuine music. Everywhere the radio is going, but I hear nothing but noise. A little jazz goes a long way with me, and if I have a radio, I want something different."

A SMALL-STORE PROBLEM

Of course, the up-to-the-minute radio shop with its separate booths and many machines has no difficulty of this kind; but the small dealer, the one who has radio as a part of a general store, the merchant with but one room in which all kinds of merchandise is displayed and whose customers come from all classes of people—he is the man who honestly wonders what can be done to prove to this skeptical customer that radio can bring him many hours of pleasure, that he can have whatever program he wants. Obviously, the Dial Twirlers can not be driven from the scene; neither can the sales force be ordered to tune in differently for this one customer. Perhaps they have customers who want jazz programs at just that time. Even if the merchant has another machine connected, the program could not be enjoyed because of the confusion in the room and the pro-

THIS is a problem which most radio merchants have experienced. It is true that some have demonstration rooms even better than home; but for those less favored, here is an excellent suggestion. A presentation of this nature is made under ideal circumstances, and free from distraction. Incidentally, it would seem desirable that the dealer have at home the set he most strongly recommends to the Prospect—that is the way in which the set builders have made an enormous amount of sales.

gram already being heard at full volume.

Hopeless? By no means! Of course, every merchant with the best interests of his business at heart sells merchandise because he *knows* what it can do, and true knowledge comes best from actual experience. In the case of radio, he must be able to say with certainty that the particular machine he is selling will do all he claims for it. The best way to know is to have one at home.

COME WITH ME

Knowing, he can invite the Honest-to-Goodness Prospect to his home calmly and with certainty. He is well acquainted with his machine at home, and can tune in more finely than is possible at the store; not only because of the noises there, but because there is less to claim his attention in his home. The Prospect relaxes and yields to the influence of the program. If he expresses a desire to try some other station,

to see what else can be done, it is a simple matter to turn the dial until he is pleased. At the store, the danger is in turning too rapidly and too frequently.

What if the Prospect will not go to the house? Offer to take a receiver to his home. Of course, that should be done anyway, but there are people who hesitate to allow a dealer to install a radio lest they should not purchase after having put others to a great deal of trouble. (Such instances may be rare, but they are possible.) Even the most particular will realize that there is no obligation connected with being invited to spend a few hours in another's home, listening to a program which would be coming whether the Prospect was there or not.

Will the scheme work? It will! Every such invitation does not result in a sale, of course. If it did, merchants might take to having "At Home" evenings instead of



Comfortable surroundings—that at-home feeling—none of the distractions of the store, or the possibility of interruption by wise-aces—a tried and tested set that the dealer knows from antenna to speaker—these make up an ideal setting for radio salesmanship.

keeping stores. However, the serious-minded prospect appreciates the consideration thus shown by the dealer and, whether he buys or not, is influenced by this act of kindness. (Continued on page 8)

The Radio Dealer

MUST KEEP WELL POSTED

by JOSEPH FAIRHALL Jr
Danville, Ill.

MANY dealers have already told why they quit the parts business and handle now only factory-built sets. Here a radio veteran, who has grown up with the art, tells why he has instead dropped sets and confined himself to parts. He points out the importance of the dealer's keeping himself better educated than his customers—and in no line of business are so many customers well posted as in radio. The dealer must study to keep ahead of them and to possess their confidence in his knowledge of the business.

IF the radio dealer wants to survive he must apply himself, study deeply in order to talk intelligently and know what he is talking about. What does a druggist or the dime store know about radio? They cannot answer your questions or explain the why of this or that; and yet the same people who buy these inferior parts will come to a regular radio dealer for information which is generally cheerfully given gratis. The radio dealer will find that, by educating himself in order that he may be a real help to the set builder, he will eventually win the customer's confidence and later will enjoy his patronage. Experimenters are growing fast day by day and it is going to be but a short time when the part business will come back better than ever; but they must be *good parts*, and the dealer who will play the game square and not cut prices will find himself still in business in the years to come.

CUSTOMERS ARE STUDYING

As I see it, too many manufacturers have been too anxious to clean up on the public with all sorts of contraptions supposed to eliminate static, etc., etc. In most cases the customer is or has been "eliminated" of his money. It is amusing for one who has made a study of the radio or wireless to wade through various advertisements and see the things that have been advertised that are absolutely worthless. Yet the public who are not educated to

these sort of things fall easy prey to them; but now they are more skeptical. I find, as a dealer, that most of our customers are becoming much more educated along the radio lines and are becoming great experimenters and like to purchase parts and build some thing to their own ideas.

It is well for a dealer to become a good amateur and to know what he buys, and know that it is good, and that there will be a call for these parts. Otherwise he will soon find his shelves stocked up with parts or material that he will be glad to dispose of at ten cents on the dollar.

CHEAP STUFF TOO COSTLY

It is true the part business has dropped off considerably. This is principally because there are so many stores all handling them and, worse, selling cheap parts. The experimenter will buy them; he is attracted by the low price, but after he has assembled these parts into a set and thinks he has made something wonderful he proceeds to test it and then wonders why it don't sound right. It is noisy, whistles, is broad tuning. There is but one answer; these parts are simply too cheap to do the work in comparison with good parts employed by leading manufacturers in their sets.

A good manufacturer has a research department in charge of skilled engineers who



are constantly developing the parts they wish to employ in their sets; and they know that after these are assembled into the set the instrument will function properly, given the right conditions, so, I find, it pays to buy and handle nothing but the best of parts that are obtainable. No matter if you do not make nearly so many sales, your customer knows that he has bought a good part, or parts that he can use over and over again in his different assemblies.

Right now we are going through the stage of using the electric light current for operating radio sets. So many devices have been brought out to replace the good old storage battery and the dry-cell "B" batteries; but to my way of thinking reception is not nearly so good with any of these devices. I have sold many of them that have been well advertised, only to find that in a short time they had to be discarded and the set put back where it was on batteries and the results were much better. Of course all of this experimenting has to go on in order to develop; but the manufacturer should make exhaustive tests and to know absolutely that

(Continued on page 8)

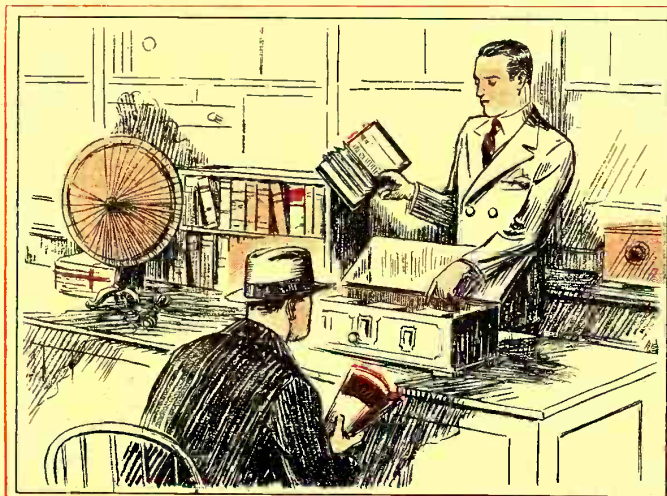

The customer for radio parts has more knowledge than the average buyer of sets. The dealer must have not only a thorough understanding of the art, but keep reference material at hand to answer questions that come up daily from the inquiring and studious customers.

NO REST *for the* WICKED Radio News Dealers' Personal Edition, March, 1928

and the Service Man!

by *M.G. GOLDBERG



YOUNG BEN FRANKLIN made it a point to be seen working long hours, late at night and early in the morning, to convince his neighbors that he was an industrious tradesman, diligent in his business, and worthy of credit. It is possible that today Ben would have been seen diligently associating with the large consumers of printing on the golf links. Long hours for long hours' sake are not in such favor nowadays. However, there is another good reason for long hours in the radio business. Mr. Goldberg puts it in a nutshell; it is necessary to make radio serviceable at all times—and customers want their radio entertainment outside of business hours.

THE DEALERS PERSONAL EDITION, with its offer for an editorial satisfactory for publication interests me; first, because I have plenty to get off my chest that might interest other radio dealers; and secondly, because the possibility of getting paid for blowing off steam proves to be an added incentive.

To begin with, I am just an average radio dealer, doing a moderate business the year around, specializing in radio, and giving service the way I think it should be given. When I say "specializing in radio," I don't mean we handle tires, shoelaces, doughnuts, or serve soft drinks as a side line. I mean just what I say.

We handle radio *exclusively!*—seven days a week, thirty days a month, for twelve months in the year, and we have been doing it for almost five years now—summer and winter—and making a profit. Of course, we have our ups and downs, the same as the others; business good one week and poor the next; set business fine one day, parts the second, and service work the third.

You'll notice I say we give service seven days a week; I mean it. I find that if there is any time a man wants service on his radio set, and wants it badly and, what's more, is willing to pay for it—that time is either on Sundays or holidays when he has gone home to rest and wants entertainment brought to him *on a platter*—and radio does it.

EVERY DAY IN THE YEAR

There isn't a service organization in the world that won't fail, I believe, that doesn't give service on the products it sells, if those products are being used like radio, 365 days in the year. We give service at least half a day on New Year's, Christmas, Thanksgiving, Sundays and July Fourth. Out of 80,000 radio sets in this city, a dozen or more are going to need service every day, and we are prepared to give it to them. Tubes will burn out, batteries will die down,

*Beacon Radio Service, St. Paul, Minn.

The service man must be prepared to give up his holidays for the benefit of his patrons. While the householder is spending his day of rest in comfort, the modern slave of the bell must get busy and hustle round to place after place, to find real and fancied troubles. We have had many articles deploring the faults of the service man—from dealer and customer alike. We should not be astonished if that humble servant turns like the well-known worm, and relieves his feelings in an article or two for these pages.

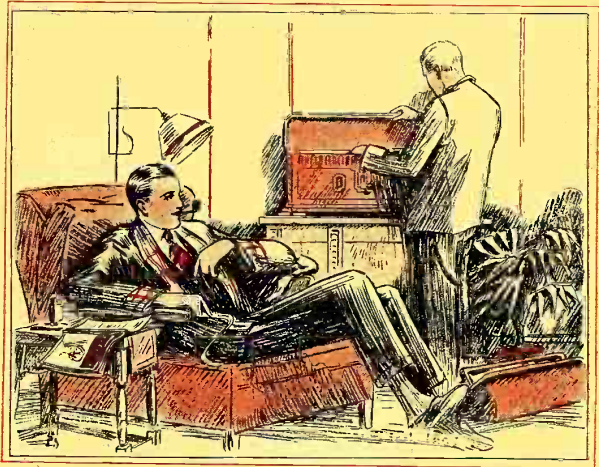

speakers will burn out—and they must be replaced at once.

The dealer who is alive to the need of his community should take advantage of this situation. Especially is this true in towns where there are more than one or two dealers; for a radio listener will remember the dealer at whose store he was able to secure service when the others were closed. Radio in this respect is not one bit different from the auto game, where the successful garages are almost invariably the ones who deliver the goods day in and day out.

UNFAIR COMPETITION

Now for the jobbers—or the so-called jobbers who sell *retail and wholesale* across the same counter—where the dealer rubs elbows with men who should by rights be his own customers. Is there any reason on earth why every Tom, Dick and Harry who buys \$25.00 worth of electrical goods at wholesale from a combination radio-electrical jobber should receive the same discount on radio material that the dealer himself does? Is there any more reason why

employees of telephone companies, power companies, packing houses (or what have you?) should be getting 25% or more off of list as a courtesy discount from the radio jobber, robbing the dealer of trade which rightfully belongs to him?

The keynote of the eventual revolution in jobbing tactics is proving to be service. The dealer will eventually concentrate on the *jobber who will give him a square deal*; who, besides, printing a lot of meaningless circulars and handing the dealer a lot of blarney about prompt and efficient handling of complaints, will talk less and do more. The dealer will have faith only in the jobber who *sticks to jobbing*; who leaves the retailing in the dealer's hands where it rightfully belongs, and *who refers all retail inquiries to such dealers*.

Lastly, the manufacturer. He sits on his high and mighty horse and laughs at the world; jobber, dealers, and consumer. If he feels like it, he will make refunds on price-cuts made without warning to the jobber or dealer. If his breakfast didn't agree with him, he will (Continued on page 14)

How We Personalize a Chain of Neighborhood Radio Stores

by J. Mukasie

General Manager, Prospect Talking Machine Shops, New York City

THE ordinary business man thinks of New York as crowded Broadway, gay Times Square, classy Fifth Avenue—or, if he is a radio man, the bustle of Cortlandt Street. But New York has its hundreds of small residential neighborhoods, with solid, steady business, that can be compared to the familiar family-trade sections of smaller towns. Shrewd business men have in many cases chosen to flourish in these family “naborhoods,” rather than enter the heavy competition of the downtown streets with their impersonal shopping crowds, where great profits may, perhaps, be made, but at great risks.

When this company entered the field of radio, we decided to manage our radio merchandising just as we had done with talking machines previously. As we have four stores in as many neighborhoods in the Bronx, we may be said to fall in the category of chain stores.

Should we make them uniform, advertise them as members of a group doing business on a single system; or should we make them individual and seek to rely on word-of-mouth advertising of satisfied customers—as a doctor or lawyer in a small town builds up a clientele? The decision was in favor of the neighborhood plan.

We trace our success to this unusual way of merchandising, with its simplified advertising and credit problems. Advertising was boiled down to essentials—neighborhood billboard advertising, window display and a small amount of direct-mail literature. The billboard advertising was found very resultful; and the window displays were from the start made interesting by clean-cut, colorful presentations of standard merchandise.

PUSHING THE BEST

Each window was given the friendly charm that appealed to women as well as to men. In order to bring customers into the store, we adopted, and consistently follow, the policy of keeping one low-priced, but handsome set attractively displayed. After the customer has entered to inspect it we explain to him that, although that model is unusual value for the money, at a slightly higher price he can purchase a set more satisfactory in every way.

(This is not, however, what is called in the trade switching—advertising a set and then practically refusing to sell it when the cus-

THE small-town merchants have told us of their close relations with their customers; the big city stores of their methods of handling business in volume. Here is an article from the head of a group of stores doing neighborhood business in the city of New York on neighborhood principles. Incidentally, his five-year guarantee policy may astonish many; but the explanation is logical.

tomers asks for it. We sell what we advertise, when the customer asks for it; and he does not have to demand it.)

We explain, quietly, though firmly, why and how we believe the recommended set

will be better for him. At the same time, we do this not so much because the larger sale will mean more direct profit, as because we believe that it will be really of greater value to the customer. The satisfaction of the customer is of the greatest importance, because we do not rely so much on newspaper advertising as larger stores, and we have to depend on our customers to bring us in more customers.

Our direct-mail literature is confined to letters addressed to customers already on our books. We try to follow up each sale in such a way that we will develop permanent good will in addition to extra sales. These letters are sent out monthly to lists carefully kept; we have had very good results, probably on account of their friendly tone, and the fact that we promise no more than we can perform. Every letter is personal, and based on a knowledge of the

(Continued on page 14)



The most important advertising of a city neighborhood store, next to its old customers, is its window. Here is a typical view of one of the Prospect Talking Machine Stores, with an attractive display of quality sets.

Converting Battery Receivers To "AC" Will Sell Them

**BUT BE SURE
Volume Is Controlled Properly**

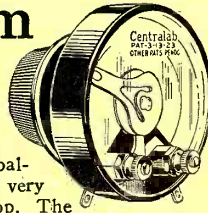

ALL "AC" circuits are built up with a very delicate balance of voltages. To keep this balance intact is very important so that no appreciable AC hum will develop. The popular methods of controlling volume in Battery Receivers are insufficient and will not give satisfactory results.

A true, smooth volume control in AC circuits is obtainable by using the new Centralab Radiohms, RX-100 or RX-025. The RX-100 Radiohm in the secondary will control oscillation as well as volume. The RX-025 across an R.F. primary provides effective control and does not defune. The same unit has the proper resistance for antenna circuit control, but no antenna circuit resistance will prove as uniformly satisfactory as when used across one of the R.F. stages.

A Centralab PR-050 Power Rheostat, in series with the AC transformer will provide accurate voltage control and lengthen the life of the tubes. Centralab wire wound Potentiometers and Fixed Resistors will prove trouble-free in the power circuits.

Write for full information about these high quality controls that are being used by so many of the prominent set manufacturers.

CENTRAL RADIO LABORATORIES
23 Keefe Ave., Milwaukee, Wis.



Features: — Perfect control—Wide range of values—Trouble proof—Holds adjustment—Beautifully manufactured. . . .

VOLUME CONTROL CLAROSTAT

Caution: — Clarostat is being widely copied. Look for the familiar green box and the name stamped on the product.

The new VOLUME CONTROL CLAROSTAT is popular with everybody—manufacturers, fans, custom set builders and dealers.

A big resistance in a small package—and at an attractively low cost! This CLAROSTAT is especially designed for all light duty applications. It has the wide resistance range of from practically 0 to 500,000 ohms. Just a few turns of the knob gives you the desired value—accurate.



—never changing—always efficient. Handsomely nickel plated. New style Bakelite knob. One hole mounting. A genuine CLAROSTAT through and through.

This New CLAROSTAT, like the other members of the CLAROSTAT family, is a good seller. Don't forget to stock its brothers, the famous STANDARD, HEAVY DUTY and POWER CLAROSTATS.

AMERICAN MECHANICAL LABS., Inc.

Specialists in Variable Resistors

285 N. 6th St., Brooklyn, N. Y.



Now--A Single Drum Dial by National Co.

—with 360 degree Rotation—easy attachment—the Velvet Vernier Quality. List price, \$4.00 plus 50c for illumination. It will pay you to sell

NATIONAL

Type F Illuminated Velvet Vernier Dial
National Company, Inc., Malden, Mass.

DEALERS-BIG DISCOUNTS

ELECTRICAL
WHOLESALE
RADIO SUPPLIES

Make more money by getting into radio. Our big radio catalog showing huge stocks of standard radio parts, sets, kits, at lowest rock-bottom wholesale prices. Newest goods—A. C. electrical, etc. Fast service. Guaranteed goods. Thousands of dealers prefer our service. Wonderful special offers on sets and newest accessories. Get your free copy NOW before you buy.

W. C. BRAUN CO. 578 A Randolph
Chicago, Ill.

The Month's Best Editorial

(Continued from page 3)

The data should be actually furnished by the service department of the manufacturer; the factory should be willing to furnish the required data to the publisher, inasmuch as the service is for dealers only. Publication details would, of course, be handled by the publisher.

In closing, let us recapitulate. There are only three possible methods of securing a union between the knowledge a man can acquire by training and the knowledge he will require as a dealer or service man. One is by experience—long, costly and detrimental to the trade. Another is through intensive and systematic study of material asked of many manufacturers—tedious and impractical. The third is the ever-growing, reliable and practical monthly Service Sheets furnished by the manufacturers through the DEALERS PERSONAL EDITION of the most useful radio magazine.

(In his letter covering this article, Mr. Hughes said "Knowing it will capture no hundred-dollar bill, I am asking that you publish it; for I feel it will stir up something that is badly needed away from the metropolitan areas." We are happy to disappoint (?) Mr. Hughes; and, more than that, undertake the gigantic task which he has outlined. To carry it through, we bespeak the whole-hearted and indispensable co-operation of the manufacturers in supplying the needed data; the importance of which is made plain to us daily by the requests of numerous dealers and service men for technical information of this kind. —MANAGING EDITOR.)

Sell Radio Under Home Conditions

(Continued from page 4)

One such Prospect, a true lover of the best in music, said, "If I could only hear a program I enjoyed! Everywhere I go it is just noise, noise, noise, and clattery-bang stuff I don't like."

The merchant to whom this remark was made sent his car after the lady, when an extraordinary good program was coming in delightfully clear, and her pleasure was most gratifying. No, she did not place an order at once; but she knows what radio can do, and is looking forward to installing one in her home shortly. And when she does, the thoughtful merchant will receive her order!

The Radio Dealer Must Keep Posted

(Continued from page 5)

his article will stand up and do what it is supposed to do. We find often that the manufacturer will not stand back of his goods and the dealer is looked to by his customer to make good. We have to do

(Continued on page 14)

DEALERS SHOULD MAKE Their Qualifications Known

by
**EDWARD D.
MACCLAREN**
Onset,
Mass.

THIS article is a presentation of the problems of a dealer, by one who takes a professional, as well as a business interest, in radio. His position is sound; the public is seeking for nothing more intently than for men whom they know to be qualified to advise them, and upon whose judgment, as well as honesty, they can depend. The opinions and experiences of dealers, pro and con, upon the respective systems of distribution, will be welcomed in these pages, regardless of their preferences.



NOW that the DEALERS PERSONAL EDITION has made it possible for the dealer to come out in the open and enlighten the "powers that be" as to just where the dealer should be placed, I hope that the dealers will cooperate in every way possible for their own benefit; thus making it possible for all to work more harmoniously for the general good and betterment of the art.

The position of this magazine is similar to that of the dealer; for it is a mouthpiece for the dealer, and the dealer is, and always will be, *the mouthpiece of the consumer*. If he wishes to give his customers real service, he will also have to take unto himself some of their burdens; especially in doing all in his power to eliminate from the air, for all time, this nerve-racking interference caused by at least two hundred broadcast stations on the air.

If the dealers would organize local radio clubs, without cost to the set owners, I am positive that a way could be found to get real and immediate results; but this cannot be done by dealers that talk only of profits. Dealers must talk to the radio listeners in language that they can understand; or otherwise the customers' faith in the dealer is lost.

A DEALER'S SELF-EDUCATION

Believing that radio dealers should know more about radio than their customers, I started a year ago to get "under its skin"; and my first step was to purchase what I thought to be the best information on radio in one book (and that was *Gernsback's Radio Encyclopedia*). After that I became so interested in what made the wheels go round that I enrolled in the National Radio Institute, and studied every spare moment I could get away from business; so that now I can easily tell a hook-up from a Chinese laundry check—something I could hardly do a year or so ago—and I can easily find out why receivers of my own customers and others do not function. So I go on

record as saying that these two means of knowing radio were of the greatest assistance and, the longer I stay in the radio business, the more valuable they become. It was the best investment I have ever made, so far, in radio.

The article by Benjamin Gross, distributor of the Stromberg-Carlson Company, in the January issue of the DEALERS PERSONAL EDITION interested me very much; possibly because I am against distribution through jobbers. It calls for an unnecessary profit, and takes away the personal contact of the dealer and manufacturer. Also, direct-from-manufacturer-to-dealer distribution strengthens the manufacturer's guar-

antee to the public, and enables the dealer to give first-hand and direct manufacturer's representation to the customer. Whereas, in dealing with a jobber, who handles many makers' merchandise and receivers, he cannot honestly advise the dealer which receiver would be best to handle, and may favor the one of which he has most stock on hand, regardless of whether it is the best or not. This, or course, is only natural.

A STANDARD FOR DEALERS

As for the retail distribution here, it is very easily pictured from one of the jokes in RADIO NEWS, in which the stranger in town asked the (Continued on page 18)

No point has been so sure to arouse a response from radio men as the certification of repairers and of all who hold themselves out as competent to do radio work for the community. Licenses from the state are often suggested. It is a problem which can hardly be solved by law, but must find an answer somehow.

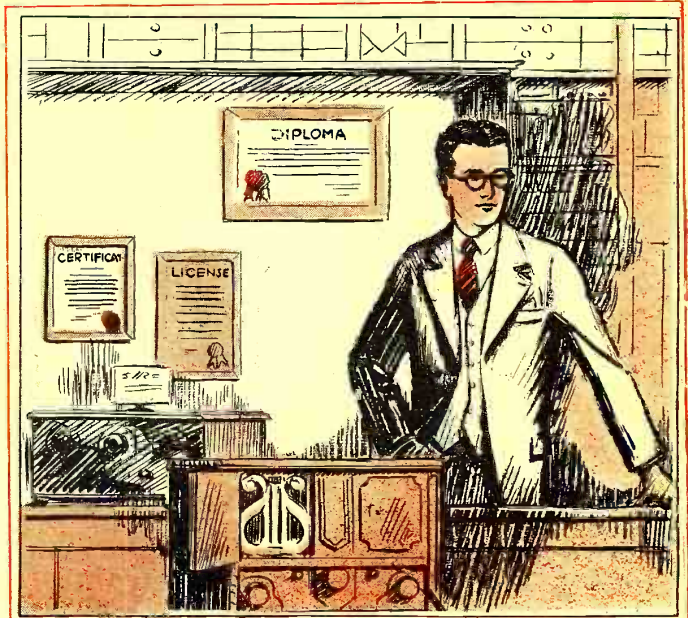

"SHADOWS"

of the Radio Business

THE writer's brief story, backed up by the attached interesting data, should compel the attention of many dealers. How many can turn stock seventeen times a year? A business like this is in far better condition to weather the changes of fashion which make radio, like the cloak-and-suit trade, so subject to vicissitudes. And how does this seasonal variation compare with that in northern cities, where the outdoor season is shorter?



by
H·D·HATFIELD
Hollywood, Cal.

AFTER reading the DEALERS PERSONAL EDITION, as well as several other trade and fan papers, I am convinced that there must have been something wrong with our industry during the past year. But at that I am not going to allow this deplorable set of conditions to interfere with *my* business; which is that of a retail radio merchant in what is usually termed a "Community" district.

In this article I will speak from two angles: one which I know about, *i.e.*, my own little sphere; and one which I know about only from hearsay, *i.e.*, the other end of the radio industry, the manufacturer.

ME AND MY SHADOW

Scene opens in 1924 when I purchased a supposedly-going concern with a small stock of parts and a few tools. The good will of the seller was not what I expected—it simply wasn't there. My capital was low—too low. So, praying for health, I went in; and in spite of 14 to 16 hours a day I still have health. That was four years ago. Now I am an "old-timer,"—have a fair jobber standing, morally at least. I did \$15,000 business in 1925, \$21,000 in 1926 and it is running pretty close to \$27,000 for 1927. The stock has been turned about seventeen times each year; buying has been from hand to mouth, and with much care as to re-

liability of merchandise. I sensed the demand for better radio sets, and do not handle the low-priced stuff. I do not care to sell where the down payment is less than one-fourth; one-third is preferred. I have lost a lot of sales this way; but have had only two repossessions in the four years. I still drive the old flivver, but I have shined up the store until it bears a good name for looks in Hollywood. I am finding the after-Christmas trade looking better than the pre-Christmas. I went haywire a little by hav-

ing a few D.C. sets on hand when the A.C. tornado busted loose; sold most of them though, and may keep one for a relic. Now, I ask you, why the slump in my business? Figure it out from the chart.

THE MANUFACTURER AND HIS SHADOW

I go all the way back to the manufacturer, as all the intermediate stages of jobber and sales-agent amplification are guided solely by the efforts of the dealer on one end and the manufacturer on the other.

Assuming that things have been rather tough on the manufacturer and the industry as a whole, we ask why. Honestly, I don't know whom to blame the most; the premature A.C.-tube makers or the manufacturers of sloop-jar "A"-battery or socket-power outfits.

Just for luck, I will take it out on the maker of undersized wet "A" batteries encased in a box with a wet trickle charger and a wet "B" supply.

The results achieved by these outfits were enough to, and did drive the set owner to the point of murdering his service man, his favorite broadcaster, and the socket-power hombre (Californian for fellow) of course.

So the A.C. tube was thrown into the breach to prevent murder, and that left the socket-power man, and the set manufacturer as well, very much (Continued on page 19)

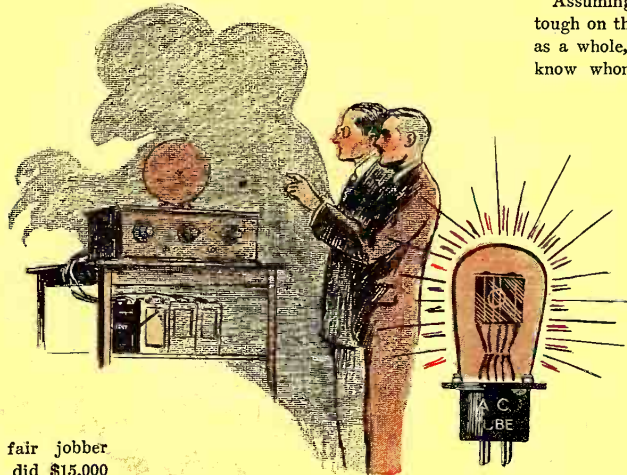

The alternating-current tube has presented a sudden problem to the manufacturer and to the dealer alike. What is the future of the battery-operated set? What will become of the thousands yet unsold? What is your experience?

INTERESTING THE YOUNG PEOPLE IN RADIO

By E·H·BRAGG
Plattsburg, N.Y.



ANYTHING that starts people talking about radio helps the radio dealer. There was a letter-writing contest in our local high school some time ago and, while it is impossible to tabulate results in terms of sales, I believe the letters written by pupils show that such contests should be encouraged.

It is easy to forget how we felt when we were young, and most of us dealers pay too little attention to the boys and girls, who might interest their parents in buying radio sets now, and who should be our best customers a few years later when they become business and professional people or homemakers.

The letters brought out the fact that small sets, using from one to three tubes, were being used in a number of homes, and that sometimes they led to the purchase of larger and better sets. I believe that, if we would make more effort to place small sets in the hands of boys and girls, we would sell more large sets to their fathers and mothers. Boys will buy parts and build sets, too, if encouraged to do so.

Read the following letters from pupils taking part in this contest and see if you do not agree with me.

ROBINSON CRUSOE'S RADIO

"If I were to be placed on an island and left there alone I should ask that a radio be left with me. With that radio I could educate myself. I should know of all the events that were happening in the world and I should have amusement.

"Daily I would hear lessons on foreign languages by college professors. In a short time I should have a good knowledge of French, Spanish, and other languages that are broadcast. My knowledge of history would also be increased.

"With a bag of seeds and a cow as my only means of obtaining food, I should be able to plant the seeds properly and make them yield a good harvest. I could keep the cow in good health and have it produce a large quantity of milk and butter fat. Why could I do all this with such success? Because there are daily agricultural talks broadcasted by all the leading stations for

YOUTH will be served in radio. In no other field have so many elders been ready to learn from the mouths of their juniors; and enormous indeed must be the number of radio sets which were purchased because the younger members of the family had learned radio and sold their parents on its wonderful advantages. There is an excellent opportunity to cultivate and foster this interest; and the increasing growth of radio utility in the schools can be turned to good account in every community in a way acceptable to parents and authorities—just as Bragg Brothers have done in Plattsburg at trifling cost.

the benefit of the farmer. The farmer nowadays has only to turn a switch and, with a little wrist movement, he can bring into his home the voice of a professor of agriculture who will give a lecture on some phase of farming.

"Now and then talks are given on cooking, and after a few lessons I should know how to prepare some dainty dishes with only my milk and seed products.

"In the morning setting-up exercises, broadcast by several stations, would keep me physically fit. In the early eve-

ning I should hear the last-minute news flashes sent out by all the stations. These would inform me of everything the world is doing and in no way would I become uncivilized. Radiospectively yours, ARTHUR F. MARTINEZ."

STARTING WITH A CRYSTAL

"My first set was a crystal outfit of the tapped-off type. The volume was not great, neither was its selectivity. The clearness of reception, however, excelled anything that I have ever heard on any tube set. In spite of this I was willing to sacrifice clearness for volume. I built myself a one-tube regenerative set. How that set could squeal! A few months later, I added two stages of audio frequency (Continued on page 18)

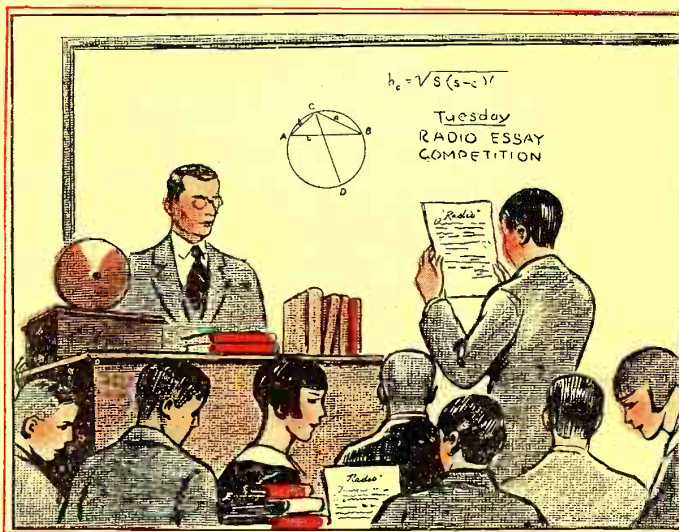

Nothing will make a community more radio-minded than to have radio in the minds of all its school children. Their elders will quickly get an earful apiece—and it is inexpensive advertising.

Looking into

RADIO TRADE PROBLEMS

SHORT EDITORIALS BY RADIO DEALERS

YOU have something you would like to get off your chest? This magazine is established for that purpose; it is first of all, a mouthpiece for the Dealer. Tell your troubles freely; but, if you can, suggest something that will make things better for you and your fellow-merchants. This is not an essay-writing contest; sincere, heart-to-heart talks and an exchange of experience will do more than literary style. A plain letter, short and to the point, will find its place here; individuality and practicality are what count in the selection of articles for this department.

Is There Money's Worth in the Set's Works?

DEALERS PERSONAL EDITION:
Gentlemen—

As a service man of some six or seven years' experience, I will try to give a brief synopsis of what, I think, is wrong with the radio industry. Among the hundreds of sets that I have serviced, including all manufactured makes, I have not found one whose results I could not duplicate for less money, by building it myself from standard parts.

For instance, sets that have been specified by radio magazines, with circuits worked out by leading engineers and laboratory-tested, have been leaders in their respective fields at a saving of, from \$25 to \$50, and even more in many cases. Too many manufacturers build sets for low prices and big dealer's profits, enclose them in beautiful cabinets, etc.—and when the shielding has been removed *there is nothing left*. In many of the sets all the parts could be bought for less than \$20, and they expect a dealer to sell them for from \$50 to \$75. Such sets make the better manufacturer lower his quality in order to meet his competitors' prices.

Of course, the customer who is buying can see no difference. He or she buys the cabinet; with the result that a good dealer must handle the cheaper class of sets in order to keep pace with competition.

Another thing; many jobbers send out

wholesale catalogs to parties who are not entitled to discounts. In a city of 3,000 population I have found in excess of fifty wholesale catalogs sent out by a certain Chicago house; I myself received three. Each of these catalogs creates a small group who send there for batteries, etc.; this compels the dealer to have a big discount or quit business. Dealer margins are too large now—35 to 50%—thus encouraging everyone to handle radio.

The automobile business allows from 12 to 20%; and the quality has been considerably increased, so that the customer's dollar will buy more—but not so in radio. I believe this same thing could be done, increasing quality and lowering discounts. This probably sounds radical, but the difference would be made up by increased sales, quicker turnover, and less service expense, fewer cigar-store radio dealers, and more satisfied customers—who, by the way, are a dealer's best advertisement.

So, unless set manufacturers get wise, use better parts and lower dealer's discounts, all small-town dealers will turn professional set builders and produce a quality the manufacturers are trying to avoid.

EDWARD B. SCHREINER,
Pella, Iowa.

(Here is a challenge to the industry: is the cost of doing business too high? How many dealers know their costs? Incidentally, Mr. Schreiner's letterhead bears two say-

ings: "Inexperienced workmen are costly," "Buy Service with your radio; it costs no more." How many experienced set builders are working and servicing for less than their time and skill is justly worth?)

Does the Service Man Know His Job?

DEALERS PERSONAL EDITION:

Gentlemen—

"Quality without service is no quality at all:" this fact means a great deal to the radio trade. There are many different makes of sets on the market today. You will always select the receiver that will sell best with the largest profits. But, do you get the same trade from the radio public that other dealers do? Take for example, your competitor across the street, who has the same kind of receivers in stock; yet his sales may nearly double yours. Now comes the question, why is it?

There are many reasons, but let us take up just one at this time. In some cases the advertising end is to blame, but not always. A dealer with a good reputation among his customers has the best advertisement there is. His reputation is built solely on the basis of truthfulness, honesty in dealing and the best service possible.

In most cases, the blame could be put upon the service man. Is he not the most important link between you and your customer? Should he not have the experience to overcome all difficulties in servicing and demonstrating your receivers? Are not those difficulties the very things that lose sales for you, if he is not the right man to overcome them?

You have, for instance, a good make of radio on display in your store. A customer comes in, studies the various receivers carefully, and after looking them all over, finally asks for a demonstration in his home. Then, Mr. Dealer, you depend on your service man to sell that receiver. My experience with some service men has shown me that the majority of them lacked the desired experience in both demonstrating and servicing. One of the great troubles with many of them is that they like to act big and make people think that they know a lot about radio—but talk will not sell a radio; it has to sell itself.



The outside of the cabinet is beautiful. Now, what is inside?

On the other hand, the inexperienced service man is a menace to the public; do not let him experiment at your customers' expense or yours. Be sure that he is capable of handling your business as if it were his own. Mr. Dealer, check up on your service men and see if they are giving the service they are being paid for.

JAMES C. ABBOTT,
252 Hanover St., Hamilton, Ohio.

(Ben Franklin once said, perhaps after bitter experience; "If you would have your business done, go; if not, SEND." The problem of obtaining dependable assistants is one that every business must cope with; but no subject elicits more vigorous comment from public and trade alike than that of the incompetent and sometimes unscrupulous radio servicer. This, however, would seem to be more of a problem for the merchant who is not primarily a practical radio man than for the head of a business who knows radio from the ground to the aerial, and is able to judge of the qualifications of his representatives.)

Do Chains Hurt Sales?

I BELIEVE that the present method of tying up a multitude of high-powered stations on cleared channels is not, to my way of thinking, a good thing for the radio industry; either from a trade standpoint, or from the standpoint of the broadcast listeners. The only time a national tie-up of radio stations should be permitted is in case of a national emergency.

With conditions as they are, an ordinary one-tube set is all that any person needs, if he is anywhere in the vicinity of a broadcast station. At first glance this would seem to be the ideal condition. However, look into the matter a little further. If only a one-tube set is needed, the dealer's average profits would be reduced almost 80%. There is no incentive for a man to invest several hundred dollars in a radio set in order to pick up one, two or three radio stations which will be the largest number of varied programs he can receive, if the broadcasting monopoly is allowed to continue.

I do not own a radio station, but I sympathize with the fellow that does, and who isn't a member of one of the networks. The statement that independent stations wish to join the chain is a fact; they've either got to do that or go out of existence unless enough of us—the broadcast listeners, who should be the judges—get together and put a stop to this monopoly of the air. I would like to see further comments from the readers of this magazine.

W. J. MURROW, Macon, Ga.

Turning Criticism Into Profits

FOR one disagree with Mr. Herring, when he said chain broadcasting is spoiling the radio business with Mr. Farmer. We have a number of Mr. Farmers on our books and find that they want just as good, or even better radios than the average city dweller.

We again think it does more good than harm; for it gives us an opportunity to sell

one of our better-class commercial receivers or better still sell him one that is custom-built.

If Mr. Farmer is very critical, or wants something better than the average person has, we offer him one of our high-class radio receivers and tell him what he can expect from same. (The greatest trouble today being the statement that "this set selling for only \$59.50 complete does just as much as one costing \$350.00"). If he expects still more we ask him what he would be willing to invest in a radio and what does he expect from a set. If he is willing,

TO OUR CONTRIBUTING EDITORS—

THE DEALERS PERSONAL EDITION is what its name indicates—primarily for you dealers. Any person in the radio trade is welcome to contribute to these pages; but the bulk of the matter which appears here will be always from those in closest contact with the customer. The best and most practical article with a constructive suggestion will go up front as the \$100 monthly prize winner—see page 3; but each article from a dealer which is printed will be paid for, so that it will not be a waste of the writer's time, nor, we trust, of the readers'.

we proceed with the building of a set, the nearest we can come to his specifications; and ten times out of eleven we have made a sale that nets us more profit than any common commercial set and have left with a feeling that we have another friend on our list.

With the radios today there is no trouble to get a set that will get almost any important radio station in the U. S., Canada, Cuba or Mexico. With one of our custom-built sets he should worry about the chain; when one station does not meet his approval he moves the dials one-half point and he has another one. He can choose whatever he pleases and knows there are more stations that are not on the chain than are on it, and if he likes some individual station he has the power with his set to get it.

Then there is another factor in favor of chain broadcasting; the general public is in favor of them and knows that we are getting better programs through this chain than would be possible if each had to be put out by one station only. The cost for some of these programs would break the average individual station.

C. W. SALE,
Sale Electric Co.,
1243—25th St., Milwaukee, Wis.

Price Cutting a Bad Old Way

AND if I pay cash—what discount will I get?"

How many times a season is this question asked the radio merchandiser? And how many times does he take the easiest way out and begin to dicker around as if he were selling dry or wet goods instead of standardized merchandise like radio? Speaking from experience, from personal contact with many dealers, I answer many, many times. And herein lies a grave danger to

the welfare of the earnest, business-minded radio dealer. For each discount sale, infrequent though it may be at first, weakens the dealer's resistance in handling such requests in the future, and extends the growing circle of people who say to their friends, "What! Pay list for your set? I should say not! Argue a little and save some money like I did."

"But a man is entitled to something off when he pays cash" is an argument used by the dealer who has failed to weigh the matter assiduously. A man is no more entitled to a saving for cash when buying a radio than he is when buying a new automobile. The only saving for cash should be, as it is in the automotive business, the saving of the carrying charges. For the margin of profit in radio, after depreciation, servicing, and other such costs are deducted, is entirely too small to warrant any other handling of the matter. The dealer who shuts his eyes and gives 5 and 10 and 20 off indiscriminately is admitting his ignorance of business costs and is inviting the auctioneer's red flag.

It is hard, admittedly, to turn down an easy \$10 or \$15, especially when things begin to slacken up. But, if the dealers in any one neighborhood would do so consistently, for even a short while, a practice which is rapidly becoming a menace, degenerating a clean-cut business into a competitive bidding proposition, would be speedily throttled. Trade associations and factory control can do their part, but it is only by the exercise of restraint and will-power by the individual dealer that this last hang-over of radio's chaotic days can be removed.

C. H. CARR,
B. F. Carr & Son,
850 E. 63rd St., Chicago, Ill.

Farmers Careful Buyers

DEALERS PERSONAL EDITION:
Gentlemen—

As a dealer in small-town and rural territory, I am chiefly interested in the farmer as a buyer. I have found that, as a rule, the farmers do not care to invest more than \$150 in a radio; in fact, they more often desire something very little over \$100.

The chief reason seems to be that at that price they believe they are buying radio and not cabinet. Of course, in this part of the country at the present time, there is no place for the electric set except in the towns.

Just as Mr. D. W. Bastion states, the small-town dealer "cracks a smile now and then himself." In one respect at least, the farmer is a good man to sell to; because your service man will seldom have to make a call, just to find an "A" battery run down, or a battery clip that has jumped off. The point I wish to bring out is that Mr. Farmer, as a rule, is well enough acquainted with his set to discover and remedy any minor trouble that develops in his batteries, aerial and ground, etc.

There is one subject on which I should like to see more discussion in these pages; namely, overcoming of competition. Over here in Ontario it is very easy for anyone to secure an agency. In fact, jewelers,

(Continued on page 19)

CARTER

Yes
we
are ready—are you?
Carter A. C.
Adapter Harness

for converting battery
operated sets into

A.C.
Sets

Here is new business, two blades of grass
where only one grew before. Call on your
customers to whom you have sold bat-
tery sets and pick up this extra profit.

Full particulars on request.

In Canada:
CARTER RADIO CO., LTD., Toronto
Offices in principal cities of the world



Carter Radio Co.
CHICAGO

TOBE

CONDENSERS - RESISTORS

Are selling consistently through a
Radio Season of upsets and surprises.
It will pay you to sell them.

Write us for particulars.

TOBE DEUTSCHMANN CO.
CAMBRIDGE, MASS.

BIG DISCOUNTS TO DEALERS

A lifetime opportunity for mak-
ing more money in radio. Get
our new big catalog, see
the bargains in stand-
ard radio parts, sets,
kits at rockbottom
wholesale prices.

RADIO
SETS-
PARTS-
KITS

Huge stocks ready
for quick shipment.
This price list
means big profits
for you. Wonderful special offers on
sets, tubes, accessories. Write for FREE
copy before you buy.

Complete
Price List

W.C. BRAUN COMPANY 379 A Randolph
Chicago, U. S. A.

KNOWLEDGE IS PROFIT

Let's exchange knowledge for knowledge.
RADIO NEWS will give you the finest of
radio information books, RADIO NEWS
"Amateur's Handbook," containing over 200
illustrations, 112 pages, and technical facts
every dealer should know—in exchange for
a simple little list of those manufacturers
whose merchandise you carry in stock. Isn't
this a fair exchange? You will find RADIO
NEWS "Amateur's Handbook" a big help.
We want your list of stock just to help you
in your merchandising, just to know which
manufacturers you have approved. Send us
the list immediately—then we can serve you
in these two ways—by sending you RADIO
NEWS "Amateur's Handbook" and by us-
ing the list to your advantage.

MERCHANDISING DEPT.
RADIO NEWS
230 Fifth Avenue, New York, N. Y.

The Dealer Must Keep Posted

(Continued from page 8)

this, quite often at much loss, but we are
not re-imbursed by the manufacturer.
This alone has discouraged many a dealer
as well as myself. I was handling a well-
known make of radio set and built up a
good business and these customers were all
well pleased and satisfied. The next sea-
son they brought out a new set—a new
line much cheaper, to meet competition, and
it was a miserable failure.

BACK TO PARTS

Right then I got completely discouraged
over handling them and have not done so
since; confining my efforts to the part busi-
ness, repairing, and servicing sets. It re-
solves itself into this; that, if the manu-
facturer wants to make good, he must build
an article that is better than we have had.
He must give this a gruelling test, as he
can, in order to know that it will hold up
and do all that is claimed for it as his ad-
vertisement reads; especially if he expects
the dealer to push it and stand back of it.
There is plenty of field left and many cus-
tomers to sell to; but today these custom-
ers are, as I have said, well educated to
the game and exacting.

I would like to see prices more stable
and the trade protected and radio sold in
the proper channels. As it is, hundreds of cat-
alogs are mailed out selling parts to any
one just as cheaply as the dealer can buy
them, and in some cases cheaper.

TOO MANY BROADCASTERS

Up till as late as 1926 business was good;
we did an exceptional good business, both in
complete sets and parts, but after this
something went wrong. I do not think
that there will be any remedy for it until

the Radio Commission eliminates many
hundred stations now broadcasting, or else
assigns them times when they may broad-
cast in turn; their turn perhaps not com-
ing to them for a week or so apart. About
twelve good high-power stations with wave-
lengths well separated should be ample for
this country, with the tremendous power
that they now have, and no others should
be on at the time. Our radio listeners
would find a wonderful difference in their
reception.

We have exactly the same air today
that we had a few years back, only it is
all torn up with so many stations trying
to get through. A dealer has a hard time
in trying to make a sale when he cannot
get distant stations satisfactorily, and yet,
in the years gone by, it was no trouble in
the radio season to get both sides of the
United States when the stations sending
had but 500-watt transmitters. Some sta-
tions put out wonderful programs that are
well worth listening to and would be much
more appreciated if they were not garbled
up with a lot of inferior programs that
could be easily dispensed with and would
not be missed.

No Rest for the Wicked

(Continued from page 6)

cut and make no refunds. If he brings out
advertising six months ahead of the product,
creates a demand for it and then, when
such demand evidences itself strongly,
doesn't produce the goods in quantity
sufficient to meet the needs of the jobber
and dealer—he should worry. The dealer
holds the sack.

But the world is only so big. It will
absorb only so much goods, and the scoffing
manufacturer—the two-faced jobber,—and
the unimaginative dealer will each get
their in time—in the neck.

How We Personalize a Chain of Neighborhood Stores

(Continued from page 7)

customer's own tastes and financial standing.

One of the reasons for our success is ser-
vice, and still more Service. We serve our
customers in a number of ways that do not
enter into ordinary business practice. But
our strictly business services will be of more
interest to readers than the varied, friendly
helps that every neighborhood merchant
knows so well how to give.

A LONG GUARANTEE

We give an unusually long guarantee with
every set—five years of usefulness is pledged
to the buyer; our guarantee reads: "The
storage battery and electric eliminators are
included." We are able to give this amazing
guarantee, which has brought in so much
business, for many reasons.

We first examine the set, noting its good
points in comparison with other makes, and
sell ourselves on it as thoroughly as we ex-
pect to sell our customers.

Manufacturers generally give a one-year
guarantee. We add our own much-longer
one for many reasons beside the worthiness

of the set. We find that it arouses an al-
most unshakable confidence in the minds of
the customers, making all in the neighbor-
hood prefer to buy in our store, rather than
in the big, impersonal shops downtown. We
know that every set is in A1 condition when
it leaves our floor and that it will certainly
give the utmost of satisfaction up to the
time when the customer will desire a new
improved model. *This will almost invariably
happen before the guarantee has run out.*

Since the customer wants a new set on
the average, once every two years, the
guarantee is actually for only two years.
We have so seldom been called on to re-
place a set that we feel any merchant, any-
where, can afford to give as liberal a guar-
antee as this.

Another method we have developed is a
thirty-day free trial. This is actually free;
because of our very close tab on the financial
integrity of our customers and their friends,
we very often let a set go out on trial with-
out a so-called deposit. We offer thirty days

(Continued on page 18)

DEALER'S PLANS THAT HAVE BEEN SUCCESSFUL

Good-Will Getters from East and West

I HAVE worked up quite a radio trade in this town, even though it has less than 500 inhabitants. Repair work is sent in from all the surrounding towns, and even from other counties. I attribute my success to the fact that I use nothing but good reliable accessories; charge a nominal fee, and do not exaggerate what my radios will do. I always make an estimate concerning the cost of the repair work; making it high enough so that it need not be raised, yet low enough so the customer will be pleased. I find the radio public is willing to pay well for work well done. I try to make my price so that I can make a legitimate profit and yet leave the customer so well pleased that he will tell everyone he meets how well pleased he is and will return when he has further radio trouble. A big profit and one sale isn't much, compared to a small profit and many sales.

I know another service man who charges about the same for his work that I do; but he uses inferior parts and so sells accessories for less. He generally gets the customer first, because of his attractive prices; but one trip usually ends their relations. I make most of my money from return calls, so try to satisfy.

ALLOWANCE FOR OLD SETS

I find lots of people wanting to trade a used set for a new one; and have decided never to give them, on a trade-in, more than the profit on the receiver itself. This leaves me the old set and the profit on the accessories. I never try to sell the used set for more than its trade-in price. In most cases accessories are bought with the used set; and thus the new set is sold and its profit made, and also an extra profit is made on the accessories of the used set. *The buyer of the used set is told that he is getting it at exactly its trade-in price.* This leaves him with a feeling that he is getting a bargain.

PROFIT ON GIFTS

I pulled off a little advertising scheme here Christmas eve that worked beautifully. At the community Christmas exercises I gave away six popular one-tube receivers. Everyone entering the building was given a number; numbers corresponding to these

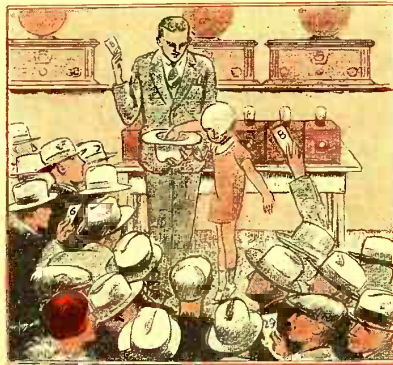

Inexpensive gifts will often bring in profitable trade as a speedy harvest

were put in a hat and a small child drew six times, thus determining the winners. With each receiver was given a trade-in price on a five-tube receiver. I received four of the one-tube sets back and made a good profit on the five-tube sets and accessories. On the other two I profited enough on the accessories so I was not a loser. The good will gained could not have been got in any other way, and my business was on the tongue of every citizen in the entire community for days.

In my opinion the DEALERS PERSONAL EDITION is just what the radio trade has been wanting. I have not missed an issue of RADIO NEWS since it has been published,



E. T. QUACKENBUSH

but I felt that lack of a dealers edition. The "hams" discuss their troubles and bright ideas by means of the ether; but you do the same thing for the dealer.

E. T. QUACKENBUSH,
New Bloomfield, Missouri.

(The plan Mr. Quackenbush outlines is perfectly legitimate, and well adapted to a closely-knit community, whether small-town or neighborhood. What are some of the ideas which you have found winners and are willing to pass on to other dealers in other cities? This page will be maintained for the purpose; and your contributions will be paid for at regular rates—and have, besides, a chance for that \$100 first prize.—MANAGING EDITOR.)

"Looking Beyond the Sky Line"

HAVE you made a concerted effort to move those old parts? Do you realize that, in not using some mode of advertising to sell them, you are not only pocketing your loss but you are hurting the manufacturer (who is putting forth every effort possible to bring out the improved parts, that are revolutionizing radio) by not purchasing a stock of new parts, causing failures, closing the doors of those concerns and throwing into the labor mart hundreds of men and women?

Research laboratories are confronted with knotty radio problems every day and the youth of this vast domain are the ones who will take the places of our present

radio engineers. Large industries have their apprentice schools, but a large number of our boys are not eligible, because they are not high school graduates. Those are the boys who aspire to greater things and those are the boys you should interest, but how?

CREATING RADIO ENTHUSIASM

You no doubt have in your radio department, if you are a large dealer, or if your store is exclusive, a man qualified to build sets, from the crystal, to the superheterodyne. All right then; offer to ten or fifteen of these boys, a free course of two or three nights a week in your store and teach them by demonstration, the fundamental prin-

ciples of radio. Teach them how transformers are built, the various aerial designs, the making of the different coils used, which is the all-important factor; and, once they acquire that knowledge, they will want to wind the coils in their own little workshops at home and they will then want the parts, that enter into the making of the sets, which you will also assist them to build.

Bring this idea along step by step. Other boys will become interested, as every boy has a "pal." It means a little work on the start, yes; but as the older boy progresses he will help you in advice to the younger one.

(Continued on page 20)

"TOURISTS" are not all of the familiar type which loads the other family possessions into the venerable Model T and sees America through clouds of dust; and whose radio equipment must perforce be limited to an extremely-portable receiver. The "tourists" of whom this article speaks, in accordance with a local custom of some years' standing, are more properly "winter residents"; a class capable of maintaining two homes, and correspondingly prosperous and desirable customers for radio. With those who can afford the best in radio, the policy of the writers in pushing the best quality of combinations is justified by the conditions of trade; and it should be wherever the barrier of price is not too formidable.

It is the policy of the DEALERS PERSONAL EDITION to present, so far as possible, the characteristics of the most various fields of the retail radio trade, and the special methods found successful by dealers in meeting different conditions; in the hope that many of our readers may perhaps gather a hint which they can translate into a valuable idea.

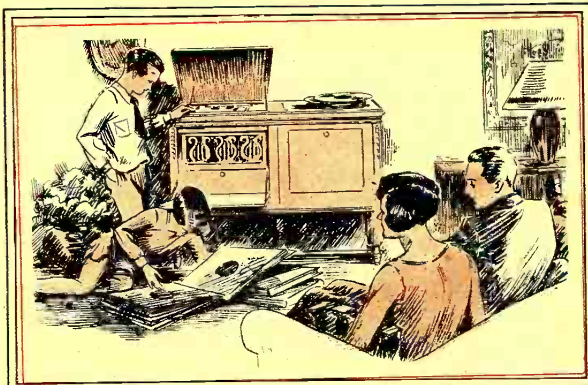

How we Sell Radio to tourists

BY J. C. & ETHEL WILDER
Kissimmee-Florida

BURTON HOLCOMBE, a local young man, walked into our studio on Main street the other day. Burton had just been north, calling on Mrs. Theodore Roosevelt at Oyster Bay, and other well-known persons, and had come back with a new interest in his home town and its business places—and especially in radio.

"How do you sell radio to tourists?" he asked.

That was a natural question, because Kissimmee is visited by thousands of tourists who come down the Atlantic Coast Line or the Dixie Highway. Once, they were mostly winter tourists; but a large number who used to come for the winters have bought homes here and now stay the year around. Others come at all seasons.

"Aren't tourists people? Don't they like music the same as other folks?" we asked Burton.

He admitted that that was true, but still he thought that there must be special methods for making sales to tourists.

There are, of course, some difference between the mental attitudes of people who are on vacation and those who are at home. The tourist usually is more free from care, being away from home responsibilities. Often he is a better spender, away from home, than he is at home. He has more spare time and needs more amusement. All of which helps the radio dealer.

Conditions here in Florida, so far as they concern radio dealers and tourists,

probably are no different from those in other parts of the country. The automobile has made us a nation of tourists; and every section of the country now is a tourists' resort in one season or another.

Tourists who settle in Kissimmee are our best customers. We always have a beautifully arranged window display and it attracts them. Our store is "The Home of Good Music" and they hear some of it as they approach our open doors. We invite them in to listen. Sometimes we have two or three hundred people at our store listening to a Victor or a Brunswick program. That gives us our opportunity.

We get all the prize fights. Everyone is eager to hear a prize fight. It seems to have a universal appeal. Our audiences always know who wins, two or three rounds before the people who wait for telegrams.

Our float in the Fourth of July parade brought us many customers. The tourists were out in force to see that.

COMBINATION SETS SELL BEST

We sell the Brunswick and the Victor combinations of radio and phonograph, Orthophonic Radiola and Panatropé Radiola. We believe these are the best made. We always are glad to demonstrate our receivers in our store, but our most effective demonstrations are made in the homes of customers. One man took a combination outfit home to try it out. When we called to see whether he wanted to keep it or wanted us to take it away, he said:

"If you take it, you must take my family, for the two are inseparable."

Our best advertisement, either for tourists or permanent residents, is a Radiola sale. Customers who buy Radiolas are always pleased and tell their friends. Often they invite their neighbors and tourists to listen in on New York, San Francisco, Mexico, or stations back home wherever it may be. One sale leads to another.

We believe that dealers make a mistake if they do not push the combination phonograph and radio outfits. Our Christmas sales were nearly all combinations. Many of our customers who have purchased phonographs from us in previous years are now trading them back to us for new combinations, so that they can enjoy the music on the air as well as the recorded music.

PHONOGRAPH USERS GOOD FIELD

Our experience shows that dealers should go after their former phonograph customers, for every phonograph user is a prospective customer for a combination outfit.

There always is a market for the lower-priced outfits and the sets taken in exchange for new sets; but the most profitable and satisfactory thing to try to sell first, to tourist or old resident, is the best outfit in the local market. That gives the customer the benefit of the superior results that the best sets give, and also the satisfaction of knowing that no one else in town has anything better.

With the time-payment and financing plans in operation today, we make it practically as easy. (Continued on page 20)

REPLACEMENT TROUBLES

Must Be Lessened By Educating the Public

A QUESTION which requires serious consideration on the part of the retailer and wholesaler, and from our end as manufacturers, is the question of replacements for the so-called "defective radio tubes."

We have found in our experiences that approximately 50% of the so-called "defective tubes" returned to us for adjustment have been first-class tubes in all respects. While our policy has always been to stand back of our product and render 100% adjustment to our distributors, it has meant considerable expense to us; as each individual tube is tested and a report made as to the defect or so-called "defect."

We believe that the consumer's unfamiliarity with the purpose of various special types of tubes intended for special purposes is to a large degree responsible for this condition. We have endeavored to supply literature explaining the functions of each special-type tube manufactured by us. It is, of course, necessary that the dealer when selling the tubes should instruct the buyer, in so far as possible, as to what may be expected from that tube and its merits over the ordinary tube in that socket of the receiver for which the special tube is designated.

INSTRUCTION NECESSARY

It has been the intention when designing

By George Colby
PRESIDENT, C.E. MFG CO.

It has been said "the customer is always right!" but it is an expensive policy to follow unless there is some assurance that the customer will be right, when he is dealing with products which require intelligent use. Mr. Colby, the president of a large vacuum-tube manufacturing company, discusses one of the special problems with which every dealer has been confronted. The manufacturer carries on an elaborate program of education, which the dealer should take advantage of and, similarly on a smaller scale, follow in his dealings with the customers, who are in close personal touch with him.



number of tubes have been returned to us which have apparently been in use from 8 to 10 months and upon which we have allowed adjustments to our distributors; which, to the writer's mind, is an imposition on the manufacturer. If more care were used by the dealer in accepting tubes from the consumer for adjustment and instructions given to the consumer in the first place on the use of specific tubes for specific purposes, it would react to the benefit of the wholesaler and manufacturer.

TELLING THE SET OWNER

A food manufacturer, a jewelry maker, a clothing producer may find it *advisable* to conduct a campaign of education to the trade and the public regarding his particular merchandise; in the radio industry it is *vitaly necessary* that this be done. It is necessary to educate the wholesaler, the retailer, and finally the consumer if he is to receive from radio the same measure of satisfaction that comes from his purchase of merchandise in other lines.

The enthusiastic reception of radio by the people of this great country, and the unprecedented growth of the industry has brought hundreds of thousands of untrained people into the business of handling, distributing, selling and using these wonderfully sensitive and complicated pieces of electrical mechanism.

No wonder they are confused—no wonder some of them are ignorantly enthusiastic about still unproved and unperfected processes and products. No wonder products of great merit are failing to give thorough satisfaction due to their use in circumstances or conditions for which they were never intended. (Continued on page 20)

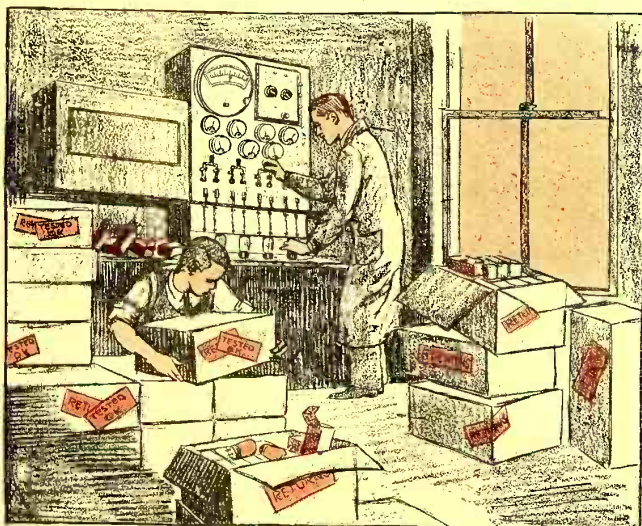

Half of the "defective" tubes returned to the manufacturer prove O.K. by laboratory test. The fault lies in the user's unfamiliarity with their characteristics and the proper method of operating them.

and manufacturing special-purpose tubes, to give to the consumer something better than the ordinary all-purpose tube and, if such tubes are used according to instructions,

there is no doubt but that reproduction is greatly improved. If the consumer would follow the instructions packed with each individual tube, and the dealer in turn would advise the consumer as to the relative merit of a special-purpose tube and its superiority to the ordinary all-purpose tubes, a large number of the returns could be eliminated and the consumer would be better satisfied.

We have also found that a

How We Personalize A Neighborhood Store

(Continued from page 14)

but, as a matter of fact, most sets so placed on approval consummate into sales within a week.

This method of selling has dangers, when the set involved is not among the best of makes. The very low-priced set usually does not perform at the crucial moment, when the sale is still unmade. We have therefore made it a rule that this offer is only on good sets.

THE PERSONAL TOUCH

We enter into every movement for community improvements and take a keen interest in all the affairs of the little residential world around us. This knowledge of the community aids us, too, in our credit problems. Since we finance ourselves, much care is needed in our credit regulation. We feel that by self-financing, we save heavy interest, which we otherwise would have to pass on to our customers. Since we lower the buying cost for our instalment customers, taking the risk ourselves, we must be sure of prompt, steady payments.

Our friendly policy is of great help to us in this matter. No man cares to go back on a friend; it's hard to go back on anybody who has treated you with decency and consideration. Our time customer will endeavor to meet his obligation to us first, if he is in difficulties. We have found that the great majority of our debtors treat us as we treat them—fair and square. We have never regretted the policy of becoming "a member of the family" in each of our neighborhoods. Every year has been one of financial profit and of the satisfaction that we have done good business, with the emphasis on the good.

Dealers Should Make Their Qualifications Known

(Continued from page 9)

bright boy where he could buy radio supplies, and was informed that the church was the only place where he could not buy them. My belief is that the only way in which this lamentable condition can be remedied is educating the people to the fact that they can be protected in buying radio sets and accessories *only* by patronizing the dealer that is qualified to sell such merchandise. That can be determined from authorities on radio such as radio colleges, institutes, etc.; and certificates of approval should be hung in a conspicuous place in the merchant's store and a copy used in all his advertising. I am sure that the owner of a Packard car would not go into a blacksmith shop to have it repaired; and this may be true also of customers who wish to buy such.

From several years of bought-and-paid-for experience, I know that a dealer's radio business is only as good as his service business; and this coming year I am planning to build an addition on my store and give the public the best repair department that I can afford, and service at all hours within

reason. I feel that in that way, and no other, I will make my radio business successful and profitable. Also, I will not offer for sale any receiver or accessory until I have given it a rigid test for performance, etc.

If more manufacturers of sets and accessories would send a sample of their products to dealers that know radio, I believe that many more sets would be sold. I am confident that many dealers are like myself; they must be shown before they buy, and pictures in magazines of sets do not give performance.

The time has now arrived when the dealer should see that all his customers are protected in all of their purchases. If he *knows* radio, and wants the good will of his people, he will see that they get protection; for, *without the customer*, the dealer is done for. So now is the time for the dealer and the manufacturer to establish extremely close relations and work hand in hand to the exclusion of all jobbers, and for the elimination of radio interference of all kinds. They should unite with one sole object in mind, and that is to do all in their power to satisfy the supreme power in radio—the everyday broadcast listener.

FINANCING AND HOW?

The radio merchandise I have handled in the past few years has been sold for cash; as I have not been able to handle paper myself, and the banks did not seem to want it. I know I could have sold many more sets, if I could get the manufacturer to take and collect the paper or leases. But at the time I was interested in selling on installments, all the business was done through financing companies; who, in my opinion, put all the risk on the dealer, and made the prices much larger to the consumer. So I still do business on a strictly-cash basis; although I believe that a big business can be done in my section if the manufacturers would handle the paper and do the collecting.

For, as you know, in a small town a dealer cannot be too strict on the people, and they know it and take advantage of it. But, if they understood at the time of the sale that a set would cost them so much—the down payment so much, and the weekly or monthly payment so much—and that the payment must be made to the manufacturer on time, each or every week or month, and that failure to do so would bring prompt action from the manufacturer—that their local dealer, who is only the representative of the manufacturer, could in no way help them if they did not live up to their agreement—then I am sure that installment selling would be a success.

There is one thing that I hope can be done for the radio listener (the bird that lays the golden eggs) and that is, some immediate steps to lessen the terribly-annoying and destructive heterodyning from crowded stations, commercial code, and regenerative sets (yes, they are *still*, but noisy, with us; and, in our section, owned by people who can afford *good* sets). I am enclosing a copy of a letter I sent to the Radio Commission, but I do not believe they will pay much attention to a small-town dealer. I do not believe that any political power has the right to appoint a board of control over radio without the sanction or recommended appointment of the broadcast listeners who

are the most vitally interested. However, whether we get immediate relief or not, the day is coming (and will soon be here if we can get the co-operation of such magazines as this) when the worm will turn; and either radio broadcasting will be censored or controlled by the people, or many radio receivers will be draped with cobwebs.

I am not a crape hanger, as I am for radio, and will do all I can to assist in making it better, regardless of profits; but I call a spade a spade, and radio is not right so far as receiving conditions are concerned, I'll gladly tell the world. I am just a plain, small-town dealer, who has taken to radio, from its earliest broadcast days, like a duck to water. The Lord only knows what we in the country would do during the long winter months, if it were not for radio; and I sincerely hope that all who are most interested in radio from a business standpoint will get together and do their best to make it bigger and better—and it can be done if all will do the right thing.

(There is no reason to believe that the Radio Commission has failed to turn an ear to the representations in good faith of any section of radio interests, small or large; but that body has not been vested with the authority or the means, to set everything right; and, as this goes to press, the entire problem is again with Congress.—MANAGING EDITOR.)

Interesting the Young People in Radio

(Continued from page 11)

and purchased a loud speaker. The whole neighborhood then seemed to be alive with cat fights.

"Finally I became convinced that the regenerative type of a set, as built by the amateur, was not practical. I figured up all that I had spent on radio. The amazing sum of \$87 glared before my eyes.

"As we grow older we become wiser. Today I have a five-tube neutrodyne for which I paid \$150. The set acts like some of our girl friends; it will entertain only on certain nights. I am glad to say, however, that I have left the ranks of those using regenerative sets.—ALFRED MILLETT."

AN OBJECT OF ENVY

"I can still remember the day when we bought our radio set. I hung around my father like a fly does to flypaper. I was so excited and anxious to work it myself. I have enjoyed our radio ever since and seldom fail to hear the concerts. I remember how I used to come to school and stand around with a look of envy on my face, listening to the other boys brag about their sets. It used to make me discontented to hear them say: 'Did you get the fight last night? Pretty good, eh?' I used to stand around with my face a mile long at such remarks, but now—well, I am just as proud of my set as the next fellow is. I feel sorry for the fellows who haven't any radios, because I understand just how they feel; so on nights when I know that there is a good program on, I invite two or three of my boy friends in to listen in with me and they always leave the house full of enthusiasm.

"I've heard it said that dogs and horses make excellent companions; but, for mine, give me our five-tube neotrodyne radio and I'll be happy.—Harold Van der Burgh."

DX WITH A 3-TUBE SET

"Our family owns a 3-tube Federal set. It is a very uncommon thing not to be able to receive a good program of some kind on this set. We have received programs from Cuba, Montana, Florida, Georgia and other stations at some distance. A neighbor told us that before listening on the radio he was quite deaf in one ear, but that now he is able to hear with both ears.—Doris King."

HE GOT MADRID!

"I, or in fact my father, own a Golden-Leutz receiver and the feature of this machine is that it uses sets of coils which may be changed to obtain high or low wavelengths. Through the use of these coils we can now receive many amateur stations which we previously could not get. During the last transatlantic tests I used the low wavelength coils, and great was my surprise when I heard a voice repeat 'Madrid' quite a few times. A man who was an expert in the radio line told me afterward it must have been an amateur in Madrid, New York.—David Miller."

EASY TO START CONTEST

Most school principals and teachers welcome any suggestion that will break the monotony of daily lessons, but stimulate interest in them. This contest was conducted in the English and science departments of our high school and the principal and teachers thought it was a good thing. Naturally, they do not want us to attempt to exploit the schools but, if we start something that will benefit the pupils, we do not need to emphasize our business.

A small cash prize was offered for the best letter and a piece of apparatus for second prize. The teachers served as judges. The contest aroused new interest in radio in many homes and brought out information of value to teachers and dealers. Such a contest can be started easily in almost any school, merely by offering to furnish the prizes.

Looking Into Radio Trade Problems

(Continued from page 13)

restaurant keepers, and farmers, as well as garagemen, carry some line of radio.

Worse yet, often two dealers in a small place will handle the same line; and, in order to undersell, the competitors cut their prices to such an extent, that they lose money if the set happens to need any considerable servicing.

ALLAN T. JOHNS,

Route 3, Seaforth, Ontario, Canada.

The Parts Dealer and The Set Builder

DEALERS PERSONAL EDITION:

Gentlemen—

A dealer can demonstrate a half-dozen manufactured sets soon after receiving them; can he do the same with as many

Shadows of the Radio Business

(Continued from page 10)

up a stump. The set manufacturer was more or less innocent of course, and already had his license troubles. And so they all and paying more than ever; and we all pray again that said A.C. tubes do hold up at last 50% as well as the good old "A" type.

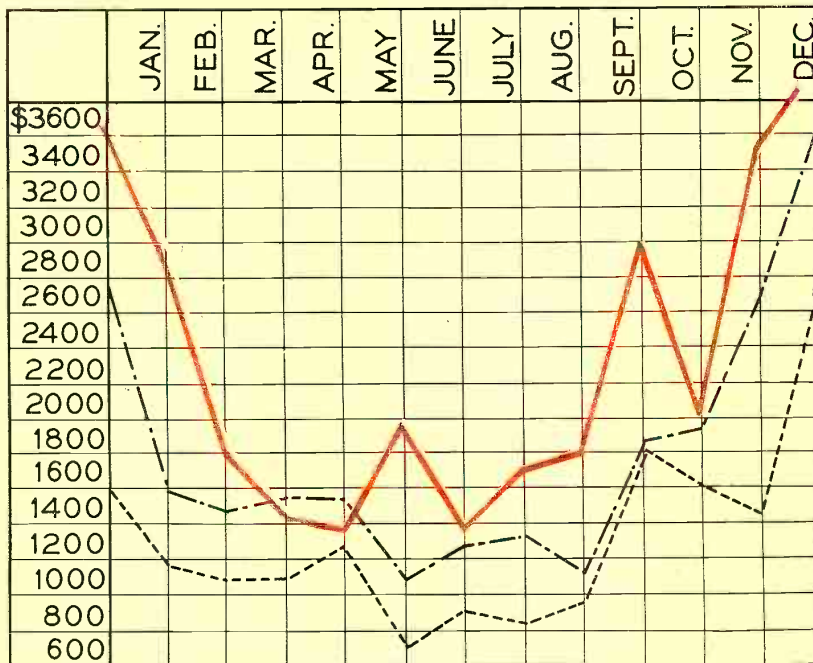

— 1927
 - - - 1926
 . . . 1925

went down into Canaan together and raised heck, and each tried to beat the other fellow to everything. And the natives saw the scrap and decided to have no trafficking with them until things cooled down.

THE SHADDER ALONE

And now that breakfast food is to be made of the unsold D.C. sets, and the Big Outlets will try to sell the remaining sloop-jar socket powers, the public considers it safe to buy, and they are buying A.C. sets

The above is a picture of my frame of mind on the radio business—a business that I like, and the one that is paying the family gas bill.

(Mr. Hatfield accompanies his article with the chart referred to, as an illustration of the seasonal variation of a growing business; and every dealer would do well to prepare one like it for his own study, if he has not already done so. What can be done to take the valleys out of the year's business? What causes them, other than the climatic changes which are inseparable from the eccentricities of our planet's motions? Tell us what You have found successful in building business in the off season.—MANAGING EDITOR.)

complete kits in three times the length of time? Why shouldn't he be able to get a model complete? This would protect him; there would be no question whether the home builder did this or that right. If this specimen set didn't come across as advertised, or come up to the standard of a manufactured set (which should exceed it at list) there would be one more circuit lie crased from the book.

Today there are a large number of experienced set builders who have had their legs pulled a good many times, and are not sticking their legs out again. They are going about radio more cautiously and now they have to be shown.

How many are there that pay more attention to pictures in radio magazines? Point out a wiring diagram, they tell you "it's all Greek." This Greek, whether he is

a boy of fourteen or a man of fifty, should be able to put together a six-tube set without any experience; and here is what the Greek and the vanishing parts dealer can come back on. "Eye values" are not needed for parts to be used under a pierced or drilled metal baseboard; but parts are wanted that are true, simple, and wired in a short time—as many one-hole mountings as possible. All parts should have a doveled pin with one holding nut; a standard doveled could be adopted by the manufacturers' association.

To put Mr. Inexperienced Builder to work, I suggest the "spot" system of wiring, free to the user. He wires one part of the circuit at a time—say "A—." Any part that is to be hooked to "A—" should have a color spot, also a number—say a green spot marked No. 1. This is where the

Natural Tone



MAJESTIC CONE

Designed for use with or without power tubes

Reproduces music or voice exactly as it comes from the broadcasting station. A full, rich, pure tone, free from distortion.

A beautiful cone, 12in. in diameter, ruggedly constructed, laminated wood frame and metal base, with sensitive, adjustable unit, finished in rich mahogany. Packed individually in fibre air-cushion cartons.

(Standard package of 6) PRICE.....\$1.75

Write for Other Special Bargains Now to
SPIEGEL RADIO COMPANY
 135 Liberty Street New York City, U. S. A.

TERMS: 2% Discount Allowed on C. O. D.
 3% Discount If Cash Is Sent With Order



BIG DISCOUNTS TO DEALERS

Write us—if you want to make more money on standard kits, sets, parts, supplies. Get our **BIG FREE CATALOG** which is the most complete dealers' catalog ever compiled. Standard lines at big discounts. Write for it now.

W.C. BRAUN CO.
 579 A Randolph Chicago

NEW EDITION OF RADIO LISTENERS' GUIDE & CALL BOOK JUST OUT!

Every Customer
 Needs One

New big Spring edition just off the press. This book is full of circuits. The Air Scout 4; The Official Browning Drake; The Two Tube Socket Power Set; The Continental Six; The Shielded Grid Six; The Super Hilodyne; The Lynch-Hammarslund; The Karas A.C. Equamatic; Combination "B" Eliminator and Power Amplifier. These are just a few of the many circuits appearing in this issue. Sell this book to your customers; it means more business.

Then there is a new revised and up-to-date log of every radio station showing their wave length, power, call letters and location.

OVER 200 PAGES

300 ILLUSTRATIONS

50c RETAIL

Write now for our special sales arrangement.

CONSRAD CO.

DEPT.-DE

230 5th Ave. N. Y. C.

first connection is made; green spot No. 2 is the second connection, and so on. Let the wire used for this purpose be colored according to the same scheme. This same builder will pay more attention to diagrams and symbols, and learn them after he has made his set.

Yesterday we started with one tube, and then worked up to the limit. Today they are starting in with bigger sets and have to get the help of an experienced man—the parts dealer of yesterday.

But he is quitting the game; he can't keep up with the manufactured sets; so he is buying and selling them instead of parts. But he is the hardest and willingest worker the trade has had; show him a reasonable chance and he will come back.

J. P. RYAN,

53 Calhoun St., Torrington, Conn.

(The problem of designing sets so that they can be put together without a schematic diagram, even, has been solved; although the old-fashioned experimenter who likes to do as much as possible of his own work writes sarcastic letters of protest to the magazines when he sees such hook-ups published. But the inexperienced builder should and must have competent advice, not only in construction, but in selection. One of the most vigorous complaints which dealers make has been due to experience with defective parts, such as Mr. Ryan's. One of his safeguards lies in the laboratory tests, such as RADIO NEWS makes, of approved apparatus.)

Good-Will Getters

We want this a magazine of suggestions as well as criticisms. What have you to offer for the good of the trade? (Each article accepted is paid for at regular rates.) Come on in.

Looking Beyond the Skyline!

(Continued from page 15)

Advertise these parts and it means nothing to the boy until you have brought him face to face with the cold facts, that the future of the radio industry, is great.

Don't equip a laboratory, to broaden their vision and understanding. Use an old work bench and a few necessary tools, wire, etc. Work with them, make them like you and the boys will do as you have done, as I have done and all fans have done, build up, tear down, and buy everything new on the market to add to.

The boys will come and go, new faces will be added to your classes. Your parts will go fast and new and better ones will be put on your shelves; then advertise and at the end of 1928, your balance sheet will show a profit opposite the account called "radio parts."

E. T. JACKSON, SR., Ft. Wayne, Ind.

(This editorial, undoubtedly suggested by previous ones which tell of old parts charged off to profit and loss and lying idle, is a hopeful and inspiring one. The greatest resource of the radio trade of tomorrow is the interest and enthusiasm of future buyers, which can be stimulated in the formative period of their career. Mr. Jackson, whose firm are manufacturers' distributors, makes a most valuable suggestion for those who are in position to act on it.)

How We Sell Radio to Tourists

(Continued from page 16)

for a customer to own the best set as a lower-priced one. *If a tourist objects that he does not want a big outfit on his hands when he starts for home, we assure him that we will pack it and ship it for him.*

RADIO HELPS MUSIC SALES

Radio helps the sale of Chickering and Gulbransen pianos, which we carry, and of other musical instruments and sheet music. Radio users hear good music; then they want it on a phonograph record, and then they want to play it themselves or to have their children play it. And, of course, the sale of a radio outfit creates a demand for batteries, tubes and other accessories.

Tourists are only people away from home for a holiday, and it is no harder to sell to them than to anyone else; provided you offer them reliable merchandise.

Replacement Troubles Must Be Lessened

(Continued from page 17)

No wonder there is dissatisfaction—misunderstanding.

Service of a soundly educational character is needed to meet and in time remedy this condition. In our business of making and selling tubes we have long recognized the importance of such educational work. The day has passed when "a tube was a tube." Today a good tube is no good if wrongly or ignorantly used. It is built by scientists, carefully tested, most cleverly adjusted to deliver a maximum service when used in the proper place. Improperly placed, it dissatisfies the user, reflects upon the standing and good will of the retailer who sold it, the jobber who sold him and the manufacturer who made the tube.

We have, as I say, seen the need of educational service and have organized to give it. One of the busiest departments of our business is that of the scientists and engineers whose services are at the disposal of the trade and the public. These experienced and able men go personally to see wholesale distributors, they are very frequently consulted by retailers; they write many hundreds of letters every week to carry on this kind of educational service and very gladly furnish data sheets free to dealers and consumers.

A part of our service and of great value to the consumer has been the daily broadcasting through Station WEEI of Boston, of special-purpose radio tubes and their specific functions in different receivers.

This service is costly, but this is a time when it is necessary to take the "long view" and work and plan for the future. All of us, retailers, wholesalers, manufacturers must go to school for a long time to come. And if this period of study, of education means a sacrifice of immediate profits, we must be satisfied to have it so, in order that the future of our businesses may be upon a sounder, more satisfactory basis. This is the sort of service all of us should be prepared to render in the present somewhat chaotic and ever-shifting condition of the radio business.

Radio News Dealers Personal Edition Service Sheet No. 1

The Crosley A.C. Bandbox, Model 602, and Crosley Power Converter, Models 104, 105 and 106

Manufacturer; Crosley Radio Corporation, Cincinnati, Ohio

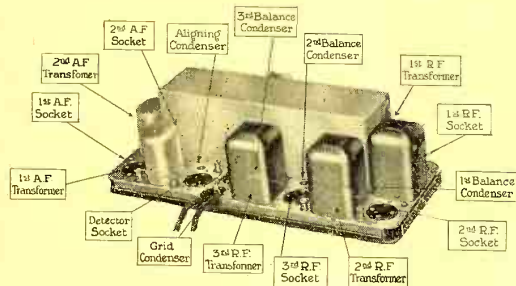

Right and left, the rear and the front views of this set removed from its metal case, showing the placement of parts. This chassis fits interchangeably in a number of console cabinets, as well as in the metal socket through the Bandbox case. It is a 6-tube set (see circuit diagram on reverse page) completely operated from the light Power Converter, illustrated below.

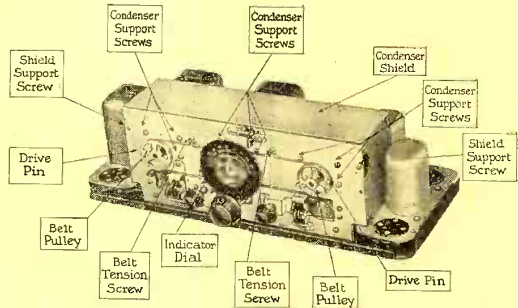

In this rear view of the chassis, after removal from the metal Bandbox or cabinet, the antenna post is at the right and the ground post at the left of the second R. F. transformer. The Musicone terminals are on either side of the first A. F. transformer.



The three tuning condensers are belted together and controlled by one dial. The two acuminators (see diagram) serve to sharpen tuning. The adjustment of these parts and the balancing is done in the same manner as with the battery-operated models.

THIS is a six-tube set, with one untuned and two tuned R. F. stages, with neutrodyne stabilization, a non-regenerative detector, and two stages of A. F., the last using a power tube. The tubes required are four 226-type, one 227 (five-prong detector) and one 171 in the last stage. It is similar to previous Bandbox models, except for the use of A. C. on the tube filaments.

The standard grid leak value used with this set is 2 megohms; though leeds of lower resistance may be used, especially for local reception.

The wires leading to the audio transformers have the following code: cotton-covered, to "B+," silvered, to socket "P," copper to socket "G," silver-and-copper to biasing resistor.

The 540-ohm power biasing resistor is reached for replacement by removing the first A. F. transformer. The 20-ohm potentiometer (W4240) is the short resistance strip; this, as well as the 100- and 110-ohm center-tapped resistors, are removed by unsoldering the terminals, and removing the nuts which hold them in place, when they are to be replaced.

The complete circuit diagram, and directions for testing the elements of the receiver are to be found on the reverse page.

A 50- to 100-foot outdoor aerial or indoor antenna may be used; the

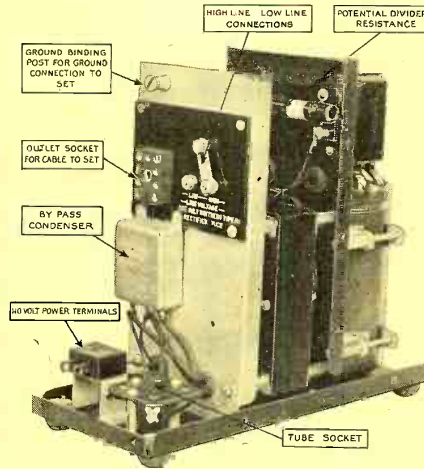

Above, a front interior view of the earlier Power Converter. In later models the "High-Line Low-Line" switch is replaced by a cartridge fuse with three clips. Care must be exercised in testing this converter as the transformer secondary voltage has a peak of 800 volts. Below, a view of the Bandbox Chassis, as seen from the bottom.

length is not critical.

The set is put in operation by the right-hand switch; when the filaments are lighted, the pilot light should glow. This switch turns in one direction only; to the right. After the set has been turned on, about a minute is required for the detector heater to reach operating condition. Should hum be present, try reversing the connections at the house-lighting receptacle. As the set is quite selective, the station selector dial should be rotated slowly to avoid passing over stations.

The Power Converter (Model 104, 105 or 106) employs a 280-type (filament) rectifier tube. In the models 104R and 105R, also usable with this set, a BH-type (gaseous) rectifier tube is used. The circuits are slightly modified for this reason. The models differ in their windings to work with different sources of voltage supply.

The Power Converter should be located as far as is convenient from the detector and A. F. circuits of the set. It is recommended that a ground lead be run from its ground post (above the multiple socket) to the ground wire of the set. The switchable socket must be pulled out before the cover of the converter can be raised. The condenser case is insulated from the supports, as it is at a "40" voltage with respect to the Converter case.

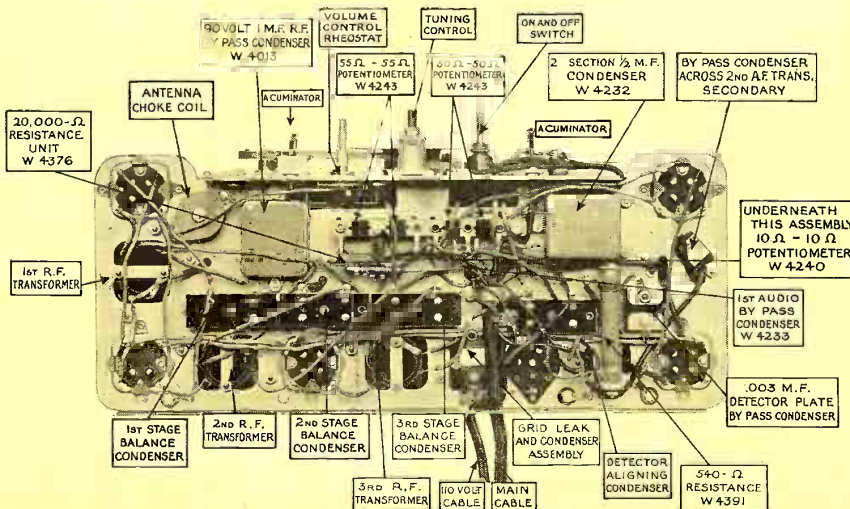

Circuits of the Crosley Model 602 A. C. Bandbox and Power Converter Models 104, 105 and 106. The dotted square at the lower right represents the plug by which the ten connections are made.

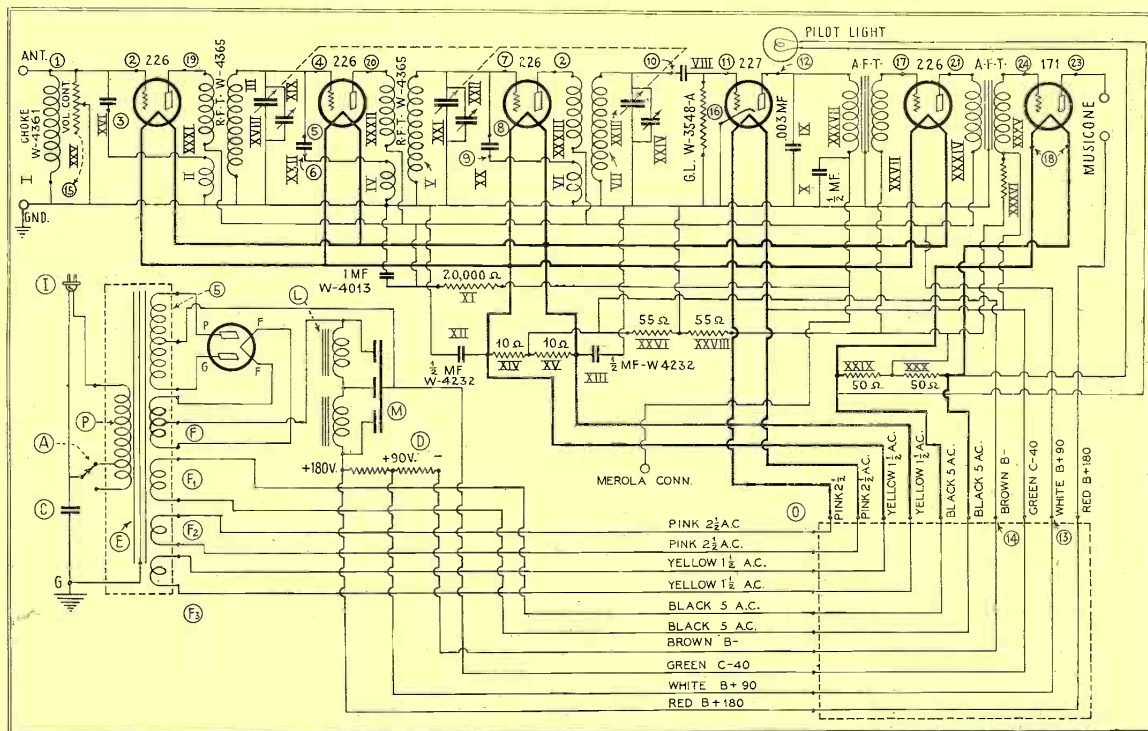

Values and Numbers Not Specified in Diagram.
 Grid Leak—2 megohms.
 VI-VII—R.F. Transformer, W4365.
 X—By-Pass Condenser, W4233.
 XI—Detector Plate Resistor, W4376.
 XIV-XV—Center-Tap Resistor, W4240.

XVI-XVII-XX—Balancing Condensers, W4258.
 XIX-XXII—Acutinators, (Compensating Condensers), W4272.
 XXIII-XXI-XXIII—Tuning Condensers.
 XXIV—Balancing Condenser, W4254.
 XXV—Volume Control, 300 ohms, W4247.

XXVII-XXXIV—A.F. Transformers, W4060B (A .0008-mf. by-pass condenser W4512 is shunted across the secondary XXXV).
 XXXVI—"C" Biasing Resistor, 540 ohms, W4391.

Circuits For Testing: (See numbers in circles).

- Remove Tubes and Pilot Light
 To Ground (connect one contact of lamp tester to ground terminal on set).
 The following contacts should light the lamp:
 (1) Through antenna choke and leads.
 (2) From "G" contact first socket.
 (3) From balance condenser terminal through coil II.
 (4) From "G" contact second socket through secondary III.
 (5) From Balance condenser terminal A through III.
 (6) From condenser terminal B through balance coil IV.
 (7) From "G" contact third tube through secondary V.
 (8) From condenser terminal A through V.
 (9) From condenser terminal B through balance coil VI.
 (10) From grid condenser terminal through secondary VII.
 These contacts should *not* light the lamp:
 (11) "G" contact detector socket, because of grid condenser VIII.
 (12) "P" contact detector socket, because of condensers IX and X. If X is shorted, lamp should light through resistor XI and white cord plug terminal (13).
 (14) "B—" (brown cord plug terminal) unless condenser XII or XIII is shorted. Short XII and lamp should light through resistor XIV; short XIII and lamp should light through XV.
 Phone Tests to Ground Terminal
 (2) Click on shorting condenser XVI—no short in XVI.
 (4) Click on shorting condenser XVII—no short in XVII. Turn tuning dial; clicks indicate short in XVIII. Turn acuminator XIX; clicks indicate short.
 (7) Same directions with reference to condensers XX, tuning condenser XXI and acuminator XXII.
 (10) Turn tuning dial; clicks indicate short in XXIII. Adjust aligning condenser XXIV; clicks while doing this indicate short.
 Antenna Circuit (Lamp Test)
 (15) Contacts to antenna terminal and 15 (free end of volume control resistor XXV) should light lamp.

- "B—" (Brown Cord) Phone Test
 (16) Emitter contact detector socket. Click should be heard through resistor XXVI.
 (17) "G" contact 1st A.F. socket. Click should be heard through secondary XXVII and resistor XXVIII.
 (18) Click should be heard at either "F" socket terminal of the power tube through resistors XXIX and XXX.
 "B+90" (White Cord) Phone Test
 Connect one contact to white cord plug terminal.
 (19) "P" contact first socket; lamp should light through primary XXXI.
 (20) "P" contact second socket; lamp should light through primary XXXII.
 (2) "P" contact third socket; lamp should light through primary XXXIII.
 (12) "P" contact 1st A.F. socket, use phones. Click should be heard through primary XXXIV.
 "B+180" (Red Cord)
 (23) Short Musicone terminals: lamp should light through circuit between plate contact of power tube socket and red cord plug terminal.
 "C-40" (Green Cord) Phone Test
 (24) "G" contact power tube socket; click should be heard through secondary XXXV.
 (18) "F" contacts power tube socket: click should be heard through resistor XXXVI and resistors XXIX-XXX.
 Merola Terminal (Phone Test)
 (12) A click should be heard through primary XXXVII between the plate contact of the detector socket and the Merola terminal.
 A. C. Leads (Phone Test)
 Connect the phones to the yellow cord plug terminals (1½ volts). Shorting the filament contacts of the three R.F. or the 1st A.F. sockets should result in a click in each case.
 The detector circuit may be tested by applying the tester contacts to the pink cord terminals (2½ volts) and shorting the detector "F" contacts. The power tube 5-volt circuit in like manner through the black cord plug terminals and the "F" contacts of the last socket.
 The by-pass condensers may be tested, without the use of phone or lamp, with a 90-volt "B"

- battery. Charge the condenser across its terminals, remove the battery leads, and short the condenser with an insulated screwdriver. A spark indicates that the condenser is good; otherwise it is shorted or grounded. Each half of XII-XIII may be tested separately.
 POWER CONVERTER
 Test the voltage supplied to the set, at the tube sockets; the R. F. and 1st A.F. tubes should receive 1½ volts "A," 90 "B;" the detector 2½ volts "A," 45 volts "B;" the power tube 5 volts "A," 180 volts "B." If the voltages are found too low, see that connections are made to the "Low Line" terminals by switch or fuse, inside the Converter; check cable leads for open circuits; try new rectifier tube in Converter; finally, test circuits in Converter. Never touch the wiring in the Converter with your hands when the power is on.
 If the set has stood idle for some time, it may be necessary to recondition the Mershon electrolytic condenser in the Converter, by allowing it to operate for some time to "form" a film on the plates. Should the electrolyte freeze or be lost by spilling, a new condenser must be obtained. A milliammeter connected across the Musicone terminals should register about 20 milliamperes plate current from the power tube when the condenser is conditioned.
 Hum may be due to bad connections to the Mershon condenser; grounding to the mounting of the condenser case; grounding to the frame of the rectifier-tube filament winding; grounding to the frame of the primary circuit; or poor contact to the set at the plug (O).
 Low voltage may be due to a worn-out tube; grounding to frame of filter circuit; open circuit; shorted turns on the secondary, which is evidenced by excessive heat and smoking insulation; defective rectifier filament circuit (with 280 tubes). In the Models 104R and 105R, there are buffer condensers (tested at triple working load) across the "B" supply secondary (5) and a breakdown would short the winding. A defective filamentless rectifier tube may also cause hum.

The information contained in this service sheet is furnished by the manufacturer, the Crosley Radio Corporation, Cincinnati, Ohio.

The Latest Radio Merchandise Offered by Manufacturers

And the Merchandising Helps That Go Along

New Alternating-Current Electric Receivers:



ARGUS ELECTRIC, type B 195 table receiver, manufactured by Argus Radio Corp., New York. 11" high, 36" wide, 15" deep. Cabinet is of burled walnut. List \$195, less tubes and speaker.

Merchandising Helps: Descriptive booklets with dealer imprint; folders; cut-outs; service manual and service sheets; cuts, mats, and electros for newspapers.

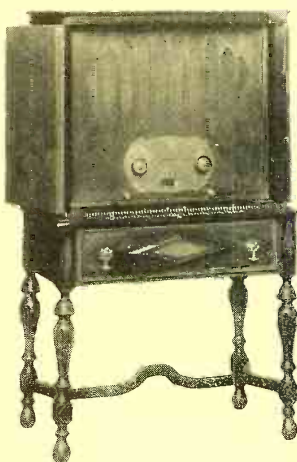

FARRAND ELECTRIC RECEIVER, manufactured by the Farrand Mfg. Co., L. I. City, N. Y. Set illustrated is the console model, built-in speaker, tubes included. 48" high, 26" wide, 15 1/4" deep. List \$350.00.

Merchandising Helps: Folders, for mailing purposes and counter use; window streamers; window and counter display cards; mats and electros for newspapers; special window display service.

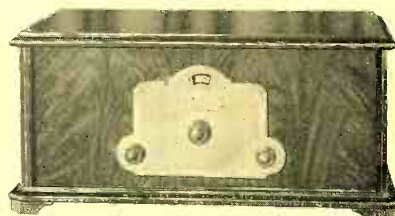

FREED EISEMANN ELECTRIC, Model NR-60, manufactured by Freed Eisemann Radio Corp., Brooklyn, N. Y. 11" high, 23 3/4" wide, 15" deep, 7 tubes, single control, individual compartment shielding. List \$160, less A.C. tubes.

Merchandising Helps: Booklets; window displays; cuts and mats; hanging sign; movie slides; literature; authorized dealer banner; direct-mail campaign.



ZENITH ALL-ELECTRIC, Model 15 EP (with built-in power speaker), 8 tubes, loop operated; list \$350 less tubes. 43" high, 33 1/2" wide, 15 3/4" deep.

Merchandising Helps: Folders; broadsides; special dealer letter; electric signs; window streamers; cut-outs, for counter and window; mats and electros for newspapers.



KELLOGG ALL-ELECTRIC A. C., Model 510, manufactured by Kellogg Switchboard & Supply Co., Chicago, Ill. Open-view, console cabinet, seven tube A.C. set finished in walnut, with built-in speaker. 44" high, 35" wide, 22" deep. List \$495, complete with tubes.

Merchandising Helps: Circulars; booklets; literature with room for dealer imprint; window cards and cut-outs; mats and electros for newspapers.



BOSCH A.C. TUBE RECEIVER, model 116, manufactured by American Bosch Magneto Corp., Springfield, Mass. Size 12 1/2" high, 25 1/2" wide, 17" deep. All tuning is centered on a single station-selector knob; the tuning scale is graduated in kilocycles and illuminated by the Bosch Line O'Lite. List \$160, less A.C. tubes.

Merchandising Helps: 17 lithograph window displays; folders; booklets for counter and mail use; bulletins; newspaper mat sheets; cuts, mats and electros for newspapers; book matches; electric illuminating sign; chassis or internal mechanism of the set for window display; special sales-demonstration case for service men who solicit business during their rounds of service.

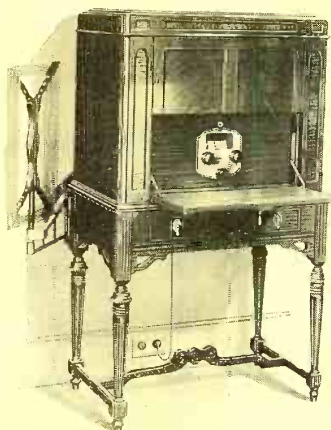

FADA A. C. SEVEN, Console Model, manufactured by F. A. D. Andrea, Inc., Long Island City, New York. 50" high, 26" wide, 17" deep. Also available for 25-cycle operation. List \$350, less tubes.

Merchandising Helps: Circulars; catalogs; slides; enameled outdoor signs; posters; window streamers; lithographed displays; co-operative newspaper advertising; window transfers; framed franchise certificates; metal easels; direct-mail campaigns; sales portfolios; window display contests; rugs, letterheads.



GREBE SYNCHROPHASE SEVEN, manufactured by A. H. Grebe & Co., Inc., New York. Size 10" high, 23" wide, 13 1/2" deep. One dial, 7 tubes, 4 stage radio, detector and 2 audio. Battery or socket-power operated. List \$135.00.

Merchandising Helps: Booklet; display card; service manual; moving-picture slides; mats and electros for newspapers.

THIS page is one of news, not of advertising. Dealers are invited to write for information about any apparatus on the market; and manufacturers to send their latest announcements, with technical and merchandising data, to the DEALERS PERSONAL EDITION.

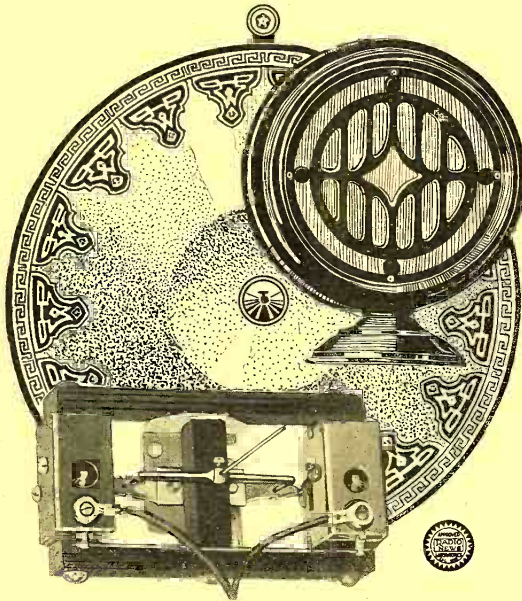

MOZART-RADIOCEIVE SPEAKERS and SPEAKER UNITS

For Season 1928-9

Fans who know that the Loud Speaker Unit is the very heart of any Radio, are demanding better and better performance, hence the reason for the Radioceive Twin Balanced Armature, far outselling all others in this market.

Here indeed is true Push-Pull Tone Reproduction at a fraction of the cost it can be obtained in any other way, and with the very minimum of current consumption, and voltages ranging all the way from 90 to 400.

And for those who want a good cone unit at a lower figure we offer our single balanced armature, which will outperform most others selling at twice its price, or in a complete speaker, our Mozart 26-in. Wall-Cone (not a kit) and Drum Type with these units.

But here is the latest craze and one that is likely to remain. Attach our Twin Unit with "Piano" adapter to the sounding board of any piano, or the underside of a table, chair or in fact almost anything that will produce sound and you have a wonderful invisible speaker.

Single Unit, 5 ft. cord (1150 ohms).....	\$4.00
Twin Unit, 10 ft. cord (2000 ohms).....	6.00
Twin Unit, 20 ft. cord, "Piano" Type.....	8.00
26-in. Wall Cone Speaker, Single Unit.....	8.00
26-in. Wall Cone Speaker, Twin Unit.....	10.00
Drum Type Speaker, Twin Unit.....	15.00

Every item guaranteed on a simple money back basis to outperform all others in their class.

Sample orders to large buyers—50% disc.

THE FERGUS CO.

239 ELIZABETH AVENUE, NEWARK, N. J.

— what would you do without *advertising*?

—you couldn't do business at all unless you had something to sell. Advertising benefits **both** sides. The manufacturers want to sell you their products, of course. You want to buy from the best manufacturers. How else could you, in turn, sell profit-making sets, parts, or accessories to **your** customers? RADIO NEWS realizes that YOU have the right to say what products you would like to see advertised in the pages of the Radio News DEALERS PERSONAL EDITION, **your own** trade magazine. Therefore, we ask you to send us your ideas on the kind and quantity of advertising that you would like to see in these pages. Send your list or article to Merchandising Department, RADIO NEWS, 230 Fifth Avenue, New York City.

Safeguarding Radio Credits

By Archie Oboler*

HAVE you ever had a customer, new in the locality, without any credit references, but with a good job and steady wages? And did you reluctantly refuse his installment business rather than take any chances? If so, then you have not been making use of one of the finest collection safeguards the radio dealer has—the "wage assignment."

This assignment enables the dealer to attach the buyer's salary, without any great legal difficulty, at any time during the life of the contract, in the event of any default of payments. Consequently, the old bugaboo of worthless repossessed merchandise is done away with; the customer must meet his payments or lose his weekly salary.

Condensed, by the use of small type, into the form which follows, this legal form can be permanently attached to the dealer's usual contract blanks by having the edges of the assignment paper gummed:

For and in consideration of the sum of One Dollar (\$1.00) and other good and valuable considerations to me in hand paid by (Dealer's Name), the receipt whereof is hereby acknowledged, I do hereby sell, transfer, assign and set over to the said (Dealer's Name), their successors or assigns, all wages earned and to be earned by me hereafter, and any and all claims for wages earned and to be earned by me hereafter, and all claims or demands due or to become due me from.....

..... heirs, executors, administrators, successors or assigns, or any other firm, person, company, partnership, corporation by whom I may hereafter be employed, or who may be indebted to me for any consideration whatsoever up to and including the last day of.....

And I hereby authorize and direct the said party or parties named or referred to above, or any of them, to pay the said wages, demands and claims, and all thereof, to the said (Dealer's Name), their successors or assigns, or to the agents of said (Dealer's Name), and I do hereby nominate, constitute and appoint the said (Dealer's Name), their successors or assigns, or their agents, or any or either of them, my attorney or attorneys in my name, to take all steps, including such legal steps as may be proper or necessary, for the complete recovery and enjoyment of the wages or claims or demands, or all of them, hereby assigned, and I hereby authorize and empower said (Dealer's Name), their successors or assigns, or their agents, or any or either of them, to receive any money or other article or thing of value which may become due hereon, and to receipt for the same in my name, and I hereby further authorize and empower them, or any or either of them, to fill in any blanks herein by inserting any name or names or date or dates which they, or any or either of them, deem proper or necessary, hereby ratifying any and all acts my said attorney or attorneys, or any or either of them, hereby constituted may take herein.

Witness my hand and seal, this..... day of..... 192.....

[SEAL]

Of course, by reason of its rather harsh and uncompromising terms, this added protection cannot be used, unless great tact is shown, with all customers. But in cases parallel with the one first mentioned, where the purchaser's only real assets are his steady wages at a permanent position, it enables the radio merchant to accept business which he would ordinarily have to waive.

(The dealer will do well, of course, to consult the laws of his state governing wage assignments before having his form drawn up. We are informed that the specimen given is quite valid in Illinois for a period up to four years.—MANAGING EDITOR).

*B. F. Carr & Son, Chicago, Ill.

FREE!

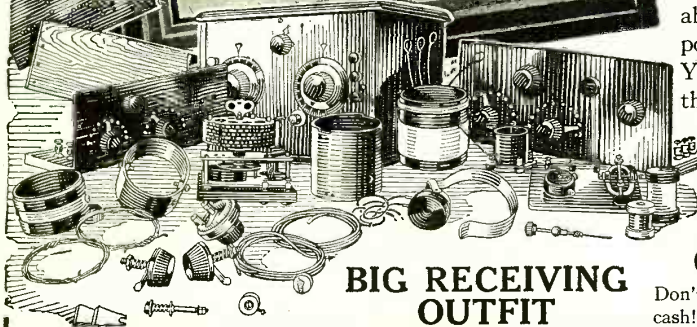

BIG RECEIVING OUTFIT INCLUDED IN COURSE



J. E. SMITH
President

Instruments shown here and others—sent to our students free of extra cost.

CLIP COUPON NOW—find out all about this big unequalled offer while you still have time to take advantage of it. Our training is intensely practical—these instruments help you learn to do the practical work. Receiving sets, from simplest kind to thousand-mile receiver. Many other big features.

My Radio Training Is the Famous "Course That Pays for Itself"

Spare time earnings are easy in Radio when you know it the way we teach you. Increase your income almost from the start of your course thru practical knowledge we give you. We show you how to hold the job, then our Employment Department helps you get one. Free book, "Rich Rewards in Radio," tells how.

Howard B. Luce, of Friedens, Pa., made \$320 in 7 weeks during his spare time. D. H. Suitt, of Newport, Ark., writes, "While taking the course I earned in spare time work approximately \$900." Earl Wright, of Omaha, reports making \$400 in a short time while taking his course—working at Radio in his spare time only. Sylvester Senso, 207 Elm Street, Kaukauna, Wis., made \$500.

And when your training is completed, you're ready to step into a real big Radio job like C. C. Gielow, Chief Operator of the Great Lakes Radio Telegraph Company; E. W. Novy, Chief Operator of Station WRNY; Edward Stanko, Chief Operator of Station WGR; and hundreds of other N. R. I. Trained men. The National Radio Institute, originators of Radio Home-Study Training, established 1914, today offers you the same opportunities these men had, under a contract that promises you full satisfaction or money refunded on completing our training. It's your big chance to get into Radio—mail coupon for FREE book and proof.

"MEN! Here's the 'dope' you've been looking for

HOW TO GET INTO THE RADIO BUSINESS"

J.E.S.

EARN BIG MONEY in Work That is Almost Romance

If you're earning a penny less than \$50 a week, clip coupon now for FREE BOOK! New Book, 64 pages, profusely illustrated, tells all about the Radio profession, thousands of opportunities—in work that is almost romance! YOU can learn quickly and easily at home, through our tested, improved methods, to take advantage of these great opportunities! Why go along at \$25 or \$35 or \$45 a week, when you can pleasantly and in a comparatively short time learn to be a Radio Expert, capable of holding the big pay jobs?

Clip Coupon for Free Book

Don't envy the other fellow who's pulling down the big cash! Our proven home-study training methods make it possible for you, too, to get ready for a better job, to earn enough money so you can enjoy the good things of life. One of the most valuable books ever written on Radio tells how—interesting facts about this great field, and how we can prepare you, quickly and easily in your spare time at home, to step into a big-pay Radio job. You can do what others have done through our training. GET THIS NEW FREE BOOK. SEND COUPON TODAY.

J. E. SMITH, President
NATIONAL RADIO INSTITUTE
Dept. 3S WASHINGTON, D. C.

Coupon Brings Free Book Mail It NOW!



National Radio Institute
Dept. 3S
Washington, D. C.

Dear Mr. Smith:

Without obligating me in any way, send me your FREE BOOK, "Rich Rewards in Radio," and all information about your practical, home-study Radio Course.

Name.....

Address.....

Town.....State.....

Occupation.....

SEND THIS COUPON TODAY

RADIO NEWS

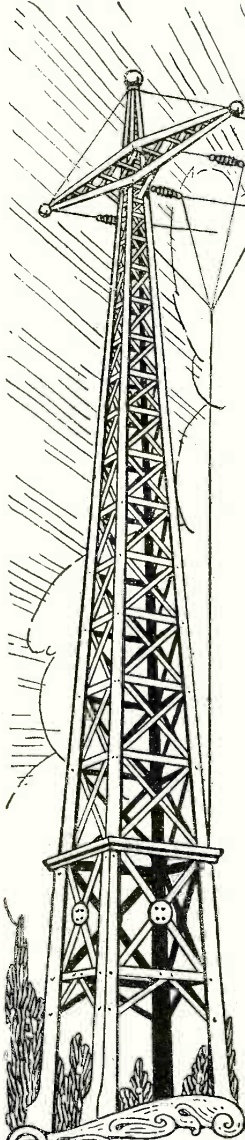

Published by EXPERIMENTER PUBLISHING COMPANY, Inc., Publishers of "Radio News," "Science and Invention," "Radio Listeners' Guide," "Amazing Stories" and "French Humor."

H. GERNSBACK, President S. GERNSBACK, Treasurer C. D. ROSENFELT, Secretary
 Member: Audit Bureau of Circulations Radio Magazine Publishers Association
 Editorial and General Offices . . . 230 Fifth Avenue, New York City

VOLUME 9

MARCH, 1928

NUMBER 9

Contents of This Issue:

Custom-Set Building, By Hugo Gernsback	985	A.C. to D.C. and How	1016
Encircling the World with a Two-Tube Set, By Armstrong Perry	986	An Unusual Nine-Tube Peridyne	1018
How to Kill Vagrant Radio Noises	988	Full-Band Tuning in Radio Receivers, By G. C. B. Rowe	1019
What Constitutes Tone Quality? By Robert Neil Auble	990	The Silver Screen-Grid Superheterodyne, By Ernest R. Pfaff	1020
The Listener Speaks	992	The All-Electric Everyman Four, By Fred C. Ehlert	1025
Radio—The Alarm Clock of a Nation, By Julia Shawell	996	The Knowles Screen-Grid Four, By Hugh S. Knowles	1028
Radio Novelties About the Globe	998	The Pacent Distant-Signal Amplifier, By Gerard J. Kelley	1031
People and Radio as Seen by the Camera	999	Letters from Home Radio Set Constructors	1034
Roasted by Radio, By C. Sterling Gleason	1000	RADIO NEWS LABORATORIES	1036
This is 2LO, London, England, Calling, By Dale Pollack	1002	Radiotics	1038
Wisdom for Radio Widows, By Larry Triggs	1003	I Want to Know, By C. W. Palmer	1039
The United States, A Broadcast Studio, By Joseph Riley	1004	Radio Wrinkles, Close of Prize Contest	1062
Bridge by Radio, By G. C. B. Rowe	1005	Australian Broadcast Stations	1072
Caring for the Socket-Power Units, By Charles Magee Adams	1006	The "Screen-Grid" Tube	1074
Broadcastistics	1008	The Girl on the Cover, Caroline Andrews	1075
List of Broadcast Stations	1009	A Novel System of R.F. Stabilization	1076
What's New in Radio	1010	World-Broadcasting—A British Proposal	1078
A Loud Speaker with Linen Diaphragms	1913	Radio "Bugs"	1079
The Radio Beginner—"Standing By" for "Contact," By L. B. Robbins	1014	Why Vacuum Tubes Become Paralyzed	1081
Repairing Simple Ailments of Radio Receivers, By Clyde A. Randon	1015	Book Review	1083

In Forthcoming Issues:

RADIO TELEVISION IN THE HOME

By G. C. B. Rowe

A complete description of the apparatus used by E. F. W. Alexanderson in his recent demonstration at Schenectady, N. Y.

RADIO RECEPTION AND LISTENER PSYCHOLOGY

By Charles Magee Adams

An interesting discussion on how the listener's frame of mind determines his enjoyment of radio programs.

A SHORT-WAVE RECEIVER WITH R.F. AMPLIFICATION

By W. Francis Goodreau

A flexible receiver that will cover all the short-wave channels, and the broadcast ones as well. Plug-in coils are used.

RADIO NEWS is published on the 10th of each preceding month. There are 12 numbers per year. Subscription price is \$2.50 a year in U. S. and possessions. Canada and foreign countries, \$3.00 per year. U. S. Cash as well as U. S. Stamps accepted (no foreign coins or stamps). Single copies, 25 cents each. Checks and money orders should be drawn to order of EXPERIMENTER PUBLISHING CO., INC.

All communications and contributions to this journal should be addressed to Editor, RADIO NEWS, 230 Fifth Ave., New York, N. Y. Unaccepted contributions cannot be returned unless full postage has been included. All accepted contributions are paid for on publication. A special rate is paid for novel experiments; good photographs accompanying them are highly desirable.

RADIO NEWS. Monthly. Entered as second-class matter, July 12, 1924, at the Post Office at New York, N. Y., under the Act of March 3, 1879. Additional entry at San Francisco, Calif. Title registered U. S. Patent Office, Copyright, 1928, by The Experimenter Publishing Co., Inc., 230 Fifth Ave., New York. The contents of this magazine are copyrighted and must not be reproduced in the United States without giving full credit to the publication. Translation into foreign languages must not be made unless permission is obtained from the publishers. Copyrighted in Germany. Reproduction of articles in Germany is reserved for Radio, Berlin 42.

RADIO NEWS is for sale at all newsstands in the United States and Canada, and at Brentano's, Ave. de L'Opera, Paris, France. European agents: S. J. Wise, Et. Cie, 40 Place Verte, Antwerp, Belgium.

HOW TO SUBSCRIBE FOR RADIO NEWS. Send your name, address and remittance to Experimenter Publishing Co., 230 Fifth Ave., New York. Mention the name of the magazine you are ordering. We also publish SCIENCE AND INVENTION, RADIO LISTENERS' GUIDE, AMAZING STORIES and FRENCH HUMOR. Write clearly.

RATES AND TERMS. The subscription rate for RADIO NEWS is \$2.50 per year. (12 numbers). When remitting do so by check, money order, or registered letter if cash is enclosed. Avoid sending cash through the mail if possible. Subscriptions for less than one year are not accepted. Subscription may be made in combination with SCIENCE & INVENTION, RADIO LISTENERS' GUIDE, AMAZING STORIES and FRENCH HUMOR.

POSTAGE. We prepay postage in all parts of the United States, Mexico and island possessions. For foreign or Canadian subscriptions we require 50 cents in addition to the subscription price for additional postage charge.

CHANGE OF ADDRESS. Notify us as far in advance as possible. It requires several weeks to make an address change on our records. Always write clearly.

The contents of RADIO NEWS are indexed in the Industrial Arts Index, copies of which can be found in every library.
 General Advertising Dept., 230 Fifth Avenue, New York City

ADVERTISING REPRESENTATIVES

L. F. McCLURE, 720 Cass Street, Chicago, Ill.
 DAVIES, DILLON & KELLY, 15 West 10th St., Kansas City, Mo.
 T. F. MAGRANE, Park Square Bldg., Boston, Mass.

HARRY F. HYDE, 548 Drexel Building, Philadelphia, Pa.
 A. J. NORRIS HILL CO., 5 Third St., San Francisco, Calif.
 412 West 6th St., Los Angeles, Calif.
 Leary Building, Seattle, Wash.

The radio leadership of 1928

NOW
\$90

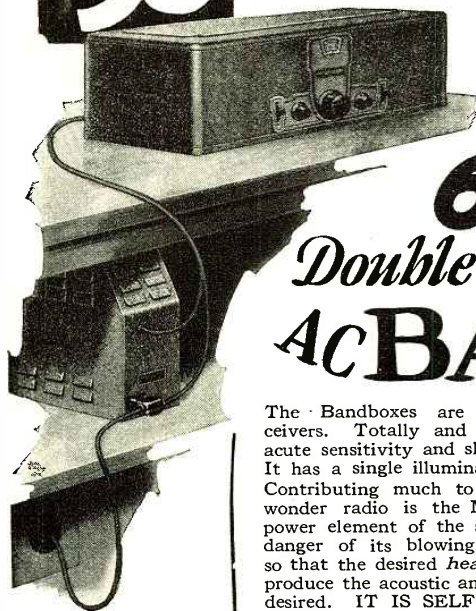

NEW

401 Dry Cell Type

BANDBOX JUNIOR

\$35

A new dry cell receiver with all the features of the Bandbox—selectivity, sensitivity, volume, and appearance. For places where AC current or storage battery service is not available or desired. Costs about 2½¢ per hour to operate.

180 volts on the output tube plate!
Gigantic *UNDISTORTED* volume from the Bandbox!

Power! Power! POWER! A feature of the Crosley AC Bandbox that lifts it head and shoulders above competition!

170 to 185 volts on the plate of the power output tube!

Comparative checkings of competitive radios show interesting figures. Under identical testing conditions the Bandbox shows a full 170 to 185 volts on the plate of the 171 power output tube. Other radios show from 100 to 110 and 130 to 140 volts on the plate of the output tube. The 171 power tube should have around 180 volts. This better than 40% superiority in one case and 25% in the other is the difference between today's radio and yesterday's.



MUSICONE
Type-D
\$15

Crosley Musicones are famous for their value. This new style is no exception. Its low price of \$15 is in keeping with Crosley traditions. It instantly demonstrated its soundness by immediate and enormous sales.

602 Double Unit AC BANDBOX Single Unit 704

The Bandboxes are genuine Neutrodyne receivers. Totally and completely shielded, their acute sensitivity and sharp selectivity is amazing. It has a single illuminated dial.

Contributing much to the success of this 1928 wonder radio is the Mershon Condenser in the power element of the set. Not being paper, the danger of its blowing out is entirely removed, so that the desired *heavy voltage* can be used to produce the acoustic and volume results so greatly desired. **IT IS SELF HEALING.** It does not have to be replaced as is the case with paper condensers.

The capacity of smoothing condensers in Crosley power units is 30 mf. Other sets use only a fraction of that condenser capacity. Undersize condensers, transformers, etc., are used in order to build down to a price. Crosley builds up to a standard.

The AC Bandbox is purposely made in two models—the 602 in a double unit—the 704 self-contained. This is to provide maximum adaptability in all sorts of surroundings and uses.

The 602 double unit provides console cabinet installation in ALL kinds of consoles.

The 704 is for those who want the entire set in one cabinet. The two sets are identical in elements, design, and performance. The physical difference is solely to meet the human differences of taste, necessity, and price! The size of the 704 is 17½ inches long by 12¾ inches wide, and is 6½ inches high.

Battery Type Bandbox \$55

This celebrated model needs no picture, for in appearance it is identical to the 602 receiver pictured above. Its amazing performance has won the radio world this season, and its value is as outstanding NOW as the day it was first presented!

SELF CONTAINED
\$95



Approved Console Cabinets manufactured by Showers Bros. Co., of Bloomington, Ind., and Wolf Mfg. Industries, Kokomo, Ind., are sold to Crosley dealers by H. T. Roberts Co., 1340 S. Michigan Ave., Chicago, Sales Representatives.



Crosley is licensed only for Radio Amateur, Experimental and Broadcast Reception

THE CROSLY RADIO CORPORATION

*Powel Crosley, Jr. Cincinnati, Ohio
Montana, Wyoming, Colorado, New Mexico, and West, prices slightly higher
Write Dept. 22 for descriptive literature*

"You're there with a Crosley"

CROSLY RADIO

INDEX TO ADVERTISERS

	Page		Page		Page
A					
Alox Company, The.....	Back Cover				
Acme Wire Co., The.....	1047				
Aero Products, Inc.....	1046				
Aerovox Wireless Corp.....	1076				
Air-Chrome Studios, The.....	980				
Alden Mfg. Co.....	1057				
All Radio Co.....	1062				
Allen-Bradley Co.....	1077				
Allen-Rogers-Madison, Inc.....	1081				
American Bosch Magneto Corp.....	1080				
American Hard Rubber Co.....	1046				
American Mechanical Labs.....	1078				
Amrad Corp., The.....	1069				
B					
Barawik Co., The.....	1060, 1074, 1080				
Benjamin Elec. Mfg. Co.....	1084				
Bogue, B. N.....	1062				
Boudette Mfg. Co.....	1057				
Brady, John B.....	1053				
Bryant & Lowry.....	1087				
Burt, Dr. Robt. C.....	1057				
C					
C. E. Mfg. Co., Inc.....	1085				
Cable Supply Co., Inc.....	1079				
Cameron Mfg. Co.....	1085				
Carborundum Co., The.....	1045				
Carter Radio Co.....	1049				
Central Radio Labs.....	1058				
Chemical Institute of N. Y., Inc.....	1043				
Chicago Radio Apparatus Co.....	1051				
Chicago Stock Gear Works.....	1047				
Clark & Tilson, Inc.....	1057				
Cloverleaf Mfg. Co.....	1080				
Comer Radio Cabinet Co.....	1068				
Conrad Co., Inc.....	1042, 1045, 1056, 1080, 1071				
Consumers Radio Co.....	1054				
Copper & Brass Research Ass'n.....	1047				
Coyne Electrical School.....	1084				
Craftsman Radio Products.....	1074				
Crosley Radio Corp.....	979				
Cunningham, Inc., E. T.....	1063				
Curtain Mfg. Co.....	1063				
D					
Deutschmann Co., Tobe.....	1063				
Dobe, Fred.....	1071				
E					
Electrad, Inc.....	1062				
Electric Specialty Co.....	1065				
Electro-Chemical Co. of America.....	1084				
Engineers' Service Co.....	984				
Erle Fixture Supply Co.....	1047				
F					
Fanspeaker Radio Co.....	1054				
Fansteel Products Co., Inc.....	1074				
Ferbend Electric Co.....	1074				
Formica Insulation Co., The.....	1061				
Frost, Inc., Herbert H.....	1082				
G					
General Electric Co.....	1051				
General Radio Co.....	1067				
Gralyna Hotel.....	1065				
H					
Hamilton-Carr Radio Corp.....	1076				
Hammarlund Mfg. Co.....	1061				
Hammarlund-Roberts, Inc.....	1080				
Hammer Radio Co., S.....	1084				
Harco Co., The.....	1087				
I					
Independent Electric Works.....	1051				
International Accountants Society.....	1080				
J					
J-M-P Mfg. Co.....	1060				
Jewell Electrical Inst. Co.....	1061				
K					
Karas Electric Co.....	1087				
Kelsey Co., The.....	1082				
Knapp Electric Corp.....	1073				
L					
Lacault Radio Electric Labs., R. E.....	1053				
Lacey & Lacey.....	1060				
Langbein-Kaufman Radio Co., The.....	1070				
Mc					
McSweeney Electrical Schools.....	1057				
M					
M. & H. Sporting Goods Co.....	1084				
Magnavox Co., The.....	1075				
Midwest Radio Corp.....	1059				
Muter Co., Leslie F.....	1055				
N					
National Company, Inc.....	1070				
National Radio Institute.....	977				
Norden-Hauk, Inc.....	1049				
O					
Omnigraph Mfg. Co., The.....	1067				
Outdoor Enterprise Co.....	1082				
P					
Pacent Electric Co., Inc.....	1078				
Parker, C. L.....	1061				
Potter Products Corp.....	1065, 1072, 1078, 1082, 1085				
Press Guild, Inc., The.....	1083				
R					
Radiall Company.....	1050				
Radio Association of America.....	981				
Radio Equipment Co.....	1066				
Radio Institute of America.....	983				
Radio Kit Co.....	1082				
Radio Specialty Co.....	1041				
Rowan Battery Supply Co., Walter.....	1068				
S					
School of Engineering of Milwaukee.....	1050				
See Jay Battery Co.....	1062				
Shure Radio Co.....	1047, 1058				
Silver-Marshall, Inc.....	1066				
Smith, B. Hawley.....	1070				
Solderite, Inc.....	1066				
Sovereign Elec. & Mfg. Co.....	1076				
Spiegel Radio Co.....	1074				
Starrett Mfg. Co.....	1066				
Straus & Schram.....	1063				
T					
Telephone Maintenance Co.....	1059				
Teleplex Co.....	1070				
Thayer, Jim.....	1058				
Tower Mfg. Corp.....	1057				
Townsend Labs.....	1053				
Tyrman Electric Corp.....	1063				
W					
Walker Co., The Geo. W.....	1054				
Warren Electric Co.....	1057				
Western Radio Mfg. Co.....	1050				
West Side Y.M.C.A. Radio Institute.....	1062				
Whitehall Hotel, The.....	1058				
Wood, Frank W.....	1070				
World Battery Co.....	1060				
X-Y					
X-L Radio Labs.....	1050				
Yaxley Mfg. Co.....	1066				

The First of Its Kind in Design - - - Performance - - - Cost



The Speaker complete in cabinet with velvet tapestry (using 24" x 24" diaphragm)..... \$65.00

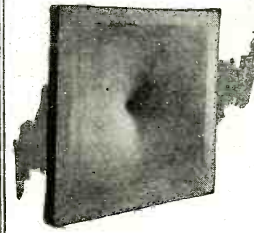
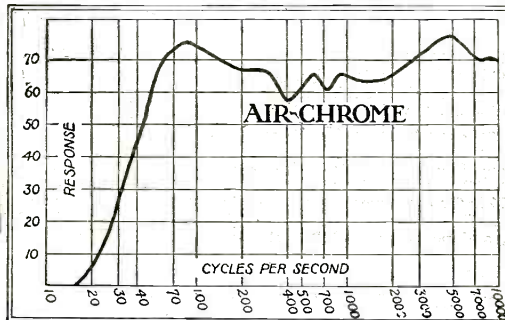

The Speaker without cabinet 18" x 23" diaphragm..... \$20.00
24" x 24" diaphragm..... 25.00

ANNOUNCING the new AIR-CHROME Speaker operating on an entirely new BALANCED TENSION principle . . . We are so proud of its performance—that we are willing to PUBLISH its operating characteristic. Here is the performance curve—FOR ALL THE WORLD TO SEE.

Here is an opportunity to obtain a speaker which will respond with practically equal facility from the

bass viol range to the highest notes of the piccolo. . . ALL musical instruments in use today ARE WITHIN ITS RANGE. . . This speaker is now for sale—with or without the housing cabinet.

The AIR-CHROME speaker represents a new field of engineering—the greatest frequency range for commercial speakers—and power without "blasting" or "rattling."

Order from us or your dealer. If your dealer cannot supply, send us his name.

The Air-Chrome SPEAKER

THE AIR-CHROME STUDIOS
168 Coit Street Irvington, N. J.



EARN \$75⁰⁰ a week — in Your Spare Time

JOINING the Radio Association enables you to cash in on Radio *now!* Follow its success-proven plans and you can earn \$3 an hour, in your spare time, from the very first. Over \$600,000,000 is being spent yearly for sets, supplies, service. You can get your share of this business and, at the same time, fit yourself for the big-pay opportunities in Radio.

Founded on a New Idea

Members of the Association do not wait for months before they make money out of Radio. Without quitting their jobs, our members are earning \$25 to \$75 a week spare time by building "tailored" radio sets, serving as "radio doctors," selling ready built sets and accessories, or following one of the many profit-making plans of the Association.

Earned \$500 in Spare Hours

Hundreds earn \$3 an hour as "radio doctors." Lyle Follick, Lansing, Mich., has already made \$500 in spare time. Werner Eichler, Rochester, N. Y., is earning \$50 a week for spare time. F. J. Buckley, Sedalia, Mo., is earning as much in spare time as he receives from his employer.

We will start you in business. Our cooperative plan gives the ambitious man his opportunity to establish himself. Many have followed this plan and established radio stores. Membership in the Association has increased the salaries of many. Scores are now connected with big radio organizations. Others have prosperous stores.

A year ago Claude De Grave knew nothing about Radio. Today he is on the staff of a famous radio manufacturer and an associate member of the Institute of Radio Engineers. He attributes his success to joining the Association. His income now is 350% more than when he joined.

Doubled Income in Six Months

"I attribute my success entirely to the Radio Association," writes W. E. Thon, Chicago, who was clerk in a hardware store before joining. We helped him secure the management of a large store at a 220% increased salary.

"In 1922 I was a clerk," writes K. O. Benzing, McGregor, Ia., "when I enrolled. Since then I have built hundreds of sets—from 1-tube Regenerative to Superheterodynes. I am now operating my own store and my income is 200% greater than when I joined the Association. My entire success is due to the splendid help it gave."

Easiest Way Into Radio

If ambitious to become a Radio Engineer, to fit yourself for the \$3,000 to \$10,000 opportunities in Radio, join the Association. It gives you a comprehensive, practical and theoretical training and the benefit of our Employment Service. You earn while you learn. You have the privilege of buying radio supplies at wholesale. You have the Association behind you in carrying out your ambitions.

What a Membership Can Do for You

- 1—Enable you to earn \$3 an hour upwards in your spare time.
- 2—Train you to install, repair and build all kinds of sets.
- 3—Start you in business without capital, or finance an invention.
- 4—Train you for the \$3,000 to \$10,000 big-pay radio positions.
- 5—Help secure a better position at bigger pay for you.
- 6—Give you the backing of the Radio Association.

A MEMBERSHIP NEED NOT COST YOU A SINGLE CENT

ACT NOW—if you wish Special Membership Plan

To a limited number of ambitious men, we will give Special Memberships that may not—need not—cost you a cent. To secure one, write today. We will send you details and also our book, "Your Opportunity in the Radio Industry." It will open your eyes to the money-making possibilities of Radio. Write today.

RADIO ASSOCIATION OF AMERICA,
4513 Ravenswood Ave.,
Chicago, Ill. Dept. RN-3

Gentlemen:
Please send me by return mail full details of your Special Membership Plan and also copy of your book, "Your Opportunity in the Radio Industry."

Name.....

Address.....

City..... State.....

Over 2,000,000 copies to date

Let me send you a copy

If you do not like it - return it!

SEND NO MONEY

Grid Bias

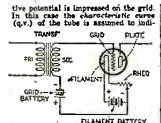

Fig. 1. Method of a grid bias with a transformer.

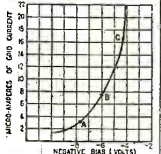

Fig. 2. Characteristic curves of a vacuum tube.

The potential is impressed on the grid in this case the characteristic curve (Fig. 2) of the tube is assumed to indicate the manner of operation.

GRID CONDENSER—A small fixed condenser, generally from .0005 to .0010 microfarads capacity, inserted in the circuit of a detector tube between the tuning coil and the grid member of the tube. The illustration shows the manner of connecting the grid condenser to the grid member of the tube. This condenser insulates the grid from the filament by means of a dielectric material. A resistor is connected in series with the grid to act as a resistor of detector. A resistor (coupled grid lead) is usually placed across this condenser to make for the simple adjustment of drawing a line on a glass electrode with a wet pencil.

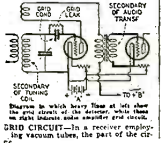

Fig. 3. Method of connecting a grid condenser.

roll containing the grid of the tube or tube, but generally referring to the tuning circuit or that part of the system which contains the tuning elements. In the illustration is shown a standard arrangement of a regenerative detector and one stage of audio-frequency amplification. The heavy lines at the left of the diagram represent the grid circuit of the detector tube, which is connected to the amplifier tube. The grid circuit of a detector tube may be varied in impedance by means of the grid leak and condenser (as marked in the illustration), which controls the incoming signals and permits the tube to function as a rectifier. (See Detector Grid Condenser, also Grid Condenser and Grid Bias.)

GRID CONDENSER—A small fixed condenser, generally from .0005 to .0010 microfarads capacity, inserted in the circuit of a detector tube between the tuning coil and the grid member of the tube. The illustration shows the manner of connecting the grid condenser to the grid member of the tube. This condenser insulates the grid from the filament by means of a dielectric material. A resistor is connected in series with the grid to act as a resistor of detector. A resistor (coupled grid lead) is usually placed across this condenser to make for the simple adjustment of drawing a line on a glass electrode with a wet pencil.

GRID LEAK—A resistor connected in series with the grid to act as a resistor of detector. A resistor (coupled grid lead) is usually placed across this condenser to make for the simple adjustment of drawing a line on a glass electrode with a wet pencil.

GRID CONTROL—The annual term used to describe the method of controlling the grid circuit of a vacuum tube for the purpose of controlling the operation. However, being applicable to any vacuum tube, the term is generally used to describe the operation of a vacuum tube.

GRID CURRENT—The current present in the grid circuit of a vacuum tube. This is generally very small, perhaps of the order of fifteen to twenty microamperes (μv). (See Plate Current, also Grid Bias.)

GRID MODULATION—The process of varying the potential of the grid of a vacuum tube by means of a variable resistor. This is generally very small, perhaps of the order of fifteen to twenty microamperes (μv). (See Plate Current, also Grid Bias.)

GRID CURRENT—The current present in the grid circuit of a vacuum tube. This is generally very small, perhaps of the order of fifteen to twenty microamperes (μv). (See Plate Current, also Grid Bias.)

GRID LEAK—A resistor connected in series with the grid to act as a resistor of detector. A resistor (coupled grid lead) is usually placed across this condenser to make for the simple adjustment of drawing a line on a glass electrode with a wet pencil.

GRID CONTROL—The annual term used to describe the method of controlling the grid circuit of a vacuum tube for the purpose of controlling the operation. However, being applicable to any vacuum tube, the term is generally used to describe the operation of a vacuum tube.

GRID CURRENT—The current present in the grid circuit of a vacuum tube. This is generally very small, perhaps of the order of fifteen to twenty microamperes (μv). (See Plate Current, also Grid Bias.)

GRID MODULATION—The process of varying the potential of the grid of a vacuum tube by means of a variable resistor. This is generally very small, perhaps of the order of fifteen to twenty microamperes (μv). (See Plate Current, also Grid Bias.)

GRID CURRENT—The current present in the grid circuit of a vacuum tube. This is generally very small, perhaps of the order of fifteen to twenty microamperes (μv). (See Plate Current, also Grid Bias.)

GRID MODULATION—The process of varying the potential of the grid of a vacuum tube by means of a variable resistor. This is generally very small, perhaps of the order of fifteen to twenty microamperes (μv). (See Plate Current, also Grid Bias.)

GRID CURRENT—The current present in the grid circuit of a vacuum tube. This is generally very small, perhaps of the order of fifteen to twenty microamperes (μv). (See Plate Current, also Grid Bias.)

GRID LEAK—A resistor connected in series with the grid to act as a resistor of detector. A resistor (coupled grid lead) is usually placed across this condenser to make for the simple adjustment of drawing a line on a glass electrode with a wet pencil.

GRID CONTROL—The annual term used to describe the method of controlling the grid circuit of a vacuum tube for the purpose of controlling the operation. However, being applicable to any vacuum tube, the term is generally used to describe the operation of a vacuum tube.

GRID CURRENT—The current present in the grid circuit of a vacuum tube. This is generally very small, perhaps of the order of fifteen to twenty microamperes (μv). (See Plate Current, also Grid Bias.)

GRID MODULATION—The process of varying the potential of the grid of a vacuum tube by means of a variable resistor. This is generally very small, perhaps of the order of fifteen to twenty microamperes (μv). (See Plate Current, also Grid Bias.)

GRID CURRENT—The current present in the grid circuit of a vacuum tube. This is generally very small, perhaps of the order of fifteen to twenty microamperes (μv). (See Plate Current, also Grid Bias.)

GRID MODULATION—The process of varying the potential of the grid of a vacuum tube by means of a variable resistor. This is generally very small, perhaps of the order of fifteen to twenty microamperes (μv). (See Plate Current, also Grid Bias.)

GRID CURRENT—The current present in the grid circuit of a vacuum tube. This is generally very small, perhaps of the order of fifteen to twenty microamperes (μv). (See Plate Current, also Grid Bias.)

GRID LEAK—A resistor connected in series with the grid to act as a resistor of detector. A resistor (coupled grid lead) is usually placed across this condenser to make for the simple adjustment of drawing a line on a glass electrode with a wet pencil.

GRID CONTROL—The annual term used to describe the method of controlling the grid circuit of a vacuum tube for the purpose of controlling the operation. However, being applicable to any vacuum tube, the term is generally used to describe the operation of a vacuum tube.

GRID CURRENT—The current present in the grid circuit of a vacuum tube. This is generally very small, perhaps of the order of fifteen to twenty microamperes (μv). (See Plate Current, also Grid Bias.)

GRID MODULATION—The process of varying the potential of the grid of a vacuum tube by means of a variable resistor. This is generally very small, perhaps of the order of fifteen to twenty microamperes (μv). (See Plate Current, also Grid Bias.)

GRID CURRENT—The current present in the grid circuit of a vacuum tube. This is generally very small, perhaps of the order of fifteen to twenty microamperes (μv). (See Plate Current, also Grid Bias.)

GRID MODULATION—The process of varying the potential of the grid of a vacuum tube by means of a variable resistor. This is generally very small, perhaps of the order of fifteen to twenty microamperes (μv). (See Plate Current, also Grid Bias.)

GRID CURRENT—The current present in the grid circuit of a vacuum tube. This is generally very small, perhaps of the order of fifteen to twenty microamperes (μv). (See Plate Current, also Grid Bias.)

GRID LEAK—A resistor connected in series with the grid to act as a resistor of detector. A resistor (coupled grid lead) is usually placed across this condenser to make for the simple adjustment of drawing a line on a glass electrode with a wet pencil.

GRID CONTROL—The annual term used to describe the method of controlling the grid circuit of a vacuum tube for the purpose of controlling the operation. However, being applicable to any vacuum tube, the term is generally used to describe the operation of a vacuum tube.

GRID CURRENT—The current present in the grid circuit of a vacuum tube. This is generally very small, perhaps of the order of fifteen to twenty microamperes (μv). (See Plate Current, also Grid Bias.)

GRID MODULATION—The process of varying the potential of the grid of a vacuum tube by means of a variable resistor. This is generally very small, perhaps of the order of fifteen to twenty microamperes (μv). (See Plate Current, also Grid Bias.)

GRID CURRENT—The current present in the grid circuit of a vacuum tube. This is generally very small, perhaps of the order of fifteen to twenty microamperes (μv). (See Plate Current, also Grid Bias.)

GRID MODULATION—The process of varying the potential of the grid of a vacuum tube by means of a variable resistor. This is generally very small, perhaps of the order of fifteen to twenty microamperes (μv). (See Plate Current, also Grid Bias.)

GRID CURRENT—The current present in the grid circuit of a vacuum tube. This is generally very small, perhaps of the order of fifteen to twenty microamperes (μv). (See Plate Current, also Grid Bias.)

GRID LEAK—A resistor connected in series with the grid to act as a resistor of detector. A resistor (coupled grid lead) is usually placed across this condenser to make for the simple adjustment of drawing a line on a glass electrode with a wet pencil.

GRID CONTROL—The annual term used to describe the method of controlling the grid circuit of a vacuum tube for the purpose of controlling the operation. However, being applicable to any vacuum tube, the term is generally used to describe the operation of a vacuum tube.

GRID CURRENT—The current present in the grid circuit of a vacuum tube. This is generally very small, perhaps of the order of fifteen to twenty microamperes (μv). (See Plate Current, also Grid Bias.)

GRID MODULATION—The process of varying the potential of the grid of a vacuum tube by means of a variable resistor. This is generally very small, perhaps of the order of fifteen to twenty microamperes (μv). (See Plate Current, also Grid Bias.)

GRID CURRENT—The current present in the grid circuit of a vacuum tube. This is generally very small, perhaps of the order of fifteen to twenty microamperes (μv). (See Plate Current, also Grid Bias.)

GRID MODULATION—The process of varying the potential of the grid of a vacuum tube by means of a variable resistor. This is generally very small, perhaps of the order of fifteen to twenty microamperes (μv). (See Plate Current, also Grid Bias.)

GRID CURRENT—The current present in the grid circuit of a vacuum tube. This is generally very small, perhaps of the order of fifteen to twenty microamperes (μv). (See Plate Current, also Grid Bias.)

(Fac-simile of a page from the Encyclopedia, greatly reduced)

The First Radio Encyclopedia ever Published

Edited by SIDNEY GERNSBACK, Editor of "Radio Listener's Guide and Call Book (Radio Review)," Author of "Wireless Course in Twenty Lessons"—"One Thousand and One Formulas"—"Practical Electricity Course"—etc.

S. GERNSBACK'S RADIO ENCYCLOPEDIA is the only standard work ever published in America attempting to classify alphabetically the countless words used in the highly specialized science of RADIO. The ENCYCLOPEDIA is written in plain English so that everybody can understand the definitions and descriptions.

classified cross-index designed to bring together radio references under one heading having relations in common. All circuits, new and old, are described by word and picture, and every part and apparatus used in Radio is explained and made understandable by means of photographs and drawings.

No expense has been spared, covering over two years in compilation, to make it worthy a place in your library. It is published in one volume—168 pages—9 x 12 inches—nearly an inch thick, and nicely accommodates the beautiful illustrations and the large, easy-to-read type. Every page is replete with illustrations—to make the text easily understandable.

The work contains 1,930 definitions, 549 photographs, drawings, and diagrams. The volume is printed upon fine paper—bound in full black Keratol, marbled paper fly leaves and end sheets, with the title stamped in gold. This volume should find a place in every library, and will be a veritable boon to you who are interested in Radio, from any angle.

The book contains as a supplement a

REMEMBER

THIS IS A REAL ENCYCLOPEDIA—NOT A DICTIONARY—and very few of the things described and illustrated in this volume can be found in any dictionary, or any other encyclopedia.

S. GERNSBACK - 230 Fifth Ave., New York, N. Y.

JUST MAIL THIS COUPON— ENCLOSE NO MONEY

SIDNEY GERNSBACK, 230-5th Ave., New York.

Send me one copy of Sidney Gernsback's First Radio Encyclopedia in one volume as advertised. I will pay postman \$2.00 plus postage on delivery.

Name.....
Address.....
Town.....

Price \$2.00

ACHIEVE SUCCESS! IN RADIO!



Mr. R. L. Duncan, Director
Radio Institute of America

Dear Mr. Duncan:

You have the heartiest support of the Radio Corporation of America in your work of radio instruction.

(Signed) J. G. HARBORD,
President,
Radio Corporation of America.

*New course gives finest
instruction obtainable*

You can learn at home!

Good pay from the start, rapid advancement, and phenomenal success—a life profession of fascinating brain-work—that is what Radio holds for the man who knows his subject thoroughly. Right now on Mr. Duncan's desk there are letters from big radio companies offering employment to RIA graduates.

Since 1909 Radio Institute of America has trained thousands to become successful in the many branches of Radio. Are you going to plod along at a thirty-five dollar a week job when REAL MONEY is waiting for you in radio?

New course finest ever

Prominent radio men have enthusiastically greeted RIA's new course as the most complete and up-to-date offered today. All this first-quality equipment is furnished FREE WITH THE COURSE—parts for making many practical radio circuits and the Peerless Signagraph for code instruction.

RIA backed by RCA, G-E and Westinghouse

You get all the benefits of instruction conducted by RCA and sponsored by RCA's associates, G-E and Westinghouse. Our employment department is at the service of graduates.

Study at Home

Moreover you can STUDY AT HOME — when you please and as long as you please.

This new informative booklet describing the course is just off the press. If you want to learn more about the well paying positions in this fascinating profession, send the coupon now for your copy. No obligation.

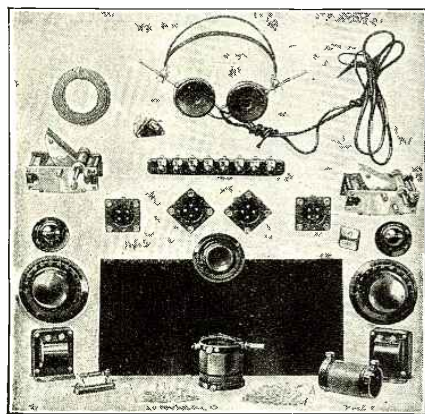

FREE WITH COURSE all this first-quality equipment for experimental work—all the parts to build many practical radio circuits, the Peerless Signagraph for code instruction.



RADIO INSTITUTE OF AMERICA

t. A-3

326 Broadway, New York City

RADIO INSTITUTE OF AMERICA,
326 Broadway, New York City

Dept. A-3

Dear Mr. Duncan:

Please send me your new catalog. I want to know more about your new radio course.

Name.....

Address.....

\$10 "Try this on your piano" **\$10**
only Here it Is! **only**

The Loudspeaker Sensation of 1928
of course

it's an **ENSCO** product

Simply attach the ENSCO piano unit to your piano and the cord to your radio set---it only takes a minute---and you have a marvelous, resonant loudspeaker.

This wonderful device makes use of the perfect sound-reproducing qualities of the piano sound-board. It took years to develop the piano to its present state of perfection, and you can now enjoy perfect radio reproduction by using this sound-board.

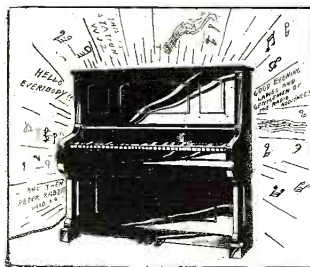

It doesn't show—it does not mar the piano in any way or interfere with its use as a piano. Fits any piano, grand or upright, and works on any radio set.

The reproduction is simply marvelous. The sonorous bass notes, the rolling notes of the middle register, and the thin, sharp tones of the upper treble—all perfect—and the voice sounds *natural*. The famous ENSCO drive mechanism—the rugged direct-drive, distortionless unit developed by Clyde J. Fitch, makes this possible. It is *new*, and the results will surely astound you.

MANY NOVEL APPLICATIONS

Musical furniture is now a reality. Imagine the dinner table, surrounded by guests, bursting forth into glorious song, a chair or bridge table telling a bedtime story, or a door or panel singing a baritone solo! All this is made possible by the ENSCO piano unit. It is made by the makers of the famous ENSCO cone speaker kits under U. S. Patent No. 1630199 and others pending.

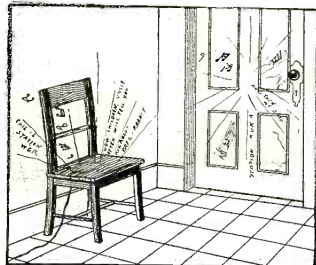

The Best
\$10

You Ever Spent!

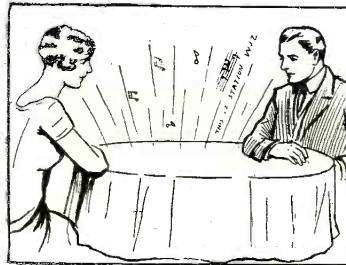

If you do not have a piano, use it on the table or a panel, or door. It works!

Sold under money-back guarantee. You must be satisfied or your money will be refunded. Price only \$10.00. Complete with 20-foot cord. Ask your dealer or send order to our nearest office. Shipped prepaid on receipt of check or money order or C. O. D. with postage added. Price in Canada—\$11.50

25 CHURCH STREET
 NEW YORK

ENGINEERS' SERVICE COMPANY
 28 E. JACKSON BLVD.
 CHICAGO, ILL.

331 BAY STREET
 TORONTO, ONT.





Editorial and General Offices, 230 Fifth Avenue, New York

Vol. 9

MARCH, 1928

No. 9

Custom-Set Building

By Hugo Gernsback

EVER since radio became popular, the vogue of the home-built set has shown a gradual but healthy increase. When broadcasting first started, it was impossible, in many cases, to buy ready-made sets, because at that time there were none to speak of on the market. It took several years for set manufacturers to develop the multi-tube set and, in the meanwhile, radio constructors and amateurs all over the country were making their own.

When ready-made sets did finally come along, in overwhelming numbers and at practically all prices, home set building naturally took a set-back. The incentive for people to build their own was no longer so great; yet even today the home-made-set builder, who now is known also as the "custom-set builder," has not vanished, by any means. Quite the contrary; his tribe is increasing steadily. The reason is not difficult to explain. In the first place, it should be understood that the radio constructor who builds only an occasional set, and the custom-set builder, are two distinct entities. The former builds for his own use and enjoyment; while the custom-set builder builds not only for himself but, rather, for his friends, and for sale. But the two classes of home builders must be considered, more or less, together; because the incentive which urges set building, whether for profit or for one's own amusement, remains practically the same.

But, particularly in the radio art, which is comparatively so new, practically every day brings along new inventions and improvements of one kind or another; these are frequently discussed in the editorial pages of radio magazines. From the very nature of things, it must be seen, set manufacturers cannot charge their models over night. It takes a long time to get ready for production and, once you are in production, you can not stop to equip the set with the latest wrinkle or the latest invention that comes along. Therefore, the large set manufacturers are usually "behind" the radio art, anywhere from three to six months—which is only natural and is to be expected. By this I do not mean to say that the manufactured sets are not as good, or are behind the times; but it does mean that in this country there are several hundred thousand people who must, perforce, have constantly the latest wrinkles, the latest improvements in radio, and these are the people who are interested in building radio sets. And this army of radio pioneers has a great influence upon the radio market as a whole.

If a new circuit is described in RADIO NEWS, or other radio publications, there are upwards of 200,000 individuals in this country who will immediately start building such sets. But that is not all; there is another class of individuals, perhaps as large, who also know about the latest improvement and desire to have such sets, but have neither the time nor the inclination to build them. So they, usually, have them built by the professional custom-set builders who, as a rule, realize a profit from the transaction.

It is easy to see that there is an excellent economic justification for the custom-set builder, for not only the reasons stated, but a number of others.

For instance, as very frequently happens, a man has a special cabinet, a bookcase, a phonograph console, or a special closet, in which he desires to place a radio set. It is frequently almost impossible to find a suitable factory-built set to fit such a space in the desired manner. Here is where the custom-set builder "shines," and where a really worth-while job can be performed. Not only will the custom-set builder construct an excellent model incorporating the latest available circuit, but he will make the set harmonize with its surroundings. If the customer wants a mahogany-colored panel, the custom-set builder will have no trouble in getting it; if the customer wishes it engraved with gold lines, in a certain manner, again the custom-set builder will oblige. But that is by no means all; frequently well-to-do customers require

special radio installations and, in this respect, the custom-set builder performs the same duty as the body builder when a rich man wishes a special automobile built to fit his requirements.

A number of cases that have recently come to my attention might very well be mentioned. There was one of a millionaire on Park Avenue, New York City, who wished to have his entire apartment so wired that every room could have an outlet for a radio loud speaker. But that was not all; the requirements were that more than one program could be received at the same time. Evidently a single receiver could not do this; so a custom-set builder was called in, and one set was installed in a Louis XIV inlaid cabinet, with a black-and-gold inlaid panel to match. The other was placed in the library, and had to be built into a sectional bookcase. A switching arrangement was provided, so that every loud speaker in the house can be switched on to either radio set as desired. This was a special requirement, and unusual; but the custom-set builder did a neat job.

In a well-known New York restaurant, a custom-set builder was called in to do another unusual job. The requirements included eight loud speakers, distributed throughout the restaurant in such a way that none would show. Furthermore, enough power was needed to fill the entire restaurant, which is of a tremendous size, with a good volume of music. It was desired, furthermore, that either radio or phonograph music could be supplied to the loud speakers, at the option of the owners. No ordinary manufactured set now on the market could possibly have been used, because of the enormous output required. It was necessary to build into a closet a special 10-tube superheterodyne receiver, with a power amplifier, and a switching arrangement for the phonograph, the music of which had also to be amplified to a high degree to deliver sufficient volume to the loud speakers. All this required special treatment and, to the credit of the custom-set builder who completed the job, he accomplished a most satisfactory installation.

Then, of course, there is always—and this applies more to the country than to the city—a big market for efficient DX sets that, under fair conditions, will bring in stations from coast to coast. Most factory-made sets, with certain exceptions, are not made for such work; and, indeed, most set makers do not claim extraordinary distance reception for their sets. The trend in the cities, where most factory-made sets are sold today, is toward a demand for sets that deliver excellent quality on local stations, with a minimum of trouble. Accordingly, the ready-made set builders bear this in mind, and manufacture such sets; but out in the country, in the small communities hundreds of miles away from the largest stations, there is a big and steadily increasing demand for special sets that will reach out and get their station, and still deliver good loud-speaker volume. It is here, particularly in the smaller localities where radio has not made the inroads which it has made in the larger cities, that the custom-made-set builder comes into his own. He may start out, innocently enough, by building simply a set for himself but, sooner or later, a friend or neighbor will drop in and hear it perform. As a rule, he does not have to use any salesmanship at all, because his friend or neighbor will want the set and offer to buy it; and that is how many custom-set builders actually were started. There are in this country today any number of custom set-builders who are assembling receivers to order for their friends and acquaintances, and making a regular business out of it—a small business, but a business nevertheless.

And let no one think that the custom-set builder sells cheap merchandise. As a rule, such sets range from \$100 upwards, because there is not a custom-set builder worth his salt who does not wish to be proud of his work. If he knows anything at all about the game he will have found out (and often to his sorrow) that a single low-priced set causes him more trouble and annoyance, in order to satisfy its purchaser, than several which are built of first-class materials, and sold at a much higher figure.

Mr. Hugo Gernsback speaks every Tuesday at 9.30 P. M. from Stations WRNY (326 meters) and 2XAL (30.90 meters) on various radio and scientific subjects.

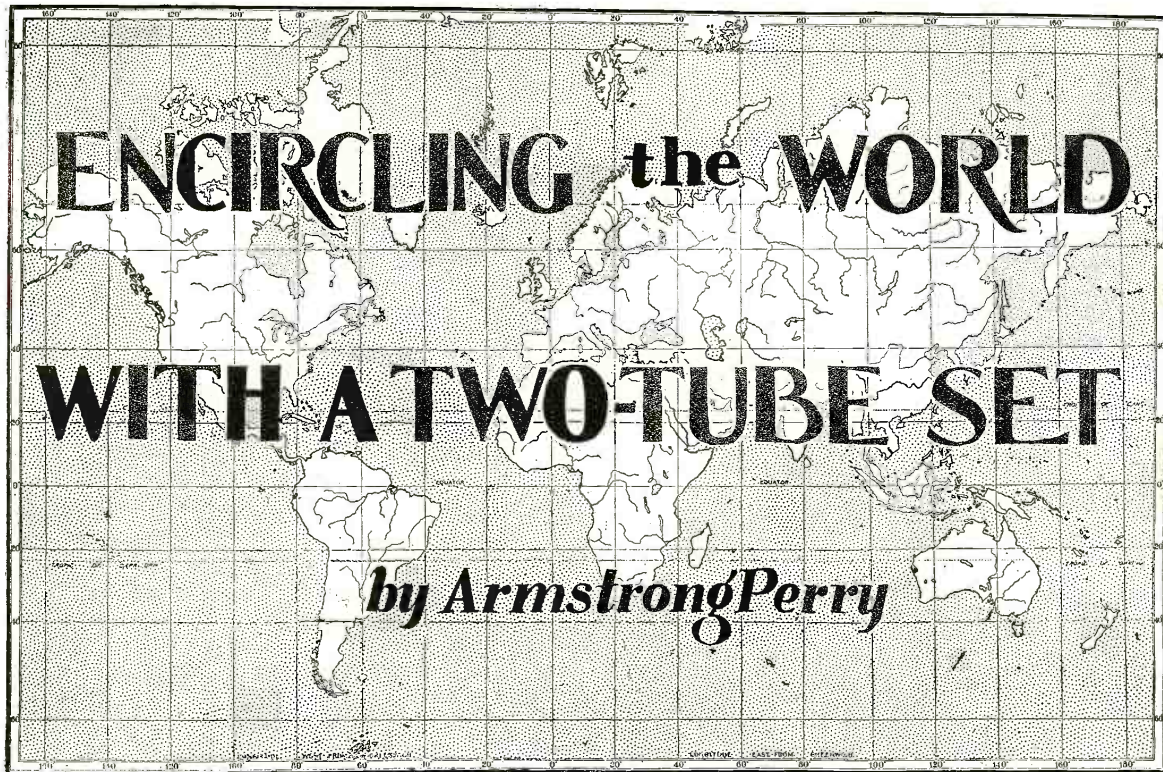

ALL who have been holding records for long-distance reception of broadcasts, and those whose imaginations have placed them in the class with world champions, now can retire from the limelight. Walter Rodman Pierce, Jr., a 17-year-old boy of Saundertown, Rhode Island, seems to have all the other known DX artists backed completely off the boards with a record of 694 stations in 41 countries.

When Pierce's friend and brother "ham," Franklin B. Rowell (IAMU) of Pawtucket, told me at a recent New England convention of the American Radio Relay League that Pierce was receiving broadcasts from Japan, the Philippines, Australia and other countries in all parts of the world, on two tubes, it sounded like the result of a super-

heated imagination. But Pierce appeared to be an honest young man; and he gave me from memory the call letters and locations of so many stations that he said he had logged, that I knew he must have either heard most of them many times or else spent most of his time memorizing the call books.

He said that he had letters and cards from many of these stations, verifying his reception. Still, his record was so remarkable, so nearly incredible, that I decided to visit his home and see the evidence before making any unqualified statement.

Several months later I visited Saundertown. Pierce's home, I found, was a farm back in the woods. A grocer on the highway took me over in his truck. I talked

with him and with members of the boy's family while I waited for the boy to come home from school. The house is in a good radio location, on a hill that rises west of Narragansett Bay, opposite Newport.

Pierce's receiver is a Radiola III, a two-tube set which was well known a few years ago, but which is now entirely off the market. He had the little set on a table in the living room; it was hooked up to three dry cells and two 45-volt "B" batteries. He was using tubes of the 199 type, with adapters, instead of the WD-11 type for which the set was designed.

ELABORATE GROUND SYSTEM

From the looks of the outfit, I would have said that New York would have been DX for it; but outside the window there was something unusual. The wire that led from the ground connection on the receiver out through the window ended at a binding post on a porcelain base. From this post twelve wires led to the same number of pipes or other pieces of metal embedded in the ground (see Fig. 1). Pierce said that he found that each new ground connection increased selectivity and reduced the effect of body capacity; so he added one after another.

A leaky automobile radiator was sunk in the ground, at the end of the row of pipes, with its cap just above the surface so that water could be poured into it. Circumstances alter cases. On a car, that radiator could only have inspired profanity; here it was an ideal device for keeping the ground connections wet. The ground clamps on the pipes were bright. Pierce said that he put on new ones every few weeks. It became evident that his phenomenal record was not the result of accident.

The aerial is 110 feet long and 26 feet

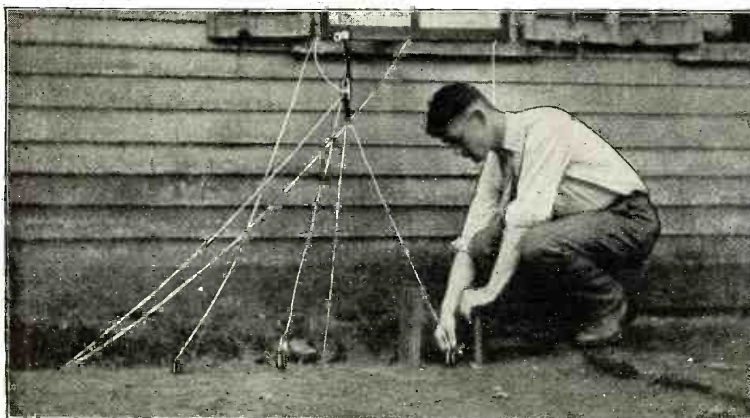

Walter Pierce going over his ground connections, a pictorial diagram of which is shown on the following page

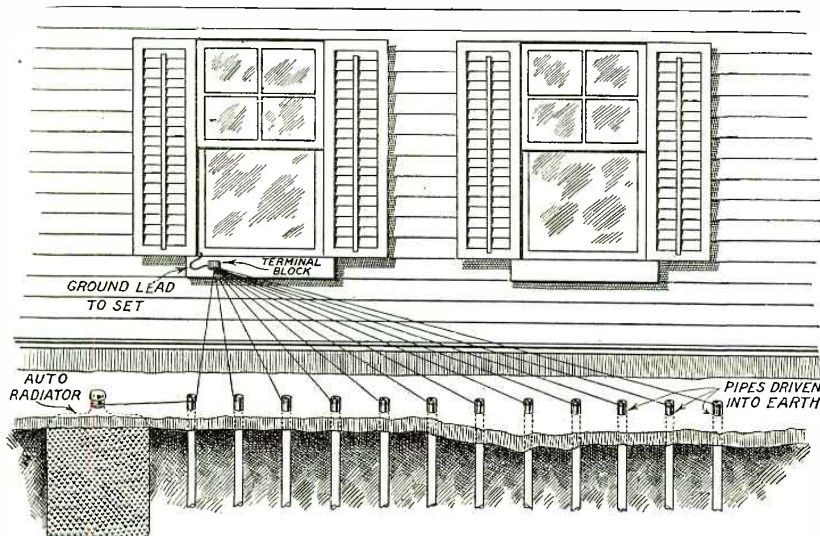

Fig. 1. The twelve pipes and the leaking automobile radiator that compose Pierce's ground system. The radiator keeps the whole ground system moist.

high; it points N. N. E., with the set at the southerly end. Two glass insulators in series at each end prevented the escape of energy. The wire was of bare copper which, Pierce said, gives better results than tinned copper. He puts up new wire to replace the old every few months, or as soon as corrosion becomes noticeable. The aerial is kept taut, to prevent swinging.

ACROSS THE OCEANS

It was still daylight, though late in the afternoon, when I sat down at the receiver. As soon as the tongue of the rheostat touched the first turn of wire, a station jumped at me. So many came in as I turned the knob that I advanced it only an eighth of the way to the maximum setting. These stations were within a radius of about 200 miles.

Pierce took charge of the set and turned the rheostat knob to the maximum position. There was another rheostat at the batteries, adjusted so that it was impossible to injure the tubes by turning the one at the set too far. Almost immediately he brought in 2LO, London, England!

When we tired of tuning in stations, we took off the phones and cut in the loud speaker, an ordinary low-priced horn. Providence and New York stations came in with volume enough to fill the room and be heard anywhere in the house. Like his phones, his loud speaker is a standard device, of a kind sold in most radio shops. There is not a piece of apparatus in the whole outfit that is of special design or expensive. Pierce is a farm boy, attending high school, and has little money to spend on luxuries. He said he had used the same "B" batteries for two years.

After a night's rest, we rose at early dawn and went back to the set to listen for stations on the other side of the earth. Station 1YA, Auckland, New Zealand, was one of the first to come in. The carrier wave was strong, but the music and announcements were weak. An orchestra was playing. When it stopped, the announcement "1YA, Auckland Station," was heard. This was between 5:35 and 5:37 A. M., Eastern Standard Time, on November 1, 1927. The announcement was logged again at 5:45.

A number of stations in the antipodes, including JOCK, Nagoya, and JOAK (no joke!), Tokio, Japan, and 2YA, Wellington, New Zealand, were recognized by their carrier waves. The average broadcast listener may doubt the ability of any person to identify stations by the sounds of their carrier waves; but some may have discovered, as Pierce did, that it can be done. For two years he has operated his set several hours a day, fishing for distant stations. He knows his dials as a navigator knows his compass. He knows the schedules of many of the broadcast stations. He can start at zero on the dial scale and tell what station he is going to bring in at each mark, and between the marks. While a station 10,000 miles away was coming in near 4 on the scale, WGY, Schenectady, was working on a wavelength very near it. Pierce separated them, and after seeing him do it, I did. His set increased its selectivity as he added extra ground wires and, as his mother says, he can "adjust the tuning lever to the sixteenth of a hair's breadth."

CONVINCING EVIDENCE

Pierce has more convincing evidence of his achievements in world-wide broadcast reception than the testimony of a visitor. When he hears enough of a program to tell definitely whether the number was a piano solo, an orchestral selection or something else, he writes to the station to secure confirmation of the record in his log. Some of the stations are so far away that four months elapse before the reply comes back. Among the letters and cards that he showed me were some from LOX, Buenos Aires, Argentina; 4QG, Brisbane, Australia; 5CL, Adelaide, Australia; KGBU, Ketchikan, Alaska; CZE, Mexico City; HHK, Port au Prince, Haiti. Several English stations answered his letters, but their replies were somewhat indefinite.

He has many verifications from stations in the United States and Canada, from coast to coast, but he considers nothing as real DX except reception from another continent or its islands.

SOME OF THE FOREIGN STATIONS

Among the stations outside of the United States and Canada that Pierce has logged, many of them several times, are:

Mexico: CYX, CZE, CYJ, CZI, CYO, CYB, CYH, Mexico City; CYS, Monterey; CYY, Merida; CYE, Tampico; FAM, Guadalajara; CYR, Mazatlan; CYU, Puebla; CYQ, Tampico.

Cuba: PWX, 2BB, 2EP, 2HC, 2HP, 2OK, 2RK, 2TW, Havana; 7SR, Central Elia; 6KW, Tuinucu (this station came in louder than any other that Pierce ever received. On Dec. 30, 1926, he thought it was going to burn out his loud speaker); 8JQ, Santiago de Cuba; 6HS, Santa Clara; 7BY, Camaguey.

Haiti: HHK, Port au Prince.

Central America: AQM, San Salvador.

South America: CMAC, Santiago, Chile; SQIG, Sao Paulo, Brazil; AYRE, Caracas, Venezuela; CBC, Santiago, Chile; OAX, Lima, Peru; LOX, Buenos Aires, Argentina; CMAT, Tacna, Chile; CWOZ, Montevideo, Uruguay; Pernambuco, Brazil; LOP, Buenos Aires, Argentina; LOS, Buenos Aires, Argentina; CWOR, Montevideo, Uruguay; CNA, Valparaiso, Chile; Rio Janeiro, Brazil (no call letters announced); LOY, Buenos Aires, Argentina; LOV, Buenos Aires, Argentina; CMAB, Santiago, Chile; SPE, Rio de Janeiro, Brazil; LOU, Mendoza, Argentina; LOZ, Buenos Aires, Argentina; LOR, Buenos Aires, Argentina; LOT, Buenos Aires, Argentina; CWOS, Montevideo, Uruguay.

(Continued on page 1048)



Walter R. Pierce, Jr., tunes the Radiola III with which he hears broadcast stations in all parts of the world. This set is no longer on the market, and inquiries for its circuit data cannot be answered.

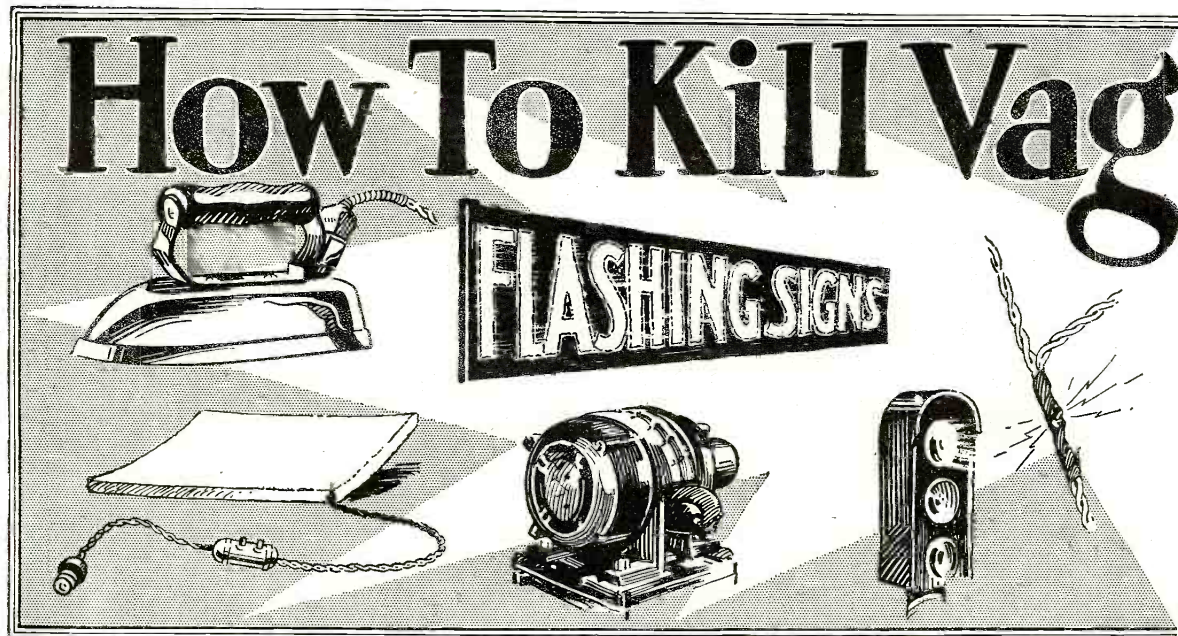

Some of the radio noise-makers. Top row: electric flat iron with poor contact or defective resistance; flashing signs or flashers in window displays. Bottom row: electric heating pad, sparking motor, railroad signals, faulty connections in lamp leads.

WE would be willing to wager a goodly portion of the munificent weekly stipend that, if you were to inquire casually of a radio fan what caused the funny little noises in his set, he would make one of the two answers; viz:

Answer No. One: "Static."

The Other: "A leak in that doggone transformer on the post in the alley."

Such a simple disposition of a difficult problem! Surely no other solutions could appeal so strongly to such a variety of minds. Somebody or other gave these simple explanations to the first radio fan; and that great love of truth which characterizes all receiving-set owners has fostered them and the radio fraternity has clasped them to its bosoms. They are magnificent in their broad generality; and, like so many other beautiful but broad generalities, they are far from being true.

After a great deal of intensive research on the part of a great deal of engineering brains, it was discovered that Grandpapa Static is innocent of a lot of crimes for which he had been blamed. After a lot more research, these same engineers ascertained that, in most cases, the people who made complaints were in the same class with the dog who sat on his own tail and howled, but was too lazy to move.

It was the consensus of expert opinion that, with the home-brew-noise industry getting along so nicely, natural static might as well be put on a sled and started on the well-known road to oblivion. A man with the hives, you know, doesn't do much kicking over a mosquito bite.

INTERFERENCE AND INTERFERENCE

As this sub-title indicates, and as those of us who get more or less enjoyment from listening to radio programs should be fully aware, there exist two kinds of interference. A type which is, happily, confined to the vicinity of large cities is the spirited interference of one broadcast station with another

and makes itself known to the listener by a beautiful whistle in the background of the music, instead of the more conventional bass. The only remedy that comes to mind at this moment is either several sticks of well-placed dynamite or aggressive activity on the part of the Federal Radio Commission.

On the other hand, if the sounds that float gently out from your loud speaker seem to be a cross-section of a kitchen working overtime frying eggs, with attendant crackles, hums, moans, roars, sputters and what you will—then this is something else again and there is a good chance that the noises can be chased down to their lair and killed. Of course, it would not be right to assume that *all* the noises come from within the home—for that above-mentioned transformer in the alley *might* be to blame; but the chances are that, if a little intelligent thought and work is put on the problem, the source of the noises can be tracked down and will be found within your own four walls or those of a neighbor.

MAKING INTERFERENCE AT HOME

The list of noise-makers that are in the equipment of the average modern electrically-equipped home is far too long to be here included. However, take heart, radio fan, and read on; for, although these noise-makers are numerous, yet it is a simple matter generally to find out where the trouble is and then to kill it. And all this does not necessarily mean that the searcher need have a wide knowledge of the mysteries of electricity, or possess a thick pocketbook; for the most part it is a relatively simple matter.

It should be stated again that "the doggone transformer out in the alley" is usually about as much of a source of radio noises as the mummy of one King Tut recently found in his old family cemetery, west of the waterworks in his home-town. To the radio public in general it may seem logical that

power companies should burn coal in the power house, at its present prices, just for the fun of pumping current through holes in the lines to ground. But they don't. They would much rather sell electricity than broadcast it.

Some of the real offenders have been classified by the National Electric Light Association, as follows:

POWER CIRCUITS: (1) lines; (2) insulators; (3) lightning arresters; (4) transformers; (5) generators and motors; (6) induction voltage-regulators.

INDUSTRIAL APPLIANCES: (1) arc-light circuits; (2) telephone and telegraph lines; (3) pole changers and converters; (4) street cars and electric railroads; (5) smoke and dust precipitators; (6) motors; (7) sign flashers.

HOUSEHOLD APPLIANCES: (1) electric pads; (2) violet-ray machines; (3) flatirons; (4) doorbells, light-switches, various small motors.

MISCELLANEOUS: (1) X-ray machines; (2) storage-battery chargers; (3) annunciator systems; (4) stock tickers; (5) ignition systems; (6) electric elevators and electric furnaces; (7) moving-picture equipment; (8) high-voltage testing equipment.

This list covers in a general way most of the field of household and industrial noise makers; but, if it were not for the lack of space, further classifications might be made; for example, under the heading of heating pads might be included all those devices, which are operated by some sort of an electrical thermostatic control; with flatirons might be included those articles which use resistance-wire heaters, such as curling irons, percolators, waffle-griddles, etc.

Now, as has been suggested, much work has been done on reducing the output of these non-licensed broadcast stations and in due time the secrets will be unfolded to a panting world and illustrated by rare old Sargents with crosses marking the spot where the body was found. We have in-

rant Radio Noises

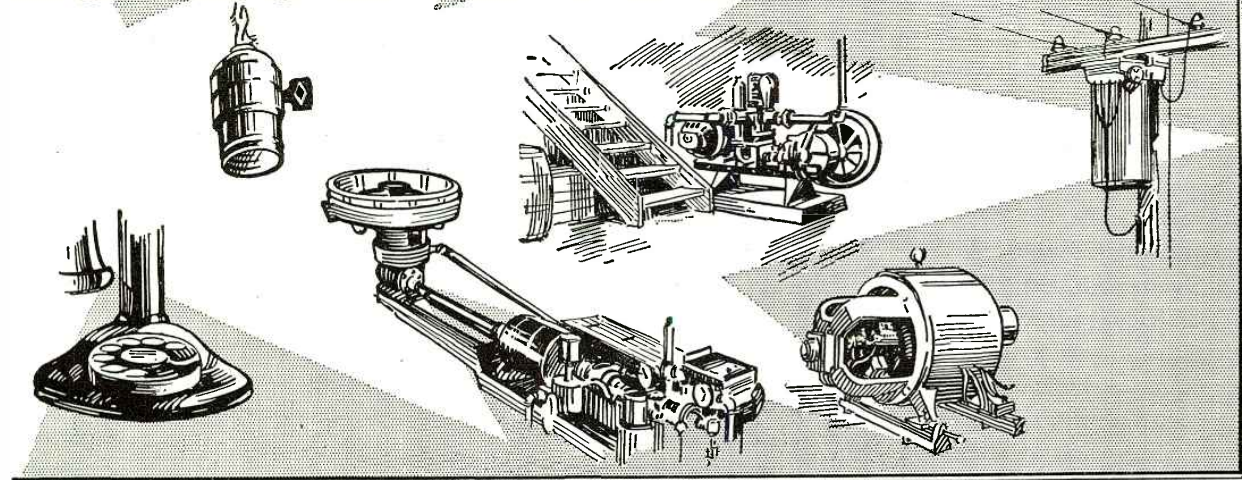

Automatic telephone dials; bad contacts in light sockets, thermostat controls on oil burners, contactors on farm-lighting equipment, dirty commutators on motors, leaky transformers, are among the sources of interference.

timated that the method of bomb-tossing is a bit too crude for this advanced day and age and should be left to those nephews of our National Uncle who get their thirty bucks a month for doing just such little odd jobs. We shall try to shunt to Oblivion, Gehenna and other way stations the hums, crackles and other noises that were given to the radio fan for his sins.

RECOGNIZING THE NOISES

Some bright student of the class might at this moment get up on his hind legs and pipe, "But how the—pardon me, how on earth are we going to tell where a hum comes from and where a crackle has its home?" Sit down, Oscar, and incline your ear this way and you will get an idea (if possible).

Suppose you hear romping through your loud speaker, a nice, low, deep hum sounding like a note pulled out of a bull fiddle by the long-haired gentleman in the orchestra pit. Such hums, which are sometimes induced in an aerial which runs parallel to a line carrying 60-cycle alternating current, may also be among those present through the medium of power-supply units with defective rectifier tubes or bad filters. A little thoughtful search by the operator will usually bring such a hum to nought.

The unwanted voices of the violet ray and X-ray machines are pitched deeper and have the added characteristic of sounding like a neighbor's winter supply of coal going down the chute into his cellar. Similar to these sounds are those of a wild and undomesticated battery charger.

Another type of grating sound is caused by spark interference, although this has sometimes a high-pitched note accompanying it. It is generally intermittent. Also intermittent is the noise from a thermostat control, like those of some types of electric irons.

Crackling noises can generally be traced to defective contactors, loose wiring con-

nections and bad sockets. A crackle with a steady hum indicates a dirty commutator on a nearby motor.

Of course, it is mighty difficult to differentiate between the fine graduations of tones which might mean an entirely different source of interference; but each annoyance has, and sticks to the bitter end to, its own pet note which we shall soon attempt to describe. The experienced trouble-shooter should know his notes, as well as the piano tuner knows the difference between middle-C and G sharp; but this is small consolation to Mr. Average Listener, whose affronted ears only tell him that his loud speaker is snarling at him. However, one need not be a grand-opera singer or a performer on the fiddle to track down the elusive interference. The methods are simple for the most part.

ON TROUBLE'S TRAIL

One of the first things that the trouble shooter should implant firmly, away in the back of his skull, is that the power company has not concocted a plot to annoy him every time he hears a queer noise in his loud speaker. Many a time and oft an investigating fist thrust rudely in the "innards" of a receiver is the cause for bent condenser plates; and plates that touch and therefore sometimes spark are every bit as potent a source of noise as any trolley car that ever wandered up a street.

And then batteries can play a little tune all their own. Corroded terminals in jacks and battery clips, corroded socket contacts and tube prongs do their stuff nicely. An excellent imitation of a 60-cycle hum is caused by an open circuit in the audio amplifier. Did you ever hear a defective grid leak fry and sputter? Well, they do. And above all, loose connections will let loose as nice an assortment of noises as has ever been your lot to listen to.

There has been much published on the subject of trouble-shooting in the mazes of a receiver and we will skip blithely over that

with this admonition: look carefully over your various batteries and socket-power units, connections fore and aft, test your tubes, for contacts and microphonic noises, your switch and jack springs, and the loud-speaker cords.

GADGETS AROUND THE HOUSE

If Sister is getting all dolled-up to go to a party and the curling iron, the violet-ray machine, and the flatiron are all working overtime to aid her, and if these various objects are doing their level best to drown out whatever music—if any—is trickling through the loud speaker, don't spoil your sister's evening by crashing a storage battery over her head. She didn't invent the noise-makers. Attack the problem in a more scientific way, look for the source of the trouble.

After sister has succeeded in waking up her boy friend, who has been waiting "just five minutes"—has it ever happened to you?—turn off all the trouble makers and then turn them on one by one and see which one is making all the fuss. If one kicks up a rumpus, first inspect the light socket from which the appliance is getting its power. The contact in there may be bad.

Of course, some cases may not be so simple to trace and it may be necessary to resort to a small portable set using a loop antenna so that its directional properties can be used. But let this word of caution sink in: be sure that the trouble is not in your own house before you go snooping around some neighbor's domicile.

Suppose that you have traced the trouble to a motor which is merrily sparking; in most cases this is due to dirt on the commutator, causing the brushes to make bad contact and resulting in a spark jumping to them. This will in time pit the commutator, and this result will not help to reduce noise. First clean the motor, and if the iron frame of the motor is not con-

(Continued on page 1044)

What Constitutes Tone Quality?

A Clear Explanation of What Sound Really Is, How It Is Produced, and Why Similar Notes on Different Instruments Sound Differently



By Robert Neil Auble

MUCH has been printed in the last few months, in radio journals and in radio advertising elsewhere, concerning the quality of tone to be expected from a given loud speaker or a particular radio set. Until about a year ago the whole emphasis had been placed upon the merits of the various circuits, the methods of coupling various stages of amplifiers, and such other technical matters of radio design. From a selling point of view, the change in emphasis has been wise; because very few users of radio sets nowadays care to spend any time in mastering intricate principles of design; on the contrary, they want the manufacturer to build a dependable radio at a price within their means.

larity of "one-knob" sets, with a minimum of gadgets and thingumbobs, and with the "works" safely concealed beneath a sub-panel, has a firm basis in American psychology.

THE CRY OF "QUALITY"

A new difficulty for many has been introduced, however, in the phrase "quality of reproduction." Those of us who have

loud speaker, are instruments for the reproduction of sound and do not in themselves, *except as inherent faults in the apparatus itself may bring about changes*, have anything to do with quality. Radio music cannot improve upon the original, any more than can any other reproduction in nature. Indeed, the copy is best when it is most nearly like the original, regardless of faults in either original or copy.

Since so much emphasis has been given to this factor of quality of tone, it seems appropriate to explain in general terms what the physical basis of quality is, and to show the part played by radio transmitting and receiving units in modifying quality.

In this article Mr. Auble explains interestingly the physical basis of the sounds which form music and speech and the method of their production; thus pointing out some of the complications which must be dealt with in their transmission and reproduction by radio. Part II will deal with loud speakers and show some ingenious novelties.—EDITOR.

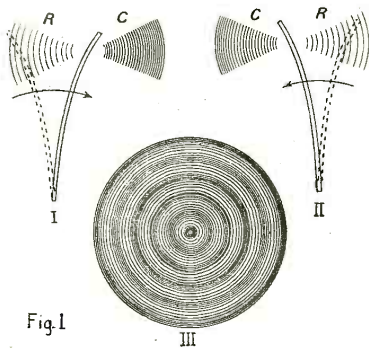

Fig. 1

As the vibrating reed moves toward C (I) a condensation is produced at C and at the same time a rarefaction is produced at R. As the reed returns to its first position (II), the air is condensed in the region previously rarefied, and rarefied at the point where it was condensed. Condensations and rarefactions succeed each other rapidly and are transmitted through the air as sound waves, as shown in III.

If the product is a musical instrument which gives reasonably satisfactory entertainment, the buyers do not complain.

The salesman who talks circuit and radio design to such non-technical prospects is likely to frighten away his customers; because not only do few men care to admit ignorance concerning the superficially-popularized terminology of radio, but the mention of inductances, potentiometers, et cetera, also leaves the impression with the average man that the set in question is too complex for him to operate and has too many possibilities of trouble requiring the services of the expensive expert. The popu-

"grown up" with radio have long since learned to enjoy radio programs, because, even though the reproduced program may or may not be faithfully like the original, it is sufficiently pleasing in itself; so that any difference between the loud-speaker rendition and the original sounds causes us little displeasure—we marvel at what we do get. But a novice at radio invariably notices such differences and is very likely to condemn a set which is excellent if judged by engineering standards, with the statement, which frequently is heard, that it "sounds too much like a radio."

Much of the present-day literature of radio, dealing as it does with the quality of speech and music heard at the loud speaker, wrongly creates the impression that the quality of tone of the music is a particular function of radio devices. Nothing can be farther from the truth.

It must be borne always in mind that radio devices, from the microphone to the

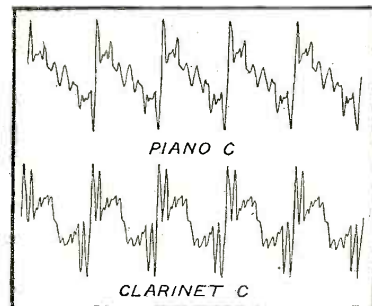

Fig. 3

The same note produced by two instruments, showing by waveform the difference in the timbre.

WHAT ARE SOUNDS?

Sounds always originate in the vibration of some material substance, such as a vibrating wire of a piano or a violin, or a vibrating air column within a flute or an organ pipe, etc. As such substances vibrate, they produce alternate regions of condensation and rarefaction in the surrounding air. These disturbances, due to the elastic character of the air, are carried to the ear; where they produce a to-and-fro movement of the ear drum and give rise to the sensa-

The height of waves in Fig. 2 indicates loudness; their width, frequency or pitch. Fig. 4 shows the sonometer or "monochord," which consists of a wire stretched by lever A across a thin-walled hollow box. The effective length of the wire is varied by moving the bridges b and b' along the box.



Fig. 2

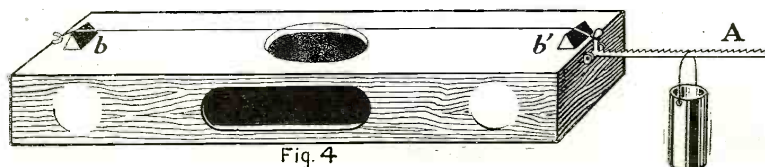

Fig. 4

tion which we call sound. If the original vibrations are perfectly periodic (i.e., if the vibrations are repeated at exactly equal intervals of time and with equal intensity) we call the resultant sound a musical sound or tone. If the vibrations are irregular and non-periodic we call the sounds noises. Both musical sounds and noises must be

transmitted by radio and reproduced by receivers. The problem is rendered much more difficult by the fact that noises—sounds from drums, cymbals, the consonant sounds in speech, etc.—are exceedingly complex and difficult to reproduce.

Sounds may differ from each other in three respects, viz., pitch, loudness and quality. If the sound waves—the condensations and rarefactions in the air—be represented like water waves, the differences in

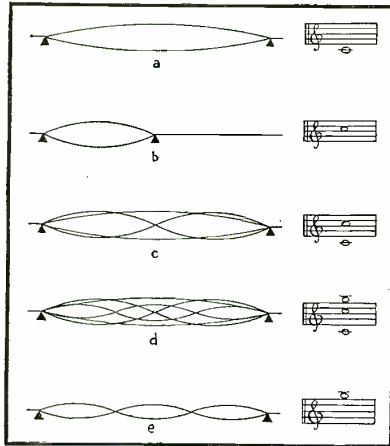

Fig. 5

Showing some of the simpler ways in which a stretched wire may vibrate. In a is shown the form of vibration (vibration limits) of a wire sounding only its fundamental note. In b the half-segment vibrat...g gives a tone an octave above the fundam...al. In c the wire is shown vibrating simultaneously to give its fundamental and the first overtone, or second harmonic. In d fundamental, first and second overtones are shown, while in e the second only is produced. To produce these effects the wire is plucked or bowed at the middle of the loops (called ventral segments) and damped at the desired stationary (nodal) points.

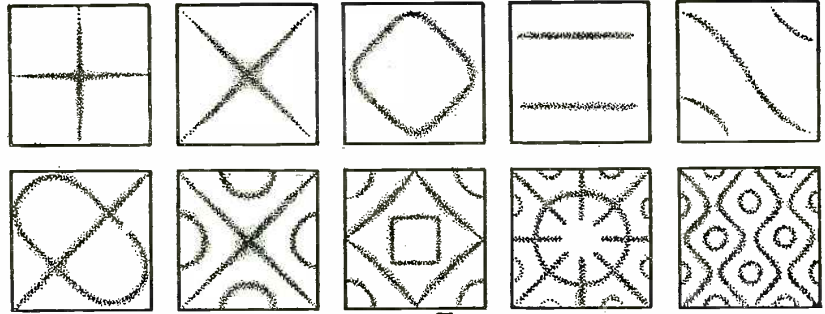

Fig. 7

The various patterns formed by particles scattered over a vibrating plate (Chladni's figures).

pitch and loudness may be shown as in Fig. 2.

It will be observed that sounds differ in pitch when the number of vibrations produced in a given time interval varies. The frequency of vibration for the production of "middle C" (physical pitch) on a piano is 256 vibrations per second, while its octave tone C' is 512 vibrations per second. Sounds differ in loudness when the force with which the air is disturbed differs. Increasing the force increases the loudness, and vice versa.

wave form. These differences give the two instruments their distinguishing characters and identities.

If quality depends upon the manner in which the source is vibrating, it is at once evident that the disturbances of the air produced by the piano wire are not like those

QUALITY OR TIMBRE

Quality is determined by the manner in which the source is vibrating. It is from difference in quality, or timbre as it was formerly called, that we are enabled to distinguish between musical instruments, or between voices. For example, no one would confuse a clarinet sounding middle C with a piano sounding the same note. The wave forms of middle C for the two instruments are shown in Fig. 3. The pitch of the principal component of the two sounds is the same, and the loudness is the same; but there are characteristic differences in the

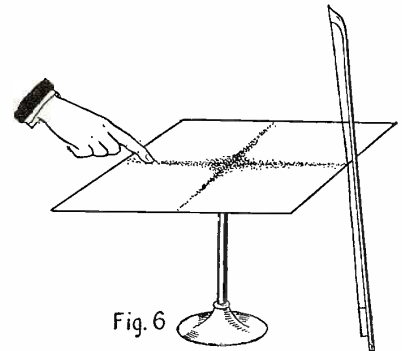

Fig. 6

Showing the plate for the production of Chladni's figures.

produced by the clarinet; even though the two are alike in intensity and fundamental frequency.

To get a more accurate idea of differences in quality, it is possible to visualize the vibrations of a stretched wire; or the reader may try the experiments with a string on a cello or a guitar. The experiments to be described are very simple, but at the same time very instructive. The device shown in Fig. 4, known as a "sonometer" or "monochord," consists of a thin-walled rectangular box about a yard long, upon the top of which is stretched a steel piano wire. The tension upon the wire is produced by means of a weight hanging from the lever A. Two bridges (b and b') are arranged to slide along the box in contact with the wire; thus enabling the experimenter to vary the vibrating section of the wire, within the limits of the length of the box. The tension should be adjusted so that the full length of the wire gives a tone approximately middle C; though this adjustment is not essential to the success of the experiment. If the wire be plucked or bowed at its center a full, rich, mellow tone is produced. Assuming for convenience that the wire has been tuned to middle C, then the tone just heard is middle C. The wire may be seen to be vibrating, somewhat as shown in Fig. 5 at a. This tone is called the *fundamental* note of the wire and is the lowest tone the wire can produce under the given conditions of length, tension, etc.

TABLE OF HARMONICS OF THE MAJOR SCALE (Physical Pitch)

Frequency	256	288	320	341.3	384	426.6	480	512
Fundamental	C	D	E	F	G	A	B	C'
Frequency	512	576	640	682.6	768	853.3	960	1024
1st Harmonic	C'	D'	E'	F'	G'	A'	B'	C''
Frequency	768	864	960	1024	1152	1280	1440	1536
2nd Harmonic	G'	*	B'	C''	D''	E''	*	G''
Frequency	1024	1152	1280	1365.3	1536	1706.6	1920	2048
3rd Harmonic	C''	D''	E''	F''	G''	A''	B''	C'''
Frequency	1280	1440	1600	1706.6	1920	2133.3	2400	2560
4th Harmonic	E''	*	*	A''	B''	*	*	E'''
Frequency	1536	1728	1920	2048	2304	2560	2880	3072
5th Harmonic	G''	*	B''	C'''	D'''	E'''	*	G'''
Frequency	1792	2016	2240	2389.3	2688	2986.6	3360	3584
6th Harmonic	*	*	*	F'''	G'''	A'''	B'''	*
Frequency	2048	2304	2560	2730.6	3072	3413.3	3840	4096
7th Harmonic	C'''	D'''	E'''	F'''	G'''	A'''	B'''	C''''
Frequency	2304	2592	2880	3072	3456	3840	4320	4608
8th Harmonic	D'''	*	*	G'''	*	B'''	*	D''''
Frequency	2560	2880	3200	3413.3	3840	4266.6	4800	5120
9th Harmonic	E'''	*	*	A'''	B'''	*	*	E''''

* The frequencies so marked do not correspond with the frequency of any whole tone. In some cases they agree approximately with the half-tone. If consonance is most perfect when the interval ratios are the smallest whole numbers, it is clear that some of the harmonics will produce dissonance with the fundamental unless they be quickly damped out.

(Continued on page 1047)



Your Radio Entertainment Is Your Receipt

Editor, RADIO NEWS:

I am very much interested in the article in the November issue, under the caption "Applause." I think that the artists and sponsors of these free programs should know that their programs were received and enjoyed. I have given this matter careful consideration, and find that when the radio listener does write, it is hardly ever that he receives an answer. I have taken this matter up with my friends, and we have come to the conclusion, "Why write, when we never know that our letters are read?" How do we know but that our letters are tossed carelessly aside and never read? In a recent test, I found that after I had written fifteen stations, only one sent me a reply, and that was KGO, Oakland. I have written that station several times, and they sent me a reply each time. I also received a prompt letter of appreciation from a foreign station that I had received. I would rather spend my spare time writing to stations outside the United States and know that they were appreciated, than to write to nearer stations and never receive a reply. I think that if the stations would send a verification card, or even a postcard, probably all the listeners would write.

HARRY DUNCAN,
126 South Elm St., Nevada, Mo.

(Unfortunately, most listeners-in, like Mr. Duncan, do not realize the narrow margin on which broadcasting is carried on. A recent broadcast, heard by millions, cost \$76,000, of which only a small proportion was received by the broadcasters. Had every family listening in written, it would have been hailed with delight by the sponsors, and would have insured many more free entertainments, of a costly variety, for the radio audience. But, at the same time, to acknowledge every note so received would have cost the stations thousands of dollars more than they received for the program. They can and do answer a few letters of especial human interest, or those that have come a long ways; but it is impossible to write to all their well-wishers. The latter may set down their letters as votes which will be counted for bigger and better programs; but the only returns which should be expected are those which will issue from the loud speaker.—EDITOR.)

A Clear Channel for All Stations in Turn?

Editor, RADIO NEWS:

Although we depend mostly on local stations for our reception, most of us occasionally get a hankering to step out and see what we can get. We more often get

NIX than we do DX. And it is all due to the multiplicity of stations. Probably 90% of receivers in use today do not tune close enough to eliminate interference on the present width of wave channels.

My idea would be to create two major channels of about double the ordinary width, clear them of all broadcasting, and then allow them to be used by only one station at a time for one day only, in rotation,

opportunity of hearing distant stations occasionally if they wish. It would take considerable time to make the rounds of all the stations, but it would be better to be heard occasionally by the DX hound than not at all.

S. A. FISCHER,
Sutton News, Sutton, Nebraska

(The ingenuity of the suggestion is admirable, but its technical practicability nearly nil. It takes considerable time to adjust a station to an exact channel, and no high-powered station would desire to leave its assigned, crystal-controlled, frequency for this purpose. As for the smallest stations, to have a cleared channel for a day would be a certain amount of recognition; but it is only by accident that some of them would be heard beyond the area in which they are occasionally received today.—EDITOR.)

A New Addition to RADIO NEWS

SINCE this magazine was established in 1919, it has become the most important in the radio field in this country, if not in the world. RADIO NEWS has been read, not only by the radio amateur, the set builder and the set owner, but by practically everyone who is interested in radio. More than 30,000 of these readers are radio manufacturers, distributors, jobbers and retailers. So great has been the growth of this circulation, that it has been found necessary to issue a trade section of this magazine, to be known as

Radio News Dealers Personal Edition

This section is for the radio trade ONLY, as its entire contents will be of interest to those who are in the radio business, but not to anyone who is deriving his livelihood from other activities. For this reason, it will not be put on sale at the newsstands, but distributed solely through the mail to the radio trade.

The publishers will be only too glad to send you, without charge, a copy of the new DEALERS PERSONAL EDITION, if you are a radio manufacturer, distributor, wholesaler or retailer. You can obtain it only by asking for it—ON YOUR BUSINESS LETTERHEAD—and you are cordially invited to do so. See page 1048 of this issue, and

WRITE FOR YOUR COPY NOW!

until all stations of a class had had the opportunity of using same. One channel would be for the use of all high-powered stations, say from 5,000 watts up; and the other for low-powered stations, from 5,000 watts down.

This would give every broadcast station the opportunity of being heard occasionally by DX fans; and give DX fans an

Who Won't Pay for Broadcasting? The Listener!

Editor, RADIO NEWS:

Yes, we think the worst nuisance is the commercial operator who cannot seem to control his buzzes; and a friend of mine tells me that most of the racket is chatter, like children gasping for words to talk.

J. E. Kitchin's letter in the February issue is insulting, to say the least. Why should RADIO NEWS cater to the commercial and amateur operators when they can sell 100 or 1,000 times the magazines, and get maybe double or triple the advertising by catering to the B. C. L.? RADIO NEWS is a business and gives the public what they want—the whole public, not a few operators; it suits my friends and myself to a T, and I haven't missed one since the first issue—and don't intend to, if I can help it. My present set and past sets are the products of RADIO NEWS articles; and the one I have now is a humdinger, 5-tube, all-electric.

I think the ideal plan for broadcasting would be on this order; about six or eight station chains, about every 50 cycles apart, each having a station in every state and making their programs to coincide so that you could tune in on one chain "classical" music—another "jazz," another operatic, another speeches, and so on. In that way, no chain would interfere with another chain.

As far as paying for the program goes, the R. C. A. or N. B. C. chain certainly gets theirs from radio tubes, storage batteries, ginger ale and other advertisements. The first cost of a set is not the last. For, in a battery-operated set, there are new "B" batteries, "C" batteries, tubes, and once in a while new "A" batteries; in the electric sets, new tubes for both set and power unit,

(Continued on page 1081)



Dolores Cassinelli

*Former star of the
silver screen, who, as
the possessor of a
lovely singing voice,
is now heard over
the Columbia radio
chain.....*



Jessica Dragonette

One of the shining lights of the W&AF musical staff. - She has sung many soprano parts in programs broadcast over the W&AF network.



Sophie Braslau

*Operatic soprano who
is increasing her fol-
lowing of admirers
by singing before the
microphones of both
the Columbia and
the N.B.C. networks.*

Radio—The Alarm Clock of a Nation

By Julia Shawell



Arthur E. Bagley directing the Metropolitan Tower Health class before WEAFF'S microphone.

TWENTY years ago, if anyone had suggested that a great alarm clock, loud enough to reach out over thousands of miles, would be heard and heeded by millions some morning in the future, that suggestion would have been repudiated by the general public as a highly-imaginative modern fairy story, the result of some unbalanced mentality.

But now, radio waves carry an audible good-morning from coast to coast and from Maine to Florida. The world's largest gym classes gather around loud speakers in every state of the union, while even isolated followers of the call of calisthenics stretch their sleepy bodies up in the cold fastness of the Canadian woods, in the lonely cabins of tramp steamers in mid-ocean and in the

warmer habitations of Panama. More than a million people a day, over vast areas, willingly cut their morning slumbers and devote their stored-up energy to exercises which a few men in a few cities direct.

For more than three years now, radio enthusiasts have been reaching out their arms for better health, bending their bodies for slimmer waistlines, riding imaginary bicycles on the parlor floor to change the pasty, white-faced look to one of rosy cheeks and brightened eyes.

While station WOR was the pioneer in the idea of the morning round-up for gymnastics, the big chains of the country have adapted and developed the setting-up programs until now those opening broadcasts of the radio day are among the most popular features on the air.

WEAF's hook-up carries the "Metropolitan Health Tower" classes to all parts of the country, while WOR, still active in the early-bird gym field, has enlisted the Colgate Company to sponsor its classes, holding its sunrise audience with the latest commercial effort to make loud-speaker athletes of its followers.

FOUR YEARS' PROGRESS

Arthur E. Bagley, director of the Metropolitan periods on the National Broadcasting Company chains, was the first physical-culture director to break out into the wide-open spaces among the ether waves with his "bodies erect, up and down, right and left, keep smiling everybody," as the uncounted students of his health cult followed direc-

tions, bending and swaying in unison, though a thousand miles divided some of their numbers.

When Mr. Bagley organized his primer school of radio gymnastics he had a limited number of adherents, which grew and grew in size until some indication of its proportions was given in the deluge of mail which swamped his studio. The first broadcasts were in the nature of an experiment, tried out in the late spring of 1924. Would people take the trouble to turn their dials and follow an unseen instructor who was making them work when sleep was so treasured? Mr. Bagley had an idea they would and, as WOR was willing to test out his ideas, the radio gym class had its inception. Almost immediately, requests poured in for further directions, for charts, for individual advice and in commendation of the plan.

Throughout the bleak December dawns, and even in sultry August sunrises, these faithful pupils were held and the results were so amazing that the Metropolitan Life Insurance Company, with its 24,500,000 policy holders, conceived the idea of aiding some of this horde to better health and to longer lives. Mr. Bagley then became director of this new school, with large studios in the Metropolitan Tower, which sent out its first greetings in March of 1925, a year after he had initiated the service on WOR. Station WEAFF was the new designated broadcaster of the Health Tower classes.

Bernarr Macfadden then took over the WOR classes in conjunction with his activities for physical culture, added an

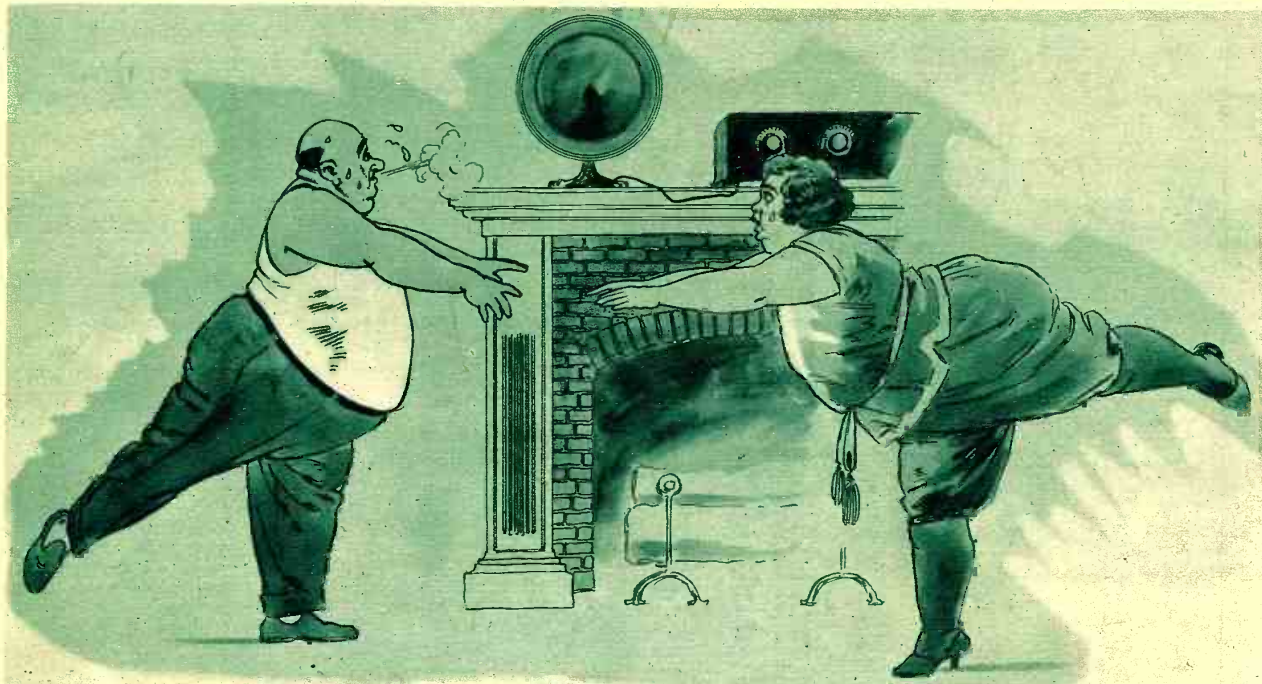

A part of the "Health Army," which consists of all shapes, all sizes, all ages and types, that daily rise to do their stuff before the loud speaker.

orchestra to incite further interest among set-owners and broadcast his theories and his practical ideas for many months. At the end of the year just closed, the Colgate people engaged the facilities of WOR for their own gym classes which have been developing previous programs, trying new suggestions to wake the public early and make them like it.

Since Mr. Bagley became associated with the "Health Tower" classes, more than 400,000 exercise charts have been sent out to persons who wrote for them. Many of these were to be used in families of from three to ten members. From these figures some idea of the enormous size of the radio gym classes on the WEAf chain alone may be glimpsed.

WAR ON THE FRONT SALIENT

At one time, the writer directed the gym classes at station WGBS (New York), which started at 10:00 a. m. and were designed for lazy women who just wouldn't get up early enough for the 6:45 or 7:15 classes, and for housekeepers who were too busy getting husbands off to work and children out to school to devote fifteen minutes of a busy period to even health measures. From personal experience, we can write that when a woman decides exercise will make her more attractive, the radio gym class is a proposition already sold to her and, whether she yawns in her downy bed on Park Avenue and slips out to thickly-padded floors or whether she runs in from the kitchen sink and her dishes to turn the dials, she's just as anxious to get that pleased feeling on the scales and to retain or attain attractive lines.

Brokers and boilermakers, clerks and clergymen, salesmen and sailors, fussy bachelors and sport-of-fate husbands, wives who have lost that girlish figure and whole families bent on being healthy, line up together at the call of a single voice, six days a week—and do they stick? Well, a glance

at some of the 400,000 letters in the Metropolitan files would convince the most difficult of the doubting Thomases.

Since his first class, Mr. Bagley has never been a moment late, never been absent a single morning, never broken his schedule. So there's no element of chance in "taking the air" for exercise.

Exactly at 6:45 o'clock, every weekday morning, on the N. B. C. stations and the WOR (Columbia) chain, as well as individual stations not allied with either group, the morning chimes or bell announces that the nation is ready for its daily dozen. This health army of all sizes, all types, all shapes and all ages bows its greeting to its unseen teacher and the fun begins. While the farmer's family in northern New York shivers and shakes off the chill zero weather, Floridians, warm in a sunny clime, evidence more perspiration but no more ambition.

All the healthy vigor that the travelling medicine men used to promise becomes not only a possibility but a fact for those who devote their first waking moments to the radio gym. All the promises which have been made are not rosier than the realization reached by thousands who have written with gratitude to those responsible.

Fat women take off the accursed pounds, anemic men take on vitality, family groups become energized, the grouchy breakfast look is wiped off with a smile; for few who stay in line for the class on the air can resist the plea to smile as they work off the sluggish conditions of their systems.

ENTHUSIASTIC FANS

The largest family group made up of faithful followers of the gym programs resides outside Newark, N. J. Mother, father and eleven children, two grandchildren and the family dog line up every morning at 7:15 o'clock and "do their stuff" for health.

The fattest fan who has made herself known to the broadcasters is a 323-pound woman in Michigan, who is slowly but surely



The Metropolitan Life Building in New York City, from the Tower studio of which are broadcast the exercises.

reducing that tonnage and who wrote that she is bent on getting back a figure—even though her husband, who weighs 375 pounds, said she is just a lapful!

What a story television would make if it could be used at 6:45 o'clock on the gym hook-ups! What a conglomerate lineup of humanity would be shown, and how many thousands would have to scurry to cover if they knew that their teacher was watching them!

A United States senator who does his daily dozen wrote Mr. Bagley: "I take your morning health exercises regularly, I thought I was to get something for nothing, (Continued on page 1052)

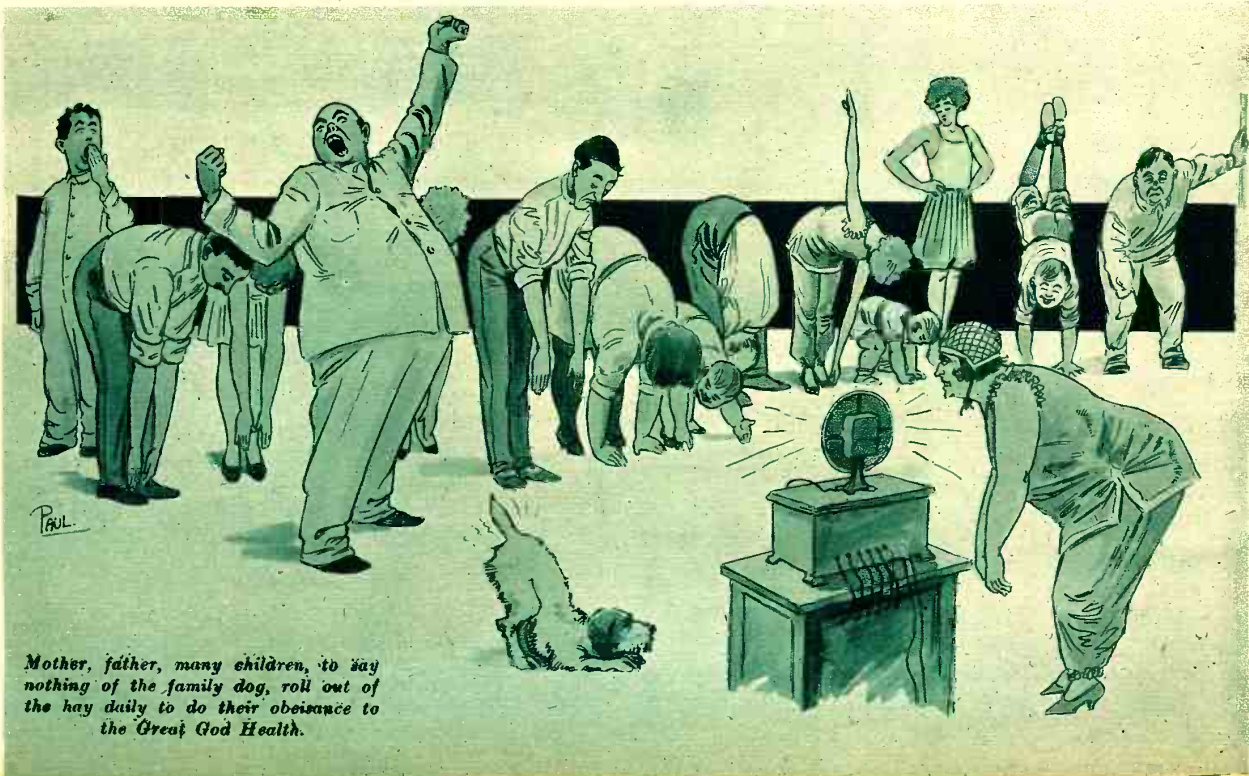

Mother, father, many children, to say nothing of the family dog, roll out of the hay daily to do their obeisance to the Great God Health.

Radio Novelties About the Globe

Some Oddities and Enterprises
Noted by News Photographers



In the above illustration is pictured a new French military motorcycle and side-car, which is equipped with a complete transmitting and receiving station. On the rear of the machine may be seen the bamboo pole to which is attached the antenna. The apparatus, which is under the hood at the back of the side-car, is operated from a seat at the front of the car. The apparatus is shown undergoing army tests.

© Herbert Photos, Inc.



In order to spread the message of radio, the largest and newest of Berlin's broadcast stations has equipped the automobile illustrated above to bring its programs to remote communities. The car is really a good-will agent, as it travels about Berlin and environs transmitting programs to the home station, for re-transmission on the regular wave. In Europe, the license fees paid by set owners provide the revenue for broadcasters, who are therefore directly interested in increasing their number.



Below is the interior of the good-will car of the Berlin radio station. With the apparatus installed therein programs may be picked up at points around the city and transmitted to the central station, where they are put on the air on the regular wave. Part of the equipment is a powerful receiving set with which the suburbanites of Berlin are treated to excellent programs.

© Herbert Photos, Inc.



NAVY RADIO MEN GET A CHANCE TO SEE THE WORLD FROM A LOFTY PERCH

Among the jobs not desired by the average man is that of inspector of the radio towers at Arlington, Va. Annually the Navy's experts examine the mammoth steel masts for loose joints, loose bolts, rust or other deficiencies. The illustration in the center of the page shows a moving picture being taken of one of the inspectors walking along the

of the girders high above the countryside. In the lower left photograph, taken from a point near the base of a tower, looking upward, the small "bumps" along the outer edge are sailors, climbing up and inspecting as they go.

© Underwood & Underwood

People and Radio as They Are Seen by the Camera



A "Mammy" song must have been coming over the air when the nurse in the picture below tuned in, for these ladies and gentlemen seem to be registering hunger. The idea of entertaining babies, while undergoing a physical examination, was tried in a San Francisco hospital, but, as the embryo radio fans protested vigorously, it was abandoned. Notice that the gentleman of color in the middle is the only one who is happy; is he trying the black bottom?

© P. & A. Photo.



When Clyde Smith of Bebe River, New Hampshire, returned to his home after the flood that swept New England, he found his receiver, shown above, under mud and water with the rest of his furniture. After it had been dried and hooked-up, the first station tuned in was playing "It Ain't Gonna Rain No More!"

© Federal-Brandes.

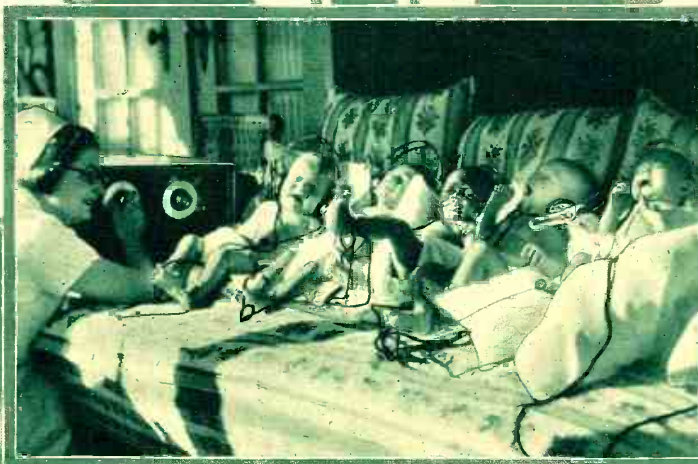

Signora Marconi, wife of the famous radio inventor, is shown above with a portable radio receiver, which is nearly unique, in that there is only one other like it; that being owned by the Prince of Wales. Senatore Marconi himself designed the set, which has an A.C. power unit and batteries enclosed.

© Herbert Photos Inc.

Dr. W. R. Whitney, director of the General Electric Co.'s research laboratory at Schenectady, with Christy Mathewson, second, son of the baseball star, who is a graduate engineer. (Below)

© Wide World Photos

Rev. W. C. Keeler of Iowa City, Ia., preaches from his bed of sickness to his congregation at the Methodist Episcopal church. A loud speaker occupies the pulpit. (Below)

© Herbert Photos.

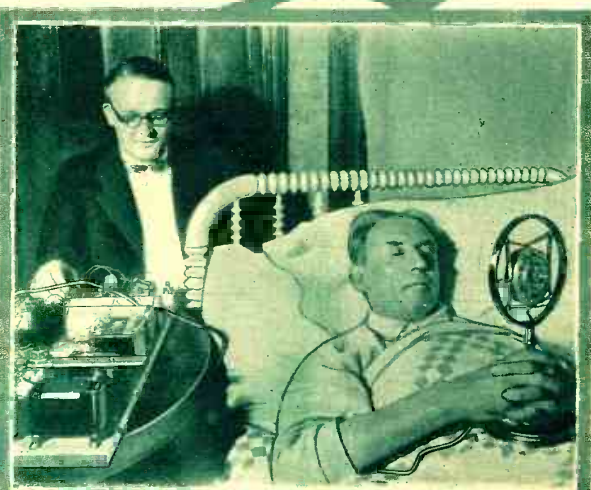

ROASTED BY RADIO

By C. Sterling Gleason

UPON a huge indoor stage, in the great Harold Dare motion-picture studios, were armored knights, beautiful ladies in gorgeous costumes, squires, yeomen, serfs, and villains of all sorts, mingled in reckless confusion; for the latest and greatest of Harold Dare super-spectacles was now in the making. On a large movable platform stood Harold Dare, clad in a shining suit of mail, megaphone in hand, assisting his most efficient corps of directors to prepare for the great tournament scene.

A voice called: "Mr. Dare!"

Dare turned, and saw standing beside the platform, a knight, fully armored and with his visor pulled low over his face. Dare opened the note he proffered.

"I must see you at once, alone. Follow this man. Gloria."

Harold Dare spoke to his chief director. "I shall return in a few moments. Let the picture proceed."

He turned and clanked off after the messenger. He was frankly puzzled. This was quite unusual. Gloria, oft his sweetheart before the camera—and, the public was wont to believe, in real life also—had never before so summoned him. What could this mean?

His perplexity increased as his guide led him into the extreme wing of the main office building, in which was located the studio and equipment of WROT, Harold Dare's own broadcast station.

His guide paused before a door marked "Operating Room." Here, Dare knew, was located the major part of the immense

equipment comprising WROT. With mounting suspicion, Harold Dare looked at the man in armor.

"She is inside," said the knight. "Inside the room."

Clumsily, Harold Dare's great gauntlet closed about the door-knob. Cautiously he pushed the door open. Yes, there was Gloria, seated in a chair. She wore a strange expression of terror, and Dare saw that she was trembling. He stepped into the room.

He caught a flash of it as it descended upon him and, even as he strove to raise his arms, it pinioned them at his sides.

He found himself imprisoned in a tall cylinder, which enclosed him up to the level of his chin. In her chair, Gloria sat motionless. In the opposite corner of the room stood a tall, black-haired, evil-faced man, and in his hand he held an ugly automatic.

Gloria screamed; but black Dandy Diavolo strode forward and seized her. "Gag the girl!" he hissed at a henchman. A villainous-looking individual drew forth a neat gag and fastened it firmly in place. In a moment Gloria was bound hand and foot.

"What does this mean, Dandy Diavolo?" demanded Dare, although he suspected well enough the intent of his captor.

"It means, Harold Dare," replied Diavolo, "that you have scorned me too long. Now you must face the consequences!"

Gag in hand, he advanced toward the helpless hero. Harold suddenly threw him-

self forward. He tottered—and three brawny henchmen caught the falling cylinder and righted it again. They removed Dare's helmet, gagged him securely, and replaced the helmet.

"Now, my fine fellow," sneered Diavolo, "you are going to rue the many times you have blocked my plans. You have begun to believe that because you triumph over me in every super-spectacle you must inevitably do so in real life. But you are wrong, Harold Dare. In this episode of your career—and it is to be your last—triumph is mine!"

Diavolo took from a package a large roll of heavy, flexible copper ribbon. He fastened one end of it to a binding post on the end of the cylinder. Looking down, Dare saw that the tube was wound with countless turns of fine insulated wire.

Diavolo unrolled the tape and stretched it from the cylinder over to one terminal of a meter on the transmitting panel of WROT. Another lead he strung from the cylinder, and wrapped the other end of it about a turn of a huge transmitting inductance.

"You may be interested to know, Harold Dare," sneered Diavolo, "that you are inside a great coil of wire, an enormous inductance, which we have connected to the huge transmitter of WROT. Now let us see if your super-mind can recall some facts regarding induction. Of course you know that when a conductor is placed in the field of an inductance through which current is flowing, currents are induced in the conductor. Because of the resistance of this conductor, the energy thus induced is dissipated in the form of heat. This heating effect becomes more pronounced as we increase the frequency of the current. So, it is readily imaginable that, if we feed our inductance a large current at a very high frequency, the heat produced in the conductor may become considerable. This phenomenon is the basic principle of the high-frequency furnace, with which metals may be melted—in *vacuo*, if you wish—simply by the action of high-frequency currents. Now you, Harold Dare, are in the field of such an inductance, and although you yourself are perhaps not a good conductor, your armor will be entirely satisfactory. You, the invincible, will be roasted alive in your armor! And then we—Gloria, and I—will leave you to your public.

"That fair female shall rue the day she scorned my advances. I remember well the day our company was out on location, when we both offered to share our lunches with Gloria. I remember well that she refused the cheese sandwich I offered her from the fullness of my heart, and accepted instead the one of roast beef which you handed her. Very well! If she prefers roast beef, she shall have it; for with the help of my

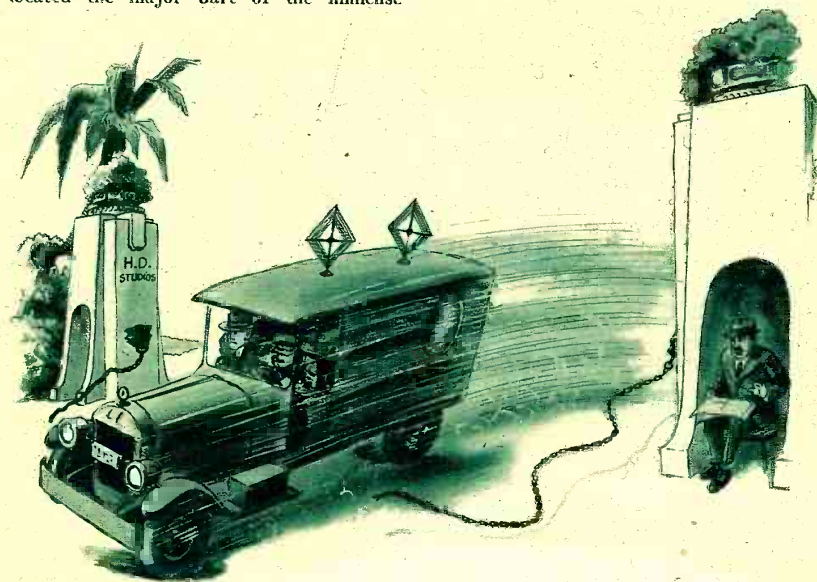

The car careened and swung into the studio driveway. With a bound it struck the chain stretched across the gate, snapped it, and skidded up the driveway.

radio-frequency oven, you, Harold Dare, shall be merely a great roast of beef!"

As he pronounced these ghastly words, Diavolo stepped to the transmitting panel. He made sure that the transmitter was disconnected from the antenna. The tubes had been glowing for some moments, and now he threw a switch. In a far corner of the great room, huge generators began to whirr. Diavolo noted the readings of the plate-supply voltmeter. He waited until it had reached a maximum; then he began slowly to turn the large fiber wheel which provided a vernier adjustment for the main tuning condenser. Meters sprang to life. He regulated rheostats and adjusted various other controls. Gradually he brought the radio-frequency circuits into resonance. The large radio-frequency ammeter climbed as the output increased.

Inside the suit of armor, Harold Dare felt his hair gradually rise, until it seemed to stand on end. His skin prickled. The armor became perceptibly warmer; his iron-meshed gauntlets became almost comfortable.

Diavolo gave the vernier condenser a final twist, and advanced the filament rheostats to their utmost. The meters leaped. Dare felt a surge of warmth. A gentle ticking sound, and a light smoke arose from the tube upon which the coil was wound. Gloria sat hypnotized. Dare signalled her with his eyes to be brave. With her own glorious orbs she sent a beseeching glance toward Diavolo; but the arch-fiend's heart of stone was impervious even

to such pitiful appeals. Her eyes filled with tears.

The armor was becoming uncomfortable. Dare's clothing was scorching; the helmet made his head feel as if it would burst. The joints of the armor made a cracking sound as they expanded. A curl of smoke arose from inside the armor, and trickled through the open visor of the helmet. Gloria saw waves of heat ascend, she could feel them herself. . . . She would have screamed, but the torturing gag stifled her cries. . . . Then she swooned.

Yet through all this time of terrible trial and torture, dauntless Harold Dare kept a cool head. He saw that Gloria was unconscious, and gave thanks. She at least was not suffering. A dozen, or more, ideas passed through his mind. He himself was powerless; he could hardly expect anyone to be searching for him soon, for he had given orders for the picture to go on in his absence. If he could only summon help.

The armor was unbearably hot. He tried to shift his position, and found that he could move his arms back and forth a few inches. He swung them helplessly.

He looked toward the transmitting panel. A needle caught his eye; it was swinging rhythmically back and forth. Unconsciously he timed its arc.

Gradually it dawned upon him that it followed the motion of his arms. He groped aimlessly for an explanation. Changing the position of his arms seemed to affect the amount of current flowing in some circuit of the huge transmitter. Why?

Then he found the answer. A wild hope seized him. His movements became purposeful. Energetically he swung his arms, clumsily enough in the heavy armor, but with definite intent.

* * * * *

A government radio field car was nosing deliberately down Hollywood Boulevard. Inside, Assistant Radio Inspector Merritt sat at the tidy bank of precision receiving instruments. He was checking the wavelength assignments of various broadcast stations, for complaints had come in regarding several small stations in that vicinity.

As he passed down the scale, he came upon a powerful whistle, as of the carrier wave of a high-powered broadcasting station. He listened. An unearthly sound it was, for not only did its pitch waver slightly, but its intensity seemed to fluctuate, so much that the whistle became a veritable warble. What could such actions mean? Inspector Merritt's jaw grew grim. The operator in some powerful station was amusing himself by playing with the controls. Surely such actions came under that section of the Radio Act prohibiting unnecessary signalling or malicious interference.

Yet this was a queer sound. He plugged in an audibility meter, with which to measure the intensity of the signals. The meter swung far across the scale, then saw-sawed quickly back and forth. Impatiently the

(Continued on page 1050)



Inspector Merritt quickly raised his pistol. He pulled the trigger and the insulator which held Diavolo's R.F. line shat-

tered, letting the bare copper tape fall across a heavy bus wire. A great arc of dazzling green, and the long ribbon melted.

This is Station 2LO, London, England, calling



By Dale Pollack

HOW many fans can truthfully say that they have actually heard the words above? Or perhaps: "You have just been listening to a piano solo from station IRO, Rome, Italy;" or maybe: "You are listening to an after-dinner concert being broadcast from station JOCK, Nagoya, Japan, owned and operated by the Nagoya Radio Broadcasting Company."

How would you like to build a set that will get all these stations and more? And it won't cost you a fabulous sum either; it can be made for less than five dollars. I knew many people who would be willing to pay \$100 to get San Francisco once a month. Then, too, the average constructor has all the parts needed in his shop anyway, and need go to no other expense.

The hook-up has been tried and proven, and so you need have no fears that it will not work. I myself have built a half a dozen of them, and not one of them has ever failed to work.

Now you too can pull the bluff with the best of them. You can now argue with the fellow who has that ten-tube superhet. With this marvelous set you have no more static to contend with; and if anyone does not believe it, just let him listen to this marvelous set. As for clearness, selectivity and quality, it has them all beat. Nothing can compare with it. The problem of fading has at last been solved. No more of it with the set described here.

A TWO MAN PROPOSITION

Of course, you must think there must be some hitch to it, but I can assure you that there is none at all. In spite of all its qualities, however, it has one fault; that is, it needs two people to operate it. One person cannot run this marvelous set. But don't let this make you think that it is complicated; as a matter of fact it has only one tuning control. Even this can be dis-

pensed with, but no one will believe it is a radio set if it has no controls, so we had better place one there. There is one other thing that can hardly be called a control, but which nevertheless is important. It is a push button, such as used to operate doorbells. It does not have to be placed near the set but it is the real control that tunes in the stations.

So far you have been kept in suspense as to the hook-up of this super-radio set. I am calling it the "Super-Bullodyne," because it is a sure cure for all radio liars. Just have them listen to it once and they will be cured of blowing about their sets forever.

THE LAYOUT

The extremely simple hook-up, or rather part of it, is shown in Fig. 1. You will note that there is no aerial to be bothered with; even this has been eliminated in the "Super-Bullodyne."

All you have to do is to run a length of double wire (such as annunciator wire, lamp cord, or Christmas-tree wire) from your regular radio receiver to any place in the house that is not within hearing distance of the receiver. (This latter point is very important, as you will shortly understand.)

A small microphone and a flashlight lamp are needed in the attic or cellar, or wherever you run the double wire. There are available on the market a number of small, inexpensive microphones which are ideally suited for use in the "Super-Bullodyne." The entire trick is to connect the microphone to the primary of the first audio-frequency transformer in the set without disturbing any of the rest of the amplifier wiring. It may be a good idea to remove the detector tube from its socket, or to leave its filament turned off; otherwise the microphone is likely to be short-circuited through the plate circuit. Make sure that your amplifier tubes light when you have connected the batteries and turned up the rheostats.

HOW TO BRING 'EM IN

You may be asked some undesirable questions as to the number of tubes, the parts, etc. I would advise those who anticipate such queries to throw in a lot of junk; such as spare parts, clock wheels, old tires, wire, or anything to make it look more complicated. Then you can say that you have lost the hook-up, and let them try to trace the circuit. There is another much simpler device to quiet questioners; it takes its most efficient form in the shape of a padded baseball bat. Its operation is obvious.

Here is the "modus operandi" of the Super-Bullodyne. Station your confederate, the indispensability of whom has already been pointed out, at the hidden microphone, to broadcast the program from whatever station you wish. Assemble your friends in front of the "Super-Bullodyne." Whenever you wish to tune in a station, simply press the push button, which will light the signal lamp and warn your assistant. You can readily arrange a suitable code—a certain number of flashes for each station—which will prevent confusion. A phonograph in front of the microphone will make

(Continued on page 1061)

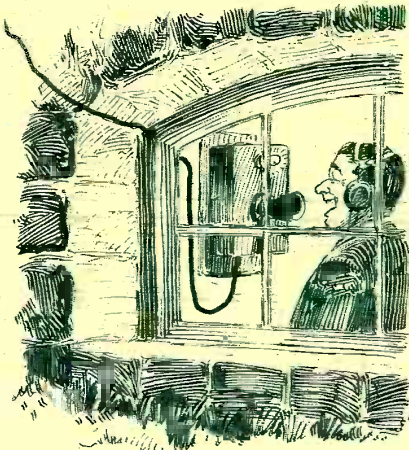

Wisdom for Radio Widows

A Straight-from-the-Shoulder Talk to the Woman Whose Husband Belongs to the Order of the Sleepless Knights of DX

By Larry Triggs



DX, DX! Ah! Whisper it softly, you Mrs. Greens, Mrs. Smiths and Mrs. Joneses. Breathe it gently into the ether whence it is to be sought and sometimes found. For it is a sacred thing, as you shall see. You who promised to love, honor, and obey your radio-fan husbands, you who darn their socks and bake their favorite pies, you who look to them for solace in time of woe, for pay-checks when the larder runs low and new frocks when it is spring—let not your hearts be troubled

with bounty from an ethereal world of jazz bands, bedtime stories and chain broadcasts. You will probably remember that first shriek from the basement the night John finally got the radio set hooked up. Wonder of wonders! With his own hands he had created the miracle which spanned continents and whispered back to him what the other half of the world was doing. The shriek came when he put on the headphones and was able to distinguish a jew's harp solo from the station on the other side of

town. Think you he slept that night? Fond woman!

Then arrived that strained period of apprenticeship which came finally to fruition in John's announcement that he was going to build a set that would get DX. Ah, mystic symbol! Breathe it softly!

You stood, arms akimbo, the fires of rage gnawing at your breast. All those weeks of nagging him to quit fussing and come to bed, or stop fiddling down there and go see what Junior's doing in the attic; all these, were they all to be done over again? Right in the middle on a wonderful concert from BOOB, was John again to spring suddenly from his chair, pliers in hand, to tear the very entrails from the machine in order to correct a slight distortion in the tone? And was he to do it again, and again, and again? And was the radio always going to be in the basement, dismembered, when company came—and with such a good program on from WUMP, too?

THE ENDLESS QUEST

Ah yes, fond woman! All these things were coming again and again and yet again. And did you let a little fire kindle in your chest and grow larger and larger, all because you didn't understand DX, or your husband? Ah, tragedy—for John, patient beast.

He wrought this miracle with his own two hands—he who couldn't have fixed a

(Continued on page 1042)



You stood, arms akimbo, the fires of rage gnawing at your breast, fussing and fuming at John while he tried for DX.

nor your minds be vexed. For it is a thing which surpasseth understanding, at least for most radio widows.

Your shoe-store-clerk or bank-president husband had probably never made anything with his hands before in his life, except possibly an elder-stem whistle or a cat's cradle. Or he might have even built a footstool once, or fixed the kitchen sink. But these things are as rain on the sea. They are commonplace creations of a moribund world. They hold as much mystery as a plate of apple sauce.

A STRANGER IN THE HOUSE

But, ah! the night John came home with a radio catalog under his arm! Then began that mystic tutelage, that divine ministrations from other spheres whereby John became a priest in the temple of vacuum tubes and "B" batteries and wrought with his own hands the miracle; the miracle that gropes in the outer darkness to return laden



questing to the ends of the earth for some faint sign, for some faraway signal, no matter how weak, getting DX and other things.

The United States—A Broadcast Studio

Forty-Seven Stations Broadcast \$1000-Dollar-a-Minute Program With Microphones at the Four Corners of the Country; 12,000 Miles of Telephone Lines Used in Tie-Up

By Joseph Riley

A STATION hook-up, termed "the greatest mechanical achievement in radio telephony ever attempted and the costliest program thus far given," gave millions of fans an hour of enjoyment on January 4, 1928. Not only was the program remarkable from an engineering standpoint, but it offered to the radio public a gathering of theatrical stars such as seldom has been grouped into sixty minutes of broadcasting.

Phillips Carlin, in New York, started off the hour by introducing Will Rogers, who was then seated before a microphone in his own home in Beverly Hills, California. The western microphone was then switched on and, in his own unique style, Rogers talked a few minutes, as befitted a master of ceremonies. He then introduced Paul Whiteman and his orchestra (who were back in New York) saying that Whiteman was "the man who brought opera up and jazz down, their meeting place being at his orchestra." The microphone in New York City was then switched on to the network,

and the wonderful strains of George Gershwin's "Rhapsody in Blue" went out over the forty-seven stations.

At the conclusion of the number, the California microphone was again put on the air and Rogers introduced Dorothy and Fred Stone, who were playing at the Erlanger Theatre in Chicago. From a dressing room in the theatre, Stone and his daughter broadcast several songs. Following came a short talk from Detroit by the sponsor of the program, Edward G. Wilmer, president of Dodge Brothers, Inc.

From California again, Rogers introduced the man known to thousands for his "Mammy" songs, Al Jolson, who was in the heart of the mammy section of the country, New Orleans. After two or three songs of, and from, the South, Rogers made his final talk of the evening, reintroducing Paul Whiteman, who wound up the program with two popular jazz numbers from New York.

before the vast radio audience, estimated at more than twenty-five millions, approximately 12,000 miles of telephone lines were employed. Engineers of the National Broadcasting Company, in conjunction with engineers of the Bell System, which supplied the lines across the country, worked on the arrangement for several weeks. During the development of the plans, many complications arose, especially with respect to synchronizing the widely distributed switching centers. It was imperative that the most careful timing be maintained, in order to run off the program smoothly.

The transcontinental line which carried Will Rogers' introductions was routed through San Francisco, Salt Lake City, Denver, Omaha, Chicago and thence to New York.

In readiness in case of trouble was an emergency circuit from San Francisco through Dallas, Little Rock, St. Louis, Chicago, into New York. Then, in addition, were the usual telephone lines, required to

LONG LINES USED

To bring these widely-separated persons

(Continued on page 1044)

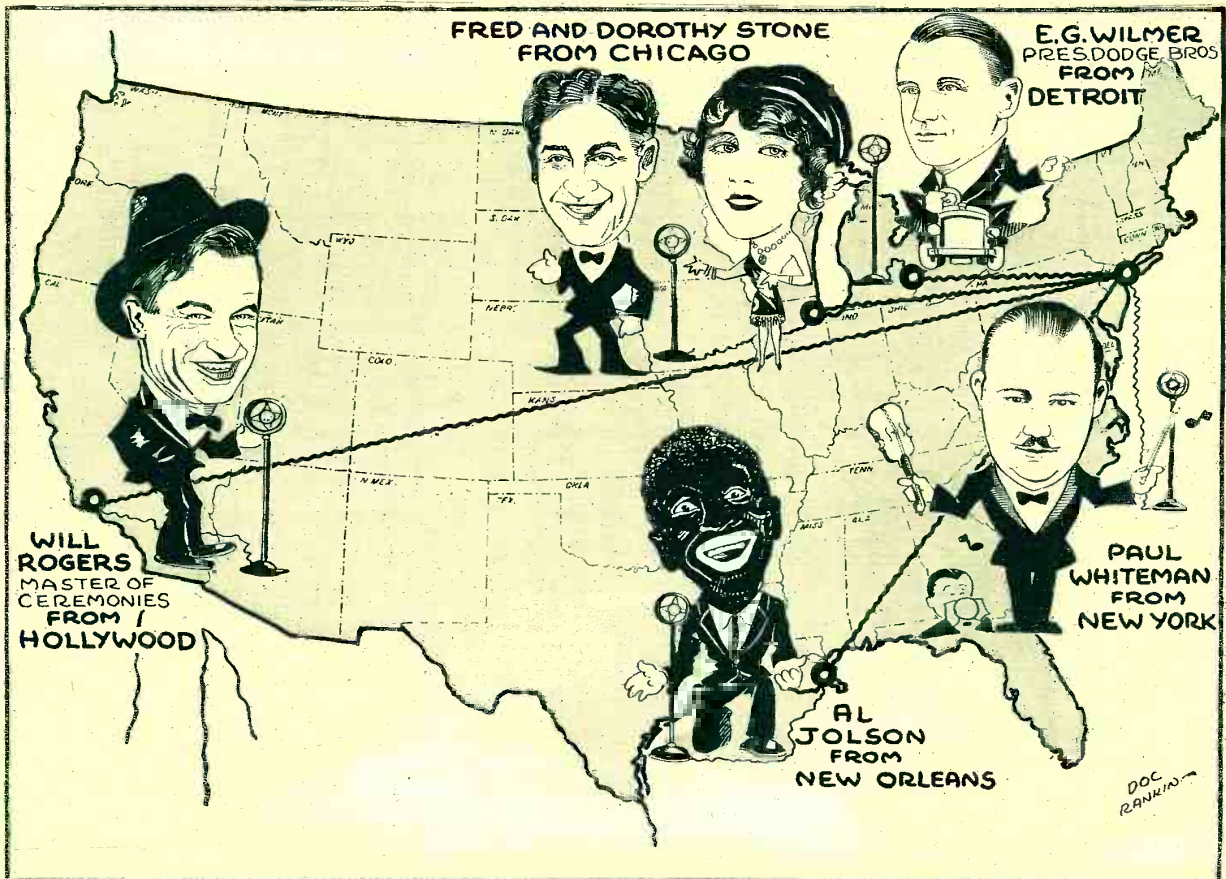



BRIDGE *by* RADIO

by G. C. B. Rowe

"I bid four diamonds.
 "Four spades."
 "Five diamonds."
 "I double the five diamonds!"
 "Redouble!" And the fight is on!

TEN years ago the above dialogue would have meant little if anything to the average man; but today it would be instantly identified by a majority of people as conversation emanating from a bridge table, whether it were heard on Fifth Avenue, Main Street, or in the middle of the Sahara Desert.

The question might well be asked, "Why this sudden interest in the game of bridge?" Taking into consideration many viewpoints, it seems safe to say that, more than to any other factor, the present popularity of the game is due to the broadcasting of bridge games over the radio. Consider for a moment the vast number of people who have listened in to the games for the past two years, and it will require little reflection to come to the conclusion that, even though many radio set owners originally knew nothing whatsoever about the game, they listened in now and then, gradually becoming interested. Bridge is similar to the game of golf in that, once the "bug" has bitten you, there is little hope that you will not become an enthusiast.

Another reason why bridge appeals to so many people—and in this respect it is unlike the game of golf—it makes no difference how bad a duffer a person is at the game. Even though he knows none of the many conventions, he can gain a vast amount of pleasure from playing, as the

fundamentals of the game are very simple. And then, too, with the examples of expert play brought to him weekly over the air, he can look forward to improving his game, thereby obtaining greater satisfaction from a growing appreciation of its finer points.

THE WEEKLY BROADCAST

The games which are put on the air every Tuesday at 10 P. M., E.S.T., from WEAJ, its twenty-six associated stations, and forty-seven independent stations, exemplify the correct conduct of hands that have actually been dealt in a game. Wilbur C. Whitehead, the foremost player in the United States, together with Milton C. Work, a player of the highest rank, choose the hands from actual play and then decide on how they should be bid and played. These two gentlemen take part in every game put on the air, and their partners are players of excellence, from different sections of the country. The bridge hands in which these other players will participate are sent in advance to them for their approval of the method of bidding and play.

A great many people have the impression that the games which are broadcast are manufactured hands: i. e., hands especially made up to illustrate different points in bidding and play. This is not done, for a very important reason. In every hand that is dealt there is an inherent probability that the cards will fall, according to a definite mathematical law, in an order scattered between the suits and denominations. For example, suppose two partners have seven cards of a suit between them. It is known, then, that in a certain number of

cases the remaining six cards will be divided between the two hands of the opponents, four and two; that all should be in one hand would be a rare occurrence. Therefore, an expert player can tell, almost at a glance, by the way in which the cards are distributed among the four hands, whether they are a "true deal," the result of pure chance, or have been rearranged by human design. In other words, to broadcast the bidding and playing of a deal in a way that will correctly illustrate certain features, the natural "card design" must be maintained, and this is possible only by actually dealing the cards.

METHOD OF ILLUSTRATION

When, in 1925, it was first decided to broadcast bridge games, a great deal of discussion arose, among the originators of the scheme, as to the manner in which the games should be put on the air. John H. Smith, who, with Mr. Whitehead, recently won the bridge championship of the United States, devised the method which was later adopted by the U. S. Playing Card Co., the sponsors of the broadcasting of the games.

The method is roughly as follows: first, the listeners are advised to have ready a deck of cards separated into the four suits. Then the respective holdings in the four hands are slowly read, the players being designated by the four points of the compass. After the four hands have been read off and the cards arranged, the bidding is made, with the bidder's reasons for each bid explained from the standpoint of his position. Then the play is started, and the

(Continued on page 1049)

Caring for the Socket-Power Units

Some Valuable Suggestions that will Aid in Securing the Longest and Most Satisfactory Service from Accessories of this Type.



By Charles Magee Adams

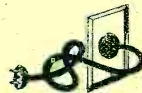

NOW and again some over-enthusiastic and under-informed salesman (and, unfortunately, some advertising writers as well) can be found confidently informing purchasers of socket-power units that, as regards care, this equipment "can simply be installed and forgotten."

Conceivably, it can. The driver of a car can also forget to supply his engine with oil and water. But few will think it wise to do so, at least after a first experience; and much the same holds with a radio socket-power unit.

The amount of attention required by any properly-designed and well-constructed device of this type is trifling. But such attention—intelligently directed and regularly applied—is indispensable. With it, the unit will function satisfactorily and dependably over a long period. But without it, the service supplied will become progressively more unsatisfactory, finally failing altogether.

This care, too—as too frequently is not recognized—must begin with the installation. Many socket-power units are being brought for receivers already in use, and there is a tendency to fit them into the existing installation in the simplest way, without any thought for their particular requirements. But this procedure often proves to be the cause of unsatisfactory results.

VENTILATING THE UNIT

A power unit must be installed with as much consideration for its operating requirements as any other piece of radio equipment; which means, first, that its location must permit ready accessibility for maintenance, and second, and still more important, that it must allow for ample ventilation.

The latter is essential, because *all units radiate a certain amount of heat during*

operation. Obviously, this must be carried away if the unit is to be kept at a safe temperature. If it is not, the results may be too-rapid evaporation of electrolyte, damage to rectifiers and filter condensers and, in extreme cases, to transformer windings.

Accordingly, if the unit is being installed inside a console cabinet, as is frequently the case, care should be exercised to see that the enclosed space contains a sufficient volume of air to

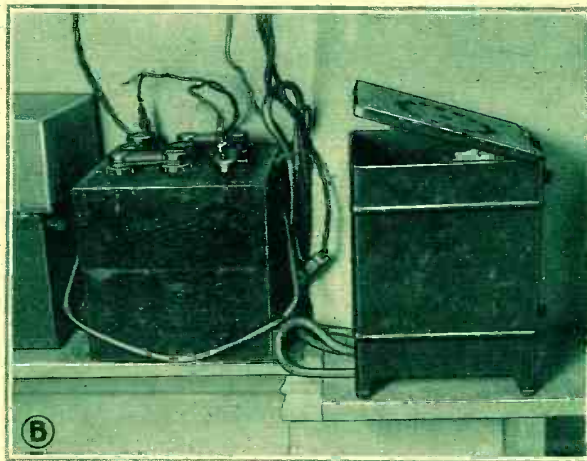
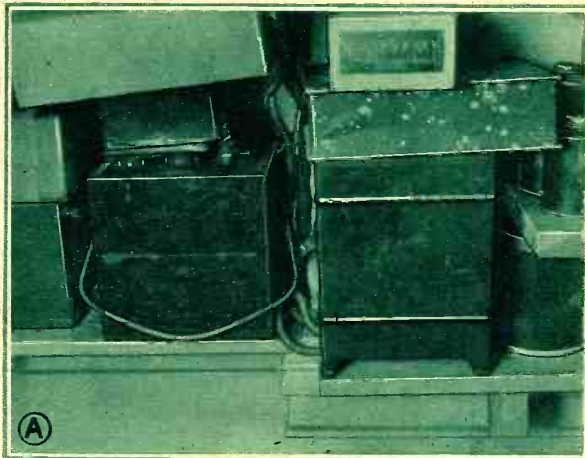

THE WRONG WAY AND THE RIGHT

(A) The wrong way to keep the storage battery and its charger; pile all the loose junk in the house over them, so that they will not have any air circulation at all around them.

(B) The right way; keep everything free and clear, and raise the lid of the charger, when it is in service, so that the generated heat can escape. Dust and wipe the instruments frequently.

(C) The easiest and safest way of putting the water into an "A" socket-power unit of the kind which employs an electrolytic condenser. Use an ordinary pitcher and a kitchen funnel. Never use the storage battery hydrometer.

assure adequate cooling. If it does not, a small opening at the back (or in some other location that will not be unsightly) may solve the problem without difficulty.

Also, when the unit is located outside the receiver cabinet, say on the floor, it should not be covered for the sake of appearance, or surrounded by other objects, in a way to prevent the free circulation of air. Most of all, if it is placed in the basement under the receiver, particular care should be

taken to be sure it is not near the furnace or any heating pipes which will cause the temperature of the surrounding air to be higher than normal.

The other detail of installation requiring attention is to keep the flexible cord connecting the unit with the lighting-circuit outlet as far away from the aerial and other receiver leads as possible. In some units, this cord is shielded to prevent induction by the alternating current; but in some it is not, and this precaution will eliminate the excessive hum which might otherwise be caused.

FOLLOW DIRECTIONS

When properly installed, the next point of importance is to see that the unit is placed in operation, for the first time, in exact accordance with the manufacturer's directions. This is particularly essential in units employing electrolytic rectifiers or electro-



lytic filter condensers. These require a preliminary period of "warming up" for "forming" the plates; and directions covering this should be followed to the letter. They are specified for good reasons, and satisfactory results cannot be expected unless they are carried out exactly.

Once it is put into service, the most important point in caring for a socket-power unit is, as previously suggested, that this care be regular. A few minutes of intelligent attention at stated intervals (not too long) will, not only keep the unit in a condition for giving better performance, but go farther toward eliminating serious trouble

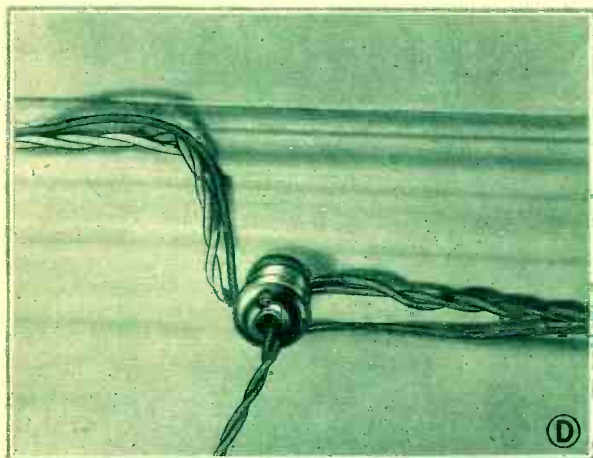

(D)

than several hours of spasmodic attention; and at most the amount of time required is small.

Adding water is an apt example. If the unit employs a storage battery to supply "A" current, it will be necessary to add water to this from time to time. If it is added at regular intervals — say, once a month if that proves necessary—the power supplied will prove much more dependable and the battery's life considerably longer than if it were neglected till the electrolyte level became dangerously low.

CHECK UP ON IT

Another detail requiring attention when a battery is used in checking the charge. Hydrometer readings should be taken before water is added (unless some visual means of indicating the charge is provided, as some manufacturers do); and if the specific gravity falls below the figure specified the charging rate should be increased or the receiver left idle for a day or two. Conversely, if an overcharge is shown the rate should be reduced. The rate itself will probably have to be adjusted to fit the particular operating conditions, which can be done after a little trial.

Distilled water must be added also to electrolytic condensers as well. In the former, it will be necessary to renew the solution after a prolonged period of operation, besides replacing electrodes. These details are

covered by directions accompanying the unit.

It will be noted that, with rectifiers of this type, manufacturers often warn against using the hydrometer or syringe employed in adding water to batteries. *The reason for this is that the solution used in rectifiers is usually alkaline*; with the result that even a slight taint of acid will cause serious damage. Great care should accordingly be exercised on this point, and some means of adding water used, other than that employed in connection with the battery.

If the unit employs electrolytic rectifiers or condensers, it will also be noted that the manufacturer recommends a period of "warming up," similar to that at putting into service, after the unit has stood idle for a prolonged period. This is necessitated by the fact that the plates must be "formed" again, as at the beginning, and such directions should be followed carefully, otherwise a distressing hum will be the result, and possibly serious damages as well.

RECTIFIER TUBES
In units using filament type rectifier

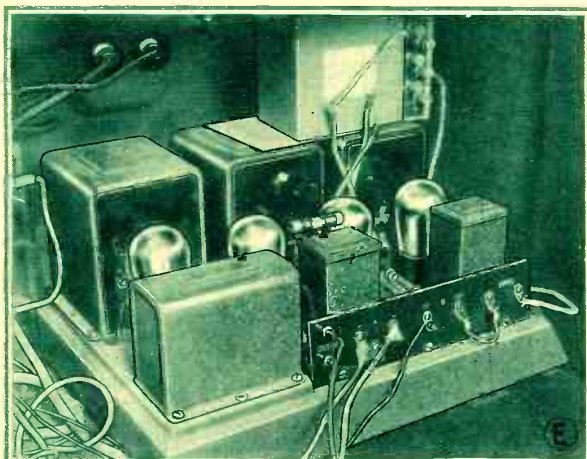

(E)

KEEP EVERYTHING IN THE RIGHT PLACE

(Above)
(D) A fine way of causing a lot of troublesome hum in the loud speaker—draping the aerial wire around a 110-volt A.C. lead. If you must run these wires near each other, separate them as far as the available space allows.

(E) The power amplifier and rectifier tubes of a set get very hot in operation, so keep them clear of obstructions of all kinds. Nothing should be nearer to them than about three inches.

(F) The heat developed by the aforementioned tubes may be great enough to char the wood of a cabinet; so if the cabinet holding your socket-power units is not already ventilated, bore a few one-inch holes in the back, as shown, and also a few in the bottom.



(F)

tubes for the "B" supply or "A" charger, failure of these to light is generally depended on as an indication of trouble; but this is scarcely to be recommended. Whenever the charge seems insufficient or the receiver "lacks pep" after six months to a year of operation, it is always well to try replacing these tubes. They will often be found to have deteriorated, though still lighting, as do vacuum tubes in receivers. The gaseous-type rectifier tubes will also require replacement after long use.

Though not actually part of the power unit, it is essential that the "C" batteries be not neglected if these, rather than the socket-power unit, are depended on for negative grid biasing. Because practically no current is drawn from these, many fans regard their life as endless; but, as a matter of fact, they deteriorate merely from age. A check of "C" batteries every few months will assure that the "B" side of the unit is free from excessive current drain and decreased voltage and maintain the tone quality at a high level.

UNIT MUST BE SUITABLE

Another word of caution seems necessary, about buying a new receiver to be supplied by a power unit already in use. When this is done, be certain that the unit, particularly on the "B" side, is of sufficient size to meet the demands of the new receiver. This can readily be determined by reference to the milliamperage consumption of the receiver and the capacity of the unit; and trouble frequently encountered through overloading may in this way be avoided.

Also, if the receiver and unit are designed for the use of 199-type tubes with filaments in series, the power rheostat should never be turned to a milliamperage reading higher than 60. Though this may not seem a definite part of the unit's care, it is so, nevertheless; because turning the rheostat higher overloads the unit as well as the tubes, with results not the best for either.

And finally, do not make a practice of tinkering with the receiver while the power unit is turned on. To be sure, there may be times when adjustments are required with the set "live" and, when they are, strict precautions against short circuits should be taken; such as the use of insulated tools. These are important because, while with batteries such a short-circuit of the "B" power might mean merely a running-down of the batteries; with a "B" supply device it may well mean the burning-out of equip-

(Continued on page 1053)

Broadcaststatics

HEARD ON THE SPEAKER MAGNET

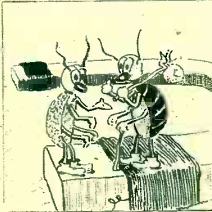

FIRST RADIO BUG: "You've been gone a long time. Where were you?"

SECOND RADIO BUG: "On a little exploring trip to the North Pole."

—Leslie Carpenter.

PRACTICE MAKES PERFECT

FIRST HUSBY: "Is your wife getting much help from the daily cooking hour?"

SECOND HUSBY: "Oh, in a way. This morning she got three new recipes while she was letting the pie burn."

BY RADIO

(To the Broadcast Artists)

The spot where I would like to be,
Is far away by a tropic sea,
While all you artists played for me,

By Radio.

I'd bask all day in the oanyan shade,
As the natives danced and the monkeys played,
Just drinking in your serenade,



By Radio.
And while you toiled in a Northern freeze,
I'd loll at ease in my "B. V. D.'s,"
Taking my winter—if you please—



By radio.
The only thing I'd ever do,
Would be to turn a dial or two,
While gladness you'd keep sending through,



By radio.
And when the long, bright day was done,
And the tropic moon relieved the sun,
I'd still loaf on and enjoy your fun,

By radio.
In fact, 'twould be my chief delight,
To stiek around in the pale moonlight,
'Till the last of you had said "Good Night,"

—Roy Coleman.

EXIGENCIES OF A CAMPAIGN YEAR

BLINKS: "The senator's a consistent prohibitionist, isn't he?"

JINKS: "I'll say he is. He wouldn't even have a wet battery on his radio set!"

—William G. Mortimer.

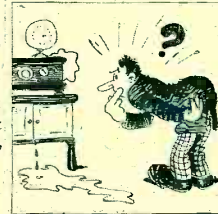

A LOSER

GRIDD: "Jimpson looks discouraged. Has he received some sort of a setback?"

LEAKE: "Well, the installment man did."

RADIO TERM ILLUSTRATED

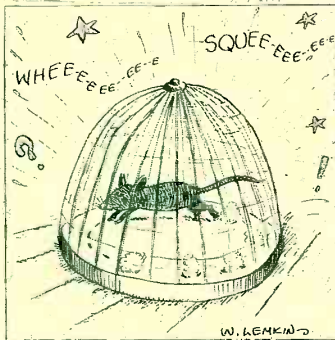

"A Single-Circuit Squealer"

SIMPLIFIED

TEACHER: "Johnny, how do you spell Schenectady?"

JOHNNY (Without hesitation): "W. G. Y."

HOME, SWEET HOME!

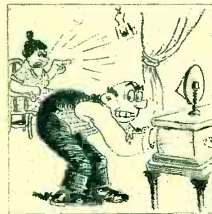

"Meeker's wife is such a persistent back-seat driver that he's decided to stay home and spend his evenings with the radio."

"What good will that do him? She's an arm-chair tuner-in, too."

—Gleason Pease.

RADIO TERM ILLUSTRATED



"Remote Control"

A TERRIFIC INPUT

"Is Mr. McGorge getting much benefit from the Daily Dozen hour?"

"Oh, yes, indeed. He tunes it in while he's eating breakfast and he says it gives him a splendid appetite."

—Gleason Pease.



RADIO RHYMES

No. 5



"AND NOW THAT SHE'S HOOKED UP, I'LL SHOW YOU HOW TO TUNE THIS RADIO!"



"I REALLY DON'T SEE WHAT YOU MEAN --! FOR HERE I'VE BOUGHT A NEW MACHINE --"



THAT HASN'T EVEN PLAYED A NOTE NOR MADE THE FAINTEST SOUND, REMOTE! --



SO TELL ME -- MISTER -- WHY AND HOW IT NEEDS THE SLIGHTEST TUNING NOW! --

List of Broadcast Stations in the United States

Table with 4 columns: Radio Call Letter, Broadcast STA. Location, Wave (Meters), Power (Watts). Contains lists of broadcast stations across the United States, including call letters, locations, and technical specifications.

THE list of broadcast stations here presented is in accordance with the temporary licenses issued by the Radio Commission; and subject to the possibility of minor adjustments being made by that authority, will remain in force until March 1, 1928.

(Continued on page 1035)

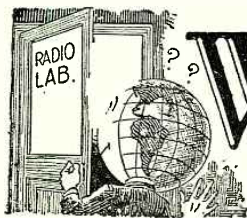

What's New in Radio



The Electrodynamic Speaker Makes Its Appearance

SPEAKER units of the electrodynamic type have been made available for the first time to the amateur constructor. These units are offered with a small free-edge cone attached, and have been designed so that they may be installed easily in a radio console cabinet, or attached to any suitable baffle. They make it possible for the set builder to realize fully the advantages of power amplification and do so at a comparatively moderate cost.

Electrodynamic speakers differ from others both in principle of operation and in construction. They possess valuable characteristics, found only in this type of reproducers and lack many of the inherent faults of the permanent-magnet type of speakers.

In speakers of the electrodynamic type there is a field winding which must be excited by an external source of direct current. In the magnetic field of this winding a separate moving coil is freely suspended, and the audio-frequency currents are passed through this coil. The cone, which is of free-edge design, is attached directly to the moving coil. This construction gives great volume and purity of tone, due to a number of factors.

from distortion harmonics introduced by the speaker itself.

The drive of the speaker is applied directly to the cone, eliminating the necessity for a connecting pin which might bend and vibrate. The inductance of the coil is extremely low and the speaker offers to the tube an almost pure resistance-load, resulting in a high power-factor and an impedance which varies but slightly with the frequency. This makes for a remarkably flat response-curve. The motion of the coil is across the air gap, instead of along the gap, and as a consequence, the unit is free of the limitations imposed by the danger of hitting the pole-pieces. Chatter as a result is almost impossible.

The freely-floating coil offers other advantages besides the ability to supply great volume without chattering. It is free to

by the current passing through the field coil.

Another important point in connection with the operation of the speaker is that a baffle is required for best results. This is true of all speakers of the free-edge cone type; as, otherwise, the air waves which are

EFFECTIVE BAFFLE IS DISTANCE ALONG DOTTED LINE FROM POINT A TO POINT B

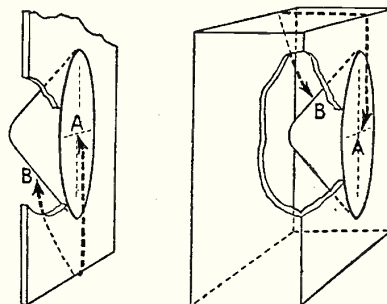

FLAT BAFFLE BOX-TYPE BAFFLE

Two types of baffles which may be used with free-edge cone speakers. As the distance AB is increased, the low-note reproduction is improved.

set up simultaneously by both the front and back of the cone would alternately neutralize and reinforce each other and seriously affect the volume. The illustration shows two types of baffles which may be used with success, the size of the baffle determines the effectiveness of the speaker on low frequencies, but considerable latitude is permissible in this construction.

The speaker unit is made in two types for operation, one with 6 volts D.C., and the other with 110 volts D.C. The 6-volt type requires for the field winding a current of 1/2-ampere and this may be furnished by the storage battery used for the operation of the receiver. The 110-volt type requires 50 milliamperes, which may be obtained by connecting the field coil of the speaker in place of a filter coil in the plate-power unit.

The construction of the speaker is clearly illustrated in the pictures on this page. A is a piece of flexible chamois which holds the cone (C) in the proper position within the frame E. The moving coil of the speaker is attached directly to the speaker diaphragm at the apex D. B is a thick piece of felt which mechanically insulates the speaker from the baffle after it has been installed.

Manufacturer, The Magnavox Company.

New Fixed Condenser Made In Grid-Leak Shape

MANY experimenters have found the design of the standard fixed condenser rather inconvenient from the mechanical viewpoint. In order to install

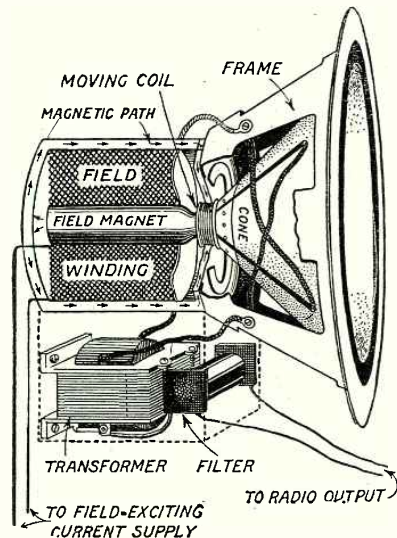

The above drawing illustrates the interior construction of the new electrodynamic speaker unit with a free-edge cone attached.

The field is of great strength and constancy, and in this field the moving coil is freely suspended. The forces on this coil, which produce the sound, are dependent only upon the current in the coil, and not upon its position in the field; and there is no iron in the armature, to be over-saturated. This results in almost complete freedom

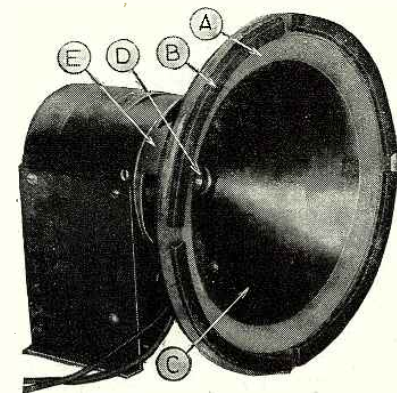

Picture shows external appearance of speaker unit: A, chamois leather insulating cone from frame; B, felt insulating unit from baffle; C, paper cone; D, cone apex; E, frame of speaker.

move an eighth of an inch at a mere touch, and is practically free from the definite resonances, which cause the characteristic pitch of other types of speakers. The impedance of the coil is practically constant for all frequencies and as a result the speaker is capable of giving full volume from 50 to 12,000 cycles. However, as broadcast stations do not transmit frequencies over 5,000 cycles, a filter has been added to the speaker, which deliberately cuts off reproduction above this frequency. Because the impedance of the moving coil is very much less than the output impedance of the power tubes used in radio reception, a step-down transformer also has been added to the speaker.

The speaker may be used in connection with radio receivers of any type; but best results are obtained when a power tube such as the 210 is used in the output stage. The unit will not deteriorate with use or age like the permanent-magnet type, as the magnetic lines of force are produced solely

these units in a circuit, they usually have to be soldered in place and, when it is found necessary to substitute a condenser of different capacity, it is necessary to heat the soldering iron, remove the old condenser and solder a new one in its place.

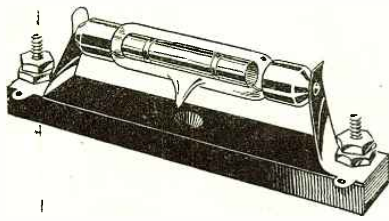

Standard grid leak clips may be used for mounting this fixed mica condenser in a receiving set.

The inconvenient feature of the standard fixed condenser, mentioned in the above paragraph, has been avoided in a new unit, which has recently been placed on the market and which is illustrated in a drawing herewith. The new condenser is mounted in a glass tube, with metal caps on each end, and resembles a grid leak in appearance. Also, it will fit in a standard grid-leak mounting, thus making it easy when desired, to substitute units of various values quickly and without inconvenience.

The new condenser uses mica of a high quality as a dielectric, and its plates are of copper foil. It is ruggedly constructed and cannot change in capacity; it is unaffected by atmospheric conditions as it is sealed in a vacuum.

Manufacturer, Tobe Deuschmann Co.

Compact Unit Provides "A" and "B" Power to Sets.

A LARGE majority of those who have hitherto converted their battery-operated receivers into electrified or electric sets, which operate from the 110-volt 60-cycle house supply wires, were forced to make changes in the wiring. In some cases it was necessary to wire the filaments in series; while in others the use of the new A.C. tubes necessitated a slightly-different

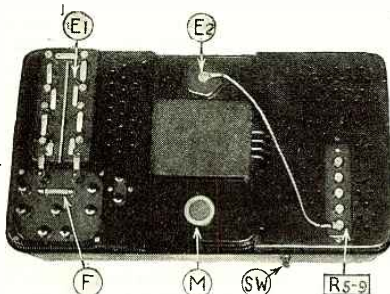

View of "A" and "B" power unit with metal cover removed. Letters refer to apparatus similarly marked in diagram.

circuit. Recently, however, there have been developed socket-power units which may be substituted for batteries without making any changes in the receiver. The unit illustrated on this page is one of the latest designs and provides plate ("B") power as well as filament ("A") power for the tubes of the receiver.

With the unit under discussion, ample power is supplied for the operation of any receiver using eight or fewer tubes of the 201A type. The "A" power circuit has a maximum output of 2 amperes at 6 volts; and the "B" power circuit delivers a current of 55 milliamperes at a potential of 180 volts. This high voltage makes it possible to use a power tube of the 171 or 112 type in the last audio stage; and the four additional binding posts provide lower voltages for the detector, radio-frequency and first audio-frequency tubes.

The complete unit is mounted in a compact case measuring only 10 1/4 x 18 1/4 inches by 7 1/2 inches high. This is only slightly larger than a set of heavy-duty "B" batteries delivering 180 volts, and the weight of the unit is approximately the same as that of the batteries.

The complete details of the power unit will be found in the schematic wiring diagram. It will be seen that this naturally divides itself into two sections; the "A" power circuit and the "B" power circuit.

of the voltage drop which takes place across the resistors R1, R2 and R3. R1 is a 6,000-ohm resistance unit, R2 has a resistance of 3,000 ohms, and R3 of 1,800 ohms. A by-pass condenser having a capacity of 0.5 mf. is connected between each

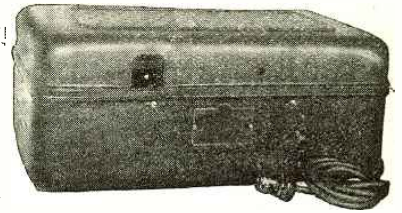

This compact metal case houses a complete power-supply unit for sets using six-volt tubes.

of these resistors and the negative lead. The resistor R4 reduces the voltage for the detector tube.

In operating a power unit of this type, it is necessary only for the owner to con-

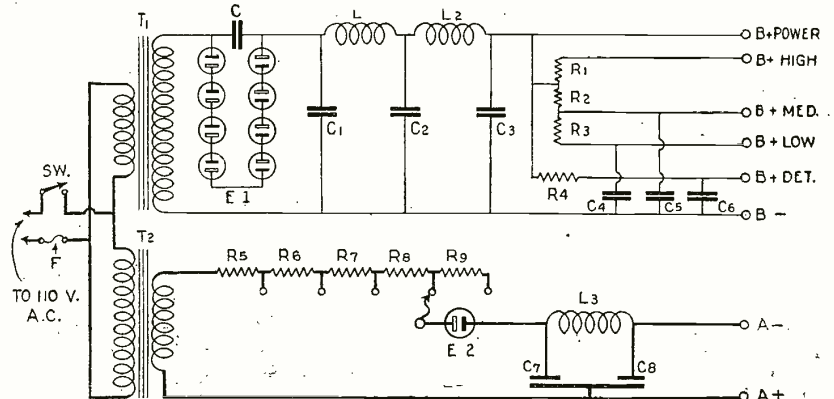

Complete schematic wiring diagram of new power unit which uses electrolytic cells as rectifiers in both the filament and plate supply circuits. It will operate sets using eight tubes or less.

Each has a separate power transformer, and the primary windings of these transformers are connected together and to the 110-volt power-supply wires. The switch (SW) connected in the 110-volt circuit controls the operation of both sections of the power unit.

The "A" power device is essentially a unit with characteristics identical to those of a device described previously in this department ("Electrolytic Rectifier and Condenser," pages 596-7 of the December 1927 issue); and those who are interested in a more complete technical description are referred to that article. The circuit employs a step-down transformer (T2); a rectifier (E2) of the electrolytic type; a filter circuit consisting of a heavy-duty choke coil (L3) and an electrolytic-condenser bank; and a voltage-regulator circuit made up of the fixed resistors R5 to R9.

The "B" power circuit is somewhat similar to the standard type, but employs an electrolytic half-wave rectifier which consists of eight small cells connected in series and is by-passed by a 0.2 mf. condenser. The step-up transformer (T1) provides power for the rectifier circuit and the current is filtered by the choke coils L and L2 and the condensers C1, C2 and C3, which have capacities of 4.5 mf., 3 mf. and 6 mf., respectively. The higher, lower and medium intermediate voltages are obtained by vir-

nect it properly the first time and, after that, to add distilled water to the rectifier cells once every three or four months. The output voltage of the "A" power unit need be adjusted only once for a set using a given number of tubes.

Manufacturer, Fansteel Products Co.

New Resistor Units For Radio Power Circuits

A SERIES of accurately-rated wire-wound fixed-resistance units, especially designed for radio purposes, has recently been developed. They are well suited for use in plate-socket power units and in amplifier circuits, and possess several new and interesting features.

In the past the constructor has always been confronted with the problem of finding a satisfactory mounting for the resistance units of his power unit or receiver. How-

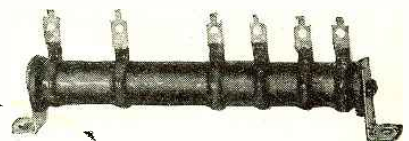

Wire-wound resistors of this new series are provided with convenient mounting-brackets.

ever, the mountings specially-designed for the resistors described here are so arranged so that a resistor may be fastened securely in position on a sub-base panel or wooden baseboard with two screws. Also, they are properly insulated so that there is no danger of a short circuit.

The mechanical construction of the resistors is also interesting. The wire is wound on an insulating tube of extreme durability, coated with a special non-vitreous enamel and baked. The baking takes place at a temperature which is much lower than with ordinary usual enamels and, as a result, the fine wire of the unit is uninjured in the process.

The new resistors are made in two types; a small size, which is 2 inches long and capable of dissipating 7½ watts, and a larger size 4 inches long and capable of dissipating 15 watts. Both types are 11-16 inch in diameter and available in nine different resistance values between 500 and 15,000 ohms. The current-carrying capacity of the 7½-watt size ranges from 125 milliamperes for the 500-ohm resistor to 20 milliamperes for the 15,000-ohm resistor; in the 15-watt size it is 175 milliamperes for the 500-ohm resistor and 30 milliamperes for the 15,000-ohm resistor.

In addition to the standard single-resistance sizes, two special tapped resistors of similar type are made for use in power units. One has been tapped to supply intermediate voltages of 22½, 45 and 90 in a plate socket-power unit, designed to deliver 180 volts under full current load for a 171-type tube, and is suited for use in all power units using the 60- and 85-milliamperere full-wave rectifying tubes. The other has been tapped to supply intermediate voltages of 45, 67½, 90 and 135 in a plate socket-power unit, designed to deliver from 400 to 450 volts under full current load, for a 210-type tube, and may be used in power units employing 216B and 281-type half-wave rectifiers. The resistor shown in the illustration is of the 171 type.

Manufacturer, Daven Radio Corporation.

Socket Identification Made Easy by Color-Code System

A COLOR-CODE standard for tube designations is one of the latest developments and with this system, which is now gaining popularity, the danger of making a mistake and the hesitation or confusion, which usually accompanies placing tubes in the sockets of a new set, are eliminated.

The large variety of vacuum tubes and circuits now being used has made it imperative that some means be employed to indicate

RICH MAROON
For General Purpose Tubes as
R.F. amplifiers and 1st Stage
A.F. amplifiers

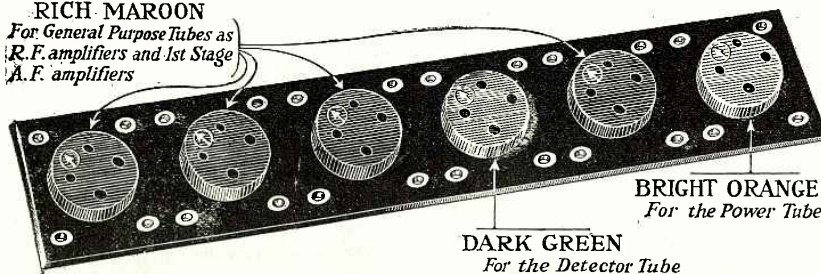

An easy method of distinguishing three different types of vacuum tubes, used in modern receivers, is provided by the color-code system shown above; the bakelite strip above contains six sockets mounted in the usual order.

which sockets receive the detector, the general-purpose, and the power tubes of a receiver. A simple, "foolproof" way of accomplishing this is available in a new line of color-code sockets which have just been placed on the market. The sockets are made with a rich maroon top for use in circuits requiring the use of general-purpose tubes, such as the 201A and 226 types. The detector sockets have a dark green top and are made in both the four- and five-prong types, for the 200A and 227-type detector tubes. In the power circuits a bright orange socket is used to indicate that a tube of the 171 or 210 type is required.

In addition to the color-code feature of the sockets, they have other mechanical advantages. The sockets are shock-absorbing and non-microphonic, and the tube-holding element floats, independently of the base, on four perfectly-balanced springs. There is a positive tube-to-terminal connection and

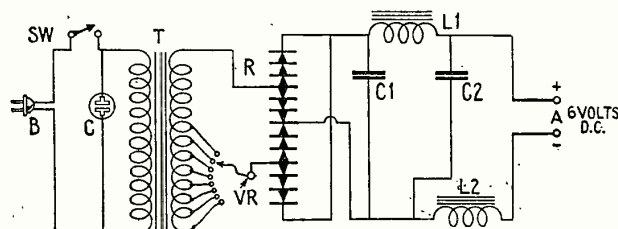

Complete schematic wiring diagram of a new "A" socket-power unit, which may be assembled by the amateur constructor. R, full-wave "dry-electrolytic" rectifier; C1, C2, dry "polarized" condensers; L1, L2, choke coils; T, transformer; VR, voltage regulator; Sw, switch.

the shock-absorbing feature is not affected by the use of stiff bus-bar wiring in the receiver. The sockets, which are compact in design and of neat appearance, are made of molded bakelite with a black base on which are mounted four binding posts and also soldering lugs. The sockets are made also in strips of five, as illustrated in these columns.

Manufacturer, The Benjamin Electric Manufacturing Company.

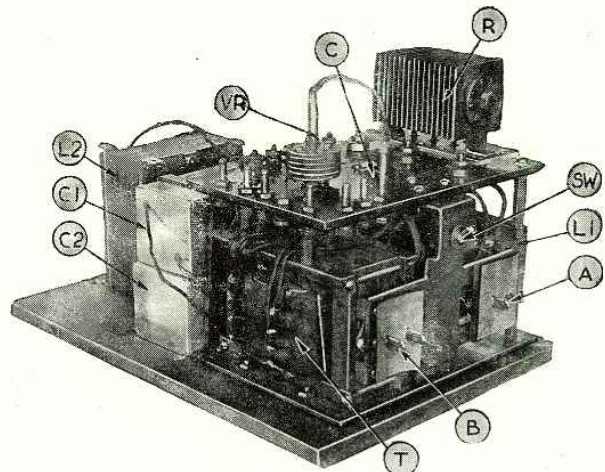

General view of the home-built "A" power unit, with its metal cover removed. The symbols identify apparatus similarly marked in the diagram and the description below.

Homemade "A" Power Unit Uses New Apparatus

PARTS for an "A" socket-power unit of a new design have recently been made available to the radio constructor. The new power unit operates on electrical principles which are entirely new and possesses many features not found in other designs.

It will supply ample current for the operation of nine- and ten-tube receivers using tubes of the 201A type, and is very easy to assemble. It employs a new full-wave dry-electrolytic unit in the rectifier circuit; and in the filter circuit high-capacity condensers of the "dry polarized" type are used.

The complete schematic wiring diagram of the unit will be found in these columns. It will be noticed that the 110-volt 60-cycle house current is connected directly to the primary of the step-down power transformer (T) and that a single-pole switch (Sw) is connected in the circuit. A plug receptacle (C) is connected directly in shunt with the primary of the transformer, and this makes it possible to control the operation of the "B" power unit from the switch of the "A" power unit. The output voltage of the power unit is regulated by connecting the rectifier with the desired tap of the secondary winding. A flexible connector (VR) is provided for this purpose.

In the power unit full-wave rectification is employed, and a standard bridge rectifier arrangement is used. This circuit is followed by a highly-efficient filter circuit consisting of two high-capacity condensers (C1 and C2) and two heavy-duty choke coils (L1 and L2). One choke coil is connected in series with each side of the line and the condensers are connected across the line at two points in the filter circuit.

(Continued on page 1056)

A Loud Speaker with Linen Diaphragms

Unique Construction Gives Instrument Wide Frequency-Response Range

FROM the standpoints of both construction and performance, the loud speaker illustrated on this page is one of the most unusual instruments of its kind the staff of RADIO NEWS has seen or heard in some time. The speaker, which is the invention of W. B. Whitmore, of Irvington, N. J., is best described as a double drum consisting of two square diaphragms mounted on parallel frames, with the exact centers of the diaphragms drawn together. The instrument does not resemble even remotely any of the hundreds of commercially-made loud speakers that RADIO NEWS has examined during the past several years.

The square vibrating diaphragms are made of high-grade linen, specially treated after manufacture to protect it from the undesirable effects of changing conditions of temperature and humidity. During the assembly process, each piece of linen, twenty-four inches square, is stretched perfectly flat and taut across a rigid wooden frame, along the edges of which it is securely tacked. Two such units are placed opposite each other (with the uncovered faces of the frames facing), and are held eight inches apart by means of strong threaded brass rods passed through the corners of the frames.

The center of each square of linen is now accurately determined, and the two points are drawn together and clamped by a hollow threaded bushing with a locking nut on

each side. As the diaphragms were stretched quite tight before, they now assume a slightly concave shape, and become so taut that when tapped with a finger they respond rumbly like a drum. At the point where the centers are clamped, the linen tapers sharply to a narrow bottle neck, about a half inch in diameter. The tension on the cloth is very great, but the special material used seems to withstand the strain without stretching or tearing.

Two parallel wooden bars, spaced about five inches apart, run across the outer face of one of the square frames. These support a husky loud-speaker driving unit (of more or less standard construction) which fits nicely in the hollow of the drawn-in diaphragms. This unit is carefully centered, so that its driving pin slides into the hollow bushing exactly at right angles to the plane of the two 24-inch frames; the pin, of course, is locked against the bushing.

PROOF AGAINST OVERLOADING

From the foregoing description it becomes obvious that the weight or tension of the vibrating diaphragms does not act as a constant load on the driving unit. Therefore, although it might be imagined that the highly-taut diaphragms require a great deal of power to actuate them, even the slightest movement of the drive pin is transmitted without loss to them; as a result the speaker is unusually sensitive, and operates with great volume even on moderately strong signals.

The new speaker is capable of handling far more power than is required for all ordinary radio purposes. In one test, for example, it was used in conjunction with a two-stage transformer-coupled audio amplifier employing two 210-type power tubes in the last stage. A strong local station was tuned in, and a direct comparison was made between this speaker and another, of the cone type, of probably the best design on the market to-day. The latter instrument started to rattle when a certain volume level was reached; whereas this linen diaphragm speaker continued to operate without distortion up to the limit of the amplifier.

VOLUME WITH QUALITY

The performance of this new loud speaker, as judged by the ear alone, is remarkable for its brilliancy and faithfulness over the whole range of musical notes transmitted

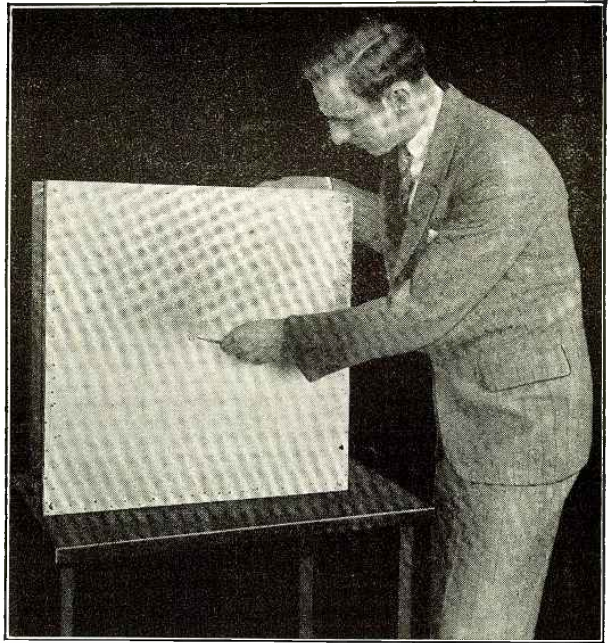

Robert F. Goodwin is shown above, pointing to bushing which draws the two linen diaphragms together. This illustration gives a good idea of the size of the speaker.

by a high-class broadcast station. Violin music comes through high and clear, without appreciable flattening of the high notes; while the sounds of drums and the low tones of a piano boom forth with clarity and realism. The unexpected responsiveness of the speaker to the low notes is somewhat disconcerting at first to a hearer unaccustomed to such reproduction; but, in a room of favorable acoustic properties (i.e., one furnished generously with rugs, thick curtains and similar echo-killing materials), the "booming" effects quickly lose their unpleasantness.

The actual range of frequency-response of this speaker, according to tests made in the laboratories of the manufacturer, is from 30 to 8,000 cycles. This more than covers the modulation range of the average

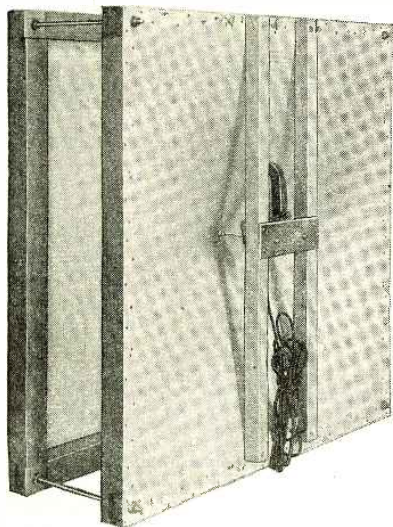

The curvature of the linen diaphragm is made plain, in this illustration, by the shadows cast upon it by the wood bars which hold the speaker unit.

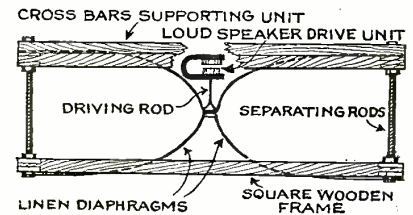

FIG. 1

A side view of the new speaker, showing the disposition of the parts.

broadcast station. The frequency characteristics of the speaker can be altered by means of the four brass rods which hold the wooden frames together, as these rods determine to some extent the tension on the two linen diaphragms.

The flexibility of the wooden frames allows the owner of the speaker to adjust it to his individual musical tastes. Some people like a low-pitched speaker; others prefer a high one.

The Radio Beginner

"Standing By" for "Contact"—A Few Hints on Diagnosing Faulty Operation or Silence in Your Receiver, Before Calling In the Doctor

By L. B. Robbins

WHY is it that, in the midst of the finest program you ever listened to, and with the set tuned up to top notch—"A" battery freshly charged, new "B" batteries and everything hitting on all six—the blamed thing suddenly goes dead? It's one of those things difficult to explain, but one of the things that, seemingly invariably happens with company hanging around to criticise or sympathize. Anyway, it's the cause of that universal malady, "The Broadcast Blues." These "Homes of Silence," in such cases, are usually due to some faulty contact in the set, speaker or headphones and it's not so difficult to trace it out, if the job is taken up systematically. Let's see just what can be done to open the program again in the shortest possible time.

First, look at the phones and see if all connections are tight. Are the cord tips in the plug or has one of them pulled out? Take a glance at the connection on the phone itself. Some types have on the outside of the shell a nut which may have dropped off and released the cord. In that

case it's only a small matter to replace the nut and the cord and find another nut to replace the lost one. When cords are connected inside the shell, unscrew the rubber cap and diaphragm and see if the cords are still held tightly by the little contact screws next to the magnets.

The loud-speaker cord should be examined in the same way for loose contacts or open circuits. If the cord itself is thought to be broken, test it out by connecting the two terminals at one end to a pair of dry cells and the other ends to a flashlight lamp. If the latter lights the cord is O.K.

TRYING THE TUBES

Next look at the tubes in the set and ascertain if they are seated down in the sockets and are all lighted. If one is unlighted take it out and put it in another socket. If it won't light there the filament may have burned out. The chances are, however, that a filament prong was not making contact with the spring in the socket. Press the tube down well and, if it lights and the music suddenly comes on, that was

the cause of trouble. Remove the tube, disconnect the battery leads to the set and then pry up the socket springs slightly with some handy tool until the tube prongs will make positive contact with them. Before replacing the tube brighten up the prongs with a fine file or bit of emery paper. If the tube will not stay down in the socket, look at the bayonet pin in the side of the base, if an old-type receptacle is used. This sometimes works out and there is nothing to hold the tube down in the slot. The only way to remedy this temporarily is to press the tube down and then drive a wooden wedge in between the tube base and the socket, for the time being. A toothpick-end will do for this purpose.

If the binding posts of the socket are loose it will be necessary to remove the socket. In this case brighten up the springs, press them up and take up the play in the springs and binding posts with a screwdriver and wrench. In sockets of the UX type, the springs sometimes are pushed back by the tube pins and do not make contact with the latter. Examine them carefully for this trouble.

Do not work on sockets or any other piece of apparatus in the set without first disconnecting all battery wires. Neglecting this point may result in blown-out tubes, because of a short circuit made by the tool you are working with. And tubes are not cheap, even yet, and often cannot be replaced on short notice. On Sundays, particularly, you may be caught with an in-operative set, and no open radio stores to visit for new tubes.

After examining these possible causes of broken contact, look to the jacks; those flat-spring affairs into which the phone plug fits. Here lies a very common cause of trouble. The usual set has from one to three jacks and each one should be inspected thoroughly. The most prevalent trouble is from dirt or scale lodging between the tiny contacts between the springs. The more springs the more contacts; clean between them with a cloth wet with gasoline. Then slide a very fine file (a nail file will do) between them several times, later brushing or blowing out any filings. Test the springs themselves, to make sure one makes solid contact with its neighbor. Insert the phone plug and see if each spring makes positive contact with the halves of the plug shaft and if the other springs make contact with each other.

THE LIGHTNING ARRESTER

The lightning arrester is seldom thought of in connection with a broken program; but it can cause more trouble than can be imagined, especially in a rain storm. Some

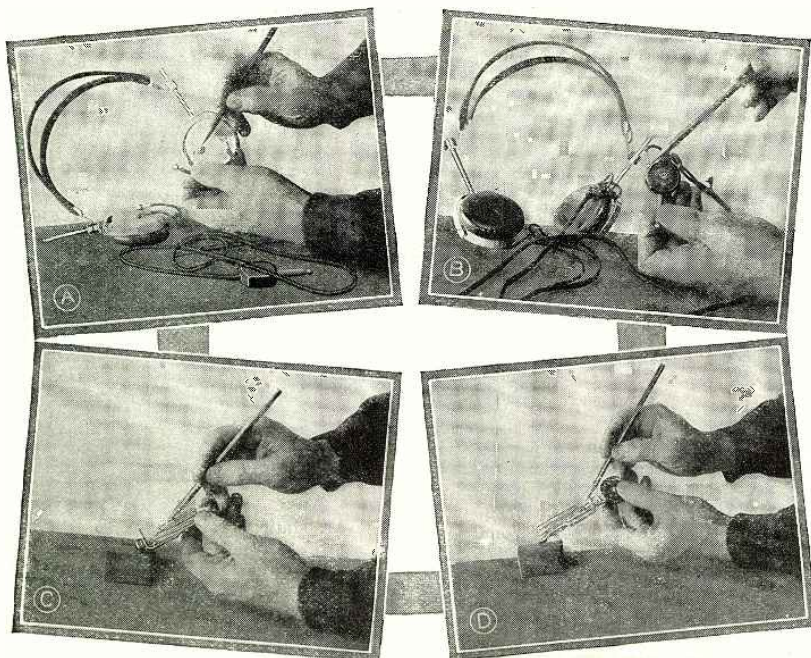

In Fig. A is indicated the nut on the rear of a phone that might be loose. Fig. B shows a loose connection at the plug. Figs. C and D illustrate possible places of poor contact in jacks. Remember that a radio receiver is no better than its poorest contact, and look to the little details that mean so much.

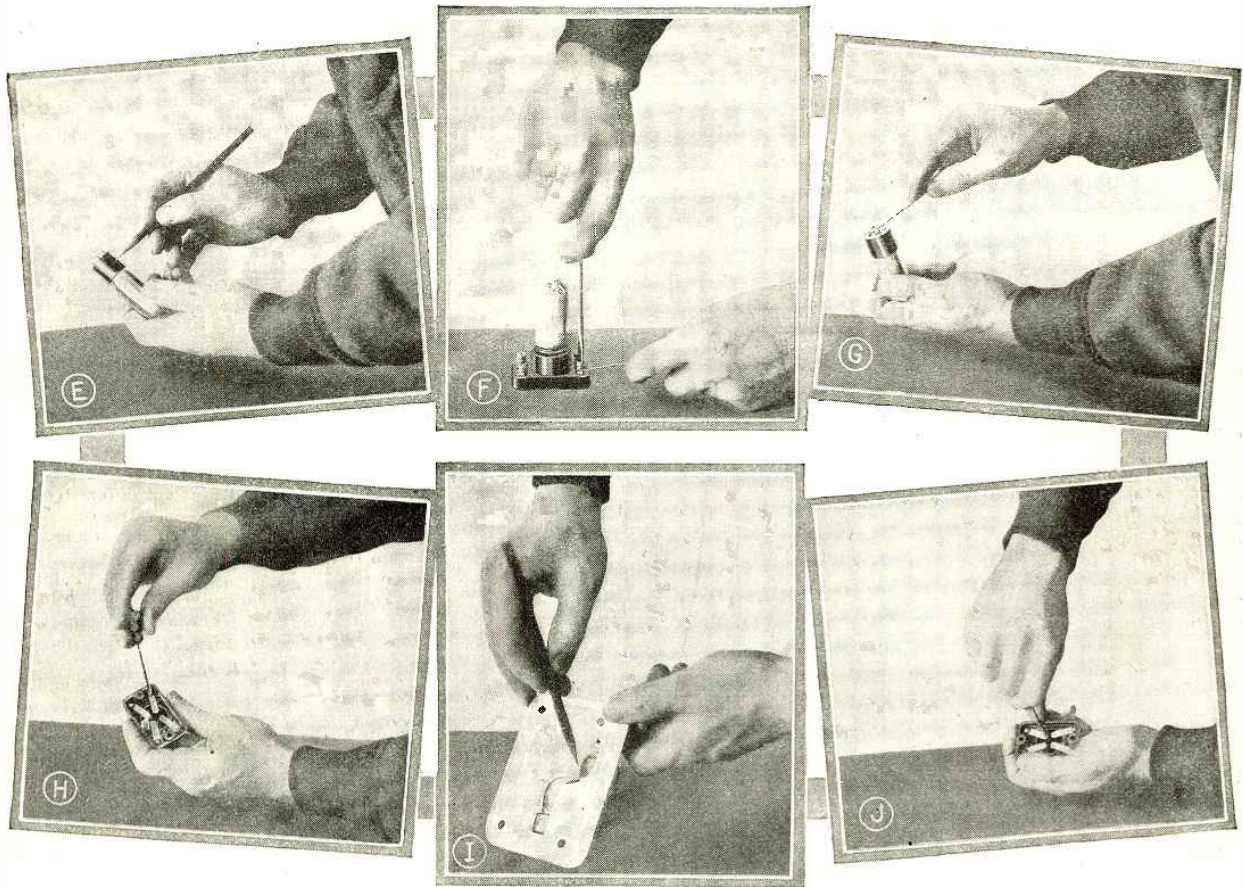

In Figs. E and G are pointed out possible poor contacts in tubes; in E the "bayonet pin" is pointed out. Figs. F, H and J show how to repair loose or dirty contacts in vacuum-tube sockets. Fig. I points out a place in a lightning arrester where dirt and moisture might cause trouble.

types use open contacts with a carbon button between. If moisture leaks down and lodges between the contacts, it shorts the antenna signals to the ground wire and all you will hear is silence. By using a sealed, vacuum-type arrester this trouble can be eliminated. In the case of a shorted gap-type arrester, remove it and take off the back so that the gap can be wiped dry.

Then replace it in as dry a location as possible and seal the removable back with rubber cement. Keeping it inside will, of course, keep it dry; but this is not always possible. Better buy a vacuum type and feel assured of safety, in that direction anyway.

With all these possibilities thoroughly gone over, you should have found some one of them to account for the interrupted pro-

gram. Of course it is assumed you have first ascertained that the particular station has not shut down temporarily due to breakdown, SOS, or some other cause. Turning the dials to some other wavelength will soon determine if the set is working. Just a few trials of the above directions may be the means of again getting "on the air" without having to keep your guests waiting too long "standing by" for "contact."

Repairing Simple Ailments of Radio Receivers

By Clyde A. Randon

THE average radio listener knows very little of the internal functions of his radio set, so when something goes wrong with it he cannot supply the proper corrective measures. In the ordinary set there are certain parts which are sometimes the cause of failure and the expert repairman can usually tell, from the symptoms which accompany such ailments, their possible causes. It is the purpose of this article to point out failings and to outline the proper procedure for eliminating them.

A common failing is a gradual or sometimes sudden diminution in loud-speaker volume from stations which ordinarily are quite loud. The expert repairman, when summoned, will first ask about the condition of the batteries. A decrease in volume

usually results about six months after the installation of new "B" batteries and about one month after new dry-cell "A" batteries are installed in the average set. If you have a small dollar voltmeter you can test them yourself and thus probably save the repairman's wages. If a "B" socket-power unit is used one usually does not have trouble from this cause.

The average radio fan imagines that something has gone radically wrong when a simple ailment results. As a matter of fact, very little can go wrong in a modern receiver. Perhaps the set has been moved slightly and a wire has become disengaged. The ground connection may have become corroded or the aerial may have blown down.

The batteries are usually connected to posts which are plainly marked, "A +," "B -," etc., and one should find little difficulty in replacing the loose wires, if any (see Fig. 1).

Often, the bearings on the condensers inside the set have become worn and the plates scrape at certain positions of the dial, producing peculiar noises in the loud speaker. One can lift the cabinet cover and easily determine which condenser is causing this trouble. The plates can be so bent that they clear their neighbors. It is usually the rotor plates which make contact with the stator plates; the former should be so bent as to pass freely between the other plates.

(Continued on page 1046)

D. C. to A. C.—And How*

How a Receiver Ordinarily Using D. C. Tubes can be Converted into an Electric Set by the Use of Adapters and A. C. Tubes

THERE is considerable confusion in the mind of the general public as to what constitutes an A.C. radio set. Various interpretations may be made of the degree to which a particular power combination can be considered an A.C. unit; it is not the purpose of this article to discuss this question, for its answer is to some extent a matter of opinion. We will briefly describe, however, what is generally accepted as the nearest approach to alternating-current operation; namely the use of raw A. C. directly on the filaments or heaters of all the tubes in the set. Some people have been led to believe that the use of A.C. tubes does away with transformers, "B" power units and the like. Such is not the case, however.

For the benefit of a great many experimenters and home set builders who wish to convert their present battery-operated sets to the use of A.C. tubes, this article covers the changes required in an average six-tube set of the tuned-radio-frequency type.

THE TRANSFORMER

For equipment, a step-down transformer for filament or heater current is the first requisite. The choice of this transformer depends upon whether the constructor wishes to use only the separate-heater tubes of the 227 type; or whether the raw A.C.-filament tubes of the 226 type are to be used for R.F. and first A.F. amplifiers. If only separate-heater tubes of the 227 type are to be used, the transformer should be capable of delivering 1.75 amperes per tube, at 2.5 volts, without any material drop in

voltage; it is preferable to have at least a 15% overload factor above these requirements. If the 226-type is to be used in the R.F. and first A.F. amplifying stages, the transformer should deliver also 1.10 amperes per tube, at 1.5 volts.

It is advisable to use for the last audio stage a 171-type tube, which is operated on raw A.C. at 5 volts. The transformer should have an additional 5-volt winding for this tube.

Unfortunately, A.C. line voltage throughout the country varies a great deal in two ways. The designed standard voltage of the particular distributing system may be 104, 110, 115, 125 volts or some point between; and, under certain load conditions, the actual voltage at any given point also may vary from hour to hour, above or below the standard voltage of the power station. This latter condition is not common in large communities, where the load is handled efficiently. However, the situation is a difficult one from the standpoint of transformer manufacturers, but several have met the problem by designing step-down transformers which will deliver full voltage at the lowest primary potential that may be expected. This, in turn, means that primary taps, rheostats or resistors of some sort will be necessary when the primary voltage is higher than this minimum.

The reader should not, however, gather the impression that the 226- and 227-tubes are extremely critical on filament or heater current; as in fact a liberal percentage of voltage variation is allowed for in the tube design. Indeed, will it be seldom necessary to change the filament or heater resistances to compensate for temporary line-voltage fluctuation, once your particular average voltage is determined and adjusted for.

Another good reason for using a transformer with over-voltage output at the terminals is that, in various converted sets, some may have more voltage drop than others due to the wiring. It is, therefore, considered the best practice to use a step-down transformer with a liberal over-voltage factor.

PLATE-POWER SUPPLY

The "B" supply device may be any good unit available and does not differ from that used with the battery-operated sets. Complete "A B C" power packs designed to supply all power requirements for A.C. sets are making their appearance on the market, and will undoubtedly be widely sold. In considering the purchase of these units, care should be taken to see that they meet the conditions previously outlined.

The center-tapped resistors (R4 and R5) may be purchased in the market, or made by winding up with fine resistance wire a 60-ohm unit tapped in the center. If a potentiometer is used, one with a resistance around 20 ohms will be satisfactory. A fixed 2,000-ohm resistor (R7), shunted by a 1-mf. condenser, is required for the last audio bias; and a similar combination (R6) is used for the amplifier bias except that the latter resistor should be variable or tapped, to meet varying conditions encountered in sets.

NEEDED ALTERATIONS

The actual rewiring and changes in sets to be converted follow in general certain standard practice. We discuss here the average six-tube set, consisting of three stages of R.F., a detector, and two stages of A.F. The accompanying schematic diagram shows the wiring for the converter when using the 226-type tubes in the R.F.

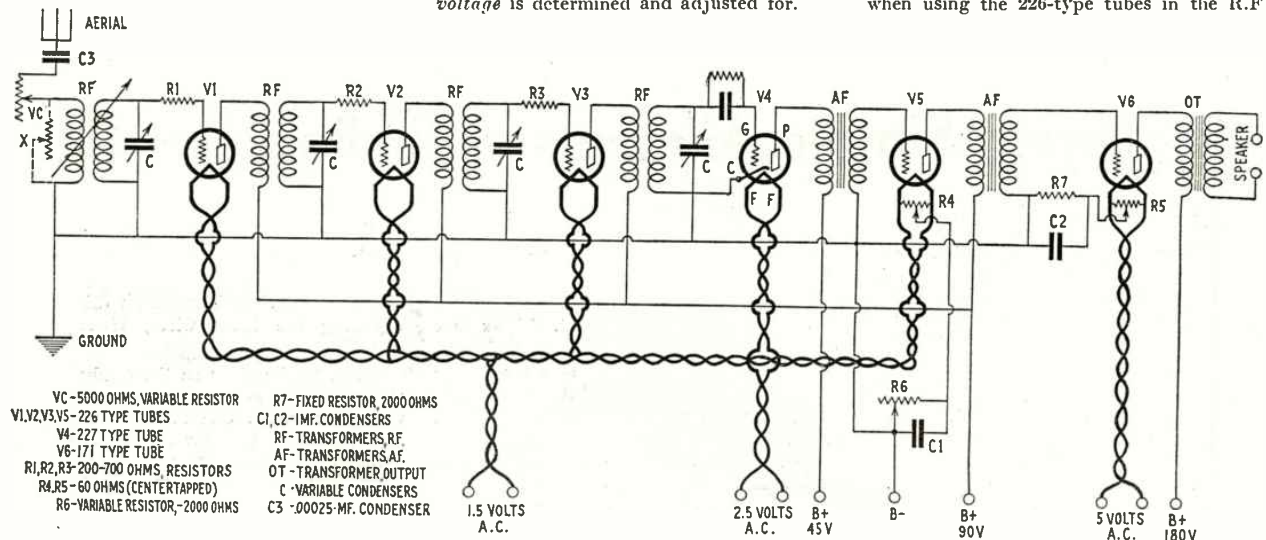

The schematic diagram shows the wiring connections of a receiver originally designed for D.C. tubes and converted

into one operating with A.C. tubes. X is an optional type of volume control; its range should be 0 to 5 megohms

* Prepared by the Engineering Department of the C. E. Mfg. Co., Inc

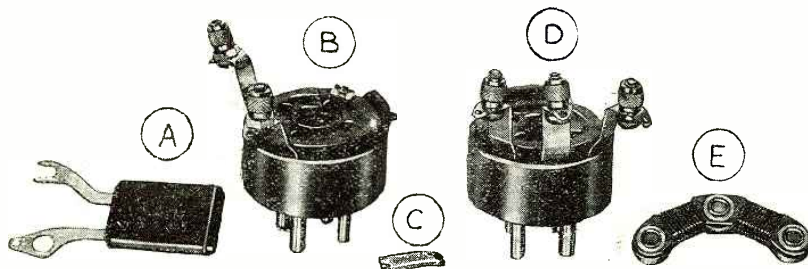

Parts used in connection with the new wiring harness: A, by-pass condenser; B, tube adapter for R.F. circuits; C, grid suppressor; D, tube adapter for A.F. circuits; E, center-tapped resistance unit.

and first A.F. amplifiers, the 227-type in the detector and the 171-type in the last audio stage. Should the constructor wish to use 227-tubes in all except the last A.F. stages, the procedure is similar; except that the cathode lead of the R.F. and first A.F. tubes is to be substituted as a connecting point for the center tap of the 227-tubes. The use of center-tapped resistors at heater terminals of the 227s, with the center lead going to the cathode, is also advisable.

The fan who wishes to convert his battery-operated receiver into a set using A.C. tubes may easily do so, and he will find that there are two methods which he may follow. In one case it is necessary to remove all filament wiring in the receiving set, and then rewire the filament circuits for A.C. tubes. This is a simple operation, but requires some experience in set construction if best results are to be obtained.

For the radio fan who does not feel competent to rewire his set, or who wishes to convert it for A.C. tubes in the least possible time and with the slightest effort, several manufacturers have developed and placed on the market simple A.C.-tube adapters and harnesses. With these adapters it is possible to convert a D.C. set into one using A.C. tubes in a very few minutes, and without the necessity of changing any wires in the receiver except a few grid returns.

USE OF A.C. TUBE ADAPTERS

As the adapters are of different types, it is difficult to write a general description which applies to all units. However, each kit is supplied with directions which explain exactly how the installation is best accomplished.

Usually each kit contains one adapter for each tube, and these adapters fit in the tube sockets of the set; while the tubes are inserted into the adapter. These adapters connect the grid and plate prongs of the tubes with the proper terminals of the socket, but insulate the filament prongs from the filament wiring of the set. On the adapters terminals are provided which connect with the filament prongs of the tubes, and the harness is connected with these posts; the harness, which is correctly arranged for A.C. tubes, replaces the filament wiring in the set. In order to light the tubes it is necessary only to connect the free ends of the harness with the proper terminals of a filament transformer.

Arrangements have also been made for installing the extra parts which are required; such as center-tapped resistors, by-pass condensers, grid resistors, and biasing resistors. The center-tapped resistors are designed so that they may be correctly connected in the circuit by fastening them to

posts provided on the adapter, and the same is true of the by-pass condensers. The 500-ohm resistors (R1, R2 and R3), which are required in the grid circuit of A.C. sets, fit into slots in the adapters of one make; and provision is usually made for installing the grid-biasing resistors in the cable. The only change which is necessary in the wiring of the set is the installation of a new volume control (VC); this is required, as the rheostats in the filament circuits are made inoperative when the harness is installed.

REWIRING THE SET

In converting the set without the aid of adapters and a harness, the first procedure is to cut away all previously-installed filament wiring and install the 5-prong sockets, for whatever number of 227-type tubes are to be used. The filament and heater wires should be twisted conductors; the average lamp cord has sufficient current capacity for this purpose. Many sets are equipped with battery switch on the panel; this cannot be used to control the A.C. current unless it happens to be one originally intended for use on 110-volt lighting supply. Should the power switch be installed on the panel, care must be taken to insulate the primary line with the same precautions usually adopted in all appliances connected directly to the house mains. Grid returns of all stages are brought directly to ground as shown in the diagram. Oscillation control is obtained by use of grid suppressors in the R.F. stages. The correct resistance values for these suppressors may run from 200 up to 700 ohms or over, because of varying circuit and R.F. transformer characteristics; the desired value is the lowest which will keep the R.F. circuits out of oscillations over the entire wavelength range. This method of oscillation control is the simplest for the constructor. Any control system affecting the 226-type tubes, whether it be for oscillations

or volume, which in effect reduces the plate current below the minimum "ripple-voltage point" will not be satisfactory; for, below this critical point, the A.C. hum becomes suddenly apparent. Another procedure for controlling oscillation, which is highly efficient and easily adjusted, is to neutralize the R.F. stages by the conventional capacitive or neutrodyne method. If the set to be converted is a neutrodyne, reneutralization for A.C. tubes will probably be necessary. Should the set have a coil system depending upon a scarcity of primary turns on the R.F. transformer to make it non-oscillatory, the use of A.C. tubes will increase the tendency to oscillate; in average sets, however, this increase will not reach the spilling point. In general, any method to control oscillation is acceptable, provided the plate current is not thereby reduced materially. By-pass condensers in the R.F. stages are usually essential.

VOLTAGE REGULATION

In the previous discussion of suitable transformers, the filament- or heater-voltage situation was brought out. Our conclusions are that, in the first place, the average line voltage must be known. Should the transformer chosen deliver the correct voltage to the tubes no rheostats or resistances are necessary. In many cases this will not occur and therefore a rheostat for all 227-type tubes, or separate ones for the 226s and 227s, will be required. No rheostat control is necessary for the 5-volt last A.F. tube.

For the dealer or service man who expects to convert a number of sets, it is suggested that he prepare strips of resistance units consisting of brass wire wound on fiber or similar material. When the set is converted and ready to install, the correct tube voltages may be determined by finding the proper point of resistance adjustment and permanently soldering or clamping the lead. This adjustment must be made on the final set location. Of course, the use of a good low-reading A.C. voltmeter, 0-3 volts, is essential for determining the proper tube voltages; do not use cheap meters, as they are apt to be inaccurate. The dealer or service man should always have a meter of this kind available for A.C.-set adjustment; for the individual who converts only one set it would be more economical to borrow a meter for the occasion, as the meter may never have to be used again. Should rheostats be used for the A.C. tubes, special types are necessary; as the rheostats ordinarily used in battery-operated sets are not heavy enough for the purpose. Suitable

(Continued on page 1058)

A D.C. set converted into one using A.C. tubes by the use of the adapters (shown above) and a special harness.

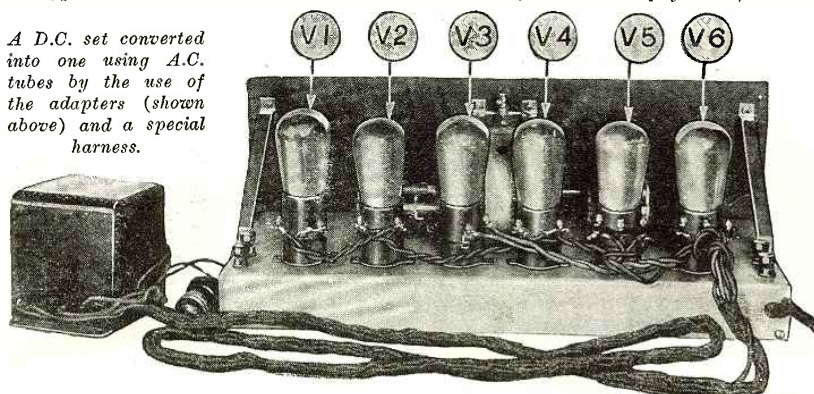
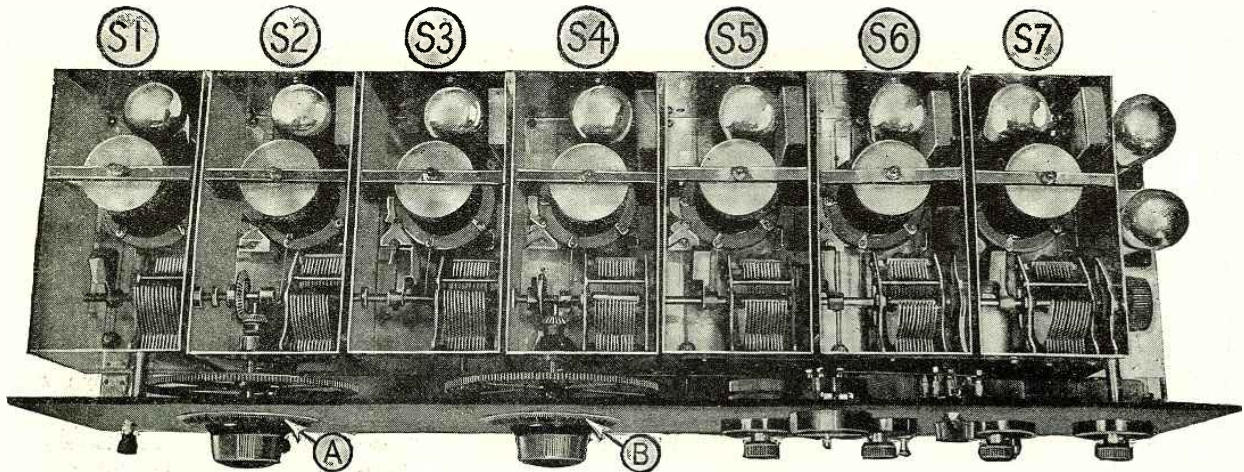

Illustration courtesy Aiden Mfg. Co.



Dial A controls only the last condenser at the left, while B controls the other six together. The stage shields are marked from S1 to S7.

An Unusual Nine-Tube Peridyne

Through an Arrangement of Bevel Gears, Seven Tuning Condensers are Controlled by Two Dials; Peridyne Shields Keep Circuits in Resonance

A NOTEWORTHY nine-tube tuned-radio-frequency receiver, employing six tuned stages with only two tuning controls, through the use of the Peridyne principle of balancing, has recently been constructed. The set employs seven tuning condensers, six of which are mounted on one shaft, while the seventh is controlled separately. This receiver has been designed and built by Mr. Frank Hanus, 2029 East Fortieth Street, Cleveland, Ohio. It is an extremely neat receiver, but quite complicated in mechanical construction, and cannot be duplicated without the use of a rather complete machine shop. For that reason, the circuit constants are not given here.

By referring to the illustration, it can be seen that the two large gears A and B are used for coupling the condensers to the dials. These gears are six inches in diameter and made of cast bronze. Under these gears are two smaller ones, about one inch in diameter, which are rotated by the vernier control knobs which can be seen in the panel view, below the main tuning dials. Because of the size of the smaller gears, a considerable vernier action is achieved. The use of these special gears allows the operator to control the condensers directly by rotating the main dials and, when vernier action is required, it can be obtained by rotating the small knobs. This method also keeps the back-lash very small.

ELEMENTS OF THE CIRCUIT

The schematic diagram is not complete, containing only the first and fourth radio frequency stages, and the detector. The intervening stages (the second, third, fifth and sixth) have been omitted, since they are duplicates of the fourth stage. The audio-frequency also has been omitted, since

have been mounted on the individual shields with the common shaft running through them. Balancing weights have been fastened to the shaft so that a smooth action is obtained when rotating the dials. It will be noticed that holes have been cut, through the tops of the shields, to accommodate the screws controlling the positions

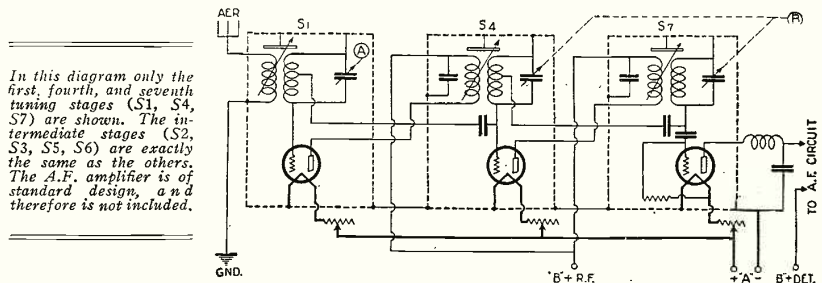

In this diagram only the first, fourth, and seventh tuning stages (S1, S4, S7) are shown. The intermediate stages (S2, S3, S5, S6) are exactly the same as the others. The A.F. amplifier is of standard design, and therefore is not included.

it is a standard two-stage transformer-coupled unit with no unusual features. It will be noticed that the circuit is primarily a neutrodyne, with total interstage shielding and with the addition of the Peridyne shields over the radio-frequency coils.

EFFECTIVE SHIELD TUNING

The shields are made of sheet aluminum, $\frac{1}{4}$ x 8 x 5 inches. The tuning condensers

of the Peridyne shields. This allows adjustment without removing the tops of the shields, and without threading the shield tops.

The front panel is 32 inches long and $8\frac{1}{2}$ inches high. It has been equipped with a double-reading voltmeter, a control switch and four filament resistors. The switch is arranged so that the filament voltages on the various tubes in the set can be measured. The first filament resistor is used for controlling the filament current on the first R.F. tube. The second one controls the other five R.F. stages; the third the detector; and the fourth the two A.F. tubes.

While this set makes a very neat job and one that any experimenter could be proud of in the line of mechanical beauty, it would be an extremely hard one for the average individual to build; since a considerable amount of special apparatus has been employed, including several castings and the special aluminum shields.

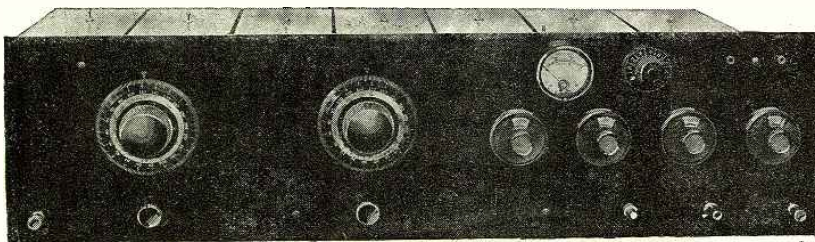

The two large dials at the left are the main tuning controls. The four small dials control the various filament resistors.

Full-Band Tuning in Radio Receivers



A Remarkable New Circuit which Tunes Sharply, Yet Amplifies a Band of Frequencies 20 Kilocycles Wide

By G. C. B. Rowe

THERE is a saying which has become almost an axiom among radio experimenters and engineers—that, if selectivity in a receiver is desired, it is necessary to sacrifice quality; because some of the “sidebands” have to be shaved off. But, thanks to Dr. Frederick K. Vreeland, this saying may become obsolete in a comparatively short time. Dr. Vreeland has developed a radio receiving circuit which permits great selectivity; yet, at the same time, all the sidebands are amplified equally in this circuit and reproduced in the loud speaker.

THE SIDEBAND PROBLEM

Just why these sidebands are so important in good reproduction may be, perhaps, not clear to the average fan. Consider for a moment the nature of a modulated radio-frequency wave, such as a broadcast station sends out. Let us assume that we have a carrier wave of 600 kilocycles (a 500-meter wave) which we are going to modulate with speech or music. If the latter is used, we will have the 600-kilocycle wave modulated by frequencies which may be anywhere between 25 and 10,000 cycles, or in some cases even higher. This means that our receiver, in order to reproduce sounds as near like those in the broadcast studio as possible, must amplify a band of frequencies about 20 kilocycles wide, say between 590 and 610 kilocycles (or 600 plus and minus the highest audible frequency which is broadcast. This, in ordinary speech, is the band from 508.2 to 491.5 meters, covering parts of three broadcast channels).

At various times articles dealing with the nature of musical sounds have appeared in *RADIO NEWS* (see, for instance, page 990 of this issue) and so it will be assumed that the reader is familiar with the fact that, in order to distinguish between the different

musical instruments, it is imperative that the “overtones” or “harmonics,” as well as the “fundamental” frequencies, be received. As some of these harmonics are of the sixth and eighth order (six or eight times the frequency of the fundamental note), they are cut off if the receiver is made ultra-selective, for reasons which appear below.

Let us assume we have a receiver of the ordinary tuned-radio-frequency type and see how the response curve of such a set appears in an *oscillograph*. We find that, because of the nature of a tuned circuit,

EQUAL amplification over a complete waveband, yet with a tuning sharpness so great as to exclude all other signals, has long been ardently desired by all radio experimenters. The invention of Dr. Vreeland described here meets this requirement, so far as conditions in broadcasting today permit. Remarkable fidelity of reproduction has been demonstrated by an experimental receiver built on this system. As it has not reached the commercial stage, and the proper proportioning of the circuit elements is all-important, constructional data cannot be given at the present time.—EDITOR.

(i.e., that a circuit has a definite peak or resonant frequency depending upon the values of its capacity and its inductance) one certain frequency is received at a certain setting of the dials with a maximum of efficiency, while others come through in a much less efficient manner. That is, we are getting through the circuit only a very narrow band of frequencies, perhaps only 2500

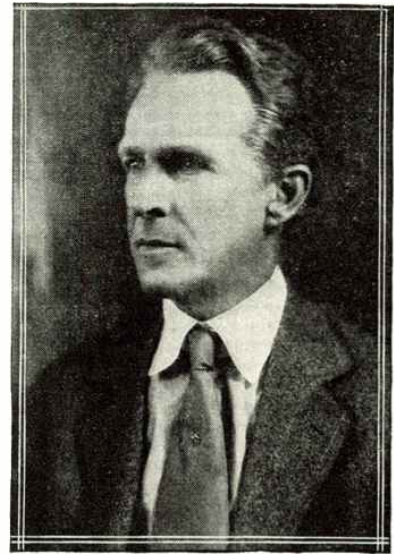

Dr. Frederick K. Vreeland, the inventor of the band-selector radio receiver.

cycles on each side of the carrier wave, to the great detriment of the music. In Fig. 1 is indicated the amplification of the peak frequency and other frequencies in such a receiver; we see what a relatively small percentage of the broadcast musical notes is passed through the receiver; at 5000 cycles, the reproduction is only a third that of the lowest notes. Yet, if the curve did not have the shape it has (i.e., such steep sides) it would include a portion of the band of frequencies comprising an interfering wave; and two stations would be heard at the same time. Of course it is possible to flatten out the curve so that the peak of the reception covers a greater portion of the 20-kilocycle wave; but this in turn makes the sides of the curve less steep and the set less selective.

WIDENING THE PEAK

The problem then reduces to finding some means that, when introduced into the re-
(Continued on page 1053)

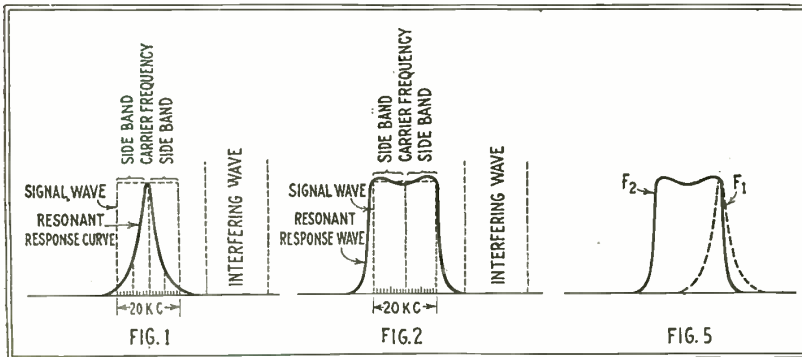
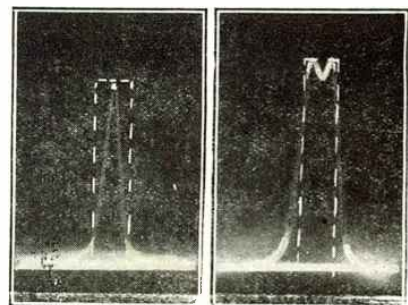

Fig. 1 illustrates the frequency-characteristic of a typical broadcast receiver. Fig. 2 is the frequency-characteristic of a band selector. (At the right are two oscillograms from which these curves were made, the dotted lines representing the modulation band of a wave). Fig. 5 shows what occurs when the reactance X3 is removed from the circuit: the response curve falls from F2 to F1.



The Silver Screen-Grid Superheterodyne*

By Ernest R. Pfaff



This picture shows the new Screen-Grid Superheterodyne mounted in an attractive walnut cabinet. Only two knobs on the front panel are for tuning; one is a regeneration control, one a volume control and one a filament control.

THE receiver pictured and described herewith is an eight-tube superheterodyne employing three of the new screen-grid R.F. amplifier tubes in the intermediate-frequency amplifier, which is a laboratory-assembled and tested shielded unit, and which effectively eliminates all possibility of anything less than peak performance in the hands of even the most inexperienced builder.

The real value of the screen-grid tubes in this receiver can best be realized from the statement that the amplification factor in the three-stage 112-kc. intermediate amplifier approaches 40 per stage, as compared to about 20 per stage for 201A-type tubes. Thus, for the three R.F. stages, the amplification when using screen-grid tubes is approximately $40 \times 40 \times 40$, or 64,000, as against $20 \times 20 \times 20$, or 8,000 gain for the same amplifier using 201A-type tubes. These values of amplification were obtained under conditions of equal apparent selectivity; for it must be borne in mind that, as the sensitivity or amplification of a radio set is increased, the selectivity must go up far faster to maintain the same apparent selectivity in tuning the set. Actually, if the receiving range is doubled, selectivity must go up four times, merely to hold the apparent selectivity constant. Therefore, in designing a screen-grid amplifier, great care must be used to prevent the loss of selectivity from accompanying the increased amplification.

HIGH INTERMEDIATE FREQUENCY

In the screen-grid "Laboratory Model"

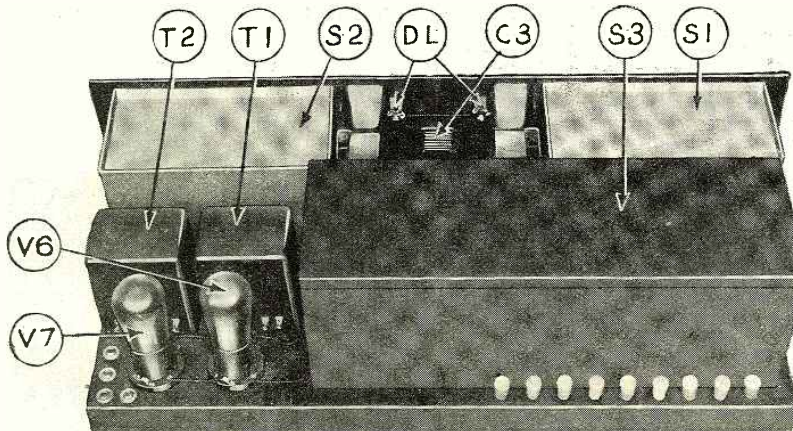

receiver described herewith, not only have the factors of increased amplification and increased selectivity been given careful consideration, but also that of tone quality, so generally neglected or, of necessity, slighted in very sensitive superheterodynes. Through the use of an intermediate frequency of 112 kilocycles, high amplifier selectivity has been obtained and the cutting of side bands is brought entirely within the operator's control. Either he may have medium range, ultra-high-quality reception or, by sacrificing tone slightly, he can boost the sensitivity of the set to a point where local noise and static, ordinarily very weak, comes in as a roar, and stations not ordinarily heard come in loudly.

Another advantageous feature of the 112-kc. intermediate frequency is that, for all stations below 215 meters or above 455 meters, the receiver is a "one-spot" set; that is, stations outside of the 215-455-meter range are tuned in at but one point

Right—This picture clearly shows the arrangement of wiring under the steel chassis. Below—General interior view of set with stage shields in place, S1, detector stage; S2, oscillator stage; S3, intermediate amplifier; T1, T2, A.F. transformers.

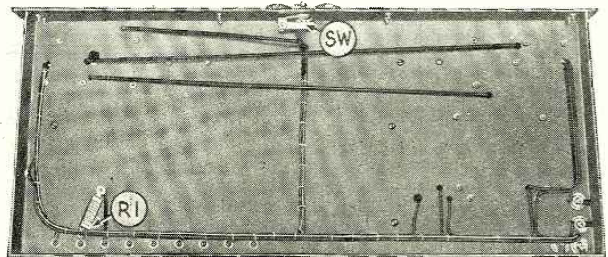

on the oscillator drum dial. Though stations between 215 and 455 meters can be tuned in at two points on the oscillator dial, by taking 25 grid turns off a standard oscillator coil, the set is made "one-spot" for all stations outside the 215-390-meter band. A further advantage of the 112-kc. intermediate frequency is that the two oscillator dial readings, for those stations that do come in at two dial settings, are widely separated; so that, with the sharp tuning of the regenerative first detector, the set is in operation practically "one-spot." Of course, all stations are received at but one setting of the antenna dial, and either a loop or a short antenna may be used. It is also possible to cut out one of the intermediate amplifier stages and one of the audio stages at will, if desired.

SUBSTANTIAL CONSTRUCTION

The set employs a regenerative first-detector circuit (S1) using a 201A- or 200A-type first detector tube (V1), with a plug-in antenna coil (L1), or loop, tuned by a .00035-mf. variable condenser (C1) which is controlled by an illuminated drum dial. Regeneration is effected through a small .00075-mf. midget condenser (C3) adjusted by the "sensitivity" knob on the panel. The second tube (V2) is the oscillator, also using a plug-in coil (L2) and a .00035-mf. variable condenser (C2). The oscillator is coupled to the first-detector grid circuit.

The use of plug-in coils allows different sizes of standard oscillator and antenna coils to be plugged into the set, thus covering all waves from about 30 to 3,000 meters. Following the first detector and oscillator, which may be shielded as shown at S1 and S2 or not, as desired (depending upon whether the set is to be operated in a congested broadcasting center or in the country) is the four-tube long-wave amplifier (S3) containing the three 112-kc. amplifier circuits and screen-grid tubes (V3, V4 and V5) and the second detector circuit and tube (V6). Each transformer and tube is in a separate compartment in the copper shielding, which is 15 inches long, 5 inches wide, and $5\frac{1}{2}$ inches high, with a cover removable to allow tube insertion and removal. To the right of this I.F. unit (which is actually a complete amplifier for time-signal reception), is the two-stage audio amplifier, using a pair of high quality audio transformers (T1 and T2). This

* RADIO NEWS Blueprint Article No. 48

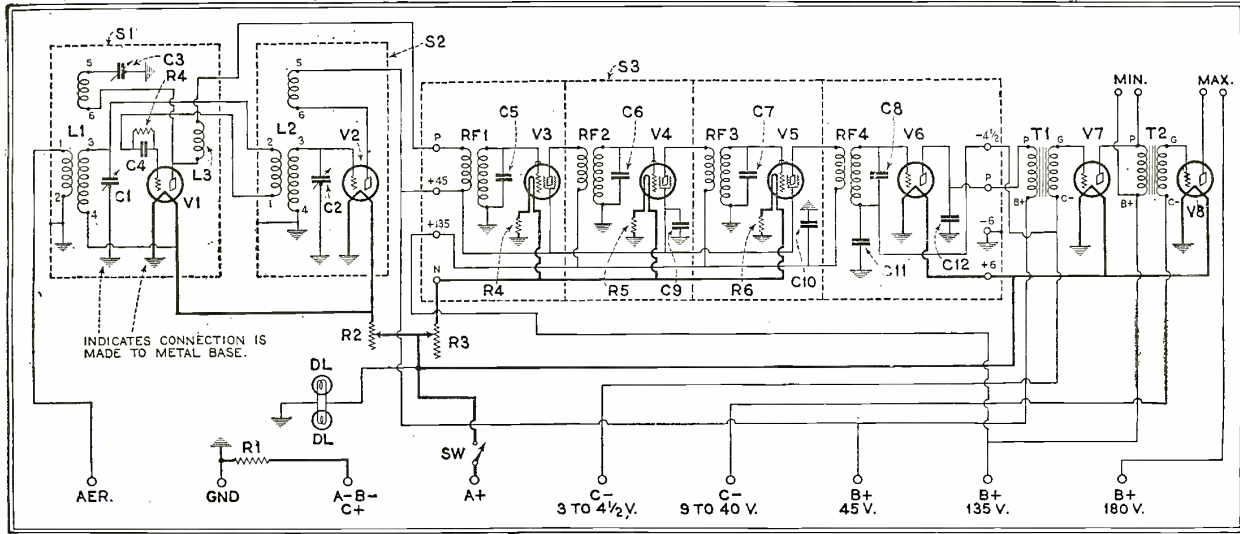

Schematic diagram of the Screen-Grid Superheterodyne. The dotted lines indicate shielding.

amplifier gives uniform amplification to all frequencies between 30 and 5,000 cycles. Above the highest frequency it cuts off to keep down background noise and the all-too-prevalent heterodyne squeals which are caused by over 600 broadcasting stations being crowded into channels, which would adequately accommodate 95 stations without interference.

The entire set is mounted on a pierced steel chassis 10 inches wide, 1½ inches high, and 23 inches long, to which is attached a 7 x 24-inch metal panel carrying the control knobs. The actual controls are the

vernier knobs actuating the two drum dials; an "On-Off" switch (Sw); a regeneration control (C3) for the first detector (the "Sensitivity" knob); a "Gain" control rheostat (R3) regulating volume for the three screen-grid amplifier tubes; and a filament rheostat (R2) for the first detector and oscillator.

REALLY "FLEXIBLE" CONNECTIONS

In a number of tests the screen-grid "Laboratory Model" receiver has been found to have no equal for DX ability; for it will reach out from Chicago on a small ten or

twenty-foot aerial, bringing in with loud-speaker volume stations on the east and west coasts that many other receivers will not bring in at all. One I.F. amplifier stage can be dropped from the eight-tube circuit by simply pulling the grid lead from the left compartment of the amplifier (S3) over the partition and clipping it to the top cap of the second tube (V4), whose clip lead is ignored. So connected and using but two I.F. amplifier stages, the set will produce results for distance, tone quality, and selectivity that will equal those obtained from other nine- and ten-tube supers.

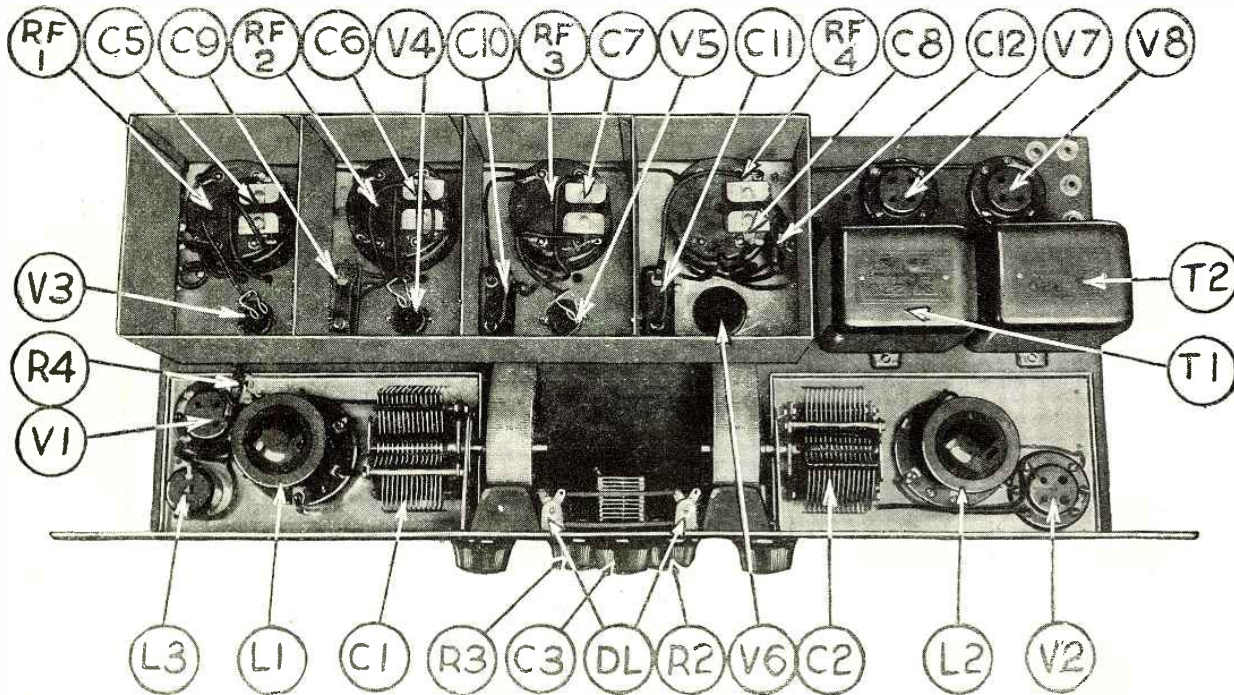

This view of the chassis, with stage shields removed, clearly shows the location of all apparatus: C1 and C2, variable condensers; L1 and L2, R.F. coils; R2 and R3, rheostats; C3, midget condenser; L3, R.F. choke coil; T1 and T2, A.F. transformers; V1, V2, V7 and V8, tube sockets; DL, Dial lights; R4, grid condenser. The remaining parts shown are located inside the intermediate-amplifier unit S3.

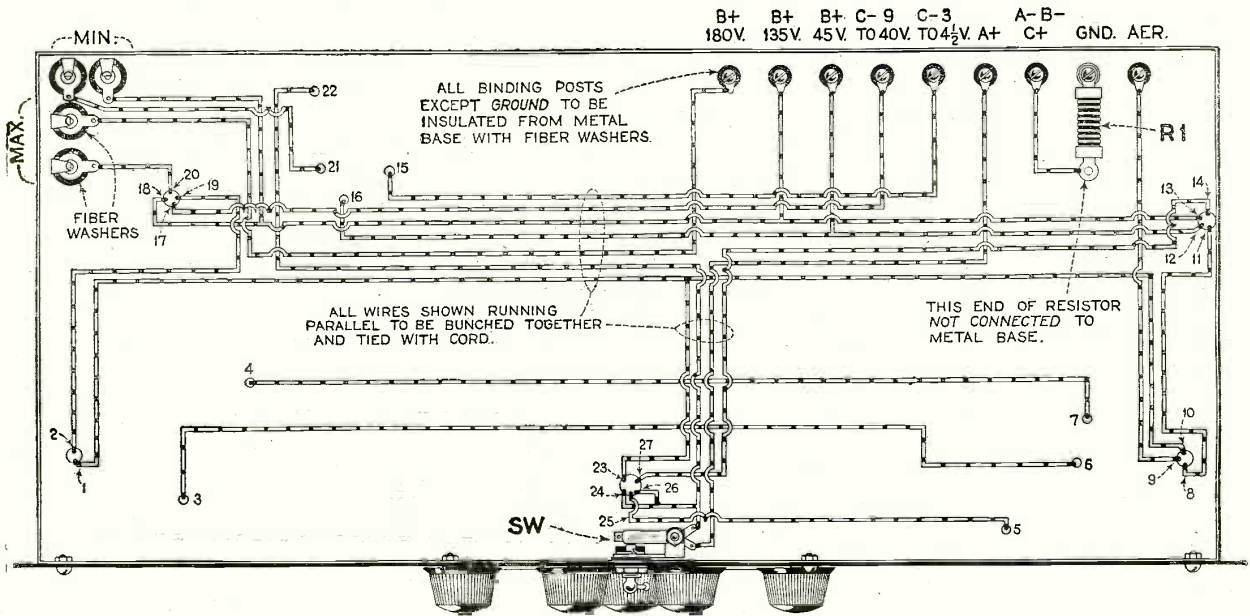

The wiring under the sub-panel, with the connections to be run in a cable, as shown on page 1020.

Even using only seven tubes (if the Sensitivity and Gain knobs are turned up) the set will bring east and west coast stations into Chicago almost like locals on a twenty foot length of wire. Truly, the set is one fully deserving of the name "superheterodyne," for even in the hands of a novice, it tunes in distant station after distant station through a maze of locals with a simplicity that is delightful while an expert can make it run rings around ordinary sets.

The parts used for the screen-grid Laboratory Receiver are named in the list of apparatus which accompanies this article and are all of standard manufacture. It will be found that the different parts bear the same symbols as in the drawings and photographs. The two aluminum stage shields (S1 and S2) are not absolutely necessary, but should be used to house the de-

detector and oscillator circuits if the set is to be operated near any powerful broadcast stations. Brass-plate variable condensers of the more expensive type are illustrated in the set, as these allow the dials to turn in the same direction for simultaneous capacity increase or decrease by means of removable shafts. Though the cheaper type made by the same manufacturer are equally

satisfactory, the dials turn in opposite directions for simultaneous oscillator and antenna increase or decrease of wavelengths.

PROGRAM OF CONSTRUCTION

The construction of the screen-grid "Laboratory Model" receiver is a simple task, indeed; for the steel chassis and panel are completely and accurately pierced so that the different parts need simply be placed upon them, in the positions in which they appear in the different pictures, and bolted down with machine screws and nuts. A few precautions should be observed, however.

The 6-ohm rheostat (R2) placed in the "filament" hole of the front panel and the 20-ohm rheostat (R3) placed in the "gain" hole of the front panel should be carefully and thoroughly insulated from the panel,

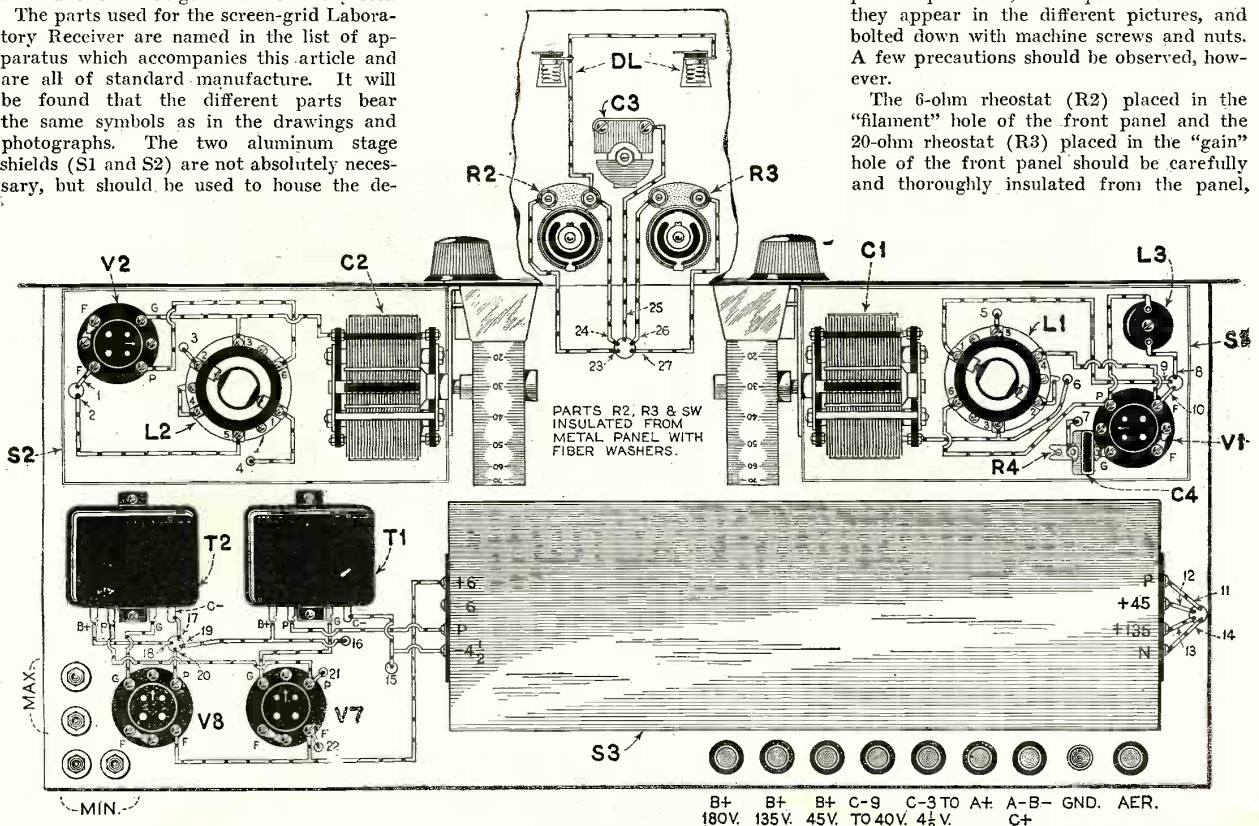

Wiring diagram of the parts above the sub-panel. A portion of the front panel is broken away to show the connections on it.

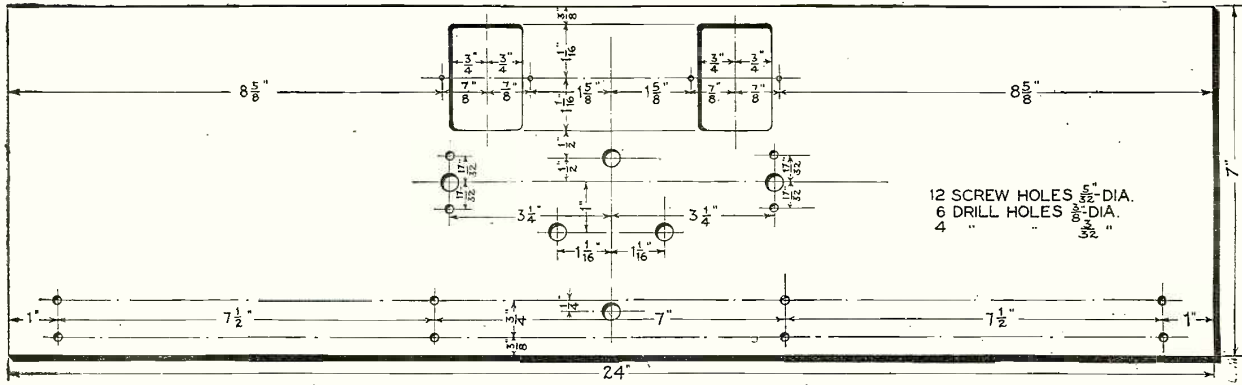

Drilling layout for the front panel of the Silver Screen-Grid Superheterodyne.

to state that the amplifier is held to the chassis by four long 8/32 screws tapped into the corners of its chassis. Each binding post should be mounted, using a pair of extruded fiber washers to insulate it thoroughly from the chassis; with the exception only of the "ground" binding post, which should be grounded to the chassis. The simplest way of doing this is to use one end lug of the 0.57-ohm filament resistor (R1) as a washer for the "ground" binding post, the binding-post screw going through the resistor lug, up through the chassis, and into the binding post. This connection serves to ground one end of the resistor, the other end being connected directly to the "A—" binding post (this connection can be seen in the schematic diagram—the resistor should be mounted, not as in the under-view picture, but as explained above.)

WIRING

The wiring of the receiver is done entirely with flexible fabric-insulated hook-up switch-board wire, with the exception of the three leads, which are put in with bus-bar in spaghetti. One of these bus-bar leads serves to connect post 5 of the antenna coil socket (4) to the stator lug of the midget "sensitivity" condenser (C3); while the other two leads serve to connect posts 1 and 2 of the oscillator coil socket (L2) to post 3 of the antenna coil socket (L1) and the first-detector grid condenser (C4). All three of these leads should be made of bus-bar in spaghetti, put in in such a way that they are at least 3/4-inch away from the metal chassis or receiver assembly at any point where they run parallel. All the rest of the wiring, with the exception only of grid and plate leads, should be bunched together as far as possible and, after final assembly and testing, may be laced or cabled, using heavy waxed shoemaker's thread, thus providing a very neat and workmanlike job, as seen in the pictures. The receiver can, of course, be wired with bus-bar in spaghetti throughout, if desired.

The wiring and assembly of the receiver having been completed, all previous operations should be very carefully checked, and the wiring compared with the schematic and pictorial diagrams to make absolutely sure that no errors, which might result in tube burn-outs, or other damage, have been allowed to creep in. This done, the set is ready for operation.

The necessary accessories should be connected to the receiver in accordance with the markings on the binding posts, and all tubes placed in the set. With both filament

rheostats (R2 and R3) turned to the left or "Off" position, and the "On-Off" switch turned on, the two audio amplifier tubes (V7 and V8) and the detector tube (V6) in the time-signal amplifier should light. With the filament rheostat (R2) turned slowly to the right, the first detector and oscillator tubes (V1 and V2) should light; and with the "Gain" knob to the right, the three 222-type tubes in the screen-grid amplifier should light. The three flexible leads with clips should, of course, be attached to the top caps of the 222-type tubes in the amplifier.

ADJUSTMENT AND OPERATION

To operate the receiver, the filament rheostat (R2) should be turned half-way on, the "Sensitivity" knob of the midget condenser (C3) should be turned absolutely all the way out, and the "Gain" knob (R3) turned fully on. If the oscillator dial is now rotated, no squeals should be heard; should they be, it will indicate oscillation of the intermediate amplifier. This would possibly be correct in the case of certain individual tube variations, in which event the "Gain" knob should be turned slightly to the left,

(Continued on page 1060)

LIST OF PARTS

SYMBOL	Quantity	NAME OF PART	REMARKS	MANUFACTURER *
C1, C2	2	Variable condensers	.00035 mf. Removable shaft type	1
C3	1	Midget condenser	.000075 mf. 17 plates	1 8, 9, 10
L1, L2	2	Plug-in coils	1111A type	1
L3	1	R.F. choke coil	2.5 millihenries	1 8, 9, 11, 12
T1, T2	2	A.F. transformers	3:1 ratio	1 9, 11, 12, 13, 14, 15, 16, 17, 18, 19
S1, S2	2	Stage shields	Aluminum - 7 1/2 x 3 1/2 x 5 inches	1
S3	1	I.F. Amplif. (112ka)	3 Stage and detector (screen grid type)	1
	3	Drum dials	Vernier action, single type	1
	2	Coil sockets	6 Contact type	1
	4	Tube sockets	UX type	1 9, 15, 17, 19, 20, 21, 22, 23, 24, 25
R1	1	Fixed resistor	.57 Ohms (wire wound strip)	2
R2	1	Rheostat	6 ohms	2 9, 13, 21, 24, 3, 25, 26, 27, 28, 29
R3	1	Rheostat	20 ohms	2 9, 13, 21, 24, 3, 25, 26, 27, 28, 29
C4	1	Fixed condenser	.00015 mf. Mica type with clips	2 3, 12, 15, 16, 25, 26, 27, 29, 30, 31
Sw	1	Battery switch	Panel mounting snap type	2 24, 26, 27
	4	Tip jacks		2 24, 26, 27
R4	1	Grid leak	2 Megohms	3 12, 21, 25, 27, 29, 30, 31, 32, 33, 34
V1, V6	2	Vacuum tubes	200A type	4 35, 36
V2, V7	2	Vacuum tubes	201A type	4 35, 36
V3, V4, V5	3	Vacuum tubes	222 type (screen-grid tube)	4 35, 37
V8	1	Vacuum tube	171 type	4 35, 36
	1	Steel chassis	Pierced, with hardware	5
	1	Front panel	Pierced and engraved	5
	9	Binding posts		6 9, 21, 22, 25, 27
		Connection wire	Insulated	7 25, 28, 39
			Amplifier S3 is sold as a unit in completely wired form.	

NUMBERS IN LAST COLUMN REFER TO CODE NUMBERS BELOW.

1 Silver Marshall, Incorporated	2 Carter Radio Company	3 Polvmet Manufacturing Company
4 E.F. Cunningham, Incorporated	5 Van Dorn Company	6 I. I. Laboratories, Incorporated
7 Acme Wire Company	8 Hamarlund Manufacturing Company	9 General Radio Company
10 Allen D. Cardwell Company	11 Sanson Electric Company	12 Leslie F. Matar Company
13 Pacent Electric Company	14 Thorderson Elec. Mfg. Company	15 Electrical Research Labs. (ENR-L)
16 Sanacmo Electric Company	17 Tyrmen Electric Company	18 Ferranti, Incorporated
19 All-American Radio Corporation	20 Kirgop Products Company	21 Sengco Products, Incorporated
22 H. H. Day Manufacturing Company	23 Benjamin Elec. Mfg. Company	24 Robert H. Frost, Incorporated
25 De Lux Products Company	26 Yasler Manufacturing Company	27 Hart & Haganan Manufacturing Co.
28 Central Radio Laboratories	29 Electrad, Incorporated	30 Dubilier Condenser Corporation
31 Aerovox Wirelase Corporation	32 International Regis. Co. (NORHAM)	33 The Carborandum Company
34 Arthur H. Lynch, Incorporated	35 Radio Corporation of America	36 C. E. Manufacturing Co. (Can.)
37 Shield-Plate Tube Corporation	38 Belden Manufacturing Company	39 Cornish Wire Company
40	41	42

* THE FIGURES IN THE FIRST COLUMN OF MANUFACTURERS INDICATE THE MAKERS OF THE PARTS USED IN THE ORIGINAL EQUIPMENT DESCRIBED HERE.

If you use alternate parts instead of those listed in the first column of manufacturers, be careful to allow for any possible difference in size from those originally used in laying out and drilling the panel and sub-base.

The All-Electric Everyman Four[★]

How to Construct a Four-tube Receiver Operated from an A. C. House Line, using Three of the New A. C. Tubes with a Power Tube in the Last Stage.

By Fred C. Ehlert

THE "Everyman Four" circuit was developed originally for that mammoth body of radio listeners who, living in districts over-supplied with broadcast stations, require primarily a receiver with a high degree of selectivity and yet one that is outstanding in its quality of reproduction. Of course it is realized by all that quality is adversely affected as the selectivity is improved beyond a certain optimum point. Accordingly, it became the task of the designers of the Everyman Four to adjust the two factors until both ends were attained. Strange to say, the

une obtained from the four tubes. Moreover, since there is no coupling to be considered between primary, secondary and neutralizing circuits, these three circuits, when once adjusted, are sure to be stable and free from cross-reaction as long as the set is used.

It will be noticed also from the diagram that the detector tuning condenser C2 practically "floats" across the inductor; the more usual filament connection to the rotor is missing entirely. Many might think that this arrangement would produce an unstable stage of amplification but, in actual

ity of the set. But also they add their part to the ability of this receiver to "go out and get DX." This latter attribute was not one of those taken into consideration by the designers, and it was only after some hundreds of sets had been assembled by enthusiastic experimenters that it became evident the feature of sensitivity could properly be added to those already to the outfit. Instances have been recorded in which this simple four-tube set had picked up and brought in distant stations which were unreadable on six-, seven- and eight-tube receivers.

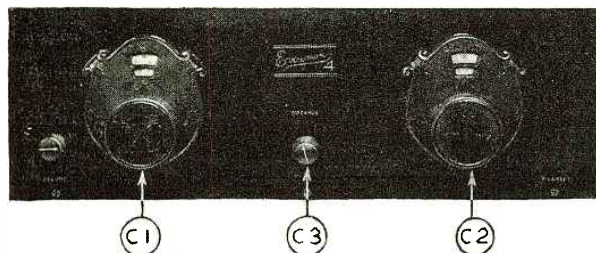

C1 and C2 (tuning condensers), C3 (regeneration control), and the volume control at the left of the panel are the only variables needed for the operation of the All - Electric Everyman Four.

ASSEMBLY

In laying out the parts for the All-Electric Everyman Four, the relations shown in the pictorial diagrams should be followed implicitly. As every good radio man knows, it is always possible to alter specifications, if the alterations are carried out according to engineering principles. But it is suicidal to shift coils, condensers and transformers if the builder knows not why he makes the change. The designers could, very possibly, have made a prettier arrangement of the individual items; in fact they tried some others with fair or nearly equal results, but, realizing that simplicity of assembly should be one of the features of the complete apparatus, they made beauty secondary to effectiveness.

selectivity finally obtained practically equals that of the average five-tube receiver embodying two stages of radio-frequency amplification; and the volume is but slightly less than that derived from the best five tubers.

Before going into the details of construction of the all-electric "Everyman Four," it would be well to point out still further some of the interesting features of the R.F. circuit.

This set consists of one stage of stabilized radio-frequency amplification, a detector with controlled regeneration, and two stages of high-quality audio amplification. There are four controls, only two of which are commonly used. This makes for simplicity.

The signal impulse from the antenna is fed to the grid of the first tube through a variable-coupling arrangement; this simple device is the only volume control required on the set. In addition, the variable primary can be utilized in extreme cases to increase selectivity.

A NOVEL R.F. TRANSFORMER

Perhaps the most interesting part of the whole circuit is the unusual form taken by the radio-frequency coil L2. This coil is a simple solenoid with 66 turns of wire and, from the single winding, come taps for the primary, for the neutralizing condenser and for the tuned detector input. As will be seen from the schematic diagram, the R.F. transformer in the "Everyman Four" is in reality an autotransformer; its primary consists of 22 turns and the secondary of 66. This form of inductor insures a high order of signal transfer, which is the principal reason for the extraordinary vol-

practice, this is not so. Unless the stator of this condenser is improperly placed, there is no hand-capacity, even on the lowest waves to which the set can be tuned.

All of these features contribute in their way to the remarkable selectivity and qual-

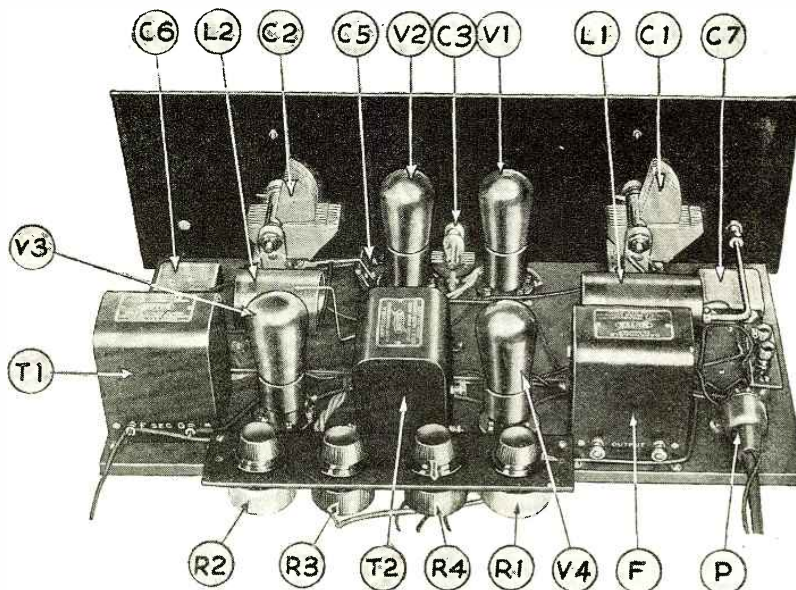

C1, C2, tuning condensers; C3, regeneration condenser; V1, V2, V3, A.C. tubes; V4, power tube; T1, T2, A.F. transformers; F, output filter; R1, R2, rheostats; R3, R4, potentiometers.

★ RADIO NEWS Blueprint Article No. 49

The antenna coil L1 lies at the extreme left of the baseboard, and the secondary S is supported on a short L-shaped stand. If the baseboard is attached to the front panel at any point other than that shown by the illustrations, the height of this coil support must be changed; as it is essential that the primary coil P match exactly the secondary coil. In other words, the two coils (one fixed and the other movable) must be so arranged that when the coupling is maximum their axes coincide. The distance of these coils behind the front panel is not a vital matter, this being decided usually by the length of the swivel-control-rod of the antenna coil. On the other hand, no harm is done if the coils are brought forward toward the variable condenser, so long as a minimum distance of 3/4-inch is observed.

The coil L2 should be kept at least 8 inches from the antenna coil. If this distance is maintained it is not necessary to alter the axis of the coil. There will then be no reaction even if the coils lie along the same axis.

COIL SPECIFICATIONS

If it is desired to wind these coils at home the data will be found of the simplest sort. The coils are wound on forms of formica, 2 inches in diameter. In the case of L1 the primary P consists of 14 turns and the secondary S of 67 turns, both wound in the same direction. It should be seen that the end of the primary and the beginning of the secondary coil are as close to the edge of the form as it is possible to make them. This insures the maximum coupling when desired.

The R.F. coil L2 consists of 66 turns tapped first at the 22nd turn and again at the 43rd turn. All coils are wound with No. 24 D.S.C. wire.

Although they play important parts in the operation of the set the location of the neutralizing condenser (C4) and the R.F. choke coil (L3) is not critical. As long as

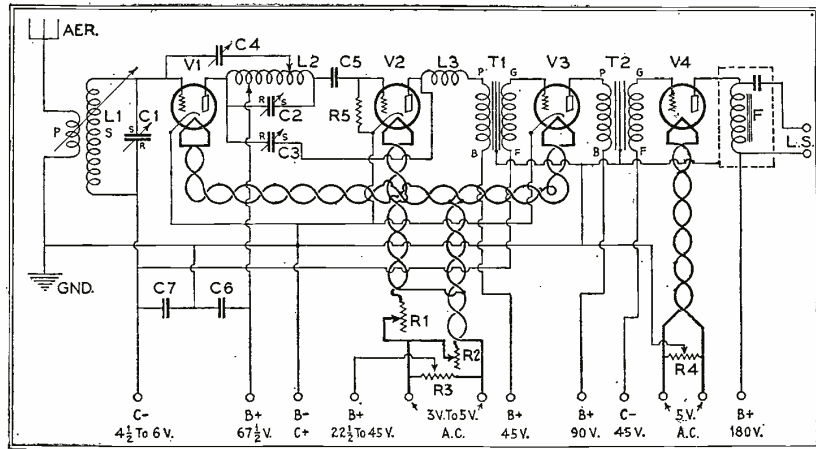

The schematic diagram of the All-Electric Everyman Four. The wiring diagram, showing the disposition of the parts, is on the opposite page.

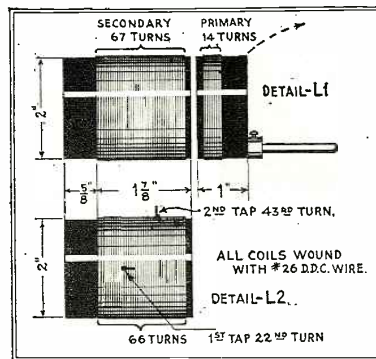

The data for winding the inductors, L1 and L2, will be found in the above sketch. See illustration below for their position.

they are placed in such a way as to require no extra leads they will function properly.

The sockets have been placed to give short leads as well as accessibility. It is not always best to shift components about with the sole purpose of saving wire; since in some many instances longer leads do no harm whatsoever. Accessibility often means more to the unskilled builder than beauty of arrangement and finesse in design.

THE AUDIO END

The audio amplification system does not demand a great deal of explaining. Both transformers (T1 and T2) were selected because in combination they possess to an unusual degree the ability to reproduce those hidden bass notes that give "roundness" and beauty to orchestral renditions. Moreover, in so doing they do not cause garbled speech, a trouble which is frequently encountered with present-day audio transformers. Containing wire of ample size and cores of good iron, these transformers handle well the signal passed on to them from the detector.

Although not essential to the operation of the "Everyman Four" the use of an output clarifier (F) is advised in order to safeguard the speaker from the high direct current that otherwise would flow through the delicate magnet windings of the unit.

So much for the materials located on the baseboard. The panel comes next. On it are the two .0005-mf. tuning condensers, C1 and C2, the control knob for the antenna coupler, and the variable neutralizing condenser C3, through which regeneration is effected. With so few parts on the panel, it is evident that only a few minutes should be required to complete the wiring, once the baseboard has been finished.

A.C. SET DESIGN

In deciding on the tubes to be used, preference was given to the 227-type heated-cathode tubes, because of their greater freedom from hum. This problem is not of such moment when straight tuned-radio-frequency amplification only is concerned; but, in a receiver such as the Everyman where regeneration is often brought into play, any residual hum in the plate circuit of the R.F. tube is amplified to a point

(Continued on page 1069)

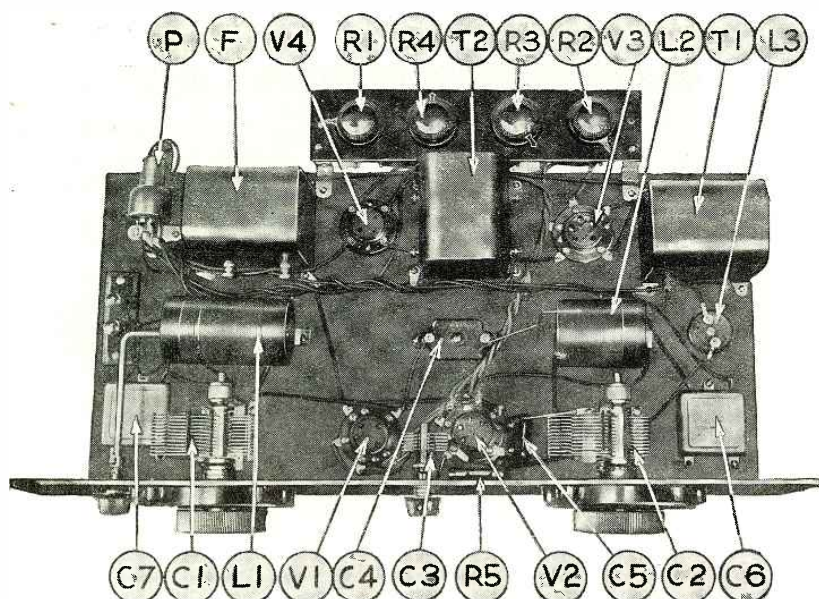

L3, R.F. choke coil; C4, neutralizing condenser; C6, C7, by-pass condensers; P, cable connector; L1, antenna coupler; L2, plate coil; V1, V2 and V3, Y-type sockets for 227-type tubes; V4, power-tube socket.

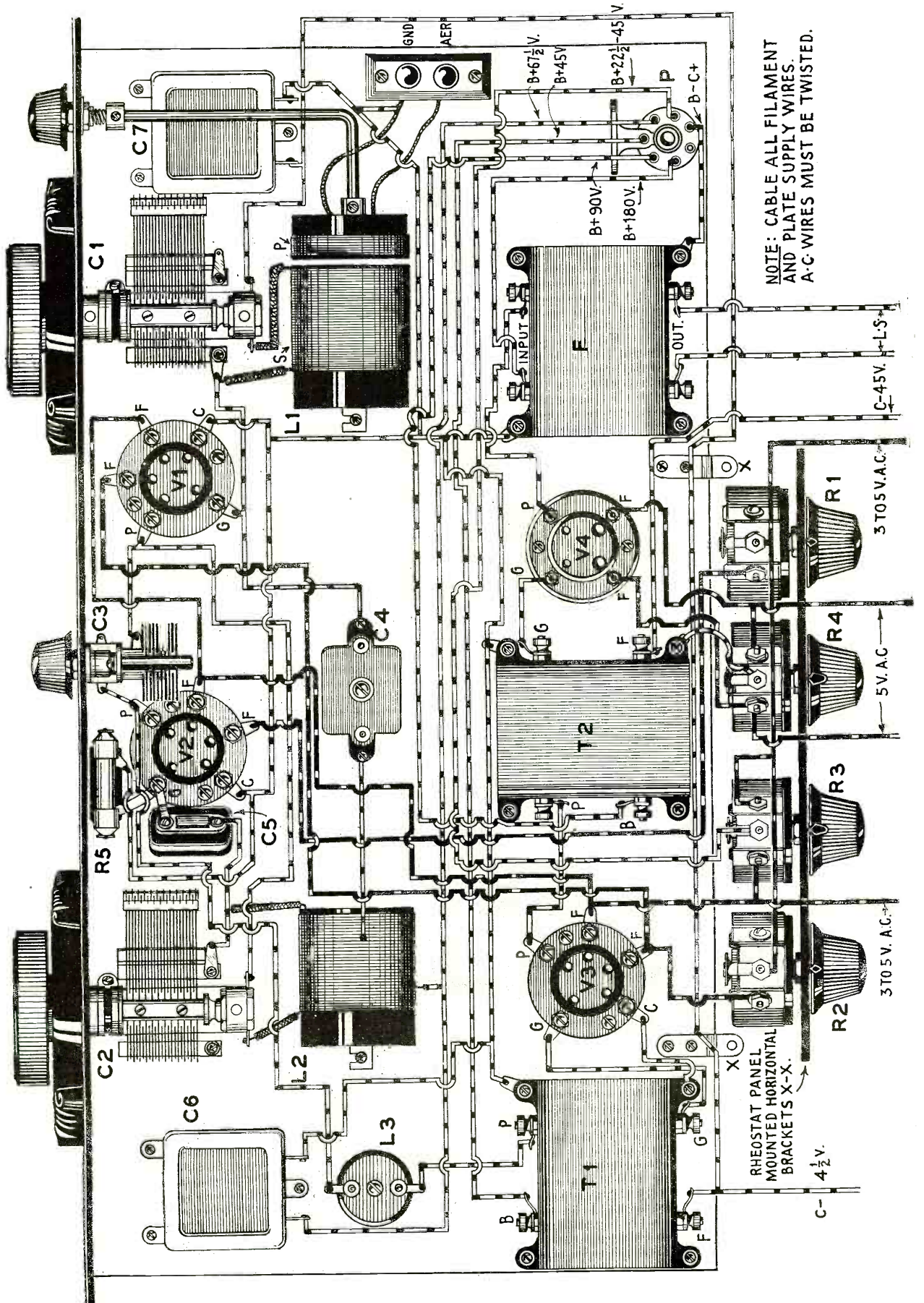

The Knowles Screen-Grid Four^{*}

Constructional Details for a Four-Tube Receiver, which is Simple to Build, and Includes One Stage of Tuned R. F. Amplification with a 222-type Tube

By Hugh S. Knowles

WE are continually told that the radio industry is "in its infancy" and that things in radio quickly become obsolete. While this would seem to be true, judging from the "new" and "revolutionary" designs that appear from time to time, there are numerous exceptions. Probably the most outstanding exception to this tendency, in circuit combinations, is that of a stage of tuned-radio-frequency amplification with a regenerative detector and an audio-frequency amplifier. This type of circuit has appeared under numerous different names—each variation calling for a new name.

The fact that this circuit arrangement is still very popular, although it has been in common use for four years or more, indicates that it has definite survival value. With the advent of the screen-grid (222-type) tube, which promises to mark a new era in radio-frequency amplification, it is very natural to ask whether this popular circuit arrangement can still be used advantageously and, if so, just what modifications are necessary. Because of the very different characteristics of this new tube it is important to modify the circuit, and not merely to insert the new tube in the old circuit with the expectation of getting greatly-improved results.

FLEXIBILITY OF OPERATION

The receiver we are about to discuss is one which combines the features of this well-known circuit arrangement with the

modifications made necessary by the use of the 222 tube. The merits which have been carried over may be summed up in the

its maximum efficiency—a thing which is much more difficult in a receiver using five or more tubes.

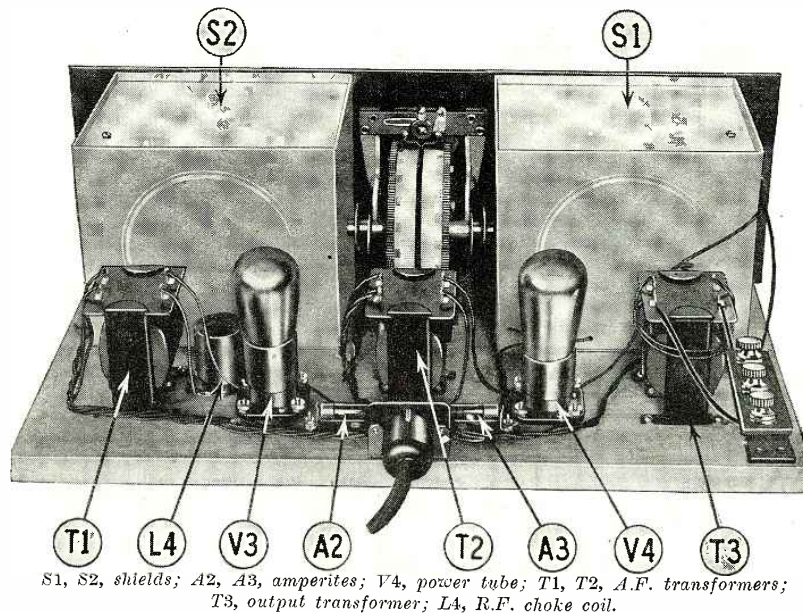

S1, S2, shields; A2, A3, amperites; V4, power tube; T1, T2, A.F. transformers; T3, output transformer; L4, R.F. choke coil.

word "performance." This is due to the fact that each tube is made to operate at

In performance the receiver combines the features that have made the sets using the 201A-type tube popular, and those that are made possible only by the use of the new 222-type tube. It combines simplicity of operation on local stations with a flexibility of control which permits the more experienced operator to get remarkable results on distant stations. The 222-type tube has made greater radio-frequency amplification possible; with the result that this set's sensitivity is equal to that of the average five- or even six-tube receiver in which controlled regeneration and individual-stage control are not used.

The antenna coupling may be varied (in the coil L1) to suit the type of antenna used and the amount of interference that prevails in a particular locality. The radio-frequency stage (S1) is tuned separately; which insures maximum amplification. The detector circuit (S2) has a separate tuning control, which may be operated in unison with the R.F. stage control on local stations, but may be more closely adjusted for the reception of distant stations. The judicious use of regeneration by means of condenser C3 makes the detector stage contribute its quota to both the selectivity and sensitivity of the receiver. This point will be discussed in more detail later.

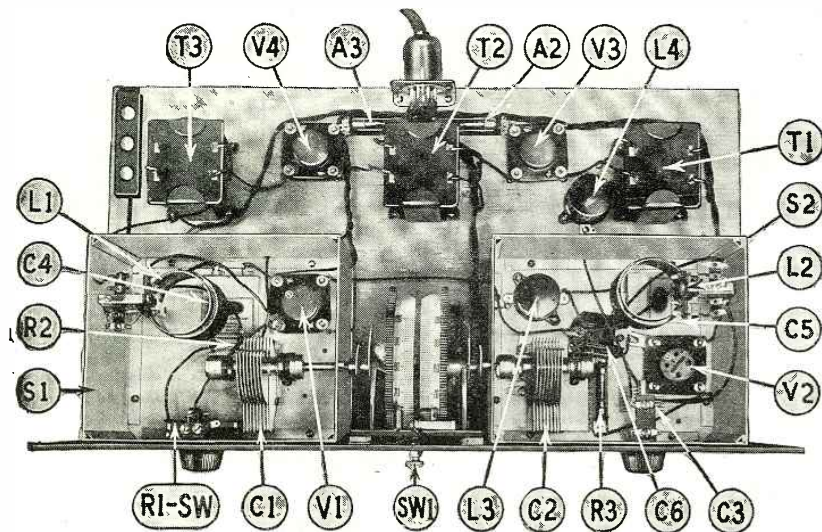

C1, C2, .00035-mf. condensers; L1, L2, coupling coils; V1, socket for 222-type tube; R2, 15-ohm resistor; R3, grid leak; C4, C5, by-pass condensers; C6, grid condenser; R1-SW, switch and rheostat.

* RADIO NEWS Blueprint Article No. 50

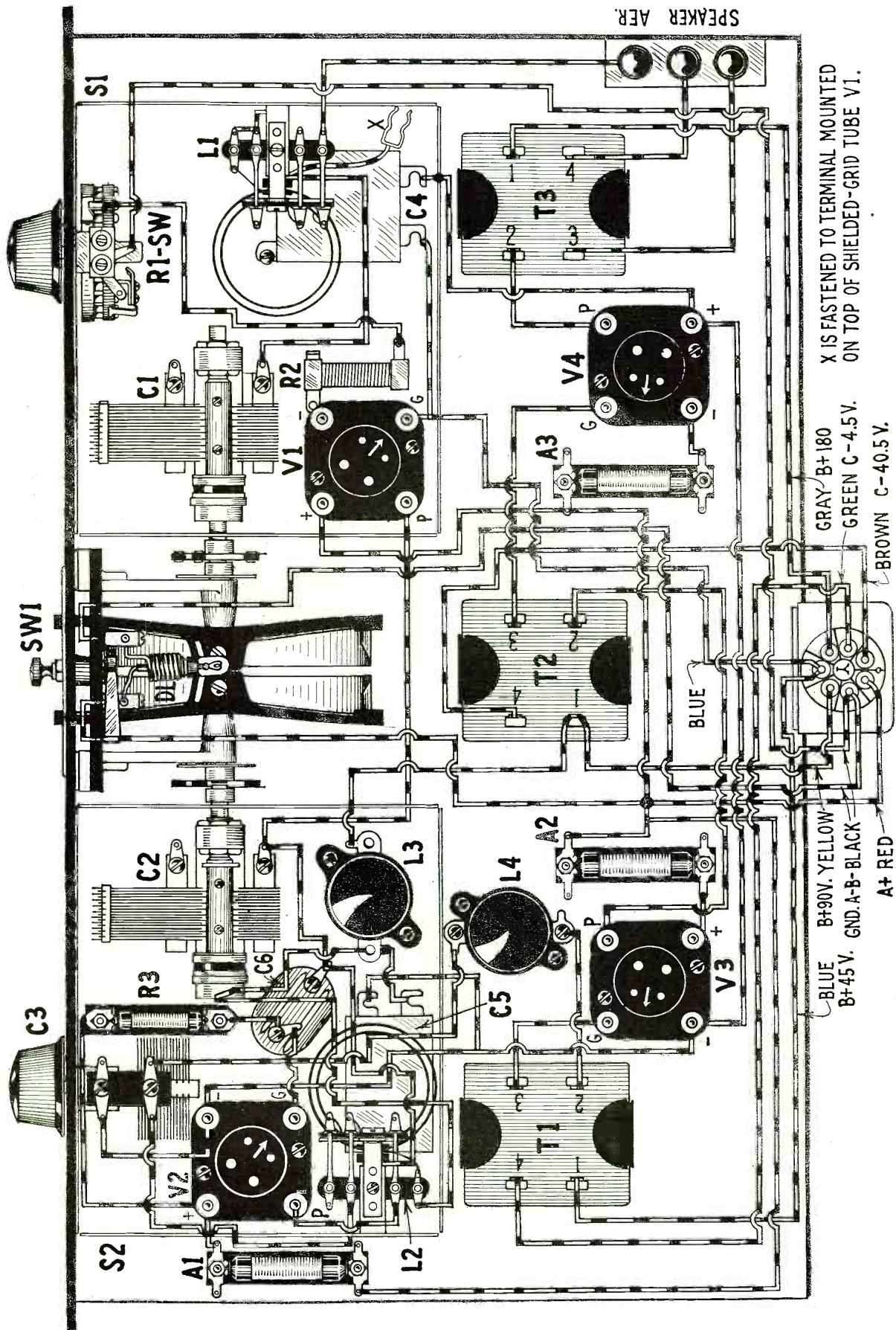

X IS FASTENED TO TERMINAL MOUNTED ON TOP OF SHIELDED-GRID TUBE V1.

GRAY-B+180
GREEN C-4.5V.

BLUE B+90V. YELLOW
B+45V. GND. A-B- BLACK
A+ RED

BROWN C-40.5V.

The complete wiring diagram of the Knowles Screen-Grid Receiver. This also indicates the location of the parts.

SPEAKER AER.

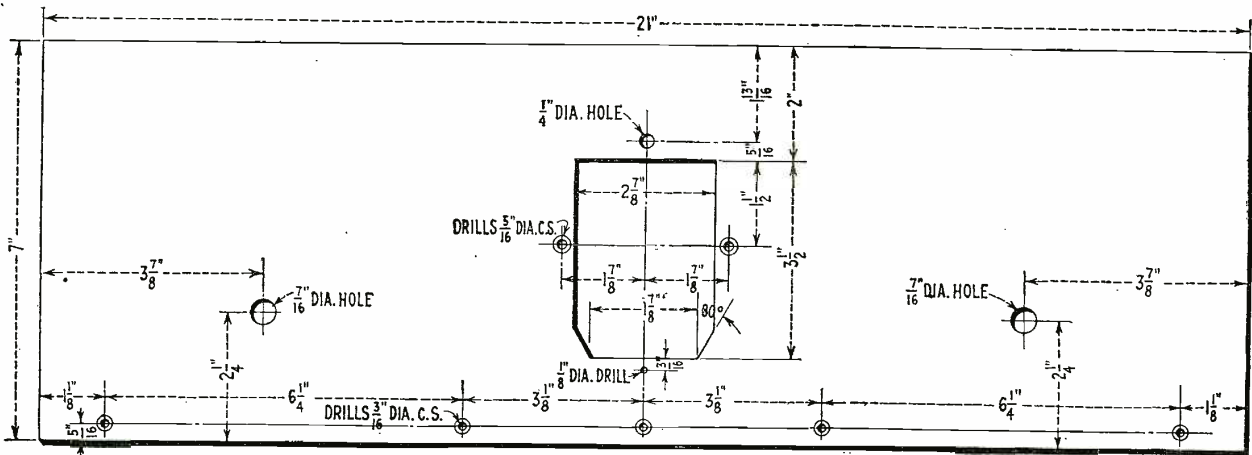

The drilling details for the front panel of the four-tube, screen-grid receiver, illustrated below.

ELEMENTS OF DESIGN

It is a comparatively simple matter to make one laboratory model of a receiver which has exceptional performance; but it is a very different thing to build a receiver which may be duplicated by the thousands in the homes of set constructors, not only in parts or appearance, but in performance as well. When this is considered we have a clue to the popularity of the R.F.-stage, regenerative-detector combination. Such a circuit normally has no component parts which have critical values; in other words, it is a *production receiver* in the sense that it is easy to duplicate and can be relied upon for excellent results consistently.

One of the most important motives in building a receiver is the economic one. Since the set builder is usually willing to

use only the best parts obtainable, to insure corresponding performance, it is important to build a receiver which is simple

reason for the survival and popularity of the circuit combination we have in mind.

An inspection of the wiring diagram of the receiver will show that two principal changes are made necessary by the use of the new screen-grid tube (V1). These are the omission of the balancing circuit, which is a distinct advantage resulting from the low inter-electrode capacity (from control grid to plate) in this tube; and the use of a tuned circuit instead of a transformer to couple the radio-frequency stage to the detector.

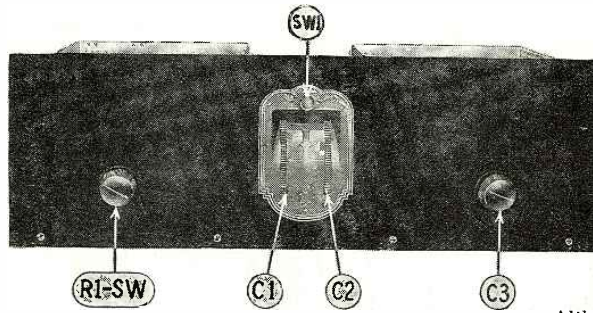

SW1, panel-light switch; R1-SW, volume control and filament switch; C1-C2, tuning condensers; C3, condenser controlling regeneration.

SPECIAL TUBE CONSIDERATIONS

Although no balancing circuit is used, certain precautions must be observed. It is important to minimize the capacity between the plate of the screen-grid tube and the control-grid. In this arrangement, it will be seen that the plate lead leaves the shield compartment within half an inch of

(Continued on page 1065)

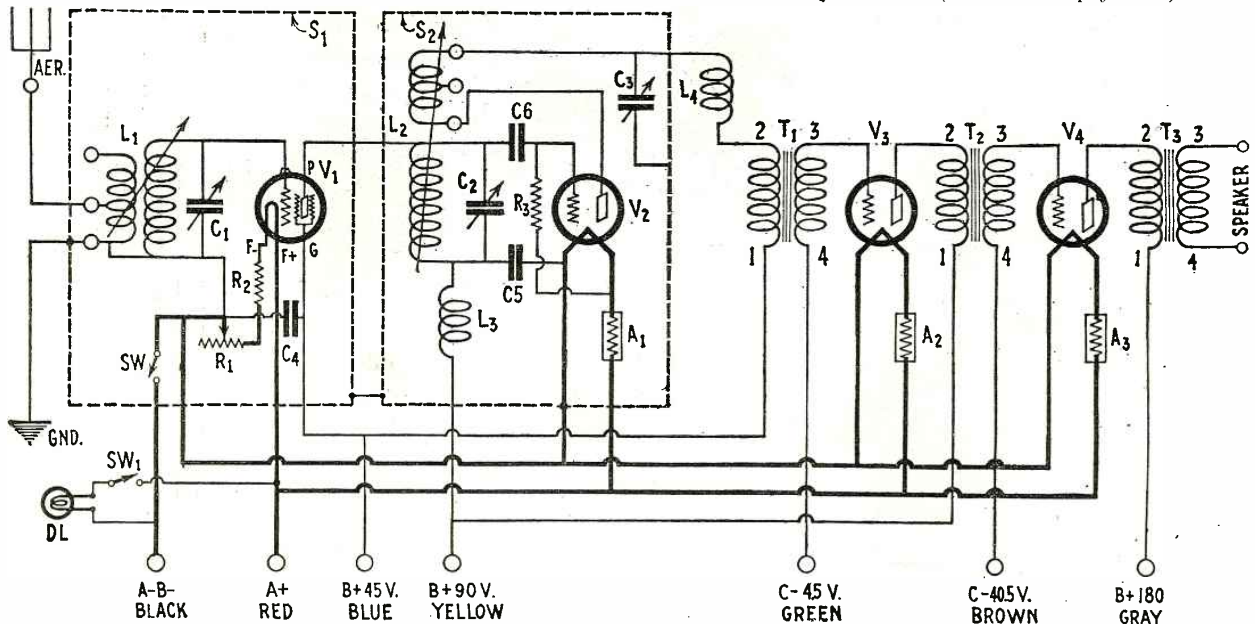

The schematic diagram of the screen-grid receiver described in the above article. The dotted lines indicate the shields enclosing R.F. portions of the circuit.

The Pacent Distant-Signal Amplifier*

Using the New Screen-Grid Tube in the First Stage,
This New Audio Amplifier Quadruples Amplification

By Gerard J. Kelley

WHO hasn't been routed out of bed at one time or another to "hear the Coast"? Few indeed are the Easterners who haven't been coaxed from between warm covers with the promise of listening to KFI or KHJ. One can't blame any normal radio enthusiast for disturbing fair dreams in his desire to listen

important being its extraordinarily high "mu" (amplification constant.) The possibilities of this remarkable new tube are many, and a lengthy treatise might be written upon its uses and applications. Experiments conducted towards the ultimate design of this distant-signal amplifier brought out several interesting points.

The 222-type tube is intended primarily for radio-frequency work. In this function, however, it requires special layout of parts, real shielding, and the use of special circuits. To do this with the information at hand, might be a little too much for some builders. As a detector, it has been found quite microphonic; in fact, so sensitive to mechanical vibrations that no information as to its ability as a detector could be obtained.

Properly used as a first-stage audio amplifier, however, this new tube offers most extraordinary rewards. It is an ideal first-stage amplifier of distant signals. This discovery, made while experimenting with the first of these tubes available, led to extended work on the application of the tube to a new distant-signal amplifier, which is here published in its final, perfected and simplified form.

The presentation at this time will undoubtedly be of special interest to those radio amateurs and broadcast listeners who strive each year to bring in Europe before the weather becomes warm. In the past a limited number of people have succeeded in getting European signals through the detector, only to have them so weak that they are practically inaudible. For those who want better volume on DX work, without

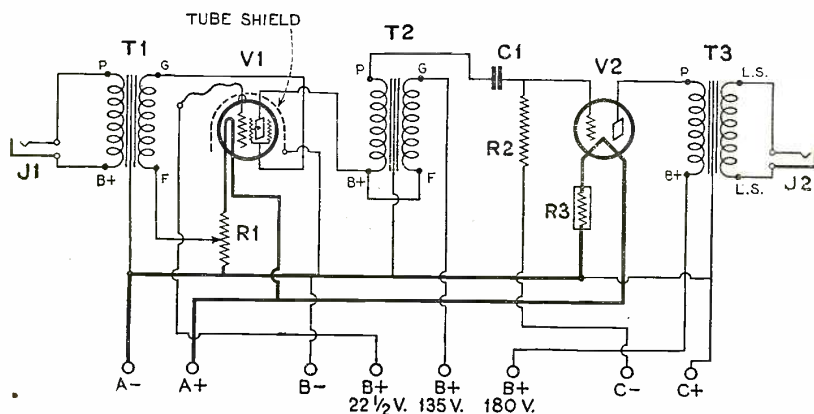

Schematic diagram of the Distant-Signal Amplifier, which utilizes a 222-type tube (V1) in the first stage. Pictorial wiring diagrams will be found on the following pages.

to sweet music three thousand miles away. Sometimes, but rarely, the desire is fulfilled to the full extent. But how seldom!

Many of us, I am sure, have heard the Coast. But the question is, *how well* have we heard it? The carrier is there, no doubt about it; but the announcement and the music are so faint that very good hearing, and not infrequently, very good imagination are essential to identify the broadcaster. Let's not belittle those persistent operators who bring in far-distant stations. Tuning them in at all is an achievement not to be laughed down by those lazy souls who shuffle off to bed early and scoff at the lure of DX.

Rather let us offer these same distance enthusiasts a simple means of bringing in faraway broadcasting with more volume and power. Here is where the newly designed distant-signal amplifier proves of remarkable assistance; for it offers more audio amplification in two stages than has ever been available to the experimenter, thus far, with the same applied battery voltages. Probably nothing in audio amplifiers has yet been presented which gives the same worth-while results with such appealing simplicity and small expense.

USES SCREEN-GRID TUBE

Most radio experimenters have undoubtedly heard of the new 222-type, screen-grid tube and its interesting features, the most

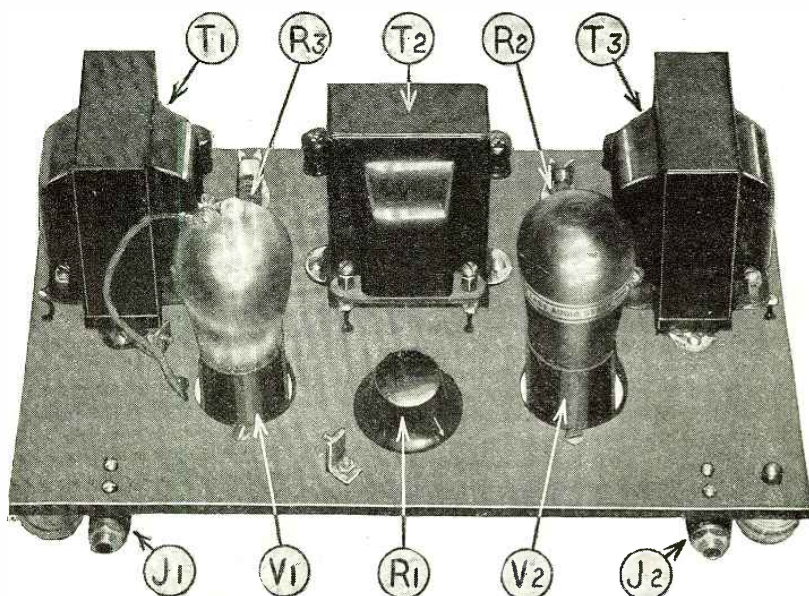

T1, T2, A.F. transformers; T3, output transformer; R1, 30-ohm variable resistor; R2, grid leak; R3, amperite; J1, J2, jacks; V1, 222-type tube; V2, power-amplifier tube.

* RADIO NEWS Blueprint Article No. 51

going in for high-priced, elaborate amplifying equipment, this simple amplifier is recommended.

COMPARATIVE AMPLIFICATION

Comparing its total amplification with that of a standard two-stage transformer-coupled amplifier, the superiority of the former becomes immediately apparent. The voltage amplification for a two-stage transformer amplifier (transformer ratio 3 to 1, a 201A-type tube in the first stage, and a 171-type in the second) is 216 as compared with 900 from the distant-signal amplifier shown in the accompanying schematic diagram.

It is obvious that we have more than four times as much amplification available with the 222 distant-signal amplifier; or, speaking roughly, on a weak DX signal, we should be able to receive the signal with at least four times as much volume on the speaker. Surely an amplifier with this extraordinary advantage appeals instantly to anyone interested in better distance reception.

It should be understood, however, that the use of the new amplifier is not restricted to DX work; as a matter of fact, this new audio system may be well employed with any standard set for both local and distance work. Considering the unusual amplification available, it is apparent that the amplifier should be worked nowhere near its full capacity. On a strong local signal, and with the amplifier going full tilt, there

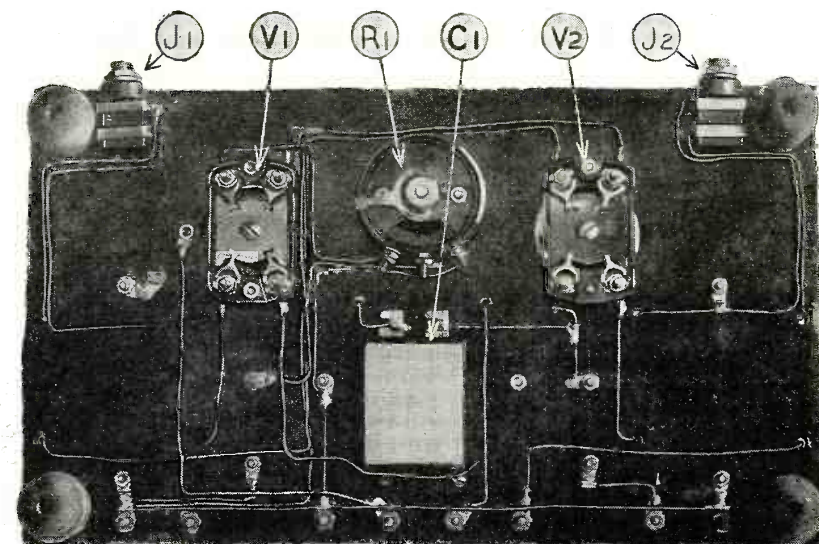

The under side of the horizontal panel of the Distant-Signal Amplifier. The parts here are lettered just as they are in the schematic and wiring diagrams. About one-third of the potentiometer R1 has been shorted, as shown by the white portion of the wire.

is no available output tube which will satisfactorily handle the load. Rather than any gain in this case, a distinct loss in tone quality will result. When properly handled, however, the amplifier gives excellent quality on strong signals; the only adjustment

needed is to cut down on the 30-ohm resistor R1 (which is a potentiometer connected as shown in the schematic diagram).

The distant-signal amplifier is excellent also for use with an electric-phonograph pick-up. For this purpose, it can be con-

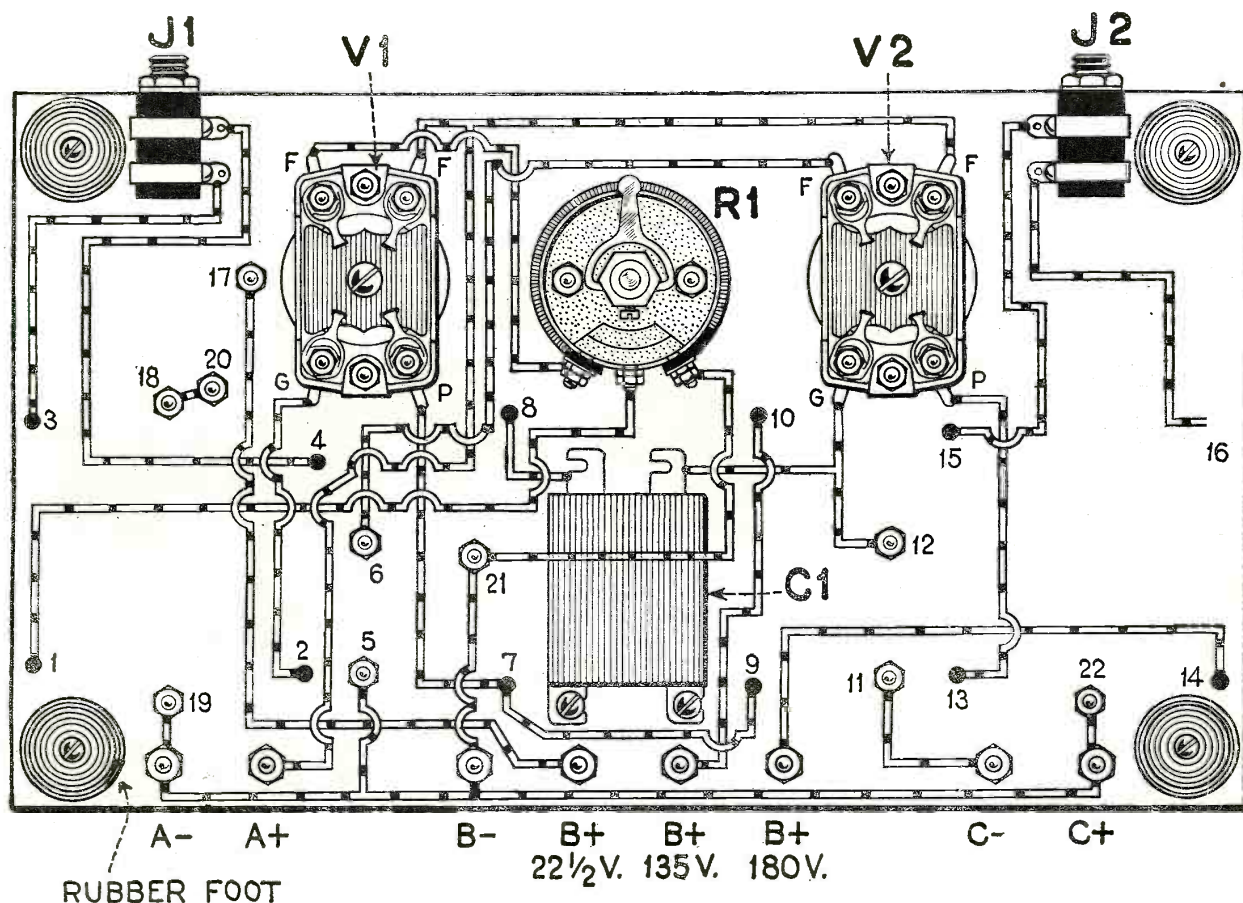

The wiring diagram of the under side of the panel is here shown, with numbers and letters corresponding to those given in the list of parts, which may be found on page 1073.

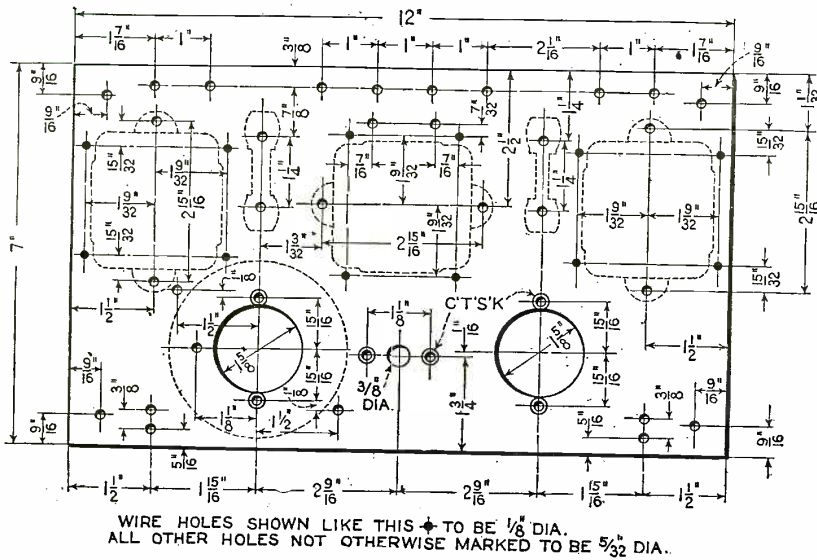

The drilling layout for the only panel used in this amplifier, which is one especially simple to construct.

The first problem centered about the type of coupling device to use in the amplifier. The first thought was of impedance coupling to work in conjunction with the 222 tube. Investigation showed that there were no available units with an inductance greater than 150 henries.

Straight transformer coupling was out of the question, inasmuch as no transformer is made with electrical characteristics suitable for work with this new tube.

Finally the idea of autotransformer coupling was considered, and one unit was found that had an inductance of over 300 henries; but this was not enough. After further investigation, the audio transformer (T2) named in the list of parts was selected for use as an autotransformer, not as a regular audio transformer. This choice resulted from the discovery that the transformer maintained a high secondary inductance, about 600 henries, with a high value of current through it. With this in mind, the transformer was selected as the ideal coupling device for the 222 tube, when used as an autotransformer with primary and secondary connected in series.

CONSTRUCTION IS SIMPLE

Once the problem of coupling was solved by finding a unit with a high value of inductance under high current load, the task of building the complete distant-signal amplifier became comparatively simple. The (Continued on page 1073)

nected to the receiving equipment in the regular manner, and an adapter placed in the detector socket of the set; or a plug from the pick-up can be run to the input jack of the amplifier, and the receiving equipment left unchanged.

FEATURES OF THE DESIGN

In starting the design of the distant-signal amplifier some months ago, a number of obstacles were encountered, and were overcome only after considerable work.

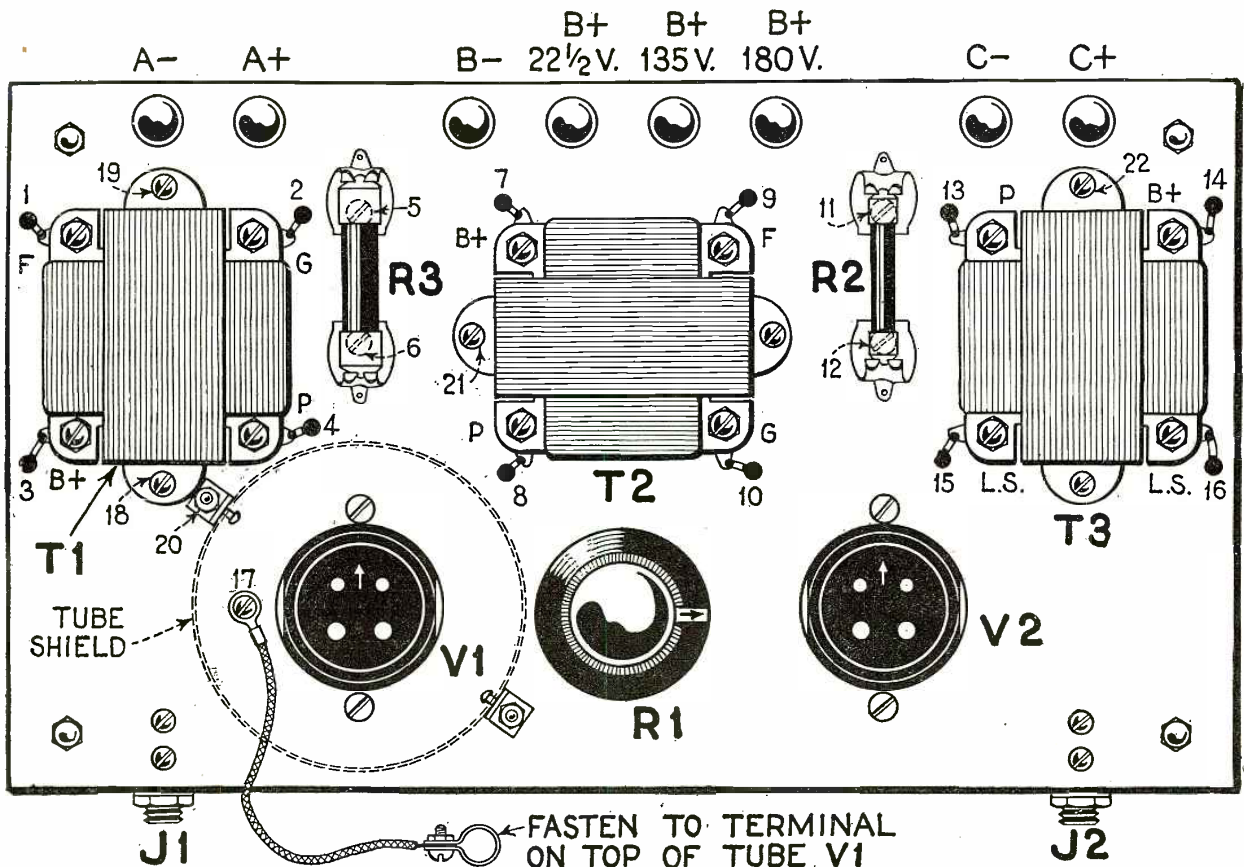

The holes, which are numbered in correspondence with those shown in the diagram opposite, are for the wires connecting the apparatus on the under side of the horizontal panel. Note the simplicity of the wiring.

Letters from Home Radio Set Constructors

A SIMPLE COIL MOUNTING

Editor, RADIO NEWS:

I am watching your magazine very closely, building very nearly everything big, just to get something better, you know. That is how I spend my spare time.

I believe very positively that Mr. F. A. Jewell has the right idea on the audio amplifier. I have mine unit-built, and at present am hooking it to the *Strobodone* circuit just to see what it will do.

Here is a very simple little idea for the novice, to vary the primary coil. I extend the coil and mount this device on a separate piece of insulation, using pin jacks if I wish to make it a detachable coil. All the coils I make are space-wound on strip celluloid. If a fellow uses a little patience, he can make a very neat and inexpensive coupler that looks as if it is factory-finished. (See third column).

A. W. DOUGHERTY,

4350 Lake Park Avenue, Chicago, Ill.

AN EXPONENTIAL SUPER-HORN

Editor, RADIO NEWS:

The articles on exponential horns are very interesting to me. I am somewhat of a speaker "nut," having constructed all types of speakers. I set to work and constructed half a dozen horns such as Mr. Millar described in *RADIO NEWS* for October, 1927; they all gave excellent results.

My brother, who lives in Reedville, Va., has a very powerful radio, and also a powerful unit; he asked me to build him a real horn. As I had to ship it, it was necessary to make it in sections. It is 20 feet long, with five four-foot sections.

It is made of beaver-board. Each section is nailed together and pasted at the corners with gummed-paper tape. Wooden strips, one-inch square, are nailed to each end of a section; and these are bolted together.

The results with this horn are simply wonderful.

ALARM CLOCK HAIR SPRING

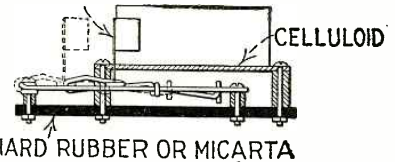

Mr. Dougherty's variable coil-mounting device is an ingenious bit of wire-twisting. A round-nose pliers and patience are required to make a good job.

THAT JAPANESE CIRCUIT

Editor, RADIO NEWS:

I thank you for kindly publishing my letter concerning the "Crossdyne" in your October issue. Since I forgot to write the data of the "crossformers," etc., I have received many letters, about a hundred, from all over the world—Czechoslovakia, Denmark, Canada, etc., asking for them.

The Crossformer is a high-frequency regenerative transformer; but quite different in construction from the ordinary R.F. transformers, because the tickler is fixed at right angles to the primary. Consequently, electromagnetic force radiated from the tickler does not directly induce R.F. current into the primary—except by the capacity effect. The secondary coil is excited, however, by the combination of the tickler and the primary. The coils are designed to have low capacity between windings; and, even with the multiplication of regenerative stages (as in the former diagram, which showed a triply-regenerative set) this prevents radiation.

In the common regenerative circuit, the tickler induces a powerful current in the primary, and the currents in the primary and in the tickler differ in phase from each other, and from that in the secondary as well. Thus harmonics, quite different in frequency from the fundamental signal wave, are set up. To remedy this, the inventor of the Crossformer has developed this R.F. transformer, with the especial purpose of producing a receiver adapted to DX.

The specifications of the transformer are: primary, 15 turns of No. 25 D.C.C. wire on a 2 1/4-inch tube of bakelite or ebonite, 2 inches long. The tickler is wound with 18 turns of the same wire on the same form, at right angles to the primary. A gap of 1/31-inch is kept to lessen the capacity between them. The secondary is wound in "basket" form 3 inches inside diameter, with 57 turns of the same wire. The combination of primary and tickler is inserted in the opening and fixed with strips of insulation. This transformer, with a .00035-mf. variable condenser, will cover the broadcast range. It is designed for use with the 201A-type tube; and some modification may be necessary for use with any other. This information is obtained from the manufacturers, the Mejiro Mfg. Co., Takadamachi, Tokio-fuka, Japan.

In my crossdyne receiver, which was diagramed in the October issue, the R.F. choke coils are Samson No. 85, and the tubes either R.C.A. or Cunningham.

MINORU NAKAMURA,
Yamate, Oiso, Japan.

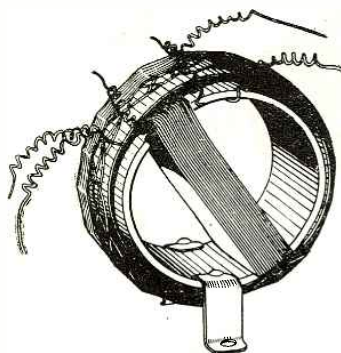

The appearance of the "crossformer," a Japanese R.F. transformer, in which the primary is wound at right angles to the tickler.



Mr. Dey is standing directly in front of his 20-foot exponential horn. Its size may be gauged by comparison with its surroundings. (It is not recommended for use in a portable set).

I have several telegrams from my brother in regard to the wonderful results he is having with this horn. A five-mile range (over water) is easy. A specially-powerful unit, of course, is required.

If the photograph and letter are of interest to anyone, I will be glad to give more details in regard to construction to anyone writing me.

J. BASCOM DEY,

3454 Fort Avenue, Lynchburg, Virginia.

(We are afraid Mr. Dey doesn't know what he is in for. Some of our other contributors have discovered something about the letter-writing ability of *RADIO NEWS*' readers. However, we would ask that readers avoid writing for details to constructors of a complicated device like this, unless they seriously intend to attempt the construction of one like it.—EDITOR.)

EXCELLENT WORK WITH THE "PERIDYNE 5"

Editor, RADIO NEWS:

I am not much on letter writing and, if I had my choice between writing letters and building radio sets, I would prefer building; but this is about your "Peridyne 5," which I built, as per your instructions in *RADIO NEWS* for December.

As soon as I read the article and saw the Interflex principle was used, I knew it was good; as I

built the Interflex when you first published it in 1925. I carried it to San Diego, Calif., on a trip the same year, and built quite a number of these circuits in San Diego. In fact, I hired a man to help me wire these sets, day and night, and every one gave complete satisfaction and is still working. So much for the Interflex circuit.

As I have said, the "Peridyne 5" was built according to your instructions and put to work. Coils and shields I made myself, as I have done since 1921. The circuit is very selective, tuning right through all the Philadelphia stations and bringing all the DX stations anyone desires; volume and quality are very good.

Using this set in Philadelphia three nights, and then taking same to Smyrna, Del., over Saturday and Sunday nights, the following stations were received:

KDKA, Pittsburgh; KEX, Portland, Ore.; KFAU, Boise, Idaho; KFDM, Beaumont, Tex.; KFEQ, St. Joseph, Mo.; KFI, Los Angeles; KFKB, Milford, Kas.; KFKX, WLJB, WOK, WJAZ, WLS, WBBM, Chicago; WBAL, Baltimore; WEAJ, WJZ, WMCA, WNYC, New York; WDEL, Wilmington, Del.; WRC, Washington; WSAI, Cincinnati; WHAR, WPG, Atlantic City; WOR, Newark; WBZ, Springfield, Mass.; KWKH, Shreveport, La.; KMOX, St. Louis; KGO, Oakland; WCAL, Northfield, Minn.; WCBD, Zion, Ill.; WGW, Schenectady; WCOA, Pensacola, Fla.; WCX, Detroit; WDAD, Nashville; WDAF, Kansas City; WDBO, Orlando, Fla.; WHO, Des Moines; WLBL, Stevens Point, Wis.; WLBW, Oil City, Pa.; WSB, Atlanta. (All the preceding were copied in Philadelphia; these following at Smyrna):

KFOA, Seattle; KFQB, Fort Worth; KGA, Spokane; KGW, Portland, Ore.; KNT, Muscatine, Ia.; KOA, Denver; KFBU, Laramie, Wyoming; KFON, Long Beach, Calif.; KGEF, Los Angeles; KOB, State College, New Mexico; KPO, San Francisco; WJAX, Jacksonville, Fla.; and many Chicago, New York, Philadelphia, Cincinnati and near-by stations. I heard KWSC, State College, Pullman, Wash., announced, but will not be sure until I receive verification. This, I think, is good reception.

The coils I wound as follows: I have two forms made of wood, three feet long and 2 3/8 inches in diameter, cut in half for the whole length, and treated with beeswax. I clamp the form together and cover it with sheet celluloid and wind as many turns of wire as are needed to make a set of three coils. After the winding is finished, I saturate the wire thoroughly with ether. This dissolves the celluloid and, when the windings are dry, they are self-supporting (as per sample enclosed).

These forms can be made of any diameter and will last forever; but I have found that the 3-inch coil is good for any set. Shorter forms, 3 1/4-inch and 2 3/8-inch, are used for primary windings. These can be made to be placed either inside or outside of the secondary. The shields I made from sheet copper.

The condensers and rheostats I used were Pilot; choke was Samson; the high resistor was a Clarostat, and Amperites were used on the audio tubes. Meters were the Jewell panel type, which I had at home, and the crystal was Carborundum, as called for in the original Interflex.

If your instructions for balancing the set are followed, no trouble will be experienced by the constructor; but I found that, as you said, the voltage to the R.F. tubes must be exactly right and using meters is the best way to know that it is.

I hope you receive other reports as good as this from those who have built the Peridyne, and I am glad you are still catering to the fans who build their own sets and wind their own coils, as I think they were the men who made radio popular. There

is no more interest shown in them by the news-papers and magazine as in 1923 to 1925, when these papers would show different circuits and the fans would build them, and the next week build others. I am sure the same interest would be shown and more parts sold if this were done again, as I hope to see it. Wishing you much success with the "Peridyne 5." WILLIAM H. KLEINBERGER, 1219 West Erie Avenue, Philadelphia.

Mr. Van Koolbergen's "Chicoutimiflex." C2, C3 and C8 are .00025-mf. on a common bakelite shaft; C1, .00005-mf.; C4, C10, .002-mf.; C5, C6, .0001-mf.; C7, .00002-mf.; C9, 0.1-mf. R1, 0-500; 500-ohm; R2, 20-ohm; R3, 30,000-ohm; R4, 100,000-ohm. First three tubes, 201A; first audio, hi-mu; last stage, 210 type. T1, Ferranti B-3; T2, Marconi 6.1. The R.F. coils are described in RADIO NEWS for December, 1927.

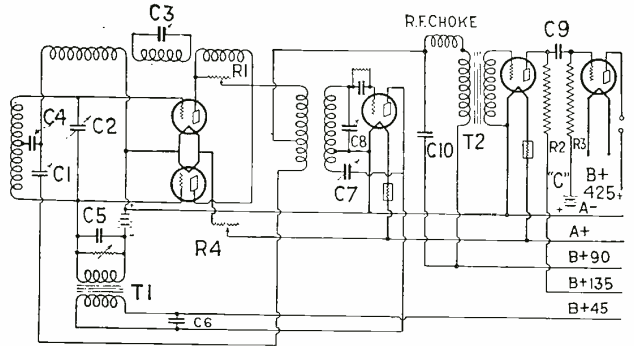

LETTERS for this page should be as short as possible, for so many are received that all cannot be printed. Unless a set is made from a published description, a schematic sketch should be sent; photos can be used only to illustrate a novelty, and then only if large and very clear. Inquiries for information not given here should be sent to the constructor direct; but he should NOT be asked to furnish data already published, here or elsewhere. This department is for free discussion to the extent that space permits; but RADIO NEWS accepts no responsibility for the opinions of readers as to the relative merits of apparatus and circuits.

ANOTHER VICTIM OF THE MAILMAN Editor, RADIO NEWS: Since you published my article on short-wave reception in your October issue, I have had to procure a bigger postoffice box, No. 531 instead of No. 338. Letters come from everywhere asking information; and, as I have no private secretary,

and like a few moments to play with my radio, I wonder if you would not be kind enough to answer my friends in a general way. Since the date of the letter published by you, the Abbé Provencner of Chicoutimi has constructed a short-wave receiver, using mine as a model. We attribute our success (Continued on page 1083)

List of Broadcast Stations in the United States

(Continued from page 1009)

Table with 12 columns: Radio Call Letter, Broadcast STA. Location, Wave (Meters), Power (Watts), Radio Call Letter, Broadcast STA. Location, Wave (Meters), Power (Watts), Radio Call Letter, Broadcast STA. Location, Wave (Meters), Power (Watts), Radio Call Letter, Broadcast STA. Location, Wave (Meters), Power (Watts).

LIST OF CANADIAN BROADCAST CALLS

Table with 4 columns: Call Letter, Location, Wave (Meters), Power (Watts). Lists stations from CFAC to CNRW.



Radio News Laboratories

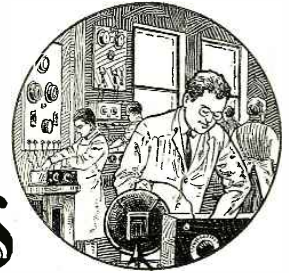

RADIO manufacturers are invited to send to RADIO NEWS LABORATORIES samples of their products for test. It does not matter whether or not they advertise in RADIO NEWS, the RADIO NEWS LABORATORIES being an independent organization, with the improvement of radio apparatus as its aim. If, after being tested, the instruments submitted prove to be built according to modern radio engineering practice, they will each be awarded a certificate of merit; and a "write-up," such as those given below, will appear in this department of RADIO NEWS. If the apparatus does not pass the Laboratory tests, it will be returned to the manufacturer with suggestions for improvements. No "write-ups" sent by

manufacturers are published in these pages, and only apparatus which has been tested in the Laboratories and found of good mechanical and electrical construction is described. As the service of the RADIO NEWS LABORATORIES is free to all manufacturers, whether they are advertisers or not, it is necessary that all goods to be tested be forwarded prepaid, otherwise they cannot be accepted. Apparatus ready for, or already on, the market will be tested for manufacturers free of charge. Apparatus in process of development will be tested at a charge of \$2.00 per hour required to do the work. Address all communications and all parcels to RADIO NEWS LABORATORIES, 230 Fifth Avenue, New York City.

AUTOMATIC RELAY SWITCH

The automatic relay switch shown, submitted by the S C O Electric Products, Jackson, Michigan, takes care of the alternate connection to the power line of the trickle charger and the "B" power unit. One lead of the power line is permanently connected to one contact spring of each of the two receptacles built into this device; while the other lead is attached to the armature of the relay which closes either the circuit of the trickle charger or that of the "B"



supply unit. This relay operates, as usual, from the filament switch of the radio receiver and is very sensitive, as it requires only 0.36 ampere for its operation. The winding of this relay has a resistance approximately 0.24 ohm, and therefore, its connection in series with the filament circuit does not affect noticeably the operating voltage.

AWARDED THE RADIO NEWS LABORATORIES CERTIFICATE OF MERIT NO. 1968.

"A" POWER UNIT

The automatic "A" power unit shown, submitted by the Prest-O-Lite Storage Battery Corporation, 508 N. Capitol Ave., Indianapolis, Ind., consists of a 6-volt storage battery, a trickle charger and an automatic relay switch; all forming a small compact unit enclosed in a sturdy sheet-iron container having a brown crystalline finish. The "A" battery has 5 plates per cell and a 40-ampere-hour capacity. One of the vent-plugs is equipped with a small

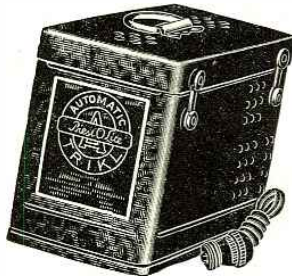

built-in hydrometer. The trickle charger is permanently connected to the battery and operates from the 110-volt 60-cycle house-lighting line; it incorporates a "dry electrolytic" rectifier. Three charging rates (namely, 0.35, 0.5 and 0.8 ampere) may be obtained through changing

the position of a special jumper. The automatic relay switch, which connects to the house line either the trickle charger or the "B" power unit, is controlled from the filament switch of the radio receiver and requires to operate it approximately 0.6 ampere. It has a very small voltage drop across its windings, and is reliable in operation.

AWARDED THE RADIO NEWS LABORATORIES CERTIFICATE OF MERIT NO. 2244.

"B" POWER UNIT

The "Speedway" "B" power unit shown, submitted by the same company, operates from the 110-volt 60-cycle house line and uses a full-wave gas-rectifier tube of the Raytheon "BH" type. Five different voltages, ranging from 22½ to 180, required for the operation of the average commercial radio receiver, are supplied from the corresponding binding posts. A special three-way switch makes it possible to keep the output voltages almost constant, even if the voltage of the power line



undergoes slight changes. This power unit is electrically and mechanically well-designed, and is housed in a strong sheet-iron case with a brown crystalline finish.

AWARDED THE RADIO NEWS LABORATORIES CERTIFICATE OF MERIT NO. 2245.

AUTOMATIC POWER SWITCH

The "Imp" automatic power switch (type No. 115 shown) submitted by the Carter Radio Company, 300 S. Racine Avenue, Chicago, Illinois, is designed to be used in radio receivers simultaneously as filament switch and controlling device for the connection



to the power line of either the trickle charger or the "B" power unit. This instrument is of the quarter-turn,

snap-switch type and of compact and rugged construction.

AWARDED THE RADIO NEWS LABORATORIES CERTIFICATE OF MERIT NO. 2246.

RHEOSTAT

The "Hi-Watt" rheostat (type HW6 shown) submitted by the same company is of the one-hole-mounting type and approximately 2½ inches

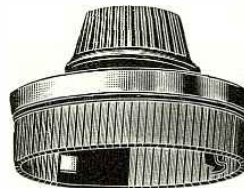

in diameter. It is constructed almost entirely of metal, the amount of insulation being reduced to the minimum. The resistance element is formed of a fiber strip, 5/8-inch wide, on which a flat resistance ribbon is wound. The contact arm runs smoothly and provides a good contact with the resistance wire. This rheostat has a resistance value of approximately 6 ohms owing to its excellent cooling characteristics, and is capable of dissipating continuously 20 watts without overheating.

AWARDED THE RADIO NEWS LABORATORIES CERTIFICATE OF MERIT NO. 2247.

FIXED RESISTOR

The fixed resistor shown, submitted by the same company, is of the wire-wound type. The resistance wire is wound on a porcelain tube, two inches long and 9/16-inch in diameter, and is covered with a vitreous enamel which protects it against oxidation or mechanical in-

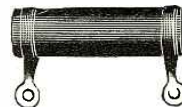

jury. The average resistance has been found to be very close to its nominal value, the difference being less than one per cent. Rated to dissipate continuously 20 watts, this resistor has been found capable of withstanding much higher loads without getting overheated and suffering injury.

AWARDED THE RADIO NEWS LABORATORIES CERTIFICATE OF MERIT NO. 2248.

BUFFER CONDENSER

The buffer condenser shown, submitted by A. M. Flechthelm & Company, 275 Broadway, New York, N. Y., is of the paper type and has

two sections of approximately 0.1-mf. capacity each, connected in se-



ries. This condenser is designed to be connected across the secondary winding of the step-up transformer used in "B" power units using gas-filled rectifier tubes. It is sealed in a metallic can whose external dimensions are 2 x ¾ x 1½ inches, and is provided with mounting feet.

AWARDED THE RADIO NEWS LABORATORIES CERTIFICATE OF MERIT NO. 2249.

RHEOSTAT

The "Gem" rheostat (type 1906 shown) submitted by Herbert H. Frost, Inc., 160 North LaSalle St.,



Chicago, Ill., is of metal-frame construction and approximately 1½ inches in diameter. Although small, this rheostat is rugged and of very fine workmanship. All the exposed metal parts are nickel-plated and its general appearance is extremely neat and pleasing. The contact arm runs smoothly and makes a perfect contact with the resistance strip, which is ¼-inch wide. This rheostat has a resistance value of approximately 6 ohms and is of the one-hole-mounting variety.

AWARDED THE RADIO NEWS LABORATORIES CERTIFICATE OF MERIT NO. 2250.

RHEOSTAT

The "Gem" rheostat (S 1930 shown) submitted by the same com-



pany, is similar in construction to the above. The difference is only that this rheostat is equipped with

an extra nickel-plated disc approximately 1-3/16 inch in diameter, which is riveted to the bushing carrying the contact arm. A small bakelite stud, which is attached to the outside surface of this metallic disc, serves to open the filament circuit by lifting the spring pressing against the disc.

AWARDED THE RADIO NEWS LABORATORIES CERTIFICATE OF MERIT NO. 2251.

ADJUSTABLE RESISTOR

The volume-control "Clarostat" shown, submitted by the American Mechanical Lab., Inc., 287 North Sixth St., Brooklyn, N. Y., employs as a resistance medium a mixture of graphite and pulverized mica, hermetically enclosed in a small brace container. The longitudinal motion of a special disc inside this container controls the degree of com-



pression of the mixture, thus varying gradually its resistance over a very wide range. This instrument may, therefore, be used very successfully as a volume-control device or in any other place in a radio receiver where an adjustable resistor with a wide range is required. As the current-handling capacity of this unit is relatively small, it is not recommended for use as a voltage divider in "B" power units.

AWARDED THE RADIO NEWS LABORATORIES CERTIFICATE OF MERIT NO. 2252.

SOCKET ADAPTER

The socket adapter shown, submitted by the Alden Manufacturing Company, 52 Willow St., Springfield, Mass., permits the use of A.C. tubes of the 226 type in radio receivers wired for D.C. operation of the filaments. This adapter has a built-in UX socket to carry the A.C. tube, and is equipped at its base with four



standard prongs which fit in any standard UX socket. The grid and plate contact springs of the socket are connected to the corresponding prongs on the base of the adapter; while the filament springs of the socket are insulated from the heavy prongs of the base, which are in fact dummies. The filament contact springs are extended outside the socket and carry at their ends two binding posts which serve to connect them to the leads supplying the low-voltage A.C. The use of this adapter simplifies enormously the problem of electrifying "A" battery-operated radio receivers.

AWARDED THE RADIO NEWS LABORATORIES CERTIFICATE OF MERIT NO. 2253.

FILAMENT POWER TRANSFORMER

The power transformer (No. 4586 shown) submitted by the Dongan Electric Mfg. Co., 2995 Franklin St., Detroit, Michigan, is a step-down transformer and supplies the necessary low-voltage current for heating the filaments of A.C. tubes of the 226 and 227 types and of a power tube of the 171 or 112 type. It has three separate windings for current supply at 1 1/2 volts, 2 1/2 and 5 volts. This transformer is of good

electrical design and well built. It is hermetically sealed in a sturdy sheet-iron box.



AWARDED THE RADIO NEWS LABORATORIES CERTIFICATE OF MERIT NO. 2254.

OSCILLATOR-COUPLER

The "Unicouple;" (CU-71 shown) submitted by the Coupler Manufacturing Company, Cleveland, Ohio, is an inductance coil which may be used very conveniently as an oscillator-coupler in radio receivers using the beat-frequency methods. It has three separate windings; the two for the plate and the grid circuits are wound on a cardboard form 2 inches in diameter and approximately 1 1/2 inches wide, and are held in their respective positions by three bakelite discs, each 2 1/4 inches in diameter. The 10 turns of the coupling coil are wound on a bakelite tube, 2 3/4 inches in diameter, and 3/4-inch wide. The housing consists of two moulded bakelite discs provided with mounting feet, and a bakelite tube 3 inches in di-

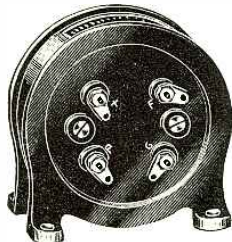

ameter and 1 inch wide. In connection with a .00035-mf. condenser, this unit when used in a radio-frequency generator covers a band which slightly overlaps the broadcasting range.

AWARDED THE RADIO NEWS LABORATORIES CERTIFICATE OF MERIT NO. 2255.

PHONOGRAPH PICK-UP

The phonograph pick-up device shown, submitted by the United Air Cleaner Company, 9705 Cottage Grove Avenue, Chicago, Illinois, makes it possible to reproduce speech and music from an ordinary phonograph record when used in connection with an audio-frequency amplifier. The instrument consists of an electromagnetic pick-up unit, attached to a hollow arm which swings freely from a horn-shaped support. This support,



in turn, is pivoted to an aluminum disc, which is attached to the motor-board of the phonograph. The electromagnetic pick-up unit proper consists of a permanent horseshoe magnet, with windings on its two pole pieces, and an armature carrying the phonograph needle. This armature almost closes the magnetic circuit of the unit and is held in position by several small pieces of soft rubber. A telephone cord, 3 feet long, serves to connect the coils to the amplifier. The volume output is controlled by a Carter potentiometer, approximately 25,000 ohms. The support and the swinging arm are made of cast bronze with an attractive Japanese

finish. This unit is sensitive and very satisfactory in its operation, and pleasing in appearance.

AWARDED THE RADIO NEWS LABORATORIES CERTIFICATE OF MERIT NO. 2256.

LOUD SPEAKER

The loud speaker shown, submitted by the Aristocrat Corporation of America, New York, N. Y., is an attractive combination of a table lamp and a cone speaker. The base of this lamp is of black onyx Fulper pottery. The gold-plated two-bulb lighting fixture carries on its top the aluminum base of the speaker unit, which is of

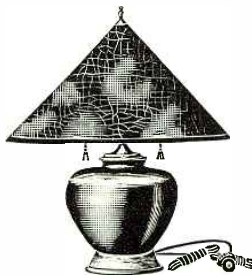

the floating-armature type. The unit's reed (driving rod) is centered in a vertical position above the lamp base, and carries a crackle-finish parchment cone which covers the two bulbs, and serves at the same time as a lamp shade. An aluminum casing, consisting of two symmetrical halves, encloses the speaker unit and guides, through a felt washer, the movement of the reed, which is heavier and more rigid than in most unit designs. A constant and stable balance of the lamp shade-diaphragm is thus secured. The tone qualities of this cone speaker are good, and its appearance is of neatness and beauty.

AWARDED THE RADIO NEWS LABORATORIES CERTIFICATE OF MERIT NO. 2257.

RESISTOR

The resistor shown, submitted by the Eureka T. & M. Company, 42 Walnut Street, Newark, N. J., is made of a resistive compound using carbon as a base. It is shaped in the



form of a small cylinder, 1 1/4 inches long and approximately 5/16-inch in diameter, and is provided with a brass cap on each end. This resistor is available in different resistance values, and has a relatively high current-carrying capacity. It may, therefore, be used very conveniently in "B" power units to supply the necessary voltages.

AWARDED THE RADIO NEWS LABORATORIES CERTIFICATE OF MERIT NO. 2258.

"A-and-B" SUPPLY TRANSFORMER

The transformer (No. 463-101 shown) submitted by the Jefferson Electric Mfg. Company, 501-11 S. Green St., Chicago, Ill., operates on 110-volt, 60-cycle house-lighting current, and is designed to supply (in connection with a full-wave rectifier tube of the 280 type) the entire

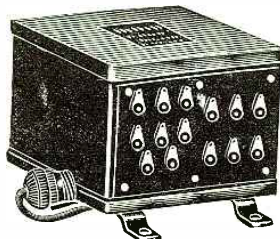

power necessary for the operation of a modern electric radio receiver using A.C. tubes of the 226 and 227 types, and power tubes in the last stage of the 171 or 112 type. This transformer has five secondary windings; the first three supply 6 amperes at 1 1/2 volts, 2 amperes at 2 1/2 volts, and 1 ampere at 5 volts, for the power tubes. The other two supply 2 amperes at 5 volts for the filament of the rectifier and 125 milliamperes at 520 volts for its plates. All but the first winding are center-tapped and have their ends soldered to lugs mounted on a special bakelite panel attached to the transformer. A cord 6 1/2 feet long, with a plug to fit a standard receptacle of the house-lighting line, is connected to the primary. This transformer is of compact and rugged construction and is sealed in a heavy-japanned-iron shell equipped with mounting feet. The external dimensions of this instrument are 5 x 5 x 4 inches.

AWARDED THE RADIO NEWS LABORATORIES CERTIFICATE OF MERIT NO. 2259.

FILAMENT TRANSFORMER

The filament transformer (type 464-131 shown) submitted by the same company, is a step-down device which operates from the 110-volt, 60-cycle house line. It has three secondary windings, which supply current at 1 1/2, 2 1/2 and 5 volts; and thus can be used in electrified radio

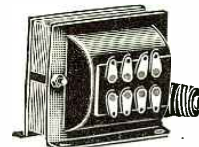

receivers to provide the heating current for the filaments of 226- and 227-type A.C. tubes and a 171- or 112-type power tube. The 2 1/2- and 5-volt windings are center-tapped; two sheet-iron shells protect the windings from injury. A cord 6 1/2 feet long, with a standard plug, is permanently attached to the primary and allows direct connection to the house line. This transformer is electrically well designed, compact and sturdy; its operation is satisfactory.

AWARDED THE RADIO NEWS LABORATORIES CERTIFICATE OF MERIT NO. 2260.

ALUMINUM SHIELD

The aluminum box shield shown, submitted by the Aluminum Company of America, 2400 Oliver Building, Pittsburgh, Pa., is designed to

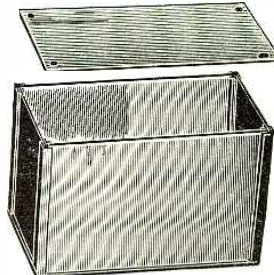

shield the different radio-frequency stages of a radio receiver, thus preventing undesirable feed-back and interference. Each box is approximately 9 x 5 x 6 inches, and is formed of six aluminum plates 3/32-inch thick, and 4 slotted corner brackets, all held together by means of 8 screws. The shielding properties of this box are very efficient.

AWARDED THE RADIO NEWS LABORATORIES CERTIFICATE OF MERIT NO. 2261.

(Continued on page 1087)



DEEP, DARK COISES!!



Melodramatic gesture from the *Buffalo Times* of Dec. 18: "Six tubes are of the HATER type." Ah-ha, Jack Dalton, now we know who done the deed! So 'twast thou who put the wicked tubes in the set, so that the beautiful Gwendolyn could not hear the prayer meeting. Avaunt, thou rascal!!

Contributed by Connell Cavanaugh.

WOTTA SPEAKER!



From the catalog of the *American Auto and Radio Mfg. Co.* we have this gem: "the speaker has a marvelous tone quality, reproducing both the high and low notes with a faithfulness that seems almost INHUMAN." We certainly thought some of the speakers near us could be put in this class, but we didn't know they advertised 'em that way.

Contributed by Harry N. Helyer.

HABERDASHERS, PLEASE NOTE

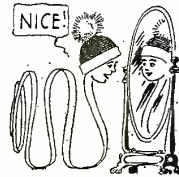

Transmission item from the *N. Y. Telegram* of Dec. 2: "WLWL suffered not at all although its wave was so broad and powerful that it was impossible to cut through for distance even with a WAVE CAP." How many tubes, condensers and coils has this new gadget? Sometimes we need one ourselves when we can't get our favorite local.

Contributed by R. R. Whittingham.

HERE'S A MYSTERY

Strange item in the *Radio Digest* of November, 1927: "Reception vastly improves over simply substituting a power tube for the LOST stage of the set." If that is the case, we are going to rip out the power stage in our family bopper and rob the Baby's set of its power tube and use that. But where is this lost stage?

Contributed by Walter Hawkins.

I CAN'T FIND THAT LOST STAGE!



YOU CAN KEEP THEM

Frank admission from the *Allen Rogers-Madison* catalog in a description of an A.F. choke. "It conserves B batteries, eliminates howling and SUPPLIES DISTORTION in audio amplifiers." We have quite enough of that in our own set without going out of the way to import any more of the nuisance. No, thanks!

Contributed by Jack Harvey.

DID YOU EVER HEAR SUCH DISTORTION?



HIGH, WIDE AND HANDSOME

Shielding as is shielding, mentioned in the *Chicago Evening Post* of Nov. 19: "Of course, the new sets may have INTERSTATE shielding, which is certain to sharpen the selectivity." And if some poor fan goes blotto in the wrong state do they have to get extradition papers out to bring him home? Or does the shielding help him to find his way back?

Contributed by N. G. Stimson.

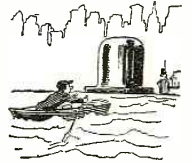

IT'S SO SIMPLE



Athletic statement in the *Chicago Herald and Examiner* of Dec. 18: "Listener Can Easily Learn to RIDE Radio Kilocycles." The other day we saw someone riding down Broadway on a funny-looking wheeled affair and we have no doubt that this is one of these new radio kilocycles.

Contributed by L. W. Hoffman.

A CLASSY SET?

In an advertisement in the *Detroit Sunday News* of Nov. 13 this announcement appeared: "Radiola: 6 tube superheterodyne with LOOK." Does this mean that the set is fitted up with a television attachment, so that we can get a glimpse of what is going on at the broadcast studio? Or does the set possess that look of distinction?

Contributed by Wm. G. Mortimer.



HOW'S IT DONE?

Magnificent contribution to radio science made by the *Providence Journal* of Dec. 4: "Mr. Davies says that he can bring in music through his set without aerial, speaker or headphones connected to it." Now you radio bugs beat that one. We would like to hear Mr. Davies' set working. Maybe it operates at superaudible frequencies.

Contributed by B. Thomas



PAGE GRANDMA



On page 18 of the catalog of the *Radio Supply Co.*, we find this nice one: "Karas Equamatic KNIT, \$60.20." If Grandma is going to use her needles to make us this set, we resign right now. We're getting tired of these woolen sets and want something that will stand the gaff and not be unravelling all the time.

Contributed by Jackson Edwards.

NEW VACUUM TUBE

This from the September issue of the *Citizens Radio Call Book*: "The filament current for the ballast tube and the two R.F. tubes is controlled by a 6-ohm rheostat, that for DEFECTOR by a 11-ohm, 1-ampere fixed resistance." Some of the tubes that we have tried in our set might well be distinguished by that name.

Contributed by Reed M. Nerhood.



HARK TO THE PICCOLO PLAYER



High notes are doubtless furnished by the set advertised in the *Pittsburgh Sun-Telegraph* of Dec. 15: "7-tube super with TOWER tube, \$30." You can never please some people. Here we thought all the while that folks were after the low notes, and what do we see but this advertisement extolling a tall tube. What next?

Contributed by Stanley R. Smith.

MORE ADVANCES IN RADIO

An advertisement in the *Calgary (Canada) Albertan* of Nov. 22 offers for sale: "Fada five-tube neotrodyne complete with built-in loud speaker tubes." Such things as this certainly look badly for the loud-speaker manufacturers, when it is generally known that the tubes do all the work. How are they on the low notes?

Contributed by Wm. A. Garrad.

AND THAT BUILT-IN TUBE DOES ALL THE SPEAKING?



YOU CAN HAVE THIS ONE



In the *Leviston (Me.) Daily Sun* of Oct. 29 we find this description of an antenna: "It is said to eliminate statics and the SHARPEST POSSIBLE TUNING." Just how this wire is strung up and what set is used with it, is not explained; but we don't think much of it just the same, for we like our programs one at a time.

Contributed by Ernest Curley.

FAST AND FURIOUS

How our Antipodes look at American industry is shown by the *Melbourne Listener* in of Oct. 26: "The Atwater Kent factory produced sets at the rate of 8000 every five SECONDS." Even Hank Ford in his wildest dreams of production never thought of anything approaching this speed. A rate like this we think is production plus.

Contributed by Robert F. Wylie, (Australia)



CHEESE IT, FELLERS, DE BULLS!

Interesting account of old time sport in the *Pittsburgh Press* of Dec. 5: "Cock fights were halted yesterday in a RADIO made by Humane agent Chas. Feisler and a squad of deputies." Forty-eight men, thirteen live birds and two dead were seized. "Quite a crowd to have in a radio set. Must have been a super-super something or other."

Contributed by B. W. Nedman.



THEY MIGHT BE BOOTLEGGERS

Contribution to fundamental radio science in the *New York Sun* of Dec. 17: "The following by Van der Bijl in THERMINION VACUUM tubes is of significance." This might seem to open up a whole underworld of tubes; but we don't feel inclined to investigate. Away all ye myrmidons and minions, we'll stick to the respectable variety.

Contributed by F. B. Thorne.





Conducted by C. W. Palmer

THIS Department is conducted for the benefit of our Radio Experimenters. We shall be glad to answer here questions for the benefit of all, but we can publish only such matter as is of sufficient interest to all.

1. This Department cannot answer more than three questions for each correspondent. Please make these questions brief; if the inquiry is concerning a circuit other than a standard, published one, delay will be prevented by enclosing a diagram and other necessary information.
2. Only one side of the sheet should be written upon; all matter should be typewritten or else written in ink. No attention paid to penciled matter.
3. Sketches, diagrams, etc., must be on separate sheets. This Department does not answer questions by mail free of charge.
4. Our Editors will be glad to answer any letter, at the rate of 25c. for each question. If, however, questions entail considerable research work, intricate calculations, patent research, etc., a special charge will be made. Before we answer such questions, correspondents will be informed as to the price charge.

INCREASING SELECTIVITY

(Q. 2268.) Mr. H. Johnson, Long Island City, N. Y. writes:

"I have a Browning-Drake receiver which is giving me very good results, although the tuning is not as sharp as I would like to have it. I am very much interested in receiving distant signals and because of this I do not want to reduce the size of my aerial to sharpen the tuning. Is there any other method by which I can make my set tune

tuned primary produces greater selectivity with some sacrifice in volume; because the primary coil, having a low inductance value and not being variable, cannot be tuned to the frequency of the incoming signal, but depends for its operation upon "shocking" the grid coil at the frequency to which this coil is tuned. The greater the number of turns, the broader the tuning will be, with an increase in volume; likewise, as the number of turns is reduced, selectivity will be more pronounced with a decrease in signal strength.

In a particular case, when the antenna coupling coil was cut down from ten turns to one, and this one turn then loaded with a specially-designed loading coil (thereby making it a combination of the two coupling methods referred to above) the selectivity was as great as if one turn alone was used, while the volume was practically the same as with the ten turns. The aerial used for these tests was about 175 feet long.

Construction of the Antenna Coil

From this it will be found that it is possible to use the long, high aerial system, with its resulting high efficiency for intercepting signal energy, yet without sacrificing that degree of selectivity which is generally obtained only by the use of a small antenna—provided that the correct apparatus is used.

The first thing to do is to build the variable loading unit, the schematic details of which are shown in Fig. 2268A. It consists essentially of a tapped spiderweb coil and a variable condenser. Great care must be observed when constructing this unit, since a considerable resistance would effectually block the passage of weak signals, making the change a disadvantage rather than an asset to the receiver.

The variable air condenser employed should preferably be of the straight-line-frequency type, and the requirements of the circuit are such that this

condenser should have a maximum capacity of .001 mf. The inductor is of the well-known spiderweb type, since such a coil offers a very low resistance to high-frequency currents and is very easy to construct. It consists of 50 turns of No. 22 D.C.C. wire, wound through every other slot of the form and tapped at the 15th turn from the beginning. The form used should be made according to the specifications given in Fig. 2268. No shellac, varnish or other material is used on this coil. After the coil has been completed, it may be mounted on a baseboard, directly behind the condenser, by means of a bakelite mounting strip or other means.

It is important that this coil shall be placed at right angles to the electrostatic field of the condenser, and also that it shall be out of inductive relation to the first coil of the receiver itself. If any coupling should exist between the loading unit and the coils of the receiver, the purpose of the one-turn coupling coil would be defeated; for no energy should be transferred except at this point. In mounting the switch points on the panel, keep them as far apart as the width of the switch blade permits.

The next point is to erect as large an aerial as circumstances permit, bearing in mind that, the higher and freer the aerial is kept, the greater will be the signal strength.

Changing Receiver Connections

Assuming that your receiver employs the same direct antenna coupling as the commercial Browning-Drake receiver, it will be necessary to remove the two interior lead wires which connect to the antenna and ground posts. In their place is attached a piece of copper wire, no smaller than No. 14 and long enough to reach from the aerial terminal *once around the grid coil*, and then to the ground post. In order that this wire may not cut into the finer wire of the grid coil, it should be covered with a good grade of spaghetti. The

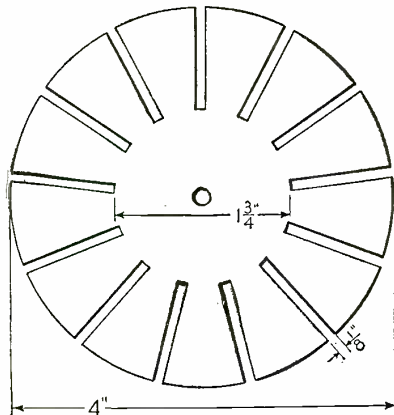

FIG. Q. 2268

The coil form for use in the antenna unit should be made as shown. A fiber disk should be used, and the wire wound in the slots cut as shown.

sharper without reducing the signal strength and sensitivity?"

(A). A long unsheltered aerial will bring in signals from far greater distances than a small one can ever hope to pick up; stations heard faintly on a small aerial will come in with a remarkable increase in volume when the set is coupled to a longer, higher aerial. This is simply because the antenna, being more extended and covering a greater area, is collecting considerably more energy; thereby resulting in a more effective radio-frequency delivery to the detector. A number of methods of increasing set selectivity are suggested by our contemporary, *Radio Broadcast*, as explained below.

There are in use to-day several types of receivers which employ a tuned-antenna circuit. By this is meant that the primary coil is capable of being tuned to the exact frequency of the incoming signal, by means of either a variable condenser of the proper capacity, a system of taps or a combination of both. There are also many receivers which employ the untuned or semi-aperiodic type of primary, as in some forms of neutrodyne and tuned-radio-frequency receivers. Each system has certain advantages. The tuned primary provides greater signal strength, since the antenna coil may be tuned exactly to the frequency of the desired signal and, in turn, the secondary may be brought into resonance with the received signal. The un-

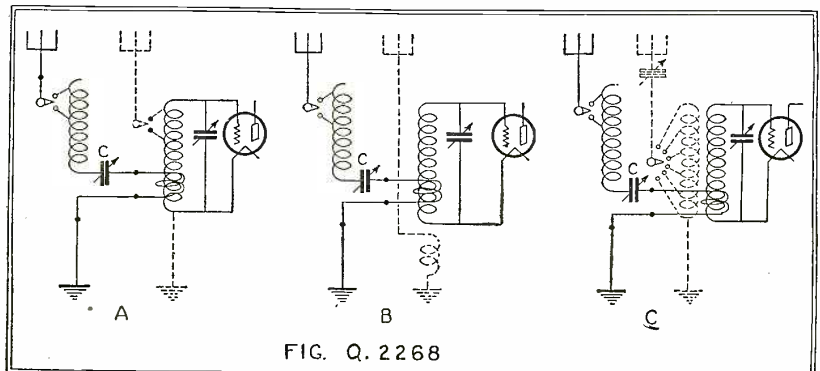

FIG. Q. 2268

Methods of connecting the unit to the three most common types of antenna couplers. The first is used in sets with conductively-coupled inputs, the second for semi-aperiodic antennas, and the third for ordinary tuned antenna couplers.

method of connecting this wire is shown in Fig. 2268A; this constitutes the coupling coil through which the received energy is transferred from the loading unit to the receiver. The output terminals of the loading unit are then connected between the lead-in and the aerial post on the receiver.

If your set employs a semi-aperiodic coupler, as in many modern receivers, the changes to be made are very similar. The small coil which is connected between the antenna and ground posts is removed, and in its place is put the single turn of heavy wire. (Fig. Q 2268B.)

In a set which the antenna circuit is tuned (such as a variocoupler set, where the outside winding is connected between the antenna and ground and the rotor used as the main tuning inductance) the primary will have to be unwound and removed. It is not, of course, necessary to dismantle the coupler, but it would not be wise to leave the unused primary coil in such close relation to the grid coil. The single turn of heavy copper wire is wrapped around the secondary and connected to the antenna and ground posts as before. (Fig. Q 2268C.)

The operation of the unit is very simple. For wave lengths below 350 meters, the switch lever is set on the first point; so that 35 turns of the loading inductance are included in the antenna circuit. The dials of the receiver are then adjusted to the setting at which a station is known to come in, after which the antenna condenser C is varied until signals are heard. The first dial of the receiver will not read exactly the same as before, because of the changed inductance of the circuit.

SHORT-WAVE ADAPTER

(Q. 2269.) Mr. R. B. Hughes, San Diego, Calif, writes:

"I would like to construct a short-wave unit similar to the Aero short-wave converter, and use the audio-frequency amplifier in my receiver in conjunction with the short-wave set. Will you kindly publish a diagram and constructional details for building this unit?"

(A.) To convert the receiver, it is necessary only to disconnect the aerial and ground wires from the receiving set and attach them to the two binding posts of the short-wave converter. Remove the detector tube from the receiver and place it in the tube socket of the converter. The cable plug from the converter is inserted in the detector socket of the receiving set. No other tubes are removed, nor are the battery wires disturbed, and the loud speaker operates as usual. The tuning is done entirely by the one dial on the converter. The tuning controls on the receiving set are not used.

This converter unit is easy to build and simple to operate. No trick circuit is used and no tricky apparatus is employed.

The converter is really a short-wave set, consisting of a regenerative detector with a simple attachment-plug for connection to the audio end of the present receiving set and battery current supply to light the detector tube, now transferred to the converter. This method of connecting the two units together consists of a five-conductor cable (two leads of which are not used) and an old vacuum tube, which has served its usefulness otherwise,

for the plug. The glass of the latter is broken off and the base cleaned out. Three wires from the cable are soldered into the terminals of the socket, one to the "A+," one to the "A-," and the other to the plate terminal. (To identify these terminals, hold the tube right side up with the pin towards you; the rear two posts are "A+," and "A-" respectively, and the left front post is the plate terminal). The base of the tube is now filled with some compound, such as that from the top of a discarded "B" battery.

Regeneration is controlled by a 0 to 500,000-ohm resistor, connected across the tickler. A .00225-mf. variable condenser is used, with a set of three Aero coils, to tune from 15 to 200 meters. A vernier dial is necessary, as the tuning is sharp. The schematic diagram will be found in Fig. Q 2269.

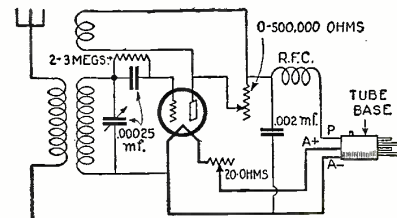

FIG. Q 2269

The diagram of a short-wave adapter, which is designed to be plugged into the detector socket of an ordinary broadcast receiver. An old tube-base is used for the purpose of making the connections.

The choke coil is important and must not be omitted. When by-passed with a .002-mf. condenser it will permit the plate lead to be long enough to reach the receiving set. If a choke coil cannot be easily secured, one can be made by winding 100 turns of No. 26 D.C.C. wire at random on a wooden spool, 1/4-inch in diameter and with a 1/4-inch core.

To operate the short-wave converter, select the plug-in-coil covering the waveband in which you want to receive and plug it into the coil jacks, connect the plug to the receiving set as previously described, and transfer the aerial and ground leads. You may listen either with headphones on the intermediate jack, if your present set is so arranged, or use the loud speaker as ordinarily connected. Turn the resistor until the receiver oscillates. Tune in a station and clear up the signal by a further adjustment of the resistor or rheostat as required.

THE SYNCHROPHASE SEVEN

(Q. 2270.) Mr. C. Williams, Salt Lake City, Utah writes:

"I would like to obtain copy of the schematic diagram of the Synchrophase Seven receiver. If possible, I would like to have you publish this diagram in RADIO NEWS.

(A.) You will find the diagram in Fig. 2270. The designers of this circuit desired a receiver in which the fan need not fear altering the neutralization if tubes were changed in the set. The frequency-response curve of the average tuned-radio-frequency amplifier shows maximum response on some short wavelength with falling characteristics as the wavelength is increased. To overcome this difficulty, the variable condenser and two resistors were placed in the grid circuit of each radio-frequency amplifier tube.

The action of these units is twofold; first, they eliminate the effect of the tube's grid-filament capacity upon the tuned circuit, particularly on the low settings of the tuning condenser, in such a manner that the tubes could be changed without affecting the original resonance setting. Secondly, they control the voltage being fed into the grid-filament circuit of the amplifying tube, so that the radio-frequency input is practically uniform over the complete tuning scale. With this arrangement, and the inherent lack of regeneration in this system, a high degree of stability of amplification is afforded.

The four stages provide ample selectivity and sensitivity and are designed to possess sideband characteristics with minimized suppression for 1,000 cycles. The detector functions by the grid-leak method, affording maximum sensitivity and selectivity. The same compensating system utilized in the radio-frequency stages is resorted to in the detector input circuit, thus permitting the use of any detector tube without unbalancing the tuning system. A non-regenerative detector is used, because the four stages of tuned-radio-frequency amplification give sufficient sensitivity and selectivity.

The capacities used in the "tone color," to regulate the characteristics of reproduced voice and music, vary from .00008 mf. down.

SHIELDING RADIO SETS

(Q. 2271.) Mr. J. W. Fenworth, Bangor, Me., asks:

"What is the best metal for use in shielding radio-frequency amplifiers?"

(A.) Copper, aluminum and brass are the metals best suited for use as shields. A shield must be of good conducting material so that eddy currents may be formed within its mass. Lead foil and tinfoil have resistances too high to make good shields. Iron and steel must never be used for shielding high-frequency circuits; these metals have relatively high resistance and, furthermore, they introduce magnetic effects of their own which make matters worse than before. Any thickness of metal from No. 6 down to No. 30 gauge may be used satisfactorily for shielding.

The best results will be secured if shields enclosing various radio-frequency stages are insulated from all circuits in the receiver. On the other hand, the best protection against pickup of outside interference will be obtained with grounded shields. If the receiver is equipped with both interstage and complete-cabinet shielding, the interstage shielding may be insulated and the cabinet shield grounded; thus affording almost complete protection.

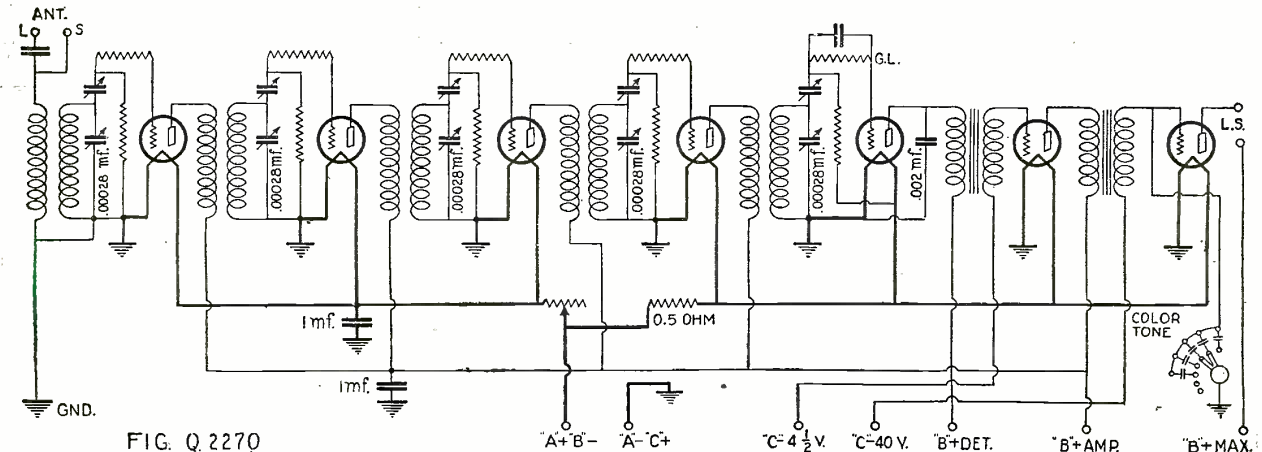

FIG. Q 2270

The schematic diagram of the Grebe Synchrophase Seven is shown above. It will be noticed that a variable condenser and two resistors have been

placed in the grid circuit of each of the radio-frequency amplifier tubes, in order to stabilize the set, regardless of changes in tubes employed.

WHOLESALE PRICES

for Dealers, Community Set Builders, General Repairmen and Agents!



Be sure to get this great 128-page book with net prices to the radio trade. Radio Specialty Company is radio's oldest radio parts mail order house in the country, and the new confidential prices on standard radio merchandise are the lowest of any radio house.

We are ready now to appoint additional agents in all parts of the country. If you are contemplating making big money in radio merchandise, be sure to get in touch with us at once.

WHEN WRITING TO US, USE YOUR LETTERHEAD

New
1928
ENLARGED
EDITION
No. 18

THIS
128 PAGE
RADIO
CATALOGUE
FREE

New 75
HOOKUPS
500
ILLUSTRATIONS

BUY from Radio's Oldest Mail Order House!

We are the oldest established, exclusive radio mail order house in the country. All orders are positively shipped within twenty-four hours; quick, prompt, courteous service. We carry a larger variety of radio parts, radio instruments, accessories and radio findings than any other radio house in the country.

"RASCO" has it

You will find in Catalog No. 18 the largest assortment of radio merchandise in this country. Radio Specialty carries more radio parts and radio material than any other house in the country. You will find in this catalog positively the largest variety of radio merchandise.

If you are in need of certain small radio parts that other radio and mail order houses do not bother to carry, get the Rasco Catalog and you will find the small parts there, anything from a screw to copper ribbon, telephone diaphragms, as well as thousands of other small radio findings. Just to mention a few:

Lugs, nuts, jacks, plugs, all kinds of knobs, cords, panels, screws, sliders, washers, selenium, tinfoil, switches, crystals, cap nuts, Litz wire, cord tips, brass rods, resistances, binding posts, switch parts, carbon balls, switch points, lock washers, carbon grains, ground clamps, metal pointers, insulated tubing, low melting metal, antenna connectors, as well as thousands of other articles. We carry the Largest Variety of Small Radio Parts in the World, BUT We also carry All Standard Radio Merchandise

ANYTHING
IN RADIO



Radio Specialty Co.



98 W PARK PLACE NEW YORK

45 Stations Broadcast Bridge Lessons Every Week

Follow Every Play
With Ease

Anyone of these bridge
books will help!

By **Wilbur C. Whitehead:**

Complete Auction Bridge.....	\$2.00
Auction Bridge Standards.....	1.50
Auction Bridge Summary.....	1.00

By **Milton C. Work**

Bridge Pointers and Tests.....	\$1.00
Contract Bridge.....	1.50
Auction Bridge Complete.....	2.00
Foster's Contract Bridge.....	1.00
Ferguson's Contract Bridge.....	.50
100 Bridge Lessons.....	.50
Practical Auction Bridge.....	2.00
Shortcut to Standard Auction Bridge.....	1.50
Auction Bridge (Annual Magazine).....	.75

Prepared by
Famous Broadcasters

"Listeners in" need no introduction to Work and Whitehead. They are the most famous of Bridge Broadcasters, and masters of the game.

This is a selection of their best books.

Many of the plays that did not clear up in your mind over the radio can now be studied at leisure.

Whatever is to be known about Bridge will be found in these books. These are books to fit every need and every purse.

Pick your books now—and be assured that your knowledge will be coming from masters

Each book is well bound, printed in legible type, and contains anywhere from 160 to 500 pages.

Order Direct

CONSRAD CO., INC.
230 Fifth Avenue, New York City

Wisdom For Radio Widows

(Continued from page 1003)

screen-door decently before; he created this thing. You probably liked it at first, thought it was a brilliant achievement; and then, exercising the legitimate prerogative of womankind, you accepted it calmly and conclusively as one accepts the telephone or washing machine. And since you are a woman, it is obvious why you grew indignant because John always had the darned thing torn to pieces. But, lady!—just as if that's not what it was for! I suppose it's an evidence of feminine logic to assume that a husband's radio set, once in working order, is to be left that way, immutable, static, a completed object. What folly!

Mrs. Jones, did you not know that a gem-like flame burns also in your husband's breast, and burns there still—in his, who couldn't properly open a can of tomatoes before?

Ah, the exaltation that surges through his veins when he turns a switch and hears music where there was only ether before! Had you understood this? Had you not seen the wild gleam in his eyes?

THE JOY OF CREATION

He did it, you understand, with his own hands, his own two hands, his very own two hands. Did you not comprehend the subtle significance of that? Thousands had labored before him, for hundreds of years, to perfect and simplify and coordinate physical theories and facts which he himself had never thought of or heard of before. Then, like a visitation from Olympus, the entire mystic scheme of things burst upon his consciousness like the dawn upon a burnished sea. And, lo! he suddenly knew as much about radio as these aged masters who toiled of old. Is that not indeed an endowment? Is that not indeed the gift of magic powers unseen? Did Balboa, or Moses, or Joan of Arc have anything on your husband now?

Ah, Mrs. Jones, fret not when John tears out the radio-frequency gadget to put in a new set of space-wound thingamagigs. Grieve not thy soul when he dismantles the audio-stage wampus to put in a new pair of giant-transformer dinguses which amplify equally at all frequencies. Tear not thy hair when he rips out both radio and audio stages and puts an intermediate whoosis in between them to make a super-heterodyne out of it.

Try hard to understand that what he is doing, Mrs. Jones, is not meant to aggravate you, but rather to appease these little electric gods of his, by amplifying signals at a much higher wavelength than that received by the radio-frequency dinglebat. It will greatly improve the reception, Mrs. Jones, reduce static, and extend DX. (Ah, marvel of sound! Breathe it softly). You must not cavil when John uses the bread box to shield his coils and condensers; for it reduces interstage coupling, whatever that is, and amplifies and purifies the harmonics.

You must not object when he builds a ten-foot horn out of papier mache, for it is a horn with principle—a horn with an exponential principle, which is to say it is a horn whose cross-sectional area doubles at equal intervals along its air-column length.

And this, Mrs. Jones, makes for more natural sound, approaching closer and closer to the fundamental wave, where purity alone is to be found. Is this not of the essence of clarity? Well, never mind. Try the next paragraph.

A MAN AND HIS HOBBY

When John explains these things to you, try, oh, struggle very hard indeed to look as if you understood, though indeed you do not understand—as you undoubtedly will not, because, as you are a woman, you don't want to. But you will try to *look* as though you understand; because if you do not, you will arouse a tiger in your husband's breast. And lady, it will be a deep throaty roar!

Two things will take place if you scorn your husband's admonitions regarding radio: (1) Your husband will say, or at least will think, nasty things about your mental powers. He will probably allege they couldn't be measured in anything larger than a coulomb or an erg; and (2) he will sense your disaffection and will anticipate your calling him away from his tinkering to mash the potatoes or give Junior his bath. This reflection will have the same effect on him as it would on a tiger whose nice, juicy chunk of meat is suddenly and malignantly snatched away. These effects, combined, arise from his intense application to the mystery of ohms, feed-back currents, plates, grids, filaments, inductors, variometers, potentiometers, volts, amperes, milliamperes, kilocycles, grid leaks and condensers. Don't ask me what they are. I only know they are the marrow of his bones, the symbols in his sacred shrine, the little gods in his miracle world to which he does obeisance. To disturb them will start him oscillating in a most fearful manner.

And it is not because he doesn't love you, Mrs. Jones, or because he doesn't love Junior or your raspberry tarts. It's because he is a mere man who has suddenly had the miracle and mystery of an inaccessible universe thrust upon him, a crimson cloak of stupendous glory thrown about his otherwise average shoulders, mantling him with wisdom which surpasses the terrestrial sphere.

WEEP NO MORE, MY LADY

When you go to bed alone at night, forbear, oh, forbear Mrs. Jones, to insist that he, too, retire, no matter how cold your poor feet may be. For it is at night that DX is abroad in the land. It is then that he communes with the infinite; it is then that he cruises the air, questing to the ends of the earth for some faint sign, for some faraway signal, no matter how weak, that he is getting DX (Breathe it softly!)

It is his Holy Grail, it is the ultimate recompense for his devoted oblation. To hear stations no one else ever heard before is not enough. To hear stations better than anyone else ever heard them before is not enough, although it has its compensations. But to hear stations farther away than anyone has ever heard them before; ah, that—that is the consummate goal, the final reward. And that is called DX, Mrs. Jones (Breathe it softly!)

Even if he wakes you up at 3 a. m. with the news that he has Australia, resist the

What These Have Done YOU CAN DO!

"Since I have been studying with your school I have been appointed chemist for the Scranton Coal Co., testing all the coal and ash by proximate analysis."
—Morlais Couzens.

"I also have some news for you. I have been made assistant chemist for the concern I am working for."
—A. G. Delwarte.

"I am now cleaner and dyer for the above named company. My salary is almost double what it was when I started the course."
—E. H. Lasater.

"Your training has opened things to me that otherwise I would probably be years in acquiring. I now enjoy comforts that before I had to do without. It enabled me to have a wonderful little home, a fine laboratory of my own, and gave me a respected position in one of the foremost textile concerns in the country."
—J. J. Kelly.

"If it weren't for your course I wouldn't have the job I've got now."
—George Daynes.

"Since beginning your course of study I have received an increase in my pay check, and as I progress my work becomes lighter through a better understanding."
—M. G. Cole.

"I am mighty glad I took this course. My salary has been increased several times, and different industrial plants are coming to me for a little advice on different things, netting me a fair side income."
—M. E. Van Sickle.

IF you are dissatisfied with your present work, if you wish to earn more money, if you want to get into a profession where the demand for trained men is increasing as the Chemist plays a more and more important role in the industrial life of this country, let us teach you Chemistry.

You, Too, Can Learn AT HOME

To qualify for this remarkable calling requires elaborate specialized training. [Formerly it was necessary to attend a university for several years to acquire that training, but thanks to our highly perfected and thorough system of instruction, you can now stay at home, keep your position, and let us educate you in Chemistry during your spare time. Even with only common schooling you can take our course and equip yourself for immediate practical work in a chemical laboratory. Dr. Sloane gives every one of his students the same careful, personal supervision that made him celebrated throughout his long career as a college professor. Your instruction from the very beginning is made interesting and practical, and we supply you with apparatus and chemicals for performing the fascinating analyses and experimental work that plays such a large part in our method of teaching, and you are awarded the Institute's official diploma after you have satisfactorily completed the course.

FORTUNES HAVE BEEN MADE THROUGH CHEMISTRY

Alfred Nobel, the Swedish chemist who invented dynamite, made so many millions that the income alone from his bequests provides five \$40,000 prizes every year for the advancement of science and peace. C. M. Hall, the chemist who discovered how to manufacture aluminum, made millions through this discovery. F. G. Cottrell, who devised a valuable process for recovering the waste from flue gases; James Gayley, who showed how to save enormous losses in steel manufacture; L. H. Backeland, who invented Bakelite—these are only a few of the men to whom fortunes have come through their chemical achievements.

NOW IS THE TIME TO STUDY CHEMISTRY

Never before has the world seen such splendid opportunities for chemists as exist today. In factories, mills, laboratories, electrical shops, industrial plants of all kinds, chemistry plays a vital part in the continuation and expansion of the business. In every branch of human endeavor the need for chemists has arisen. Those who have the foresight and ambition to learn chemistry now will have the added advantages and greater opportunities afforded while the chemical field is growing and expanding.

EASY MONTHLY PAYMENTS

You do not have to have even the small price of the course to start. You can pay for it in small monthly amounts or earn it as many others are doing. The cost is very low, and includes even the Chemistry outfit—there are no extras to buy with our course. Write us and let us explain how you can qualify for a trained technical position without even giving up your present employment.

COMPLETE LABORATORY EQUIPMENT

We give to every student, without additional charge, his chemical equipment, including fifty-two pieces of laboratory apparatus and supplies, and fifty-two different chemicals and re-agents. The fitted heavy wooden box serves not only as a case for the outfit, but also as a laboratory accessory for performing countless experiments. Full particulars about this special feature of our course are contained in our free book, "Opportunities for Chemists."

TUITION PRICE REDUCED

Besides furnishing the student with his Experimental Equipment, we have been able, through the big increase in our student body, to reduce the price of the course. Write today for full information and free book, "Opportunities for Chemists."

MAIL THE COUPON FOR FREE BOOK

Clip the coupon below and mail it at once. Your name and address on the coupon will bring you by return mail our interesting free book "OPPORTUNITIES FOR CHEMISTS" and full particulars about the course and what it will do for you.

CHEMICAL INSTITUTE
OF NEW YORK, Inc.
Home Extension Division 3
16-18-R-E, 30th St., New York, N. Y.

Please send me, without any obligation on my part, your book "Opportunities for Chemists," and full particulars about the Experimental Equipment given to every student. Also please tell me about your plan of payment and the reduction in the tuition price.

Don't Wait—Mail the Coupon NOW!

CHEMICAL INSTITUTE of NEW YORK, Inc.

16-18-R-EAST 30th ST. Home Extension Division 3 NEW YORK, N. Y.

NAME

ADDRESS

CITY
3-28

STATE



**Greatest of All
Great
Superheterodynes
shown in the
New Improved
CONSRAD PATTERN
SIMPLE - PRECISE**

WHEN you build, build the best and with the best—the Consrad Book Pattern—it will cost no more! When Consrad publishes a pattern of a circuit, it must rank high in the Radio World.

And, of this Strobodyne, none ranks higher—it is the greatest of superheterodynes.

Consrad knows what it is to build sets—knows the sad experience of mistakes caused by confused instructions.

So when this pattern of the great Strobodyne comes to you, it is in the most simple, precise terms possible—easily understood, with all possible chance of doing the wrong thing eliminated.

- 4 Full-size Blueprints
- 1 9x12 book
- Self-explanatory illustrations
- Step-by-step Instruction

It is a glorious feeling of accomplishment when the set shines in its finished splendor before you.

50c the Pattern

Start Now—Use Coupon
Immediate Delivery

CONSRAD COMPANY, Inc.,
230 Fifth Ave., New York, N. Y.

Gentlemen: I enclose 50c. for one copy of the New Official STROBODYNE PATTERN, containing complete constructional information and all Blueprints.

Name.....
Address.....
City.....State.....

impulse to say: "Well, what of it?" Oh, be not so murderous, so cruel. Bear with him, rather, in this hour of gladness, this moment of divine rhapsody. Try hard, try hard to make the eyes shine and the face illuminate. It will be balm to his poetic soul (otherwise so dull, so dead). For DX is his faith, his hope and his dear desire—his religion. It may burn out after a while, and again it may flame higher. But despair not. It might be worse. He is happy now. You could put crackers in his bed and he wouldn't mind. But treat his DX disdainfully and he will go mad; he will go mad if

you do not grant him his hour of glory. Poison will gnaw within him if you do not understand that, in his soul of souls, he bears you no malice but is simply a radiofan, exultant in his victory over the mundane earth, a giant of power in his own demesne, wrathful as a tiger when disturbed or taunted, but gentle as a lamb and sweet as a June day when he is getting his (say it softly!)—his DX!

Ah, to have understanding, Mrs. Jones, or at least to *seem* to understand—ah, this is the ultimate charity!

The United States—A Broadcast Studio

(Continued from page 1004)

carry the program from the New York switchboard, through which the different performers' voices were all routed before they were put on the air from the broadcast stations. This meant thousands of miles of lines from New York to the forty-seven broadcast stations scattered over the country. In short, three transcontinental telephone circuits were required for the broadcast—one to serve the broadcast stations, one to transmit the program of the performers to New York and a third for emergency.

It is stated that the cost of putting on this hour of broadcasting was over \$1,000 per minute; of the total, about \$25,000 went

to the artists appearing before the microphone, \$35,000 to the telephone company and about \$7,000 to the broadcasting company for the time the stations were on the air.

This broadcast, which is one of the most ambitious ever attempted, is said to have been received by one of the largest audiences that ever tuned in on a program. There seems to be no need for broadcasters to fear that sponsors think radio advertising does not pay, when a single company is willing to invest any such amount as was spent for this program. In short, this hour of broadcasting is remarkable from three standpoints, the celebrity of the artists participating, the cost, and the remarkable engineering work that was necessary.

How To Kill Vagrant Radio Noises

(Continued from page 989)

needed to ground, make this connection. The last of the interference may be killed by connecting a 2-mf. condenser (tested to stand 1,000 volts D.C.) across the brushes. Place the condenser as near as possible to the place where the sparking occurs. See Fig. 1.

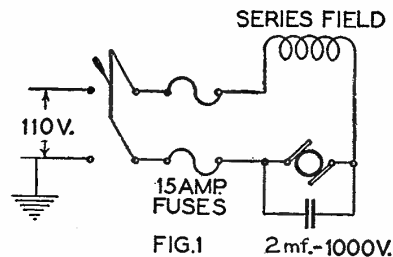

FIG. 1
One way to stop a motor from broadcasting without a license is by placing across the brushes a 2-mf. condenser of suitably high-voltage rating.

If the line is over 110 volts and ungrounded the design of the filter should be changed. Two condensers of the same size mentioned above are connected in series, with their common point grounded. This system is then shunted across the commutator, as will be seen in Fig. 2. For very small motors, such as are used in hair driers, vacuum cleaners, soda-mixers, etc., a highest condenser of 1/4-mf. will do the trick.

In the case of a refrigerator control, furnace control, heating pad, or like device, giving trouble, more than likely sparking is

taking place at the thermostat contacts. Hook a 1/4-mf. condenser across the input. The result should be silence.

Then we have the case of bad contacts. Of course the best remedy that we can advise is to fix the contact. But then we just know that someone is going to yelp, "Suppose you can't fix it. What then?" If you find for instance, that the delicatessen man

**LESS THAN
600 VOLTS
UNGROUND**

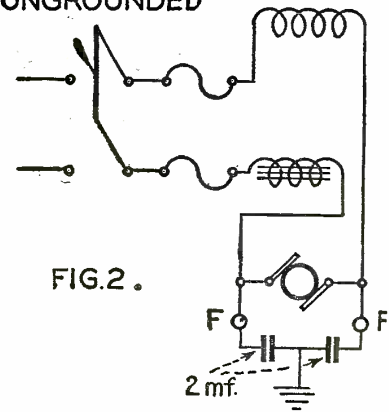
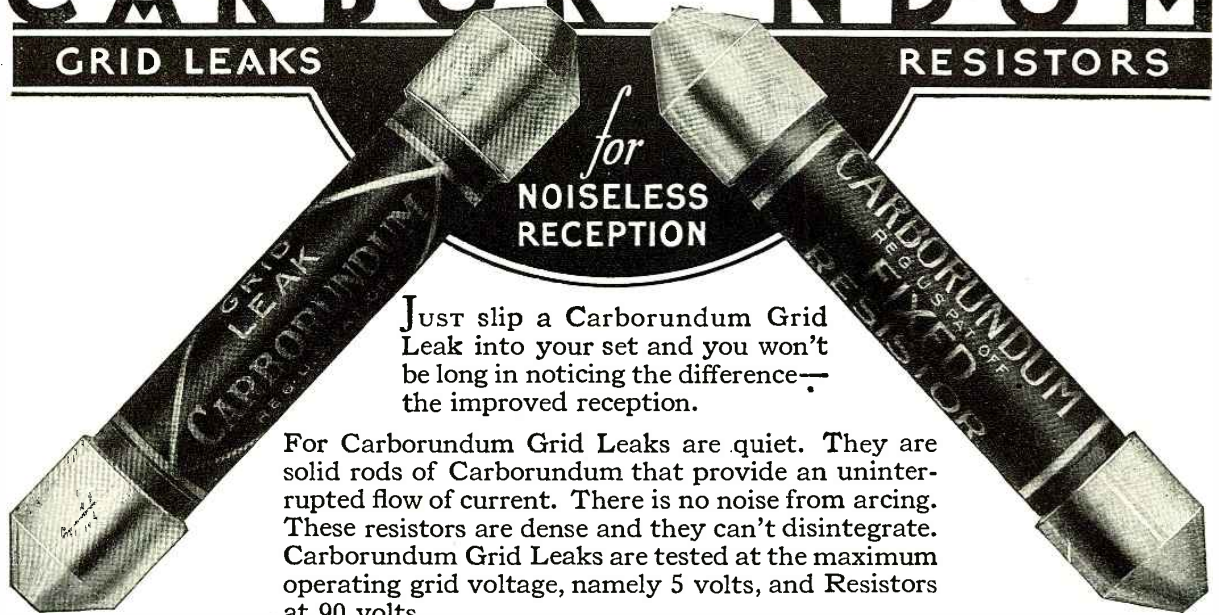

FIG. 2.

The choke coil consists of 100 turns of No. 18 D.C.C. wire wound in a single layer on a 3-inch tube form, 1/8-inch thick and 8 inches long. It is wrapped with insulating tape after winding.

CARBORUNDUM

GRID LEAKS RESISTORS



for
NOISELESS
RECEPTION

Just slip a Carborundum Grid Leak into your set and you won't be long in noticing the difference—the improved reception.

For Carborundum Grid Leaks are quiet. They are solid rods of Carborundum that provide an uninterrupted flow of current. There is no noise from arcing. These resistors are dense and they can't disintegrate. Carborundum Grid Leaks are tested at the maximum operating grid voltage, namely 5 volts, and Resistors at 90 volts.

BUY FROM YOUR DEALER OR DIRECT Write for Booklet D-1, "Carborundum in Radio"



THE CARBORUNDUM COMPANY, NIAGARA FALLS, N. Y.

Reg. U. S. Pat. Off.
CANADIAN CARBORUNDUM CO., LTD., NIAGARA FALLS, ONT.

Sales Offices and Warehouses in New York . Chicago . Boston . Philadelphia . Cleveland . Detroit . Cincinnati . Pittsburgh . Milwaukee . Grand Rapids
The Carborundum Co., Ltd., Manchester, England Deutsche Carborundum Werke, Dusseldorf, Germany

Carborundum is the Registered Trade Name used by The Carborundum Company for Silicon Carbide. This Trade Mark is the exclusive property of The Carborundum Company.

It's Here ~ with the latest

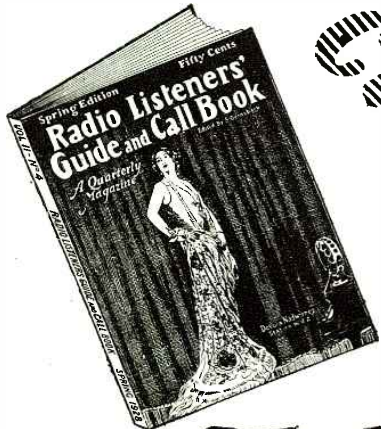

stations
50¢
news

The Greatest Call Book of the air!

RADIO LISTENERS' GUIDE AND CALL BOOK—50¢.
Why the circuits, the listed stations, are worth ten times more! For money's worth, remember the name—**RADIO LISTENERS' GUIDE AND CALL BOOK!** Most complete, convenient, helpful!
Circuits—the very latest—dozens of them—written and prepared for use by experts—all ready to build.

Stations—a wonder index of radio stations of the world, completely listed by call names and cities, with wave lengths and other important data—and special space for dial markings.
News—the interesting, illustrated intimacies of the studios which you will thoroughly enjoy.

RADIO LISTENERS' GUIDE AND CALL BOOK—50¢.

AT ALL NEWSSTANDS OR DIRECT

CONSRAD COMPANY, Inc., 230 FIFTH AVENUE, N. Y. C.

New Aero Circuits for Either Battery or A. C. Operation

Proper constants for A. C. operation of the Improved Aero-Dyne 6 and the Aero Seven have been studied out, and these excellent circuits are now adaptable to either A. C. or battery operation. A. C. blue prints are packed in foundation units. They may also be obtained by sending 25c for each direct to the factory.



Aero Universal Tuned Radio Frequency Kit

Especially designed for the Improved Aero-Dyne 6. Kit consists of 4 twice-matched units. Adaptable to 201-A, 199, 112, and the new 240 and A. C. Tubes. Tuning range below 200 to above 550 meters.
Code No. U-16 (for .0005 Cond.)..... \$15.00
Code No. U-163 (for .00035 Cond.)..... 15.00



Aero Seven Tuned Radio Frequency Kit

Especially designed for the Aero 7. Kit consists of 3 twice-matched units. Coils are wound on Bakelite skeleton forms, assuring a 95 per cent air dielectric. Tuning range from below 200 to above 550 meters. Adaptable to 201-A, 199, 112, and the new 240 and A. C. Tubes.
Code No. U-12 (for .0005 Cond.)..... \$12.00
Code No. U-123 (for .00035 Cond.)..... 12.00

You should be able to get any of the above Aero Coils and parts from your dealer. If he should be out of stock order direct from the factory.

AERO PRODUCTS, INC.
1772 Wilson Ave. Dept. 105 Chicago, Ill.

over the way is using his sign to put your radio reception on the blink, tell him about it and we will bet another nickel that he will gladly let you hook a 1-mf. condenser across the terminals. Business is business.

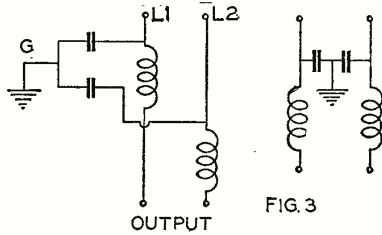

A compound filter that silences bell-ringers, so far as the radio set is concerned.

Now suppose that you are located far away from sign-flashers, street cars and the other noise-makers of the city and that,

when you want to get your telephone operator to put through a call to Mary's house, you have to turn a funny crank on the side of the box. That, being attached to a magneto, can do plenty in the way of noise making. In order to have radio reception such as you read about, make a filter of two condensers grounded at their common point and put them in series with two choke coils, one in each side of the line. Consult Fig. 3.

As we have said, somewhere in the first portion of this advice, there are many sources of interference, which we have no room to treat of here. We respectfully suggest that, if you are bothered with some ill to which radio is heir, you should consult the "Manual on Interference" prepared by R. J. Casey for the Radio Manufacturers Association. We are indebted to this excellent booklet for some of the suggestions herein given.

Repairing Simple Ailments of Radio Receivers

(Continued from page 1015)

Where a storage "A" battery is employed, the leads to the terminals often become corroded, resulting in poor contact and in clicking or grinding noises in the loud speaker.

In neodynes, "squealing" often occurs, which usually means that the radio-frequency stages must be rebalanced. Ordinarily, an expert should do this work and the charges are nominal. Often, if the tubes in the set are changed around, all squealing can be eliminated.

Other howls in some sets are caused by turning the filament or volume controls up too high. One should adjust these until good volume is secured at the lowest possible setting. If the filaments are kept turned on

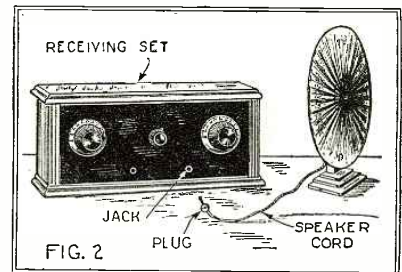

FIG. 2

If reception is poor, see if the speaker connection cord is intact, and if the plug makes good contact in the jack.

One can often remedy simple ailments by gently jarring the set. Any wiring that has become loosened will usually thus be discovered.

One listener found that in the middle of a program the volume would often suddenly fall off. This remained unexplained for a long time until one night he chanced to move the loud speaker, and discovered that there was a break inside its flexible connecting cord. The phone jacks often become worn and make poor contact with the loud speaker-plug and crackling noises and variation in volume then result. The loud-speaker cord, being usually subjected to much bending, often develops breaks (see Fig. 2).

One should be careful not to touch internal wiring when something goes wrong, but first to inspect thoroughly all outside connections. It is well to remember that 90% of all troubles are easily remedied by the set owner. Isn't it reasonable to say that only those parts which are external and subject to wear are the ones usually found out of order?—Clyde A. Randon.

NO USE! SOME CAN PUT THEIR FOOT IN IT

Did you see the item about the fellow who put a billiard ball in his mouth and couldn't get it out?

If you happen to know any radio announcers, ask them to try it.—Ted Cook, in Los Angeles Examiner.

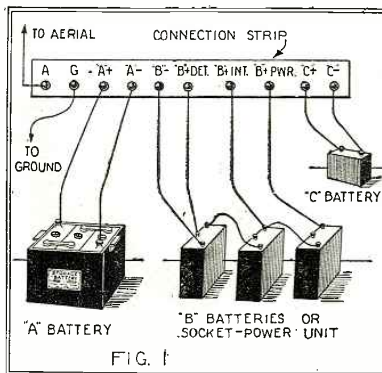

One of the prime requisites for good reception is a tight connection between batteries and the receiver. Loose connections, whether at the batteries or at the terminal board, are easily found.

too high over an extended period, the tubes employed will become "deactivated;" that is, the filaments will cease to function properly and lower volume in the set as a whole will result. One can often remedy this difficulty by changing the tubes around; if the results are no different, the tubes should be tested. One should remember, in changing tubes, that the tube marked "last audio stage" should remain in place, as it performs in this position better than the other can.

Build Any Set but use ACE Hard Rubber PANELS

Their high insulating values insure the utmost protection against leaks and losses which often cause poor reception.

Made with Crackle or plain Polished Surface in all regular sizes:

- 7 x 10, 7 x 12, 7 x 14
- 7 x 18, 7 x 21, 7 x 24
- 7 x 26, 7 x 30 inches.

Low prices at all dealers or write to

AMERICAN HARD RUBBER CO.
11 MERCER STREET
NEW YORK, N. Y.

Makers of famous "RADION" PANELS

What Constitutes Tone Quality?

(Continued from page 991)

Now move one of the bridges until the length of the vibrating part of the wire is exactly one-half as long as before. The tone produced will be observed to be an *octave higher* than the first tone; the frequency of vibration will be exactly *twice as great*.

Now, having memorized the last tone, move the bridge back to the first position, and pluck the wire at one-quarter of its length. On touching the wire lightly at its mid-point with a feather or the folded edge of a piece of cloth, it will be noted that the fundamental tone is "damped out" or very much weakened, but that the octave tone C' is still sounding. Evidently the wire was vibrating in such a way as to produce both the fundamental and the octave tone, somewhat as shown in Fig. 5 at c. Similarly plucking the wire at one-sixth of its length and damping it at one-third of its length gives a still higher note G'. Plucking at one-eighth of its length and damping at one-fourth gives a fourth tone C'', two octaves above the fundamental. The process may be continued more or less indefinitely, showing that the true condition of the vibration of the wire at any time is very complex; it vibrates simultaneously for its full length, one-half, one-third, one-fourth, etc., with frequencies twice, three times, four times, etc., the fundamental. The complex vibration form gives rise to a whole series of tones above the fundamental, called "over-tones" or "partials." The first nine over-tones of each of the notes of the major scale (physical pitch) are given in the table, to which reference will be made in Part II of this article, which will appear in the next issue of RADIO NEWS.

EFFECT OF OVERTONES

It will be also noted that, as the number of overtones is increased (*i.e.*, as the wire is plucked nearer and nearer to the end), the complex tone becomes more and more strident and metallic in character, and at the same time less pleasing to the ear. From this fact it becomes apparent that the pleasing character of any tone depends largely upon the quick damping out of certain of the upper overtones. A musician would explain that the sound produced by these overtones (note especially the sixth and eighth in the table) is discordant with the lower tones. If the string is plucked at "nodal points" (those where the wire vibrates least) for the disagreeable discordant harmonics, they are not produced. Since the sixth and eighth harmonics are totally discordant, musicians seek to eliminate them; which accounts for the bowing of a violin string at one-seventh or one-ninth of its length, and the placing of the hammers of a piano so that they strike the wires at nodal points for these two partials.

The study of the manner of vibration of plates and membranes, while it is involved in some difficulty, may also be undertaken by the amateur experimenter. The classical experiments of Chladni, discussion of which will be found in any standard work on acoustics, may be easily repeated. His apparatus consisted of a square plate of glass or metal, supported by a clamp or a bolt through the center, as in Fig. 6. Sounds

DISTANCE *lends* ENCHANTMENT

When you buy or build a radio set make sure that it has **Copper Shielding**. Where long distance reception is desired **Copper Shielding** is essential. It is a refinement to your set that will enable you to hear the programs of distant stations much more clearly.

Copper Shielded sets give:

BETTER RECEPTION
FINER SELECTIVITY
IMPROVED TONE QUALITY

By virtue of its easy working qualities and its high conductivity **Copper Shielding** is a decided improvement to any set.

COPPER & BRASS

RESEARCH ASSOCIATION

25 Broadway, New York

Write for your copy of this book.



There is no cost nor obligation on your part.



LIGHTING FIXTURES

Ready to Hang

Direct from the manufacturer. Completely wired, including glassware. Send for new catalogue No. 29. Just Reduced Prices.

Special Proposition to Dealers. Erie Fixture Supply Co., Inc., Station R, Erie, Pa.

PARVOLT

WOUND CONDENSERS

Stand The Surges

The ACME WIRE CO., New Haven, Conn.

FREE Wholesale Radio Catalog

Dealer-Set Builders! Save Money!

Send for this book of bargains. Everything in Radio—all the newest hook-ups. Sets, kits, parts, cabinets, consoles and supplies. If you want the best for the least money, you need this catalog.

SHURE RADIO COMPANY
363-C West Madison St. Chicago, Ill.

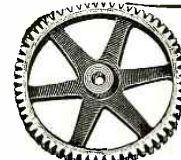

GEARS

All kinds—Small

The most accurate made and prices reasonable. We carry a complete line of gears in stock for immediate shipment. Can also quote on special gears of all kinds. Send us your inquiries.

Write for Catalog 40
Chicago Stock Gear Works
105 So. Jefferson St., Chicago

Insure your copy reaching you each month. Subscribe to Science and Invention—\$2.50 a year. Experimenter Publishing Co., 230 Fifth Avenue, N. Y. C.

DEALERS
*the country over
 have heard—
 have seen—
 and now acclaim*



The
Modern Business Builder

Radio News DEALERS PERSONAL EDITION—a magazine devoted to the Radio Trade—a *personal edition*.

Supplying to the industry a service that otherwise would be next to impossible to obtain.

Market Research—Surer Profits
 Buying Trends—Quicker Turnovers
 Outlets of Waste—How to Stop Them
All the Finer Points of Conducting a Progressive Radio Business

In short, this DEALERS PERSONAL EDITION is an intimate magazine only meant for dealers—containing the current, vital talk of direct bearing and much interest to every dealer.

If you are one of the few who has not become acquainted with the DEALERS PERSONAL EDITION, you must do so at once.

This magazine is doing for the Radio Business what Radio did for many businesses—a complete revolution for the better—with the backing of *Radio News*.

**GOOD ONLY IF
 ATTACHED TO
 YOUR
 LETTERHEAD**

RADIO NEWS,
 Merchandising Dept.,
 230 Fifth Avenue,
 New York City.

My name.....

My address.....

My firm.....

(Please make sure I receive my sample copy of the DEALERS PERSONAL EDITION promptly.)

RN-3-28

are produced by bowing the edge with a violin bow; the pitch of the sound being varied by the manner and place of bowing and by the positions at which nodal points are produced, by touching the plate with the fingers while the plate is being bowed. Fine sand or resin sprinkled on the plate is thrown off the portions which are vibrating, collecting over nodal lines. Some of the figures thus obtained are beautifully symmetrical. A few of Chladni's sketches are shown in Fig. 7.

If the plates be thin enough and large enough in diameter, it will be found that they can respond to an almost infinitely large number of vibration frequencies; the pitch increasing as the thickness is increased and decreasing as the linear dimensions are increased. The sand patterns will indicate that the size of the vibrating segments becomes smaller and smaller as the pitch increases. The complexity of the pattern is likewise a measure of the complexity of the tone which the plate may produce; that is, the pattern indicates how the plate is vibrating while producing a fundamental tone with a number of overtones.

As the experiments above are continued, and as other more exhaustive investigations are undertaken, it becomes increasingly cer-

tain that the quality of a sound depends upon the number and relative prominence of the overtones.

A clarinet sounding middle C, for example sounds the fundamental together with a certain set of overtones (see Fig. 3). Some of the overtones are strong, some less prominent, and others are so weak as to be scarcely perceptible to the most sensitive musical ear. The sum total of these overtones gives the clarinet its individual character by means of which we identify it. If any one of these overtones is removed or weakened, or if any additional tone is sounded to blend with the clarinet's tone, then its individuality is destroyed and we are no longer certain of identification. The reader will recall the sound of a "muted" clarinet for verification of the last statement. The "mute" changes the emphasis upon some of the partial tones, introduces some new ones, and removes others; so that the muted tone is really a new sound.

Comparison of the two wave forms in Fig. 3 will show that the fundamental frequencies are the same, and that the intensities are the same. But the partial tones are very dissimilar. Each little kink and curve in each wave is essential, however, to the complex sound.

Encircling The World With a Two-Tube Set

(Continued from page 987)

Greenland: OGG, Godthaaven.

Iceland: Reykjavik.

Alaska: KGBU, Ketchikan; KFQD, Anchorage

Europe: 2LO, London; EAJ3, Cadix, Spain; IMI, Milan, Italy; 5PY, Plymouth, England; Skattudden, Finland; Oslo, Norway; Berne, Switzerland; EAJ7, Madrid, Spain; SRB, Brussels, Belgium; FPTT, Paris, France; 2ZY, Manchester, England; 5SC, Glasgow, Scotland; 5IT, Birmingham, England; 5NO, Newcastle, England; EAJ1, Barcelona, Spain; LL, Paris, France; LA, Langenberg, Germany; 2RN, Dublin, Ireland; EAJ4, Madrid, Spain; EAJ12, Oviedo, Spain; Stuttgart, Germany; EAJ2, Madrid, Spain; EAJ22, Salamanca, Spain (this was the loudest European station heard); HA, Hamburg, Germany; PTT, Toulouse, France; INA, Naples, Italy; 6CK, Cork, Ireland; Copenhagen, Denmark; EAJ13, Barcelona, Spain; Bordeaux, France; EAJ25, Malaga, Spain.

Africa: Senegal, West Africa; WAMG, Cape Town, South Africa; Radio Casa Blanca, Morocco.

Asia: KZUY, Baguio, Philippine Islands; JOAK, Tokio, Japan; JOCK, Nagoya, Japan; JOBK, Osaka, Japan; JODK, Keijo, Japan; KZRQ, Manila, Philippine Islands; 1SE, Singapore (reception uncertain); KRC, Shanghai, China; 5HK, Hongkong, China; 7CA, Calcutta, India; KZRM, Manila, Philippine Islands; XOL, Tientsin, China.

Australasia: 2BL, Sydney, Australia; 3CL, Adelaide, Australia; 4QG, Brisbane, Australia; 3LO, Melbourne, Australia; 4YA, Dunedin, New Zealand; 3AR, Melbourne, Australia; 2FC, Sydney, Australia; 1YA, Auckland, New Zealand; 4RN, Rockhampton, Australia; 2KY, Sydney, Australia; 2YA, Wellington, New Zealand; 3YA, Christchurch, New Zealand; 5DN, Adelaide, Australia.

Hawaii: KGU, Honolulu.

Pierce logged Australian stations every month in 1927. They and others in the antipodes came in best about 4.30 to 5 o'clock in the morning, when he had to get up to do the milking and other chores. European stations were best from 4.30 to 7 P. M., and South American stations from 5 to 11 P. M.

THE BEST RADIO NIGHT

During the evening of March 13, 1927, Pierce startled his family by loud whoops of joy. It was one of those rare nights when radio was at its best. He logged the following: KGU, Honolulu; KGBU, Alaska; AGM, San Salvador, Central America; CNAD, CMAT and CMAB in Chile; LOX, LOZ, LOV, LOP and LOY in Argentina; EAJ22, Spain; SQLG, Brazil; Rio de Janeiro, Brazil (no call letters announced); CWOZ, Uruguay; OAX, Peru; Durban, South Africa; CYR and CYU in Mexico and PWX, Havana.

Pacific coast stations in the United States came in almost as easily as those near home. Unidentified foreign stations came in on 345, 288 and 307 meters.

Pierce's radio log, kept with painstaking care for two years, will convince anyone who examines it that it is an authentic record. Many of his records are verified by letters or cards from the stations heard. And there is other evidence almost as strong, or perhaps stronger.



Pierce holding a receiver which was built by North Kingston High School Science Club under his direction.

The character and reputation of the family are above question. They live on the homestead where their ancestors settled more than a century ago. The father is a farmer who supports the fine old traditions of a line of forebears with a record stretching back to the days of William the Conqueror. Mrs. Pierce held a responsible position in business before her marriage and is a leader in the Parent-Teachers' Association of the local schools.

I met five other members of the family. Fond parents may overrate a boy's achievements, but little brothers and sisters are brutally frank. From "Baby" in the third grade of school to big sister in the Rhode Island State College, they all believe that Brother Walter is a marvel. They too have heard the distant stations and they repeat the announcements and call letters with all the linguistic colloquialisms of Spain, Australia and the rest.

Bridge by Radio

(Continued from page 1005)

declarer's partner (dummy) lays his hand on the table, the other three players retaining theirs. As the cards are read off at the station, in the order in which they are played, the listeners play the corresponding cards. Instead of gathering the cards into tricks of four cards, however, each player recovers the card he has just played and puts it either face up or face down, depending on whether his side won the trick or not. This is done in order to keep the hands intact, so that they can be rearranged after the play, when Mr. Whitehead will give further explanation of the bidding and play.

WIDESPREAD ATTENTION

Although twenty-seven stations are tied up for the broadcasting of the bridge games direct from New York City, there are forty-seven others which put the games on the air independently. Throughout this and foreign countries, thousands of bridge fans who are owners of radio receivers have clamored for their nearby station to broadcast the games; so that every week an average of seventy-four transmitters are telling the American public how to play a certain hand of the aristocrat of card games.

Many thousands of letters have been received from listeners in all parts of the United States, Canada, and foreign countries, telling how much the bridge games have been enjoyed, and asking that the "advance hands" be sent them. Some of these letters follow:

"Just a line of appreciation from one who is a dub at any card game, but who enjoys any and every game of bridge broadcast," writes D. Kerr, of Omaja, Cuba. "The set isn't functioning as it should, due to faulty transformers, but there are others on the way; so at present I'm getting along with substitutes, but it does not permit the use of a speaker so that the local bridge club can enjoy it. This club has been recently organized and get quite a kick out of playing the advance hands as advertised; and said kick will be complete as soon as we can get an careful of how the experts play it."

From Leicestershire, England, Henry

A HIGH-POWERED 10-TUBE MODEL FOR 1928

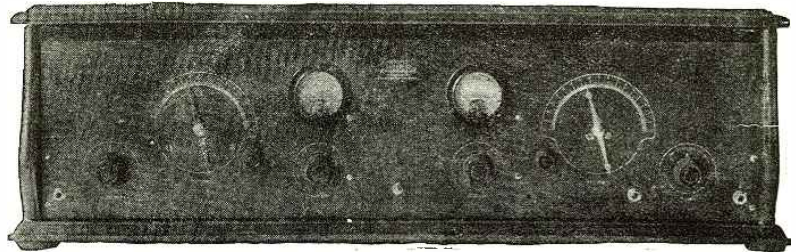

NORDEN-HAUCK IMPROVED SUPER-10

LICENSED UNDER HOGAN PATENT 1,014,002

"Highest Class Receiver in the World"

This new and advanced design brings to you all the luxury and performance you could possibly desire in a radio receiver. Absolutely nothing has been omitted to provide supreme reception—a new standard previously unknown.

The up-to-the-minute engineering principles found exclusively in the improved Super-10 are comparable to the high compression head and super charger in an automobile engine.

In the Norden-Hauck Improved Super-10 you have

- Wonderful Selectivity
- Faithful Reproduction with any Degree of Volume
- Signals received at only one point
- Two major tuning controls for all wave lengths
- Wave band 200/550 meters (adaptable down to low waves and as high as 6000 meters with removable coils)

Material and workmanship conform to U. S. Navy specifications.

The improved Super-10 is sold complete as a manufactured receiver, or we are glad to furnish blue prints and all engineering data for home construction.

Upon request, new attractive illustrated literature will be promptly mailed to you without cost or obligation on your part.

Tear off and mail today—

Your correspondence or inquiry for further information is cordially invited

Write direct to

NORDEN-HAUCK, INC.
ENGINEERS

"Builders of the Highest Class Radio Apparatus in the World"

MARINE BLDG., PHILA., PA., U. S. A

Cable: Norhauck

NORDEN-HAUCK, INC.,
MARINE BLDG., PHILA., PA.

Gentlemen:

- Without obligation on my part send me complete literature on the new improved Super-10.
- I enclose \$2.00, for which send me, postpaid, complete Blue Prints and operating instructions for the new improved Super-10.
- I enclose \$1.00, for which send me Blue Prints of the Model 500 B. C. Power Unit.

Name

Address

CARTER

New

A. C. Adapters

For use in converting sets to A. C. operation. Again Carter leads.

Adapters for both CX 326-CX 327 type tubes 90c \$1.10

Any dealer can supply

In Canada: Carter Radio Co., Ltd., Toronto

MEMBER RMA
 Carter Radio Co.
 CHICAGO

ACME WIRE CO.

CELATSITE

for RADIO WIRING

Flexible stranded Celatsite is composed of fine, tinned copper wires with non-inflammable Celatsite covering in 9 bright colors. Strips clean, solders readily. Sold only in 25' coils, in cartons colored to match contents. Solid Celatsite has same colored covering, but over bus bar wire. Write for folder to The Acme Wire Co., Dept. D, New Haven, Conn.

Insure your copy reaching you each month. Subscribe to Radio News—\$2.50 a year. Experimenter Publishing Co., 230 Fifth Avenue, N. Y. C.

XL Products



Model "N" Vario-Denser



MODEL "G" VARIO-DENSER



X-L NEW BAKELITE INSULATED PUSH POSTS

Used in Every High Grade Circuit or Receiver Today!

INCLUDING

Strobodine, Loftin-White Constant Coupled, Qualitone 6, Improved Aristocrat, Oliver Lodge, Best's Super-Heterodyne, B-T Power Six, Hammartund-Roberts, Daily News 4, World's Record Super, Goodwin Aperiodic Detector Circuit, Quadriformer 6, Best's 1927, Silver's Knockout, and many others.

MODEL "N" VARIO-DENSER
Micrometer adjustment easily made, assures exact oscillation control. Quick, easy tuning, more volume, clearness and stability. Capacity range 1.5 to 20 micro-micro farads. Price \$1.00.

Obtains the proper grid capacity on Cockaday circuits, filter and intermediate frequency tuning in super-heterodyne and positive grid bias in all sets. Three variable capacity ranges. Price complete, with grid clips, \$1.50.

X-L NEW BAKELITE INSULATED PUSH POSTS
The perfect binding post at last! Convenient, simple; permanent connections. You don't have to remember to tighten them. Push down the X-L, insert wire, remove pressure. Connection is tight and will stay tight. No vibrations can loosen. Releases instantly. Standard markings, or boxed in complete sets. Price each, 15 cents.

FREE Big new up-to-date book of wiring diagrams of all leading circuits. Write today for copy. Investigate the Goodwin Aperiodic Circuit. This is applicable to any set and adds a stage without added tuning controls.

X-L RADIO LABORATORIES
2426 Lincoln Ave., Chicago, Ill.



Phillips Carlin and Graham McNamee broadcasting the playing of a bridge game

Field, G6ZX, writes: "You will recall that I received WSAI over here some time ago and I am writing to thank you for your series of bridge games played by radio. The booklets are very interesting indeed and today the value of auction bridge, both as a recreation and as a mind-trainer, is already appreciated and will be more so, due to your pioneer work in this direction."

unique experience, which certainly has had no precedent in this state of Matto Grosso, and I do not think anywhere in Brazil, was made possible by an experimental short-wave set carried by Mr. Francis Gow Smith, of the Explorers' Club, New York, who is making an exploration through the little-known regions of Matto Grosso."

From Wailuku, Hawaii, A. F. Costa writes: "I have been enjoying your bridge games since you began broadcasting, but last night I was unable to get home and missed it. Therefore, please send me a copy of the game. I have four or five friends who are just as enthusiastic over your bridge games, and usually come to enjoy them."

FROM THE JUNGLES

Simon Quass, British vice-consul at Corumba, Brazil, writes: "You may be interested to know that last Saturday I had the pleasure to listen in to a bridge lesson broadcast by WGY of Schenectady. This

Roasted by Radio

(Continued from page 1001)

inspector waited for it to come to a stop; but it did not. His brain mechanically began to attempt to translate the movements of the needle into Continental Morse.

Inspector Merritt started. Three short jerks, three long swings, three short jerks—SOS! He seized his pencil. "SOS SOS SOS Harold Dare at WROT SOS SOS SOS Dare SOS Help. . ."

Inspector Merritt waited no longer. He flung up the window—sprang into the driver's cab. "To the Dare studios—and step on it!"

The great car leaped ahead, with shrieking siren it roared through the heavy traffic, dashed across busy intersections, missing careless drivers and pedestrians by inches, and swung round corners at a sickening speed. Inspector Merritt sat beside the driver and outlined a plan of action.

Ahead appeared the walls of the immense plant of the Dare studios, and the driver let the siren die. The car careened, and swung into the driveway leading to the main offices. The policeman at the gate dropped his newspaper, rose from his comfortable chair—and dodged aside as the

great car paused not, but with a bound struck the chain stretched across the gate, snapped it, and skidded upon the gravel up to the main office building. The policeman followed at a run. "Come on, my friend!" cried Inspector Merritt. "We may need you too."

The inspector's keen eye at once located the broadcast studio by its lead-in. Through the corridors they raced. At the end of the hall they saw a door marked "Operating Room." Inspector Merritt drew his heavy Army automatic; his companions pulled their revolvers, and stealthily the trio strolled down the corridor. Outside the door they halted. They could hear a faint hum of generators.

"Ready!" whispered Inspector Merritt. Suddenly he flung open the door.

With an exclamation, the black-haired arch-villain wheeled and saw that he was covered by three ugly-looking revolvers. Automatically his hands sought the ceiling.

Inspector Merritt looked round and saw Dare. In a flash his quick mind took in the situation. The courageous hero was almost unconscious.

What Filament Control

Good tube performance demands perfect filament control. AMPERITE alone gives it, automatically. Eliminates hand rheostats, guessing and tube damage. Simplifies wiring and panel design. Backed by 6 years of perfect service. There is no alternative. Insist on AMPERITE. \$1.10 mounted (in U.S.A.). All dealers sell it.

RADIALL CO.
50 Franklin St. New York



FREE Write for "Amperite Book" of best circuits and latest construction data to Dept. RN-3

AMPERITE

REG. U.S. PAT. OFF.

The "SELF-ADJUSTING" Rheostat

BIG RADIO CATALOG

From the "Big, Friendly Radio House"

NEW 1928 Book offers finest, newest well-known sets; parts, eliminators, accessories at lowest prices. DEALERS WRITE FOR THIS CATALOG!

Western Radio Mfg. Co.
126 West Lake St., Dept. 12, Chicago, Ill.

ELECTRICITY

Est. 1905

SCHOOL OF ENGINEERING

of Milwaukee

Short-Cut your way to BIG P.A.Y., A.C. and D.C. Armature Winding, Radio, or Refrigeration in 3 mo. Elect. Eng. 2-3 Years. 3 yrs. Gen. Elect. Eng. 1 yr. Big Book Free helps you plan your life. Write today, mention age and education. RN328 Milwaukee, Wis.

Inspector Merritt quickly raised his pistol. He pulled the trigger—and the insulator which held Diavolo's temporary radio-frequency line shattered, letting the bare copper tape fall across a heavy bus wire. There was a great arc of dazzling green light and the long ribbon sagged and melted in two. The inspector dashed over to the panel and threw the generator switches. The immense transmitting set was dead. Inspector Merritt seized a fire extinguisher from its bracke' and began to play the foaming liquid over Dare's armor. Hissing clouds of steam arose, but quickly subsided. Harold Dare opened his eyes.

"How did you do it?" demanded Inspector Merritt, as he and the policeman lifted the long inductance over Dare's head and began to strip off the screen star's armor.

"I really do not deserve such a great deal of credit for it," modestly replied Harold Dare. "I merely recalled that, since my armor formed an absorbing circuit within the inductance, any movement of the armor changed the relation of the two circuits, thus altering the period of the coil. So, by moving my arms, I was able to throw the transmitter in and out of resonance. I thus signalled in Continental Morse, hoping that someone might be listening."

"Very cleverly done," admired the inspector.

At last the hero stood free of the deadly armor. In an instant he was at the side of the beautiful Gloria, cutting the cruel cords that bound her to the chair. Tenderly he lifted her head and removed the gag from the girl's rosebud mouth. Her eyelids flickered.

"Gloria," he cried.

Gloria's eyes opened, she rose unsteadily to her feet, looked wildly around, and, as she swayed forward, Harold Dare caught her in his strong, tender arms.

Piercely, Dandy Diavolo gritted his teeth. "Foiled again!" he muttered.

Harold Dare looked steadily at him. "Yes, you are foiled again, as wrong inevitably is foiled."

And the noble Harold Dare and the Fair One went forth to another glorious dawn.

AMAZING STORIES

IN OUR MARCH ISSUE

TEN MILLION MILES SUNWARD, by Geoffrey Hewelcke, evolves a most novel point—to change the axis of the earth by human energy. It is one of the cleverest stories of this kind

that we have ever seen—and when you have finished, we will ask you what is wrong with it.

BARON MUNCHHAUSEN'S SCIENTIFIC ADVENTURES, by Hugo Gernsback. In installments 3 and 4 the wily Baron gives us in detail, a picturesque story and description of his space flyer, his trip to the moon, his landing on the moon, and his views of the earth from the moon.

LAKH-DAL, DESTROYER OF SOULS, by W. F. Hammond, contains good science, thrilling episodes and tense situations, and will remain a vivid memory for many years to come. If you are at all addicted to nightmares, don't read this story at bedtime.

THE MASTER OF THE WORLD, Part II, by Jules Verne. The uncanny appearances and disappearances of the mysterious thing that threatens the safety of the world continue, until Inspector Strook solves the mystery in an extremely unexpected manner.

And many others.

A General Electric battery charger



will solve your battery problem

MORE than a million owners of General Electric battery chargers now enjoy radio programs without ever thinking of run-down batteries.

At night, as they switch off the radio they just turn on Tungar [the name of the General Electric battery chargers] . . . in the morning their radio storage batteries are pepped up and ready for active duty.

The Tungar is waiting to give you the same dependable, trouble-free, economical service. It is absolutely dry.

Your dealer can help you. Ask him to show you the popular 2-ampere Tungar that gives both trickle and boost charging rates. It charges "A" and "B" radio batteries and auto batteries, too.

New low prices
East of the Rockies

2-AMP. TUNGAR \$14

\$24 5-AMP. TUNGAR

TRICKLE TUNGAR \$10

Guaranteed by General Electric

Merchandise Department
General Electric Company
Bridgeport, Connecticut



Tungar—a registered trademark—is found only on the genuine. Look for it on the name plate.

GENERAL ELECTRIC

\$75 to \$125 Weekly

Charging Batteries Starts You



Let me show you how to make big money right from the start. I've prepared a FREE book explaining all details. First week's profit pays for all equipment. You can get all the battery charging business in your community with my Service Station Charger—it's years ahead of ordinary chargers—handles 50% to 70% more batteries. I explain everything—start you in a business of your own and put you on the way to big money. Write for FREE BOOK.

C. F. HOLMES, Chief Engineer, Dept. R.N.
Independent Electric Works
5116 Ravenswood Ave. Chicago, Ill.

FREE BOOK—Just Out



TRANSMITTING APPARATUS

A Complete Stock at "Chi-Rad"
In addition to our regular broadcast apparatus we carry a very good stock of transformers, chokes, grid leaks, high test condensers, etc., for transmitting purposes.

NEW SHORT-WAVE COILS
Specially built by "Chi-Rad." Write for descriptive bulletin and catalog. Dealers and set-builders please use business letterhead when writing for discounts.

Chicago Radio Apparatus Co.
415 S. Dearborn St., Dept. RN, Chicago

**What's
your trouble
Here's the answer
to any Radio Problem
that ever existed**

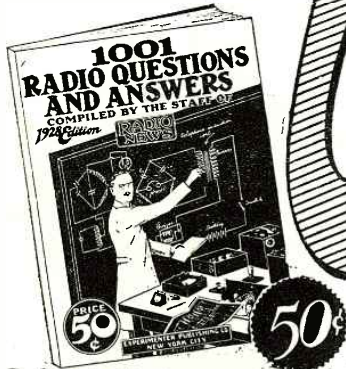

**1928 EDITION
of
Radio's Greatest
Question & Answer Book**

116 Pages—9 x 12 Inches

*Be prepared—This means but 50c,
and it is well within the means
of everyone.*

**1001 RADIO QUESTIONS
AND ANSWERS—50c**

THESSE questions are the ones arising every day of the year—they are the ones that are costing you money through lack of knowledge. But it is so unnecessary now! This great Question and Answer Book, compiled by the staff of *Radio News*, probes into Radio and its problems from every angle—and gives answers that have the sweet tinkle of money saved.

Circuits, Amplification, Balancing, Regeneration, Transmission, Set Construction, Operation, Speaker Design, Control, Electrification, Accessory Installation, Antenna Possibilities—there's not a thing about Radio that it misses.

**1001 RADIO QUESTIONS
AND ANSWERS**

50c at all newsstands or direct

EXPERIMENTER PUB. CO., INC.
230 Fifth Avenue New York, N. Y.

Radio—The Alarm Clock of a Nation

(Continued from page 997)

but find that I must work for all I get, just as in other activities of life. These classes are better than electric horses, too."

Men who go down to the sea in ships, men who go under the sea, too are numbered among the students. The crew of the submarine V-3 line up for the daily bends and in the Marine Barracks at Quantico, Va., many followers of the health classes may be found.

From Albany, a barrister wrote that, after exercising for a month, he felt "eight per cent better physically and ninety-five per cent better mentally." Some overweight students have reported losing as much as forty pounds from the exercises.

Men, as well as women, exercise to reduce; but the women stress the woes of wide hips or fat legs, which they are anxious to make more symmetrical, if one is to believe the pleas for personal advice which they direct to the instructors.

THE FLAVOR LASTS

An old lady of eighty-one in a Pennsylvania town has been taking the exercises for one year and in all that time has missed but two mornings. Showing that young women aren't the only ones interested in how their clothes look, this elderly enthusiast writes with pep: "My dressmaker thinks my figure has improved wonderfully and my health has kept company."

Filled with irony was this message from a man in Massachusetts who wrote the insurance company: "Keep up the good work. If my health improves much more I will give up my insurance policy."

Judging from many of the letters, the family groups start with one enthusiast who finds it difficult work as missionary among the less interested members of her family. A mother of five children in East Orange, N. J. described her difficulties: "I get up every morning at 6:30 o'clock, start things going and then run into the dining-room where I tune in on the gym classes. I get up the kiddies, but I never could manage my husband, who lays in bed until the last minute. Finally, one morning, I persuaded him and since then I've had no difficulty at all. You should see us all together. From the baby who is four years old and bends his curly-head to touch the floor when you tell us to do it, to the "old man" of the group who is becoming of a much more sunny disposition since taking the exercises, we are all deriving great benefit from our class."

HOW TO DO IT

There are six rules which are most important if the listener is to derive any benefit from the exercises and Mr. Bagley lists them as follows:

- Drink a glass of water before exercising;
- Have windows open, top and bottom;
- Good ventilation is important, but the room should not be too cold;
- Have clothing loose at neck and waist;
- Follow the director's instructions carefully;
- If possible, give a full half hour to the exercises every morning.

Doctors all over the East are recommending these gym classes to patients, for all sorts of ills and ailments. Whole clubs make it a rule to devote fifteen minutes or a half hour each morning to the radio calisthenic school.

Realizing that, while the early bird may get his audience for exercising, he has to keep them interested to hold them, all the physical-culture directors of the air try to inject the human note into their instructions and find that a little humor before breakfast always goes a long way. They all emphasize the importance of the good-morning smile and, when a cheery voice urges this day after day, even the worst grouches must succumb to the infectious good-humor. Soon, a million people lined-up in many thousands of homes are smiling at the same time.

While exercise is so important for health, Mr. Bagley and his associates stress the importance of the right kinds of food, of drinking plenty of milk and of eating slowly.

The morning line-up is no place for a fat person, for he must stand plenty of kidding, which comes through his loud speaker and is directed against excess avoirdupois.

Healthy outdoor exercise and plenty of games are urged to augment the broadcast effort for stronger bodies. Statistics show that, in the past fourteen years, the average span of life has been lengthened five years, giving the lie to the general idea that this world is killing itself off in youth by the wrong kind of living.

The "Health Tower" classes and the WOR group have reached countless numbers of people who never exercised before. Men and women, prevented from leading an active physical life by their jobs and their environment, can undo some of the possible harmful results by spending a short period in exercise which meets their needs, sends their blood circulating freely and starts them on their daily duties in good shape.

And so the little gym class of the air, which was an experiment three and a half years ago, is now one of the most important and far-reaching agencies to aid the health of the entire world. It goes right into the home, requires none of the intricate accessories associated with old-fashioned gymnasiums and costs nothing.

For those of sedentary habits, the first try-outs may result in stiffened muscles which have rebelled against sudden work; but persistency is what is needed and, after a month, health is a habit and radio has done it.

Use of a Charger with 4-Volt Battery

TRICKLE CHARGERS, designed for charging 6-volt batteries can be easily adapted to 4-volt batteries without much expense and without any changes in the regular construction. It is necessary only to attach the end of a resistance winding from a 6-ohm rheostat to one of the posts on the charger. The resistance unit taken from one of the air-cooled type of rheostat is best for this purpose.

Caring for the Socket-Power Units

(Continued from page 1007)

ment, such as transformers, costing several times more than batteries.

From all this it will be seen that the attention required by a socket-power unit, though small in amount, must be intelligent; and, if it is intelligent and if, still more essential, it is regular and systematic, the best of service over a long period can be expected from any of the many standard makes now available. Accordingly, performance proves to be determined quite as much by the user as the manufacturer.

Full-Band Tuning in Radio Receivers

(Continued from page 1019)

ceiver, will enable it to be tuned so that it will cover the broadcast wave of 20-kilocycle width and, at the same time, be selective. In Fig. 2 is shown the response curve of the set developed by Dr. Vreeland; it will be seen that the peak of the curve is relatively flat with a slight dip in the middle at the carrier-wave frequency and that the sides of the curve are extremely steep, thereby insuring good selectivity. In other words, there is practically equal amplification of all notes up to 10,000 cycles, and above that a sharp cut-off, thereby minimizing the effects of wave interference.

First of all, Dr. Vreeland has developed a band selector. It comprises, in general, a system of reactances so related to each other that they are mutually balanced—not merely at a single frequency, as in the case of an ordinary tuned circuit (Fig. 1)—but also at any frequency within a given band. At any frequency outside of this band the reactances are not balanced and the unbalanced impedance is high. As a result of this design, the band selector responds to all frequencies within its characteristic band, but is non-responsive to all frequencies outside it. As explained, if the system is correctly proportioned the cut-off at the limits of the band is very sharp.

The elements of a circuit in which such a band selector is incorporated are shown in Fig. 3. It employs two reactive couples X1 and X2, preferably alike, having each a capacity and an inductance that cancel out or balance each other at the same frequency, together with a third reactance X3 which is common to both circuits. The third reactance is small, in comparison with the reactances of the two reactive couples, and may be either inductive or capacitive.

FUNCTIONING OF THE CIRCUIT

At some particular frequency F1 (this being the frequency at which the reactances of the couples X1 and X2 are balanced) the overall reactance of the circuit including X1 and X2 will be zero; current at the frequency F1 will circulate through the branches X1 and X2 without going through X3, and the system will have zero reactance at this frequency.

A Sensational Success!

Tested -- Proved --
Over 35,000 Times

We defy anyone, anywhere, to match the quality and performance of the Townsend "B" Socket Power—performance that is your privilege to obtain for only \$6.85. Thousands of reports show astounding results beyond the capabilities of many of the highest-priced "B" Eliminators. Convince yourself without delay at our risk.

A.C.--D.C.--Any Cycle

Delivers up to 100 volts on any set. Full tone, clarity, and volume. Sold on REAL GUARANTEE OF MONEY BACK IF NOT SATISFIED.

SEND ONLY \$1.00

Simply fill out the coupon and slip it into an envelope with only \$1.00, and mail at once. Your Townsend "B" Socket Power Unit will be sent promptly. Deposit only \$5.85 plus postage with the postman. Try out for 10 days—then if it does not do everything we say, return it to us and purchase price will be refunded.

TOWNSEND LABORATORIES
713 Townsend Street Dept. 25 Chicago, Ill.
MONEY BACK GUARANTEE

Townsend "B" Socket Power

Approved and passed by the rigid laboratory tests of Popular Radio and Radio News

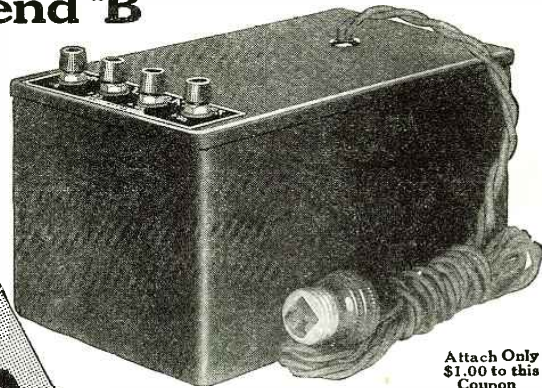

Attach Only \$1.00 to this Coupon



Send for Literature

TOWNSEND LABORATORIES
713 Townsend St., Dept. 25 Chicago, Ill.
Gentlemen: Attached find \$1.00. Kindly send at once Townsend "B" Socket Power Unit, C.O.D. for \$5.85, plus postage, on guaranteed 10-day free trial.

Name

Address

City..... State.....

Special Library of Information on RADIO PATENTS and TRADE MARKS

JOHN B. BRADY
Patent Lawyer

Ouray Building Washington, D. C.
Cable address: RADIOPAT Telephone: Main 4806



Build LACAULT'S Latest ALL WAVE ELECTRIC "R. E. L. 9"

ALL PARTS IN STOCK
—Quick Shipment—
Write for our list of "Specials"—lowest prices in country.
Take and Show Your Own Movies with a

PATHEX

Precision Automatic Amateur Camera
PRICE \$30—PROJECTOR \$32.50

R. E. LACAULT
RADIO ELECTRIC LABORATORIES

116 WEST 65th STREET NEW YORK CITY

Insure your copy reaching you each month. Subscribe to Radio News—\$2.50 a year. Experimenter Publishing Co., 230 Fifth Avenue, N. Y. C.

Victoreen

To hear the wonderful programs which literally fill the air every night, a receiving set of the highest quality is needed.

You need knife-like selectivity to operate the stations, sensitivity for distance, and highly scientific design for tone quality.



**Victoreen
R. F. Transformers**

are necessary to build a set to meet present day demands. Matched and tuned to a precision of one-third of one per cent, they give marvelous results. \$7.00 each.

Practically anyone can build a Victoreen, using the blue print which we will gladly send you free.

The New Victoreen A. G. blue print is ready. Full information for the asking.

The GEORGE W. WALKER Co.
MANUFACTURED BY VICTOREEN RADIO PRODUCTS
 2929 CHESTER AVENUE CLEVELAND OHIO

Save 1/2

Satisfy your self!

30 days FREE TRIAL

CONRAD 6

SINGLE DIAL CONTROL

Completely Shielded
GENUINE LICENSED CIRCUITS
 Manufactured under license grants of Radio Corporation of America and Affiliated Companies

The set that is the talk of the Radio trade. Acknowledged as the greatest radio value. A Con-Rad 6-tube completely shielded chassis with single illuminated dial control. Absolutely the latest in radio receivers. Manufactured under license grants, insures highest quality; chassis incorporates all of the features found in most efficient receivers. Complete shielding insures freedom from all foreign noises. Very selective and sensitive. Brings in long distance stations with wonderful tone and volume. Both table and console cabinets come in the newest styles and most beautiful woods.

Prove It Yourself—30 Days Free Trial
 A Con-Rad Receiver is ready to pass any test you demand. Try it in your home on our 30 day Free Trial Offer and be satisfied. If you are not, return the receiver to us and your money will be refunded. You must be satisfied!

Demonstration sets sent on FREE TRIAL. Make big money working full or spare time taking orders for Con-Rad Radios. Write today for special prices and proposition. **Send for Catalog TODAY!**
 Write today for complete information. Our catalog gives full details of the Con-Rad Line of 1928 and our liberal 30 day Free Trial offer.

CONSUMERS RADIO CO., Dept. 142 4721 Lincoln Ave., Chicago

POWER UNIT

For large cones. Operates on "A" battery current. Gives enormous volume. Most amazing tone quality you have ever heard from any loud speaker unit. Sent C.O.D. PAY POSTMAN \$12. If not satisfactory, returned in ten days and your money will be refunded.

**FANSPEAKER RADIO CO., Dept. X
 199 Fulton Street, New York**

Insure your copy reaching you each month. Subscribe to RADIO NEWS—\$2.50 a year. Experimenter Publishing Co., 230 Fifth Ave., N. Y. C.

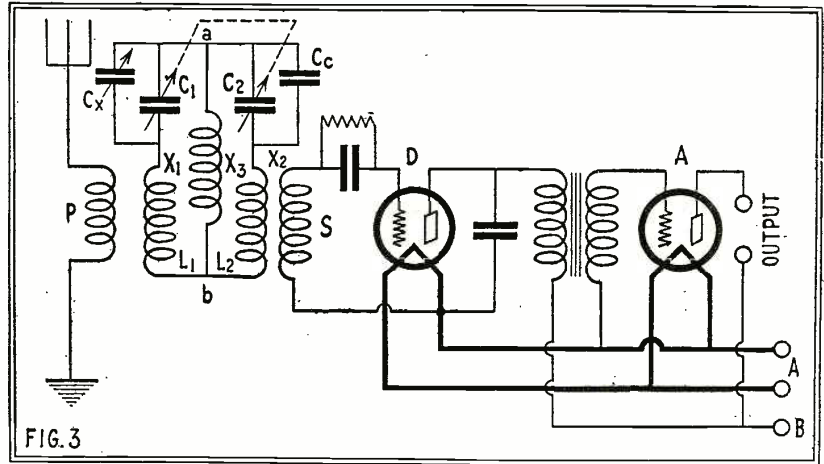

FIG. 3

Diagram of a broadcast receiver including a single band selector, X1, X2 and X3.

At any other frequency, the reactive couples X1 and X2 will not be balanced within themselves; the result will be a difference of potential between the points a and b. If the given frequency is lower than F1, the reactances of X1 and X2 will be capacitive. If, therefore, the reactance

depends upon the relation of this inductance to the inductances L1 and L2. If the reactance X3 is a capacity, the band's width is determined by the relation of the capacitive reactance of X3 to the capacitive reactance of C1 and C2.

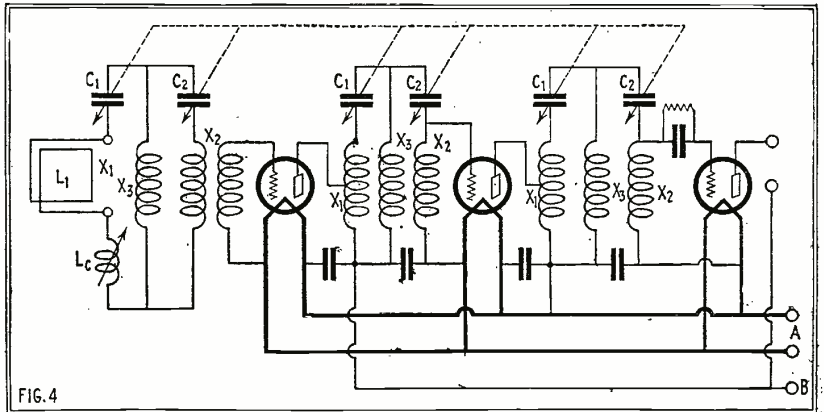

FIG. 4

Circuit of a completely assembled receiver in which are incorporated three band selectors, X1, X2 and X3.

X3 is inductive as shown, it will tend to neutralize the unbalanced capacities of branches X1 and X2; provided that their combined reactance is not greater than X3. The width of the band amplified depends primarily upon the relation of X3 to the other two reactances of the circuit. Thus, if X3 is an inductance, the band's width

EFFECT OF BRIDGING REACTANCE

It is interesting to note the relation of the frequency-characteristic of the band selector to the characteristic of a tuned resonant circuit. When the bridging reactance X3 is removed, the two branches X1 and X2 together constitute a resonant circuit

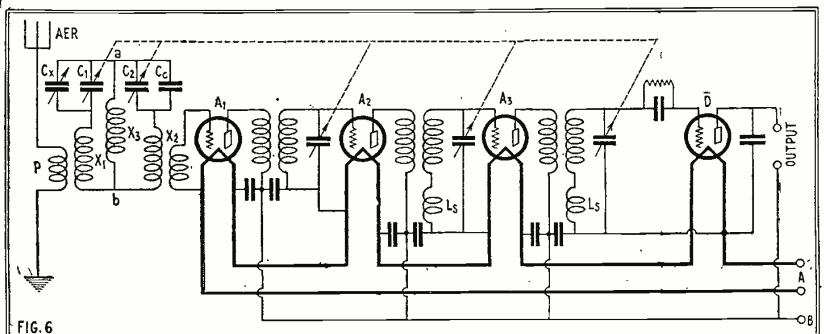

FIG. 6

Schematic diagram of a receiver having a single band selector coupled to an aerial, and a spaced band R.F. amplifier. Ls are the "spacing inductors."

tuned to a certain frequency F1; this being one of the limiting frequencies of the band of the selector unit. (See Fig. 5.) When the common reactance X3 is added again to the circuit the curve takes the band form shown in full lines; the limiting frequency F1 corresponds to the natural frequency of the tuned circuit and the limiting frequency F2 is either below or above this frequency, depending upon whether the reactance X3 is inductive or capacitive.

In Fig. 3 the band selector is shown in use with an aerial; but the circuit may be as readily used with a loop antenna. The capacity introduced into the branch X1 by the antenna is compensated by a fixed capacity Cc in the branch X2. In order to permit compensation for an antenna of any desired capacity without disturbing the frequency-calibration of the system, there is an additional variable capacity Cx, which makes up the difference between the capacity introduced by the antenna and the capacity Cc, so that the balancing of the system is assured. Cx is adjusted until the signal has maximum strength; after which the setting is permanent while the same antenna is used.

MULTIPLE R.F. STAGES

The band selector also lends itself readily to use as an interstage coupling element of a radio-frequency amplifier, as shown in Fig. 4. In this arrangement each of the selective elements has, in itself, a substantially rectangular band-characteristic. With two or more such units combined in an R.F. amplifier, the overall frequency-characteristic has a similar rectangular form with a sharper cut-off. Increased sensitivity and selectivity are thus secured, with no diminution of the band width. This is in marked contrast to the tuned-radio-frequency amplifier, where each increase in the number of stages narrows the characteristic.

When the various band selector units are made alike, as they may readily be, the whole system, including the antenna selector, is symmetrical and all the elements may be operated by a single control, as is shown. In the band amplifier of Fig. 4 the several stages have different frequency-characteristics which are not rectangular in themselves; but, in combination, they produce an over-all band-characteristic of rectangular form. It should be also noted that, in this case, the cut-off is so sharp that stations can be separated with the greatest ease.

OTHER VALUABLE FEATURES

An important feature of the spaced-band amplifier is its inherent stability. Since the several circuits are not synchronized, the tendency to regeneration and oscillation is small. Other features include an *astatic* winding of the coupling coils or transformers, which renders negligible the magnetic coupling between the stages; and mutually-reversed primary and secondary windings, which cause a phase reversal of any external electrostatic couplings, thus putting the potentials of the several stages in such phase relation that they do not cause regeneration. The resultant of these three features is an amplifier of such stability that no capacitive neutralization or balancing of any kind is required; and the coupling transformers may be placed close together without shielding of any kind.

Another variation of the band selector is shown in Fig. 6. The band selector is coupled to the antenna and feeds the am-

Step A Year Ahead
with the
Everyman 4

Build the World's Premier 4 Tube Set

Low Price, Spectacular A. C. Tube Set
Big New York and Chicago Hit!

THE simplicity, dependability, and splendid performance of the A. C. EVERYMAN 4 has made it one of the most popular 4-tube sets ever achieved. Carlton E. Butler, Technical Radio Editor of the *Chicago Evening American*, in his article of January Third, declares the A. C. EVERYMAN 4 to be "One of the best, if not the best, circuit brought out this year, for selectivity, ease of operation, volume and distance, with low initial cost and low operating cost."

Complete List of Quality A. C. Parts—Only \$68.95

	List
1 Set Everyman Four Coils	\$5.00
1 7" x 21" Engraved Micarta Panel	3.75
2 Hammarlund .0005 Midline Condensers	11.00
1 Hammarlund Jr. Condenser (Balancing)	1.75
3 No. 9040 Benjamin Cle-Ra-Tone Sockets	2.25
1 Benjamin 5-Prong Socket	.90
7 X-L Binding Posts (Ant. Gnd. B Plus 45, B Plus 90, B Plus 180, Speaker)	1.05
1 10" x 20" x 1/2" Frits Baseboard	.80
1 Muter No. 3300 Supreme Transformer	7.00
1 Muter No. 3320 Supreme Transformer	7.00
1 Muter No. 2700 Clarifier	5.00
1 Muter No. 3710 1 Megohm Grid Leak	.50
1 Muter No. 800 Grid Leak Mounting	.15
1 Muter No. 301 .0001 Bakelite Condenser	.40
3 Muter No. 507 Mid. By-Pass Condensers	2.25
1 Muter No. 508 1 Mid. By-Pass Condenser	.90
2 Muter No. 2750 R. F. Choke Coils	3.00
1 Muter No. 1900 Variall Condenser	.75
1 Muter No. 2305 1/2 Ohm Power Rheostat	1.00
1 Muter No. 2315 1 1/2 Ohm Power Rheostat	1.00
1 Muter No. 2331 30 Ohm Potentiometer	1.00
1 Muter No. 2902 2000 Ohm Power Resistance	.50
1 Muter No. 2975 750 Ohm Power Resistance	.50
1 Muter No. 2950 500 Ohm Power Resistance	.50
1 Muter No. 3600 A. C. Filament Transformer	8.50
1 Muter Binding Post Strip, 1" x 6" x 1/2"	.50
1 Muter A. C. Bakelite Control Panel, 2" x 6" x 1/2"	1.50
1 Muter No. 1650 Approved Power Switch	.50
Total	\$68.95

SPECIFIED PARTS INSURE BEST RESULTS

This Is the Set FOR YOU TO BUILD
CAN BE BUILT IN ONE HOUR!

See Your Dealer for Everyman 4 parts and full directions for assembly. You may also write Everyman 4, Dept. 827-C, 76th and Greenwood Aves., Chicago, Ill., for folder giving full information on this world's greatest 4-tube set.

Associated Manufacturers—Leslie F. Muter Co., Chicago, Ill.; Twin Coupler Co., Poughkeepsie, N. Y.; Hammarlund Mfg. Co., New York, N. Y.; Benjamin Elec. Mfg. Co., Chicago, Ill.; X-L Radio Laboratories, Chicago, Ill.

For Amateur or Professional Set Builders who want long distance, selectivity, and faultless natural tone, without the troublesome complications of multiple tubes—the A. C. Everyman 4 shows the way to satisfaction. Radio Engineers and practical set builders have combined to give you a four-tube set which out-performs nearly all six-tube sets—and yet is simple to build, easy to operate, and dependable in performance.

The satisfaction of thousands of fans who have already built the Everyman 4 is illustrated by this letter from Sidney Greenstein, 828 Dawson St., N. Y.: "I have built hundreds of receivers, of all types, and never yet have I been so pleased as with the results obtained with Everyman 4. It is simple to tune, voluminous, and a bear for distance. The quality is just flawless. Really it seems too good to be true."

Feats of Reception

REPORTED BY BUILDERS IN NEW YORK CITY

A builder of the Everyman 4 in Newark has no trouble in getting WPG, Atlantic City, at 3 P.M., with WAAM and WAAT on the air. Not a trace of interference.

A radio fan on University Ave. listens to WBBM, Chicago, and WTAM, Cleveland, while WRNY is on full power.

WNYC was separated from WEAP without any trace of interference at a distance of 500 feet from WNYC transmitting aerial. (Impossible with other sets having more tubes, and costing twice as much to build.)

WOC—at Davenport—at all times like a local station. Forty stations in one hour.

Western stations on loud speaker during early evening hours while locals are on. And what volume!

PROFESSIONAL SET BUILDERS

will find in the A. C. Everyman 4 a Real Producer. Write us for full information



MARCH BLUEPRINTS

You can obtain a complete set of blueprints for these receivers direct from RADIO NEWS

- THE SILVER SCREEN-GRID SUPERHETERODYNE—Radio News Blueprint Article No. 48...\$1.50
- THE ALL-ELECTRIC EVERYMAN FOUR—Radio News Blueprint Article No. 49...\$1.00
- THE KNOWLES SCREEN-GRID FOUR—Radio News Blueprint Article No. 50...\$0.75
- THE PACENT DISTANT SIGNAL AMPLIFIER—Radio News Blueprint Article No. 51...\$1.00

Order Direct from RADIO NEWS
230 FIFTH AVENUE, NEW YORK, N. Y.

MENTION NAME OF RECEIVER AND ARTICLE NUMBER

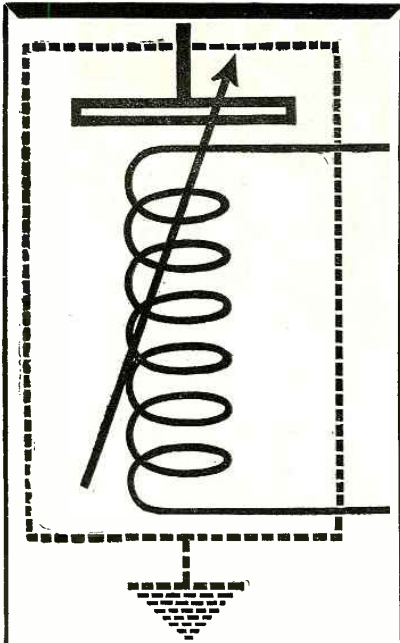

The new Peridyne Symbol

PERIDYNE

THE PERIDYNE principle and PERIDYNE circuit, as developed by Hugo Gernsback, Editor of *Radio News*, is one of the great circuits of the year.

An entirely new principle—so new, in fact, that a new symbol had to be designed for it, is used in this remarkable circuit. The PERIDYNE uses the new shield tuning system, which makes the set unheard of in selectivity and as a distance getter. Thousands of PERIDYNES have already been built, and every user is highly enthusiastic with the results.

The PERIDYNE is a single-dial set, and uses five tubes. It can be operated on batteries or from alternating current. The complete Conrad pattern describing this circuit gives all data, of every sort, how this circuit can be built in a minimum space of time.

The PERIDYNE is a most simple set to build. 50c., enclosed with coupon below, will bring the Official Construction Book, including 5 full-sized blueprints, and detailed instructions.

Use Coupon
Immediate Delivery

CONRAD COMPANY, Inc.,
230 Fifth Ave., New York, N. Y.

Gentlemen: I enclose 50c; kindly send me one copy of the Official Sixteen-page PERIDYNE Pattern with Booklet, and full-sized Blueprints.

Name.....

Address.....

City.....State.....

plifier through its output coil S. A spaced-band amplifier of the type just described is employed. In the arrangement here shown the three stages are all structurally similar and the spacing of the waveband is accomplished by the use of fixed "spacing inductances" in two of the stages as shown; or two of the stages may have small "spacing capacities."

What's New in Radio

(Continued from page 1012)

Probably the most interesting feature of the power unit is the new rectifier unit which is used. It consists of a series of couples made up of cupric-sulphide discs facing others of magnesium. The rectifier is clearly shown in the pictures at R. The square fin-shaped copper sections are the heat radiators, and the rectifying discs of the couples make up the solid section which may be seen between the fins. There are sixteen couples in the unit and they are

In the design of the apparatus due attention must be given to securing a suitable relation between the effective inductance and the effective capacity of the amplifier stages and the same factors of the band-selector elements. When this is done the frequency-control curves of the various elements are readily synchronized, so that the whole system may be operated by a single control.

of parts in the unit. The two cables A and B are for connecting the device with the "A" posts of the set and the lamp socket, respectively. The switch (Sw) is located on the front panel and the voltage regulator (VR) and rectifier (R) are mounted on the top panel. The choke coils (L1 and L2), filter condensers (C1 and C2), and the power transformer (T) are mounted inside the metal can.

Manufacturer, the Knapp Electric Corporation.

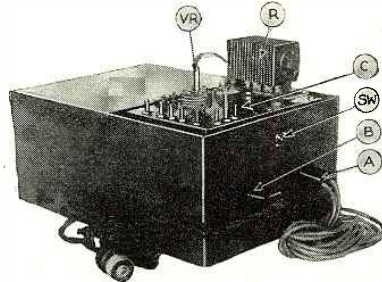

View of home-made "A" power unit installed in a compact metal case.

New Pleated Diaphragm is Used in Fan Speaker

As a result of several months of experiment with various types of loud speakers, a new reproducer has been developed which is neither a horn or a cone. It employs the Loumiere type of pleated-paper diaphragm, 20 inches in diameter, attached at the center to a direct-drive loud-speaker unit. Its unique construction is clearly illustrated in the two pictures given here and the advantages which are gained by the design are not difficult to appreciate.

forced together under a pressure of almost a half ton.

In its operation, a thin film forms on the surface of the discs in a rectifier of this type. This film functions much like a series of small electrically-charged bubbles; which offer practically no resistance to current flowing in one direction, yet act as an almost perfect insulator to currents of reverse polarity. If, because of an overload, the film breaks down the unit heals itself; and as a result the rectifier has a normal life of over 1,000 hours. The cells are connected in a series-parallel or "bridge" circuit which gives more efficient rectification and, at the same time, increases the current-carrying capacity of the unit.

The dry polarized type of condenser used in the power unit is the second interesting feature; these condensers operate on much the same principle as the rectifier unit (as they hold a charge one way only) and are an entirely new development. Two such are used in each unit, each having a capacity of approximately 1,500 microfarads and being contained in a case only 2 x 2 x 7 inches. The condensers employ a fabric core to which is cemented one side of the active charge-holding material. The other plate of the condenser consists of a double outer layer of metallic foil. Experiments with condensers of this type show that they improve with age; the total capacity increases and the leakage decreases with continued use.

The pictures given above show the appearance, mechanical construction, and lo-

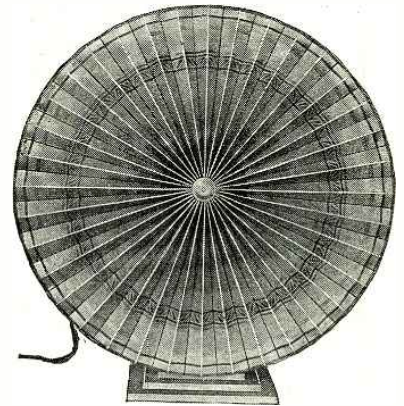

View of fan speaker with diaphragm installed in the proper position.

From the electrical viewpoint, the new speaker is not unusual; but it is entirely satisfactory. It may be operated in connection with radio receivers employing three or more tubes, and it responds over the full orchestral range with unusual fidelity. It gives good volume for any given signal and provides startling distinctness in radio reception.

Because of the striking resemblance between the folds of a fan and the diaphragm of this instrument, it is known as a "fan speaker." The pleated diaphragm is made

of a very tough paper material and is, not only collapsible, but reversible. It is shipped in a knocked-down form to conserve space and packing material, but may be assembled in a few moments without the aid of tools. Also, the diaphragm may be folded up, opened and reversed many times without damage.

A feature of the plated diaphragm is

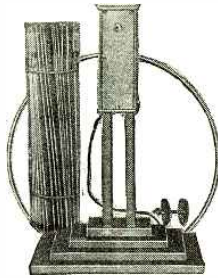

The speaker in knocked-down form.

that it is artistically decorated with four distinctive designs. A beautiful brown-and-gold design has been printed on one side and, on the other, there is an equally attractive silver-and-black design. When the diaphragm is opened, two different designs are available; then, by collapsing the diaphragm and turning it inside out (so that what was formerly the edge becomes the center and the center becomes the edge) two new designs are brought into view.

One picture of the "fanspeaker" shows the unit ready for operation and the other the various parts after they have been unpacked but before they have been assembled.

When placing the loud speaker in operation, it will be noticed that one cord has been marked; this should be connected to the "B" battery side of the circuit.

Manufacturer, Fanspeaker Radio Company.

New Crystal-Detector Unit Fits in Tube Socket

THE black tube-shaped unit, a cross-sectional drawing of which is printed on this page, looks like a radio vacuum tube, fits into a tube socket and is used in place of a detector tube; but it is not a vacuum tube. It is a stabilizing-detector unit of the carborundum-crystal type and may be substituted for the detector tube in any radio receiver after slight changes have been made in the wiring.

Use of a carborundum stabilizing-detector unit in place of a vacuum tube in the detector socket of a set provides the receiver with the desirable clarity of a crystal set and, at the same time, retains practically the entire sensitivity of the original receiver. It clears up reception and tends to mini-

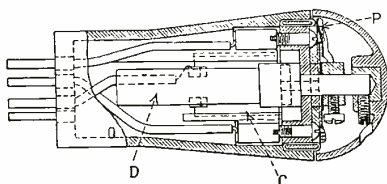

Drawing shows mechanical construction of carborundum-detector unit. P, potentiometer; D, crystal unit; C, fixed condenser.



A. C. Connectoralds

provide a new and remarkably easy way to convert battery operated sets to use the new A. C. Tubes

NO REWIRING : : RESULTS ARE REMARKABLE
SIGNALS CLEAR : : PICKUP IMPROVED

You can now run your battery set with the New A. C. tubes and no batteries at all. Na-ald CONNECTORALDS provide a remarkably easy way to do this, at the same time assuring you of the full efficiency from these excellent tubes.

All you need is a Na-ald A. C. CONNECTORALD kit (No. 905 for 5-tube sets, No. 906 for 6-tube sets, No. 907 for 7-tube sets), Na-ald volume control, any good filament transformer, and "B" eliminator (your present eliminator will do if you are using one).

The Na-ald A. C. CONNECTORALD kits include Y tap resistors, By-pass condensers and midtaps, giving proper C bias for both power and radio frequency tubes.

The harness is so arranged it can be quickly, easily, and neatly connected, regardless of location of tubes.

IMPORTANT—Na-ald A. C. CONNECTORALDS are equipped with a special device for controlling oscillation. Small suppressors or resistors slip into slots in the connectoralds, automatically going into series with the grid of the tube. This feature not only controls oscillation, but gives you any desired amount of sensitivity for your particular locality. The new A. C. tubes with Na-ald Patented A. C. CONNECTORALDS will help you get better quality and greater distance.

Na-ald A. C. CONNECTORALDS work in Atwater Kent, Crosley Bandbox, Kolster, Radiola 16, and practically all other battery sets.



No. 927 For Detector



No. 926 For All Purposes



No. 926GT—For 1st Audio & R. F. Stages

Order your kit today from your dealer or direct.

- No. 905—For 5-Tube Sets.....\$9.00
- No. 906—For 6-Tube Sets.....10.00
- No. 907—For 7-Tube Sets.....11.00
- Na-ald Volume Control.....3.00

Also write us for free Na-ald A. C. Booklet. Address

Dept. RN1 ALDEN MANUFACTURING CO. Springfield, Mass.

There is a NA-ALD Adapter—Connectorald—Socket—for all tubes, all sets, all purposes

The SONOCHORDE
CONE \$25.
Brings the Studio Home

DEALERS & SET BUILDERS
Complete stock of nationally known parts and accessories. Send for illustrated catalog and discount sheet.
Radio Exclusively Since 1921
CLARK & TILSON, Inc.
122 CHAMBERS ST. New York
The Nationally Known House

TOWER RADIO PRODUCTS
ON SALE EVERYWHERE

The BURT Cell
A photo-electric cell without fatigue. Absolutely reproducible, instantaneous in response. Described in Bulletin 271.
Stabilized Oscilloscope
The only visual oscillograph having a linear time axis. Gives an accurate picture of high frequency wave forms. Write for Bulletin 273. **DR. ROBERT C. BURT.**
327 South Michigan Avenue, Pasadena, California.

ELECTRICITY Easily Learned **FREE**
Learn with real tools on real equipment. No books no lessons. Actual shop experience. Only a few short weeks fits you for a big-pay job—\$50 a week and up. Write for big FREE book on electricity and remarkable tuition offer, which includes R. R. fare and board. Address nearest school.
McSweeney Electrical Schools, Dept. 78CA
CINCINNATI, OHIO CLEVELAND, OHIO

\$21 WARREN B
For 1 to 10 tubes. Complete with tube. Guaranteed. Was \$35. Now DIRECT to you, \$21.00. Write!
WARREN ELECTRIC CO., Dept. R.N., Peoria, Ill.

A Smooth, Positive Volume Control for Circuits Using "AC" Tubes

THE delicate balance of "AC" circuits requires a different method of volume control than that commonly used with battery sets.

Centralab Radiohms RX-100 or RX-025 have been developed especially for smooth volume control with "AC" tubes. They have the same appearance as standard Radiohms, but the taper of resistance is entirely special.

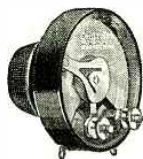

The RX-100 Radiohm in the secondary of an R.F. stage will control oscillation as well as volume.

The RX-025 across an R.F. primary provides volume control and does not detune. The same unit has the proper resistance for antenna circuit control, but no antenna circuit resistance will prove as uniformly satisfactory as when used across one of the R.F. stages.

A Centralab PR-050 Power Rheostat in series with the "AC" transformer will provide accurate voltage control and lengthen the life of the tubes. Centralab wire wound Potentiometers and Fixed Resistors will prove trouble-free in the power circuits.

Write for full information about these high quality controls. The new "AC" information sheet is now ready for you

CENTRAL RADIO LABORATORIES
19 Keefe Avenue Milwaukee, Wis.

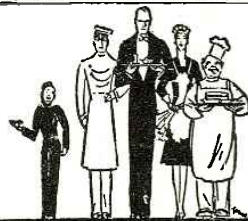

AT YOUR SERVICE

THE
WHITEHALL HOTEL
100TH ST. AND BROADWAY
NEW YORK

The ideal hotel selection when you visit New York. All rooms have both bath and shower and at rates of \$5 per day for two! A perfect hotel. Ample parking space and near numerous garages.

Exceptional Restaurant

J. J. McAULIFFE—Res. Manager

BOYS

You can earn money and win prizes in your spare time.

Write Me Today

Jim Thayer, Dept. 53, Crowell Publishing Co. Springfield, Ohio

FREE Wholesale Radio Catalog

Dealer-Set Builders! Save Money! Send for this book of bargains. Everything in Radio—all the newest hook-ups. Sets, kits, parts, cabinets, consoles and supplies. If you want the best for the least money, you need this catalog.

SHURE RADIO COMPANY
351-C West Madison St. Chicago, Ill.



mize extraneous noises, because of the inherently-good rectifying characteristics of this type of detector.

In addition to the advantages named above, use of this detector unit eliminates the plate-battery drain of the detector tube and reduces the detector drain on the filament battery from 0.25 ampere to .025 ampere, the current required by the potentiometer and crystal of the detector unit. The stabilizing detector makes possible also a check to self-oscillation of the radio-frequency tubes, thus controlling howls and permitting peak efficiency over the entire waveband. Also, the resistance of the detector may be made so high that it will have but slight damping effect upon the tuned circuit, with the result that greater selectivity is obtained.

The wiring diagram accompanying this article shows how the carborundum-detector unit may be inserted in a standard receiver, using tuned radio-frequency amplification, a non-regenerative detector, and transformer-coupled audio amplification. In this case short-circuiting the grid leak and condenser is the only important change which it is necessary to make in the wiring of the receiver; but in other circuits, especially those which use a regenerative detector, the change will be slightly more elaborate.

In almost all cases, however, the set may be adapted to the new detector in a few minutes' time; and complete instructions are provided with each detector unit.

The drawing shows the mechanical construction of the detector unit. It consists of a small fixed condenser, a crystal unit and a potentiometer. These parts are all correctly wired and sealed inside the bakelite case, which takes the form of a vacuum tube. The potentiometer may be adjusted by turning the top of the tube until the most satisfactory reception is obtained and then no further attention is required. The schematic wiring diagram shows the connections inside the detector unit.

Manufacturer, the Carborundum Company.

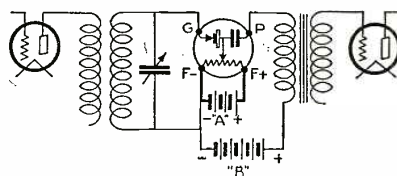

Diagram shows how a carborundum-detector unit is connected in the detector socket of a standard receiver.

D. C. to A. C.—And How

(Continued from page 1017)

heavy-duty rheostats are already on the market.

We have previously referred to temporary line-voltage fluctuation; this usually occurs at the time when the heaviest load falls on the lighting company's mains. The voltage at the central station may be maintained constantly at a fixed standard, but the drop in various circuits causes this line fluctuation. If this condition prevails, the tube voltage will naturally follow the rise and fall in the main line. The operating characteristics of the A.C. tubes, however, are such that average fluctuation will not affect their operation or life; but, as we have said before, it is very necessary to know just what the average voltage is and adjust for it. In the re-wiring of the set keep the grid and plate leads away from the filament lines as much as possible.

A properly-converted set should not produce A.C. hum audible more than a few inches from the loud speaker.

It is suggested that some means of identifying easily the last audio socket be adopted by constructors. The accidental insertion of the 226 tube in this position will result in an almost-immediate burn out.

VOLUME CONTROL

Considerable difference of opinion exists regarding the best method to control volume in A.C. sets. The favorite method in battery-operated sets was to vary the filament temperature in one or more of the R.F. tubes. Although some manufacturers of A.C. sets use this method today on A.C. tubes of the 226 type, it is not considered ideal. The heating of the heavy filament is slow in following the rheostat adjustment, and this naturally introduces a very annoying time-lag. It is particularly noticeable when trying for distant reception.

We have previously discussed the necessity for keeping the plate current of the 226 tube at the minimum ripple-voltage point; this happens to be at about 3 milliamperes. If the bias on the R.F. tubes can be reduced simultaneously with the filament temperature, this will hold up the plate current and keep out the ripple. Some bias must be maintained at all times, however; as an uneven flow of grid current, and consequent modulation and distortion of the signal, will result without it.

A high variable resistor across the secondary of the first audio transformer has been used by some; but this method is not recommended as it has a tendency to overload the detector. Varying the grid bias as a means of volume control is quite effective on circuits using 227 tubes as amplifiers, but is not recommended for 226s; as this method is apt to shorten the life of the tube. A high variable resistor (100,000 ohms) in the R. F. plate returns will do the job, in a way, but the disadvantages have already been mentioned. It would seem that the most logical procedure in controlling volume is to go to the heart of the matter and control the signal instead of trying to suppress it after it is amplified or rectified. Naturally this must be done in the antenna circuit. The most approved method is to couple variably a semi-aperiodic primary to the secondary of the antenna-coil unit. Unfortunately this is not always easily done in converting sets, as the antenna coil is usually of the fixed-coupling type. If it is at all possible to rotate the primary antenna winding, or secure a similar effect through taps, it is strongly recommended that this be done to obtain best results. A semi-aperiodic antenna coil of 8 or 10 turns of wire, wound on a bakelite tube and variable in its rela-

tion to the secondary, will work out very well.

A variable resistor with a maximum of around 5 megohms, in shunt with the antenna coil, will control volume quite satisfactorily. It is suggested that for local or very strong signals the aerial be disconnected entirely from the set; this may be done by means of a snap switch conveniently placed.

A.C. sets give the very best reproduction when the circuits are tuned to exact resonance with the received signal. Any departure from this condition will detract from one of the most pleasing features of A.C. operation. Volume control is right only when the strongest signal is not too loud when the set is tuned to exact resonance with the volume control at minimum. Any attempt to control volume by detuning condensers will result in some distortion and an apparent lack of selectivity.

THE TUBES

Due to the fact that the A.C. tubes of the 226 and 227 types are new on the market, many experimenters are inclined to be skeptical regarding their performance. The actual development of these tubes has been going on for some time, however, and their performance has been under observation over a long period. The characteristics of the 226 are approximately the same as those of the familiar 201A type; long life may be expected, provided the tubes are operated under proper conditions. Maintaining the correct grid bias is quite essential for the successful use of the 226.

The characteristics of the 227 are such that by using this tube in all stages, except the last A.F., greater signal volume as compared with the 226 will result. There will be less tendency towards A.C. hum, although a properly designed or converted set using 226s should be practically free from this trouble. The 227 will probably have a longer useful life, due to the nature of the emitter. The user of A.C. tubes is particularly cautioned to read thoroughly the instruction sheet accompanying each tube.

The 227 (separate-heater tube) requires about 30 seconds to come up to operating temperature. The momentary application of excess heater voltage to accelerate emission should never be tried. The A.C. tubes are operative at 25 cycles as well as at 60 cycles.

TROUBLES

Pronounced A.C. hum in the set may be due to several causes; the wiring of the filament lines if not twisted may cause hum. Frequently the "B" supply unit is at fault because of a defective rectifier tube. Should an internal leak develop between the cathode and the heater of the separate-heater tube, hum or noise will result; but this latter condition is of rare occurrence. Unshielded power transformers, if in close proximity to the set, will introduce line disturbances which sound very much like static. When separate-heater tubes have an excessive voltage on the filament, signals will gradually become weaker until, in some cases, they disappear. This is due principally to what is called secondary emission; namely, that caused when the grid gets sufficiently hot to emit (independently) electrons. This will, of course, disturb the stream of electrons and, consequently, the current between the cathode and the plate.

TRY IT 30 DAYS FREE BEFORE YOU BUY

FACTORY PRICES - SAVE 50%
Choice of beautiful cabinets offered

3 Year Guarantee

8 tube - one dial

MIRACO
TRADE MARK REGISTERED

only 69⁷⁵

Retail List Completely Assembled

ALL METAL SHIELDED CHASSIS

MAGNIFICENT TONE-SUPER SELECTIVE-POWERFUL DISTANCE GETTER

All Electric or Battery Set! Yes! Big Discounts to User-Agents

America's big, old, reliable Radio Corporation (8th successful year) guarantees in its big, powerful, latest 6, 7 and 8 tube Miraco sets "the finest, most enjoyable performance obtainable in high grade radios." Unless 30 days' use in your home fully satisfies you a Miraco is unobtainable at any price for beautiful, clear cathedral tone, razor-edge selectivity, powerful distance reception, easy operation, etc.—don't buy it! Your verdict final. Save or make lots of money on sets and equipment—write for testimony of nearby users and Amazing Special Factory Offer.

Miraco's work equally fine on "AC" electric house current or with batteries. Take your choice. Many thousands of Miraco users—who bought after thorough comparisons—enjoy programs Coast to Coast, Canada to Mexico, loud and clear—with the magnificent cathedral tone quality of costliest sets. Don't confuse Miraco's with cheap, "equivalency" radios. Miraco's have finest parts, latest approved shielding, metal chassis, etc.—as used in many \$200 sets.

DEAL DIRECT WITH BIG FACTORY
Your Miraco reaches you completely assembled, rigidly tested, fully guaranteed. Easy to connect and operate. 30 days trial free. 3 year guaranteed if you buy. You take no risk, you insure satisfaction, you enjoy rock-bottom money-saving prices by dealing direct with one of radio's oldest, most successful builders of fine sets. 8th successful year.

Dealers Write! USER-AGENTS! Make big profits showing Miraco to friends. Get Our Special Wholesale Prices!

MID-WEST RADIO CORPORATION, Cincinnati, O.
BEAUTIFULLY ILLUSTRATED CATALOG AND AMAZING SPECIAL OFFER

Free! SEND NO MONEY—30 DAYS' TRIAL—FREE! Wholesale Price Offer to User-Agents. Bank References, testimony of nearby Miraco users—all the proof you want—sent with catalog.

mail coupon right now!

7 tube one dial METAL SHIELDED CHASSIS \$49⁷⁵ RETAIL LIST

MIRACO "Powerplus" sets—6 and 7 tube models—have magnificently beautiful, clear cathedral tone quality. Turn one dial for stations everywhere. Ultra-selective. Latest illuminated dial. Fully guaranteed. Try one free for 30 days! Big selection of beautiful cabinets.

6 tube Super 36⁷⁵ RETAIL LIST

Electrify Any Radio with MIDWEST NO-BATTERY "AC" Light Socket Power Units

SAVE \$'s "A", "B" and "C" power, direct from light socket, without batteries! Write for Midwest prices and discounts. Units are highest grade—lastingly dependable, quiet in operation, fully guaranteed. Mail coupon!

MIDWEST RADIO CORP'N
Pioneer Builders of Sets
404-C Miraco Bldg., Cincinnati, Ohio.

THIS COUPON IS NOT AN ORDER

WITHOUT OBLIGATION, send me free literature, AMAZING SPECIAL WHOLESALE PRICE OFFER, testimony of nearby users, etc.

NAME _____
ADDRESS _____

IT'S HERE!

You Will Like It—and Profit!

THE WORLD'S GREATEST

RADIO CATALOG

Now Free—Send for your copy today!

The best in Radio—at a big saving—all under one roof. You don't need to look elsewhere. Contains all the information you need.

Established 1918

TELEPHONE MAINTENANCE CO.
123 South Wells Street Dept. 67 Chicago, Illinois

CHICAGO'S OLDEST RADIO HOUSE

WHOLESALE ONLY

INSURE your copy reaching you each month. Subscribe to Radio News—\$2.50 a year. Experimenter Publishing Co., 230 Fifth Avenue, N. Y. C.

Guaranteed
Socket Power
Unit—\$13.75



90-Day Guarantee

An absolutely unequalled value! We want you to test the World "A" Socket Power Unit and compare it with any other of two or three times the price. Try for ten days at our risk. Then if you are not convinced that it is unsurpassed as to quality and wonderful results, purchase price will be refunded in full. Operates on 50 or 60 cycles at 110 volts A. C. Highest quality Westinghouse electrical equipment. No hum or noise. Approved by Radio News Laboratories and other leading Authorities.

Send Order Today Just write your name and address on a slip of paper—pin a one dollar bill to it and mail today. We will ship same day order is received for \$12.75 C. O. D. 5% discount for cash with order. Remember you are the judge and are fully protected—so send order NOW.

only \$1.00 Down Balance C. O. D.

WORLD BATTERY COMPANY
 1219 South Washburn Avenue
 Dept. 60 Chicago, Illinois

Station W. S. P. C., owned and operated by World Battery Company

Changes Your Set Into a Short-Wave Receiver

Sent postpaid anywhere in U. S. upon receipt of \$15.00 M. O., or C. O. D., plus postage, upon receipt of \$1.00 to guarantee carrying charges.

When ordering state kind of set so that detailed directions for use may be given if necessary. Also state type of tubes, such as UX139, UV139, WD11, or 201A.



The SUBMARINER

Regardless of the kind of set you have, this device will permit you to listen to short-wave stations between 26 and 68 meters. Operates with sets such as T. R. F., Neutrodyne, Super-Heterodyne, regenerative sets, and many other types. No additional tubes or batteries required. No changes to the wiring of the set. A short aerial and ground is connected to the "Submariner" and a cable and plug attaches it to the set. Requires less than a minute to attach or detach. Operates as a wave changer with Super-Heterodynes, and as a detector unit with others.

SHORT-WAVE RECEPTION

Is practical because they penetrate better, and there is less static. There are several powerful stations using the wave band covered by the "Submariner" for broadcasting programs. You may also learn code by listening to amateurs from all parts of the world. You will have a highly efficient short-wave receiver when the "Submariner" is attached to your set. Nothing else like it on the market. Take a trip in the low waves on board the "Submariner."

ORDER TODAY

We guarantee to refund if the "Submariner" fails to operate

ADDRESS
J-M-P MANUFACTURING CO.
 Dept. 120 Milwaukee, Wis.

FREE RADIO GUIDE

BIG NEW 1928 CATALOG—4000 items
 Shows the latest 172 circuits, the newest ideas in radio at startling low prices. Get the sets and parts you want here. Save money. The best in parts, kits, complete factory-built sets and supplies. Orders filled same day received. Write for free copy now.

Standard discounts to dealers, set builders, agents.
Barawick Co., 129 N. Jefferson St., Dept. 803B Chicago, U.S.A.

PATENTS As one of the oldest patent firms in America we have inventors at lowest consistent charge, a service noted for results, evidenced by many well known Patents of extraordinary value. Book, Patent-Sens. Fred. Lacey & Lacey, 631 F St., Washington, D. C. Estab. 1869

The Silver Screen-Grid Superheterodyne

(Continued from page 1024)

decreasing the filament voltage for the 222-type tubes until oscillation stops and rotation of the oscillator drum produces no squeals. The receiver may now be tuned at a regular superheterodyne, the Antenna and Oscillator dials serving to select stations. As mentioned previously, stations between approximately 215 and 455 meters will be heard at two points upon the oscillator dial. In preliminary testing, some station between 440 and 460 meters should be tuned in for best response on both dials. It will be observed that while the station can be heard at two points on the Oscillator dial, one point will be stronger than the other. Which of these points is strongest is determined by the position of the oscillator-coil rotor, which should be turned about 180 degrees in order to make the lower wavelength point (with oscillator-condenser plates least engaged) strongest, and this oscillator-coil rotor should be left set at about 45 degrees with respect to the stator coil. The selectivity of the Antenna dial is determined by the position of the antenna coil rotor; greatest selectivity at least volume being obtained with the antenna rotor at right angles to the stator coil. Antenna selectivity and the sensitivity of the receiver are further affected by the position of the "Sensitivity knob;" this, through the midjet regeneration condenser, controls regeneration and oscillation in the first detector and if turned too far in, will naturally cause first-detector oscillation, so that a large number of squeals will be heard in operation. Care should be taken never to use this condenser except on very weak stations, when, after the station is tuned in, it should be turned up gradually to increase signal strength with slight readjustment of the Antenna dial to compensate for the variations in tuning caused by the Sensitivity condenser.

If it is desired to operate the receiver as a seven-tube set, omitting one intermediate stage—and this is really desirable except for extreme long-range reception—the first R.F. amplifier stage can very easily be dropped by simply pulling the clip lead in the left-hand compartment of the time-signal amplifier over into the next compartment to the right and clipping it on to the top lead of the second 222-type tube. The clip in the second compartment, ordinarily going to the second tube, should be ignored. Thus the first transformer in the intermediate amplifier feeds the second tube, which, in turn, feeds the third transformer; so that the tube in the first compartment and the transformer in the second compartment (from the left) are simply dropped out of the circuit. It will be found in operation that the tone quality will be somewhat better when using only two intermediate stages than when using three; but the sensitivity in the receiver will be greatest using three stages, and, of course, greater sensitivity means greater noise and stronger signals. The last audio-amplifier stage can also be dropped very easily by simply moving the loud-speaker cord tips from the two "maximum" tipjacks to the two "minimum" tipjacks; although this course is not recommended except where an external power amplifier is used, in which case it is best to leave off the second audio stage altogether.

An output transformer should be used connected between the output jacks of the set and the loud speaker.

FOUR TUNING RANGES

It will be observed in tuning the set that, when using the lower-wavelength heterodyne point of the Oscillator for all signals, both dials will not track. This condition can be remedied by tuning in (say, KYW or KSD) a very high-wave station, and removing turns from the top end of the oscillator coil until the Oscillator dial reading for this high-wave station coincides with that of the Antenna dial. Actually, it may be desirable to remove turns from both oscillator and antenna coils so that KYW or any other 535-meter station will come in with both Oscillator and Antenna condensers inter-leaved to within all but five degrees of their maximum position. If this stripping of oscillator and antenna coils, which is done in steps of two or three turns at a time, is carried out, it is possible to extend the range of the receiver down so that it will actually go a little below 200 meters. In stripping the coils, only the enamel wire winding at the top end of the stator forms should be touched, the rotors and slot windings being O.K. Generally 10 turns may be removed from the antenna and 25 turns from the oscillator coil.

The receiver will, of course, cover other than the regular broadcast wavelength range, a pair of 111B coils allowing it to tune from about 70 to 210 meters, and a pair of 111C coils covering the range of about 30 to 90 meters. Two type 111D coils will cover the range of 500 to 1,500 meters; while the addition of one 111E coil for the antenna socket (using a 111D oscillator) will allow the set to tune up to about 3,000 meters. All of these coils are interchangeable plug-in types fitting the standard coil socket.

For short wavelengths a three-tube regenerative receiver will generally give entire satisfactory results, or even for medium range broadcast reception. It is a simple matter to add a three-contact switch, with all contacts insulated from the frame, on the front panel of the receiver under the detector stage assembly. The lead from post P on the left end of the intermediate amplifier to the R.F. choke coil (L3) should be broken, and the wire from the choke coil led to the blade of the switch. One contact to the switch should go to post P on the left of the intermediate amplifier and the other contact should connect to post P on the right of the intermediate amplifier. The switch then serves to throw the output of the regenerative first detector either directly into the audio amplifier or into the intermediate amplifier. Naturally, when the detector output is connected directly to the audio amplifier, the oscillator tube and all tubes in the intermediate amplifier are unused and may be turned out by an extra pair of contacts on the throw-over switch; or the tubes may be removed from the set, if desired.

If any difficulty is experienced in getting the set to function properly in the matter of sensitivity, selectivity, or tone quality, the change above suggested should be made and the lead from the choke (L3) connected directly to terminal P on the right end of the I.F. amplifier. The set should then be operated as a three-tube regenerator, and the results carefully observed, in order that the operator may familiarize himself with the operation of the first detector circuit and the nature of the regeneration control of the "Sensitivity" knob. Naturally, when the intermediate amplifier is added to the circuit, volume, sensitivity and selectivity should increase very much and the oscillator dial would then come into play. In tuning, the oscillator dial should be extremely sharp, requiring only a degree or two at the outside to eliminate practically any station, local or distant. The antenna dial will be broad comparatively, local stations covering as much as 20 to 30 degrees of the Antenna dial when it is rotated alone, and out-of-town stations from 5 to 10 degrees or more.

The real test of the receiver's performance, however, is a comparison against any other standard set—the screen-grid "Laboratory Model" receiver should give greater selectivity and far greater distance range than any other set on the American market, and the tone quality, when using but two intermediate stages, should be on a par with that of the very best T.R.F. receivers. When using three intermediate stages for extreme sensitivity, it should be equal or better than that of practically all other superheterodynes. A loop may be used, connected to antenna coil socket posts 3 and 4, with the antenna coil removed from the set.

2LO Calling

(Continued from page 1002)

it possible to supply almost any kind of musical program.

You will notice that this set fulfills all the conditions set forth at the beginning of this article. I guarantee it to pull in easily any station on the earth.

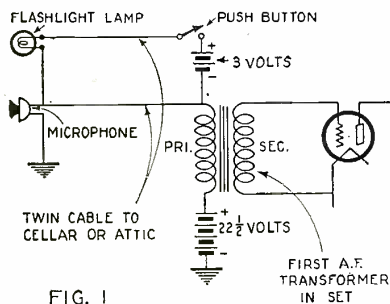
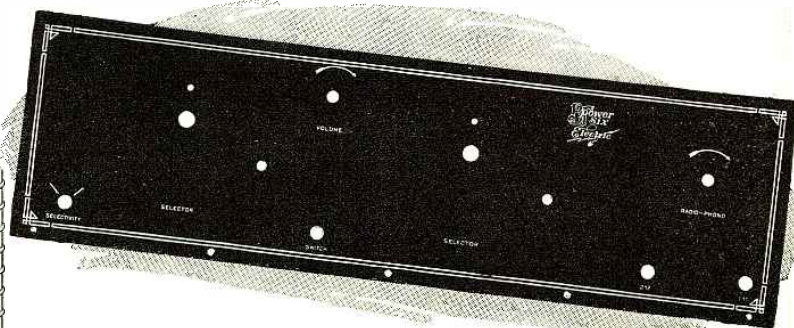

FIG. 1

How the microphone is connected in the input circuit of the A.F. amplifier of a receiver.

"Scare-Speakers"

RECENTLY Radio News described a device for picking up the conversation of birds. The system is reversed by a Dutch farmer who has installed loud speakers in his orchards, to frighten birds away from the fruit trees. If this method is adopted in England, unkindly suggests a British paper, "a use will be found for those educational talks which we hear so much about."



Four New Kit Panels!

Bremer Tully Power Six Electric; Karas A-C Equamatic; Karas Knickerbocker Four and Tyrman "70" front and sub panels are recent additions to the Formica line. There are also available panels for battery sets of the same makes and the World's Record Ten; H. F. L. Nine-In-Line; Magnaformer front and sub panels; Madison-Moore; Melo-Heald; Camfield Nine and many others.

Special panels cut to any size and tubing and rods, etc., is also available for amateur use

THE FORMICA INSULATION COMPANY
4618 SPRING GROVE AVENUE CINCINNATI, OHIO

Any jobber or dealer can get Formica panels for you



Formica has a Complete Insulating Service for Manufacturers

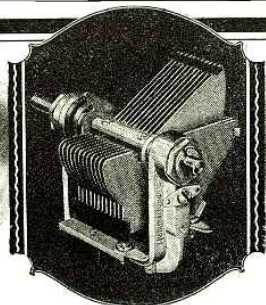

HAMMARLUND "Midline" CONDENSER

Soldered brass plates with tie-bars; warpluss aluminum alloy frame; ball bearings; bronze clock-spring pigtail; full-floating, removable rotor shaft permits direct tandem coupling to other condensers. Made in all standard capacities.

Write for Folder

HAMMARLUND MFG. CO.
424-438 W. 33rd St., New York
Canadian Representative
WHITE RADIO COMPANY, Ltd.
41 West Ave. N. Hamilton, Ont.

Hammarlund Accuracy Assured

Michael Angelo, the great artist, once said, "Genius consists in the capacity for taking infinite pains." While we are too modest to claim that Hammarlund Products are the result of genius, we do insist that they have attained leadership because we take the pains to make them right.

Above is shown how accurate alignment of Hammarlund Condenser plates is assured—firmly anchored in a metal holder, each plate in its own slot, while the tie-bars and solder are applied.

For Better Radio
Hammarlund
PRECISION PRODUCTS



JEWELL WRITE
For Our 32 Page
Radio Instrument Catalog
No. 15-C
JEWELL ELECTRICAL INSTRUMENT CO.
1650 Walnut St. Chicago

C. L. PARKER
Ex-Examiner U. S. Patent Office
Attorney-at-Law and Solicitor of Patents
McGill Building, Washington, D. C.
Patent, Trade Mark and Copyright Law



5 BIG REASONS
Why You Should Use

TRUVOLT RESISTANCES

IN BUILDING ELIMINATORS AND POWER SETS

1. Unit develops less heat, due to greater radiation surface.
2. This assures long life, with non-varying accuracy.
3. Choice of radio designers and engineers.
4. Made entirely of copper-nickel alloy resistance wire—the finest known.
5. Especially adapted to power devices and electrified sets.

A full line of Variable, Fixed and Tapped Wire Wound Resistances for all radio purposes

Write for complete Free Truvolt Resistance Circular
Dept. 12-E, 175 Varick Street, New York, N. Y.

ELECTRAD

YOU CAN SUCCEED IN RADIO—HE DID!



Scores of young men like him are now our graduates. There is a constant demand for radio operators. Our course qualifies you in a short time for a splendid, well-paying position.

Write today for free booklet on our Radio Course

West Side Y. M. C. A. Radio Institute
319 West 57th St., New York, N. Y.

DEPENDABLE "B" BATTERY POWER



100 Volt Edison Element.
Non Destructive, Rechargeable "B" Battery with charger. Shipped dry with solution, \$12. 140 Volt with charger, \$17. Free sample cell. See how it operates. SEND NO MONEY—PAY EXPRESSMAN
Write for our Free Illustrated 28-page Booklet
SEE JAY BATTERY CO., 915 Brook Ave., New York

You can be quickly cured, if you

STAMMER

Send 10 cents for 288-page book on Stammering and Stuttering. "Its Cause and Cure." It tells how I cured myself after stammering 20 yrs. B. N. BOGUE, 676 Bogue Bldg., 1147 N. 111 St., Indianapolis.

EVERYTHING IN RADIO

AT ATTRACTIVE PRICES. SETS OR PARTS.

Orders shipped exactly as ordered. Prompt Service.
Write for Prices. Mail Order Only. Send Your Address.
ALL RADIO COMPANY, 417 North Clark St., Chicago

Radio Wrinkles

Final \$50 Prize Award

FIRST PRIZE

A Home-Made Loud-Speaker Unit for a Cone

By Oren E. Staubrough

THIS loud-speaker unit may be built almost without cost by the mechanically-inclined radio amateur. It will operate a 36-inch cone-type loud speaker very satisfactorily, and most of the parts required may be found in an experimenter's junk box. All that is needed are a Ford spark coil, a magnet from a Ford magneto, a small bobbin from a buzzer, a piece of soft iron $10' \times \frac{3}{4} \times \frac{1}{8}$ inches, a piece of thin flexible iron $2\frac{1}{4} \times 1/32$ inches, a brass driving rod, nuts and screws.

In the construction of the unit the first

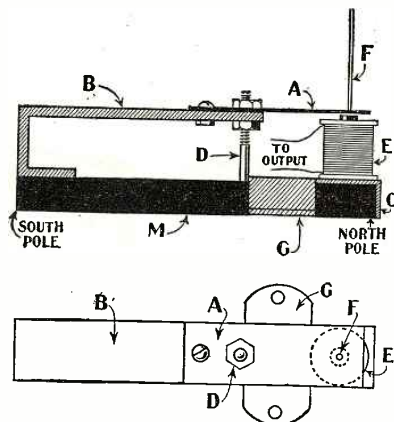

Fig. 2
Two drawings showing complete mechanical details of home-made speaker unit.

step is to break the magnet in two pieces and discard one half. Next, take the half which is to be used in building the speaker unit and determine the north and south poles with a pocket compass. This magnet is $4\frac{1}{2} \times \frac{3}{4} \times 7/16$ inches.

The 10-inch length of soft iron must be cut into three pieces with a hack saw. The first section is $4\frac{3}{4}$ inches in length and this is formed as illustrated at B (Fig. 1); the second section is $1\frac{1}{2}$ inches long and is formed as shown at C; and the third section is used as a mounting bracket for the unit. The last section may be formed after the construction has been completed, and the design which should be followed is shown at G.

Winding the loud-speaker coil is the next problem to consider. Take a bobbin, similar to the one illustrated at E (Fig. 1) and wind it with wire removed from the secondary winding of a Ford spark coil. As much wire as possible should be placed on the bobbin.

After the directions given in the above paragraphs have been followed out the various parts have been prepared and the unit may be assembled. In Fig. 2 the mechanical details of the completed unit are shown. As the magnet is hard and cannot

PRIZE WINNERS

FIRST PRIZE \$25

A Home-Made Loud-Speaker Unit for a Cone

By OREN E. STAUBROUGH
2845 Shiver Avenue
Indianapolis, Ind.

SECOND PRIZE \$15

Four Jacks and a Tube Base Make a Novel Tester

By T. WESTON BROWN
Box 122, Carencro, Iowa

THIRD PRIZE \$10

How to Build a Simple Inexpensive Tester

By C. W. MAC ELROY
4306 Horrocks Street,
Philadelphia, Penn.

This marks the final prize award for Radio Wrinkles. In the future all Wrinkles which are received will be given the same consideration as other articles submitted to this magazine. Wrinkles which are published in future issues will be paid for at regular space rates.

be drilled, the various parts must be soldered in place. The $2\frac{1}{4}$ -inch piece of flexible iron strip (A) serves as the armature and is fastened to section B as illustrated. Also holes must be drilled in A and B for the adjustment screw D. Now proceed by soldering the various parts to the magnet and the driving rod (F) to the armature.

After the speaker unit has been completed it may be connected to a cone in the usual manner; and the two wires from the coil connected to the output binding posts of the set. In order to adjust the speaker, the air gap between the armature and the pole-piece of the coil is changed

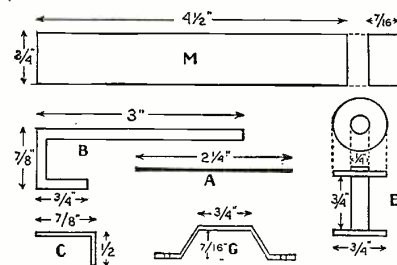

Fig. 1
Exact dimensions of parts used in building speaker unit are given above.

until best results are obtained. This is accomplished by running the two nuts on the adjustment screw up and down.

SECOND PRIZE

Four Jacks and Tube Base Make Novel Tester

By T. Weston Brown

THE circuit tester which will be found illustrated here is very interesting and quite useful. It enables the experimenter to test various parts of the circuit, under actual operating conditions, in a very simple manner and without the necessity of mak-

ing any changes in the wiring of the set. The tester is capable of detecting many faults in a receiver and is also particularly helpful in determining the particular part of the circuit where trouble exists.

To use the tester, a tube is removed from its socket and the tester is substituted. The vacuum tube is then inserted in the "sockettes" on the top of the tester and the receiver is placed in operation. The voltage or current of the various circuits may now be measured by plugging meters into the jacks on the panel of the tester. To determine the filament voltage, a plug connected with an 0-10-scale voltmeter should be inserted in the topmost jack. The jack second from the top is for measuring the plate voltage, and the meter which is connected

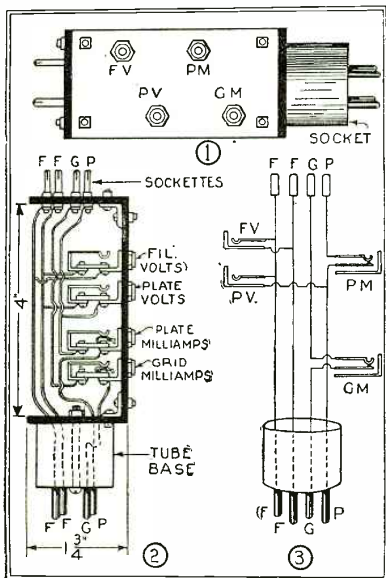

The above drawings give complete details for building and wiring this novel circuit-testing device.

in this position should have a range from 0 to 150 volts. The two lower jacks are for measuring the plate and grid currents of the tube; the same meter may be used for making both of these readings and should be a milliammeter having a range of 0 to 25. The third jack from the top is for the plate current, and the fourth from the top for grid current.

The construction of the tester is very simple and only a few inexpensive parts are required. The four jacks used are of the midget variety; the two for the voltmeters are of the single-circuit type, and the two for the milliammeters are of the double-circuit type. The three panels may be bakelite or hard rubber; two of the panels are 1 3/4 inches square and the third is 1 3/4 x 4 inches. The tube prongs are from the base of an old vacuum tube and the only additional parts needed are machine screws, brass angle brackets, and four sockettes or a standard socket.

The details of assembly are clearly illustrated in the two drawings, and the wiring is shown in the schematic diagram. Although it is impossible to show this in the pictures the wires from the plate and grid terminals should be separated as far as possible. For the wiring, either flexible wire or bus bar may be used; but either should be well insulated to prevent possible short circuits.

Tyrman "70"

Shielded Grid Amplimax

USING TYPE SP 122 TUBES

FOR A-C OR BATTERY OPERATION

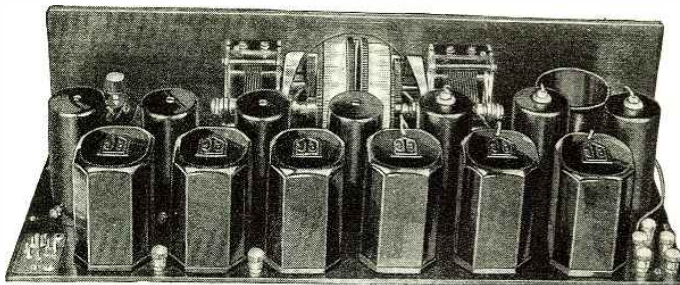

Brings in JAPAN—AUSTRALIA with VOLUME and QUALITY

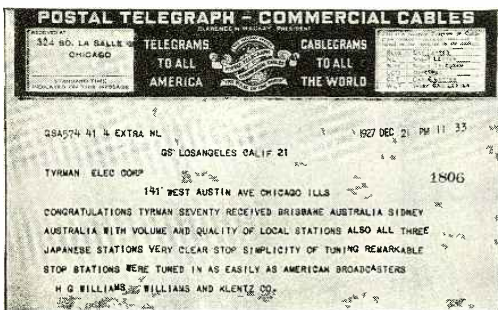

Until now all claims for distance, selectivity, volume, and tone quality have been based upon number of tubes employed.

Now greater results are obtained through Tyrman Laboratories by the development of the Tyrman "70" without distortion or oscillation.

Build this new receiver and benefit by this revolutionary improvement.

TYRMAN ELECTRIC CORP. 143 W. AUSTIN AVENUE CHICAGO, ILLINOIS

Amazing New Ground Antenna

GETS EVERYTHING BUT STATIC Brings in Far Away Stations Loud and Clear Regardless of Static Conditions

Fans everywhere are replacing their troublesome and static gathering roof aerials with the marvelous new Ground Antenna—Aer-O-Liminator. Radio engineers and hundreds of users testify that Aer-O-Liminator gets better long distance reception, almost unbelievable freedom from outside noises, far greater selectivity and marvelously true, clear, sweet tone quality.

John E. Christenson, Radio Engineer, Chicago, writes: "I have tested and thoroughly approve the Aer-O-Liminator. I find it increases selectivity and volume without distortion, practically eliminates static, gives good clear tones, both on local and distant stations. I would recommend the use of the Aer-O-Liminator to every radio owner to get the best reception from his set."

FREE TRIAL

Make this thrilling test at our risk! Install an Aer-O-Liminator (Ground Antenna). Leave your old overhead aerial up. Try out on a night when static is bad. If you do not get a wonderful improvement in freedom from static, greater selectivity and clear, sweet tone without interfering noises, if you can't get good reception on stations that are drowned out by static on your old aerial, you need not pay us a red cent for this test. Send coupon at once for scientific explanation of Aer-O-Liminator (Ground Antenna) proof of performance and our exclusive iron-bound guarantee and remarkable Free Trial Offer.

CURTAN MFG. COMPANY
Dept. 827-C
154 E. Erie St., Chicago, Ill.

Rush This Important Coupon

CURTAN MANUFACTURING CO.,
154 E. Erie St., Dept. 827-C,
Chicago, Ill.

Please send me at once complete description of Aer-O-Liminator with details of guarantee, Scientific Proof and FREE TRIAL OFFER.

Name.....
Address.....
City.....
State.....



CONDENSERS and VERITAS RESISTORS

Stand 'up on their Jobs
Tobe Deutschmann Co., Cambridge, Mass.

HOME FURNISHINGS ON CREDIT - Catalog FREE

Over 1,400 bargains in living room, dining room, and bedroom furniture, rugs, dishes, etc. A year to pay. 30 days trial. Write today for free catalog.
STRAUS & SCHRAM Dept. 3573 Chicago, Illinois

Insure your copy reaching you each month. Subscribe to Radio News—\$2.50 a year. Experimenters Publishing Co., 230 Fifth Avenue, New York City.

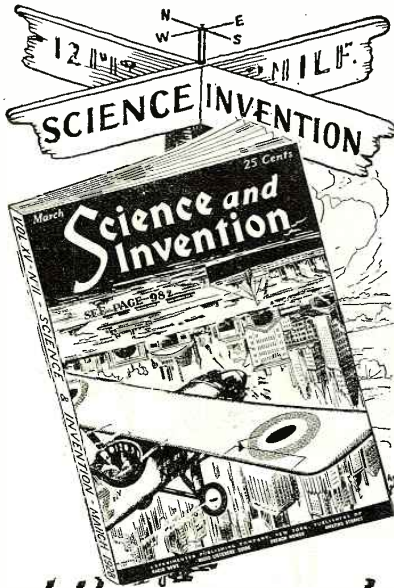

at the crossroads

Scientific Fact Radio Activity Inventive Thought Experiment

everything of note
in a matter-of-fact
manner

SCIENCE AND INVENTION—at the crossroads of the nation! Everything of interest and of scientific note — Science, Invention, Radio, Chemistry, Astronomy, Electricity, etc.

The selected topics in *Science and Invention* are treated in a non-technical manner, giving them an everyday appearance and an understanding for all.

What is more, a year's subscription to *Science and Invention* will mean 12 volumes chock full of interesting topics, valuable information, helps for the home and business, and many hours of entertainment.

SCIENCE AND INVENTION
A Preview of Modern Scientific Endeavor

25c

on all newsstands

100 pages or more in each issue

If your news dealer has none on hand, the little time spent in writing directly to us will be well rewarded.

EXPERIMENTER PUB. CO.
230 Fifth Avenue New York City

The above paragraphs give general details for operating the tester but the experimenter will, no doubt, discover many different ways in which the unit may be employed to answer his particular requirements.

THIRD PRIZE

How to Build a Simple, Inexpensive Tester

By C. W. MacElroy

A OTHER form of tester which is equally as valuable as the one described elsewhere in this department may be made from an old radio headset and a flashlight battery. This tester may be used in a thousand and one different ways, and will be found particularly useful when checking the wiring of circuits and when testing parts for open circuits or short circuits. Also, the tester may be used to advantage when tracing the wiring of a receiver.

The construction of this unit is clearly explained in the drawings and does not re-

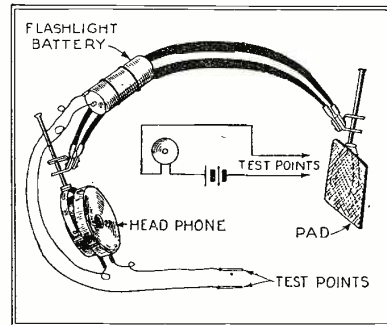

A headphone and flashlight battery are the only parts required for building this unit.

quire an elaborate description here. Only one phone is required in the head set and, if two phones are available, one should be removed and a felt pad substituted to protect the ear from the metal of the head set. The battery used is a small flashlight unit of 3 to 4½ volts, and is fastened to the head set in the position shown with friction tape. The wiring is equally simple and is shown in the wiring diagram. The phone unit and the battery are connected in series and one wire from each is used as a test point.

The advantage of this tester over other designs is that it is entirely self-contained. The battery and the phone are in one unit and this avoids the necessity of having the wiring of the tester unit on the table.

The operation of the tester is very simple and requires but little explanation. The tester indicates when there is a complete conductive circuit between the test points by a click in the phone unit, and the intensity of the click is determined by the resistance of the circuit. Therefore, when testing an instrument, if the test points are touched to two terminals and a click is heard it indicates that there is a connection between the two posts; but if no noise is heard there is an open circuit. Also, in testing a receiver it is possible to locate all parts of the circuit which are connected with the ground by attaching one test point to the ground binding post and touching the other point to all other terminals in the set.

It is often possible to make other tests by comparing the intensity of the sound. For example, when testing an audio-frequency transformer the test points should be touched to the various posts until the two pairs of terminals which connect with the windings are located. It is now possible to determine which pair of terminals connect with the primary winding and which pair connects with the secondary. As the primary winding of the transformer has a much lower resistance than the secondary, the click will be much louder when the test tips are touched to the terminals of this winding.

A Power-Tube "B" Unit Without a Step-Up Transformer

THE expense of constructing a plate ("B") power unit may be greatly reduced by making use of the circuit arrangement illustrated on this page and, if certain precautions are taken, the system will be found entirely satisfactory and safe. The usual step-up power transformer, which is one of the most expensive items of the average power unit, has been eliminated by using two rectifier tubes in a voltage-doubling circuit arrangement. The power from the 110-volt lighting circuit is connected directly to the rectifier tubes, and it is rectified and doubled simultaneously. In this way it is possible to obtain ample power for the efficient operation of receivers using 171-type power tubes in the last audio stage.

The complete circuit of the power unit will be found in the illustration. Two standard bell-ringing transformers may be obtained for a small amount from any electrical store. The rectifier tubes are two receiving tubes of the 112 type which are converted into two-element rectifiers by connecting the grid and plate terminals to-

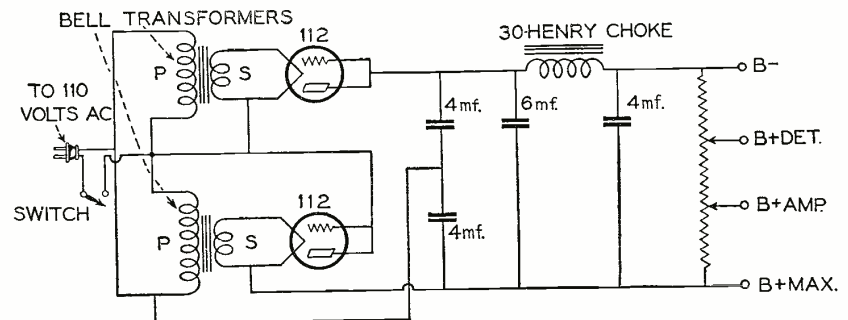

When using this voltage-doubling circuit in a "B" power unit, a step-up transformer is not required

gether. The two 4-mf. condensers connected in series across the high voltage are the voltage-doubling condensers, and the remaining 6-mf. and 4-mf. condensers are in the filter circuit. All of the condensers used in the unit should be rated for operation at 400 volts. The 30-henry choke is a standard filter-choke coil and the voltage-dividing resistor is also of the usual design.

In operation, the rectifier tubes charge each of the two 4-mf. condensers individually at the peak of the A.C. voltage, which is approximately 155 volts. Therefore, as the condensers discharge, the power pack has an output voltage of about 310 volts at no load. Of course this voltage decreases when a set is connected; but this device will usually deliver 180 volts to a 5- or 6-tube set using a 171-type power tube.

When operating a receiver in connection with this power unit, it is *necessary to disconnect the ground wire*. This is very important, as one side of the A.C. circuit is grounded and, if the set were also connected to the ground, a short circuit might result.

Contributed by J. R. Balsley.

The Knowles Screen-Grid Four

(Continued from page 1080)

the terminal. To prevent any coupling through the common battery, or through the battery leads, a radio-frequency choke and a by-pass condenser are used.

Because of the high plate impedance of the 222-type tube it is important to use a coupling device of high impedance. This is most readily obtainable, without the use of a special coil, by using a tuned circuit such as recommended by the manufacturer of the tube. In some cases a transformer with a 1:1 ratio has been recommended, but this has no particular advantage where the coupling device is used immediately ahead of the detector tube. When such a transformer gives perfect coupling between the primary and secondary, it is similar to the tuned-impedance stage. When increased selectivity is obtained, it is due to looser coupling or to the omission of the grid leak; and this cannot be omitted in the detector stage without making the detector itself much less efficient.

This circuit normally tunes very broadly. This is due partly to the fact that the grid leak is connected across the tuned circuit; but principally to the fact that the 201A-type tube must be operated with a positive bias on the grid to secure efficient rectification in the grid circuit (that is, with a condenser-leak arrangement). This positive bias is obtained by connecting the leak (R3) to the positive A filament terminal. Under these conditions the grid attracts electrons and this greatly decreases the grid-to-filament resistance, resulting in loss of sensitivity and selectivity.

EFFECT OF REGENERATION

To insure good quality reproduction the radio-frequency circuits need not pass more than about ten kilocycles. When the tuned circuit "looks into" the detector, the band it will pass depends on the frequency but is from 30 to 60 kilocycles wide; indicating that it contributes little or nothing to the selectivity. Furthermore what is known as the "dynamic" resistance of the circuit

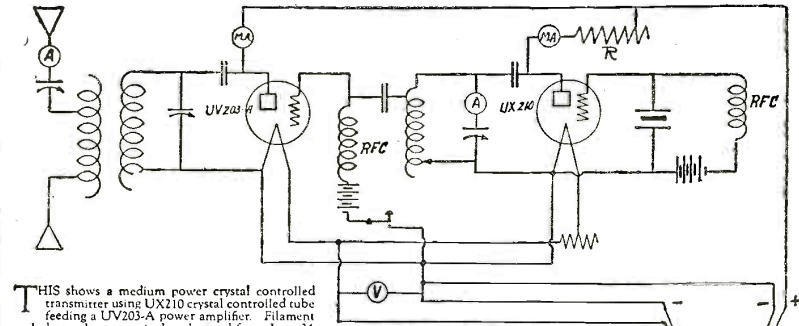

THIS shows a medium power crystal controlled transmitter using UX210 crystal controlled tube feeding a UV203-A power amplifier. Filament and plate voltages are to be obtained from item 34, operating from either DC or AC house mains. The voltage to the filament of the tubes is variable, either by the field resistor in the filament generator circuit (not shown) or by the resistance in the filament circuit of the UX210 tube. Keying is done in the bias circuit of the 203-A power amplifier. As the amplifier is NOT neutralized, the power amplifier must work on some harmonic of the crystal tube (preferably the second), for all operations in the 20, 40 or 80 meter bands. A crystal having a fundamental of 160 meters will allow operation in all bands with best output in the 80 meter one. An 80 meter crystal is best for 40 meter operation and in like manner the 40 meter crystal would be best for 20 meter operation. Forty meter crystals are hard to get and blow up easily, so for 20 meters the 80 meter crystal is used again. Both tubes obtain plate supply from the plate end of item 34, the UX210 being supplied with not over 350 volts through resistance R, and the 203-A taking the full 1000 volts.

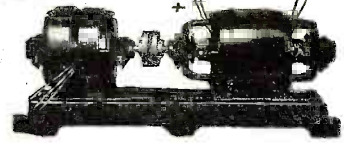

ELECTRIC SPECIALTY COMPANY

211 South Street TRADE "ESCO" MARK Stamford, Conn., U.S.A.
Manufacturers of Motors, Generators, Motor-Generators, Dynamotors and Rotary Converters for Radio and other purposes

Spend the Winter in MIAMI, FLORIDA

Take the time away from the chilling cold and give your family a comfortable winter where every outdoor recreation may be had, including ocean bathing

You can live for less here than at home—stop at

HOTEL

GRALYNN

Write for our illustrated booklet and rates

H. H. Mase, Proprietor

A beautiful hotel conducted upon both the American and European Plans

Summer Resorts

Churchill Hall and REXMERE CLUB Stamford, N. Y. Open May to November

you have not built or played with a new circuit in three years unless you have built the SUPER-HILODYNE

A new basic circuit employing nine tubes. World's latest—most acclaimed circuit—the SUPER-HILODYNE—radically new—much in demand—a sure money-maker for custom set builders.

WANTED

POTTER PRODUCTS CORPORATION
245 Fifth Avenue, New York, N. Y.
Gentlemen: Please send me immediately full details of your plan to help me make big profits. I understand this does not obligate me in any way whatsoever.

Name.....
Address.....
City.....State.....RN-228

We want direct factory representatives in all territories. Write for details and our unusual money-making proposition.

POTTER PRODUCTS CORP.
245 Fifth Avenue, New York City

All Metal Chassis Shielded Ready to Wire

6 TUBE SUPERPHONIC

Radio ALL PARTS MOUNTED

Only \$16.95

FREE/6 TUBES UX 201-A TYPE Tested and Matched

Can be wired in a few minutes

COAST TO COAST RECEPTION

An amazing value that can't be beat! Latest six-tube tuned radio frequency circuit. Extremely selective, marvelous sensitivity. Three stages of radio frequency, detector, and two stages of low ratio audio frequency for improved tone quality. Two-dial control. Straight-line frequency condensers. All metal chassis. Shielded. Clear and realistic reception guaranteed. Beautiful black front panel (7 in. x 18 in.); ornamental design, degree and kilocycle markings in gold. Metal panel and sub-panel. Complete chassis. No extra parts to buy. All parts mounted. Simply connect a few wires. No special tools needed. Kurtz-Kasch indicator knobs. New type UX sockets. All hook-up wire and colored battery cable included. Value \$60.00; our price, \$16.95.

TESTED AND APPROVED

Severe laboratory tests have proved the remarkable efficiency of this set. Owners everywhere are sending us letters praising its wonderful receptive qualities. "Wired set in short order. Getting stations all over the country. Plenty of volume. The set sure is a dandy." B. J. Gillis, Denver, Colo. Telegram from M. A., Syracuse, N. Y.: "Ship at once two more Superphonics."

SIMPLE WIRING DIRECTIONS

Very easy to wire this set with the instructions we furnish. Just connect a few wires. All you have to do is follow numbers. That is all. Can be wired in a few minutes by anyone. No special knowledge needed. Make money by wiring these sets in your spare time and selling them to your friends.

NO RADIO KNOWLEDGE NEEDED

SEND NO MONEY

Just write your name and address on a post card and ask us to send you this great outfit together with six tubes. We will ship them right away. When they arrive, pay only \$16.95, plus a small delivery charge. (Foreign countries send \$19.50 with order. We pay shipping charges.)

RADIO EQUIPMENT CO.
Dept. 12C 549 S. Wells St. CHICAGO, ILL.

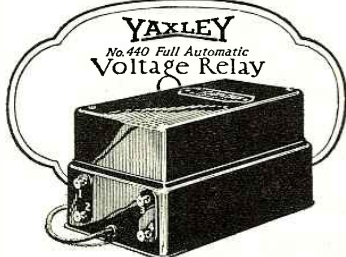

For automatically switching on and off your B Eliminator and Charger, or either, and in addition, automatically switching off your Charger when the battery is fully charged.

With the Full Automatic Voltage Relay it is now practical to utilize the advantages of a high rate charger and at the same time control the switching of the charger as well as the B Eliminator with the switch or filament control on the set.

No. 440.....\$7.50

Yaxley Mfg. Co.
Dept. N, 9 So. Clinton Street
Chicago, Ill.

RADIO PANELS BAKELITE—HARD RUBBER

Cut, drilled, and engraved to order. Send rough sketch for estimate. Our Complete Catalog on Panels, Tubes and Rods—all of genuine Bakelite or Hard Rubber—mailed on request.

STARRETT MFG. CO.
520 S. GREEN STREET - CHICAGO

SOLDERITE

Insure your radio connection by using SOLDERITE soldering fluid.

ABSOLUTELY NON-CORROSIVE

2-ounce trial bottle 25c. postpaid.

SOLDERITE, 22 Greene St., Newark, N.J.

is decreased to such a low value that the 222-type tube gives only moderate amplification.

To offset these effects regeneration has been used. The effect of regeneration is to decrease the losses in the circuit or to increase the resistance across the circuit. When used in moderation it results merely in bringing this stage up to par without impairing the quality. In other words, sufficient regeneration may be used to increase the amplification considerably and to narrow the band the circuit passes to approximately 10 kilocycles. The adjustment is made by the operator, who can regulate it until he detects no appreciable distortion.

When the radio-frequency stages are adjusted so they do not discriminate against the higher audio frequencies, then the problem of good reproduction rests with the audio-frequency amplifier and speaker. A high quality audio-frequency amplifier has been used together with an output transformer, which makes it possible to use the 171- or 171A-type tube in the last stage.

CONSTRUCTION

The receiver may very easily be constructed by following the instrument layout and schematic wiring diagrams. The location of the parts should follow the layout shown on page 1028. In the pictorial wiring diagram the location of the parts has been altered slightly to make the wiring easier to follow.

A few general precautions will permit the constructor to duplicate the receiver quite easily. If three hours are available in which to assemble the receiver, one of them will be well spent in considering the sequence that is to be followed in the assembly, and in becoming familiar with the various parts and leads.

Partially assemble the two shields by holding the sides together and forcing the corner pieces down about half way. Place the bottom of the shield in what seems to be the proper position and then hold the assembled side walls immediately over it. The shields should be so placed that they are next to the panel and their sides clear the couplings on the drum dial by about 3/16-inch.

After all the necessary holes are drilled in the panel and drum-dial sides of the shields, these may be securely fastened to the baseboard with the bottom piece in place. An ice pick or similar tool may be used very conveniently to locate the screw holes and to start the wood screws.

Mount the rheostat R1 and the variable midget condenser C3 on the panel. The shafts of these two instruments are at shield (ground) potential so they should not be insulated.

Solder an 18-inch piece of wire to the "P" terminal of socket V1 and another to the "F+" terminal. These two leads go through the side of the left-hand shield, next to the drum dial. Thread them through the holes provided and mount the socket in the position shown.

TUNING-CONTROL MOUNTING

Details for aligning the variable condensers are given in the instructions with the drum dial so they need not be repeated. The condenser C1 should be so mounted that its stator plates clear the side of the rheostat R1 by about 3/16-inch. The condenser C2 should be mounted so the frame is 1/8-inch from the side of the shield.

The location of C2 is quite important, since its frame and rotor plates must be insulated from the shield. They are connected to the "B+90" lead. The frame may be insulated from the bottom of the shield by using a thin piece of varnished cambric or empire tape; or two or three pieces of paraffined paper may be used. The holes in the shield bottom should be quite large and the hole through the insulating strip just large enough to clear the screws. The hole in the side of the shield, through which the shaft goes, should be large enough to clear the shaft by 1/16-inch unless a short piece of bakelite shaft is available.

After C2 has been mounted a test may be made from its frame to the shield by using a battery with a voltmeter, head-set or speaker. There should be no "click" or deflection of the voltmeter.

The sockets and by-pass condensers may then be mounted. A long lead should be soldered to one terminal of the choke L3. This should be threaded through the hole in the shield, after which the two mounting



The shield-top of the R.F. amplifier stage removed, with the pencil indicating the top terminal of the screen-grid tube.

screws may be inserted. The two machine screws on the soldering lugs should be removed, to prevent the possibility of one's touching the shield bottom.

RUNNING THE LEADS

Flexible rubber-covered wire is used throughout for the wiring. This, together with the use of "bee" or direct-line wiring and cabled battery leads, makes the wiring very simple. Long leads should be soldered to the terminals which are difficult to reach with a soldering iron after the apparatus is mounted. The grid-leak mount is an example of this; after it has been screwed in place the leads may be cut to the proper length and soldered to the grid condenser and to the filament terminal. If a 201A-type detector is to be used the filament connection of the leak should be made to the "A+" terminal. If the 200A-type is used, it should be connected to the "A—" terminal.

The wiring should progress with a view to completing the coil connections just before the shield is to be assembled. No parts are mounted on the rear side of the shields and these may be added after all the connections have been made. This makes it possible to solder the leads to the coils and other parts more easily.

After the wiring in both shielded compartments has been completed the three A.F. transformers (T1, T2 and T3), the A.F. sockets (V3 and V4), and the amperites (A1, A2 and A3) should be mounted. The left-hand shield should have five long leads, which are to be connected externally. They are the following: "A—" lead, which goes to the cable terminal; aerial lead from the primary of L1, which goes to the aerial binding post; plate lead from V1, which goes to the stator of C2; screen-grid lead, which is attached to the "G" terminal of V1 and goes to the "B+45" terminal (blue) on the cable connector, and the "A+" lead, which goes to the red cable terminal.

The right-hand shield should have the following external leads: one from the stator plates of condenser C3 to the choke L4; "A+" battery lead, which goes to A1 (to the right-hand side of the detector shield and not visible in the pictures); from the choke L3 to the yellow terminal on the cable connector; and that which goes across to the other shield and connects the stator plates of C2 with the "P" terminal of V1.

After these leads have been checked, the audio-frequency amplifier may be wired. The bottom leads to the cable terminal should be wired first to simplify the soldering.

There is ample room on the baseboard to permit the use of any type of audio-frequency amplification. If the constructor prefers push-pull amplification a pair of push-pull transformers may be substituted for T2 and T3, and another socket and amperite added.

The amperite used in the last stage will depend on the power tube. The 1A type should be used for all 1/4-ampere and the 112 type for all 1/2-ampere tubes.

OPERATION

To place the receiver in operation, connect the two "A" battery leads to the cable. Insert the 222-type tube in V1, 201A tubes in V2 and V3 (unless a special detector is used in V2), and the power tube in V4. The filament switch (R1-Sw) should break the connection to all the filaments and

A. C. OPERATION!



Type 440-A Transformer
Price—\$10.00

THE Type 440-A Transformer illustrated is designed for use on 105-125 V. (50-60 cycle) A. C., and is rated at 65 watts. The following voltages and currents are available:

2 Volts	10 Amperes
3.5 "	5 "
5 "	2.5 "
7.5 "	2 "

The use of this transformer, together with the new A. C. tubes, and a dependable plate supply unit such as the General Radio type 445 Plate Supply and Grid Bias Unit, makes the conversion of a battery-operated receiver into one operated from the light socket very simple. If you do not care to undertake this change yourself, go to your community set builder. He is well qualified to serve you.

GENERAL RADIO CO.

Write for Bulletin No. 929

30 STATE STREET

CAMBRIDGE, MASS.

Bring Your Set Up to Date

no
more
batteries



25c
ON ALL
NEWSSTANDS

THE set owner can now electrify his own set—in a most economical way. Do it yourself! This book will show you how!

HOW TO ELECTRIFY YOUR RADIO SET

Good, clear, understandable English, with detailed instructions to build the eliminator. It discusses the first principles of wave rectification; gives reasons why the electric set is coming to stay; and specifies parts necessary to construct the eliminator.

Many illustrations showing various eliminators and parts.

Splendid two-color cover—6 x 9 inches.

Get it from the newsstand, or write direct

CONSRAD CO., INC., 230 Fifth Avenue, New York City

LEARN THE CODE AT HOME

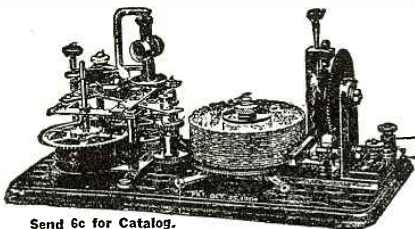

WITH THE **OMNIGRAPH**
THE **OMNIGRAPH** Automatic Transmitter will teach you both the Wireless and Morse Codes—right in your own home—quickly, easily and inexpensively. Connected with Buzzer, Buzzer and Phone or to Sounder, it will send you unlimited messages at any speed, from 5 to 50 words a minute. THE **OMNIGRAPH** is not an experiment. For more than 15 years it has been sold all over the world with a money back guarantee. THE **OMNIGRAPH** is used by several departments of the U. S. Government—in fact, the Department of Commerce uses the **OMNIGRAPH** to test all applicants applying for a Radio license. THE **OMNIGRAPH** has been successfully adopted by the leading Universities, Colleges, and Radio Schools.

Send 6c for Catalog.
THE OMNIGRAPH MFG. CO. 15 HUDSON STREET, NEW YORK CITY
If you own a Radio Phone set and don't know the code—you are missing most of the fun

Insure your copy reaching you each month. Subscribe to Radio News—\$2.50 a year
Experimenter Publishing Co., 230 Fifth Avenue, N. Y. C.

Conner Cabinets REDUCED!

Entire factory stock of Conner Convenient Cabinets now being closed out at

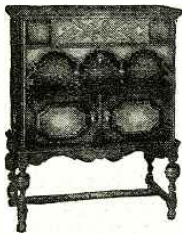

**25%
REDUCTION**
Prices NOW
\$26.25 to \$74.75

Jacobean, Renaissance and Sheraton designs, done in beautifully lighted walnut and mahogany. Fronts open down into convenient desks. Write today for illustrations.

A Conner Cabinet assembles every detail of your receiving set, batteries and accessories, in a scientifically convenient arrangement and encloses everything in an exceptionally beautiful piece of period furniture. You can secure one at this emergency bargain price if you act quickly. Write today for illustrations and details.

CONNOR RADIO CABINET CO.
New Albany, Indiana

Free

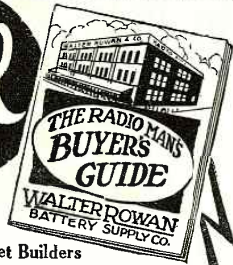

Dealers and Professional Set Builders

Write for this new 1928 RADIO DISCOUNT CATALOG which illustrates and describes everything worth while in radio.

We have in stock complete parts for the new TYRMAN "70" as described in Radio News, as well as Karas-Silver-Marshall—Remler A C—Hot Spot 14—9 In Line—Scott 10—Camfield 7—St. James Twin Four—and all other popular designs.

BUY DIRECT

from the LARGEST Radio Jobbing House in the middle west and save money on all radio equipment. Try us for quick, accurate service. No delays, no substitutions.

WALTER ROWAN
Battery Supply Co.
Dept. N, 227 N. Peoria St., Chicago, Ill.

This handy book should go with every Radio!

It is concerned with radio parts—their functions—where they are—and their names. It gives the symbols used in radio hook-ups, so that you will be able to read any diagram and understand it. It discusses air waves—the aerial—then takes you through every radio part—and finally the actual reproduction of sound.

This is a book that will give you a full understanding of your set.

ALL ABOUT RADIO PARTS

5 1/2 x 7 1/4 inches, fully illustrated
Get it from any newsstand or direct

THE CONRAD COMPANY, INC.
230 Fifth Avenue New York City

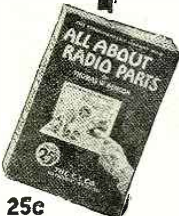

should control the brilliancy of the 222-type tube. If the rheostat seems to work satisfactorily complete the battery connections. The small initial spark on the blue and yellow leads is due to the current which charges the by-pass condensers. There should be no second spark when it is disconnected and quickly reconnected.

All of the cable markers are correct except that on the yellow lead. This lead should be connected to the "B+90" terminal instead of the "B—."

Connect the aerial, ground and loud speaker and tune in a local station. If the aerial is quite long, the position of the primary of L1 should be adjusted by turning the primary screw (which protrudes through a small hole in the top of the shield) until the primary is near the top of the shield; that is, until the coupling is very loose. If a small indoor aerial is used, the primary should be adjusted so that it is near the secondary. If a very short wire, having a total length of not over 30 feet, is used the connection should be changed so that all of the primary, instead of half of it, is used. The adjustment of the primary will depend on the selectivity and sensitivity wanted. It may be adjusted, while listening to a station, until the desired selectivity is obtained on the left-hand drum.

The right-hand drum will be found to tune broadly, for the reasons previously mentioned. To sharpen up this circuit, the

regeneration control must be adjusted. Turn the rotor of the midget condenser (C3) until the plates are fully meshed. Set the rotor knob with the arrow pointing downward, so that this position may be determined after the shield top is replaced. Set both drums at 100 and adjust the regeneration or tickler coil, just as the primary coil was adjusted, until the set begins to make a hissing noise or otherwise shows signs of oscillating.

When short-wave stations are tuned in it will be found that the capacity of the midget condenser must be decreased to stop oscillations.

The tuning is done as follows: move both dials, keeping them in the same relative positions and with about the same setting. When a station is found, tune the left-hand drum, which should be quite sharp, until maximum intensity is found. This should be done with the volume control in the "on" position; that is, with no resistance in the rheostat circuit. If the station is a local, the volume control may be turned to the left until the volume is moderate. Adjust the right-hand dial and gradually increase the capacity of the midget condenser C3 (make the plates intermesh more completely). It will be found that the setting of the drum must be changed slightly to secure maximum volume, and that the tuning becomes sharper. If the regeneration control is turned too far, the quality becomes poor and there is a piercing whistle

LIST OF PARTS

SYMBOL	Quantity	NAME OF PART	REMARKS	MANUFACTURER *
C1, C2	2	Var. condensers	.00035 mf.	1
C3	1	Midget condenser	65 mmf.	1 4, 26, 34, 48, 50, 91
C4, C5	2	By-pass condensers	0.5 mf. (paper insulation)	2 14, 15, 16, 17, 18, 19, 20, 21, 22
C6	1	Grid condenser	.00025 mf. (mica insulation)	3 2, 7, 15, 16, 17, 18, 19, 20, 23
T1, T2	2	A.P. transformers	3:1 ratio	4 3, 5, 20, 24, 25, 26, 27, 28, 29, 30, 31
T3	1	Output transformer	1:1 ratio	4 20, 24, 25, 26, 28, 29
L1, L2	2	Coupling coils	Auto-couple type	1
L3, L4	2	R.F. choke coils	85 millihenry	1 4, 4, 26
A1, A2	2	Amperites	5 volt, 1/4 ampere type	6
A3	1	Amperite	5 volt, 1/2 ampere type	6
R1-Sw	1	Switch-rheostat	40 ohms	7 16, 17, 45
R2	1	Fixed resistor	15 ohms	7 17, 18, 45
R3	1	Grid leak	8 megohms	8 2, 10, 15, 16, 18, 19, 20, 23, 34, 44
V1	1	Vacuum tube	222 type (screen-grid tube)	9 32, 35
V2	1	Vacuum tube	200A type	9 32, 33, 34
V3	1	Vacuum tube	201A type	9 32, 33, 34
V4	1	Vacuum tube	171 type	9 32, 33, 34
P	1	Cable plug	7-wire type	7 36, 37
S1, S2	2	Stage shields	Aluminum	1
	1	Drum dial	Double type	1
	1	Leak mounting	Single type	10 15, 16, 18, 19, 20, 23, 34, 44
	3	Binding posts		11 26, 43, 44
	4	Sockets	UX type	12 4, 11, 25, 44, 45, 46, 47, 48, 49
	1	Front panel	7 x 21 x 1/2 inches	13 40, 41, 42
	1	Terminal strip	3 x 3/4 x 1/8 inches	13 40, 41, 42
	1	Baseboard	Wood	
		Hook-up wire	Insulated	14 36, 38, 39

NUMBERS IN LAST COLUMN REFER TO CODE NUMBERS BELOW.

- | | | |
|--------------------------------------|-------------------------------------|--------------------------------------|
| 1 Hamerlund Manufacturing Co. | 2 Toke Deuschmann Company | 3 Sangano Electric Company |
| 4 Silver-Marshall, Incorporated | 5 Carson Electric Company | 6 Radiell Company |
| 7 Tuxley Manufacturing Company | 8 International Resis. Co. (BURHAN) | 9 F. T. Cunningham, Incorporated |
| 10 Arthur H. Lynch, Incorporated | 11 R. R. Fry Manufacturing Company | 12 Benjamin Electric Mfg. Company |
| 13 Winton Laboratories, Incorporated | 14 Acme Fire Company | 15 Bellier Condenser Corporation |
| 16 Polymet Manufacturing Company | 17 Carter Radio Company | 18 Electrad, Incorporated |
| 19 Aerovox Wireless Corporation | 20 Leslie E. Water Company | 21 John E. Fast Company |
| 22 Potter Manufacturing Company | 23 Wisemold Radio Corporation | 24 Ferranti, Incorporated |
| 23 Patent Electric Company | 26 General Radio Company | 27 Acme Apparatus Company |
| 28 Tyrman Electric Company | 29 Karas Electric Company | 30 Jefferson Electric Mfg. Co. |
| 31 Donnan Electric Manufacturing Co. | 32 Radio Corporation of America | 33 G. E. Manufacturing Co. (DeCa) |
| 32 Raven Radio Corporation | 35 Stoll-Plets Tube Corporation | 36 Selden Manufacturing Company |
| 37 Howard B. Jones | 38 Cornish Wire Company | 39 Kellogg Switchboard & Supply Co. |
| 40 American Hard Rubber Company | 41 Formico Insulation Company | 42 Diamond State Fibre Company |
| 43 X-1 Radio Laboratories | 44 Amaco Products, Incorporated | 45 Herbert H. Frost, Incorporated |
| 46 Airzap Products Company | 47 Alden Manufacturing Company | 48 Hart & Hopeman Manufacturing Co. |
| 49 De Jur Products Company | 50 Allen D. Garwood Mfg. Corp. | 51 Precise Manufacturing Corporation |
| 52 | 53 | 54 |
| 55 | 56 | 57 |

* THE FIGURES IN THE FIRST COLUMN OF MANUFACTURERS INDICATE THE MAKERS OF THE PARTS USED IN THE ORIGINAL EQUIPMENT DESCRIBED HERE.

If you use alternate parts instead of those listed in the first column of manufacturers, be careful to allow for any possible difference in size from those originally used in laying out and drilling the panel and sub-base.

which varies in frequency as the drum is rotated. At some intermediate position good volume may be secured without any loss in the quality of the reproduction.

The selectivity of the detector circuit, in all such circuit arrangements, seems particularly poor because no other tuning control is operated from the same drum. If another tuned circuit were operated from the same control and sharply tuned, the "apparent" selectivity would be much better; although the actual selectivity might be the same. The important measure of selectivity is the distance to which all frequency controls must be moved in unison to tune out a station; this gives a measure of the over-all selectivity.

In this receiver the over-all sensitivity and selectivity are quite high and both may be controlled largely by the regeneration control. In adjusting the receiver *both controls should be rotated together*, before judging that the selectivity is inadequate. If it must be increased, either more regeneration may be used or the aerial coupling may be decreased as explained before.

Both the selectivity and the sensitivity may be increased when this is necessary by employing the 200A-type detector tube; this may be used with an "A—" return or with the filament end of the leak connected to this terminal. This greatly increases the grid-to-filament resistance of the detector tube and results in sharper tuning and increased sensitivity.

The All-Electric Everyman Four

(Continued from page 1026)

where the reception of weak signals, is seriously affected. The employment of 227-type tubes in the R.F. detector and first audio stages is the most certain method of forestalling this trouble. As the diagram indicates, and as most radio experimenters know, the 227-type has a five-prong base, thus requiring a special socket to correspond.

The standard 171-type power tube is recommended for the last audio stage; although a 112-type semi-power tube may be substituted, with very satisfactory results, if the "B" supply of the builder does not give the desired 180 volts for the first mentioned tube.

Although the operation of these new A.C. tubes may not be thoroughly understood by the average radio builder, there is nothing about them that need cause uncertainty. The grids and plates are connected in the same manner as in ordinary tubes. The cathode connection is brought out through the socket in the usual way and carried direct to the "CX" terminal. The heater leads connect through the low-resistance rheostats R1 and R2 direct to the proper voltage terminals of the step-down transformer. But these filament leads must be braided, throughout their length, in order to keep the hum at its lowest value.

In a set as simple as the "Everyman Four" it is not necessary to describe the wiring step by step. The pictorial diagram shows all connections, and if these are made in the proper order the completed receiver must of necessity function properly.

OPERATING THE RECEIVER

The operation of the set is as simple as

Let us Send You This Book!



Manufacturers of the Finest Electrical Radio Sets Use Mershon Condensers!

You, too, will find the Mershon invaluable. More efficient than paper condensers, and less expensive.

For "B" Eliminators, Power Supply and Filter Circuits, nothing compares to the Amrad Mershon Condenser, which is self-healing, absolutely unaffected by weather conditions, and has an extremely high capacity in an extremely small space.

Let us send you our new book, showing hook-ups and explaining in full detail the many uses of the Mershon in the field of modern radio. Address Department 18

THE AMRAD CORPORATION

Medford Hillside

J. E. HAFF
President

Mass.

POWEL CROSLY, JR.
Chairman of the Board

90 Vol Power Unit :: \$12.75

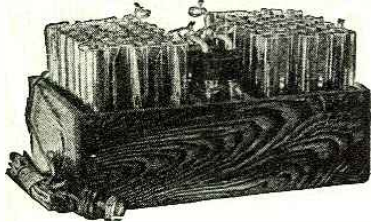

Hums, line noises, etc., positively impossible with this new advanced unit. Plug in and forget. Non-acid and noiseless. All detector and intermediate voltages plainly marked. Simpler to hook up than dry cells. Operates any type set 1 to 12 tubes. Greater volume and clearness guaranteed. If not thoroughly satisfied return after using 30 days for complete refund. Guaranteed further 2 years. For 110-120 volts A.C. 25 to 60 cycle current. 90 volts, \$12.75; 112½, \$15.25; 135, \$17.50; 157½, \$19.50; 180, \$24.00; 202½, \$26.00. Also built for D. C. current 110 and 32 volts at only \$3.00 additional, any size above. Ample stocks—same day shipments. Simply say—ship C.O.D. or write for my interesting literature, testimonials, etc.

B. HAWLEY SMITH

334 Washington Ave. Danbury, Conn., U. S. A.

NOW—

A Single Drum Dial by National Company

—with 360 degree Rotation—easy attachment and, the Velvet Vernier Quality,—just ask your dealer for

NATIONAL

TYPE SD ILLUMINATED VELVET VERNIER DIAL
NATIONAL COMPANY, Inc., Malden, Mass.
W. A. READY, President

Conis

GERMAN 3-COIL UNIT

"Best I ever heard" is what you'll say.

Will stand up. Will not burn out. Marvelous tone and volume. Fully guaranteed. Easy to mount. NOTHING TO IT—BUT THE UNEQUALLED

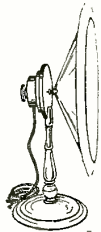

3-Coil Unit.....\$4.95
18-in. Cone Disc.....1.00
Table Stand.....1.00

Or complete.....\$6.95
For 45 in. Floor Stand add....1.00

Dealers Write

FRANK W. WOOD
2100 Gale St., Indianapolis, Ind.
New York
66 Cortlandt St.
Chicago
416 S. State St.

Master the Code

Wireless or Morse—at home with the TELEPLEX Automatic Code instructor. No better method for self instruction exists. Quick—Easy—Thorough. Endorsed by U.S. Navy. The only instrument that REPRODUCES actual sending—messages, radio-grams, etc. Any speed. Complete Course furnished. Thirty times as many words as any other instrument. Avail yourself of the TELEPLEX for a quick mastery of the code. Write for booklet NR—TELEPLEX CO., 76 Cortlandt St., New York, N. Y.

ELKAY EQUALIZORS

and Suppressors are made by The Langbein-Kaufman Radio Co. (Dept. N), 62 Franklin St., New Haven, Conn. Write for prices and tables of values.

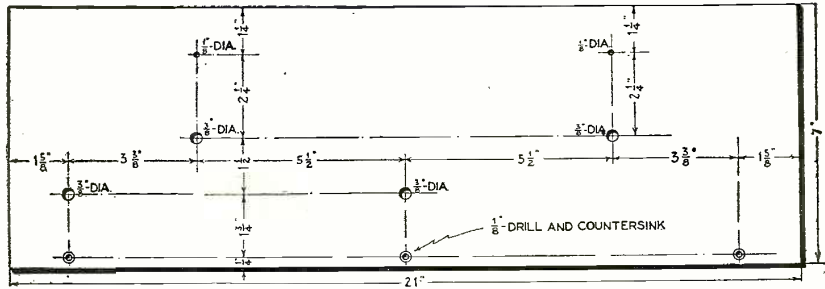

Drilling details of the front of the All-Electric Everyman Four.

the circuit itself. Attach the aerial post to an aerial at least 60 feet long; one of 125-foot length should be even better. Use the customary ground connection, with care that it is a good one. Attach the "B" power unit to the proper terminals. Do the same with the "C" battery taps. Plug the A.C.

transformer into a nearby light socket and turn up the two rheostats about half way. The tubes will light dimly and no sound will come from the speaker for about 45 seconds. Do not attempt to tune in a station for at least this length of time. A low hum coming from the speaker will first

LIST OF PARTS

SYMBOL	Quantity	NAME OF PART	REMARKS	MANUFACTURER ★
L1	1	Antenna coupler	Variable primary (special)	1
L2	1	Plate coil	Tapped (special)	1
L3	1	R.F. choke coil		2 3, 4, 10, 11
T1	1	A.F. transformer	First stage type	2 4, 10, 11, 12, 13, 14, 15, 16, 17, 18
T2	1	A.F. transformer	Second stage type	2 4, 10, 11, 12, 13, 14, 15, 16, 17, 18
F	1	Output filter	Choke-condenser type	2 13, 18, 19
C4	1	Neutralizing cond.	.15 - 25 mf.	2 3, 20
C5	1	Fired condenser	.00025 mf.	2 18, 21, 22, 23, 24, 25, 26, 27, 28, 29
C6, C7	2	By-pass condensers	.5 mf.	2 24, 25, 26, 27, 28, 29, 30, 31, 32
R5	1	Grid leak	3 megohms	2 19, 22, 24, 25, 26, 28, 29, 33, 34, 35
	1	Grid leak mount		2 19, 22, 24, 28, 29, 34, 35
C1, C2	2	Variable condensers	.0005 mf.	3 4, 8, 10, 11, 12, 13, 19, 26, 37, 38
C3	1	Midget condenser	11 plates, 50 mf.	3 4, 11, 37
R1	1	Rheostat	1/2 ohm	4 23, 27, 39
R2	1	Rheostat	1-1/2 ohms	4 23, 27, 39
R3, R4	2	Potentiometers	200 ohms	4 12, 19, 23, 24, 27, 29, 35, 39
	1	Tube socket	UY type	4 4, 11, 17, 19, 35, 39, 40, 41, 42, 43
	3	Tube sockets	UY type	4 4, 11, 17, 19, 35, 39, 40, 41, 42, 43
V1, V2, V3	3	Vacuum tubes	7-227 type	5 34, 44, 45
V4	1	Vacuum tube	771 type	5 34, 44, 45
P	1	Cable connector	7-wire	6 9, 23
	1	Front panel	21 x 7 x 3/16 inches	7 46, 47, 48
	1	Terminal strip	3 x 1 x 3/16 inches	7 46, 47, 48
	1	Rheostat strip	2 1/2 x 10 x 3/16 inches	7 46, 47, 48
	2	Vernier dials		8 10, 11, 12, 18, 51, 52
	1	Baseboard	Wood - 20 x 9 x 1/2 inches	9 30, 35, 49, 50
	1	Connection wire		9 30, 35, 49, 50
	2	Binding posts		40 4, 39, 20
	1	Filament transformer	2.5 volt and 5 volt secondaries	2 4, 10, 11, 13, 51
	1	"B" Power unit	Sec. voltages: 22, 34, 67, 90 and 180. Any good home-made or manufactured unit may be used.	

NUMBERS IN LAST COLUMN REFER TO CODE NUMBERS BELOW.

1 Twin Coupler Company, Inc.	2 Leslie F. Water Company	3 Hamerlund Manufacturing Company
4 General Radio Company	5 C. V. Manufacturing Co. (OsCo)	6 Howard B. Jones
7 Niagara Fabricators, Incorporated	8 Martin Copeland Company	9 Belden Manufacturing Company
10 Sanson Electric Company	11 Silver-Marshall, Incorporated	12 Parsons Electric Company
13 Karas Electric Company	14 Tyrman Electric Company	15 Ferranti, Incorporated
16 American Transformer Company	17 All-American Radio Corporation	18 Electrical Research Labs. (ERL)
19 Amco Products, Incorporated	20 W. L. Radio Laboratories, Inc.	21 Sansano Electric Company
22 Alconoid Radio Corporation	23 Tuxley Manufacturing Company	24 Polymet Manufacturing Company
25 Dubilier Condenser Corporation	26 Tube Deutchmann Company	27 Carter Radio Company
28 Arcovox Wireless Corporation	29 Electrad, Incorporated	30 Acme Wire Company
31 Potter Manufacturing Company	32 John E. Fest Company	33 International Res. Co. (DURHAM)
34 Davan Radio Corporation	35 De Jur Products, Incorporated	36 Camfield Radio Manufacturing Co.
37 Allen D. Cardwell Mfg. Corp.	38 Precise Manufacturing Company	39 Herbert H. Frost, Incorporated
40 H. H. Fby Manufacturing Company	41 Benjamin Elec. Mfg. Company	42 Airsep Products Company
43 Alken Manufacturing Company	44 Radio Corporation of America	45 R. T. Cunningham, Incorporated
46 American Hard Rubber Company	47 Perma Insulation Company	48 Diamond State Fiber Company
49 Cornish Wire Company	50 Kellogg Switchboard & Supply Co.	51 The National Company
52 Brooklyn Metal Stamping Company	53	54
55	56	57

★ THE FIGURES IN THE FIRST COLUMN OF MANUFACTURERS INDICATE THE MAKERS OF THE PARTS USED IN THE ORIGINAL EQUIPMENT DESCRIBED HERE.

If you use alternate parts instead of those listed in the first column of manufacturers, be careful to allow for any possible difference in size from those originally used in laying out and drilling the panel and sub-base.

Form copyright 1927, Ex. Pub. Co.

be noticed; but, as the tubes heat to their proper temperature, this hum will gradually disappear.

Finally, when the 45 seconds have elapsed, rotate the two tuning dials to approximately 50 on their scale. Set the antenna coils at maximum coupling (primary close up against the secondary). Now waggle the two condensers C1 and C2 simultaneously back and forth until a station is heard. If the station comes in with a squeal alter the setting of the neutralizing condenser C3, which is also the regeneration control. A point will finally be found at which the station will come in clear and loud. Retune slightly to get squarely on the station's wave, and regulate the volume by swiveling the antenna coupler. *And, as a last bit of advice, turn the filaments of the A.C. tubes as low as possible without losing signal strength.* This will help tremendously in getting your money's worth from the tubes.

Since the filament of the power tube V4 also is worked direct from a transformer tap, it is necessary only to switch off the current from the light socket when the period of listening-in is over.

Once the proper heating temperature of the A.C. tubes has been worked out, through varying the two rheostats, it should not be necessary to touch them again. But, unfortunately, in some portions of the country the voltage on lighting lines varies within wide limits—particularly during those hours when many consumers are drawing on the power station for energy. If a distinct fading of all signals is noticed, this is a pretty certain sign that the voltage being supplied the tubes has dropped below a point where the heaters are sufficiently supplied. A slight touch on one or both rheostats then becomes essential.

An Emergency Repair of a Burnt-Out Transformer

THE primaries of audio-frequency transformers sometimes burn out when the plate circuit is opened suddenly. In cases like this, possibly the best method for repairing the damage is to obtain a new transformer and to be more careful in the future. However, if a variable high resistor, of approximately 500,000 ohms maximum, is connected across the primary terminals of the broken transformer, this stage may be converted into a resistance-coupled amplifier, and the set may be used in this manner until the new transformer is procured.

Station
WRNY
NEW YORK
326 METERS—920 KILOCYCLES
and 2XAL—30.90 METERS

is owned and operated by the publishers of this magazine
Our Editors will talk to you several times every week—
See your Newspaper for details
TUNE IN ON WRNY

FREE

This Genuine
**Ivoryine
Pocket
Rule**



Get out your pencil and copy the Jack right now

← You get this rule for copying this Jack →



Can you copy it? Try it. How you copy it may give me some idea of what kind of a draftsman you would be. If you are 16 years old or older and will mail me your sketch at once, I will send you, free, and prepaid, a draftsman's Ivoryine Pocket rule, shown here.

This will go to you entirely with my compliments. In addition I will send you my book on Successful Draftsmanship. Don't wait. Copy the sketch now and mail it to me.

Draftsmen Needed In

Auto Work

The automobile industry is one of the greatest in America. Thousands of draftsmen are needed. I'll train you for the work.

Electricity

Electricity is the coming motive force of the world. Draftsmen are needed in every department of this fascinating work. I'll train you at home. Get a job here.

Aviation

Aviation is just in its infancy. It is bound to expand to enormous proportions. Draftsmen are essential to it. I'll train you quick at home for drafting position.

Motor Bus Work

Motor bus building and motor bus transportation have become leading world industries. Hundreds of draftsmen engaged in this work. I'll show you the way.

Building Work

There will always be building. No structure can be erected without plans drawn by draftsmen. I'll make you an architectural draftsman at home.

Get My Free Pay-Raising Plan



Write to me. I will send you this new book. Not a catalog. My Pay-Raising Plan and Money-Making Advice. I can prove that John Savadge, trained by me, makes \$300 a month. Earl J. Dupree, trained by me, refused \$600 a month because he makes more in his own business. A. H. Bernier, trained by me, earns \$7000 to \$9000 a year. Arthur Dewalt, trained by me, makes more than \$400 a month. D. C. Stroop, trained by me, makes \$475 a month. L. V. Broughten, trained by me, makes \$300 a month.

I can give you many more names of Dobe trained draftsmen who are making big salaries. They wrote to me just as I am asking you to write. They asked for my Free Book. They saw that opportunities in all of the great industries were tremendous for draftsmen. Through drafting you can get into almost any industry you want.

Money Back If Not Satisfied

What could be fairer than that? I don't ask you to take any chances. I train you under a positive Money Back Agreement. If my training does not satisfy you after you have finished you get every penny back.

Earn While You Learn

You can start earning extra money a few weeks after beginning my training. I give you special work and tell you how to make money.

Age or Lack of Education No Drawback

You do not need previous experience. You do not need to be a high school graduate. My practical home study course gives you just the kind of training you need to become successful. Your spare time is all that is necessary.

Employment Service

After training you I help you to get a job without charging you a cent for this service. Employers of draftsmen come to me for men because they know that men I train make good.

I Train You at Home, New, Quick, Sure Way

My practical working method makes every step in learning drafting, as clear as a moving picture. That's why I train you so fast to be a draftsman.



You get these tools as my student

You GET THESE FINE QUALITY, GENUINE, IMPORTED DRAFTSMAN'S TOOLS, just as soon as you are my student. No finer tools can be made for practical drafting work.



"I will train you at home." — Engineer Dobe

If You Earn
Less Than

\$70 a Week

Write Me Today!

ACT NOW Before You Put This Magazine Down. Let me send you my books "Successful Draftsmanship" and "My Pay-Raising Plan." Remember Draftsmen are needed everywhere. That's the kind of profession to get into. Get started now. Get into a better position, paying a good straight salary the year around.

Engineer Dobe 1951 Lawrence Avenue Div. 10-03 Chicago, Ill.

FREE RULE COUPON!

ENGINEER DOBE
1951 Lawrence Ave., Div. 10-03 Chicago

Here's the sketch. Send me free rule; also send me free of all cost, books "Successful Draftsmanship" and "My Pay-Raising Plan"—how to earn money while learning and proof of big money paying positions.

Name _____ Age _____

Address _____

Post Office _____ State _____

Radio's Finest Book of Hookups

WHAT more could you ask?—150 of the very finest, selected hookups most popular today. Each one completely explained and fully illustrated so that a complete receiver can be constructed from the information. No out-of-date hookups—all the finest and best in common

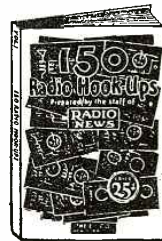

use today. 64 pages, illustrated. Large size, 6 x 9 in. Don't miss this opportunity—All Radio and news dealers have fresh copies Now. If there is no dealer near you write us direct, enclosing 25c.

25c

THE COPY

If your dealer cannot supply you, write direct

THE CONSRAD CO., INC., 230 Fifth Ave., New York City

Get Your Copy
Now!



Practical Radio Advice for all!

Set Construction—The New Shielded LR4, The Loftin-White Constant-Coupled Receiver, The Radio News Batteryless Receiver, Superheterodynes, Neutrodyne, dozens of circuits of all sorts, with diagrams and complete instructions for building.

Construction of batteries.

Construction of Loudspeakers—from ship model to 36-in. cone type.

The construction of anything in Radio—from dials to wave traps—the most modern methods.

Radio Helps of every sort, concerning every radio part—Transformers, Tubes, Shielding, Amplification, Alleviation of Static, How to Install Radio Equipment Permanently, etc., etc., etc.

Radio News
Amateurs' Handibook

116 pages—fully illustrated

It took Radio News to put this invaluable Radio Book before the public. It contains a series of selected articles from Radio News, by the most eminent of Radio Experts.

25c

SOLD EVERYWHERE

If your dealer has none on hand write directly to

EXPERIMENTER PUB. CO., INC.
230 Fifth Avenue New York City

Australian Broadcast Stations

By Raymond M. Bell and
E. R. Midgley

SINCE reception of the Australian broadcast stations has become possible in nearly all sections of the United States, interest in them has been aroused. One of the most interesting factors is the difference in time. The stations in Sydney and Melbourne are 15 hours ahead of our Eastern Standard Time. When it is 9 p. m. in Sydney, it is 6 a. m. the same day in New York. Although the Australian stations can be received any month in the year, March and October seem to be the best months.

The stations of Australia are divided into two classes; Class A stations receive revenue from the license fees charged all owners of receiving sets. Class B stations are not so favored. The list is as follows:

CLASS A		
	Meters	Watts
2FC	Sydney.....	442 5000
2BL	Sydney.....	333 5000
3LO	Melbourne.....	371 5000
3AR	Melbourne.....	516 5000
4QG	Brisbane.....	385 5000
5CL	Adelaide.....	395 5000
6WF	Perth.....	1250 5000
7ZL	Hobart.....	535 3000
CLASS B		
2GB	Sydney.....	316 3000
2KY	Sydney.....	280 1500
2UW	Sydney.....	267 500
2MK	Bathurst.....	275 250
2UE	Sydney.....	293 250
2BE	Sydney.....	316 100
2HD	Newcastle.....	288 100
3DB	Melbourne.....	255 500
3UZ	Melbourne.....	319 100
4GR	Toowoomba.....	294 100
5KA	Adelaide.....	250 1000
5DN	Adelaide.....	313 500

3LO is the most popular Australian station, with 2FC a very close second, and 2BL easily in third position. All other Class A are considered equal, with 5DN and 2UE the best of the B class. This is the approximate order of the stations as regards the service they give. 2BL and 3LO are very good on long distance. 2BL appears to be received better in the United States and Canada, while 3LO is picked up better in Asia. In spite of this, 2FC holds the record, having been picked up in Labrador, and also in England on test. 4QG is good on long distance.

Crystal reception, still common in Australia, is good up to 200 miles from each

station, depending on weather conditions and set. 2FC and 2BL commence broadcasting each morning at 7:00 a. m. and continue with a few breaks until 11:30 p. m. Other "A" stations commence at noon (local time). An Australian station rated at 5,000 watts has an output of about 2,500 watts (U. S. rating). During the past year Australian stations have relayed 2NM, PCJJ, 2XAD, 2XAF, WLW, 2LO, Berlin, Paris, and Daventry.

Among the stations received in Australia, besides New Zealand and United States, are: JOAK 375 meters, JOBK 385, JOCK 360, Japan; 7CA 370, 7BY 357, in India; and Radio-Manila KZRM 413.

Outstanding amateurs in Australia are 3BY, 38W, 3EF, 3BU, all in Melbourne, and 7UX, in Hobart. These experimenters broadcast on 200-300 meters.

The best New Zealand stations are:

	Meters	Watts
1YA	Auckland.....	333 500
2YA	Wellington.....	420 3000
3YA	Christchurch.....	306 500
4YA	Dunedin.....	463 750

Wellington's 2YA is a new station. New Zealand is about 1,500 miles east of Australia, and is an hour and a half earlier in time.

Adelaide is half an hour later in time than Eastern Australia; Perth is two hours later. All the other stations are, as stated, 15 hours ahead of New York's Eastern Standard Time.

A Good Position for the Volume Control

It is often found, when receiving sets incorporating power tubes are used for local reception, that the volume is excessive. The usual method to reduce this volume is to turn down the filament current on one or more of the tubes in the set; but, this sometimes produces distortion and unnatural tone. Possibly the simplest method for controlling the volume without harming the quality is the utilization of a fairly high resistor in the plate lead of the last R.F. tube. This method controls the volume effectively without introducing any noticeable distortion.

you

have never tuned a
radio at its best unless
you have tuned the

SUPER-HILODYNE

A new basic circuit employing nine tubes. World's latest—most acclaimed circuit—the SUPER-HILODYNE—radically new—much in demand—a sure money-maker for custom set builders.

WANTED

POTTER PRODUCTS CORPORATION
245 Fifth Avenue, New York, N. Y.

Gentlemen: Please send me immediately full details of your plan to help me make big profits. I understand this does not obligate me in any way whatsoever.

Name.....
Address.....
City..... State..... R.N-228

We want direct factory representatives in all territories. Write for details and our unusual money-making proposition.

POTTER PRODUCTS CORP.
245 Fifth Avenue, New York City

The Pacent Distant-Signal Amplifier

(Continued from page 1033)

illustrations accompanying this article give proof of the compactness and simplicity of the entire unit.

Careful attention should be paid to the hook-up of the 222-type tube in the circuit, as well as to the layout of parts, and to small details such as the shield over this tube. The shield, incidentally, is essential as well as novel in form. It is required for two reasons: to allow of the speaker being placed in back of the amplifier; and to suppress the tendency of the tube to howl slightly. It further provides protection for the tube against shocks which might result in the filament touching the inner grid and burning out.

The shield consists of the lower part of a metal beverage shaker purchased at the ten-cent store. It serves the purpose admirably and costs only a dime. It is held in place over the 222-tube by means of short studs, secured to right-angle brackets fastened to the bakelite horizontal panel.

CONSTRUCTION OF AMPLIFIER

Layout and mount the parts as shown in the illustration. Pay particular attention to the matter of battery voltages indicated in the schematic diagram. The bias on the 222-type tube is about $\frac{3}{4}$ of a volt when about 27 volts is applied to the control grid. The control grid is the inmost one, which is brought out to the terminal on top of the tube; in this circuit it is used as a "space-charge" grid. (For detailed explanations of this function see pages 896 and 897 of RADIO NEWS for February, and page 763 of RADIO NEWS for January.)

This $\frac{3}{4}$ -volt bias is secured by means of the potentiometer placed in the filament lead of the 222-type tube and connected as shown in the schematic diagram. A slight change is necessary in the 30-ohm rheostat

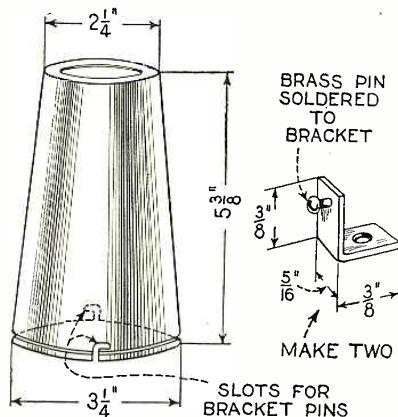

-SHIELD FOR TUBE V1-
DIMENSIONS SHOWN, ARE THOSE OF AN ALUMINUM BEVERAGE SHAKER, WHICH CAN BE PURCHASED.

An aluminum shaker, such as that shown above, with two L-shaped slots, makes an excellent shield for the screen-grid tube.

(R1) to adapt it for use here. The arm is the separate connection and the two ends of the resistance strip have been brought out on separate screws, one of which leads

electrify your set the easy practical Knapp way....

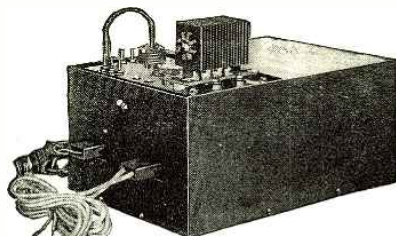

The Kit completely assembled with metal cover in place. Operates on 105-120 volts AC, 50 to 60 cycles.

Knapp "A" POWER KIT

No expensive short lived AC Tubes, no troublesome re-wiring, no annoying hum. Increase instead of decrease the efficiency of your set, no waiting... the Knapp "A" Power gives you music *instantly* at the snap of a switch.

This absolutely dry "A" Power is not in any way a battery combination... not something to add to your battery... it is the most efficient "A" Battery Eliminator ever designed. It supplies unflinching "A" current to any set using 201-A or 6 volt tubes, regardless of number.

Magic Silence

So silent is Knapp "A" Power, that you can place a pair of head phones directly across the output and not be able to detect a hum. This is made possible by the efficient Knapp filter system, consisting of 2 over sized chokes and 2 condensers of 1500 microfarads each. A new discovery makes these amazing capacities possible in the small space of 2x2x8 inches!

Absolutely Dry

There is not a drop of moisture in this absolutely dry unit. The condensers are baked so that not a drop of moisture remains. The unique, fully patented, solid, full-wave rectifier is absolutely dry. No water... no acid... no alkali... no tubes... no electrolytic action. Nothing to get out of order. Nothing that needs attention.

Assemble in Half an Hour

The Knapp "A" Power Kit is so easily assembled, that within half an hour after you receive it you can have it in operation. The parts seem to fall in place, No drilling and very little soldering. Everything supplied, even to the screws, wire, drilled base-board and metal cover. It is so complete, that even a plug is supplied so that a "B" Eliminator may be operated from the same switch. We have never seen such simple instructions.

Big Profits for Set Builders

Our president, Mr. David W. Knapp, is offering the set builders of America, for a limited time only, a money-saving, profit-making plan which is unique in the annals of radio. Send the coupon today, before it is too late.

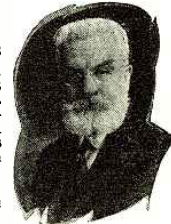

Knapp Electric Corporation
Port Chester, N. Y.

MR. DAVID W. KNAPP, Pres.

Knapp Electric Corporation
311 Fox Island Road,
Port Chester, N. Y.

Send me complete information regarding the Knapp "A" Power Kit and your special discount to Set Builders.

Name.....

Address.....

LIST OF PARTS

SYMBOL	Quantity	NAME OF PART	REMARKS	MANUFACTURER *
T1	1	A.F. transformer	3:1 ratio	1 17, 23, 24, 25, 26
T2	1	A.F. transformer	(Connected as autoformer)	1
T3	1	Output transformer	1:1 ratio	1 17, 23, 24, 25, 26
R1	1	Rheostat	30 ohms	1 17, 18, 29, 30, 31, 19, 38
R2	1	Grid leak	0.25 to 0.5 megohms	2 4, 18, 19, 30, 31, 34, 35, 37, 39, 40
R3	1	Amperite	5 volts, 1/2 ampere	3
C1	1	Fixed condenser	0.1 mf.	4 9, 27, 30, 31, 34, 35, 36
J1, J2	2	Jacks	Single circuit type	1 27, 28, 29, 31
V1	1	Vacuum tube	222 type (screen-grid tube)	5 20, 21
V2	1	Vacuum tube	171 type	5 20, 22
	2	Tube sockets	UX type	1 7, 17, 18, 19, 23, 25, 29, 32, 33, 38
	4	Grid leak clips		6
	8	Binding posts		7 16, 17, 18, 19
	1	Sub-base panel	7 x 12 x 3/16 inches	8 13, 14, 15
	4	Rubber fast		
	1	Beverage shaker		
		Connection wire	Insulated	9 10, 11, 12, 38

NUMBERS IN LAST COLUMN REFER TO CODE NUMBERS BELOW.

1 Pacent Electric Company	2 International Pesis. Co. (MURRAY)	3 Radiall Company
4 Tobe Deutchmann Company	5 Radio Corporation of America	6 Sansone Electric Company
7 H. B. Eby Manufacturing Company	8 American Hard Rubber Company	9 Acme Wire Company
10 Belden Manufacturing Company	11 Cornish Wire Company	12 Kellogg Switchboard & Supply Co.
13 Micerita Fabricators, Inc.	14 Formica Insulation Company	15 Diamond State Fiber Company
16 E. I. Radio Laboratories	17 General Radio Company	18 Amoco Products, Incorporated
19 Hart & Hanson Manufacturing Co.	20 F. T. Cunningham, Incorporated	21 Shield-Plate Tube Corporation
22 C. F. Manufacturing Co. (CeCo)	23 Silver-Murshall, Incorporated	24 Ferranti, Incorporated
25 Tyrman Electric Company	26 Bremer Tully Manufacturing Co.	27 Carter Radio Company
26 Vexley Manufacturing Company	29 Harbath H. Frost, Incorporated	30 Polymat Manufacturing Co.
31 Electro, Incorporated	32 Benjamin Elec. Mfg. Company	33 Airzer Products Company
34 Dubilier Condenser Corporation	35 Argovox Wireless Corporation	36 John P. West & Company
37 Arthur H. Lynch, Incorporated	38 De Sur Products Company	39 Rayan Radio Corporation
40 The Carborundum Company	41	42
43	44	45

* THE FIGURES IN THE FIRST COLUMN OF MANUFACTURERS INDICATE THE MAKERS OF THE PARTS USED IN THE ORIGINAL EQUIPMENT DESCRIBED HERE.

If you use alternate parts instead of those listed in the first column of manufacturers, be careful to allow for any possible difference in size from those originally used in laying out and drilling the panel and sub-base.

Form 100-1071, 1927, K. B. Pat. Co.

FERBEND LEADS AGAIN!



NOW!—Lowest-Priced Quality Tube "B" \$18.50 Eliminator

Since 1921 Ferbend Products have been famous for outstanding quality and long-life efficiency at lowest prices—prices "Within Reach of All."

The new HEAVY DUTY "B" Power Unit is no exception. In workmanship, performance, materials and appearance it is the equal of any. We INVITE comparison.

SEE YOUR DEALER, OR SEND DIRECT

Shipment will be made upon receipt of price or C. O. D. Use for thirty days to convince yourself—then if not satisfied write us within that time and purchase price will be refunded. Order today.

Complete,
Including
Long Life Perfected 85 MIL. TUBE
Delivers up to 180 volts on any set
NO LIQUIDS OR ACIDS

30 Days' Trial

FERBEND ELECTRIC COMPANY
425 WEST SUPERIOR STREET CHICAGO, ILL.

Natural Tone

Majestic Cone

Designed for use with or without power tubes
Reproduces music or voice exactly as it comes from the broadcasting station. A full, rich, pure tone, free from distortion.
A beautiful cone, 12 in. in diameter, ruggedly constructed, laminated wood frame and metal base, with sensitive, adjustable unit, finished in rich mahogany. Packed individually in fibre air-cushion cartons.
Standard package of 6.

PRICE.....\$2.75
Write for Other Special Bargains Now to
SPIEGEL RADIO COMPANY
135 Liberty Street New York City, U. S. A.
TERMS: 2% Discount Allowed on C. O. D.
3% Discount If Cash Is Sent With Order

\$1.00 WILL SAVE YOUR SPEAKER

The Craftsman Dollar Speaker Filter is Guaranteed to relieve your speaker of the DC plate current (up to 250 volts). It gives speaker a chance to operate at its best. Attached in a second. Send dollar bill NOW!

CRAFTSMAN RADIO PRODUCTS
9 Orchard St. Newark, N. J.

Balkite

Radio Power Units

Fansteel Products Co., Inc., North Chicago, Ill.

SET BUILDERS BIG DISCOUNTS

Big New 1928 Catalog—Shows latest A-C circuits, newest ideas, 4000 leaders. Get sets and parts you want here. Save money. Parts, kits, complete factory-built sets, supplies. Quick service. Write for free copy. Standard discounts to dealers, set builders, agents. Barawik Co., 129 N. Jefferson St., Dept. 803, Chicago, USA.

to the filament, the other to the battery. The arm connects to the "F—" point of the input transformer.

With the 30-ohm rheostat R1 in the filament leg, the voltage applied to the tube is too low; so a section of the resistance wire is shorted by means of solder. The actual resistance in the strip required to secure three volts for filament use is 22 ohms. This gives a potential about 0.3 of a volt low; but it tends to increase the tube life without materially decreasing its efficiency in the amplifier circuit.

The adjustment on the potentiometer is made with the knob in the center of the baseboard, on top, between the two tubes.

Those who want to save much time and experimentation will do well to follow to the letter, directions in regard to the amplifier. Inductance values in transformers are highly important; so are voltages; so is layout of parts. The 222-type tube functions in excellent fashion and the best arrangement is shown here. Many hours of conscientious laboratory work have gone into the development of this new distant-signal amplifier. You can save endless trouble by following the diagram and specifications—and that goes down to the ten-cent beverage shaker.

MOUNTING AND WIRING PARTS

From the drawings and diagrams accompanying this article it should be easy for the builder to construct an amplifier which will immediately duplicate the results secured with the original. The layout shown in the drawings is unusually compact, yet one which calls for no difficult or intricate wiring. If this placement of apparatus and general wiring plan is followed, the top of the completed amplifier will be quite free from wiring.

On top of the horizontal panel mount the three transformers, the two input types and the third the output type. At the rear of the panel go the eight binding posts for battery connections. For convenience in wiring, these may be mounted in the order indicated in the drawing.

The two tube sockets mount near the front of the panel, through which a hole 1 1/8 inches in diameter is drilled for each socket; and the socket is mounted from the under side of the panel, with the cushioned receptacle coming about flush with the top.

SHIELD IS NECESSARY

The builder should not regard the shield over the 222 type tube as a useless novelty in any sense of the word. Its use is absolutely imperative; for, without it, when the amplifier is operated there may be heard squeals or stray howls which are attributable purely to the lack of a shield over the screen-grid tube. The shield shown in the sketch makes about as handy a one as you can get. It costs only a dime at any five-and-ten-cent store, and does the work just as well as a more expensive one.

The potentiometer, R1, mounts between the two tube sockets and on a line with them. The position of the two fixed resistors R3 and R2 is clearly indicated.

To allow satisfactory mounting of parts under the bakelite panel and to allow clearance for these parts when in place, it will be necessary to use four rubber mounting feet, one at each corner. The use of these also puts a nice finishing touch to the whole job and, since the amplifier is not very

heavy, helps to keep it from slipping or sliding on a slippery surface.

Mount the parts under the panel exactly as shown in the pictorial sketch of this part of the assembly. With the arrangement shown, the wiring can be readily kept short and direct, with the finished job a very neat and workmanlike one. Flexible rubber-covered wire will be found excellent for the actual work of connecting the various parts.

POINTERS ON OPERATION

While 22 volts and 135 volts are shown for the inner grid and the plate, respectively, voltages of 45 and 180 may also be used, if desired.

By using a higher value of grid leak (1 to 2 megohms) and allowing distortion in the last tube, due to the large signal voltage built up, and the time lag of the grid leak, a very good code amplifier is secured.

The maximum value of the amplification securable is a function of the grid leak of the 171-type tube. When this is high, allowing the full effect of the high inductance used in the plate circuit of the 222-type tube to come into play, the signal voltage becomes greater than the allowable grid-voltage swing of the 171-type tube.

The whole unit is controlled by the inductance of the coupling unit and the value of the grid leak, which forms the shunt circuit for the choke.

While if necessary, a value as low as 25,000 ohms may be used for grid leak with good volume and tone, it is better to employ a leak of at least 150,000 ohms. If time lag seems great, due to using a large value of resistance for grid leak, this may be partly overcome by increasing value of bias from a normal of 45 to about 60 volts.

The "Screen-Grid" Tube

THE new four-electrode vacuum tube used in several circuits described in this issue, and which was designated in the January and February numbers of Radio News as the "shielded-grid" tube, will hereafter be known as the "screen-grid" tube in the editorial columns of this magazine. The proper designation of this interesting device has been the subject of much discussion in the Radio News office, and varying opinions were expressed by the members of the editorial staff. The term "screen grid" was finally chosen because the leading tubes of the type are so marked and marketed. "Screening," in British radio parlance, is the equivalent of "shielding."

Readers are advised that in other publications they may see this same tube referred to as the "screened-grid," "shield-grid," "shielded-grid," "shield-plate" or "shielded-plate" tube.

FOR SAFETY'S SAKE

A note of caution: Some experimenters have reported unexpected burn-outs of the screen-grid tubes, caused evidently by contact between the grid elements and others. Before putting a new tube of this type into service, it is a good idea to test all the contact pins in relation to each other with a six-volt battery. The filament should light only when the battery wires are touched to the filament pins. If any other connection flashes the filament or if there is a circuit between the screen grid and the control grid or the plate, the tube is defective.

The Girl on the Cover --- Caroline Andrews

IF a canvass of all the female artists on the air were made, it is doubtful whether one would find a more popular or a more distinguished voice than that of Caroline Andrews, the "Lark" of Major Bowes' "Capitol Family," which broadcasts every Sunday evening through the WEAF chain.

Miss Andrews has a distinguished musical career to her credit, boasting association with such nationally-prominent organizations as the DeKoven Opera Company, Philadelphia Opera Company, St. Louis Municipal Opera Company, and more recently, with "The Student Prince" operetta. She really began "backstage" at the age of five, with the opera company in which



her mother was singing. She used a wardrobe trunk for a stage and sang the "Jewel Song" from "Faust," and the "Last Rose of Summer" to the delight of the adult members of the company. It was when the late Reginald DeKoven engaged her for his own opera company in revivals of his famous operas, "Robin Hood" and "Rob Roy," that Miss Andrews reached the rank of prima donna, singing the soubrette role with sensational success from coast to coast. Then, at the Philadelphia Grand Opera season, in a company composed of Chicago and Metropolitan Grand Opera stars, Miss Andrews divided the honors with Florence Easton and Ricardo Martin in "Carmen."

The millions of radio fans who listen-in on the Capitol "Family" look forward to the weekly appearances of Miss Andrews, whose glorious coloratura soprano is equally delightful whether heard in an ambitious operatic aria or a simple, lovely ballad or folk-song.

A SLIGHT DIFFERENCE

ANN: "Is your neighbor's set portable?"
TENNIE: "No, insupportable."

—Gleason Pease.

Australian Short Waves

AMERICAN short waves have been re-broadcast in Australia frequently, and recently the compliment was returned at Schenectady. Both Sydney and Melbourne put frequent broadcast programs on the short waves. Melbourne's 3LO transmits regularly Monday on 36 meters (at hours corresponding to 1:30 to 3:30 P. M. Sundays, Eastern Standard Time) and will be glad of reports from listeners.

Japanese Aerial Radio

PUBLIC telephone and telegraph service is now available from the Japanese airplane "Naniwago," whose call letters are her name, and whose transmitter operates on the standard 600 and 900 meters. This is the first such service in Japan, if not in the world. The plane is owned by the Nippon Koku Kabushiki Kwaisha, or Japanese Aviation Co., Ltd.—T. Yamada.

Much Heat Liberated in Power Units

WHEN rectifier tubes of some larger types are used in power-unit circuits, it may be noticed that they heat up excessively. It is a good plan, in such a case to place a piece of asbestos between the tubes and the other apparatus in the power unit to prevent damage. The importance of ventilating apparatus which is generating such a quantity of heat is apparent.

"Microphonic" Noises

VERY often in amplifying circuits where "high- μ m" tubes are used, a howl is noticed in the loud speaker, which is not changed by adjustments of the receiver. If this happens the tubes are said to be "microphonic." This condition can usually be corrected by moving the reproducer away from the receiver; although it may be necessary to mount the tubes on sponge rubber to dampen the vibrations. There are on the market at present several types of shock-proof sockets which are helpful in preventing this microphonic ringing. Exchanging tubes in the sockets is also helpful in some cases.

Pepping Up the Veteran Radio Tubes

A SIMPLE and efficient method of rejuvenating tubes which have "gone dead" is to turn their filaments up to normal brilliancy and then to reverse the polarity of the "B" battery, connecting its positive terminal to "A+" and its negative to the lead which is normally connected to the "B+." The tubes should be left connected in this manner for a full hour; the filament current should then be turned down to the lowest point and left this way for another half hour.

In cases where the tubes are unusually poor, the treatment may have to be repeated. After the tubes have been allowed to cool off, the batteries should be connected in their correct manner. It should be borne in mind that some types of tubes are not suitable for rejuvenation; such are the 200A, and certain power tubes.

MAGNAVOX



R500 Unit

Dynamic Power Speaker

and power amplifier combination

THE wonderful Magnavox Dynamic Speaker, with a matched power unit, self-contained on steel frame, is ready for installation in any radio set or phonograph cabinet having space available of 14 in. wide and 12 in. high.

Power unit for 105-125 volts 60-cycle A. C. supply. Requires one 316B type rectifying tube and one 310 or 210 type amplifying tube. Can replace last audio tube of set or use all tubes of the set. For use with phonograph electrical pickup head; two additional audio stages recommended between pickup and R500 unit.

Only the dynamic type of speaker can bring out the full qualities of reproduction demanded today. With this carefully matched power unit the combination is the highest grade of radio device. Price \$120 for complete unit less tubes. Write for speaker bulletin.



Loboy Cabinet

LOBOY MODEL
R500 Unit in handsome cabinet, finished in rich old English brown mahogany. \$165.00, less tubes.

The Magnavox Company
Oakland, California

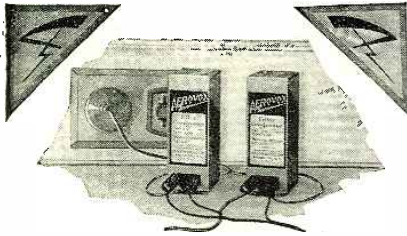

More Silent Operation

THE radio frequency bypass system illustrated will be of interest to all who use "B" Eliminators.

It increases receiver selectivity by excluding interfering radio signals picked up by the house power system. It makes possible more silent receiver operation by bypassing noise signals found in the power supply.

The condensers are of 1 mfd. each and rated at 220 volts A. C.



70 Washington St. Brooklyn, N.Y.

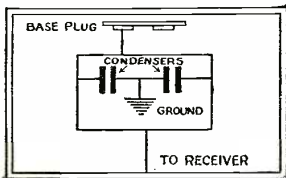

Write for literature and Aerovox "Research Worker"

Sovereign

A C

HEATER TYPE STANDARD SOCKET

Tube

More "Pep"

WITH SOVEREIGN A. C. TUBES

In addition to freedom from all "A" Batteries or "A" Battery Eliminators—freedom from hum—noise—microphonics—Sovereign A-C Tubes will make your set seemingly 100% more powerful. Full, rich, clear-toned music.

Tubes will not paralyze when voltage changes.

Write for treatise on how to easily convert your set to A-C power.

SOVEREIGN ELECTRIC & MFG. CO.
125 N. Sangamon St., Chicago, Ill.

FREE RADIO CATALOGUE

To Dealers—New, illustrated 1928 Wholesale Radio Catalog gives lowest prices on accessories, kits, packs, parts and sets. Features master-built single control radio sets for both battery and all-electric operation. Full showing of "A" and "B" Eliminators and thousands of other great values. Write on business letter-head for this free book today.

HAMILTON-CARR RADIO CORPORATION
711 West Lake St., Dept. 396, Chicago, Ill.

A Novel System of R.F. Stabilization

RADIO amateurs, who are always looking for a new circuit with which to experiment, may find the system shown in the accompanying diagram very interesting. It provides a new method for preventing oscillations in the radio-frequency stages of a set, and it may be adapted readily to a large number of receiving circuits.

Several advantages are claimed for this system by its originator. In the first place, it is said to be entirely automatic, and does not require the adjustment of control; not even when the tubes have been changed for others of different characteristics. Secondly, energy which is usually lost in other systems of neutralization is employed in this circuit to increase the amplitude of the signal.

Señor Alfredo Pujol of Barcelona, (Spain), is the inventor of the circuit described here, and has filed an application for an American patent on this system. For the operation, it is explained that the Pujol method overcomes the effect of the plate-grid capacity of the radio-frequency amplifier tubes by providing the filament of the tube with a radio-frequency potential of a value equal to that of the plate circuit but with a lag of half a cycle. Thus the grid

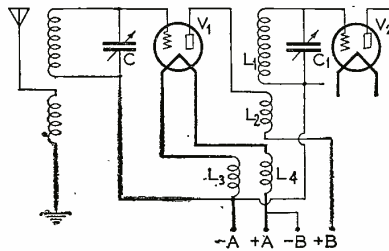

This circuit contains the novel idea of a coupling coil in the filament ("A") circuit.

of the tube receives from the filament impulses in one direction, and from the plate impulses in the opposite direction, with the result that equilibrium follows.

In order to secure this effect it is necessary to couple closely a coil, connected in the filament circuit, to the primary winding of the radio-frequency transformer. The coil in the filament circuit has two windings (both wound in the same direction) having each inductance equal to that of the primary of the radio-frequency transformer. The filament of the tube is in series between the two windings; and the "A" battery is connected to the two remaining free terminals of the coil.

In the diagram L1 and L2 are the secondary and primary windings, respectively, of the radio-frequency transformer which couples tube V1 to tube V2. This R.F. transformer is of standard design, and its secondary winding is tuned to the desired wavelength by the condenser C. Closely coupled to this transformer is the coil in the filament circuit, with the two windings L3 and L4. One winding is connected in each leg of the filament, as shown in the diagram. For successful operation, L3 and L4 must have each exactly the same inductance as L2. In operation, the degree of coupling between L3-L4 and L2 is varied until the desired results are obtained.

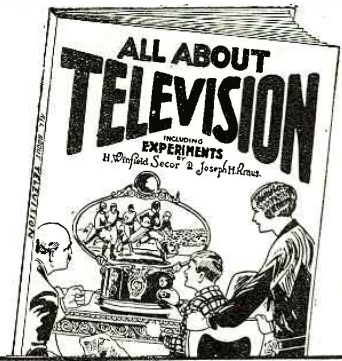

TELEVISION

Wonder of the Age
It soon will be in
full swing!
be a pioneer—
build your own

Excerpt from Science & Invention:

"Television may solve star secrets. Color images of planets can be broadcast from observatories and flashed on screen at distant points."

—Donald H. Menzel, Ph.D.
Lick Observatory

Scientific men the world over are directing their attention to this discovery of the age—Television. Everything points to its becoming as world-wide as Radio.

Get into this interesting subject, and take an active part in the important experiments that are being conducted daily.

In its infancy as it is, you may unearth an important discovery that will reap a good profit.

This book — ALL ABOUT TELEVISION—will enable you to build a fine workable set.

116 pages, 9 x 12, illustrated

Start Now!

50c

on the newsstand
or use coupon

EXPERIMENTER PUB. CO.,
230 Fifth Ave., New York, N. Y.
Gentlemen: I enclose 50c. for one copy of TELEVISION.

NAME.....

ADDRESS.....

CITY.....STATE.....

That British Sense of Humor

"JUST about the last kind of receiver I would put in the hands of a boy or enthusiastic beginner is one of these swinging-coil plain aerial affairs," says Thermion, in *Amateur Wireless* (London). "Yet the B. B. C. scatters these circuits abroad, stamps them with its official seal, tells us that they are the goods—and then becomes worried over an increase in the matter of catcalls, chirps, squeaks, yells, howls, and moans that in some localities accompany its transmissions." Pausing to insert a tongue in a cheek, the Englishman then jibes: "Circuits such as these could not be tolerated for a moment in America."

Manchuria to Germany

THE longest regular radiophonic service which has yet been established, is reported in effect since December 2nd between Mukden and Berlin, according to the news bulletin of the Department of Commerce. It does not appear whether this is a single span by radio, or whether there are links of land lines.

Short Waves in a Mine

WHILE experience with short waves has been that those under five meters are absorbed by the ground, so that communication beyond a point of visibility is almost impossible, an Indian experimenter will test them between the ground and the workings of a coal mine near Calcutta, in the hopes of perfecting a means of communication between the surface and points underground.

What's in a Name?

THERE is a professional distinction between a "journalist" and a "newspaper man." Perhaps something of the kind is intimated in the suggestion to a Melbourne, Australia, station that those who describe sporting and other events in progress as they occur, over the radio, be known as "radiographers." Whether they will rank above or beneath announcers is not stated; but it will doubtless be a moot point.

If and When

The *Atlanta Constitution* wonders whether a radio announcer, when he says his prayers, asks the Good Lord, from force of habit, to "please stand by." Probably he does, and also politely suggests, if the Lord likes his prayer, "to kindly write or wire in and say so."—*Washington Post*.

For DX Listeners

THE Australian station 4QG, Brisbane, announces "Australia" after its call letters, for the benefit of listeners in America and elsewhere who may be tuning in for distance. As the number of short-wave broadcasts in America increases, a similar precaution may be desirable in this country.

Short-Wave Radiophony

STATION WND, Ocean Township, New Jersey, supersedes 2XG as a call. This station is in transatlantic communication on 13.88 and 46.48 meters.

Presidential Station

The radio station aboard the President's yacht, the *Mayflower*, has the call letters NJV.

Day vs. Night Reception

IT is reasonably certain that long-wave daylight radio signals both from distant stations and from those only two or three hundred miles away were stronger in 1927 (when the eleven-year sunspot cycle was near its maximum) than in 1923, when it was at its minimum, according to Dr. L. W. Austin and Miss I. J. Wymore, of the Bureau of Standards.

On the other hand, Dr. Greenleaf W. Pickard has shown that at night, in the broadcasting range, signals grow weaker when the number of sunspots increases. Hence it appears that the effect of solar activity on signals is reversed when day gives place to night. This corresponds to the conclusions of the engineers of the Bell Laboratories, that magnetic storms, which are known to be connected with sunspots, weaken medium- and long-wave signals at night and slightly strengthen them in the daytime. The evidence regarding the influence of magnetic storms and solar activity on ultra-short waves is somewhat conflicting.

Excuse It, Please!

THE cactus-lined earphones go to a Dutch telephone operator for the prize wrong-number stunt of the century. A resident of The Hague picked up his phone and asked for a number in Amsterdam, according to *Wireless World*. After having his ear filled with the usual number of splutters he heard a voice saying "Hello!" or the Dutch equivalent thereof.

"Hullo," he inquired, "is this Amsterdam?" "No," replied the voice, "this is Bandoeng" (on the island of Java.)

The telephone operator had inadvertently switched the subscriber to the input side of the powerful radiotelephone station at Eindhoven, Holland, which communicates with Java and other points on the other side of the world. Isn't that enough to jar a resident of Leyden?

The Kilowatt as a Measure of Enthusiasm

RADIO statisticians who try to determine the relative popularity of broadcast features have a new measuring stick to work with: the kilowatt-hour. According to Arthur Williams, vice-president of the New York Edison Company, New Yorkers burned up \$6000 worth of extra electricity the night of the Tunney-Dempsey fight, listening to the radio description of the battle and staying up to read the newspaper accounts that appeared shortly afterward. The extra load carried by the company's generators did not fall off until three o'clock the next morning.

Broadcasting in Russia

THERE are 56 broadcast stations in the Union of Soviet Socialist Republics, (U. S. S. R.) Of these nine are in Moscow and five in Petrograd. In sending your report cards to these stations don't address them to "Russia;" they will be returned.

Praise from the Master

THE United States has progressed in radio until it is ahead of all the other nations of the world, stated Senatoro Guglielmo Marconi on the occasion of his most recent visit to this country, early this winter.

Proven Parts That Are Popular With Set Builders

*Bradleyunit-A



provides the ideal resistance for B-eliminators requiring fixed resistors of permanent resistance value. Not affected by age, temperature or humidity. Will not deteriorate in service.

*Bradleyohm-E

provides accurate plate voltage control for B-eliminators. Used extensively by B-eliminator manufacturers. Not affected by time or moisture.

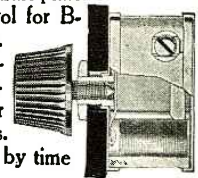

*Bradleyleak

A variable grid leak that assures the ideal grid leak value. Easily installed on any set. Enables operator to get the best possible results with any tube.



Bradleystat

This pioneer in filament control of radio tubes is still mighty popular. Provides noiseless, stepless filament control for all tubes. Try a Bradleystat on your next set.



Allen-Bradley Co.

Electric Controlling Apparatus
MILWAUKEE, WISCONSIN



**PACENT
No. 322**

**Distance
Signal
Amplifier**

Pacent Transformers plus
Pacent Cushion Sockets plus
CX322 or UX322 Shielded
Grid Tubes plus Pacent En-
gineering made possible the
design of the

**DISTANCE SIGNAL
AMPLIFIER**
Described in Radio News

Pacent Electric Co., Inc.
91 Seventh Ave. New York, N. Y.

**World Broadcasting—A
British Proposal**

“DON’T you think it is high time we wakened up from our typically British apathetic attitude towards the infinite possibilities of a system of Empire or even world broadcasting?” inquires the vivacious “Halyard,” who enlivens the pages of *Wireless Magazine* (London) each month. “I certainly thought so recently when I read through a fascinating article on this important subject in an *American radio periodical*.” (Modesty forbids us from naming the writer and the magazine; but the readers of our September issue will probably guess.—EDITOR, RADIO NEWS.) “The writer of the article I have in mind

don’t you think that we ought to be able to reply with something of the same kind from this side of the Atlantic?

“What about it, then? Shall we go in for a double, treble, or some higher-ble super-station at Daventry which will tell the whole world of the greatness of Britain and the British Empire? We have the Rugby station as some kind of a start for such a scheme.

“As an alternative, we might work out our scheme in terms of beam transmissions from England. There are, or soon will be, efficient beam-transmitters to North America, Australia, South Africa, India, South America, and Egypt.

“Looking at a map of the world, it seems to me as if we have, in the above-mentioned beam transmissions, the basis of as fine a

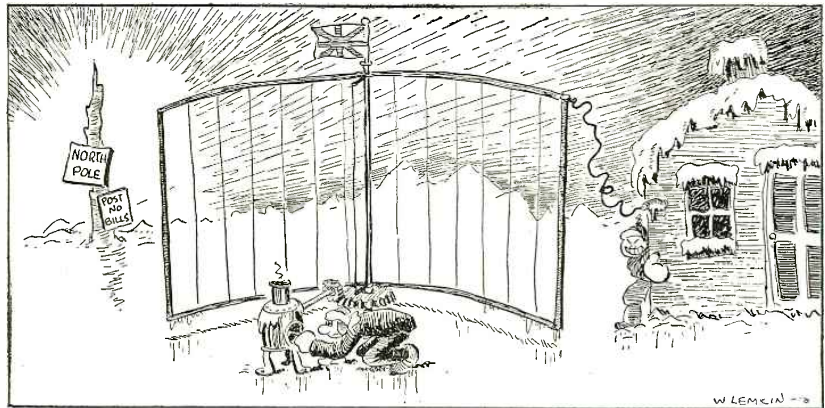

The Radio Engineer thaws out the gear at 28 days past April, North Polar Time.

CONTROL your AC TUBES!

JUS- CONNECT A
**VOLUME CONTROL
CLAROSTAT**

across antenna and ground binding posts of your set. Now you have distortionless control that gives you anything from full output to mere whisper, from dance music for shuffling feet, to soft background for dinner conversation. All for \$1.50, and instantly applicable to any receiver!

AGAIN, your A-C tubes must be operated at correct voltage. Yet line voltage fluctuates. The solution here is a Power Clarostat (25-500 ohm range), connected in primary circuit of power transformer. You can instantly adjust all A-C tubes for required voltages at one operation. Applicable to any A-C tube set. And all for \$3.50!

Write for data on how to improve your radio, whether A-C or battery operated. And when you buy Clarostats, be sure you get the genuine, in the green box, and name Clarostat stamped on nickle-plated shell.

AMERICAN MECHANICAL LABS., Inc.
Specialists in Variable Resistors
285 North 6th Street, Brooklyn, N. Y.

said that, when it comes to telling the rest of the world about the greatness of America and its achievements, radio has as yet a great and important duty to fulfill.

“To provide the world with American broadcast transmissions, this writer put forward a plan for the erection of five super-stations of immense power. Four of these stations would be placed at the corners of the United States, and these four corner stations would work on the beam-transmission system.

scheme for broadcasting to the whole world as could possibly be devised.

“Our North American beams could be made to cover the whole of North America. Our Australian beam could be made to cover Australasia, our South African beam Africa, our Indian beam Europe and Asia, and our South American beam Central and South America. We should scarcely want the Egyptian beam.

WHILE THE WORLD GOES 'ROUND

“George has a beaming scheme up his sleeve. It consists of two twenty-four-hours-a-day-continuous-programme-revolving-beam transmitters, one at the North Pole and one at the South Pole, the stations revolving on the earth’s axis so as to throw their beams always along the daylight zone. I can’t imagine a radio engineer wanting to live at the North Pole or the South Pole, though.”

AN EMPIRE SCHEME

“If an American writer can put forward such a fine scheme of world broadcasting,

you have never heard radio at its best unless you have heard the **SUPER-HILODYNE**

A new basic circuit employing nine tubes. World’s latest—most acclaimed circuit—the SUPER-HILODYNE—radically new—much in demand—a sure money-maker for custom set builders.

WANTED

POTTER PRODUCTS CORPORATION
245 Fifth Avenue, New York, N. Y.
Gentlemen: Please send me immediately full details of your plan to help me make big profits. I understand this does not obligate me in any way whatsoever.

Name.....
Address.....
City..... State..... RN-228

We want direct factory representatives in all territories. Write for details and our unusual money-making proposition.

POTTER PRODUCTS CORP.
245 Fifth Avenue, New York City

**An Effective Regeneration
Control**

ONE of the simplest and most effective methods of controlling oscillation in radio-frequency circuits is to connect a midget variable condenser and a variable high resistor across the grid and plate of the radio-frequency tube. An ideal arrangement consists of a .00025-mf. condenser together with a universal-range resistor, wired in series and connected to the grid and plate terminals of the tube socket. The instruments should be mounted close to the tube, to keep the radio-frequency wiring as short as possible.

Radio "Bugs"

"I AM sorry," says Entomologist Harry Shive, of West Pittston, Pa., "that in my adventures in Radio Land I did not have my camera with me; but as soon as I returned home, I made a drawing for RADIO NEWS of the most amazing animal I saw there; it is known as the Battery Charger. It is very wild and vicious; its rider is called a vibrator. Its diet consists wholly of full-grown cycles and volts, which it consumes in quantities of 60 of the former

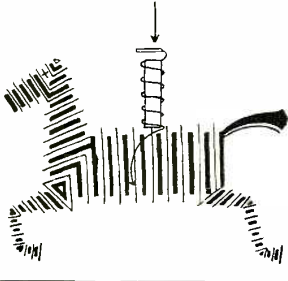

to 110 of the latter. Sometimes the vibrator holds his charger still, and a battery can approach within a few inches in perfect safety. But this is only when the vibrator is externally indisposed. The vibrator, as you know, is quite a villain in Radio land, and I hope you agree with me that there should be a law passed therein, causing the death or expulsion of every vibrator therein or therefrom."

A pathetic scene is often seen on the highways of Radio Land, a puny, over-worked tube pulling a huge loud speaker.

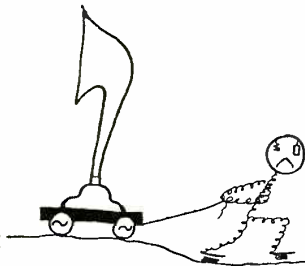

The look of despair on the face of a poor little 199 was noted and put on paper by Brinton Sullivan, of Macomb, Ill. It is recommended that an able-bodied 210 be given the job of pulling, with an equally hefty brother to do the pushing. The ayes have it.

Much conjecture has been occasioned as to the latest output in the form of flivvers.

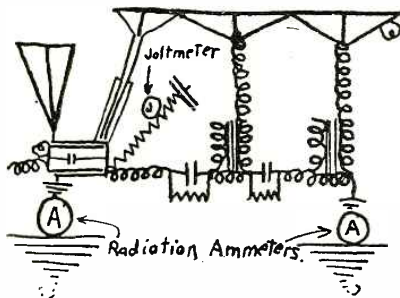

The special model designed for the use of Radiolanders is illustrated here; and a spe-

cial type of meter is required for the circuit. The collaborating engineer, Jack Shields of Los Angeles, suggests that this type be known as "Henry's Farad." That will be all from you for the present, Jack.

F. C. Houghton, of Newark, Delaware, has an eye for bathing beauties. Here is

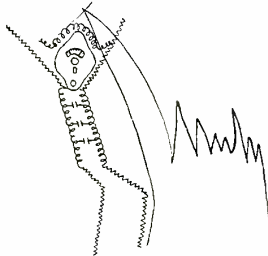

a filter hesitating on the beach at Capa City. "A wave met 'er," explains our artist, "but fortunately for her it wasn't a continuous one." The same pen sketches a scene of domestic discord, and comments: "This powerful transformer is especially efficient in amplifying distress signals." We

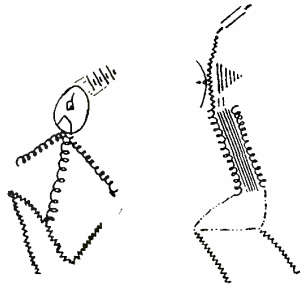

would say that the transformer is doing very well, but the rectifier seems to be in for a session with the radio doctor.

Another of the strange beasts in the forests of Radio Land is known to zoologists as Phonae Resisticus. He prowls around, especially at night, looking for his prey, commonly called signals—the weaker the better—and when he finds one that seems a long way from home, he pounces upon it. This specimen was captured—

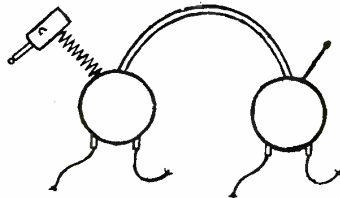

alive—by Robert L. Hood, of Pittsburgh, Penn'a.

Harry K. Shibuya, of Vancouver, Canada, has discovered another nocturnal prowler, whom he identified, after some study, as the common or garden variety of "Tohm Cat." Its capacity to ground is high, and the circuit appears to be a noisy

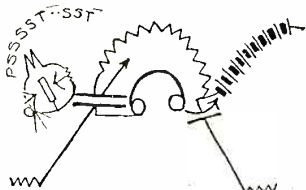

one. Another study by Mr. Shibuya is an Eliminator in the process of eliminating.



*Everywhere
Under
The Sun*

Speed SUPER EMISSION Rad. Tubes

*A Tube for
Every Radio Need*

Test the Superb
Quality of the New

SPEED
X226 A. C. Y227
TUBES

**VOLUME
NO HUM**

Long Life

CABLE SUPPLY CO. INC.
MANUFACTURERS
EXECUTIVE OFFICES
31 Union Square, New York

MAKE MONEY IN RADIO

Over 4,000 Men Now Making Big Money Through Our Plan

THE CUSTOM-BUILT HI-Q SIX is the most remarkable receiver of recent years. Designed by 10 of America's leading radio manufacturers — incorporates every modern feature and many ideas distinctly in advance of its time — acknowledged by experts as supreme in selectivity, sensitivity and tone—now being built and SOLD by over 4,000 novices and professionals—actually costs about \$100 less than finest ready-assembled sets—crendents, nation-wide demand opens big money-making opportunity for many more wide-awake young radio men. Send 25c today for complete 48-page Construction Manual, with graphs, charts, photos and complete proposition showing how we establish you in this fascinating profit-making business on whole or part-time.

HAMMARLUND-ROBERTS, Inc.
1182 Broadway, Dept. C, New York

**Hammarlund
ROBERTS
Hi-Q SIX**

Associate Manufacturers

Carter Radio Co.	Benjamin Elec. Mfg. Co.
Sanson Elec. Co.	Acme Wire Co. (Parvot)
Sangamo Elec. Co.	International Resistance Co.
Yaxley Mfg. Co.	Co. (Durham Resistors)
Hammarlund Mfg. Co.	Radial Co. (Ampertie)
H. H. Eby Mfg. Co.	Westinghouse Micarta

TRY SUBANTENNA FREE

Enjoy Louder, Clearer Better DX at our Risk
Why listen-in on weak, noisy, scratchy, squeaky air waves when ground types are clean, smooth and strong? Why listen to fading, jumbled-up distant reception when you can bring it in loud, sharp and clear? SUBANTENNA—the first and only satisfactory device to pick up ground waves, completely does away with the old style "aerial" and enables any set to get distant stations that it never could get before.

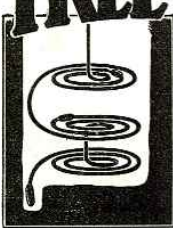

Approved by Thousands of Fans and Leading Engineers
John White of Brooklyn, N. Y. plainly received both Melbourne and Sydney, Australia on a six tube set with a SUBANTENNA—a distance of 10,144 miles when an "aerial" brought in nothing but noise. W. C. F. of Chicago got Havana, Cuba and Buenos Aires, S. A. on a Subantenna. Radio News, Radio Age, Radio Digest and other leading laboratories approve and recommend Subantenna. Easily and quickly installed. Never needs attention. Write at once for particulars of FREE TRIAL GUARANTEE OFFER which permits you to test SUBANTENNA on your set entirely at our risk. Write today.

CLOVERLEAF MFG. CO.

2711-B Canal St. Chicago, Ill.

ACCOUNTING

How to learn Accounting

THOUSANDS of ambitious men are earning more money today because they know Accounting. Send for our 80-page book, "How to Learn Accounting," and the first lesson. Both will be sent free.

International Accountants Society, Inc.
A Division of the
ALEXANDER HAMILTON INSTITUTE
Dept. 26 3411 So. Michigan Ave., Chicago, Ill.

BIG DISCOUNTS TO SET BUILDERS

Big New 1928 Catalog—4000 Bargains—Latest A-C circuits, newest ideas in radio, at startling low prices. The sets and parts you want. Save money. Best parts. Kits, complete factory-built sets, supplies. Orders filled same day. Write for free copy. Standard discounts to dealers, set builders, agents. Dept. 803A.
Barawik Co., 129 N. Jefferson St., Chicago, U. S. A.

BOSCH RADIO includes five A.C. tube models, five standard tube models—"A" and "B" Power Units, Cone-Type Reproducers, and Phonographic Pick-up device.
AMERICAN BOSCH MAGNETO CORP.
Springfield Massachusetts

Its late rider appears to have received instructions to dismount directly from

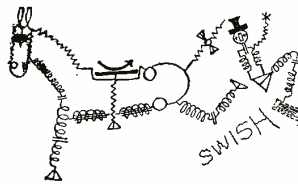

hindquarters. We surmise also that his first name is Mike.

At the vesper hour, when the Heavside layer is laying most heavily, strange nocturnal creatures make their appearance from the ionized atmosphere. We thought at first glance that it might be an owl, the bird of wisdom; but closer inspection justifies the assertion of its discoverer that it is the Bat. (Not "A" Bat, however.) Its



polarities, however, are entirely too positive, and we do not feel justified in recommending our constructive readers to "C" this Bat. It was discovered by Marad Serriov, of Palo Alto, Calif.

After these surprises, we feel that it is high time to retire for another month; some of the remaining revelations in our archives might be too much for the sensitive reader to accept at one sitting. But there are more bugs in Radio Land than the average fan has yet dreamed of in his philosophy; at a later date we shall perpetrate the remainder of them.

Liquid Air in Radio

SCIENTISTS have discovered that a piece of metal cooled to extremely low temperatures becomes almost a perfect conductor. An English experimenter, Mr. Alan J. Brenner, has announced to his radio society that when the antenna coil of a set is immersed in liquid air, while the strength of the signal is not increased, the selectivity becomes remarkably high. Soon no DX fan's workshop will be complete without a thermos bottle of liquid air.

RADIO TERM ILLUSTRATED

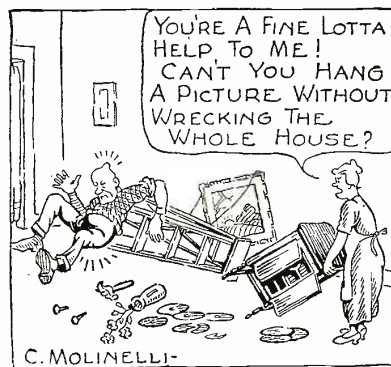

"A Phonograph Pick-up."

AVIATION

the dawning
A new field for men
3
instructive books

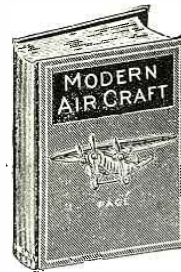

PRICE
\$5.00
700 Pages
500 Illustrations

Contents of each chapter—
I. Aircraft Types. II. Lighter-than-Air Craft. III. Early Airplane Designs. General Design Considerations. IV. Design and Construction of Aerofoils. V. Arrangement, Fabrication and Bracing of Airplane Wings. VI. Airplane Fuselage and Landing Gear Construction. VII. Airplane Power Plant Types and Installation. VIII. Aviation Engine Design and Construction. Air-Cooled Engines. IX. Aviation Engine Design and Construction. Water-Cooled Engines. X. Aviation Engine Auxiliaries. XI. Aircraft Propeller Construction and Action. XII. Airplane Equilibrium and Control Principles. XIII. Uncovering, Setting Up and Aligning Airplane. XIV. Inspection and Maintenance of Airplanes and Engines. XV. Details of Modern Airships and Airplanes. XVI. Seaplanes, Flying Boats, Amphibians and Other Aircraft. XVII. Some Aspects of Commercial Aviation. XVIII. Aircraft Instruments and Aerial Navigation. XIX. Standard Nomenclature for Aeronautics Report No. 240, Part I.

This book is written in simple, understandable language.

AVIATION ENGINES

This treatise, written by a recognized authority on all of the practical aspects of internal combustion engine construction, maintenance, and repair, fills the need as no other book does. The matter is logically arranged; all descriptive matter is simply expressed and copiously illustrated, so that anyone can understand airplane engine operation and repair even if without previous mechanical training. This work is invaluable for anyone desiring to become an aviator or aviation mechanic.

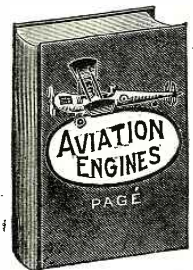

274 PAGES

PRICE \$1.25

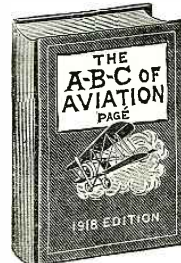

A. B. C. OF AVIATION

This book describes the basic principles of aviation, tells how a balloon, or dirigible is made, and why it floats in the air. Describes how an airplane flies. It shows in detail the different parts of an airplane, what they are, and what they do. Describes all types of airplanes and how they differ in construction, as well as detailing the advantages and disadvantages of different types of aircraft. It includes a complete dictionary of aviation terms and clear drawings of leading airplanes.

PRICE \$1.25

Remit by cash, stamps, check, or money order
No C.O.D.'s

We Pay Postage On All Books

CONSRAD COMPANY, Inc.
230 FIFTH AVENUE NEW YORK

Why Vacuum Tubes Become "Paralyzed"

PRESENT-DAY vacuum tubes, for the most part, have so-called thoriated tungsten filaments, the action of which, even at this late date, is not fully appreciated by the average listener.

The electronic emission of such a filament depends upon the presence of a layer of thorium atoms on the outer surface of the filament. Unlike the oxide-coated filaments found in some tubes, the thoriated tungsten filament is not merely coated but permeated throughout its entire mass with the rare element thorium. During the normal operation of such a filament, the thorium on the outer surface is gradually evaporated, reducing the emission current and, if this action is permitted to continue, rendering the tube short-lived. However, while the heat of the filament serves to evaporate the thorium particles on the surface, it is also boiling fresh thorium particles out of the mass and up to the surface. Thus the surface is being continually replenished. Just so long as the filament voltage is not increased beyond about 10 per cent above the rated value, this evaporation and replenishing process continues at an equal rate, so that a constant layer of thorium is maintained on the surface.

When the filament is subjected to an over-voltage, however, the evaporation is excessive, so that the tube consequently becomes more or less paralyzed. Operating these tubes at sub-normal voltages is also liable to paralyze them slowly, as the filament temperature is then so low that the process of boiling out the thorium from the interior of the filament becomes abnormally retarded. Hence it is important that tubes with thoriated-tungsten filaments be operated strictly at their rated voltage.

Test Soldered Connections

AFTER soldering a wire to a condenser or other heavy piece of apparatus, it is a good plan to give it a strong pull with a pair of pliers to be sure that it is really soldered and not merely held in place by the strength of the flux.

40 Non-Technical Radio Articles

every month for the beginner, the layman and those who like radio from the non-technical side.

SCIENCE & INVENTION, which can be bought at any newsstand, contains the largest and most interesting section of radio articles of any non-radio magazine in existence.

Plenty of "How To Make It" radio articles and plenty of simplified hook-ups for the layman and experimenter. The radio section of SCIENCE & INVENTION is so good that many RADIO NEWS readers buy it solely for this feature.

Radio Articles Appearing in MARCH Science & Invention

"S. & I." Three-Tube A.C.-D.C. Set—Details Describing How to Build a High-Quality, Good-Volume Regenerative Set, Using The New A.C. Tubes.
The MacLeod Gauge—For Measuring the Vacuum of Radio Tubes. By Ed. V. Sundt
Radio Guides Torpedo Boat, By Lucien Fournier
The "Laboratory" Shielded Super, By Philip Radwelsky

The Listener Speaks

(Continued from page 992)

blown condensers, etc. The way, therefore, to support these stations should be that every radio manufacturer should pay one mill or whatever is necessary of his sales to the broadcasters, being evenly or otherwise divided. Certainly these manufacturers get enough profits for their merchandise, for some of them have grown into millionaires "overnight"—as radio is only about five years old. Why "sock us guys" any more than we have paid? Being a home set builder, I'll bet radio cost me a thousand bucks in the last five years, on my own sets; and many another "bug" has paid as much or more. And then they (the N. B. C.) have the crust to ask us to pay more—3 to 20 dollars a year. They want "whole hog or none," evidently.

D. V. CHAMBERS,

510 West 144th Street, New York City.

(Our reader sets forth quite clearly the position of, probably, a majority of broadcast listeners and set constructors: yet, perhaps, does not attach enough weight to the "other fellow's story." We fear that the commercial operator is unjustly accused; though undoubtedly there is still in existence old-style commercial and ship equipment enough to cause annoyance to many listeners.

The plan for simultaneous chain broadcasting has been very attentively considered by engineers; but it is not yet sufficiently developed for general adoption. As to the proposal that an assessment on radio apparatus sales should pay for broadcasting, the cost of broadcasting has evolved far beyond that stage. There are two stations, at least, so costly that the expenses of either run beyond the proposed assessment on radio several times. Quoting an old proverb, "the mill cannot grind with the water that is past."

Neither the N. B. C. nor any other American broadcaster has asked for a tax on receiving set licenses, such as governments levy in all other parts of the world for the benefit of broadcasters. The only other alternative is that set owners shall buy radio-advertised goods to an extent sufficient to warrant the advertisers in presenting good programs; just as the purchase of other advertised goods warrants the advertisers in defraying a large part of the cost (sometimes 90%) of publishing newspapers and magazines. As another old proverb says, "Those who pay the piper call the tune"—without advertising to a third, which assures us that "The piper's pay is more kicks than halfpence."—EDITOR.)

A Woman's Choice

Editor, RADIO NEWS:

Every woman fond of music wants to hear that, of course; but I think, more than that, the woman whose household duties keep her tied up more or less around her own home wants something which will inform her of things outside her home. Something which a woman can be interested in and have to think about later, or discuss, or read about in her spare moments, would be light lectures on various simple but interesting topics.

The subjects might pertain to interesting observations of nature, unusual events of

WE RECOMMEND

ULTRADYDE ELECTRIC SIX

Licensed, manufactured, and sold under rights owned and (or) controlled by R. C. A., Gen. Elec., Westinghouse, and A. T. & T.



Six genuine R. C. A. alternating current tubes, built-in air column loud speaker, genuine walnut cabinet—two-tone finish. No batteries of any kind required. Never before was an all-electric set offered at such a low price.

SET BUILDERS AND DEALERS
This is one of the many bargains listed in our new 1928 BUYING GUIDE. SEND for your copy today.

Allen-Rogers-Madison

Incorporated

35 W. 31st St.

New York City

FROST-RADIO

OFFERS TO READERS OF RADIO NEWS TWO VALUABLE NEW BOOKLETS FREE!



Write for Them

Offer readers of *Radio News* two valuable new Frost-Radio publications free on request: "What Set Shall I Build?" the answer to a question which puzzles many set builders, and the new Frost booklet, "For Better Reception," a complete and helpful manual of Frost Parts. Every set builder should have both of these booklets. They will be found chock-full of useful information that is right up to the minute.

What they Contain "What Set Shall I Build?" tells much about the newest and most popular circuits. "For Better Reception" tells you proper size rheostat for multi-tube sets, has wiring diagrams for high resistance units, contains valuable facts about Frost-Radio Parts.

Mail Coupon NOW To secure these two booklets FREE, just fill out and mail the coupon below, printing your name and address carefully. These books will amaze you with their completeness. Write for them to-day—NOW.

HERBERT H. FROST, Inc.
150 North LaSalle Street, Chicago, Ill.

Please send me free your two booklets, as advertised in *Radio News* for March.

Name.....
Street Address.....
City..... State.....

EVERYMAN 4

OFFICIAL SERVICE STATION

CUSTOM BUILT SET ON DEMONSTRATION

Wired by experts to your order

We keep abreast of all changes and improvements of this wonderful circuit, including the latest screen grid tubes.

RADIO KIT CO.

72 CORTLANDT ST., New York City
Room 401 Tel. Cort. 1849

RAISE BELGIAN HARES

New Zealand Reds - Chinchillas - Flemish Giants

MAKE BIG MONEY—W& Supply Stock

and pay you following prices for all you raise:
Belgian Hares \$2 each—New Zealand \$3 each
Chinchillas \$4 each—Flemish Giants \$5 each.

82-page illustrated book, catalog and contract, also copy of *Fur Farming* magazine, tells how to raise blank, milk, fox, etc., for big profits, all for 10c. Address **OUTDOOR ENTERPRISE CO., Box 73, Helms Park, Missouri**

Print Your Own

Cards, Stationery, Circulars, Paper, etc. Save money. Printing for others, big profit. Complete outfits \$3.85. Job press \$11.25. Rotary \$149. All easy, rules sent. Write for catalog presses type Stationery, etc. **THE KELSEY CO., P-72, Meriden, Conn.**

you

will not be sitting on top of this coming Fall Season unless you climb aboard with the

SUPER-HILODYNE

A new basic circuit employing nine tubes. World's latest—most acclaimed circuit—the SUPER-HILODYNE—radically new—much in demand—a sure money-maker for custom set builders.

WANTED

POTTER PRODUCTS CORPORATION
245 Fifth Avenue, New York, N. Y.

Gentlemen: Please send me immediately full details of your plan to help me make big profits. I understand this does not obligate me in any way whatsoever.

Name.....
Address.....
City..... State..... RN-228

We want direct factory representatives in all territories. Write for details and our unusual money-making proposition.

POTTER PRODUCTS CORP.
245 Fifth Avenue, New York City

the day and their influence on the public, brief accounts of interesting incidents in the lives of noted men, without going into a detailed account of each year, or any educational topic of human interest.

MARION K. ZERBE,
Riverdale-on-Hudson, N. Y.

A Guide to Current Reading

Editor, RADIO NEWS:

I am particularly interested in magazine articles of all kinds and, as I am unable to buy many magazines and would like to know what is of most interest in the month, I have often thought that perhaps our afternoon radio adviser might give us a resumé of several magazines each week. This would cover those most worth while, and from them one could select her magazines for the month.

I hear books discussed, recipes, fashions and, of course, the daily news items; but I never hear a word about magazines and I surely would appreciate the information.

MRS. J. PAUL ELLIS,
Delmar, Delaware.

Daylight Reception

Editor, RADIO NEWS:

Your magazine is quite obviously an awe-inspiring success among periodicals of our time; the reason is equally obvious. I have before, as the continuing successes appeared in print, thought of writing you; but it's too obvious, and your mail is already heavy.

However, another old subscriber writes, and you defend your policy (page 949 of February RADIO NEWS). Quite so; I, too, care nothing for pictures, or even jokes. But I well know what a great game it must be to run such a magazine, and other publications, too, in this modern world. I am still reading your issues of several years back, over and over again; as I learn more, I see more. Everything is said there; there is no room for further explanation if you took the whole magazine for it.

I have just written to Mr. Woodruff (whose letter appeared on pages 872 and 946, of the same February issue), on the subject of daylight reception. WHO at Des Moines, is reporting the noon money market in New York, strong enough (with an

aerial) to run the horn off the detector circuit; it can be heard with all connections off.

I turn to WBAP and the announcer says we are being entertained by the Fort Worth Club Orchestra. I go to the back of the house and ask Friend Wife to observe that the music she hears there is from WBAP. I have had Asheville, Amarillo, New Orleans, etc.; WJZ will come through on a loop. The professors' lectures at WSU, Iowa City (500 watts) come beautifully at noon.

Over three years ago, in a winter shack on the Arkansas side of the Ozarks (three 199 tubes), I was listening, with my wife, to a Sunday afternoon concert from W.H.B., Kansas City; and the announcer around 4 P. M. read a telegram from New York City stating that reception was enjoyable. So I rise with my compliments to remark that daylight reception of a sort has been possible for several years. Personally, I now dab at short waves; made the wave-changer described in RADIO NEWS of December, 1924, and use a 125-foot aerial. The superhet has a regenerative stage ahead—5-inch spiderweb—that will pick up CYA or CNRR.

D. BURKHALTER,
Route 8, Bloomington, Indiana.

Chicago to England

Editor, RADIO NEWS:

The brief article on daylight reception in last month's issue is interesting to me, because I have been gathering data for years. I know of a receiver in New Hampshire which tuned in a Chicago station at noon; and I have been told by an employee of a Chicago station that there was a verified report of reception of a game of the White Sox in the British Isles.

Last December, on a Silver-Marshall Six, I tuned in WLWL before sunset from a Central Illinois location—the report of which will, in the opinion of most readers, entitle me to a life membership in the Ananias Club. An attendant at WJZ informed me that a program from there had been heard in Colorado in broad daylight. My best effort in this locality, a few miles from the WJZ towers, is KDKA; my best distance-getter, either for day or night, is a 4-tuber. I hope other daytime anglers will report.

J. C. SCOTT,
Plainfield, New Jersey.

Short Waves in Java

Editor, RADIO NEWS:

The short-wave phone transmitter at Maabar, Java, is now working again regularly with 25 kilowatts on 17.4 meters with the Dutch short-wave phone station PCLL, 18.7 meters, from 120 to 1820 GMT on Mondays, Wednesdays and Fridays. As these stations now come through very well, there will be opened within a few weeks a short-wave phone service between Holland and Java. This will be the longest in the world—more than twice the length of the transatlantic system.

As to heavy tropical static; this is indeed very serious, especially on the higher wave-

lengths, but depends also on the season. On the short waves, however, it is no obstacle. Most of the inland and foreign traffic of the Dutch East Indies is handled by the short-wave transmitters, ANC, AND, ANP and ANH (Laboratory)

D. HEKEL,
Bandoeng, Java, Kartiniweg 13.

Book Review

RADIO PROSPECTING. A portion of a complete course in practical radio. 28 pages, paper cover, 5¼ x 8½ inches. Published by the National Radio Institute, Washington, D. C.

A great deal has recently been published, concerning the methods of searching for precious ores by means of radio-frequency currents. To many people this means of prospecting has seemed to smack more or less of the long-haired gentleman who dispensed snake oil from the rear of a wagon. However, according to the book mentioned above, there are several different methods which can be utilized for the locating of iron, copper, gold and other ores without the expense of digging.

The first to be described is called the Equi-Potential method. The fundamental principle used in this method is that an electric field is generated in the area to be investigated; with the help of a telephone receiver, a series of "level lines" is determined upon the surface and, by observing the disturbances in these level lines, it may be determined whether deep-lying ores are present or not.

The Chilson Method is quite like that used in the determining of a ship's position at sea by radio. It embodies the old principle that a transmitting station will come in on a loop antenna connected to a receiver strongest when the loop is pointed directly at the transmitter. The signals are picked up by a loop receiver at different points on one side of a supposed bed of ore. If the signals cannot be received, it is indicative that a metallic ore between the transmitter and the receiver is absorbing the radio waves. Then, by triangulation, the exact location of the bed or vein can be calculated.

The Re-Radiation process depends on the principle that, if a conductor is in the path of a radio-frequency wave, there will be induced in it similar currents. These secondary currents are traced down with a loop-operated receiver in much the same way as in the Chilson method; except that the ore itself in this case is really a secondary transmitter and not an absorber.

For those interested in this phase of radio, this work may be recommended, as the principles are clearly outlined and explained in such a way that those having but a fundamental knowledge of electricity and radio can comprehend.

HOW TO OPERATE YOUR RADIO WITH A "B" POWER UNIT. Published by the Modern Electric Mfg. Company, Toledo, Ohio. Free for distribution; 3¼ x 5½ inches, 14 pages, paper covers.

The above is the title of a booklet issued by its publishers for the purpose of assisting radio fans in choosing a "B" power unit, as well as operating it correctly. It contains a wealth of information on the theory and operation of various types of "B" power devices. Several of the subjects covered by this booklet are: the principle of operation of the rectifier tube; the types of "B" power units; the correct methods for connecting them to radio sets; determination of power-tube voltage; the correct methods for reducing voltages of power units; a table showing the correct "C" bias for various tubes; and a list of possible difficulties to be encountered when using power units, and their corrections.

In the first section the theory of rectifier tubes and operation in "B" power units is explained, together with the correct use of "C" bias in vacuum-tube amplifiers. The second section deals with the use in "B" power units of various rectifier units, including the electrolytic and the gaseous and filament types of rectifier tubes. The next two sections deal with methods obtaining correct "B" voltage on the various tubes and the calculation of the voltage obtained from the power unit. In the following section a list of correct "C" voltages for different combinations of tubes in receivers is given.

The final section in this booklet deals with the possible difficulties encountered when using power units in radio receivers. Common remedies for squealing, blasting, hum, motor-boating, paralyzed tubes and fluctuating volume are clearly stated. This booklet will be of particular interest to all radio fans who are operating their receivers from A.C. and power-lighting source; since correct operation of receivers with power units can be obtained only through a knowledge of the operation and characteristics of the power units used.

Letters from Home Radio Set Constructors

(Continued from page 1035)

to the shielding panel, use of a Bretwood variable grid leak, low-loss coils of different inductance—one new coil for every additional turn—and last, but not least, *patience*. We bring in Europe regularly; London at 4:30 p. m. with loud-speaker volume. Three times around 1:00 p. m., we heard a station announcing in a Slavish language, and caught the word "popolski."

Both of us use the circuit published in RADIO NEWS for August, 1927, attached to a Kolster eight-tube set. As you know, this has four stages of R.F., detector, and three of audio, with one control. We use a spring-coil aerial and a really good ground. On taking the attachment to a friend who has a Golden-Leutz set and an outdoor aerial we obtained splendid results there as well. On the other hand, attaching it to a Radiola X, even short-circuiting the tickler, we failed to bring in a sound. I believe that short-wave experimenting for the present, is the only thing worth while for the amateur.

Permit me to present the "Chicoutimiflex," a five-tube combination of Roberts' non-oscillating reflex and the first stage of the Jewell Super-Hilodyne. When trying this circuit out with the phones, I got a feeling as if I were looking into the space on the other side of the static level or beyond the Heavieside layer. It was an uncanny feeling of unlimited distance close at hand; and when I started out to get some station, the results justified that sensation.

Selective? Well, if you know what that means, I can tune in Montreal regularly. Volume? Enough for a big theatre. Tonality? Beethoven would like a chance to hear it. Distance? Better than anything I know of. Chicago in the day time, the Watch Tower in the morning, with indigestion at noon!

I have made this a one-control affair, with the oscillator-condenser as a volume regulator. It does not work well on the so-called "B" eliminator. Possibly the Bee is eliminated, but its hum is ever present. If you do not mind my conservatism, with your kind permission, and to please the Goddess of Music, as well as Terpsichore (or was it Postum?) I will stick to the wet batteries. With all that eliminating business around here, something is humming, and that is the by-pass condenser; something like a Leyden jar, if you know what I mean. Something with a tremendous kick in it; after you took a good try at it, you would understand what we mean by "body-capacity."

Yes, sir, the set is working fine, no cutting of the sidebands, with best reception when the moon shines.

J. H. VAN KOOLBERGEN,
Chicoutimi, Quebec, Canada.

LOOP AND OUTDOOR AERIAL

Editor, RADIO NEWS:

While not new, the following may interest some. I have a 9-tube loop set and a 7-tube set using an aerial. These are near each other, and I noticed that when the loop set was in use, signal strength could be greatly increased when the antenna coil on the other set was tuned to the desired frequency, even though the latter receiver was entirely shut off.

For greater convenience, I purchased a National antenna tuning coil and condenser, mounted them on a board, connected them to outside aerial and ground, and placed conveniently near the loop set. By tuning this to the incoming signal, greater volume is secured with less battery drain. Roughly estimated, I should say that fully 25% less power is required, when the antenna tuner is used.

Of course, it is easy to see that the loop set could readily be altered to a combination loop-and-aerial tuner; but the above method does the same thing very simply, with no change in the set and with no difference in the dial readings. There are two taps on the coil of the antenna tuner; the long

Enjoy LOUD SPEAKER OPERATION from a CRYSTAL

NO "TUBES" - NO "B" BATTERIES - NO COSTLY "ELIMINATORS" WITH THE SKINDERVIKEN TRANSMITTER UNIT

Simple microphone unit provides a most effective and inexpensive way to satisfactory speaker operation. Easy to build and operate circuit.

Everybody can do this now with a Skinderviken Transmitter Unit. The unit is fastened to the diaphragm of the speaker unit. It will act as a "microphonic relay." Every time an incoming signal actuates the diaphragm, the electrical resistance of the microphone unit will be varied correspondingly and the current from the battery, in series with it and the loud-speaker, will fluctuate accordingly. Thus the problem of securing sufficient power to actuate the Loud-Speaker is simply and adequately solved.

The results from this very novel and simple unit will astound you.

The expense of this hookup is trifling compared to elaborate tube circuits that give no greater actuation of the speaker.

Besides this there are many other valuable uses in Radio Circuits for this marvelous little unit. Every builder of Radio sets should have a few on hand.

LISTENING THROUGH WALLS

This Unit makes a highly sensitive detectaphone, the real thing—you listen through walls with ease. Plenty of fun and real detective work too.

CONDUCTING SOUND THROUGH WATER

Make yourself a miniature submarine signaling apparatus like those used during the war. Simple circuit with this microphone unit gives splendid results.

12-PAGE INSTRUCTION BOOKLET

containing suggestions and diagrams for innumerable uses mailed with each unit.

We Pay \$5.00 in Cash

for every new use developed for this unit and accepted and published by us.

SEND NO MONEY

Order as many as you want—use the coupon below. When the postman delivers your order you merely pay him 95c plus a few cents postage. If you order two units you pay him only \$1.75, plus postage.

PRESS GUILD, INC. R-3-28
16-18-R—East 30th St., New York, N. Y.

Please mail me at once..... Skinderviken Transmitter Units, for which I will pay the postman 95c. plus postage, or \$1.75 plus postage if I order two units.

Name.....

Address.....

City..... State.....

BENJAMIN

Cle-Ra-Tone Sockets

Red Top For Standard UX Type Tubes. For quick and easy finding of correct position of tube and prongs.

Green Top A new Five Prong Socket for A. C. Detector Tubes. Especially designed for heavy current-carrying capacity for these new tubes.

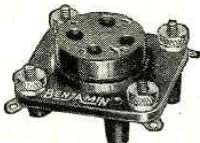

At All Radio Jobbers and Dealers

Benjamin Electric Mfg. Co.
120-128 So. Sangamon St., Chicago
247 W. 17th St. New York
448 Bryant St. San Francisco

M&H

Radio's largest kit supply house

ESTABLISHED 30 YEARS

ALL THE LATEST 1928 KITS!

HAMMARLUND 222
Shield Grid—4-Tube Set
Price on request

SHORT WAVE RECEIVER
as described in Radio News
Price on request

PERIDYNE
Coils and Shields in Stock

We carry a complete line of
"B" Eliminator and Power Pack Parts

SET BUILDERS—Send for Our Handy CIRCUIT BOOKLET and CATALOG
Just Off the Press

M & H SPORTING GOODS COMPANY
512 Market Street Philadelphia, Pa.

ELECTRICITY

Easy at Last! You can learn BIG PA Y profession. No advanced education or previous experience needed. Learn by actual work. Not by correspondence, but on real equipment. COYNE prepares you for jobs that lead to \$50 and up a week. Learn by doing. Earn while you learn. Prepare for BIG PAY job in 12 weeks.

Send Now for Big FREE Book and full details of free employment service, Radio, Automotive and Aeronautics electrical courses that are included and how many earn while learning. **COYNE ELECTRICAL SCHOOL**, Cor. 1699 E. C. Levin, P.O. Dept. 38-77 500 So. Paulina St., Chicago, Ill.

LOOK !! IT'S FREE !!

DEALERS and PROFESSIONAL SET BUILDERS!
Your BIG NEW 1928 Catalog is NOW READY!
Contains Nationally Known Parts and Kits

Send for it Now! It's FREE!

S. HAMMER RADIO CO.
307 Atkins Avenue Brooklyn, N. Y.

B Eliminators, G. E. Bulb, 4 taps, forty milliamperes capacity. Silent, unfailling. Steel case, bronze finish, \$9.50; fifty-five milliamperes, 5 taps, \$11.50. 2 Ampere SILITE chargers, \$9.00. Rectifiers, parts, kits, catalog, "A" Eliminator, 2 amp. \$16.50. Electro-Chemical Co. of America, Indianapolis

coil gives the greatest volume on short-wave stations, and the short coil on above 400 meters. I have the short coil connected with a clip so that the change can be quickly made. With this, the greatest volume is secured by having the variable condenser fully open on the long-wave stations.

C. F. RODGERS,
Conneaut, Ohio.

A BUILT-IN HORN

Editor, RADIO NEWS:

The number of letters I have received, in regards to the sixteen-foot horn which I constructed and you described in your November issue, is so great that it is impossible to answer them. They come from not only the United States, but all over the world. For the benefit of the writers, I ask you to print the following answers to the questions sent me.

The horn is made of clear spruce boards, 3/4-inch thick and fastened together with screws; it may be made straight if the constructor prefers, as the only reason for bending or curving a horn is to fit it into smaller space. A Baldwin concert unit was used in mine, with a Bodine twin-eight receiver, a 112 power tube and Amso output filter. My aerial is 100 feet long, including lead-in; my ground wire is soldered to a copper teakettle buried in the earth.

There is no perceptible difference in volume above that obtained with a smaller horn; the improvement is in tone quality. All cracks in the assembly should be filled with putty and painted over with white lead. I advise anyone constructing a horn of this type to test it before installing it in the house; and to avoid using a phone unit which gives a metallic ringing sound.

R. E. WHEATON,
Jackson, Michigan.

A REAL "MUSIC MAKER"

Editor, RADIO NEWS:

In your issue of March, 1926, you published instructions for making a "Parlor Music Maker," in an article by Volney G. Mathison. I have built a number of these sets, and consider this an ideal receiver. The clarity of tone, volume and DX abilities are unbeatable. I think, to be brought up to date, it deserves further experimentation, however. I have never yet been able to construct the single-winding aerial coil mentioned in the article, however, without getting an adjustment too low on the left-hand dial; so I substituted the old Roberts double coil with the seven-point switch on the primary and a "wig-wag" secondary. This is a life-saver in cutting through when stations are all piled up on one wavelength—as you so often find them. For instance, when WPG, KDKA, WMSG and half a dozen more are all coming in at one time, with the point switch I can cut down to 20, 15 or 5 turns; then advance my left-hand dial to compensate the lessened inductance, and clear up one or the other station. It also helps in coming down the dial, to adjust to the increased volume.

I make the primary 40 turns, with taps at the first, 3rd, 5th, 10th, 20th and 30th turns. This could be simplified by taking only the 10th, 20th and 30th; as you seldom need to cut further. The secondary is 50 turns and put on a "wig-wag." This is also a big help in clearing up stations, especially if you have strong locals to cut through.

Recently I built a Roberts 5-tube Resistoflex; this has two R.F. tubes with a resistance coupler between. I was not satisfied, so threw it back into a "Music Maker," but left the R.F. coupler in. The result was a set of tremendous volume, and I picked up stations I never heard before. Its DX is great; I have picked up KFI several times this fall.

A good filter circuit helps the set, too. In fact, I believe, if you would put this set through your laboratory and bring it up to date, adding choke coils, etc., you would have the last word in a set. The tickler can be used on anything near by; but is a great help in DX. In place of the fan tickler, a Royal high resistor is just as good. My present set, which I'll stack up against any of them, cost at "five-and-ten" prices about \$25.00.

T. R. EDSON,
603 1/2 Third St., Towanda, Pa.

BURIED ANTENNA FOR SHORT WAVES

Editor, RADIO NEWS:

I am a devoted reader of RADIO NEWS, and have tried its hook-ups with success for many years. I am especially interested in radios that are home-constructed, and therefore much interested in letters from their constructors. I have read many letters telling about success on short waves, and others dealing with distance heard on underground antennas; but never one which combines the two. I therefore am telling you of my success with the RADIO NEWS "Special Short-Wave Broadcast Receiver" described by Kendall Clough in the October

1927 issue, when using an underground antenna described in the same issue by H. Winfield Secor. Probably the average B. C. L., when he reads about or hears others discuss the short waves, gets the idea that this reception is only for the amateur who knows the code, and thinks it will not be worth his while to explore these little-known bands. I do not know the code at present, but I assure you I intend to learn it soon; because the fan who does not know the code is missing the cream of the radio reception.

Since November I had heard over one hundred and fifty phone stations below 200 meters, and I do practically all my listening on the lower bands. Almost any noon I can tune in 2XAD on 22 meters as loud and clear as the best stations heard at night. There are also many other low-wave stations broadcasting music, and every night 2XAF and KDKA come in with wonderful volume and clearness.

The most fun I derive from low-wave listening is hearing the "Hams" chew the rag on 180 and 200 meters. These boys are sure a fine bunch and much sport can be had from reporting their signals and receiving their QSL cards. I have a special card printed, which I fill out and send to them; and they in turn send me a card telling me about their station, etc. I have about a hundred QSL cards which I have received to date. (A list of stations ranging from Canada to Texas enclosed.)

The greatest thrill I ever had in reception was when I heard 5SW, Chelmsford, England, on 24 meters at noon, January 10, 1928. It was testing with 2XAD and came in with fair volume. They also broadcast some music, which was in turn rebroadcast by 2XAD on 22 meters. It sure was interesting to hear two great countries linked together by radio, talking together and to be able to hear both sides of the conversation.

ROBERT W. BENROTH,
Bluffton, Ohio.

SELECTIVITY WITH THE "PERIDYNE"

Editor, RADIO NEWS:

The "Peridyne Five" is running as I write this letter; the time is 10:00 p. m., WJZ and WEAF are both on, and my W. E. speaker is bringing in WJR, with no cross-talk, and plenty of volume. I just came away from WBBM and WLS (now get me right); WBBM is alongside of WHN on the dials, and still I cut out WHN clean on one side, and cut out WMCA on the other. Some selectivity! I also bring in WSM, WBS, KMOX, WBAL, any time from 8:00 p. m. daily. Remember, I am going through the New York local stations all the time.

Now let's get back to the set itself; what a "howling success" it was the first time I turned it on. My better half thought the house was coming down; but, after playing with the set for about thirty minutes, I had it tamed down to my size. I use all 301A tubes, except the 112, and I had to come down to 45 volts on the R.F. to clear up the speaker; but what a set it turned out to be!

Let me say, in closing, that I have built all the so-called tone, selectivity and DX sets that have been printed in the many different radio magazines; but the "Peridyne Five" has stepped out like a champ, and is my favorite set.

M. J. MURPHY,
498 West 158th St., New York, N. Y.

ANOTHER "PERIDYNE" ENTHUSIAST

Editor, RADIO NEWS:

Recently I constructed a "Peridyne Five" receiver, and am now taking the liberty to say that you have in no way overemphasized the importance and desirability of variable-shield tuning. Having stood in awe of shielding in general, I was greatly delighted to find that it is certainly easy to balance a tuned R.F. circuit to its maximum workable output by this system.



Having made some study of the effect of shielding upon inductors, I immediately saw that the metal cans surrounding the coils in the "Peridyne" were spaced sufficiently wide to insure against interference with their magnetic fields; and that only the variable shields could interfere, and that too, only if placed too near the ends of the coils.

I am using a Balkite "A-B" power unit in conjunction with the set, and coast-to-coast reception is easily obtained. Last night I listened to KFI (Los Angeles) for a solid hour and enjoyed every minute of it. The loud speaker was an Ensko three-foot cone.

I did have doubts regarding the crystal detector, but they are all dispelled now; and I wish to say that I never knew so many stations were on the air until I tuned them in on the "Peridyne."

Many thanks for this circuit of circuits and for the worthwhile magazine that brought it to my attention.

L. E. EASLEY,
Keokuk, Iowa.

DAYLIGHT WORK ON A SUPER

Editor, RADIO NEWS:

I have been a reader of your valued publication for some time. "The Listener Speaks" and "Letters from Home Set Builders" are both very interesting. I have built a "Silver Laboratory Super" and it beats anything I have tried. Mid-day reception is a test for the sensitivity of any set. I have received the following stations on this set at the times indicated (List of 29 stations, from 11:10 a. m. to 2:16 p. m.): WSMB, the nearest, is about 150 miles in an airline; and WEAJ and WJZ, the most distant, are about 1100 miles.

I use an outdoor aerial, 300 feet long, including lead-in, and about 40 feet high. A good aerial is sometimes overlooked by many DX hounds. I have no trouble separating any two stations 10 kc. apart, using this aerial. Using Thorardson 200 audio transformers, a Silver-Marshall 221 output transformer, and a Pathe "Cathedral" cone, the quality is excellent.

WILLIAM McCALP,
Carlisle, Mississippi.

LIKE A LETTER FROM HOME

Editor, RADIO NEWS:

I am writing to tell you that I had just constructed the RADIO NEWS Special Short Wave Broadcast Receiver and was listening to the various code stations without much edification when suddenly I made out voice sounds which proved to be English and then came the announcer's words clear, "WGY General Electric—New York." I also heard snatches of news items and music. This was between eight and nine o'clock Tuesday morning, December 13. We are located quite a ways from civilization as we Americans know it and the possibility of receiving directly from the United States in this part of the world is a stimulating thought, indeed. I am very anxious to learn all about short-wave receivers and would appreciate it if you could refer me to literature on the subject.

While in California last year I constructed a number of simple regenerative sets and wish to continue experimenting out here, but on the short waves. I have as yet only an indoor aerial. The winter temperature gets down to between 30 and 40°F. at night and the ground is frozen two or

three feet along in January. I soon will have access to electric-light current. I am engaged in medical missionary work under the Presbyterian Church, whose foreign missionary offices are located at 156 Fifth Ave., New York.

ROY M. BYRAM, M.D.,
Kangkei, Korea (Chosen).

HEARS MANILA ON SHORT WAVES

Editor, RADIO NEWS:

I have built the RADIO NEWS special short-wave receiver described in your October issue, and have had wonderful results from it. In the past week I have received the short-wave station of 2LO, London, England (this is the high-power Marconi relay transmitter at Chelmsford, on 24 meters—EDITOR.) four times with loud-speaker volume; and only this morning I received a station in Manila, Philippine Islands, with very good volume, and at times I could use the loud speaker on it. Many thanks for interesting me in short-wave sets.

WRAY GILLETTE,
Lemon City Junction, Miami, Florida.

COMPETITION IN SELECTIVITY?

Editor, RADIO NEWS:

When I read some of the DX challenges, I thought "a regular fan—no set better than his present one;" then started in to see just how much selectivity mine has, which is the World's Record Super. As you are well aware, there are four channels between WJX and WEAJ. When WRC is on at noon, it can be put on the speaker; at 1:00 p. m., when WJZ starts, there is no hangover from that station, which is about 35 miles from here. WCFL and WSB can be brought in with no hangover from either WEAJ or WRC, but sometimes WTIC and WJAR make a mess of them. (This was written before the late frequency readjustments.)

How about someone in the East challenging me, and pick a spot where the aerials are more numerous than Jersey mosquitos, and interference thicker than aerials? I have demonstrated in between a flashing sign and a converter—neither being fixed. I would like to see a DX competition in a place like the Grand Central Palace instead of the wide and open spaces; then I would be there myself.

(Mr. Cox then prepared a set of acknowledgment blanks and proceeded to collect data from the stations.)

Last night, after mailing a letter to you, I logged WHAS for the last thirty minutes of their transmission, using the loop. Thirty miles airline from WJZ, and ten-kilocycle separation without cutting sidebands! Of course, I can only do this when WJZ is right on its wave. Sometimes it takes almost 20 kc. to lose them entirely, but I guess everyone knows the faults of that station. There are some small stations which have a young fellow in charge who is capable, and are really worth listening to, though they don't have the talent on their programs that the N. B. C. do. The new 50-kw. station of WEAJ is not as good here as the old one. Your station, for instance; I have never had distortion from WRNY on my 9-tuber. On the A. K. I used to get some due to fading, but only on the maximum fadeaway.

DX is noisy, but there are times when KFI equals five-tube reception of nearby stations. Again, there are multi-tube sets with high milliammeter

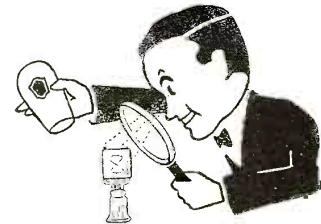

Inside Information

About A. C. Tubes

You never gamble when you buy CeCo. They are as reliable as a fine, expensive, American-made watch—as truly a product of engineering skill and care as the best automobile built today. Yet they cost no more than ordinary tubes.

Buy CeCo and be sure of results—certain of full value for your money.

- CeCo A. C. TUBE.....Type M.26 (226)
For Radio and Audio Frequency stages,
Standard Base.....\$3.00
- CeCo A. C. TUBE.....Type N.27 (227)
Separate heater type. Detector or Amplifier.
5-Prong Base.....\$6.00
- CeCo.....Type R.81 (281)
Half wave rectifier, for use in A. B. C.
Eliminators or Power Packs.....\$7.50
- CeCo.....Type R.80 (280)
Full wave rectifier. For use in A. B. C.
Eliminators or Power Packs.....\$5.00



Write for descriptive circular

C. E. MFG. CO., Inc., Providence, R. I.
Largest Exclusive Radio Tube Mfrs. in World.

OVER 3 MILLION TUBES IN USE

you! No Radio in the past, and perhaps none in the future, has, or will give you the thrill that is to be had out of the

SUPER-HILODYNE

A new basic circuit employing nine tubes. World's latest—most acclaimed circuit—the SUPER-HILODYNE—radically new—much in demand—a sure money-maker for custom set builders.

WANTED

We want direct factory representatives in all territories. Write for details and our unusual money-making proposition.

POTTER PRODUCTS CORP.
245 Fifth Avenue, New York City

Gentlemen: Please send me immediately full details of your plan to help me make big profits. I understand this does not obligate me in any way whatsoever.

Name.....
Address.....
City.....State.....RN-228

CAMERON ANTENNA

WORLD'S CHAMPION STATION GETTER!

SENSATION of year. Makes every set selective. Positively gets more distance. 418 stations including England, Germany, Alaska and Mexico tuned with Cameron Antenna in national contest. Entirely new, patented principle. Nothing else like it. Comes in convenient knock-down form. Installed out of doors in a few minutes.

Endorsed by Radio Engineers Everywhere. Thousands of enthusiastic users. You'll never know what your set can do till you hook it to a Cameron. Send no money. Pay postman \$5.00 plus few cents postage. Money back if not satisfied.

CAMERON MANUFACTURING CO., Dept. A3
517 Elliott St.
Buffalo, N. Y.

If it's in the air the Cameron Antenna will get it!

OPPORTUNITY AD-LETS

Follow these advertisements every month. Reliable advertisers from all over the country offer their most attractive specials in these columns.

Classified advertising rate twenty-two cents a word for each insertion. Ten per cent discount for 6 issues, 20 per cent discount for 12 issues. Names and addresses must be included at the above rate. Cash should accompany all classified advertisements unless placed by an accredited advertising agency. No advertisements for less than 10 words accepted.

Objectionable or misleading advertisements not accepted. Advertisements for the May issue must reach us not later than March 1st.

CIRCULATION LARGER THAN THAT OF ANY OTHER RADIO PUBLICATION

EXPERIMENTER PUBLISHING CO., INC., 230 Fifth Avenue, New York, N. Y.

Agents Wanted

Big Money and fast sales. Every owner buys gold initials for his auto. You charge \$1.50; make \$1.35. Ten orders daily easy. Write for particulars and free samples. American Monogram Co., Dept. 133, East Orange, N. J.

Guaranteed Genuine Gold Leaf Letters anyone can put on store windows. Large profits, enormous demand. Free samples. Metallic Letter Co., 422 N. Clark, Chicago.

Sell subscriptions to magazines known the world over. Steady monthly income with absolutely no investment required. Hundreds of selling arguments every month. Start now. Full information sent free, no obligation. Agency Division, Experimenter Publishing Co., 230 Fifth Avenue, New York.

\$40.00 Suits for \$23.50! All one price. Union-made, of finest quality Virgin Wool. You don't have to know anything about selling clothing. We guarantee your success if you are honest and willing to work. Write at once. William C. Bartlett, 850 Adams, Dept. 754, Chicago.

Business Opportunities

Inventions Commercialized. Patented or Unpatented. Write Adam Fisher Mfg. Co., 278 Enright, St. Louis, Mo.

67 Ways to Increase Income. 96-page book "Spare-time Money Handbook" contains 67 practical and complete plans to operate sparetime business. For everyone who wants more money. Price only 50c. Conrad Company, Inc., 230 Fifth Avenue, New York.

Amateur Cartoonists: Make money in spare time with new cartoon selling plan. Write Smith's Service, Wenteche, Wash.

Free Book. Start Little Mail Order business. Hadwil, 5A-74 Cortlandt Street, N. Y.

Agents wanted to advertise our goods and distribute free samples to consumers; 90c an hour; write for full particulars. American Products Co., 1502 Monmouth, Cincinnati, Ohio.

Chemistry

Learn Chemistry at Home. Dr. T. O'Conor Sloane, noted educator and scientific authority, will teach you. Our home study correspondence course fits you to take a position as chemist. See our full-page ad on page 1043 of this issue. Chemical Institute of New York, 16 E. 30th Street, New York City.

Correspondence Courses

Used correspondence school courses sold on repurchase basis. Also rented and exchanged. Money-back guarantee. Catalog free. (Courses bought). Lee Mountain, Pisgah, Alabama.

Detectives

Detectives Needed Everywhere. Travel. Experience unnecessary. Particulars free. Write, American Detective System, 2190 Broadway, N. Y.

Electricity

Electric Fun! Seventy stunts, 110 volts, \$1. Cooperco, Campbell, Calif.

For Inventors

Inventions Commercialized. Patented or Unpatented. Write Adam Fisher Mfg. Co., 278 Enright, St. Louis, Mo.

Help Wanted

Become a Landscape Architect. Uncrowded profession; wonderful opportunity for money-making. Easily mastered by mail. Earn while you learn. Est. 1916. Write for details. American Landscape School, 11 Newark, N. Y.

National Publisher, needs agents, boys and shops to help sell great national magazines. No investment required. Big profits, sparetime work very successful. Write Agency Division, Experimenter Pub. Co., 230 Fifth Avenue, New York.

\$100 per month in your home, folding and mailing circulars. We furnish everything. Particulars and samples 25c. Adams Mailing Service, R-1292, Greenfield, Ohio.

Help Wanted, Instructions

Earn \$25 Weekly Spare Time, writing for Newspapers and Magazines. Experience unnecessary. Copyright Book, "How to write for Pay" Free. Press Reporting Inst., 978, St. Louis, Mo.

Do you drive a car? U. S. Government Chauffeur-Carrier job pays \$141-\$175 month. "How to Qualify" mailed FREE. Write, Instruction Bureau, 251 Arcade Bldg., St. Louis, Mo.

Instruction

Learn Chemistry at Home. Dr. T. O'Conor Sloane, noted educator and scientific authority, will teach you. Our home study correspondence course fits you to take a position as chemist. See our full-page ad on page 1043 of this issue. Chemical Institute of New York, 16 E. 30th Street, New York City.

Practical Radio is unusually successfully taught by the McKay Instrument Co. Students study at home, understand radio and earn big money. Railway Exchange Building, Portland, Oregon.

Male Help Wanted

A representative to do missionary work among radio manufacturers in New York City territory. Must have some idea of radio designing and engineering. Send full particulars, such as experience and references, to Bastian Bros. Co., Inc., 1600 Clinton Ave., N., Rochester, N. Y.

Miscellaneous

Inventions Commercialized. Patented or Unpatented. Write Adam Fisher Mfg. Co., 278 Enright, St. Louis, Mo.

Save Money at Home. You can build many home necessities yourself, such as furniture, kitchen utensils, decorative material, etc., thus saving many dollars. All construction information on hundreds of things given in 116-page book "How to Make It." Price 50c. Experimenter Publishing Co., Inc., 230 Fifth Avenue, New York.

Musical

Play Piano by Ear. A sound system. Booklet Free. Boucher's Harmony Studio, Ottawa, Can.

Old Money Wanted

Old Money Wanted. Do you know that Coin Collectors pay up to \$100.00 for certain U. S. Coins? And high premiums for all rare coins? We buy all kinds. Send 4c for Large Coin Folder. May mean much profit to you. Numismatic Co., Dept. 112, Ft. Worth, Tex.

\$2 to \$500 each paid for hundreds of Old or Odd Coins. Keep all old money, it may be very valuable. Send 10c for New Illustrated Coin Value Book, 46c. Guaranteed prices. Get posted. We pay Cash. Clarke Coin Company, 14 Street, LeRoy, N. Y.

Old Coins

Old Coins. Large Spring selling catalogue of coins for sale, free. Catalogue quoting prices paid for coins, 10c. William Hessein, 101 K, Tremont St., Boston, Mass.

Patent Attorneys

Patents—Send for form "Evidence of Conception" to be signed and witnessed. Form, fee schedule, information free. Lancaster and Altwine, Registered Patent Attorneys in United States and Canada, 289 Ours? Bldg., Washington, D. C.

Patents—Send drawing or model of your invention for examination and instructions. Advice and booklet free. Highest references. Best results. Promptness assured. Watson E. Coleman, Patent Lawyer, 724 9th Street, N.W., Washington, D. C.

Inventors—Should write for our Guide Book, "How to Obtain a Patent" and Record of Invention Blank, sent free. Send model or sketch of inventions for our Inspection and Instructions Free. Radio, Electrical, Chemical, Mechanical and Trademark Experts. Terms Reasonable. Victor J. Evans & Co., 922 Ninth, Washington, D. C.

Patent Sense—Valuable book free. See Lacey's ad, page 1060. Lacey & Lacey, 631 E. St., Washington, D. C. Established 1869.

Patents secured. Easy terms. Inventors Service Bureau, Box 1648, Washington.

Patents

Inventions Commercialized. Patented or unpatented. Write Adam Fisher Mfg. Co., 278 Enright, St. Louis, Mo.

Postage Stamps

Stamp Collectors—Phillips Monthly Bulletin (Illustrated) offers over 2,000 special bargains, sets, packets, single stamps, etc., each issue. Free. Phillips, Box 1012, Hartford, Conn.

Printing Outfits and Supplies

Print your own cards, stationery, circulars, paper, etc. Complete outfits \$8.85; Job Presses \$11, \$29; Rotary \$149. Print for others, big profit. All easy, rules sent. Write for catalog presses, type, paper, etc. Kelsey Company, F-13, Meriden, Conn.

Multigraph typewritten letters sell anything. Two dollars thousand. Miscellaneous printing. Meyer Rey Corporation, Monmouth, Illinois.

Printing, Engraving and Multigraphing

200 Letterheads and 100 Envelopes, \$1.10, postpaid. OBERMAN COMPANY, Box 1268, Chicago.

Radio

Are you making money in radio? If not, send for booklet, Co-Operative Radio Doctors, Dept. N, 151 Essex St., Salem, Mass.

Radio trouble finder. Log and Station Book Dictionary. Postpaid, \$1.00. Chester, Box 404, Oyster Bay, N. Y.

Use what ocean liners and ships use. Genuine S A W C A 722 silicon bronze Ship Aerial. The most efficient Antenna wire obtainable; price, two cents per foot. Ship Aerial Wire Co. of America, Dept. B, 217 Wyckoff Ave., Brooklyn, N. Y.

Set Builders. We furnish jobs. No fee. Register now on our list of professional set builders. Inquiries from your locality will be referred to you. We are headquarters for parts of Hammarlund-Roberts, Silver Shielded Six, Karas Equamatic, Bremer-Tully Power Six, Harkness Counterfone and other popular circuits. Register at once. Give references and experience. Allen-Kogers-Madison, Inc., Dept. RN, 35 West 31st Street, New York, N. Y.

Radio Equipment

Direct Factory Sale. Wholesale prices. Tremendous savings. Selling direct to you. Here are some of our many items: 50 Henry Choke, 100 M.A., \$2.19; 16 Henry Choke, 400 M.A., \$5.48. Power Transformers for all kinds of eliminators and for all types of A.C. tubes at special low prices. EVERY ITEM FULLY GUARANTEED. Promptly shipped, upon receipt of order. Send for free illustrated catalog today. Todd Electric Co. Inc., (Manufacturers) 36 West 20th Street, Dept. G, New York City.

Salesmen Wanted

Large Manufacturer of popular priced Radio Cabinets wants representatives selling radio dealers. Models listing at \$18 and up. Well made in large modern plant. Quantity sellers. Straight commission basis. For full details, address Drawer E 10, Boonville, N. Y.

A paying position open to representative of character. Take orders shoes, hosiery, direct to wearer. Good income. Permanent. Write now for free book, "Getting Ahead." Tanners Shoe Mfg. Co., 873 So. C. St., Boston, Mass.

Scenery to Rent

World's Most Beautiful settings for operas, plays, minstrels. Amelia Grain, Philadelphia.

Song Writers

Song-Poem writers. Address Monarch, 236 W. 55th St., Dept. 122, New York.

Song Poems

Song Poem Writers address Hibbeler, D7X, 2104 N. Keystone Ave., Chicago, Ill.

Telegraphy

Telegraphy—Both Morse and Wireless taught thoroughly. Big salaries. Wonderful opportunities. Expenses low, chance to earn part. School established fifty years. Catalog free. Dodge's Institute, Cour St., Valparaiso, Ind.

Wanted to Buy

Full Value Paid for Old Gold, Jewelry, Watches, Diamonds, crowns, bridges, dental gold, silver, platinum, gold or silver ore; magneto points, old false teeth. Packages returned if our offer is not satisfactory. United States Smelting Works (The Old Reliable), 39 So. State St., Dept. 16, Chicago, Ill.

that create their own static. I know of a Cr. for instance, with the B return for the meter around the milliammeter; 28 ma. reading, and a slight turn of the rheostat will meter to 50 on a less powerful station.

able makes a good condenser for interferers, and costs a good deal less than a dol-picrofarad. Connect across the interfering as with a condenser, and solder a ground the armor, being sure to tape the ends not It will stand 220 volts A.C. for a life-d not blow.

reading in your columns about constant of Australia and Japan. There is no being in a location where DX comes night after night. Last night I logged San Francisco, which has never before in this locality. Another feather in my DX thrills come in getting stations when re hard to bring in; and this does not in-

with our regular radio programs. I have several hopeless tries for Australia; even I know there isn't much chance before next and I really hope to get them at that time.

HERBERT COX,
Easton, Pa.

ropos of this blanketing of stations, facts ed by station engineers seem to indicate that is a station interference which is not due to dyming, or to straying from frequency, but is due to high power. This has been no-between stations 20 kilocycles apart, more ly than between those separated by but a channel. Investigations are now being made this line.—EDITOR.)

EXCHANGE OF NOTES

R. RADIO NEWS:

would like to correspond with fellow experi-ers in radio. I am interested in the following have notes on hand: distance-getting crystal with volume, underground antenna and counter-elimination of aerials, tuned devices for socket antenna, 110-volt tube sets, automobile equipment and results. I will exchange let-and notes with any that are interested, for al radio progress. LESLIE CARPENTER,
111 Loomis St., Burlington, Vermont.

R. RADIO NEWS:

am a young reader of your magazine and a -wave radio ham, owning a poor short-wave ving set. I want to exchange letters with -wave amateurs in your country. Kindly duce me to the earnest amateurs.

S. HANDA,
56 Kitamisuji-machi, Arakusa,
Tokio, Japan.

Radio News Laboratories

(Continued from page 1037)

POWER-CONE UNIT

ie power-cone unit, submitted for test by the eaker Radio Company, 199 Fulton Street, York, N. Y., employs a powerful electro-mag- instead of the customary permanent magnet used most speaker units. This allows the use of ively-long air gaps; thereby eliminating al- bility of chattering, even when the speaker is ing in connection with the most powerful of ; receivers. The electromagnet draws 0.3

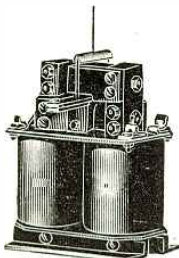

ere; this current is supplied either by the 6- storage "A" battery or from a trickle charger, h is operated from the 110-volt A.C. line. The e construction is large and rugged. The is shaped to fit into the average cone speaker, employs a balanced armature. The coil is layer nd and insulated, to withstand voltages up to without using special protective devices. This is an excellent reproducer where volume and ity are required.

WARDED THE RADIO NEWS LABORA-RIES CERTIFICATE OF MERIT NO. 2262.

Wash Your Aerial's Face Occasionally

AFTER a receiver has been in operation for sometime, it will generally be found that reception can be improved by overhauling the antenna system. The best method, of course, is to put up both a new wire and new insulators; although carbon tetrachloride can be used very effectively for cleaning the insulators. It will be found in some cases, that simply cleaning the soot off the insulators will cause a material improvement in the reception.

An Experimental Push-Pull Transformer

WHEN experimenting with push-pull amplifiers, the fan often finds trouble in obtaining the correct transformers at short notice. Two ordinary audio-frequency transformers, if of the same type, can be used by connecting their primaries and secondaries in series to form an emergency transformer for this purpose. The connecting wire between the two secondaries should be used as the center tap; the two transformers so connected are used on the input side of the circuit.

Higher Value Rheostats are Advisable

WHEN 201A-type tubes are used as detectors, it is advisable to use a filament rheostat of about 30 ohms; because although these tubes are not very critical to changes in filament voltage they are most sensitive at one particular point. A 6-ohm rheostat does not permit the fine regulation of voltage that is obtained with one of higher resistance; in some cases the point at which the tube operates most efficiently is much lower than the rated voltage.

LOCATION UNSUITABLE FOR A SUITABLE RECEPTION

FIRST MOUSE: "So you're not going to be married here at Station WBQY? Don't you think this nice pleasant basement is suitable for the wedding?"

SECOND MOUSE: "No, indeed! I don't think that any self-respecting mouse should marry beneath her station."



—The Wireless Constructor, London.

CONVERT Your Set to A.C.!

with the new KARAS

A-C-Former

Easy to do—No Rewiring!

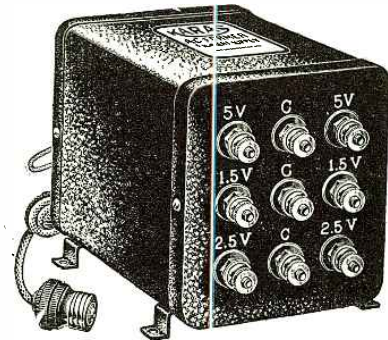

Amazing New Accessory

THE amazing new Karas accessory, the A-C-Former, when used in conjunction with the Carter Converting Cable Harness or similar harnesses now available, enables you to quickly and easily convert your present battery operated receiver to a full-fledged A. C. receiver. No rewiring. No hum. No bother. So simple a ten-year-old boy can do the job in a few minutes. Simply take out your present tubes, insert the Adapter Cable Harness, attach one end of this harness to the Karas A-C-Former, put in your A. C. tubes, and you have a fine, sensitive, distance-getting, genuine A. C. receiver.

Banish Batteries Forever

The Karas A-C-Former banishes batteries forever. No need for A batteries, chargers, relays or C batteries. No more tube troubles. BUT YOU MUST USE THE KARAS A-C-FORMER. A. C. Tubes are extremely sensitive to fluctuations in voltage, and the slightest variation in the building or windings or any appreciable surge or overload in the supply line will bring trouble. Don't risk your A. C. Tubes with cheap, inefficiently designed transformers. Insist on the Karas A-C-Former. You will then have a constant, unvarying filament potential. Costs less with cable harness than a good battery and charger. Your dealer can supply you. See him today.

Mail Coupon for Information

The coupon below brings full information on how you can convert your set to A. C. with the Karas A-C-Former. We tell you every detail—send you a complete data. Fill out and mail today.

KARAS ELECTRIC COMPANY

4038-C North Rockwell Street, Chicago, Ill.

KARAS ELECTRIC COMPANY
4038-C North Rockwell Street, Chicago, Ill.

Send me complete data on how I can convert my..... receiver, Model No..... having.....tubes, to A. C. operation, as advertised in Radio News.

Name.....
Street Address.....
City.....State.....

WHOLESALE RADIO CATALOGUE

FREE

The Book They are all talking about

WHOLESALE RADIO CATALOG

Listing thousands of items in standard radio parts, Kits, Accessories, Complete Sets, Furniture, etc. Every Set Builder and dealer should have a copy. Read wholesale prices. Send for your copy today.

THE HARCO COMPANY
1257 So. Wabash Ave. Chicago, Ill.

The HARCO CO. 1257 So. Wabash Ave. Chicago

PATENTS Protect your inventions and Trade-Marks today. Write for illustrated patent book and sketch sheet and terms free. BRYANT and LOWRY, 314 Victor Bldg., Washington, D. C.

THEN

Know your Radio Repair your Radio Set yourself--it's easy!

No matter how much or how little you know of your radio receiver, this new "Radio Trouble Finder" book is going to be a big help.

It explains the common and special faults of all the standard receivers of today; tells how to recognize instantly, by various methods, where the trouble lies and also gives special simple tests by which you can determine what is wrong with your receiver. Then for each particular fault there is explained the proper procedure for correcting it.

Book Contains 64 Pages
Size, 6 x 9, Illustrated
Handsome 2 Color Cover



he bought the

25c
the copy
Sold on All Newsstands

THE CONSRAD CO., Inc.

230 Fifth Avenue

New York, N. Y.

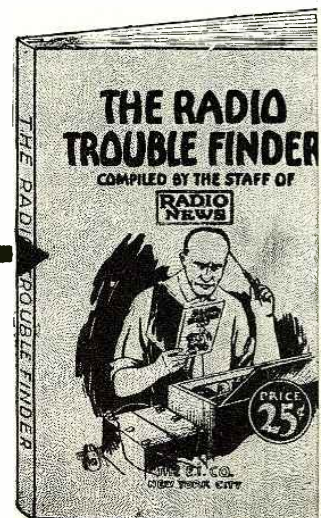

SM

112 Kilocycle Amplifier Catacomb for Screen Grid Tubes

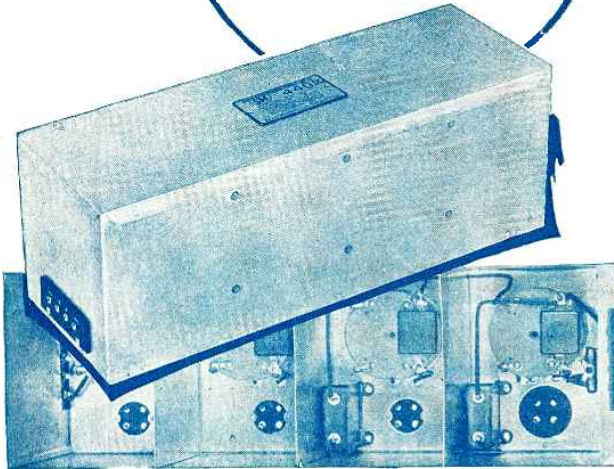

NOW Silver-Marshall offers for immediate delivery the famous 112 K. C. time signal amplifier catacomb, improved and refined to take full advantage of the tremendous amplification possibilities of the new screen grid R. F. amplifier tubes. Every experienced fan and professional set builder knows the remarkable efficiency of the famous S-M 440

amplifier, with its high amplification, absolutely accurate peaking, and perfect uniformity, and the new 440-SG model of this famous unit, designed especially for screen grid tubes, is capable of providing *greater amplification than any other long-wave amplifier ever marketed.* The 222 type screen grid tubes are used in the three individually shielded low-loss R. F. amplifier stages, followed by a super-sensitive detector (UX 200 A) in cushioned socket. The amplification is tremendous, the selectivity hair-splitting, yet tone is well-nigh perfect. The 440-SG amplifier catacomb is laboratory tuned and calibrated to exactly 112 K. C. and either two or three R. F. stages may be used at will. It is 15 inches long, 5 inches wide, and 5½ inches high, with removable cover, finished in beautifully burnished copper. It requires three 222, and one 22-A type tubes, 6-volts at .65 amperes, 135 volts B at only 6 milliamperes and 4½ volts of dry C battery for operation. Its current consumption is so low it may be operated on batteries, yet no finer amplifier can be had for use wherever a sharply tuned long wave amplifier is needed. Unconditionally guaranteed against mechanical and electrical defects, the 440-SG amplifier catacomb stands unequalled in the long-wave amplifier field. Price \$40.00, ready to use, less tubes.

All Your "A" Power for \$5.00

That's the story—no matter what your set, you can drop your A batteries and charger today and completely replace it with an S-M 247 filament transformer, priced at \$5.00. This transformer supplies all "A" power to your present set by using a Naald, Eby, or Carter A. C. tube harness, which enables you to insert A.C. tubes in your present battery set *without a single change to the set.* Then the 247 transformer supplies all "A" power for any 5, 6, or 7-tube set for years to come—no run-down batteries, no hum, just positive sure operation costing less than half a cent an hour! The S-M 247 filament transformer supplies 5 volts for one to four 112 A or 171 A power tubes, 1.5 volts for one to five 226 A. C. amplifiers and 2.25 volts for one or two 227 A. C. detector tubes. You can use it with any combination of A. C. tube harnesses or adapters, or A.C. tube equipped set. It's the biggest "A" power value you ever saw, for costing but Five Dollars, it replaces the A battery and charger, or expensive twenty to forty dollar A power unit!

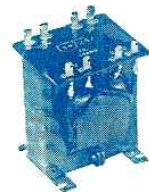

Let Your Ear Be the Judge

A better transformer than the S-M 220 can't be made. It has the heaviest core—it has more turns of wire—it is a real power job. These features, coupled with the rising low note characteristic means real quality, real bass note reproduction. The famous 5,000 cycle cut-off accounts for the absence of most heterodyne squeals and set noises. The maker of the finest electrically cut phonograph records stopped looking for reproducing equipment when his laboratory reported on 220's and 221's. The unofficial report of the largest telephone manufacturing company in the world set S-M 220's up as the finest they had ever tested. Broadcasting stations everywhere use and monitor their reproduction with 220's. Every important magazine has recommended them unqualifiedly—they are in more prominent receiver designs than any others—and they have outsold all other makes.

S-M 220's are unconditionally guaranteed to be the finest audio amplifying units available. Buy a pair—let your ear be the judge, and if you've ever heard anything finer you can return them for refund.

That's fair enough, isn't it?

The S-M 220 Transformer is \$8.00, and the S-M 221 is \$7.50.

Silver-Marshall, Inc.
848 W. Jackson Blvd., Chicago, Ill.

SILVER-MARSHALL, INC.
848 W. Jackson Blvd., Chicago, Ill.

- ...I enclose 10c for which please send me full information on quality audio amplification, power supply equipment, the new Shielded Grid Sixes, Universal All Wave Tuners, and the 440-SG.
- ...I enclose 25c for complete instructions and blueprints for the Shielded Grid Sixes.
- ...I enclose 25c for instructions and blueprints for building the All Wave Tuners.

Name.....
Address.....
City.....State.....



Abox

"A" BATTERY ELIMINATOR

Set Owners— Here's Electric Operation

Why everybody wants electric operation—
Simply because it forever releases the set owner
from the chore of charging and replacing batteries,
and permits uniformly better reception.

How to get it—the next question.

If you own a battery-operated set, the answer is
simple. Any good "B" unit and an ABOX "A"
Eliminator will electrify your present set. Think
of it—no change in tubes—no change in set wiring.

Don't confuse ABOX with so-called "socket power
units." ABOX contains no battery, but is a true
electric device that will make your set "Electric"
in every sense of the word.

Why deny yourself the convenience of electric
operation any longer—the endorsement of over
100,000 users is your guarantee.

*Send for circulars and free reprints
of recent construction article on
Abox "A" "B" "C" Eliminator and
power amplifier. Use the coupon.*

THE ABOX COMPANY
215 No. Michigan Avenue, Chicago, Illinois
Please send me circulars and free reprints of construction article on
ABOX "A" "B" "C" Eliminator and Power Amplifier.

Name

Address

Check here and attach to your letterhead if you are a dealer and
want window display material and supply of circulars

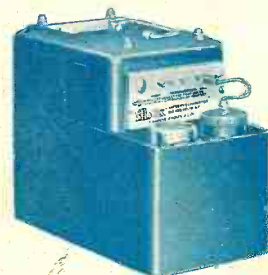

**6-Volt Abox
Eliminator**

This model will op-
erate any set using
eight or less stand-
ard 6-volt tubes.
Not necessary to
change set wiring.
Over 100,000 of
this type in use.

\$ 32⁵⁰



**4-Volt Abox
Eliminator**

A new model for sets
using 4-volt tubes. Fits
Radiola battery com-
partment. Size 8³/₄ in.
long, 4 in. wide, 6⁷/₈
in. high. Output—6
amperes, 4 volts D. C.

\$ 27⁵⁰

All Prices Slightly Higher on West Coast

The Abox Company