

CIRCULATION LARGER THAN ALL OTHER RADIO MAGAZINES COMBINED

# RADIO NEWS

REG. U.S. PAT. OFF.

20 Cents  
July  
1921

Over 100 Illustrations  
Edited by H. GERNSBACK

"MONKEY BUSINESS"<sup>DD</sup>



"THE 100% WIRELESS MAGAZINE"



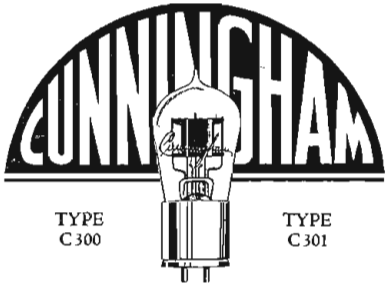

TYPE C300      TYPE C301

**RECEIVING TUBES**

Operating Instructions and Circuit Diagrams including an Explanation of Vacuum Tube Operation and Characteristics

*E. J. Cunningham*

TRADING AS  
AUDIOTRON MANUFACTURING CO.  
35 Montgomery St.      SAN FRANCISCO



AMPLIFIER

Completed by the amplification...  
 used as a detector...  
 voltage plate cur...  
 increase during...  
 the following...  
 current below...  
 in the plate...  
 normal value...  
 equal radio...  
 equal value...  
 fication with...  
 ee. By dis...  
 icy impulses...  
 ert a pull in...  
 e and plate...  
 the normal...  
 the point

... detector...  
 incoming...  
 it is, cur...  
 ment to...  
 change is...  
 changes...  
 negates...  
 nected...  
 ideo up...  
 oscill...  
 ye de...  
 here, te...  
 sig...  
 late...  
 private...  
 way...  
 text...  
 tal...  
 id...  
 al...  
 de...  
 ign...  
 tu...  
 e...  
 e...  
 tips



This 8-page Cunningham Direction Sheet is now in the hands of your dealer and is supplied with each receiving tube.

The trade-mark GE is the guarantee of these quality tubes. Each tube is built to most rigid specifications.

# CUNNINGHAM TUBE SERVICE

Nationally Known Since 1915  
General Electric Quality Plus Cunningham Service

Cunningham Type C-300  
Gas Content Detector Tube  
of low plate voltage. Price \$5.00

Cunningham Type C-301  
Pliotron or Navy Type. High  
Vacuum Amplifier. Price \$6.50

## TRANSMITTER TUBE SPECIFICATIONS

Model	Output Conservative Rating	Filament Amps.	Volts	Plate Voltage	Price
C 302	5 watts	2.35	7.5	350-400	\$ 8.00
C 303	50 watts	6.5	10.	1000	30.00
C 304	250 watts	15.	12.	4000 Max	110.00

C 304 for New York or San Francisco  
C 302 is mounted on the standard four prong receiving tube base. The larger tubes have special bases.

Cunningham Service is more than a trade expression—it is an in-built quality which has served the most rigid tube tests in the radio field for the past six years.

DEALERS: Standard Packages F. O. B. Cleveland, San Francisco, New York. Broken Packages F. O. B. San Francisco



Trading as Audiotron Mfg. Company  
Since 1915

35 MONTGOMERY STREET

SAN FRANCISCO, CAL.

# Gradually increase the range of your station — with ABC sectional UNITS

You can start with the ABC receiving cabinet, add on a VT detector and as many stages of amplification as you want, *at any time*, yet never discard a nickel's worth of apparatus as you go along!

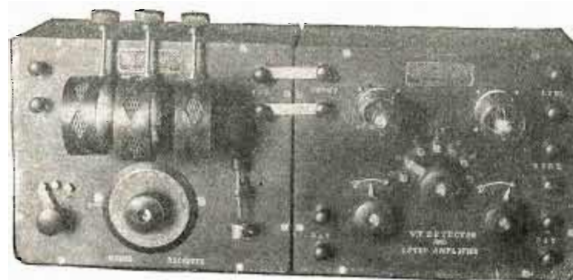

The combination shown here is the ABC Receiving UNIT and the ABC Combined VT Detector and One-Step Amplifier UNIT. This set is highly recommended for receiving all classes of signals on all known wave lengths. A One or Two-Step Amplifier or the ABC Clarion may be added at any time. Price of the Receiving Cabinet complete, \$24.50. Price of the Combined VT Detector and One-Step, \$37.50 (without tubes and batteries). This entire outfit, including aerial, phones, tubes and batteries may be secured for about \$84.00, a price never previously approached for guaranteed, high quality radio apparatus.

**W**HEN YOU start to build your receiving station, keep in mind the gradual development of your range. Avoid buying a lot of miscellaneous apparatus, much of which may be useless when you want to improve your set. Buy equipment that will be just as efficient a year from now, *when you want to add to it*, as it is today! You can do this by concentrating on ABC sectional receiving UNITS.

## The Sectional Principle

ABC sectional UNITS were purposely designed to work together and to save you money when you want to add to your set. The first cabinet is the Radio Receiver, a completely equipped crystal detector station. And altho this Unit is highly efficient and complete in itself, here is the important part of the ABC system: Whenever you want to increase your range, you simply hook the next cabinet (the ABC Combined VT Detector and One-Step Amplifier), directly on to the receiver and proceed. It takes about as long to do it as to say it, and you haven't discarded a nickel's worth of equipment. There's no tinkering, no adjusting to be done. Your new set works perfectly from the start. The Units are designed for each other, and the standardized methods of production makes it certain that every new combination of Units, as you go along, *will* make a smooth-working efficient outfit.

IN PLACE of the ABC Combined VT Detector and One-Step Amplifier UNIT, you may add on these Units separately. But we strongly recommend the Combination Unit because it gives you (with the proper coils) sufficient range and sensitiveness to pick up any known type of sending station, code or phone, on any known wave length.

OTHER cabinets of the series are the ABC Two-Step Amplifier UNIT and the ABC "Clarion," a loud speaker that hooks right on to any previous combination of Units without any additional batteries or extra equipment.

## The ABC Receiving UNIT

**T**HE FIRST cabinet, the receiver itself, comes to you equipped with three ABC coils, an ABC 41 plate variable condenser, a tested crystal detector, a switch for varying the wave length range, etc. The panel is a special impregnated fibre, highly polished, and carefully fitted to the handsome Kodak-finish cabinet. The price is \$24.50.

FOR THOSE who want it, there is also provided the ABC Completion Package to go with this Unit. The Completion Package contains phones, aerial, insulators, ground clamp; in fact, all the equipment needed to set up a complete working station in two hours. This package is an unusually good buy at \$7.50.

## "Professional Radio Equipment at Amateur Prices"

ABC APPARATUS is highly standardized and produced by automatic, machine methods, down to the smallest switch point. We took three years to make the design right. Other Units, in the same standard design will be ready for you, *whenever you want them*. And the economies of quantity production in the best equipped radio factory in the world makes it possible for us to offer "Professional Radio Equipment at Amateur Prices," and back up every ABC instrument with our unequalled guarantee, "Your money's worth or your money back!"

## Booklets

**I**N ORDER to explain the ABC sectional UNIT system thoroughly, we have prepared a 16-page booklet in two colors, profusely illustrated. It is entitled, "How I Put Up a Complete Radio Station in Two Hours," a true story written by a young man with no previous radio experience whatever. You will be interested to learn how amazingly simple it is to get results with ABC UNITS. Send 10 cents for Booklet R7.

**F**OR AMATEURS who prefer to build their own sets, we offer ABC Standardized Unassembled PARTS, identical with the parts used in the UNIT system. The complete ABC line including the UNITS is described and illustrated in our new 2 color catalogue. Gladly mailed for 10 cents in stamps or coin. Request Catalogue CR7. The coupon below is for your convenience. Mail it today.

WIRELESS EQUIPMENT CO., Inc.  
Newark, New Jersey

Dealers: If you are not now stocking the ABC Line, it will pay you to write for our portfolio, "The ABC Sales Plan in a Nutshell."



WIRELESS EQUIPMENT CO., Inc.  
Newark, New Jersey.

I enclose one dime. Send me by return mail your Booklet R7, "How I Put Up a Complete Radio Station in 2 Hours."

I enclose one dime. Send me by return mail your new catalogue CR7, of "Professional Radio Equipment at Amateur Prices."

Name .....

Address .....

City..... State.....



# RADIO NEWS



## CONTENTS

VOL. 3

FOR JULY

No. 1

PAGE	PAGE
Editorial.....By H. Gernsback 5	Alleviating QRM.....By Clyde L. Fitch 22
The Lyon Radio Station..... 6	The Efficient Design of Vacuum Tube Telegraf and Telephone Sets—Part II, By Jesse Marsten 23
Some Transmitting Tube Data, By B. F. McNamee 8	Radio Telephony.....By E. W. Stone 24
A New Automatic Recorder, By S. R. Winters 9	Who's Who in Radio—General G. O. Squier 25
The Oscillograf.....By Jesse Marsten 10	The Radio Constructor—Triple Inductance Coil Mounting.....By F. C. Shelley 26
A New Modulator for C. W. Transmitters 11	Radio Digest ..... 27
Nauen Time Signal Radio Service, By Dr. Alfred Gradenwitz 12	The Mystery of the V.T., By W. Andrews 28
New Radio Apparatus..... 13	The Acid Test.....By George L. Sharp 29
Eight-tenths of an Ampere with a Single "J" Tube.....By Arthur H. Lynch 14	With the Amateurs..... 30
Awards of \$100 Portable Radio Prize Con- test ..... 15	Junior Radio Course..... 32
How to Construct a Heavy Current Micro- phone.....By Albert Marple 16	Junior Constructor ..... 33
Amateur Radio Helps Police..... 16	Correspondence from Readers..... 34
Crystal Amplifier.....By G. Gatis 17	Club Gossip ..... 35
Short Wave Tuning Systems, By J. Stanley Brown 18	I-Want-To-Know ..... 36
Determination of Percentage Modulation in Radio Telephony.....By M. Wolf 19	Regular Transmission of European High Power Stations ..... 38
Experimental Measurements and Calcula- tions.....By P. F. Geagan 20	

RADIO NEWS is published on the 25th of each month at 233 Fulton Street, New York. There are 12 numbers per year. Subscription price is \$2.00 a year in U. S. and possessions. Canada and foreign countries, \$2.50 a year. U. S. coin as well as U. S. stamps accepted (no foreign coins or stamps). Single copies, 20 cents each. A sample copy will be sent gratis on request. Checks and money orders should be drawn to order of EXPERIMENTER PUBLISHING CO., INC. If you should change your address notify us promptly, in order that copies be not mis-carried or lost. No copies sent after expiration.

All communications and contributions to this journal should be ad-dressed to: Editor, RADIO NEWS, 233 Fulton Street, New York. Unaccepted contributions cannot be returned unless full postage has been

Published by EXPERIMENTER PUBLISHING CO., INC.

H. GERNSBACK, President

S. GERNSBACK, Treasurer

R. W. DE MOTT, Secretary

included. ALL accepted contributions are paid for on publication. A special rate is paid for novel experiments; good photographs accompanying them are highly desirable.

RADIO NEWS, Monthly. Entered as second-class matter June 6th, 1910, at the Post Office at New York, N. Y., under the Act of March 3, 1897. Title registered U. S. Patent Office. Copyright, 1921, by E. P. Co., Inc., New York. The Experimenter Publishing Co., 233 Fulton Street, N. Y., N. Y. The contents of this magazine are copyrighted and must not be reproduced without giving full credit to the publication.

RADIO NEWS is for sale at all newsstands in the United States and Canada; also at Brentano's, 37 Avenue de l'Opera, Paris.

233 Fulton Street, New York City

# RED-HEAD Radio Phone

Now **\$8<sup>00</sup>**  
**8<sup>00</sup>**

**Complete  
Postpaid to  
Any Address**

**Price Cut from \$12.50 to \$8.00 at one Big Slash!  
Buy Now—Profit by our bigger sales and lower costs**

**Improved 1921 Model  
3000 Ohms  
Latest and Best we ever made**



### Higher Quality at a Lower Price

Newman-Stern sets the pace back to normal! The self-same Red-Heads which literally swept the country and sold everywhere at \$12.50 are now yours for only \$8.00. They were admittedly the world's best buy at \$12.50; they have absolutely no competition at this new, low, bed rock price of \$8.00.

The reasons we can make this cut are, briefly: Bigger sales and greater production. Lower manufacturing costs, A determination to bring prices back to normal, To put Red-Head quality within reach of every experimenter.

The new and improved 1921 Red-Heads are as rugged and sturdy as ever—but even more exquisitely sensitive. The same snug fit; the same high grade minutely accurate interior. The same handsome, well finished appearance—but wound to a higher resistance. They are now better than they have ever been before, during five years of leadership.

When we first made Red-Heads we challenged every user to test them out in competition with his favorite receiver; scores of letters from delighted users prove Red-Head superiority in tone and sensitiveness. You will say the same. Try them under our guarantee; we refund your money if they are not just as represented.

### Specifications

3,000 Ohms resistance (each receiver 1,500 Ohms) wound with electrolytic copper wire of the highest grade; the best magnet steel available is used—and plenty of it; cast aluminum backs; genuine Bakelite unbreakable ear caps; furnished with braid-covered military type or genuine phosphor-bronze split head-band; extra fine 6 ft. cord with strain loops and posts; cord connections made on outside of receiver, easily adjusted without tampering with carefully adjusted interior; interior parts are highly nicked and polished.

Remember the ear caps fit snug and are practically unbreakable.

### ARLINGTON TESTED CRYSTALS



**NOW 25 CENTS**  
(Reduced from 35c)

NAA (Arlington) tested minerals are the original tested crystals—absolutely the best that money can buy for radio detector and wave meter work. Exquisitely sensitive.

We scour the world for the best obtainable raw galena; we secure scores of samples from every known source

Sold by reputable dealers everywhere

Any of the above articles sent post paid on receipt of price

### DEALERS

Write at once for our new proposition on Red-Heads

### Our Broad Guarantee

We rely upon the fairness of our customers. A refund or satisfactory adjustment will be made for any merchandise not found entirely satisfactory by you, its purchaser. You are to be the sole judge. Your decision will be ours.

of supply and select only those of just the right crystalline structure for perfect radio work.

Each crystal is cut into right detector size, tested for sensitiveness and only those found perfect are good enough for us to sell you. Each "Arlington" is carefully wrapped in foil, packed in a convenient lithographed metal container and comes to you perfect. Increase your receiving range with an "Arlington." To avoid the many imitations, look for the signature of J. S. Newman on each box.

### We Distribute the Reputable Radio Products of Leading Manufacturers

Being one of the very oldest firms in the country dealing in radio apparatus, the best manufacturers have appointed us as their distributors. We list a few of the well known companies we represent: Remler, Murdock, DeForest, General Radio, Amrad, Grebe, Acme, Federal, Radio Corporation, Magnavox, Burgess, Signal, Federal, Baldwin, Tuska, Corwin, Adams-Morgan.

### IMMEDIATE DELIVERY

Prices Include Postage

UV-200 Radiotron	.....	\$5.00
UV-201 Radiotron	.....	6.50
UV-202 Power Tube	.....	8.00
P1 Corwin Dial, with Knob	.....	1.30
P2 Corwin Dial, less Knob	.....	.75
981 Tuska Variometer	.....	6.25
810 Remler Panel Rheostat	.....	1.00
1421-W Federal Open Circuit Jack	.....	.70
1423-W Federal Two Circuit Jack	.....	1.00
92 Remler V.T. Socket	.....	1.50
A-2 Acme A.F. Amplifying Trans.	.....	5.00
550 Murdock V.T. Socket	.....	1.00
HM-100 DeForest Hand Microphone	.....	6.00
R-500 DeForest V.T. Socket	.....	1.25

Jewel Radio Meters in all needed scales. The New DeForest C.W. Unit Panels. All the Radio Corporation New C.W. Apparatus. All Amrad Cabinets and Units. The New Westinghouse Receiving Cabinets. Our tremendous stocks, the largest in the Middle West, comprise over 2,500 separate items. Your requirements will receive our immediate attention.

We pay all transportation charges on ALL goods that we ship.

**The Newman-Stern Co.**  
Newman-Stern Building  
Cleveland, Ohio

Send for catalog on Electrical supplies, Wireless Goods, Athletic Goods, Toys, etc.





185  
Illustrations

# A COLOSSAL EVENT

The new RASCO catalog just off the press is one of the greatest events in amateur radio. There are many radio catalogs, but the RASCO catalog is an event by itself for the simple reason that it

## Contains 50 Vacuum Tube Hook-Ups

This is the one and only radio catalog containing such wonderful free information. Complete hook-ups of all important vacuum tube circuits are given in clear diagrams with complete explanation. Just to name a few—the V.T. as a detector; detector and one-step amplifier; regenerative circuit; De Forest ultra-traction; V.T. to receive undamped and spark signals; Armstrong circuits; one step radio frequency amplifier and detector; three stage audio-frequency amplifier; short wave regenerative circuits; V.T. radio telephone; 4-stage radio frequency amplifiers; radio and audio frequency amplifier, inductively coupled amplifier; Armstrong super-audiotone; radio frequency amplifier and crystal detector; C.W. transmitters; self-recycling 2 tube C.W. transmitter; V.T. transmitter with 6 volt battery; radiophone using plate and grid modulation; one tube radio transmitter and receiver; experimental radiophone; radiophone using Colpitt oscillator circuit.

This list is only a partial one. You must positively see this wonderful book to appreciate it. It is made to fit the pocket—has heavy covers to withstand the wear and tear which it is sure to have at your hands because it will be your constant companion.

And Oh yes! Before we forget it. If you are in need of the following, remember "Rasco has it." These are only a few things contained in this catalog: Lugs, Nuts, Dials, Knobs, Washers, Crystals, Litz Wire, Selenium, Cord Taps, Cap Nuts, Tin Foils, Name Plates, Spring Posts, Switch Parts, Metal Ribbon, Carbon Balls, Binding Posts, Switch Points, Switch Levers, Carbon Grains, Metal Pointers, Contact Points, Low Melting Metal, Carbon Diaphragms, Screws, Copper Strip, "Spaghetti," Name Plates, Sliders, Mica, Switches, Resistance Wire, Variocoupler Rotors, Test Clips, Condenser Plates, Condensers, Antenna Connectors, Threaded Brass Rod, Ground Clamps, Etc., Etc.

The catalog contains 185 illustrations. On account of its great cost, this catalog cannot be distributed free of charge. It will only be mailed upon receipt of

15c in stamps.

## THE RASCO "BABY"

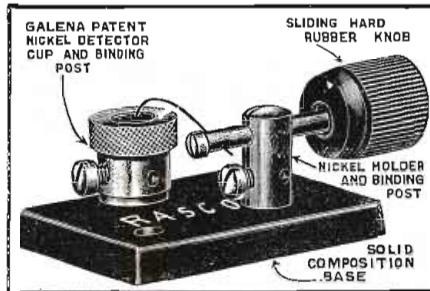

Illustration Full Size

### The Rasco "Baby"

Here it is boys! The smallest and most efficient detector in the world—as well as the cheapest. Our illustration is full size, and while the various details can be seen at a glance, we feel so enthusiastic about it that we must tell you all of its good points. First, there is a solid hard rubber composition base, size 1 1/2" x 1 1/2". We have not forgotten two holes to screw down the detector.

Then we have the nickel holder and binding post combined which holds the sliding, knurled, hard rubber composition knob. As you see, this knob not only revolves in its holder, but can also be moved back and forward in order to explore each point of the detector crystal.

Next we see the patent nickel detector cup and binding post combined. This is a little marvel all by itself and will not fail to evoke your admiration. No clamps, no soft metal to fuss with. You

simply unscrew the knurled cap and insert your crystal into the stand, screw home the cap which leaves a goodly portion of the galena exposed. The contact is perfect, while the crystal can be exchanged quickly in less than three seconds. By slightly unscrewing the cap, the crystal can be changed in position, in order to explore other sensitive spots. The esthwisker is of phosphor bronze and is attached to the horizontal bar by means of a fillet head screw. Can be readily exchanged in less than two seconds. Wires can be connected to the binding post in a jiffy. All metal parts are nickel plated, and you will be proud of this little masterpiece.

No. 1898 Rasco Baby Detector complete with galena crystal, prepaid..... 50c

No. 1899. The same but furnished with an additional piece of tested radioactive crystal, prepaid..... 75c

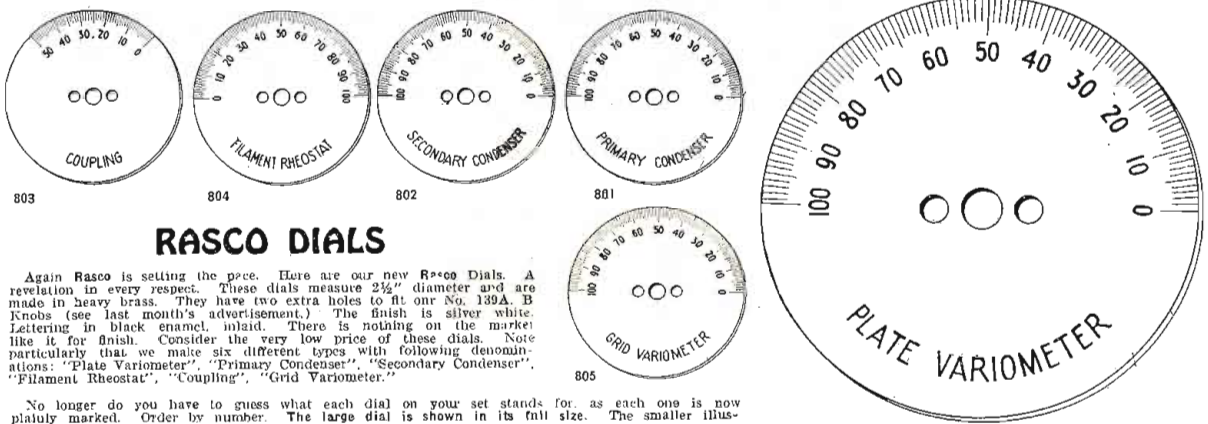

## RASCO DIALS

Again Rasco is setting the pace. Here are our new Rasco Dials. A revelation in every respect. These dials measure 2 1/2" diameter and are made in heavy brass. They have two extra holes to fit our No. 139A, B Knobs (see last month's advertisement.) The finish is silver white. Lettering in black enamel, mild. There is nothing on the market like it for finish. Consider the very low price of these dials. Note particularly that we make six different types with following denominations: "Plate Variometer", "Primary Condenser", "Secondary Condenser", "Filament Rheostat", "Coupling", "Grid Variometer."

No longer do you have to guess what each dial on your set stands for, as each one is now plainly marked. Order by number. The large dial is shown in its full size. The smaller illustrations are only given to show style.

Prices all styles . . . . prepaid ea. 30c  
A series of 6 dials complete prepaid, \$1.70

Do not compare these dials with some other makes as there is positively no comparison between them. Must be seen to be appreciated. Money back if not satisfied.

800 Designs Copyright 1921 by R. S. Co.

DEALERS' GET OUR SPECIAL PROPOSITION

# Radio Specialty Co.

96-98 PARK PLACE, NEW YORK CITY

Factories:  
Brooklyn, N. Y.—Elkridge, Md.

Did you see our full page ad in the June issue? We expected a good deal of business but we were actually snowed under! It shows that Rasco goods are wanted. In one week we filled over 600 orders and each and every order was shipped within 24 hours! Surely a record. We even filled orders for articles not listed. Our prices are low—our service the quickest—and your small order is never side-tracked as all our orders are small. One trial order will make you a life customer. Try us with a 50c order. We can only "stick" you once!

**Rasco**  
Trade Mark

**WE GUARANTEE EVERY ORDER SHIPPED WITHIN 24 HOURS.**



# RADIO NEWS

H. GERNSBACK—Editor  
ROBERT E. LACAULT—Associate Editor

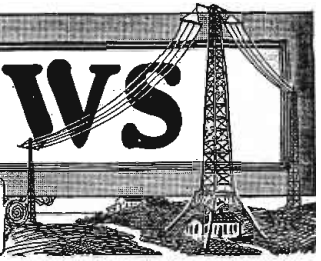

Vol. 3

JULY, 1921

No. 1

## WHY WE DO IT

**A** CHAP from the West wrote in to us the other day in the following strain. Says he, "I read your Editorials every month, but somehow or other I feel that they are a waste of space. Why not use this good space and give us some how-to-make-it stuff and the like, instead of telling us what we should do and what we cannot do most of the time?"

This letter is well put and to the point, and we like it. As for ourselves, we confess that writing editorials is about as difficult a job as we would like to have, and if we could get out of it gracefully, we would have done so long ago. However, there is our pride—which may be foolish. And then, again, we have been writing editorials ever since the inception of the magazine. A foolish idea perhaps, but then what can you expect of a poor editor who has to say something every month, whether he has anything to say or not?

Now, writing editorials for *RADIO NEWS* is not exactly a cinch as we mentioned above, and as the country editor is apt to say "the news is scarce." Not that news about radio and all that sort of thing is scarce—quite the contrary, there is too much of it. If our readers only knew how much material finds its way to the waste basket every month and how many articles are crowded out, they would be very much surprised. This in face of the accusation when we first started out that we would never be able to fill 48 pages of text month after month for a year to come. And now look at us! Here we are printing 88 pages a month chuck full of good radio material, and if we were a philanthropic institution instead of a dollar chasing one (and not catching the dollars at that) we might get out a 200 page book comfortably every month without much ado. But we were talking about editorials, and we are not supposed to talk shop.

Why then is a radio editorial? As far as we can figure it out ourselves, it is supposed (we say supposed advisedly and guardedly) to instruct and to encourage and perhaps to push the art forward if ever so little. We admit that this is a grand and glorious undertaking, and we also admit

that nine times out of ten, we fall down with a bad thump, and end up with a lot of QRM. If, however, we succeed only once in a while, in implanting the germ of a good idea into the cranium of a young and budding radio bug, then we feel that next month we can sling the ink as carelessly as may be.

Our readers have probably noticed often that radio amateurs, as a rule, like to imitate each other a good deal. When one gets a new hook-up or a new style panel switch the whole fraternity goes wild about it, and they all adopt it. Of course, we do not discourage that sort of idea too much, but at the same time it stifles originality, and in any new art originality is one of the vital things, which should be cultivated, and that has been the reason why most of our editorials have been along the lines of trying to bring the best out of the amateur for the benefit of the others.

Now these ideas that we try to instil in your minds are not necessarily always our own, and we do not think for one minute that in advising them we know it all ourselves. But we see so many communications, so many suggestions, so many articles that come to our desk every day that we necessarily take most of our suggestions from them. Therefore, the next time you read one of the editorials remember that it may only be the crystallization of a hundred communications coming to our desk all boiled down into a few concrete ideas. In other words, the editorial on which we justly pride ourselves is not our editorial at all, but fundamentally it originated with you, and we are sorry to say we take all the credit for it. But then that is the nature of the editorial "beast" who is "supposed" to know more than the ordinary mortal, but who, nine times out of ten, does nothing of the sort.

We started out saying that it is not always simple to get up an idea for an editorial. We admit that this month the editorial wisdom had run dry, but we simply had to fill this page and we were rather desperate about it. So you see we did not write a radio editorial after all, and we are not quite sure if the joke is on you or on us.

H. GERNSBACK.

### IMPORTANT TO NEWSSTAND READERS:

In order to eliminate all waste and unsold copies, it becomes necessary to supply newsdealers only with a sufficient amount of copies for which they have actual orders. Please note that your newsdealer will be glad to reserve a copy for you every month. This costs you nothing and you will

be assured of your copies. Hand your newsdealer a slip of paper on which write your name and address with a request to reserve a monthly copy of *RADIO NEWS* for you. This will be the only way to assure you of your copy hereafter.



# The Lyon Radio Station

By THE PARIS CORRESPONDENT OF "RADIO NEWS"

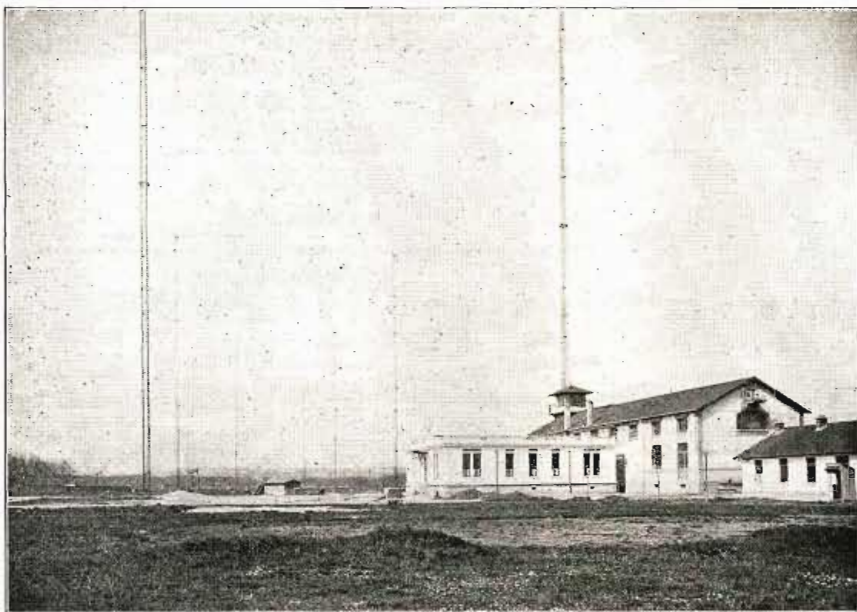

General View of the Lyon Station Showing the Eight Towers, and on the Extreme Right the Power House.

**T**HE Lyon Radio Station is a son of the war. In 1914, the Eiffel Tower was the only high powered French station, and altho a new station had been erected under ground in the Trocadero Palace, with another aerial fixed on top of the FL Tower, the necessity was felt to have, far from Paris, in a place out of reach of German airplanes, another Radio station having the same range as the Eiffel Tower, and if possible, a greater one. The suburb of Lyon was chosen to erect that station. The first sending set, which it was necessary to install as soon as possible, was the 150-k.w. station which had been built for Indo-China, and which was kept for this need. Some other apparatus was installed later, of which we shall speak in detail. Before describing the station as it is, we shall say a few words of the different rôles which it played during the war. Then, after the description, we shall conclude with a few words regarding the results obtained and the studies and experiments carried out at the present time.

## THE VARIOUS ROLES OF THE YN STATION

Before 1917, the Lyon Station had been designed to help the Eiffel Tower in the traffic with the Allied stations in Russia and the Orient. That is why its antenna, of the inverted L type and erected on eight 400-ft. towers, had been directed towards Russia. In fact, the station corresponded as early as the end of 1915, and in 1916 with Russia, Serbia and Rumania, at first with a spark transmitter and later with a Poulsen arc.

As soon as it was known, at the beginning of 1917, that the great Republic of the United States would fight beside France, a test was made by the Eiffel Tower and Lyon Stations to communicate with the American Stations on the Atlantic Coast. At first, Lyon obtained very good results, as good, said the receiving stations of America, as Naucon, which was more powerful than Lyon. The results were very good during the Spring, but when the hot months arrived, the atmospherics, very strong in America, shortened the hours during which the messages could be sent. Then General Fer-

rie proposed the erection of high towers and the increase of the power. He proposed at the same time the construction of an ultra powerful station that General Pershing asked for, and which was to be the Lafayette Station. Lyon, after that time, became the correspondent of the American Stations. Thanks to the higher towers and to the extra power, it insured, in 1918, daily communication, and even in summer, when the number of quiet hours was few, traffic could be handled without long delay; the traffic with America still lasts at the time these lines are written, and gives full satisfaction.

YN has disposed of three different sending sets, the second and third of which are

still in use at the present time. These three sets are the following: First, a spark set, of which we have already spoken and which was built for the Indo-China Station; second, an arc set of the Poulsen type; third, a high frequency alternator.

The spark set was used very little except at the beginning. It consisted of a 1,000-cycle alternator run by a motor, on the shaft of which is mounted a synchronous spark gap. The alternator supplies a step-up transformer, the secondary of which is connected to the oscillating circuit. This circuit includes a capacity of 1.4 microfarads formed of 20 elements and an inductance made of copper strips. The condenser is made of a metallic tank containing a certain number of aluminum armatures separated by glass plates about  $\frac{1}{8}$  of an inch thick, the whole thing being immersed in oil. The oscillating circuit, when charged, is discharged either thru the rotary gap at the rate of 1,000 sparks a second, or thru a fixed spark gap equip with an air blast device. The antenna is connected to a loading coil and reaches the ground thru a part of the oscillating circuit inductance. By introducing a more or less important part of this inductance into the antenna circuit, coupling between the aerial and oscillating circuit is varied. The ground is the same for all the sets and is made of a zinc plate of about 5,360 square feet, and of a certain number of copper wires buried under the antenna.

The antenna used at the beginning with the spark set was of the inverted L type mounted on the eight towers which have previously been spoken of.

## THE ARC SETS

In 1917, undamped wave transmission was substituted for the former one. It was a Poulsen arc, the hook-up of which is shown in Fig. 1, which supplied the antenna with a little less than 100 k.w. This arc was supplied by two 750-volt dynamos connected in series, or by another machine which could deliver 1,500 volts. The manipulation was made by the short circuit of a certain number of turns of the antenna inductance, which is the system of manipulation with compensating waves. When the key is

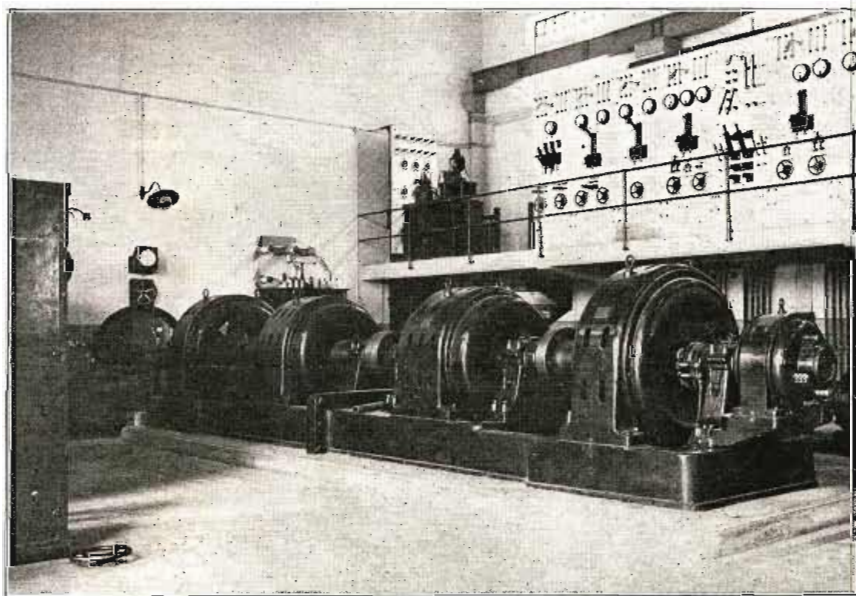

This Photograph Shows the 150 K.W. Spark Set Which Consists of Two 1,000 Cycle Alternators Run by Two Motors. Either of These May Be Used With the Same Oscillating Circuit. Note the Switch Panel on the Gallery.



pressed, the signals are sent on a certain wave-length, and when it is released, the arc still radiates, but on another wave-length, owing to the different values of inductance in the circuit. The receiving set is tuned on the first one of these wave-lengths and receives the dots and dashes only.

The principle of the production of high frequency oscillations in a circuit connected to an arc is well known. It was discovered by Duddell, and is as follows:

If, to the electrodes of an arc supplied with D. C., an oscillating circuit consisting of inductance and capacity is connected, an alternating current, the frequency of which depends upon the electric constants of the system, is produced. This set, consisting of the arc and oscillating circuit, transforms the D. C. into an A. C. of high frequency. This system still works when the closed circuit connected to the electrodes of the arc is replaced by the open circuit having capacity and inductance constituted by the antenna and ground. The functioning of the system is improved by cooling the electrodes and the tank in which the arc burns, and which is filled either with gas, petrol or alcohol, and last of all by submitting it to a magnetic field obtained with an electro magnet between the poles of which the arc burns. In several French systems these magnets are supplied by the same current that starts the arc; see Fig. 1. The first arc set of Lyon was replaced in 1918 by a much more powerful one of the same type, but which, supplied with 400 to 450 k.w., puts almost 200 k.w. of useful energy into the antenna. A new improvement which was introduced recently and which we shall describe later, is the suppressing of the manipulation with a compensating wave. In fact, this compensating wave is detrimental, it consumes energy, causes unnecessary interference and very often troubles the reception of the signals, as it is almost always heard even when the receiving set is carefully tuned.

The use of a more powerful arc was decided upon in order to have constant communication with America. At the same time, it was decided to increase the height of the towers and to erect a new antenna. It is this new antenna that should radiate the energy supplied by the high frequency alternator of which we still have to speak. However, we shall first say a word about the antenna. The towers of the Lyon Station are held up by guy wires; they are, as we have said, 400 feet high. It was at first decided that the two nearest ones to the lead in would be increased up to 670 feet. Then it was found necessary to give the same height to the other towers. This operation, begun at the end of 1917, was entirely finished in the summer of 1918, and the work was so conducted that the inter-

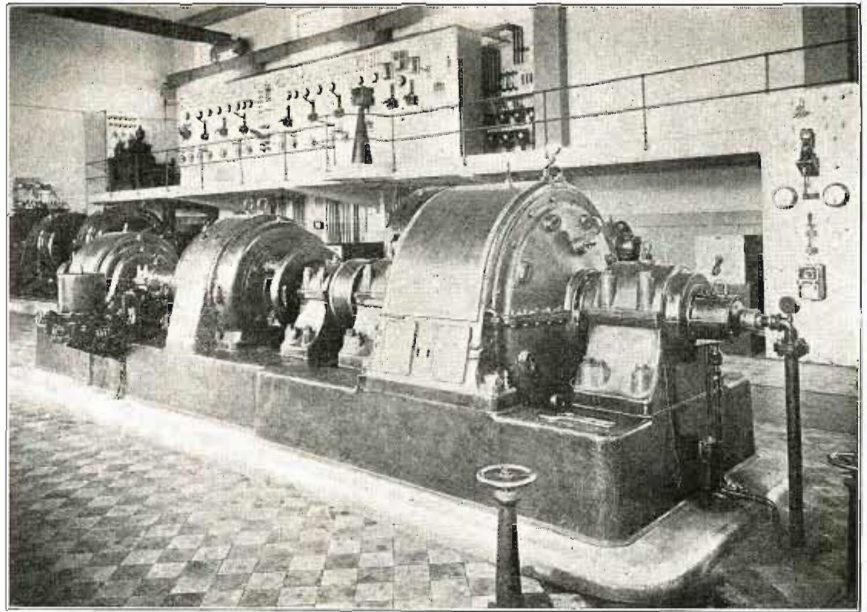

This is the Bethenod-Latour H.F. Alternator. On the Gallery May Be Seen the Control Switchboard.

ruptions in the traffic of the station never lasted more than a few hours. The new 670-foot towers were erected farther apart than were the smaller ones. The construction of this did not interfere at all with the traffic of the station. Then, when these new towers were completed, it was merely necessary to attach the antenna to the top

plied by the powerful arc of which we have already spoken, or by the H. F. alternator, this antenna gave, even during the summer, very good communications with the United States. During the worst days of July and August, the quiet hours during which traffic could be handled were sufficient to allow all the messages to be sent out without long delay, but it can not be said that Lyon can work with the United States at any hour of the day in any season, as does the Lafayette Station. It works every day, but during the hot months, a few hours only. The high frequency alternator used at YN is of the Bethenod-Latour type; it is a French machine which has been in use more than a year, during which time it has given excellent results, and it has needed no repairs.

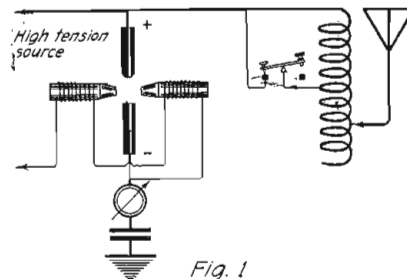

Fig. 1

Simplified Hook-up of the Arc Set, Showing the System of Manipulation.

of the new ones, this operation being completed in a very short time.

A few wires were added on the flat top of the new antenna which consisted of 20 wires and had a capacity of about .03 mfd. and a resistance of from 1.5 to 1.6 ohms. Sup-

**THE BETHENOD-LATOURE H.F. ALTERNATOR**

This alternator, like the American Alexanderson, gives directly the high frequency necessary. The frequency is not multiplied inside the machine, as in the Goldschmidt alternator, nor outside with frequency transformers, as it is done in the German Station at Nauen. This high frequency is obtained by the high speed of rotation (3,000 revolutions per minute) and by a great number of poles and a few details which we cannot describe here, and which constitute the improvements of the machine. This alternator which can supply the antenna with 150 to 180 k.w. at a frequency of 20,000 cycles, is run by a 5,000-volt D. C. motor.

As the speed is very important in order to have a constant frequency, thus a constant wave-length, a double system of regulation of the speed is used. First: the D. C. dynamo supplying the motor running the alternator has its voltage regulated by a Thury regulator, and the motor itself is equipped with a mechanical regulator which acts on the field current in case of variation of speed. By this device, a great regularity in speed is obtained and the variation cannot exceed 0.05 per cent.

The alternator supplies the primary of an oscillation transformer which is made of several pancake coils, and which acts by induction upon the secondary similarly constructed and connected into the antenna circuit between the loading coil and the ground. (See Fig. 3.) The manipulation is made by opening and closing the circuit without any compensating wave. Between the dots and the dashes, the alternator is short circuited and no current flows in the antenna:

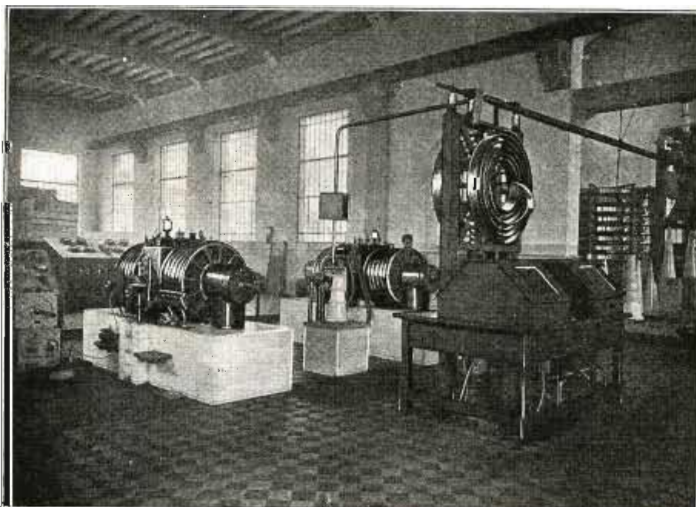

In this photograph may be seen the arcs and oscillation transformer. Note the loading coils on the right.



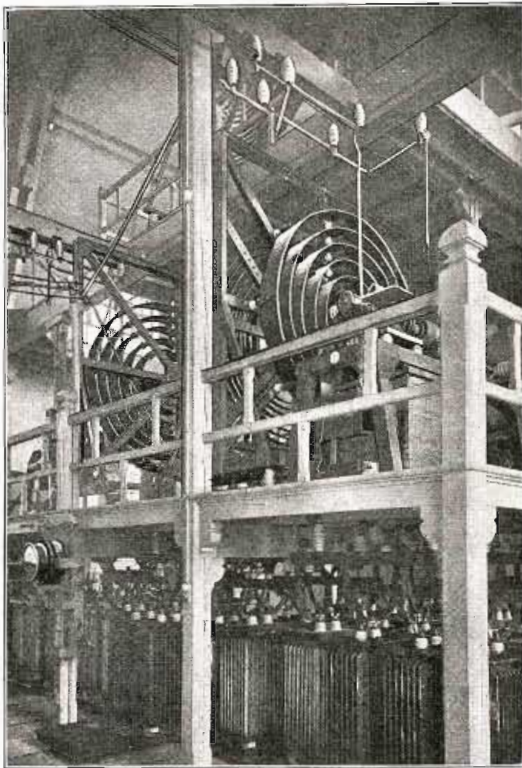

The Oscillation Transformer and the Sending Condensers at YN

the reading of such signals is very easy and all the receiving stations corresponding with YN have declared that the reception of signals sent with the alternator is much easier than the reception of those sent with the arc. The Lyon Station is actually a very powerful one, equipt with the most up-to-date apparatus. Besides the spark set which is used only at exceptional times, it has two powerful undampnt sending sets, an arc and a high frequency alternator. One or the other of these sets can deliver from 150 to 200 k.w. of energy in the antenna. Both have had satisfactory communication with America, the excellent results of which we shall now speak.

The American Stations, as we have stated, received the signals from YN several hours each day. The number of hours during which traffic can be carried on is greater in the winter than in the summer, but it can be said that even during the worst days in the summer it is still possible to send during at least six hours. The corresponding station of Lyon, in America, is Annapolis, NSS. YN is heard very satisfactorily in Shanghai, China, and in Central Africa. The reception is so regular that upon the demand of the correspondents, it sends news and press messages daily, especially for Central Africa.

Since March, 1918, it has also sent press notices for the Far East, and since September of the same year, YN has also been received in Australia and in New Zealand and its signals will be used in the determination of longitude at Sydney and Adelaide, Australia, by a method that will be described later.

If YN has good results in transmitting, the reception is also being greatly improved. Some receiving sets, using loop aerials equipt with multi-stage amplifiers, are used. These receiving sets, being installed inside of some Faraday cage, make possible the reception of the corresponding stations to be carried on less than a mile away, while the big station is sending at full power. Duplex communication is then easily obtained and allows the antenna to be used in transmitting constantly. All the modern high-power stations are so equipt.

The YN station sends time signals which are used in the determination of the longitude at the points where they are received with a precision of 1/50 of a second. The principle of these measurements is very simple. For instance, YN sends 300 beats consisting of a dot, lasting from 20 to 25 hundredth of a second, spaced by one second less 1/50 of a second. These dots are automatically sent by a clock making contacts at the required speed. At the Paris Observatory one determines the exact hour at which the first and the last of these dots are sent, by listening into the same telephone the dots sent by Radio and the dots made every second by a stand-ard clock.

At any time the dots made by the pendulum of the Observatory and the dots sent by Radio do not coincide with one another. As the first are produced every second and the others every second less 1/50 of a second, the difference of time between the two series of dots does not stay invariable, and at a certain time coincidence is produced, which is noted, and allows the operator to determine at exactly what second of the clock one of the beats from YN was produced. It is sufficient to know the order number of the dot sent

to the receiving station, which, by means of the same system as the one just described, notes the time of a coincidence between the signals from YN and its own clock. It can then, with this exact time, compare the local time with the time of the Paris Observatory. This comparison determines its longitude with the same degree of accuracy that the time from Paris is received, that is to say, 1/50 of a second. The two Observatories in Sydney and Adelaide have just determined their exact longitudes by this means.

The last improvement which has been experimented with at the YN Station is the one consisting in the suppression of the compensating wave of the arc set. This result is obtained by connecting to the arc a non-radiating oscillating circuit composed of an inductance and a capacity. The key is connected in the antenna circuit itself, instead of short circuiting a few turns of the antenna inductance, as shown in Fig. 2.

The coils of the electromagnet are supplied by a separate source, instead of being connected in series with the arc supply. When the key is not pressed, the antenna disconnected from the arc does not radiate, but the arc is not shut off, for it works with the non-radiating circuit. By this system, only one wave is sent and less energy is consumed, and at the reception, the reading of the signals is made much easier. This device, invented by a Radio engineer of the Eiffel Tower Station, has been experimented with before, and has given entire satisfaction. It has recently been installed at Lyon and is expected to be used with the extra powerful arcs of the Lafayette Station.

Such is the Lyon Station. With its arc sets working without compensating waves, with its high frequency alternator supplying from 150 to 180 k.w. in the aerial, with its receiving stations using loop antennae in the vicinity of the sending station; it is the type of the up-to-date high-powered station, the great progress of which was made during the war. For more than two years it has insured without difficulty the handling of the traffic that was asked of it, and in the future will help the Lafayette Station in its communications with the United States and the French Colonies.

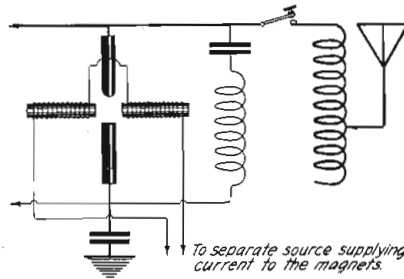

Fig. 2. In This Circuit the Arc is Connected in Series in the Aerial Circuit and Signals are Sent Without Compensating Wave.

by YN that coincided, to know the exact time of the first and last beats, with a precision of 1/50 of a second. The exact hour of the first and last beats is sent by Radio

### Some Transmitting Tube Data By B. F. McNamee\*

The amateur who has just started experimenting with CW generally finds out that he has something to learn about transmitting tubes. The sad fact is that he generally

\*Chief Engineer, Moorhead Laboratories, Inc.

(Continued on page 77)

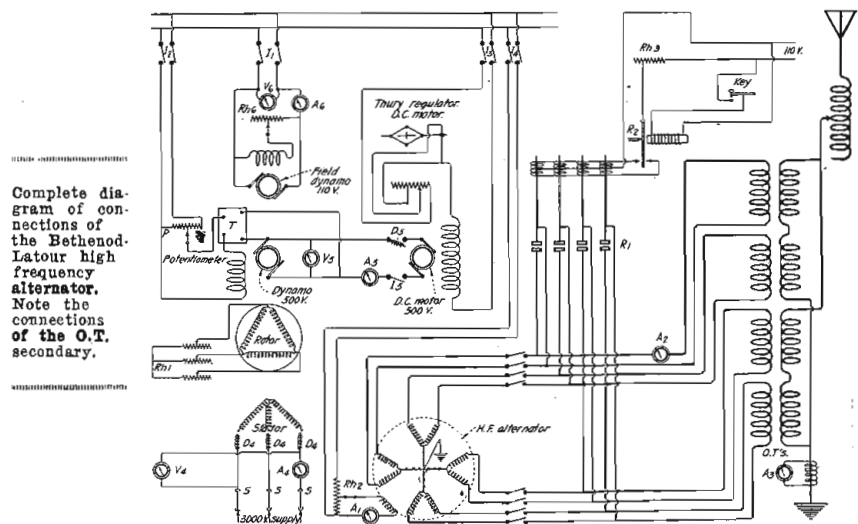

Complete diagram of connections of the Bethenod-Latour high frequency alternator. Note the connections of the O.T. secondary.

Fig. 3



# A New Automatic Recorder

By S. R. WINTERS

**W**ITH 3,800 miles intervening, the manipulation of a fountain pen on the third floor of the Northwest building, in a laboratory of the National Bureau of Standards, Washington, D. C., by the action of an individual in Lyons, France, would seem to suggest the eighth wonder of the world. The apparent phenomena is explained by a description of an instrument for automatically recording radio signals, an invention jointly sponsored by Dr. E. A. Eckhardt and Dr. J. C. Karcher.

The writing of wireless messages in the absence of the human ear is not without precedent, a variety of mechanical means having been devised. The Eckhardt-Karcher progeny, however, has established claims to novelty and its use for field service by the Coast and Geodesic Survey this summer is a testimonial subscribing to its practical application. In fact, the device was developed for the specific purpose of recording radio time signals, its adaptation to the writing down of other wireless signals being but a natural outcropping. Compactness, being portable, and its simplicity, are virtues vouchsafed for the invention.

The apparatus itself consists of a regenerative electron-tube circuit. This involves the use of an electron tube, popularly known as an audion bulb, and a potentiometer for adjusting the mean potential to any specified value. A variable condenser and fixed inductance comprise a tuned circuit in the grid circuit of the tube. In the plate circuit there is a fixed inductance and a plate battery.

In actual operation, the inductances, when agreeably coupled, excite a rise in the plate current which will stimulate the grid potential to action. This rise in grid potential will likewise result in a further rise in plate current. In a word, the circuit is regenerative. For a suitably selected filament temperature, starting with an adequate grid potential and gradually altering the same in the direction of more positive values, a grid potential will be attained at which the circuit becomes self-oscillatory.

The beginning of oscillations is attended by a rise in the mean plate current. The volume of the excitation of the latter is largely determined by the design of the circuit. One circuit employed by the Bureau of Standards was responsible for a variation in rise from a fractional milliamperes to several milliamperes, while in another unit, the excitation ranged from one or two mil-

This photograph shows the complete recorder designed by Messrs. Eckhardt and Karcher. On the left is the radio receiver and amplifier, while on the right is the recording instrument.

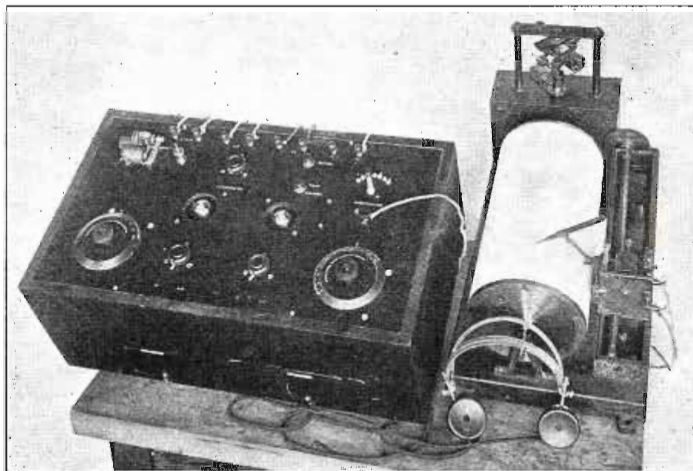

liamperes, to an ultimate value of 50 milliamperes. By inserting the windings of a telegraf relay in the plate circuit of the regenerative system the relay may be so adjusted that the inception of self-oscillations in the regenerative circuit will cause the relay magnet to attract the relay armature. Similarly, reversing the order, the ceasing of the oscillations will release the relay armature. Ultimately, if the circuit is prop-

the critical potential.

The utter absence of kick-back, or readjustment in the regenerative circuit when the oscillation-silencing contact opens, is the primary source of sensitivity and range of the Eckhardt-Karcher invention. Therein, claim to distinction is beyond peradventure—the first device to record mechanically, employing a single audion bulb, wireless messages from far-away European points. Freak performances are not credited to the invention, but the continuity of its behavior in recording wireless conversations daily for a period of many months identifies the apparatus as being well-ordered. In the parlance of the street, as the phrase applies to human relations, this device is a "regular fellow." Its operation is under perfect control and in the reception of Transatlantic messages, the process may be repeated "world without end."

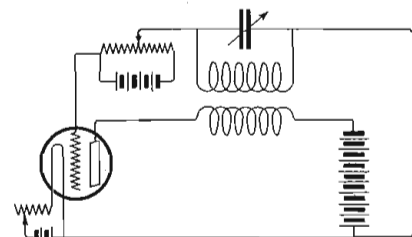

Simplified Hook-up of the Receiver Showing the Battery and Potentiometer by Means of Which the Grid Potential is Adjusted.

erly tuned and agreeably related to a wireless-receiving antenna, with the mean potential adjusted to a value immediately below the critical one, an incoming signal raises the grid potential for the moment above the critical value. The regenerative circuit becomes self-oscillatory and the telegraf relay functions.

Thus the telegraf relay can be forced to operate any recording device. Not unlike the Irishman, however, who when being induced by the automobile salesman to purchase a speed-demon of a car inquired, "How fast can you stop the thing?"; similarly, how can you stop the oscillations of the regenerative circuit? Drs. Eckhardt and Karcher have successfully answered this question. A restoral of the circuit to a receptive state, when the wireless signals cease, is accomplished by two contacts on the relay, one of which is closed when the relay armature is released and the other contact closed when it is attracted. The barring of the inner contact short-circuits a low-resistance coil of a few turns sandwiched between the two regenerative coils. In effect, this action screens one of the regenerating coils from its companion, the self-oscillations ceasing. The opening of the screening coil is not penalized by readjustments in the regenerative circuit, hence avoiding a kick-back. This safety valve, figuratively speaking, renders it possible to operate with an extremely narrow margin with reference to

The recording apparatus is deservedly of interest. A sheet of paper, in a receptive mood for obtaining the record, is wound around a cylinder. The latter is rotated at a uniform rate of speed by a clockwork, picturesquely described by Doctor Eckhardt as being actuated much in the same fashion as the grandfather clock, by falling weights. When off duty, the recording fountain-pen traces a straight line, which for the sake of identification is described as the datum line. By tuning in on any transmitting station, the pen bids goodbye to the datum line when the signal begins only to return, when the message is concluded. Short and long humps in the datum line, bearing similarity to the dots and dashes comprising telegraf signals, are means of interpreting the long-distance communications so faithfully re-

(Continued on page 46)

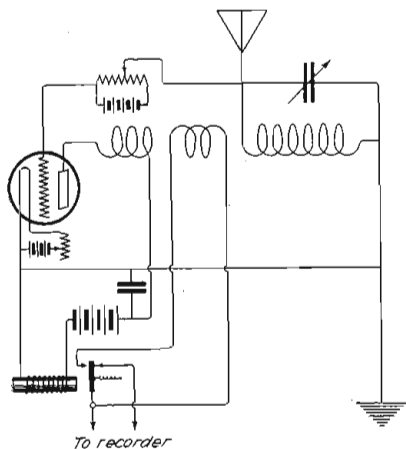

Complete Diagram of Connections of the Receiving Set.

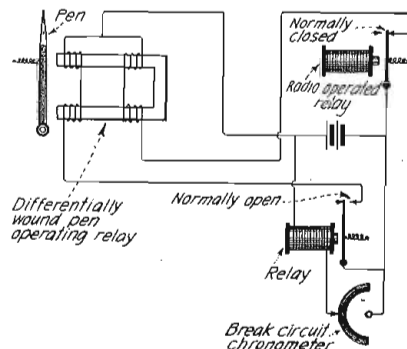

Hook-up of the Recording Apparatus.

# The Oscillograf\*

By JESSE MARSTEN

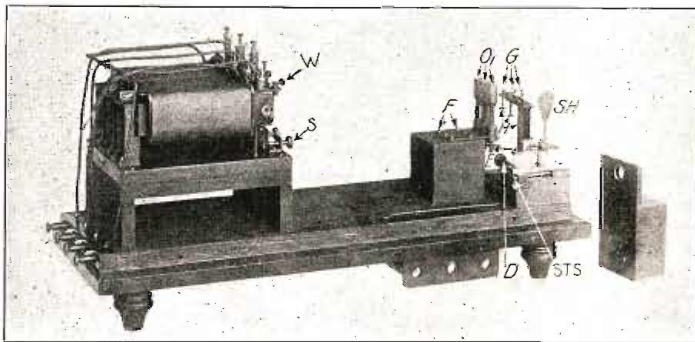

Fig. 4. General view of a complete oscillograf. On the left are the galvanometer units while on the right are the small slits for adjusting the width of the light rays.

IN discussions of radio telephone methods and modulation systems placed before amateurs one frequently comes across a statement to the effect that the percentage of modulation can be determined by the use of the oscillograf. Just how much information this gives the amateur it is difficult to say—it probably depends upon the amount of his electrical training and reading. However, it is fairly safe to say that most amateurs have not seen an oscillograf and do not know how it is used. Still the determination of the degree of modulation is important, and the method of doing this by means of the oscillograf, the only accurate method, ought to be understood by the amateur. Especially so since a large percentage of radio engineers are recruited from the amateur fraternity, and are frequently put on such work with little preliminary notice or preparation. In such cases, a little previous reading on the construction and operation of apparatus comes in good stead.

Not only is the oscillograf of importance in radio telephony, but it has a general use in all alternating current and telephone work. In general it may be said that the oscillograf is used to obtain electrical data and information when the qualities to be determined vary too rapidly to be recorded by the usual electrical instruments. Thus, it is not possible to obtain the instantaneous values of voltage and current in a telephone speech wave by the use of voltmeters or ammeters, for the values fluctuate too rapidly for the meter to follow. The oscillograf will picture the complete wave and thus show values from instant to instant.

One of the most used oscillografs in this country is that made by the General Electric Co. and called the Type EM Form C Oscillograf. This oscillograf belongs to the class of "Moving Coil" oscillografs, and the principle on which it operates is as follows:

Figure 1 represents an elementary oscillograf in which a steady constant magnetic field is produced either by means of a permanent magnet or a direct current electro-magnet. Between the poles of this magnet is suspended a coil of wire of one turn, made up of two wire filaments ff. The current of which the oscillograf is to be taken is sent thru this coil. At any instant the direction of the current is up one wire of the coil and down the other as indicated by the arrows. Therefore, due to the electromagnetic force action between the magnetic field and current, one wire will be displaced forward and the other backward. Thus the coil is twisted first in one direction, then in the other, with the alternations in current. The amount of this twist is proportional to the strength of the current oscillograf, consequently the coil follows exactly all the variations of the current. If now, a small mirror is attached to this coil at *m* and a source or ray of light is played on the mir-

ror, this ray will be reflected in the various positions of the coil as it rotates. Thus, this reflected ray of light will also follow the variations in current. If this ray of light is reflected on a screen which is moving at right angles to the motion of the ray, a continuous wave will be produced on the screen, which will be a true copy of the current oscillografed. It is readily seen that if the moving screen is a sensitized photographic film, a negative will be produced, which when developed will give a permanent fotograf of the wave.

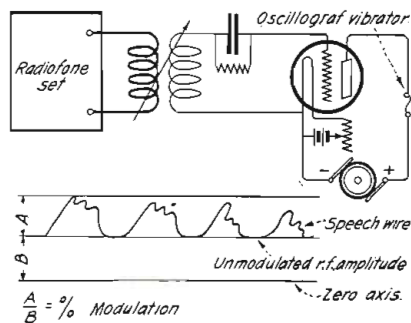

This Diagram Shows How a Radiophone Set is Connected to an Oscillograf. A Rectifying Circuit is Used Between, So That the Vibrator of the Oscillograf Can Vibrate at Audio Frequency.

In observing the wave of the oscillografed current a stationary screen is actually employed. In this case instead of the moving screen, whose motion is at right angles to that of the reflected ray, a rotating mirror is used, the motion of which is at right angles to that of the coil mirror. Thus the effect produced is the same as with the moving screen, for the reflected ray is given two motions which are at right-angles to one another, and a continuous wave is observed on the stationary screen.

This is the simple theory underlying the operation of the moving coil oscillograf. The important conditions which must be met by such an oscillograf are as follows:

1. The natural period of vibration of the oscillograf coil (or element as it is sometimes called) must be very small. For in order to follow such rapid variations as that of speech currents, the coil itself must have a high natural frequency.
2. The coil must be critically dampd, so as to prevent the movement of the coil becoming oscillatory. The necessity for this is evident when one considers that when the current reaches its maximum value the coil deflection may overshoot its marks, unless it is properly dampd, and thus gives false records of the wave.

The accompanying fotografos will give a

very clear idea of the construction of the oscillograf. The oscillograf is enclosed in a light tight box. The internal parts are shown in Figs. 2, 3 and 4.

Fig. 2 shows a detailed view of the oscillograf vibrator complete. The vibrator coil is clearly visible in the cell and is connected between the terminals VT, and passes over the grooved pulley near the bottom of the cell. The tension on the wires is adjustable by the tension screws TS, and this tension is indicated by a spring balance SB. For the usual vibrator this tension should be six ounces. The small vibration mirror VM is cemented to the two wires in the narrow air gap between the wedge shaped pole tips PT. The necessary damping of the motion of the vibrator is secured by filling each cell with a damping liquid just sufficient to cover the top of the pole tips PT. This liquid usually consists of a mixture of white castor oil and pure turpentine. The free period of the vibrator, as usually made, is about one-six-thousandth of a second. This is sufficiently high to secure accurate results in the ordinary work usually met. However, special high sensitivity vibrators have been made whose periods are around one-ten-thousandth of a second. This vibrator, of course, should never be used with currents of the same frequency as the vibrator. Due to possible resonance effects the swing of the coil may become so great as to cause damage to it.

Fig 3 shows the complete galvanometer unit assembled. As can be seen, there are three vibrator elements, each alike so that they can be substituted for one another in case of necessity. For the magnetic field electro-magnets are used, as they are found to be superior to the permanent magnet type. Posts MP connected to the magnet frame are provided so that if necessary the vibrator elements may be conveniently grounded to it. In general the vibrator

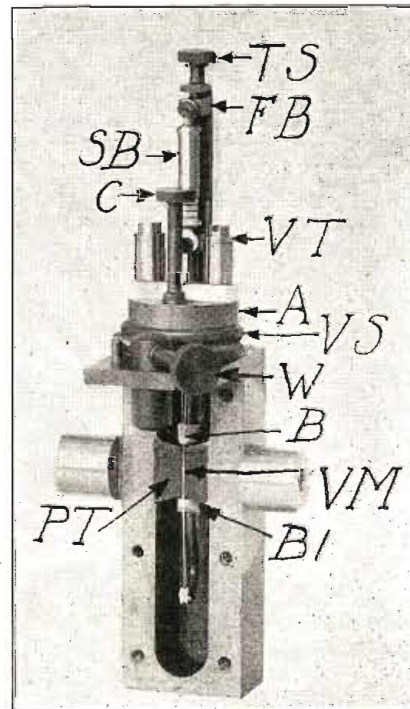

Close-up View of a Unit. The Small Mirror VM May Be Seen Fixt on the Coil, Which is Placed Between the Poles PT of the Field Magnet.

\*Constants and fotos by courtesy of General Electric Co.



should always be grounded, but when the voltage between the elements is greater than 150 volts, it must be grounded.

The small vibration mirrors attach to the coils are clearly visible as the bright spot in the centers of the cell windows in Fig. 3. The ray of light when reflected from this mirror can be observed on a white screen fixed on the top of the case. On the screen this should appear as a white point practically for best results. If it is a white point, the curve which the spot traces will be a clear-cut white line or curve, but if the spot is not a point, but a square of appreciable dimensions the curve which it traces will not be a clear-cut line, but a band having a definite width. This is not desirable for measurement purposes. Furthermore, the image of the curve will not be distinct. In order to secure this fine image of the mirror on the screen an adjustment of the light spot is made. By turning the pin E in Fig. 4, the slits O are opened and their widths adjusted to the size required. These slits allow the ray of light to pass thru to the mirrors and by narrowing down the beam the necessary adjustment is made to suit.

In this way the three clear-cut images of the mirrors can be seen on the screen. Now, for purposes of observation, it may be desirable to have these separate images in definite positions on the screen. This can be taken care of by the adjustment screws S and W, Figs. 3 and 4. Screw S controls the vertical motion of the mirror and screw W the horizontal motion. Thus by manipulating these two adjustments, the image can be located at any point of the screen. The three small prisms G in Fig. 4, thru which the light from the arc lamp, or other source passes on its way to the mirrors, may also be adjusted by the screws H, thus playing the light directly on the mirrors.

The application of the oscillograf to alternating current measurements and radio telephony will be understood from the following. Since the determination of the percentage modulation in radio telephony is really a problem in comparing amplitudes of oscillations we will consider first the problem of determining the instantaneous values of an alternating current of audible frequency.

By making the adjustments described above on the image of the vibration mirrors, the three images may be made coincident, leaving on the observation screen just one point, which point will trace a straight line on the screen. This straight line may be used as the zero line. A direct current of known magnitude is now applied to, say, the left hand vibrating element, and this element will therefore be deflected an amount proportional to the known current and another straight line will be traced on the screen above the zero line. The amount

Fig. 3. This fotograf shows a complete galvanometer unit. The small mirrors may be seen thru the cell windows.

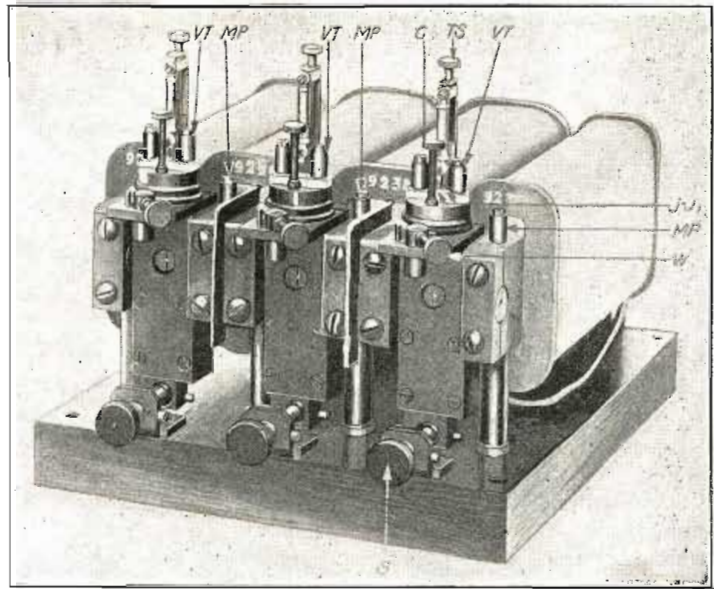

by which it is above the zero line is a measure of the value of the current. The current to be measured now, say, the audio current in the plate circuit of a modulation amplifier, is applied to the right-hand vibration element. This element will be deflected thru varying angles each instant, depending

on the values of the current at each instant, and the curve it will trace will be an alternating current of varying amplitude therefore, and will appear on the observation screen as such. The screen will show the following:

1. A straight line traced by the center mirror thru which no current flows, and which acts as the zero axis.
2. A straight line traced by the left hand mirror thru which a known current flows. This line is above the zero axis.
3. An alternating current curve traced by the right-hand mirror thru which the alternating current to be measured flows.

These will be seen in Fig. 8. Since the known current is measured by the distance of its curve or straight line above the zero axis, we can easily find the value of the alternating current at any instant by noting its distance above the zero axis and comparing with that of the known current; in a similar way voltages may be measured. It can be seen also that by tracing a voltage wave with the left hand element, and the current wave with the right hand element, using the center element as zero line, we can observe both voltage and current waves simultaneously and thus obtain data as to the phases relationships.

We can now consider its application to radio telephony, particularly to the determination of the degree of modulation in a telephone set. The problem here is to determine the ratio of the audio frequency amplitude

(Continued on page 60)

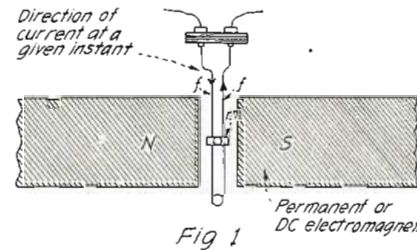

FIG 1

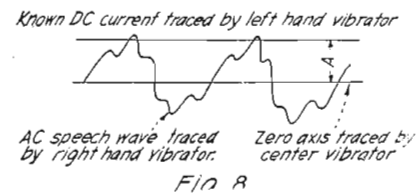
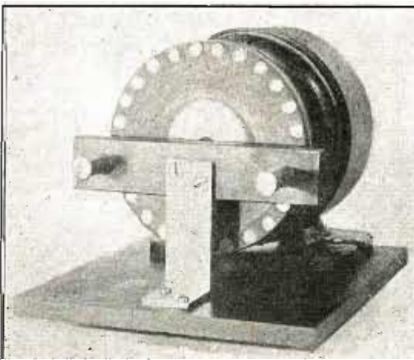

FIG 2

Fig. 1 Shows Diagrammatically How the Little Mirror is Fixed on the Coil Submitted to a Strong Magnetic Field, While Fig. 2 Shows the Lines Traced by Three Vibrators When the Oscillograf is Used to Determine the Percentage Modulation of a Radiophone Set.

## A NEW MODULATOR FOR TUBE TRANSMITTERS



Here is an Efficient Chopper for That C.W. Set of Yours. By its Uses D. X. Stations Are More Easily "Raised." Foto by courtesy of the Northern Electric Co.

The accompanying illustration shows a new device offered to the amateur field for I. C. W. (interrupted continuous wave) transmission.

The advantages of a modulator of this type, when used in the proper circuits of a tube set are, as yet, not fully known to many experimenters in this country, but they will shortly be found in all modern stations. All the tubes may be operated as oscillators and with correct adjustments, the peak value of antenna current may attain twice its normal C. W. value without causing any overload on the tubes. The increased range obtained is at once evident.

No heterodyne receiver is necessary to receive signals sent out with this modulator and any frequency note up to 1,500 cycles may be obtained by adjusting the motor speed. A special type of brush and brush-gear has been designed so that the time in-

tervals between interruptions are of the proper value.

The construction has been made very sturdy and no critical adjustments are required, as is characteristic of rotary gaps in spark transmitters.

Complete instructions and wiring diagrams are supplied by the dealer with each modulator.

### CONSTRUCTION OF BALL-AND-CUP VARIOMETERS.

Mr. E. S. Smith, who wrote the article on the construction of variometers, on page 862 of the June issue, requires the following rectification to be made:

The number of feet on both the primary and secondary should be 48 feet each, instead of 24 feet, as mentioned, and which is the number of turns in each half of the coils.



# Nauen Time Signal Radio Service

By DR. ALFRED GRADENWITZ  
Berlin Correspondent of "Radio News"

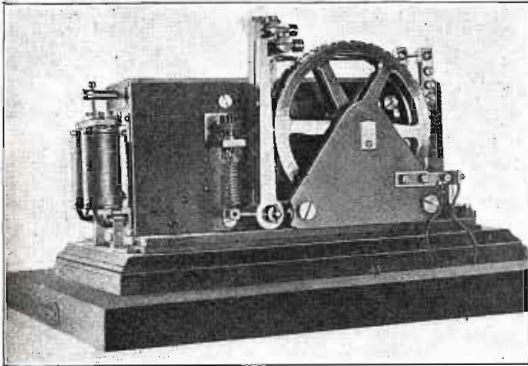

Fig. 3. This Apparatus Sends the Preliminary Signals, Which Consist of 20 V., a Call Signal, POZ and MGZ.

**N**O reliable navigation can be imagined without an accurate determination of time. This was, in the prehistoric days, before the advent of wireless, effected exclusively by means of the chronometers provided on board each ship, which, of course, in spite of their remarkable precision, did not preclude the occurrence of small divergences. Since the invention of radiotelegraphy, centralized services have, however, been organized in several countries, by which regular time signals of remarkable accuracy are at proper intervals transmitted to ships equip with wireless receivers. Some particulars as to the German Time Signal Service are given in the following:

Time signals are given out by the German Oceanographic Observatory at Hamburg (formerly by the Hamburg Astronomical Observatory) and transmitted by the Nauen Radio Station. The remarkable precision with which this service has been carried out for the last few years is mainly due to the co-operation of Professor Schorr, Director of the Hamburg Observatory.

The time signals are given out automatically by a pendulum clock fitted with a contact device at 1 a. m. and 1 p. m. (Central European time, corresponding to 12<sup>h</sup> midnight and 12<sup>h</sup> noon mean Greenwich time) respectively, thru a cable strand set apart by the Postal Department. In spite of this relatively complicated arrangement, the time signals arrive at Nauen with admirable precision.

Whereas the whole sequence of time signals was formerly led over the cable strand, a change has recently been made, in so far as only two short current impulses, destined to start the signals, are now caused to pass thru it. Starting clocks (second-pendulum clocks of remarkable precision) are installed at the Hamburg Oceanographic Observatory. On the hour-axle of each of these (one rotation in 12 hours), on the minute-axle (one rotation in one hour) and on the second-axle (one rotation in one minute), there are mounted slotted discs. Levers are provided which at certain time intervals are inserted into these slots, thus closing an electric contact. The three contacts are arranged in series, so that a current is only allowed to pass in case all three are closed simultaneously. The first contact is made for about 40 minutes, viz., from 12h. 40m. to 1h. 20m. (a. m. and p. m.), the second, corresponding to the two slots of the minute-axle disc, twice each hour, viz., from 54m. 30s. to 55m. 20s. and from 56m. 30s. to 57m. 20s., and the third, each minute from 55s. to 57s. The three contacts are thus made simultaneously from 12h. 54m. 55s. to 57s.

and from 12h. 56m. 55s. to 57s., a. m. and p. m. (Central European time), when a polarized relay will be actuated, which in turn closes the telegraf current.

At the Nauen Radio Station there is likewise installed a polarized relay (Fig. 2) which under the action of the first current impulse starts the preliminary signal sender (Fig. 3). After the latter has been actuated, the main signal sender (Fig. 4) is ready to be started by the second current impulse, at 12h. 56m. 55s.

Previous to sending the time signal, a Morse communication

*Zeit* = mean Greenwich time) are cut. After being once disengaged, the contact discs are set rotating by weights.

The main signal sender (Fig. 4), as constructed by Prof. Wanach, of Potsdam, mainly consists of an ordinary second-pendulum mechanism, causing a toothed disc to rotate once every 200 seconds. To the right of this disc, there is arranged a pair of contact springs, closing a circuit as soon as a tooth of the disc presses the longer spring (by a steel piece attach to it) against the other spring. The pointed teeth corresponding to the time signal dots will give current closures each of .1 second duration, whereas the broader teeth corresponding to dashes cause the current to be completed for a whole second. The current completed by the pair of contact springs causes a Siemens and Halske printing telegraf relay to be operated, which in its turn actuates the intermediary relay of the musical spark sender.

The mechanism for disengaging and stopping the pendulum is interesting: The lower point of the pendulum at the state of rest is hooked fast behind the movable armature of an electro-magnet. As the current impulse comes from the Hamburg Oceanographic Observatory, the movable armature is attracted, thus disengaging the pendulum, after which it is stopt by the movable armature of another electro-magnet. After the rotation of the disc has been completed, at 1h. om. 14s. (Central European time), a metal piece fixt to the signal disc compresses a pair of contact springs fixt at the left side of the signal disc, thus sending a current impulse into the second electromagnet, disengaging the resilient armature of the first magnet and causing the pendulum to be hooked fast again, until the next disengaging current impulse is started 12 hours afterwards.

The disengaging clocks at the Observatory are always kept accurately timed, a regulation being made twice a day. These clocks will work with well-nigh incredible accuracy, depending only on the atmospheric pressure, so that the daily correction does not exceed a very few hundredths of a second. This correction is ascertained by comparing the clocks with the astronomical chronometers of the Oceanographic Observatory. The accurate time is determined at intervals of five days each, in case of bright weather, by means of a Bamberg transit instrument. Moreover, the Potsdam Geodesical Institute and the Wilhelmshaven Nautical Observatory are watching the Time Signal Service, wiring each time to the Oceanographic Observatory a bulletin comprising their own calculated corrections. This is of the highest importance, especially in the event of long spells of hazy weather. Moreover, the Hamburg Observatory does

(Continued on page 78)

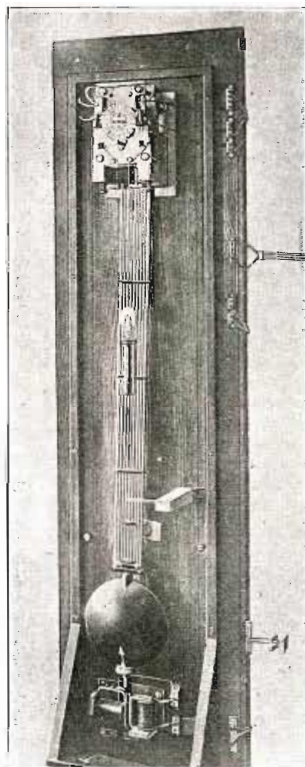

Fig. 4. This photograph shows the main signal sender. It is a pendulum making contact each second, and closing the circuit of the relay which may be seen at the bottom. The upper photograph shows the time signals sent by POZ.

is obtained from Nauen with the Hamburg Oceanographic Observatory and the line is tested. After completing the time signal, the Observatory is informed from Nauen whether the time signal has been sent properly or whether there has been any trouble interfering with the time service.

The preliminary signal sender (Fig. 3) comprises two contact discs into which the preliminary signals (viz., 20 "V," a call signal, the conventional word for Nauen "POZ" and "MGZ" *Mittlere Greenwich-*

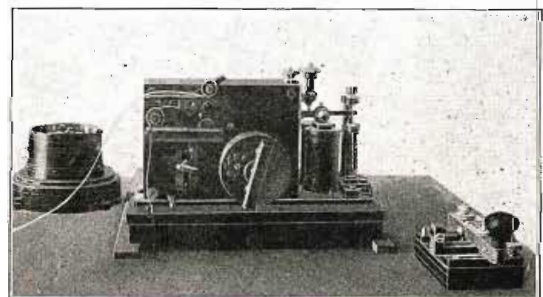

Fig. 2. This Polarized Relay Starts Automatically the Preliminary Signal Sender Shown in Fig. 3.



# New Radio Apparatus

## The "Phonotron"

SINCE the invention of the telephone, it has been the goal of experimenters to produce a telephone system which would transmit and reproduce not merely intelligible sounds, but the human voice with all its qualities. It was in realization of the great advantage in so reproducing the voice that the development of the "Phonotron" was undertaken. The theory of the investigation was based on the assumption that it was undesirable to use a horn or megafone in order to transmit to the surrounding air, as reverberation or "horn tone" would be encountered. It was considered advisable to act upon a large area of free air and for this a rigid diafram was used. It will be noticed that the sound from such a diafram has a freedom of its own and lacks the confinement and directivity of a horn.

The "Phonotron" combines such a diafram with an actuating electrical system. This electrical system consists of an enclosed electro-magnetic solenoid producing an annular field in which an armature coil is suspended from the apex of the conical diafram. The magnet is energized by a six-volt storage battery supplying 2½ amperes to a field winding.

The "Phonotron," because of its faithful acoustical and electrical properties, is particularly adapted to the field of radio telephony. It is reversible, that is, it may be used to convert sound into electrical energy

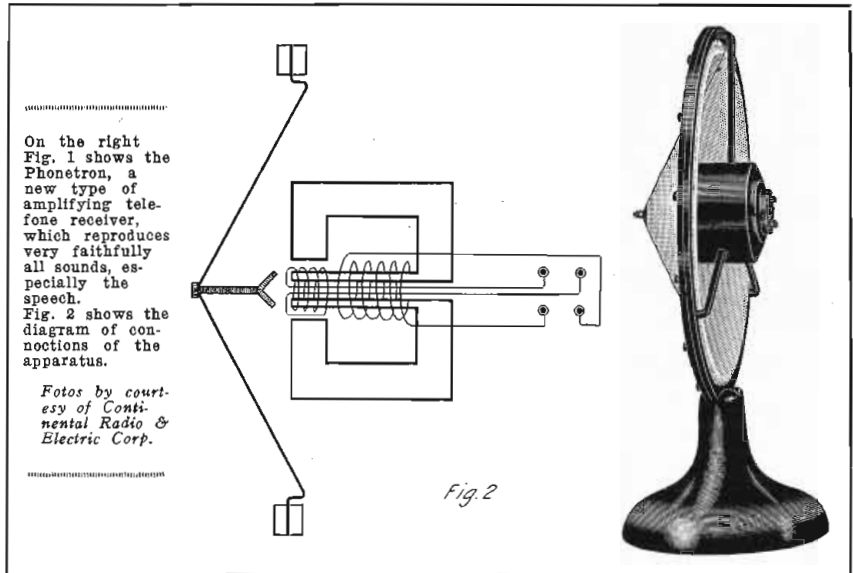

On the right Fig. 1 shows the Phonotron, a new type of amplifying telephone receiver, which reproduces very faithfully all sounds, especially the speech. Fig. 2 shows the diagram of connections of the apparatus.

Fotos by courtesy of Continental Radio & Electric Corp.

Fig. 2

or to convert electrical energy into sound; in other words, the "Phonotron" is not a loud speaker; it is an electrical sound con-

verter. It can be used either for reception of radio signals or for radio telephone trans-  
(Continued on page 75)

## New Inter-Tube Tone Frequency Amplifying Transformer

IT is a well-known fact that the impedance of a tone frequency amplifying transformer for maximum amplification must at least be equal to the output impedance of the preceding tube in a cascade amplifying set. There is an allowable variation for the impedance of the transformer when loaded on the secondary by an amplifying tube, but, nevertheless, the maximum signal is obtained from a transformer especially designed to fit the output impedances of the tubes with which it is used.

Prior to the introduction of this amplifying transformer, amateur experimenters were compelled to employ intervalve transformers of various characteristics, none of which were designed specifically for the Radiotron detector tube and the Radiotron amplifier tube. This transformer not only has been designed to fit these vacuum tubes, but especial care has been taken to reduce the transformer losses to the lowest possible milliamperes.

The accompanying illustration shows the new amplifying transformer which, in recent tests, has proved most conclusively that it is superior to any on the market today.

### ELECTRICAL CHARACTERISTICS

1. Ratio of secondary to primary turns, 9/1.
2. Useful frequency range, 60/3000 cycles.
3. Allowable current on each winding, 10 milliamperes.

4. Test voltage between windings and between core and windings, 300 volts at 60 cycles.
5. Terminal voltage limit of secondary winding, 300 volts.
6. D. C. resistance of windings: Primary 430 ohms, Secondary 5100 ohms.
7. Impedance at 1000 cycles (one milli-ampere).  
Primary with secondary open, 19,000 ohms (approximate).  
Primary with secondary shorted, 650 ohms (approximate).  
Secondary with primary open, 1,400,000 ohms (approximate).  
Secondary with primary closed, 43,000 ohms (approximate).

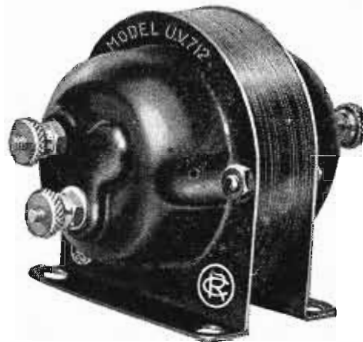

A New Amplifying Transformer Entirely Enclosed in a Metallic Shell.—Foto by courtesy of the Radio Corporation of America.

In general, a tone-frequency amplifier transformer should occupy the same position in the output circuit of a vacuum tube as the receiving telephone. The terminals P and F of this transformer may be connected to the binding posts which ordinarily are connected to the telephone receiver. The secondary terminals should connect to the grid and filament of the following tube of a  
(Continued on page 72)

## A Safety Fuse for Vacuum Tubes

What did you feel the day you saw the filament of your V. T. burn out because you tried to increase the filament current a little too much? We won't describe it, as you

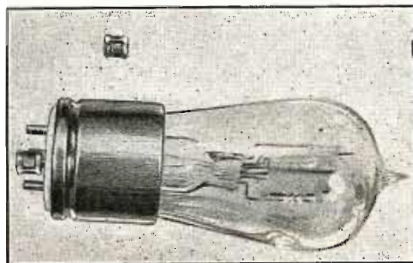

This Fotograf Shows the Safety Fuse Itself and How it is Mounted on the Prong of a V.T. Foto courtesy of the Radio Equipment Co.

KNOW it and we feel sure that, at the very second when darkness succeeded the light inside the bulb, the wall of the operating room echoed with a few curses—

It is a fact that most of the time the amateurs little know that a very slight increase over the normal filament current and voltage decreases the life of a tube in great proportion. For instance, an increase of about four to five per cent. in current decreases the life of certain tubes about 25 per cent.

Then, to obtain the maximum life from a tube filament, it should always be run at its normal current value. Unfortunately, up to the present time, there had been no practical device that could be used by the amateurs to protect their tubes, and the price of an ammeter is beyond the reach of the majority.

To overcome this, an engineer who has

had much experience with tubes, designed a fuse that protects them very efficiently. This type of fuse, shown in the accompanying fotograf, may be fixt to any tube in use, and several models have been designed to protect each particular tube, used as detector, amplifier or oscillator in C. W. sets.

This safety fuse, which is now being manufactured and sold to the public, will certainly be welcomed by the amateurs if they realize that for a few cents they can protect a tube which is worth \$5 to \$8, or even more.

The fuse itself fits the prongs of any V. T., as may be seen in the fotograf, and is easily mounted. It is made of a tubular piece of insulating material with a brass cap at one end, this coming in contact with the spring in the socket, and a ring at the other end, making contact on the prong it-

(Continued on page 72)

# Radiating Eight-tenths of an Ampere with a Single "J" Tube

By ARTHUR H. LYNCH

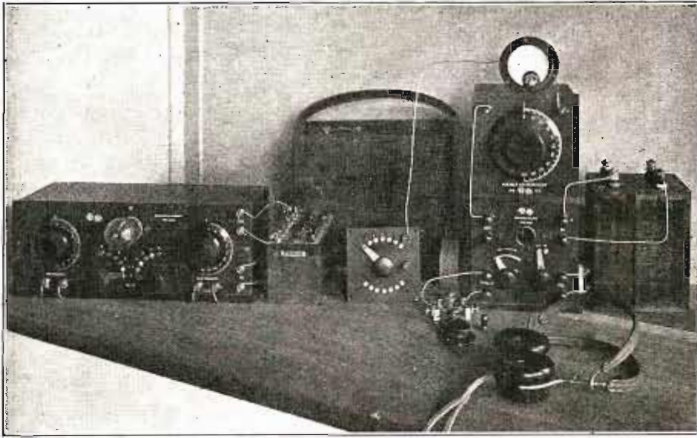

On the left is a fotograf of the complete set with which the experiments were made. On the right Fig. 1 shows the hook-up of the transmitting unit.

Foto by courtesy of A. H. Grebe & Co., Inc.

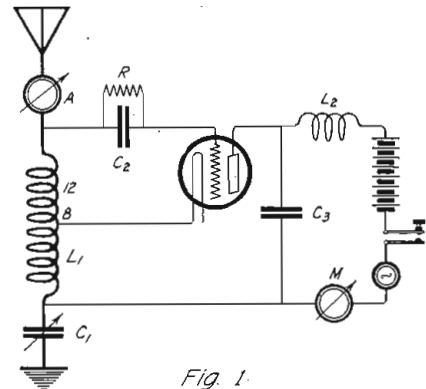

Fig. 1.

of C. W. may be outlined, as follows:

More distance for a given power input, due to the low absorption factor of C. W. and the lack of decrement in the emitted wave, and the ease with which C. W. may be read thru QRM. More reliable communication, due to the adjustment of the receiving set for the production of a beat note corresponding to the natural frequency of the ear and the telephone diaphragm. Elimination of interference, due to all the energy being radiated on but a single wave-length. Flexibility of wave-length control and tone control. Use of various forms of transmitters employing straight C. W., voice modulation, tone wheel or buzzer modulators. The further elimination of interference by employing as little as from two to five watts for local work. Noiseless operation and a very great reduction in the space required for installation.

### SURMOUNTING THE DIFFICULTIES

As previously mentioned, the greatest impediment to the use of C. W. for amateurs is the amount of plate voltage necessary for the proper operation of the tubes. Mr. William F. Diehl has succeeded in arranging several circuits, which may be used to advantage for the obtaining of different results to suit the requirements of the experimenter, at the least possible expense. This is found to be true where there happens to be an alternating current supply of 60 cycles available. From the following list and reference to the various diagrams accompanying this article, it will be seen that a very good set may be put up without much difficulty. In all of the diagrams it will be seen that the marking is the same for the units employed in the various circuits.

(Continued on page 78)

THE advantages which C. W. holds forth in the perfection of radio communication have long been realized by certain radio engineers in this country and abroad. This is especially true in stations designed for long distance communication and those stations, which during the war were under the command of military and naval authorities. They realized and put into practice this distinct departure from the beaten track and this resulted in the remarkable short route to radio efficiency which is nearly universally established today.

The timed spark, arc, reflector alternator and frequency transformer all furnish an interesting story of this development, but none of these methods compare with the Alexanderson alternator for high power or the vacuum tube for low power and semi-low power transmission. Much has already been said concerning the Alexanderson alternator and much continues to be said regarding the use of the V. T. in all of its very diversified field of usefulness. By reason of the natural characteristics of the apparatus involved, even if price has nothing to do with the making of our decisions, we are forced to refrain from considering the use of the alternator for our own particular research.

It is safe to say that prior to 1914 there were hardly a dozen amateurs in this country who had any practical knowledge of continuous wave apparatus, and most of those who had were experimenting with the "singing arc" transmitter. It was found

that this piece of apparatus was very troublesome and inefficient on short waves. And it should be remembered that but little general attention had been given to the newer forms of receiving circuits, which have contributed so much toward making the use of C. W. so satisfactory. There is little need of reiterating the story of the V. T., in its application to receiving apparatus; that is more or less common knowledge, but regardless of all that has been said and written and published concerning C. W. transmitters, we find that the air is still filled with the irrepressible buzz of the malevolent spark coil, with its broad, interference-producing wave. This is greatly due to the fact that many of those who would like very much to own and operate a tube transmitter are led rather instinctively to feel that the use of such a set requires a great amount of expensive apparatus to say nothing of skill in assembling and operating. More than anything else, the supplying of the plate potential acts as the bugaboo. Consideration of the equipment herein described and the simplicity of the circuits used should relieve the feeling that it is necessary to spend great sums or much time in procuring and assembling a good, workable, cheap C. W. transmitter and methods for obtaining the plate voltage are shown. In many cases it will be seen that much of the apparatus already found in the modern receiving station may be called into activity as a transmitter. This is very apparent from the illustration; most of the apparatus will be recognized as forming the units for receiving sets.

### ADVANTAGES OF C. W. TRANSMITTERS.

Some of the most important advantages

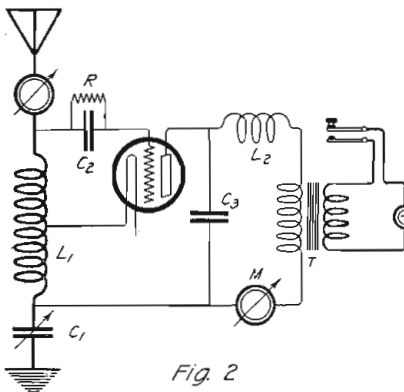

Fig. 2

On the left Fig. 2 shows the hook-up using a step-up transformer to supply the high tensions to the plate, while Fig. 4 is the hook-up when two tubes are used. Both halves of the cycles are used.

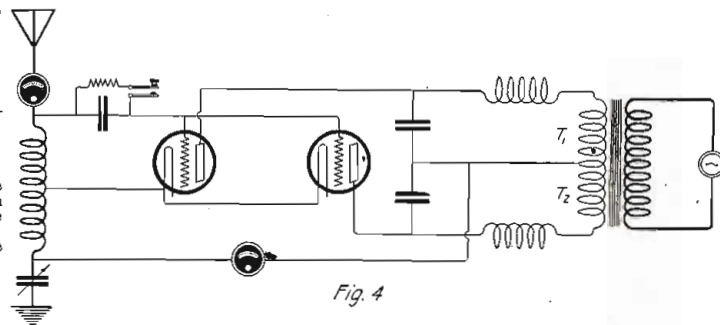

Fig. 4



# Awards of \$100 Portable Radio Prize Contest

## FOURTH HONORABLE MENTION



Fotograf of Mr. Philip J. McManus, the Designer and Builder of the Small Receiver Described in This Article.

THE accompanying fotograf are of a small portable receiving set which I designed and built myself. The first shows the receiver cabinet with the crystal detector. The second foto shows the set with the audion detector and also gives a glimpse of the interior.

### THE CABINET

The cabinet measures over all 3" x 3" x 2½", and is made of rosewood. The panel is a piece of hard rubber three inches square taken from an old battery jar. On the left are the switches for the primary; in the center are the controls for coupling and regeneration; and on the right, the rheostat knob and the secondary switch. Four binding posts are provided: two for the aerial and ground and two for the fone connections. The switch contacts are short pieces of No. 14 hard brass wire glued into the panel.

### THE COILS

For the tuning inductances honeycomb coils were adopted, as they occupy a minimum of space and are very efficient. The primary consists of 64 turns of No. 28 wire wound on a tube 2¼" in diameter and 1" long. It is tapt by units and eights and the inductance is varied by two switches on the panel.

The secondary is wound on a cardboard tube 1¾" in diameter and 5/8" long. It consists of 240 turns of No. 36 wire tapt

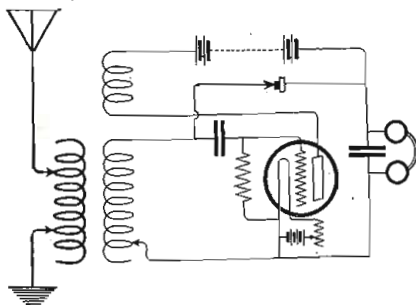

General Hook-up of Mr. McManus' Portable Set. Either a Crystal or V.T. Detector May Be Used.

every 30 turns. In winding, care was taken to leave an opening for the tubular shaft which supports this coil. Any degree of coupling is obtained by rotating the secondary a quarter turn. The tickler coil consists of 150 turns of No. 36 wire wound on a small wooden form 1" in diameter shaped like the ball of a variometer. It is placed inside the secondary and rotates with it. Its inductive relation to the secondary is varied by means of a rod which passes thru the shaft of the secondary.

### THE DETECTOR

Probably in making a set the size of the one described, and especially a portable set, one would not consider anything but a crystal detector. I thot, however, that it would greatly improve the set to add audion controls and connections. This allows for better reception whenever it is possible to have the necessary "A" and "B" batteries, and does not bother in the least when the crystal alone is used. The crystal detector is of a peculiar design which is very simple, easy to adjust and more efficient than most types. It can be dissembled and carried in a small box. The mineral cup is the brass cup from a small battery carbon. Each of the parts fits into a short piece of brass tubing on top of the cabinet, to which connections are made. The audion shown is one of French make which I use with this set. Of course any other would do as well; in fact the French bulb is unusually large and a smaller one would be preferable. No socket is used. Holes were bored in the top of the cabinet and small brass tubes inserted to hold the audion and to serve as connections. The rheostat was made by winding 10' of No. 28 German silver wire on a piece of leather 2" x 1" and bending into a semicircle. The grid condenser is made up of three pieces of mica 2" x 1½" and two pieces of tinfoil 1½" x 1½". The telephone stopping condenser is similar, but takes nine pieces of mica and eight of tinfoil. A grid leak is obtained by drawing pencil lines on the base of the audion between the grid and filament contacts. "A" and "B" battery connections are made by a small four-prong connection block. As will be seen from the diagram of connections, no switches are needed to change from crystal to bulb.

### THE AERIAL

It was not deemed practical to use an ordinary loop or spiral antenna with this set, as the smallest of these would be much larger than the set itself. I use a single No. 20 copper wire, 100' long which is supported as high as possible from a tree or building. The ground is another wire of the same length, laid on the earth directly beneath it. Each wire is wound on a small spool for transportation. Thus the entire set including a telephone receiver could be slipped into an overcoat pocket.

### THE RESULTS OBTAINED

The receiver described will tune up to 1,000 meters with a suitable aerial. It was completed too late to give it any exhaustive test, but a few trials have shown its working ability. Using the regular amateur aerial and the crystal detector, I have heard stations along the coast from Portsmouth, N. H., to New York and amateur stations five miles away. One amateur, 10J, exactly one mile away, was heard very QSA without any aerial at all. I find it gives almost as good results as my regular equipment.

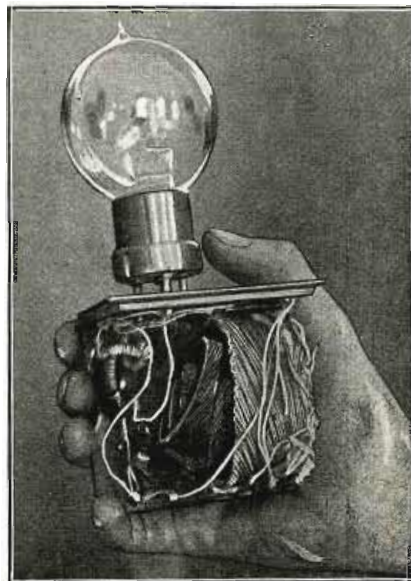

Inside View of the Set. Note Arrangement of the Inductances with the Tickler Coil Rotating Inside the Secondary Which Itself Can Rotate.

which consists of condenser-tuned honeycombs, but it is not so selective. Using the small wire aerial suspended between two trees I could hear NAF, NAD, WBF, WLC, NAH1, and a few others whose call I did not get. I heard one amateur station very loud; he was about three miles away. As it was in the afternoon it was not possible to further test its efficiency on 200 meters, but the above will suffice to show what it can do.

Everything considered, I believe the novelty of this receiver, its good appearance, and results obtained are sufficient to repay the time and patience it took to build it.

### Editor's Note:

This set is the only one using a V. T., that was entered in the contest.

Undoubtedly much better results may be obtained with a V. T. detector, but the need of "B" and "A" batteries makes it too heavy for a portable set.

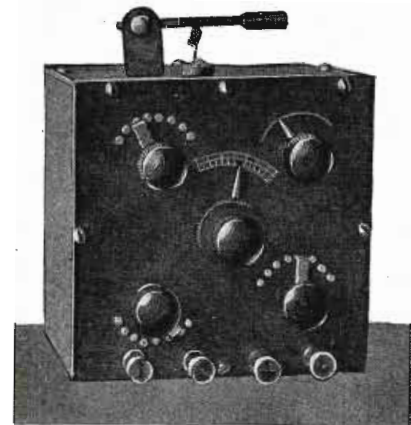

Front View of the Receiver With the Crystal Detector Mounted on it, Note in the Center the Double Knob Controlling the Coupling of the Secondary and Tickler Coil.



# How to Construct a Heavy Current Microphone

By ALBERT MARPLE

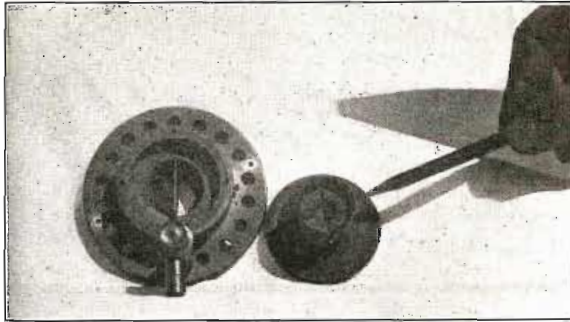

On the right is Fig. 2, showing the cup containing the carbon grains, while on the left Fig. 3 shows the slate chamber and the insulating asbestos ring.

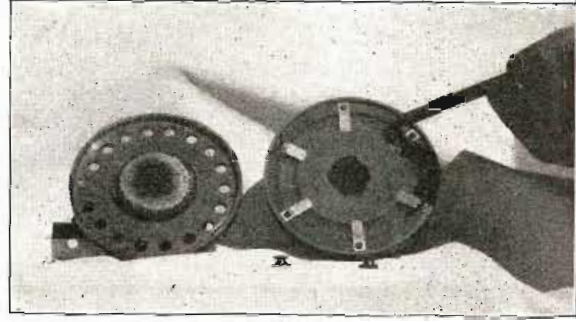

VERY often the amateur radio telephone operator and experimenter has asked the question as to "How to build a reliable heavy current radio telephone transmitter?" and just about as often the inquirer is told that "We have no data on this subject." While a transmitter of this kind is not the hardest thing in the world to construct, it must, like all other sections or parts of wireless apparatus, be put together *right*, or it will fail to respond to commands and even tearful pleadings. The transmitter shown in the accompanying illustrations is not a thing of great beauty, we will admit, but when it comes to carrying a mighty big load, or working overtime, it is worth its weight in gold.

In this story we will give no dimensions, except to say that the face of this transmitter is four inches in diameter. Figures would "eat up" valuable space, while they would not change the actual workings of the completed transmitter. Two views of this transmitter are shown in Fig. 1. This illustration shows clearly the construction of the chamber holding the insulated slate cup, the purpose of which is to hold the teaspoonful of carbon grains. In size these grains are considerably larger than those found in the ordinary telephone transmitter, and for this reason they do not burn up as do the finer grains.

The fibre insulation used to conduct the electrodes into the cup containing the carbon grains is shown at the rear of the chamber. These grains may be purchased from or thru any electrical store handling telephone supplies.

The detail of the round fibre piece mentioned above is brot out clearly in Fig. 2. The electrodes, shown in the center of the fibre plate, are kept from moving in or out after being once placed, by the two set screws which may be seen at the circumference. One wire of the aerial circuit connects these electrodes, while the other wire of this circuit is fastened to the metal standard, which is used to support the transmit-

ter in any desired position. The transmitter is held rigid by the set screws shown in the metal projection. The front and back halves of the transmitter are held together by means of two set screws shown near the circumference of the 4" diameter piece, while the holes near the circumference have been drilled out to allow air to circulate and to keep the inner chamber cool.

In Fig. 3, left hand character, is shown the inner chamber holding the carbon grains. The main chamber of slate is clearly shown, while a ring or gasket of asbestos may also be seen. The purpose of this asbestos is to keep the carbon grains from packing under the slate cup and the carbon diaphragm. The thick piece of mica seen in the center of the cup is not absolutely necessary, having been used in experiments calling for two sections of carbon grains. Also in Fig. 3, right hand character, is shown the inner view of the front half of the transmitter. A piece of thin mica, indicated by pencil, is employed to hold the carbon diaphragm in place. The long-threaded screws are those mentioned as holding the front and the back halves of the transmitter together.

The back inner construction of the slate chamber may be seen in Fig. 2, as may also the electrodes which conduct the current into the cups holding

(Continued on page 59)

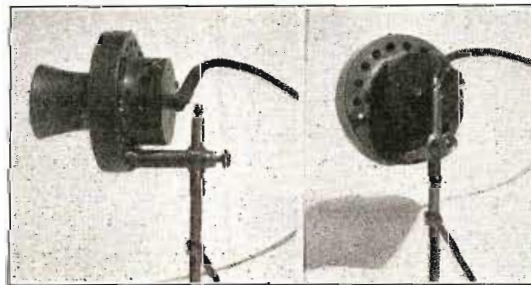

Fig. 1, on the Left, is a Side View of the Transmitter, While on the Right is a Back View of the Same. The Microphone is Mounted on a Rod Along Which it May Slide and Be Fixed by a Screw.

## Amateur Radio Helps Police

AMATEUR Radio is becoming more popular every day among the public and it may be said that in a very short time, it will be recognized as an indispensable thing. Amateur stations of the country now receive the market and weather reports, and in California a test was made by a newspaper to use them as Radio reporters.

For those in the East, there is something that they should listen to—the police reports of stolen automobiles, which are sent at 7:30 and 11:30 o'clock in the evening. The reason for sending these alarms at night is because most of the amateurs are "on the job" at that time, and there is more possibility of the alarm being received by the greatest number of stations.

It would be highly desirable that all amateurs listen to these police reports and deliver them to the local police forces as they may lead to the recovery of stolen automobiles before the thieves can get very far away.

The following example shows how a stolen auto truck was recovered, thanks to an amateur. A few days ago the following

article appeared in a local paper:

### Radio Finds Stolen Auto Truck

Union Hill, N. J., Boys Relay Brooklyn Alarm to Police at West Hoboken.

A five-ton automobile truck stolen from Gillen Brothers, truckmen, of 324 Twelfth street, Brooklyn, has been recovered through the cooperation of an amateur wireless operator in Union Hill, N. J., who relayed to the West Hoboken police an alarm sent out by wireless from the New York Police Department.

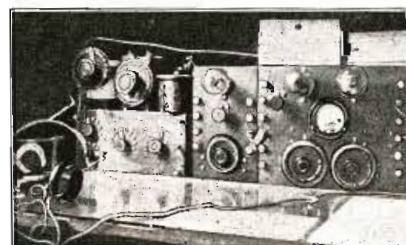

Mr. R. Frank's Station, Thanks to Which a Stolen Truck Was Recovered.

We have asked Mr. Richard Frank to send us some details about this, to show other amateurs how they could use their sets to a useful end. The following is Mr. Frank's reply:

Only a few minutes before reading the description of the stolen car Lieut.-Detective Stanton, of the West Hoboken police, had seen a truck answering the description sent by Radio of the missing one, in a West Hoboken garage. His investigation revealed that it was the Gillen truck, and immediately a "found" message was relayed to headquarters, New York, thru our station.

This, according to the wireless operators at police headquarters, is only one of such recoveries recorded. They say that wireless hunting of automobile thieves has proved its practicability.

The amateurs are requested by the New York operator to relay all wireless alarms to the police of their towns. The system has been taken up in serious earnestness by the small town police departments of Hudson County, N. J., with the car recovery, the second within a week. And in both in-

(Continued on page 59)



# \$100.00 RADIO ACCESSORY PRIZE CONTEST

**H**ERE is a new contest for our budding radio geniuses. This time the contest is not so much about big sending or receiving outfits, but it centers on radio accessories.

When the automobile business was young, the main thing was the automobile itself. No one thought of manufacturing, advertising and selling accessories. But every city now boasts of one or more stores where nothing but auto accessories are sold, be it a tire, a spark plug, a crank, a horn, a tail-lamp, auto gloves, a pressure gauge, a gasoline tank, a washer or a valve—you can buy them all readily at a low price.

What holds true in the automobile business is now being repeated in the radio field. At first there was nothing but the actual complete outfits or the apparatus. Gradually the radio accessory business came to the front and today dozens of concerns are engaged in selling and manufacturing nothing but little adjuncts. To mention only a few, as can be readily appreciated by glancing at the advertising columns of this journal: Composition knobs, switch-points, minerals, all sorts of parts, panel switches, dials, sockets, sliders, connection plugs, bulb safety fuses and dozens of others.

There are always new improvements cropping up as everyone can see by looking over the advertising pages of our radio publications.

But there is much room for improvement; there are many little things needed that will make transmission and reception of radio messages better and easier. There are a thousand such

ideas waiting to be exploited by the radio fraternity.

Every once in a while we publish a little stunt that means a small revolution in radio construction. For instance, some years ago a clever "bug" showed us how to put the scale, previously always attached to the panel, right on a rotating dial. Today, there is practically no instrument on the market which does not include a revolving graduated dial and knob attached to it.

That is what we are trying to get at in this contest. *We want ideas on*

1st Prize	\$50.00	in Gold
2nd	20.00	" "
3rd	15.00	" "
4th	10.00	" "
5th	5.00	" "

*little things* that can be readily made by the amateur and can also be manufactured and standardized by the manufacturers. What we want therefore, are *ideas on little improvements* on radio apparatus and it makes no difference whether the improvement is for the transmitting or receiving set, or whether it is a new wrinkle that can be attached to the aerial or to the ground. It **MUST** be a little thing, a *true accessory to existing radio apparatus*.

In other words, no prize will be given to anyone who designs a complete instrument, such as a detector,

condenser or the like. For instance, a new plug, a new dial, a new switch lever, a new panel switch, a new socket, a new switch point, etc., is the kind of idea we desire, *always providing that the idea is new and has not been used before*. It is immaterial from what materials the article is made. This is left to the designer.

While it is not absolutely necessary that a model be submitted with your entry, we venture to say that the judges would rather like to see a model, as it is often much simpler to judge an idea if you have the actual article before you; but as we said before, this is not absolutely necessary, but desirable. In all events a complete sketch must be furnished by the contestant.

No manuscripts entered in this contest can be returned. We reserve ourselves the right to publish all worthy ideas, which did not win a prize by paying regular space rates. In publishing the various ideas, all the rights revert to the publishers. Use only one side of the paper for writing and keep sketches on a separate sheet. No penciled matter can be considered. More than one idea may be entered by contestants. The contest is open to everyone, radio clubs included, except manufacturers of wireless apparatus. All prizes will be paid upon publication.

This contest closes at noon, August 10th, New York, and all entries must be in at that time in order to be qualified. Should two contestants submit the same idea, then in that case the same prize will be paid to both. Address all communications to *Editor Radio Accessory Prize Contest*, care of this publication.

## Crystal Amplifier

By G. GATIS

*This communication from one of our Brazilian subscribers will be of interest to our readers. If we are not very much mistaken, this is the first time that someone has succeeded in amplifying signals from a crystal detector by using several stages of crystal detectors. We are also pleased to see that our Editorials are not an expensive luxury on our part, but are of help to the radio fraternity once in a while.*

Having read in the November issue of RADIO NEWS an editorial by Mr. H. Gernsback, re experimenting on crystal amplifiers, it rather took my fancy.

Being a mad radio enthusiast and having

taken it as my hobby for the past 10 years, I have carefully followed up all the new stunts together with my friend, Mr. Augusto Pereira.

He and I tried to get up a Radio Club here, and managed to get about 20 members, but unfortunately the Brazilian authorities in Rio would not consent to it. We are, therefore, hindered as regards transmission, etc., but keep ourselves amused with reception only, this seemingly the authorities don't object to.

It seems a great drawback, as I am sure it would interest lots of people here.

It makes me quite upset when I read your

magazine about other fellows breaking records in sending, and we here have to be content to sit down and only listen. Well it can't be helped I suppose, so let's get to work. I have been in the electrical trade as electrical engineer to a firm out here for many years, and have lately opened on my own, this facilitating my knowing something about radio, which as I have said always has interested me exceedingly.

I am in possession of an excellent receiving set consisting of a two-step valve amplifier and valve detector. I use a Western Electric V.T. as detector and two Moorhead V. T.'s as amplifiers, and am able to receive about 1,000 miles in normal conditions. Hearing SPN, SPA, SPT, and many other stations and ships, and as for SPO, can hear him without antenna or earth. He is about 15 miles from where I live.

Taking Mr. Gernsback's ideas in hand I started working on a crystal amplifier, using my amplifier transformer for same. At first I was disappointed, but after many alterations I get fairly good results with the accompanying diagram. Of course it cannot be compared to V.T.'s, as you have so many crystals to find their sensitive spot on, but there again I rigged up a most sensitive and difficult to knock-out detector, as can be seen from the lower diagram. I

(Continued on page 70)

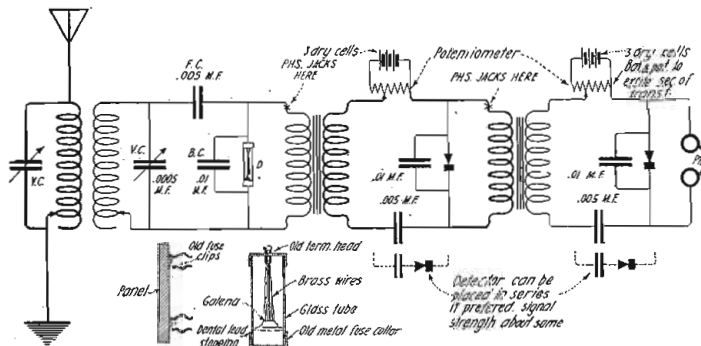

In this amplifier circuit crystal detectors are used instead of V.T.'s. No doubt that by experimenting with this new type of amplifier some of you fellows may obtain good results.



# Short Wave Tuning Systems

By J. STANLEY BROWN

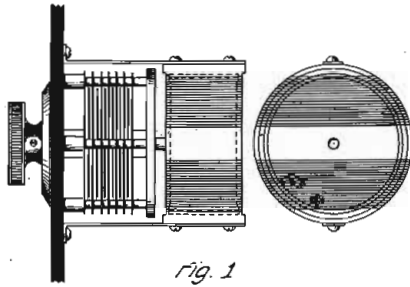

By Mounting the Variometer and the Condenser on the Same Shaft in a Short Wave Set, Only One Control is Necessary.

**D**URING the construction, or the contemplated construction, of short-wave receiving systems, many points are often mentally traversed in regard to the relative merits of variable capacity and variable inductance tuning. The discussion often comes up as to which method gives the greatest stability of operation, which is the least expensive, which is electrically right and which gives a maximum of ease in operating, or that will efficiently cover the greatest wave range. The writer has done considerable work along these lines and as perhaps some of the readers of RADIO NEWS will remember, described, in the May, 1920, issue, a very efficient little short-wave regenerative set with capacity tuning and honeycomb windings, thereby bringing upon himself the enmity of some of the distributors of similar sets having mutually variable inductances as a means of tuning. Since that time over 50 letters have been received thru RADIO NEWS, stating that the results attained were beyond the greatest expectations of the builders. Due to the way in which the first design was received by a few, it is to be expected that the arrangement of tuning elements to be described will meet with the same form of ridicule from the same few.

Now let us consider a few points in regard to the standard variometer tuned set of the present day. As we know an inductance presents voltage amplifying properties which make it quite suitable for operation in connection with the vacuum tube which is essentially a voltage operated device. This condition is particularly valuable during the reception of waves from 150 to 300 meters in length, but from then on capacity other than the inherent capacity of the inductance coils may be brot into the circuits without detrimental effect on said voltage amplifying properties so that signals of greater power at the source and better carrying properties are being dealt with.

Of course no circuit having inductance only, were such a condition possible, would have a natural period or wave-length to which it is attuned. As wave-length is the product of a constant times the square root of the product of the inductance and the capacity of a circuit, it is easy to see why this is so. In a variometer, the capacity present is simply the inherent capacity of the device and inductance predominates. For a given wave-length, various values of inductance and capacity may be used, the capacity always being inversely proportional to the inductance.

The inductance range of the usual variable mutual inductance is seldom more than one to ten and the capacity variance of the windings as they assume different relations. follows a distorted curve that may increase or decrease with the inductance. Let us assume that the capacity remains the same at

various settings and the inductance has a one to ten range. Starting, then, at zero on the control dial we may have a wave-length of 150 meters. Moving to the 180 degree position we will have the square root of 10 times that amount, or about 475 meters. Is this not the range of the average short-wave regenerative set? This range is run up to 550 meters in the better sets due to the enormous amount of high-class development they have gone thru, thereby increasing the inductance ratio and in some cases making the capacity increase slightly with the inductance.

When a circuit is in resonance with a certain frequency or wave-length the inductive reactance always equals the capacitive reactance at that frequency and the two tend to neutralize each other, thereby leaving only the D. C. resistance and the high frequency resistance of the circuit to be overcome by the induced electromotive force, thereby allowing a maximum of energy to oscillate thru the circuit. Values of inductance and capacity may be used for any wave-length, which in combination give the circuit the least resistance. This condition is attained with a very large capacity and a relatively small inductance, which proportions are kept to in the design of transmitting equipment, as the voltage and current are local and may be had in any desired values. However, in the case of an intercepted wave these values are out of the control of the operator and he must make

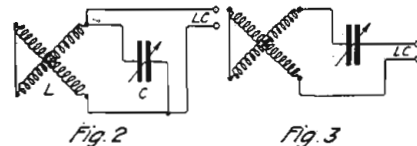

To Increase the Range of Variation of a Variometer Tuned Set, a Condenser That May Be Connected in Serie or Parallel May Be Used.

the best of the circumstances. Due to the foregoing, inductance is allowed to predominate in order to make the best usage of the induced voltage. This is logical, for an infinitely small value of current is all that is necessary to give a good signal.

In the design of a receptor, which is to be very efficient, it is necessary to limit its range such as is done in the variometer tuned set, or sacrifice some of its efficiency by making use of a variable capacity and a tap inductance in order that a greater range may be covered. It occurred to the writer, during the latter part of this summer, that a tuning element could be designed that would retain the highest state of efficiency where it is required, between the waves of 150 and 300 meters, and from that point on, bring capacity into the circuit as needed to complete the range. It was highly undesirable to tune any of the circuits by more than one control so the idea of using uni-control was conceived. The method is to couple together a variable condenser and a variometer on the same controlling shaft, so designing the condenser plates that the variable capacity does not enter in as a factor until a point slightly over 300 meters is reached, which will be about midway of the swing. If from then to the completion of the 180 degree swing the capacity is allowed to enter into the circuit in the same proportion as the inductance the range of the latter half of the scale will be about twice that of the other half, making the range of the circuit from 150 to 900 meters or twice that of the variometer alone. The writer does not claim to be the inventor of

this idea, altho he is not aware of its being in use as yet. Figure 1 shows some of the constructional points of such a tuning element and, as will be noted, a rather unconventional type of variometer, the merits of which can be readily seen.

Tuning elements of the type to be described suggest themselves for a multiplicity of uses, among which are in antenna tuning circuits in which the capacity inductance may be in series for short waves or in parallel for long waves, in the place of the grid variometer, in which case the capacity may be shunted around the variometer and the coupling coil, as an excellent wave meter unit, or if more heavily constructed, as tuning elements for vacuum tube transmitters. When used in connection with a loop one would have a uni-control circuit of the utmost simplicity.

## CONDENSER CONSTRUCTION

Semi-circular and quarter-circular plates for variable condensers, as well as spacers and end plates, may be bot at your dealer's and one should have no trouble in designing a condenser giving any desired capacity increase. Plates for the so-called straight line condenser should adapt themselves to many combinations and enable the builder to get any wave-length curve he desires. It is well to make a special shaft of brass of such length that the variometer can be mounted directly upon it. Either use balanced construction or have a stiff spring washer exerting a thrusting force axially to the shaft to keep the setting from shifting. Vernier control will be of especial value with this combination. By mounting the variometer behind the condenser, as shown, the effect of the operator's hand on the signals will scarcely be observed. To further better operation it is well to put a metal shield between the operator and the condenser and ground this shield. Done in this way instead of placing the shield near the inductance, the sensitivity of the set will not be decreased.

## VARIOMETER CONSTRUCTION

There is probably not a living amateur who is not possesst of several hundred ideas in regard to the construction of variometers. The variometer shown in Fig. 1 is rather a new departure in that it is as efficient as any other type and it is so very simple to make. As can be seen, it consists of two concentric tubes which may be of cardboard, celluloid or any other good insulating material, the inner tube being of such size as to just clear the outer tube by about 1/16" to 1/8", which distance allows space for the windings to rotate freely. Each of these winding forms are slightly cut down across their ends in order that the slight extensions left can be made use of to keep the windings from slipping off. If desired, the inner coil may be wound on a wooden spool instead of a tube. The outer coil is made fast to the panel by means of two or more brass brackets.

(Continued on page 66)

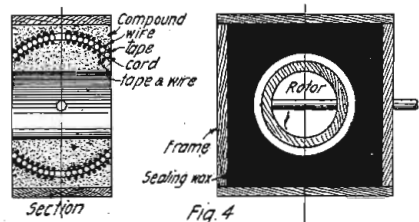

This is an Easily Built Variometer in Which No Stator Form is Necessary, and Which Has the Windings Very Close Together, Thus Giving Maximum Range of Variation.



# Determination of Percentage Modulation in Radio Telephony

By M. WOLF

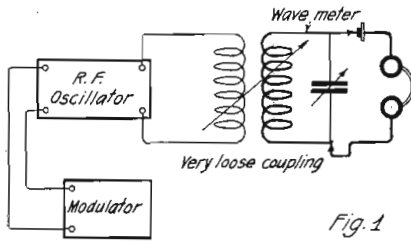

Fig. 1

Here is a Simple Way of Determining the Proportion of Modulation by the Use of a Wave-Meter Loosely Coupled to the Radiofone Set.

THE amateur who has a radio telephone set is, of course, interested in securing as complete modulation as possible with the apparatus which he has available. But most always he is at a loss to know just what his percentage modulation comes to, and has not the facilities for determining it. The object of this article is to describe a comparatively simple method for obtaining this information.

Of course the most accurate and the best way of determining this is to use the oscillograf, but this expensive instrument is not accessible to the amateur. His next best bet is to use the wave-meter in the manner described in the following. The wave-meter is tuned to the transmitting wave, and when no speech is applied the intensity of the click in the wave-meter fones is observed by opening and closing contact A in Fig. 1. Speech is applied to the set and the intensity of the received speech is noted in the same way, making sure to keep tuning and coupling of wave-meter constant. If the modulation is complete the click will not be heard thru the speech. This method is, of course, not very accurate, as the click will not be evident if the modulation is anything over 60 or 70 per cent. At any rate, it will give the amateur a fairly decent notion as to how his modulation is getting on, and as to the condition of his set, which he would not have otherwise.

The method to be described in the following is somewhat analogous to this crude method of the wave-meter, but is much more accurate and gives pretty good and reliable results. Briefly the method consists in chopping up the received wave, and measuring the audibility of received current with and without speech. The ratio thus obtained, as shown below, is the per-

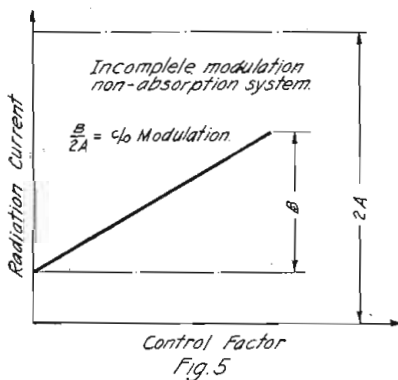

Fig. 5

Characteristic Curve of Constant Current Modulation Showing the Percentage of Modulation Obtained by This Method.

centage modulation. The method does not require any apparatus other than that which amateurs as a rule are bound to have.

A sustained wave generator, say a vacuum tube, will radiate oscillations as in Fig. 2, the amplitude of these oscillations depending on the magnitude of the radiated current. If this wave is now modulated the amplitude of the resultant wave will vary in proportion to the modulation control, and the R. F. oscillations will be moulded into the shape of the audio modulation wave, as in Fig. 3. In general, if we assume that the control is linear, the curve showing the relationship between the radiated current and the controlling factor will be as in Fig. 4a. and the limits between which this curve runs, will depend on two factors: The method of modulation used, and the degree of control.

With regard to the first factor, the following may be said in general: If an absorption system of modulation is used, energy is abstracted from the oscillator by the modulator, but none is supplied and the resultant wave is as shown in Fig. 3a. That is, the control factor varies the amplitude

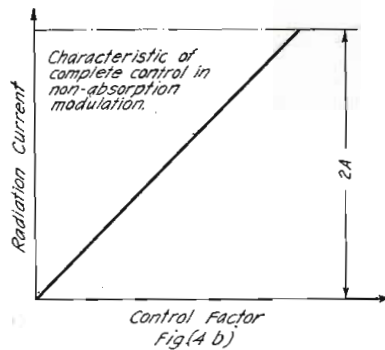

Fig. 4b

This Curve is Obtained When the Output is Completely Modulated. The Ideal Condition for a Radiofone Set.

of the R. F. wave from zero to the maximum unmodulated amplitude A, and the corresponding control curve is Fig. 4a. This is on the assumption of complete modulation. If a non-absorption system of modulation is used, energy is abstracted from and added to the oscillator by the modulator and the resultant wave is as shown in Fig. 3b. That is, the control factor varies the amplitude of the R. F. wave from zero to twice the maximum unmodulated amplitude A, and the corresponding control curve is as in Fig. 4b, again assuming complete modulation. If the modulation is incomplete the control curve will run between limits smaller than either A or 2A (depending upon whether absorption or non-absorption systems are used, and greater than zero. Fig. 5 gives the case for non-absorption modulation, and the percentage modulation will be given by the ratio  $\frac{B}{2A}$ . A similar curve can be drawn

for the absorption system. If, now, we can get a simple means for determining the ratio of the actual amplitude of the modulated wave to the maximum amplitude as required for complete modulation, we will be able to determine the percentage modulation of our set.

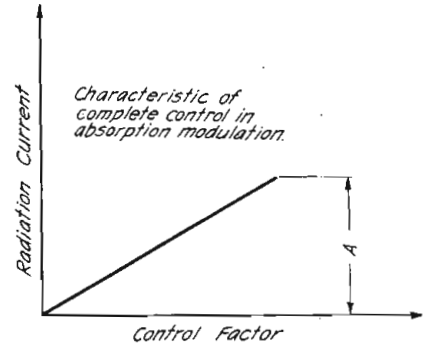

Fig. 4a

Characteristic Curve of Linear Control in Absorption Modulation Method.

Since the degree of control is measured by the ratio of amplitude as shown above, it can also be measured by the ratio of any two quantities which are proportional to the mentioned amplitudes. Thus using a receiver with crystal detector, the telephone current, and therefore the signal intensity, is proportional to the received current, which is proportional to the transmitted current. Hence by using an audibility meter, which consists really of a telephone of known resistance and a calibrated resistance, in conjunction with a receiver, the modulation control can be readily determined. The following methods will then be found applicable.

### METHOD 1

#### (a) ABSORPTION SYSTEM

A simple receiver consisting of a coil and variable condenser with detector and telephones is connected and tuned to the wavelength of the transmitter, Fig. 6. With no speech applied, the coupling M is varied by moving along a straight line the receiver coil C to or from the transmitter, until unit audibility is had. A chopper is used in the receiver for making audible the unmodulated continuous waves. The distance between transmitter and coil C is noted. Call this distance OA. For unit audibility this coupling is now proportional to the maximum amplitude possible for complete modulation in an absorption system. Apply speech now to the set and without altering the tuning of the receiver vary the coupling of coil C to transmitter until unit audibility is again had. Note distance between coil C

(Continued on page 61)

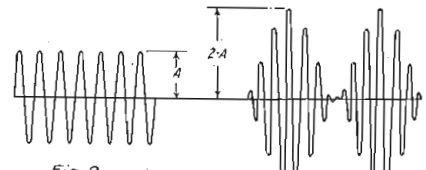

Fig. 2

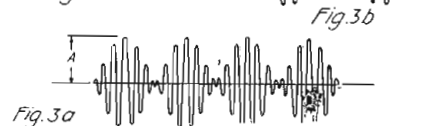
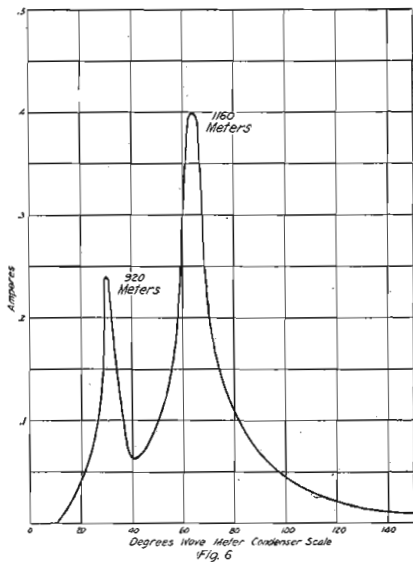

Fig. 3a

Comparison of Modulated Amplitude in the Absorption and Constant Current Methods. Fig. 3b Shows That When the Latter is Used the Maximum Amplitude May Amount to Double the Normal.

# Experimental Measurements and Calculations

By P. F. GEAGAN



This Curve Was Plotted With the Closed and Aerial Circuits Set at 1,080 Meters With 22 Percent Coupling.

**A** FORMER article described means of determining a number of the different electrical values present in radio circuits without the use of a laboratory equipment. In this article we will discuss means of measuring or calculating another of these values with limited facilities and without becoming too technical. It will be assumed that we have our home-made wave meter and other items described in the former article. The experimenter who goes to the trouble of making such measurements and calculations, will feel repaid if he is really interested in his work, and will do better work in the building and handling of his apparatus thru having a better knowledge and fuller understanding of what effect he produces when he cranks the knobs, han-

dles and sliders of his set. Aside from this also, it will be very gratifying to prove to his own satisfaction that I am wrong.

A term very commonly used is "coupling." This plays a very important part in both transmitter and receiver. On the transmitting side it is this coupling which most often gets the station owner in wrong with the government inspector thru its being of such value as to cause a decrement higher than is allowed by law. On the receiving side the degree of sharpness of tuning depends in part upon the coupling, and in receivers using regenerative feed back methods it is of the greatest importance. Troublesome howling of the tubes is due largely to too strong a coupling or regenerative action. The coupling has a definite value which may be measured, and while it is not of special importance or advantage to know this, the experiment is interesting. It may be defined as the measure of magnetic strength with which two or more oscillating circuits are linked together, also within certain limits, it is the rate at which energy is transferred from one circuit to another. Numerically the coupling, which we will designate by K, is equal to the mutual inductance, which we will call M, divided by the square root of the product of the self-inductances of the

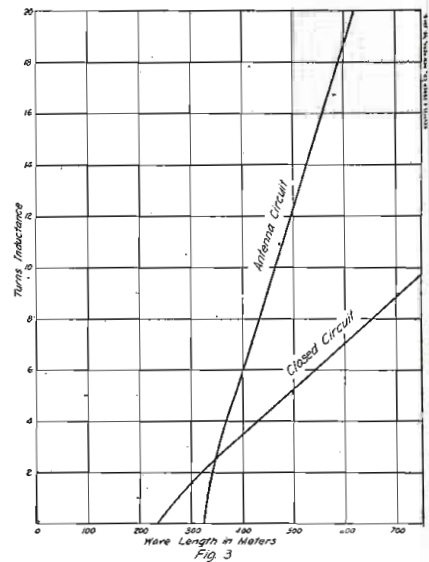

This Curve Enables the Operator to Find the Proper Number of Turns of Primary and Secondary Inductance for a Certain Wave-length.

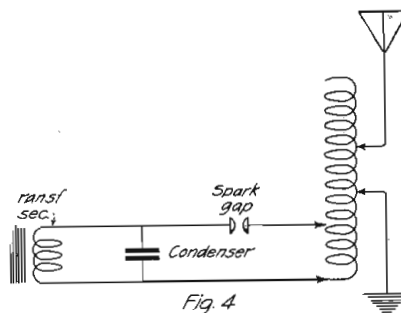

In This Circuit the Coupling is Varied by Moving the Aerial and Ground Clips Together Along the Coil.

1, since the fields of the two react mutually upon each other in the same direction, will be equal to the sum of their separate self-inductances plus twice the mutual inductance or  $A = L + 2M + L_1$ , and when connected as in Fig. 2, since the fields oppose each other, it will be equal to the sum of the separate self-inductances minus twice the mutual inductance, or  $A_1 = L - 2M + L_1$ . Let us further assume a value of 85 MH or 85,000 CM for A, and 45 MH or 45,000 CM for  $A_1$ , then the difference of the two must be equal to four times the mutual inductance, or

$$\begin{aligned} (1) \quad & 85000 = 30000 + 2M + L_1 \\ (2) \quad & 45000 = 30000 - 2M + L_1 \\ (3) \quad & 40000 = \quad \quad + 4M \\ (4) \quad & \quad \quad M = 10000 \text{ CM} \end{aligned}$$

two circuits L and  $L_1$ , all in centimeters,  $M = \frac{K \sqrt{LL_1}}{100}$  (Fleming, Principles of Electric Wave Telegrafy).

To work out an example as an illustration, let us assume an inductively coupled oscillation transformer of a radio transmitter of which we wish to obtain the range of coupling from maximum to minimum. It will be necessary first to measure the mutual inductance M; to do this we must determine the inductance of one side of the transformer, and for the sake of convenience we will take the primary side. This may be found, as described in a previous article, by measuring the wave-length which it will give when a condenser of known value is discharged thru the entire coil. Let us say that our primary measured in this manner gives us a value of 30 MH, or 30,000 CM inductance. We next connect this coil in series with the antenna or secondary coil, with the coils at the maximum of coupling or as close together as we can place them, as shown in Figs. 1 and 2, first, so that the fields of the two coils are in the same direction, and then so that they oppose each other, and measure the total inductance in each case. The inductance A of the two coils when connected as in Fig.

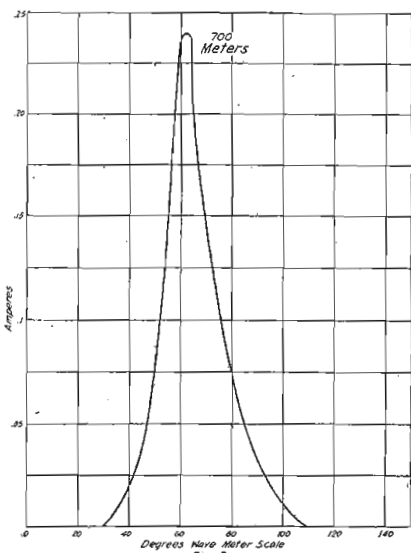

Curve Obtained With Closed and Antenna Circuits Set at 700 Meters With Less Than 10 Percent Coupling.

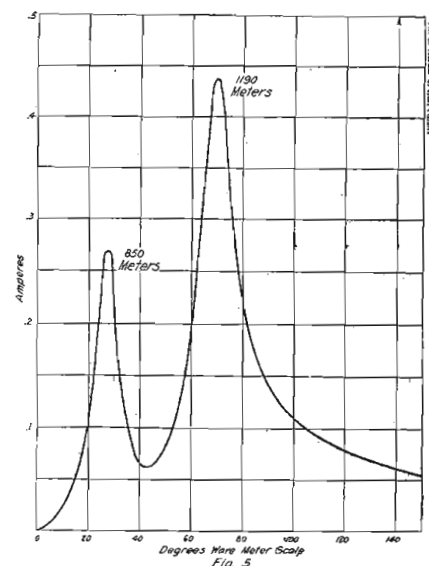

Resonance Curve for the Antenna and Closed Circuit Set at 1080 Meters With 29 Percent Coupling.



Knowing the values of L and M we may now extract the value of  $L_1$  from the equation

- (1)  $85000 = 30000 + 2M + L_1$
- (2)  $85000 = 30000 + 20000 + L_1$
- (3)  $85000 - 50000 = L_1$
- (4)  $L_1 = 35000 \text{ C.M.}$

We may now find the product of the two inductances  $30000 \times 35000 = 1050000000$  and the square root of this, 32403, divided into the mutual, or  $\frac{32403}{100000} = .308$ , the coefficient of coupling.

Next we move the coils as far apart as possible and again measure the mutual inductance as before. Let us assume that the inductances, with the coils placed thus, measure 75,000 C.M. and 35,000 C.M. respectively. These values then give us:

- (1)  $75000 = 30000 + 2M + 35000$
  - (2)  $45000 = 30000 - 2M + 35000$
  - (3)  $30000 = \quad \quad + 4M$
  - (4)  $M = 7500 \text{ C.M.}$
- and  $\frac{32403}{7500} = .231$

the coupling value with the coils placed as far apart as possible.

The limits of coupling then for this oscillation transformer with all turns cut in would be from .231 to .308. This, however, would not be true when the transformer is in use as a part of a transmitter;

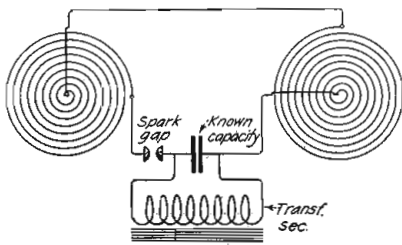

Fig. 1

Hook-up Showing How to Find the Range of Coupling of an O.T. In This Circuit the Two Fields React Mutually Upon Each Other.

it would then be necessary to add on the primary side the inductance of the transformer and spark gap leads and on the secondary side the inductance of the antenna including the ground lead and loading coil if any. On the primary side the inductance of the leads is low and may be neglected unless very accurate measurements are required; on the secondary side, however, it is large and must be taken into account. Let us suppose an antenna circuit of 15 MH or 15,000 C.M. inductance connected to the transformer above. The total inductance of the secondary circuit then becomes 35,000 plus 15,000 or 50,000 C.M. Then  $\sqrt{30000 \times 50000} = 38729$  and  $\frac{38729}{100000} = .258$ ; also  $\frac{38729}{7500} = .194$ . That is,

the limits of coupling of this transformer in actual use on the antenna described would be from .194 to .258 percent. As the coupling is increased the reactions increase, and if carried far enough will result in two frequencies in the antenna which are indicated very plainly by the wave meter.

A very interesting experiment is to build an oscillation transformer of sufficient flexibility to give wide limits of coupling from very loose to very tight, and plot a series of resonance curves at different degrees of coupling. The direct coupled transformer will give a wider range, so is desirable for the experiment and should be provided with a large number of turns and four connecting clips. Let us take for example such a coil having 30 turns. With the antenna disconnected from it, we will take a series of wave-length readings at one, two, three, four turns, etc., and from these

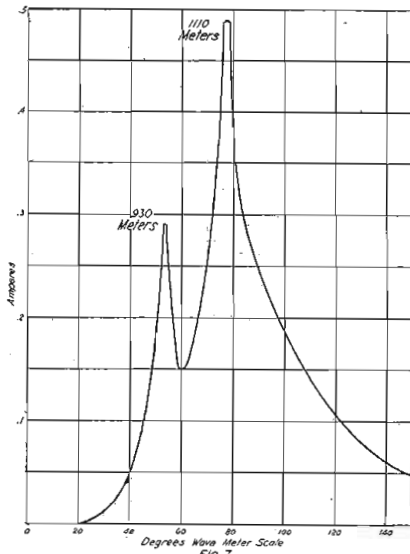

Resonance Curve for Oscillating and Aerial Circuit Set at 1080 Meters With 17 Percent Coupling.

readings plot a wave-length curve for the closed circuit as in Fig. 3. This enables us to set the closed circuit at any desired wave-length by reading from our sheet the number of turns or fraction of turns required for any wave-length. A similar curve plotted for the antenna circuit allows us to fix the antenna setting for different wave-lengths also. Thus, referring to Fig. 3, if we desire to set at 550 meters we find that six turns are necessary in the closed circuit, and 16 turns are necessary in the open or antenna circuit. In like manner we may set at any other desired wave-length within the limits of our coil and antenna. In order to obtain maximum range of coupling, we make the clip connections to the coil as shown in Fig. 4. This enables us to move the two closed circuit clips up and down the coil while maintaining the same wave-length. We will select a wave-length of 700 meters, which by Fig. 3 gives us 8 1/2 and 24 turns for the closed and open circuits respectively. For our first resonance curve we will make the coupling as loose as possible, that is, with the closed circuit and open circuit turns at opposite ends of the coil. In a recent issue of the RADIO NEWS a method of taking the resonance curve was described, and

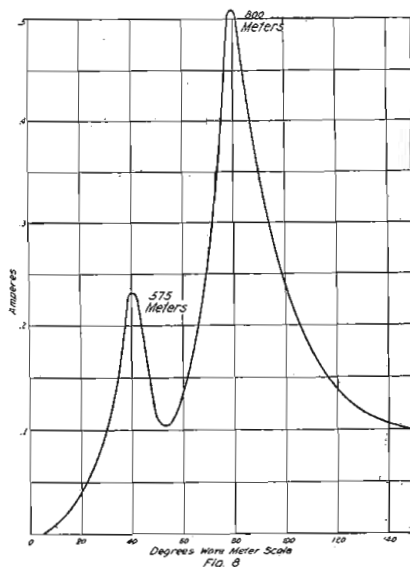

Resonance Curve Obtained With Both Circuits Tuned at 700 Meters With 32 Percent Coupling.

without again going over the ground, we will proceed in the manner described. The antenna and ground clips are now moved down the coil, let us say ten turns each, and another series of readings taken; repeat this operation up to the limits of the coil, and then plot the curves. The curves should be of different shapes provided the range of the coil is sufficient. Curves at different wave-lengths will give resonance curves also, and an assortment of such curves shows plainly the effect of different couplings. Figs. 5, 6 and 7 show three curves taken by the author on such a coil. Note that in each case both circuits were set independently at 1,080 meters, and two distinct frequencies resulted in each case when coupled up strongly. As the coupling was decreased, the two maxima approached each other, and had the test been carried a step further, would have merged into one at about 1,080 meters. Figs. 8 and 9 show where this was done on a setting of 700 meters. With the inductively coupled spiral wound oscillation transformers, which are in almost universal use today, we are unable to obtain a strong enough coupling to produce such frequencies in the antenna, which explains why we have them. It is possible to obtain low coefficients of coupling by reducing the antenna and closed circuit capacities and loading up with inductances to the same wave-length; a glance at the

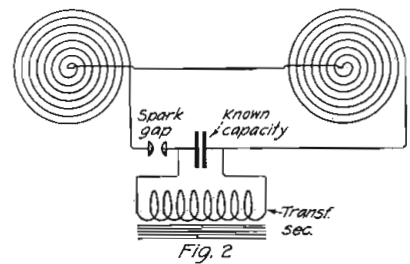

Fig. 2

When Connected This Way, the Fields of the Two Coils Oppose Each Other.

formula  $K = \frac{M}{\sqrt{L L_1}}$  will show this, since it follows that to increase L and  $L_1$  must result in a smaller quantity for K, provided M remains constant. This is one way an English company kept within the law without going to the expense of refitting some of its ships; our inspectors raved about it, but the figures were indisputable, and they were obliged to pass the sets.

A transmitter using a wave changer for shifting to a number of wave-lengths requires proper setting of this coupling. In order that the operator may not have to adjust the mutual inductance between the two coils at each change of wave-length, but perform the operation by merely turning the indicator, it is necessary in tuning

the set that the value  $\frac{M}{\sqrt{L L_1}}$  remain constant for all tunes. As we place more turns in each coil for each wave-length as we go up from the lowest, the value of M and the value of  $\sqrt{L L_1}$  both increase, as well as the number of turns in the loading coils, we are allowed no latitude on the primary side of the transformer, but must cut in whatever turns are necessary to give the desired wave-length, and we do not wish to have to change the distance between the coils, so we must make the value of K come right by properly proportioning the antenna turns between the secondary side of the transformer and the loading coils. For instance, if at 600 meters we have in the secondary side of an oscillation transformer 10 turns with four in the loading coil, and when tuned to

(Continued on page 70)

# Alleviating QRM

By CLYDE L. FITCH

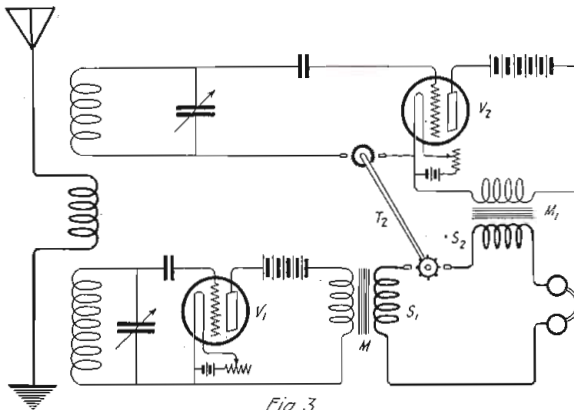

Fig. 3

Here is a clever arrangement to receive C.W. only, and cut out the interference caused by spark stations. This circuit will be found useful by DX men using C.W. In Fig. 3 two tappers mounted on the same shaft are used, but the circuit may be improved by using a rotary condenser as in Fig. 4.

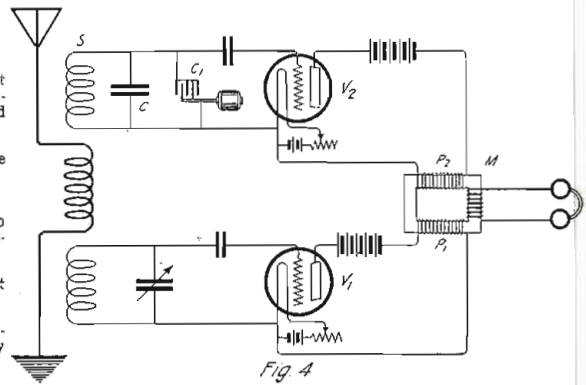

Fig. 4

WITH the continual increase in the number of amateur radio stations which spring up from year to year, a condition will soon be reached when it will be an absolute impossibility to do any long-distance or relay work at all. Even now in the thickly settled districts, QRM is intolerable. Communication is unreliable. As a consequence, amateur radio development has been drastically checked. New methods must be devised to meet the coming calamity.

It is almost certain that continuous wave transmitters will eventually be used for alleviating QRM. Due to the great selectivity obtained, too much cannot be said in favor of them. At least 25 times as many C. W. stations as spark stations can operate simultaneously in the amateur range of wave-lengths, without interference. Surely continuous waves will be the last word in amateur radio communication.

With the present methods of reception, it is absolutely necessary that all amateurs employ C. W. transmitters, if the desired results are to be fully achieved. A single spark station will wreck the whole system. But the beginner, the young fellow just entering the radio field, must use a spark coil. Usually he is not financially able to own a C. W. transmitter. Even if he were, he would not have the training necessary to skilfully operate the set. He must start at the beginning. For this reason C. W. transmitters have been little used.

If the C. W. stations could work independently among themselves without hearing a buzz from the spark stations, QRM would soon be forgotten, communication would be uninterrupted, and the little fellows could sit on their keys to their hearts' content, and relay work could go on forever.

Many systems have been evolved in attempts to eliminate atmospheric disturb-

ances and retain all spark and C. W. signals; but no systems have been devised that will eliminate all damp waves and retain all undamp waves, a condition necessary for the effective operation of the C. W. stations. Fully appreciating the necessity of such a system, the writer devised the following circuits.

Fig. 1 shows a simple vacuum valve receiving circuit, which will respond to spark signals only. The spark signals impinging on the antenna circuit are transferred to the secondary circuit S, causing the potential of the grid to vary in unison with the incoming wave train. This variation is accurately repeated in the plate circuit, causing the plate current to vary at an audio frequency corresponding to the spark frequency of the distant transmitter. This audio frequency is transferred to the telephone circuit S, by means of the audio frequency transformer M, and is heard in the fones. A C. W. signal impinging on the antenna is also repeated in the plate circuit; but, since the wave is continuous, there is no audio frequency current, and hence the C. W. signal is not transferred to the telephone circuit, and cannot be heard in the fones.

Fig. 2 is substantially the same as Fig. 1, except that a tapper is inserted in the circuit at T. The function of the tapper is to break up the continuity of the C. W. signals into an audio frequency, so that they will be transferred to the telephone circuit by means of the audio frequency transformer M, and made audible in the fones.

The fundamental idea of the new system is to combine these two circuits in such a way that the spark signals received on the circuit in Fig. 1 will oppose and balance out the spark signals received on the circuit in Fig. 2, leaving the C. W. signals received on the circuit in Fig. 2 to exist alone and be heard in the fones.

The spark signals received on the circuit in Fig. 2 are chopped up by the tapper, hence the spark signals in the circuit in Fig. 1 must also be chopped at the same frequency to completely balance out the spark signals received on the circuit in Fig. 2. This is accomplished by mounting two tappers on the same shaft, as indicated at T<sub>2</sub> in Fig. 3, which shows the two combined circuits.

Valve V<sub>1</sub>, Fig. 3, is connected the same as in Fig. 1, and valve V<sub>2</sub> is connected the same as in Fig. 2. Therefore, the audio frequency transformer M transfers only the spark signals to the telephone circuit, where they are chopped up by the tapper. The audio frequency transformer M<sub>1</sub> transfers both C. W. and spark signals, which are chopped up by the tapper, to the telephone circuit. The secondary coils S<sub>2</sub> and S<sub>1</sub> are connected dif-

ferentially, that is, they oppose each other, so that the spark signals are completely balanced out and only the C. W. signals, impressed on the transformer M<sub>1</sub>, can be heard in the fones.

There is a continual hum inherent to the operation of the tapper which makes its use undesirable. To overcome this, the circuit in Fig. 4 may be employed. This circuit is simpler than the circuit in Fig. 3 and should be preferred. In place of a tapper, the Bucher rotating condenser, C<sub>1</sub>, is employed, for modulating the C. W. signals. The circuit SC is first tuned to resonance with the incoming wave. C is a small fixed condenser. The rotating condenser, rotating at a high speed by a motor, throws the tuned circuit off resonance about 600 times per second, which varies the amplitude of the incoming C. W. signal. This causes the plate current to vary accordingly, at a frequency of 600 cycles, which will be transferred to the telephone circuit thru the transformer M. As only a slight fluctuation of the capacitance (about 20 micromicrofarads) of the rotating condenser will throw the C. W. signal off resonance, it will not distort the characteristic tone of the spark signals in the least. This is due to the high damping of the spark signals. Consequently the spark signals will also be transferred to the telephone circuit without any perceptible distortion.

The valve V<sub>1</sub>, being connected as shown in Fig. 1, will transfer only the spark signals thru the audio frequency transformer M to the telephone circuit. The two primary windings, P<sub>1</sub> and P<sub>2</sub>, are connected differentially, so that the spark signals impressed on P<sub>1</sub> will completely balance out the spark signals impressed on P<sub>2</sub>, and only the C. W. signals impressed on P<sub>2</sub> will be transferred to the telephone circuit and made audible in the fones.

The signal strength will be somewhat

(Continued on page 59)

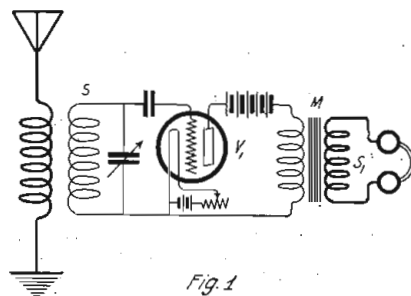

Fig. 1

This is a Typical Audion Circuit for the Reception of Damp Signals Only. A Telephone Transformer is Used.

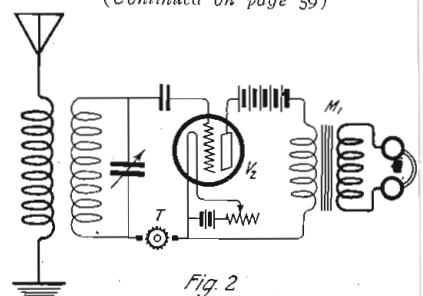

Fig. 2

This is the Same Circuit as Fig. 1, But With a Tapper Dividing the Undamp Waves Into Trains That Are Audible in the Telephone.



# The Efficient Design of Vacuum Tube Telegraf and Telephone Sets

By JESSE MARSTEN  
Part Two

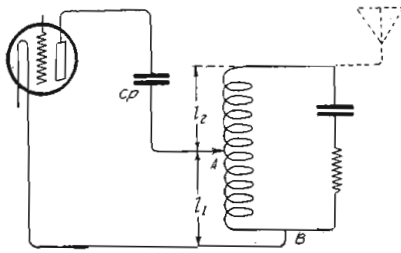

Fig. 9

Only a Part of the Loading Coil is Used in the Oscillating Circuit.

### PLATE CONDENSER.

The design of this condenser, which is  $C_p$  in Fig. 1, is entirely a matter of choice of proper capacity. A consideration of this diagram will show that the plate condenser serves the purpose of blocking the D.C. plate voltage, thus preventing it from short-circuiting to ground thru the plate inductance, and also to by-pass the radio frequency current from the oscillating circuit thru the valve. The first function necessitates one condition of the condenser design, namely, that it must be able to withstand the maximum plate voltage. This can be accomplished by the use of mica condensers. The second function necessitates the condenser having a low impedance to radio frequency currents. Consequently if the set were exclusively a telegraf set the condenser value could safely be of the order of 0.01 to 0.1 mf.

If telephony is to be employed, these values will not be correct. The use of telephony introduces another condition which must be satisfied, namely, that the reactance of the plate condenser must be very high to audio frequency currents. If Fig. 1 is partially redrawn as in Fig. 1a, it will be seen that the condenser  $C_p$  is practically shunted across the audio choke coil A. Now, as will be shown later, there is a high audio voltage across this choke which audio voltage modulates the radio frequency. If this voltage is reduced the modulation will decrease. If, therefore, the condenser C has a low reactance to audio frequency it acts as a short circuit to the audio voltage and thus reduces the voltage, and hence modulation. Consequently the condenser must have a low capacity so that its audio reactance is very great. Consider a value like 0.01 mf. for the plate condenser, working so on a wave length of 600 meters. Its reactance at 600 meters and also at 500 cycles is as follows:

$$(a) X_c = \frac{1}{\omega C} = \frac{1}{2\pi \times 5 \times 10^3 \times 1 \times 10^{-9}} = \frac{1}{\pi \times 10^{-5}} = 275 \text{ ohms (approx.)}$$

at 600 meters.

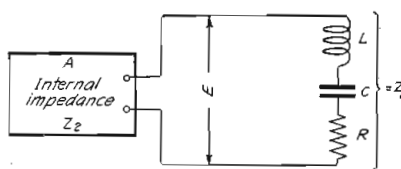

Fig. 7

The Impedance of the Load Circuit Must Equal the Impedance of the Generator. A is the H.F. Generator, While LCR is the Load Circuit.

"Use of A.C. Potential With Vacuum Tube Transmitters," RADIOE NEWS, March, 1921.

$$(b) X_c = \frac{1}{\omega C} = \frac{1}{2\pi \times 500 \times 10^3} = \frac{1}{\pi \times 10^6} = 275000 \text{ ohms (approx.)}$$

at 500 cycles. The radio reactance is very small compared to the valve resistance and thus would satisfy the requirement for by-passing the radio currents. Its reactance at audio frequency is extremely large and thus would have practically no effect on the voltage across the audio choke. This value is satisfactory for this kind of work. However, the choice of an exact condenser value is not very critical and there is sufficient latitude to allow the use of available apparatus. Thus good results will be obtained with condenser values between the extreme limits of 0.0004 and 0.004 mf. But it will be found that these values satisfy the conditions named above. When alternating current is used on the plate, care must be taken not to choose a value of C, which will produce resonance high voltage effects, as mentioned in a previous article.\*

### DESIGN OF R.F. OSCILLATING CIRCUIT FOR MAXIMUM OUTPUT AND EFFICIENCY.

We come now to the question of the design of the radio frequency oscillating circuit itself, namely circuit 1, consisting of

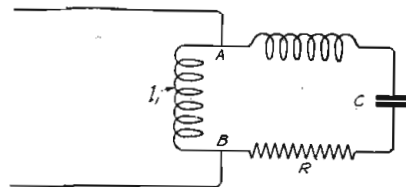

This is the Hook-up of a Dummy Aerial Connected to the Inductance of the Set.

L, C, R in Fig. 1. C and R are the capacity and resistance of the antenna and for purposes of analysis we will consider the equivalent closed circuit 1.

The problem confronting the engineer is usually of the following nature: He is given the tube which has known performance values, and he is given the constants of the antenna system within limits, and the working wave lengths. To design the best r.f. oscillating circuits for his set. He has first to choose the type of circuit to use, and having done that the problem of his circuit constants arises. We are considering the shunt circuit, but the choice of constants for the oscillating circuit is independent of the circuit used, and for the best output is determined by the valve constants. We consider the tube as a radio frequency generator delivering a radio frequency output in the oscillating circuit.

Any electrical generator may be worked to give maximum output at the corresponding efficiency (50 per cent., as will be shown), or at reduced outputs with correspondingly higher efficiencies. In the case of most electrical devices delivering power of large magnitude, it is largely a matter of cost economy whether the machine is to be worked at maximum output or at lower output and higher efficiency. However, in the case of vacuum tube generators of radio frequency energy, where the outputs obtainable are relatively small at best, the question of cost economy must be set aside for the present at least, and the device worked so as to

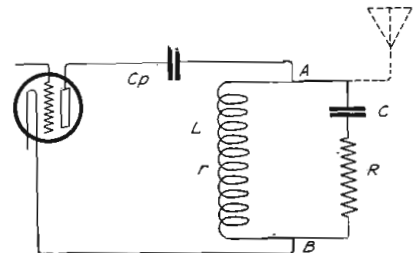

Fig. 8

In This Case All the Loading Coil is Used in the Oscillating Circuit.

give all the power it can at the highest possible efficiency.

Whether a generator delivers maximum output or not depends on the constants of the load circuit and generator. It will now be shown that an electrical device delivers maximum output when the load circuit impedance equals the generator impedance.

Consider in Fig. 7 any electrical device A having an internal impedance  $Z_1$  delivering energy in a generalized output circuit consisting of L, C and R, whose impedance is  $Z_2$ .

Let  $\epsilon$  be the generated EMF

E be the terminal EMF

i be the circulating load current

Then,  $\epsilon = E + Z_1 i$

Multiply both sides by  $i \cos \theta$ , where  $\cos \theta$  = power factor of load.

Then  $\epsilon i \cos \theta = E i \cos \theta + Z_1 i^2 \cos \theta$ .

Now  $E i \cos \theta = P$ , is the power in the load circuit, therefore

$\epsilon i \cos \theta = P + Z_1 i^2 \cos \theta$ .

$\therefore P = \epsilon i \cos \theta - Z_1 i^2 \cos \theta$

The condition for maximum power is

$\frac{dP}{di} = 0$ .

$\therefore \frac{dP}{di} = E \cos \theta - 2Z_1 i \cos \theta = 0$

$\therefore \epsilon - 2Z_1 = 0$

$\therefore Z_1 = \frac{1}{2} \times \frac{\epsilon}{i} = \frac{1}{2} (Z_1 + Z_2)$

for  $\frac{\epsilon}{i} = Z_1 + Z_2$

$\therefore Z_1 = Z_2$

Which means that for maximum output, the impedance of the generator must be one-half the total circuit impedance (for  $Z_1 + Z_2$  is the total circuit impedance). Or in other words the impedance of the load circuit must equal the impedance of the generator. In the case of our valve generator, its internal impedance is in the form of a resistance, and the r. f. circuit, being tuned to the wave-length used, is in

(Continued on page 48)

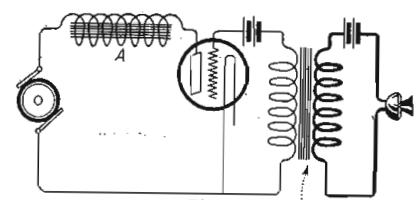
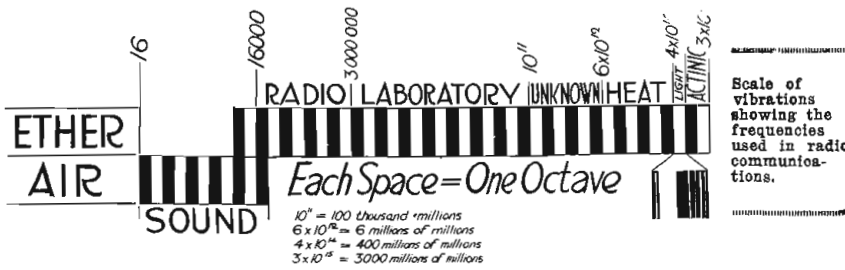

Fig. 10

Detail of the Modulation Circuit.

# Radio Telephony

By E. W. STONE



*Editor's Note.—Here is a lecture which was delivered by Lieut. Ellery W. Stone, U. S. N., R. F., before the San Francisco Electrical Development League on Jan. 24, 1920, and the Commonwealth Club of California, on March 18, 1921. Owing to the facts explained in this lecture, the Editors that it would be of interest to the readers who, having just started in the game, are not quite familiar with the principle of Radiotelephony and undamp't waves. This lecture was followed by a practical demonstration of a Radio concert which was received thru a magnavox in order to make it audible to the entire audience.*

*It would be very desirable if, whenever it is possible, such lectures be delivered to the public by Radio Clubs and dealers, in order to interest people in Radio and make them study the subject further; and you know what happens, once the bug has come!*

**I**N order to have a proper conception of the radio telephone, it will be necessary for me to review briefly a few of the facts concerning its theory and development, and I hope you will not consider that I am turning this luncheon into a school room.

Communication by wireless is carried on by ether waves, and it is helpful in understanding these etheric or electromagnetic waves to consider waves on water, which are closely analogous. If we drop a rock into a pool of distilled water, there will be waves radiated in all directions from the center of the disturbance. These waves consist of crests and troughs—the crests, of course, constitute the top part of each wave, and the troughs, the lower part between each two waves. We measure the length of such waves by taking the distance between the crest of one wave and the crest of the next succeeding one. This distance is, of course, the same as the distance between the troughs of any two successive waves, and this measurement is called the wave-length. It is obvious that as we increase the number of waves radiated in any unit of time, say a second, they will be more closely crowded together, so that the wave-length is decreased. The number of waves radiated per second is called the "frequency," and it is readily seen that as the frequency is increased, the wave-length is reduced.

Sound waves, which affect the ear, travel on a gas, a liquid or a solid, as their conducting media. The ear is only sensitive to sound waves of definite frequencies—from 16 to about 32,000. This range of frequencies is indicated on the chart, as shown, but the waves used in radio transmission travel on an entirely different medium, which pervades all space and which, for want of a better name, we term the "ether."

In the 1830's, I believe it was 1883, an English physicist by the name of Maxwell, advanced the theory that light-waves, as we commonly know them, are electromagnetic waves traveling on this mysterious ether—

the difference in color in light-waves being simply a difference in frequency or wave-length. These light-waves travel at a speed of 186,000 miles per second, or 7½ times the circumference of the earth. Wireless waves are of exactly the same nature as light-waves, and have the same velocity, so that if it were possible to build a sufficiently powerful station, we should be able to transmit a radio wave 7½ times around the earth in one second.

Since Einstein publishes his now famous "Principle of Relativity," there has been some doubt in the minds of scientists as to the necessity for our arbitrary conception of this almost fictitious ether. If Einstein is correct, there is very possibly no mysterious ether at all, but I hope you will not ask me any questions about his Theory of Relativity because I happen to be one of the unfortunate many who are not educated to the point of understanding the fourth dimension and theories of relativity.

Just as the ear has certain frequency limits of sensitivity, so also will the eye respond to waves of given frequency only. The lowest frequency to which the eye will respond is about four hundred millions of millions per second, and electrical waves striking the retina of the eye at this frequency register the color red on the brain. The highest frequency to which the eye will respond is just about double this frequency, and at this rate of vibration, we sense the color violet.

It is interesting to note that while the ear responds to an actual, physical vibration, the eye responds to an electrical one, and while we do not fully understand these things at present, it is very possible that the phenomenon which actually occurs is the generation of alternating currents of various frequencies in the nerve channels connecting the eye and the brain. In other words, our sense of sight is really a detector of electromagnetic waves.

Now, I have shown that the eye is sensitive to etheric electromagnetic waves of certain very limited frequencies. There are frequencies very much higher than those of the color violet which are popularly termed "ultra-violet" waves, and we find such very high frequency waves emitted from radioactive substances such as radium, thorium, uranium, and so on, X-ray tubes, and bodies under extremely high temperatures, such as the sun or the electric arc. These ultra-violet waves are also called actinic waves, and while they are of too great a frequency to affect the eye, nevertheless they are registered on a fotografic plate.

Similarly, below the light waves, there are a great many other electromagnetic waves, the frequencies of which are too low to be distinguished by the eye, but which may be detected by other media. For example, below the color red we have a series of radiations popularly termed "infra"- (or below) red waves, the commonest of which are heat waves. You are familiar with the fact that when a piece of metal is heated, such as an iron poker, the vibratory energy imparted to the molecules of the metal cause them to emit electromagnetic heat waves which can be detected by holding the poker near the face of the hand, but which cannot be seen until more energy has been imparted to the poker, until finally the waves are radiated at so great a frequency that they are able to affect the eye and we say the poker is "red hot."

Below the infra-red, or heat waves, there are electrical waves of frequencies which have been produced in the laboratory but which are too short to be used for wireless communication.

At the lower end of this chart are shown the waves actually used for radio communication and their frequency varies from about 16,000 to 3,000,000.

Altho I have shown the frequencies of sound-waves which are sensible to the ear, at the lower end of the chart, they are really not electromagnetic waves, but are included to show you the magnitude of the radio frequencies.

Each division on this chart represents an octave; that is to say, each unit of frequency is twice that of the one next below it. This means that this chart is laid out according to geometric law and not a straight line progression, because each unit doubles the one preceding. This is similar to the laying out of a slide rule.

Now we have seen that to produce waves, whether they be sound-waves or electromagnetic waves, it is necessary to have some vibrating medium which will set up these waves. In the case of sound-waves, it is a vibrating solid, gas or liquid, but in the case of electromagnetic waves, it is a conductor which is vibrating electrically, or which contains a vibrating electrical current, and this we term an alternating current.

It has long been known that the discharge of a condenser or Leyden jar is oscillatory. In other words, it sets up electrical currents of a radio frequency; that is to say, one of the frequencies shown on the lower end of this chart and which is suitable for Radio communication. In building a Radio station, therefore, we must erect a condenser big enough to handle powerful electrical currents, so that the current in this condenser can be of the power frequency to radiate waves. As you know, a condenser consists of two conducting surfaces separated by an insulator, which may be of paper, glass, oil, or mica. This big condenser which we use in a Radio station is called the aerial or antenna and consists of the elevated portion which constitutes one plate of the condenser, the other conducting plate being the earth, and the air between

(Continued on page 62)

This fotograf shows a DeForest 500-watt transmitting tube. It is one of the largest in actual use.

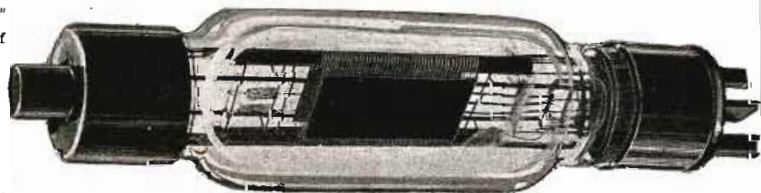



# Who's Who in Radio

## No. 6 GENERAL GEORGE O. SQUIER, K.C.M.G., D.S.M., Ph.D., F.A.I.E.E., F.I.R.E.

THE faculty of achieving renown in two fields of human endeavor is rarely possessed by a single personality, but scientific and military organizations have been working overtime in their lavish bestowal of honors upon Major-General Sir George Owen Squier, Chief Signal Officer of the United States Army. His services as a military leader have won for him enviable recognition, while science joins in the chorus of praise for his contributions in discovering new knowledge. His recent progeny, "wired wireless," would alone challenge for him the recognition of a scientist of outstanding note and qualify his name among the distinguished group, "Who's Who in Radio."

George Owen Squier was born March 21, 1865, at Dryden, Michigan. He was graduated from the United States Military Academy, at West Point, N. Y., in 1887, and was appointed Second Lieutenant in the Third Artillery. He rose to the rank of Lieutenant-Colonel of the United States Volunteer Signal Corps, and was honorably discharged on December 7, 1898. His affiliation with the Signal Corps of the United States Army dates from Feb. 23, 1899, being given the rank of First Lieutenant. Commissions of Captain and Major were subsequently awarded him, and from 1900 to 1902 he commanded the United States Cableship *Burnside* during the laying of the Philippine cable-telegraph system.

The chronological data just enumerated might, with slight variation, apply to a vast army of graduates from the United States Military Academy, so search must be made elsewhere for the distinguishing characteristics of this country boy from Michigan. It was shortly after graduation from West Point that seemingly destiny pitchforked young Squier for duty to Fort McHenry at Baltimore. Here, at Johns Hopkins University, his early zest for exploring into the wonders of physics was fired by such eminent scientists as Rowland, Renssen, and Newcomb. The foundation for the inventions which were in after years linked with his name was unerringly laid. His researches in the electro-chemical effects due to magnetization of the sine wave system of telegraphy and ocean cabling, the polarizing foto-chronograf, and multiplex telephony and telegraphy, are at least traceable to the inspiration imbued by contact with these master physicists.

Pure science—such terms as polarization, electro-chemistry, and foto-chronograf—is by its very nature robbed of any fascinating appeal to the popular imagination. The attainments of Major General Squier, however, have not been altogether clothed in a drab technical garb. He has frequently caught the public eye with peculiar effectiveness. His demonstrations of the radio properties of growing plants and conversion of trees in a forest as wireless antennae are vividly recalled. "Wired wireless"—whereby expensive cables may be displaced by bare wires for long-distance communication—is a subject easily comprehended outside of academic cloisters and the councils of scientific societies. Recently, a fresh adaptation of this discovery was demonstrated when heart beats were amplified so that physicians might diagnose them when listening anywhere in a spacious building. Characteristic of the sense of humor of the Chief Officer of the Signal Corps, in commenting to the

writer on the instantaneous popularity of the demonstration, he remarked: "Everybody has a heart—even Congressmen."

"Wired wireless" was first broached in 1911 when a report entitled "Multiplex Telephony and Telegraphy by Means of Electric Waves Guided by Wires," was published by authority of the Signal Corps. The announced discovery was like John the Baptist preaching in the Wilderness. The marvelous audion tube was in the realm of dreamland—a theory awaiting development. The absence of this device made prohibitive the realization of "wired wireless." Now, thanks to the audion tube in the capacity of a generator, the Squier progeny lends itself to development without entailing excessive ex-



General G. O. Squier, Chief of the U. S. Army Signal Corps.

penditures and elaborateness of equipment. Briefly, by way of explanation, the term "wired wireless" is a system whereby common wireless waves, as applicable to Radio communication, are guided instead of conducted to their appointed destination by means of a bare wire. The waves, however, do not course thru or along the wire, as might be implied, but apparently travel thru the ether of space in proximity to the wire. The virtues of the system are obvious; namely, trueness of direction, and a single wire answers the purposes of dozens of ordinary telephone circuits. That is, normally a pair of telephone wires can convey only one telephone message at a time by usual telephone currents, whereas the system under discussion can direct a large number of "wireless" radiations of varying frequencies simultaneously. The flexibility of the invention is suggested by its working capacity when linked with a common telephone system and with the wireless telephony. A dozen telephone messages may be conducted by one circuit and then satisfactorily untangled at the receiving station by a group of tubes containing heated electric wires.

Achievements in science are not without signal recognition, and honors have been bestowed liberally upon George Owen Squier. He is a fellow of the Physical Society of London, and a member of the Royal Institution of Great Britain. The scientist is not without honors at home. Major General Squier, in 1896, was the recipient of the John Scott Legacy Medal from the City of Philadelphia, acting on recommendation of The Franklin Institute, in recognition of his triumph of polarizing foto-chronograf. Again, in 1912, The Franklin Institute bestowed another honor by awarding him the Elliott Cressen gold medal for his activities in multiplex telegraphy or "wired wireless." With a brief intermission, the Chief Signal Officer was the subject of renewed plaudits from science, beginning with April 30, 1919. He was elected a member of the National Academy of Sciences, and on May 21, 1919, was awarded The Franklin Medal by The Franklin Institute. The reasons ascribed for the tribute were, "in recognition of his valuable contributions to physical science, his important and varied inventions in multiplex telephony and telegraphy and in ocean cabling, and in his eminent success in organizing and directing the Air and Signal Services of the United States Army in the World War." Nor were military authorities stingy in bestowing laurels. On July 2, 1919, Major General Squier was decorated with the insignia of the Order of Knight Commander of Saint Michael and Saint George, by Field Marshal Sir Douglas Haig, at London. From his own country he received the Distinguished Service Medal "for exceptionally meritorious and distinguished service."

Had not this biographical sketch already extended beyond the limitations of the editor, the human side of Major General George Owen Squier offers appealing fascination for discussion. His erect, soldierly bearing is of common knowledge to his acquaintances. To his friends there is a human relation which makes his, indeed, a likable personality. His sense of humor is keen. His philanthropic nature is outspoken; notably, he has recently endowed a \$7,000 community country club for the rural dwellers of his native home at Dryden, Mich. As this sketch is being written, General Squier is aboard the *Olympic* en route to Paris, France, to represent the War Department at the International Conference on Electrical Communications. He is chairman of the delegation from the United States which will attend the meetings of the Provisional Technical Committee of the Conference.

## OUR COVER CONTEST

Following the suggestion of one of our readers, we offered, in our March issue, a prize of \$10 for ideas for the cover of this Magazine. We have received quite a number, but very few are suitable.

We are glad to announce that this month's cover was suggested by Mr. G. W. Hall, 135 Scholes, Wigan, England, who consequently wins the prize.

However, we would like to receive some ideas on technical subjects, which is especially why we offered the prize, as the 19th Assistant Editor, whose job it is to find ideas for cover designs, has a liquefied brain during the summer months, and is unable to produce anything.

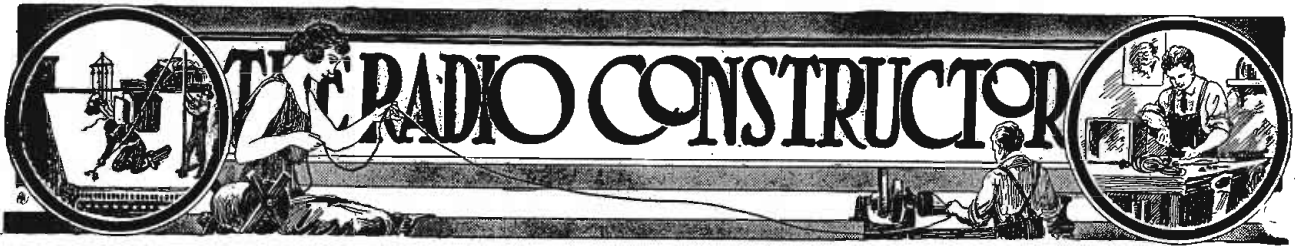

# Triple Inductance Coil Mounting

By F. C. SHELLEY

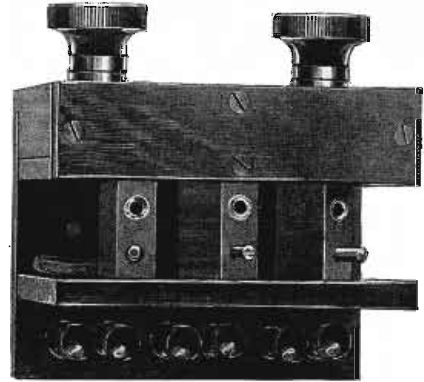
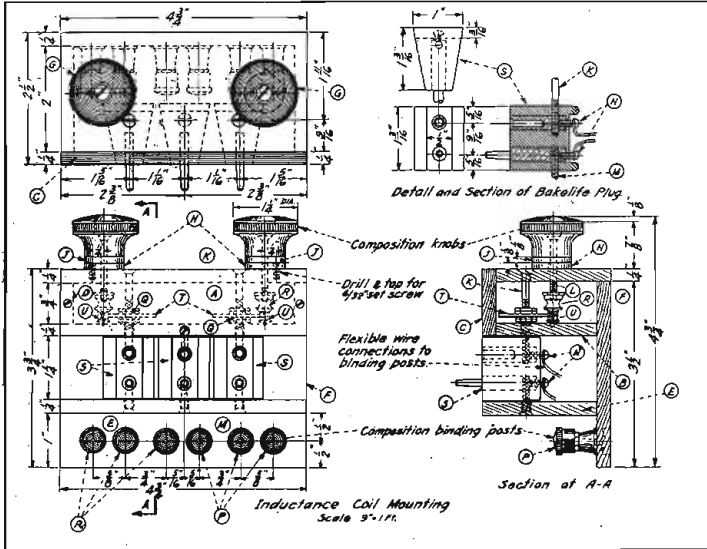

Fig. 1. On the right is a photograph of the coil mounting as it appears when built. On the left Fig. 2 shows the constructional details of this piece of apparatus that may be built by the amateur having but a few tools.

I have read a number of articles in the RADIO NEWS describing the construction of inductance coil mountings, all of which were easy to construct and serviceable, but in nearly every article, when adjusting the coils, the operator was required to touch the coils with his hand. This caused the signals (particularly arc signals) to vary in pitch or to fade out until the hand was again taken from the coil, and because of this defect, the best adjustment was only obtained after several trials.

The accompanying drawings show an inductance coil mounting in which the coils may be adjusted, or angled, by simply turning either of the two composition knobs and eliminating the previously mentioned defect.

The one difficulty in the construction of this type of mounting was to obtain suitable gears and pinions, as it would naturally be too expensive to have special ones made, so the ones used in this mounting were obtained from an old broken clock. The steel shafts on the pinions U-U were filed off flush with the end of the pinions and then were soldered to battery nuts R-R. Then the shafts in the two gear wheels were removed, leaving a hole large enough to pass an 8/32 machine screw.

The next step was to construct bearings for the composition knobs G-G. As I had no lathe, I obtained a piece of 3/4" diameter brass rod and using a hacksaw, cut four discs 1/8" thick from the rod. These were then filed down until the surfaces were smooth. Next, they were centered and two discs, H-H, drilled to pass an 8/32" machine screw and the other two, J-J, were drilled and tapt with 8/32" tap. Then discs H-H were drilled and tapt as shown in the sketch for 6/32" screw. This screw holds H-H stationary when the knob is being turned.

The next step was to drill and tap the bakelite plugs as shown in sketch No. 2. Note that the set screws A are also used for connections for the flexible leads to binding posts.

Next, the wooden case was constructed, the pieces being cut and finished to size as shown in sketch No. 3. All holes were then drilled and countersunk where necessary. Then all pieces were stained and later shellacked. (Several dimensions are purposely omitted on piece A, Sketch No. 3, as these distances will depend on the diameter of wheels to be used).

Then the parts were assembled as fol-

lows: The brass bearings H-H were secured to the wooden top A, then the wooden pieces B, E and ends D-D were fastened to the back F, then machine screws K-K were put in the top A and the gear wheels fastened on these machine screws with the check nuts Q. Then machine screws L-L were passed thru the knobs G-G and secured to same by tightening up on the brass bearings J-J. Now, this screw or shaft L-L was passed thru top A, then the battery nuts R to which the pinions U-U were previously soldered were fastened in place. See sketch No. 2.

Next, the center or stationary bakelite plug was secured to the wooden case by means of the screws M-M; turned around so that the set screws N-N could be tightened and then placed in its final position. Then the two end or adjustable plugs were placed in position and the wooden top piece set in place and fastened permanently.

(Continued on page 70)

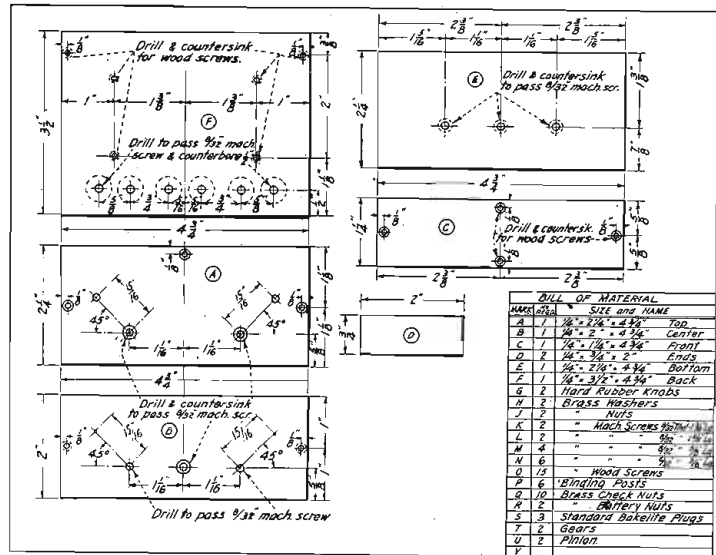



# RADIO DIGEST

## MARKET NEWS BY RADIOFONE.

Agricultural market reports by radiofone, is the latest innovation announced by the Bureau of Markets, United States Department of Agriculture. This service has been launched experimentally at East Pittsburgh, and with the necessary radiofone apparatus, farmers and others within a few hundred miles of Pittsburgh are able to learn agricultural market conditions and prices immediately after the close of the markets. The reports are sent from radio station KDKA over a wave-length of 330 meters.

The department's experimental radiofone service follows shortly the inauguration of sending agricultural market reports by wireless. Daily radio market reports are now being dispatched from Omaha, St. Louis, Washington and Bellefonte, Pa., and received by wireless operators in twenty-two Central and Eastern States, who immediately relay the news to farmers, shipping associations, distributors of farm products and others. Altho in existence but a short time, the department is receiving many gratifying reports regarding the usefulness of this service, and marketing organizations everywhere are not only watching the work with keen interest, but are arranging as rapidly as possible to utilize the service.

Sending the reports by radiofone would greatly simplify their receipt by farmers and others direct, inasmuch as the operation of a radiofone set does not require a knowledge of wireless codes. Instead of coming in dots and dashes the market news would be received in English, the same as conversation over an ordinary telephone. At present those desiring the radio market reports must make arrangements with local experienced wireless operators to receive and relay the messages to them.

## MEDICAL SERVICE.

All ships at sea within a wide radius of New York may obtain free medical advice by wireless telegraphy. This unique free dispensary is the first of its kind in the world. It will be available for hundreds of ships in New York Harbor, up and down the Atlantic Coast and for half way across the Atlantic. Except for the great liners few ships carry doctors, but practically all are equip with radio. The new service will be carried on by the Seaman's Church Institute on South Street, which meets all the expenses of the undertaking.

This long-distance dispensary work has already proved thoroly practical. There have been many cases of ships calling for medical advice for considerable distances, and lives have been saved in this way.

Under the new system of wireless medical service installed by the Institute, any ship can obtain this service at any time thruout the day or night. Wireless operators are constantly on guard listening in on wireless calls. By using three sets of operators the service is thus made continuous thruout the 24 hours. The service has been organized so that medical assistance is available at any hour, at an instant's notice.

To prevent confusion a new signal has been decided upon, the "H D K E," which is wireless for "Help wanted for an individual." This call has precedence over every other wireless message except S O S.

## WIRELESS TELEGRAPY.

By Bernard Leggett.

It is a matter for comment that while numerous works have been published, and others are still being produced, dealing with the

highly important science of Wireless Telegraphy, yet none of these give more than a mere outline of the quencht-spark system, a system which has been employed in almost every country thruout the world. In view of its extensive adoption in such countries as the United States of America, Australia, Japan, China and Germany, and considering that it can, for land stations, claim to rank with the Marconi System in importance, this lack of literature in England is difficult to understand. It is, however, probably the result of national prejudice, since the system had its origin in Germany, where it was experimented with and established by the Telefunken Co. The history and development are given in detail in the introductory chapter, and the efficiency of the quencht-spark gap is so undoubted that its scientific merits cannot be ignored or dismissed by appeals to false patriotism. The original Telefunken System has been developed to such a large extent in other countries, including England, that the quencht-spark system, which is its outcome, can now be viewed as an International system.

## List of Radio Articles Appearing in the July Issue of Science and Invention

The Chicago Police Radio System fully illustrated and described.

The Radio Lullaby at last.

Working Two Radio Watches at the Same Time, by Arthur H. Lynch.

Radio Time Signals at the Hotel Ambassador, New York's newest hotel.

Question and Answer Column.

The present book fills a distinct gap in wireless literature, as there is no volume at present in English which deals in detail with the quencht-spark system, either as manufactured in this or in other countries; or of the original Telefunken System. Much of the apparatus has never previously been illustrated and described in the English language, and much, including very many illustrations, has never yet been published in any country.

Besides the special study of the quencht gap system, the author describes the new wireless apparatus, such as vacuum tubes and high frequency alternators, and their use in Radio communication. The receiving instruments, and all modern receiving equipment are also described in this book, with details of their functioning. In fact, this very complete volume represents a great deal of work and contains most valuable information, which has never before appeared in print. It will be a useful addition to the library of the Radio engineer as well as a handy book on modern Radio for the student.

*Wireless Telegraphy* is published by E. P. Dutton & Co., 681 Fifth Ave., New York City.

## RADIO SERVICE FROM PARIS TO LONDON.

Stations for regular communication between these two cities are located in Neuilly-Levallois, France, and Chelmsford, England. A high-frequency generator of 10 k.w. to 25 k.w. is used for sending. Signals are first recorded by perforation by means of a special machine upon a strip of paper and are then sent at about 100 words per minute. The received messages are considerably amplified and are registered upon a fast-rotating wax disk similar to that of

a fonograf. For transcribing, the disk is revolved much more slowly, to enable the operator to copy the message on a typewriter.—*Abstracted from Radioelectricité.*

## THE CATHODE-RAY OSCILLOGRAF AND ITS APPLICATION IN RADIO WORK.

By Lewis M. Hull.

The general construction and details of the design of cathode-ray tubes are given. The brightness of the spot obtained, the sensitivity of the tube and its behavior in use are described. The various excitation sources available are compared. A number of applications of such tubes to radio research (for example, spark-gap characteristics and associated synchronizing of oscillating triodes) also are dealt with.—*Proceedings Institute of Radio Engineers.*

## BEHAVIOR OF A THREE-ELECTRODE VACUUM TUBE AS AN OSCILLATION GENERATOR.

By Eijiro Takagishi.

The writer states that the subject should be handled by starting from the dynamic or derived characteristics. These differ greatly from the static characteristics, which can be experimentally determined with ease. The writer then proceeds to derive mathematically the characteristics solely from the circuit conditions.—*London Electrician.*

## OPERAS BY RADIO.

The State Opera of Berlin, Germany, recently gave a performance of "Madame Butterfly" that was transmitted by wireless and could be heard by all European wireless stations. Microfones placed on the stage bore the music to the wireless station at Koenigs wuesterhausen.

The experiment was organized by the Post Office Department, which intends to establish a concert and opera service by telephone for villages in the rural districts as a means of raising revenue. If the new device for the transmission of music works out satisfactorily, telephone subscribers will be furnished with performances at stated times and all they will have to do to hear the best artists of the German capital will be to take up their telephone receivers and listen.

A given wave-length will be used exclusively for the transmission of these performances by wireless to avoid interference by other wireless sending stations.

## MEASUREMENT OF RADIATION OF RADIOTELEGRAPHIC AERIALS.

By G. Vallauri.

This article aims at discussing the measurement of radiation, and deals with the following points:

(a) *Radiated Power.*—The measurement of radiation reduces itself to that of an electromagnetic field carried out at a certain distance from the oscillator by means of determination of the Poynting's vector. (b) *Radiation of the Dipole.*—The dipole being an ideal oscillator, the radiated power is found equal to

$$P_i = 1,600 \left( \frac{h}{\lambda} \right)^2 I^2$$

where  $2h$  is the length of the oscillator,  $\lambda$  the wave-length and  $I$  the current. (c) *Effective Height of Aerial.*—After calculation in the case of the simple linear oscillator of length  $2h$  it is sufficient to substitute

$\frac{2h^3}{\pi}$  for the value  $h$  required. (d) *Receiving and Measuring Aerials.*—Various

(Continued on page 77)



# The Mystery of the "V. T."

By W. ANDREWS

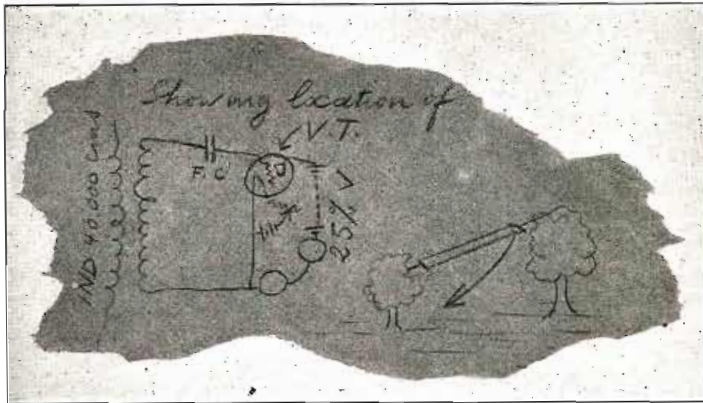

Fac-simile of the scrap of paper found by Joshua Kent on the beach.

**J**OSHUA KENT was an ordinary business man. Perhaps not quite up to the average, for the average business man of today knows something of science; he has to, his business demands it. Joshua knew nothing about any branch of science. Why grown men and boys should collect a lot of "junk," or apparatus and spend all their spare time "monkeying" with it, was more than he could see.

Joshua was the proprietor of a book store. His greatest ambition was to sell books, books and more books. Very well, but he didn't get much pleasure out of it. Many men have hobbies. They work at night to perfect some little problem. They study, and work. Sometimes they become nationally known as authorities. Joshua had no hobby or other interest beside his store. He was a little wizened man with large gold-rimmed spectacles set astride his nose. What purpose these served, is more than one can guess, for he rarely looked thru them, always over. But let us begin our story.

It was an early day in spring; Joshua Kent was out for a walk. He lived in the little town of Crescent Harbor, and on this day he was making his way toward a cove a mile or two above the town.

A rocky promontory jutted out into the Ocean and beyond this were hidden reefs. The surf incessantly boomed along the point, but beyond there was quiet water and a clean, white, sandy beach. Half buried in the sand were the remains of what once had been a coasting schooner. Only the prow and part of the frame work now remained. Written across the bow in letters that had once been a bright gaudy yellow, but now were faded and barely discernible, was the name "Salvador."

It was this little sandy beach that was the destination of Joshua. Upon reaching it he settled himself comfortably in the lee of the wreck where he could watch the waves as they rose and broke on the rocky outcroppings of the point. On these wanderings he often brot a book with him, and today it was one of Edgar Allen Poe's. The title of the story was "The Gold Bug," and it dealt with a treasure hunt in which a part of Captain Kidd's vast mythical treasure was found. An hour skipt by; Joshua finisht the story. He started to rise as if intending to depart, but settled back and aimlessly began prodding the sand with the tip of his cane. Suddenly, in a little furrow made by his cane, he noticed the edge of a small brown slip of paper. He picked it up. It was rather a heavy grade brown paper, somewhat water soaked, and had strange writings and diagrams on it. It looked something like this—

Perhaps it was due to the story just finished, perhaps to the rumors often circulated thru the town of Crescent Harbor about hidden treasure near there, but whatever the cause, Joshua Kent was certain that he had unearthed the key to a buried treasure. What else could it be?

"It surely must be, it surely must," he mused to himself.

Let us leave Joshua for a moment and go back a week or so to a scene taking place on the very spot where Joshua was then standing.

Crescent Harbor, altho only a small town, had its share of the ever present radio bugs. They had formed a club known as the "Crescent Harbor Radio Association." But what interests us more, is that on a certain evening they had packed up their little portable set and started out on a camping trip, making their first night's stop at the cove which we have previously mentioned. The next morning they went away, leaving behind them the customary seraps of paper which mark the camping places of most hikers. Among these bits of paper was a diagram giving the hook-up of a vacuum tube and also a rough sketch of their aerial. This had been hastily drawn by Kenneth Wells, the secretary of the elub, to explain the question of a younger member regarding inductance. He had drawn it on a piece of paper torn from a paper bag, thus giving the effect of age that Joshua had noticed.

But let us forget this little incident and return to Joshua. He had walked back to his house and was now endeavoring to puzzle out the strange diagram.

"The first thing I must find out is what 'V. T.' stands for," he mused. "Showing

location of V. T.' The 'T' must mean treasure, but what about the 'V'? I must find out what that V means." So saying he reached over to a bookcase and drew out a dictionary. Turning to V he hastily ran his finger down the page.

"Valley, valonia, valuable—ah, yes, to be sure, valuable—Valuable Treasure. Yes, that is what 'V. T.' means. Funny I didn't think of it sooner." Evidently satisfied with his explanation of the mysterious V. T., Joshua turned his attention to the other writings on the map.

"Ind. 40,000 cms.' Cms., that is the abbreviation for centimeters, a unit of measure, which is about—let me see—yes, about .4 of an inch." To be sure of this he looked it up and found that a centimeter was .393 of an inch and by a little figuring he also found that 40,000 cms. would equal 436 yds., English measure. He began to rub his hands and started to dance about in his glee, for as he thot, he was "getting it." But the "25% V." was his stumbling block. Try as he might he couldn't see any rhyme or reason in it. True, it must be some sort of a measurement. But what was a 'V'? Had he only known it, the "25% V." was meant to mean, one-fourth usual voltage. Ignorance is bliss. At last Joshua took down the faithful dictionary and turning once more to the letter V, he scanned the pages carefully. On the sixth page his eye caught the word: Verst—the Russian mile equal to 3,500 English feet. Now he had found it indeed. Twenty-five per cent. of 3,500 ft. was 291 yds. They couldn't fool old Joshua Kent. No, sir! On the right of the paper were pictured two trees joined by a wire (an aerial) and from the tallest one an arrow pointed off in some unknown direction.

"In the diagram those two circles connected must be the trees," thought Joshua, "and the line leading up from them the arrow, for it terminates within the treasure circle. It's coming, it's coming, and now what are those little humps beside the 'Ind. 40,000 cms.?' We know that it is the symbol for a loose coupler, but Joshua did not. After looking up various conventional signs and symbols he decided that they must be little hills or hummocks. He took a lot for granted.

The next time that the opportunity presented itself, Joshua took the map and set out for the cove. The first things he looked for were the two trees and by stretching his imagination he was able to pick out two that resembled those of the diagram. In

(Continued on page 40)

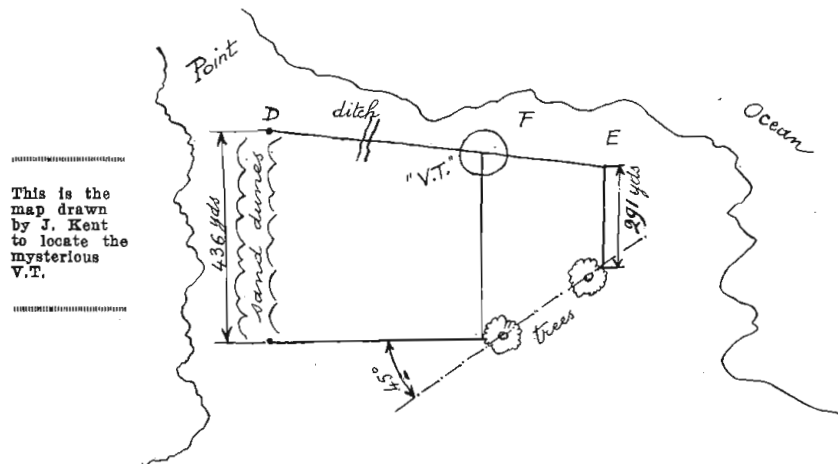

This is the map drawn by J. Kent to locate the mysterious V.T.



# The Acid Test

By GEORGE L. SHARP

STEWART ANDREWS, red faced, perspiring and out of breath, dropt his luggage to the ground and looked at the station master.

"What! The train left an hour ago? Well, wouldn't that eat you!" "Yes," said the man at the station. "You're a bit slow. Your friends are well on their way to Asynth by this time."

Stewart was disappointed. He, the president of the Dayton Radio Association, had forgotten the new train schedule and his fellow radio bugs had gone on their excursion to the mountains without him.

"Just my confounded luck," sighed Stewart as he turned to go.

"I have it," interrupted the station master. "The pay train is due in 40 minutes. She's running light, just a mail car and two box cars. You can board her when she stops for water and catch your friends at Layton. They lay over there till evening."

"Bully!" shouted Stewart, his eyes sparkling with joy. "Say, but won't the gang be surprised when I come oscillating into their midst?"

It may be well to state that Stewart Andrews had been elected president of the Dayton Radio Association because of his knowledge and intense interest in the wireless game. Not only had Stewart conducted the club in a very creditable manner, but he had also designed a rather unique and compact radio transmitter which he hoped to patent, with the view of installing a system of railroad wireless with the local branch.

It was by this means that Stewart was to raise funds to put him thru college. Twice he had interviewed the president of the railroad in an effort to gain his support, but twice the president had said, rather gruffly, "What need have we for such infernal contraptions?"

Stewart, however, did not give up. He decided to give his portable transmitter a thoro series of tests while the club was camping in the mountains, and thus it was that he had carried his brain-child to the

depot, along with his camping outfit.

The pay train arrived and Stewart, stowed away in the car next to the mail coach, was soon speeding towards his comrades. As the rails clicked merrily under the car wheels, he settled himself comfortably and mused. He would spend his time, while in the mountains, experimenting with his wireless transmitter. If he succeeded in covering reasonable distances with its signals he would seek financial backing for obtaining a patent. If the railroad president still remained unconvinced he could go to the place where they shovel coal and have no winters.

The train, which had been speeding steadily along, was slowing down. Stewart heard the screech of brakes suddenly applied.



The Collapsible Loop Antenna Was Erected and in a Twinkling Stewart Was Pounding the Key as He Had Never Pounded it Before. K.R.M.—K.R.M.—S.O.S.—S.O.S. Three Bandits Looting Mail Car Just North of Langshire Curve. For God's Sake Come Quickly!

There wasn't a station within 10 miles. Something must be wrong! Stewart rushed towards the door, but before he reached it there came a crashing shock, so violent, that he was hurled to the floor, where he lay stunned.

When he regained consciousness Stewart got unsteadily to his feet, staggered to the half-open door of the car and gazed with-

out. He was horrified at what he saw. The engine was ditched. Half buried in earth and débris it was hissing frightfully as the water from the boilers drenched the smouldering coals in the firebox.

The track ahead was torn asunder and so twisted were the rails that Stewart guessed correctly that they had been dynamited. Only by the greatest of miracles had the mail car and the box cars remained on the tracks.

Adding to his amazement, Stewart saw a man of dusky hue in the act of poking a revolver into the ribs of the chalk-faced mail clerk. Another man of unfavorable appearance was tying the arms and legs of the clerk while a third stranger was stooping over the figures of the dead engineer and the unconscious fireman. The brakeman was lying, bound and helpless, at the foot of the embankment. The mail clerk was thrown down the grade and landed in an uncomfortable position beside him.

Stewart understood; it was a holdup. The bandits had ditched the train and were about to loot the mail car of its \$50,000 in gold and currency. Stewart thought quickly. Like a flash an idea came to him. He had not been discovered; why not send an SOS call from his portable transmitter?

K.R.M., the wireless plant of the aerial mail station, was situated not far from the Dayton Depot. Perhaps the operator would hear the signals of distress and notify the railroad officials.

The portable transmitter was quickly unpacked. The collapsible loop antenna was erected, and in a twinkling Stewart was pounding the key as he had never pounded it before.

K.R.M.—K.R.M.—K.R.M. SOS—SOS. Send a posse. Three bandits looting mail-car just north of Langshire curve. For God's sake come quickly!

Time after time the spark spit forth the call for help. Time after time Stewart sent forth the message of distress. He had no receiver with which to listen for an answer-

(Continued on page 60)

## A Clever Solution

Denver has solved the problem of the wireless amateur disturbance in a very happy manner. For several months the Denver Gas & Electric Company had been driven frantic by complaints of flickering light circuits, burned out transformers and even fires in residences. In practically every instance the cause was traced to the aerial of some industrious son of Jove. With about four hundred aerials in the city it seemed impossible to regulate conditions to avoid trouble so steps were taken to shut up the whole works by introducing an ordinance in councils prescribing prohibitive conditions and also placing a heavy license on wireless sets operated within the corporate limits. No provision was made for receiving sets, every aerial being placed in the same class. Before going to this extreme, however, the company officials

called into consultation H. H. Buckwalter, one of the advanced amateurs, and asked for suggestions.

The result of the conference was a stay of execution for a few days. Buckwalter got busy at once. Instead of calling the boys together—an impossible thing—he called them on his wireless fone and asked their co-operation. The response was immediate. Every amateur promised help and within a week every offending set was provided with the necessary protective apparatus to prevent kick-backs and other disturbances. In a few instances where aerials were running parallel to the light or telephone circuits the direction was changed with very good results. The light company offered the services of its trouble-shooting squads and the boys were given free assistance in making the alterations.

The feeling of hostility decreased very rapidly with the improved conditions and last Wednesday night R. A. Hammack, superintendent of electric distribution, went to Buckwalter's station and talked to the boys by fone. He explained that for two or three weeks there had not been a single complaint and he also had the assurance of the boys that they stood ready to help out quickly should any more trouble show up. On the part of the company Mr. Hammack offered the services of the line gangs as well as the engineering department—entirely free of charge—to help any amateur who was not getting best results on account of aerial construction or kick-backs from transmitting apparatus.

A very pleasant change has also taken place in the status of the wireless chaps.

(Continued on page 61)



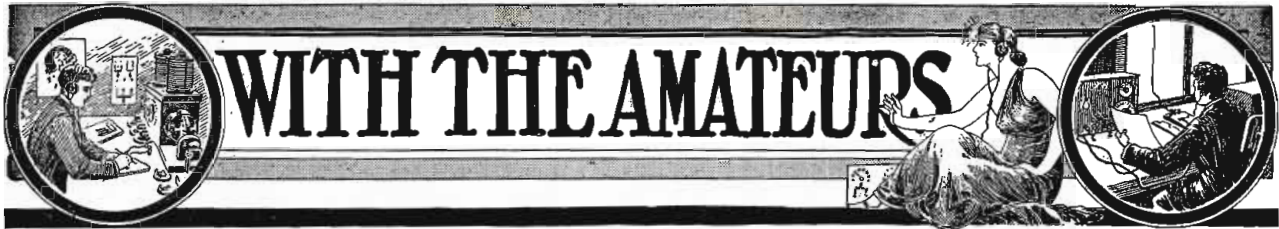

**T**HIS Department is open to all readers. It matters not whether subscribers or not. All photos are judged for best arrangement and efficiency of the apparatus, neatness of connections and general appearance. In order to increase the interest in this department, we make it a rule not to publish photographs of stations unaccompanied by a picture of the owner.

We prefer dark photos to light ones. The prize winning pictures must be on prints not smaller than 5 x 7". We cannot reproduce pictures smaller than 3½ x 3½". All pictures must bear name and address written in ink on the back. A letter of not less than 100 words giving full description of the station, aerial equipment, etc., must accompany the pictures.

**PRIZES:** One first monthly prize of \$5.00. All other pictures published will be paid for at the rate of \$2.00.

## Station of the Radio Club of Mansfield, Ohio

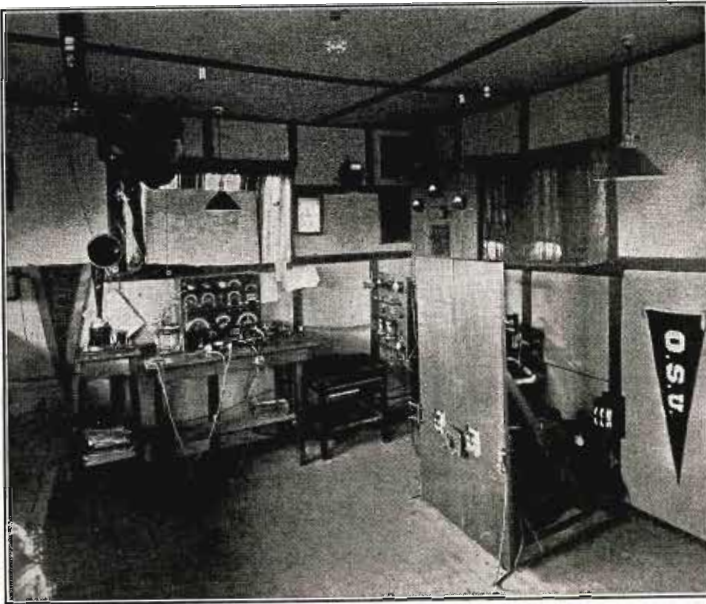

Here is a fine station which is equip with efficient apparatus, and which does some good DX work.

The Radio Club of Mansfield, 8ZR, has been heard many times on the Pacific Coast, using 1,000-watt power.

Following is a description of the station: 8ZR, is located on the outskirts of Mansfield, O., in a large, open field. The aerial is fan-type, eight wires, 110' high, and 80' across the horizontal part.

The ground system is the Round's Round Ground type 130' in circumference, consisting of copper plates buried vertically in a trench 6' deep, with 3 copper leads 2" wide, supported on insulated posts converging at the center just below the tip of the fan aerial.

The lightning switch is mounted in a weatherproof box just at the bottom tip of the fan. From there the leads enter the side of the station building, going thru a large change-over switch to the receiver and transmitter. This change-over switch is 2' high and 2½' long, with blades and jaws 1½" wide. No lead anywhere is smaller than 1½" and most are from 2" to 3". The transmitter is tuned to 200 and 375 meters. On 1 k.w. input, as shown by a Roller-Smith wattmeter, nine amperes antenna current obtains on 375 meters and seven amperes on 200 meters—true amperes. The transformer is the old type Thordarson, condenser .01 mfd. Dubilier, and an American Radio Sales and Service Co. type DX-53 oscillation transformer, which has heavy ribbon 3" wide on both primary and secondary, and both members are variable while transmitting by simply turn-

ing two large bakelite handles which vary the inductance in both the open and the closed circuits. The coupling is also instantly variable. This oscillation transformer has bakelite insulation throughout. We feel that this oscillation transformer has been one of the most important factors in our success. It alone increased

our radiation 25 per cent. The gap is that manufactured by the American Radio Sales and Service Co., which consists of their DX-51 3400 r.p.m. induction motor and rotary disc with eight points. The leads in the closed circuit, by use of the above mentioned oscillation transformer, are so short that, even using the relatively high capacity .01 mfd. condenser, waves as low as 170 meters are easily obtainable. The fine quenching action of the gap and the short leads are two other factors of the success obtained.

The receiver shown consists of C.R.L. regenerator and detector and two-step audio frequency amplifier, together with DeForest LS-100 loud speaking horn and a magnavox and Baldwin fones.

Relay traffic was consistently handled thru the heavy winter Q.R.M. in jumps up to 1,000 miles and we have been smashing thru the terrific summer static up to 500 miles on relays. The station is tuned to wave-length and resonance by means of a C.W. circuit driver manufactured by the American Radio Sales and Service Co.

This gives quick and minutely accurate readings and insures a clean cut sharp and emitted wave of maximum energy and lowest decrement.

The receiving equipment has also been replaced by similar equipment manufactured by The American Radio Sales and Service Co.

A very great deal of credit for the success of 8ZR is due Mr. H. L. Chapman, engineer for the American Radio Sales and Service Co., inasmuch as he designed practically all of the apparatus which has been

(Continued on page 75)

This is a real aerial installed in a field. Undoubtedly the location helps them a lot in their long distance work. Too bad we can't all have one like this!

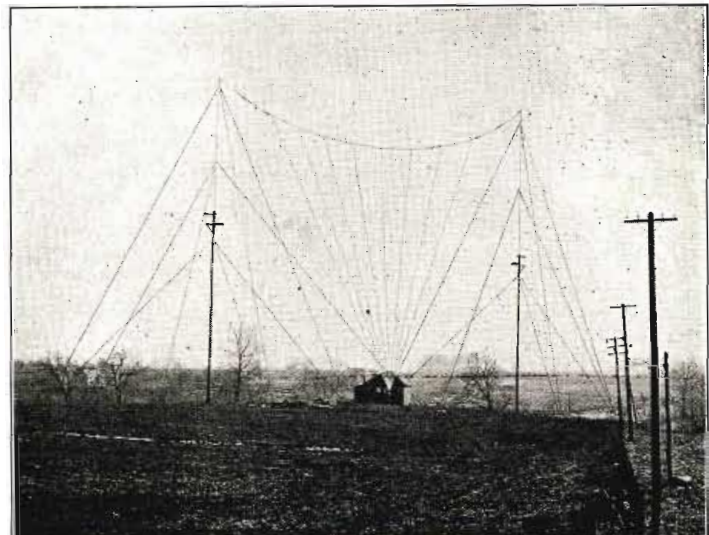



# Mr. Buckwalter's Station



Mr. Buckwalter Gives Some Real Radio Concerts as May Be Seen in This Fotograf. Unfortunately There is Often a Spark Coil Bug Who Wants to Show the Other Amateurs How Nice His Spark is in Comparison With the Singer's Voice.



The Radio Room at 9XAG. On the Right May Be Seen the Radiofone Set and on the Left the Motor Generator.

The accompanying fotograf shows Mr. Buckwalter with his wife, and the very complete Radio station he owns. Mr. Buckwalter is a well-known experimenter and amateur of Denver, Colo., and has helped a great deal with amateur Radio in that city.

Thanks to his efficient Radiofone, he is able to give Radiofone Concerts very often, which are much appreciated by all the amateurs in Denver and within a very large radius.

The other fotograf shows Madam Frieda Hempel singing into the microphone of the set of 9XAG, for Mr. Buckwalter not only sends fotograf music, but also arranges some real concerts. One of these was given recently by Horace Wells, accompanied by Miss Lucy Brandicon and the Harbeck Sextette, composed of young women musicians of Denver.

Lately, during some experiments made with a 15-watt set, the voice was heard

plainly 100 miles away, and the concert was received on a portable station mounted on an automobile which traveled around the town.

In the fotograf showing the sets may be seen on the right the Radiofone and in the background the receiver. On the left are the antenna and power switches, and the Ray-di-co H. T. motor generator, as well as the Navy type receiver for short waves.

On the shelf is a homemade loud talker.

# P. Denison's Station

## THIS MONTH'S PRIZE WINNER

As a reader of your very valuable publications RADIO NEWS and Electrical Experimenter for the last 10 years and a "prof" operator for seven of them, I feel sure your readers will be interested in the accompanying fotos of my station here in England.

I have a very complete tuning range of from 150 m. to 27,000 m. on various receivers, all of which utilize Duolateral windings. I have two seven-valve sets of my own construction which are used for long and short waves independently. In the large fotos you will see the standard British Short Wave Tuner on the left, which

uses reaction amplification or crystals.

Below it are control switches for the long wave loading inductances. Automatic switches change all connections from sending to receiving on starting the transmitting generator. The two tuners in the middle of the table are for 700 to 1,700 meters and 1,500 to 27,000 meters and are accurately calibrated thruout.

The dials are of white xylonite engraved with the scale and turn behind heavy glass windows. Each scale carries seven calibration rings indicating the exact wave-length of the secondary circuits on one side and

the call signal of station and condenser degrees on the other. An automatic pointer indicates which scale is in use and this is operated by the dead ending switch on the secondaries. Each dial is turned thru reducing gears so that very fine adjustment is possible for tuning telephony.

My transmitter consists of a 10-watt C. W. valve set, sending on 1,000 meters only, and this uses high tension from a generator driven by the lighting mains. I also have another valve transmitter for 180 meters entirely separate from the 1,000 m. set, this latter being visible in the fotos.

Both of these transmitters can be used for telephony, C. W. and buzzer modulation. Under the terms of my licence, I am only permitted to work two specified stations with my 10 watts, but have been heard on this low power at an amateur station 220 miles away very clearly. My aerial is supported by a square tower on the roof surmounted by a mast up to 84' high. I use the maximum aerial allowed of 100' single wire and this consists of a thick litz rope highly insulated. Regarding results, I may say, I have on various occasions copied NPO Cavite, P. I., on 12,200 meters arc and NPM working him. This is over 1,200 miles from here.

I hear many U. S. N. stations on your coast and can read NSS easily 50' from the fones, when jamming is not bad.

I also use two seven-valve signal corps type amplifiers as a direct 13-valve HF amplifier, one rectifier with two note magnifiers. This is only possible on waves of about 1,500 to 2,000 meters, but gives enormous amplification, even on a 4' frame aerial.

Contributed by P. DENISON,  
Radiofone Calls "2GU," "2KD."

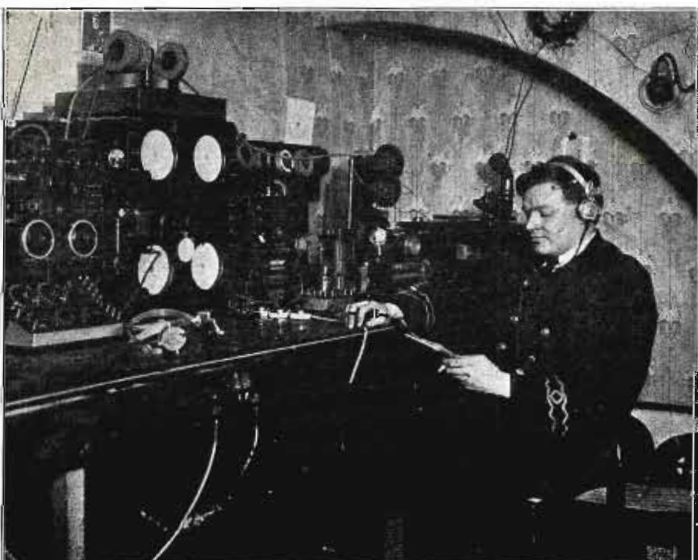

A fine station you have, Mr. Denison. You fellows over there seem to do quite a lot of experimenting and get good results in spite of the restrictions.



# JUNIOR SECTION

## Junior Radio Course

### THE WAVEMETER

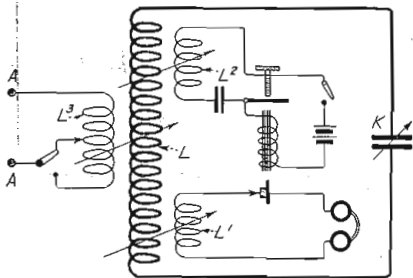

Here is the Hook-up of a Standard Wavemeter. The Inductance L and Condenser K Form the Calibrated Circuit.

The wavemeter is an instrument that should exist in every Radio station, as it may be used for several purposes, as will be explained in this lesson.

Not only may it be used to find the wave-length of a closed or oscillating circuit, but also for measuring the natural wave-length of an aerial, or tune up a receiver to a desired wave-length in advance. It may also be used to determine the capacity of a condenser by the comparison or substitution method and to measure the wave-length of the signals received by the station.

#### PRINCIPLE OF THE WAVEMETER

The wavemeter consists chiefly of an inductance generally fixed, or variable by steps, shunted by a variable capacity with a measuring instrument in the circuit which shows when the wavemeter is in resonance with the circuit to be measured. It may be a hot wire meter, a lamp or a detector and fones. Fig. 1 shows a complete wavemeter circuit which may perform all the operations mentioned above.

In this diagram, L and K constitute the calibrated circuit, L1 the listening circuit, L2 the buzzer circuit and L3 the aerial circuit. The coils, L1, L2 and L3 are so constructed that the coupling may be varied between the main inductance L and any of these; thus, when one circuit is not used, it may be loosely coupled to L to avoid losses and detrimental induction effects.

In order to obtain accurate readings and avoid damping effect, no instruments are connected in the calibrated circuit which oscillates freely and is set in resonance with the circuit to be measured by means of the variable condenser only. The calibration may be either furnished by a chart on which is drawn a curve, or by a direct reading, the wave-length being written directly on the scale of the condenser K.

#### THE USE OF THE WAVEMETER

For tuning a spark sending set with such a wavemeter, the aerial and ground are disconnected from the O. T. secondary, and the wavemeter placed in the vicinity of the O. T. with coils L2 and L3 loosely coupled. The key is then pressed and the operator, having the fones on, adjusts the detector and slowly turns the condenser until he hears the sound of the spark at the loudest; the coupling between L1 and L2 is then de-

creased and set so that the signals from the sending set are just heard faintly in the fones. In this position, the "maximum" is easily found. If the wave-lengths are directly written on the condenser scale, the pointer shows the wave-length emitted by the station. After the number of turns of the V. T. primary is adjusted for the desired wave-length, the secondary is then brought near, and the aerial and ground connected. The number of turns on the secondary is then adjusted until maximum radiation is obtained at the aerial hot-wire ammeter.

#### TUNING A C. W. SET

To tune a C. W. set, a different method is used. The wavemeter is set up to the desired wave-length, and the buzzer started. The operator listens into the receiving circuit L1 of the wavemeter, adjusting the coupling so that the sound of the buzzer is faint. The wavemeter being placed near the inductance of the C. W. set, the key is pressed and the tuning condenser of the set is turned until the sound of the buzzer becomes mushy, a very characteristic tone, easy to recognize. The C. W. transmitter is then set at the same wave-length as the wavemeter.

When a wavemeter, having a meter or lamp in the oscillating circuit, is used, the wave-length is found as follows:

The wavemeter is placed near the transmitter, either spark or C. W., and the resonance is found when the ammeter shows the maximum reading, or when the lamp glows at its maximum brilliancy, according to the system used.

#### MEASURING THE NATURAL WAVE-LENGTH OF AN AERIAL

To find the natural wave-length of an aerial, it should be done as follows:

The coil L3 of the wavemeter, consisting of a few turns, is connected in series in the aerial and the primary of the receiver, consisting also of a few turns. (Fig. 2.) The buzzer is started and the operator, listening in the aperiodic circuit of the receiver, that is the secondary without any capacity con-

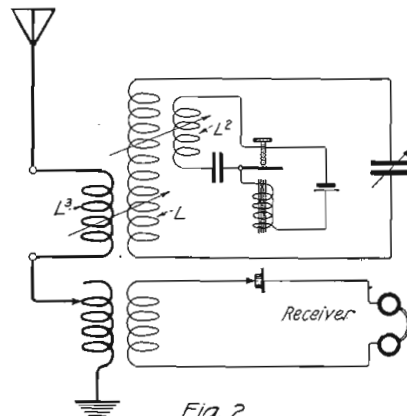

Fig. 2

This Hook-up is Used to Find the Wave-Length of an Aerial.

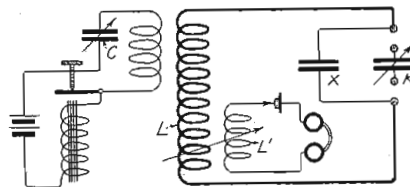

Fig. 3

This Diagram Shows How the Wavemeter is Used to Find the Capacity of a Condenser by the Substitution Method.

nected across, turns slowly the condenser of the wavemeter until he hears the sound of the buzzer the loudest; at this instant, the aerial is in resonance with the wavemeter which shows the wave-length of the aerial.

Of course, the few turns of inductance connected in the aerial increase the wave-length a few meters, but in practice the result is accurate enough within a few meters, if a total of say eight turns of inductance are used.

In order to ascertain that it is the wave-length of the aerial which is found, and not the one of the secondary of the receiver, another wave-length should be found when some more turns of the primary are introduced in the aerial circuit.

If it is desired to adjust the receiver on a certain wave-length in advance in order to avoid loss of time in tuning, and missing the beginning of a message, the best method is to adjust the secondary first, by placing the wavemeter with the buzzer running and the condenser set on the desired wave-length, near the receiver of which the aerial is connected.

The secondary is then tuned, until the sound of the buzzer is heard at maximum intensity in the receiver, and left fixed. The wavemeter is then connected as above for the measurement of the wave-length of an aerial and the primary tuned in the same manner, without changing the secondary tuning. The receiver is then tuned on the chosen wave-length and needs very little adjustment thereafter, if the coupling is varied.

#### FINDING THE CAPACITY OF A CONDENSER

To measure the capacity of a condenser, either fixed or variable, a calibrated condenser should be used in the wavemeter circuit, and it should be done as follows:

In case no other wavemeter is available, a buzzer is connected to an oscillating circuit, as in Fig. 3. The condenser, X, the capacity of which is to be found, is connected in place of K in the wavemeter and the capacity of the condenser C adjusted until the buzzer is heard with maximum intensity in the wavemeter. The calibrated condenser K is then substituted for the unknown capacity and adjusted for maximum reception. The capacity found is the capacity of the condenser X.

#### MEASURING THE WAVE-LENGTH OF SIGNALS RECEIVED BY THE STATION

The wave-length of the signals received by the stations may be measured by the

(Continued on page 40)



# Junior Constructor

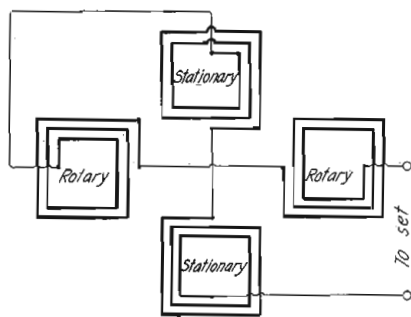

## A PANCAKE TYPE VARIOMETER.

Having need for two variometers and not wishing to use the usual ball form, led to the construction of a type which is illustrated here.

After completing and hooking up this variometer, the results were much better than expected, especially the sharpness of tuning, probably due to the form of winding, reducing distributed capacity to a minimum, closer coupling, more inductance giving a higher ratio.

The inductance form can be made of

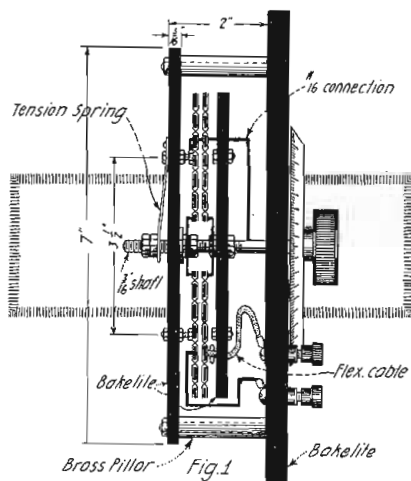

Here is a New Idea in Variometer Construction. Using Spider Web Type Inductances a Variometer May be Built That is Very Efficient and Small. On the Left is the Diagram of Connections and on the Right a Drawing Showing the Shape of the Forms on Which the Wire is Wound. The Drawing in the Center Gives the Size of the Variometer Itself.

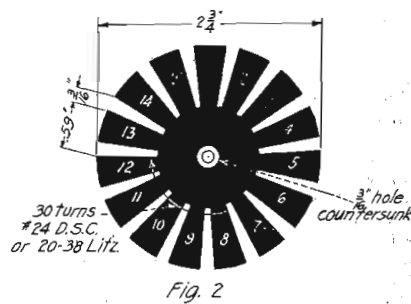

some good thin insulating material  $\frac{3}{32}$ " thick, such as bakelite, fibre, celluloid or perhaps a good grade of cardboard, given a number of coats of shellac after cutting.

In laying out the forms, cut out four pieces  $2\frac{1}{4}$ " square, then mark out one as shown in Fig. 2, place the four pieces together and drill a  $\frac{3}{16}$ " hole thru the center of all four pieces, then place an  $8/32$  screw thru to bind them and saw out with a scroll or hack saw; almost all the other parts can be left to the builder.

Contributed by B. A. ENGHOLM.

## An End Cell Switch for the "B" Battery

Several of the newer vacuum tubes, which are without doubt far superior to previous types as regards sensitiveness and stability of operation, require for their most efficient operation a rather close adjustment of voltage in the plate circuit.

To secure this variable voltage, many amateurs have discarded their block type "B" batteries and have substituted flashlight batteries with taps between cells. While this arrangement affords all that could be desired in point of potential adjustment it is far from satisfactory from an economic standpoint. The standard "B" batteries have been developed to such a point that their open circuit depreciation is much less than that of flashlight batteries, and they are much more reliable in every respect.

Fig. 1 is a schematic diagram of a system employing one 22.5 volt block "B" battery and only two three-cell flashlight batteries. Flashlight batteries of the tubular type are preferable, as the cells may be readily separated. All six flashlight cells are connected in series and taps taken off at every cell, as shown.

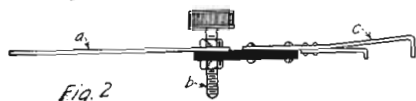
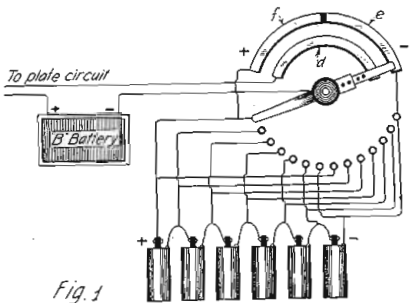

This Type of Switch May Be Mounted on a Panel With the Other Controls of a Set and Allows a Fine Adjustment of the Plate Voltage of the V.T.

The selector switch consists of two parts as shown in Fig. 2. The part "a" is connected with the center bolt "b", but the part "c" is insulated from both "a" and "b" by the hard rubber strip, and its two contact blades serve as a pole changing switch, connecting the common segment "d" with segment "e" or segment "f".

Blade "a" moves over a series of fourteen switch points, and acts as an end cell switch. With the switch in the position shown it will be seen that all six flashlight cells are in series with their positive pole connected to the negative of the block battery. This gives the added voltage of all flashlight cells and the block battery, or about 30.5 volts. As the knob is turned to the left, each successive point cuts out one cell, and thereby decreases the voltage, until point "M" is reached, where all flashlight cells are out of circuit, and we have the 22.5 volts of the block battery only. By referring to the diagram it will be seen that when the switch is moved from the seventh to the eighth tap, blade "b" has moved from segment "e" to segment "f". From now on each successive step cuts in one cell, but with reversed polarity, so that the flashlight cell voltage opposes, and is therefore subtracted from the block battery voltage. Thus, if we allow eight volts for the series of six flashlight cells we have a plate circuit potential variation from 22.5 plus eight or 30.5 volts maximum to 22.5 minus eight volts, or 14.5 volts minimum and this variation is secured in steps of about 1.33 volts each.

On the Right is a Very Simple Thermo Ammeter, Which May Easily Be Built and Yet Give Good Results. For the Fellow Who Can't Afford a High-Priced Instrument, it is "the" Thing.

This range is entirely sufficient for most tubes used in receiving circuits. For higher voltage block batteries may be employed, and the flashlight battery needed will be only that sufficient to give a total voltage equal to one-half the range of variation.

Contributed by HOWARD H. PRENTISS.

## A Thermo-Ammeter

Many's the time you amateurs have needed an ammeter, and those you tried to make worked as good as a telegraf sounder. How about it, eh? Why don't you make a thermo-ammeter? You all know about the thermostat—that copper expands more than iron on being heated. All right, then, proceed.

First, get a board about six inches square, "trim it up" to your taste, and bore two holes for binding posts—B and B'. Now get a strip of copper, C, and iron, I, as shown, and insulate same with two layers of newspaper, or better still, thin mica. On them wind one layer of well insulated (rubber) German silver wire or other wire that gets hot when a current goes thru it. Now fasten to the end of this a pointer, E, and "curl" the thermostat about two or three times. Make this "curl" as small in diameter as possible, for on this rests the success or failure of the instrument. Now mount the thermostat on a block, A. Also fasten on a scale S, with stops P and P', and connect up. See that the pointer is at zero before testing. Let the current pass thru the coil a minute or two and she will show the amperage (?).

Contributed by ESTEN MOEN.

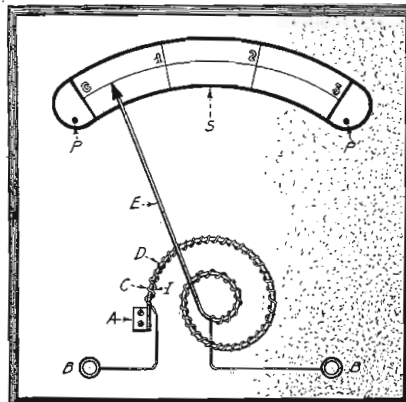

# Correspondence From Readers

## ENCOURAGES EXPERIMENTS.

Editor RADIO NEWS:

In your April issue there is an article well worth reading and studying, by 2AUG, Mr. P. Jessup, of Ridgewood, N. J. It shows that excellent receiving was accomplished with an indoor aerial, and amplification by the use of choke-coils in place of the usual transformers. Your readers will do well to experiment with this method of amplification, and also with indoor aeri-als. The point to which I wish here to draw attention, is that this young man came to my notice thru his having written me a letter to the effect that he had "heard my spark." This started a correspondence between us which has continued with great profit to me. At my request he presented a paper before the second Annual Convention of the Third District, held in Philadelphia recently. At my suggestion he rewrote the paper and sent it to your journal.

This young man is only 17 years of age, and demonstrates the value of getting into the game very early and of using brain, common sense and the mental acumen which comes to those who are scientifically inclined. The fact of Mr. Jessup being able to read signals from so many stations thru QRM makes his statements worthy of consideration by all amateurs desiring to do effective work in radio. Too many "cabinet" their sets, and then find little desire to improve on the circuit provided for them. Whether a variometer removed a foot away from its set position will improve signals; whether a few turns of wire removed from an inductance or added to it, will sharpen tuning; whether a change in the capacity of a fixed or variable condenser will add to efficiency; whether means for widening the inductance coupling will reduce interference, or bring in signals not otherwise audible; whether a few wires added to or removed from the aerial improves reception or transmission; whether changes in the ground lead to reduce resistance increases efficiency; and a number of other matters, do not seem to enter into the minds of many radio amateurs. That many are doing exactly as Mr. Jessup did, namely, improving their opportunities for advancing not only their knowledge of Radio, but, which is of more ultimate importance, the science itself, is evident by the many articles appearing in your journal demonstrating that the amateur is delving into the various problems offering themselves for solution in this branch of activity.

My reference to Mr. Jessup and his article is with the design not to throw "houquets" in his direction, but to encourage the increase of correspondence among radio enthusiasts, which often has most beneficial results.

Let us older men encourage the younger, for on them rests the burden of making the future one of profitable experimentation, invention and, therefore, greatly advanced development in radio communication.

GORDON M. CHRISTINE, M.D. (3BF).  
2043 N. 12th St.,  
Philadelphia, Pa.

## ABOUT RADIO COMPASS.

Editor RADIO NEWS:

Might I call Mr. Vernon's attention to the fact that "QTE" does not mean "where am I" any more than "SOS" means "save our ship" or anything like that, as some people would assure us. Its meaning is "what is my true bearing?" The bearing being given directly from the station, is checked up by comparison with the dead reckoning or an observation, according to circumstances.

I would also point out that when bearings are taken from two or more stations, the compass stations do not give their bearings simultaneously. In the case of harbor-entrance stations, one alone acts as control and carries on communication with the ship, transmitting its own and the findings of the other stations. In the case of independent stations, they are called, and will answer in geographical rotation, north to south. When the testing is concluded, they transmit their bearings independently of each other, but in the original order as referred to. In this way confusion is avoided and the radio operator is enabled to get the ship's position with a minimum of trouble and interference.

Procedure in testing seems to vary with the operator. Some content themselves with making the signal MO an indefinite number of times and signing off; others simply repeat the ship's call letters endlessly, while again others combine the two. It is very seldom that one hears an operator carry out the instructions as given on page 99 of the "Commercial and Government Radio Stations of the U. S.," i. e., "radio call letters for 30 seconds and then make dashes 5 seconds long for one minute, making their call letters three times after each five-second dash, and terminating with the conventional signal 'K' (go ahead)." I think, of the three, the official method is the best from the compass station's point of view. However, I would like to hear from other operators as to their ideas upon this matter of maximum power, irrespective of distance, and also procedure in testing.

THOMAS B. CROKE (KIVG),  
S. S. Mercer Victory.

## IMPROVEMENT OF JESSUP'S SET.

Editor RADIO NEWS:

I find that very much better results may be obtained with my hook-up, published on page 686 of April RADIO NEWS, if a slight change is made. The grid condenser of the second bulb should go to the other side of the tickler coil, instead of the "plate" side of the tickler coil. If this change is made, the set will oscillate much better. Will you please announce this change in your magazine?

Yours respectfully,  
P. JESSUP, 2AUG,  
93 California St.,  
Ridgewood, N. J.

## DOESN'T LIKE FUN.

Editor RADIO NEWS:

In the May RADIO NEWS the stuff that Mr. Burgess let out of the asylum from G. Rid- leak is not fit to be published. The A. R. R. L. is a league promoting amateur radio and if you say R. N. stands for the same, show it. I would like this published and invite discussion on it. Could R. N. put thru the transcon equal to the A. R. R. L. No. If R. N. publishes this stuff it won't have any chance at all along side of Q. S. T. Do you dare to put this in R. N. and invite discussion?

ANDREW POTTER, 8B1P.

(As you see, we dare to publish your letter without a squirm. We not only publish bouquets, but brick-bats are interesting as well. Mr. Potter's attention is drawn to the fact that we pity the man who has read Mr. Burgess' article seriously. That man's humor is dead and gone. RADIO NEWS recognizes the good work done by A. R. R. L. as well as any other league or organization, and Mr. Burgess' idea to poke a little innocent fun at them was probably read thus by

most readers. There was no attempt made to belittle the League, but the expression "The Awful Racket Raiser's League" is true not only of the League in question but of all leagues. Unfortunately, all amateurs are as yet addicted to raising an awful racket, whether they be individuals or leaguers, but we cannot for the life of us see where it hurts to tell the truth once in a while, especially when it is done in gently poking a little innocent fun.—Editor.)

## RADIO MEN WANTED.

Editor RADIO NEWS:

Beginning about the middle of this month, the Naval Militia of the State of New York will start a state-wide publicity campaign to enlist recruits in all the various branches of the service. H. M. Gabrielson, chief radio man of the Second Battalion, N. M. N. Y. located at the foot of 52nd St., Brooklyn, has been asked to inquire if you will give this outfit a write-up in the next issue of the RADIO NEWS, being very desirous of enrolling high-grade amateurs and others who can handle spark and C.W. sets. There has been assigned to the Second Battalion by the Navy Department three Eagle boats for the purpose of training recruits. These boats will make week-end trips in and about New York until July, when they are to make three 15-day cruises, stopping at numerous ports along the coast. A member may make one or all of these trips, if he so desires. The ships are all fitted with modern one-KW spark sets and one-half KW radio telephone sets, so there will be no end of experience to be gained by those who join us. Besides these week-end trips and cruises, a member may enjoy unlimited use of a fine big armory with its swimming pool, bowling alleys, pool and billiard tables, indoor track, tennis, handball and basketball courts, etc. We have two 40 ft. steam launches and a number of sailing cutters used for little pleasure trips to Long Island, up the Hudson and along the Jersey coast. Any man between the ages of 18 and 35 is eligible to join and any one desiring any information regarding enrollment may obtain same by calling at the Armory any Monday or Friday evening at 8 p.m., or by letter addressed personally to Mr. Gabrielson. Such letters will receive prompt attention.

## THEY LIKE IT IN SOUTH AFRICA.

Editor RADIO NEWS:

As a new subscriber I would like to express my appreciation of RADIO NEWS, the first copy of which (March, 1921) has just reached me.

I have had samples of a couple of other Radio magazines, but have found them too full of "Club News" and "Calls Heard," which are merely of local interest. If you want a world-wide circulation, which I am sure you do, keep the magazine as it is now. Your articles are real good and I should greatly regret to see them crowded out by page upon page of Calls Heard.

There are very few Radio amateurs in South Africa; the game is under Government control, and transmission beyond a radius of 10 miles is absolutely forbidden. How would the Radio people in the U. S. like that?

Yours sincerely,  
K. McLEAN

## SAYS STORIES ARE USELESS.

Editor RADIO NEWS:

In reading over your "Correspondence from Readers" I notice a letter from Mr. Grimm in regard to the stories which have been published (Continued on page 70)





#### THE RADIO CLUB OF BROOKLYN, INC.

Mr. Gawler, one time radio inspector of the First District, gave an illustrated lecture at the last meeting of the club, May 11, 1921. This lecture was identical to the article which appeared on page 776 of the May issue of RADIO NEWS, entitled "Some Operating Characteristics of Electron Tubes," by W. C. White. The fortunate members who were present at that meeting had the pleasure of seeing the portable set, which was described on page 770 of RADIO NEWS for May, in actual operation. This demonstration was under the supervision of Mr. Gawler, who also had a few samples of the new transmitting tubes, which are being put on the market by the Radio Corporation of America. Mr. Gawler then gave those present a little "side lecture" on how to get rid of some of the tickets for the dance and package party which the club gave on May 28.

At the conclusion of the meeting Mr. Gawler touched upon some of the radio laws, which finally led to the mention of the case of Mr. Hewitt (2RK), whose license has now been cancelled for three months. (Rumor has it that Mr. Hewitt's license has been permanently cancelled for the violation of the International Laws.)

Mr. Gawler then described the system of co-operation which is followed by the radio clubs of the First District, and told how a violator of this system could be handled outside of the Radio Inspector's office.

#### RADIO RESEARCH CLUB OF CANADA

The formation of the Radio Research Club of Canada marked a decided advance in radio matters in Canada. The club was formed as a central body of Canadians interested in wireless. Among its members are the leaders in wireless as a commercial proposition as well as many of the leaders in various organizations for the radio amateur. The club was formed March 17 last, with the following officers: Honorary president, Prof. Rosbrugh; president, H. Galbraith; secretary-treasurer, Dr. Culver. Committee—W. C. C. Duncan, E. Bowers, C. R. Fraser, Capt. Gennet.

Meetings are held every third Thursday evening at temporary quarters in the new Physics Building at Toronto, University. A course of lectures is being given, the first three of which are being delivered by Prof. Rosbrugh. Members are requested to bring their radio

troubles to the meetings, as after the regular lecture, time is devoted to a discussion of the various problems arising from time to time in the experiments of those interested in wireless.

Owing to a falling of the cliff, it became necessary a short time ago to close temporarily the station at Port Burwell on Lake Erie. A building has now been erected on a new site, a short distance away, and the station is again open for communication.

The club held a regular meeting at 7.30 p.m. May 19 in room 28 of the Engineering Building at the University of Toronto.

The third lecture in the series on "Alternating Currents" was given by Prof. Rosbrugh. The lecture was followed by an interesting discussion. Time was also given for raising questions not directly connected with the lecture.

#### KINGSTON RADIO ASSOCIATION

Kingston, Ontario, has come to the front with a progressive wireless club, and a most successful association is looked for. At the first meeting the energies of all present were put into making rules and to drawing up the constitution and by-laws. After considerable discussion regarding the need of such a club in Kingston, officers were elected as follows: Honorary president, Capt. S. A. Lee, M.C.; president, Orton H. Donnelly; vice-president, Robert M. Davis; secretary-treasurer, Staff Sergt. T. G. Brown; traffic managers, Harold Stewart and Gordon A. Thompson.

Traffic rules were also brot up and adopted and these are to be looked after by the traffic managers. All the members with transmitting sets are taking turns to transmit the Q.S.T. each evening at 7 o'clock. This Q.S.T. is sent out with the purpose of letting all amateurs know of any special news regarding the club, and also because it affords practice for them. First transmission is at fifteen words per minute and the

second one is at eight words per minute.

When the new clubrooms are made ready, a transmitting and receiving set will be installed and operated by the association. Meetings are held every Friday evening at 7.30 and in the future there will be lectures by prominent radio men in Kingston. Altogether, this will be a live-wire organization, as all the members are doing their best to make this one of the successful radio clubs of the country.

Code practice will also be taken up. There are about 25 members in the association. On account of the wave-length which the government has in force, amateurs are compelled to transmit only on 50 meters, and all sets are tuned to this length.

Communications are solicited from other clubs.

#### RADIO ENGINEERING SOCIETY OF PITTSBURGH

The accompanying fotograf was taken recently at the time the Radio Engineering Society of Pittsburgh formulated plans for an outing to be held at a summer resort near the heart of Pittsburgh, called "The Pines," on August 8, 1921.

The picture shows the men who assembled and formed committees to properly function the outing.

The committees appointed were as follows:

Reception Committee: W. K. Thomas, C. E. Urban, W. F. Mills, J. R. Ball, J. O. Olson, H. W.

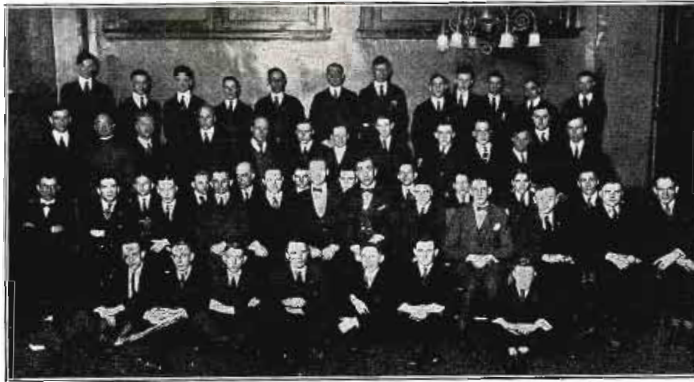

Here Are the Members of the Radio Engineering Society of Pittsburgh, Pa.

Whitby. Program Committee: P. E. Wiggins, W. K. Thomas, J. B. Coleman, C. T. Hewitt, H. D. Hindline. Arrangement Committee: W. E. Menges. Ticket Committee: J. O. Olson. Radio Installation Committee: W. Ela, F. J. Ritter, R. DeVaney, Earl Koch. Publicity Committee: P. E. Wiggins, C. E. Urban, W. F. Mills, Chas. MacSwiggan, W. E. Menges.

This club is the leading radio organization in Pittsburgh, and has had a great deal to do with the reduction of QRM. A short time ago a crusade was made on unlawful licensed stations as well as unlicensed amateurs and to date the club has been very successful and has a standing committee whose duty it is to report unlawful acts to the club and bring proper action.

W. E. Menges, Secretary.

#### CHESTER COUNTY RADIO ASSOCIATION

On May 17 at Parkesburg, Chester County, Pa., the Chester County Radio Association was organized. A meeting was held at the Parkesburg Iron Co.'s basketball hall; more than 300 being present.

Mr. Horace A. Beale, Jr., president of the Parkesburg Iron Co., was elected president of the association, after which an address was made by Mr. H. G. Gawler, of the Radio Corporation of America, who had travelled from New York to make the address. Mr. Gawler spoke on the value of vacuum tubes in radio operation, also giving a brief talk on the subject of organization. Mr. Lloyd M. Knoll, Professor of Physics in the Central High School Philadelphia followed Mr. Gawler on the platform; his address made a decided hit with those present. Mr. Knoll talked in language that could be understood by even those unacquainted with any of the fundamentals of wireless telephony or telegraphy; he told in plain words the pleasure he had derived and could be derived by others from the following up of wireless as a pastime.

A practical demonstration was then given by Mr. Thomas Appleby, of Philadelphia, the time being received from Arlington and then a musical program which was sent out from Mr. Beale's garage about a mile distant. In his demonstration Mr. Appleby used a Pathé diafram detector amplifier, which was the first of its kind ever seen at Parkesburg.

Mr. Beale, the president of the Chester County Radio Association, has one of the best equipped experimental and radio stations in this section of the country. It is located in a building especially erected for the purpose, the call is 340; every evening from 8 to 8.30 a musical program is sent out; these are being heard thru New York, New Jersey and Massachusetts, we are informed by various stations.

A meeting of the Chester County Radio Association is scheduled at this place for Tuesday, June 21st, when many interesting events are slated to take place.

David Logan, Acting Secretary, Chester County Radio Association.

#### THE RADIO CLUB OF THE BRONX

The Radio Club of the Bronx recently held a raffle which proved to be very successful. The proceeds of this raffle will go to the building of a larger and better club set. The present receiving set consists of a DeForest receiver using honeycombs in combination with a one wire aerial. The operating room is open to the members who may either listen in or receive code practice before and after each meeting.

The meetings are now held on Saturday evenings instead of Wednesday, at 8 P. M., due to the inconvenience of mid-week meetings. Visitors are cordially invited and all amateurs living in the vicinity of the Bronx Y. M. H. A. are requested to become members. The address is 1281 Franklin Ave., New York City.

Due to the astonishing success of the raffle the club will shortly engage in another venture which will prove to be of greater and of more extensive benefit. The Radio Club of the Bronx is contemplating the holding of a dance and hopes to have every amateur in New York City attend. This dance will require the co-operation of every member in the club and we are therefore seeking to enroll new members to insure its success.

The newly elected officers of the club are Nat Sauberman, president; Jonas Cohen, secretary; and William Fox, treasurer. Address all communications to Nat Sauberman, 789 East 163rd St., Bronx.

#### GREATER SOUTHERN CALIFORNIA RADIO ASSOCIATION

The Greater Southern California Radio Association was organized June 6, 1921, in Los Angeles, Calif., by Mr. Ira W. Wolfe, radio and industrial engineer, of 70 Fifth Ave., New York City, with temporary headquarters at 1331 W. 71st St., Los Angeles. Full details regarding the Association are now being prepared for the press and all those desiring to get copies as well as those living in and around Los Angeles are requested to write to the secretary, Robert L. Davies, 1331 West 71st St., Los Angeles. Meetings will be held at the Auditorium, supplied by the Los Angeles Evening Express, a local newspaper, which has a wireless station in operation. Lectures will be delivered and general exchange of ideas will take place at every meeting. Every progressive operator should write for particulars immediately.

#### PATERSON RADIO CLUB

The first meeting of the Paterson Radio Club was held on Saturday, June 14, at 319 Madison Ave., and the following officers elected: President, Philip Del Vecchio; secretary-treasurer, S. Cristiano; assistant radio engineer, Alfred Zisa; purchasing board, S. Cristiano and N. Del Vecchio.

We have to date 15 members and three prospective members. We are planning to build a modern radio telephone station with a transmitting distance of approximately 50 miles. The club has at present at its disposal a 4,000-mile radio receiving set, built by N. Del Vecchio, and capable of copying the great foreign stations at Nauzen,

(Continued on page 46)





**T**HIS Department is conducted for the benefit of our Radio Experimenter. We shall be glad to answer here questions for the benefit of all, but we can only publish such matter of sufficient interest to all.

1. This Department cannot answer more than three questions for each correspondent.
2. Only one side of the sheet should be written upon; all matter should be typewritten or else written in ink. No attention paid to penciled matter.
3. Sketches, diagrams, etc., must be on separate sheets. This Department does not answer questions by mail free of charge.
4. Our Editors will be glad to answer any letter, at the rate of 25c for each question. If, however, questions entail considerable research work, intricate calculations, patent research, etc., a special charge will be made. Before we answer such questions, correspondents will be informed as to the price charge. You will do the Editor a personal favor if you make your letter as brief as possible.

### GROUND IN WATER.

(1) F. C. Taylor, of Seattle, Wash., wants to know:

Q. 1. How can I get a good earth connection in 60' of water?

A. 1. A good ground may be made by laying a copper wire about 100' long in the water.

Q. 2. Would a big hill in the back of the station interfere with the signals?

A. 2. The hill may act as a screen, and have an effect upon the waves, but if it is far enough from the station, it may not have a very great influence.

Q. 3. Please draw a diagram showing the connections for a crystal set, V. T. detector and two-step amplifier.

A. 3. This hook-up appears on this page.

### EFFICIENT RECEIVING SET.

(2) Wilbur C. Brown, Jr., of Norwich, Conn., would like to know:

Q. 1. Which is the best receiving set for all-around work, short and long waves, not above 5,000 meters: the Paragon, R. A. 10, the Wireless Equipment Co.'s three-unit cabinet receiver, or the De Forest 15-unit panel set?

A. 1. The Paragon R. A. 10 regenerative set is the best you could use for wave-lengths up to 1,000 meters. For longer waves and all-around work, we would give the choice to the DeForest panel set, owing to its flexibility, and the advantages it has over some other forms of receivers.

### PLATE VOLTAGE.

(3) John V. Priante, of Brooklyn, N. Y., inquires:

Q. 1. What voltage is the safest to use on the plate for detector and amplifier, diagram published on page 512 of the February, 1921, issue of RADIO NEWS?

A. 1. In this hook-up, if Radiotrons U. V. 200 and U. V. 201 are used, 20½ volts should be used for the detector and up to about 80 volts for the amplifying tubes.

Q. 2. Does it make much difference if the grid leak is inserted across the secondary coil, instead of in series with it?

A. 2. No, the grid leak may shunt the grid condenser or be connected directly to the grid and the positive side of the filament.

### PIPE MAST.

(4) L. S. Rogers, of Huntington Park, Calif., wants to know:

Q. 1. Is a pipe mast as satisfactory as one made from wood?

A. 1. Yes, provided the pipes used are strong enough to stand the traction of the aerial and the mast is properly held up with guy wires.

### RECTIFIED A. C. FOR AMPLIFIER.

(5) H. Miller, of New York City, and

D. C. Strawn, of Calexico, Calif., ask the following:

Q. 1. Can A. C. be used to light the filaments of a detector and two-stage amplifier?

A. 1. With an audio frequency amplifier, it is very difficult to cut out the hum entirely and the amplifier is not so sensitive as when used with a battery. Several experiments carried out along this line have proved unsatisfactory.

Q. 2. What is the best type of amplifying tube to use with a double filament audiotron?

A. 2. Radiotron U. V. 201 could be used to advantage with this type of tube as detector.

### 20,000 METER LOADING COIL.

(6) Fred Rafferty, of St. John, N. B., Canada, would like to have the following information:

Q. 1. Will you kindly give data for the construction of a 20,000 meter loading coil?

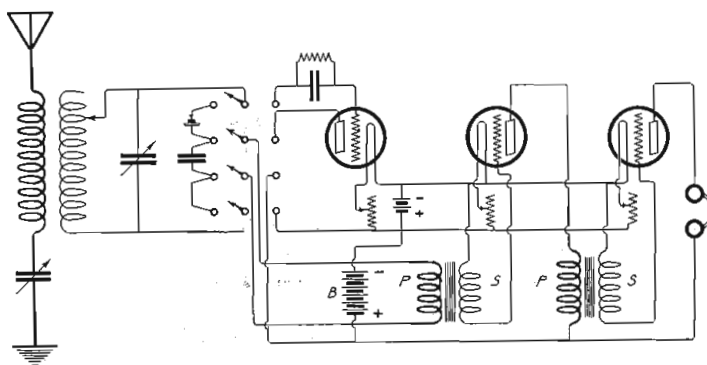

In This Hook-up a 4 P.D.T. Switch is Used to Change From Crystal to Audion, Using The Two-stage Amplifier With One or the Other Detector.

A. 1. A 20,000 meter loading coil may be wound on a tube 7" in diameter and 24" long, with No. 24 wire; three layers should be wound with about 920 turns per layer. Taps should be taken every 138 turns.

Q. 2. Give data for the construction of a loose coupler to tune wave-lengths up to 5,000 meters.

A. 2. A 5,000-meter loose coupler may be built as follows: Primary, 7" in diameter and 14" long, wound with 532 turns of No. 24 wire; secondary, 6" in diameter and 14" long, wound with 742 turns of No. 28 wire. The secondary should be shunted by a small variable condenser of .003 or .0005 mf.

### FIFTY MILE SET.

(7) Francis V. Long, of Bocaraton, Fla., asks:

Q. 1. What apparatus would I need to send 50 miles with a 32-volt Delco electric light plant, and where could I get them?

A. 1. We would suggest that you build a C. W. set and use a small Ray-Di-Co

motor generator using 32-volt D. C. These are manufactured by Ray-Di-Co, 2653A North Clark St., Chicago, Ill. You will find complete data for building the set on page 690 of the June, 1920, issue of RADIO NEWS.

Q. 2. How should I make a condenser for a half-inch spark coil?

A. 2. A H. T. condenser may be made of 15 glass plates 8" x 10" with 14 tinfoil armatures 6" x 8", provided with a lug for connection. Seven tinfoil sheets are used in each armature.

Q. 3. How far would the following apparatus send: Half-inch spark coil, fixt spark gap O. T., glass plate condenser and key?

A. 3. Under good conditions, a range of about three miles may be obtained.

### EFFICIENT RECEIVER.

(8) George Balko, of Chicago, Ill., sends us this request:

Q. 1. Please publish a diagram, using variometers and other necessary parts for good Radiofone reception. Also please explain the operation of V. T. in the circuit.

A. 1. A very efficient hook-up was published on page 443 of the January, 1921, issue of RADIO NEWS. We refer you to Fig. 2 on that page. The functioning of the V. T. in this circuit was explained on page 702 of our April, 1921, issue.

Q. 2. Please explain the difference between arc, spark and C. W., which two are alike?

A. 2. Spark means signals sent by a spark set.

C. W. means continuous

waves, and is often used with arc to designate undamped waves.

### LONG AND SHORT WAVE RECEIVER.

(9) Harold Lunt, of Pittsburgh, Pa., sends the following:

Q. 1. Please advise me as to which long and short wave receiver is the best for general use, the one described by Mr. Spon in the March issue of RADIO NEWS, or the one by Mr. Lynch, or else the one by Mr. Shalkhauser, in the April issue?

A. 1. The first two sets you mention are somewhat alike in design, except that the second has three steps of amplification instead of two as in the first one. For all-around work, the second one will, of course, give the best results for the reason mentioned. This apparatus is manufactured by A. H. Grebe & Co., 72 Van Wyck Boulevard, Richmond Hill, N. Y.

### AUDIBILITY INCREASED.

(10) Robert H. Rose, of Lanham, Md.  
(Continued on page 68)



# MURDOCK

## THE LATEST VARIOMETER No. 345 VARIOCOUPLER No. 346



No. 345 Variometer

**\$7.50**

- No. 345-P Variometer, complete as illustrated with panel, knob and dial and panel mounting brackets.....\$7.50
- No. 345-G Variometer, complete as illustrated with panel, knob and dial and panel mounting brackets.....\$7.50
- No. 345-P or 345-G Variometers without knob and dial.....\$6.75
- No. 346 Variocoupler, as illustrated with panel, knob, dial, and panel mounting brackets and back connected tap off switch.....\$8.50
- No. 346 Variocoupler without knob or dial.....\$7.75

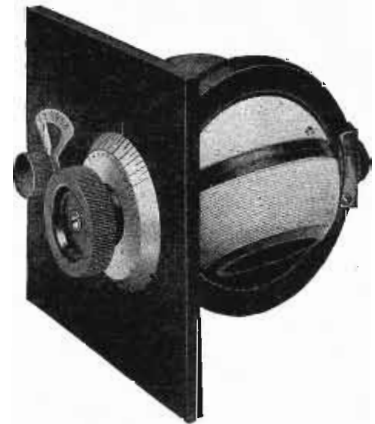

No. 346 Variocoupler

**\$8.50**

WINDING FORMS ARE  
"MURDOCK MOULDED"

"THE PRICE IS UNUSUALLY LOW,  
THE QUALITY IS  
REMARKABLY HIGH"

SEE THEM AT YOUR DEALERS

### MURDOCK No. 55 RADIO RECEIVERS



**2000  
OHM  
DOUBLE SET  
\$4.50**

**3000  
OHM  
DOUBLE SET  
\$5.50**

### MURDOCK Variable Condensers

- No. 366—43 plate .001 mfd. with oil containing case.....\$4.75
- No. 367—43 plate .001 mfd.....4.50
- No. 368—23 plate .0005 mfd.....4.00

#### PANEL MOUNT TYPES

- No. 3660—43 plate .001 mfd.....\$4.00
- No. 3661—43 plate .001 mfd.....4.25
- No. 3662—43 plate .001 mfd.....5.00
- No. 3680—23 plate .0005 mfd.....3.25
- No. 3681—23 plate .0005 mfd.....3.50
- No. 3682—23 plate .0005 mfd.....4.25

### MURDOCK Variable Condensers

"PERFECT SATISFACTION GUARANTEED OR YOUR MONEY BACK"

BUY THEM FROM YOUR DEALER

SEND FOR BULLETIN No. 20

**WM. J. MURDOCK CO.** 50 CARTER STREET  
CHELSEA, MASS.

509 MISSION STREET, SAN FRANCISCO, CALIF.

**MEMORIZE WIRELESS CODE IN ONE HOUR**

**BEGINNERS HAVE REPORTED MASTERED CODE IN 30 MINUTES. IN 45 MINUTES. IN ONE HOUR, ONE EVENING. ETC., ETC.**

Dear Sir:—Was busy putting up set and did not really study your chart until one week before examination. With a few nights practice after having mastered Code was able to pass Government Examination with little effort. Your method is sure some easy way to learn that sticker—Continental Code. Earl Cassell Grafton, West Va. Call 8BCR 45 Lincoln St.

Dear Sir:—Think your short cut Continental Code Chart a wonder. Learned half the Code in fifteen minutes. Attention to wireless limited by High School studies. \* \* \* My success due almost entirely to your method. Call 2A0I. William A. Oetler, Woodhaven, N. Y., 840 Woodland Ave.

Worthless methods are advertised as best, easiest, quickest and other enticing titles. To avoid disappointment purchase no Code Memorizing Chart, Card or Device until satisfied by statement from actual user that same has proven efficient in use as well as in theory.

**INVESTIGATE**

**DODGE ONE DOLLAR RADIO SHORT CUT TEACHES WITHOUT INSTRUMENTS**

**C. K. DODGE**

Box 200 MAMARONECK, N. Y.

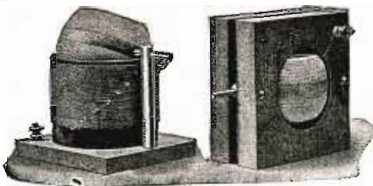

**Variometers Couplers \$3.75 each**

These instruments embody finest workmanship and best materials, all wooden parts genuine mahogany, coupler primary wound on formica tubing. Metal parts of brass. Wound for maximum results on short wave work. Money back if they fail. With Chelsea Dial \$1 extra.

Send for Bulletin Describing Unwired Regenerators

**FREDERICK WINKLER, JR.**  
304 Columbus Ave., New York City, N. Y.

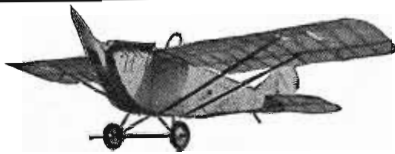

**Build Model Planes**

Wading River models are exact scale reproductions of real planes, that's why they fly. You can't go wrong with Wading River plans and parts. Send 10 cents for new 56 page catalogue, showing 26 different models that you can easily build.

**WADING RIVER MFG. CO.**

Dept H, 672 Broadway, Brooklyn, N. Y.

**RADIO KITES**

Tested and recommended by MR. A. H. GREBE personally  
Price each \$4.00

**R. N. SEYFANG** 1465 BROADWAY NEW YORK CITY

**Regular Transmissions of European Wireless Stations**

Time E. S.	Station.	Call letters.	Wave-length.	System.	Remarks.
Midnight	Nauen	POZ	12,600	C.W.	Calls Annapolis NSS.
Midnight	Rome	IDO	11,000	C.W.	Working with BUC.
Midnight	Lyons	YN	15,000	C.W.	Working with WII.
Midnight to	Devizes	GKU	2,100	C.W.	Marine traffic.
0:30	Sofia	FF	3,800	Spark	Meteorological message.
0:30	Azores	BWP	4,000	C.W.	
0:30	Paris	FL	8,000	C.W.	Working with WAR.
1:05	Azores	BWP	4,000	C.W.	
1:30	Bucharest	BNS	4,000	Spark	Meteorological message.
2:00	Bordeaux	LY	23,450	C.W.	Working with HZH (Brazzaville).
2:00	Nauen	POZ	12,600	C.W.	Calls FL.
2:30	Paris	FL	8,000	C.W.	Reply to POZ.
2:30	Azores	BWP	4,000	C.W.	
2:30	Paris	FL	6,500	C.W.	Working to AFB.
2:30	Nantes	UA	9,000	C.W.	Calls FRI (general call to French war vessels).
2:35	Air Ministry	GFA	16,800	C.W.	Meteorological message.
2:50	Lengby	OXE	5,000	C.W.	Danish meteorological message.
3:00	Eilvese	OUI	9,600	C.W.	
3:00	Nantes	UA	2,800	Spark	Navigation warnings.
3:05	Air Ministry	GFA	1,400	C.W.	Meteorological message.
3:15	Paris	FL	2,600	Spark	Meteorological message.
3:30	Azores	BWP	4,000	C.W.	
3:30	Aberdeen	BYD	3,300	C.W.	Meteorological message.
3:30	Lyons	YN	15,100	C.W.	Service to Central Africa.
3:40	Warsaw	WAR	2,100	Spark	Meteorological message.
3:45	Air Ministry	GFA	1,680	C.W.	Calibration waves.
3:45	Christiania	LCH	8,000	C.W.	Meteorological message.
3:50	Christiania	ZM	1,680	C.W.	Meteorological message.
3:58	Lyons	YN	15,100	C.W.	Time signals.
4:00	Bordeaux	LY	23,450	C.W.	Working to WII.
4:00	Sofia	FF	3,800	Spark	Meteorological message.
4:00	Malta	BYZ	4,200	C.W.	Meteorological message.
4:00 to	Devizes	GKU	2,100	C.W.	Marine traffic.
4:30	Nauen	POZ	3,900	Spark	Meteorological message.
4:00	Air Ministry	GFA	1,400	C.W.	Calibration waves.
4:04	Lyons	YN	15,100	C.W.	Service with FRU.
4:05	Air Ministry	GFA	900	C.W.	Calibration waves.
4:05	Paris	FL	6,500	C.W.	Press in German for OHD.
4:10	Air Ministry	GFA	1,300	C.W.	Calibration waves.
4:15	Air Ministry	GFA	1,400	C.W.	Meteorological message (general report in plain language).
4:20	Prague	PRG	4,100	C.W.	Meteorological message.
4:30	Azores	BWP	4,000	C.W.	
4:30	Poldhu	MPD	2,800	Spark	Admiralty meteorological.
4:30	Rome	IDO	1,100	C.W.	Meteorological message.
4:30	Rome	ICD	2,200	Spark	
4:35	Air Ministry	GFA	1,680	C.W.	Meteorological message.
4:53	Paris	FL	2,600	Spark	International time signals.
5:00	Vienna	OHD	5,600	C.W.	Spanish meteorological bulletin.
5:00	Madrid	EGC	1,600	C.W.	Working with BUC.
5:00	Nantes	UA	6,700	C.W.	Working with PRG.
5:03	Paris	FL	6,500	C.W.	Working is irregular.
5:20	Amsterdam	STB	1,680	C.W.	
5:30	Azores	BWP	4,000	C.W.	Meteorological message (aviation).
5:35	Air Ministry	GFA	1,680	C.W.	
5:30	Budapest	HB	3,100		
5:30	Paris	FL	2,600	Spark	Astronomical time signals.
5:44	Paris	FL	2,600	Spark	Time signals (old system).
5:50	Paris	FL	2,600	Spark	Times for 1030 signals.
6:00	Paris	FL	3,200	Spark	French press.
6:00	Prague	PRG	4,100	C.W.	Calls, Annapolis NSS.
6:15	Scheveningen Haven	PCH	1,800	Spark	Dutch meteorological message.
6:30	Azores	BWP	4,000	C.W.	
6:30	Paris	FL	2,600	Spark	French meteorological message.
6:35	Air Ministry	GFA	1,680	C.W.	Meteorological message (aviation).
6:45	Paris	FL	8,000	C.W.	
6:55	Nauen	POZ	3,900	Spark	Time signals and telegram, Karl, Fritz, etc.
7:00	Norddeich	KAV	600	Spark	Meteorological message (or at 1700 if not sent at 1200).
7:00	Paris	YA	1,950	C.W.	
7:00	Horsea	BYC	6,000	C.W.	Press in English.
7:00	Prague	PRG	4,700	C.W.	Press in French.
7:05	Paris	FL	6,500	C.W.	Working with HB.
7:20	Nauen	POZ	9,400	C.W.	Press in German repeated on 4,700 meters (chopped C.W.).
7:30 to	Königswusterhausen	LP	4,000	C.W.	Telephony.
8:00	Lyons	YN	15,100	C.W.	Press in English for NSS.
7:30	Azores	BWP	4,000	C.W.	
8:00	Devizes	GKU	2,100	C.W.	Marine traffic.





# The Recognized Symbol of Superior Performance

**Ideal  
Long Wave  
Receiver**



L. W. Tuner  
\$30.00



S. W. Variometer  
\$14.50



S. W. Coupler  
\$17.50



**Long Distance  
With  
One Adjustment**



VT 1 Stage Amplifier  
\$21.00



B Battery Box  
\$9.85

## "LISTENING IN" ON THE WORLD'S NEWS

With the NEW AMRAD LONG WAVE TUNER you can hear the news from France, Germany, Italy, the Arlington time signals, and other flashes from far distant stations.

The wavelength range is from 2,000 to 20,000 meters with a 60-foot antenna. The popular honeycomb or lattice-wound coils are employed in this Tuner. But these are thrown into circuit by means of plugs, **THUS GREATLY SIMPLIFYING OPERATION.** Formerly, it was necessary to change coils for nearly every desired wavelength. Now, you simply "plug in," like a telephone operator, for whatever wavelength you wish to work.

THE NEW AMRAD LONG WAVE TUNER is regularly used with two Amrad Variable Condensers of .001 mfd. capacity and one Amrad VT Detector-Amplifier. Several other effective combinations are of course quite possible. To effect permanent economy and highest efficiency, as well as to preserve symmetrical appearance, these additional items should be Amrad units, although other short wave sets will work well with the Amrad instrument.

**LONG DISTANCE WORK WITH A SINGLE ADJUSTMENT!** *Think of it!*

*Write us for complete details in Bulletin L sent free. Complete Amrad catalog 10c.*



2-Stage Amplifier  
\$39.50



VT Detector  
\$15.00

# AMERICAN RADIO AND RESEARCH CORPORATION

203 College Avenue

Medford Hillside, Massachusetts

(4 miles north of Boston)





# "ATLANTIC RADIO"

# JULY BULLETIN

Have YOU Received  
particulars of the  
new  
**DE FOREST**  
"INTERPANEL"  
EQUIPMENT?

Special bulletin on request.

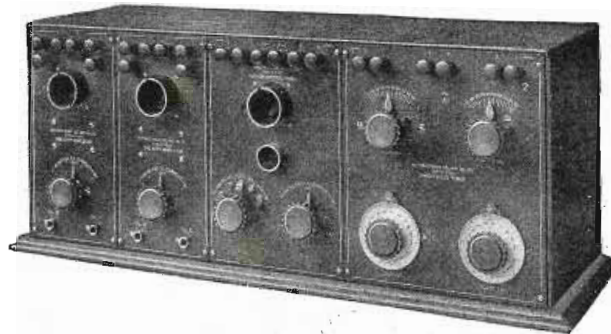

A new idea in Radio Telephone Transmitting and Receiving Apparatus. Panels are all 9 inches high, varying widths. Designed for placing side by side with binding posts in line for convenience in wiring. Adaptable to any operating requirement,—short or long wave reception,—telephone transmission,—one or two stage amplification,—etc., etc. Panels supplied with or without cabinets.



**De Forest Hand Microphone**

Furnished with cord and terminals for connection to binding posts.

Price \$6.00  
Ship. Wt. 5 lbs.

### The Dubilier Universal Condenser

May be used in audio and Radio frequency circuits, for receiving equipment, self-rectifying circuits, direct current transmitters and other tube transmitters up to 100 watts.

No. 301.....	1000 Volts.....	.0005 mfd.
No. 303.....	1000 Volts.....	.001 mfd.
No. 305.....	1000 Volts.....	.002 mfd.
No. 307.....	1000 Volts.....	.005 mfd.

\$2.00

Shipping Wt. 1 lb.

### A New Amplifying Transformer.—G. R. 231A

Are you getting the most out of your tube? A complete amplifier is more than a mere assembly of parts. It consists first of the selection of units of correct electrical characteristics. An amplifying transformer must be more than a coil of wire and a core. It must have incorporated in it the results of engineering skill. Type 231A amplifying transformer is designed specifically for the new Radiotron tubes. The design is right, the appearance is right and the price is right.

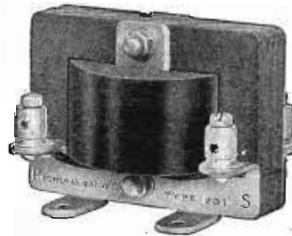

Price completely mounted, \$5.00  
Shipping weight 1 lb.

### Transmitting Tube Rheostat



The new five watt Radiotron tubes require a filament current of 2.95 amperes. Type 214A is a 2-ohm transmitting tube rheostat which will carry 2.5 amperes. This resistance is sufficient to regulate the new tubes on as high as a 12 volt supply source. This rheostat does not run hot and may accordingly be mounted inside of enclosed transmitting cabinets where space is often very limited. Like the G. R. receiving tube rheostats and grid biasing potentiometers, it is made in two styles, 214A for back of panel mounting and 214B for surface mounting.

Price \$2.50

Shipping weight 1 lb.

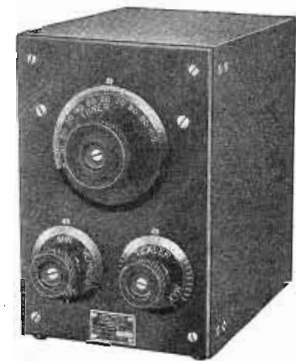

### Westinghouse Radio Equipment

Westinghouse Radio Equipment embodies the latest ideas in receiving equipment, providing a most efficient set for telegraph and telephone reception over the amateur and normal ship wave-length ranges.

Type R. A. Short Wave tuner, Style 307189, responds to a wave-length of 180 to 700 meters and is especially selective.

Type D. A. detector-amplifier, style 307190, combines a vacuum tube detector with a two-stage amplifier. Both units are mounted on Micarta panels attached to a polished mahogany cabinet. Simple in design—easy to operate—single-tuning circuit. Highly efficient.

Type R. A. Tuner.....	\$65.00
Type D. A. Detector Amplifier.....	65.00
Type R. C. (Combination of above mounted in single cabinet).....	125.00

## NOW READY The Radio Corporation's Model U. V. 712

Inter-tone frequency amplifying transformer

Specially designed for use with Radiotrons, U.V. 200 and U.V. 201.

Send for literature and price list on the R. C.'s complete line of V.T.s and accessories.

Price \$7.00

### General Radio "A" Battery Potentiometer

Similar in appearance to Type 214A, but wound to a resistance of 400 ohms. Price \$4.00. (Shipping weight 1 lb.)

**SPECIAL** Just a few Roller-Smith Type T-A-W Hot Wire Ammeters, (0-1, 0-2.5, and 0-5 amps) still offered at the remarkable price of \$3.00 each.



### New Patent Universal Plug

New Patent Universal Plug consists of three parts, two moulded Bakelite pieces, each with a recessed finger grip, and the plug with it connecting spring clip. The two Bakelite pieces are held together with a screw that fits into a threaded brass insert. This screw is "dead" electrically, a necessary precaution when the plug is used with high potentials or extreme high amplification. The plug may be used

to "plug" in a telephone headset, a Microphone transmitter, a manipulating key, a loading inductance, a plate battery, etc. In fact its adaptability renders its name synonymous with its uses.

Price \$2.00

Shipping Wt. 1 lb.

# ATLANTIC RADIO COMPANY, Inc.

88 Broad Street  
Boston 9, Mass.

REQUEST "BULLETIN 14"

Branch: 15 Temple St.  
Portland, Me.

# ACME C. W. APPARATUS

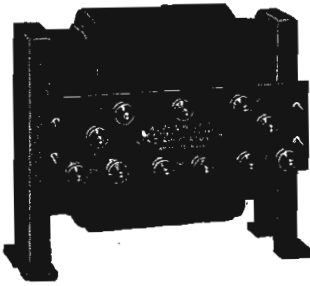

C.W. Power Transformer

## C. W. Power Transformer

For use with rectifying devices or for A. C. directly on the plates of power tubes.

SPECIFICATIONS 110 volts 60 cycles				
Out-put	Filament voltage	Filament current	Plate voltage	Plate current
50	10	2.5	350	100
		Two filament windings		
200	12	5	250-550	200
		Two filament windings		
500	0	0	1000-1500	400
		No Filament windings		

## 1½ Henry Choke Coils

For use in ironing out pulsations and for modulating single and double 150 MA and 500 MA capacity.

## Filament Heating Transformers

allow the use of A. C. for power tube filament heating.

SPECIFICATIONS 110 volts 60 cycles		
Output	Secondary voltage	Secondary current
75	8-10	7
150	10-12	13

## Modulation Transformers

give maximum modulation without distortion.

**"The Apparatus  
with a  
Guarantee"**

*Your Dealer will be glad to  
show these*

*Ask for Bulletins*

**ACME APPARATUS COMPANY, 188 MASSACHUSETTS AVE. CAMBRIDGE 39, MASS**

*Transformer and Radio Engineers and Manufacturers*

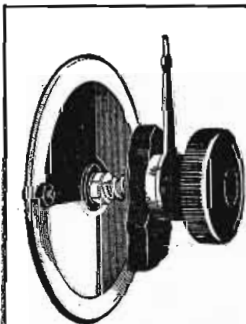

## A New Invention

The Parkin .001 mf Variable Condenser (pat. applied for) fills the long felt want for a rugged, low priced, balanced variable condenser for panel mounting. No plates to bend and short circuit. Cannot get out of order. Has very low minimum capacity. Easily mounted, only one small hole being necessary in the panel. Guarantee: All Parkin Condensers are sold subject to return within five days if not fully satisfactory.

No. 50 .001 mf Unit alone, may be mounted on any shaft, postpaid	\$1.50
No. 51 .001 mf Unit with knob, pointer, etc., as shown, postpaid	2.00
No. 52 .001 mf Unit with knob, etc., and 3-inch black dial, postpaid	2.50

Write for full description of this new invention  
Ask for Catalog No. 5 Dealers: Write for discounts  
**PARKIN MFG. CO., San Rafael, Calif.**

shovel struck a piece of wood which gave forth a hollow sound as he hit it. Instantly all the weariness that he had felt before vanished. He began to dig furiously as if his very life depended on it. In a short time he had uncovered what appeared to be an old sea chest. The wood was fairly sound, but the lock and hinges were so rusted that the cover came off at the least touch. It would be impossible for us to even try to picture Joshua as he bent down to lift off the cover. His face fairly radiated his happiness and his hands trembled.

But instead of a chest filled with Spanish doubloons or gold bars that Joshua had expected, this chest differed in no way from those usually found on old schooners. It contained some money, amounting to twelve dollars, a mariners' compass, sextant, a few articles of clothing, various books, papers, and sundry other articles. Joshua was somewhat disappointed; we don't blame him, but he soon brightened up. For had not he, Joshua Kent, solved by the use of his brain alone, a most mysterious map, and thru the information imparted therein found a valuable treasure? Joshua was somewhat conceited and now his self-esteem knew no bounds. He surely was a brainy man.

He hired a cart and took the chest home late that afternoon. On examining the papers he found that the chest had been on board the "Salvador" when she was wrecked on the point. But how it came where he found it still remained a mystery. He made an effort to find out to whom it formerly belonged, but failing, he kept all he found in the chest himself.

Whenever anyone came to visit Joshua he would take out the little map and recount, not missing the least detail, how he found the treasure. Thus it happened that one Saturday, Joshua buttonholed Kenneth Wells, who worked after school in his store, and taking him into the little office in the rear of the building he began to tell for the hundredth time, how he had found the chest. But imagine his surprise when, upon showing the map to Kenneth, he burst into a fit of laughter, and drawing a little notebook from his pocket he showed Joshua a diagram almost identical to the one showing the "Valuable Treasure." He then explained the former history of the map and how it was only thru pure luck that Joshua had found the chest. There were a million chances to one that Joshua wouldn't find anything. But the one chance had come his way.

Joshua was dumbfounded. To think that after all his work and study and labor it was only luck that had aided him in finding the chest. It was terrible! He hadn't even known enough to know what a simple radio diagram was! He told Kenneth Wells to get out of his sight P. D. Q. and never to show up there again! And the humiliation, the misery that Joshua underwent!! But he resolved that he would never, never be caught as he had been, again. If there were three million radio diagrams he'd find out all about them. Yes, the whole three million of them. Dad blast it!

A month passed, two months. Mysterious rumors concerning Joshua Kent were circulated thru the little town of Crescent Harbor. The best authorities, two old maids, whose chief occupation in life was to pry into everybody's business except their own, had it that Joshua was receiving various packages and letters from "down New York way." They even questioned the postmaster, but to no avail. He could tell them nothing. Finally their curiosity reached such a pitch that they determined to find out the truth, no matter what the consequences. So one evening they crept over to the house in which Joshua lived. They crouched down beside the living room window, but hearing nothing they made so bold as to open one of the shutters just a little, and look in.

**READ the CLASSIFIED ADVERTISEMENTS on PAGES 84-86. YOU'LL FIND MANY GOOD THINGS THERE**



# GENUINE AMPLIFICATION



RADIOTRON U.V. 200  
*The*  
long distance detector  
PRICE \$5<sup>00</sup>

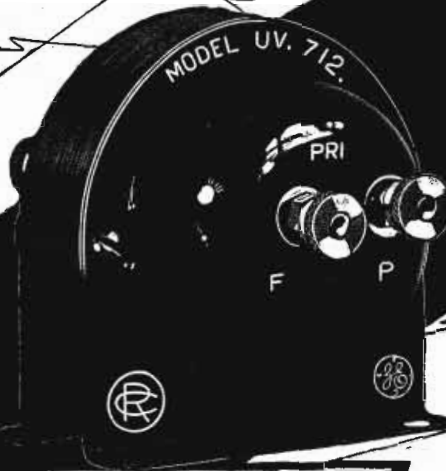

*Introducing*  
Model U.V. 712

RADIOTRON U.V. 201  
*An*  
exceptional amplifier  
PRICE \$6<sup>50</sup>



## *The new inter-tube tone frequency amplifying transformer*

RADIO AMATEURS! The problem of obtaining maximum signals in radio telegraphy is easily worked out.

SOLUTION: Radiotron U.V. 200 + Inter-tube transformer U.V. 712 + Radiotron U.V. 201 = maximum amplification.

Inter-tube transformer U.V. 712 is not a compromise. It was designed to "fit"

Radiotrons by the engineering forces responsible for the development of Radiotrons. Tests prove conclusively its mechanical and electrical superiority. U.V. 712 provides unequalled amplification. Try it!

A descriptive bulletin on transformer U.V. 712 can be obtained from your Dealer or write direct to

The Radio Corporation's tubes are covered by patents dated November 7th, 1905, January 15th, 1907, and February 18th, 1908, as well as by other patents issued and pending. Tubes licensed for amateur and experimental use only. Any other use will constitute an infringement.

SALES DIVISION, COMMERCIAL DEPARTMENT, Suite 1802

# Radio Corporation *of America*

233 BROADWAY - NEW YORK CITY

# REMLER

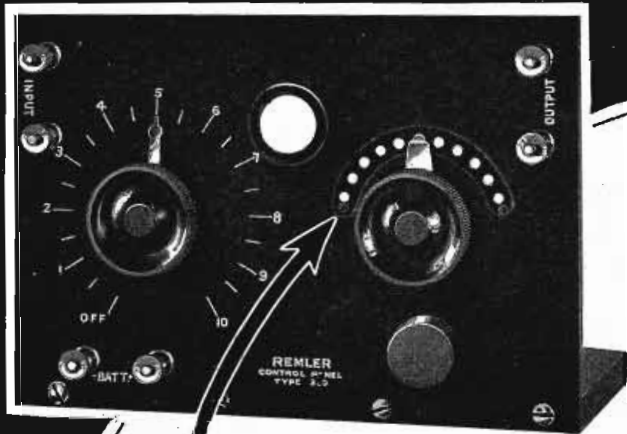

## TYPE 330 PANEL CONTROL DETECTOR Price

**A-Battery Potentiometer**  
*Note the Exclusive Remler Features*

REMLER TYPE 330 PANEL CONTROL is designed to provide a suitable mounting for the standard four-prong base tubes, especially the new gas content detector such as Cunningham Type C 300.

Remler resources have been devoted to making this TYPE 330 PANEL CONTROL, with its exclusive features, the greatest value ever offered. It is truly a quality article at a quantity production price.

The Following Specifications When Compared With Any Other Panel on the Market is Convincing Proof that Remler Excels

The panel is genuine molded bakelite, 5x7¼x3/16 inches. The surface is highly polished glossy black and the lettering and scales are recessed and filled with white enamel.

The filament current is controlled by REMLER No. 810 RHEO-STAT, back mounted, and is provided with an open position. REMLER No. 93 POTENTIOMETER connected across the storage battery provides the close adjustment of plate potential necessary for sensitive detector action. Terminals at the

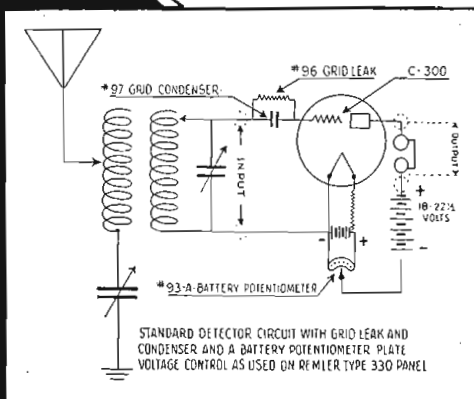

REMLER APPARATUS

## REMLER RADIO

E.T. CUNNINGHAM  
163 SUTTER ST.



# REMLER

330  
PANEL

\$8 00

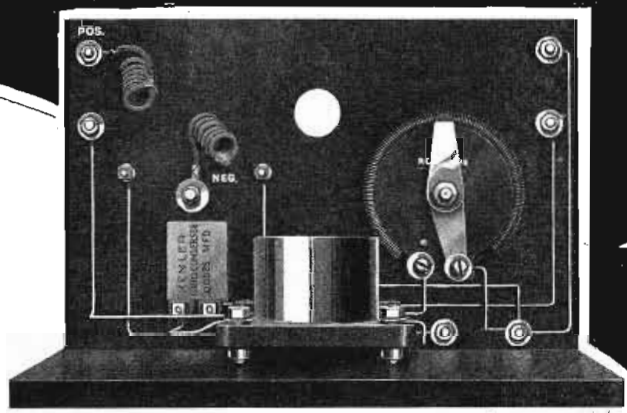

## Plate Voltage Control

*Guarantee with every Remler Product*

Back of the panel are provided with flexible leads for the B Battery connection. The rheostat and potentiometer knobs are polished bakelite,  $1\frac{3}{8}$  in. diameter. The GRID LEAK is variable and grid condenser back mounted is the correct capacity for the new gas content detector tubes. REMLER No. 92 V. T. SOCKET is used and supports the tube vertically, insuring maximum filament life. Its all bakelite construction tends to eliminate induction and ground hums. An orifice in the panel permits a view of the filament. Binding posts and all metal parts are finished in polished nickel. The panel is mounted on a hardwood base  $7\frac{1}{4} \times 3\frac{1}{2}$  inches, finished in black, but can readily be mounted in a cabinet. The wiring is the approved bus bar type, and is laid out so that the input and output terminals are at opposite sides.

Send for Bulletin No. 1002 and 1003 on the Remler Bakelite Detector and Amplifier Panels, Types 330, 331 and 333. Two or more of these panels can be mounted in a cabinet to make any desired detector-amplifier combination.

DEALERS: There is an exclusive and very profitable proposition for you on Remler Apparatus. Write for full particulars.

RADIATES QUALITY

M'F'G COMPANY

GENERAL MANAGER

SAN FRANCISCO

### Remler Guarantee

The value of any guarantee is not in the wording, but in the policy back of it. My policy (Audiotron) known since 1915—that the customer is always right—is your absolute guarantee of a square deal. Remler Apparatus is fully guaranteed and any item can be returned for exchange or, if you wish, your money will be refunded in full.

*E. J. Cunningham*

# SHRAMCO REO

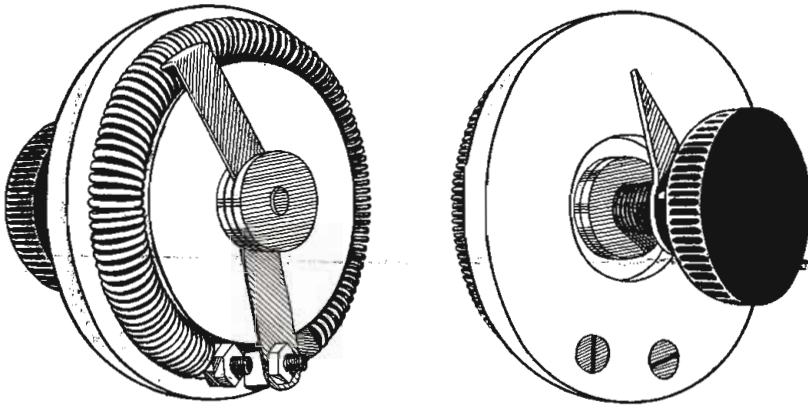

## for your power tube—

New type Shramco Reo, No. 90P. 1.5 ohm  
Nichrome resistance. Current capacity  
6 amperes. Price \$2.00, 1 lb. postage.

A BACK MOUNTED panel rheostat, specially designed for the Radiotron U.V. 202 and other transmitting tubes. Resistance element (1.5 ohm) is "Nichrome" wire, mounted on a solid block of asbestos. Allows unusually accurate and delicate variation of the filament current. All metal parts

brass. Spring phosphor bronze blade. Base 3". Overall height 2½". Handsomely finished and accompanied by an unconditional guarantee of complete satisfaction. Get the most out of your expensive power tube by using a good rheostat. Order a Shramco Reo today! Now ready for immediate shipment.

## for your VT detector—

and amplifier, use the original Shramco Reo type 90. Similar to the power tube type, but with a "Nichrome" resistance of 6 ohms. Price \$2.00, plus postage for two lbs. Also available—"Midget" type 90A, same construction, but a 5 ohm resistance and 2¼" base.

## SHOTTON RADIO MFG. CO., INC.

P. O. Box 3, Scranton, Pennsylvania

Catalogue "K", listing a complete line of high grade parts at reasonable prices, sent to any reader of Radio News for five cents in stamps.

# RADIO DEALERS

You take no chances in placing your orders with KLAUS RADIO. The Klaus line embraces the most advanced designs in all wireless equipment.

Let us send you our Sales Proposition and Trade Bulletin

KLAUS RADIO CO.

Eureka, Illinois

Get a Handy Binder for your RADIO NEWS. Holds and preserves twelve issues, each of which can be inserted or removed at will. Price 66c. Experimenter Pub. Co., Inc., Book Dept., 238-A Fulton St., New York.

On a table in one corner of the room was the most amazing collection of mechanical devices that they had ever seen. Joshua Kent and Kenneth Wells were seated beside the table and each had a peculiar contrivance on his head. It consisted of two little black discs connected by a wire band. And on the table, what could it be?

There were various dials and metal cases and boxes with black fronts covered with knobs and lettering, and on top of one of these boxes, three little lamps blinked reassuringly.

Down in New York a radio telephone concert was being given. Up on the coast in a village called Crescent Harbor a little old man who wore gold-rimmed spectacles and who was very bald was listening to it. Slowly a smile made its way across his face. It spread and spread until it reached from ear to ear.

Joshua Kent had a hobby. It was radio.

## A New Automatic Recorder

(Continued from page 9)

produced by this wonderful piece of mechanism. The recording apparatus employed is a chronograf on the pen, thus establishing the uniform practice of reading from right to left.

The device is portable, and can be readily transported on the back seat of a touring car. Furthermore, when connected to an improvised antenna, it can be operated from an automobile. For illustration, the resonance wave coil, described in the May issue of RADIO NEWS—whereby a complete antenna might take the form of a walking cane or thermometer—would serve admirably as a companion piece of radio equipment to the automatic recorder. As a field instrument, the Eckhardt-Karcher invention will undoubtedly prove its usefulness in recording radio time-signals in the unfrequented places explored by the Coast and Geodesic Survey of the United States Department of Commerce. It will be given a practical demonstration this summer.

Its serviceableness at radio-receiving station of wireless messages will doubtless be established in the not remote future. Not establish in the not remote future. Not unlike all mechanical means for recording radio signals, the Eckhardt-Karcher progeny recognizes static and "strays" as well as well-ordered signals. Possibly this inherent weakness may be surmounted by modifications not yet divulged to the science of wireless communication. Then, too, there is a school of thought which is partial to the human ear as the most feasible method of recording radio signals. The claim is made, however, for the apparatus described in this article, that it is a selective agent and as such will faithfully reproduce messages conveyed by electric waves—even from the uttermost ends of the earth. Certainly, the Eckhardt-Karcher creation is a notable contribution, and one whose practical usefulness will abundantly justify for it a place of enduring recognition among scientific achievements.

## Club Gossip

(Continued from page 35)

Germany; Lyons, France, and others. We are building a meeting place of our own where we will formally open our station. S. Cristiano, Secretary.

## TRIANGLE RADIO SOCIETY

The Triangle Radio Society, of Rochester, N. Y., held a business meeting at the home of C. Heisler, No. 194 North Union St., recently. Various committees gave reports. After the meeting a key and buzzer were loaned by C. Heisler and G. Hall.





No. 766 Eveready Wireless Station Battery. Standardized for use in U. S. Navy



No. 763 Eveready Airplane Wireless Battery. Standardized for use in U. S. Signal Corps Aviation Section

# For your wireless receiving set

—these distinctive features of the Eveready Wireless B Battery have established its superiority. You'll find it the ideal battery for your receiving set.

Long Life

Perfect Insulation

Noiseless Operation

High Voltage Maintenance

Sold by radio equipment dealers everywhere—name of dealer in your locality furnished on request.

AMERICAN EVEREADY WORKS  
of National Carbon Company, Inc.

226 Thompson Avenue, Long Island City, New York  
Chicago Atlanta San Francisco



Every Wireless Operator Has Use for an Eveready Flashlight

# EVEREADY

VACUUM TUBE BATTERIES  
FLASHLIGHTS AND BATTERIES



**EASTERN  
RADIO**

TEL.  
BACK BAY  
5 9 6 4

**INSTITUTE**

899 BOYLSTON ST.  
BOSTON, MASS.



## SUMMER CLASSES!

This year the EASTERN RADIO INSTITUTE will conduct their SUMMER CLASSES as usual. New students may begin to advantage in the DAY or EVENING school on any Monday. Special effort will be made to give every possible assistance to those desiring to accomplish the work during the Summer months and in this respect our DAY school offers unusual advantages.

For the last few months we have been telling you of the "RESULTS" accomplished by the EASTERN RADIO INSTITUTE. This month we want to tell you of its "ADVANTAGES."

### "RELIABILITY"

Founded in 1913.  
Ninth Successful Year.

### "FACULTY"

All Experienced Radio Men.  
Each Instructor a Specialist in his Department.

### "EQUIPMENT"

Latest Spark, Arc, and Wireless Telephone Sets.  
Only School in New England with "Federal Arc Transmitter."

### "INSTRUCTION"

The most Systematic, Comprehensive and BEST Radio Course of Any School in the East.  
Only School in New England giving "Arc" Instruction upon Actual Apparatus.

### "POSITIONS"

Successful graduates of the EASTERN RADIO INSTITUTE are found in responsible radio positions all over the World—Radio Inspectors, Superintendents, Shipping Board Radio Supervisors, Engineers, etc.

### "SERVICE"

Remember—Our Organization with over EIGHT years of Continued RESULTS and SUCCESS is behind every student who enrolls. If you want to become a Commercial Radio Operator let us train you.  
Just join our SUMMER CLASSES!

Our latest illustrated prospectus is free. If you cannot visit the Institute send for one.

F. D. PITTS, Director

## The Efficient Design of V. T. Telegraf and Telephone Sets

(Continued from page 23)

resonance and therefore is also a resistance, half the energy is consumed in the valve and the other half in the output circuit, thus giving an efficiency of 50 per cent.

Thus the problem of designing our circuit for maximum output reduces itself to apportioning the constants of the output circuit so that its effective resistance is the same as that of the valve. The following analysis will show how this is accomplished and what the relation must be between the various constants for this result.

Consider the circuit in Fig. 8, which is the output circuit of our set, when the plate inductance equals the total circuit inductance (neglecting the antenna inductance as negligible for the time being). This entire circuit is seen in Fig. 3.  $L$  and  $r$ , are the inductance and resistance of the coil,  $C$  and  $R$ , the capacity and resistance of the antenna. The r. f. voltage is impressed between points  $A$  and  $B$ , at the working wave-length corresponding to  $\omega$ , let us say 600 meters. The impedance of this circuit is given by  $Z$ :

$$Z = \frac{I}{\frac{I}{r + j\omega L} + \frac{I}{R + \frac{I}{j\omega C}}}$$

$$Z = \frac{I}{\frac{I}{r + j\omega L} + \frac{j\omega C}{j\omega CR + I}}$$

$$= \frac{I - \omega^2 LC + j\omega CR + j\omega Cr}{(r - \omega^2 LCR) + j\omega(L + CR)}$$

(Eq. A.)

In discussing this equation we will discuss for a moment, and consider the case where  $R = 0$ , and  $r = 0$ . Then

$$Z = \frac{j\omega L}{1 - \omega^2 LC}$$

$$\text{if } \omega = \frac{1}{\sqrt{LC}},$$

$$\therefore Z = \frac{j\omega L}{0} = \infty$$

Thus the impedance of this circuit to currents of its natural frequency is infinite. If the more practical case is considered where  $R = 0$  (loss-free condenser) and  $r$  the coil resistance is very small compared to the coil reactance, then the impedance, altho not infinite, is very great at its natural frequency. Thus this circuit would act as an extremely efficient choke coil to currents of its own frequency.  $C$  need not be a concentrated capacity, but may be the distributed capacity of a coil. This analysis is the basis of the discussion above under the sub-heading "Radio Choke."

Now let us go back to our equation "A" and consider the circuit as an oscillating r. f. circuit.

$C$  is the antenna capacity, say 0.0008 mf.  
 $R$  is the antenna resistance, say 6 ohms at 600 meters.

$L$  is the loading inductance and plate tap.  
 $r$  is the coil resistance, say about 5 ohms at 600 meters.

The circuit is tuned to the working wave-length 600 meters.

## Quality Radio Equipment

### New Grebe Portable Radio Station Type KT-1

Especially Adaptable and Efficient for  
Boy Scouts, Campers and Tourists

Absolutely the newest and neatest combination Transmitting and Receiving Portable Outfit on the market. Complete with Grebe CR 5 Receiver, Transmitter, Vacuum Tubes, Batteries and Head Set in attractive and durable case.

**\$175.00 Complete**

Full line of Radiotron Vacuum Tubes and Accessories and other Highest Grade Radio Supplies.

Dealer's Special Proposition—Mail orders promptly filled

**DOUBLEDAY-HILL ELECTRIC CO.**

715 Twelfth St., N. W., Washington, D. C.

Radio Dept.—Desk B

719-21 Liberty Ave., Pittsburgh, Pa.

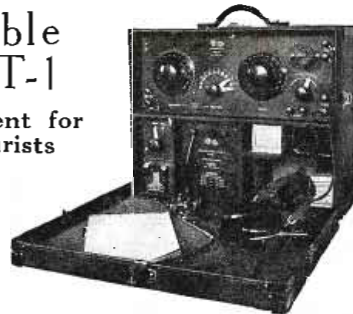



# Five Hundred Opportunities For Profit and Distinction

By HENRY WOODHOUSE

## May Lead YOU To Success

In this work Mr. Woodhouse, who unaided achieved financial independence and international prominence and distinction before thirty-five, and has assisted hundreds of men and women to "get into something worth while" discusses the subjects and answers the queries defined by the following chapterheads:

*Five Hundred Important Professions, Industries, Branches of Science and Vocations Affording Opportunities to Men and Women to Earn Substantial Incomes and Distinction.*

*What Can I Do That's Worth While?*

*How Do I Get Into Something Worth While?*

*A Dozen Billion Dollar Industries Still Growing in Leaps, Affording Hundreds of Stupendous Opportunities.*

*Inventions, Discoveries and Activities That Created Billion Dollar Industries.*

*Billion Dollar Industries To Be.*

*Why One Billion Dollar Oil Dividends Have Been Paid in a Decade, Though Striking Oil Was Considered Disastrous Less Than a Century Ago.*

*Why the Production in Steel in U. S. Grew from 4,901,000 Tons in 1900 to Close to 40,000,000 Tons in 1920.*

*How the Automobiles in Use Increased from 5,000 in 1899 to 8,000,000 in 1921.*

*Mineralogy as a Business—Over \$5,000,000,000 Minerals Produced in U. S. Last Year!*

*How U. S. Railroads Grew from An Experiment To a Twenty Billion Dollar Industry in Less Than a Century—And Firemen Have Become Presidents of Railroads!*

*Why Electric Railways, a Wild Dream Forty Years Ago, Bring \$1,000,000,000 Yearly Revenue.*

*Opportunities in Shipbuilding and Ship Equipment.*

*How It Is Possible to Create Opportunities for Leadership Even in the \$10,000,000,000 Insurance Business.*

*Opportunities in the Ten Billion Dollar Expansion To Take Place in Public Utilities.*

*Opportunities in the Billion Dollar Telephone and Telegraph Industry.*

*New Branches of Human Endeavor Affording Substantial Ground Floor Opportunities.*

*Why Aeronautics Offers Stupendous Opportunities for Pioneering.*

*Alluring Chemical Business in Infant Stage.*

*Why Radio Will Become a Billion Dollar Business.*

*Fortunes in Minimizing Friction That Wastes Billions.*

*Who Will Produce Substitutes for Wood Pulp?*

*Can You Think of Something That Will Minimize Fire Losses Which Cost the U. S. \$500,000,000 a year?*

*21,000,000 Homes in U. S. Are the Market for Certain Products.*

*Edison's Thousand Keys to Success.*

*Why Anybody Can Be Made by Circumstances, But Circumstances Alone Won't Keep Him Made for Any Length of Time*

*How to Learn to Run Your Affairs So the World Can't Kick You Around.*

*How to Analyze Your Ambitions.*

*The Secret of Making the Person "Higher Up" Want You.*

*How To Get On Top of Your Own Life.*

*How I Learned Impromptu Public Speaking.*

*How I Learned To Write for the Big Magazine At From Five To Ten Cents a Word.*

*How to Avoid Becoming: Executive Flunking on Dictation and Systems, Public Men Flunking on Public Speaking, Guardians Unfit for Guardianship, Receivers Unfit for Receiverships, Bookkeepers Who Can't Keep Books, and Assistants Who Don't Assist.*

SEND \$2.00 FOR A COPY OF THIS HELPFUL WORK TO

**THE SCIENTIFIC AGE CORPORATION**  
299 MADISON AVENUE  
NEW YORK CITY

# ESCO

**GENERATORS—MOTOR-GENERATORS—DYNAMOTORS**

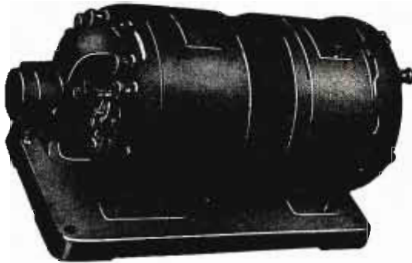

4 to 32 Volts for Filament  
350 to 2000 Volts for Plate

Capacity  
20 to 2000 Watts

**Liberal Ratings**

Write for Bulletin 231  
which lists  
200 Combinations

**Motors and Generators Developed and Built for  
Special Purposes**

**PIONEERS IN THE MANUFACTURE  
of  
HIGH VOLTAGE DIRECT CURRENT  
RADIO GENERATORS**

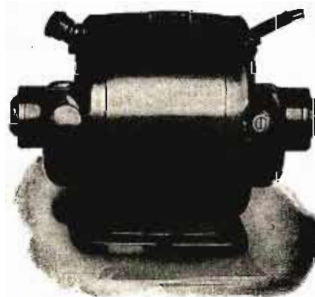

**ELECTRIC SPECIALTY CO.**

**STAMFORD, CONN., U. S. A.**  
211 SOUTH STREET



Type 156 Socket

## REBUILDING YOUR SET FOR RESULTS

Summer is the season in which to rebuild your set so that you may get the maximum of results during next winter. By rebuilding your set now, you will have more time in which to look over all of the available radio apparatus and to make a careful selection of those instruments most suited to your needs.

We have several instruments built particularly for the discriminating experimenter. In making your selection we invite you to consider these instruments. They are fully described in Bulletin 904N, copy of which will be sent on request. Prominent among these instruments are the following:

**TYPE 156 VACUUM TUBE SOCKET . . . \$1.75**

Adapted for receiving or transmitting tubes. Positive contact springs.

**TYPE 214 RHEOSTAT . . . \$2.50**

Made for receiving and transmitting tubes, and panel and portable mountings.

**TYPE 231A AMPLIFYING TRANSFORMER, \$5.00**

Designed to give the maximum amplification possible with a UV201 tube.

**TYPE 231M MODULATION TRANSFORMER, \$5.00**

Designed to give the maximum modulation possible without distortion, using a UV202 tube.

**TYPE 127 HOT WIRE METERS, . . . \$7.75**

Flush or front of board mountings, and a variety of ranges. For filament and antenna currents.



Type 231 Transformer

Your dealer can obtain a complete supply of the standard parts, such as switches, binding posts, etc., used in the assembly of our instruments.

**STANDARDIZE ON  
GENERAL RADIO EQUIPMENT  
THROUGHOUT**

**GENERAL RADIO COMPANY**  
Massachusetts Ave. and Windsor St.,  
Cambridge, 39 Massachusetts

The following assumptions may be legitimately made:

$r$  is very much smaller than  $\omega L$ ,  $r \ll \infty L$

and since  $\omega L = \frac{I}{\omega C}$  (tune circuit)

$r$  is very much smaller than  $\frac{I}{\omega C}$ ,  $r \ll \frac{I}{\omega C}$

$\therefore \omega CR \ll 1$ , i. e.  $\omega CR$  is negligible; also  $R$  is very much smaller than  $\omega L$ .

By simplifying equation "A" and using these assumptions, the impedance of this oscillating circuit turns out to be

$$Z = \frac{\omega L}{\omega CR} = \frac{L}{CR} = \frac{I}{R\omega^2 C^2} \text{ (Eq. B)}$$

There are no terms containing the factor "j," thus this expression is in the nature of a resistance, and we may call it the "effective resistance" of the oscillating circuit, and denote it by the expression  $R_{eff}$ .

$$R_{eff} = \frac{L}{CR} = \frac{I}{\omega^2 RC^2}$$

For maximum output in this circuit, therefore, the value of  $R_{eff}$  will have to equal the value of the valve resistance, and the circuit designed so that the constants give this value for  $R_{eff}$ .

$$R_{valve} = R_{eff} = \frac{L}{CR} \quad (1)$$

$$R_{valve} = R_{eff} = \frac{I}{R\omega^2 C^2} \quad (2)$$

With these two equations, since  $\omega$ ,  $R$  and  $R_{valve}$  are known we can determine the required values for  $L$  and  $C$  to obtain maximum output.

Now the value of  $C$  thus obtained may be smaller or larger than the actual antenna capacity. If smaller, a series condenser may be used to adjust this antenna capacity to the required value. If larger, a readjustment would have to be made in the required valves, which would alter the effective resistance of the circuit and result in a reduction in output. In either case a redesign is preferable in the manner shown below.

The use of the entire loading inductance, as the plate tap, makes this a very inflexible circuit, requiring readjustments of values of  $C$  and  $L$ , which is difficult. It will generally be found that the value of  $R_{eff}$  with a given value of wave-length, and antenna capacity and resistance will be much higher than the value of  $R_{valve}$ , and the simplest way of overcoming this difficulty is to use a portion of the loading inductance as the plate tap.

In the case cited, the value of  $R_{eff}$  is as follows:

$$R_{eff} = \frac{I}{R\omega^2 C^2} = \frac{I}{(6) \times (2\pi \times 5 \times 10^6)^2 \times (8 \times 10^{-10})^2} = \frac{I}{10^7} = 30,000 \text{ ohms (approx.)}$$

which is far too high for maximum output, for the valve resistance is generally of the order of 10,000. This difference increases as the wave-length is increased.

Therefore we will consider the set of Fig. 1, the oscillating circuit of which is reproduced in Fig. 9. Constants of this circuit are as in the previous case, except that the loading coil  $L$  is divided into two,  $l_1$  the plate tap, and  $l_2$ .  $l_2$  may be considered to include the antenna inductance. The impedance of this circuit is given by the following analysis:



**ACCURATE**  
as a high priced watch  
One five hundredth of an inch (.002), a tiny fraction of a hair's breadth—that's the standard of measurement that makes the

**NEW RADISCO VARIO-COUPLER**  
the most perfectly constructed coupler you can buy!  
You can take replacement parts for this coupler at random, and find that in all essential dimensions they vary less than one five-hundredth of an inch. *Anything but a perfect fit is impossible!*  
Examine this coupler at the nearest agency listed below. See for yourself the excellent quality of Formica. Brass and Moulded composition used throughout. *Then invest \$7.60 in permanent satisfaction.*

This Mark  Your Guarantee



**T**HE RADIO DEALERS listed below are progressive merchants. They are equipped to give you helpful advice and real service in selecting your radio equipment. As an indication of their up-to-date methods, they carry a complete line of Radisco apparatus, including the new vario-coupler shown above, Radisco Coils, Better "B" Batteries, Corwin Dials, etc. Buy from the nearest Radisco agency, and be sure of satisfaction.

- ALBANY, N. Y.  
Shotton Radio Mfg. Co.  
8 Market St.
- ASHEVILLE, N. C.  
Hi-Grade Wireless Instrument Co.
- ATLANTIC CITY, N. J.  
Paramount Radio Supply  
Arkansas & Pacific Aves.
- BOSTON, MASS.  
Atlantic Radio Co.  
88 Broad Street.

- BROOKLYN, N. Y.  
Kelly & Phillips  
312 Flatbush Ave.
- CHICAGO, ILL.  
Chicago Radio Labs.  
1316 Carmen Ave.  
Branch, Peoria, Ill.
- EUREKA, ILL.  
Klaus Radio Co.
- KANSAS CITY, MO.  
McCreary Radio Supply  
4th and Delaware Sts.
- McKEESPORT, PA.  
K & L Electric Co.  
427 Olive St.
- NEWARK, N. J.  
A. H. Corwin & Co.  
4 West Park St.
- NEW BRUNSWICK, N. J.  
Geo. N. DeLaplaine  
306 George St. and  
8th and Magnolia Sts.

- NEW ORLEANS, LA.  
Rose Radio Supply  
604 Gravier St.
- OMAHA, NEBRASKA.  
O. B. Radio Supply Co.  
406 Brown Building.
- PHILADELPHIA, PENN.  
Philadelphia School of  
Wireless Telegraphy  
Broad and Cherry Sts.
- PITTSBURGH, PENN.  
Radio Electric Co.  
3807 Fifth Ave.
- PLAINFIELD, N. J.  
Paul F. Collier,  
154 E. Front St.
- PORTLAND, ME.  
Atlantic Radio Co.  
15 Temple St.
- PROVIDENCE, R. I.  
Rhode Island Electrical  
Equipment Co.  
45 Washington St.

- SCRANTON, PENN.  
Shotton Radio Mfg. Co.  
P. O. Box 3  
Branch 8, Kingsbury St.  
Jamestown, N. Y.
  - SEATTLE, WASH.  
Northwest Radio Service  
609 Fourth Ave.
  - WASHINGTON, D. C.  
Eastern Radio and Elec.  
Co., 1405 Florida Ave.,  
N. W.
  - WICHITA, KAN.  
The Cosradio Co.  
1725 Fairmont Ave.
- Canadian*
- BEINVILLE, QUEBEC.  
Canadian Radio Mfg. Co.
  - MONTREAL, QUEBEC.  
J. B. Miller  
136 Vendome Ave.,  
N. D. G.
  - TORONTO, ONTARIO.  
The Vimy Supply Co.  
567 College Street

Radio Distributing Co. Newark, N. J.

**To Responsible Dealers**  
If you are in a town where there is no Radisco Agency, you will benefit by writing for the Radisco plan.

# RADISCO

*"Your Assurance of Satisfactory Performance"*

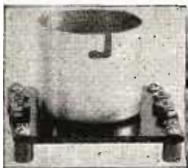

## RADIO SERVICE

Type S10—Single Socket REDUCED TO \$1.00

The Best Socket Obtainable Regardless of Price

- Type S24—Aluminum Socket only.....50c
- Type S3—Double Socket.....\$2.50
- Type S4—Triple Socket.....\$3.50

### Here's the Wonderful Little Radio Set

that was described in April's Radio News, page 680. Just the thing for Boy Scouts, Campers and for use on bicycles, etc. Complete in every respect and guaranteed to give complete satisfaction. Just connect your aerial, ground and phones and you are ready to receive messages. Tunes to 800 meters.

Mr. Dealer: This little receiving set will help your business over the summer months and obtain new customers for you.

- Type S8 (as illustrated) price.....\$7.50
- Type S8A complete (incl. phone, aerial, insulators and instruction book).....12.50

TYPE S8 SET WITH MURDOCK 2000 OHM HEAD-SET \$11.00



### CONDENSERS

Do you know that a properly designed condenser has a great deal to do with the working of your set? Try a Radio Service Condenser and note what a difference a really good condenser makes.

- Type S15—Special Grid Condenser.....35c
- Type S16—Special Phone Condenser.....35c
- Type S22M—Mica Grid Condenser.....\$1.00  
(Stands 1800 volts—suitable for C.W. transmission.)
- Type S30—Combination Grid Leak Condenser.....50c

#### SPECIAL

#### SPECIAL

We have a new lot of the famous Radio Service Aluminum Dials, and only...30c  
Navy Cage Type Rheostats, for this month only.....\$1.50

**RADIO SERVICE & MFG. CO.,**

Factory, Lynbrook, L. I.  
Sales Office, 110 West 40th St., N. Y. C.

## "ILLINOIS" THE RELIABLE MADE RIGHT - STAYS RIGHT

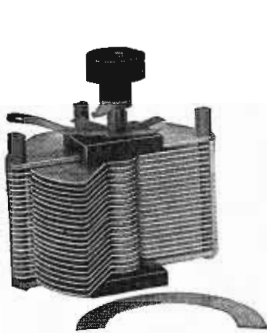

STYLE No. 1



STYLE No. 2

Three Styles: No. 1, Panel; No. 2, Open Type as shown; No. 3, Fully Encased. Anti Profiteer. Less than pre-war prices. Fully assembled and tested.

	Style No. 1	No. 2	No. 3
67 Plates,	\$7.00	\$8.00	\$8.50
43 "	3.50	4.50	4.75
23 "	2.75	3.75	4.00
13 "	2.25	3.25	3.50

Money back if not satisfied. Just return condenser within 10 days by insured Parcel Post.

With Style No. 1, we will, if desired, furnish 3 inch Metal Dial with large Knob, instead of Scale and Pointer. Extra Price 75 cents. Or we will, if desired, supply the Condenser with smooth 3-16 inch center staff, without Scale, Knob and Pointer, at 15 cents off the list to those who prefer to supply their own dial.

Vernier with single movable plate applied to 13, 23 or 43 plate condenser, \$3.00 extra.

We allow no discounts except 5 percent on orders of 6 or more.

#### Sent Prepaid on Receipt of Price

Except: Pacific States, Alaska, Hawaii, Philippines and Canal Zone, add 10c. Canada add 25c.

Foreign Orders other than Canada not solicited.

**G.F. JOHNSON, 625 Black Ave., Springfield, Illinois.**



VERNIER

READ the CLASSIFIED ADVERTISEMENTS on PAGES 84-86. YOU'LL FIND MANY GOOD THINGS THERE.

$$Z = \frac{1}{\frac{1}{j\omega l_1} + \frac{1}{R + j\omega l_2 + j\omega C}}$$

$$= \frac{1}{\frac{1}{j\omega l_1} \times \frac{j\omega C}{(1 - \omega^2 l_2 C) + j\omega CR}}$$

$$Z = \frac{j\omega l_1 - j\omega^3 l_1 l_2 C - \omega^2 l_1 CR}{1 - \omega^2 l_2 C + j\omega CR - \omega^2 l_1 C}$$

$$= \frac{j\omega l_1 (1 - \omega^2 l_2 C) - \omega^2 l_1 CR}{1 - \omega^2 C (l_1 + l_2) + j\omega CR}$$

$$= \frac{j\omega CR}{\omega l_1 (1 - \omega^2 l_2 C) - \omega^2 l_1 CR}$$

$$= \frac{l_1}{CR} \left( 1 - \frac{l_2 C}{(l_1 + l_2) C} \right) - \frac{\omega l_1}{j}$$

$$= \frac{l_1}{CR} \left( 1 - \frac{l_2}{l_1 + l_2} \right) + j\omega l_1$$

$$= \frac{l_1}{CR} \left( \frac{l_1 - l_2 + l_2}{l_1 + l_2} \right) + j\omega l_1$$

$$= \left[ \frac{l_1}{CR} \cdot \frac{l_1}{l_1 + l_2} \right]^* + [j\omega l_1]$$

$$= R_{eff} + X$$

Thus the impedance of this oscillating turns out to be an effective resistance plus a reactance. We will assume it to be entirely an effective resistance, and will neglect the reactive term which we will show later to be entirely negligible. Thus the circuit has an effective resistance  $R_{eff}$

$$R_{eff} = \frac{l_1}{CR} \cdot \frac{l_1}{l_1 + l_2}$$

This term is composed of a term  $\frac{l_1}{CR}$  exactly identical with the effective resistance of the circuit previously discussed

and a multiplying factor  $\frac{l_1}{l_1 + l_2}$ . It was

shown that in a circuit where the entire loading coil was the plate tap, the value for  $R_{eff}$  turned out to be too high for most efficient design. With this divided circuit, where a portion of the loading coil is the plate tap, this resistance may be very easily adjusted to the correct value, for if the

term  $\frac{l_1}{CR}$  turns out to be very high, by

adjusting the plate tap  $l_1$  to as low a value as we require, we make the term  $\frac{l_1}{l_1 + l_2}$

as small as we please and thus reduce the effective resistance to the optimum value.

Thus take the case previously considered where the effective resistance of the oscillating circuit turned out to be 30,000 ohms and the valve resistance was assumed to be 10,000 ohms. To redesign that circuit so that its effective resistance would be the optimum value, namely 10,000 ohms, we would have to divide the coil so that the plate tap  $l_1$  would be a portion of the total inductance in the circuit, and so that the

expression  $\frac{l_1}{CR} \times \frac{l_1}{l_1 + l_2}$  equals approxi-

mately 10,000 ohms. This could be easily accomplished by tapping the coil and choosing by experiment the best value for  $l_1$ .

$l_1 + l_2 = L$

\*Unpublished paper "Theory of Three-Element Fleming Valve," by A. E. Reoch, Asst. Chief Engr. Radio Corp. of America.



# RADIO APPARATUS

*Distributors of Reliable Radio Apparatus  
to Schools, Colleges and Experimenters  
All Over the World!*

"PITTS CO"

SERVICE FILLS ORDERS ON  
EVERY CONTINENT!

WHY NOT LET US SERVE YOU?



"PITTS CO"

SERVICE REACHES ALL OVER  
THE WORLD!

WHY NOT LET IT REACH YOU?

<p><b>AMPLIFYING TRANSFORMERS</b></p> <p>No. UV-112 Radio Corporation, new type just out. (For radiotrons)..... \$7.00</p> <p>No. 226-W Federal..... 7.50</p> <p>No. 231-A General Radio, new type..... 5.00</p> <p><b>MODULATION TRANSFORMERS</b></p> <p>No. A-3 Aeme, unmounted..... 4.50</p> <p>No. A-3 " semi-mounted..... 5.00</p> <p>No. A-3 " fully mounted..... 7.00</p> <p>No. 231-M Gen. Radio new type, just out! (for radiotrons..... 5.00</p> <p><b>AUDION CONTROL PANELS</b></p> <p>No. RORH Grebe in cabinet, with tickler connections..... 17.00</p> <p>No. 330 Remler, with "A" Battery potentiometer..... 8.00</p> <p>No. P-1 Paragon, moulded type, very small and compact..... 6.00</p> <p><b>"B" BATTERIES</b></p> <p>No. 7623 Standard, 22.5 V. small..... 1.50</p> <p>No. 7625 Standard, 22.5 V. large..... 2.85</p> <p>No. 7666 Standard, 22.5 V. variable..... 3.50</p> <p>No. 766 Everready, 22.5 V. large..... 3.50</p> <p>No. 766-A Everready, large, variable..... 3.00</p> <p>No. 763 Everready, 22.5 V. small..... 2.25</p> <p>No. P-1 "Sorsine" new type, just out! 22.5 volts, extra long life..... 4.00</p> <p><b>AMPLIFIERS</b></p> <p>No. RORIK Grebe two step with automatic filament control..... 55.00</p> <p>No. RORD Grebe Del. and two step with automatic filament control..... 75.00</p> <p>No. P-1 Amrad Type A, two step..... 39.50</p> <p>No. DA Westinghouse, det. and two step, just out!..... 65.00</p> <p><b>CONDENSERS (Fixed mica type)</b></p> <p>No. ROCC Grebe .0002 MF..... 1.00</p> <p>No. R OCD Grebe .0005 MF..... 1.20</p> <p>No. ROCE Grebe .001 MF..... 1.60</p> <p>No. ROCF Grebe .005 MF..... 3.80</p> <p>No. ROCA Grebe .0002 MF and .5 meg. leak..... 1.20</p> <p>No. ROCB Grebe .0002 MF and 3 meg. leak..... 1.20</p> <p><b>GRID LEAKS</b></p> <p>No. MW-1 Radio Corporation, .5, 1, 1.5, 2, 3 and 5 megohms complete..... 1.25</p> <p>Grid leaks only..... .75</p> <p>Bases only..... .50</p> <p>No. 21 Chelsea, variable .5 to 5 megohms..... 3.00</p>	<p><b>MAGNAVOXES</b></p> <p>Type R-3 Magnavox loud speaker, latest model, just out!..... 45.00</p> <p>Magnavox Radiophone hand transmitter..... 25.50</p> <p>Magnavox Radiophone transmitter tone-arm..... 37.50</p> <p><b>REGENERATIVE RECEIVERS</b></p> <p>No. CR-2 Grebe 175-680 meters..... 51.00</p> <p>No. CR-3 Grebe 175-680 "Relay-special"; splendid set..... 65.00</p> <p>No. CR-3A Grebe 175-375 meters with tube control, complete set..... 45.50</p> <p>No. CR-5 Grebe 175-3000 meters, "Super-special" with tube control, complete set. Ideal for jewelers..... 80.00</p> <p>No. CR-6 Grebe 175-680 meters, receiver, det. and two step amplifier self contained, complete set..... 200.00</p> <p>No. CR-7 Grebe 500-20000 meters, "Long-wave special" with tube control, complete set. Ideal for arcs..... 210.00</p> <p>No. RA Westinghouse, 180-700 meters, new type, just out!..... 65.00</p> <p><b>PLUGS</b></p> <p>No. 50 Pacent universal type..... 2.00</p> <p>No. 1428-W Federal, brass..... 2.00</p> <p>No. 1428-W Federal, silver-plated..... 2.50</p> <p><b>JACKS</b></p> <p>No. 1421-W Federal open circuit..... .70</p> <p>No. 1422-W " closed circuit..... .85</p> <p>No. 1423-W " Two circuit..... 1.00</p> <p>No. 1435-W " automatic filament control type..... 1.20</p> <p>No. 1438-W Federal Auto. filament type..... 1.50</p> <p><b>MICROPHONES</b></p> <p>No. 260-W Federal hand type..... 7.00</p> <p>No. HM-100 DeForest hand type..... 6.00</p> <p>No. 5176-A Conn. with short adjustable arm, ideal for panels..... 4.25</p> <p><b>RHEDSTATS</b></p> <p>No. 214 General Radio 2.5 Ampere type, just right for one UV-202 5-watt radiotron tube..... 2.50</p> <p>No. 132 National Controller type, 6.4 amperes, just right for 2 UV-202 5-watt radiotrons..... 5.50</p> <p>No. P-1 Paragon, very compact..... 1.75</p> <p><b>SOCKETS</b></p> <p>No. MW-1 Radio Corporation..... 1.50</p> <p>No. 166 Gen. Radio..... 1.75</p> <p>No. 550 Murdock..... 1.00</p> <p>No. S-2 Radio Service double..... 2.50</p> <p>No. S-3 Radio Service triple..... 3.50</p> <p>No. UV-203-A Radio Corporation type for the UV-203 50-watt tube..... 5.00</p>	<p><b>RECTIFYING DEVICES</b></p> <p>No. P-1 DeForest rectifying tubes for radio- phone work..... 7.00</p> <p>No. FF France battery booster, 6 amps..... 15.00</p> <p>No. P-1 Tungar 2 amp. size, complete..... 18.00</p> <p>No. P-2 Tungar 5 amp. size, complete..... 28.00</p> <p>No. UV-216 Radio Corp. "Kenotron"..... 7.50</p> <p><b>TELEPHONES</b></p> <p>Type C Baldwins, Navy type..... 16.50</p> <p>Type E Baldwins, ultra-sensitive..... 20.00</p> <p>Type F Baldwins small, super-sensitive..... 21.00</p> <p>Brandes "Superiors"..... 8.00</p> <p>" " "Trans-atlantics"..... 12.00</p> <p>" " "Navy-type"..... 14.00</p> <p>" " New headband only..... 1.50</p> <p>" " New double cord..... .75</p> <p>Browns 4000 ohms English type..... 20.00</p> <p>" " 8000 ohms English type..... 22.00</p> <p><b>VACUUM TUBE (Radiotrons)</b></p> <p>No. UV-200 Radiotron detector..... 5.00</p> <p>No. UV-201 Radiotron amplifier..... 5.50</p> <p>No. UV-202 Radiotron 5 Watt transmitter..... 8.00</p> <p>No. UV-203 Radiotron 50 Watt transmitter..... 30.00</p> <p>No. UV-204 Radiotron 250 Watt transmitter..... 110.00</p> <p>Note. All radiotrons sent postage and insurance prepaid to any part of U. S. A. Radiotrons always in stock.</p> <p><b>STORAGE BATTERIES</b></p> <p>No. BX-3 Harvard 6 volts 40 ampere-hours, complete..... 16.50</p> <p>No. BX-5 Harvard 6 volts 60 amp-hours..... 19.50</p> <p>No. BX-7 Harvard 6 volts 80 Amp-hours..... 24.50</p> <p><b>VARIOMETERS</b></p> <p>No. 200 Tuska, moulded type..... 6.25</p> <p>No. 200-A Tuska, moulded type with dial..... 7.25</p> <p>No. 345-G Murdock grid type..... 7.50</p> <p>No. 345-P Murdock plate type..... 7.50</p> <p>No. 346 Murdock Vario-coupler..... 8.50</p> <p>No. ZRV Clapp-Eastham Variometer with dial..... 6.50</p> <p>No. ZRV-A Clapp-Eastham Variometer only..... 5.75</p> <p>No. P-1 Turney's spider web inductance; ideal on radio-phones..... 8.00</p> <p><b>POTENTIOMETERS</b></p> <p>No. 214-C General Radio "A" Battery type, 400 ohms, ideal with radiotrons..... 4.00</p> <p>No. 93 Remler "A" Battery type..... .75</p> <p>No. F-743 Clapp-Eastham "B" Battery type, 5000 ohms, fully mounted..... 3.00</p> <p>For panel mounting..... 2.50</p> <p><b>RESISTANCE (Phone Work)</b></p> <p>No. 1 Ward Leonard 5000 ohms..... 2.25</p> <p>No. 2 Ward Leonard 10000 ohms..... 3.50</p>
---	--	--

"Let 'PITTS CO' products, super-service and delivery solve your Radio problems"

**SEND US YOUR ORDERS TODAY!**

Send ten cents in stamps for Catalog No. 22. Over 100 pages, over 150 illustrations, over 600 items

**F. D. PITTS CO., Inc.**

12 Park Square

Dept. C

Boston, Mass., U. S. A.

## VARIABLE-ACE "B" BATTERIES-PLAIN



**Amateurs—Insist on Getting "Ace" "B" Batteries from Your Dealer or Write Direct to Us.**

**Dealers—Sell the "Best" with our special inducements**

**Write for Catalog No. 15**

Cat. No.	Size.	Voltage.	Hrs. Ser.	Lbs.	Taps.	Price.
623	Plain 2 1/2 x 2 x 3%	22 1/2	400	1		\$1.50
623	Variable 2 1/2 x 2 x 3%	22 1/2	400	1	5	1.75
625	Plain 3 x 4 x 6%	22 1/2	1400	5		2.50
625	Variable 3 x 4 x 6%	22 1/2	1400	5	5	3.00
626	Plain 3 x 8 x 6%	45	3000	10		5.00
626	Variable 3 x 8 x 6%	45	3000	10	5	6.00

ACE "B" BATTERIES are made according to government specifications, and are especially adapted for Plate Circuit in Detector or Amplifying Tubes.

Guaranteed not to Depreciate more than 10% in 1 year when not in use Absolutely Moisture proof

A few of the dealers handling Ace "B" Batteries

- |   |                                       |
|---|---------------------------------------|
| Am. Electro Tech. Appliance Co., New York.    | David Killoch, New York.              |
| Continental Radio & Electric Corp., New York. | Manhattan Elec. Supply Co., New York. |
| Dreyfuss Corporation, New York.               | M. Muller, Boston, Mass.              |
| W. B. Duck, Toledo, Ohio.                     | Vimy Supply Co., Toronto, Canada.     |
| Wilcox Lab., Inc., Lansing, Mich.             | Whitall Elec. Co., Springfield, Mass. |

### ACE BATTERY MFG. CORP.

44 COURT STREET Phone Main 8373 BROOKLYN, NEW YORK  
AGENTS WANTED

## July **EMPIRE RADIO** Bulletin

### "FOR IMMEDIATE SHIPMENT"

<b>VACUUM TUBES</b>	<b>DIALS</b>
Audiotron, two filaments.....\$6.00	Chelsea, 3 in. diameter.....\$1.00
Radiotron, detector.....5.00	Empire, 2 1/4 in. dial......25
Radiotron, amplifier.....6.50	
<b>V.T. CONTROL SETS</b>	<b>ROTARY SWITCHES</b>
Remler.....5.00	No. 100 Switch, radius 1 in......60
Paragon.....6.00	No. 130 Switch, radius 1 1/2 in......75
<b>VARIOMETERS AND VARIOCOUPLERS</b>	No. 150 Series Parallel Switch......85
Radisco Variometer.....7.00	Hard Rubber Binding Posts......10
Radisco Variocoupler.....6.50	Nickel plated switch points, per doz.... .50
<b>JACKS AND PLUGS</b>	<b>CABINETS</b>
Jack and Plug.....1.50	High grade cabinets to take 6x9x1/4 in. panel.....2.00
Jack only......85	
Plug only......75	<b>MARCO STORAGE BATTERIES</b>
Acme Amplifying Transformers, mounted 5.00	4 volt 40 to 60 Amp.....11.00
Turney Short Wave Sets.....5.50	6 volt 20 to 40 Amp.....12.00
<b>VARIABLE CONDENSERS</b>	6 volt 40 to 60 Amp.....16.00
Chelsea .0009 for panel mounting....4.25	6 volt 60 to 80 Amp.....20.00
Chelsea .0011 for panel mounting....4.75	

## Empire Radio Equipment Co.

Manufacturers and Distributors of Radio Apparatus

271 West 125th Street New York City

## ANNOUNCEMENT!

Due to the fact that the repair of vacuum tubes for radio communication is considered an infringement upon the patent rights of the manufacturers, we wish to advise our prospective customers that no more vacuum tubes will be accepted for repair work by our laboratories.

### EASTERN VACUUM TUBE LABORATORIES

178 WASHINGTON STREET BOSTON, MASS.

A welcome addition to your library! Send \$2.00 today, plus postage for 7 lbs., and your copy of bound volume No. 1 of Radio Amateur News will come forward by return mail. Experimenter Publishing Company, Inc. 236a Fulton Street, New York City

This arrangement makes the circuit much more flexible than the previous one and does not necessitate a readjustment of circuit values, for the use of a split coil enables the plate tap to adapt the circuit to any kind of valve.

This method of adapting the oscillating circuit to the tube for obtaining maximum output, namely proper choice of plate tap by tapping the oscillating coil, is satisfactory and sufficient for a small number of wave-lengths on one set and where the antenna constants are not subject to change. If a large number of transmitting waves were employed it would be necessary to take a large number of taps from the oscillating coil and use a tap changing switch in conjunction with a wave changing switch. While this could be done, it might not be very convenient. Furthermore if the antenna constants are subject to change, as is the case on airplanes, at sea, or due to weather changes, it will be seen from the preceding analysis that the effective resistance of the antenna circuit will vary, and thus the plate tap will have to be altered correspondingly. A fixt tap will not accomplish this.

A further development would, therefore, be that where the plate tap is continuously variable, thus taking care of any changes in antenna constants or other variable conditions which might arise in the set. The use of a plate tap from the oscillating coil itself is in effect equivalent to using an auto-transformer. Adjusting the plate tap is equivalent to adjusting the transformer ratio, which is equivalent to adjusting the mutual inductance between plate and antenna. Hence by using a separate plate coil, inductively coupled to the oscillating coil, the inductance and coupling of which is continuously variable, we have the means of altering the mutual between plate and antenna and taking care of any changes which might necessitate a corresponding change in plate tap. With this modification of a continuously variable plate tap any condition can be met. (Figs. 3 or 4.)

### EFFECT OF REACTIVE TERM.

In the preceding analyses the assumption was made that the circuits considered reduced to non-reactive circuits. That this is not absolutely true is evident from equations A and B, which contain reactive terms. However, a comparison of these terms shows that the reactive term is always negligible. To show this assume the following working constants:  
λ = 600 meters. C = 0.001 μf. L = 100 μh.  
By adjusting the plate tap as described above let us say that the effective resistance is made to be 10,000 ohms. Consider the value of the reactive term compared to the effective resistance. The reactive term is ωl<sub>1</sub>. l<sub>1</sub> is approximately, let us say, 40 μh.

$$Z = \frac{l_1}{CR} + \frac{l_1}{l_1 + l_2} + \omega l_1$$

$$\frac{l_1}{l_1 + l_2} = 10,000 \text{ ohms;}$$

CR = 1/120 = 120 ohms,  
∴ ωl<sub>1</sub> is approximately 1 c/o of R<sub>eff</sub>, or negligible.

$$\text{Phase angle } \theta = \tan^{-1} \frac{\omega l_1}{R_{eff}} = 30' \text{ approx.}$$

or, practically nothing.

Thus we see that the reactance is negligible compared to the effective resistance and that the phase angles are so small as to warrant our assumption of non-reactive oscillating circuit. It can be shown very simply that the circuits can be made absolutely non-reactive by equalizing the resistances in the two parallel branches of the oscillating circuit. This refinement is unnecessary since very little is gained thereby.



# NOW IS THE TIME TO MAKE BIG MONEY

# LEARN WIRELESS

## AT HOME

**Know a Dignified  
Uncrowded Profession**

**In Shortest Time  
At Lowest Cost**

### The Demand for Good Wireless Operators Far Exceeds the Supply

The New York Wireless Institute—America's foremost fastest growing Wireless Institute gives you the best instruments, theory, text books and diagrams available. We will **MAKE YOU AN EXPERT WIRELESS OPERATOR AT HOME**, qualifying you for first grade license, in your spare time, easily, thoroughly, in shortest possible time and at lowest cost. No previous training is necessary. Our Home Study Course is prepared by Mr. L. R. Krumm, formerly Chief Radio Inspector, Bureau Navigation, New York, now in position of greater responsibility with one of the largest Commercial Radio Corporations in the United States. Our Radio Experts, able to impart their practical and technical knowledge to YOU in an easy-to-understand way, will direct your entire Course. The graded lessons mailed you will prove so fascinating that you will be eager for the next one. The instruments furnished free will make it as easy for you to learn the Code as it was to learn to talk. *All you will have to do is to listen.*

## BIG SALARIES

Wireless operators receive salaries from \$125 to \$200 a month and it is only a stepping stone to better positions. There is practically no limit to your earning power. Men who but yesterday were Wireless Operators are now holding positions as Radio Engineers, Radio Inspectors, Radio Salesmen at salaries up to \$5,000 a year.

## TRAVEL THE WORLD OVER

A Wireless Operator can visit all parts of the world and receive fine pay and maintenance at the same time. Do you prefer a steady position without travel? There will be many opportunities for you at the numerous land stations or with the Commercial Wireless or with the Steamship Companies.

*The New Intercity Wireless Company will need  
hundreds of new operators*

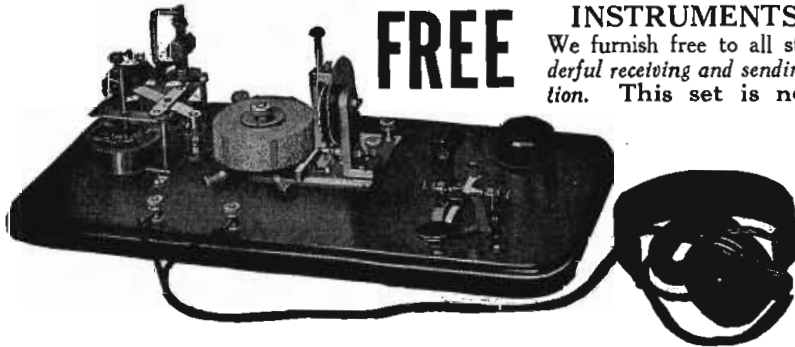

FREE

## INSTRUMENTS AND TEXT BOOKS

We furnish free to all students, during the Course, the wonderful receiving and sending set exactly as shown in the illustration. This set is not loaned, but given to all students completing the Course. One cell of dry battery all that is required. No additional wiring, aerials, etc., needed. The wonderful Receiving and Sending Set, Text Books, etc., all become your property upon completing the course.

The transmitter pictured is the celebrated Omnigraph, used by several Departments of the U. S. Government and by the leading Universities, Colleges, Wireless and Technical Schools throughout the United States and Canada. Thousands have learned telegraphy with the Omnigraph. Place the phone to your ear and this remarkable invention will send you wireless messages, thousands of different ones, the same as though you were receiving them thru the air from a wireless station hundreds of miles away.

When you apply for your license the United States Government will test you with the Omnigraph—the same model Omnigraph as we furnish to our students. Ask any United States Radio Inspector to verify this.

## FREE WIRELESS TELEPHONY COURSE

We have incorporated in our Institute an up-to-date and Complete Course in Wireless Telephony, written by our Chief Instructor, Mr. L. R. Krumm.

*This Course is included FREE*

## FREE POST GRADUATE COURSE

A month's Post-Graduate Course, if you so desire, at one of the largest Wireless Schools in N. Y. City—the Wonder City—the largest port in the World and Headquarters of every leading Wireless and Steamship Company.

## Endorsed by United States Government

by allowing our graduates highest credit given any Wireless Correspondence School in first grade license examinations.

**U. S. SHIPPING BOARD will testify to the value of our instruction.**

Medina, N. Y.  
November 28, 1920.

Dear Sirs:—  
I have found the Theory Course, the Omnigraph Set and Text Books most satisfactory. I think your Wireless Course is the best and easiest to learn for it's interesting from the beginning to end, and the way the questions are written gets you interested at once.  
Yours Truly,  
(Signed) S. B.

Sea Cliff, L. I.  
December 6, 1920.

Dear Sirs:—  
Received your letter of December 1, and was very pleased to learn of the lessons in Wireless Telephony to be given to the students of your school. It shows you do not overlook any phase in order to furnish the students with "up to date dope in the Radio line". And I am sure it will be as explicit as your Theory course of Wireless Telegraphy. The course is as thorough and explicit as one could ask for and I wouldn't hesitate a moment in recommending it to any of my Radio friends.  
Respectfully yours,  
(Signed) C. D. H.

Milford, Conn.  
Oct. 25, 1920.

New York Wireless Institute,  
New York City.

Dear Sirs:—  
I received your letter and am very glad to tell you that I am completely satisfied with your course. It sure is an easy way to learn.  
Thanking you for your kind attention, I am,  
Sincerely yours,  
(Signed) J. H. A., Jr.

(Names and address gladly furnished on application.)

## NEW YORK WIRELESS INSTITUTE

Dept. 204, 258 Broadway New York City  
Send me, free of charge, your booklet "How to Become an Expert Wireless Operator," containing full particulars of your Course, including your FREE INSTRUMENT OFFER.

Name .....

Address .....

City or Town .....

State .....

### SEND FOR FREE BOOKLET

*Without obligating you in any way, send for our booklet "How to Become an Expert Wireless Operator"—it is free. Mail the coupon opposite or postal or letter—but do it today.*

**NEW YORK WIRELESS INSTITUTE,** Dept. 205  
258 Broadway  
New York City

## Announcement

In addition to furnishing the highest possible grade of instruction to wireless men in preparation for their First Grade Commercial License examinations, the MASSACHUSETTS RADIO and TELEGRAPH SCHOOL, INC., wishes to announce their entry into the field of .....

### C-W SALES and SERVICE

We handle a complete line of C-W transmitting and receiving units and accessories.

Let us estimate on and assist you with your C-W problems.

Our 14 years' experience in amateur radio activities should be of some VALUE to you.

### Summer Classes

Enroll now for our Summer Wireless Course to be given during July and August. High School students can get the proper start during these two months to enable them to finish their course in the regular Fall Classes or at home.

#### RATES:

Day Classes . . . . \$10.00 per month

Evening Classes . . \$ 5.00 per month

To Summer Students only.

Write, 'phone or call for particulars.

**MASSACHUSETTS RADIO AND TELEGRAPH SCHOOL, Inc.**  
 18 Boylston Street, Boston, Mass. Tel. Beach 7168  
 R. F. Trop, Treas. G. R. ENTWISTLE, Pres.

## Dealers and Amateurs have you our proposition?

What is more unpleasant and aggravating than an ill-fitting Battery?

Make up your mind once and for all, you will have a battery that will satisfy you and your followers, a battery that does not corrode before the time expires, a battery that has proven to outlast any other make on market. Make up your mind, that this time you will buy a battery that follows the lines of your outfit, that from the very day you connect your wires to the battery it will increase your service and stand up to its test.

SAB-IS-CO batteries combines the three features, that you have been looking for, Battery, Guarantee and Price. Our variable battery observe so closely, the posts that economize and give you the full value for the money.

For the SAB-IS-CO battery, whether variable or plain, large or small, are made of the very best and highest grade material that science can produce. Select your styles and order them by number as follows:

- No. 923 Small, plain . . . . . \$1.25 each
- No. 923 Small, variable . . . . . 2.00 each
- No. 925 Large, variable . . . . . 3.50 each
- No. 925 Large, plain . . . . . 2.10 each

Dealers have you our proposition—send for your discounts.

Amateurs, if you cannot obtain a SAB-IS-CO battery from your dealer, write direct to us for your discounts, and we will send you free of parcel post charge. Your money will be refunded if found not satisfactory. Mention your dealer's name when ordering.

Watch for our advertisement in the August issue.

## J. H. SABINSKY & CO.

640 Broadway,

New York City

## NOTE OUR NEW ADDRESS

We have taken over a five story building to accommodate our increasing business

Get your name on our mailing list.

**PHILADELPHIA SCHOOL OF WIRELESS TELEGRAPHY**

1533 Pine Street

Philadelphia, Pa.



Reg. U. S.

Trademark

### MODULATOR.

This practically covers the radio frequency oscillating circuit and we can now turn to a consideration of the modulation circuit in telephony. The modulation circuit is shown in detail in Fig. 10.

The manner in which the modulating voltage developed by the modulator tube effects the modulation of the radio oscillations was described at the beginning of this article. The manner in which this modulating voltage, which is developed across the audio choke A, is generated is as follows: A constant current flows thru the microphone circuit, the current being supplied by the dry cells B. When the microphone is spoken into, the diaphragm moves back and forth, thus varying the contact pressure on the carbon granules and causing the microphone resistance to vary. Thus a pulsating direct current flows thru the primary of the microphone transformer, which results in an alternating voltage being developed across the secondary terminals, this alternating voltage corresponding to the speech. This voltage is applied to the modulator grid. The plate current is thereby controlled and a variation corresponding to speech variation is produced. This variation in current produces an alternating voltage across

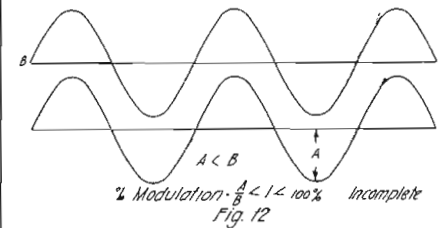
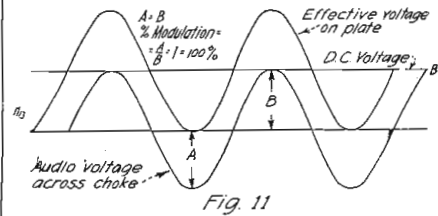

These Curves Show the Percentage of Modulated Current in a Radiophone Set.

the audio choke coil A and it is this voltage which is the modulating voltage. This voltage is in effect superimposed on the D. C. plate voltage of the oscillator, and since the r. f. current of the oscillator is proportional to the applied plate voltage, modulation is thereby effected.

If the maximum amplitude of the a. c. voltage across the audio choke coil is equal to the oscillator plate voltage, the effective voltage on the oscillator plate will vary from zero to a maximum of twice the d. c. value. Thus the output will vary from zero to a maximum of twice the normal output when modulator is not working. In this case the modulation will be complete. If the maximum value of the a. c. voltage across the choke is less than the d. c. plate voltage, then the effective plate voltage will vary between a lower limit greater than zero and an upper limit less than twice the d. c. voltage. This is evident from Figs. 11 and 12. In this case the modulation will be incomplete and the percentage modulation will be given by the ratio

$$\frac{A}{B}$$

### AUDIO CHOKE COIL.

The required voltage across the choke for complete modulation is conditioned by the proper design of the choke. The choke coil has high enough reactance to prevent any appreciably large audio currents flowing in the d. c. generator circuit, thus leav-



# "The Greatest Radio Catalog In the World"— The Universal Verdict of Tens of Thousands of Radio Amateurs

Duck's Big 225-Page Wireless Catalog

Mailed upon receipt of 12c in stamps or coin. This catalog is a veritable treasure house of everything worth while and dependable in radio. It is the largest and most comprehensive, artistic and educational radio catalog published.

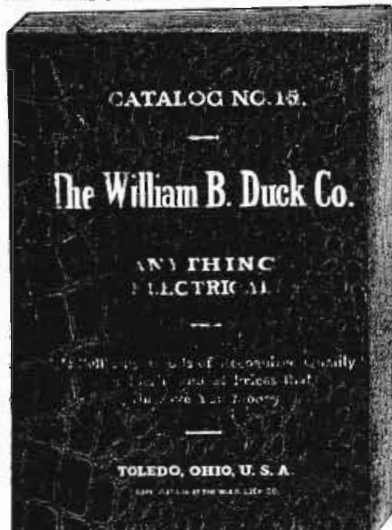

### Substantial Reductions on many Radio Instruments that appear in Catalog No. 15

The prices of DeForest Honeycomb Coils and all DeForest instruments as set forth in catalog No. 15 have since been reduced to the previous DeForest list which appears in the first edition of our catalog No. 14.

No. R40 Receiving Set	\$22.50
No. R41 Receiving Set	\$8.50
No. R41a Receiving Set	\$8.50
<b>THORLADSON TRANSFORMERS</b>	
1 K.W. Type R	40.00
1/2 K.W. Type R	28.00
1/4 K.W. Type R	22.00
1 K.W. Type RS	30.00
1/2 K.W. Type RS	20.00
1/4 K.W. Type RS	15.00
No. A1792 Thorladsen Condenser	25.00
No. 50, 51, 52	
Switch Contacts, each	.08
No. 1023 Mica Condenser	.60
No. B870 Detector	2.75
No. A882 Detector	2.75
No. A1915 Detector	1.50
No. A387 Murdock Condenser	4.50
No. A1002 Receiving Set	9.75
No. A1916 Condenser	1.85
No. 61x08A Tuning Coil	2.95
No. 61x10 Tuning Coil	4.95
No. 14 Aluminum Wire, per lb.	.90
All Binding Posts reduced 33 1/3%	

### Only a few of the many New Instruments in Catalog No. 15

Type C-300 Cunningham Bulb	5.00
Type C-301 Cunningham Bulb	6.50
UV-200 Radiotron Bulb	5.00
UV-201 Radiotron Bulb	6.50

### A Complete Line of New Detector, Regenerative and Amplifying Sets.

Connecticut Variable Condenser	6.50
Turney Spider-Web Unit	6.00
No. 550 Murdock Socket	1.00
No. 3680 Murdock Condenser	4.00
No. 3681 Murdock Condenser	4.25
No. 3682 Murdock Condenser	5.00
No. 3683 Murdock Condenser	3.25
No. 3684 Murdock Condenser	3.50
No. 3682 Murdock Condenser	4.25
No. 3684 Murdock Dial Assembly	1.25
MC-1 DeForest Set	40.00
MC-2 DeForest Set	59.00
MR-1 DeForest Set	65.50
MR-2 DeForest Set	85.50
MR-3 DeForest Set	105.00
MS-2 DeForest Set	209.00

Note: The above DeForest Sets are just out and constitute panel detectors, amplifiers, regenerative receivers and complete radio telephone transmitting and receiving sets. The various sets above mentioned comprise the various units in cabinets. These units may be bought separately and later added to.

No. MS-2 comprises a complete Midget Radiophone with a thirty-five mile speaking range, regenerative receiver; also receiver for wave lengths of 25,000 meters, and a detector and two-stage amplifier each in separate units but all mounted in a mahogany cabinet.	
Type OT-3 Midget Radiophone consisting of antenna circuit panel and power tube panel	\$95.00
Microphone, extra	6.00
Power Tubes, extra	22.50
Magnavox Radiophone Hand Transmitter	22.50
Magnavox Radiophone Transmitter Tone Arm	37.50
Magnavox Loud Speaker	45.00

## DUCK'S No. 15 BIG 225 PAGE WIRELESS CATALOG. JUST OUT

A Veritable Treasure House of Everything Worth While and Dependable in Radio. The largest, most comprehensive, artistic and educational wireless catalog published. The Beacon Light to guide you right in the selection of your radio purchases, and at prices that will command your attention. Every instrument guaranteed with privilege of return if not satisfied.

### For 12 Years the Name "DUCK"

has had a meaning all its own to radio amateurs.

Next month we shall reproduce a number of late testimonials out of thousands pouring in upon us, which will tell you why the overwhelming majority of radio amateurs buy from "Duck."

Ever since the year 1909 Duck's catalog has always occupied the foremost rank among radio amateurs; in each succeeding year, with the constant development of radio this catalog blazed the way with most everything new and dependable listed between the covers of all other catalogs. It has truly been a "BEACON LIGHT" to the novice and the expert in radio. In keeping with the size and completeness of this catalog there has always been a stock of radio instruments in our place many times larger than that of any other radio house; in fact we believe several times larger than the next largest. Our many years in this business and the immensity of our stocks is conclusive proof that you are dealing with a big, well-established and dependable concern.

## SERVICE

Among many other things, has made our business tremendous, and except for a limited time after the war, when without actively inviting the business we were literally snowed under with orders, our service has always been our pride and the delight of radio amateurs. SERVICE—the most abused word in advertising and the hardest and most complex thing to give to radio experimenters. We do not tell you that we can always ship every item in our catalog immediately, but our records for some time past prove that we are giving our pre-war service and shipping 98% of all orders complete within twenty-four hours after receipt.

### New Short Wave Regenerative Set with Detector

Listen in to the Radio Concerts with this wonderful receiver.



For damped and undamped stations from 150 to 600 meters. Variometer and varia coupler construction. Variometer coupling extremely close giving maximum inductance. Varico-coupler primary provided with single and multiple tap switches giving extreme selectivity. Wiring bus bar type insulated with oiled cambric tubing. Brushed Bakelite panel. Beautifully finished mahogany cabinet. Tested before shipment in Toledo for radio music from Pittsburgh and Washington. Absolute certainty of getting what you buy. The maximum range obtained from any type of transmitting station, damped or undamped, using up to 600 meters. We unqualifiedly guarantee that there is nothing like it on the market for the price.

No. A204 New Short Wave Regenerative Set with Detector and "B" Battery	\$65.00
Cunningham or Radiotron Detector Bulb, extra	5.00
No. A210 Short Wave Regenerative Receiver only (style, construction and appearance same as No. A204, but without detector)	50.00

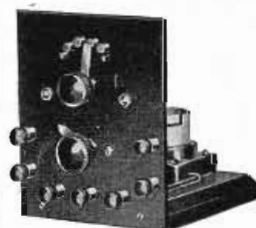

No. A200

An excellent Audion Control Panel for use with new four-prong bulbs. Grid leak and grid condenser are mounted on rear of panel. New type panel rheostat mounted on center of panel. The formica panel is attached to a wood base, upon which is mounted the tube receptacle.

"B" Battery control permitting of four regulations of "B" Battery. Voltage from 18 volts to 22 1/2 volts in steps of 1/2 volts. A fine adjustment of "B" Battery is necessary for the best results.

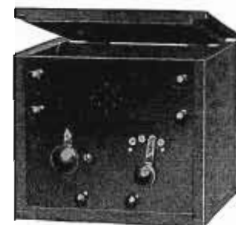

No. A200 Panel Detector Set, less batteries and bulb	\$7.50
No. A201 Cabinet Detector Set, with batteries less bulb	15.00
No. A202 Cabinet Detector or Amplifier Set, with Batteries less Bulb	\$22.00

Duck's Big Summer Sale is Now On  
Send for pamphlet illustrating and describing the biggest bargains ever offered in the history of radio on countless radio instruments, including many complete receiving sets, regenerative sets, panel detector sets, detector and amplifier sets, Navy and Arlington receiving transformers and other items.

# THE WILLIAM B. DUCK CO., 231-233 Superior St., Toledo, Ohio

**THIS WONDERFUL DETECTOR**

**BOYS**

Are you interested enough in Wireless to spend this small sum for something you cannot be without? Needs no adjusting—just snap it in your hook-up and receive—very convenient. Comes in four styles—GALENA—SILICON—IRON PYRITES and CARBORUNDUM. You can have



**FOR 25c ONLY**

*including postage*

five of them for half the cost of any one other detector, and you have the advantage of experimenting with four crystals and using the mineral most suited to your apparatus. **FIVE WRIGHT DETECTORS**—any selection—\$1.00 or 25c each. Act quickly—write at once before you forget.

---

**THE WRIGHT RADIO CO.**  
 P. O. Box 534, City Hall Station, New York, N. Y.

Enclosed is ..... for which please send me:

.....Galena Detector.                      .....Silicon Detector.  
 .....Iron Pyrites Detector.              .....Carborundum Detector.

Name..... Address.....

**A 6 VOLT BATTERY WILL OPERATE A C W TRANSMITTER**  
 when used with a

**Ray-Di-Co "DYNAMOTOR"**

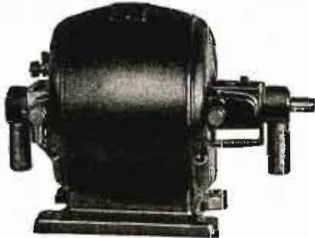

Ray-Di-Co "DYNAMOTOR" operates on 6 volts delivering 400 volts for space current. "DYNAMOTOR" entirely closed—foolproof—portable—can be placed on automobile, motor boat or used for portable work. Capacity 15 watts—Net weight 18 lbs.

**Price \$52.35**

F. O. B. Chicago

*Usual Ray-Di-Co standard of construction prevails.*

**RAY-DI-CO**  
 (Ray-Dee-Ko)  
**Radio 9AG                      Chicago, Ill.**

2653A N. Clark St.  
 H. H. Buckwalter, 713 Lincoln St., Denver, Colo.  
 Representative  
 Colorado, Wyoming, Utah, Nebraska, Western Kansas, Northern New Mexico,  
 Deadwood and Lead, S. Dak.



*"Meet us at the National Convention"*

**TRESCO TEN \$ TUNERS**

When you think of tuners say TRESCO.  
 One for every need and wave length.  
 CIRCULAR FREE.

**Knocked-Down Condensers**

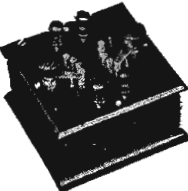
Assemble them and save money.

11 Plate.....	\$1.80
21 Plate.....	2.25
41 Plate.....	3.20 Add P. P.

If you want us to assemble them for you add \$1.00, plus P. P., to above prices. Shipping weight 2 lbs.

10c brings a wonderful catalog of 16 pages. 100 testimonials and freak hook ups for our tuners.

**TRESCO — DAVENPORT — IOWA**

ing it to exert its effect on the oscillator tube where it produces its modulating effect. As stated in the previous discussion of chokes it does not follow that the reactance of the choke must be extremely large and that there is no advantage gained in exceeding a certain limit. We may consider the modulator in the nature of a generator of audio frequency voltages which we desire to utilize for modulating radio currents. This audio voltage is produced in the output circuit of the audio choke. Thus, according to the principle outlined in the discussion of the r. f. oscillating circuit, for maximum voltage across the audio choke its impedance should be equal to that of the modulator valve. Since the resistance of the coil is very small compared to its reactance, its reactance should equal the modulator valve resistance. To go one step further, the oscillator valve may be considered to be the load on the audio choke (which is in the nature of an auto transformer) and for maximum effect (modulation) on the oscillator the reactance of the choke should also be the same as the resistance of the oscillator. Thus the audio choke should have a reactance equal to and possibly a little greater than the resistance of modulator or oscillator valve. (Generally the oscillator valve will have the same resistance as the modulator, so that no difficulty arises.)

This choke coil will invariably be an iron core choke, since the reactance is very high and the frequency low. Economy of space and copper necessitates this. The best type of coil is the open core choke, no difficulties due to saturation or distortion arising with this design. The actual design of the iron section, winding, is a matter of straight magnetic circuit design, data for which is obtainable in electrical engineering handbooks.

**MICROPHONE CIRCUIT.**

The microphone is a matter of choice and the best that can be said is that a standard make should be chosen, which is known to be stable and operative.

The grid of the modulator will generally have to be biased by a negative potential so that it is at the center of the straight line portion of the valve characteristic. This insures uniform variation of plate current with grid voltage on either side of the average grid potential, thus reducing to a minimum the distortion which results from a flattening out of the plate currents at each end of the characteristic.

The microphone transformer steps up the primary pulsating current to a high alternating voltage in the secondary. This voltage must be high enough to produce complete modulation. Whether this voltage can be obtained depends upon the valve used and the microphone and transformer. Sometimes this is impossible with the apparatus available. The voltage that can be generated across the secondary is limited and cannot be increased indefinitely by simply increasing the transformer ratio. On the contrary, with a given valve and microphone, it cannot exceed a quite definite limit.

The microphone transformer like any other transformer serves to adapt the load impedance on one side of it to the impedance on the other side, for maximum output. It is absolutely desirable that this be done for the output of any microphone is exceedingly small, a fraction of a watt, and all the available output must be utilized to secure complete modulation. The impedance on the primary side of the transformer is the resistance r of the primary coil, the impedance on the secondary side is the resistance R of the grid-filament circuit. Thus the method of adapting these two impedances to each other is accomplished by designing a transformer with such a ratio n, that the following relation holds:



$$n^2 r = R$$

Assume that the maximum output obtainable from the microphone is  $W$ . Then assuming that this entire output is available on the secondary side (actually a little less will be available due to losses in transformer), we have the following relations:

$$i = \text{current in secondary circuit}$$

$$E = \text{voltage across secondary}$$

$$W = iE = \frac{E^2}{R} \cdot E = \frac{E^3}{R}$$

$$\therefore E^3 = WR$$

$$\therefore E = \sqrt[3]{WR}$$

Thus since  $R$  is definite for a given type of valve and  $W$  is fixed for a given microphone this result gives the maximum value of  $E$  obtainable across the secondary. Thus it's sometimes necessary, in order to obtain higher voltages to use an extra valve (modulation amplifier) to step this voltage up to that required for complete modulation.

In the design of the transformer it is wise to follow, as a starting basis, standard telephone design. The closed core trans-weakened, but it can be amplified. A two-stage audio frequency amplifier can be inserted between the antenna frequency transformer and the fones. If this is not sufficient, a two-stage radio frequency amplifier can be inserted between the antenna circuit and the input circuit of the two valves. The Armstrong Super-Autodyne Amplifier can also be inserted in this place, if desired.

### Alleviating QRM

(Continued from page 22)

It should be noted here that it is impossible to use the beat method of reception for modulating the signals received on the circuit embracing the valve  $V_2$ . This is because the original tone of the spark signals is distorted and will not entirely balance out in the differential circuit. Anyway, the rotating condenser method is better, as it is positive in action and can be relied upon.

This system not only eliminates all spark signals, but all atmospheric disturbances as well. With a thunder storm roaring overhead, and a thousand spark stations buzzing on all sides, C. W. communication can continue without interruption.

### How to Construct a Heavy Current Microphone

(Continued from page 16)

the carbon grains. Pieces of ordinary hard carbon, indicated by pencil, are located at the ends of the electrodes. A novel feature about this transmitter is that the chamber holding the carbon grains may be increased in size by the simple loosening of the set screws holding the electrodes in place and drawing them outward, thereby leaving more room for additional grains. This feature assists, also, in making the first adjustments, while the transmitter is receiving its initial testing out. A mouthpiece, such as is found on ordinary instruments, is used.

### Amateur Radio Helps Police

(Continued from page 16)

stances the stolen automobiles were recovered just a few hours after they were taken.

# "The Promised Land"— YOUR OPPORTUNITY

"The Promised Land" is the name professional operators have given to the New York Central Radio Station of the Radio Corporation of America on Long Island, which, when completed, will be the largest and most powerful radio station in the world.

This immense station which is now in course of erection, is a striking example of the great opportunity radio offers you for a successful, secure future. It will be equipped to work simultaneously with five other nations in widely separated and distant parts of the world and will be epoch-making in the field of international communication.

A large number of trained men will be required for its operation and maintenance. A position at this station is the height of every operator's ambition, for it means unlimited opportunity to succeed and progress to higher, more responsible and better paying positions in the radio industry. So far as opportunity goes the successful future of these men is assured.

## HOW ABOUT YOU?

Right now, today, radio offers you big opportunities—if you are properly trained. Radio companies need trained executives, engineers, draftsmen, operators and mechanics. Hundreds of positions in the ever-broadening field—from ship operator to general manager—are open to you, if you have the required training. The Radio Institute of America will give you this training, as it has to thousands of others. If you cannot come to the Institute, the instruction will come to you—to your home.

This new home course of radio training, which has been developed for the benefit of those who cannot attend the Institute personally, is the same course used at the Institute. It includes everything from basic principles of electricity and magnetism, to actual operation of commercial radio equipment. It also includes the same textbooks used in the Institute classes, as well as an Omnigraph set of greatly improved design, with a variable automatic transmitter, for code practice.

#### What Our Former Students Are Doing

Mr. H. Payne, former student, now Assistant Treasurer of the Radio Corporation of America.

Walter E. Wood, Superintendent in charge of the powerful trans-oceanic radio station at Chatham, Mass.

Irving Ellingham has a greatly prized position in his assignment as radio operator on "Vincent Astor's yacht 'Cristina'."

Raymond Blauvelt, although only 20 years old, is now a high salaried operator in trans-oceanic service.

Watson Sidney, Manager of the office of the Radio Corporation of America, Savannah, Ga.

Harry Sadenwater, assistant in research in the world famous radio laboratories of the General Electric Company.

E. N. Pickrell, manager of the Radio Corporation's shore station for the port of New York.

Lee L. Manly, assistant superintendent of the Maintenance Department of the Radio Corporation.

William S. Fitzpatrick, Assistant Marine Superintendent.

The graduates of the Radio Institute of America enjoy a great and exclusive advantage in the close connection existing between the institute and the Radio Corporation of America, world's largest radio manufacturing and commercial radio company. The Radio Corporation employs thousands of men, in its executive departments on ships and at shore stations and in factories and laboratories. A large percentage of these men are graduates of the Institute.

#### What the Man Who Employs the Operators Says—

Radio Institute of America, New York.

Gentlemen—I have known the Radio Institute of America so long and so favorably under its present title and its earlier name, Marconi Institute, that it is difficult for me to conceive that anyone can think of instruction in radio without instantly recognizing its leadership. When employing operators, your students are given preference because several thousand of them have proven their ability to me over a long period of years.

Sincerely yours,  
(Signed) J. B. DUFFY,  
Superintendent, Eastern Division, Radio Corporation of America

The Radio Institute of America has been an established and successful institution for over fifteen years. The year round average attendance in its classrooms is now 298 students per month. It has trained over 6,000 men, 95% of whom have successfully engaged in this new branch of science and industry. You, too, can be successful in this new field if you properly train yourself by means of the Home Study Course of the Institute. Radio offers an unlimited opportunity for future advancement—why not take advantage of it. Write for our booklet and further details.—NOW.

HOME STUDY DIVISION

## RADIO INSTITUTE OF AMERICA

(formerly Marconi Institute)

324 BROADWAY, NEW YORK

# ACE Three New ACE Products ACE

Type AVA Variometer Tuner . . . . .	\$45.00
Type AVB Variometer Tuner . . . . .	32.00
Type ATC Detector . . . . .	12.00

LICENSED UNDER ARMSTRONG PATENT NO. 1,113,149

Send 3 cents in stamps for  
SPECIAL PRICE BULLETIN No. 102  
Mail Orders receive prompt attention

## THE PRECISION EQUIPMENT CO.

2437-2439 Gilbert Ave. Dept. A. Cincinnati, Ohio

"YOU MAY PAY MORE BUT YOU CAN'T BUY BETTER"

MEMBER A. R. R. L. RADIO CALL "8XB"

SEE OUR PRODUCTS AT THE A. R. R. L. NATIONAL CONVENTION, CHICAGO.

## DETECTOR and TWOSTEP AMPLIFIER

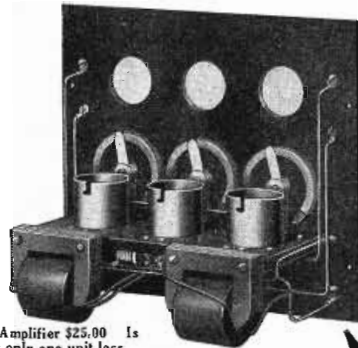
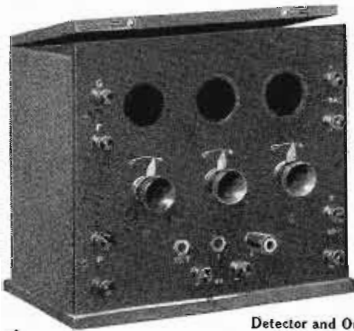

Detector and One-Stage Amplifier \$25.00 Is duplicate of above cut only one unit less

The operating characteristics of this instrument are equal to any on the market regardless of price.

**\$35.00**

The Design and Construction are such that Maximum Amplification is Obtained and No Howling.

Panel 3/16". Bakelite is 7-1/2" x 8-3/4".

Cabinet, Waxed Oak Finish, 5" Deep.

Panel hand rubbed and engraved with white letters

**INSTRUMENTS EXACTLY LIKE PHOTOGRAPH**

"Notice Clean Cut Wiring." Plug for Fones Furnished with Each Instrument.

**ALL INSTRUMENTS ABSOLUTELY GUARANTEED**

361 E. Ohio St. **G. M. PROUDFOOT** CHICAGO, ILL.

## WIRELESS

You should have it even if only superficially interested. Around about you every day you read of some marvelous occurrence in which wireless played a distinguished part. It may not be entirely clear to you. The Manual will explain it. To the student of Wireless Telegraphy, the Manual contains much that is indispensable to a proper understanding of the art. It contains 206 pages, fully illustrating and describing the many instruments used in Radio. 45 pages cover general instructions, diagrams, station calls, tables, codes and other information.

The book is printed on highly finished paper with a two-color cover and measures 8 x 5 1/2 inches.



## MANUAL M12

Containing as it does a fund of valuable information not generally contained in a catalogue, it approaches nearly a text book in the fascinating field of wireless telegraphy. No expense has been spared to make it accurate and reliable.

No Wireless Experimenter Should be Without the Mesco Wireless Manual. We ask 25 cents (25¢) for it—give you a coupon receipt which can be applied on any future order.

Send your name and address now, and get one of the most complete, comprehensive and reliable wireless books published.

**MANHATTAN ELECTRICAL SUPPLY CO. INC.**

17 Park Place  
New York

114 S. Wells St.  
Chicago

1106 Pine St.  
St. Louis

604 Mission St.  
San Francisco

A welcome addition to your library! Send \$2.00 today, plus postage for 7 lbs., and your copy of bound volume No. 1 of Radio Amateur News will come forward by return mail.  
Experimenter Publishing Company, Inc. 236a Fulton Street, New York City

Besides the wireless station at headquarters, which has a sending and receiving radius of 1,800 miles and more, the police department has a station aboard the police boat *John F. Hylan*.

Union Hill, N. J., is now getting the reports thru (2UE), Mr. J. Erhard, 311 Maple St., West Hoboken, N. J. West New York, Hoboken, Jersey City, Rutherford, and I might say most outlying districts, are now being taken care of, which was not the case when the above recovery was made. As you probably know this form is but in its infancy, and we hope that further co-operation among the Radio amateurs will continue, bringing it to a higher and more practicable level.

A few amateurs have already taken the view: "Oh, what good is derived from it?" All I have to say is, a fine organization we would have, if we were all to think along those lines. I think Amateur Radio would be just about on the edge of the precipice, ready to "topple," instead of where it is to-day. One thing more, that is, I trust that the Radio Amateur will give his support in the future, as he has in the past, and co-operate to the best of his ability, and not let an "idea," such as I have just mentioned, get the best of him.

### The Oscillograf

(Continued from page 11)

to the radio frequency unmodulated amplitude. If the ratio is unity, then the modulation is complete or 100 per cent. If less, then the percentage modulation is proportionately less.

Consider then a radio telephone set in Fig. 9. The radio frequency oscillations from this set will not be able to influence the vibrator of the oscillograf because its frequency is too high for the vibrator to follow when both negative and positive cycles of the wave effect. The vibrator will stand still. However, if this radio frequency

(Continued on page 83)

### The Acid Test

(Continued from page 29)

ing call and many were his fears that his signals would not be heard.

Thru a crack in the side of the car where he could see and not be seen, Stewart noticed that the desperadoes were tossing bags of mail down the embankment and from the noise they were making he concluded that they were industriously pillaging the mail coach. The safe containing the money had not been blown. No doubt the bandits were experiencing difficulty in opening it, but then there was plenty of time. In this desolate place, far removed from human habitation, the robbers could make a big haul and a clean getaway.

Once more Stewart stole back to his transmitter and again sent out the signals for help. Would anyone be listening; if so, would his transmitter send far enough to be of any value? Would help come in time? This was the test Stewart had often dreamed of—the acid test.

Stewart mused: suppose his efforts were of no avail—better to lie low than to fight against such heavy odds.

BOOM! CRASH!—Stewart jumped to his feet. The bandits had blown the safe. The \$50,000 was in their possession. Stewart glanced at his watch; the robbery had taken an hour to complete. He felt weak and helpless. He had done his best and had failed. But what was that? Stewart listened. His eyes sparkled and a radiant smile spread over his face. He heard the puffing of an approaching locomotive; the rescue train was drawing up.

As Stewart looked cautiously from the door of the car he saw an engine crowded with armed men; but the bandits had seen



too. Loaded heavily with loot the robbers were stumbling down the embankment towards their horses which were picketed in an oak grove near by. Shots were exchanged, the bandits replying as they ran. The rifles of the posse spoke with accuracy. The desperadoes fought a losing battle. The \$50,000 was saved.

Stewart scrambled from the car as members of the rescue party ran towards the wreck. The mail clerk and the brakeman were released and the injured fireman was receiving attention. The president of the line was speaking excitedly and as Stewart approached unnoticed he heard him inquire, "Where in thunderation did the wireless signals come from?"

"Search me," spoke up a young chap, evidently the operator at the aerial mail station. "I heard the signals clear as a bell, but no call letters were given."

Stewart caught the president by the arm. "Maybe I can—"

"Jumping rattlesnakes!" interrupted the president. "Can it be possible that you saved the day with that infernal contraption you tried to peddle off on me? Speak up, young man, let's have it."

Stewart did speak. He modestly related all that had occurred and added finally, "I not only saved your money, but I proved that my railroad wireless is a great success."

"Right you are, son," said the president, as he placed his hand on Stewart's shoulder. "I'll back you with the money for the patents and I want the first dozen transmitters that are turned out. My railroad can't operate without them."

### A Clever Solution

(Continued from page 29)

A few months or more ago they were looked upon as necessary pests in the homes. Then came wireless concerts every Sunday and Wednesday evenings, sent out by Lieutenant W. L. Winner, of the U. S. general hospital, and Buckwalter. Mother and father were invited to the wireless department of the house to listen in and soon they became even more enthusiastic than Willie. Now wireless concert parties have actually reached the dignity of society events and Willie has graduated from the pest class to the hero guild. Invitations to these gatherings are very, very popular and the number of new sets that are being installed is very large indeed. Mother has learned to operate the sets and frequently she calls up Buckwalter or Winner with the request, during the afternoon, "won't you please send a record or two? I have some ladies here spending the afternoon and I would like so much to have them hear some wireless music." Of course the music starts. Why not? It makes friends and really is not much trouble.

### Determination of Percentage Modulation in Radio Telephony

(Continued from page 19)

and transmitter and call it OB. This coupling is now proportional to the amplitude of the radiated modulated wave. The ratio of the coupling distances OB to OA

will give the percentage modulation.

$\frac{OB}{OA} = \text{do Modulation.}$

(b) NON-ABSORPTION SYSTEM

The same circuit is used, and the coupling distance noted for unit audibility when no speech is applied. Since in this system the amplitude is doubled for complete modulation, this coupling distance is really proportional to half the amplitude of a completely modulated wave, which fact will have to be considered in getting the per-

# KENNEDY EQUIPMENT

## ANNOUNCING

### THE NEW KENNEDY UNIVERSAL REGENERATIVE RECEIVER

TYPE 110

EFFECTIVE RANGE: 175 TO 25,000 METERS

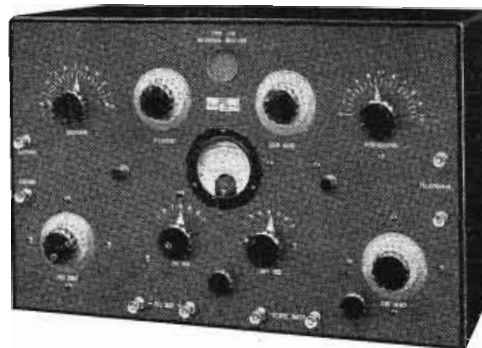

Detects  
Regenerates  
Oscillates  
on all wave  
lengths in  
common use.

Licensed  
under  
Armstrong  
U. S.  
Patent  
No. 1,113,149

**SURPASSING** even our highest hopes when we undertook its development, this latest addition to the Kennedy line is of interest to everyone who uses a radio receiving set.

**OUR** engineering staff spent many months in developing this unit and released it for production only when its performance surpassed every requirement we had set for it. By our long specialization in receiving equipment we have built up a reputation which is so precious that we can afford to put the Kennedy trade-mark on only the highest quality product.

**WE** have spared no effort to make this the best receiver on the market. We honestly believe that it is.

#### These are some of its features:

- Variable inductive coupling between primary and secondary.
- Extremely sharp tuning because of very efficient inductance units.
- Special Kennedy bank-wound moisture-proof inductors.
- Generous overlap between inductance steps.
- Large balanced primary and secondary variable condenser.
- Micrometer adjustment of secondary condensers.
- Variable grid condenser with air dielectric, permitting most effective use of all types of available receiving tubes.
- Adjustable feed-back circuit.
- Fine adjustment of plate voltage by means of potentiometer connected between terminals of filament battery.
- Weston ammeter for measuring filament current.
- Bus-bar type insulated wiring.

Further details in Bulletin 101, mailed on request

**ASK** your dealer for a demonstration. Compare the performance of this receiver with any other you have ever seen. The users of Kennedy Equipment are our best advertisers.

**THE COLIN B. KENNEDY COMPANY**  
INCORPORATED  
RIALTO BUILDING SAN FRANCISCO

As The  
**Sole Distributors In  
Philadelphia For De Forest**

**Radio Apparatus**

We Have in Stock for Immediate Delivery Practically  
Everything Needed by the Amateur, Including Complete

**Radio Telephone**

**Transmitting and Receiving Sets**

See the New Interpanel Sets Receiving 125 to 2500 Meters

Catalog E Free on Request

**Central Electric & Lock Co.**  
1309 Arch Street Philadelphia, Pa.

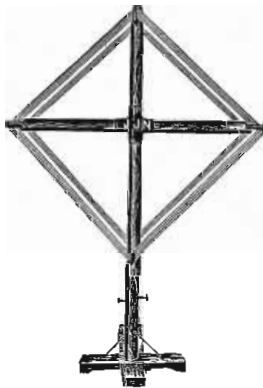

**Why not use a Loop Antenna?**

Does your landlord object to your aerial?  
Does Q R M and Q R N bother you?  
Does your location prohibit the use of an aerial?  
Does lightning worry you?  
Do you want a portable Antenna in a box 36 x 3 1/2 x 3 3/4"?  
Do you want to take bearings on any station you choose?  
Do you want to cut out signals from two directions?

The J J N 4 loop is well constructed of seasoned hard wood. The bare copper wire is supported by slotted BAKELITE STRIPS. The center casting is of aluminum. Supplied complete in cardboard box 36 x 3 1/2 x 3 3/4".

PRICE COMPLETE - - \$6.50

Send Stamp for Catalogue R21

**DAVID KILLOCH COMPANY**  
57 MURRAY STREET NEW YORK CITY

**Cyclone "B" Battery**

World's Best "B" Batteries

Variable and Plain

American products. Contains highest grade materials and best workmanship. Guaranteed to give the fullest and best satisfaction.

The best inducements for dealers.  
Write for catalog.

Ask your dealer for Cyclone "B" Batteries or write direct to us.

**Standard Electric & Novelty Co.**  
182 Lafayette St. New York City

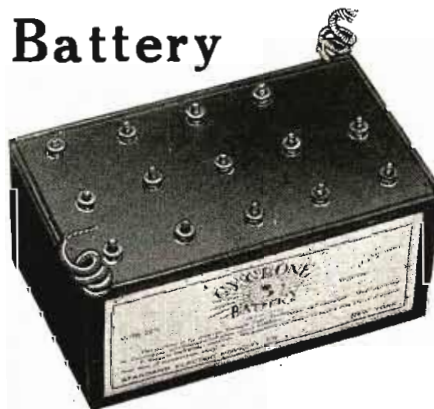

centage modulation. Call this distance OA, Fig. 6. Apply speech and vary coupling until audibility is again had and call this coupling distance OC, which is proportional to the amplitude of the actual modulated wave. The percentage modulation will then be given by the ratio OC to twice the distance OA.  $\frac{OC}{2OA} = \text{do Modulation.}$

**METHOD 2.**  
**(a) ABSORPTION SYSTEM**

While the first method is based on a determination of the ratio of couplings at a fixt audibility, this method is based on a determination of actual audibilities with a fixt coupling. This is the more accurate of the two methods. The receiver is connected to an audibility meter and the same set up used as in Fig. 6, the coupling between receiver and transmitter to be very loose, however, in fact at opposite ends of the room, or in another room. Using the receiver the secondary will pick up the transmitter signals. Receiver is tuned and coupling fixt and the audibility of the unmodulated chopped transmitted wave is measured by the audibility meter. Call this audibility A, which is proportional to the maximum amplitude for complete modulation. Keeping all conditions fixt, apply speech to the modulator and measure the audibility of the received speech, and call this B. The ratio of B to A will be the

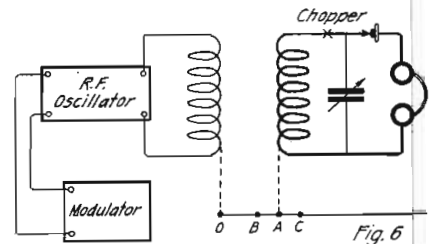

This Diagram Shows How an Audibility Meter is Used with a Radiofone to Determine the Percentage Modulation.

percentage of modulation.  $\frac{B}{A} = \text{do Modulation.}$

**(b) NON-ABSORPTION SYSTEM**

The same method is applied as above, but in figuring the ratio, it must again be noted that the audibility of the unmodulated wave is but one-half of that when complete modulation is obtained. Thus, if again we call the audibility of the unmodulated wave A, and that of the modulated wave C, the ratio of C to twice A will be the percentage

modulation.  $\frac{C}{2A} = \text{do Modulation.}$

These methods are quite simple, and easily applied. They have been tried and found to be quite satisfactory, giving results which check with those obtained by more reliable and accurate methods.

**Radio Telephony**

(Continued from page 24)

the two forming the insulator.

The different systems of radio telegraphy are simply the different methods of charging this enormous condenser, and the nature of the waves radiated from this condenser depends upon the kind of current which the particular charging apparatus supplies to the antenna. Thus, it is sufficient for wireless telegraphy to set up electrical currents in the antenna which can be regulated by a telegraph key, but for the



# Summertime Radio

NO NEED FOR YOU TO SHUT UP SHOP WHEN SUMMER COMES, THAT IS, IF YOU OWN A



## KT-1 PORTABLE



Licensed Under the Original Armstrong Patents.

At last here's the outfit that makes Summer radio work a pleasure.

Take it out into the country and send up a few hundred feet of antennae on a Grebe Radio Kite, and surprise yourself at its range.

Find out the range of your home station.

If you live near a body of water, procure a canoe or row boat and you have a ship station that sails under power of your kite.

Then, when Winter comes again, merely replace the CR-5 Regenerative Receiver in its cabinet and use it in your station for *real results*.

See it at your Dealer's, today!

Bunnell & Co., J. H., New York City.  
 Central Radio Company Inc., Kansas City, Mo.  
 Continental Radio and Electric Corp., New York.  
 Detroit Electric Co., Detroit, Mich.  
 Doubleday-Hill Electric Co., Pittsburgh, Pa.  
 Electrical Specialty Co., Columbus, Ohio.  
 Holt Electric Utilities Co., Jacksonville, Fla.  
 Hurlburt Still Electrical Co., Houston, Texas.

Kelly and Phillips, Brooklyn, N. Y.  
 Klaus Radio Company, Eureka, Ill.  
 Manhattan Electrical Supply Co., New York, Chicago, St. Louis.  
 Leo. J. Meyberg Co., San Francisco, Cal.  
 Newman-Stern Co., Cleveland, Ohio.  
 F. D. Pitts Co., Inc., Boston, Mass.  
 Philadelphia School of Wireless Telegraphy, Philadelphia, Pa.  
 Western Radio Electric Co., Los Angeles, Cal.  
 Hickson Electric Co., Inc., Rochester, N. Y.

**A. H. GREBE & CO., Inc., 72 Van Wyck Blvd., Richmond Hill, N. Y.**

# ASSURANCE

**Cast en Bloc  
 Moisture Proof  
 Ruggedly Built**



**Fully Guaranteed  
 Long Life  
 Silent Performance**

When you need a "B" battery and want to feel assured of long life and satisfactory service, buy the guaranteed STANDARD VT BATTERY.

Built into the STANDARD VT BATTERY is quality—every STANDARD VT BATTERY is a solid moulded unit of power that will give the service which you expect.

Reasonably priced, these batteries are offered to meet the pockets of all.

The next time you are in need of a "B" battery ask your dealer about the STANDARD VT BATTERIES, especially our No. 7600, which are now in the hands of the most reliable dealers throughout the United States and Canada.

Number	Description	Volts	Price
7623	SMALL TYPE UNTAPPED	22½	\$1.50
7625	LARGE TYPE UNTAPPED	22½	2.65
7600	LARGE SEMI-VARIABLE TYPE	16½-22½	3.00
7650	LARGE TYPE FULLY VARIABLE	1½-22½	3.50

DEALERS—Have you our literature and prices?

# PACENT ELECTRIC COMPANY, Inc.

LOUIS GERARD PACENT, President

Sole Distributors for

Wicony's complete line of "Eventual" apparatus

Pacient Plugs

Dubilier Condensers

Special distributors of Brandes Phones.

Sullivan Apparatus

Seibt Condensers

Duo-Lateral Coils  
 Standard VT Batteries

150 NASSAU STREET

Telephone Beekman 5810

NEW YORK CITY

## SOME "IDEAL" CW EQUIPMENT



Type MG-100

When a motor-generator is used in CW and Fone work a disagreeable hum is experienced from the commutator of the generator. When tube or electrolytic rectifiers are used to change high voltage A.C. to direct, the resultant current is slightly pulsating. To eliminate these difficulties it is only necessary to connect an Ideal Filter in the direct current leads.

Ideal Type MGF Filter.....\$15.00

The Ideal Motor-Generators were designed for vacuum tube work and rated voltage is delivered at full load, continuous service.

Are wick oiled and run at 1,750 rpm. Motors are run from 110 Volt 60 Cycle A.C., 110 Volt D.C. or 32 Volts D.C. Supplied with A.C. motor unless otherwise specified.

500 Volt 100 Watt .....	\$70.00
500 Volt 200 Watt .....	85.00
500 Volt 100 Watt Generator only.....	40.00
1000 Volt 200 Watt .....	150.00
1000 Volt 500 Watt .....	175.00

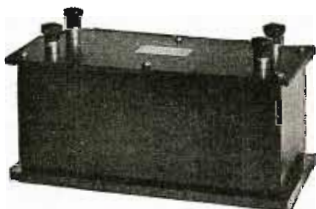

Type MGF

Amateurs: Send 10c for CW Catalog  
Dealers: Send for our Attractive Proposition  
**IDEAL APPARATUS CO., 1901 E. La. St. Evansville, Ind.**

## DO YOU MAKE YOUR OWN APPARATUS?

LOOK AT THESE PRICES

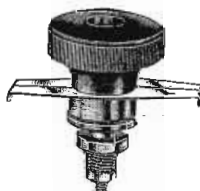

SP No. 2 80c ea.

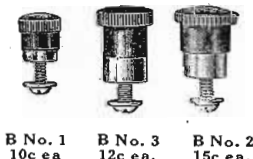

B No. 1 10c ea. B No. 3 12c ea. B No. 2 15c ea.



S No. 3 75c ea.



SP No. 1 80c ea.



S No. 1 50c ea.



S No. 2 75c ea.



C No. 1 30c ea.

SUMMER PRICES CUT.  
WESTERN ELECTRIC  
PHONES, \$12.  
ALL PARTS AT A DIS-  
COUNT.

DEALERS  
WRITE FOR PROPOSITION.  
STATE QUANTITY.

**American Electro Technical Appliance Co.**  
Dept. R 235 Fulton Street New York City



New! NEW! New!  
**Bunnell** MULTIPLE RHEOSTAT  
28 OHMS

"Bunnell Quality"

Sample by Mail, . . . . \$3.00

Get descriptive circular  
Send Stamp for Catalog 42 R.N.  
We Carry High Grade Radio Goods

**J. H. BUNNELL & CO.**  
32 Park Place New York

wireless telephone, these currents must be modulated by the human voice in order to produce speech at the receiving end. This is exactly similar to wire communication. In the telegraf, a continuous flow of current is made and broken with a telegraf key, while in the telephone, a microphone or transmitter, thru its varying resistance, modulates these currents to conform to the human voice.

It is interesting to note that in wire communication, the telegraf preceded the telephone, and so in Radio, Marconi's telegraf preceded by some years the Radio telephone, as we know it today.

The delay in the development of the Radio telephone is due to the fact that until recently we did not have a generating device which would produce oscillations regularly and continuously enough, so that no distortions would be introduced into the Radio telephone speech. The waves produced by the old time spark sets were so irregular that to superimpose voice currents on these spark waves would have produced an unintelligible jumble. The device which made the Radio telephone possible is known as the "audion" or vacuum tube.

This tube came into being as the result of an early discovery of Edison's, known as the "Edison Effect," and which consists of the radiation of electrons or minute electrical charges from an incandescent lamp filament. Fleming, an English scientist, made use of this phenomenon in a small gaseous rectifier, a development of which we find on the market in the form of the familiar "Tungar" rectifier.

It remained for Dr. Lee DeForest, of New York, to improve upon Fleming's work by the introduction of two electrodes into the ordinary electric lamp, thus producing what is known today as the three electrode audion, or vacuum tube.

The operation of these tubes is a little too complex to enter into here, but I may say that they are unique in that they play the three-fold rôle of detection, amplification, and generation. In other words, they will not only set up electrical oscillations at a transmitting station, but they will make them audible at a receiving station, and, in addition, and by a different process, will amplify them to almost any given strength.

The audion shown in Fig. 2 is used for transmission purposes and rated at 1/2-kw. capacity. As many as eight of these have been used in parallel, thus producing a 4-kw. transmitting set.

These tubes are exhausted to a very high vacuum and a potential of 1,500 volts D. C. is applied to the plate.

The DeForest Company has a 1-kw. telephone, using tubes of this type, installed at the California Theatre, in San Francisco, and by a suitably placed microphone, which is connected to a large horn and suspended in the "fly" galleries, the music is collected from the Herman Heller Orchestra and transmitted, three times a day, many hundreds and even many thousands of miles, to all wireless stations within range. It may interest you to know that an ordinary wireless telegraf receiver is capable of receiving wireless telegraf messages, so that all vessels within a suitable range from San Francisco are receiving two concerts a night from the California Theatre.

The radio telephone finds its greatest use in those places ashore where it is not economical to build a telephone line to connect two points, on account of the very small amount of traffic handled over such a line, so that power companies, and other large industries and public utilities which have widely separated plants or branches, have been installing radio telephones for communication. As an example, I may say that the Southern California Edison Company has recently purchased three sets, and other power companies are expecting to follow suit. During the War, radio telephones were installed on aeroplanes, battleships, and so on, and rendered very excellent service.



# use A-P tubes for efficiency

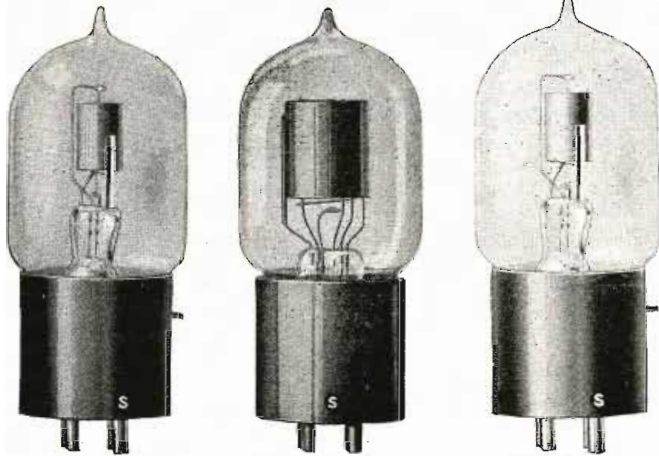

THE A-P VT  
AMPLIFIER-  
OSCILLATOR

—the amplifier used  
by the U. S. Navy.  
“Use the tube the  
Navy uses.” Price \$7.

THE A-P  
ELECTRON RELAY

—the most sensitive  
detector of spark signals  
known to the  
radio art. Price \$8.

THE A-P  
TRANSMITTER  
TUBE

—an efficient un-  
damped wave trans-  
mitter for use in radio  
telephony. Price \$7.50.

A-P Tubes are licensed by the Radio Corporation of America under the DeForest Audion and Fleming patents for amateur and experimental use in Radio communication.

Order from your dealer or write direct to

The Atlantic Radio Supplies Co., 8 Kirk Place, Newark, New Jersey

The Pacific Radio Supplies Co., 638 Mission St., San Francisco, Cal.

Distributors for Moorhead Laboratories, Inc.

## read this letter

A-P Tubes have been imitated but never equalled. Those who use them know. Scarcely a day passes but what we receive, unsolicited, enthusiastic testimonials similar to the following:—

Gentlemen:—“We have recently received a shipment of E.R.’s and Amplifier oscillator tubes. It is our policy to test out all tubes received, under actual operating conditions. They were absolutely the finest bunch of tubes we ever received. It is indeed a pleasure to be able to sit down and with a clear conscience write a letter stating that we are at last receiving really good tubes for the amateur.”  
THE PRECISION EQUIPMENT CO., 2437 Gilbert Ave., Cincinnati, Ohio, by H. F. Brickel, Vice-President.

And for the best book on Radio, ask your dealer for “Elements of Radiotelegraphy,” by Lieut. Ellery W. Stone, U. S. N.

# MAGNAVOX RADIO PRODUCTS

## HAND TRANSMITTER \$25.50

Magnavox special transmitter will modulate one ampere of voice current and enable you to cover maximum distance. To increase your transmitting range use this most efficient micro-phone.



## RADIO MAGNAVOX \$45.00

This instrument solves the loud speaker problem for all. With a 2-stage amplifier, signals voice or music will be reproduced loud enough to be heard over a large room or hall.

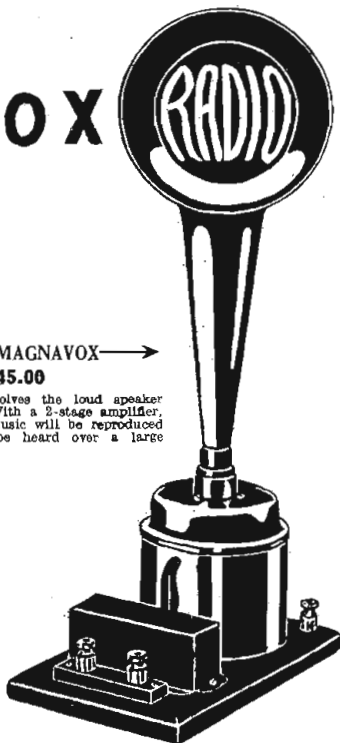

## MUSIC TRANSMITTER \$37.50

Use a Magnavox transmitting tone arm for efficient transmission of phonograph music over your Radio phone. Easily attached to any phonograph without removing the regular tone arm.

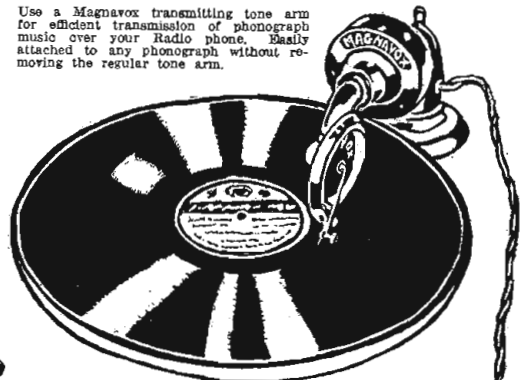

Immediate delivery. Order from your dealer or send remittance direct to the

**MAGNAVOX COMPANY**  
2725 E. 14th Street, Oakland, Cal.

Room 214-370 7th Avenue,  
Penn., Terminal Bldg., New York City

# THE STAMP OF APPROVAL!



We've won it men! The stamp of approval has been unreservedly placed upon CINO TUNERS in the last 60 days by the only men who are qualified to do so, when it comes to radio apparatus: The man who has been doing distance and who has established a record!

We know you don't like "patent medicine" testimonials, but would you like to correspond with real DX men and ask them what they think of this Tuner? Just drop us a line and

we will furnish you with a list of calls that will convince you!

Then let us have the distinction of being the first radio firm to show you what is meant by PERSONAL SERVICE! The Keystone of our success! The open door between your operating room and our laboratory.

We build C-W apparatus and stock all standard makes of radio accessories.

- CINO CT-1 TUNER \$50.00
- CA-2 AMPLIFIER \$40.00
- CD-1 DETECTOR \$18.50



**CINO RADIO MFG. COMPANY**

218 WEST 12th STREET  
CINCINNATI, OHIO

**RADIO  
8-XY**

## Mail Order Service That Satisfies Is What We Offer You

Think it over—instead of ordering your set from several different manufacturers, you can secure almost any piece of standard apparatus at list price from us. Orders filled and shipped within 24 hours. A few lines that we carry are: Amrad, DeForest, Murdock, Bunnell, Radisco, A-P, Federal, Brandes, Radio Corporation and others.

Send for Price List

**NORTHWEST RADIO SERVICE CO.**  
609 FOURTH AVENUE SEATTLE, WASH.

## MIGNON-SYSTEM WIRELESS TELEPHONE

Write for Literature describing  
LATEST DEVELOPED  
RADIO APPARATUS  
IT'S FREE

**MIGNON SYSTEM MFG. CO.**  
BUFFALO, N. Y., U. S. A.



"EVERYTHING IN RADIO"

**WESTERN RADIO ELECTRIC COMPANY**  
SEND FOR OUR MARCH  
STOCK BULLETIN AND PRICE LIST

550 South Flower Street

Los Angeles, Cal.

### ALKALINE STORAGE "B" BATTERIES

In oak cabinets, gives years of service without expert attention. Are not harmed from overcharging, short circuiting, or standing idle. Plain with clips, for single cell control, including rectifier, chemicals and directions. Thirty-two volts \$8.00; fifty volts \$10.00; sixty-eight volts \$12.00. Add 25% for batteries with control switches mounted in neatly engraved hard rubber panels. Pictures upon request.

**KIMLEY ELECTRIC COMPANY**  
No. 290 Winslow Ave., Buffalo, N. Y.

### PLATE BATTERIES

Always something doing with Ersoo Batteries on your plate.  
Ersoo No. 503 22½ volts.....\$2.00  
Ersoo No. 803 36 volts..... 3.20  
Black Fibre Panels, ¼x20x7..... 3.00  
Or cut to size .02½ per square inch.

**ECONOMY RADIO SUPPLIES CO.,**  
232 Sanford Street East Orange, N. J.

## Short Wave Tuning Systems

(Continued from page 18)

This type of variometer is particularly adaptable in that the same diameter of tube may be used for a great variety of inductance ranges by simply increasing or decreasing the length. It may be made very short providing it is not so short that the parallel inductive fields set up by the opposite sides of the windings are not too closely interlinked. It is possible to make a variometer of this type of inductance range that would be out of reason in the roundtype. After winding, it is better not to shellac or varnish the windings, as they are in no danger of shifting position. However, if the long form of tube is used, it will be well to band the windings with silk thread, not unlike the way in which the armature of electro-plating generators is banded with tinned steel wire. Leaving off the usual coat of insulating liquid will keep the inherent capacity of the windings at a minimum and allow shorter wave-lengths to be received. (This ought to offer a few suggestions to our 50 meter Canadian friends.)

As regards the kind of wire to be used in winding the coils, Litzendraht is not to be recommended. Rather use double or single cotton covered wire. True, the high frequency resistance of Litzendraht is comparatively low, but its use increases the capacity of the windings greatly due to the enamel which has such a high inductivity. This is also the opinion of Mr. R. H. G. Matthews, of the Chicago Radio Laboratory, who has had as much experience with regenerative sets as any one in that section of the country. About the best winding ever tried on a variometer had its conductors composed of many fine strands of bare copper wire contained in a silk sleeve. This gave much less high frequency resistance, due to the great surface area offered, yet did not have the drawback of being coated with an insulator such as is Litzendraht. This wire may be obtained from Belden, the American Wire Co., or most any other concern that caters to the manufacturers of standard electrical machinery.

Many types of variometers may be worked out successfully by experimenters, if they simply keep in mind that at minimum inductance, the inductive fields of the two windings must be opposed to each other, while for maximum inductance, they must assist each other.

Variometers made with figure eight coils are not as efficient as the other types, due to their greater capacity properties and also the fact that more wire must be used to arrive at a desired inductance value, thereby increasing the high frequency over that of the other types.

The type of mutual variable inductor in most general use is the ball type and, as many of us know, requires a great deal of patience to construct. The rotor is easy enough to wind, but the winding of the stator must be made on a form, shellacked so that it will hold shape and then be set into the stator frame and made fast with more shellac. Many variometers progress only as far as the stator windings and are then consigned to the "junk box." A very good method to surmount the difficulty is to first wind the rotor and then cover it with a layer of friction tape, allowing one end to stick over a few inches when thru. Now wind over the tape a layer of stout cord about ¼" in diameter, again allowing an end to stick out. Refer to the tape again and cover the cord smoothly and very tightly. Take a look at Fig. 4 before going any further. This shows in exaggerated cross-section the different layers of wire and tape.



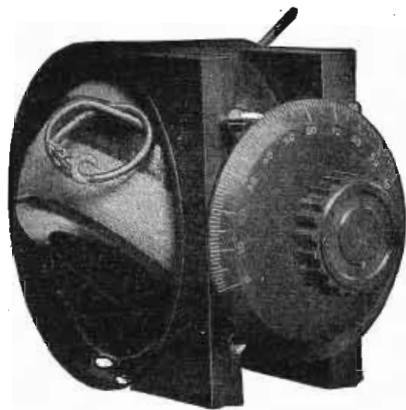

**The Variometer**

The now famous Z. R. V. Variometer has met with a tremendous sale to *thousands* of discriminating purchasers who know the quality of Clapp-Eastham products.  
 Complete with knob and dial...\$6.50  
 Complete without knob & dial 5.75  
 Variocoupler to match, with knob and dial..... 7.50

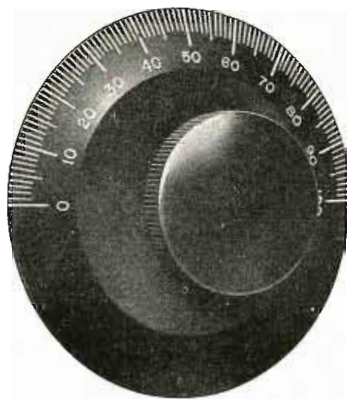

**The Dial**

This 3" knob and dial is our own product, heavy brass dial, black oxidized finish, composition knob 1 3/8" diameter. Supplied for 1/8" shaft only. This dial can not chip or warp and *will run true*. Its beauty is in keeping with the best products of the instrument maker.  
 Price, Dial & Knob F800H complete .....\$ .75  
 No. 19 instrument switch to match above .....1.00

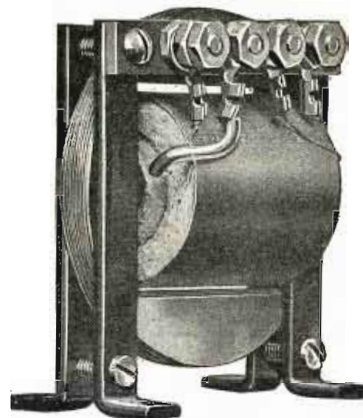

**The Amplifying Coil**

Our amplifying coils are distinctly different in design and their remarkable power of amplification with the tubes at present on the market can be testified to by several thousand satisfied users. You need not experiment with untried products unless you want to.  
 Type Q. O. Amplifying coil as illustrated .....\$4.00

*Complete Catalogs Sent for 6c Stamps*

Patronize your local dealer: If he won't supply our material your order will receive immediate factory attention.

**CLAPP-EASTHAM COMPANY**

120 Main Street

Cambridge, Massachusetts

HEADQUARTERS FOR RADIOTRON TUBES. ALL TYPES IN STOCK

**PARAGON**

MEANS

**"A PERFECT MODEL OF EXCELLENCE"**

AND IT IS FOUND ONLY ON

RHEOSTATS  
 RECEIVERS  
 V. T. CONTROLS

CONDENSERS  
 VARIOMETERS  
 DIALS

DETECTORS  
 KNOBS  
 SOCKETS

SWITCHES  
 AND OTHER  
 SPECIALTIES

*Manufactured by*

**ADAMS-MORGAN CO.**

**No. 70 Paragon V. T. Control**

A compact control panel consisting of a standard socket, rheostat, grid condenser, grid leak and nine binding posts mounted on a moulded condensite panel. Polished nickel metal parts. A high-grade inexpensive instrument that will do as good work as the highest priced cabinet.

Price - - - \$6.00

**No. 25 Paragon Rheostat**

For either panel or table mounting. Moulded condensite base. Resistance six ohms. Smooth operation. Capacity 1 1/2 amperes. The highest grade rheostat on the market.

Price - - - \$1.75

**MOST ENTERPRISING DEALERS CARRY PARAGON PRODUCTS AS REGULAR STOCK.**

*Illustrated Bulletins will be mailed upon receipt of a two cent stamp. Send us your dealers name.*

**ADAMS-MORGAN CO.**

UPPER MONTCLAIR

NEW JERSEY



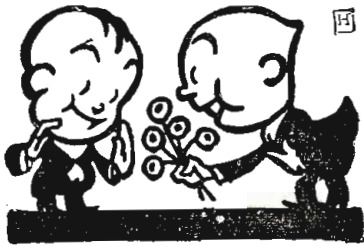

When it comes to handing out bouquets—

Our customers tell us that they can't beat Kelly & Phillips for quick delivery, quality goods and right prices.

But that's the reward for "On the Job" service,—satisfaction guaranteed.

Anything and everything in radio goods. Send 25 cents for 200 page catalog.

Radio Department

# KELLY & PHILLIPS

312 Flatbush Ave., Brooklyn, N. Y.

## Miraco Radio Parts

We have the parts for that set you are building  
Prices in Tune with the Times

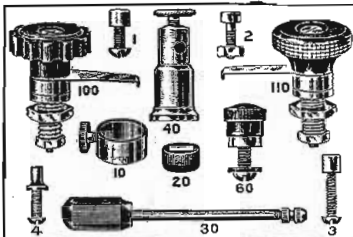

No.	Description	Price
1	1/4" x 1/4" contact point	.04
2	1/2" x 1/4" contact point	.05
3	7/32" x 7/32" contact point	.05
4	Switch stop	.06
10	Crystal detector cup, 5/8" diam.	.35
20	Tested Galena in Woods alloy	.40
30	Detector rod with chuck	.35
40	Detector binding post	.35
60	Blinding post with hard rubber top	.12
100	Switch lever, heavily knurled knob	.60
110	Switch lever, finely knurled knob	.60

All above parts polished nickel

Postpaid Immediate delivery

CATALOGUE FREE

MIDWEST RADIO COMPANY

3423 Dury Ave., Dept. A, Cincinnati, Ohio

### LATEST AND BEST BOOKS ON WIRELESS

Design data for Radio Transmitters and Receivers; Construction of a Trans-Atlantic Wireless Receiving Set; Radio Time Signal Receiver; Radio Hook-Ups; and many other subjects of special interest to the radio man. All books illustrated and postage prepaid. Send for free illustrated circular.

D. ALTMAN COMPANY  
223-225 East 110th Street New York, N. Y.

Now take the wire that was intended for use in the stator and wind it over the last layer of tape, as if a new rotor were being wound. As a further relief we can see that it is not necessary to turn a wooden form for the stator. A simple, square, wooden frame is all that is required. It is like a bottomless box. Put a brass bearing in either side of it and shove the shaft thru the wound rotor, thus centering it. Make these bearings sufficiently long so that they will bear from both sides on the frame of the rotor. The rotor must be of the same thickness as the frame for the stator. Lay this assembly on a flat surface covered by a sheet of greased paper. Melt up a pot of sealing wax or red battery compound and pour it in the space between the rotor and the frame, filling it to the top. Smooth off the surface with a hot knife. Allow this to set, and look around for the free end of the cord that should have been left out. Give it a slow, steady pull and it will soon be entirely out. Then pull the tape off from both windings. All that remains to be done now is to affix the knob and dial and the instrument is complete. If it is desirable to make a stator that may be removed from around the rotor, it is only necessary to make the rotor and the stator in two parts each and follow the same process of manufacture. This idea is accredited to Mr. M. B. West, of Amateur Radio fame. As many of you will remember, Mr. West operated 8AEZ prior to the war. No dimensions or winding data are given in this article as the real amateur does not want anyone to work out all his details for him.

Coupling coils for the set under construction can be made in the same way as the windings shown in Fig. 1, and thus made will occupy a minimum of space and present a very neat appearance.

#### TRANSMITTING CIRCUITS

This same general scheme may be carried into transmitting circuits and a quick change of wave-length is thereby made available in case of QRM on any particular wave. In vacuum tube transmitting circuits, the windings should be of heavy Litzendraht, as here high frequency resistance is very undesirable. If the operating voltage justifies it, it is a good plan to notch the ends of the winding forms and space the windings.

The rotor windings may be used in the open or antenna circuit, while the two halves of the stator may be used, one in the plate circuit and one in the grid circuit. Separate variable condensers would be used in this case.

Countless arrangements of tuning elements should suggest themselves to the serious builder, in which some of the apparatus described could be used to advantage. Simplicity and solidity of construction cannot be too much urged. Sliding contacts should be avoided, all joints soldered with the help of a non-corrosive paste or resin-core solder. All leads should be run in "Empire Cloth" tubing and supported by "Formica" or "Bakelite" strips when necessary. Dead-end switches should be used when the inductances are tapt. Remember that the prettiest and most sensible job is that which is plainest and constructed with the greatest care.

### I Want to Know

(Continued from page 36)

desires information:

Q. 1. Kindly tell me if the audibility of the incoming signal can be increased by the use of a battery and potentiometer in conjunction with a galena detector and 3,000 ohm fones.

A. 1. The use of a battery and potentiometer does not practically increase the sensibility of a galena detector, but is used to advantage with a carborundum detector.

### SECOND INTRODUCTORY OFFER

#### of the Bronx Radio Equipment Co.

687 Courtlandt Ave. BRONX, N. Y.

Variometers and Variocouplers same as advertised at \$7.50 and \$8.50.  
Our price ..... \$6.75  
Real Two Step Amplifiers—Size of panel—11 1/2" x 7 1/2". Old English Oak Cabinet. Shipping weight—packed—15 lbs. Price each..... 50.00  
Regular stock size amplifiers—5 1/2" x 8" panel. Price each..... 40.00  
Containing: Federal transformers, plugs and jacks, Paragon rheostats—XX Bakelite.  
Special 6 Volt—60 Ampere Storage Battery, price each..... 12.35  
B Batteries—Small Type..... .95  
B Batteries—Large Type..... 1.75  
Navy type electrose insulators, 7 1/2" length, 1/2" column, complete.... .50  
Navy type ball electrose insulators, 8" length, 5" diameter, complete. .60  
Estimates furnished on receiving, transmitting and phone sets built to your specifications.

FULL LINE OF ALL STANDARD MAKES OF RADIO APPARATUS

## Canadian Amateurs

### ATTENTION

It will save you \$\$\$\$ to keep in touch with us.

We give you QUALITY, SERVICE, and a SQUARE DEAL.

### Brown's Famous Receivers

used by, The Admiralty, Air Force, Foreign and Colonial Armies and Navies. Tests lately made show an efficiency of three times that of any other telephonic head gear.

4000 Ohm ..... \$19.25  
8000 Ohm ..... 20.50

Shipping weight 2 lbs.

Send .05c for our list

THE VIMY SUPPLY CO.  
567 College Street TORONTO, ONT.

### IMMEDIATE DELIVERY

on any standard make of Radio Apparatus. Chicago and Middle West distributors for:

Acme	Clapp-Eastham	Federal
Amrad	Radio Corp.	General Radio
Brandes	DeForest	Grebe
Burgess	John Firth	Murdoch
Chelsea		Thordarson

Complete stock—every order shipped same day it is received. New, big catalog ready soon; send now for free bulletins. Blue Print of Radio Telephone and C.W. Transmitter for 10c.

Chicago Amateurs—Come and see our new Radiophone in actual operation.

CHICAGO RADIO APPARATUS CO., Inc.

50 So. Dearborn St. (Room 210) Chicago, Ill.



The Midget "FIVE-IN-ONE" Slide Rule is a combination Mannheim, Log-Log, Add and Subtract, Polyphase and Binary Slide Rule. It will instantly add, subtract, multiply and divide any combination involving whole numbers, fractions, decimals and mixed numbers. Gives every possible root and power of every quantity. The graduations are printed on metal coated with white celluloid and are grease and waterproof. While it is the most versatile calculator

ever invented, its operation is simple and easily understood. Diameter 4". Price with 16-page Instruction Book, \$1.50. Leatherette carrying case 50c extra. Catalog free. Your money back if Gilson Slide Rule Co., Niles, Mich you are not satisfied.

You can be quickly cured, if you

## STAMMER

Send 10 cents for 288-page book on Stammering and Stuttering, "Its Cause and Cure." It tells how I cured myself after stammering 20 yrs. B. N. Bogus, 812 Bogus Bldg., 1147 N. Ill. St., Indianapolis.



*If it's a Radiophone it's a DeForest Invention*  
**A New Idea In Radio—A C.W. Design**

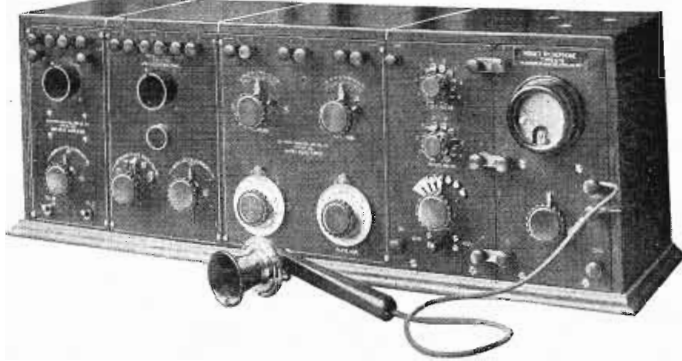
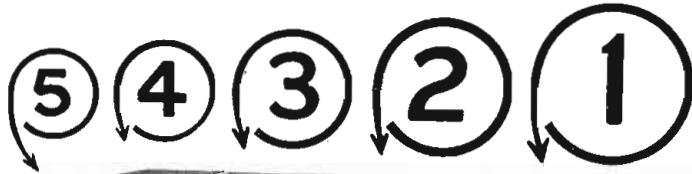

Complete set of four units mounted vertically.

- (1) Complete radio "midget" transmitter Phone sending range 30 miles (UT-3).
- (2) Complete short wave tuner, 150 to 600 meters (MT-100).
- (3) Complete audion control, especially for standard gaseous tubes (MP-100).
- (4) Complete one-step amplifier (MP-200).
- (5) Any additional step of amplification may be added.

# Radiophone "Interpanel" System

*For Commercial and Amateur  
 Telephone & Telegraph Service*

The "Interpanel" System marks an advance in radio apparatus design equal in importance to C.W. for transmission.

The "Interpanel" System has all the convenience and expandability of sectional book cases.

Each panel is only 9 inches high. Each panel mounts a *complete apparatus*. Each panel gives a minimum amount of space to the apparatus. Each panel gives all the space the apparatus requires. The panels lend themselves to stacking in any position and in any direction.

Two panels make a complete listening station.

The panels may be added one by one to increase the range of your station.

*Get the "Interpanel Idea." Send for catalog 77*

**De Forest Radio Telephone & Telegraph Company, 1415 Sedgwick Avenue, New York City**

*Inventors, Licensers and Manufacturers of Highest Grade Radio Apparatus*

# "INSULATE"

**MOULDED COMPOSITION  
 ON THE MARKET 20 YEARS**

ALSO  
**'Hi Heet'**  
 SYNTHETIC-PHENOL  
 Moulded - Compositions



**100** } Different Style Knobs, Binding Posts,  
 etc. In Stock in Quantities for  
 Immediate Shipment.

**WE SELL THE TRADE ONLY. NO RETAIL ORDERS TAKEN**

**GENERAL INSULATE COMPANY**

**999 Atlantic Avenue, Brooklyn, N. Y.**

Trade Mark



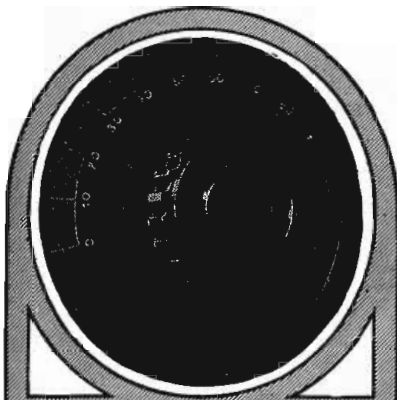

## CORWIN DIALS

It is not particularly to Corwin's credit that Corwin Dials are the best on the market. With their experience and volume of sales, it would be to their shame if Corwin Dials were any less Perfect.

3<sup>1</sup>/<sub>2</sub>" Dial, 75c; with knob, \$1.30  
3<sup>7</sup>/<sub>8</sub>" Dial, \$1.00, with knob, \$1.70

*At all Radisco Agencies,  
and other reliable dealers  
or sent postpaid anywhere.*

**A. H. CORWIN & CO.**  
4 West Park St., Newark, N. J.

## Special Price Reductions

Paragon Control Panel with Radiotron Tube	\$10.50
Audiotron Tube, Two Filaments	5.50
Radiotron Detector Tube with .0005 mf. Grid Condenser	5.00
Murdock 2000 Ohm Wireless Head Sets	4.00
Murdock 3000 Ohm Wireless Head Sets	5.00
Wireless Practice Sets	2.70
Nickle Plated Binding Posts, per doz.	.80
Rubber Cap Binding Posts, per doz.	1.00
Cyclone 22.5 Small B. Battery	.98
Cyclone 22.5 Large B. Battery	1.75
No. 766 Eveready Large B. Battery	2.75
No. 703 Eveready 4.5 volt Batteries	3.25
Chelsea Dial and Knob with Paragon Rheostat	2.50

### MARKO STORAGE BATTERIES

6 volt 20 to 40 Amp.	10.95
6 volt 40 to 60 Amp.	16.00
6 volt 60 to 80 Amp.	20.00

Prompt Attention Given to Mail Orders.  
The Above Prices Are F.O.B. New York.

Hygrade Electrical Novelty Co.  
41 W. 125th Street New York

## AMATEURS!

Use the apparatus

### 8 Z R

uses. The apparatus that makes possible transcontinental transmission.

*Write for a bulletin  
describing this apparatus*

**The American Radio Sales and Service Company**

Great American Bldg. Mansfield, Ohio  
Testing Station 8 Z R

## Experimental Measurements and Calculations

(Continued from page 21)

800 meters we have 16 turns with 10 in the loading coil. If we find that we must move our coils further apart on the 800-meter setting than on the 600-meter setting to obtain maximum radiation, it means that the mutual inductance on the 800-meter setting is too strong and we must take out of the secondary a few turns, say two turns, and place them in the loading coil. This reduces M and also K. This procedure is followed until the maximum radiation on all tunes is obtained with the two coils spaced the same distance apart, this is termed "constant coupling." In some cases due to the antenna values present it is not possible to obtain this constant value of coupling over a wide range of wave-lengths, but in most cases it may be had and is an advantage in operation.

## Triple Inductance Coil Mounting

(Continued from page 26)

Next, the flexible leads were passed thru the back F, and led down to the binding posts P.

Finally, the front piece was fastened in position and the case was completed.

The mounting has a neat appearance, is small, compact and the gears being enclosed in the case, are dust-proof.

If at any time I wish to examine the gears or oil them, all that has to be removed is the front piece C.

I found that it was much cheaper to make this type of inductance mounting than to buy any of those now on the market, as the cost of constructing same was something less than three dollars.

## Correspondence from Readers

(Continued from page 34)

in your Magazine. I fully agree with Mr. Grimm in believing that these stories are becoming a detriment to your good paper.

The average distance-speaker (or radio enthusiast of today is inclined to be of a serious temperament and awaits the arrival of your Magazine with a certain degree of anticipation regarding the technical and practical knowledge which it will contain. This anticipation and eagerness of the enthusiast is directly stimulated by the resulting improvements to his particular instrument, thru some article of your publication, rather than by some impossible story.

My assumption may be that of an absent minded professor having little regard for the amusement of the younger generation; however, I should like to read further comments on this subject in your paper.

I wish to congratulate your good Magazine upon the excellent up-to-date Radio Data which it is continually publishing.

A. H. DREESNER,  
Dept. Mechanical Engineering,  
Connecticut State College,  
Storrs, Conn.

## Crystal Amplifier

(Continued from page 17)

am pleased to say the results are wonderful.

The detector consists of old fuse, cartridge type with fiber removed for glass, the galena being fixt with dentist's lead stopping and allowed to set for a day. The rest is understood.

## Reynolds Radio Specialty Company

The Largest Exclusive Wireless Supply Store in this section of the Country.

We carry a large stock of the following radio supplies and can make immediate delivery.

AUDION BULBS	CRYSTAL DETECTORS
SOCKETS	MOUNTED & UN-
RHEOSTATS	MOUNTED CRYSTALS
PHONES	DIALS
CONDENSERS	BUZZERS
TUNING COILS	AMPLIFYING TRANS-
COUPLERS & VARIO	FORMERS
COUPLERS	PLUGS & JACKS
LIGHTNING GROUND	SWITCHES, POINTS &
SWITCHES	BINDING POSTS
DEFOREST COILS	DE FOREST UNIT
COTO COILS	PANELS
MOTOR GENERATOR	PRACTICE SETS
KEYS	WIRELESS BOOKS &
METERS	MAGAZINES

Complete Stock of De Forest, Murdock, John Frith and Clapp Eastham Supplies.

Our "Reynrad" Short Wave Coils are the best thing on the market. \$2.00 each.

Send 2 cent stamp for bulletins

**REYNOLDS RADIO SPECIALTY CO.**  
613 19th Street Denver, Colorado

## RADIO

TELEPHONE & TELEGRAPH APPARATUS OF MERIT

K20A Rotary Enclosed Gap	\$25.00
K20B Same without motor	20.00
K1 Open Rotary Gap	16.00
UV200 Radiotron Detectors	5.00
UV201 Radiotron Amplifiers	6.50
UV202 5-Watt Transmitter	8.00

Send 4c for our 55-page Catalog.  
Full of illustrations, information  
and prices that will prove attractive

## KARLOWA RADIO CO.

611 Best Bldg., Rock Island, Ill.

## CHALLENGE "A" BATTERY

(JOHNSON PROCESS)



Size of each cell 8 3/4 high x 6 3/4 wide x 2 1/4 long over all.

NONE BETTER

Price in sets of three cells (6 VOLTS) \$11.48

Challenge Battery Co., 16 W. Illinois St., CHICAGO, ILL.

## NEW ORLEANS RADIO

APPARATUS and SUPPLIES

ROSE RADIO SUPPLY

604 Gravier St., New Orleans, La.

Send 10c for Latest Catalog

## TELEGRAPHY

(Both Morse and Wireless) and RAILWAY ACCOUNTING taught thoroughly and quickly. Big salaries now paid. Great opportunities for advancement. Oldest and largest school; established 46 years. Endorsed by Telegraph, Railway, Radio, and Government officials. Expenses low—opportunities to earn large portion. Catalog free.

DODGE'S INSTITUTE

D Street, Valparaiso, Ind.





# KEYSTONE WIRE

Wire for every wireless purpose

## MAGNET WIRE

We are prepared to furnish best grade magnet wire on 1/4 and 1/2 lb. spools at the following revised prices:

B&N No.	PRICE PER 1/4 LB. SPOOL			
	Single Cotton	Double Cotton	Single Silk	Enameled
4	.60	.77	.67	.47
26	.85	.88	.71	.49
28	.75	1.10	.85	.52
30	.85	1.24	.97	.53
No. 32			1.15	.55
No. 34			1.52	.59
No. 36			1.77	.69

Price on 1/2 lb. spools double above list.  
All prices are net and include cost of spool and delivery charges via Parcel Post to any Post Office address in the United States; safe delivery guaranteed. Send for Circular 21-A giving prices on other sizes, insulations and quantities of Magnet Wire. This circular lists "WIRE FOR EVERY WIRELESS PURPOSE."

**KEYSTONE WIRE COMPANY**  
P.O. BOX 120 SCRANTON, PA.

## RHAMSTINE RADIO PRODUCTS

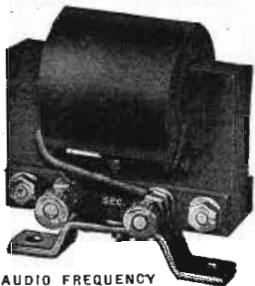

AUDIO FREQUENCY  
**AMPLIFYING TRANSFORMER**  
Mounted \$3.50

ADD 10c FOR POSTAGE AND PACKING  
Successfully combined with the new tubes and attractively designed and finished—the Rhamstine Transformer is rapidly gaining in popularity. It is the transformer of the day.

Most supply houses carry them in stock, or immediate shipments direct.

Manufactured by  
**J. THOS. RHAMSTINE\***  
2152 E. Larned St. Detroit, Mich.  
Dealers write for discount

\* Plugs and Jacks—Amplifying Transformers.

## AMATEURS

Our stock of CW and Spark Radio apparatus is complete. Send us your order and it will be filled same day it is received.

**T & H RADIO CO.**  
ANTHONY, KANSAS

## PLUGS

Cut from solid stock, not moulded. Nickel plated inserts forced in. Can be used for repairing old or making new mountings.

**A. K. LAING, RADIO SUPPLIES** PELHAM MANOR NEW YORK



The most remarkable thing, and one which I frankly can not explain, is that the other two crystals must be different from the first; I myself using Silicon on amplifiers, Galena positively refusing to work in this case.

I have come to the conclusion this is due to different resistances of crystals.

Well, let the other radio bugs have a shot, and see if they can perfect this, as I should be extremely interested in hearing about same, and any little new stunt I hit upon I will forward to RADIO NEWS with pleasure.

## A Safety Fuse For U. T.'s

(Continued from page 13)

self. The fuse wire is soldered to the two brass parts and is inserted in a groove made in the wall of the insulating tube.

This little device is really useful and will certainly save a great number of tubes that would otherwise go dead in a very short time.

## New Inter-Tube Tone Frequency Amplifying Transformer

(Continued from page 13)

multi-stage amplifier. Such a circuit using two stages of tone frequency amplification is shown in Fig. 1.

In many radio receiver circuits, it is of great advantage to connect a vario condenser from the plate of the detector tube to the negative side of filament, as shown by the dotted line at C. It is also frequently advisable to ground the point shown by the dotted lines at G in order to obtain complete stability and eliminate inductive noises, altho it is possible that noisy operation may be caused by run down batteries, loose connections and faulty adjustment of the amplifier.

If the Radiotron amplifier U. V. 201 is used in the circuit of Fig. 1, a plate potential of from 40 to 100 volts may be used, the resultant amplification increasing with the voltage; 40 volts, however, is sufficient for ordinary purposes. When using 100 volts on Radiotrons U. V. 201, the plate current is approximately 5 milliamperes, and if this voltage is used, the polarity of connection to the telephone receivers should be such as to increase the magnetization of the permanent magnets rather than to decrease it. Using Radiotron U. V. 200, as a detector, the plate voltage should be adjusted to some value between 18 and 22 1/2 volts.

It is highly essential to connect the transformer terminals as marked and as shown in Fig. 1. Transformer terminal marked "G" must always be connected to the grid of the next tube.

In all radio amplifier circuits using this transformer, the insulation of all apparatus connected to the secondary must be as perfect as possible. Leakage from the grid to the filament of amplifier tubes, thru the socket, mounting, panel, wiring, or otherwise, will decrease the amplification. The lead from terminal "G" should be kept reasonably short, but in cascade amplifier sets adjacent transformers should not be mounted too close; a separation of at least three or four inches should be allowed.

R<sub>1</sub>, R<sub>2</sub> and R<sub>3</sub> are the filament control rheostats, and R<sub>4</sub> is a special "A" battery potentiometer.

The circuit diagram here given has the

## Canadian Radio Experimenters

SPECIAL

### Radio Storage Batteries

40 Ampere hour, 6 volts.....	\$22.00
60 Ampere hour, 6 volts.....	25.00
Baldwin Telephones, Type C.....	24.75
Brands Telephone, Superior.....	12.00
THI.....	18.00
NEL.....	21.00
Murdock Telephones, 2,000 ohm.....	6.00
3,000 ohm.....	7.20

Lateral Coils to order.  
Inductances for Wireless Telephone.  
Milliammeter and Hot Wire Meters.  
Vario-Couplers and Variometers..... 4.25  
Transmitters for Radio Purposes... 3.50  
LOOK LOOK LOOK  
1/2 HP 110 volt 25 cycle Menominee Motors..... 30.00  
1/5 HP 110 volt 25 cycle Menominee Motors..... 25.00  
1/10 HP 110 volt 25 cycle Menominee Motors..... 20.00

Send 5c for 30 page catalogue

**J. M. PAQUIN**  
The Electrical Shop  
787 Queen St., West, Toronto, Ont.

## WINO BATTERIES

For Use With Radio Apparatus

BUY DIRECT FROM MANUFACTURER

6 Volt—40 ampere hour.....	\$13.40
6 Volt—60 ampere hour.....	15.58
6 Volt—80 ampere hour.....	19.85

War Tax included—Express prepaid.

Fully Guaranteed.

Send Postoffice or Express Money Order.

**The Wino Manufacturing Co.**  
717 Sycamore St. Cincinnati, Ohio



## AJAX LEARNERS KEY & BUZZER SETS

"built for service" with code \$1.75  
"HYTONE" BUZZERS 60c

external tone adjustments  
"as good as the best"

Postpaid  
**AJAX ELECTRIC CO.**  
Palmer St. Cambridge, 33, Mass.

# STAMMER

If you stammer attend no stammering school till you get my large FREE book entitled "STAMMERING, Its Origin and The Advanced Natural Method of Cure," bound in cloth and stamped in pure gold. Ask for special tuition rate and a FREE copy of "The Natural Speech Magazine." Largest, best equipped and most successful school in the world for the cure of stammering, stuttering, etc. No sing-song or time beat. Write today. The North-Western School, 2366 Grand Ave., Milwaukee, Wis.

## CONNECTICUT RADIO EQUIPMENT

Variable Condensers, Transmitters, Head Bands, Panel Switches, Etc.

Connecticut Tel. & Elec. Co., Meriden, Conn.



## LEARN WIRELESS

at the largest radio school in the Central States. Modern complete equipment. Experienced instructors. Dormitory in connection. Students may earn expenses if necessary. Write today for catalogue and full information.

**CENTRAL RADIO SCHOOL**  
Independence, Mo



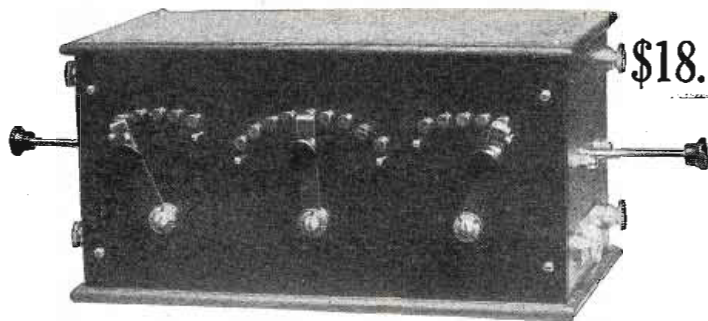

**\$18. A Wonderful Regenerative Tuner for Amateur, Commercial and Radio Phone Stations**

This tuner is absolutely the biggest value ever put on the market for only \$18.00. It reduces body capacity and other interference to a minimum. It does all that any tuner can do. It does more than other tuners on the market costing much more. It is the very best obtainable for radio phone work. It is enclosed in a handsome quartered cabinet with hard rubber panel. Dimensions 11 1/4 x 5 1/2 x 4 1/2 inches.

Mr. William G. Jackson, 13 Ave., Syracuse, N. Y., says: "I have heard distinctly the phone from both Washington and Pittsburgh without interference. My aerial is in the attic and I am using the one bulb 'sent me'."

**The Top of Radio Tuners for Long Waves—Tested and Won Out With Many Points In Its Favor**

It has been tested beside other tuners and showed many points in its favor when receiving from 2,000 to 20,000 meter stations. It is the product of thousands of experiments, years of experience and a thorough knowledge of radio tuners. Its tuning range includes everything from Arlington time signals to the largest stations in use in this country and across the great deep, the foreign countries. It brings in signals as clear as a whistle. It is very selective and efficient. You must use it to appreciate its worth. Dimensions 10 3/4 x 10 1/4 x 5 3/4 inches.

Price in quartered oak cabinet.....\$34.50  
Price with hard rubber panel..... 40.00

"I consider your New Long Wave Tuner a marked improvement over older type. The easy and selective tuning, makes this new apparatus a very satisfactory receiving instrument. Theodore W. Case, Case Research Laboratory, Auburn, N. Y."

Send a 2-cent stamp for bulletins

**COLBY'S TELEGRAPH SCHOOL, Auburn, N. Y.**

**\$34.50**



**THE THIRD EDITION OF THE CONSOLIDATED RADIO CALL BOOK**

**Very Greatly Enlarged — 192 Pages 32 pages more than 2nd edition, better paper, stiff covers, etc.**

**READ WHAT SOME OF THE PURCHASERS SAY**

S. S. Newton April 26, 1921, Claremont, Va.  
Gentlemen:—Rec'd your new call book yesterday. It is fine. Many thanks. Sincerely, T. T. Scholey, Rdo. Elec.

Mattituck, N. Y.  
Dear Sirs:—Received my call book to-day and it is well worth the waiting I did for it. Thanks. Yours truly, Louis C. Gildersleeve, April 28, 1921.

Buckhannon, W. Va., April 25, 1921.  
Gentlemen:—I have received my copy of the Call Book Third Edition and I want to thank you for it. I must say that it is wonderful and I would not want to be without a copy. Yours truly, W. M. Oliver, P. O. Box 127.

Some of the special information contained in the new book: Radio rate sheet (charges to and from vessels, etc.); Cable rates; Table for finding cable charges to various points; Weather reports and hydrographic reports of the world; Time signal section of the world; American, French, British and Canadian radio compass stations; General information section; International abbreviations; High power radio stations of the world; Press schedules of spare stations. The only book in print officially listing all the Radio calls as issued by the Bureau of Commerce. Every vessel and land station in the world is listed alphabetically, according to names of vessels or land stations, and according to call letters; Revision of American coastal stations under U. S. Naval control, and their new calls.

**Every New Amateur Call Is Listed**

**SPECIAL—Wireless Map of the World in Colors Given FREE With Each Copy**

**Price \$1.50 Prepaid**

Either Direct from us or for sale by the following responsible Dealers:



- American Electro Tech. Appliance Co.
- American Hardware Stores, Atlantic City, N. J.
- Bamberger & Co., L., Newark, N. J.
- Benwood Specialty Co., St. Louis, Mo.
- Brodie Electric Co., Los Angeles, Cal.
- Bunnell & Co., J. H., San Francisco, Cal.
- California Electric Co., Honolulu, T. H.
- Caton, Neill & Co., Independence, Mo.
- Central Radio Co., Chicago, Ill.
- Chicago Radio Apparatus Co., New York City
- Continental Radio & Electric Corp., New York City
- Cutting & Washington Radio Corp., Detroit, Mich.
- Detroit Radio Laboratories, Detroit, Mich.
- Dewey Sporting Goods Co., Milwaukee, Wis.
- Doubleday-Hill Electric Co., Pittsburgh, Pa.
- Electro Importing Co., New York City
- Findley Electric Co., Minneapolis, Minn.
- Fuller Co., Seth W., Boston, Mass.
- Gurd & Co., Wm., London, Canada
- Hico Wireless Supply Co., Marion, Ill.
- Holt Electric Utilities Co., Jackson, Fla.
- Jenkins, Lester I., New Bedford, Mass.
- Katzenbach & Co., F. S., Trenton, N. J.
- Kendall Co., W. D., Worcester, Mass.
- Kilchoh Co., David, New York City
- Kluge, Arno A., Los Angeles, Cal.
- Krause & Co., A. F., Detroit, Mich.

- Lehigh Radio Co., Philadelphia, Pa.
- Linze Electrical Supply Co., St. Louis, Mo.
- McCarthy Bros. & Ford, Buffalo, N. Y.
- McClurg & Co., A. C., Chicago, Ill.
- Manhattan Electric Supply Co., New York City
- Meter Electrical Construction Co., Oshkosh, Wis.
- Meyberg Co., Leo J., San Francisco, Cal.
- Mohawk Electric Supply Co., Syracuse, N. Y.
- New Era Shop, Milwaukee, Wis.
- Newman-Stern Co., Cleveland, Ohio
- Nola Radio Co., New Orleans, La.
- Noli & Co., E. P., Philadelphia, Pa.
- Northwest Radio Service Co., Seattle, Wash.
- N. S. W. Bookstall Co., Sydney, Australia
- Paramount Radio Supply Co., New York City
- Parks, Henry Francis, Atlantic City, N. J.
- Pearlman's Book Shop, Butte, Mont.
- Penn Radio Apparatus Co., Washington, D. C.
- Pennsylvania Marconi Wireless School, Reading, Pa.
- Philadelphia School of Wireless Telegraphy, Philadelphia, Pa.
- Piedmont Electric Co., Asheville, N. C.
- Pioneer Electric Co., St. Paul, Minn.
- Pitts Co., F. D., Boston, Mass.
- Post Office News Co., Chicago, Ill.
- Precision Equipment Co., Cincinnati, Ohio
- Radio Distributing Co., Newark, N. J.

- Radio Electric Co., Pittsburgh, Pa.
- Radio Equipment Co., Boston, Mass.
- Radioelectric Shop, Cleveland, Ohio
- Ray-Di-Co., Chicago, Ill.
- Reuter Electric Co., Cincinnati, Ohio
- Riverside Laboratory, Milwaukee, Wis.
- Rose Radio Supply, New Orleans, La.
- Saunders Co., Geo. S., Boston, Mass.
- Schmidt & Co., Rudolph, Rochester, N. Y.
- Sears, Roebuck & Co., Chicago, Ill.
- Service Radio School, Washington, D. C.
- Shaffers', Norfolk, Va.
- Shotton Radio Mfg. Co., Scranton, Pa.
- Smith Bros., Sarnia, Ont., Canada
- Smith Norotory Electric, Inc., Charlotte, N. C.
- Southern Electrical Supply Co., San Diego, Cal.
- United Radio Telegraphers' Assoc., Baltimore, Md.
- Western Radio Electric Co., Los Angeles, Cal.
- Whittall Electric Co., Westley, R. I.
- White Co., The, Columbus, Ga.
- White & Boyer Co., Washington, D. C.
- Williamson Electric Co., H. F., Seattle, Wash.
- Wilmington Electrical Specialty Co., Wilmington, Del.
- Wireless Mfg. Co., Canton, Ohio
- Wireless Press, New York City
- Yountz & McCombs, Rock Island, Ill.
- Young Men's Christian Assoc., Los Angeles, Cal.
- Zamotski Co., Jos. M., Baltimore, Md.

**Consolidated Radio Call Book Co., Inc., 98 Park Place, New York City**

# Canadian Amateurs

Write to our nearest branch for Price List "B" of Radio Apparatus, Supplies and Publications.

## Scientific Experimenter Limited

Dominion Bldg.,  
Vancouver, B. C.  
Arcade Bldg.,  
Halifax, N. S.  
Head Office,  
11 St. Sacramento St.

Confederation Life Bldg.,  
Winnipeg, Man.  
Vaughan Electric Co.,  
94 Germain Street  
St. John, N. B.  
**MONTREAL, QUEBEC**

93 King St. E.,  
Toronto, Ont.  
Board of Trade,  
St. John's, Nfld  
Show Rooms,  
88 McGill College Avenue

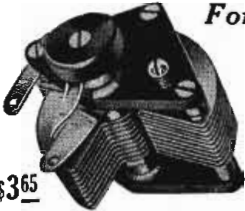

### For Bringing in the Long Distance Signals

This familiar panel type condenser is unexcelled and costs less than any other model on the market. We guarantee that it will increase the efficiency of your set or your money back.

PRICES	
43 plate .....	\$4.50
21 plate .....	3.65
Dial extra .....	.75

Postage extra on 2 pounds.

**EMPYREAN RADIO CO.,** Masonic Temple Building  
Chicago, Illinois

## Bound Volume of RADIO NEWS

THE second year Bound Volume of RADIO News Magazine is ready for shipment. Volume No. 2 contains twelve numbers, starting with July, 1920, and ending with June, 1921.

There are 936 pages, containing over two thousand articles and over three thousand illustrations, bound in red cloth, gold stamped.

With its wide variety of original articles, editorials, suggestions and drawings, this bound volume forms a valuable reference book on all questions of radio.

Send your orders at once, as we have only a very limited supply on hand.

Vol. No. 1 is sold out completely and cannot be procured any more; supply of Vol. No. 2 will not last very long; orders will be filled within 24 hours. Mail coupon below, today.

-----COUPON-----

Experimenter Publishing Co.,  
233 Fulton St., New York.  
Gentlemen: Enclosed find \$2.50 for which send me bound Vol. No. 2 of Radio News as described above. Send by Express collect. Send by Parcel Post and find enclosed \$..... extra for Postage (8 lbs.). (Indicate mode of transportation.)  
Name .....,  
Address .....,  
Town..... State.....

## A CHANGE THAT'LL INTEREST YOU

The quality of the FADA crystal detector remains the same—same bakelite XX base, carefully polished nickel plating and super-sensitive galena crystal. The only change is that the price has been reduced from \$3.00 to \$2.50. The reason—the very large demand during the last few months has allowed the manufacture of the parts on automatic screw machines and punch presses where formerly they were made in small lots. Instead of making hundreds,

now several thousand are made at once. You benefit by this reduction in cost. With crystals it's the same way. Although thousands are made up in one job lot every one must pass a mighty rigid test for sensitive spots. That's why the ones you purchase are called Super-sensitive.

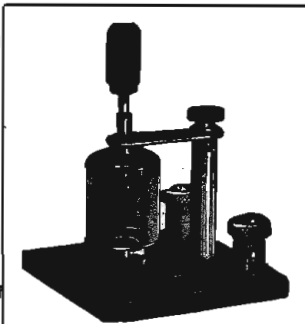

### FADA CRYSTAL DETECTOR

Now \$2.50 Each



50 Cents Each

### ASK ANY OF THESE DEALERS

- WHAT THEY THINK OF FADA INSTRUMENTS AND PARTS—THEN PURCHASE THE SUPPLIES YOU NEED
- Manhattan Elect. Supply Co., Chicago, Ill. and N. Y. City.
  - Cino Radio Mfg. Co., Cincinnati, Ohio.
  - L. Bamberger & Co., Newark, N. J.
  - Kelly & Phillips Co., Brooklyn, N. Y.
  - K. & L. Electric Co., McKeesport, Pa.
  - Somerville Radio "Lab.," Somerville, Mass.
  - Shotton Radio Mfg. Co., Albany, N. Y. and Scranton, Pa.
  - Tiber Drug Company, Jamaica, N. Y.
  - Wilkesburg Battery Service, Wilkesburg, Pa.
  - Continental Radio & Electric Co., New York City.
  - The Radio Electric Co., Pittsburgh, Pa.
  - American Electro Tech. Appliance Co., New York City.
  - A. H. Corwin & Co., Newark, N. J.
  - Bronx Radio Equipment Co., New York City.
  - Radio Instrument Co., Washington, D. C.
  - Chas. G. Rosewall Co., Brooklyn, N. Y.
  - United Electric Stores, Pittsburgh and Braddock, Pa.
  - George DeLapline Co., New Brunswick, N. J.
  - Mutual Purchasers Association, New York City.

### The FADA RHEOSTAT

is another "best buy for the money." The base (2 7/8" dia.) is made of Thermoplox which is an asbestos synthetic product that resists heat better than Bakelite. This rheostat has a resistance of 6 ohms and will carry 1 1/2 amperes. Furnished with a good bakelite knob, nickel plated pointer and screws for mounting. You can't buy better.

\$1.25 Each

### F. A. D. ANDREA

Manufacturer of F. A. D. A. Radio Instruments  
1882-A JEROME AVE., NEW YORK CITY

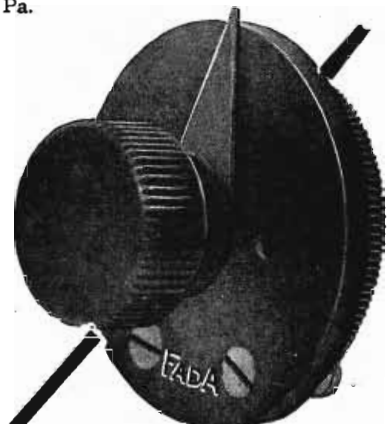
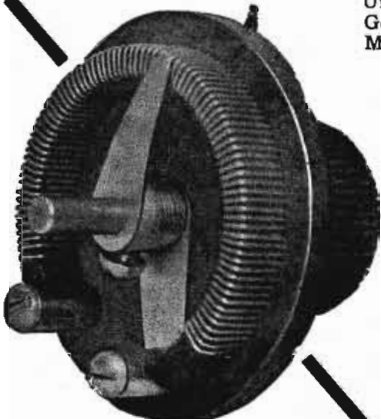



secondary F terminal connected to the filament rheostat on the side away from the filament. This puts a bias negative potential on the grid of the amplifier tube which will have a value of approximately one volt providing a six-volt battery is used and the filament current is adjusted to the normal value of one ampere. Separate biasing batteries may be used if it is desired to get the absolute maximum of amplification. One or two dry cells may be connected in series with the grid circuit. These cells should be connected near to the low potential terminal of the secondary, that is, next to one leg of the filament. The positive terminal of the battery should connect to one leg of the filament and the negative terminal to the tuner secondary.

**The Phonetron**

(Continued from page 13)

mission in place of a microphone transmitter. Fig. 1 shows a general view of the instrument. The large paper diaphragm is clearly shown supported on a metal ring fastened to a heavy base to insure stability. The magnet block may also be seen suspended in the center of the ring by three rigid supports. The connection block with its four binding posts can be seen at the right hand end, while the thumb screw for adjusting the armature coil can be seen at the left on the apex of the conical diaphragm.

Fig. 2 shows the internal wiring and construction. The large field magnet winding is connected to the terminals marked F.F., while the small armature winding is connected to the terminals marked A.A.

The advantages of the "Phonetron" over other types are manifold. It faithfully reproduces signals and speech with practically no distortion. Like other loud-speaking devices, the "Phonetron" is not an amplifier, but permits of the conversion of large amounts of electrical energy into sound, in a most efficient manner. With sufficient amplification, signals can be heard many hundred feet with perfect clearness.

**Station of the Radio Club of Mansfield, Ohio**

(Continued from page 30)

used at the station, and incidentally has made it available to the amateur fraternity. The Radio Club has been answering hundreds of inquiries about 8ZR and will be glad to continue this practice as a help to all amateurs. Inquiries should be addressed to The Radio Club of Mansfield.

**Washington's Birthday Relay**

**PRIZE WINNERS.**

- 1—Leander L. Hoyt, Hayward, Calif.—Clapp-Eastham ZRF regenerative receiver.
- 2—Miss Winnie Dow, Tacoma, Wash.—One baby carriage, or if she does not need it just yet, she can have the navy type tuner donated by Sears Roebuck Co., of Chicago and Philadelphia, Pa.
- 3—M. S. Andelin, Richfield, Utah, gets the Chicago Radio Laboratory Zenith regenerator.
- 4—N. Hood, Casper, Wyo., gets the Grebe CR3A regenerative receiver.
- 5—D. I. Bailey, Clinton, Iowa, gets the Electric Specialty Co. ESCO receiver.
- 6—H. Berringer, Burlingame, Calif., gets the two-step amplifier from Montgomery Ward Co., of Chicago and Kansas City. This will help him to get even better signals from the East.

**3 \$1 for 1 PROTECT YOUR VACUUM TUBES INDEFINITELY!**

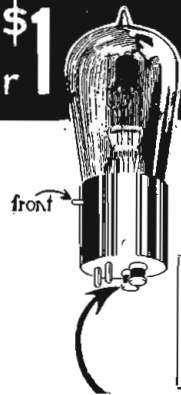

**Multiplies the Life of Your Set**

Destructive excessive amperage cannot reach the delicate filaments of any vacuum tube if protected by a

**Radeco SAFETY FUSE**

Pat. Pending

**Carrying Capacity**  
1 1/4, 1 1/2, 2, 2 1/2 and 3 amp.  
Size 1/4 inch over all.

Slips directly on filament terminals of any standard socket without distorting springs or lowering efficiency. RADECO Safety Fuses positively protect your tubes indefinitely.

3 For \$1.00

35c Each

FROM YOUR DEALER OR BY MAIL

**FILAMENT RHEOSTAT**

For Back or Front of Panel Mounting, 6 ohms, 1 1/2 amps., 1 1/2" dia.

\$1.75 Post-paid

Immediate Shipment.

Standard VT Socket

Improved Contact Type

\$1.00 Post-paid

Copper foil condenser

35c p.p.



**Aerial Wire 1c Per Foot**

7 strands No. 22 copper—tin plated to prevent oxidation. Maximum radiation and strength. Include postage on 15 lbs. per 1,000 ft.

**44 V. VARIABLE "B" BATTERY \$3.60**

Include postage on 4 lbs.

Complete in handy wooden case and adjustable phosphor bronze "jiffy" connectors. Better than block batteries—If one 4.4 V. unit weakens prematurely, it can be removed and replaced—thereby not impairing total voltage, which makes this the best battery value to be had at any price. Set of 10 Renewal Units, 44 Volt, \$3.10 postpaid. Just the thing for C.W. work.

**Ground Wire 7c Per Foot**

No. 4 solid copper—rubber covered—triple braid—Include postage on 20 lbs. per 1000 ft.

100 amp. 600 volt lighting switches, \$3.75

**ASSEMBLE YOUR CW. & PHONE SET NOW**

We have the complete parts

Power Tubes; G. E., Cunningham 5 Watt.....	each	\$8.00
G. R. V.T. Sockets.....	each	1.75
G. R. Filament Rheostat, 2 1/2 amp.....	each	2.50
Acme C.W. Power Transformer, 50 Watt.....	each	15.00
Acme Choke Coils, Double Coil.....	each	8.00
Acme Modulation Transformer, semi-mounted.....	each	5.00
Western Electric 1 mfd. Condenser; tested 1,000 volts.....	each	2.50
Conn. Telephone Transmitter.....	each	3.50
Radiation Ammeter; Jewell, 0-1 amp.....	each	8.00
Radiation Ammeter, General Radio, 0-1, 0-1 1/2.....	each	7.75

**RADIO EQUIPMENT CO.**

630 Washington Street (4th Floor) Boston

**GALENA -- SILICON**

Galena Crystal Mounted.....	\$0.50	Silicon Crystal Mounted.....	\$0.50
Galena Crystal Unmounted.....	.25	Silicon Crystal Unmounted.....	.25
Galena Crystal Mounted in Std.		Silicon Crystal Mounted in Std.	
Murdock Detector Cup.....	.55	Murdock Detector Cup.....	.55

Every Crystal Tested Under Actual Working Conditions and GUARANTEED SENSITIVE

DEALERS WRITE FOR DISCOUNTS.

**ROLAND BROWNLIE, Mfg., 27 Oakland Avenue, EVERETT, MASS.**

Insure your copy reaching you each month. Subscribe to Radio News—\$2.00 a year. Experimenter Publishing Co., 236-A Fulton St., N. Y. C.

## COMPLETE SETS OR UNASSEMBLED PARTS

We can supply all necessary parts for those who build their own apparatus, or complete, ready-to-operate sets. Our complete stocks offer you a wide choice of dependable apparatus at reasonable prices.

### A Few Specials:

Contact points.....3 for 10c  
Binding posts.....Brass 5c, Nickel 6c  
Switch units.....40c each  
Copper aerial wire, No. 14.....50c lb.  
Lightning switches.....\$3.85 each  
(100 amps., 600 volts)  
1/4 HP A.C. Motor.....\$17.50

Reasonable prices, good apparatus, and courteous attention has earned for us the confidence of our radio friends. You, too, will find this store a pleasant place to visit.

**Dreyfuss Sales Corp.**  
179 Greenwich St. New York

## SPECIAL PROCESS PANELS OF NATURAL OAK OR BLACK FINISH.

Treated with a special process made by us. Will not Warp or Shrink and is not effected by Temperature changes Waterproof and possesses High Dielectric properties. Easily machined and will not Crack or BREAK.

Looks much better on your set than Formica or Bakelite and costs considerably Less. We are prepared to ship promptly and without delay the following standard sizes:

5 x 5 1/4" thick...\$35	6 x 12 x 1/4" thick \$.95
6 x 8 1/4" thick... .50	9 x 12 x 1/4" thick 1.10
6 x 8 1/2" thick... .60	12 x 12 x 1/4" thick 1.50
6 x 9 1/2" thick... .70	12 x 18 x 1/4" thick 2.00
6 x 10 1/2" thick... .80	16 x 22 x 1/4" thick 3.00
Strip 3 1/2 x 6; 3 1/2 x 6; 3 1/2 x 10. \$4.00 each.	
3 1/2 x 12; 3 1/2 x 18, \$6.00 each. All 1/4" thick.	

SPECIFY WHAT FINISH, NATURAL OAK OR BLACK.

We will be pleased to quote prices on these panels cut to a different size on receipt of your specifications.

We also carry Tenso C.W. Inductance, Mounted, \$6.00; Unmounted, \$4.50.

In purchasing your Panels and Radio equipment of us of which we have all standard makes and our prices are the same as advertised we will mount it on any of the above panels you purchase according to your specifications FREE OF CHARGE. Progressive dealers stock these panels.

**TENSO MFG. CO.** Marshall, Minn.  
Specializing in the construction of Radio sets to your specifications.

## CARDBOARD TUBING

In any length up to 25". 3" and 3 1/2" Dia., 2 1/2 per inch, 250 per foot, 4" and 4 1/2" Dia., 80 per inch, 800 per foot, 3" 3/4" and 4" Tubing has 1/4" wall. 4 1/4" Tubing has 5/32" wall.

**VARIABLE B. BATTERIES**  
22 1/2 Volts.....\$2.50 45 Volts.....\$5.00  
Postage Extra—Circular for Stamp.  
**JEFFERY-CRAWFORD CO.**  
2173 Hillier Ave. Detroit, Mich.

## STANDARD RADIO EQUIPMENT

AGENTS FOR  
MURDOCK FEDERAL TEL.  
BRANDES AMERICAN RADIO  
BURGESS AUDIO TROW.  
GREBE CHICAGO RADIO LAB.  
BENWOOD SPEC. DUBILIER  
DE-FOREST TRESCO AND OTHERS  
U. of I. SUPPLY STORE, Inc.  
827-29-31 SOUTH WRIGHT STREET  
CHAMPAIGN, ILLINOIS

## COMBAT

A storage battery especially designed for Radio work. The only battery with non-corroding binding posts. Write for particulars and incidentally get your name on our mailing list to receive our monthly bargain sheets.

Here is one of the many items listed for July.  
Dry cell B-Battery 45 volts.....\$1.65  
**INDEPENDENT RADIO SUPPLY CO.**  
3716 W. Douglas Blvd. Chicago, Ill.  
Better Results With Less Effort

- 7—J. R. Hall, Washington, Pa., gets the one-step amplifier donated by the General Radio Co., of Cambridge, Mass.
  - 8—E. Staats, Sacramento, Cal.—One Illinois watch, donated by the Illinois Watch Co., of Springfield, Ill.
  - 9—V. McIlvane, Auburn, Ala.—One NSR 300 or 600 rotary gap, donated by Wireless Mfg. Co., Canton, Ohio.
  - 10—R. McCommon, East Palestine, Ohio—One storage battery, donated by Klaus Radio Co., Eureka, Ill.
  - 11—Xenia Radio Club, Xenia, Ohio—One \$50 coupon for goods from catalog of the AMRAD, New York, N. Y.
  - 12—E. W. Wilson, Olympia, Wash.—One spider-web inductance tuner, donated by E. Turney, Radio Hill, Holmes, N. Y.
  - 13—D. A. Wheelow, Pierre, S. Dak.—One pair lattice variometers, donated by A. Hallbauer, Chicago, Ill.
  - 14—G. Robinson, Richmond, Va.—One antenna switch, donated by Atlantic Radio Co., Boston, Mass.
  - 15—J. E. Cain, Nashville, Tenn.—One 20,000 meter tuner, donated by TRESCO, Davenport, Ia.
  - 16—S. Ruth, Lacey, Wash.—One pair 50,000 ohm fones, donated by C. Brandes, Inc., New York, N. Y.
  - 17—Lowell Radio Club, Lowell, Mass.—One C.W. 20B enclosed gap, donated by Karlowa Radio Corporation, Rock Island, Ill.
  - 18—J. Bickel, Whittier, Cal.—One No. 14A rotary gap, donated by The Wilcox Laboratories, Lansing, Mich.
  - 19—W. Arnold, Southbridge, Mass.—One pair Baldwin fones, donated by John Firth Co., Inc., New York, N. Y. These are the Brownlee wireless fones.
  - 20—W. Shoop, Vandergrift, Pa.—One pair of Baldwin-Brownlee fones, donated by John Firth Co., Inc., New York, N. Y.
  - 21—R. Parker, Augusta, Me.—One pair No. 55 fones, donated by W. J. Murdock Co., Chelsea, Mass.
  - 22—E. Thatcher, Oberlin, Ohio—One Acme 200-watt C.W. transformer, donated by Acme Apparatus Co., Cambridge, Mass.
  - 23—J. Coleman, Pittsburgh, Pa.—One new type microphone for radiofones, donated by Federal T. & T. Co., Buffalo, N. Y.
  - 24—R. Willison, Portland, Ore.—One No. 3 condenser with dial, donated by Chelsea Radio Co., Chelsea, Mass.
  - 25—S. Ayer, Waterville, Me.—One Radisco coupler, donated by Radio Distributing Co., Newark, N. J.
  - 26—B. Benning, Atlanta, Ga.—One-quarter KVA transformer, donated by Thordarson Elec. Mfg. Co., Chicago, Ill.
  - 27—A. Kiser, Fairmount, W. Va.—One oscillation transformer, with clips, donated by Shotton Radio Co., Scranton, Pa.
  - 28—A. Selby, Boise, Idaho—One R87 tuner set, donated by Signal Elec. Mfg. Co., Menominee, Mich.
  - 29—G. Barnes, East Stonebridge, Quebec, Canada—One No. 181 inductance, donated by the C. D. Tuska Co., Hartford, Conn.
  - 30—Major H. Stethen, St. Johns, Canada—One pair of Baldwin Brownlee type fones.
  - 31—Rev. Father Burns, Marshall, Texas—One pair of Baldwin Brownlee type fones.
  - 32—B. Phelps, Minneapolis, Minn.—One 0.5 Eldridge H.W. meter, donated by J. Firth Co., New York, N. Y.
  - 33—J. Guehaug, Baudette, Minn.—One 0.5 Eldridge H.W. meter donated by J. Firth Co., New York, N. Y.
  - 34—F. Mahr, San Francisco, Calif.—One 0-1 H.W. Eldridge meter, donated by J. Firth Co., New York, N. Y.
  - 35—J. Martin, Amarillo, Texas—One 0-1 H.W. Eldridge meter, donated by J. Firth Co., New York, N. Y.
  - 36—Benzee Bros., Buffalo, N. Y.—One 0.3 Midget Advance meter, donated by J. Firth Co., New York, N. Y.
  - 37—J. DeWitt, Nashville, Tenn.—One pair Baldwin Brownlee type fones, donated by J. Firth Co., New York, N. Y.
  - 38—A. Lorimer, Montreal, Can.—One set honeycomb coils, donated by Coto Coil Co., Providence, R. I.
  - 39—C. Jones, Northfield, Vt.—One No. 21 variable grid leak, donated by Chelsea Radio Co., Chelsea, Mass.
  - 40—F. Fallain, Flint, Mich.—One No. 182 inductance, donated by C. D. Tuska Co., Hartford, Conn.
  - 41—E. Brack, Midville, Ga.—One No. 41 bakelite dial, donated by Chelsea Radio Co., Chelsea, Mass.
- The two following get one Connecticut variable condenser, donated by Connecticut Tel. & Tel. Co., Meriden, Conn.
- 42—O. Bowers, Marietta, Ohio.
  - 43—J. Miller, Hammond, Ind.
- Each of the following get a UV200 bulb, donated by the Radio Corporation of America. These bulbs may be had by writing direct to QST explaining your wish.
- 44—M. Powell, Warren, Ariz.
  - 45—D. Culbert, Warren, Ariz.
  - 46—L. Runey, Belmont, Mass.
  - 47—R. Taggart, Pasadena, Calif.
  - 48—F. Weyerhaeuser, Pasadena, Calif.
  - 49—K. Lloyd, Erie, Pa.

## 10c CHARGES YOUR BATTERY AT HOME WITH AN F-F BATTERY BOOSTER

and your station will never be closed because of a discharged battery. Is it not gratifying to feel that your filament battery will always be ready when you want it and that you will never have to give up in disgust when working a distant station?

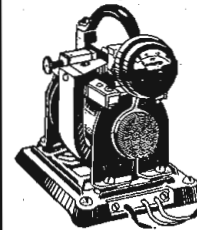

F-F Battery Boosters are automatic and operate unattended. Screw plug in lamp socket, snap clips on battery terminals and see the gravity come up.

The ammeter shows you just the amount of current flowing. The full wave of current is rectified thru adjustable carbon electrodes which maintain a constant efficiency and last for thousands of hours. Everything complete in one compact, self-contained unit.

The F-F Battery Booster is a Magnetic Rectifier for 105-125 Volt 60 Cycle Alternating Current. Bantam Type 6 Charges 6 Volt Battery at 6 amperes. \$15 Type 16 charges 6 Volt Battery at 8 amperes. \$32 Type 166 charges 6 Volt Battery at 12 amperes. \$32 Shipping Weights 10, 12 and 15 lbs. Also Boosters for 12 Volt Batteries at same prices. Order from your dealer or Send Check for prompt Express Shipment. If via Parcel Post have remittance include Postage and Insurance Charges. Will also ship C.O.D. Also F-F Battery Boosters for charging batteries from Farm Lighting Plants, Direct Current Circuits and Direct Current Generators. For GROUP CHARGING use the Full Wave, Automatic F-F ROTARY RECTIFIER of 100 Volt, 36 cell capacity. Order now or write today for Free Descriptive Bulletin No. 32 or ROTARY Bulletin No. 32A.

**THE FRANCE MFG. CO.,** Offices & Works: Cleveland Ohio Canadian Rep: Battery Service & Sales Co. Hamilton, Ontario

## AUDIO TRONS Double Filament

The original tubular vacuum detector, amplifier, oscillator.

Mail orders promptly filled.

**\$6.00**

We pay Parcel Post

## The Whitall Electric Co.

Bridge St. at Stearns Sq. Springfield, Mass.



**NEW YORK BOSTON**

Offers a thorough course in all branches of wireless telegraphy. Radio Operators earn at the start \$125.00 per month, and first class board, etc., free.

Our school prepares you for your license in three to four months. Positions guaranteed to first grade licensed operators. Also MORSE TELEGRAPHY.

Day and evening classes.

The leading Nautical School in U. S. A. Established 1804.

**CAPTAIN F. E. UTTMARK, Principal**

Write, call or phone for illustrated booklet.

**8 STATE ST., NEW YORK, N. Y.**

Facing Battery Park, N. Y. Telephone, Bowling Green 8079

**UTTMARK'S** for Nautical Education



Each of the following get a UV201 bulb, donated by Radio C. of A., by writing to QST.

- 50—T. Banks, Williamstown, Mass.
- 51—H. Brewer, Emery Ville, Calif.
- 52—A. E. Bessey, Sunnyvale, Calif.
- 53—T. House, Dublin, Tex.
- 54—M. Apple, McKinney, Texas.
- 55—R. Stott, Douglas, Ariz.
- The following get a bulb from the Audiotron Mfg. Co., thru E. T. Cunningham, San Francisco.
- 56—L. Peine, Houston, Tex.—One C-300 bulb.
- 57—G. Riddell, Sheboygan, Wis.—One C301. The writer has these bulbs at Davenport, Ia. The following get a yearly subscription to the *Pacific Radio News*.
- 58—C. Lundquist, Winfield, Iowa.
- 59—H. Dunn, Oxford, Ohio.
- 60—R. Bingham, Oneonta, N. Y.
- 61—J. Kolb, Louisville, Ky.
- 62—H. Sairs, Ambridge, Pa.
- 63—J. Copeland, Ashland, Ohio.
- 64—R. Winchester, Syracuse, N. Y.
- 65—P. Harmegnies, Rapid City, S. D.
- 66—L. Mathias, Antigo, Wis.
- 67—W. C. Bridges, Superior, Wis.
- The following get a one-year's subscription to *RADIO NEWS*.
- 68—F. Breene, Iowa City, Iowa.
- 69—E. Beardmon, Glasgow, Kansas.
- 70—J. Lmsdahl, Pitt, Minn.
- 71—D. L. Caston, Gainesville, Ga.
- 72—M. Koupal, Eugene, Ore.
- The following get a one-year's subscription to *QST*.
- 73—A. Welch, Gardiner, Me.
- 74—G. Turner, Independence, Mo.
- 75—M. Flynt, Madison, Me.
- 76—F. Miller, Emporia, Kans.
- 77—W. Harris, Marshfield, Ore.
- The following gets a two year subscription to *Radio Topics*.
- 78—E. Anderson, Marshfield, Ore.

**Radio Digest**

(Continued from page 27)

types of receiving aerials are described to serve for reception and measurement of the magnetic field. (e) *Measurement of the Receiving Current*.—This is generally carried out by one of the following methods: (1) Inserting in the aerial circuit the heater wire of a thermo-couple and connecting the ends of the couple to a galvanometer; (2) inserting in the aerial circuit the heater wire of a "Duddell" thermogalvanometer, which is merely the combination in a single instrument of the couple and galvanometer; (3) inserting in the aerial circuit a bolometer connected to a Wheatstone bridge, which allows the variations of resistance of the wire to be measured. These three methods are given in the order of increasing sensitiveness. All the instruments must be calibrated so as to give by their readings the effective value of the current and the use of the thermogalvanometer seems to be preferred as being simple, easy to handle, accurate and sensitive.—*Radio Review*.

**Some Transmitting Tube Data**

(Continued from page 8)

burns out a few while learning, so some precautions are therefore timely.

Of course, we all know that an overdose of voltage across the filament terminals will soon terminate the activities of any respectable vacuum tube, but only a few seem to realize that there is any other method of overloading a transmitting tube.

It is not safe to operate a tube on high plate voltage without a plate current meter. This should be a D.C. milliammeter having a range suitable to the size and the number of the tubes used. The correct plate current for any particular make of tube should be obtained from the manufacturer, as the life of the tube depends very much on how closely one conforms to this rating. With a plate current of 20 milliamperes the life of an A-P transmitting tube is about 250 hours, while if the plate current is kept down to 15 milliamperes the life is about doubled. It is easy to obtain a plate cur-

**A QUALITY PRODUCT FOR THOSE WHO DEMAND THE BEST**

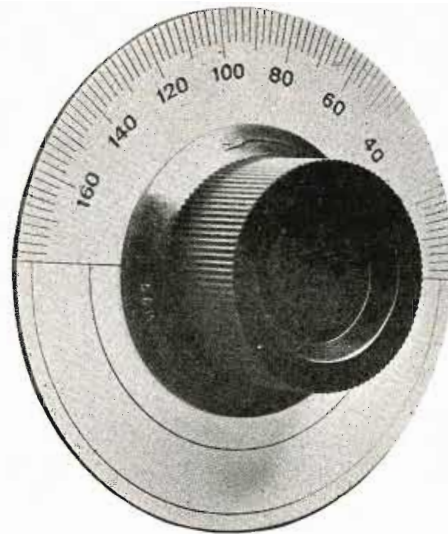

**Somerville Dial Indicator \$2.00**

These are extremely desirable on the single circuit Tuners which we predict will be the coming vogue. The lower half of scale is admirably for direct calibration with call letters. Waterproof India Ink is suggested. By Rotating the Dial to the right—The Natural Way—The Reading Increases. Dial is of No. 16 gauge Brass, 4" Dia. Silver Plated and Lacquered. Will not Tarnish. The Flanged Knob is of Real Bakelite and has a permanent Gloss not to be had with cheap Composition Knobs. Will Not Warp. The Knob has a 1/4" hole and is Fastened to the shaft by a set screw. Knob Diameter is 1 3/4". Flange Diameter, 2 1/4". Much experiment shows this to be the right size.

**SOMERVILLE KNOB INDICATOR—90c.**

This is the same Moulding as used on the dial and is useful on coupling and Ticker Rotors, etc. Its Non-Melting Feature Makes it invaluable as a Rheostat Knob.

**SOMERVILLE SWITCH LEVER—65c**

1 3/8" Bakelite Knob to Match the Larger Knobs. 1 3/8" Radial Bronze Blade Locked to the Brass Shaft With Bushing. 2 Locknuts. All metal parts Polished Nickel.

**AMATEURS!**  
Be the first in your town to Rejuvenate your set with Somerville Super-Fine Accessories.

**DEALERS!**  
An excellent investment for profit. Order filled in Rotation. Send yours Now.



**NEW PRODUCTS: We Have Them First**

Murdock No. 56 2000 OHM Headset \$5.00. The same high quality and Moderate Price as the 55's with the added feature of the New Comfortable Navy Style Headband.  
Murdock Improved Crystal Detector, 70c. This New Type has the Universal Adjustment.  
Tested and Guaranteed Galena Crystal, 25c.



**Westinghouse Products in Stock**

Tuner Cabinet, \$65.00; Detector and Two Stage Amplifier, \$65.00. Both in One Cabinet. A Complete Receiver, \$125.00.



**Products in Stock**

C. R. 5 Receiver, \$80.00; C. R. 3 Relay Tuner, \$65.00

**Radio Corporation Products in Stock**

U.V. 200 Detector, \$5.00; U.V. 201 Amplifier, \$6.50; U.V. 203 Power Tube, \$8.00; U.V. 203 Power Tube, \$30.00; U.V. 204 Power Tube, \$110.00; U.V. 216 Kenetron Rectifier, \$7.50; U.V. 217 Kenetron Rectifier, \$26.50; U.P. 1816 Power Transformer, \$38.50; U.P. 1368 Power Transformer, \$25.00; Y 414 Microphone Transformer, \$7.25; U.V. 712 Amplifying Transformer, \$7.00; U.R. 542 VT. Socket, \$1.00; P. R. 536 "A" Potentiometer, \$2.00; Special R O A Power Tube Circuits on Request.

CHELSEA 3 B D .0011 Panel Condenser, \$4.75; .0006 size, \$4.25. CHELSEA 3 3/4" Bakelite Dial—Non-Warping—1/4" or 3/16" Hole, \$1.00.

**SPECIAL**

\$2.25 Ward Leonard 5000 Ohm Grid Leaks, \$1.88.  
Paragon RA-Tons. Two Left, at \$78.00; unmounted, \$12.00.  
Western Electric Headsets, \$12.10 each.  
Send 20c for Catalogue and Treatise on C.W. and Phone Transmitters.  
**REMEMBER.—We Pay Postage in First Five Zones:**

**Somerville Radio Laboratory, 102 Heath Street, Winter Hill, 45, Mass.**

**TUSKA MOULDED VARIOMETER**

*Mechanically and Electrically Peerless*

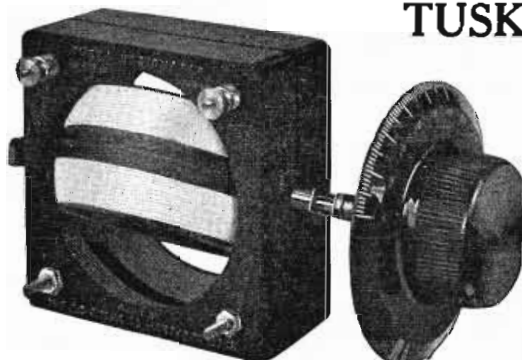

See them at your dealer's  
Send 5c for Catalog No. 2  
Receiving Sets, Knobs, Dials, Variometers, Variocouplers, C.W. Inductances, C.W. Transformers.

TYPE 200

PRICE \$7.25

**The C. D. Tuska Co. HARTFORD CONN.**

## More Sensitive Than The Ear of An Owl

Ernest Thomson Seton, the naturalist, says owls have the most sensitive ears known.

Brandes Wireless Receivers are more sensitive—an improvement on nature. The two telephones are perfectly matched in tone and this exclusive Brandes feature adds force to the supersensitive mechanical tympanums.

The minutest sound vibrations quivering through the air from out the far distances are caught and focussed into the clean, clear notes of the readable message—Brandes headsets getting it all, where other equipment gets little or none.

Send 5c for Catalog "G"

DEALERS—  
Write for Special Proposition

**C. BRANDES, Inc.**  
Room 823  
32 Union Square  
New York City



# BRANDES Matched-Tone HEADSETS

## NEW PRICE ON SPIDER-WEBS

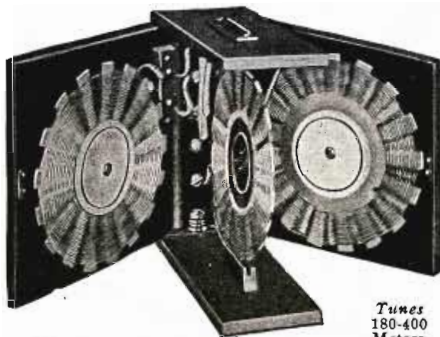

Illustration shows front of cabinet removed.

You will hear more stations and hear them better no matter what apparatus you now have. The Bureau of Standards are using Spider-Webs.

PACIFIC COAST AGENTS  
HERROLD LABORATORIES  
SAN JOSE CALIF.

Owing to the big drop in all costs we are giving the wireless man the full benefit.

**SPIDER-WEB  
REGENERATIVE COIL SETS**

are now  
**\$5.50**

FORMERLY \$8.00

In getting all the 200 meter stations including wireless telephone this little set can not be surpassed regardless of cost—over 3000 now in use. Send for full particulars and new circuit. No charge.

EUGENE T. TURNEY LABORATORIES  
Radio Hill Holmes, New York

rent of 50 or 60 milliamperes thru one of these tubes, but its life under such conditions would be about half an hour.

When an amateur has been obtaining an antenna current of several amperes with his spark set, and starts CW work, it is most natural that he would try to obtain just as much. Many articles in former numbers of this magazine have shown that a small CW antenna current will carry as far as a spark set having an antenna current many times greater. The writer has obtained as much as one ampere in an average amateur antenna from a single A-P tube; the space current was excessive, and the life of the tube some 20 minutes. Consequently, a boast about high antenna current from a small tube set means nothing as to the ability of the booster; it really means inefficiency when one considers the ratio of output to upkeep.

A case somewhat analogous to overloading a tube would be attempting to use a 1 h.p. motor on a 2 h.p. load. The motor might revolve with such an overload, but it would draw about twice as much current from the line, would heat badly and would soon burn out.

Because a tube will oscillate with a full six volts on the filament is no reason why a filament rheostat should not be used. After a tube has started oscillating, it is generally possible to cut down the filament current quite a bit without decreasing the antenna current. This will, of course, lengthen the life of the tube. The filament of the A-P transmitting tube is designed to work on six volts with a rheostat in series. The filament current is .75 to .8 amp.

Recent tests made at the University of California by Mr. A. K. Aster, of the Physics Department, show that the resistance between adjacent prongs in the condensite base of these tubes is 100 megohms. The measurement was made with 1,500 volts D.C. Moisture in the atmosphere has no appreciable effect on this result.

The results obtained with the A-P transmitting tube show that CW is not only the solution of the QRM problem for the amateur, but the means of carrying on the long distance relay work as well. The achievement of Mr. Hugh Robinson (2QR) of talking to Scotland was accomplished with four of these tubes. Very recently Mr. R. Rheem (6AH) of Oakland, Cal., talked to Los Angeles with the same equipment in the daytime. Both these amateurs were using rectified A.C. on the plate.

## Nauen Time Signal Radio Service

(Continued from page 12)

not cease to improve its precision apparatus, thus making the Nauen time service an ever more useful link in the economical life of the world.

An improved Time Signal Receiver designed by the Telefunken Company affords everybody a means of profiting by the Nauen time service, without any considerable outlay.

## Radiating Eight-Tenths of an Ampere With a Single "J" Tube

(Continued from page 14)

L1—Inductance—4" tube, wound closely with 20 turns of No. 22 double cotton covered magnet wire.

C—Condenser—Grebe Type RCVE (any condenser of .001 to .0005 mf. will do).

A—Radiation Ammeter—Weston, 0-1 amps.

## FREE With Each U.V. 202 Power Tube FREE

With each Radiotron U.V. 202 power tube, for radiophone and C. W. transmission, we will supply free of charge your choice of either the latest Murdock Improved contact type V.T. socket for use with the above tube or the Radio Corporation of America's special 5000 ohm. size "M" Grid Leak with midtap at 3,500 ohms, designed by the General Electric Company for use with the U.V. 202. Price \$3.00. Only new and high grade apparatus carried in stock and all goods guaranteed to arrive in perfect condition.

All orders are filled within twelve hours and are shipped postpaid and insured.  
THE KEHLER RADIO LABORATORIES, ABILENE, KANSAS



- R—Grid Leak—5,000 ohms, standard carbon potentiometer type.
- C<sub>2</sub>—Condenser—Grebe, Type ROCE, .001 mf.
- L<sub>2</sub>—High frequency choke—Radisco or Duolateral No. 750 or Honeycomb No. 600.
- M—Space current meter—Weston Milliammeter, 0-100.
- C<sub>3</sub>—By-pass condenser—Grebe, Type ROCF, .005 mf.
- K—Key—Any make.
- A. C.—60 cycles—Line current, from A. C. supply.
- V. T.—Vacuum tube—In this case a Western Electric receiving tube, commonly called a "J" tube.

From the fotograf it will be seen that a vacuum tube control unit, such as is ordinarily used for receiving and includes the filament rheostat, V. T. socket and grid condenser and leak, forms the nucleus for the transmitter and the inductance was mounted inside the cabinet of this unit. Fig. 1 shows the wiring diagram of the circuit and it is interesting to note that its use in conjunction with an antenna of .0003 mf. and a resistance of 8 ohms the radiation was .2 of an ampere.

With this very low radiation reliable communication was carried on in daylight for a period of 10 days with a station 30 miles distant. Signals were in every case reported very distinct and easily readable, altho the note was very low, corresponding to the frequency of the current used to supply the plate circuit.

Using the same circuit in conjunction with a plate voltage of 220 volts the radiation was exactly doubled and the distance for reliable communication was increased to 40 miles. A further increase in the plate potential was provided by placing a 60-volt storage battery in series with the A. C. supply. A curve of the emitted wave produced by such an arrangement is shown in Fig. 3.

**WHERE NO MORE THAN 110 VOLTS IS AVAILABLE**

We are all not fortunate enough to have 220 volts at our disposal and for this reason the circuit shown in Fig. 2 was tried out and found to be satisfactory in every way. An Acme transformer, Type CWM19, having a Ward Leonard 62 ohm standard resistance unit in series with the primary was used to step up the A. C. supply voltage to approximately 400. The radiation in this case was found to be .8 of an ampere and reliable communication was carried on in daylight over a distance of 50 miles. It will be noted from the diagram that the key used in the primary circuit, altho it may just as well be used in the filament lead or in series with the grid leak.

In this form of transmitter a perfect modulation of the supplied current is obtained. The curve in Fig. 3 indicates the result obtained. Since the tube will function only when the plate is at a positive potential and since there is a periodic alternation in the line frequency, which, in this case is 60 cycles, it will be seen that a group of waves will be emitted for every positive alternation and that 60 distinct groups will be emitted per second of operation. From the above it will be observed that a rather low note results, which may be raised by any of the following methods.

A huzzer may be inserted in the grid circuit, the buzzer may be substituted by a chopper or tone wheel, or a chopper may be placed in series with the antenna.

A good tone wheel may be made from a commutator having four segments driven at a speed of 3,600 r.p.m. Where it is possible to secure a synchronous motor, for use in connection with a tone wheel, it will be possible to obtain a full and even output at a frequency equal to 480 cycles, when a commutator is provided with eight segments. Where insulation difficulties are found to exist it is advisable to insert the chopper in the grid circuit.

# WHY ?

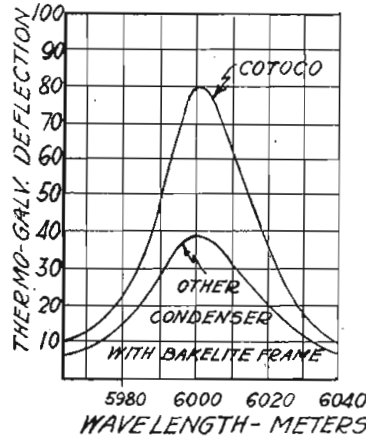

## WHY did we start building condensers? should you investigate Cotoco condensers? should you use a Cotoco condenser?

The curves above were made to compare the sharpness of resonance of our condenser with the usual type assembled between bakelite heads. It gives the essential reason WHY this condenser will produce results you want. If this is not sufficient reason, let us send you our descriptive bulletin, which will give you all the details.

Made in three sizes .0005 M.F., .0007 M.F. and 001 M.F. in case as shown, or unmounted.

Get on our mailing list NOW

**COTO-COIL CO.** 87 Willard Avenue PROVIDENCE, R. I.

## Chelsea Variable Condensers

(DIE CAST TYPE)

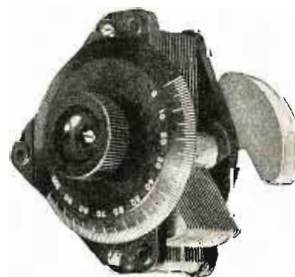

No.	Capacity	Type	Size	Weight	Price
1	.0011m.f.	Mounted	4 5/8 x 4 5/8 x 3 1/4	1 3/4 lbs.	\$5.00
2	.0006m.f.	Mounted	4 5/8 x 4 5/8 x 2 3/4	1 1/4 lbs.	4.50
3	.0011m.f.	With Dial	4 1/4 x 3 3/4	2 lbs.	4.75
3	.0011m.f.	Without Dial	4 1/4 x 3 3/4	2 lbs.	4.35
4	.0006m.f.	With Dial	4 1/4 x 3 3/4	1 1/4 lbs.	4.25
4	.0006m.f.	Without Dial	4 1/4 x 3 3/4	1 1/4 lbs.	3.85

Top, bottom and knob are genuine bakelite, shaft of steel running in bronze bearings, adjustable tension on movable plates, large bakelite dial reading in hundredths, high capacity, amply separated and accurately spaced plates.

Unmounted types will fit any panel and are equipped with counter-weight.

Purchase from your dealer, if he does not carry it, send to us. Bulletin sent upon request.

**CHELSEA RADIO CO.,** 17 Fifth St., Chelsea, Mass.

Manufacturers of Radio Apparatus and Moulders of Bakelite

# SPECIAL 30 DAY OFFER

## Save Money—Get a FREE Premium Besides

The subscription price of Science and Invention has been \$3.00 per year. For 30 days, not only will we give you a full year's subscription (12 big numbers), for \$2.50, but we will also give you absolutely FREE, your choice of any of the well known books shown below. Read the special offers. If you want more than one book free take a two or three-year subscription. For each year you can take advantage of one offer.

If you are already a subscriber to one of our magazines, take advantage of this opportunity and send in your renewal subscription, stating what free pre-

mium you prefer; you are at liberty to send as many subscriptions or renewals as you desire, and you can pick out a free premium for each year's subscription.

You may also take subscriptions of your friends and earn the free premium for yourself.

You must act at once—Today.

These sensational offers are made by us at a tremendous sacrifice in the hope that your acceptance will make you a life-long friend of our magazines.

!! Please use order blank below !!

### The Experimenter Publishing Co., Inc.

236 FULTON STREET, NEW YORK

#### Special Free Premium Offer No. 1



#### The How and Why of Radio Apparatus

By H. W. Secor, E.E.

This newest of Radio Works has 160 pages, 6 x 9 inches.

#### OFFER No. 1

Above Book, bound in special cloth, flexible, hand sewed. FREE with a year's subscription to Science and Invention for \$2.50.

#### Special Club Offer



THE 100% WIRELESS MAGAZINE AND



THE UNDISPUTED AUTHORITY ON SIMPLIFIED SCIENCE AND MECHANICS

BOTH MAGAZINES

With any one of the FREE Premiums, as described:

**\$3.50**

- |          |                                    |                |
|----------|------------------------------------|----------------|
| Offer 6A | SCIENCE & INVENTION and RADIO NEWS | with Premium 1 |
| Offer 6B | "                                  | with Premium 2 |
| Offer 6C | "                                  | with Premium 3 |
| Offer 6D | "                                  | with Premium 4 |
| Offer 6E | "                                  | with Premium 5 |

**The Biggest Clubbing Bargain Ever Offered.**

#### Special Free Premium Offer No. 3

#### Wireless Course in 20 Lessons

By S. Gernsback, A. Lescarboura and H. W. Secor, E.E. (10th Edition)

Size of book is 7 x 10 1/4 in., 160 pages, 850 illustrations, 30 tables.

#### OFFER No. 3

Above Book, bound in special cloth, flexible; hand sewed. FREE with a year's subscription to Science and Invention for \$2.50.



#### Special Free Premium Offer No. 2



#### A Thousand and One Formulas

By S. Gernsback

It contains 160 pages. The paper has been especially selected to stand rough handling in laboratories. Size 6 x 9 inches.

#### OFFER No. 2

Above Book, bound in special cloth, flexible, hand sewed. FREE with a year's subscription to Science and Invention for \$2.50.

#### Special Free Premium Offer No. 4

#### Experimental Electricity Course in 20 Lessons

By S. Gernsback and H. W. Secor, E.E.

The book contains 128 pages and more than 400 illustrations. Size of book is 6 x 9 inches.

#### OFFER No. 4

Above Book, bound in special cloth, flexible; pocket size. FREE with a year's subscription to Science and Invention for \$2.50.



EXPERIMENTER PUBLISHING COMPANY, Inc.  
236 Fulton Street, New York City, N. Y.

Gentlemen:

Enclosed find \$..... for which send me:

- |                                      |                                       |
|--------------------------------------|---------------------------------------|
| <input type="checkbox"/> Offer No. 1 | <input type="checkbox"/> Offer No. 6A |
| <input type="checkbox"/> Offer No. 2 | <input type="checkbox"/> Offer No. 6B |
| <input type="checkbox"/> Offer No. 3 | <input type="checkbox"/> Offer No. 6C |
| <input type="checkbox"/> Offer No. 4 | <input type="checkbox"/> Offer No. 6D |
| <input type="checkbox"/> Offer No. 5 | <input type="checkbox"/> Offer No. 6E |

MARK SQUARE ABOVE FOR ITEM WANTED.

Name .....

Address .....

Town..... State.....

#### Special Free Premium Offer No. 5



Design and Construction of Audion Amplifying Transformers Radio and Audio Frequency Type

How to Make Wireless Sending Apparatus

How to Make Wireless Receiving Apparatus

#### OFFER No. 5

Above three Books as described FREE with a Year's Subscription to Science and Invention for \$2.50.



**USING BOTH SIDES OF THE CYCLE**

Mr. Diehl introduced the following circuit for using both sides of the cycle for the production of C. W. at a meeting of the Brooklyn Radio Club, before which he delivered a paper on his findings in C. W. work, several of which are here described. Tho some of the circuits have been used since that time and their use is rapidly growing, Mr. Diehl made his experiments several months ago and explained his circuits to the club as far back as February.

Using two tubes, as is shown in Fig. 4, it is possible to use both sides of the A. C. supply, with the resultant wave shown in Fig. 5. It will be seen from the diagram that a transformer with a single primary and two secondaries is provided, allowing one secondary to function with each tube. The result produced is as follows:



Fig. 3 shows the oscillations produced by a C.W. set using only the positive halves of the cycles, while

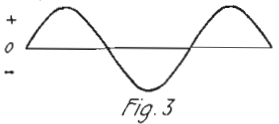

Fig. 3



Fig. 5 shows the oscillations produced by a self-rectifying set.

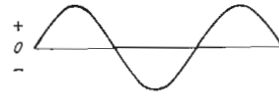
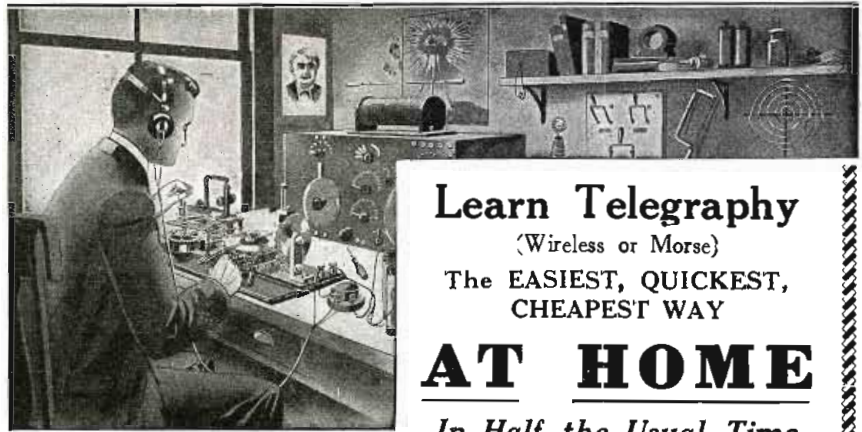

Fig. 5

When the line voltage is positive the transformer secondary indicated in the diagram by T1 is positive and tube No. 1 functions. When the line current is reversed the plate potential supplied to tube No. 1 is negative and it does not work, but tube No. 2 operates from the positive potential supplied by the secondary indicated by T2. In such a system a 120-cycle note may be produced without the use of a chopper or other form of mechanical circuit breaker. When suitable choke coils are provided, it is also possible to smooth out the resultant current so as to allow voice modulation to be used. The greatest drawback in this form of circuit is that there is a continual burning of both filaments, tho there is a wave emission which corresponds to a little less than would ordinarily result from the use of a single tube where a constant source of positive potential was available. The loss in a set using two five-watt tubes is about six watts. This loss is not of much consequence, when the advantages of such a circuit over any other, which could be used under the same conditions, are considered.

It is quite doubtful that a transmitter of the spark type could be obtained which would lend itself to such very favorable working conditions and would cover the same distance, regardless of power consumption, for anything like the same price, even if the majority of the parts were not to be found in the receiving station, which is very unlikely to be the case. Where these units are to be found it is quite simple to estimate the ultimate cost of a good C. W. transmitter, arranged from the foregoing information which will suit quite well the needs of most small stations and will result in the ultimate reduction of interference caused by the less efficient and bothersome spark transmitters, even tho they are of a design which



**Learn Telegraphy**

(Wireless or Morse)

The **EASIEST, QUICKEST, CHEAPEST WAY**

**AT HOME**

In Half the Usual Time

**WITH THE OMNIGRAPH**

"Just Listen—The Omnigraph will do the teaching"

The Omnigraph is an *Automatic Transmitter* that teaches you both the Wireless and Morse Codes, at home, without any expense except the cost of the machine itself. Merely connect to battery and your Buzzer, or Buzzer and Head Phones, or to your Sounder and the Omnigraph will send unlimited messages by the hour, at any speed you desire.

**USED BY THE U. S. GOVERNMENT**

The Omnigraph is used by the Government in testing all applicants applying for a Radio License. It is also used extensively by the large Universities, Colleges and Telegraph Schools throughout the Country for teaching Wireless and Morse. Hundreds of the Army's skilled operators who served during the war learned with the Omnigraph.

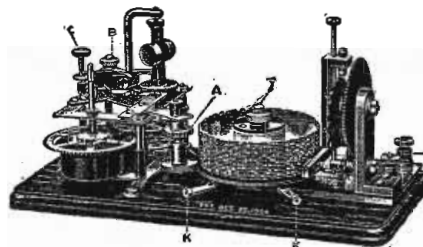

**Let The OMNIGRAPH Teach You Wireless**

For a few dollars you can have a complete outfit that will make you an experienced operator in the shortest possible time. No hard, laborious work—just learn by listening. The Omnigraph is adjustable so you can start receiving messages slowly, gradually increasing the speed as you become proficient.

You'll be surprised how quickly you will attain speed. Even if you are already an operator the Omnigraph will help you. It will make you more proficient, more accurate and more confident. Thousands of Omnigraphs are in use today and thousands of operators owe their success to them.

**Write for Free Catalog**

Send for a catalog today, showing the 3 different models, \$14 to \$30, or purchase through your Electrical Dealer. Every Omnigraph is sold with the absolute guarantee that you must be satisfied or your money back for the asking. Mail the coupon today—the catalog will come to you by return mail.

**The Omnigraph Mfg. Co.**  
26 F Cortlandt St.,  
New York City

Gentlemen:—

As per your ad in RADIO NEWS please mail me your free catalog of Omnigraphs.

Name .....

Address .....

City..... State.....

**The Omnigraph Mfg. Co.**  
26 F. Cortlandt St., New York City

**THE ROTARY MODULATOR**

For Successful 200 Meter Tone Transmission with Power Tubes

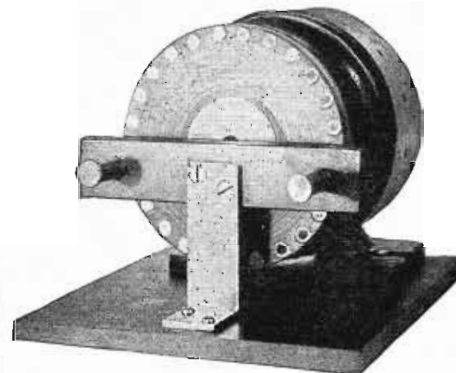

Is your new CW set difficult to heterodyne at 200 meters? Then use the **ROTARY MODULATOR** in the circuit and watch how easily your tube set cuts thru the summer static.

You can operate this modulator in self-rectifying circuits where straight CW is impossible on account of the ripple.

Remember that we furnish with each modulator a blue print and complete design data for a modern tube transmitter.

Price of modulator complete, not including motor..... \$10.00

We can supply a dependable Westinghouse motor to drive the modulator. Prices upon application.

Order from your dealer or direct from

**Northern Electric Company**  
**SCHENECTADY, NEW YORK**  
P. O. Box 371

# KLITZEN RADIO MFG. CO.

RACINE, WIS., U. S. A.

## VARIOMETER No. 220

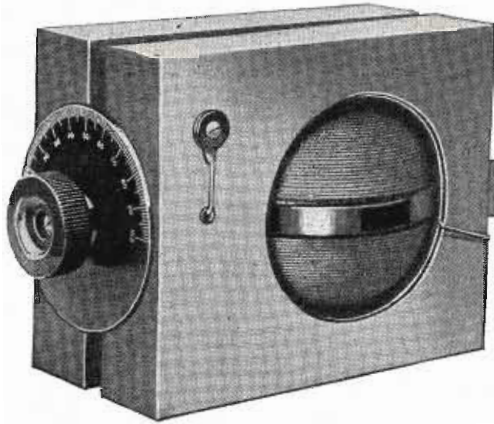

WATCH  
THIS  
SPACE  
AND  
GET ON  
OUR  
MAILING  
LIST

Forms kiln dried wood  
Offset windings  
No friction contacts  
3/16" shaft  
Gorton engraved bakelite dial.

No. 220 Variometer      \$6.00  
With Knob and Dial      \$6.75

## VARIOCOUPLER No. 230

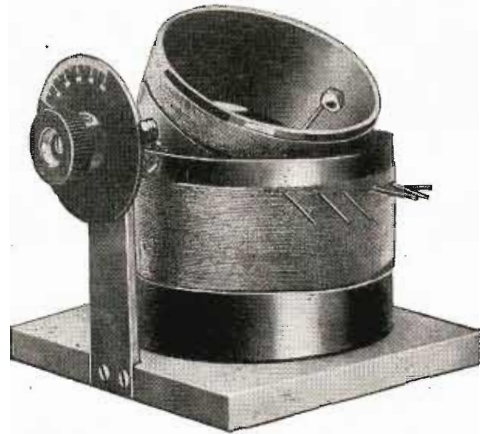

Formica tubes  
Variable in steps of two turns per tap  
Gorton engraved bakelite dial  
For use on wavelengths up to 475  
meters.

No. 230 Variocoupler      \$6.00  
With Knob and Dial      \$6.75



## INVENTORS

If you have a worth-while idea and have not the time or the equipment to develop it successfully, let us do it for you. Your rights will be fully protected. We will even assist you in taking out a patent if you so desire.

This company has specialized for years in the building of models, electro-magnets, solenoids and developing inventions.

While we have never advertised except in our former catalogs that we did this class of work there has been a more and more persistent demand for such work, and we have decided to let the public at large know that we do such work as a regular thing. We have a well-equipped shop in which every kind of research work can be done and any invention can be developed at a lower cost than it could be done anywhere in the United States. This work is done under the personal supervision of

## MR. H. GERNSBACK,

*Editor of SCIENCE AND INVENTION and RADIO NEWS*

Mr. Gernsback has had vast experience in patent matters and has given advice to thousands of inventors during the past fifteen years thru his patent advice departments in "Modern Electrics" as well as "Science and Invention" (formerly "Electrical Experimenter"). Mr. Gernsback understands the needs and wants of the inventor, being an inventor of several hundred devices himself. You may therefore rest assured that the building and developing of whatever devices you require will be done under expert guidance. Let us have your inquiries and blue prints or drawings.

## E. I. CO.

H. GERNSBACK, *President*      233 Fulton St., New York City

*Established 1904*





is within the law. Being on the shady side of the law is not the only thing to look out for: with the rapid growth in the number of stations which transmit, it is essential that each and every one, in order to eventually help itself, so conduct its transmitting as to cause as little interference to the other fellows as possible. The application of the Golden Rule may sound a little too much like Sunday School, but in it we will only find the acme of operation even tho the rule is applied from the selfish realization that it will eventually be for our own benefit.

In addition to the circuits herein described, others will suggest themselves to the reader, whereby he will be able to use the same tube for sending and receiving, by using a switching arrangement. Such a concentration of apparatus would allow for the best possible kind of a portable set to be used where it was possible to use an A. C. supply.

### The Oscillograf

(Continued from page 60)

wave from the telephone set is rectified, then the vibrator will be effected only in one direction due to the rectified wave acting on it, but because of the too rapid frequency of these oscillations the vibrator will simply be deflected an amount proportional to the effective amplitude of the wave. Thus, altho the r. f. wave acts on the vibrator, it simply records a straight line proportional to the effective amplitude of the wave when unmodulated. In order to secure this rectification of the r. f. wave, a tube circuit is set up as shown in Fig. 9, which is coupled to the telephone set and which acts as a rectifier. The rectified current in the plate circuit is then passed thru the vibrator of the oscillograf, which makes the record on the screen.

The rectifier circuit is coupled to the telephone set as shown. As above, the mirror images are made coincident and the center vibrator acts as the zero axis with no current thru it. The unmodulated r. f. from the telephone set is then rectified and passed thru the left-hand vibrator which is deflected, as stated above, and traces a straight line, the distance of which above the zero axis is proportional to the r. f. unmodulated amplitude. The right-hand vibrator, which has no current thru it, is coincident with the zero axis, and by means of the mirror adjusting screws S and W (Figs. 3 and 4) can be brot to coincide with the line traced by the r. f. This is done and we have now, fixt on the observation screen, a zero line and a fixt line representing the amplitude of the unmodulated r. f. from the telephone set. Speech may now be applied to the telephone set, which is picked up by the rectifier tube and applied to the left-hand vibrator. This vibrator will follow the speech wave, since its natural period is high enough to do this, and a speech wave is traced which is a copy of the speech given out by the telephone set. The amplitude of the speech wave can now be compared with the fixt amplitude of the unmodulated r. f. wave and thus the percentage modulation can be determined.

The size of the curves thus obtained depend of course on the amount of current passed thru the vibrators. This can be adjusted to proper values giving good sized curves by varying the coupling of the rectifier tube to the telephone set and by adjusting grid and pate voltages on the tube to the best values. Further applications will become obvious after the general mode of operating the oscillograf is understood, thus for example a current wave may be traced by one vibrator and a voltage wave by another simultaneously, and the difference in phase between current and voltage studied.

## CORWIN'S improved SWITCH LEVER

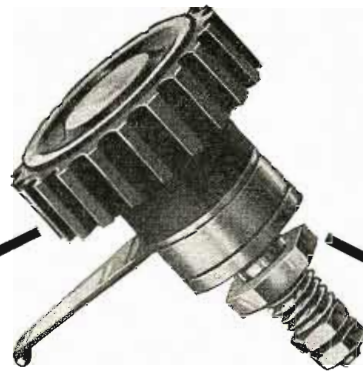

**PRICE: 90 cents, Postage, 5 cents.**

A switch lever may be just a small item, but it pays to get a smooth running, well made switch like the one pictured above. This new Corwin switch is a handsome accessory that will add to the appearance as well as the efficiency of your set. The knurled knob is a special composition,—identical with the knobs used on the standard No. 67 Corwin Dial. The brass shaft is moulded right into the knob, so that it can never come loose. Blade, bushings, etc., are nickel-plated brass. Contact radius, 1/4". Send your order today. Satisfaction guaranteed!

### NEW RADISCO VARIO-COUPLER

This is the coupler that caused such a sensation when it was announced two months ago. Sales have been tremendous, but we, never-the-less, have a generous supply on hand, ready for immediate shipment. "Accurate to the .002 part of an inch!" Moulded base, Formica tube, all metal parts brass. Price \$7.50 postpaid.

### CORWIN'S 1921 CATALOGUE, 10c

If you haven't already sent for your copy, don't lose another day. You will certainly want these 32 pages, listing all Corwin and Radisco instruments. You will find in this catalogue a good instrument for every part of your station at a price that won't "take the joy out of life." One dime and your name brings the catalogue by return mail.

**A few specials from our catalog—ready to ship [at] once.**

- New Patent Plug, postpaid ..... \$2.00
- Firco Vocaloud. The ideal loud speaker. Requires no batteries, no adjustments, no extra equipment whatever.
- Station type, in mahogany cabinet.... 25.00
- Laboratory type, on metal base ..... 23.00

- VARIABLE CONDENSERS
- A.R.CO. 001 ..... \$6.25
- A.R.CO. .0005 ..... 5.00
- With No. 67 Dial add 1.00
- Shipping Weight 1 Lb.

- CORWIN DIALS
- No. 66, 3 in. .... .75
- No. 67, 3 in. with knob 1.30
- No. 68, 3 3/4 in. .... 1.00
- No. 69, 3 3/4 in. with knob, postpaid .... 1.70

- GRID CONDENSERS
- Radisco, postage 3c.. .35
- "B" BATTERIES
- Radisco No. 1 (2 lbs.) 1.50
- Radisco No. 5 (5 lbs.) 2.65
- Eveready Storage Battery prices on application.

- RECEIVERS
- Murdock No. 55, 2000 ohm ..... 4.50
- Murdock No. 55, 3000 ohm ..... 5.50
- Brandes Superior..... 7.00
- Baldwin O ..... 18.50
- Baldwin E, improved 20.00
- Brownlie, new ..... 12.00
- Shipping weight, 2 lbs.

### Universal-Coil Mounting Plugs

Anyone can easily make smooth-running mountings with these plugs. No bending, no filing, they are made to fit exactly, in the first place. Suitable for Radisco and all hand wound coils. A few minutes work with these plugs will save you dollars that can be put into better apparatus. Price 80 cents, postpaid.

- ALL RADISCO COILS and Wireless Press Books
- VACUUM TUBES
- Electron Relays ..... 6.00
- VT Amplifier (1 lb.).. 7.00
- VT Extra hard for transmitting ..... 7.50

- CONTACT POINTS
- CP No. 1, Brass, doz. .25
- F No. 4, Brass, doz. .35
- CP No 5, Nickel plated .45
- Postpaid

- ROTARY SWITCHES
- Clapp-Eastham No. 19 1.00
- Clapp-Eastham No. 19A .35
- Our Own No. 1..... 40
- Our Own No. 2..... 55
- Postage ..... .05

- VARIOMETERS
- Radisco No. 1..... 7.00
- Radisco No. 1D..... 8.50
- 3 pounds

All orders for apparatus not listed as postpaid must be accompanied by postage charges.

## A. H. CORWIN & CO.

Dept. B2, 4 W. Park St., Newark, N. J.

Remember Corwin's reputation for shipping mail orders promptly and in perfect condition.

## ATTENTION AMATEURS

IF YOU WANT SERVICE, ORDER OF "RTS"

PRICES THAT SATISFY—READ THIS LIST

- Aerial Wire, solid copper, No. 14, per 100 ft.. 58c.
- RTS Switch Levers, nickel plated, 1/2 radius, Marconi knob and bushing, each..... 52c.
- RTS B Batteries, 22 1/2 V. Block, special this month ..... \$1.25
- RTS Tested Galena Crystal ..... 25c.
- RTS Hard Rubber Binding Posts, each ..... 13c.
- Per Doz. .... \$1.25
- RTS Tested Silicon, per box..... 25c.

### MR. DEALER

IF YOU HAVE NOT RECEIVED OUR LETTER ON THE RTS CONDENSERS, WRITE AT ONCE FOR DISCOUNTS, ETC.

LIVE WIRE DEALERS AND AGENTS WANTED.

Send 10c for Catalogue. This Amount Deducted on Your First Order.

RADIO TESTING STATION

BINGHAMTON, N. Y.

READ AD ON PAGE 74 ON BOUND VOLUMES



# OPPORTUNITY AD-LETS

Follow these advertisements every month. Reliable advertisers from all over the country offer you their most attractive specials in these columns.

Classified advertising rate six cents a word for each insertion. Ten per cent discount for 6 issues, 20 per cent discount for 12 issues. Name and address must be included at the above rate. Cash should accompany all classified advertisements unless placed by an accredited advertising agency. No advertisement for less than 10 words accepted.

Objectionable or misleading advertisements not accepted. Advertisements for the September issue must reach us not later than August 10.

## THE CIRCULATION OF RADIO NEWS IS OVER 40,500

EXPERIMENTER PUBLISHING CO., INC., 233 and 236 Fulton Street, New York, N. Y.

### Aeronautics.

New and Used Aeroplanes, Motors and Flying Boats, send for free copy of our current issue. It contains helpful, instructive information on overhauling, ignition troubles, wiring, carburetors, storage batteries, etc. Over 130 pages, illustrated. Send for free copy today. Automobile Digest, 528 Butler Bldg., Cincinnati.

### Automobiles.

Automobile Owners, Garagemen, Mechanics, Repairmen, send for free copy of our current issue. It contains helpful, instructive information on overhauling, ignition troubles, wiring, carburetors, storage batteries, etc. Over 130 pages, illustrated. Send for free copy today. Automobile Digest, 528 Butler Bldg., Cincinnati.

### Automobile Accessories.

Auto Motors Supplies—Duick, Michigan, Stoddard-Dayton, E. M. F., Cadillac, Overland, Continental and Buick Motors. All types, \$50 each and up. New Dixie magnetos, \$20; Spilldorf high tension magnetos, \$10; Kellogg pumps \$3.50; Auto-Lite generators, new, \$10; air gauges, 65c; Remy ignition coils, new, \$3; electric and gas headlamps, coils, distributor heads, air compressors, etc. Write for catalog. Motor Sales Dept., 16 West End, Pittsburgh, Pa.

### Motorcycles—Bicycles.

Used Parts for all motorcycles. Schuck Cycle Co., 1922 Westlake, Seattle, Wash.

Don't Buy a bicycle motor attachment until you get our catalog and prices. Shaw Mfg. Co., Dept. 1607 Galesburg, Kans.

### Motors, Generators and Dynamos

Special Garage Motors—Manufactured by the General Electric Co. H.P. \$78.50; 2 H.P. \$110; 3 H.P. \$128.50; 5 H.P. \$166.50. All sizes both single and polyphase motors for immediate delivery. Special charging generators, all voltages. Write for catalog. Motor Sales, Dept. 16, West End, Pittsburgh, Pa.

### Agents Wanted.

Big Money and fast sales. Every owner buys gold initials for his auto. You charge \$1.50; make \$1.35. Ten orders daily easy. Write for particulars and free samples. American Mouogram Co., Dept. 133, East Orange, N. J.

### Help Wanted.

Earn \$25 Weekly, spare time, writing for newspapers, magazines. Experience unnecessary; details free. Press Syndicate, 5665, St. Louis, Mo.

Be a Mirror Expert, \$3-\$10 a day; spare time home at first; no capital; we train, start you making and silvering mirrors. French method. Free prospectus. W. R. Derr, Pres., 579 Decatur St., Brooklyn, N. Y.

Radio Operators—Amateur radio operators wanted to form a communication division 1st Battalion Naval Militia and U. S. N. R. F. Practical work and instruction radio and radio telephones. Many Summer advantages. Week-end and fifteen-day cruises in Eagle boats to West Indian ports. Re-learner pay while serving. Full pay when cruising. No interference with civilian duties. Inquire any Monday evening. Communication Officer, U. S. S. Granite State, foot W. 97th St. (via 96th St. and Broadway), North River, Manhattan.

Detectives Earn Big Money. Excellent opportunity. Travel. Great demand everywhere. Fascinating work. Experience unnecessary. Particulars free. Write, American Detective System, 1368 Broadway, New York.

### Health.

Tobacco or Snuff Habit Cured or no pay; \$1 if cured. Remedy sent on trial. Superba Co., 515, Baltimore, Md.

Pyorrhea (King's disease—bleeding or swollen gums)—hundreds have been helped by "Pyorrident," the successful home pyorrhea treatment. Purifying, healing, preventative. Full month's treatment, consisting of a very beneficial massage paste and an antiseptic tooth-cleansing paste to be used in place of your ordinary dentifrice, together with full directions for treatment, \$1 postpaid. Or write for free booklet "R." Pyorrident Mfg. Co., 439 Seventh St., Brooklyn, N. Y.

### Correspondence Courses.

Dollars Saved—Used correspondence courses of all kinds sold, rented and exchanged. List free. (Courses bought.) Lee Mountain, Pisgah, Alabama.

### Miscellaneous.

Bargain!!! 95c 14 K. solid gold lever self filling fountain pen. Fully guaranteed, money back if not entirely satisfied. An enduring and serviceable gift for wedding, birthday, or graduate. De Coligny Co., 238 N. 64th St., Philadelphia, Pa.

### Electrical Supplies and Appliances.

Storage Batteries for automobiles. We furnish all parts and moulds for making them. Sample plate, 40c. Foreign countries, 50c. Windsor Specialty Co., 5419 Windsor Ave., Chicago, Ill.

Electricians—Wiremen, linemen, send your name and address for descriptive literature of our modern blue print chart method of electrical wiring. Over 350 practice diagrams. Electrical Wiring Diagram Co., Box C-173, Altona, Pa.

### Business Opportunities.

Send \$1 Money Order for Washburne's simple method sign show card painting (in one lesson); earn \$50 weekly. 251 West 125th St., New York City.

Make Big Money—Start a business of your own. We give full instruction to succeed. Guaranteed formulas how to manufacture: Silverplating powder, liquid court plaster, straw hat bleach, re-silvering mirrors, dressing and polish for tan shoes, luminous paint, toothpastes for collapsible tubes, soap bubble liquid. All for 50 cents. The Sydney Specialty Co., 43 Murray St., New York City.

Substantial Manufacturing Corporation wants capable men to establish branch and manage salesmen; \$300 to \$2,000 necessary. Will allow expenses to Baltimore as explained. Address Mr. Clemmer, 603 N. Eutaw St., Baltimore, Md.

Make Big Money opening safes and setting combinations. Wavve Street, Box 1430, Los Angeles, Cal.

High Grade Investments—Railroad, public utilities, yielding 6% to 8%. Write for descriptions. C. H. Fuerstenberg, Investment Dept., 25 Broad St., New York.

Rubber Stamps.—Manufacture and sell. I furnish everything necessary. Three line, sample with your name and address and instructions, 25c. Rubber Stamp Co., Grampian, Pa., Box 24.

### Books.

The Amateur Electrician—Pocket size, 20c, coin. Joe Tillberg, Proctor, Vermont.

Concordia Magazine, Quarterly, 9 Vator, York, Penna., prints essays, stories, current events, poetry, formulas and plans. Send \$1 for three-year subscription.

We Buy and Sell back issues of Radio Amateur News and Electrical Experimenter. Boston Magazine Exchange, 109 Mountfort St., Boston, Mass.

Lieut. Stone's Book, "Elements of Radiotelegraphy" 400 pages, \$2.50. Aro Radio Manuals, \$2.50. Radio Sales Co., 251 DuBoise Ave., San Francisco, Calif.

What? "Wireless Telegraphy and Telephony Simply Explained," by Alfred P. Morgan, 154 pages, 156 engravings, price, \$1.50. "Radio Hook-ups," by M. B. Sleeper, price 75 cents. "Design Data for Radio Transmitters and Receivers," by M. B. Sleeper, price 75 cents. "Radio Time Signal Receiver," by Austin C. Lescarboura, price 35 cents. "Construction of a Trans-Atlantic Wireless Receiving Set," by L. G. Pacent and T. S. Curtis, 36 pages, 23 illustrations, price 35 cents. Complete your radio library. Radio Distributing Co., Abilene, Kansas.

Do You Know? "Experimental Wireless Stations," by P. E. Edelman. The theory, design, construction and operation is fully treated including Wireless Telegraphy, Vacuum Tube, and Quenched Spark Systems. The new and enlarged edition is just issued and is strictly up to date, collect and complete. This book tells how to make apparatus to not only hear all telephoned and telegraphed radio messages, but also how to make simple equipment that works for transmission over reasonably long distances. Then there is a host of new information included. The first and only book to give you all the recent important radio improvements, some of which have never before been published. This volume anticipates every need of the reader who wants the gist of the art, its principles, simplified calculations, apparatus dimensions, and understandable directions for efficient operation. Vacuum tube circuits; amplifiers; long-distance sets; loop, coil, and underground receivers; tables of wave-lengths, capacity, inductance; such are a few of the subjects presented in detail that satisfies. It is independent and one of the few that describe all modern systems. Endorsed by foremost instructors for its clear accuracy, preferred by leading amateurs for its dependable designs. The new experimental wireless stations is sure to be the most satisfactory for your purposes. 27 chapters, 392 pages, 167 illustrations, price \$3. A four-inch nickel plated radiophone dial will be supplied with first 25 orders. Complete your radio library. Radio Distributing Co., Abilene, Kansas.

Can Dead Talk? 150 pages. Exact truth. Both sides, 25c. No stamps. Winsor, Box 815, San Jose, Calif.

Just Off the Press.—Design and Construction of Audion Amplifying Transformers (Radio and Audio-Frequency Types). By Edward T. Jones, late Associate Editor Radio Amateur News. The transformers shown in this book have never been described in print before and have usually been considered a manufacturer's secret. The designs are very rugged and simple. A book that every radio "bug" should have. Written so you will understand every word. Price 25c postpaid. Experimenter Publishing Co., Book Dept., 230-A Fulton St., New York City.

### For Men.

Tested Razors sent on free trial. Zitka, Fairview, Mass.

### Farms, Land, Etc.

Pecan and Orange Orchards on the Gulf. Easy terms. Big quick returns. Dept. R, Suburban Acres Co., Ocean Springs, Miss.

### For Advertisers.

Don't Wait for Business.—Advertise and get it. We will help you. Jacobus Service, 41 Bruen, Irvington, N. J.

### For Inventors.

Model Making and Experimental Work of every description. Manufacturing, Lamson Model & Experimental Works, 625 W. Jackson Blvd., Chicago.

Don't waste time making models. I improve, develop and make accurate drawings of your idea! My plans are guaranteed to work, charges \$5 and up. Emil T. Dahlens, Manson, Iowa.

### Instruction.

Mathematics Taught By Mail—Spare time home study course, including arithmetic, geometry, algebra, and trigonometry. J. A. Harding, 76 Brighton Ave., Highland Park, Mich.

### News Correspondents

Earn \$25 Weekly, spare time, writing for newspapers, magazines. Experience unnecessary; details free. Press Syndicate, 566 St. Louis, Mo.

### Novelties.

Genuine Indian Baskets.—Wholesale catalogue. Marion Gilbruns, Highland Springs, California.

### Patent Attorneys.

Patents—Send for free book. Contains valuable information for inventors. Send sketch of your invention for free opinion of its patentable nature. Prompt service; twenty years' experience. Talbert & Talbert, 440 Talbert Bldg., Washington, D. C.

Patents Secured. Prompt service. Avoid dangerous delays. Send for our "Record of Invention" form and Free Book telling How to Obtain a Patent. Send sketch or model for examination. Preliminary advice without charge. Highest references. Write today. J. L. Jackson & Co., 133 Ouray Bldg., Washington, D. C.

E. T. Brandenburg (former patent expert, Ordnance Division, War Department), Attorney-at-law and Solicitor of Patents, 927 Loan and Trust Bldg., Washington, D. C. Send sketch and description, or model of your invention for careful investigation at Patent Office and unbiased report as to patentability.

Millions Spent Annually for Ideas. Hundreds now wanted! Patent yours and profit! Write today for free books—tell how to protect yourself, how to invent, ideas wanted, how we help you sell, etc. 301 Patent Dept., American Industries, Inc., Washington, D. C.

### Patents For Sale.

Power Driven Post Hole Auger. Patent No. 390,517. Outright sale, or rights to manufacture on royalty basis. E. L. Decker, Center, Mo.

### Phonographs.

Build a genuine Choralion phonograph and save over half. Fine profits building and selling. We furnish motors, tone arms and necessary parts. Send for our catalog and free blueprint offer. Choralion Phonograph Co., 721 15th St., Elkhart, Indiana.

### Photo Developing.

Get Acquainted Offer—Mail us 20c with any size film or six negatives for development and six velvet prints. Twenty-four hour service. Fine work. Roanoke Photo Finishing Co., 324 Bell Ave., Roanoke, Va.

Your Film and 25c brings you prints made with attractive border designs. Something new. New England Photo Service, Box 1202, Boston, Mass.

### Stammering.

Stammerers—My simple and natural method will correct your impediments. Instruction individual. Samuel I. Robbins, 246 Huntington Ave., Boston.

St-Stu-t-t-tering and Stammering cured at home. Instructive booklet free. Walter McDonnell, 121 Potomac Bank Bldg., Washington, D. C.



Printing.

Labels, 60c per 1,000 up. Irvin J. Wolf, Station E, Philadelphia.

Everything Printed.—Long run specialists. Samples. Quality Printery, Marietta, Ohio.

125 Letterheads, 100 white envelopes, printed and mailed for \$2. Samples Rec. Sun Co., Mahanck, N. Y. 250 Bond Letter Heads and Envelopes for \$2.75. Balkow Printing Company, Meriden, Conn.

Stamps and Coins.

20 Liechtenstein; 5 Utrania; 2 Poland; 3 Jugo Slavia; all for 10 cents. Regularly 2 35c packet. Sent only to applicants for approval sheets. Lakewood Stamp Company, Dept. R, Lakewood, Ohio.

1000 Different Stamps, \$3; 500, \$1.25; 200, 50c; 100, 12c. Approvals. Michaels, 5602 Prairie, Chicago.

Wanted to Buy

You can raise cash by mailing us any old, broken jewelry, diamonds, platinum, broken watches, false teeth, bracelets, old gold, silver, silver plate, magento points, platinum wire, contact points or crucibles, mercury, and all valuables. We will pay you the highest price in cash by return mail, and will return your goods in ten days if you're not satisfied. The Ohio Smelting & Refining Company, 207 Lennox Bldg., Cleveland, Ohio.

Wireless.

Radiohone Concerts.—Would you like to tune in easily and clearly the radiohone concerts in the ether and on the other hand be able to transmit them yourself with practically no more apparatus or power than used to receive them? If so, it will pay you to get acquainted with the Electrical Specialty Regenerative Receiver and Radiohone (150 to 600 meters). This set although designed for radiohone and C. W. reception brings in spark signals as clearly and loudly as the best on the market. The secret lies in the construction of the radiohones and variocoupler with bakelite framework throughout and with capacity reduced to nil, thereby permitting very sharp and close tuning. In addition to its use as a regenerator the Esco regenerative receiver may be used as a radiohone. By actual experiment a hook-up has been discovered whereby with the use of a microphone and a simple detector unit, distances of from 10 to 40 miles have been covered with the Esco receiver. The human voice and all kinds of music have already been transmitted in this manner. The hook-up and full instructions for its use are available to every purchaser of an Esco set. Wiring diagram, full instructions for operation and wave-length chart are furnished with each receiver, price \$50. Bulletin on request. As a further inducement we will supply for a limited time free of charge with each set your choice of a Paragon V.T. control unit, a pair of Murdoch 1000 ohm phones, a radiohone U.V. 200 V.T. detector or a Moorhead A.P. V.T. detector. Only new and high grade apparatus carried in stock. Orders filled within twelve hours. Unsatisfactory goods subject to return in five days. The Kehler Radio Laboratories, Dept. R, Abilene, Kansas.

Bargains! Few unused A. P. Tubes. Detectors, \$5.25; amplifiers, \$6.25, postpaid. Also few Cunningham detectors, \$4.25; amplifiers, \$5.75, postpaid. Radio Sales Co., 251 Duboce Ave., San Francisco.

Complete, Two tube telephone set, priced extremely reasonable for quick sale. Made at well-known, Midwest supply company. Full particulars to all interested. Turner, Kansas and Pearl, Independence, Mo.

Bargain—New one stage amplifier, \$10. Winston Sizer, Port Washington, N. Y.

For Sale—Amrad one kilowatt quenched gap. Practically new, \$25. R. J. Knout, 1344 21st St., Des Moines, Iowa.

Oh, Boy! Grebe Special—Type CR-3. The Grebe special—short-wave regenerative receiver type CR-3 (150 to 350 meters, with sharp capacity, 250 to 600 meters), recognized as the standard among all professional amateurs, will, for a limited time, be sold in a combination offer. With each set purchased from us we will supply free of charge your choice of one of the following: Paragon vacuum tube control, \$6; Radiotron u.v. 200 V.T. detector, \$5; Moorhead A.P. V.T. detector, \$6; pair of Murdoch 2000 ohm phones, \$4.50; Type CR-3, price \$65. Was illustrated in May issue of Radio News. Only new and high grade apparatus carried in stock. All goods subject to return after five days trial if not satisfied. Orders filled in twelve hours. The Kehler Radio Laboratories, Dept. R, Abilene, Kansas.

Regenerative Coils. Amateur raise. Complete three-coil set and hook-up, \$2. Theodore Cutting, Campbell, Calif.

The new Crosley V-T socket, suitable for either base or panel mounting. Price only 60c. Also new variable condenser, 0005 capacity, \$1, without dial; \$1.75 with dial. Also stock cabinets for radio apparatus and other specialties. Circulars on request. Crosley Manufacturing Company, Dept. R, N. No. 1, Cincinnati, Ohio.

Audion Protector will save your Audion Bulbs. Complete set, \$2. Buckley Glass Wks., Toledo, Ohio.

N and W Radio Store. New and used wireless apparatus for sale, send stamp for list, 113 So. 10th St., Mazon, Ill.

Special offer for a limited time only. Hex. brass nuts, 5c per doz. Hex brass cup nuts, 30c per doz. Brass washers, 30c per 100; 6/32 knurled screws 1/2 in. thread, 30c per doz.; 5/32 disks, 40c per doz.; knurled nuts, 6/32 or 5/32, 45c per doz. Threaded brass rods, 5/32 or 3/32, 5c per ft., plain brass rods 1/2 to 1/2 inch, 6c to 30c per ft.; zinc plated 3/16, 1/2 in. stud, 40c per doz. Small brass lugs for wiring receiving sets, 30c per 100. No order for less than 50c accepted. All goods sent prepaid. Money order must accompany order or goods will not be shipped. Trost, 1630 First Ave., New York City.

Now is the time to buy—New and used apparatus at special prices. Tell me what you need. W. Freeland, 34 Baldwin Ave., Newark, N. J.

Order New—While they last—1/2 K.W. Thordarson transformer, \$18; 1/2 K.W. Dubilier transmitting condenser .007 m.f., \$25; Connecticut condensers, \$5; inductance coil, mounting tube, L.C-100, \$8; No. 5 omniograph, \$10. Elmer Hoffman, 713 Bound Brook Road, Danellen, N. J.

(Wireless continued)

Stop! Look! and Act! V.T.'s. With each radiotron u.v. 200 V.T. detector or A-P Moorhead V.T. detector or radiotron u.v. 200 V.T. Amp. or A-P Moorhead V.T. amp. we will supply free of charge your choice of either a Murdoch V.T. socket improved contact type, or a Chelsea Bakelite smooth running rheostat latest type, or a Chelsea bakelite grid condenser with clear India mica dielectric, or a 3% in. Chelsea Bakelite knob and dial control, Radiotron u.v. 200, \$5; Radiotron Amp. V.T. u.v. 201, \$6.50; Moorhead A. detector, \$6; Moorhead A-P Amp. V.T., \$7; Remier Bakelite Rheostat latest type, \$1; Murdoch V.T. socket, \$1; Chelsea India mica grid condenser, 75c; Chelsea Bakelite dial and knob, \$1; Paragon Rheostats, \$1.75; Paragon V.T. control panels, \$8; Federal amplifying transformers, \$7.50; Radio Corporation of America's latest amplifying transformer u. v. 712, magnetic shield, especially designed by General Electric Co. for use with Radiotron V.T.'s, \$7; Remier control panels, \$8; Burgess B batteries, largest size, 22 1/2 volts with 1 year life, \$3.50. We absolutely guarantee the foregoing apparatus. Only new and high grade equipment carried in stock. All orders are filled within twelve hours and shipped postpaid and insured, thereby saving time and money. Remember us. The Kehler Radio Laboratories, Dept. R, Abilene, Kansas.

Orders filled in 12 hours. The Kehler Radio Laboratories.

Memorize Continental Code in one hour. Quality quickly for amateur license. No instruments. See our ad in display section this magazine. C. K. Dodge, Mamaroneck, N. Y.

Attention—Your radio questions answered two for dime. Reliable information. For special circuits write Devore, Gibson City, Illinois.

Get these weak signals you're not getting now by using variable Eveready detachable unit plate batteries. Made so any weak battery unit can be replaced by new unit at fractional cost of new battery. Variable 2 1/2 volt battery, \$2; special electron relay 36 volt battery, \$3.20, postpaid. Davenport Laboratories, 5 Temple St., Paterson, N. J.

Amateurs—All kinds of wireless receiving apparatus made to order. Robert Stephens, 4154 McKee Ave., Monessen, Pa.

Bi-Lattice Coils (Duo-Lateral). For long distance reception this is the best type of inductive Single Layer Coils. For short wave reception a set of these coils compares favorably with the best regeneratives; and the cost is but a fraction of the regular regenerative set. Send 3c for bulletin. Our prices will surprise you. P. J. Stockwell, Box 157-C, Reading, Mass.

Quenched Gaus. Amrad. 1 1/2 K.W., \$8; 1 1/2 K.W., \$15.50; 1 K.W., \$29; 1 1/2 Volt Amrad induction coil, \$25. Earle Rishard, Lemoyne, Pa., Box 313.

Special Offer—Until August 15 we are offering the Turney Spiderweb Short Wave Regenerative Set at 150 to 400 meters. List price \$5 at \$5. Radio Distributing Co., Abilene, Kansas.

Audion Detector and Amplifier, V.T., 50 cents. Honeycomb coil mountings, 25 cents. Back mounted rheostats, 40 cents. Composition for molding your own knobs, panels, etc. 5c pound. Send stamp for particulars. Palmers Electrical Equipment Co., Palmers, Minn.

Costs too much? Oh, no! On Sept. 30 we shall give everyone a chance to buy a reliable amplifying transformer of correct design at the lowest price on the market. We are offering the Clapp-Eastman Amplifying Transformer, which gives results second to none (same as illustrated in recent issue of Radio News). List price \$4, at \$3.45 postpaid. Immediate delivery. Guaranteed \$30.00 or return if not satisfied. The Radio Distributing Co., Abilene, Kansas.

Radiotron Power Tubes. Do We? Yes. We supply free of charge with each Radio Corporation of America 5 watt power tube u.v. 202 a 5000 ohm, size M grid leak with midtap at 3500 ohms, especially designed to be used with B, and with each 50 watt tube U.V. 203, a special 5000 ohm size B grid leak with midtap at 2500 ohm size M grid leak, \$1.15; size B grid leak, \$1.65. Specifications of u.v. 202. Power tube: Filament voltage 7.5 v. filament current 2.35 amperes. Normal plate voltage 250 V. normal plate current .645 amperes. Normal output 5 watts, price \$2.50. 203 power tube. Filament voltage 10 V. filament current 6.5 amperes. Normal plate voltage 1000 V. Normal plate current 15 amperes. Normal output 50 watts, price \$30. R. C. Standard rheostat, Model P.E. 535, designed for u.v. 202, \$3. R. C. Standard rheostat, Model P. T. 527, designed for u.v. 203, \$10. R. C. Standard porcelain sockets, Model U. R. 542, for U.V. 202, \$1. R. C. Standard porcelain socket, Model U.T. 541, for radiotron U.V. 203, \$2.50. Kinotron rectifier u.v. 216-20 watt (for 5 watt radiotron), \$7.50. Kinotron rectifier u.v. 217—150 watt (for use with 50-watt radiotron), \$26.50. Power transformer U.P. 1016—750 watt for tube sets, \$35.00. Power transformer U.P. 1068—325 watt, \$25. Anti-tube box for kinotron rectifier sets. Filter condenser, filter reactor. Magnetic modulator for radio telephony n.p. 1367 160 watt, U.P. 1357/10-20 watt, Microphone transformer Y-414, \$7.25. Rectifier plate circuit 3 watt tube sets, Y-425, \$4.75. Sending key U. Q809 for tube sets, \$3. Arctovox ammeter U.M. 533, 0-5 amp., \$6.25. I.M. 530, 0-2.5 amp., \$6. Grid condenser and plate circuit bypass condenser \$6. 577, \$2. Special antenna series condenser No. 500 for tube sets, three capacities, 0005, 0001, 0005 M.F.D., \$5.40. Oscillation transformer U.L. 1005 for tube sets, \$11. The foregoing apparatus is designed and manufactured for the radiotron power tubes by the General Electrical Co. whose world-wide reputation insures the greatest workmanship. We absolutely guarantee their products. Orders supplied with operating instructions, are filled within 12 hours and are shipped postpaid and insured. Remember us! The Kehler Radio Laboratories, Dept. R, Abilene, Kansas.

Any amateur with wireless outfit can transmit and receive pictures with the Radiograf. Only practical system for amateurs. Price complete, \$30. The Radiograf System, Box 164, Eureka, Kansas.

C. W. Generators, \$13. I have a few 220 volt D. C. motors which give excellent results as generators. Voltage 220 to 450 volts, at 3400 R.P.M. Excellent condition. H. F. Witzler, Perryburg, Ohio.

Build your own transformers. We handle only the finest grade silicon steel, cut to any size. Stuart McIntosh, Ludington, Mich.

Variometers wound on Bakelite tubes, \$5.25; Variometers inside windings, \$4.25; No. 22 D.C. magnet wire, 30c per quarter pound, all sizes. Choke coils ideal for radiohone. Oak cabinets all sizes. Bakelite tubes and panels. Meade Bakelite and Radio Apparatus, 522 Central Ave., Brooklyn, N. Y.

(Wireless continued)

Slab Inductances—Set of eight, tuning with .001 M.F. condenser from 300 to 50,000 meters. Forward money order, \$4, made payable at Atlantic Road Brixton to Terry & Jeff, 400 Brixton, London, England, and secure a set post free by return.

Blue Prints—We put your favorite hook-up on tracing cloth, 9 x 12 inches for 50 cents, three for \$1.25. You can then make all prints you want. Have you obtained our V.T. diagrams for receiving and phone sets? They are making a h.t. 50 cents for either set of 12 separate sheets. Full range of circuits at your finger tips. We prepare drawings, carrying out your ideas for any kind of apparatus. Finest drafting at dirt cheap prices. Cabinet sets planned. Send stamp. Plus wall print of Continental Code, 6 by 28 inches, 25 cents. Readable 30 feet. No stamps with orders. The Plan Bureau, 1929 McCausland Ave., St. Louis, Mo.

Orders filled in 12 hours. The Kehler Radio Laboratories.

300 Miles on an Indoor Aerial.—This can be done with an indoor aerial of annunciator wire 25 feet long, 20 feet high. Amateurs 300 miles distant are nightly heard with our simple circuit. Send 25c (no stamps) for blue print showing all constructional details. We make blue-prints, design apparatus for schools and colleges and are also prepared to answer any and all questions of a radio nature at a very moderate cost. Consult Engineers for the Radio Amateur, Washington, D. C.

Radio Phonists' Attention.—High voltage generators. We supply motor generator units in various capacities especially designed for radio phone work. Low powered rotary converters, dynamotors, fractional H.P. motors, storage batteries. Various types of meters, condensers, the new synchronous spark gap. Get acquainted with our service. Ray-d-co., 2653 A. N. Clark St., Chicago, Ill.

Quality Apparatus.—Made to your own specifications. Reasonable prices. Marvin Fallgatter, Waupaca, Wis.

Variometers.—Complete, \$3; couplers, \$2.50 and \$3.50; Dials and cabinets extra. Rotors, stators and forms, each 75c. Marvin Fallgatter, Waupaca, Wis.

Build your own Radiohone transmitter, 5-50 miles on B-Battery, also radiohone receiver (Instantaneous oscillation) no interference from spark transmitters, easily built at small expense. Detailed instruction and diagram for radio-phone transmitter \$1; for radio-phone receiver, \$1. Ernest C. Mignon, R.I. 366 Hudson St., Buffalo, N. Y.

Exchange.

450 Volt D. C. direct from 110 volts 60 cycle line for radiohone transmission. Capacity 50 watts; price \$30. Order early for quick delivery. C. J. Fitch, 181 W. Housatonic St., Pittsfield, Mass.

Giving 4 Edison 400 Ampere Cells, \$25. Murdoch and Beeko variables, \$4.50 and \$5, respectively. Arnold coupler, \$14; DeForest crystal, \$2.25; Murdoch transmitting condenser, \$2.25. Brector No. 7 and extra parts practically unused worth \$25, sell \$17; Brector, \$3.50. Robert Spinner, 480 Palisade Ave., Weehawken, New Jersey.

DeForest Buzzer Radiophone.—Has 200 mile record voice and C. W. Used 20 hrs., \$75. Other bargains. Lloyd DeBribe, 1103 Douglas St., Sioux City, Iowa.

For Sale.—DeForest double coil unit receiving set, ten panels, with VT and coils, \$75. Mounted on oak panel. Hardly used. Write for description and photograph. Harry Boyce, Jr., Mt. Vernon, Indiana.

Exchange.—2 H.P. gasoline engine for 1 K.W. transmitting apparatus. Write J. Burke, Geldard St., Valley Falls, B. I.

Sale or Exchange.—Combination radiohone, C. W. transmitter, Universal motor, etc. Write, J. Wm. Anderson, East Tawas, Mich.

Selling Out.—Complete sending and receiving set. Excellent condition. Write for particulars. All letters answered. Price \$60. Reed Owen, 333 Broadway, Toledo, Ohio.

For Sale.—Complete Gilbert set, \$45. M. Rollberg, 5440 Lake Park Ave., Chicago, Ill.

Selling Out.—Sacrifice home made audion control with B batteries \$12 spider web receiver, \$2.50; 2500 to 25,000 damped undamped receiver, \$25; DeForest crystal detector, \$2; Connecticut variable condenser, \$6. Arthur Studer, Kirkwood, New York.

For Sale or Trade.—Cyclemotor bicycle engine, 1/2 K.W. Thordarson transformer, want A. C. Power Motor, what have you to swap. Harold Sturm, Macomb, Ill.

Leaving City.—Must sell brand new "Duck" apparatus, \$50; tuner cabinet, 150 to 20,000 meters, sell for \$25. Also \$15 detector cabinet, \$12, \$15 detector, order for \$45 sets both. E. Saul, 187 St. Marks Ave., Brooklyn, N. Y.

For Sale.—Two sets of Colby wireless telephones, \$90. R. Schurman, 7247 Morgan St., Chicago, Ill.

Wanted.—1 K.W. complete set, R. Schwartz, Buchanan, Mich.

Trade.—\$10 J. W. York & Sons B (flat) Cornet in case, also music stand, for radio receiving apparatus. Make offer. Will sell for \$35. William Shipley, Quaker City, Ohio.

Bargain—Audion detector panel, \$6; amplifier, \$11; portable regenerative receiver with audion control, \$25; regenerative set, \$15. Money back if not satisfied. R. D. Tygart, Hyattsville, Md.

Trade DeForest 12 panel receiver with 12 coils for radiohone or sell, \$60. Howard Toft, 282 Oak St., Perth Amboy, N. J.

For Sale Cheap—1/2 inch spark coils with helix, gap, condensers, key, \$10; one Cunningham tube, model C509, with socket, grid condenser, rheostat, \$7.00; one for \$2.50, \$5.00, 55 phones. Write Ralph Underwood, Box 7, Azra, Kansas.

For Sale.—Cabinet coupler, 150 to 10,000 meters. Gets all large Government and commercial stations, \$20. E. Decker, 30 Strong Place, Brooklyn, N. Y.

For Sale.—Audion detector cabinet; in excellent condition. Write for particulars. Robert Fairchild, Parville, N. Y.

Bargain—5 dial omniograph including 84 dials, \$18; Thaco variometer, unused, \$6. Cecil Guyatt, 1635 New York Ave., Brooklyn, N. Y.

For Sale.—Complete wireless telegraph and telephone set including A & B battery, price \$50. Write for description. R. S. Hope, Denmark, S. C.

(Continued on page 86)





## The Undisputed Authority on Simplified Science and Mechanics

SCIENCE & INVENTION is just chock full of interesting articles and illustrations that appeal to everyone. It will hold your interest from cover to cover because it contains everything new in the field of science, invention and mechanics. Quoted by hundreds of newspapers and magazines all over the world every month.

Its editorial contributions constitute the brains of the scientific world. Just a few of our regular contributors include such prominent men as

- |                              |                             |                             |
|------------------------------|-----------------------------|-----------------------------|
| Thos. A. Edison              | Prof. Quirino Majorano      | Inspector Owen Eagan, Bu-   |
| Nikola Tesla                 | Maj. Gen. Geo. O. Squier,   | reau Combustibles, N. Y.    |
| Dr. Lee DeForest             | Chief Signal Office, U. S.  | Fire Department             |
| Rogers D. Rusk, M.A.         | Army                        | Dr. H. A. Cotton, Medical   |
| James H. Rogers, Ph.D.       | Dr. Robert H. Goddard       | Director, N. J. State Hos-  |
| Isabelle M. Lewis, of the U. | Hon. Jas. D. Hartness, Gov- | pital                       |
| S. Naval Observatory         | ernor State of Vermont      | John J. Furia, M.A.         |
| Prof. T. O'Connor Sloane,    | Dr. C. S. Brainin, Ph.D.    | Hereward Carrington, Ph.D.  |
| Ph.D., LL.D.                 | Prof. F. L. Darrow          | Prof. H. F. Richards, Ph.D. |
| Prof. Augustus Trowbridge    | Dr. A. W. Hull, Ph.D.       | William M. Butterfield      |
| Dr. Alfred Gradenwitz        | Dr. A. O. Rankine           | G. L. Hoadley, M.E.         |
| Prof. Jean Baquerel          | Prof. H. E. Austin          | Dr. E. Bader                |

Its four color cover designs are both artistic and attractive.

### REGULAR DEPARTMENTS

- "How to Make It"—a department devoted to stimulate experimenters towards accomplishing new things with old apparatus or old material. Three money prizes are offered each month for the most useful, practical and original ideas submitted.
- "Wrinkles, Recipes, Formulas"—a section containing interesting information about chemical experiments.
- "Radio Department"—edited for the benefit of our thousands of radio enthusiasts who constitute 17% of our total readers.
- "Latest Patents"—a most interesting department containing illustrations and articles describing the very latest patents.
- "Scientific Humor"—this department contains a collection of jokes contributed by our readers for which a money prize is offered each month for the best.
- "The Oracle"—a department devoted for the sole benefit of scientific experimenters where questions are answered every month for our readers.
- "Motor Hints"—containing many hints of vital interest to the chauffeur and owner alike, together with illustrations. Three money prizes are offered each month to the contributors of the best articles for this department.
- "Home Mechanics"—this section contains numerous articles, together with illustrations, showing how to make useful articles for the home from old or unused material.
- "Home Electrics"—a most helpful department by G. L. Hoadley, M.E., with its many articles and illustrations showing how one may take advantage of electricity as a labor-saving device, at the minimum possible cost.
- "Practical Chemical Experiments"—a department by Professor Floyd L. Darrow, in which he shows by plain wording and illustrations how to make simple food tests.
- "The Constructor"—this section contains helpful and practical ideas by H. Johnstone on how the amateur may build or construct useful things in a quick, cheap manner.
- "Popular Astronomy"—by Isabel M. Lewis, the well known author on astronomy.
- "Fortunes From Little Things"—Charles Frederick Carter writes this department, in which he gives some startling information—how inventors have been made rich quick by inventing simple but useful articles.

ON SALE AT ALL NEWS STANDS—  
25c THE COPY

Subscribe for a year and save 50c. Get the twelve big interesting issues delivered monthly to your door by mail without further trouble to you.

**Experimenter Publishing Company**  
231 Fulton Street New York

### Special Offer for Short Time Only

Gentlemen:  
Please enter my subscription for *Science and Invention* for the term of one year for which I enclose herewith \$2.50 (add 50c for postage outside of United States.)

Name..... Town.....  
Address..... State.....

(Continued from page 85)

(Exchange continued)

- Omnigraph—New 15 dial omnigraph with Continental dials, sent prepaid in original package. Cost \$30, sell \$20. First M. O. takes best little code teacher in the world. Sidney Kroenigold, 535 56th St., Brooklyn, N. Y.
- Wanted—Loud talker or magnavox. Sol Lawson, 1219 Wyoming Ave., Philadelphia, Pa.
- For Sale—6 V. Knapp dynamo and Arlington transformer. Want 6 V. storage battery. Robert Leslie, Oregon, Wis.
- For Sale—3000 meter crystal receiver complete, \$10; Variocoupler, \$4; variometer, \$3; photo 5c. Ralph Leffler, Tiffin, Ohio.
- For Sale—Detector and amplifier cabinet, including bulbs, \$38; Brandes phones, \$6.50. Perfect condition. Geo. Marsden, Corona, California.
- Wireless Receiving Outfit, \$30—(Crystal type). J. D. MacGregor, 52 Pleasant St., Sanford, Conn.
- CW Transmitter complete, a bargain at \$85. Puts 1.6 in antenna, working dx in JUNE. Replacing with high power set. W. C. Bridges, 1625 Tower Ave., Superior, Wis.
- For Sale—Old style 1 K.W. Thordarson transformer in perfect condition, \$20. Fred L. Brown, 509 6th Ave., Huntington, W. Va.
- Spark Coil—Amrad 6 V. with quenched gap—both brand new, never used. Retail price, \$45. Will sacrifice for \$25. R. H. Barelay, 120 Liberty St., New York.
- Grebe CR-1 short wave regenerative receiver. Western Electric phones. Marko six volt, sixty ampere storage battery (40 volt Eveready "B" battery recently purchased thrown in), all in perfect condition, \$100. Other apparatus. Joseph Becker, 129 Monroe St., Hoboken, N. J.
- Articles no longer necessary in my laboratory which I must sacrifice. 75 V. 30-40 Amps. D. C. Generator, \$25; 1 HP. 110 or 220 V. D. C. motor, \$25; 2 1/2 HP. motorcycle engine, \$9; 7 HP. clutch and belt, \$4; omnigraph No. 5, 8 dials, \$9; accurately cut and finished formula panel, \$30; 1/2 in., \$4.50; Want A. C. motors; 350-2000 V. D. C. generator, 50-500 watts. What have you? Everything in good running order. E. T. Ballou, Ware, Mass.
- For Sale—1/4 K.W. spark transmitter absolutely complete 4000 meter coupler, condenser, all new, \$60. N. A. Wehrman, 975 Summit Ave., New York City.
- Edison Storage Cells—300 ampere hours, \$8 each; 1/4 K.W. rotary converter, \$25; 16 S. C. C. magnet wire, 50c lb., 20 lb. lots, 40c lb. A. R. Spartana, 615 N. Washington St., Baltimore, Md.
- For Sale—Audion receiving set complete, also new Omnigraph. John O'Donnell, 856 Summit Grove Ave., Bryn Mawr, Pa.
- Must Sacrifice Detector, two stage amplifier, Treco tuner, 30,000 meter coupler, storage battery, receivers, five dial omnigraph. Write for description and prices. Ralph Oaker, Ripley, N. Y.
- Extra Bargain—Nary loose coupler, two 20,000 meter loading coils, detector and amplifier, DeForest type bulbs. First money order for \$65 takes it. Alonzo Maginnis, Rockelle, Illinois.
- Sacrifice—2 variometers and 1 vario-coupler. Radio Shop, with bakelite dials, \$15; Clapp-Eastman balanced condensers .0006 MF, \$5.50; .001 MF, \$7.50 with dials, one Deollite ampifone, \$15; 1 brand new Moorehead amplifier tube, \$6. All guaranteed satisfactory, no postage included. F. Wankel, 2 Burr Ave., Cedar Manor, N. Y.
- For Sale—Complete set. Telephone and spark sets, also entire receiving apparatus 2QM. W. S. Willis, 347 W. 14th St., New York City.
- For Sale—Holtzer-Cabot phones, 3000 ohms, \$8; tuning coil, \$30 meters, \$3.50; 1/4 inch spark coil, \$3.50. J. Williams, 800 Grant St., Easton, Penn.
- Sale—Audiotron, \$4; 3 DeForest .0005 Mfd. unit condensers, \$5.75 each. L25, 35, 50, 75, 100, 200, 300, 400, 600, 1500 honeycomb coils, \$18. Geared triple mounting, \$8; W.E. VT-1, \$4; Acme amp. trans., \$5; 18"x24" solid mahogany cabinet, \$10; Marconi rotary, \$20. Francis H. Pratt, Whitewater, Wis.
- Sell—Complete receiving outfit, \$20, also 25-20 Winchester repeating rifle. Isaac Johnson, Vasca, Minn.
- To Trade—Pair of high powered French field glasses for a 2 step amplifier or what have you? Wayman Davenport, Plainview, Texas.
- Remarkable—National Radio Course, complete, \$50. L. Ashley, Templeton, Calif.
- Sacrifice—Quarter kilowatt panel transmitter. Write for details. William Hanlon, 5815 Rippey St., Pittsburgh, Pa.
- DeForest \$135 T.100 tuner for \$85; 1 1/2" spark coil, \$6; Murdock molded condenser, \$2.75. Frey, 208 Freeman Ave., Jersey City.
- Special sale York apparatus, \$75 200 meter regenerative sets at \$55. Fully engraved Bakelite panel, 7"x19". Send M.O. J. Hammel Sample, 135 S. Beaver St., York, Penna.
- Wanted—Detector 2 step reasonable. Buehrer, 260 St. Nicholas Ave., Brooklyn.
- Bargain—Radio apparatus of all kinds, slightly used. Discounts of 20 to 40% off. Enclose stamp for big list. Replies and shipments made in 24 hours. I. Krieger, 2120 Mapes Ave., New York City.

### Song Writers.

Song Writers!—Learn of the public's demand for songs suitable for dancing and the opportunities greatly changed conditions offer new writers, obtainable only in our "Song Writers' Manual and Guide," sent free. Submit your ideas for songs at once for free criticism and advice. We revise poems, compose music, secure copyright and facilitate free publication or outright sale of songs. Knickerbocker Studios, 319 Gaiety Bldg., New York.

### Postcards and Pictures

Sixteen pictures—French Models, 25c, postpaid, sealed Box 67, Pontiac, Mich.



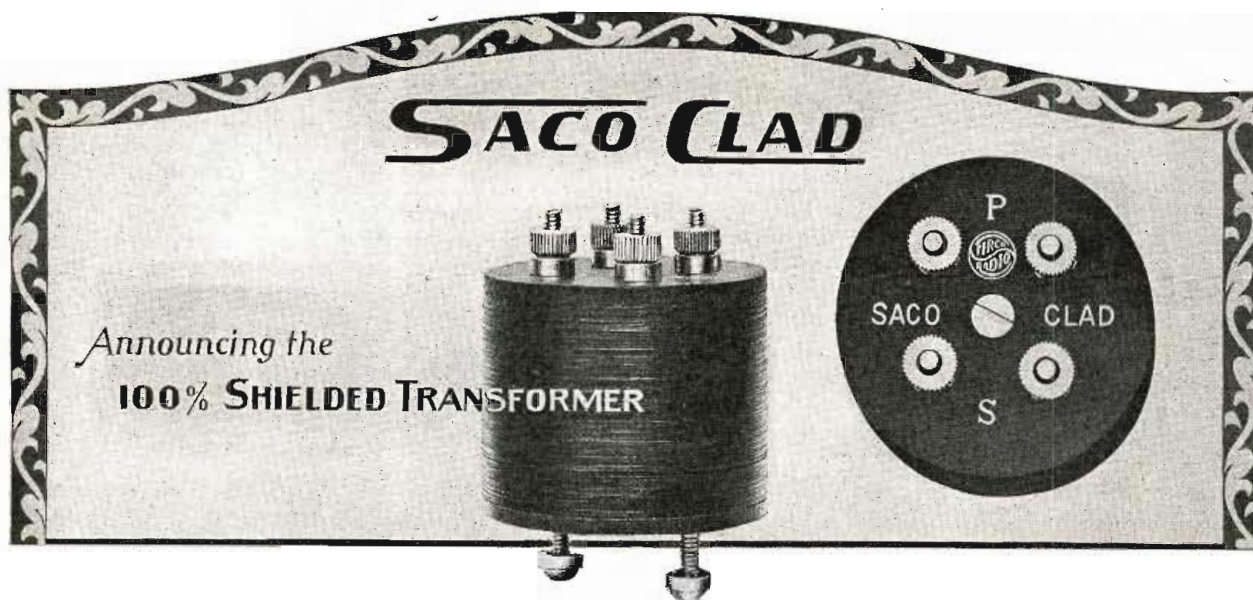

Announcing the  
**100% SHIELDED TRANSFORMER**

### SIX STAGES AUDIO FREQUENCY —THE BANDMASTER SAID “STOP!”

A week ago a stranger walked into our offices. He was soon talking about Saco Clad transformers and, without a word of exaggeration, here is what he said:

“... and during a recent municipal demonstration with our Six Stage Saco Clad Amplifier, the amplification was so great that our radiophone music interfered with the local band and could be heard ¼ of a mile thru the hubbub of the city’s noises. . . .”

Another letter from a disinterested dealer says:

“... We have tried practically every make of transformer and believe that Saco Clad is by far the best transformer of them all. . . .”

If you study the cross section at the left, you will see the reason for these commendations.

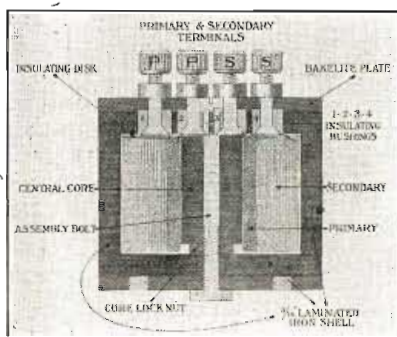

The 3-16" continuous shell of laminated silicon steel serves three purposes.

- (1) A perfect path for the magnetic flux.
- (2) A 100 percent magnetic shield—eliminates howling on even six stages and diminishes tube noises.
- (3) It is literally impossible to damage a Saco Clad by physical forces.

No other transformer at any price has such outstanding features.

Don't accept substitutes. Demand the Firco Saco Clad put up in separate cartons bearing the Firco Trade Mark.

#### A Summer Necessity—Saco Clads and Vocalouds

Saco Clad amplification pulls a Vocaloud (advertised last month) means you can carry on your radio activities in comfort during the hottest Summer days—just sit back and listen to loud, clear signals and radio phone concerts from the Vocaloud—no head phones or straining for weak signals. And of course, any number of friends can listen with you. This combination is economical. The Saco Clad Transformer is only \$5.00; after July 15th the Laboratory Type Vocaloud will be \$25.00 and the station type \$30.00.

If your dealer hasn't these instruments in stock, it is easier for him to sell you something else—but you should demand that he obtain them. Then make every possible comparison.

**DEALERS:** We have a new loose leaf catalogue for radio dealers. A charge of \$.25 is made to all except dealers. Amateurs should go to their radio dealer and ask to see this catalogue.

**NOTE:** Ask your dealer to show you the Firco Audion Units. They are made in two units—Standard and Midget—and are absolutely the best buy on the market.

John Firth & Company, Inc., 18 Broadway, New York



FIRCO Audion Detectors and Amplifiers  
Radio Frequency Amplifiers  
High Voltage Units  
*(with any primary voltage)*

Baldwin Phones

Firco Vocaloud

Saco-Clad Transformer

Firco Accessories

Kolster Decremeter  
United States Bureau of Standards Wavemeter

Eldredge Meters  
*(individually calibrated)*

Brownlie Phones  
*(adjustable)*

# FIRCO RADIO

## EQUIPMENT

“Pioneers—since 1901”

# CONTINENTAL NEWS

JULY, 1921

PUBLISHED EVERY MONTH IN RADIO NEWS BY THE CONTINENTAL RADIO AND ELECTRIC CORPORATION

For use with the Phonotron, these long-lived 6 volt storage batteries are specially recommended

10003 20-40 amps.....	\$14.60
10004 40-60 amps.....	18.00
10005 60-80 amps.....	23.60
10006 80-100 amps.....	29.30

A few items from the Continental catalogue are listed below. Every one is right here in stock, ready to ship the day you order it.

**Amplifying Transformers**

No. A-2 Acme, mounted.....	\$7.00
No. A-2 Acme, semi-mounted	5.00
No. A-2 Acme, unmounted..	4.50
No. 226W Federal.....	7.50

**"B" Batteries**

No. 7623 Standard 22.5 V. small	1.50
No. 7625 Standard 22.5 V. large	2.65
No. 7650 Standard 22.5 V. variable	3.50
No. 768 Eveready 22.5 V. large	3.50
No. 763 Eveready 22.5 V. small	2.25
No. 703 Eveready flashlight cells, set of 10, 45 V....	3.50

**Books**

Practical Wireless, by Bucher	2.25
Experimenter's Manual, by Bucher	2.25
Vacuum Tubes, by Bucher...	2.25
How to Pass U. S. Exams, by Bucher	.75
How to Conduct Radio Club, by Bucher	.75
Practical Wireless Stations, by Bucher	.75
Radio Telephony, by Goldsmith	2.50
Radio Inst. and Measurements	1.75
Elem. Prin. of Wireless, by Bangay	
Part 1	1.75
Part 2	1.75
Both for	3.25
Robinson's Manual of Wireless Tel.	2.50
Consolidated Call-Book (new edition)	1.50

**Audion Control Panels**

No. RORA Grebe, in cabinet	12.50
No. RORA Grebe with tickler connections	17.00
No. ZRD Clapp-Eastham (new type)	12.00
No. Y-1 Acme (latest model)	10.00
No. P-500 DeForest audion ultra-audion type with 45 V. "B" battery.....	24.00
No. 70-17 Adams-Morgan "Paragon Special" just out	6.00
A1-10 Radiocraft	15.00

**Loose Couplers**

No. A-1 Arnold 3,500 meters	22.00
No. Y-673 Clapp-Eastham 3000 meters	14.00
No. 344 Murdock 1500 meters	9.00
No. RKAB Grebe Variometer-coupler 1000 meters in cabinet	25.00

**Variable Condensers**

Connecticut 41-C 001 Mfd....	6.50
Connecticut 42-C panel mounting	6.50
Gen. Radio 182-A .007 Mfd..	12.00
Murdock 366 .001 Mfd.	4.75
Murdock 367 .001 Mfd.	4.75
Murdock 368 .0005 Mfd.	3.75
Chelsea 1-40 .0012 Mfd.	5.00
Chelsea 2-40 .00068 Mfd....	4.50

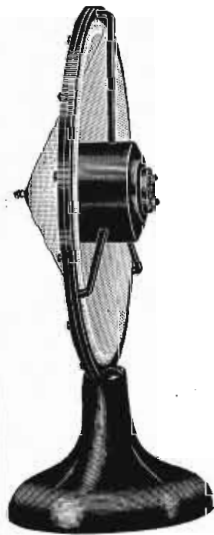

## The PHONETRON

ELECTRIC SOUND CONVERTER

*More than a loud speaker!*

Designed on an entirely new principle for reception of both wireless telephone and telegraph. Also used successfully with two stages of amplification as a radio 'phone transmitter, in place of a microphone.

**Price \$45.00**

PHONETRON is distinguished from an ordinary loud speaker by the wide, rigid, cone diaphragm, in place of a horn-shaped megaphone. It re-creates voice and music by wireless telephone, with a full, rich, natural tone. You will be surprised and delighted with the complete absence of any "horn tone" or reverberation. The sound waves emitted from the Phonotron are fully rounded and retain all the original sound values.

Phonotron is more than a loud speaker,—it is a converter of electric energy into sound, or of sound into electric energy.

The illustration shows magnet block suspended in the center of the diaphragm by three rigid supports. Thumb nut at the apex of the cone diaphragm provides an easy way for critical adjustment.

Phonotron is rigidly constructed and mounted on heavy metal base. Size 17 in. high by 9 in. wide. One 6 volt storage battery will supply sufficient current. For best results use at least one stage of amplification. With two or three stages, signals can be read distinctly several hundred feet distant.

Send for illustrated leaflet, showing construction.

AS LONG as a PACKARD is worth more than a Ford, so long will a PARAGON R. A. TEN Receiver be worth more than other receiving sets. PARAGON is built to last a life time, and absolutely guaranteed for two full years. Spread over its years of service, the cost of a PARAGON will be lower than any similar piece of apparatus. And all during that time, you get

PARAGON's marvellous selectivity and amplification, never duplicated. As one amateur said, "Nothing like it ever heard before, especially for strength of signals on detector alone."

The best is always cheapest, regardless of initial cost. Order a PARAGON now, or send for free descriptive booklet.

# CONTINENTAL RADIO AND ELECTRIC CORP.

EXCLUSIVE DISTRIBUTORS FOR PHONETRON AND PARAGON R. A. TEN

J. DiBlasi, Sec.

J. Stanley, Treas.

Dept. C36 6 Warren St. New York City

Order by mail from New York's leading Radio Store

It's a lucky thing for a good many radio stores, that amateurs are willing to blame the mails when they have to wait for their goods. You can order from Continental with the assurance that you won't have to wait. You can bank on it that your order will start toward you the day we get it. Everything listed in our catalogue is right here in stock—no delays. And there isn't much worth having, in radio, that isn't listed in the CRECO catalogue. It's not out of place to say that the Continental mail order stock includes *worth-while* apparatus for every part of your station. No matter what wireless equipment you need, you can be sure that Continental has it, or will get it for you quicker than you could get it yourself.

Send your next order to Continental. No matter how large or small, it will be filled promptly, courteously, carefully. Please make all remittances by bank draft or Post Office Money Order, to avoid any possible delay.

C. W.

ARE you interested in C.W.? If not, get interested. Continental makes a specialty of Continuous Wave apparatus. See Creco catalogue.

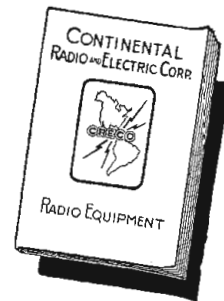

Do You Still Own a Quarter?

If so, and if you haven't already sent for the Creco catalogue, that's the best way to invest it. 112 pages for a quarter, chock full of illustrations, descriptions, prices, and all the radio apparatus you ever heard of. Also codes, abbreviations, tables, etc., that you will use daily. Be a sport. Risk a quarter on the best radio buy ever offered you! Anyway, you get credit for your quarter on your first \$5.00 order, so you really get the catalogue for nothing. Your copy is all ready to be mailed. Slip your name and your quarter into an envelope now!





# Every Electrical Man Wants These Books and we ship them for your inspection **FREE**

Flexible  
Covers  
—  
Handy  
Pocket-  
Size  
Volumes

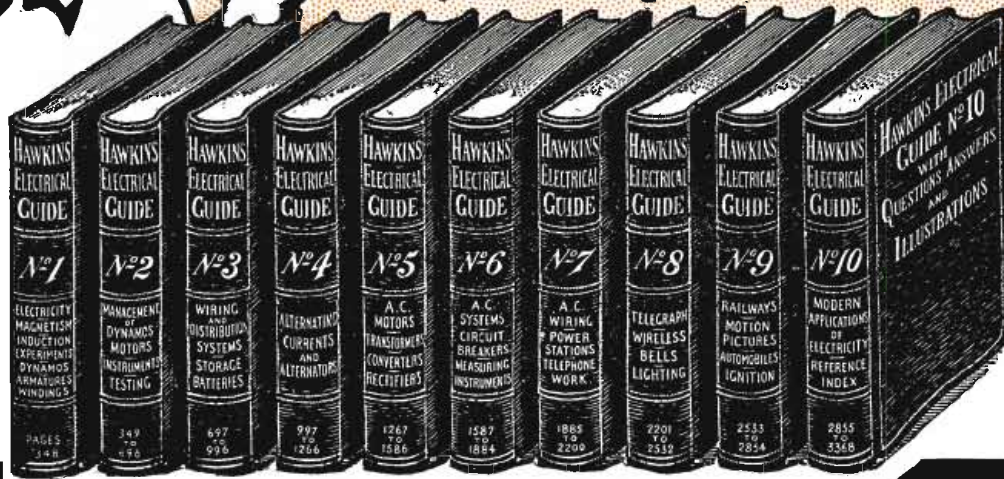

10  
Volumes  
3500  
Pages  
4700  
Pictures  
\$1 Per  
Volume  
\$1 Per  
Month

## Just what you need to know to succeed in **ELECTRICITY**

EVERY electrician, every engineer, every mechanic should know about these wonderfully helpful instructive books, which give in plain words a complete working knowledge of electrical engineering in all its phases.

You run into some new electrical problem almost every day. The information you need to help you in your every day work is in

# HAWKINS ELECTRICAL GUIDES

These books place electricity at your finger ends. They cover every imaginable subject, principle, theory, problem, trouble, and way of doing things electrically. Every subject is indexed so that you can turn right to it. They are a study course and a reference guide in one, written in plain every day language—no wasted words—only what you need to know—check full of up-to-the-minute electrical knowledge. The guides are a complete course in electrical engineering. They will help you in every detail of the day's electrical work. You can't ask an electrical question that Hawkins Guides can't answer.

### Pocket-Size Flexible Covers

The books are small enough to slip into your coat pocket—handsomely bound in flexible black covers. You can carry each volume with you until you have mastered its contents. 3,500 pages of actual information and 4,700 illustrations. Once you see these books and put them into actual use you will never again want to be without them. Try it at our expense.

## SEND NO MONEY

It will cost you nothing to receive these books—to look them over—ask them all the questions you can think of—use them in your work—study them—pick up some information that will increase your earning ability. We will ship you the entire set of 10 volumes entirely FREE.

This is a sign of our confidence in the guides. Pure gold does not object to being tested. Keep them for seven days and if you do not decide that you can't get along without them, return them to us and owe us nothing.

When you decide to keep them you only have to pay \$1.00 down and remit the balance of \$9.00 on the easy payment of \$1.00 a month till paid for. Use this coupon to get the books. It will pay you many times over.

**THEO. AUDEL & CO.**  
72 Fifth Ave. New York, N. Y.

SEND NO MONEY—USE THE COUPON

### READ THIS PARTIAL LIST OF CONTENTS

**No. 1** Contains 348 pages, 388 illustrations. Electrical signs and symbols—static and current electricity—primary cells—conductors and insulators—resistance and conductivity—magnetism—induction coils—dynamo principles—classes of dynamos—armatures—windings—commutation—brushes, etc.

**No. 2** Contains 348 pages, 394 illustrations. Motor principles—armature reaction—motor starting—calculations—brake horsepower—selection and installation of dynamo and motors—galvanometers—standard cells—current measurement—resistance measurement—voltmeters—wattmeters—watt hour meters—operation of dynamos—operation of motors, etc.

**No. 3** Contains 300 pages, 423 illustrations. Distribution systems—wires and wire calculations—inside, outside and underground wiring—sign flashers—lighting protection—rectifiers—storage battery systems, etc.

**No. 4** Contains 270 pages, 379 illustrations. Alternating current principles—alternating current diagrams—the power factor—alternator principles—alternator construction—windings, etc.

**No. 5** Contains 320 pages, 614 illustrations. A. C. Motors—synchronous and induction motor principles—A. C. commutator motors—induction motors; transformers; losses, construction, connections, tests—converters—rectifiers, etc.

**No. 6** Contains 298 pages, 472 illustrations. Alternating current systems—switching devices—circuit breakers—relays—lighting protector apparatus—regulating devices—synchronous condensers—indicating devices—meters—power factor indicators—wave form measurement—switch boards, etc.

**No. 7** Contains 316 pages, 379 illustrations. Alternating current, wiring power stations—regulating devices—management, selection, location, erection, testing, running, care and repair—telephones, etc.

**No. 8** Contains 332 pages, 436 illustrations. Telegraph—simultaneous telegraphy and telephony—wireless—electric bells—electric lighting—photometry, etc.

**No. 9** Contains 322 pages, 627 illustrations. Electric railways—electric locomotives—car lighting—trolley car operation—miscellaneous applications—motion pictures—gas engine ignition—automobile self-starters and lighting systems, electric vehicles, etc.

**No. 10** Contains 613 pages, 599 illustrations. Electrical apparatus—electric heating—electric welding—soldering and brazing—industrial electrolysis—electro plating—electro-therapeutic—X-rays, etc.

Also a complete 126-page ready reference index of the complete library. This index has been planned to render easily accessible all the vast information contained in the 10 electrical guides. There are over 13,500 cross references. You find what you want to know instantly.

**THEO. AUDEL & CO.**  
72 Fifth Ave.  
New York, N. Y.

Please submit me for examination Hawkins Electrical Guides (price \$1 each). Ship at once, prepaid, the 10 numbers. If satisfactory I agree to send you \$1 within seven days and to further mail you \$1 each month until paid.

Signature.....

Occupation.....

Employed by.....

Residence.....

Reference..... R. N. July

### What Electrical Men Say Helped Him Make Good

"It is only right for me to recommend highly the Hawkins Guides, for they have been of the greatest assistance to me in placing me in my present position as Superintendent of Construction Department of one of Ohio's largest Electrical Companies. I would like to see every man have a set of Hawkins Guides."  
Geo. Knecht, Columbus, Ohio.

### In the Naval Electrical Dept.

"The Hawkins Guides are great help to me in the Naval Electrical Department, which they cover very thoroughly."  
C. J. Cornell,  
U. S. Receiving Ship, Brooklyn, N. Y.

### Superintendent

"I am now superintendent of the Dunnville Hydro Electric Systems and Hawkins Guides were a great help to me in holding down a responsible position."  
W. E. Swartz, Dunnville, Ontario.

### Wireless Operators

"I have worked wireless for ten years—but I wish I had these books years ago, as they have saved me a great deal of trouble."  
H. Marshall,  
Steamer M & S No. 2,  
Walkerville, Ont.



# It's Only a Step for You Now to a Fine Wireless Position

**S**URELY you have noticed how wireless is spreading over every part of the world. Every day you learn of some new field that is utilizing it—some new firm organized to push it forward. But do you realize that YOU can easily qualify for the wonderful opportunities that are opening? Do you know that you can quickly build upon your present knowledge of Wireless—and be ready any time you wish to for a fine Wireless position, either on land or on sea? Through our special method of home-study instruction a short period of your spare time can be turned into preparation for a worthwhile future in the fastest-growing field in America today—Wireless. No one is in a better position than you to cash in big on the wireless expansion that is sweeping over the world. You have the whole foundation, all ready to build upon. Our new easy method of instruction makes the rest pure fun—but fun that pays big.

**Commercial wireless expansion is sweeping over the world like wildfire! Big opportunities are open—and every day get more numerous and attractive. You are in a fine position to cash in big on this growing field. Right at home in spare time you can easily build upon your present knowledge and quickly qualify. The coupon below will bring you an interesting free booklet—telling about the splendid opportunities open, and how you can share them. Mail coupon for booklet today!**

## New Method Makes It Easy to Qualify

Without obligation to yourself we would like to tell you more fully about the future wireless offers you. We would like to tell you about our Institute, which is officially recognized by the U. S. Dept. of Commerce and whose name heads the list of the schools recommended by the U. S. Shipping Board. The National Radio Institute was the original and is today the oldest and largest school in America teaching wireless by mail. The government allows our graduates five to ten points credit when taking First Grade Government License examinations. We have graduates in almost every part of the world who have quickly qualified through our special new method.

This method not only includes a comprehensive course of instruction written exclusively for us by some of America's greatest wireless experts (members of our own staff)



*Both on sea and on land a fine future awaits the man who is qualified in wireless. No matter whether you wish to visit every nook and corner of the world or whether you prefer a land station, wireless awaits you.*

but also includes, Free, a wonderful new invention patented and controlled only by us. This device, called the Natrometer, teaches you in half the usual time how to send and receive, with speed and accuracy. This Natrometer (which can be purchased separately) is superior to any other device of its kind. Without aerials or any outside device it sends you any one of 600 different messages at a speed which

you can vary from 3 to 30 words per minute. It is portable; also very attractive in appearance. It is noiseless; and it sends in a natural manner, not like a mechanical device. You get the messages thru its 'phones at whatever speed you wish. And this is *only one* of the features which our new method brings you. Others are listed below. Read them and you will realize why our students quickly qualify and why they step into the fine wireless positions that are waiting!

## 11 Points That Make This School the Best

1. New Easy Method of Instruction.
2. Wonderful Natrometer Given Free.
3. Government Credit and Recognition.
4. Our Location in Washington—Passing New Official Developments on to You.
5. Personal, Individual Attention of Great Experts.
6. Our Service in Obtaining You Employment.
7. Free Training in Wireless Telephony.
8. Unlimited Consultation and Advisory Service.
9. Free Post-Graduate Course in Our Washington Residence School If You Wish.
10. Membership in the Relay League.
11. Low Tuition Cost and Easy Terms of Payment.

Mail coupon today for our free illustrated booklet. "Wireless, the Opportunity of Today." Without cost or obligation, we want to tell you more about this field, its big opportunities both on land and on sea, and just how our new method quickly qualifies you. No agent will call upon you. We just want to send you the facts. Mail coupon at once! National Radio Institute, Dept. 17, Washington, D. C.

### MAIL COUPON FOR BOOKLET

NATIONAL RADIO INSTITUTE,  
Dept. 17, Washington, D. C.

Send me your free booklet, "Wireless, the Opportunity of Today." Tell me about the opportunities open in wireless, about your Institute, and about your special limited offer.

Name .....  
Address .....  
City..... State.....