

# RADIO NEWS

Editor: THE WHOLE RADIO TRADE  
MANAGING EDITOR: HUGO GERNSBACH

## DEALERS PERSONAL EDITION

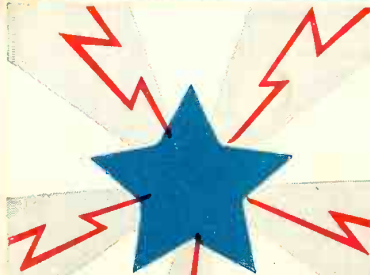

"ARCTURUS"  
The principal or leading  
star in the constellation  
Bootes.



## 127 A New Standard in A-C Radio Tubes

The most advanced tube yet—the Arcturus 127 Long Life Tube—operating on 2.5 volts detecting circuits.

### TWO DISTINCT ADVANTAGES

#### Long Life

Several thousand hours is not an unusual record for the life of ARCTURUS A-C Tubes. Short life has been the BIG PROBLEM of A-C Tubes.

#### Quicker Reception

10 seconds after turning on your radio, reception

begins — with ARCTURUS 127 Tubes. This is about half the time lag of other A-C Tubes.

### A Great Demand for the Arcturus 127

The longer life, quicker reception and better tone qualities in the Arcturus 127 Tube make it far superior to any other A-C Tube on the market.

Arcturus products are nationally distributed and advertised. Dealers write, right now, for the Arcturus proposition. It's interesting and profitable.

ARCTURUS TUBES  
The principal and leading  
A-C tubes in the Radio  
field.

ARCTURUS RADIO CO.  NEWARK, NEW JERSEY

# ARCTURUS

# 127 LONG LIFE TUBE

# Cunningham

## RADIO TUBES



**Take Notice**  
of the marked  
improvement in  
your radio reception  
when new Cunningham  
Radio Tubes are per-  
forming their special  
tasks in the various  
sockets of your radio.

*Don't use old tubes with new  
ones — use new Cunningham  
tubes throughout.*

**E. T. CUNNINGHAM, INC.**  
NEW YORK CHICAGO SAN FRANCISCO



9  
in  
1

(See panels below)

## A.C. or D.C. Radio Set Analyzer

*...the Efficiency, Precision  
and Thoroughness of a  
Laboratory in Your Service  
Department*

Answers The Urgent Demands of Thousands of  
Progressive Dealers

The equivalent of nine instruments all specially designed for radio set, tube and accessory, testing and measuring every radio voltage, amperage or fraction thereof, are built into the sturdy Jewell Radio Set Analyzer No. 137!

It is the most complete instrument of its kind—and the first! The Jewell Analyzer solves the dealer's service problem. It will test every phase of a radio installation, the circuit of the set, the integral parts, transformers, resistances, etc., tubes, including 210 power and all A.C. types, power supplies, batteries, eliminators, power packs, A.C. transformers, etc.

All tests are made direct from the tube sockets. Current readings are shown on the respective meters and are obtained by pressing buttons which are clearly marked and

throw the desired meter into the circuit, either for a momentary or permanent reading. Mistakes are impossible. The analyzer can be attached in only one way and pressing the wrong button does not injure the meters.

The instruments used in a Jewell Pattern No. 137 Radio Set Analyzer have the following nine ranges: 0-10, 0-50, 0-100, 0-500 volts; 0-10, 0-100 milliamperes; 0-3, 0-15, 0-150 alternating current volts. All direct current ranges have a resistance of 1000 ohms per volt.

Tests apply to new A.C. and A.C. converted sets, as well as D.C. sets. Adapters for all tubes are furnished.

Price, complete with adapters and extension leads, built into a leather covered velvet lined carrying case. Over all dimensions:  $4\frac{3}{8} \times 8\frac{3}{8} \times 13''$ . List \$115.00.



Write for reprint of Jewell Service  
Articles and descriptive literature.

**Jewell Electrical Instrument Company**

1650 Walnut St.

Chicago, Ill.

**“ 28 Years Making Good Instruments ”**

Editor:  
THE WHOLE RADIO TRADE  
Managing Editor:  
HUGO GERNSBACK  
Associate Editor:  
C. P. MASON



EDITORIAL AND GENERAL  
OFFICES:  
230 FIFTH AVENUE,  
NEW YORK, N. Y.

VOLUME 9

MAY, 1928

NUMBER 11

(This issue of the DEALERS PERSONAL EDITION includes also that for April, 1928)

### Table of Contents

The Month's Best Editorial—\$100 Prize Winner <i>By Clifford J. Seimers</i>	3
The theme of this short, practical talk is "Making a Successful Demonstration." Like a good showman, Mr. Seimers rehearses his act carefully.	
Far From the Madding Crowd, <i>By T. DeWitt Woods</i>	4
More small-town stuff, with a discussion of the need of being weather-wise when you sell to farmers.	
Boy Scouts a Big Field for Radio Dealers <i>By S. R. Hipple</i>	5
Mr. Hipple, who before exposed so keenly the need for better-radio publicity, here presents an opportunity for many dealers.	
How a Custom Set-Builder Makes Radio Pay <i>By Stuart J. Myers</i>	6
Some hints on the sales methods which win customers for the enterprising young constructor.	
How Do You Rate with Your Banker? <i>By G. S. Corpe</i>	7
That's a personal question, and you needn't answer to anyone but yourself. Good advice, however, on this page.	
Taking Radio Out on the Road <i>By E. A. Blank</i>	9
When the customer can't come to your display room, take the display room to him. An Illinois jobber does it very profitably.	
Troubles of the Custom-Set Trade—Little Dabblers and Big Business <i>By a Small Manufacturer</i>	10
The writer prefers not to sign it—but he is seriously in earnest. What do you think of the situation?	
What Manufacturers and Customers Do To Me <i>By a Radio Dealer</i>	11
Not quite so sensational as the foregoing, but a plain statement of grievances which hundreds might sign. What's the remedy?	
Why I Am Getting Out of Radio <i>By M. Eisenberg</i>	12
Radio is ill-fitted for a sideline; a prosperous merchant whose principal business is otherwise tells his experience.	
"Service" Salesmanship <i>By Frank S. Tower</i>	13
Can you see things from your customer's angle? It is hard to do, sometimes; but it is a viewpoint of value to the salesman.	
Why Dealers Should Sell Fewer Batteries <i>By Alfred S. Clark</i>	14
Many opinions find expression here; this is a frank one which differs from some previously printed. What do you think?	
Advertise Radio From the Customer's Viewpoint <i>By F. R. Pray</i>	15
A small, but effective, advertisement, is submitted here as the first prizewinner of our monthly advertising contest. Can you match it?	
The Latest Radio Merchandise	16
New apparatus on the market, with its prices and a list of the helps which manufacturers offer in dealers' sales work.	
Service Testing Equipment Creates Sales <i>By Robert D. Harden</i>	17
A dealer, who has made service pay through being in position to do it inexpensively, suggests that a service page be made a regular feature. This will be done if you want it.	
Dealers' Service Sheets—No. 2	21
Another popular line of sets is added to this feature. These pages should be preserved for reference; they will come in handy.	
The Distributor Issues a Declaration of Independence <i>By W. A. White</i>	24
We shall be disappointed if this article does not stir up much comment; that is what it is written for. Let us have your constructive suggestions.	

### Invest In Warm Weather

THIS is the time when every radio dealer throughout the country, unless he is in Alaska, begins his usual fretting about the radio weather bugaboo. In my opinion, more radio set sales are killed in the summer time by the dealers' mental attitude than through natural causes. It is true, of course, that in the summer time not as many radio sets are sold as in the winter, and it would be foolish to pretend otherwise. All of this is understood; but the point I wish to make is that, in the winter time, there is a natural market condition when selling is not at all difficult, whereas in the summer time it is more difficult. This means that more effort must be put behind sales in summer than at any other time of the year and, if such an effort is made, it usually succeeds.

I would advise dealers to enter upon a campaign, wherein they will demonstrate in their stores that the fear of "summer static" is an anachronism, which might have been in vogue in 1922, but certainly not in 1928. Make a deliberate bid for summer business by letting your customers listen in to radio broadcasting on the worst summer day, simply by not using an outdoor aerial. Use an indoor aerial or one of the buried underground aeriels, which get the signals just the same, minus the static. Of course, none of these devices do away entirely with all static, but they at least make radio reception enjoyable; particularly when the signal from the radio station is so strong that it easily overrides what little static there is. Educate your customers to the fact that the lightning danger is practically nil anywhere in the United States; as no one has been killed by lightning striking an aerial.

RADIO NEWS, several years ago, offered a prize of \$300.00 for proof of any property damage from lightning striking an aerial. The prize went to Canada because the United States could not produce a case during the entire summer of that year; and even where the damage occurred, the lightning first struck another metal part before the secondary charge actually hit the aerial and, even then, no one was injured.

Dealers can make good money this summer, through canvassing their customers, merely by installing indoor aeriels with a switch to throw the radio from the outdoor aerial, to the indoor aerial, or by installing underground aeriels. All of these things mean extra money to dealers who are wide awake and who have the confidence of their customers. There is no reason today for any customers to put away their radio sets for the summer; any more than they would put their cars in storage for the winter. Educate your customers to summer radio. Appeal to their public spirit this summer, particularly when the political conventions are about to go into session and no man has the right *not to know* what the country is doing.

Very little business comes to anyone—you must go out and get it.

HUGO GERNSBACK, *Managing Editor.*

# \$100<sup>00</sup> Prize Winner

## THE MONTH'S BEST EDITORIAL

### "Making A Successful Demonstration"

I FIND that too little thought is given to the demonstration end, in selling radio to a prospect. In the February issue of the DEALERS PERSONAL EDITION, Mr. DeVore tells us how to "Get In," or "Get Acquainted." This article starts in where that one left off.

Now that we have the prospect and the date for demonstrating the set down on the follow-up card, let us take up the situation at that stage. When I made my first demonstration, I thought the only thing to do was to take the set over to my prospect's home, set it up and twirl the dials to bring in stations at random, and that I could do this without any preparation at all.

That is one way of demonstrating; but I have found that it is not a business method of demonstration or a sales maker. Not until after a good many demonstrations had fallen flat did I wake up to the fact that my method of demonstration was my jinx.

#### PREPARING THE WAY

I always try to sell my prospect on installing a first-class outside aerial before demonstration. I have found that the best length is about 60 feet, including the lead-in, and the best height about 30 feet. I tell my customer that this is the only right way to find out exactly what the set demonstrated will do for him. The installation charge is made large enough only to cover actual cost—from \$5.00 to \$7.00 according to conditions. I have a sound argument, aside from a perfect demonstration, including that of distance; if the customer is going to buy a radio set sometime, he may as well have the aerial put in now.

If I can not sell the prospect on installing an aerial, I have found, the most satisfactory all-around temporary aerial is 30 feet of wire laid around the room on the floor; unless the building has a steel frame, or metal lath on the walls. In the latter case, the wire may be stretched along the eaves of the house, or as much as possible of it simply hung out of the window.



By CLIFFORD J. SEIMERS,  
5927 Oakwood Street, Los Angeles, Calif.

*MR. SEIMERS is a salesman, not an order taker; that we can tell by looking at his manuscript. He is the first competitor for the monthly prize who has sent in his picture with the article; so that it should be ready for immediate use, in case the article was accepted—like the little girl who was the only one to take an umbrella to the meeting which was called to pray for rain. Though not a professional writer, he arranged his ideas in logical order, suitably grouped, and sent them in with the neat touch: "There still exist grammatical errors; but after it passes your criticism it will be O. K. for the press." These articles are selected and published, not for their literary merit, but for their PRACTICAL value in discussing and, so far as possible, solving the problems of the radio trade. Your contribution has an equal chance for the money; send it in today.—MANAGING EDITOR.)*

#### TESTING THE SET

*I do not "suppose" the set I am going to demonstrate is all right. I hook it up, put the tubes in their proper sockets and test the complete set with loud speaker, and with the temporary aerial if I intend to use one. After testing, I take the tubes out and return them to their carrier to avoid possibility of breakage. It is always best to carry two or three extra tubes along; as you never know when one will go "hay-wire."*

A demonstrator does well to be prepared; it costs too much to secure the opportunity for demonstrations to take a chance on their falling flat. Nothing is quite so bad as a bad first impression.

#### ARRANGING THE PROGRAM

The last but, according to my experience, not the least detail is preparing a program for the demonstration.

In arranging the program, I get the local paper and select the program for the evening's entertainment, either in my mind or on a piece of paper; also making a list of the stations that I know will be coming in good and clear at the time I am going to make my demonstration. I also have in mind the dial locations of the stations I select for my demonstration.

By knowing all of these things beforehand, a salesman improves his demonstration greatly; cutting out all the delay in bringing in the stations clear and quickly. This is one of the biggest selling points for the radio.

With all of this done and the evening's program in mind, I am ready to take the set to the prospect's home and set it up for demonstration.

#### DEMONSTRATING

When I arrive at the prospect's home, I ask him to excuse me a moment while I make connections and set up the set to be

(Continued on page 18)

The article chosen each month as the most helpful of those received from our Editors (The Whole Radio Trade), will appear on this page, and its author will receive the prize of \$100.00. This is awarded on the basis of the best ideas—not the best literary effort—and their practical and useful features.—MANAGING EDITOR.



# Far from the MADDING CROWD

By T. DEWITT WOODS  
Universal Radio Co.  
McGregor, Iowa

**R**ADIO sales in towns distant two hundred miles from any broadcast station involve a more meticulous attention to details than sales consummated in cities within the shadow of broadcast-antenna towers.

The city dealer is concerned chiefly with the *selectivity* of the sets he sells; so that the local stations can be de-dialed in favor of outside stations, in case the locals fail to please. Good quality reception is assured locally, even in the most enthusiastic thunder storm.

But the dealer, working a town with a two-hundred-mile interval between it and the nearest broadcast station, is concerned not only with the selectivity factor, but with extreme sensitivity. Here, the weather condition is the *radio barometer* indicating good, fair, or bad reception.

The remote-town dealer must have one or more good outside antennas, and an elaborate ground system, if he is to do his line the fullest justice. He should preferably use a somewhat longer antenna for daylight reception than Dame Convention dictates; for height and length boost the daylight signal strength to a greatly-needed extent, station-crowding being a negligible proposi-

**O**UT in the Mid-West, where fans sit up nights to think of scathing remarks about chain programs, is one of the most valuable, yet critical markets of the radio business. Here sets, both selective and sensitive, are required; and to the western farmer, the radio set, as well as the automobile, is a business necessity no less than a source of pleasure. This article is practical and suggestive; and, while we give another of high merit the prize in this issue, Mr. Woods is entitled to most honorable commendation for the excellence of his editorial in presentation and contents.

tion during the day. But, for night reception, the antenna should be of a length giving both selectivity and maximum signal strength; enabling one to tune out at least part of the survival-of-the-fittest pandemonium that some of the stations conduct with each other.

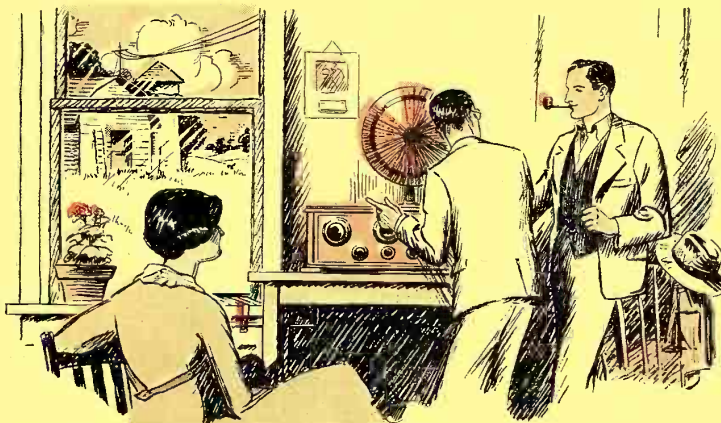

The trial installation should be first-class, the demonstration under favorable circumstances, and the rural buyer should be instructed, when the sale is made, that on good weather depends the best reception.

#### A SWITCHBOARD NEEDED

In placing the antenna for the best results, the directional proclivities of the particular type of antenna should be taken into consideration. And, to demonstrate effectively several outfits on his floor, the dealer should have a system of switches for connecting any outfit to the desired antenna—the switches doing away with the cumbersome and unsightly connecting and disconnecting of wires. Here, simplicity of connections is important, as a complexity of wires serves only to confuse and discourage the prospective purchaser.

Demonstrations should be made only when receiving conditions are favorable. The antenna giving the best signals at the time should be switched on; the ground should be chosen by the trial-and-error method—water pipe, heating plant, deep well, buried plate, and counterpoise all tried individually, and the one that gives the best results at the time switched on. Sometimes the results can be bettered by connecting several of the individual grounds collectively; this should be done if improvement ensues.

Now, the dealer having done all this to demonstrate on the signals received from a few choice stations at their best, the prospect should be impressed by the tonal quality and volume of the signals, by the selectivity, and by the appearance of the set; and he will be more than glad to accept an offer of a trial installation in his own home.

#### A GOOD AERIAL NEEDED

Generally, in the trial installation lies the sales-closer, or the sales-killer. A dealer in any community may profit by taking an inventory of the activities of the dozen other dealers operating there, observing that most of the competitive sales failures can be traced to a slovenly-done trial installation—a poor antenna and ground system, with the invisible stamp "Temporary" on the inside installation.

The wise dealer is he who reads these signs, and, therefore, puts up a good permanent antenna— (Continued on page 18)

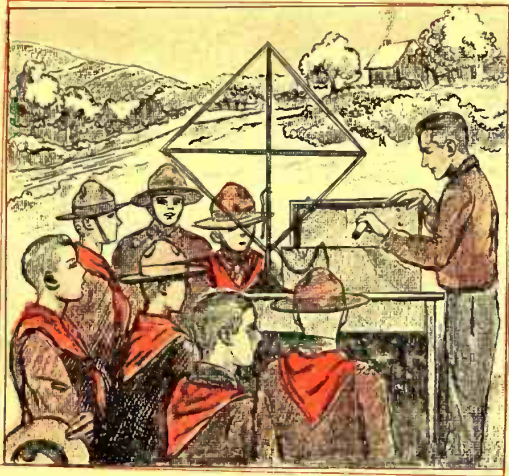

# BOY SCOUTS A BIG FIELD FOR RADIO DEALERS

by  
**S. R. HIPPLE**  
*Williamsport, Pa.*



**T**HERE are 837,000 Boy Scouts and scout officials in the United States. A scout must learn a signalling code before he can pass from the tenderfoot to the second-class or first-class rank; and the International Morse code, used in radio, usually is chosen because the letters can be made with many kinds of transmitting apparatus. Boy Scouts naturally become interested in radio.

The Scout organization offers a merit badge in Radio to first-class scouts who pass a test on the construction and operation of transmitting and receiving apparatus.

New impetus will be given to Boy Scout radio by a movement started recently for increasing the membership in the department of Sea Scouting. The officials in the New York district, headed by Marshall Field, have opened a campaign to secure 3,500 more Seascouts. There is increased interest in this department throughout the country.

Radio is even more important in sea scouting than in other departments of the organization. The handling of ships and boats today depends largely on the use of radio. Orders that govern the movements of vessels are sent via radio. The radio compass helps to keep ships on their courses and guides them into port. The reception of radio weather reports and forecasts, storm warnings, reports of obstructions to navigation and other broadcasts is of vital importance. The SOS saves many lives and much property by bringing prompt aid to disabled ships.

**MR. HIPPLE**, who is a radio inventor as well as manufacturer, discussed in the February issue of the DEALERS PERSONAL EDITION the neglect of radio in the free publicity so lavishly bestowed upon less important and certainly less romantic activities. In this article he suggests another method by which radio enthusiasts may be created at a formative period of youthful education, through cooperation with well-established local organizations. It may be summed up; "Catch 'em young, treat 'em kindly, and tell 'em everything."

#### AN OPPORTUNITY

Dealers should take advantage of the present wave of interest in sea scouting and of the great opportunity offered by the immense scout organization. The national headquarters of the Boy Scouts of America, which recently leased the entire seventeenth floor of the new Park Avenue Building, New York, sells only a limited variety and amount of radio equipment through its supply department. The competition which it gives the local dealers is practically negligible.

There are 639 local offices of the organization in the leading cities. Each has from two to three hundred to several thousand scouts under its supervision. Troops of scouts are found in many churches, schools and other institutions.

Every Boy Scout is a potential buyer of a broadcast receiver. It is easy to stimulate the interest of scouts in building transmitting and receiving outfits. The organization, locally and nationally, is a market for radio parts that never has been developed.

The radio dealer who tries to sell to Boy Scout officials should remember that the organization is a philanthropy, supported in large part by voluntary contributions. The Scouts pay membership fees and buy their own uniforms and equipment; but the overhead expenses, which are several times the amount paid by the scouts, are covered by money raised in financial campaigns. Sometimes the Scout budget is included in the community chest.

#### DIPLOMACY REQUIRED

Any attempt to exploit the scouts for commercial purposes is likely to be resented by them and their officials. The approach should be made with a view to rendering service to boys. This does not mean that the dealer is expected to sacrifice his profit, though some dealers in scout uniforms and equipment find the good will of the organization so valuable that they gladly handle these goods on a mark-up of 10% when their actual overhead expense is 24%.

Radio dealers may approach the scouts themselves, by old or new advertising methods, or through the local officials. One of the most effective ways is to offer the local organization the services of a technical radio man who understands boys. This man can teach the local scoutmasters and scouts how to use radio in scout work. He can design

low-priced transmitters and receivers that can be built by boys and used in their scout work. Demonstrations can be given, showing how such outfits are built and operated.

Code practice, with the radio man sending from an amateur station and the scouts receiving in their homes or troop headquarters, will be helpful. The radio man who renders such service usually is offered an official position in the organization.

The contacts and good will developed in service to scouts are sure to result in more business for the dealer, for boys have more influence than most dealers imagine in the buying of things for the home.

It is possible to start a scout organization building radio sets for the blind, the shut-ins, and hospitals. Rotary Clubs and other organizations sometimes furnish money, material or even complete receivers for the scouts to install. In one city, not long ago, hundreds of sets were installed by scouts as a result of a community-wide movement.

As a summer market, to be developed when other business is falling off, the scout organizations offer an attractive opportunity. The Seascouts are most active then. Many of them go on cruises and need radio.

There are more than 3,000 summer camps for scouts in the country, and a considerable number of winter camps. Every one of them could use radio more than it does. The

(Continued on page 18)



# How a Custom Set Builder MAKES RADIO PAY

By STUART J. MYERS  
Warren, Pa.

**T**HERE are, no doubt, a vast number of custom set-builders, young men of high-school and collegiate years, who have spent valuable time in the last several years educating themselves in the intricacies of radio; but who have realized little financial gain. There are hundreds who have studied radio theory and design just for the enjoyment they receive from such endeavor; yet who deserve employment remuneration comparable to their knowledge in the field they have mastered. It is to this school of "radio fiends" that I wish to dedicate this article; that they may be assisted by any kinks or instructions of procedure that they may find applicable.

I have discovered that the simplest manner in which to get started is to go after that business that is most neglected by the commercial radio dealer. That is, the repair end. Every fan has the necessary stock on hand to begin a repair business; so all that is necessary is a classified advertisement in the local newspaper such as:

\* \* \* \* \*  
\*RADIO'S REASONABLY REPAIRED\*  
\* For immediate service call 9999-X \*  
\* \* \* \* \*

Before some notable broadcast feature event, an ad similar to the following will prove effective:

\* \* \* \* \*  
\* Get that radio working 100% before \*  
\* the Tunney fight by calling 9999-X \*  
\* \* \* \* \*

Just a few of these inexpensive advertisements result in quite a start of business; for the real advertising begins after several sets have been repaired. The "mouth-to-mouth" form of advertising is the really valuable kind; as the word of a friend is usually taken in preference to an advertisement. I have had one repair job done well result in four additional ones.

### JOHNNY-ON-THE-SPOT

The "radio man" has it all over the average dealer, in that he can furnish immediate service. A great many dealers

pack a defective set and return it to the manufacturer; which necessitates several weeks of waiting and excessive charges for the owner. If a radio man is called, the set usually can be fixed on the spot; or at

***T**HIS article, sent to RADIO NEWS by an enterprising custom-set builder, is interesting to compare with some others in this issue. While the radio trade is endeavoring to apportion, by buck-passing among its factors, the responsibility for service problems, the set builder has to make good on the spot. Upon his ability to do so depends his continued success among his closely-knit clientele. He is his own engineer, factory, salesman and service staff; he must make up by skill, experience and enterprise the other considerations in which his highly-organized competitors surpass him. The dealer in ready-made sets may well consider his ways and be wiser.*

paired in an hour or less if the conveniences of his laboratory are at hand.

Satisfactory and quick service soon advertises itself and numerous sales of power units, batteries, power tubes, replacement transformers, etc., result. I usually stock a sufficient number of the usual accessories so that I can satisfy ordinary demands; but, if necessary I buy from local dealers who co-operate by giving a small discount. Do anything to give real service. That makes "call-again" customers.

I find that a pack of calling cards and a gum eraser filled with thumb tacks constitutes my best advertising agency. Beneath the cover of every set I repair or sell I tack one of these cards (which I continually carry with my tools). This keeps the owner and his friends informed of my whereabouts when trouble is encountered.

When I encounter a particularly antiquated or decrepit receiver I attempt, in a congenial way, to interest the owner in a new and more efficient receiver. If possible, I install a modern receiver while I repair the old one; that he may better realize the improvements on the new one. There are many people, I believe, who could

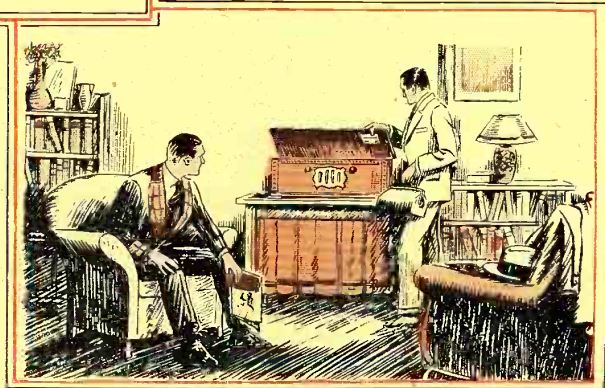

*The set builder puts his advertisement on his work, just as does the big manufacturer. By its performance he is willing to be and will be judged. He is, at his best, one of the examples of a revival of congenial craftsmanship in a machine age.*

least in an hour of work at home in the radio man's laboratory. I will not attempt to instruct in my methods of testing and repairing sets; as every fan has his simple methods and realizes the truth in the statement—that nine sets out of ten can be re-

be induced to have their old receivers made into all-electric sets. This field, I believe, will constitute a large part of the "custom builders'" work for the coming months. Its remunerative possibilities appear inviting.



# HOW DO YOU RATE *With Your Banker?*

By C.S. CORPE  
Corpe Brothers  
El Monte, Cal.

ONE of the greatest problems in the radio trade, as with all others in which sales to the public are involving increasingly large investments, is that of finance. Installment selling has had the attention of the country's principal economists, and the opinion is freely expressed that only careful conservatism can justify it; yet, in order to maintain industry under modern conditions, it is necessary to capitalize the future earning powers of the public. The writer of this article has been actively engaged in financing radio credit sales, and is therefore familiar with his subject; he is a strong advocate for the need of correct business, as well as electrical technique on the part of radio dealers.

THE following suggestions may not be applicable to many radio dealers in cities, where bank credits and financing are common; but it is hoped these ideas will be assimilated by dealers in smaller towns, and by many repair shops and custom-builders even in cities.

Every radio dealer should establish a banking connection and build up his credit, for a number of good reasons. Some of these are:

(1) An unforeseen emergency may demand some extra money, when the lack of it may mean even the entire loss of the business.

(2) Any successful business demands credit—no matter how large or how small; your business is no exception. Therefore, don't be afraid to establish bank credit and use it.

(3) Many opportunities for making much more money will present themselves if you can use your bank credit. You may be offered an exceptionally good buy for which you need immediate money; or any extra amount of business offered you may be financed by borrowed money until you have an opportunity to carry it through to completion.

ages, on the ground that "them what has, gets," or that "it takes money to make money." I have heard these expressions, dozens of times, from proprietors of radio stores and repair shops. Here is how to establish a successful credit connection:

(1) Start a bank account, no matter

(4) Borrowed money will always make you money by permitting you to discount your bills—something your jobber won't forget, either, when you need some special service,

how small, and stick with it. Put every cent you get in this account, and pay every cent out by check.

(2) Run your business as it should be: that is—"keep your business and your business will keep you." Keep your store or shop clean; keep your windows attractive, and your shelves ship-shape. Have your set or sets on the floor at top efficiency. In short, have things in such shape that if your banker or his wife come into your store they will be favorably impressed.

#### MAKING A START

By this time you are probably asking "Well, how am I going to establish a credit rating?" It is a mistaken idea among many dealers that the "big feller" has all the advant-

(3) Keep a simple but complete set of books, and know where you are, financially, all the time. Be able to furnish an accurate and conservative statement to your banker at any time.

(4) Borrow some money from your bank occasionally, whether you need it or not. Pay your interest on it for, say, 10 days and then pay it back—*don't wait until you are in a jam and have to get money in a hurry.* If you borrow from time to time and always pay back promptly, you will be building up the most valuable asset of any business—Credit; and you won't have any trouble getting money when the real need comes. (Continued on page 19)

Your banker is an important silent partner in your business enterprises, unless you are able to carry your own credits—and in that case, as the writer suggests, you are yourself a banker and should follow that profession. By practicing the rules laid down here, you avail yourself of a capital much larger than your own, and of its consequent greater earning power. The banker will always welcome the radio dealer who is a business man; and with whom it is therefore pleasant and profitable to associate. Your principal asset should be your business ability and methods, and not merely merchandise, which must be appraised with a parambroker's eye.

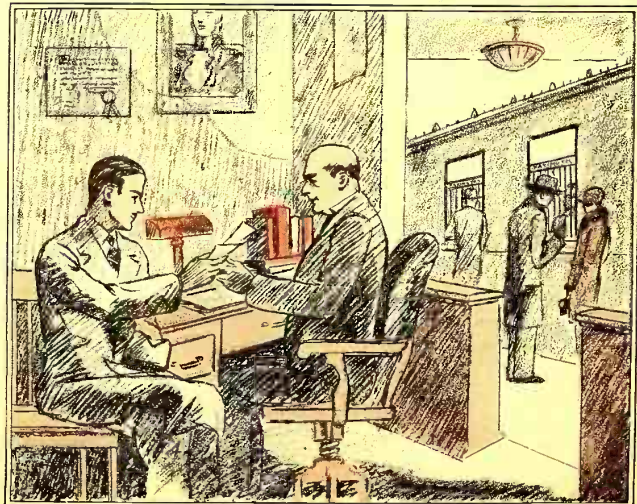

## Converting Battery Receivers To "AC" Will Sell Them

*But Be Sure*

### Volume Is Controlled Properly

ALL "AC" circuits are built up with a very delicate balance of voltages. To keep this balance intact is very important so that no appreciable AC hum will develop. The popular methods of controlling volume in Battery Receivers are insufficient and will not give satisfactory results.

A true, smooth volume control in AC circuits is obtainable by using the new Centralab Radiohms, RX-100 or RX-025. The RX-100 Radiohm in the secondary will control oscillation as well as volume. The RX-025 across an R.F. primary provides

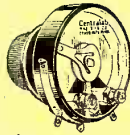

effective control and does not detune. The same unit has the proper resistance for antenna circuit control, but no antenna circuit resistance will prove as uniformly satisfactory as when used across one of the R.F. stages.

A Centralab PR-050 Power Rheostat, in series with the AC transformer will provide accurate voltage control and lengthen the life of the tubes. Centralab wire wound Potentiometers and Fixed Resistors will prove trouble-free in the power circuits.

Write for full information about these high quality controls that are being used by so many of the prominent set manufacturers.

**Central Radio Laboratories**  
23 Keefe Ave., Milwaukee, Wis.



## GOOD RESISTANCES *are made of paper.*

RESISTANCE  
Paper

For Fixed and Variable  
Resistance Units.

*Call or Write for Samples*

**WALKER, GOULARD, PLEHN Co.**  
448-450 Pearl Street, New York, N. Y.

Phone Worth 0051

## A Special Offer to Dealers **S. Gernsback's RADIO ENCYCLOPEDIA**

When a dealer answers his customers' questions as though he knows his business, he immediately impresses them with the idea that he is reliable. In S. Gernsback's "Radio Encyclopedia" you will find every word used in Radio thoroughly covered, every worthwhile circuit and principle is honestly and unbiasedly treated. Then, there is biographical accounts of all those men responsible for bringing radio to its present state of perfection. To each milestone of progress—through each stage of development—let S. Gernsback's "Radio Encyclopedia" take you. There are 1,930 definitions, 549 diagrams, photographs, drawings. A complete cross index is just one of the many features of this remarkable book. This is not a dictionary, but a real encyclopedia.

Regular price for S. GERNSBACK'S RADIO ENCYCLOPEDIA with semi-stiff Keratol binding \$2.00.  
**SPECIAL PRICE TO RADIO DEALERS.....\$1.50**

Twenty-five thousand copies of this complete history of radio progress have already been sold to individuals. We are prepared to quote special discounts to those dealers desiring quantity lots. Write us.

**S. Gernsback, 230 5th Ave., N. Y. C.**

# CARTER

## Adapter Harness

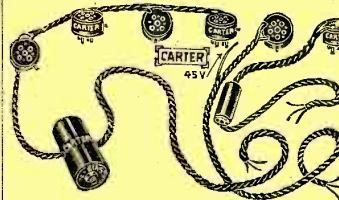

Sell your old sets at a profit by converting them into A. C. sets by means of the Carter Adapter Harness.

No changes in wiring necessary. Connection can be made in ten minutes and then you can sell the old D.C. sets you have in stock at a profit.

The most complete line of Adapter Harnesses on the market—for use with all standard filament transformers—a type to fit any set and every need.

Write for illustrated folder and price list.

In Canada:  
Carter Radio  
Co., Ltd.,  
Toronto



Office in Principal Cities  
of the  
World

# Dealers - - -

In order to assure a copy of the RADIO NEWS DEALERS PERSONAL EDITION reaching you each month take advantage of this special subscription offer. The regular rate for yearly subscription is \$2.50—by our special introductory subscription offer you can get the RADIO NEWS DEALERS PERSONAL EDITION for one year beginning with the next issue for the amazingly low price of \$1.50. Remember, bound in with the DEALERS PERSONAL EDITION is a copy of *Radio News* just as it is bought by over one hundred and sixty-five thousand radio enthusiasts. This copy of *Radio News* you receive **FREE**.

Mail this coupon now. In this way you will be sure to get the next copy of the RADIO NEWS DEALERS PERSONAL EDITION. This is your own magazine—it is edited by the whole radio trade.

EXPERIMENTER PUBLISHING CO.  
230 Fifth Avenue  
New York, N. Y.

**Attach Your Letterhead—This is Important**

EXPERIMENTER PUBLISHING CO., N. Y.  
230 Fifth Avenue, New York, N. Y.  
Gentlemen: I wish to take advantage of the special introductory rate of \$1.50 for one year subscription to the Radio News DEALERS PERSONAL EDITION. Enclosed find \_\_\_\_\_ to cover.

Name \_\_\_\_\_ Address \_\_\_\_\_ City \_\_\_\_\_ State \_\_\_\_\_

# TAKING RADIO OUT On the Road!

by  
**E. A. Blank**  
Churchill Drug Company  
Peoria Illinois

*THE old-fashioned drummer was a master of the art of demonstrating his wares, but he would have been surprised as well as enthused by this substitute for the task of carting and carrying his well-filled sample cases to his merchant customers. The company which has put on this successful salesroom-truck is a wholesaler with large branches in Peoria, Ill., Burlington and Cedar Rapids, Iowa, and Omaha, Neb. It handles many other lines, but radio presented special problems.*

the car; and in it are installed—and kept in working order—receivers covering the complete line of the models that we handle.

#### AN EFFECTIVE ADVERTISEMENT

As the car is painted in bright colors, and is of strikingly unusual appearance, it attracts every one in the small towns through which it passes. This is especially true when it is lighted up and the radio receivers are being demonstrated. We make a special effort to obtain a parking place on a good corner, and particularly on Saturday nights, in towns where we have a good dealer.

This attracts hundreds of people, and our radio man in charge of the truck reports that on many nights the car is kept in operation almost to midnight, with visitors still coming to see the latest models and hear them demonstrated.

We have found also an opportunity to enter this truck in many parades and celebrations; and we (Continued on page 19)

**T**HE radio department of this company has always presented us with a peculiar problem, in the way of displaying our merchandise to our prospective dealers, to the best advantage for both of us. In the other departments of our varied business, such as sundries and fountain supplies, we displayed our merchandise in the usual way, in the hotels of the key cities throughout our territory. We attempted this also on behalf of our radio department, but the effort proved a failure.

We found also, in trying to take out a line of radio sets and consoles for display in this manner, that we were constantly confronted with the necessary unpacking and repacking, and the hooking up of the various sets under very trying conditions, so that the most satisfactory demonstration was not obtained.

After coming to the conclusion that, in order to sell our radio merchandise, we would have to display and demonstrate it properly, we originated the truck idea,

illustrated here; and had constructed a body 16 feet 6 inches long and 7 feet wide, forming a very compact, but attractive show room, as may be seen. This body is lighted electrically by running a cord from a plug in the dealer's store to the side of the car. Suitable aerials are built into the roof of



The extremely attractive appearance of the interior of the radio demonstration truck will be seen from this picture above. The space is skillfully used, and a large line of the most modern sets, for both aerial and loop operation, is thus presented for the inspection and approval of the rural merchant and his customers; so that many sales are thus made for the dealer in advance of his commitments. While many radio houses derive advertising from special truck bodies, this one has special advantages, as will be seen. The truck itself, with its ample window space, is shown below as it appears on the street.

(Photographs by courtesy of the Reo Motor Car Co.)

# Troubles of the Custom-Set Trade

## -LITTLE DABBLERS & BIG BUSINESS

by  
A SMALL MANUFACTURER

WHEN we sent to the contributor of this article the usual request for a picture to personalize his forceful remarks, he answered: "The writer has invested some sixteen years in the radio business and does not feel that he should in any way jeopardize his earning powers in that field by flaunting a red rag in the bull's face and rubbing it in by the picture of the flaunter." We, therefore, present this view of the radio situation for our readers, who will assign to it such value as they find in its presentation of conditions; we will be glad to have comments, with or without names for publication. The writer, it may be said, is a resident of the Pacific Coast.

THE writer has just read your "change of policy" notice, and believes that your move is sound.

However, there is much light to be shed on matters leading up to this change which might not have occurred to you.

In the first place, because of the fickleness of the average experimenter with various circuits, as well as the professional custom-set builder who jumps from one circuit to the other and never stays with one long enough to plumb its deepest possibilities or to make any money at it, it is necessary that over-night results be obtained from advertising by the parts manufacturer. If the professional set-builders—those who make their livelihood wholly or in part by building sets—were to pick out something good, specialize in it, and stick by it, we would all be better off; then the parts manufacturer could "invest" in yearly contracts, etc. As it is, something new must be brought out all the time, even though it is the same old words set to a different tune.

Then, we have the "dabbler"—the would-be professional, the experimenter pure and simple, who has no primary intent to make money from his discoveries if any. This class of "radiotrician" does more to hurt the trade than anyone else; because those things which he does turn out which prove practical and salable, are sold at cost or less, and thus destroy a portion of that market open to the bread-and-butter man.

### LACK OF KNOWLEDGE

We have the beginner, who picks up his little knowledge of the art from current magazines, parrots what he reads, creates

a false idea of his ability, "gums up" every job he tackles because of lack of foundation obtained only by practical experience, and thereby destroys confidence in the custom-set-builder class.

In my opinion, the publishing of "picture hook-ups" has contributed more to these two classes than any one cause. We have one thing to learn—it takes more than mere wiring to make a successful hook-up. Consequently, when trouble occurs in the parts used, the accessories, or slight mistakes of one kind or another, together with rotten workmanship, these "dabblers" without any groundwork are stumped to find and remedy the difficulty. Most of the deep-seated troubles in successful radio construction can be located and remedied only after a thorough course of sprouts from magnetism upward; and the "dabbler" doesn't go that far back.

If a set-builder can not read a regulation schematic diagram, he should not be building sets. He should go to those who specialize in that trade, pay out a few dollars, and get a real job. It would not be so bad if these "dabblers" were to confine their activities to their own backyard—instead, they get chesty and start advertising themselves as experienced radiotricians; which

gets many people into hot water, and ruins the otherwise good reputation of the custom-set builder making his living at the business.

It is not to be inferred that all professional set-builders are good—as in all other lines of endeavor, there are black sheep. Nevertheless, as much should be done as possible to prevent the man without sufficient groundwork from stealing the bread from those professionals with years of time invested in their business. The first step toward this end is to cut out the publishing of "picture diagrams" and other similar short-cuts.

### PROPAGANDA AGAINST DX

The worst thing confronting the custom-set building business, as a profession, is the evident propaganda by the Big Business section of the industry, in an effort to wipe out all desire for getting DX. DX, as we will all admit, is one of the biggest talking features of the professional set builder; inasmuch as practically any well-designed factory receiver will play locals as well, and in some cases better, because many improvements in audio amplification and reproduction are not available to the trade, at least within the season. It would follow, then that the shortest way to stop the custom-set builder from making any further inroads on factory sales is to stop DX. This has been done more or less successfully in congested areas in past years, by the attempt to impress the public merely with the good reception of local stations directly, and the unsatisfactory features of DX-hunting indirectly. In suburban districts, however, the propaganda has not taken hold until this season, because of im-

provements in receiving equipment which is still able to "pull" the DX.

But in the past six months, due to the activities of our Federal Radio Commission, pyramiding of (Continued on page 19)

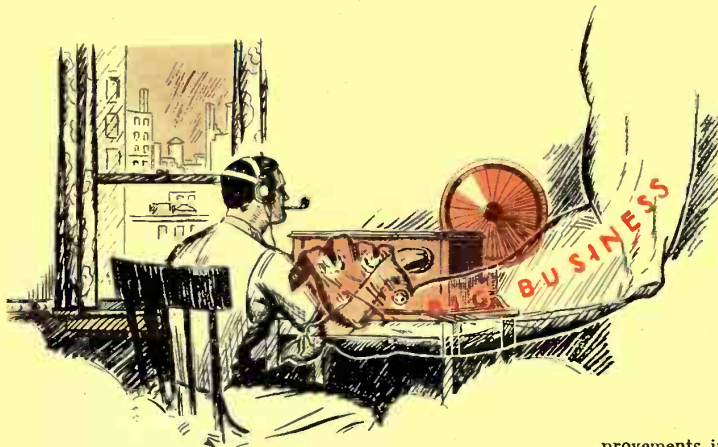

DX is not to be longer considered among the important things in radio, we have been told on high authority. Will this destroy radio enthusiasm and progress; or will the extension of high-class chain service enlist more listener interest than it will drive away?

# What manufacturers and customers do to me

## By a Radio Dealer

*THE hero of this story is what he claims to be—a fairly successful dealer in a good little town. His tale of woe will meet with many sympathetic ears; and it is probable that many of our editors will voice complaints of a not dissimilar nature. At the same time, there are always two sides to a question—and in that of distribution there are at least three—manufacturer, dealer and customer. The discussion of well-founded complaints should lead to a possibility, at least, of improving trade conditions. What are your suggestions for better radio business?*

I HAVE declined with thanks, the invitation to have my name appear with this article, because the manufacturers might do other and even more unpleasant things to me. Also, I have refused to give the editor my photograph for publication—because somebody might want to punch my face as soon as he saw it.

If it will satisfy the curiosity of you other dealers who read this, I will say that my store is within one hundred miles of New York, in a manufacturing town surrounded by rural territory. When some of you fellows follow my example and tell your troubles, I will read them with pleasure. Misery loves company.

My store is a fairly prominent one and I have had many opportunities to take agencies for the better radio outfits. I picked out several of the best, those that do plenty of national advertising. So far, so good. Customers responded to the local advertising and business looked good.

Then, bang! Out came one of the manufacturers with a whole new line. The national advertising was such as to convince any customer that the new stuff was built on radically different principles and that everything that had preceded it was obsolete. I was left holding the bag. The advertising affected, not only my business in sets made by that

manufacturer, but also everything else I had in stock.

### A SQUARE DEAL!

Another manufacturer was more considerate. He notified me that new developments in tubes had made it possible to produce sets that would operate directly from any light socket, without any batteries; and he asked me what old stock I had on hand and how long it would take me to move it. That gave me a chance.

Not long ago I began to receive complaints about a job that was put up with defective or poorly-designed amplifying transformers. I began replacing the burnt-out transformers; for some of them hadn't stood up even for a week. I depended on the manufacturer's guarantee and felt sure that he would want my customers to be satisfied that they were getting a square deal. Did he give me the new transformers? Try and get them! After writing him sev-

manufacturer got out from under the sets.

Just now there is a new tube that is giving trouble. It goes dead in two or three months, although guaranteed for a much longer time. The manufacturer replaces them free of charge, but I wish he had kept them off the market until they had been tested long enough to make them a sure thing. He is square, but free replacements on one thing get the customers to asking for free replacements on other things, when they have no right to expect them.

They do not take their shoes back to the shoe store and demand that they shall be half-soled and heeled free of charge, but some of them expect a dealer to keep a radio receiver in working order, and supply new batteries free of charge indefinitely. This is caused in part by out-of-town dealers, who promise customers in my territory free service, but put them off when they ask for it. They get the idea of free service and the local dealer has to give it because he is where they can get at him.

When the electric jobs came out they increased my trouble with customers. In our territory the dealers do not follow certain uniform rules, as they seem to in New York. Each one has his own policy and there is so much competition that the tendency always is to go the limit to sell a prospect by giving him demonstrations, and then keep him happy after he is sold so that he will bring in his friends.

### THE WARY CUSTOMER

Everyone wanted to try the electric sets but they did not want to buy until they had a chance to see how they worked in their own homes. We have plenty of foreign population, none too intelligent and often inclined to be suspicious. They will hear a set in the store and agree that it is the goods; but they suspect that there is a trick in it somewhere and that it will not work as well somewhere else. The native Americans express themselves more smoothly, but lots of them have the same idea.

Some customers (Continued on page 20)



*The dealer is the goat, not only for the mistakes of both the manufacturer, and the customer, but also for the optimism of both parties. Small wonder that he is inclined at times to be a bit of a pessimist.*

eral times without result I took my loss on sixty sets, myself! My only consolation was that I made a few dollars by replacing transformers in sets of the same kind that had been sold by dealers who did not shoulder the responsibility after the

# WHY I AM GETTING OUT OF RADIO

by M. EISENBERG  
Proprietor of Westport-Conn.  
Specialty Shop

I AM getting out of radio—and having troubles of my own in doing it. The sets that I have on hand are among the best on the market, Radiolas, Atwater Kents, Grebes; but nothing I can do seems to move them. I have offered them at one-third off, with no takers. It may be partly my fault. I am not a radio man. But I have studied the situation and I believe there are other causes as well.

The manufacturers came out last year with electric sets. They and the dealers in general advertised them in such a way that they put battery sets and electrified sets in the class with ox yokes, so far as sales in my store are concerned. The idea of just plugging into the light socket and turning on the radio appealed strongly to the public, which always stampedes immediately to anything that promises to eliminate work.

#### THE TIMID PUBLIC

The public, or that part of it which was served by electric-light companies, demanded electric sets. Many of these were sold, and very soon it was discovered by the purchasers that the alternating-current tubes had been placed on the market a year or two before they should have left the laboratory. Some lasted three months, and some burned out within a week or less. In spite of free replacements, the bad news travelled fast. Prospective purchasers, having already been convinced that battery sets were obsolete, and now learning that electric sets were not giving satisfaction in all cases, decided to wait. Judging from my experience, they are still waiting.

To cap the climax, one manufacturer came out with a tremendous price cut, just at the start of the holiday business, when it was least needed so far as business in general was concerned. That killed off most of what was left of my radio prospects. If there was to be a price war, the customers wanted to wait and see if sets would not go still lower.

If I were a radio man, and could coax my trade along by giving extra service and smoothing out their troubles at the expense of time and trouble only, I would work and wait patiently

for better conditions. Some of my fellow merchants are doing so, and apparently they are getting along all right. But I handle many other lines and I have to pay cash for radio service that I furnish free of charge to my customers. I do not need radio and I have found it unprofitable.



Mr. Eisenberg, who is a successful dealer in office supplies, stationery, and gifts, has learned that radio is a specialty by itself, and no side line. His frank statement of experience will be of interest to many.

#### "LOCAL INTERFERENCE"

Another difficulty is that I never can be sure of giving a satisfactory radio demonstration in my store. I have one of the best electric sets made and I keep it in the front of my store to give demonstrations. Sometimes it works beautifully and customers are charmed by the music. But, with the perversity of inanimate things, it often goes wrong at a critical time. A trolley car passes, or some fellow steps on the starter of his car in front of the door. There is a succession of deafening crashes from the loud speaker and the customer turns away in disgust.

Demonstrations can be given in the homes, where conditions are more favorable for radio than they are at my store, but there again is the problem of paying out cash which never comes back. At best it eats into the profits—all radio dealers know how quickly they are absorbed—and a little bad luck in the home kills a sale, even more surely than it does at the store.

#### FOR RADIO MEN ONLY

Looking at the matter from the point of view of the whole community, and we all ought to think of the other fellow as well as of ourselves, why should I sell radio? My main lines are stationery, typewriters, office supplies, books, phonographs, records, gifts, lamps and specialties. If the radio man a block away, without any experience with my lines, should add those lines to his stock of radio sets, accessories and auto supplies, the rest of us merchants would think he was crazy. Is it not just as ridiculous for me to try to sell radio? I have plenty to do without it. Why not leave the radio field to the radio man, and do what I can to help him to win even greater success?

In a city, conditions would be different. The volume of business there would justify making an investment. Here, the population is only 6,000 and we have the competition of several cities without having city opportunities.

#### PRICE CUTTING FAILS

My experi- (Cont. on page 20)

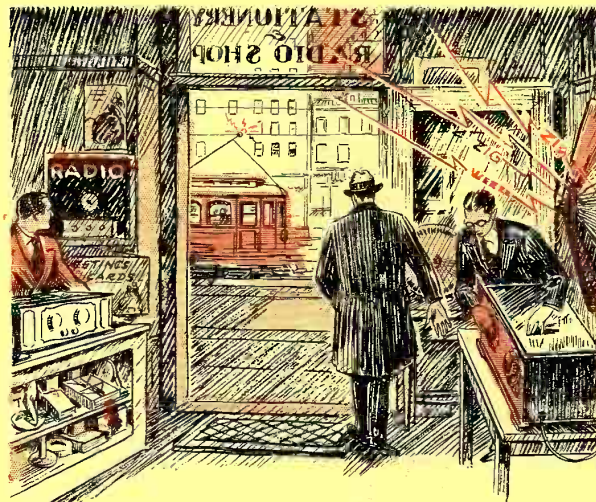

A radio man might find the answer to this interference question; but it is too much for a plain merchant.

# "SERVICE" SALESMANSHIP

By FRANK S. TOWER  
President-Tower Mfg Corp.

COMPETITION, the father of all enterprise, has made it necessary for modern sales methods to consider the innumerable factors influencing sales procedure. Out of this study there has emerged one dominant element that is all-powerful in salesmanship—and that is service. For today the storekeeper measures the degree of his success by the idea of service which he conveys to the minds of his customers. The public has been "educated" to look for it, almost to demand it.

And no better application of this principle can be found today than in the field of the retail radio dealer. His product, while not a luxury, is still far from being considered a necessity. The average radio purchaser looks upon a set as an extra investment, one that family pressure may have forced him to consider. Frankly, he is skeptical. He knows little concerning the apparatus, but has a vague impression that it is extremely delicate, amazingly complicated, and susceptible to continual breakdown. The state of his mind, and the very nature of the product itself, demand an added inducement to gain his attention and, eventually, his confidence.

It is at this point that the idea of service plays its first important part, and it is here that the majority of potential radio sales are lost. If, instead of a head-on sales approach, the radio dealer enters into a frank, friendly discussion of his prospect's problem; if the dealer outlines the enjoyment to be derived from such an investment; if he can do this and one thing more—instill into the mind of his prospect that he has the sincere wish to help him instead of merely selling him a radio, then he has made a material step toward a completed sale.

This can be done in many ways. There are tactful suggestions to be offered as to prices best suited to the purchaser's income, advice to be given regarding certain equipment, and innumerable other matters to be discussed that are closely connected with the problem. It is only natural for the customer to react favorably to such

*"PUT Yourself in His Place" is the title of a best seller of many years ago. It is still the keynote of really good salesmanship. While the sale may be the most important thing to the dealer, the purchase represents only a beginning for the customer. Usually but poorly informed as to what he really needs, he will appreciate a frank and friendly interest in his special problems. The dealer who can see them through his customer's eyes possesses an invaluable business asset, and one which he should cultivate to the fullest extent.*

treatment. It instantly diminishes any preconceived antagonism he may have had. Instead of the ordeal he expected, he finds a really interesting problem, with someone who really knows the technical details, ready to help him find the solution.

Of course, this is being done daily and very often not meeting with success; but a study of these examples would undoubtedly reveal the fact that the salesman employed what has been termed the "head-on

*Visiting the customer introduces an extremely valuable personal element into business contact.*

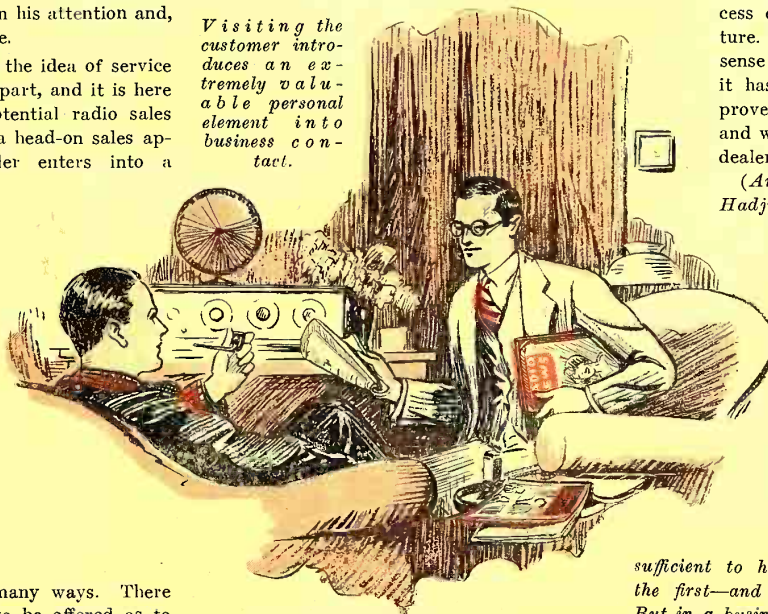

sales approach." To be sure, the salesman may have stressed the idea of service, but only as a means to sell his prospect one certain radio set. This is the very thought to be eliminated.

If, as suggested, the conversation can be carried on at first in the manner of friendly counsel, with the dealer stressing his own wish to help the prospective purchaser, he will find that person eventually giving him his confidence. A procedure of this sort carried through to the completed sale, and even after, with the salesmanship based on service at all times, will gain not only the confidence of the purchaser, but his respect as well. The logical result is additional sales made to the friends of the original buyer; and so an endless chain of prospects and sales would result, all transactions resulting from faith in the dealer's honesty and integrity.

Many radio dealers encourage the habit of friendly visits among their customers. They introduce into this business contact, a *personal element* that is extremely valuable. Free repairing for a limited time after date of purchase is oftentimes allowed each buyer; and for a nominal sum this service can be obtained after that period. There has been much question as to the financial success of a department of this nature. Based upon a common-sense payment method, however, it has, in the majority of cases, proven itself a highly desirable and well-paying proposition in the dealer's organization.

*(An oriental philosopher—the Hadji-er-Squibb, we think—once observed that the priceless ingredient of any commodity is the integrity of him who made it. Certainly, the priceless element of any successful trade is the confidence of the buyer in the integrity of the seller. For some lines of business, such as that followed by the Indian doctor who sells aboriginal panaceas from the rear of a wagon, it is*

*sufficient to have confidence endure until the first—and last—sale is consummated. But in a business such as radio should be, his clients' confidence should be, not only a permanent, but a growing asset of the radio dealer. He should have as many enthusiastic friends as customers. (Here we seem to hear a low murmur, and the*

(Continued on page 20)

# Why Dealers Should Sell FEWER BATTERIES

by ALFRED S. CLARK  
C. and C. Radio Service  
Cranfield-N. J.



*A SHORT time ago a battery manufacturer contributed an article suggesting that the battery is not yet to be placed alongside the dodo in the museums; and that, for distance getting, it is essential. The author of this article presents the position that for money-getting—which is the principal purpose of the trade—catering to the set owner who wants distant reception is a waste of time which could be spent in selling good modern receivers to the public. How many agree with him?*

**T**HERE never has been any money in selling batteries unless you were doing a cash business large enough to get the inside discounts. If you charge a price that will give a fair profit, you are "a robber" and your customers go or send to the big cash store in the city. If you try to meet their price, you do not make enough to cover the cost of selling.

Servicing battery-operated sets is a losing proposition. If an electrified set goes wrong you have something to charge for; while it is very hard to collect for the actual time and cost if you have only to replace a battery. An honest service man is often at a loss to know whether he should replace a whole set of "B" batteries, when only one is run down but the others test rather low.

#### SWAT THE RADIO BUG

The distance bug is probably the best customer for batteries, outside of those that never have the price of a power unit. He is a nuisance to the average dealer trying to sell factory-built sets. He kills sales of good efficient ones, because they do not bring in the Pacific Coast when the locals are operating. His own set probably will; but he has sacrificed tone and simplicity for distance reception.

He comes into the store and takes up the service man's time discussing circuits. He puts on his own batteries, and knows where he can get them cheaper than you can afford to sell them. He can buy his parts as cheap or cheaper than you can; because he can pick the good ones out of a job-lot in the 5-and-10 or cut-price store.

Good local reception has a year-round appeal. Distance has an attraction only during the dark months. Sell a set on its distance-getting qualities, and someone must spend an evening with the purchaser to show

him that it will perform as guaranteed. For these reasons it pays the dealer to "soft pedal" on the subject of distance-getting as much as possible.

It is a joke to say that the old sets were more efficient because you could get better distance than at present. I have beside me a duplicate of the set I logged 150 stations on when 500 watts was super-power. Tried out against a modern one-dial 110-volt A. C. set, it sounds like a paper-covered comb in comparison with a brass band. This set sold, stripped, for forty odd dollars more than the A. C. set with its "A" and "B" power supply. For getting distance nowadays it is hopeless, as the locals spread half way across the dials. This is not exceptional, as one hears the same story continually from owners of old sets. No adjustment of battery voltage will enable these sets to pierce through the blanket spread by the local stations.

Good "B" units are adjustable, if one wishes to experiment, to give the most efficient voltage on radio-frequency and detector tubes. It requires a specially-built receiver to really do anything in DX nowadays, if you are near any powerful locals.

When the Radio Commission and the natural law of the "survival

of the fittest" cuts down the number of stations in the metropolitan districts it will pay to cater to the distance hunter. At present 90% of our customers say that they spend more than that percentage of their time listening to the three leaders of the "chain gangs," and almost never try for distance. If a set will bring in several distant stations, loud enough to enjoy them when an SOS shuts down the locals, it seems to fill the bill in most cases.

*(We can imagine the disturbance this article would stir up in the regular edition of RADIO NEWS among fans blissfully unconscious of the dealer's sentiments toward them. We wish to know how many of our readers vote with Mr. Clark, and how many will work for DX trade.—MANAGING EDITOR.)*

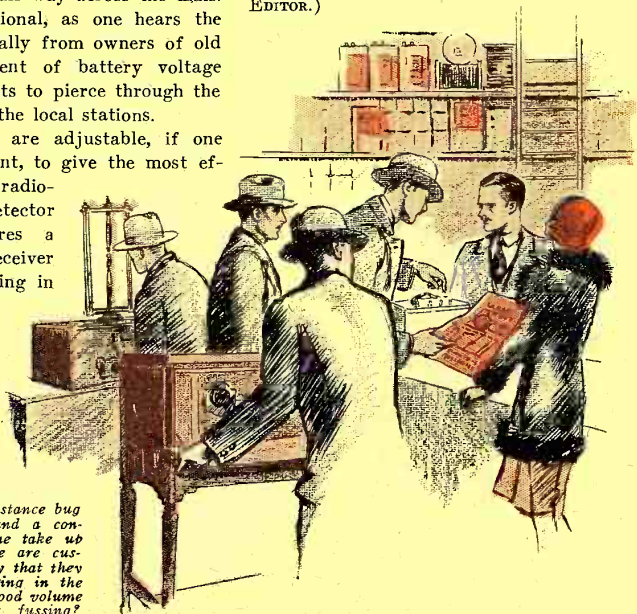

*The fan who is a distance bug is also a bargainer and a conversationalist. Does he take up your time when there are customers who know only that they want something to bring in the chain programs with good volume and quality, without fussing?*



# ADVERTISE RADIO from the CUSTOMERS' STANDPOINT

by F. R. PRAY

F. R. Pray & Co., Boston, Mass.

**T**HIS article by a prominent Boston wholesaler and retailer is accompanied by a reproduction of the best retail advertisement yet submitted under our standing prize offer. (We can use many more.) It is worth reading carefully; for it embodies the principle of good advertising. It talks to the customer first about what modern radio sets can do for him; then it tactfully broaches the subject of prices. Incidentally, how many advertisements are spoiled because the reader is unwilling to expose himself to high-pressure personal salesmanship to find out the price limits of the goods offered, but fears the worst? Send in the advertisement you have found the best, and tell how well it "pulled." The best one received each month will be awarded a \$5.00 prize and published here.

We think it a mistake to run "bargain sales" for profit, as a business. A dozen specials, changed each week (not advertised) on a cost plus 10% basis, will bring customers to the windows, continually; and most of them, inside to buy. We do not find direct-mail advertising pays in a large trading center like Boston; but we would spend all of our newspaper appropriation, except national advertising tie-ups, were we in the suburbs, in mailing or distributing weekly folders.

The advertisement reproduced here cost about \$18.00 and sold three Zenith Electric sets, complete, at \$235.00 each.

A competitor sold eight \$88.00 electric set (plus tubes and speaker) from a \$200.00 ad, using copy supplied by the manufacturer, who probably paid for part of the advertising. This was on terms of \$5.00 down and the rest when convenient.

the trend of radio, suggest the best way of adapting them to his requirements, and link our sales and service facilities therewith. A mention of price is essential too, because it makes the customer think about money, and then, how to get enough together to buy our radio—all without conscious thought that we are trying to sell.

The writer is sorry that he hasn't a photo handy but, if this is necessary for a well-rounded article, you may be able to find one in your files of RADIO NEWS about 1922 in the Set Contest Department. (Unfortunately, a little too far back to locate the original. The DEALER'S PERSONAL EDITION, however, likes to publish the pictures of its contributing editors, even though they be only snapshots, like some which have appeared in these pages. They bring the readers closer to the writers.—MANAGING EDITOR.)

We hope you will be able to "boil down" the above ideas to help the radio dealer to realize that "bargain sales" and "price wars" will get him nothing but customer's distrust and create a better chance that a competitor in another industry will get the customer's money. Radio is still partly a luxury; and luxury is not sold at cut prices.

#### THE CUSTOMER'S VIEWPOINT

We find that every paying advertisement of ours this season has been worded to help the customer crystallize his own idea on

**O**VER half our business is wholesale, and a great deal of that is to competitors of our retail department within a hundred yards. Consequently our newspaper advertising must produce results, not antagonize, and it must show competing retail dealers how our purchasing power and selling ability can profit them as well as ourselves, if they buy supplies through us. Such co-operation betters customer confidence in radio, which is more important than anything else in these days of competition between industries.

We use the newspapers very sparingly and then only to print real news or put over a new thought. Continued "bargain-sale" advertising does not seem to pay as customers are becoming used to it now; and the so-called "dollar down" houses blanket most legitimate advertisements with seemingly little profit to themselves.

#### VALUE OF WINDOWS

Our most important retail sales help is a spacious window hung with velvet drapes, well lighted, including colored spotlights. Merchandise is changed or rearranged once a week. Our next most important sales help is a staff of selling agents on commission, regularly employed in many types of businesses, who are competent to build or install radios. We also have dealer-agents in small towns, who carry a representative stock of supplies and the kit-sets we sponsor.

**Ever changing!**

... therein lies the charm of radio ... but to enjoy it to the utmost ... programs must roll in ... one after another ... without a thought of run-down batteries, adjusting eliminators, switching on chargers—in short, you must have one of the new

**Electric Radios**

Zenith leads ... \$175 ... then comes the Mohawk Console at \$152 ... then the Bosch at \$114. Down payment as low as \$50, and liberal allowances on your now obsolete battery operated sets ... what more could you want?

**F. R. Pray & Co.**

New England's oldest exclusive radio distributor ... where keen buying, small profits, volume sales, low costs and low selling expense assure up-to-the-minute stock and unusual values.

**26A Brattle St. Boston**  
Cap. 1749

(This is the winning advertisement)

## Necessity of Installment Selling

By E. S. KINNEY, JR.

Kinney Bros., San Diego, Calif.

**A**N interesting field is opened up by Mr. Dimmock when he "Takes a Look at the Credit Situation," in your January issue. However, I feel that his conclusion that all dealers should obtain a down payment equal to their net cost imposes a restriction on the city dealers that is rather binding. His method may be ideal for the South at the present time; but, even there, he will find the trend toward installment selling on year contracts steadily mounting during the next few years. Installment selling has become so firmly entrenched, and is proving so effective a merchandising tool, that very few radio dealers will be able to do business without it. That being the case, it will pay the smaller dealers who are having trouble in financing this type of business to face the problem squarely and try to devise methods of adapting their resources to the apparently inevitable.

(Continued on page 20)

# The Latest Radio Merchandise Offered by Manufacturers

## And The Dealer Helps That Go Along



**ALL-AMERICAN ELECTRIC, Model 98**, made by All-American Radio Corp., Chicago; 6-tube; carved walnut console, 48" high, 28" wide, 18" deep. List price with tubes, \$196. Dealer Helps: displays, signs, literature, mats and cuts.



**A. C. CONSOLETTA, Model 540**, made by Stewart-Warner Speedometer Co., Chicago, contains model 535, 6-tube circuit; console table, 40"x21"x13 1/2" deep. List without tubes, \$137. Dealer Helps: "Radio Bible" selling book, electric signs, displays and literature, mats and cuts, picture slides, posters.

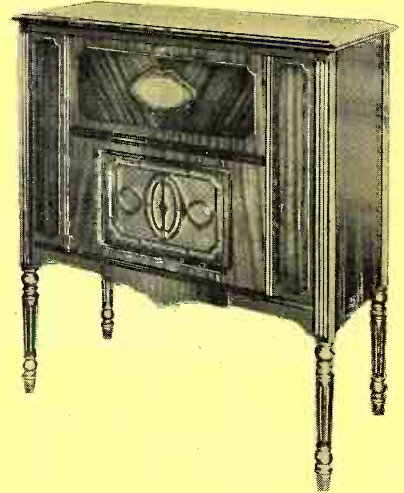

**"EQUAPHASE" ELECTRIC, Model G-10**, made by Chas. Freshman Co., Inc., New York. (circuit described elsewhere); Mahogany, 35" high x 31" x 15" deep; list \$139.50 with tubes. Dealer Helps: literature, window displays, electric signs, cuts and mats, allowance of 50% on approved local advertising by dealer.



**"SYNCHROPHASE" A. C. SIX**, made by A. H. Grebe & Co., Inc., New York. Metal chassis and inlaid bronze panel; cabinet 10 1/2"x24 3/4"x18" deep; list without tubes, \$227.50. Dealer Helps: displays, slides, booklets, mats and cuts.

**This page is one of news, not of advertising. Dealers are invited to write for information about any apparatus on the market; and the manufacturers to send their latest announcements, with technical and merchandising data to the DEALERS PERSONAL EDITION.**

**PRICE CORRECTION NOTICE:**

The Model 16-EP, made by the Zenith Radio Corporation, Chicago, lists at \$375; not \$350, as erroneously shown on this page in our March issue.



**A. C. ELECTRIC, Model 38**, made by Atwater Kent Mfg. Co., Philadelphia, seven tubes, metal cabinet 7 1/2"x21 1/4"x10 1/4" deep; list \$125. Dealer Helps: displays, trims, large and small posters, literature, line of leather goods and specialties, electros, picture slides.



**RADIOLA 50**, made by Radio Corporation of America, New York. Radiola 17 circuit (rearranged) and 100A speaker in walnut cabinet, 38"x24 1/2"x14" deep. List \$285 with tubes. Dealer Helps: Displays, direct-mail, imprints, poster program service, cuts and mats, cards, imprint tape, illuminated canopy and signs.

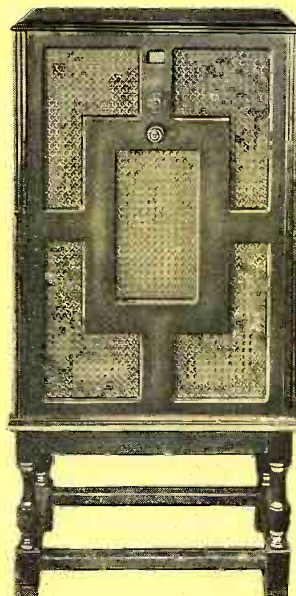

**SPLITDORF "AVON"**, made by Splitdorf Radio Corp., Newark, N. J. Walnut cabinet, 40"x20"x15" deep, cane-backed grill; 6-tube "duplex," convertible from tuned R. F. to regenerative; list \$295 without tubes. Dealer Helps: trims, streamers, envelope stuffers, photos.



**"RADIO ART" CABINET, Model 40**, made by Musical Products Distributing Co., Inc., New York. Will accommodate Radiola 16 and other receivers; walnut, 51"x23"x20" deep. List, \$110. Dealer Helps: literature, displays.

## Service Testing Apparatus Creates Sales

By ROBERT D. HARDEN—Harden Electric Co., Columbus, Indiana

**T**HIS article on cheap testing apparatus is written in the interests of the trade in general. We own complete laboratory testing apparatus, but the simple set tester described below, which we developed two years ago, has been worth more to us than all the others combined. With a little study, it can be made to do almost anything in set testing.

We are turning out an average of fifteen repair jobs a day with two men and one truck. We are now doing service work for other dealers, and billing them 25%, so that they can make some money on the service also. While this article probably will not bring the hundred dollars, it may be worth that much to some poor dealer struggling to exist, so perhaps space can be found to publish it.

*(Our contributor asks for comments, and we pass this request along to the trade. Several dealers have already submitted shop kinks dealing with a similar line, and we desire the sentiment of our readers on creating*

*a technical department of this nature in the DEALERS PERSONAL EDITION.)*

Most dealers have been more interested in selling than in servicing, since selling has been the more profitable of the two. Most dealers do not have an expert service man in charge, and few have complete laboratory testing equipment for locating trouble; so too much time is wasted in guessing. Result, they are ashamed to charge enough to make a reasonable profit; so all but the houses completely equipped have shunned the up-keep repair work as one would a snake.

Well, so much for the synopsis; let's analyze the case and see what can be done, and how.

### SERVICE THAT SELLS NEW SETS

First, unless the fault is readily seen, do not attempt to make the repair in the customer's home, but leave a new set in place of the old one until the latter is returned O. K. The public call this "Service De-

Luxe," and how could a better entrance to a demonstration be made?

A word of caution must be given the set owner, and that is that it will be impossible to make the old set perform like the new one, as several improvements have been made since the old one came out. Do not mention sales at this point unless the owner makes inquiries; as a sales talk at this point will break down the good will. Build up on the service.

When worked right, the sales resulting from this policy will be a surprise. But be very careful that the repaired set is given a good tryout before returning, and you will find that you have the edge on your competitors; because no amount of advertising by other means will compare with satisfied customers.

### BUILDING A TEST BOX

Every dealer has several Radiola III and IIIA trade-ins; so use the boxes for instru-  
*(Continued on page 20)*

## New Manufactured Equipment for Radio Dealers' Servicing

**T**HE popular conception of vacuum tubes as "accessories" to a set is one fundamentally erroneous, as consideration for a moment will show; the remainder of the set is rather an accessory to the tubes. The receiver is only a coupling and selecting device to pass the correct frequencies and needed current from one tube to another; to make possible their functioning, as amplifiers and detectors, to the best advantage.

In servicing a radio receiver, therefore, the promptest and most expeditious method of determining what parts are functioning correctly, and where any incorrect adjustment may exist, is to measure the voltages and flows of current at the tubes under operating conditions. Those delivered by the batteries or source of current supply are important only as they bring about correct operating conditions between the tube elements.

The most satisfactory test instruments, therefore, are those which may be plugged into the successive tube sockets of the receiver, and provide as well a suitable tester for the performance of each individual tube. Much ingenuity has been devised in the design of testers for this purpose; but the problem has been greatly complicated by the special tubes recently devised, especially for the new electric sets, with their several alternating filament voltages and high plate voltages.

### A PORTABLE LABORATORY

The latest device placed on the market for this purpose is a remarkable exhibit of ingenuity, in the compactness of its construction; which may be seen from the illus-

trations herewith, which were taken in the RADIO NEWS Laboratories. The instruments, with connecting cords and adapters, are contained in a neat carrying case which may readily be taken anywhere; yet they afford the opportunity to make accurate measurements as quickly and effectively as at a laboratory testing panel. The entire equipment weighs less than eight pounds, and the case is but 8½ x 13½ x 4½ inches.

The set analyzer may be placed beside the receiver and tests made of every tube and its connecting circuits, in five or ten minutes. The record, as it is noted down, instantly shows what trouble exists, if any.

As will be seen from the panel view, three meters—two A.C. and one D.C.—are mounted in the instrument case; and an array of push buttons, which cut in and out of the circuit, special resistors, makes available nine scales of readings. The precision obtained with these devices is a matter of careful calibration, not possible with ordinary commercial resistors of the type used  
*(Continued on page 23)*



*Left: The set analyzer as it appears placed beside a receiver for quick testing of the successive stages at the tube sockets. A tube put in the receptacle beside the lower dial will be in its proper circuit in the set. Right: The analyzer closed for carrying.*

## Making a Successful Demonstration

(Continued from page 3)

demonstrated. I have studied how to do this in the least amount of time. Don't try to explain anything about the set, or what you are doing; this takes considerable time, and you are only delaying the sale.

After I have made the set-up, and have looked it over a second time to make sure all the connections are correct, I bring in immediately the strongest, clearest station first, to satisfy myself that the installation is right. I have made sure from my program that this station is on, before I touch the dials.

When I have done this, the first thing *not to do* is to lecture on the set, or on radio in general. (Of course I will answer questions.) The moment the station comes in clearly, I note the exact dial readings, and turn it off by throwing the dials out of position. Then I tell my prospect the dial numbers, and have *him or her bring the station back in*.

### LET THE DIALS ALONE

Expert dial-twisting has ruined more demonstrations than anything else in the world. I know of one demonstration, and an immediate sale, made on the evening when a famous artist was singing a wonderful selection. The prospects were over middle age, and very fond of this music. The salesman was wise enough to hold the program until it was completed. Very little further demonstration was made, and the sale was completed the same evening. When a station is coming in clear, let the dials alone; juggling them won't improve the program.

Now, by giving my prospect the dial readings for other stations, picking only the clearest and best, and being satisfied with instant response, selectivity, volume and tone, I have demonstrated to him the simplicity of operation and the quality of the radio.

However, it has often happened that the prospect is a DX fan and wants to try the set for distance. In this case, I have to be familiar with the distance possibilities and limitations. Knowing what they are with such an aerial, I go after such DX as I know will come in. I carry it on only long enough to reach the peak of interest and enthusiasm; and do not wait to close my sale until everyone is tired out. It is necessary to start closing my sale when everybody is keenly interested.

### ON THE DOTTED LINE

Let's see what I have done in the way of giving a proper demonstration: I have put the set in place quickly, connected it up and brought in a good clear station, all in a short time. I have showed the prospect and his family that it is simple and easy to bring in stations without squeals, roars and objectionable noises. I have proved that the set has wonderful tone—so natural that

it is like being in the same room—that it is an ideal set for them.

After carrying all the demonstrations through smoothly and quickly, without appearing to be in a hurry, I start to close my sale before everybody begins to yawn—assume that the sale is made—and ask whether this particular model is the one desired. Knowing this is a good time to get down to the details of payment, I state clearly the price of the set. If the prospect hesitates, I remind him that he has been pleased with the demonstration, and knows that he is delighted with his radio, just as well as he will a week later.

I appeal to his pride by stating that not everyone can buy this make of radio; it is owned by people who want the best. Yes, it is the highest-priced; but in a home like this, you don't want anything less wonderful than this receiver.

I never tell the prospect about the easy-payment plan until he indicates his unwillingness to spend the money at once. I then tell him that the cost need be no worry; then go through the detailed plan of down-payment and the agreement form.

I make it a definite rule to *close my sales on the first demonstration*; and for only two prospects have I had to come back another night to demonstrate to both the prospect and her husband. Out of twelve good prospects, I have sold six; so you see *prospects are sales* if the right procedure is used in making the demonstration.

From my experience of salesmanship, and demonstration, there are no hard-and-fast rules governing them. Although for demonstration the procedure remains the same for practically every prospect, the conversation is never the same. It is here that the salesman needs tact and psychology; you have to judge the prospect and size him up by his talk and actions. Be careful and do not crowd the prospect with conversation when numbers are being played; if *he* wants to talk while the program is on, O. K. You can tell *your* story between numbers, and while you are looking up new stations.

Fellow radio salesmen, with all of this in mind, the next time you get out to demonstrate, follow the procedure outlined here from the writer's own experience; and you will find that very few prospects will slip out without a sale.

## Far From the Madding Crowd

(Continued from page 4)

and-ground system for every trial installation, whether the sale is a remotely-probable one or an obviously-closed one. And when he has given this first and all-important detail its deserved attention, he will give the trial outfit a thorough operating scrutiny at his shop before it is placed in the prospect's home. Nothing is such a sales-destroyer as to have to change outfits in the prospect's home because one was not in operating condition. Further-

more, the set should be re-tested in the prospect's home before the initial home-demonstration is given. If the receiving conditions are unfavorable at that time, some sort of postponement should be effected, until the conditions are such as to do the fullest justice to the performance capabilities of the outfit.

The dealer, or his representative, should be on hand at the time the set is first tuned in, to see that the outfit is functioning in the best possible manner; inasmuch as familiarity with the tuning and volume adjustments gauges the quality and quantity of the results.

### EDUCATING THE PROSPECT

Having thus fortified his claims for the merits of the set with the reception of good, clear, and amply-loud signals, the dealer should diplomatically explain to the prospective purchaser that radio programs are carried through space without wires, and that the weather, therefore, has a very direct bearing on receiving conditions (just as power lines and long-distance telephone lines fail in inclement weather); that the radio signs of unsettled weather conditions are static and fading. The dealer may then point out that settled weather conditions will insure radio reception that can be depended upon very nearly as much as the long-distance telephone. This explanation will iron out any subsequent inclinations on the part of the purchaser to lay static and fading to the failure of the outfit.

Next in order is the careful and simple explanation of the tuning operation and general care of the set; as seven persons out of ten *will not bother to understand what is in the book of directions* furnished with the set. And, after insuring that the set is working to the satisfaction of all concerned, the dealer should not leave without assuring the prospective purchaser that a telephone call will bring his assistance whenever desired.

With these assurances of willingness to serve, supplementing the meticulous attention to installational and operational details, the dealer will have launched his proposition on the business highway leading to acceptance.

## Boy Scouts a Big Field for Radio Dealers

(Continued from page 5)

building of radio sets is one of the finest activities for handicraft groups such as meet in the camps. Camps that have amateur radio stations, to keep them in communication with the headquarters in the city and with other camps, are very proud of it.

The scouts should be building sets in the long winter evenings for use in camp later. If one boy in a troop becomes enthused over radio and starts to build a set, there are thirty-one others who are likely to be buying parts in the near future.

(The summer season is now on. What have you found successful in maintaining radio interest in the outdoors?)

## How Do You Rate with Your Banker?

(Continued from page 7)

### BE ON THE DOT

(5) Make it a strict rule to *pay your interest promptly* at your bank, always. Incidentally, take care of all your financial obligations the same way. If a note comes due at your bank and you need the money for a longer time, go to your banker on the day it is due, or a few days before, pay your interest, explain the need of additional time, and ask for a renewal. Don't put this off for one day or two days or ten days after your note is due, thinking all the time you will have the money available to take the note up. See your banker *before* the obligation is due. Banks dislike nothing more than "past due" paper, or borrowers who fail to be prompt in settlement.

(6) Don't make any large purchases, or sign any contracts, or leases, or make any other important move in connection with your business, without first checking it up to your banker. Even if it seems more or less unimportant to you, the banker's viewpoint is valuable; and also, being human, your banker will appreciate the implied confidence or flattery.

(7) A highly important, but often overlooked point is this: be a good collector. Don't be afraid to have your customers pay you what they owe you. Of course, don't overcharge anyone; but be sure to get what money you have coming, when it is due, promptly. *A customer who owes you money will dodge your place of business and pay cash elsewhere.* Also, true to human nature, your customer will imagine his repair job isn't satisfactory as long as he owes you money for it! And another thing: don't be afraid to let your banker know you are a good collector and believe in getting the money—it helps!

### CREDIT MAKES MONEY

I have talked with dealers who said, proudly: "I don't owe anyone in the world a cent, and don't intend to." This is without doubt a commendable spirit, but the actual truth is that such a dealer's future is certainly mighty limited. He will never be able to build up a large-enough business without using his credit, to come anywhere near making him a fortune. If you have so much money all your own that you never need to borrow any, you have no business in the radio trade—why not just live on the interest of your money?

In closing, let me remind you that more than 90% of this country's business is based on credit; don't forget your banker is your best friend; and remember that a credit limit of \$10,000.00 is better than \$10,000.00 actual money in the bank.

(Do you disagree with any of the opinions expressed in this issue? Write in your statement of your viewpoint; it has an equal opportunity to appear here.—MANAGING EDITOR.)

## Taking Radio Out on the Road

(Continued from page 9)

know that in this manner we have derived untold benefit, with direct returns, from the advertising thus obtained.

We find that this method of merchandising the line of radios we handle has been very successful; and we have determined on continuing the policy of sending the automobile show room over our territory at the opening of this season, in order to show our lines.

## Troubles of the Custom Set Trade

(Continued from page 10)

stations on the same frequency channels has caused such heterodyning that DX is impossible except with sharply directional loop-operated receivers, during the normal hours of listening-in. We must remember that the farmer can not stay up until the small hours waiting for some of the stations to clear out so that he can play through with some degree of satisfaction. The poor listener in the Middle West is just "sunk" until the East signs off for the night; because for every Eastern station on a channel, there is a corresponding Western station transmitting and causing a most discouraging whistle. WE KNOW!

### ARE STATIONS TOO FAR APART?

Briefly, the remedy lies in the assigning of more channels, with no two stations transmitting on the same channel simultaneously. To the contrary notwithstanding, stations CAN be placed closer than 10 kc. We have received, night after night, WLIB between KOMO and KSL, without any hang-over whatsoever, also WQJ between KFRC and KFOA, etc.; and we used only an ordinary four-tube receiver to do it. Not only that, but such receptions were the rule rather than the exception prior to Dec. 1, 1927. We have a perfectly blank space between half of the 10 kc. bands, indicating that even 5 kc. separation of stations properly placed geographically is not impossible. At least, it would be no worse than at present.

When the question between the relative merits of the custom and factory set arises, it will be found that it is efficiency of the R.F. end in the former against the efficiency of the A.F. end in the latter, in the matter of pulling DX, that decides the prospective purchaser. So, the parts manufacturers, with the exception of those specializing in A.F. amplification and reproduction, are doomed to the rockpile; inasmuch as DX signals show up to advantage on the efficient R.F. end only, and without DX there will be no showing, nor will there be any more custom-set building as we know it today. As for price competition, the factory sets have it all, by force of mass

production, but they *can't* get efficiency in their R.F. amplifier per stage (as compared to custom-sets built by men who know their mmfs.) under the mass production that gives them the price edge.

It remains to the parts manufacturers as a whole, if they wish to preserve their largest and most profitable market, to bring pressure to bear in the right direction, toward fostering the confirmed dial-twisters' ambitions to get all the DX on the air without staying up all night to do it. It will also behoove them, as far as the professional set builder is concerned, to put less "fancy fixings" and more "efficiency" in their products, with corresponding lower prices; there is no rhyme or reason in prices that prevent the *professional* from meeting factory-set competition with the existing conditions regarding satisfactory DX reception.

On the other hand, the professional set-builder trade needs organization; because so many of them are poor merchandisers and scare away more trade than they attract by failure to observe a few common rules of the road. One of these rules is co-operation with other set builders, whereby the prospective customer can be supplied with exactly the kind of receiver that meets his requirements. There is much to be done along this line alone, and we nominate RADIO NEWS as chairman.

By the way, we might say that the DX fan and custom-set builder would appreciate some sort of action that will *compel* non-announcing radio announcers to give the station call letters and location between *every* number, and to begin and end *every* announcement with the call and location. As it is, we have to stand by as much as fifteen minutes to hear Quinn Ryan say "WGN" sandwiched in with a lot of hooey that no one cares to hear. To make matters worse, Mr. Ryan even seems to be *ashamed* to give the call letters, and especially "Chicago." We have written him to that effect.

For every station whose announcer really announces, we have fifty (conservative estimate) whose announcers, to say the least, are extremely lax on the matter of call letters and location. They seem to think that their waves are grounded completely at fifty miles, or maybe the powers have at last convinced them that DX is no more! Maybe they are getting paid for *not* announcing! (See above)

Now about RADIO NEWS, we have been hearing a criticism that may be here worth repeating, coming, as it does, from radio men of some prominence, and that is that RADIO NEWS "is always full of circuits that look well on paper but don't work out in practice." How true this may be is something we can not decide; but we do know that many experimenters are in the habit of haywiring test circuits with 5 & 10 parts and expecting them to function right off the bat. On the other hand, many circuits do not include proper data, leaving much to be guessed at. At least, we have always had a kindly feeling for RADIO NEWS, since away back in 1919; possibly be-

cause we have believed that magazine to be less influenced by Big Business.

Much can be done by some magazine that will treat the situation in detail and spare the whitewash. However, we are not of the mind to see anyone do something that we would not do ourselves; because there is every possibility that such action by a magazine depending largely upon Big Business advertising would result in curtailment of that advertising, or at least some of it.

But, as you have pointed out, the confidence of your readers is just as valuable, if not more so; and, although many of the so-called "radio dealers" tied up closely to Big Business will put a black mark after the name of a magazine with such an out-and-out policy, the increased popularity in the ranks of the custom-set builders, together with the satisfaction of backing such a just cause, will more than make up the deficiency.

We are sure that you would be surprised at the response obtainable from real honest-to-goodness custom-set builders, on anything bearing directly upon the actual cause of that thing tending to destroy their main talking point, and therefore their livelihood.

And we further believe that the parts manufacturers will co-operate to the extent of giving you more advertising, and by putting out quality merchandise without the "fixings," and at lower prices direct to the custom trade.

*(It is the belief of RADIO NEWS that radio must be learned from the beginning; that the simple pictorial illustration arouses interest in those who would be repelled by the more formidable and involved diagrams which are easy to the expert; and that the non-professional set builder is a good prospect for the best manufactured product the market can afford, as he will appreciate it better after he has worked with his own hands to obtain results and developed a taste for DX with his own outfit. If our contributing editors believe this to be an unsound theory, we shall be glad to know it. To every practical proposition for the betterment of trade conditions, in all their branches, we are glad to lend what aid we may. As a first step, the DEALERS PERSONAL EDITION has been established as a medium through which every honest opinion by those who are in touch with the needs of the hour, can find uncensored expression.—MANAGING EDITOR.)*

## What They Do To Me

(Continued from page 11)

are not above asking for a home demonstration of one set after another, just to keep a set in the house a week or two until they are ready to buy.

It was bad enough when all sets worked on batteries or eliminators and all had two or three dials. Now they want to try everything from a three-dial battery set to a single-dial electric set before making up their minds. There is no use of explaining to a prospect that all these demonstrations cost us money; that only sends him to a

competitor. And there is no chance of adding anything to the list price after advertising free demonstrations.

But, while we have our troubles with manufacturers and customers, radio is going pretty well on the whole. If Dempsey and Tunney would fight once a week, and the football season last from October to April, and the World Series the rest of the year, we could sell quite a few sets in my territory.

## Why I Am Getting Out of Radio

(Continued from page 12)

ence in cutting prices to close out my stock of radio sets indicates that it is not always the best method. A lady looked at my sets and seemed interested in the saving that I offered her. Then she went out of town and bought a set exactly the same as I offered her—and paid the full list price! The same people who kick because they believe the prices of merchandise too high are often the first to harbor suspicion and distrust against a new and perfect article that is offered at a radical reduction.

I have nothing against radio. It is a marvelous invention and the results that I secure in my own home are good enough, on the average, to justify my owning and using a good set. I listen in daily and will continue to enjoy radio. But, in my opinion, it is not a line to carry in a specialty shop in a small town where local radio dealers and those from neighboring cities can cover the field to better advantage.

## Service Salesmanship

(Continued from page 13)

*rattle of editorial pens being taken from retail penracks to tell of the afflictions which the dealers have unsuspectingly passed on to friends who soon passed out of that category. The next mail will tell.) Yet some and, we hope, many shrewd and sophisticated dealers have been able to identify themselves with their customers' interests without impairing their own. What have you to say about this, Mr. Dealer-Editor?*

## Installment Selling

(Continued from page 15)

Of course if strong discounts were offered the public for paying cash, it might be possible to create considerable cash business; but this would involve danger to the radio business as a whole. Offering that extra discount will convince the public that radio prices are artificially held above their true level; and they will be more than ever inclined "to fall for bargain sales" and distant mail-order merchandise.

The only permanent solution, it seems to me, lies in an intensive application of in-

stallment selling methods, but always according to well-defined principles. If necessary to take a small down payment, plenty of good references should be required. If a dealer belongs to a Merchants Association, he should use its facilities constantly to "get a line on" people. The contract should be so written that the dealer can repossess his set if the customer becomes delinquent, and still be able to sue for back rental on the set. Some customers will let a set return if they know they can not be sued for back rental. Otherwise they will be more inclined to maintain their set in good condition and, incidentally, keep up their payments.

Whether or not a dealer knows, or thinks he knows, a customer is sure pay, he should mail a reminder a week before due date of the next payment. A circular on some radio or electrical specialty should also be enclosed. Overdue accounts should be promptly, persistently, but politely dunned.

## Quick Testing Apparatus

(Continued from page 17)

ment cases, by putting a new panel on top and mounting the instruments in it. A hundred dollars will take care of all meters and parts for average use; and anyone can use them. A good 0-10 voltmeter and a good 0-150 D. C. voltmeter are used in one IIIA box for testing all transformers and practically all wires except tuning controls, in 99 cases out of 100, through the tube sockets, with the set hooked up ready to run. How many of you have found that, on hooking up the set, a 0-150 voltmeter between the "P" and "G" of any tube socket tests the primary of one and the secondary of another transformer, whether R.F. or A.F., and also all grid resistors, chokes, "B" supply and lead wires? (This is not true of the detector of course, unless the grid condenser is shorted by a piece of wire.)

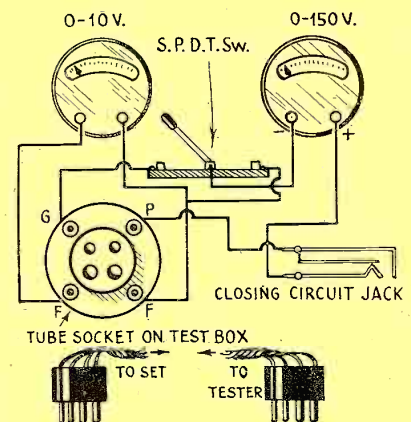

Diagram of Mr. Harden's set tester, described below.

The 0-10 voltmeter is connected across the filament prongs of the socket for testing the "A" supply and all connecting apparatus. Use a four-wire cable from the test box to an old tube base, and all the test

(Continued on page 23)

## Radio News Dealers Personal Edition Service Sheet No. 2

## Freshman Equaphase, "Model G"

110-volt A.C. Operated

Manufacturer: Chas. Freshman Co., Inc., New York City

THE "MODEL G" receiver illustrated below is a six-tube tuned-radio-frequency set with three tuned R. F. stages, stabilized by the Freshman "Equaphase" system, the circuit of which will be seen in the schematic diagram on the following page;

a non-regenerative detector and two stages of transformer-coupled A. F. amplification. It is operated directly from 105- to 120-volt house-lighting current, through the Freshman "G-60-S" power-supply unit, the connections of which are also shown. The grid returns of the receiver are grounded to the metal frame, and its filament circuits, therefore, are kept floating at "—" potentials, sufficient to maintain the required grid bias in each circuit.

For testing the set, suitable meters are desirable; a 0-50- and 0-250-volt D. C. voltmeter and a 5-volt A.C. voltmeter. When the set has been connected to the power-supply unit, and has been turned on until the tubes reach their normal operating temperature (which requires about 45 seconds) the following D. C. voltages should be measured between the terminals of the power-supply unit (see diagram of leads on next page):

Between 10 and 9; 225 volts—plate plus grid voltage on 171 power tube.

Between 10 and 8; 140 volts—plate plus grid voltage on amplifier tubes.

Between 10 and 7; 50 volts—detector plate voltage.

Between 10 and 5 or 6; 40 volts—power tube "C" voltage.

Between 10 and 3 or 4; no voltage.

Between 10 and 1 or 2; 7 volts—amplifier grid voltage.

The A. C. voltmeter should show the following filament voltages across these pairs: 1 and 2, 1.35 to 1.65 volts; 3 and 4, 2.25 to 2.75 volts; 5 and 6; 4.7 to 5.0 volts. If any of these voltages are found to vary appreciably from the normal above, the set should be turned off at once.

The fault may be in the receiver or in the power unit; if a spare one of either be available, a substitution will at once narrow down the problem of finding it.

When the power-supply unit is disconnected from the receiver, the D.C. voltages

relation occurs. The screws should then be tightened back about a quarter of a turn each.

To test for short circuit one of these condensers (which is connected across a center-tapped resistor and the R. F. primary) it is necessary to unsolder one lead.

The "Model G" is designed for use with an outdoor aerial, with a length of between 75 and 125 feet, including the lead-in. When an indoor aerial is used, it should consist of from 50 to 75 feet of insulated D.C.C. wire.

The two aerial connections are designed to compensate for the characteristics of the aerial used, and that one which gives best results should be used.

In the "G" models, except "G-3", the opening and closing of the door turns on and off the power from the supply unit; in the "G-3," it is operated manually from

the front of the unit. The switch is provided with three operating positions, in addition to the "off" and should be adjusted to the lowest one which gives satisfactory reception; this is to compensate for the variations in line voltage which may be encountered in different communities. Once the adjustment has been made, it is not necessary to alter this.

The fundamental receiver circuits of the Equaphase receivers are the same; the differences in different models are due to the nature of the filament current supply. The "Model F" is battery-operated, with the conventional "C" batteries, or with battery and a "B and C" power unit; or with an "A, B, and C" unit. It has a UX-200A detector tube and a UX-171 in the second A. F. stage in which a UX-112 is optional. The "Model G" is designed with the power-supply unit shown, in some cases with one choke coil and two condensers in the "B" supply filter: the "Model K" for 110- to 115-volt supply only, with the "K-60-S" power unit; and the "Model L," for use with 105- to 120-volt D. C. supply only.

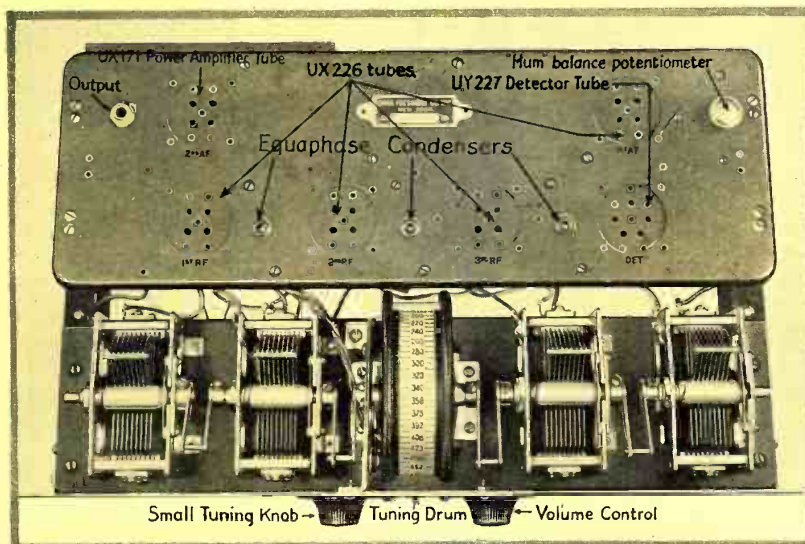

View from above of the chassis of the "Model G" Equaphase, an electric set. It differs in appearance from the previous "Model F," battery-operated, in having a five-prong Y-type socket (at the right) for the detector tube. The Equaphase condensers, in this as in previous models, are adjusted with a screwdriver through the three eyelet holes indicated by arrows.

at the unit terminals should be as follows:

Between 10 and 9, the needle should go off the 250-volt scale; between 10 and 8, 225 volts should register; between 10 and 7, 100 volts. If the voltages are all low, a defective rectifier tube or transformer is to be suspected; if they are zero, an open choke coil or a shorted filter condenser. If voltage 10 to 9 is high, the resistor R3 (1800-ohm) or its wiring leads are probably open; if 10 to 9 and 10 to 8 are high, 10 to 7 zero, a broken resistor, or open circuit to No. 7 binding post or second resistor tap is to be looked for.

Tests on the receiver may be made as described on the following page.

## THE EQUAPHASE CIRCUITS

Adjustment of the Equaphase condensers, to prevent oscillation of the receiver, is made through the three eyelets shown in the illustration on this page, by means of a narrow-bladed screwdriver. To restore their adjustment, these should be tightened as far as they will go, and then loosened equally by a half-turn at a time of each, until oscil-

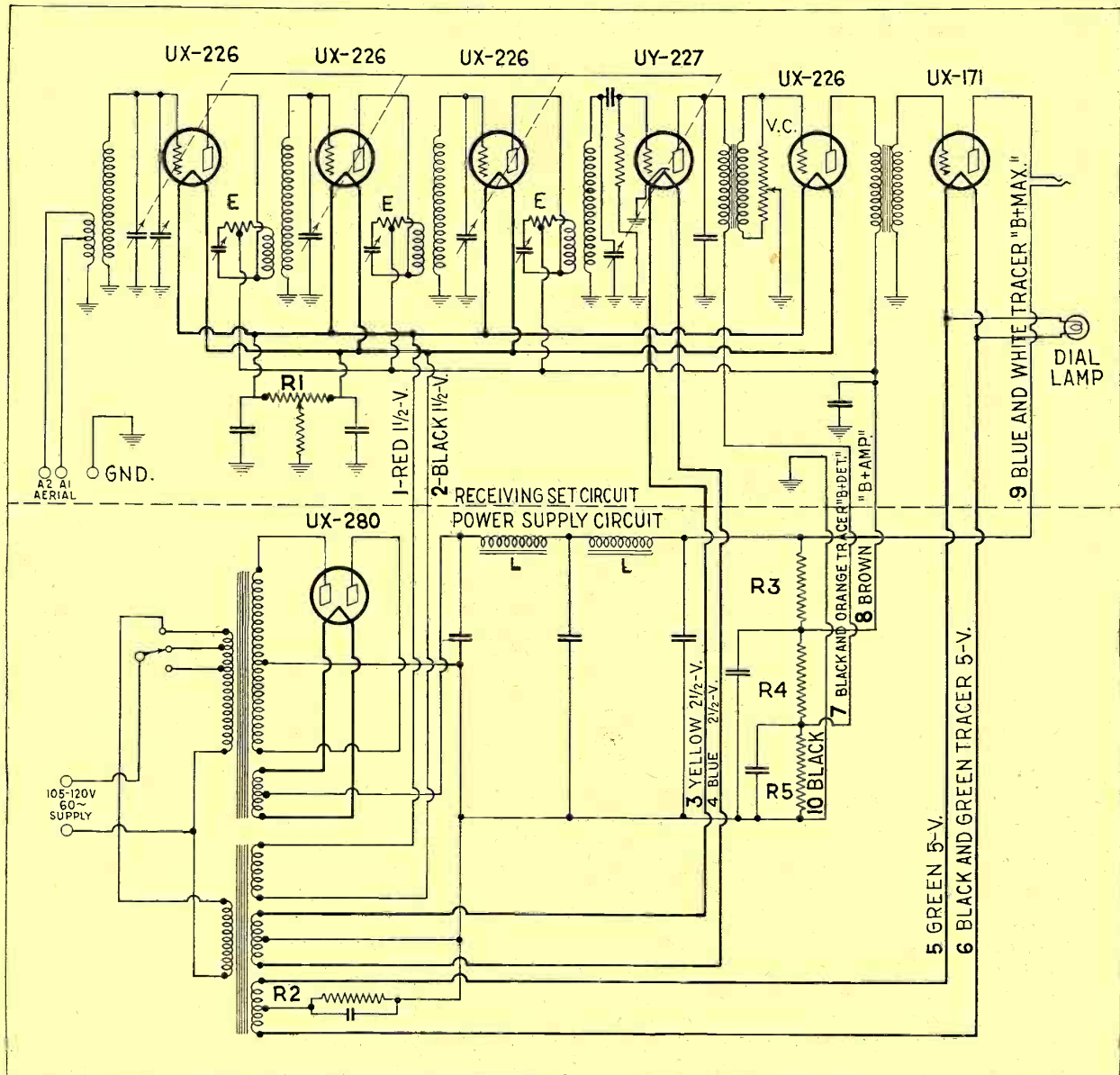

Circuits of the Freshman "Model G" Equaphase and the "Model G-60-S" Power Supply Unit.

## Circuit Tests

Terminal voltage tests may be made upon this set, in connection with a power-supply unit, as follows. The power unit itself must be in good operating condition; then, when the voltage available at the unit terminals is unduly increased, it is evident that the resistances of the plate circuits have been increased—as by increased grid bias—or circuits have been opened. Conversely, a fall of voltage at the power unit terminal indicates grid bias too low, or shorts in the plate circuits. Measurements between the terminals of the unit, while the set is drawing full current, may indicate the following defects:

Between terminals 10 and 2, grid voltage zero or low (normal 7); and between 10 and 8, plate voltage also low (normal 140) "C" biasing resistor R1 is shorted, or the filament leads of the 226 amplifier tubes (from terminals 1 and 2) are grounded.

If the grid voltage is high and plate voltage high between the same pairs of terminals, the resistor R1 or its lead, or the amplifier circuit from No. 8 lead is open.

Between 10 and 5; power-tube grid voltage low (normal 40); between 10 and 9 voltage low ("B+Max.")—Normal 225). The filament wiring (from terminals 5 and 6) of the power tube, or the dial lamp in that circuit, is grounded.

If the same grid voltage is low, but the plate voltage is high at No. 9 terminal, the No. 9

lead in the set, plate connection of the 171 tube, or the telephone jack connection is open.

If all plate voltages (10 to 9, 10 to 8, 10 to 7) are low, the No. 9 lead in the set ("B+Max" lead to 171 tube) or the telephone jack or else No. 8 lead ("B+AMP.") is presumably grounded. (Detector voltage normally 50.)

### TESTS ON THE RECEIVER

Continuity tests may then be applied as indicated below, with a battery and meter, or phones. With the power unit disconnected, the following terminals on the receiver are tried:

With one contact made to No. 8 lead on the set, the plate prongs of the three R.F. tubes are successively touched. An open circuit in any case indicates a break in the plate wiring, R.F. transformer primary or "Equaphase" resistor in that stage. An open circuit to the plate prong of the first A.F. tube indicates open plate wiring or a break in the second A.F. transformer primary.

From the No. 7 lead of the set to the detector plate prong an open circuit indicates open plate wiring or a break in the first A.F. transformer primary.

From the No. 9 lead of the set to the 171 plate prong an open circuit indicates open plate wiring or an open connection at the telephone jack.

From the No. 10 lead, which is grounded, to the grid prong of each tube (except the detector) an open circuit indicates an open grid lead or a defect in the transformer just ahead of the tube.

From the No. 10 lead there should not be a circuit to either 3 and 4, or 5 and 6 leads. The completion of the circuit indicates that the detector or the power-tube filament wiring, respectively, is grounded.

### SETTING THE CONDENSERS

To readjust the tuning condensers, should they have been put out of alignment, it is necessary to loosen very slightly the left-hand setscrew on each one, except that at the extreme left (antenna circuit), so that the rotors may be moved, but will not fall of their own weight. A faint broadcast signal, in the center of the band (about 300 meters) should be tuned in, or a signal obtained from an oscillator. The condensers are then adjusted until it is evident that the maximum intensity of signal has been obtained, and then locked. The left-hand condenser should be locked in position so that its plates are in mesh at the same time with those of its neighbors. As this condenser is compensated by the small vernier at the left of the tuning drum, its setting is not critical like the others.



## Quick Testing Apparatus

(Continued from page 20)

readings can be taken at the same time. Get out a diagram of any set—superhets included—and you will find that, except in rare instances, this will work. Two men in our shop are turning out a complete repair job every thirty minutes with this and a few other simple instruments; and in a thousand cases the above test failed but once.

It tests the grid condenser also for shorts, as a reading should not be shown here until the condenser is bridged with a jumper. Even the speaker has to be O. K. before a reading is obtained in the last audio socket.

To find whether it is the primary or the secondary that is defective, we have arranged a S. P. D. T. switch which, in one position, connects the “—” side of the 0-150 voltmeter to one filament, thereby testing the primary; while in the other it connects the same side of the meter to the grid prong, thereby testing the secondary. A jack may be inserted in the plate-to-meter “+” lead, so that a set of phones may be plugged in to detect a noisy transformer. A slight change in cable design will allow this to be used in the detector socket of the new electric sets.

### ARRANGEMENT OF THE BENCH

You will be astonished at the impression this test box makes on your customer when you step up to his set and test, not only the “B” battery, but the “A” and all the wiring through the tube sockets in less than five minutes. We have found also that any number of sets may be connected to the same “A” and “B” supply. To do this, place several complete sets of binding posts at the back of your test bench. Place a 1-mf. by-pass condenser in series with each ground post and the common ground. Connect “A—” and “B—” together at the batteries, and leave “B—” post on the board blank. There is thus no chance for error this way; as you merely fasten your set “B—” wire to a dead post, the actual connection having been already made at the battery. The reason for this is to keep from short-circuiting the “A” battery, as you will find if you attempt to employ other methods for this arrangement.

The aerial may be connected to a selector switch, so that it may be thrown to any test panel. A 0-50 milliammeter with a 10-watt 110-volt bulb in series may be inserted in the lead that connects the “A” and “B” together. This is optional; but the arrangement is quite handy; as the “B” current drain of the set on test is always in plain view and, in case of a bad by-pass condenser, the 10-watt bulb lights.

### A PICK-UP AND OSCILLATOR

Practically every dealer has some form of modulated oscillator; but the general run of them make a noise so much like set trouble that it is difficult to pass a set as O. K. without waiting for a station to come

in. A good way to overcome this is to construct an oscillator on the principle of a small broadcast station and fit it into the lower compartment of a small phonograph; thus making it entirely portable. This may be modulated from the phonograph with an electric pick-up, which is also arranged to plug into the detector socket of any set for testing the audio end of the set and, incidentally, giving the speaker an operating test. Three 199-type tubes and ten dollars' worth of junk will make the oscillator.

If enough inquiries warrant, detailed drawings can be furnished to the DEALERS PERSONAL EDITION for any or all of this apparatus. I believe that it would be a revelation to most dealers to have a page a month devoted to service methods and practice; and then give the manufacturers a boost toward a parts price list, so that a new part might be systematically ordered and not guessed at. The manufacturers might furnish several good diagrams, also, for test equipment. Lets improve the service and watch the sales increase.

## New Servicing Equipment

(Continued from page 17)

in receiving sets, which are only approximate in their accuracy.

The high-reading A.C. voltmeter (upper left) is for the purpose of measuring accurately line voltages, the variation in which is often reflected in unsatisfactory operation of electric power devices in localities where the voltage regulation is poor or the lines are long and overloaded.

The low-reading A.C. voltmeter (upper right) has two ranges, from 0 to 3 volts for A.C. tubes of the 226 and 227 types, and from 0 to 15 meters for the power tubes, and other makes of A.C. tubes which require a voltage, in some cases as high as 15, for their filaments.

### AUTOMATIC CONNECTIONS

The lower meter, a D.C. instrument, has six scales, readings on which are controlled by eight push buttons; so that it is not necessary to change connections while testing

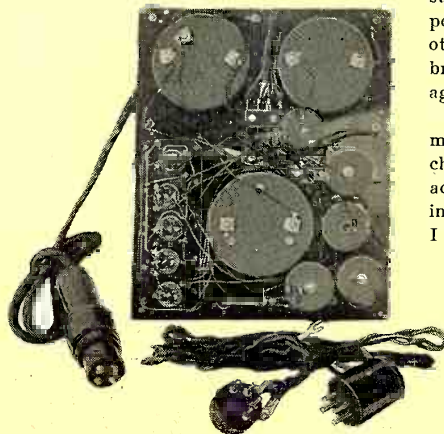

the voltages at the empty socket in the set, or at the tube itself, which for this purpose is inserted in the test socket on the panel of the analyzer. The scales of this meter give milliamper readings from 0 to 10 and 0 to 100—ample for the output of any “B” power unit, or for the plate current of the largest power tubes; the voltage readings are 0 to 10, 0 to 50, 0 to 100 and 0 to 500; which are also adequate, with any receiver made, for its filament, plate and grid readings, as well as for its power supply.

The ten binding posts permit connections to be made to any light line, power unit, battery, or any electrical device it is desired to test; tube and socket connections are made automatically without them as mentioned above. Adapters for all standard tube bases, including those of the new A.C. tubes, are provided with flexible cords, as well as contact lugs for attachment to the binding posts. These are carried in the small compartment above the instruments. The instrument may well be characterized as a portable radio laboratory; and, as such, would be complete equipment for the experimenter; but it has been designed and built with a special view to dealers' service work, the time and labor of which is reduced to the minimum by its numerous automatic connections. It is supplied with service charts for many standard receivers, and record sheets for set analyses, which not only make it a matter of certainty what needs adjustment or replacement, but will facilitate future service work on the same sets by comparison. A copy of his set's examination sheet may be given to the set owner, as a certificate of the condition of his set, as well as an evidence of the thoroughness of the service test, and the scientific method of its application. The set analyzer illustrated is Pattern 137, manufactured by the Jewell Electrical Instrument Co., Chicago, Ill.

## Time-Signal Service

DEALERS PERSONAL EDITION:  
Gentlemen—

I believe that you can sound a helpful note to the various electric and clock companies who broadcast time signals over such stations as WLIT, KDKA, and especially the smaller stations. Each noon we check our jewelry-store chronometer by station NAA. A minute after noon it is possible to receive “accurate time” from other stations; but I always find that these broadcasters are about forty seconds in disagreement with Naval Observatory time.

It seems to me that it would be a simple matter for the station to tune in NAA, check its chronometer, and then send really accurate time over the air. This broadcasting of incorrect time by clock companies, I think, is rather poor advertising policy.

H. A. SLATER,  
P. O. Box 343, Vineland, N. J.

View of the rear of the instrument panel of the set analyzer. The shunt resistors controlled by the push buttons are in the tubes at the left.

# The Distributor Issues A DECLARATION OF INDEPENDENCE

By W. A. WHITE  
Manager Automotive & Radio Dept.  
Orr Iron Company  
Evansville, Indiana

**W**E do not do such a whale of a big business; but it runs in the one hundred thousands for this small community and we think that is pretty fair.

We have found a good many dealers who have some peculiar ideas as to what is right and what is not right in handling radio as far as service is concerned. Personally, I have contacted possibly fifty in the last six weeks who have made this remark, "We didn't have time to fool with the set

*The customer and the dealer can quickly agree to put service troubles up to the distributor. The latter feels at once that he is "goat"; what will he do about it? One answer is given below.*

to find out what was the matter with it; so we sent it back to the distributor for him to fix." That is exactly what has caused us to adopt a radio policy, copy of which appears below; and we are wondering if it would be possible, with improvements possibly as to its general set-up, that some

**"PASSING THE BUCK"** is sometimes called, for a change, "the old army game"; for reasons which will at once occur to a large number of our readers who have reached the years of twenty-eight and upwards. It might also be called the "radio game"; for reasons equally apparent to those in the trade. This article is self-explanatory. Millions of radio sets are sold to those who do not understand their proper care; and the resulting complications leave a burden to be distributed between the parties in interest, from the sometimes innocent and often ignorant customer up to the manufacturer. This article will be read with mingled feelings by all except the customer, to whom this Edition does not go.



Mr. White's picture has a genial and carefree look which contrasts strangely with his tale of trouble; but he informs us it was taken in 1920, which explains the mystery.

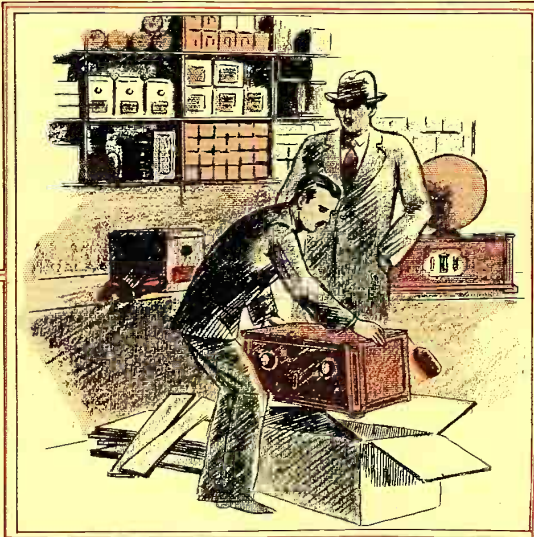

### A RADIO POLICY

Radio is sold by the distributor on such a short margin of profit that it is necessary to make certain policy rules as set out in the following articles:

1. Radio when shipped to a dealer is *not* subject to return for credit or exchange under any circumstances.
2. The manufacturers guarantee their radio against defects in material and workmanship and all defects along these lines will be adjusted by the factory subject to a charge for transportation to and from factory on all such equipment, allowing from ten days to two weeks for such adjustment.
3. Tubes are subject to adjustment only upon return to us to be sent to the manufacturer and only on manufacturer's adjustment with us. It takes from two to four weeks for all tube adjustments.
4. All radio sets, speakers, tubes and other equipment sent to us for adjustment or repair must come to us transportation charges prepaid.
5. Minimum charges on equipment which has to be sent by us to factory will be charged to customer on the following basis:
 

A. C. Radio Sets in Table Cabinet	\$2.00
A. C. Radio Sets — Converters not included	1.50
A. C. Radio Converters	1.00
D. C. Radio Sets	1.50
Speakers	.75
Tubes, each	.10

publicity be given it by the trade journals—so that the dealer would recognize his responsibility and the distributor take care of his responsibility. In this manner, those responsible for the ultimate owner receiving what he pays for would handle the business on the basis where it would be profitable.

### BUSINESS MUST BE PROFITABLE

If we did all the things the average dealer asked us to do, we would not make enough to interest us in the radio department. Every distributor and manufacturer and, in fact, the dealer is pretty well posted on what the average distributor's spread is on the wholesale volume; and a survey of the industries of the United States indicates that the net between the cost of doing bus-

iness and the gross margin of profit is mighty slim on this particularly sensitive business.

We are interested in the radio dealer's welfare and, if the radio dealer is not interested in himself to the point of looking after the service, we don't see what in the world the distributor is going to do; when 90% of the claims made against us are through no fault of the equipment but due to carelessness on the part of either the dealer or the owner.

### SUGGESTIONS ARE DESIRED

This is a long-winded article; but this is a long-winded subject and it might be a good idea to give it whatever you can in the way of publicity.

If you don't think it is worth that publicity, we suppose the waste basket is just as handy to you as it is to us. In any event, we would like to do something for the good of the cause; but we don't know what we want to do nor how to do it.

*(Our readers will undoubtedly supply several criticisms of this outspoken article and the declaration of policy which accompanies it. Before you undertake to sum up the subject in a few well-chosen words, carefully consider the situation as you know it, and endeavor to suggest what will in your opinion be the most constructive solution from all standpoints. Service problems must arise so long as radio receivers are what they are, and customers are what they are; and for the health and long life of the radio business, they must be solved in a manner to satisfy the customer who pays the ultimate bills, as well as the trade which shares the proceeds.)*



# EARN \$75<sup>00</sup> a week — in Your Spare Time

**J**OINING the Radio Association enables you to cash in on Radio *now!* Follow its success-proven plans and you can earn \$3 an hour, in your spare time, from the very first. Over \$600,000,000 is being spent yearly for sets, supplies, service. You can get your share of this business and, at the same time, fit yourself for the big-pay opportunities in Radio.

### Founded on a New Idea

Members of the Association do not wait for months before they make money out of Radio. Without quitting their jobs, our members are earning \$25 to \$75 a week spare time by building "tailored" radio sets, serving as "radio doctors," selling ready built sets and accessories, or following one of the many profit-making plans of the Association.

### Earned \$500 in Spare Hours

Hundreds earn \$3 an hour as "radio doctors." Lyle Follick, Lansing, Mich., has already made \$500 in spare time. Werner Eichler, Rochester, N. Y., is earning \$50 a week for spare time. F. J. Buckley, Sedalia, Mo., is earning as much in spare time as he receives from his employer.

*We will start you in business.* Our cooperative plan gives the ambitious man his opportunity to establish himself. Many have followed this plan and established radio stores. Membership in the Association has increased the salaries of many. Scores are now connected with big radio organizations. Others have prosperous stores.

A year ago Claude De Grave knew nothing about Radio. Today he is on the staff of a famous radio manufacturer and an associate member of the Institute of Radio Engineers. He attributes his success to joining the Association. His income now is 350% more than when he joined.

### Doubled Income in Six Months

"I attribute my success entirely to the Radio Association," writes W. E. Thon, Chicago, who was clerk in a hardware store before joining. We helped him secure the managership of a large store at a 220% increased salary.

"In 1922 I was a clerk," writes K. O. Benzing, McGregor, Ia., "when I enrolled. Since then I have built hundreds of sets—from 1-tube Regenerative to Superheterodynes. I am now operating my own store and my income is 200% greater than when I joined the Association. My entire success is due to the splendid help it gave."

### Easiest Way Into Radio

If ambitious to become a Radio Engineer, to fit yourself for the \$3,000 to \$10,000 opportunities in Radio, join the Association. It gives you a comprehensive, practical and theoretical training and the benefit of our Employment Service. You earn while you learn. You have the privilege of buying radio supplies at wholesale. You have the Association behind you in carrying out your ambitions.

### What a Membership Can Do for You

- 1—Enable you to earn \$3 an hour upwards in your spare time.
- 2—Train you to install, repair and build all kinds of sets.
- 3—Start you in business without capital, or finance an invention.
- 4—Train you for the \$3,000 to \$10,000 big-pay radio positions.
- 5—Help secure a better position at bigger pay for you.
- 6—Give you the backing of the Radio Association.

**A MEMBERSHIP NEED NOT COST YOU A SINGLE CENT**

### ACT NOW—if you wish Special Membership Plan

To a limited number of ambitious men, we will give Special Memberships that may not—need not—cost you a cent. To secure one, write today. We will send you details and also our book, "Your Opportunity in the Radio Industry." It will open your eyes to the money-making possibilities of Radio. Write today.

RADIO ASSOCIATION OF AMERICA,  
4513 Ravenswood Ave.,  
Chicago, Ill. Dept. RN-5

Gentlemen:  
Please send me by return mail full details of your Special Membership Plan and also copy of your book, "Your Opportunity in the Radio Industry."

Name.....

Address.....

City..... State.....

# RADIO NEWS

Published by EXPERIMENTER PUBLISHING COMPANY, Inc., Publishers of "Radio News," "Science and Invention," "Radio Listeners' Guide," "Amazing Stories" and "French Humor."

H. GERNSBACK, President S. GERNSBACK, Treasurer C. E. ROSENFELT, Secretary  
Member: Audit Bureau of Circulations Radio Magazine Publishers Association  
Editorial and General Offices . . . 230 Fifth Avenue, New York City

VOLUME 9

MAY, 1928

NUMBER 11

## Contents of This Issue:

A New Radio Cycle, By Hugo Gernsback	1201	Seeing Across the Atlantic Ocean! By A. Dinsdale	1232
Coming—A Program Pool? By Charles Magee Adams	1202	Regeneration—What It Is and What It Does, By Fred H. Canfield	1234
High-Frequency Magic in the Radio Laboratory, By Knox Baxter	1204	R.F. "Booster Unit" Improves DX Results, By David Grimes	1236
"Folks, Meet 'Mike,'" By C. W. Palmer	1206	A Motor Operated by Radio or Static from the Air, By S. R. Winters	1240
The Listener Speaks, A World-Wide Election by Radio News Readers,	1208	From Paul Revere to Paul Whiteman, By Charles Strayer	1241
Favorite Broadcast Artists, How Broadcast Programs Reach Broadcast Stations, By G. C. B. Rowe	1209	A New System of Radio-Frequency Amplification, By Arthur T. Brown	1242
In the Bright Darkness, By C. Sterling Gleason	1214	A New Receiving-Set Combination—The Neutroheterodyne, By Herbert J. Reich	1244
Broadcastatics, Listener Psychology and Radio Reception, By Charles Magee Adams	1216	How to Build a Dynamic Speaker, By Edgar C. Nichols	1246
The Eveready Hour, By Julia V. Shawell	1218	Suggestions for Power-Amplifier Current Supply,	1247
Around the World by Radio, List of Broadcast Station Calls, A Britisher Chats on Radio, By E. Blake	1221	Building a Linen-Diaphragm Loud Speaker, By John M. Thompson	1248
Radio in a School Teaches Thrift to Its Pupils, Radio Polices a Western City, By J. E. Squires	1222	Producing R. F. Oscillations with a Buzzer, By Emil Reisman	1249
What's New in Radio The Radio Beginner—A Simple, "Extension" Two-Tube Set, Television—Quartz Crystals Control Television Apparatus, By H. Winfield Secor	1223	Letters from Home Radio Constructors,	1250
	1224	Radio News Laboratories,	1252
	1228	Radiotics,	1254
	1230	I Want to Know, By C. W. Palmer	1255
		Editorial Policy Ballot,	1275
		"Television," By Viva Snow	1275
		Compensating Line-Voltage Variations in an Electric Set's Power Supply,	1280

## In Forthcoming Issues:

**THE "RADIO GUN"**  
Scientists have demonstrated the lethal powers of extremely short wavelengths. The "Radio Gun" is envisioned as the military weapon of the future.

**THE NEUTROHETERODYNE**  
Complete constructional data on the interesting receiver described briefly in this number. Full-size working blueprints of this set will be available free of charge to all readers.

**HOW TO LISTEN TO RADIO PROGRAMS**  
Some sound and practical advice on operating your radio receiver so as to obtain the most satisfactory musical performance from it.

RADIO NEWS is published on the 10th of each preceding month. There are 12 numbers per year. Subscription price is \$2.50 a year in U. S. and possessions. Canada and foreign countries, \$3.00 per year. U. S. Coin as well as U. S. Stamps accepted (no foreign coins or stamps). Single copies, 25 cents each. Checks and money orders should be drawn to order of EXPERIMENTER PUBLISHING CO., INC.

All communications and contributions to this journal should be addressed to Editor, RADIO NEWS, 230 Fifth Ave., New York, N. Y. Unaccepted contributions cannot be returned unless full postage has been included. All accepted contributions are paid for on publication. A special rate is paid for novel experiments; good photographs accompanying them are highly desirable. RADIO NEWS, Monthly. Entered as second-class matter, July 12, 1924, at the Post Office at New York, N. Y., under the Act of March 3, 1879. Additional entry at Dunellen, N. J. and San Francisco, Calif. Title registered U. S. Patent Office. Copyright, 1928, by The Experimenter Publishing Co., Inc., 230 Fifth Ave., New York. The contents of this magazine are copyrighted and must not be reproduced in the United States without giving full credit to the publication. Translation into foreign languages must not be made unless permission is obtained from the publishers. Copyrighted in Germany. Reproduction of articles in Germany is reserved for Radio, Berlin 42.

The contents of RADIO NEWS are indexed in the Industrial Arts Index, copies of which can be found in every library.

General Advertising Dept., 230 Fifth Avenue, New York City

### ADVERTISING REPRESENTATIVES

HARRY F. HYDE, 548 Drexel Building, Philadelphia, Pa.  
L. F. McCLURE, 720 Cass Street, Chicago, Ill.  
DAVIES & DILLON, 15 West 10th St., Kansas City, Mo.

RADIO NEWS is for sale at all newsstands in the United States and Canada, and at Brentano's, Ave. de L'Opera, Paris, France. European agents: S. J. Wise Et Cie, 40 Place Verte, Antwerp, Belgium.

**HOW TO SUBSCRIBE FOR RADIO NEWS.** Send your name, address and remittance to Experimenter Publishing Co., 230 Fifth Ave., New York. Mention the name of the magazine you are ordering. We also publish SCIENCE AND INVENTION, RADIO LISTENERS' GUIDE, AMAZING STORIES and FRENCH HUMOR. Write clearly.

**RATES AND TERMS.** The subscription rate for RADIO NEWS is \$2.50 per year. (12 numbers). When remitting do so by check, money order, or registered letter if cash is enclosed. Avoid sending cash through the mail if possible. Subscriptions for less than one year are not accepted. Subscription may be made in combination with SCIENCE & INVENTION, RADIO LISTENERS' GUIDE, AMAZING STORIES and FRENCH HUMOR.

**POSTAGE.** We prepay postage in all parts of the United States, Mexico and island possessions. For foreign or Canadian subscriptions we require 50 cents in addition to the subscription price for additional postage charge.

**CHANGE OF ADDRESS.** Notify us as far in advance as possible. It requires several weeks to make an address change on our records. Always write clearly.

A. J. NORRIS HILL CO., 5 Third St., San Francisco, Calif.  
412 West 6th St., Los Angeles, Calif.  
Leary Building, Seattle, Wash.



# The New CROSLLEY JEWELBOX

**\$95**  
WITHOUT TUBES

*Take advantage of the most amazing offer ever made in all Radio History!*

Try this remarkable new Crosley Radio with Crosley new, type D Musicone without cost or obligation. Just phone a Crosley dealer—tell him you want to test the new Crosley Jewelbox.

*Home is really the place to buy radio!*

Home is where you can decide leisurely and surely. Crosley dealers are authorized to home demonstrate this new radio. Antenna unnecessary for such demonstrations—30 feet of wire on the floor of the room will do nicely.

*Put the Jewelbox to any test!*

Compare it with your old set. Try it with any other! Learn what radio reception can be. Note how easy it will be to break through any surrounding wall of local stations—to bring in distant programs quickly, clearly, and in full volume. Be sure you test the Jewelbox with the Crosley new type D Musicone that you may fully realize, if you own an old set or have not heard a Crosley, how far radio has progressed. Remember—you do this all in your own home—at no cost and no obligation to you!

*Buy Radio Reception—not Furniture!*

The Jewelbox is a radio fine enough to go into the finest furniture you can buy and as such is easily installed—but it is distinctive, decorative, and desirable by itself. In Crosley radio you buy perfect reception and radio enjoyment first!

Try it in your home  
—that's the only way  
to buy a Radio!

Every Crosley Dealer  
is now authorized to  
give you this **FREE**  
trial!

**THE CROSLLEY RADIO CORPORATION**  
Powel Crosley, Jr., Pres. Cincinnati, Ohio

*Licensed only for Radio Amateur, Experimental and Broadcast Reception.*

*Montana, Wyoming, Colorado, New Mexico and West prices slightly higher.*



The Musicone finished to match the Jewelbox, \$15

*The new Crosley Jewelbox is self-contained to operate from light socket.*

All in one beautiful case. Add tubes and it's ready to operate! It is powerful. Supplying 180 volts to power output tube it gives full undistorted volume. Other sets supplying 110 to 135 volts result in poor quality, distortion, and less volume.

*The new Jewelbox is acutely selective.*

The Acuminators, an exclusive Crosley feature enable you to tune sharply on distant stations, increasing signal strength and volume to a surprising degree.

*The new Crosley Jewelbox is up-to-date.*

The dial is illuminated—a modern necessary feature. The set is completely shielded as all high grade radios should be. The rich brown finish high-lighted with gold makes it an ornament to grace the finest room. The beauty of the Jewelbox will charm you.

*The price of the new Jewelbox is a triumph of manufacturing genius!*

Crosley engineers designed this new Crosley Jewelbox under explicit instructions to make first a perfect radio. If the production of their final design had been limited to a few hundred, only wealthy persons could have afforded them. But with efficient Crosley production methods, facilities to manufacture parts in million quantities, and a faith in the enormous demand such values would create, this splendid radio receiver is priced at \$95.

Write Dept. 22 for literature.

## INDEX TO ADVERTISERS

	Page		Page		Page
<b>A</b>					
Abox Company, The.....	Back Cover	<b>D</b>		Lacault Radio Elec. Labs.,	
Acme Wire Co., The.....	1290	Deutschmann Co., Tobe.....	1286	R. E. ....	1295
Aero Products, Inc.....	1281	<b>E</b>		Lacey & Lacey.....	1279
Aerovox Wireless Corp.....	1271	Electric Specialty Co.....	1269	Langbein-Kaufman Radio Co.....	1290
All Radio Co.....	1262	Erie Fixture Supply Co.....	1269	Leutz, Inc., C. K.....	1267
American Bosch Magneto Corp.	1290	<b>F</b>		<b>M</b>	
American Mechanical Labs.....	1291	Fanspeaker Radio Co.....	1200	M. & H. Sporting Goods Co.....	1295
American Transformer Co.....	1272	Fansteel Products Co., Inc.....	1286	Mack Co. ....	1273
Amrad Corp., The.....	1263	Ferbend Electric Co.....	1285	Massachusetts Radio and Tele-	
<b>B</b>					
Barawik Co., The.....	1269-1287-1291	Fergus Co., The.....	1283	graph Schools .....	1271
Brady, John B.....	1291	Formica Insulation Co., The.....	1283	Midwest Radio Corp.....	1281
Burt, Dr. Robt. C.....	1269	Fort Shelby Hotel.....	1266	Monmouth Products Co.....	1289
<b>C</b>					
C. E. Mfg. Co., Inc.....	1279	Freshman Co., Inc., Chas.....	1271	Muter Co., Leslie F.....	1273
Carborundum Co., The.....	1262	Frost, Inc., Herbert H.....	1293	<b>N</b>	
Carter Radio Co.....	1287	<b>G</b>		National Co., Inc.....	1281
Central Radio Labs.....	1266	General Radio Co.....	1271	National Radio Institute.....	1197
Chemical Institute of N. Y.,		Guaranty Radio Goods Co.....	1262	Norden-Hauke, Inc.....	1257
Inc. ....	1261	<b>H</b>		Northern Mfg. Co.....	1277
Chicago Radio Apparatus Co.....	1265	Hammarlund Mfg. Co.....	1269	North Shore Radio Labs.....	1271-1289
Cloverleaf Mfg. Co.		Harco Co. ....	1279	<b>O</b>	
Inside Back Cover		<b>I</b>		Oak Park Mfg. Co.....	1285
Conrad Co. ....	1264-1268-1276-1286	Independent Electric Works....	1265	Omnigraph Mfg. Co.....	1267
Consumers Radio Co.....	1271	<b>J</b>		Outdoor Enterprise Co.....	1285
Craftsman Radio Products.....	1293	J-M-P Mfg. Co.....	1295	<b>P</b>	
Crosley Radio Corp.....	1195	Jewell Electrical Inst. Co.....	1286	Parker, C. L.....	1286
Cummings Radio Corp.....	1271	<b>K</b>		Peerless Mfg. Co.....	1295
Cunningham, Inc., E. T.,		Karas Electric Co.....	1287	Press Guild, Inc., The.....	1274
Inside Front Cover		Knapp Electric Corp.....	1272	<b>R</b>	
Curtan Mfg. Co.....	1198				
<b>L</b>					
<b>S</b>					
<b>T</b>					
<b>X</b>					
<b>Y</b>					

# Now! in limp, suede leather binding

## S. Gernsback's Radio Encyclopedia

THE most valuable of Radio Books—S. Gernsback's Encyclopedia—now the most beautiful. This foremost Radio Encyclopedia is now offered in this luxurious new binding to meet the demand for a more handsomely bound volume. The limp suede leather edition sells for \$5.00. The Keratol-leather stiff binding still can be had for \$2.00.

Remember—this is an encyclopedia—not a dictionary! It took over two years of intensive labor to compile it. It is the first Radio Encyclopedia ever published.

S. Gernsback's Radio Encyclopedia contains the

meaning of every word and phrase used in the entire Radio Art. Every circuit, part and apparatus is thoroughly explained. A complete cross index is just one of the many features of this remarkable book.

There are 1,930 definitions—549 diagrams, photographs and drawings—all simple and easily understood. The book is nearly 1 inch thick and measures 9x11 inches.



S. GERNSBACK,  
230 Fifth Ave., New York City

Kindly send me one copy of the  
Radio Encyclopedia. I will pay post-  
man.

Limp suede leather binding  
\$5.00 plus postage.

Keratol leather binding  
\$2.00 plus postage.  
(check which binding you want)

Name.....

Address.....

Town.....

State.....

**SEND  
NO  
MONEY**

Simply pay the post-  
man on delivery.  
Over 25,000 copies in the  
stiff binding already sold.

S. GERNSBACK, 230 FIFTH AVENUE, NEW YORK CITY

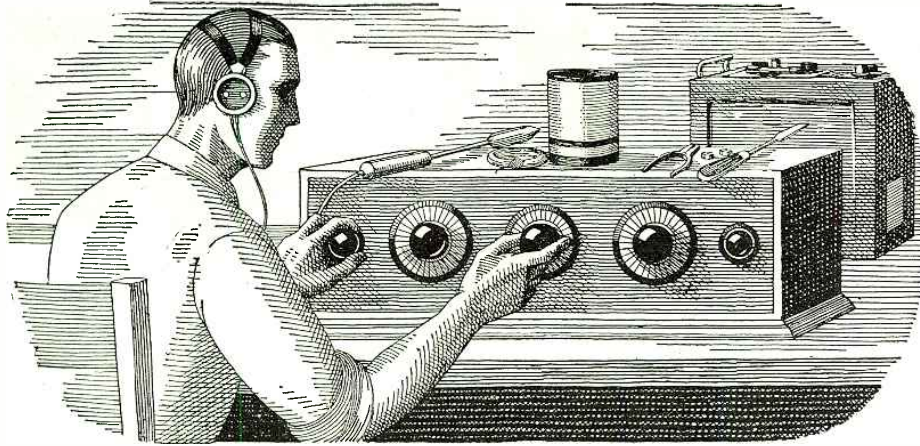

*If all the Radio set I've "fooled" with in my time were piled on top of each other, they'd reach about halfway to Mars. The trouble with me was that I thought I knew so much about Radio that I really didn't know the first thing. I thought Radio was a plaything—that was all I could see in it for me.*

# I Thought Radio Was a Plaything

*But Now My Eyes Are Opened, And I'm Making Over \$100 a Week!*

\$50 a week! Man alive, just one year ago a salary that big would have been the height of my ambition.

Twelve months ago I was scrimping along on starvation wages, just barely making both ends meet. It was the same old story—a little job, a salary just as small as the job—while I myself had been dragging along in the rut so long I couldn't see over the sides.

If you'd told me a year ago that in twelve months' time I would be making \$100 and more every week in the Radio business—whew! I know I'd have thought you were crazy. But that's the sort of money I'm pulling down right now—and in the future I expect even more. Why only today—

But I'm getting ahead of my story. I was hard up a year ago because I was kidding myself, that's all—not because I had to be. I could have been holding then the same sort of job I'm holding now, if I'd only been wise to myself. If you've fooled around with Radio, but never thought of it as a serious business, maybe you're in just the same boat I was. If so, you'll want to read how my eyes were opened for me.

When broadcasting first became the rage, several years ago, I first began my dabbling with the new art of Radio. I was "nuts" about the subject, like many thousands of other fellows all over the country. And no wonder! There's a fascination—something that grabs hold of a fellow—about twirling a little knob and suddenly listening to a voice speaking a thousand miles away! Twirling it a little more and listening to the mysterious dots and dashes of steamers far at sea. Even today I get a thrill from this strange force. In those days, many times I stayed up almost the whole night trying for DX. Many times I missed supper because I couldn't be dragged away from the latest circuit I was trying out.

I never seemed to get very far with it, though. I used to read the Radio magazines and occasionally a Radio book, but I never understood the subject very clearly, and lots of things I didn't see through at all.

So, up to a year ago, I was just a dabbler—I thought Radio was a plaything. I never realized what an enormous, fast-growing industry Radio had come to be—employing thousands and thousands of trained men. I

usually stayed home in the evenings after work, because I didn't make enough money to go out very much. And generally during the evening I'd tinker a little with Radio—a set of my own or some friend's. I even made a little spare change this way, which helped a lot, but I didn't know enough to go very far with such work.

And as for the idea that a splendid Radio job might be mine, if I made a little effort to prepare for it—such an idea never entered my mind. When a friend suggested it to me one year ago, I laughed at him.

"You're kidding me," I said.

"I'm not," he replied. "Take a look at this ad."

He pointed to a page ad in a magazine, an advertisement I'd seen many times but just passed up without thinking, never dreaming it applied to me. This time I read the ad carefully. It told of many big opportunities for trained men to succeed in the great new Radio field. With the advertisement was a coupon offering a big free book full of information. I sent the coupon in, and in a few days received a handsome 64-page book, printed in two colors, telling all about the opportunities in the Radio field, and how a man can prepare quickly and easily at home to take advantage of these opportunities. Well, it was a revelation to me. I read the book carefully, and when I finished it I made my decision.

What's happened in the twelve months since that day, as I've already told you, seems almost like a dream to me now. For ten of those twelve months, I've had a Radio business of my own. At first, of course, I started it as a little proposition on the side, under the guidance of the National Radio Institute, the outfit that gave me my Radio training. It wasn't long before I was getting so much to do in the Radio line that I quit my measly little clerical job, and devoted my full time to my Radio business.

Since that time I've gone right on up, always under the watchful guidance of my friends at the National Radio Institute. They would have given me just as much help, too, if I had wanted to follow some other line of Radio besides building my own retail business—such as broadcasting, manufacturing, experimenting, sea operating, or any one of the score of lines they prepare you for. And to think that until that

day I sent for their eye-opening book, I'd been wailing "I never had a chance!"

Now I'm making, as I told you before, over \$100 a week. And I know the future holds even more, for Radio is one of the most progressive, fastest-growing businesses in the world today. And it's work that I like—work a man can get interested in.

Here's a real tip. You may not be as bad off as I was. But think it over—are you satisfied? Are you making enough money, at work that you like? Would you sign a contract to stay where you are now for the next ten years—making the same money? If not, you'd better be doing something about it instead of drifting.

This new Radio game is a live-wire field of golden rewards. The work, in any of the 20 different lines of Radio, is fascinating, absorbing, well paid. The National Radio Institute—oldest and largest Radio home-study school in the world—will train you inexpensively in your own home to know Radio from A to Z and to increase your earnings in the Radio field.

Take another tip—No matter what your plans are, no matter how much or how little you know about Radio—clip the coupon below and look their free book over. It is filled with interesting facts, figures, and photos, and the information it will give you is worth a few minutes of anybody's time. You will place yourself under no obligation—the book is free, and is gladly sent to anyone who wants to know about Radio. Just address J. E. Smith, President National Radio Institute, Dept 5S, Washington, D. C.

**J. E. SMITH, President,  
National Radio Institute,  
Dept. 5S, Washington, D. C.**

Dear Mr. Smith:

Please send me your 64-page free book, printed in two colors, giving all information about the opportunities in Radio and how I can learn quickly and easily at home to take advantage of them. I understand this request places me under no obligation, and that no salesman will call on me.

Name.....  
Address.....  
Town.....State.....  
Occupation.....

Amazing  
New

# Ground Antenna

## Gets Everything— Reduces Static

*Brings in Faraway Stations Loud and  
Clear Regardless of Static Conditions*

Fans everywhere are replacing their troublesome and static gathering up-in-the-air aerials with the marvelous new GROUND ANTENNA—Aer-O-Liminator. Radio engineers and hundreds of users testify that Aer-O-Liminator gets better long distance reception, almost unbelievable freedom from outside noises, far greater selectivity and marvelously true, clear, sweet tone quality.

John E. Christenson, RADIO ENGINEER, CHICAGO, writes: "I have tested and thoroughly approve the Aer-O-Liminator. I find it increases selectivity and volume without distortion, practically eliminates static, gives good clear tones, both on local and distant stations. I would recommend the use of the Aer-O-Liminator to every radio owner to get the best reception from his set."

### FREE TRIAL

*Make this thrilling test at our risk!*

Install an Aer-O-Liminator (Ground Antenna). Leave your old overhead aerial up. Try out on a night when static is bad. If you do not get a wonderful improvement in reduction from static, greater selectivity and clear, sweet tone without interfering noises, if you can't get good reception on stations that are drowned out by static on your old aerial, you need not pay us a red cent for this test. Send coupon at once for scientific explanation of Aer-O-Liminator (Ground Antenna), proof of performance, and our conclusive iron-bound guarantee, and remarkable Free Trial Offer—Mail Coupon TODAY!

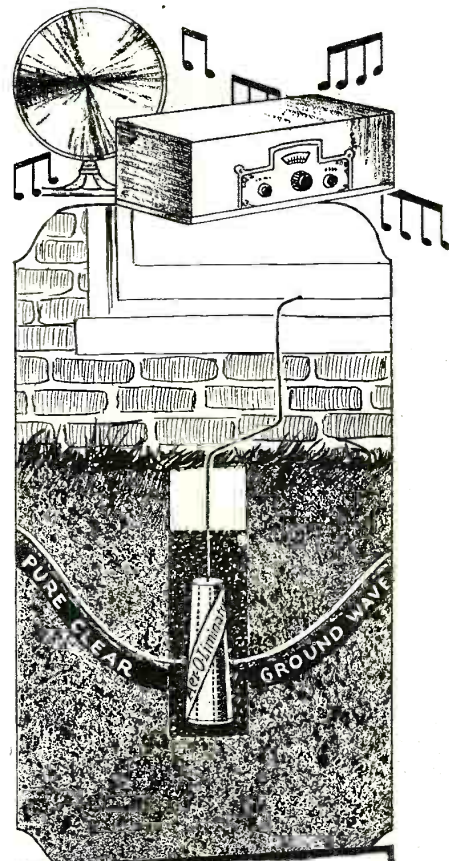

#### EASY TO INSTALL

Just dig a small hole about 6 inches in diameter and drop Aer-O-Liminator into it.



CURTAN MFG. COMPANY  
154 East Erie St., Dept. 827-G, Chicago, Ill.  
Please send me at once complete description of Aer-O-Liminator, proof of performance, and our conclusive iron-bound guarantee, and remarkable Free Trial Offer.

Use  
this  
coupon

Name.....  
Address.....  
City.....  
State.....

## Aer-O-Liminator (Ground Antenna)

*Endorsed by Foremost  
Engineers and Dealers*

**CURTAN MFG. COMPANY**  
Dept. 827-G, 154 East Erie Street, Chicago, Ill.



# The three essentials for the fullest enjoyment of Summer Radio features!

**SUMMER**



**A PORTABLE RECEIVER**

**fun with this powerful portable set!**

**MAKE THIS A RADIO SUMMER**

Touring, camping, or at home, a portable Radio Receiver is a real summer enjoyment. It's convenient to carry, in your car, with your baggage, or if at home from room to room or out on the lawn.

You can build your own "portable" at a small cost—from a "Consrad" pattern which gives 4-page instruction booklet of parts needed, together with full size blueprints 7 1/2 inches wide by 20 inches high, of panel and wiring diagram.

The Consrad method is the simplest ever devised—you do not have to know anything about radio to follow it.

**THIS CONSRAD PATTERN**  
50c—EVERYWHERE  
Or send direct on receipt of 50c.

**THE CONSRAD CO., Inc.**  
230 Fifth Ave., New York, N. Y.

**WHEN**  
*stations crowd the air & spoil your programs*



**use a wave trap!**

**Improve your Reception—build a wave-trap with a Consrad Pattern**

**NO** matter how large or small, how expensive or inexpensive a Radio Set may be, it can be decidedly improved with a good WAVE-TRAP.

The new Consrad pattern contains a gigantic blueprint, 27 1/4 inches by 20 1/2 inches, containing simplified Panel layout, Front View, Top View, Side View and Picture Wiring diagram. All measurements are shown actual size. A complete Illustrated Pamphlet is enclosed that shows exactly how to proceed throughout the entire construction; these are enclosed in a heavy folder envelope size 9 1/4 x 9 1/2 inches.

**ONLY 25c—EVERYWHERE**

If your dealer cannot supply you, write direct  
**The Consrad Co., Inc., 230 5th Ave., N.Y**



**12 P.M. Gives up in disgust!**

**The man who forgot to buy**

**THE RADIO TROUBLE FINDER**

**FROM** 8 o'clock to 12 he was frantically trying to tune in on the big anniversary program, but his radio set positively would not work.

He had a dozen books on the care of his car but not one for his Radio.

Radio Sets rarely need an expert's attention, if you have a copy of "The Radio Trouble Finder" handy.

It's a 68-page, simplified manual for trouble correcting—written expressly for home users.

Common Radio faults are charted and remedies are given in language as devoid of technical expressions as is possible.

**ORDER YOUR COPY TODAY**

**25c** Every Where

If your dealer cannot supply you write—

**The Consrad Co., Inc., 230 Fifth Ave., New York**



# The 5 essentials of a complete Radio Education



**THEORY** **DESIGN** **CONSTRUCTION** **OPERATION** **MAINTENANCE**

**Radio Educator**  
by Sidney Gernsback  
A Reading Course in Five Books  
**BOOK 1**

**\$1.97**

Published by **The Consrad Co. Inc. New York**

**RADIO** can be learned—from beginning to end—from raw, practical theory to maintenance and operation of large installations—all from this compact, finished set of 5 volumes. They contain the five component parts of an entire Radio Instruction course and not only the essentials but all that any modern, up-to-date textbook on any subject would cover. They teach every possible portion of Radio Science.

Size of each book is 6 x 9 inches, handsomely bound and illustrated with charts, diagrams, drawings and tables. Each book contains 52 pages.

**SEND NO MONEY**

Send us no money for these books—just your name and full address—On receipt of same you pay the postman \$1.97 plus postage (a few cents) and then they are yours. Note: This is the second new reprint of these books—Order early and be sure of quick delivery.

**THE CONSRAD COMPANY, Inc.**  
230 Fifth Avenue New York, N. Y.

# The ELECTROMAGNETIC POWER SPEAKER Is Here!

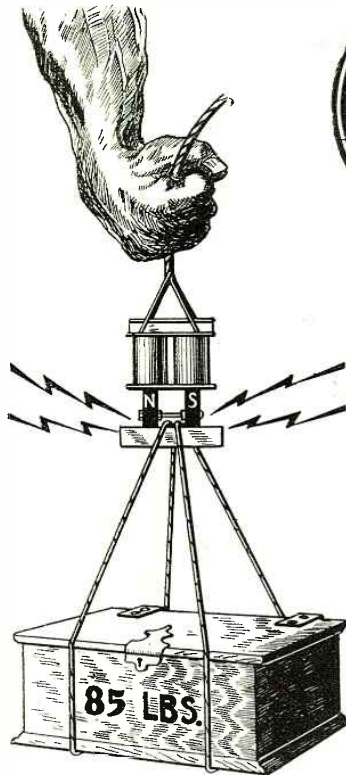

**YOU KNOW YOURSELF** how the 171 and 210 type power tubes improved the quality and volume of your radio set. But your tubes are better than your speaker—whether you have a horn, a small cone, or large cone.

Now the DYNATONE Electromagnetic Power Speaker Unit is here—an advance as far above the regular cone speaker unit as the cone was above the standard horn.

## Power Gives Tone

Power tubes give better quality because they handle more power without distortion. If you have distortion it is in your speaker, rather than in your set or tubes. The DYNATONE Power Unit gives you maximum quality and volume without distortion *because it is powerized*. It requires no more plate or “B” voltage, but gets its added power and quality from the powerful electromagnet energized by the “A” battery or your trickle charger. *No change in your set is required.*

Only an energized electromagnetic unit can bring out the full resonant, rounded quality of the finest orchestral instruments.

## Prove This Yourself

The permanent magnet in your regular cone speaker unit will lift about three to four times its own weight. The DYNATONE Electromagnet will lift TWENTY-FIVE TIMES its own weight—or over 85 pounds. An astonishingly wide air-gap is made possible by balancing the armature in this powerful magnetic field. This means that the armature (the part that moves and makes it speak) can never hit the magnet on low tones like the bass viol, the tuba, or the tympani. It *cannot* chatter, and therefore *cannot* produce load distortion.

You can operate it on any type of speaker, whether paper cone, balsa wood, or airplane cloth.

## Only Advance in Speaker Quality

Up to now the only attempt has been to improve the diaphragm by using different kinds of paper cones, balsa wood, airplane cloth, etc.

After designing one of the most outstanding speaker units on the market for use with a 3-foot cone, Mr. Clyde J. Fitch, the famous loud-speaker expert, gave his attention to still further improving the unit by adapting it to universal application, and still further improving the tone quality. The DYNATONE Power Unit is the perfection of his researches.

**TRY IT 10 DAYS FREE**

Mark what you want to try, clip out the coupon, and mail it to us. Pay the postman when he delivers it. Hook it to your radio

FANSPEAKER RADIO COMPANY  
74-76 Dey Street, New York, N. Y.

Send me for TEN Days' free trial:  
 Dynatone Electromagnetic Power Unit only ..... \$12.50   
 Dynatone Electromagnetic Power Unit and Special  
 Cone ..... 15.00   
 Dynatone Electromagnetic Power Unit, Cone, and  
 Baffle Cabinet ..... 18.50

Name.....  
 Street.....  
 Town..... State.....

set. Then, if it is not BETTER than any speaker you ever heard, AT ANY PRICE, send it back, and your money will be refunded. No delay; no argument. Your money goes back to you at once.

## Powerize Your Own Speaker

The DYNATONE Power Unit will fit your regular console cabinet, or you can let stand alone. It operates *any size cone*. No special output transformer is required for 171 type power tube; it will carry 200 volts “B” battery with perfect safety. With these later improvements in cone design and material the DYNATONE Power Unit gives astonishing reproduction. Even fine musicians can rarely distinguish DYNATONE reproduction from the original voice or orchestra. Piano tones don't merely “sound like a piano,” but are real vibrant, resonant piano tones.

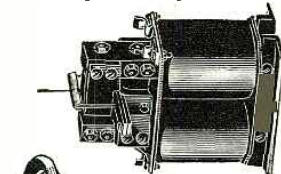

Unit Only

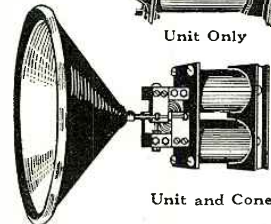

Unit and Cone

## Unsurpassed at Any Price

With the DYNATONE Power Unit and our Special Cone you have the very best that radio science knows today. You can prove this yourself and to your friends in your home AT OUR EXPENSE. Use the Coupon.

## Direct-to-You Cost

Dynatone Power Unit, to fit your own cone ..... \$12.50  
 Dynatone Power Unit, fitted to Special Cone to fit your  
 Console ..... 15.00  
 Dynatone Power Unit, fitted to Special Cone, and with  
 Baffle Cabinet to fit console, or stand alone ..... 18.50

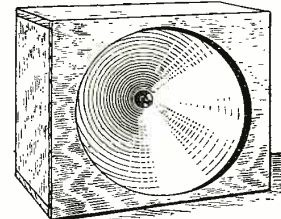

Unit, Cone and Cabinet

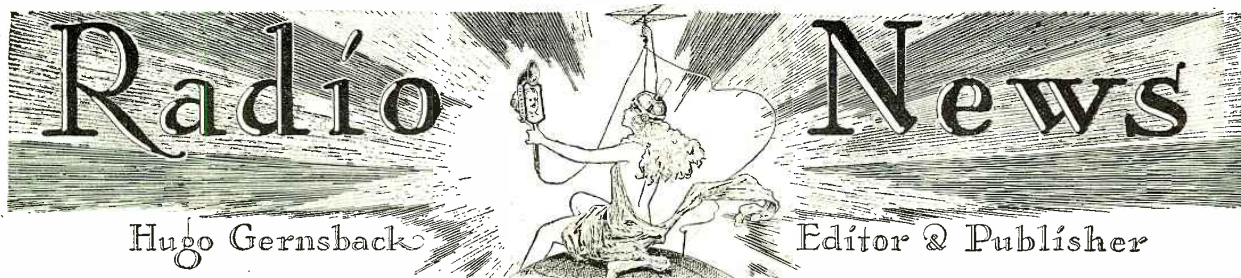

Editorial and General Offices, 230 Fifth Avenue, New York

Vol. 9

MAY, 1928

No. 11

## A New Radio Cycle

By Hugo Gernsback

**I**F a thoughtful person were to review the history of radio, he would find that the art moves in certain cycles—in a definite wave-formation—which rise and fall with more or less constancy.

When radio first started, we had, at the transmitter end, the spark-coil and fixed-spark-gap cycle. This soon gave way to the cycle of the alternating-current transformer and the "quenched" or rotary spark-gap. At the receiver end, there was the coherer period, which coincided with that of the spark coil. The cumbersome coherer was soon superseded by the detector, for the period when we used electrolytic and crystal detectors. Then came the marvelously-versatile vacuum tube, which eliminated the previous receiving devices almost completely, and which caused only slightly less sweeping changes in transmitting apparatus. With the advent of broadcasting commenced a triumphant and as yet unchecked ascendancy of the tube. The rise of the latter probably has not yet reached its zenith.

Previous to broadcasting, we had the loose-parts fashion, when a radio set consisted of various parts screwed to a bread-board or to the top of a table. Such a thing as a radio outfit complete in one box was not known; it did not appear until the advent of broadcasting created a demand for it. Then, immediately, the complete-set cycle started and gained headway. However, up to a year ago, we had not yet freed ourselves from some of the loose parts which had been in vogue since 1900. I refer to the power or battery system which supplies the operating energy for the radio receiver.

The battery cycle seems to have had a longer life than most of the others. It is true that the power-unit cycle started a few years ago, but this is already on the decline. The "A, B and C" power unit, operating from the electric-light socket, was designed to supplant all batteries and to furnish the same kind of power the latter had been generating. We will probably have such power units for many years to come; for the simple reason that there are millions of battery-tube sets in existence and a large proportion of them will certainly be equipped with such devices instead of being scrapped altogether in favor of A.C. receivers. But the external-power-unit cycle will probably not survive many years.

The ascendancy of the alternating-current vacuum-tube cycle has been a tremendously sweeping one, and its vogue threatens to obliterate not only the battery cycle, but the eliminator cycle as well.

Right now, a new cycle, that of the *true* socket-operated set, is gaining headway. The socket-operated set uses vacuum tubes whose filaments work from the alternating house current. The complete "A and B" unit is no longer an "eliminator," but becomes an integral part of the set itself. That, of course, eliminates the "eliminator" itself. We already have the small, completely self-contained, so-called electric set, which requires no accessory other than a loud speaker. Everything else is contained within the set itself. Even the aerial and ground, the oldest survivors in the radio art, are now threatened with extinction, because you can use the electric-light system for both the aerial and ground. It is only a matter of time before our good old aerial masts will have vanished entirely from the housetops.

The advent of the modern alternating-current vacuum tube has left a great wreckage behind it; this tube has made obsolete the great majority of the old battery-operated sets, which will now be used only where there is no house current available. As far as the United States is concerned, that is true for only about 40% of the population; the other 60% of the houses are wired for electric current, and ready for socket-operated sets.

It is a curious fact that some of our largest set manufacturers are the greatest sufferers from the march of progress. When, late in 1927, it became necessary to make the switch from the battery set to the alternating-current-tube set, a number of manufacturers were left with huge stocks of battery-operated sets on their hands. They could not dispose of both types of these sets, any more than you could sell straw hats and fur overcoats in the same month; so a number of them had to take huge losses on great quantities of their battery sets. That is the cost of progress.

It is true that the radio industry is striving hard to stabilize itself, and every leader in the trade will tell you constantly that that has happened; but this assertion must also be taken with a grain of salt, because very few industries are ever stabilized. It was thus, and is thus, with the automobile industry, and it is thus with many other industries. No industry can hope to stand still while the world moves onward. It simply cannot be done.

How long the present new cycle will last, no one can foretell. If you took a consensus of opinion of the leaders of the radio industry, you would probably find that all are unanimous, that with the present alternating-current tubes and self-contained radio sets, the industry is now sufficiently stabilized for many years to come.

Frankly, I do not believe it. It has never happened in the past, and probably will not happen in the future. By all of this, I do not mean to say that, if you have any intention of buying a radio set today, you should wait to see what happens; that would be foolish. You keep on buying electric lamps and automobiles and phonographs whenever you want them; although you know very well that within a comparatively short time they will be obsolete. Radio is nowise different.

Yet it must be said, to the credit of the radio art, that the radio sets now in operation, which were built in 1925 and which are battery-operated, can still hold their own with the new sets. While there may not be a great market for them any more, they are still doing their work; just as many 1925-model automobiles, even though they have no four-wheel brakes and balloon tires, are still running and giving good service.

What will happen in the future and during the next cycle, no one can foretell exactly; but, for one thing, it is quite certain that during the next two years a new adjunct to radio's utility will come along in the form of television. You will have a television attachment, just as you have a loud speaker today. You will plug it in to your radio set at the same time you plug in your radio loud speaker; and you will see the distant events on your television "screen" as you hear them on your loud speaker, both at the same time.

At first, the television accessory will be separate from the set; it will be sold separately. That will be one more cycle. Later on, no doubt, the television appliance will be built into the radio set, and we will then have a self-contained radio receiver with radio television, all operated from the house-lighting current.

At the present time, it would seem that the radio set will continue to decrease in dimensions. It will become smaller and smaller; at least as regards the console set. Of course, we will always have the radio set in its more elaborate make-up as fine furniture, but console sets will shrink in size during the next few years. Sets will become smaller and they will become simpler, with fewer things to get out of order, with greater refinements and with superior adjustments.

Whether the sets will always be tuned as we tune them now is to be doubted. Already, the push-button set has made its appearance; for local reception, you push a number of buttons and instantly you get the station indicated. For distance, you probably will tune the set of the future much as you do today; for locals, the tuning will be done almost automatically.

It is quite within the range of possibility that sets will be entirely automatic and will start operating daily at a predetermined time, switching themselves off automatically when the station goes off the air; only to be switched on again when a station goes on the air, if such should be desired. To be sure, you could still switch the set on and off by hand if you should wish to do so.

Then, too, there is always the chance that a totally-new discovery will come along that, in itself, will obliterate the vacuum tube in one way or another; and it is even within the bounds of possibility that there will be invented some new device that will require so little power that a small dry-cell battery will operate it for a considerable length of time. This, in turn, would again make the radio set independent of the lighting current and would make it more transportable. But all these things are yet in the future.

Mr. Hugo Gernsback speaks every Tuesday at 9.30 P. M. from Stations WRNY (326 meters) and 2XAL (30.90 meters) on various radio and scientific subjects.

# Coming — A Program Pool?

Some Suggestions for a Method of Solving This Problem, which Has Vexed the Entire Radio Industry Since the Beginning

By Charles Magèe Adams

**F**INANCING is still one of broadcasting's major unsolved problems. This statement doubtless comes as somewhat of a surprise to most listeners, and for reasons altogether understandable. Technical developments, the evolution of programs, and the frequency-allocation difficulty have absorbed popular attention to the virtual exclusion of financing; and, even when this has been thought of by those at the loud speaker, the comforting assurance that nearly 700 stations are managing to meet their operating expenses "somehow or other" has served to allay concern.

Nevertheless, the fact remains that financing is not only one of the really grave problems confronting broadcasting, but the one perhaps farthest from permanent solution (with special emphasis on *permanent*, since a history of the subject down to the present day discloses a succession of merely partial and makeshift solutions.)

## A MODEST BEGINNING

When broadcasting came into being back in 1921, it was assumed that its then trifling cost would be met by listeners through the purchase of receiving equipment from the radio manufacturers supplying programs—an arrangement which seemed admirable. It was practicable because the handful of pioneer stations were owned by the few radio manufacturers of that day. It was painless, as compared with the license fee

system adopted in Europe, since the cost was levied indirectly; and fair in that the cost borne by each listener was roughly pro-

*SOME years ago an eminent electrical scientist, Dr. Benjamin Franklin, assured his associates that, if they did not all hang together, they would assuredly hang separately. A prospect of this kind for radio producers seems to be envisaged by the writer of this article, who is an impartial observer of long experience in the radio field. It is his belief that a close union of the radio industry, for the purpose of supporting broadcasting in better style, is quite feasible and the next logical step. We shall be glad to learn the mental reactions of our readers, not only those in the industry and engaged in broadcasting, but also those on the outside, merely listening in.—EDITOR.*

portional to the amount of reception. But the plan had hardly been outlined before it was complicated—not to say upset—by the entrance of numerous non-radio interests into the field of broadcasting.

This invasion was a welcome one, to be sure. What was needed just then to popularize radio was more broadcasting, regardless of who supplied it. The financing of

the newcomers' operations, too, was along sound lines. In return for their broadcasting they secured the good will of the audience. But the result, on the support of broadcasting as a whole, was to put it on a composite, and more or less confused, basis. Radio manufacturers continued to recoup their outlay for broadcasting through the sale of receiving equipment, while the non-radio interests depended on good will.

Then, while these two dissimilar plans were engaged in adjusting themselves to each other, came still a third complication—advertising.

## THE COMMERCIAL PROGRAM

Again the results justified the innovation, for the moment. The cost of operating stations had been mounting so rapidly that owners were receptive to any expedient which offered partial relief from the increasing burden. Many interests, both radio and non-radio, which did not own stations, wished to secure good will through broadcasting; and the additional revenues from commercial programs, which were the result, played no small part in the subsequent development of the art. Once more, how-

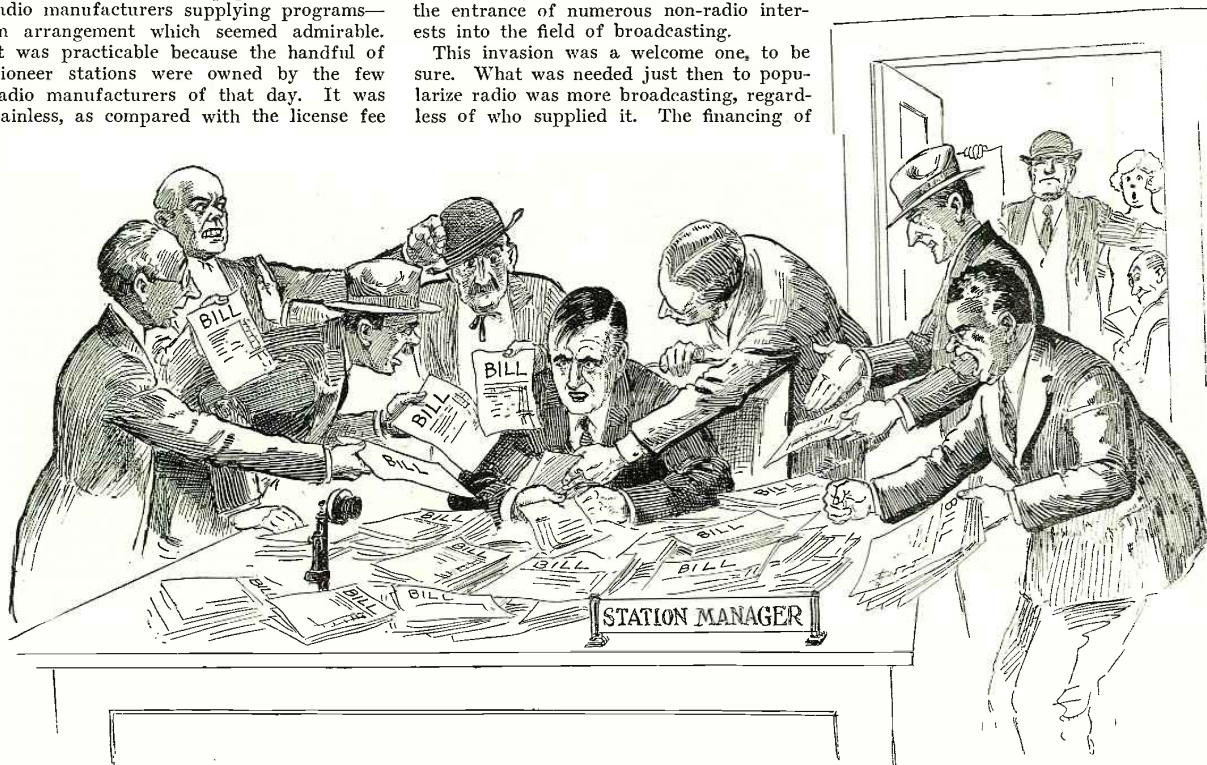

*It must be remembered that the cost of operating a modern station, of even 5000 watts, is in the neighborhood of \$100,000 a year; and that only some 30 hours a week are available for sale, to defray the mounting expenses of continuous operation.*

ever, the effect on broadcasting's financial basis was still greater confusion—continuing down to the present day.

A survey of the field as things now stand reveals the following situation: a few stations are owned by radio manufacturers, who finance their operation wholly by the sale of receiving equipment; a few are operated by non-radio interests, recouping their entire outlay through good will secured by programs; and an overwhelming majority of them are owned by both radio and non-radio

members that the cost of operating a modern station of even 5,000 watts is in the neighborhood of \$100,000 a year, exclusive of artists fees, and that only some 30 hours a week are available for sale.

So it is obvious that the commercial program, now relied on most heavily, has not only failed as a solution of broadcasting's financial problem, but offers little, if any, hope for further relief. Listeners are remarking that the predominance of the sponsored feature, even in its present quantities, and when it is kept within the bounds of true good taste, is making broadcasting essentially an *advertising* rather than an entertainment medium; and that if the ex-

To non-radio interests, broadcasting is at best merely a publicity medium; valuable, to be sure, but only as such. Curtailment or even suspension of the service could easily be compensated by increased use of some other medium. To radio interests, on the other hand, broadcasting is their life-blood. Without it there can be no radio industry, and even its curtailment carries a serious threat. Hence the increasing efforts of radio interests to build up broadcasting.

This explains the second current trend—that toward cooperative broadcasting. It is noticeable that manufacturers, distributors, and dealers, who might as easily pre-

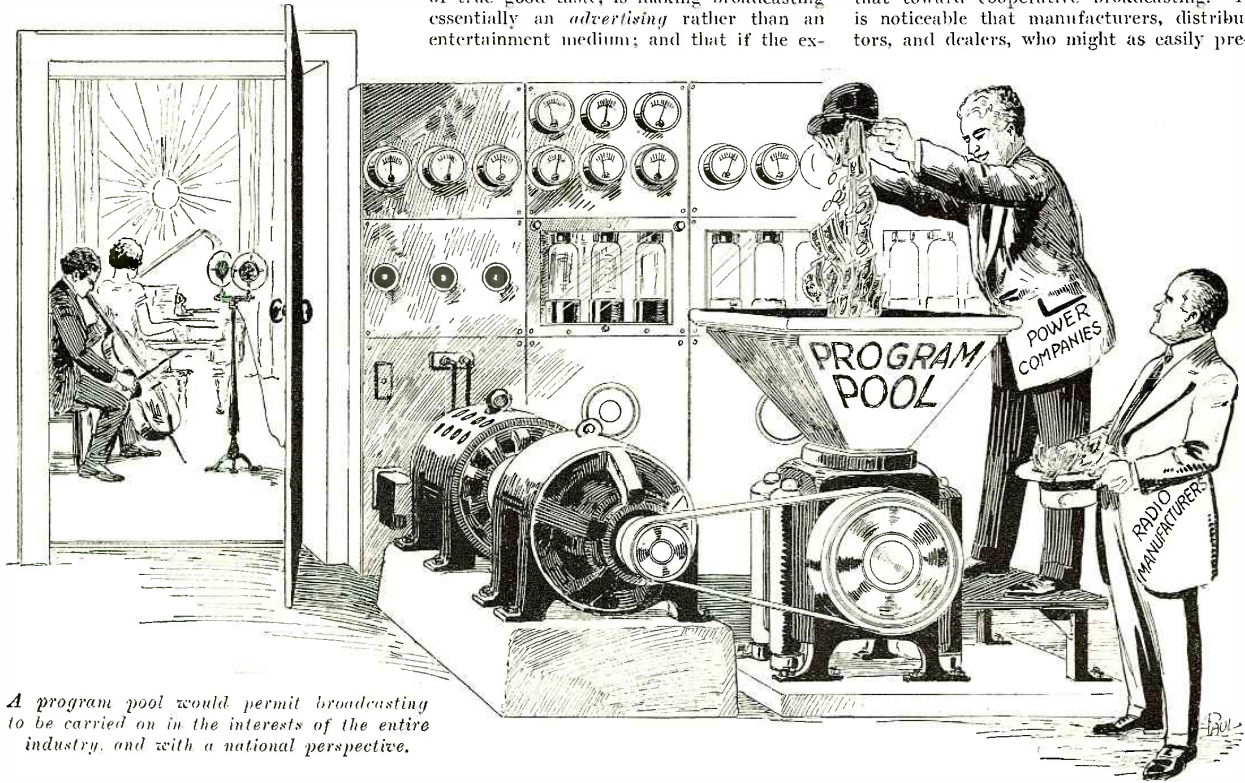

A program pool would permit broadcasting to be carried on in the interests of the entire industry, and with a national perspective.

interests, financing themselves in part by the sale of receiving equipment or through good will, and in part by the sale of time on the air to other interests, radio and non-radio. This involved and haphazard arrangement *seems* to be succeeding in spite of its manifest lack of definite policy or coherence.

"Seems" deserves all the emphasis that can be given it. It is assumed by most listeners that the development of the commercial program in particular has virtually solved the problem of financing broadcasting. Accounts of the impressive sums paid for time on the air suggest that stations reap not only a handsome revenue, but a comfortable profit from this source. But the facts are quite to the contrary.

#### NOT A BONANZA

A man, whose long experience and intimate contact with broadcasting from the inside make his statements carry the weight of authority, informs the writer that, far from showing a profit, even those stations which sell a maximum of their time on the air still operate at a loss. Further, and more significant, there is the fact that the National Broadcasting Company, the largest and most successful agency for commercial program dissemination, shows an annual deficit of more than \$2,000,000; and this is not difficult to grasp when it is re-

laxation of this advertising plan continues radio will lose much of its appeal to the public. Advertisers, too, are indicating that the rates charged for time on the air are already all the traffic can profitably bear.

The situation today accordingly is this: only the few largest radio and non-radio interests are strong enough to supply modern broadcasting single-handed, and further development of the commercial program as a means of distributing the burden seems inadvisable; which would make it appear that the present haphazard method of financing can scarcely be relied on to carry the increasing load the future will inevitably bring to broadcasting.

At the same time, analysis discloses certain trends which, if they follow their indicated course, may well develop a sound and permanently satisfactory solution of the difficulty.

#### BROADCASTING VITAL TO RADIO

First—even a cursory survey reveals that, of all the diverse industries now engaged in national and near-national broadcasting, the radio industry leads by a comfortable margin; also that there has been a steady increase in the amount of such broadcasting, particularly by manufacturers, distributors, and even dealers employing single stations; and the reasons are not far to seek.

sent small individual programs, are finding it to their common advantage to furnish more pretentious features under the auspices of their trade bodies. The same idea, further developed, also appears in the proposal for national programs provided by national trade associations of the industry. This may infuse new life into the suggestion of a comprehensive program pool, made some four or five years ago.

At the time it was brought forward, this plan contemplated the general financing of broadcasting through a common fund collected from all the varied interests benefitting from broadcasting. It failed to progress beyond the status of a suggestion for several reasons.

The component interests of the industry were too far apart to make such a high order of cooperation practicable at that time; and other methods of financing—notably the commercial program, just then developing—held out promise of a solution along different lines. But in view of the failure of these methods, and more especially in the light of the two trends just noted, there now seems ample justification for reconsidering the possibilities of the pooling plan; the more because of still another development—the Radio Corporation's licensing policy. (Continued on page 1262)

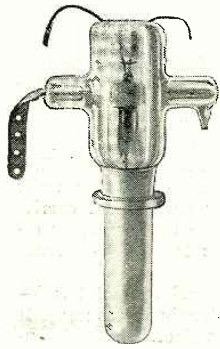

FIG. A

The ZT-6 vacuum tube, especially designed for use in transmitting ultra-high frequencies with power up to 15 K.W.

# High-Frequency Magic in the Radio Laboratory

Description of the Latest Experiments with A New Short-Wave Vacuum Tube Using a Power of 15 Kilowatts

By Knox Baxter

**B**ACK a few years, it was considered to be quite a feat to cook an egg in a frying-pan, placed on a cake of ice, without a visible source of heat. The experienced reader will at once guess that, beneath the cake of ice, was concealed a coil through which was flowing an alternating current, which induced in the iron frying-pan *eddy currents*, thereby heating the bottom of the pan sufficiently to cook the egg. But now the cake of ice, the coil, and even the frying-pan are not needed to cook an egg. Just a wire supporting a glass tube, in which the egg is placed, is needed—plus the new vacuum tube developed by the research laboratory of the General Electric Company at Schenectady, N. Y.

There are many other remarkable things accomplished by this tube, operating on a frequency of 50,000 kilocycles with a power of 15 kilowatts. An incandescent lamp, pulled from its carton for the first time, lights to full brilliancy without wires or socket; a copper bar, lying on the floor, blisters the hand that picks it up, although the metal is cold; a neon tube floods the room with its characteristic red glow when

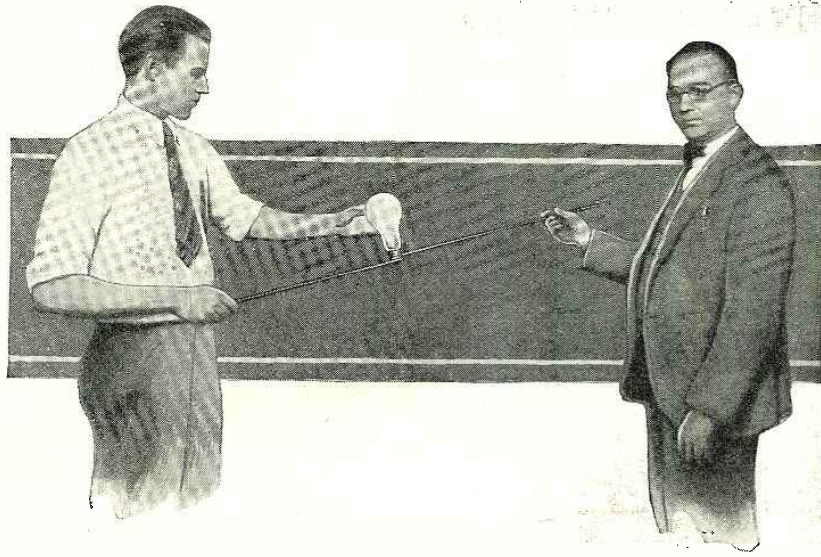

If an electric lamp's socket is touched by metal rods in the field of the transmitter, the lamp will light to full brilliancy.

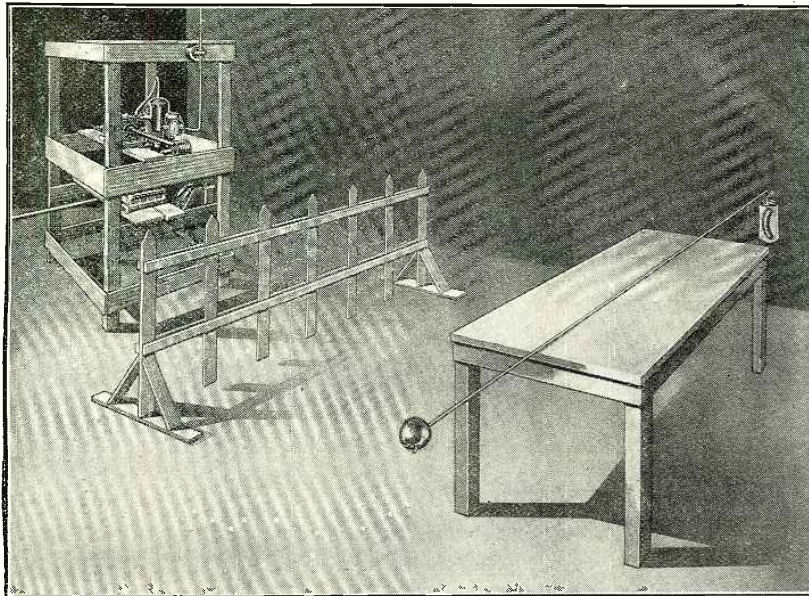

A sausage hung in a glass tube attached to the aerial and an apple impaled on the aerial can be thoroughly cooked by the power transmitted from the 6-meter tube, at a considerable distance.

it is merely touched by someone's hand; electrical meters in adjacent rooms run wild, and delicate instruments are twisted or broken, so that all scientific measuring work in the vicinity of the operating tube is impossible.

The source of all these phenomena is a large, innocent-looking vacuum tube about five inches in diameter and two feet in length (See Fig. A), placed in a framework of wood, which carries also a number of meters, coils, resistors and wires (See Fig. B). The tube operates as a self-excited oscillator on a wavelength of six meters and is capable of radiating from ten to fifteen kilowatts, or probably fifty times as much as any other ultra short-wave tube has yet been able to generate. The tube is connected through a coupling system to a copper bar approximately three meters (10 feet) long, and is able to radiate into space practically the full fifteen kilowatts generated by the oscillator.

This tube exemplifies no new principle and it should be remembered that it has lately been comparatively simple to produce very high frequencies at low power. But this recent demonstration comes at the first time that it has been possible to combine the ultra-high frequencies with the high power hitherto available only for the longer wavelengths, and to obtain a resultant high-

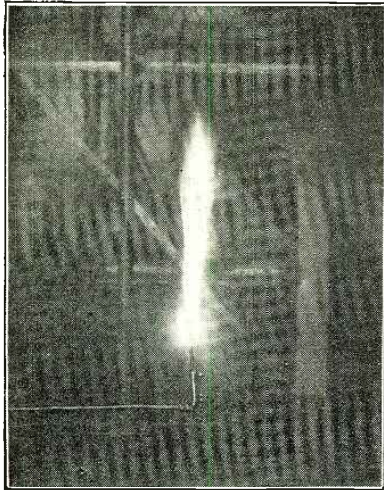

An unretouched photograph of the "standing electric arc," which gives an idea of the vast power the ZT-6 tube can set at large.

powered output on the short wavelengths in one tube. As yet, however, no method has been devised to control the generated frequency within the close limits required by commercial transmission.

100 degrees F., in about fifteen minutes; after which the experiment was discontinued.

Dr. W. R. Whitney, director of the G. E. research laboratory, states, "It may be assumed that, if we had a perfectly harmless method for warming the blood, it might be of medical value; because fevers are sometimes artificially produced in order to start convalescence, and it may well be, as asserted, that raised blood temperature, or fever, is one of Nature's factors in recovery from infectious diseases."

As mentioned at the beginning of this article, one of the most unusual experiments possible with this high-frequency tube is "radio cooking." An insulated wire was suspended over a table, at some distance from the radiating aerial and parallel to it. A sausage was placed in a glass tube, which was hung from the end of this receiving aerial and, in a few minutes, the sausage started steaming, showing that it was being cooked. When the meat was removed from the glass tube it was found that the "hot dog" had been cooked by the high-frequency currents that had been induced in it, and was pronounced to be every bit as tasty as any ever eaten. An apple was strung on the end of the aerial wire and, in a short time, was thoroughly cooked to the very core. With a slightly

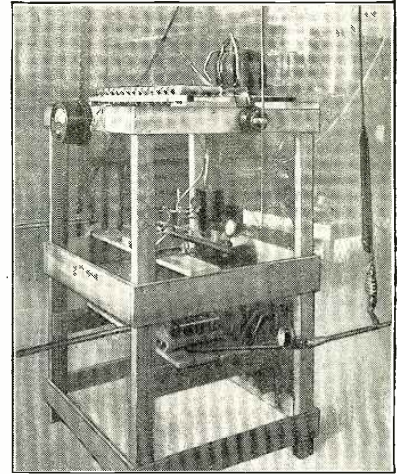
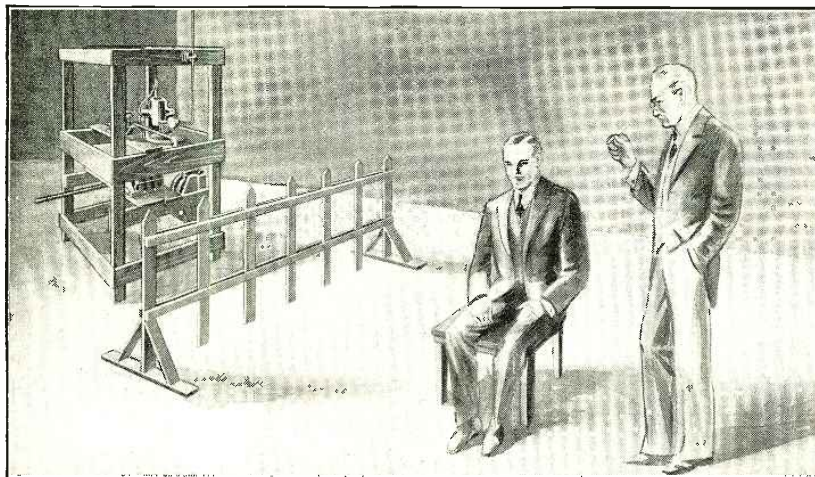

Fig. B—The 6-meter-tube transmitter. The antenna may be seen attached by the insulator on the side and standing straight up.

different hook-up, cookies have been baked and water boiled by the induced currents. The fact, that only a small fraction of the 20 horsepower delivered by the radiating system went into this cooking, detracts not at all from its novelty.



When a man remains for about fifteen minutes within six feet of the transmitter operating on 6 meters, his body temperature is raised 1.5 degrees from the normal of 98.5; or to a heat approaching fever.

**PHYSIOLOGICAL EFFECTS**

Several very interesting physiological effects have been observed in connection with the new tube, which is designated by the figures ZT-6. The effects on fruit flies and rats of the field set up by this tube are very remarkable, and, at the present time, cats are being experimented upon. At a frequency of approximately 50 million cycles, a salty solution (which is a conductor of electricity) can be heated in a glass tube placed very close to the high-frequency generator, and, at approximately this frequency, the salt solution corresponding in strength to blood serum is heated most.

Men who have been working near the apparatus have noticed distinct warming effects, which increased as they neared the tube. Different experiments were performed and it was discovered that the body temperature could be increased to nearly

**POWER THROUGH SPACE**

One of the most spectacular effects of the demonstration of the short-wave generator is the "standing electric arc," which is an excellent imitation of the famous ball of fire said to accompany tropical thunderstorms. An operator touches the end of the radiating aerial with a metal-tipped rod, and immediately a greenish-white arc rises to a height of more than a foot. When the metal-tipped rod is removed the arc remains sputtering and sending molten copper in all directions. By skillful manipulation as many as three of these arcs have been established simultaneously along the aerial, giving the appearance of a series of flaming gas jets. It is difficult to imagine a more extraordinary sight than a powerful electric arc, representing thousands of volts, standing entirely by itself

(Continued on page 1276)

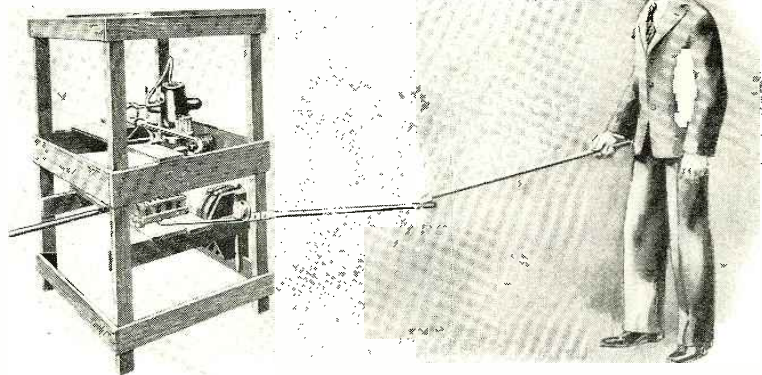

If a metal-tipped wooden rod be touched to the antenna, "standing electric arcs" will be established and will flame after the rod is removed. This can be done on a receiving aerial also.

# Folks Meet "Mike"

*He is small  
and silent, but  
through him  
you hear the  
radio programs.  
by C.W. Palmer*

*A front view of the "studio type" of microphone now employed almost exclusively in American broadcast stations; the spring suspension is clearly shown.*

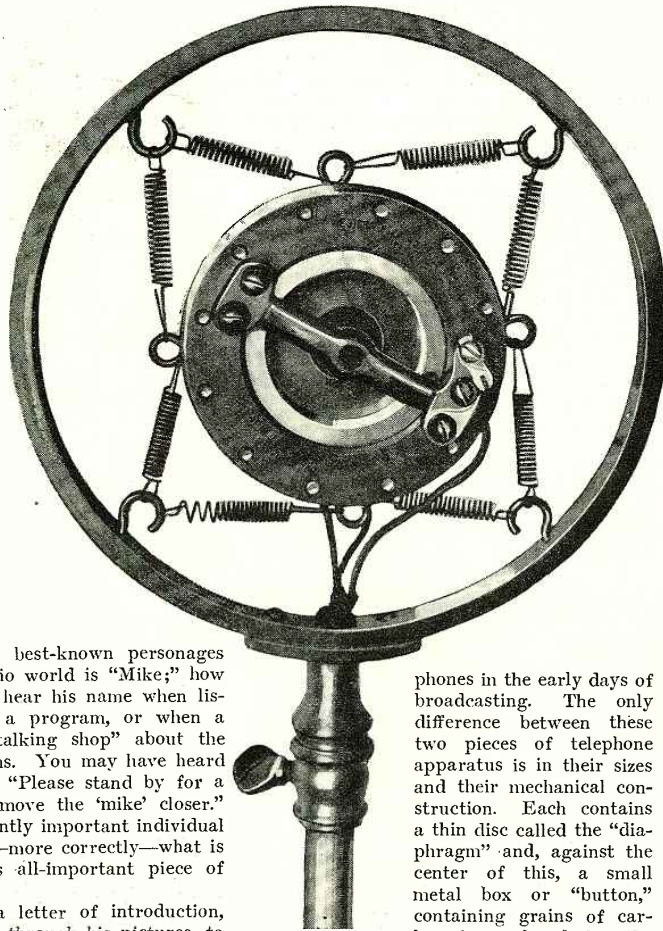

ONE of the best-known personages in the radio world is "Mike;" how often you hear his name when listening to a program, or when a radio expert is "talking shop" about the quality of programs. You may have heard the announcer say "Please stand by for a moment until we move the 'mike' closer." Who is this apparently important individual named "Mike," or—more correctly—what is the nature of this all-important piece of radio apparatus?

This article is a letter of introduction, presenting "Mike," through his pictures, to his many friends in the radio audience. You have often used a telephone, and are most familiar with the mouthpiece, otherwise known as the "transmitter," into which you talk. This, electrically, is exactly the same as the microphone used to pick up programs and speeches at the broadcast station; in fact, the usual type of telephone transmitter was originally used for micro-

phones in the early days of broadcasting. The only difference between these two pieces of telephone apparatus is in their sizes and their mechanical construction. Each contains a thin disc called the "diaphragm" and, against the center of this, a small metal box or "button," containing grains of carbon, is so placed that the carbon presses lightly against the disc. These are, electrically, the only important parts of the microphone; since the other mechanism is used only to support and adjust the relative positions of the diaphragm and the carbon grains.

#### FROM THE AIR TO THE ETHER

Sounds, whether discordant noises or harmonious music, arise from vibrations of the air which are picked up and recorded by the ear. The microphone serves to change the sound-vibrations, caused by talking, singing, or playing of instruments in its neighborhood, into electrical currents which

vary according to the sound which is being transmitted. In the transmission of voice and other sounds, either over the telephone wires or by radio, the sound-vibrations first strike the thin disc (or diaphragm, as it is called) of the telephone transmitter or the microphone, and cause it to vibrate.

Since the microphone's diaphragm is extremely thin, it is susceptible to nearly all vibrations. Care must be taken, in designing a microphone, so that the diaphragm will not have a tendency to vibrate more strongly on one note than on others; as this would spoil the *quality* of the transmitted signals. This tendency to vibrate in resonance with sound-vibrations of any pitch makes it possible to use this disc for a useful purpose. A small metal box partly filled with carbon grains, as explained before, is placed lightly against the middle of the diaphragm, which touches the carbon grains. The size of these grains determines the sensitivity of the instrument.

It can easily be seen from this description that, as the diaphragm vibrates in resonance with the sound waves, it will alternately push against and pull away from the carbon grains in the metal box. If an electric current is sent through the carbon grains, by connecting wires to the metal box and the diaphragm, this current will vary in strength as the carbon grains are compressed and released; since this compression and expansion causes a change in the *resistance* of the circuit. When the carbon grains are tightly compressed, more current can flow than when they are free; as the points of contact are larger—a principle used in making "rheostats." (See Fig. 1.) Thus it can be seen that the sound-vibrations, causing the diaphragm to vibrate, cause a corresponding electrical vibration in the circuit to which the microphone is connected. These fluctuating electrical currents are used in conjunction with other apparatus, either to transmit the messages over wires, in the case of the telephone; or through the "ether," in the case of the radio.

#### CONSTRUCTION OF THE MIKE

Several illustrations of microphones used in radio transmission are shown on these pages. The standard microphone used by practically all American broadcast stations measures  $3\frac{1}{4}$  inches across the microphone itself, and is supported in a frame 6 inches in diameter. As you will notice, it is sup-

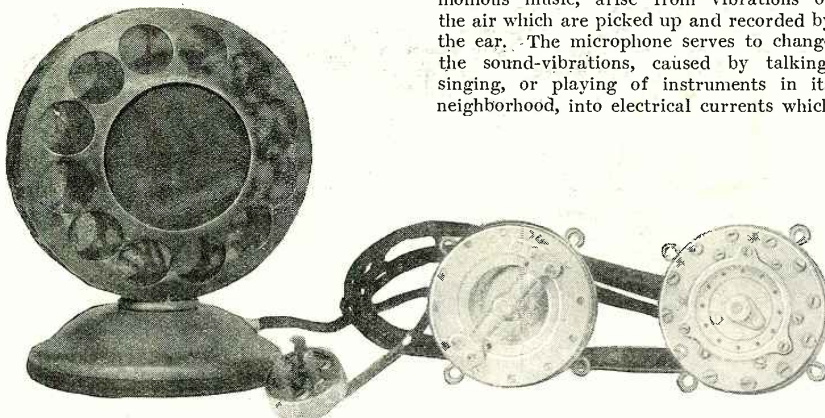

*At the left is shown the microphone housing which was most familiar a short time ago, and is still used frequently for outside work. At the right, the "works" of two such "mikes," showing the front and back surfaces.*



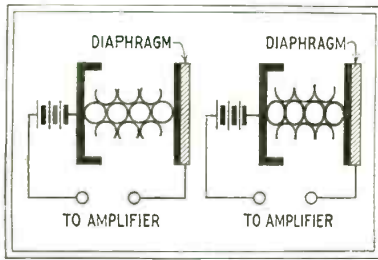

FIG. 1

The action of the carbon "button" is shown here in greatly-exaggerated form. The resistance decreases as the contacts flatten out.

ported on four springs so that mechanical vibrations cannot affect the quality by introducing rasping noises, etc., which might be caused by mechanical vibration of the supporting frame.

The large illustration at the bottom of this page shows one of these microphones, cut away so its internal construction can be seen. In this case, two carbon buttons or boxes containing carbon grains are used, one at the front and one at the back of the diaphragm. The parts of this microphone are lettered and are as follows: A, the bridge which supports the front carbon "button," or box holding the carbon grains; B, the clamping plates which serve

to hold the diaphragm firmly in place; C, the diaphragm; D, the front carbon button; E, the rear button; F, the small carbon grains; G, paper rings or gaskets which are used to hold the carbon grains in the box, while permitting a free vibration of the diaphragm; H, the rings which hold the paper gaskets in place.

The metal used in the diaphragm of this transmitter is an alloy of aluminum which supplies both strength, lightness and flexibility. The disc is about .002-inch thick or slightly heavier—about as thick as a good grade of tissue paper. This metal sheet is stretched in the frame or clamping rings, so that it will be perfectly flat. The carbon grains in this type of microphone are quite small, since great sensitivity is required.

Well, folks, you now know just who "Mike" is and what he is used for. When the announcer says "Please stand by for a moment until we move the mike closer," you will know that the distance between the microphone and the artist is too great to permit the sounds to be picked up correctly and it is necessary to move the microphone. The wires running to the microphone are, almost always, equipped with a switch; so that the announcer can disconnect the microphone from the circuit when the musicians are tuning and when it is necessary to shift the microphone to

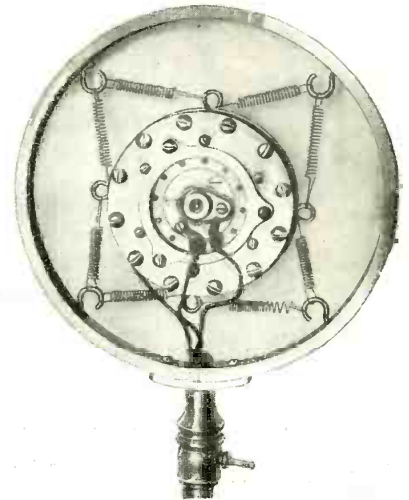

The back view of the studio microphone is shown here; the mounting screws and the terminals for connecting wires are located on this side.

another point in the studio. This is the reason why you do not hear the announcer, in a well-managed studio, anxiously request the name of the next selection, or excitedly explain that the bass viol is out of tune, making the transmission sound "terrible."

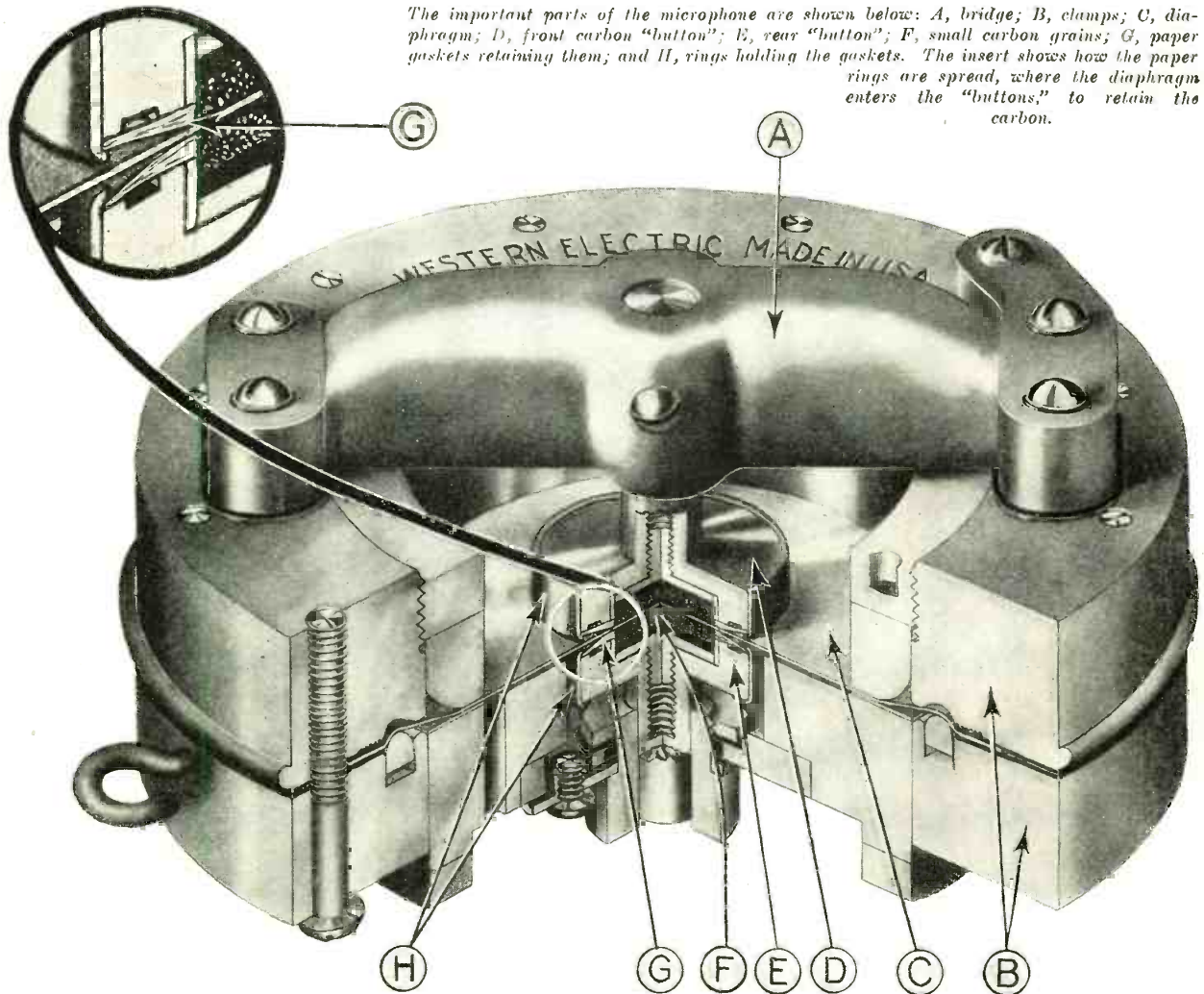

The important parts of the microphone are shown below: A, bridge; B, clamps; C, diaphragm; D, front carbon "button"; E, rear "button"; F, small carbon grains; G, paper gaskets retaining them; and H, rings holding the gaskets. The insert shows how the paper rings are spread, where the diaphragm enters the "buttons," to retain the carbon.



## A Tip to the Caterer

Editor, RADIO NEWS:

I wish to make a comment on Mr. Larson's letter which was published in February. The portion I have in mind runs as follows:

"Let the stations be thick and close together, as it will kindle the desire to build and invent more selective receivers which will in time be able to tune them in and out to the tenth and fiftieth of a meter..."

Mr. Larson signs himself as being of the Naval Radio Station at Guantanamo Bay, Cuba. For a radio man he shows either a lack of knowledge or a superabundance of thoughtlessness. A little thought will show anyone that a receiver so selective as the ones he expresses himself as desiring would cut sidebands to the nth degree. I suppose that it would be all right for bass-note reproduction, in fact, it should be exceptionally good for that purpose; but for my part, I prefer to hear something else beside 30-cycle notes.

Perhaps Mr. Larson would be interested in knowing that there are receivers which will separate stations less than one-fiftieth of a meter apart. However that is in the 5-meter band, not in the broadcast band—to which, I believe, Mr. Larson was referring.

For a lowly, struggling servicer who doesn't even hold an amateur "op's" license, this letter may sound a trifle "high-hat," but you must take it in the spirit in which it was written.

May I state that I entirely agree with Mr. J. E. Kitchin except insofar as his views on "The Listener Speaks" and "The Home Constructor" go. He is doggone right about the rest of the magazine. I don't like the type you used in the February

issue because it is too hard on my eyes. Other people may like it but not Robert C. Potter.

Like Mr. Larson, I realize that you are, no doubt, catering to the majority.

Even QST is becoming feminized. The only thing that is not is *The Proceedings of the I.R.E.* and I hope they never will be.

I will say that RADIO NEWS is the best all-

band. The best of inventive minds are working on the problem. As for the type in which RADIO NEWS is now printed, it was selected especially for its legibility. If other readers agree with Mr. Potter, we shall be glad to hear from them. This is your magazine, and we want you to feel free to criticize it whenever you see an opportunity to do so. Brickbats will be received cheerfully, as well as bouquets.  
—EDITOR.)

*THIS page belongs to the readers of RADIO NEWS. It is theirs for the purpose of discussing fairly and frankly the needs of broadcasting from the standpoint of the great public who listen in. The letters represent, not necessarily the editorial opinion, but that of the writers; who are, in the editorial belief, fairly typical of groups of opinion among the radio public. Make your letters concise and offer constructive criticism when you can; remembering always that there is something to be said for the other fellow's side.*

Address The Editor, RADIO NEWS, 230 Fifth Avenue, New York City.

round radio magazine on the market today; but it does not contain much that is of interest to the experimenter who can not afford a transmitter. In fact, there is no magazine that does.

I hope that this will be taken in the spirit in which it was written.

ROBERT C. POTTER,  
R.R. 3, Beamsville, Ontario.

*(It is not impossible that receivers will yet be invented which will tune successfully to the fiftieth of a meter in the broadcast*

## "You Can't Get Nothin' for Nothin'"

Editor, RADIO NEWS:

The letter in the February issue which is titled "The Navy to the Rescue" is about as funny a contribution as I have had the pleasure of reading in some time—truly, it's a joke of the first water—naval type.

I hold no brief for the chap from South Dakota—or his views—but when anyone suggests that the listener in North Dakota is getting his radio entertainment for nothing that's a good place for a raucous laugh.

Getting radio entertainment for nothing? Huh—I suppose that chap in Cuba thinks he is getting the entire value of the contents of RADIO NEWS every month for his two bits. Far be it from so—just how long would the owners of RADIO NEWS continue to give what they do for a quarter of a dollar per copy if they carried no advertising? YOU TELL 'EM. Presumably Cuba thinks that he is paying for all he gets when he gives up a jitney for the Saturday Evening Post—and that he gets nothing for nothing. That nickel for the S. E. P. wouldn't pay the cost of printing and transportation. Who pays the authors?  
(Continued on page 1292)

# A World-Wide Election by Radio News Readers in 1928

SINCE RADIO NEWS is edited and published for you, the problem of giving you exactly what you want is always foremost in the minds of its editors. They have two ways of finding out—first, to give you what they think you want, and wait to see if you continue to be a reader—and, second, to come out frankly and ask you to say what you want.

This election, therefore, is to learn how many of you want one thing, and how many another; what you want to read more of, and what you want dropped. Whatever most of you vote for, the editors will see that you get more of; they have no reason to impose their personal likes or dislikes in the matter. The editorial selection of articles

for RADIO NEWS is governed by your preferences, so far as they can be learned; and it is up to you to express your suggestions for improvements in this magazine to suit your taste. We trust that you will consider it your privilege, no matter where you live, no matter how long you have been a reader, to fill in the ballot which follows, and send it to the Editor. It will be carefully checked and counted.

If you do not wish to cut your copy of this magazine, a note or a card indicating your principal preferences and suggestions will be gladly received. If you dislike anything, tell us; if you wish any subject given more attention and lengthier description, feel free to say so. Sign your name or not

as you prefer; but if you do not sign and are a woman, please indicate the fact—for RADIO NEWS wishes to be equally interesting to all in the household and to carry articles of special interest to our feminine readers, whom we know to be already numerous.

The result of the voting will be announced, as soon as a sufficient number of ballots have been received; and the wishes of the majority will be respected. Departments will be retained only if they meet the demands of a substantial element of our readers; those which are favorites of the greatest number will be improved and enlarged. Vote early—and often, if you wish.  
(Ballot on page 1275)



**Sylvia  
Miller**

*Youthful soprano  
who is featured re-  
gularly in the Sunday  
evening broadcasts of  
the Capitol Family  
through W&A and  
its chain of stations.*



*Mitza  
Stillman*

*One of America's  
foremost viola play-  
ers, who is heard  
frequently over the  
Columbia radio  
chain as a soloist  
on his instrument.*



*Adelaide  
De Loca*

*A frequently-featured artist in the weekly program of Roxy's Gang from the WJZ network. She has sung many contralto parts. —*

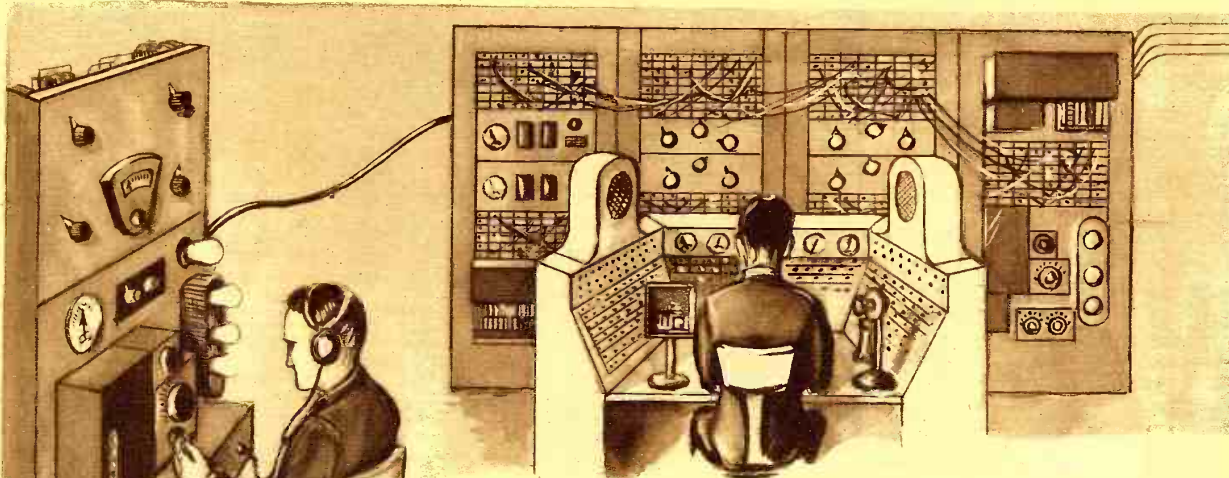

## How Broadcast Programs

Careful Study and Painstaking Operators "Behind the Scenes"

By G. C.



**T**HE general conception of the method of broadcasting a program, entertained by the average listener, is that a microphone is placed before a performer and somehow or other the music goes out on the air from the transmitting antenna and is received by his set. The intermediate steps through which the electrical energy goes, between the time the artist performs before the microphone and the time the signal reaches the transmitting antenna, are varied and interesting, though not popularly understood.

It is common knowledge, of course, that during these steps the energy is magnified to an enormous extent, but that is not the entire story by any means. Let us consider the various processes which must be gone through between the time it is decided to

broadcast a program and that when the transmitting antenna is energized.

### ARRANGING THE PICK-UP

As an example, let us trace the operations necessary for the broadcasting of orchestral music from a night club in New York City over WEAJ and its chain of stations, the Red Network. First of all, an engineer must install the microphones (two of which are used in an ordinary orchestral broadcast) in such a way that every instrument in the ensemble will be picked up with the proper volume. This placement is very important; for if the microphones are placed so that the saxophones are too close to them, for instance, then the music from these instruments may drown out that of the violins.

The quality of the music is, of course, affected by the surroundings. In some cases it becomes necessary to "dampen" the hall by hanging draperies about to cut down the echo. In other cases no hangings are required; for a certain amount of echo is needed to give naturalness to the music. In the case of a large orchestra there must be in the music "brilliance," provided by the string instruments, and the microphones must be so placed that these high tones are not impeded in any way.

When the proper position for the microphones has been found the amplifier and the microphone mixer are placed so that their operator will have an unobstructed view of the orchestra leader.

### TESTING THE LINES

Then the telephone lines from the night club to the National Broadcasting Company's building at 711 Fifth Avenue are tested to see that they will carry the entire range of frequencies required in the proposed transmission. This test is not made with music or by ear, because of the deceptive variation of human hearing. Different



Below, the scene of "remote control"—a night club in New York. Follow the pictures around.

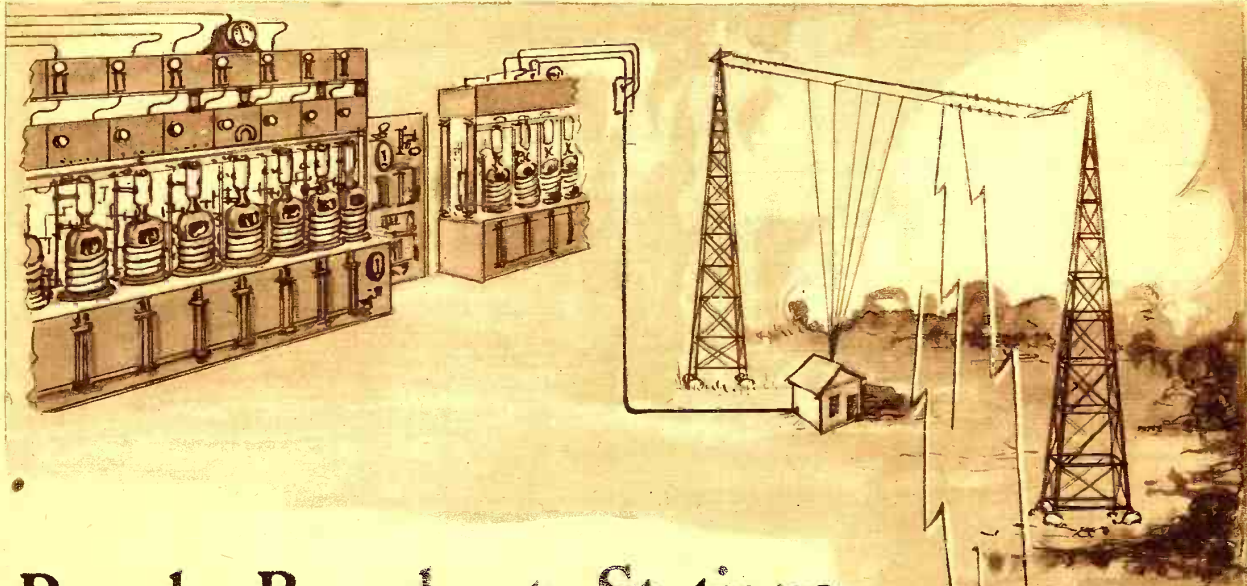

# Reach Broadcast Stations

Attention Required of Unheard From Studio to Transmitter

B. Rowe

notes are introduced into the lines by an oscillator, giving a range of frequencies covered by an average orchestra's program; these frequencies are measured by a meter. These tests show also whether the lines will carry the necessary frequencies at equal volume; which is an important point for the same reasons as those given above for the proper placing of the microphone.

In the microphone mixing panel the proper proportioning of the frequencies is made for the particular "set-up." The amplifier, which is connected with the mixing panel, is used to "boost" the output of the microphone, so that there is a high ratio between the volume of the music and the noises on the telephone lines. On the output-side of this amplifier is a galvanometer, which functions as a volume indicator, and it is at this point that programs can be made or marred.

To make this point clear, it is necessary to digress for a moment. It has doubtless been the experience of the reader, when listening to a large orchestra, to have certain passages that are played *fortissimo* ring in his ears. On the other hand, some portions of the same selection were played so softly that it was almost impossible to hear them at all. In other words, there is a ratio between *fortissimo* and *pianissimo* of approximately fifty to one; that is, the loud parts are approximately fifty-times louder than the soft parts. (This ratio, of course, varies with every selection played.) When music is broadcast this ratio must be greatly reduced; as the average receiving set has a ratio of selective audio reproduction amounting to only six or eight to one. This means that, if the volume of the music at the place of pick-up were undiminished, it would blast at the loud speaker and be greatly distorted.

### CONTROLLING THE VOLUME

It is the function of the volume-indicator

meter to show just how the music is going over. The scale of the meter is divided into 100 divisions and, as the music is played, the needle of the meter is continually varying according to the intensity of the music. Now, in order to keep the volume within the desired limits, we will say that the needle must not go above 60 for *fortissimo* passages and below 30 for *pianissimo* parts. The operator must see to it that these limits are never exceeded, and he controls the volume by a rough and fine adjustment.

The control of the volume may be likened to that of an automobile traveling along a road through hilly country. It is desired to maintain a speed of at least 30 miles per hour going up-hill, and not to exceed 60 miles per hour on the down grades. The accelerator will often have to be used on

(Continued on page 1260)

At the bottom of the opposite page, we see the microphone placed to pick up with equal fidelity all the instruments of the orchestra. Above is the "remote-control" operator sent by the broadcaster to the point where program is given, with his portable "mixing panel." Above is the "monitor" at the central control station, correcting the signals before they go to the distributing switchboard at the right. From the latter the program is sent out to the local transmitter, as well as to other stations on the same chain. The familiar steps by which it is radiated and received in the home follow in order.

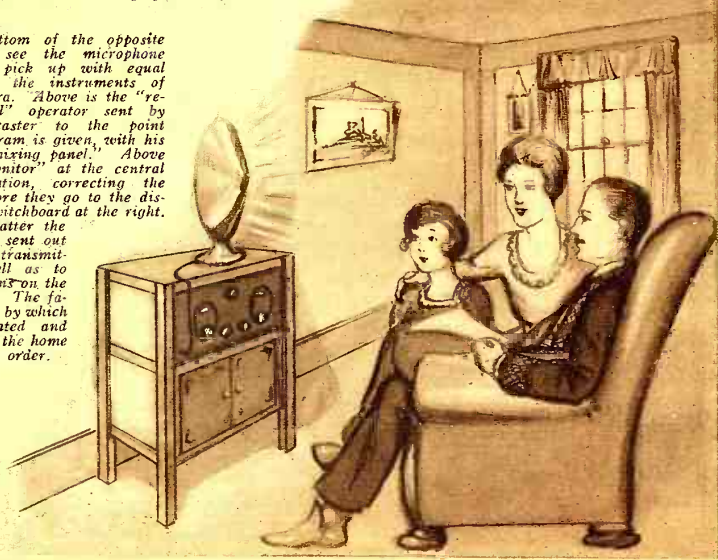

# In the BRIGHT Darkness



BY

C. Sterling Gleason



**I**N the offices of his great motion-picture studios, Harold Dare, hero of a thousand Flicker Films, held conference with his engineers. "What have you unearthed, men, that required this urgent call?" he demanded. "Is it possible that Dandy Diavolo, my unscrupulous arch-enemy, proposes to perpetrate another perfidious plot?"

The great Scott, chief of the stern-faced, silent group, addressed him.

"Yes, Mr. Dare, you have pierced directly to the heart of the matter. Our detectives have unearthed conclusive evidence that Dandy Diavolo has purchased machine guns, rifles, and ammunition, which he proposes to smuggle to the rebels in the South American republic of Habanera. Knowing how anxious you are always to further the ends of justice, I felt it my duty to apprise you of our findings."

"You have done right, Scott," approved Harold Dare. "We must foil this dastardly attempt to further strife and bloodshed. Diavolo's present plot is perfectly on a par with his past performance. Little cares he for the letter of the law, the spirit of the Monroe Doctrine, the Constitution, the Eighteenth Amendment, or any of those glorious principles for which our forefathers fought, bled and died—"

"Exactly," agreed Scott. We await only your word to go forward with plans for the foiling of Diavolo's plot. We realize

that it is your first duty to your public to maintain your schedule of pictures; but we assure you that while you are giving heart and soul to your work, we will be doing our utmost to devise a plan that will foil Diavolo very thoroughly."

"Scott," spoke Harold Dare, his heart touched by such devotion, "you are right. My first duty is to my Art. Go! do your utmost. I am behind you. Prepare everything. Spare no expense. Assemble your men and await me tonight at the dock. I shall conduct the work in person. And, again, the attempt to smuggle the guns must be foiled; but, also, Dandy Diavolo must be made to suffer the consequences of this outrage. Some means must be devised to prevent his throwing the arms overboard when he is discovered. We must procure positive proof that will fasten the crime upon him."

"Mr. Dare," replied Scott, "the entire Dare technical staff will weave a web to entangle this arch-fiend, whose fell design it is to flout the forces of law and order. We shall devise such a means."

Standing on his platform, behind the battery of cranking camera-men, Director Topping, of the Flicker Films, raised his megaphone. "Cut!" he bellowed. "That will be all for today." The great Kliegs died. From every corner of the huge set, extras, electricians, cameramen, and yes-men, poured forth. Stars came hurrying past, nodding to the directors, and disappearing through their private exits into the

inner court, where a dozen incredibly long and splendid automobiles waited to whisk them away. Among them, beautiful Rose Blush, charming ingenue of the Flicker Films, came tripping through the door and stepped into her glistening new 1930-model Hexpenso-Wheeza limousine. "Home, Jimmy," she murmured. She sank back on the goofer-feathered cushions and closed her eyes, while the great car rolled smoothly down Hollywood Boulevard and toward the lights which sparkled on the hills overlooking the city. A sudden swerve of the car threw her to a sitting position. She screamed. On the running board stood a man, holding a pistol to her chauffeur's head. The car stopped with a jerk. The doors opened; arms clutched her and carried her toward a great black sedan at the edge of the road. Again she screamed. Something wet and sweet-smelling was thrust under her nose. As she sank into unconsciousness, she glimpsed an incredibly evil, sneering face, and heard the hard ring of a cruel, mocking laugh.

In his luxurious town car, Harold Dare was being whirled swiftly toward the wharf. A signal flashed red, a semaphore rose, and an endless stream of traffic poured before them. Newsboys dodged between the halted cars. Dare rapped on the window; a paper was handed to him. A headline met his eye:

#### "FAMOUS FILM STAR DISAPPEARS"

Rose Blush, Flicker Film favorite, missing. Police comb city. Chauffeur held at point of gun as star is chloroformed by bandits in mysterious black car. Foul play suspected.

*Suddenly the man stood up and millions of gasping film-fans recognized Diavolo on the television screen.*

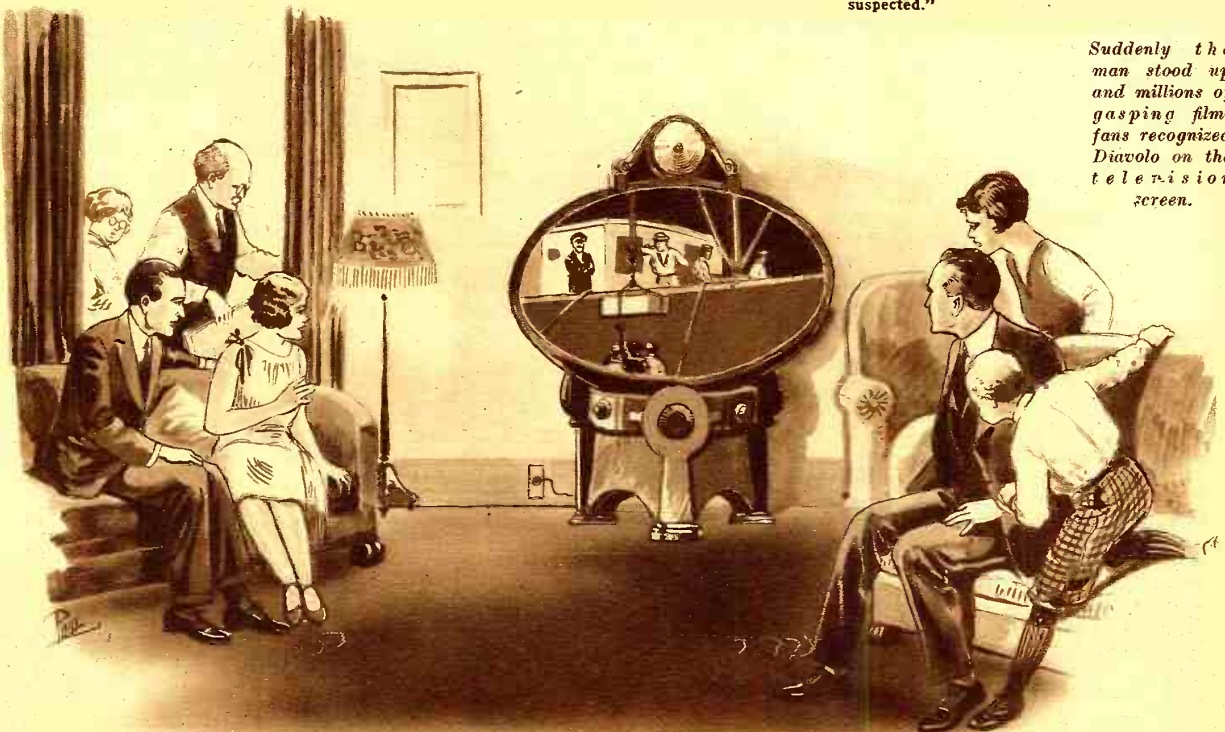





*Then the motor rose to a roar, and a purling of water told that the launch was speeding away from the yacht.*

What incredible catastrophe was this? Only a few hours ago, he had played the hero's part opposite beautiful Rose Blush, in the new Dare superspecial. Now she was helpless in the clutches of some heartless monster, whose evil intentions were only too evident. He must rush to her rescue at once! Yet, his duty lay before him: he must insure the success of his men against that supervillain, Dandy Diavolo, whose perfidious plot threatened the very foundations of international relations. What course should he choose? His keen judgment came to his rescue. If he abandoned his men, their venture would assuredly fail; he himself could do nothing toward finding the missing maiden until he assembled his experts and wove that thorough chain of analysis, which was the secret of his countless previous triumphs over his unscrupulous arch-enemy. In a few short hours, the traitorous gun-runner would be captured, then he could concentrate the efforts of his entire organization upon the search for his radiant Rose. He must take one step at a time.

*The motor-driven cameras whirred; with a cracking sound the huge infra-red-ray generators warmed to their task. Harold Dare jumped into the speed boat, which was off like an arrow for the yacht.*

Aboard his palatial yacht Harold Dare took full command. "Have you everything ready, Scott?" he asked.

"Yes, Mr. Dare," replied Scott, leading him forward on the deck, where a group of grim-faced men sat, silently adjusting instruments by the light of tiny hooded bulbs. In the dim light Dare distinguished various pieces of equipment. Nearby stood a huge concave reflector like an enormous kettledrum. "What is this?" asked Dare.

"This is a paraboloid sound reflector," replied Scott. "It works on the reverse of the principle of the searchlight: that is, it picks up a 'beam' of sound (from one direction only), reflects and concentrates it upon a microphone held by those arms in front of the reflector. This tremendously sensitive sound-detector is now pointed toward Diavolo's yacht. No doubt he also has some such device, therefore absolute silence on our part is necessary."

"And are you prepared to board Diavolo's yacht?" asked Dare.

"Yes, Mr. Dare," replied Scott. "Our yacht has full steam up, and we are prepared to pursue Diavolo, also, in speed boats, hydroplanes, and submarines. The Coast Guard forces have joined us; their

chief and a Federal officer wait alongside in a fast launch."

"Yet I do not see," Dare pursued, "how; without being detected, we are to procure evidence that Diavolo actually took aboard the guns."

"There is the answer to that question," replied Scott, pointing to what appeared to be a bank of huge searchlights, arranged in strong frames along the upper deck, and pointed toward Diavolo's yacht. A bank of motor-driven motion-picture cameras also stood trained on the yacht. "What does this mean?" demanded Dare. "Do you propose to photograph Diavolo and his crew in the light of those search lights? I cannot endorse such a plan. The very instant that that powerful beam is turned upon him, he will abandon his plan and hastily dispose of the guns he has taken aboard. We shall have no evidence of value."

"That is exactly the chain of reasoning Diavolo undoubtedly followed," said Scott. "Yet he does not know that *what to his eyes is darkness, is actually, to the all-seeing eye of the camera, the brightness of noonday.* He will be searched out in the blackest darkness as surely as in the brightest daylight. Those searchlights above you are tremendously powerful—so powerful that the human eye cannot detect them. Our eyes respond only to that narrow band of light rays between the darkest red and the deepest violet; but these great searchlights give light waves longer than the longest visible red. They emit rays of infra-red light, which is invisible to the human eye. These cameras are equipped with color filters, and the film is sensitized to infra-red light, so that when it is developed, everything will appear exactly as it would in broad daylight. Yet, this is not all. The infra-red light that affects the sensitized photographic plate, affects the photoelectric cell as well. Diavolo's movements will be picked up by television ap-

*(Continued on page 1258)*

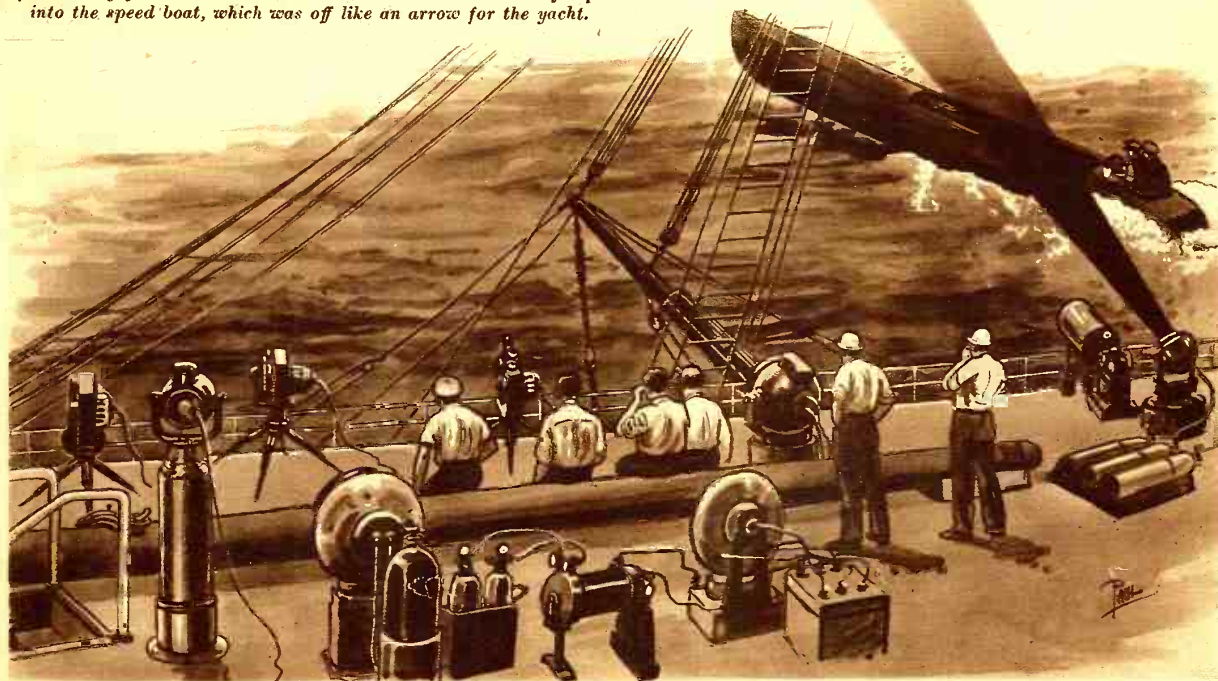

# Broadcastatics



**HOW SHOCKING!**



**INDIGNANT NEIGHBOR:** "Talk about your rabid radio fans, why that man Brown can't think of anything else. A few days ago, when his wife remarked that the baby looked a little 'run-down,'

he went and hooked the poor kid up to the battery charger!"—*H. N. Webster.*

**NO ALIBI LEFT**



**FIRST RADIO FAN:** "Really, you know, you miss a lot by not being married."

**SECOND RADIO FAN:** "Yes; when I fall asleep at my desk next day I can't blame it on the baby."

**CALL DIOGENES**



**MISSOURIAN:** "I don't know whether to believe Bill's DX reports or not."

**HAWK - EYE:** "Oh, Bill's honest. He even writes to the local stations, for verification of selections heard, before he puts them down in his log book!"

**PUT A CONDENSER ACROSS HER**



**RADIO EXPERT:** "Perhaps the three greatest sources of interference are X-ray machines, circuit-breakers and electric railroads."

**THE OTHER FELLOW:** "By, the way, you haven't met my wife, have you?"

**CALL FOR MR. CASEY**

**FAN:** "I got a new radio set, Jim."  
**NEIGHBOR:** "Is that so? What kind is it?"  
**FAN:** "I don't know, but I call it "Football Radio."  
**NEIGHBOR:** "Why is that?"  
**FAN:** "There's a lot of interference in it."—*Stanley Rodnite.*

**SIMILAR CONTENTS**

**FILBERT:** "I really can't figure out what's wrong with my radio set. Maybe I need a new vacuum tube."  
**HICKORY:** "Just use your head, man; use your head!"—*Mrs. Bill Howard.*

**THIS** page is devoted to humor of purely radio interest; and our readers are invited to contribute pointed and snappy jokes—no long-winded compositions—or an original nature. For each one of this nature accepted and printed, \$1.00 will be paid. Each must deal with radio in some of its phases. Actual humorous occurrences, preferably in broadcasting, will be preferred. Address Broadcastatics, care RADIO NEWS, 239 Fifth Avenue, New York City.

**CENSURE NEEDS CENSORING**



**STATION FLUNKY:** "Telephone! Somebody's calling the piccolo player!"  
**CORNETIST (sotto voce):** "What are they calling him this time?"

**A TOWER OF TRUTH (?)**  
*The Woolworth tower looks big and bold,  
 Its stories are many and high;  
 But more and taller the stories told  
 By the one-tube DX guy.*  
 —*Arthur Wolfendale (England)*

**RETALIATION**

**MOTHER:** "What is your father sputtering about?"  
**DAUGHTER:** "He can't get the radio to stop sputtering."—*Gleason Pease.*

**GRIN AND BEAR IT**

**VISITOR:** "Pretty nice, eh Bill, having a radio to entertain you when you've got a broken leg?"  
**PATIENT:** "Well, I certainly can't kick."



**WHAT HE NEEDED WAS EXERCISE**

**FIRST PIANO MOVER:** "You ain't lookin' well, Bill."  
**SECOND PIANO MOVER:** "Naw. Ever since my set went flooic last week I been missin' out on the Daily Dozen hour."



**THE 100 PER CENT FAN**

**BRIDESMAID:** "What? The groom can't show up? What was wrong?"  
**GROOMSMAN:** "Oh, he managed to tune in Melbourne just before train time."



**RADIO RHYMES**



SINCE RADIO CAME INTO STYLE  
 WITH TUNES THAT CHEER  
 AND BRING A SMILE,

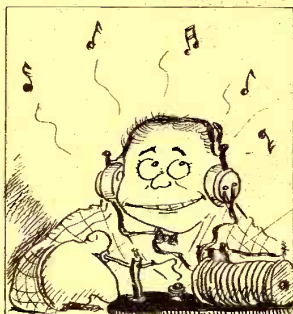

THE ETHER WAVES WITH RAPTURE SWAY --  
 "THERE'S MUSIC IN THE AIR!" WE SAY

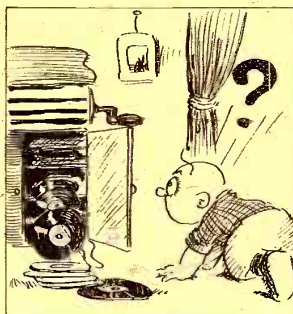

AND HERE'S A CASE THAT YOU CAN TELL  
 IS VERY CLOSELY PARALLEL --



FOR NOW ONE MUST CONFESS THAT THERE IS ALSO "MUSIC IN THE HEIR!"

# Listener Psychology and Radio Reception

How Your Own Frame of Mind at Any Time Affects Your Enjoyment of a Program; A Discussion of a Little-Known Subject

By Charles Magee Adams

**D**ID you ever invite a group of friends in to hear your receiver perform? If you did, you have no difficulty about recalling what happened.

With the air of a proud parent describing the prowess of a first baby, you told them how, the night before, it had brought in stations 2000 miles away—"just like local." Then you twirled the dials, only to make the dismaying discovery that you were doing exceedingly well to get as much as a whisper from stations 500 miles away. At this embarrassing juncture one of your friends suggested, with suspicious readiness, that perhaps atmospheric conditions were not so favorable as on the night before, a diagnosis to which you agreed immediately. But after they left, you worked till the wee hours, checking tubes, batteries, connections, everything that might be wrong with the pesky receiver.

Maybe you did find something wrong, and maybe atmospheric conditions weren't all they might have been. But, be that as it may, the odds are more than even that the chief trouble was psychological.

You have probably heard the man who reaches the ninth hole, six down, offer psychology as an alibi, all too often; or listened to salesmen discourse on psychology as a factor in persuading prospects to sign on the

dotted line. But, as something affecting radio reception, it has never occurred to you. Nevertheless psychology does play a part in reception nearly as important as the state of your receiver or atmospheric conditions, which usually get all the blame and credit.

Radio has two elements, the technical—transmitter, receiver, static, man-made interference, etc.; and the human—the operator, the listener; and whenever you introduce the human element you inevitably, if as a rule unconsciously, must introduce psychology.

### "DIAL FRIGHT?"

That night when you invited your friends in to hear your receiver perform is a typical example. Your set was probably in apple-pie order, and atmospheric conditions excellent. But it failed to do what it had done the night before, simply because you were suffering from a case of "buck fever," or stage fright. You would not have admitted it; perhaps were not even aware of it. But just the same, knowing that your friends were there waiting to see what your set would do, you were a bit excited, nervous; and, as a result, lost that delicate touch, that little margin of skill with the dials indispensable for the best DX work.

In other words, you found yourself in

much the same situation as a young pianist who can perform superbly alone, but who becomes merely mechanical when playing before an audience; though, if your friends had not been there, you could probably have done just as well as the night before.

I hope you begin to see by this time that psychology plays an important part in radio reception; for it does, even though as a rule this is not recognized.

### "IS THERE COTTON IN YOUR EARS?"

As another example, you have no doubt tuned in some evening and, after listening a few moments, remarked that "the set doesn't seem to be as loud as it should." A check-up may show everything about the receiver as it should be. Yet the lack of volume persists; and you conclude that the station to which you are listening must be using less power than normal, or that atmospheric conditions are bad. Either of these explanations may be correct. But the chances are that your psychological response is simply below normal.

If you are tired and distracted after a trying day, or if you have been subjected to excessive noise a short time before, say, riding through the evening traffic, your hearing will be dulled. As a result, volume

(Continued on page 1265)

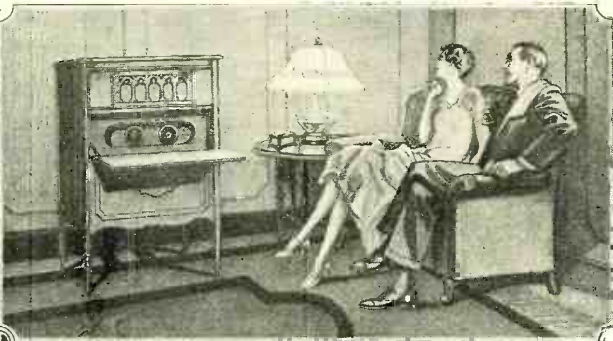

When you're alone with your set and feeling at ease, you can make it work wonders; but when company is present you get "dial fright," and everything seems thoroughly hopeless.

When the house is quiet and you can sit back comfortably, you are able to really appreciate a talk or a musical rendition; but, if the local atmosphere is irritating, everything will sound "sour."

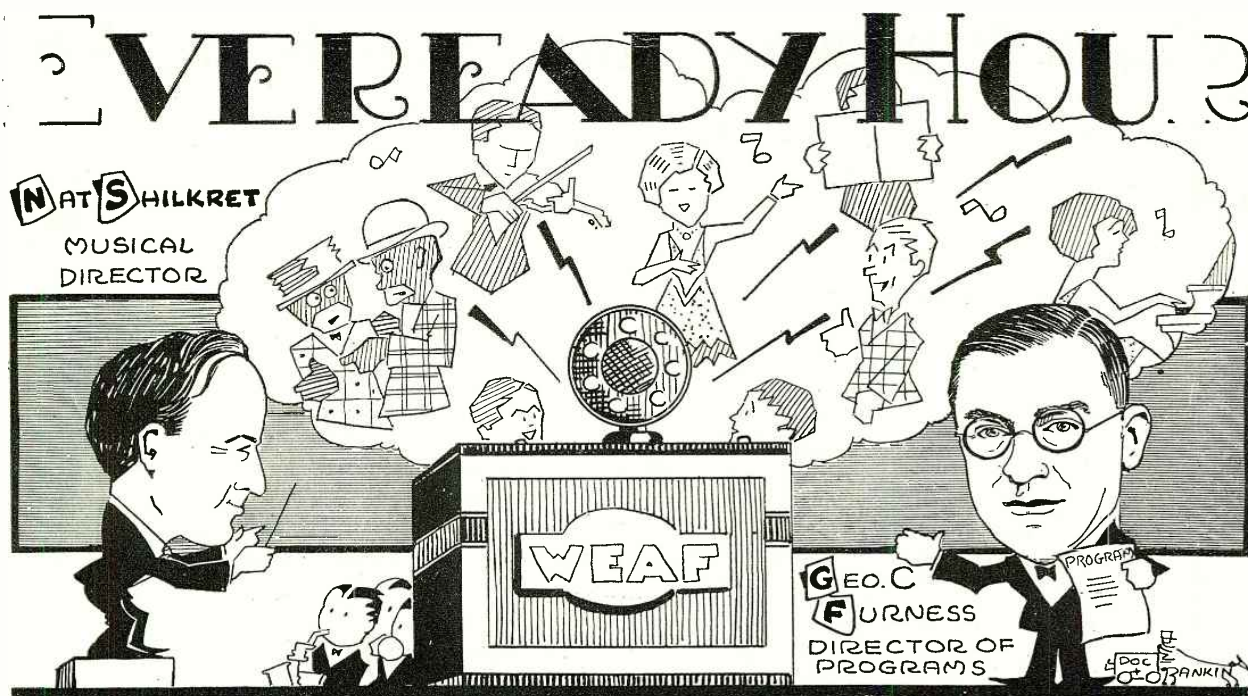

By Julia V. Shawell

**R**ADIO entertainers have come and gone. Waves of popularity have raised artists and features to celebrity, and receded again. There have been many ups and downs in an industry yet so young. Whole organized periods have disappeared and new modes of entertainment have followed them. But the oldest commercial broadcaster on the air is still holding its place, and is sold more than ever on the value of radio as a medium of exploiting public favor.

Of all the toll-time periods now sent out on the ether, the Eveready Hour is pioneer. Back in December of 1923—and that is a long way back in broadcast annals—the National Carbon Company first engaged the facilities of WEAF for its Eveready period and, since that time, the public has been confident in turning, with the assurance of a worthy entertainment, to whatever this organization has offered on its program.

There is no place where American broadcast stations are received, no matter how remote, where the Eveready Hour is not known as one of the finest of all air features. It revealed an early high standard of performance in its infancy, and has maintained that standard ever since. It has changed its form of program, it has taken advantage of new possibilities in holding its hearers and gaining further attention but, in more ways than one, the Evereadytes have been leaders of broadcasting ideas.

That this hour has been commercially a successful one for the National Carbon Company, in building up its battery business, is only part of the story. At least, it emphasizes what one company has been able to do with a consistent policy of air exploitation, backed by an even more systematic campaign of following up its radio programs with the printed word.

#### INTRODUCING A NEW IDEA

The "continuity" idea was first tried out by Eveready, and some of the finest pro-

grams ever broadcast may be credited to this hour. In every new season its executives have carefully worked out plans for entertainment. They have sought novelty, promoted new ideas and at the same time carefully avoided any repetition that would reach the boring stage.

Since the inaugural program on December 4, 1923, G. C. Furness has been Eveready's air pilot. As manager of the radio division of the National Carbon Company, he has been directly and finally responsible for every weekly feature that has gone out. Paul Stacey, then director of the entertainment, evolved the plan for writing a continuity plot around musical broadcasts; just how generally this method has been adapted may be realized by tuning in on any hour now. Last year, Mr. Stacey took up other work and Douglas Coulter has been arranging the Eveready presentations since that time.

It was also Eveready which first sent out a radio entertainer to make personal appearances. Their ambassador was Wendell Hall, one of the most popular of the early artists on this hour, who went out on a regular barnstorming tour of the country in the fall of 1924; but more of that later.

Nathaniel Shilkret first gained a radio following through his orchestral direction in these programs and the Eveready Revellers now have an international reputation. Some of the names best known in other fields which have been recruited for various Eveready hours include: Eddie Cantor, John Drew, Ignaz Friedman, Julia Marlowe, Lionel Atwill, George Palmer Putnam, D. W. Griffith, Beatrice Herford, George Gershwin, Francis Wilson, Van and Schenck, Belle Baker, Laurette Taylor, Richard Dix, Elsie Janis, the Flonzaley String Quartette, Ernest Hutcheson, Weber and Fields, "Bugs" Baer, Pablo Casales and a host of others.

From little incidents in the busy lives of individuals, important events develop; and the Eveready Hour, while it was bound to materialize in an organization with the foresight and wide scope to be found in that company, was hastened by a Sunday afternoon radio program sent out from Newark, N. J.

#### RADIO SELLS ITSELF

On a hot-summer Sunday afternoon in 1923, Mr. Furness tuned his crude little set to WJZ's program from the old Newark station. He heard Edgar White Burrill broadcasting a dramatic presentation based on Ida Tarbell's "He Knew Lincoln." Mr. Furness was what his family called a "radio nut" even in those days, but this particular program held him spellbound, and he pondered on how much influence this sort of thing could have on countless people who might be made to listen in. He then conceived the idea of his own company's radio activities and, on every Lincoln's Birthday since, the Eveready Hour has been built around Mr. Burrill's offering of that same selection.

The month of December, that same year, found the Eveready period, at irregular intervals on the air, devoted to a minstrel show, to poems by Edwin Markham, or to a sketch, "The Governor's Lady," with Emma Dunn. Throughout the early part of 1924 the company was expanding its business, while the Eveready entertainers kept their places before the ever-growing radio public. But there was no definite time for them. Occasionally they went on the air three times a week. Sometimes they appeared only once a week. But even through this irregular stretch, they presented imposing programs offered by Cissie Loftus, May Irwin, Yap's Hawaiian Ensemble, Ernest Thompson Seton, etc. Then, in September of that year, arrangements were made to engage an hour a week on

(Continued on page 1273)

# Around the Musical World by Radio

Musical Appreciation Taught in a Series of Attractive Programs Based on National Melodies



ONE of the greatest gifts of radio, especially with the wonderful fidelity of reproduction obtained from modern receivers, to the great audience of music lovers is an increased appreciation of the finest interpretations which trained artists can give to the masterpieces of great composers. This applies not merely to the classical music which requires long training to value at its full worth, and which will always be limited in its appeal, but also to those melodies which speak of the soul of a people. As there are many languages now stirring the ether from radio stations in every land, so there is a distinct element of nationality in music; but this universal language has the inestimable advantage of being intelligible to all.

The national music of a people stirs the hearts of those among whom it originates, as does "one's mother tongue in a far

land"; but it nevertheless has a charm of its own to those who lend a listening ear to the interpretation of a nation's emotions. At the foundation of national music, however complex its development, lie the simple, pleasing melodies which are the spontaneous production of a people.

To combine pleasure with instruction in the myriad languages of music has been the fundamental idea of the series of weekly programs which have been broadcast during the past year from the RADIO NEWS station, WRNY, through the co-operation of the New York Edison Company; and thousands of appreciative letters from our readers show how this remarkable feature has become a looked-for event in their weekly radio calendar. To enhance its value to the radio audience, a handsome book dealing with the series of current programs of the Edison Hour has been prepared by

Josef Bonime, director of the well-known Edison Ensemble; and in interesting form it describes the characteristics of the music of some forty peoples, which are topically arranged in the programs of the coming season. To this little volume has been given the appropriate title of *The Music Map of the World*; and it will be a welcome addition to the bookshelf of every lover of radio music.

All trained lovers of music can readily distinguish the national characteristics in the music of different countries; for through years of listening they have learned to associate certain moods of music with certain races. There is something in the music of a country that labels it as peculiar to its people, and it is with these characteristics that *The Music Map of the World* deals.

(Continued on page 1291)

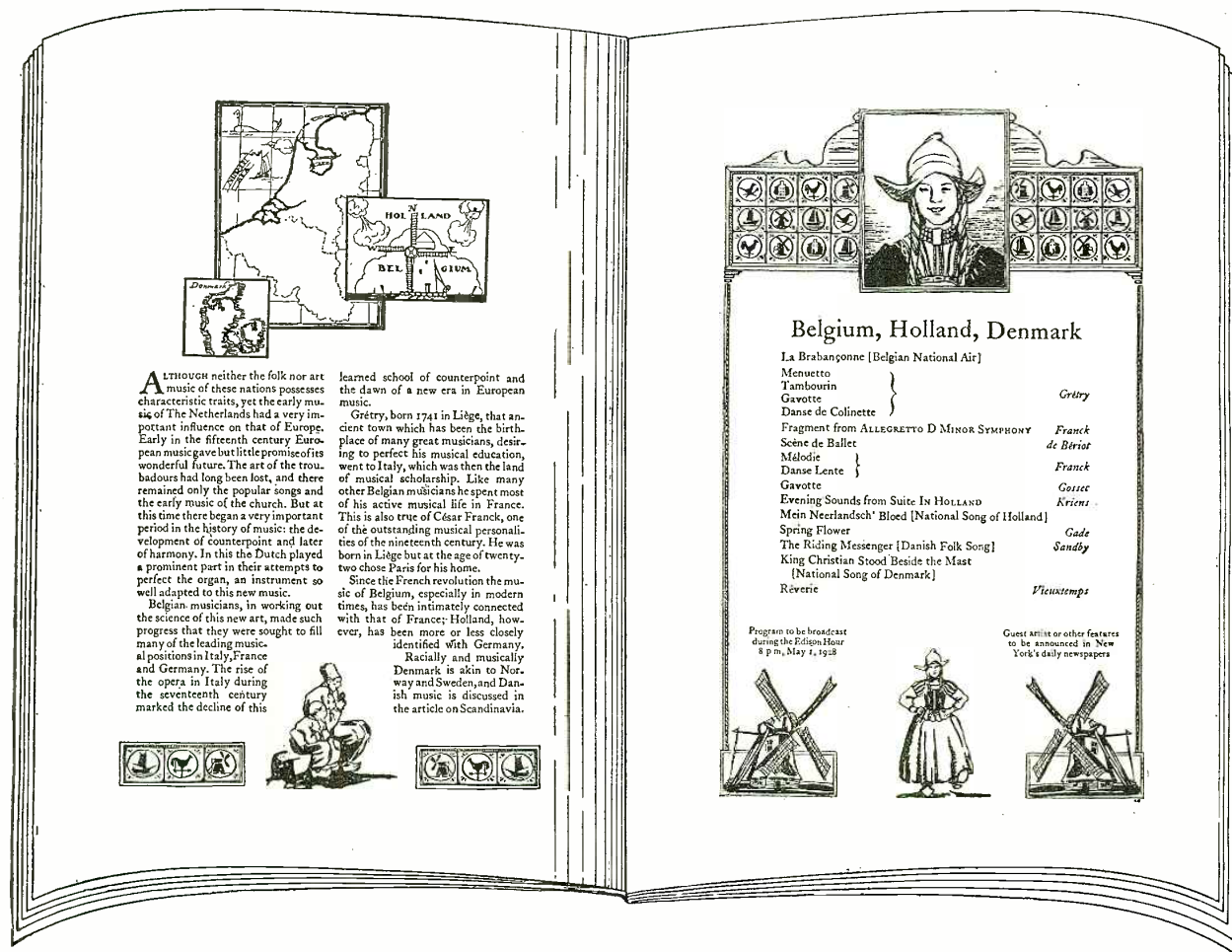

ALTHOUGH neither the folk nor art music of these nations possesses characteristic traits, yet the early music of The Netherlands had a very important influence on that of Europe. Early in the fifteenth century European music gave but little promise of its wonderful future. The art of the troubadours had long been lost, and there remained only the popular songs and the early music of the church. But at this time there began a very important period in the history of music: the development of counterpoint and later of harmony. In this the Dutch played a prominent part in their attempts to perfect the organ, an instrument so well adapted to this new music.

Belgian musicians, in working out the science of this new art, made such progress that they were sought to fill many of the leading musical positions in Italy, France and Germany. The rise of the opera in Italy during the seventeenth century marked the decline of this

learned school of counterpoint and the dawn of a new era in European music.

Grétry, born 1741 in Liège, that ancient town which has been the birthplace of many great musicians, desiring to perfect his musical education, went to Italy, which was then the land of musical scholarship. Like many other Belgian musicians he spent most of his active musical life in France. This is also true of César Franck, one of the outstanding musical personalities of the nineteenth century. He was born in Liège but at the age of twenty-two chose Paris for his home.

Since the French revolution the music of Belgium, especially in modern times, has been intimately connected with that of France; Holland, however, has been more or less closely identified with Germany.

Racially and musically Denmark is akin to Norway and Sweden, and Danish music is discussed in the article on Scandinavia.

## Belgium, Holland, Denmark

- La Brabançonne [Belgian National Air] Gribry
- Menuetto Franck
- Tambourin de Bériot
- Gavotte Franck
- Danse de Collette Gossec
- Fragment from ALLEGRETTO D MINOR SYMPHONY Krieger
- Scène de Ballet Cade
- Mélodie Santby
- Danse Lente Vieuxtemps
- Gavotte Gade
- Evening Sounds from Suite IN HOLLAND Santby
- Mein Neerlandsch' Bloed [National Song of Holland]
- Spring Flower Gade
- The Riding Messenger [Danish Folk Song] Santby
- King Christian Stood Beside the Mast [National Song of Denmark]
- Réverie Vieuxtemps

Program to be broadcast during the Edison Hour 8 p. m., May 1, 1928

Guest artist or other features to be announced in New York's daily newspapers

A reproduction of typical pages from "The Music Map of the World," which contains the itinerary of this radio cruise to forty or more foreign countries and their musical shrines.

List of Broadcast Stations in the United States

Table listing broadcast stations across the United States, organized into four columns. Each entry includes the Radio Call Letter, Broadcast STA. Location, Wave (Meters), and Power (Watts). Stations are listed alphabetically by call letter within each column.

THE list of stations here corresponds to the latest list of licenses issued by the Radio Commission; and is subject to changes ordered by the regulating authority after March 15, 1928.

\*Allowed higher daylight power. \*\*Standard or constant-frequency transmission. † Remote Control.

(Continued on page 1251)

# A Britisher Chats on Radio

A Breezy Discussion of the British Broadcasting Company,  
Its Listeners, Their Trials and Tribulations and What Not



By E. Blake

**R**ECENTLY in London Town Harry Lauder gave a farewell broadcast to Britain, before setting out for a tour of the United States of America. He has said here that he does not expect to broadcast in your country; I think he has some notion that he will be unable to roll his r's properly if his "turn" should be sandwiched between a coon song and an advertisement relating to "Zeileiger's Zero Cold-drawn Molasses;" but I have a bet on that Harry will risk it if one of your Broadcasting people begin to talk figures. Harry will roll his r's for dough, charity or friendship; but never for his health alone.

Among other candid confessions he told us that he had been saving hard; so hard, in fact, that he had not bought a box of matches for a year. Being an amateur statistician I began to calculate what he had saved by that self-denial, on the assumption that he uses one box per day; and this led me easily to an estimate of what the English, who evidently supplied him with his matches for nothing, must have lost. And then I came to the solar plexus of our economic system—money; a delicate oint!

#### THE GOLDEN HOARD

We have no gold worth mentioning, except our souvenirs. What are our souvenirs?

It's like this; when in 1916 I learned that the War Office was to appoint a committee to consider the advisability of destoning the troops' plum jam, I realised that the war was going to last for a long time. So I, in common with a lot of other people wrapped a golden sovereign (£1 or four-point-something dollars) in paper, together with a golden half-sovereign, and locked them away in a safe "for auld lang syne." These coins are nowadays produced on Sunday evenings before the astonished eyes of my children (born since 1914) while I tell them the story of the bygone English "quid" and its departed glory.

But we have lots of paper money and very handy it is. It has no such a nice, rich golden feeling as the sovereigns, but is much safer and easier to carry. And print is cheap. So we have no lack of pound notes and, as I heard a man in the Waldorf bar say today, "there's enough boodle blued (*i.e.*, spent) per annum on radio in England to keep the northern Mexican border quiet for a week." A sad-faced fellow (gink or gu'y) who had just walked across from the Bush Building opposite—an American, I believe—lowered his glass of barley-water and said, "Yup! And if it were spent on the supply of ice-water and bathrooms in your English hotels it would cement the friendship of the English-speaking peoples for half a century."

Here follow a few figures, worked out by the writer, confirmed by slide-rule, checked by the Astronomer-Royal, and guaranteed by King George Fifth.

#### A NATION'S EARS

At the end of November, 1927, the number of licensed radio receiving sets in Britain was 2,355,600; which is equivalent to one set per 14 head of population, including Swiss waiters, Belgian barbers and Greek ice-cream magnates. (Yes, we have them here too!). That, as we say here, is not so dusty. It means that we use one set for every 3.63 families, not counting the boarders or "lady helpers."

Blind persons in this country do not pay license fees; 10,200 free licenses have been issued to the blind, and most of their apparatus has been given to them by radio manufacturers.

With such an enormous amount of listening going on in a small community, it is not surprising that our anthropometricians report that last season's crop of population (young Brits) shows distinct signs of evolution towards "elephant's ear." It is estimated that in five years our schoolboys will not need to wear collars and that washing behind the ears will have become a national problem. This is all on the assumptions that we don't have to fight the Chi-

(Continued on page 1266)

NOW GENTLEMEN HAVE YOU ANY GOOD IDEAS ON HOW TO MAKE THIS THING WORK?

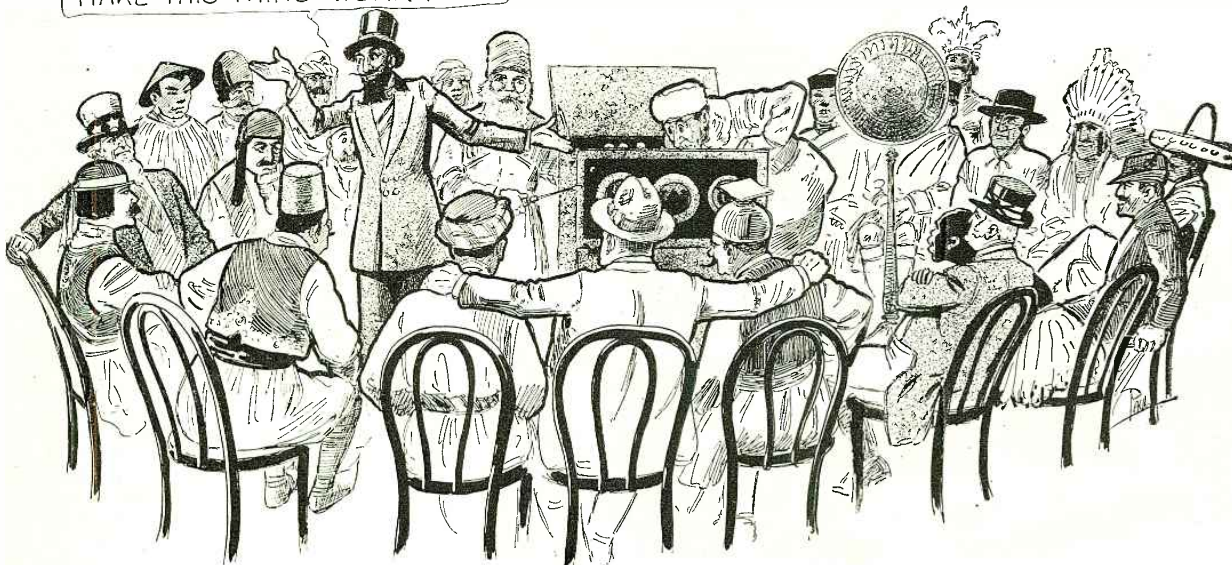

When there's a millivolt lacking on the grid the whole world's akin; the "wop" concedes with the "dago" and the "squarehead" with the "chéé-chée." Radio is the real League of Nations.

# Radio in a School Teaches Thrift to Its Pupils

Good Habits, as well as Scientific Knowledge and an Appreciation of Current Events, Are Inculcated by Aid of Excellent Installation, which also Entertains



**I**F someone were asked to write down five maxims dealing with good habits, it seems safe to say that at least two of these would be on those of prudence and saving money. There is little doubt that, if the excellent habit of thrift can be made a part of the economic life of the children, they will grow up into better and more self-reliant citizens.

Following this course of reasoning, the authorities of the Reeb Avenue School in Columbus, Ohio, have utilized their very elaborate radio system to encourage saving among the students. They have had a complete radio receiving system installed in the building, each of the twenty-five class rooms being provided with a loud speaker. The radio apparatus proper, which is housed in a cabinet (see illustration) in the principal's office, consists of two receivers, one suited for the broadcast waveband and the other for short-wave work. The latter set is intended for use when a proposed short-wave transmitter is placed at some central location, so that the schools can broadcast their own programs; and may serve also for foreign reception, as short-wave programs increase. There is contained in the cabinet also a power amplifier operating from the light lines, and a switchboard which permits the programs to be sent to any room. All the wires to the class rooms are hidden in the

walls, each terminating in a wall receptacle into which the loud speaker is plugged. A microphone also is included in the equipment, and thereby it is made possible for anyone to address the entire school from the principal's office.

As the auditorium is too small to accommodate all the classes at one time, there is on the stage a microphone from which portions of the programs, such as will interest other classes, can be sent to them. Two loud speakers are installed in the auditorium to furnish a background of music for entertainments, school plays and public assemblies. If no appropriate radio program is available, phonograph records played in the office supply the music through the loud speakers. Music for entrance and dismissal into the auditorium is furnished by a large loud speaker in the hall.

#### THE CAMPAIGN FOR SAVINGS

By the use of the microphone and the switchboard, any room or any combination of rooms may be addressed from the office. Every Wednesday morning, which is "bank day" at the Reeb Avenue School, a representative pupil from each class room broadcasts to the school his or her room's standing in the percentage of deposits made. Each class room has "station call letters," which are the initials of a thrift slogan. Some of these slogan are: WSOM, We

Save Our Money; WATC, We Are Thrifty Children; WSP, We Save Pennies; WSAH, We Save And Have; MTAH, Make Thrift



One of the thrifty young ladies, Miss Anna Peterfy, is broadcasting to her fellow-pupils the bank standing of her room. The radio equipment is in the background.

A Habit; SABH; Save And Be Happy; GCS, Good Citizens Save; SFTF, Save For The Future; and many others of like nature.

The school has been equipped with radio for three years and during that time every program of national importance which has been broadcast during school hours has been picked up and listened to by the children. At present they can boast that they are receiving music lessons from Walter Dänrosch, who is on the air with his orchestra with special concerts for school children.

Two other schools in Columbus have been similarly equipped with radio receiving apparatus and their pupils enjoy the programs and the use of the radio equipment as much as possible. Educators all over the world are beginning to realize the great possibilities in radio as a schoolmaster, and it is to be hoped that, within a comparatively few years, it will be possible to say that every school in the country is equipped to pick up some of the wonderful programs, which can make school work more enjoyable.

The radio equipment of the Reeb school is the work of John H. Melvin, of Columbus, who for years has been urging on his fellow-citizens the slogan, "Every School in the U. S. A. Equipped with Radio." Such was the success of the first installation, that Mr. Melvin was recently commissioned to equip the Livingston and First Avenue schools in Columbus with complete equipment. For the information on which this article is based, RADIO NEWS is indebted to Principal W. C. Dyer of the Reeb school.

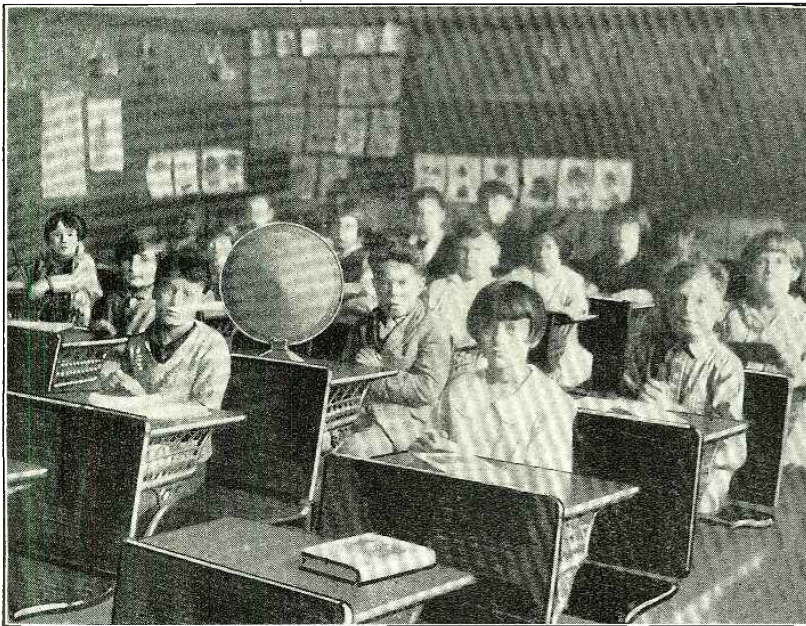

The pupils in one of the rooms of the Reeb Avenue School listening to the broadcasting of their fellow pupils, who are reporting the bank standings in the schools.

© The Columbus (Ohio) Dispatch



# Radio Polices A Western City

How Berkeley, California, Police Headquarters Communicates With Patrolmen Throughout the City by Short-Wave Radio

By J. E. Squires

**A**n entirely new and scientific method of policing his jurisdiction has been devised by Chief of Police August Vollmer, of Berkeley, and is now in permanent use in that California city. By means, instructions are conveyed instantaneously to patrolmen in all parts of municipality; and one or all of the police force may be called so quickly to a certain point that, in actual tests they have required in three minutes, though the time it given was five minutes.

This new and novel method of directing police force is short-wave radio. All the patrolmen of Berkeley, a city of 80,000 inhabitants, are mounted in automobiles, the majority of the cars being small, high-speed models. On each of these has been installed a radio receiving set, with headphones, a loud speaker on the dashboard, flashing red neon-gas lamps on the dash on the outside of the rear of the car. Two distinct methods of communication are employed, one by signals made in code with Morse key at the central broadcast station in police headquarters, appearing on flashing red lamps on the cars; and other by speech through either of microphones, one in the office of the chief of police, and the other on the part of the captain or sergeant on duty.

In case the patrolman should be summoned from his car, watching a building for a person, the red lamp on the outside of the car flashes instructions to stop, or calls him to the car, where he can hear general instructions through the loud speaker, or secret orders through the headphones, as the red lamp and its code may direct. In case

he is inside the car, the flashing of the lamp on the dash directs him to put on the phones, or transmits other instructions; or the loud speaker may give him general orders when there is nothing secret about them. It has been found that, by means of the red lamps and the code (in which all the patrolmen have been thoroughly instructed), involved orders can be given instantaneously, or the men can be called to any point in the city, without speaking to them.

The broadcasting is done on a 160-meter wavelength, which several months of experiment in 1927 proved to be the most efficient. It has been found that the messages are conveyed clearly, either by voice or by signal, to patrolmen in their cars while traveling at speeds up to sixty miles an hour. By a system of selective sending, devised by one of the members of the Berkeley police force (all of whom, by the way, are university graduates), any desired number of patrolmen, from one up, can be called and instructed, without the need of talking to or signalling the other members of the force.

Up to the end of 1927, it was necessary, in all American cities, to call patrolmen to a point where they were needed by special messenger, telephone, or other slow means, resulting in the escape of many criminals in those few precious minutes between the discovery of a crime and the arrival of the officers. Now, the patrolman can be called instantly, within a few seconds after police headquarters is advised of a crime, and, in a few seconds more, can be on his way to the scene of the crime, thereby cutting down tremendously the "escape time" of the crook.

The broadcast station in the police headquarters, at Berkeley, has a rating of fifty watts. Direct current at 1,200 volts is used to actuate this set, being built up from the 110-volt alternating-current city line by a transformer working through a chemical rectifier. The aerial is of the L-type, with four 50-foot lengths of wire, and a counterpoise consisting of an equal number of wires of the same length. The transmitter is handled also by a remote control directly under the hand of the telephone operator in the central station.

The receiving sets in the patrolmen's automobiles are locked after being tuned to the fixed 160-meter wavelength; so that there are no dials or other controls for the officer to adjust. They are five-tube receivers, each with loud speaker, and available headphones for secret communications.

The sending set is so constructed that an operator, wishing to call a patrolman, presses a button for his "radio number," whatever it may be, and the set starts calling that number automatically.  
(Continued on page 1264)



The patrolman can receive a message without taking his hand from the wheel, while traveling at full speed.



Sergeant on duty at police headquarters at Berkeley, Calif., under his hand buttons each of which will light a red signal in a patrolman's car. He can thus send a flashing signal in Morse code; or direct the patrolman to listen in through phones or turn on his loud speaker.

The 160-meter transmitter of the Berkeley police department, used by the chief or captain on duty for voice or telegraphic communication with officers on the automobile patrol. Every man on duty is thus under the control of headquarters for instantaneous mobilization.

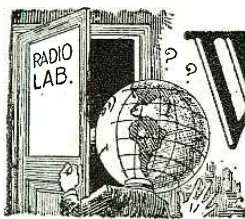

# What's New in Radio



Names and addresses of manufacturers of devices described in this department may be obtained by writing to the "I Want to Know" department of RADIO NEWS.

## Power Tube Designed for Larger Output

A NEW power-amplifier tube, which has a far greater output than any tube previously designed for reception purposes, has recently been developed. The tube is known to the radio trade as the 250 type and it has a maximum output of 4,650 milliwatts; that is to say, the 250-type tube is capable of delivering more energy than two 210-type tubes connected in a push-pull circuit, or it can produce 6.6 times as much undistorted output as a single 171 type and three times as much as the 210 type. The tube has been designed primarily for use in conjunction with auditorium loud speakers where enormous volume is required; and it may be used for the operation of a plurality of loud speakers in hospitals and exposition work where a number of reproducers are supplied with energy from a common amplifier. Also, it is ideal for use in a roomy home; as the tube may be operated with low potentials at only a fraction of its maximum output. In this way it is possible to insure ample reserve power, thus guaranteeing distortionless output at all times.

The chart below shows the electrical characteristics of the 250-type tube for various values of plate voltage:

	Recommended				Max.
Plate voltage .....	250	300	350	400	450
Grid voltage .....	45	54	63	70	84
Plate current (MA) .....	28	35	45	55	55
Plate resistance ....	2100	2000	1900	1800	1800
Mutual conductance .....	1800	1900	2000	2100	2100
Amplification factor .....	3.8	3.8	3.8	3.8	3.8
Output (Milliwatts) .....	900	1500	2350	3250	4650
Filament current .....	7.5	7.5	7.5	7.5	7.5
Filament voltage .....	1.25	1.25	1.25	1.25	1.25

In size the new tube is considerably larger than the 210 type (6 1/2 inches in height and 2 11/16 inches in diameter), but it is mounted on a standard UX-type base.

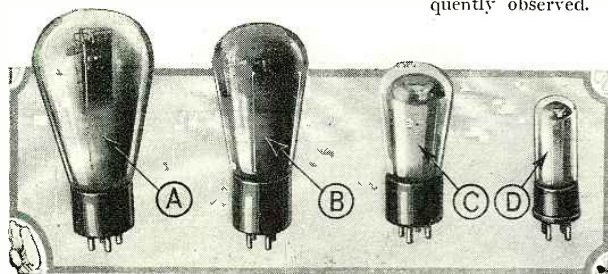

This illustration shows the comparative sizes of the new 250-type power-amplifier tube and other standard receiving tubes; A, 250-type; B, 210-type; C, 201A-type; and D, 199-type. The new tube has an undistorted output of over 4 1/2 watts, or approximately three times that of the 210-type tube.

The filament is of the rugged oxide-coated ribbon type, which operates at a dull red heat. The current for heating this is usually obtained from a 7 1/2-volt winding of a power transformer; and the design of the transformer should be such that, with normal line variations, the voltage applied to the filament is maintained within 5% of the rated value. The plate of the tube is blackened, and is tall and narrow, as in the 281-type rectifier.

In operation the new tube should preferably be mounted in a vertical position, and provision should be made for sufficient air circulation (natural) to prevent overheating. Because of the high plate voltages used the power supply should always be turned off when the tube is inserted or removed from the socket, or when adjusting.

The parts shown in this internal view of the "A-B-C" converter are: T, step-down transformer; L, filter chokes; C, filter condensers; V, rectifier socket. It may be connected to a receiver without any wiring changes.

ments are made to the circuits.

By using low plate voltages the life of the tube may be greatly increased; and this is always recommended where the volume requirements are such that the maximum output of the tube is not essential. A plate potential of 350 volts permits greater output than is usable in most installations. In cases where maximum plate voltage is used, the receiver design should be such that, even during the maximum expected line-voltage variations, the plate voltage will not exceed 450.

When deciding upon the plate voltage to be used it should always be remembered that the use of a high potential does not in itself appreciably increase the volume, but only allows greater volume without distortion. Also, it should be remembered that, when operating the tube at maximum voltages, the plate of the tube should be frequently observed. Plate temperatures ex-

ceeding a dull red heat indicate an excess of plate current, which may be caused by an overload of plate voltage or insufficient grid-bias voltage. Always, when operating this tube, it is essential to make sure that the grid-bias potential is of the correct value for the plate voltage used. It is also necessary to make sure that a coupling device (output transformer) is connected between the plate circuit of the tube and the loud speaker.

## Power Converter Simplifies Receivers

A COMPACT and ingenious device recently placed on the market, makes it a very simple task to convert a battery-oper-

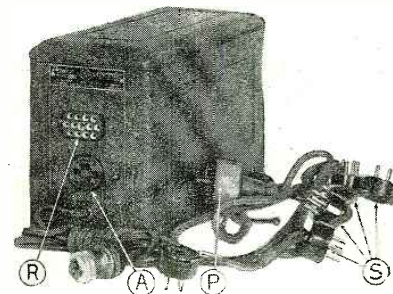
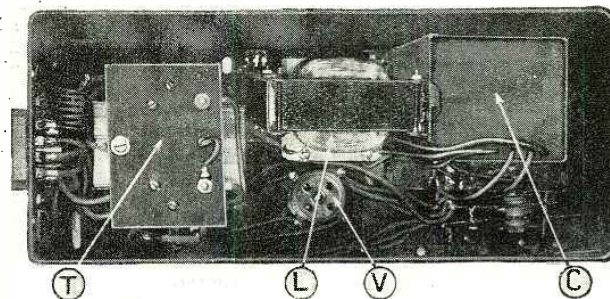

External appearance of the new "A-B-C" power converter, with wiring harness.

ated set into an electric set using the new A.C. tubes. The change may be accomplished without changing a single wire in the old set, and little technical knowledge is required. The device manufactured for this purpose is known as an "A-B-C" converter, and may be used in connection with any ordinary five-, six- or seven-tube receiver.

Pictures on this page show the appearance of the new converter. It is housed in a metal case only 5 x 7 x 11 inches, and is comparatively light in weight; yet this unit provides all filament, plate and grid potentials required by the receiver. In construction it is somewhat similar to the standard "B" power unit using a full-wave rectifier. Of course, three extra windings have been incorporated in the power transformer, to heat the filaments of the tubes in the set; and resistors have been added.

In the picture it will be noticed that, alongside the power unit, there is a wiring harness to which are attached a number of small plugs (S) which fit into vacuum-tube sockets. It may also be seen that at one end of the harness is provided a large plug (P) which fits into a socket (R) in the power unit.

To convert a receiver from D.C. to A.C., the old D.C. tubes are removed from the

sockets and the plugs (S) on the wiring harness are fitted into the sockets instead. One of the plugs is of special design and must be inserted in the detector socket, and another can be used only in the last audio stage; while the other plugs may be distributed as desired among the remaining sockets. Next, a 227-type tube is inserted into the plug placed in the detector socket; a 171-type tube is placed in the plug in the last audio-stage socket; and 226-type tubes are inserted in the remaining plugs. The "B" circuit may now be completed by connecting the binding posts of the set with the free wires of the harness which are similarly marked. As grid-bias is automatically provided, all "C-battery posts of the set must be short-circuited. The plug (P) at the other end of the wiring harness may then be inserted in the socket (R) on the power unit, and the conversion is completed.

Before operating the set, a new switch must be provided, as the old filament switch no longer has any effect on the circuit. A cord and plug is provided with the power unit and any 110-volt switch may be connected to this cord. To connect the switch into the circuit, it is necessary only to insert the plug into the socket (A) provided on the power unit. Also, it may be found that the change renders the volume control of the receiver useless; and, if this is the case, a new one must be provided. For this purpose a variable high-resistance unit may be connected across the aerial and ground binding posts of the receiver.

To place a receiver in operation after the changes described above have been completed, it is necessary only to connect the power unit with the light socket and snap the switch. The receiver will operate as before, and no other adjustments are necessary.

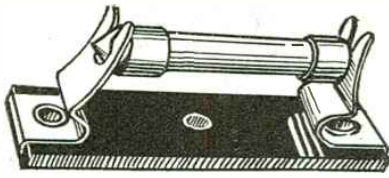

This new grid-suppressor resistor fits in any standard grid-leak clip.

### "Grid Suppressors" are Now Made in Handy Tubes

IN the design of modern tuned-radio-frequency receivers, the "grid suppressor" has been quite generally employed, by set constructors and radio manufacturers, to prevent oscillations in the R.F. stages. In well-designed sets, this method has produced entirely satisfactory results, and such receivers are very stable in operation over the entire broadcast waveband. However, faulty application of this system has been the cause of a considerable amount of grief in some instances. Usually, poor results are caused by the inductance and capacity of the resistors used; and, when such a condition exists, it is most difficult to determine the reason for the unstable operation of the receiver.

A "grid-suppressor" unit, to accomplish its purpose, should be as nearly as possible free from inherent inductance and capacity. If a measurable amount of inductance is present, it is almost certain to affect the circuit, as well as to nullify the advantages sought

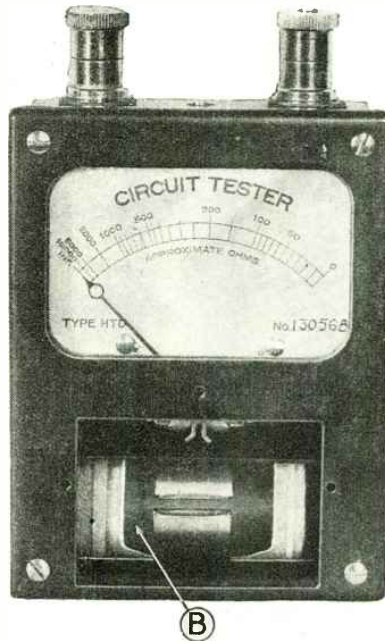

This meter automatically measures the resistance of an electric circuit in ohms without the necessity of an external battery. B is a small flashlight cell.

in the use of the grid suppressor. It is the sole purpose of such a component to provide a "pure-resistance" load in the grid circuit; and the apparatus which accomplishes this, without introducing appreciable inductance or capacity, best answers the requirements of the set builder. The ohmic value of resistors suitable as grid suppressors varies with different types of sets; however, in most cases, the resistance of the units must be between 250 and 3,000 ohms.

A resistor of a new type is illustrated on this page; it is similar in appearance to a standard grid leak and fits into a standard grid-leak mount. It is short, hermetically-sealed, and of metallized-filament construction and, consequently, free from troublesome inductive or capacitive effects. It is available in a large number of values between 250 and 3,000 ohms.

### Simple Instrument Measures Resistance of Circuits

SERVICE men will find a new meter, recently placed on the market, a great aid to them when trying to locate trouble in radio receivers. The meter is known as a "circuit tester," and indicates the approximate ohmic resistance of the circuit in which it is connected, without the use of an external battery. Although the readings of this meter are not to be compared with laboratory precision measurements, they

"A" power units of compact construction are made possible by use of the new "dry-electrolytic" condensers, which house an enormous capacity in a very small space.

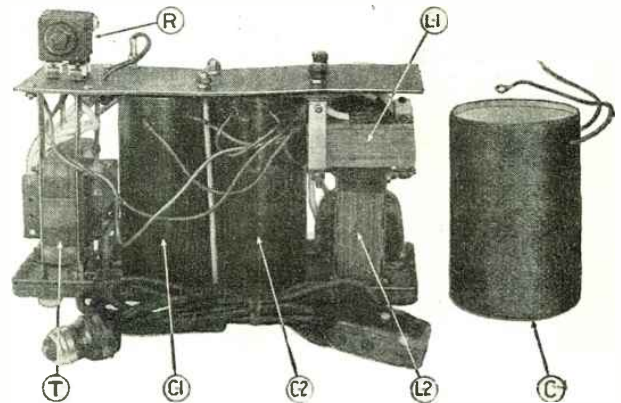

are sufficiently accurate to be of great service to the radio repair man.

When computing the resistance of a circuit by the usual methods, three instruments are required: viz., a voltmeter, an ammeter and a battery. The voltmeter is inserted in shunt with the instrument or circuit to be measured, and the ammeter is inserted in series; while the battery is so connected that a current passes through the circuit. To determine the resistance, the current and voltage readings must be made simultaneously on the voltmeter and ammeter, and these measurements must be substituted in the "Ohm's Law" formula; i.e., resistance is equal to voltage divided by current. To make a measurement in this way, considerable apparatus is needed; and it takes time and trouble to connect up the apparatus, make the measurement and solve the formula.

In the meter described here, a small 1½-volt flashlight battery is located inside the case, directly behind the name-plate; its location is clearly shown in the illustration, which pictures the meter with the name-plate removed. The meter and battery are connected in series, and the free terminal of each is connected to one of the binding posts. Therefore, when the two binding posts of the meter are connected to two ends of a resistance, there is formed a series circuit consisting of the meter, the battery and the resistance. As the voltage of the battery is known, it is possible to graduate the scale of the meter in ohms, and in this way save the service man the trouble of making computations. In the case of the meter under discussion, it is possible to make approximate measurements of circuits whose resistance is not less than one ohm and not more than 100,000 ohms.

It is not difficult to find hundreds of useful ways in which such a meter may be used when testing radio receivers. For example, one can detect open circuits, short-circuits, defective apparatus, etc. It is also possible to determine which is the primary winding of an audio transformer, and many other facts of a similar nature.

### "Dry-Electrolytic" Condensers Used in "A" Power Units

THE design of a suitable filter system has been one of the most difficult problems for radio engineers to solve, in connection with the construction of "A" power-supply devices. In low-voltage devices of this type which operate from a 60-cycle source of alternating current, the capacity

quired in the filter circuit is in the order of several thousand microfarads; and for this reason the use of paper condensers is not the answer. The cost of a paper condenser having a capacity of 5,000 mf., for example, would probably be several thousand dollars; and, in addition, the filter would weigh several hundred pounds and would require many cubic feet of space.

In their search for a suitable solution of this problem, engineers have developed the electrolytic condenser; and devices of this type are now giving excellent satisfaction in thousands of commercial "A" power units.

The electrolytic condenser is compact, inexpensive, and has ample capacity for the purpose; and was at once thought the ultimate solution to the problem. However, notwithstanding this invention, engineers have continued their search for an ideal condenser.

The "dry-electrolytic" condenser is a new development which is exciting interest throughout the entire industry. It is a "chemical" unit, capable of providing enormous condenser capacity in a very small size; yet it does not use any liquids nor require any attention after it has been installed.

The picture on page 1225 shows an "A" power-supply unit of very compact design which uses two of the new dry-electrolytic condensers; and, at the right of the power unit, one of the new condensers is shown. The condenser is hermetically sealed in an aluminum can, 2 3/4 by 4 inches, by 6 inches high; inside the can are two strips of aluminum foil, each of which is 4 inches wide, 68 inches long, and .009-inch in thickness. The two pieces of foil are separated by strips of mica which have been impregnated with an electrolyte which causes an electrolytic action. Two strips of aluminum separated by mica paper are coiled up and make a total of 1/2 turns.

The picture gives a clear idea of how compact an "A" power device may be constructed by using these condensers; the unit illustrated fits into a metal case 4 1/2 x 8 1/2 x 1 1/2 inches. In the picture, T indicates the power transformers; L1 and L2 are the inductor coils; C1 and C2 the electrolytic condensers; and R is a full-wave dry-electrolytic rectifier of a new type.

The electrolytic condenser illustrated has an effective capacity stated to be approximately 1,250 mf., when properly connected to the circuit. However, because of the peculiar features of this type of condenser, it is difficult to make accurate measurements of capacity with the usual laboratory methods. In this connection, it should be explained that condensers of the electrolytic type can be used only in direct-current circuits; because these condensers, when connected in one direction, act as a short-circuit across the line but, when connected in the opposite direction, they offer a very high resistance and there is no appreciable leakage.

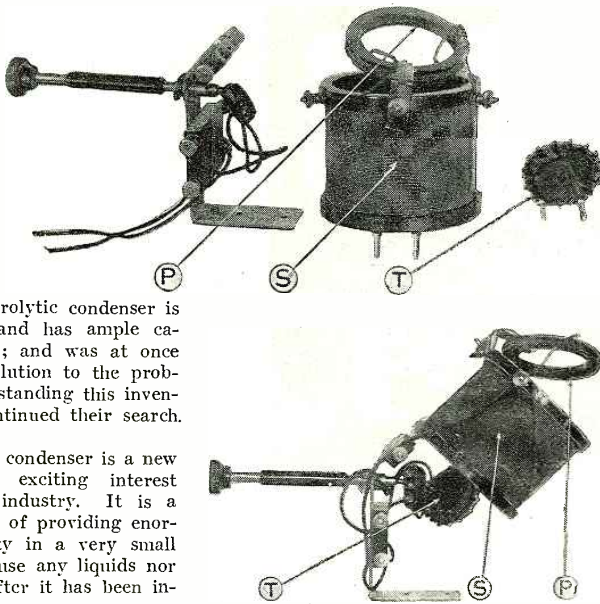

Plug-in secondary (S) and tickler (T) coils are a salient feature of the new three-coil coupler pictured above. (P) is the primary.

age of current on low voltages. In operation, these condensers may be used on only low voltages; but, should one accidentally break down from an overload in voltage, it will heal itself when connected to a low-voltage source.

### Plug-In Coils Used in New Coupler Unit

There are a great many listeners who wish to have the opportunity of receiving broadcasting, and the opportunity as well to receive signals which are transmitted on other wavelengths. For example, the wavelength range to which the average American broadcast receiver responds is approximately 200 to 550 meters; but there

are many excellent programs which may be heard on wavelengths below 200 meters, and most high-power European broadcasts are carried on on wavelengths above 550 meters.

Of course, there have been in the past systems for increasing the wavelength range of radio receivers; but the methods used do not measure up when compared with present-day standards of efficiency. Before the days of broadcasting "honeycomb" coils were used for this purpose, and a different set of coils was utilized for each wave band. However, these coils are not very satisfactory on waves below 600 meters and for this reason have not been popular in broadcast receivers. Other methods required the use of large shunt condensers or loading coils; but these also were intended primarily for use on long waves.

Accompanying this article is an illustration of a new type of regenerative tuner which has been designed especially for use in receivers intended to cover several wavebands. In appearance the coupler is identical to the standard design used generally in this country for broadcast reception. However, it is so constructed that the secondary and tickler coils may be removed and others substituted for shorter or higher wavelengths. Electrically the unit has the same efficiency as standard types of similar design, but its use makes possible the more convenient construction of a receiver with a universal wavelength range. It is of Austrian manufacture.

### New A. C. Set is Example of Modern Design

The receiver illustrated on this page is an interesting example of an inexpensive, but completely modern, all-electric radio set; it features single-control tuning, chassis construction, complete shielding, a metal cabinet, power amplification and a built-in power-supply unit.

The pictures which accompany this article clearly illustrate the construction of the receiver; it is assembled on two metal chassis, firmly attached together. On the front chassis, the parts used in the receiving circuit are mounted and, on the rear one, all power apparatus is located. Practically all wiring is located beneath the assembly and, in this way, the appearance of the receiver is greatly improved. Also, the receiver unit includes a structural panel

Two views of a modern all-electric six-tube receiver. Right—Top view of chassis, with shielding removed. Apparatus at the rear of the chassis is in the power-supply circuit. Below—Front of chassis, showing condenser coupling gear for single control.

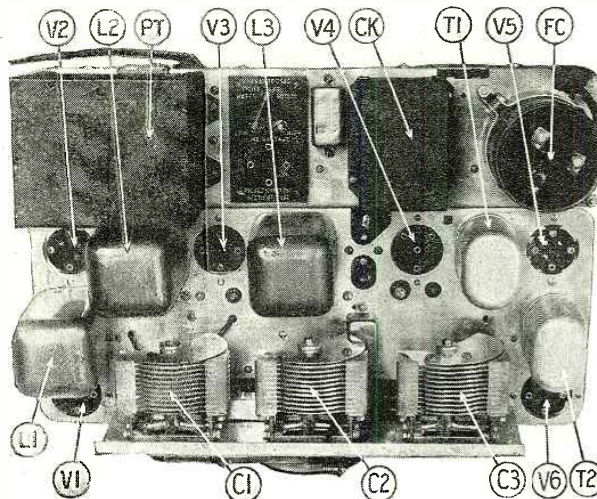
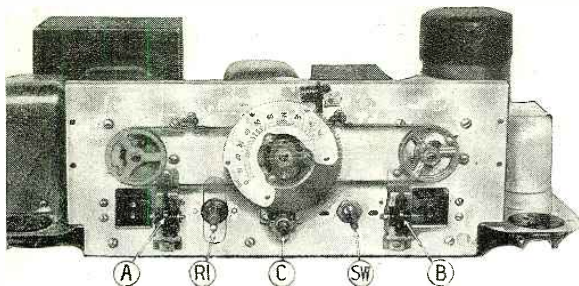

for mounting the various tuning units. This is necessary because the front panel of the receiver is part of the metal cabinet and cannot be removed with the chassis.

The assembled set is shown, in the front view on page 1292, with receiver and power unit completely enclosed in the metal cabinet. The knob C, in the center of the panel, turns the illuminated vernier dial which controls the three tuning condensers of the set. This is the only wavelength control in the receiver. The switch turning the set on and off is controlled by the knob marked "Sw," and the volume-control knob is located at R1. The levers A and B adjust small compensating condensers which are used only for making critical adjustments when receiving distant stations.

Another picture on page 1226 shows the appearance of the receiver chassis when viewed from the front, and especially the small metal panel on which the tuning instruments are mounted. Three pulleys have been attached to the shafts of the three variable condensers, and coupled together for single-control operation by belts of copper ribbon. (In the case of the center condenser the pulley is concealed by the scale of the dial.) Holes have been drilled in the front panel of the cabinet to pass the shafts of the various instruments. These are independent of the front panel, but it is necessary to remove their knobs to take the chassis from the cabinet, or replace it.

In the top view of the chassis, the shielding around the variable condensers has been removed to show the construction. In this picture, L1, L2 and L3 are the three R.F. transformers; C1, C2 and C3 the three tuning condensers; T1 and T2 the A.F. transformers. V1 to V6 are the sockets for the tubes in the receiving circuits; PT is the

# \$100.00

## To a Set Builder

*RADIO NEWS is paying, each month, \$100 to the constructor or set builder who submits the best radio circuit or constructional development, which will be printed as a "Blueprint Article." It will pay also for a patent taken out in the inventor's name, if the idea is patentable. The apparatus must have been assembled and operated by the experimenter, and the product of manufacturers' laboratories will not be considered. Send photographs and schematic circuit with your entry; but do not send the apparatus until it is asked for. Other rules of this competition appear on page 1119 of Radio News for April. Address Editor, Monthly Construction Feature, Radio News, 230 Fifth Avenue.*

power transformer; CK the filter choke coils; and FC is the electrolytic filter-condenser bank.

### THE CIRCUITS

The wiring diagram on this page shows the complete electrical circuit of the set, including the power-supply unit. It will be seen that the receiver includes one untuned stage of R.F., followed by two tuned stages, a non-regenerative detector and two stages of transformer-coupled A.F. amplification.

The plate current is supplied by a power transformer and rectified, in this model, by a full-wave tube of the filament type. The filament current for the receiving tubes and the rectifier is supplied by four low-voltage windings in the power transformer. The R.F. stages of the receiver and the first A.F. stage use four A.C. tubes of the 226 type; the detector circuit a 227-type A.C. tube; the last audio stage a 171-type power tube; while the rectifier is a 213- or 280-type tube.

It is interesting to note that the grid of the first tube is directly coupled to the antenna, across an untuned choke coil, and that the receiver's volume is regulated by a variable resistor connected in shunt across a section of this coil. This system is used to keep the tuning operation as simple as possible. If the antenna circuit were tuned, it would necessitate the use of an additional tuning control to obtain maximum efficiency. The second and third R.F. stages are tuned, and in these oscillation is prevented by use of the standard neutrodyne circuit. The circuit of the detector and audio stages is standard transformer coupling.

All voltages required for the operation of the tubes in this receiver are supplied by the power unit, and the set is turned on and off by a single-pole switch connected in series with the 110-volt A.C. supply wires, which run directly to the primary winding of the power transformer. This transformer has five windings; one for high-voltage (plate-power) supply, and four for the different filament voltages. After the plate current has undergone full-wave rectification, it is delivered to the filter, which consists of a double choke coil (CK) and an electrolytic condenser bank with a total

*(Continued on page 1292)*

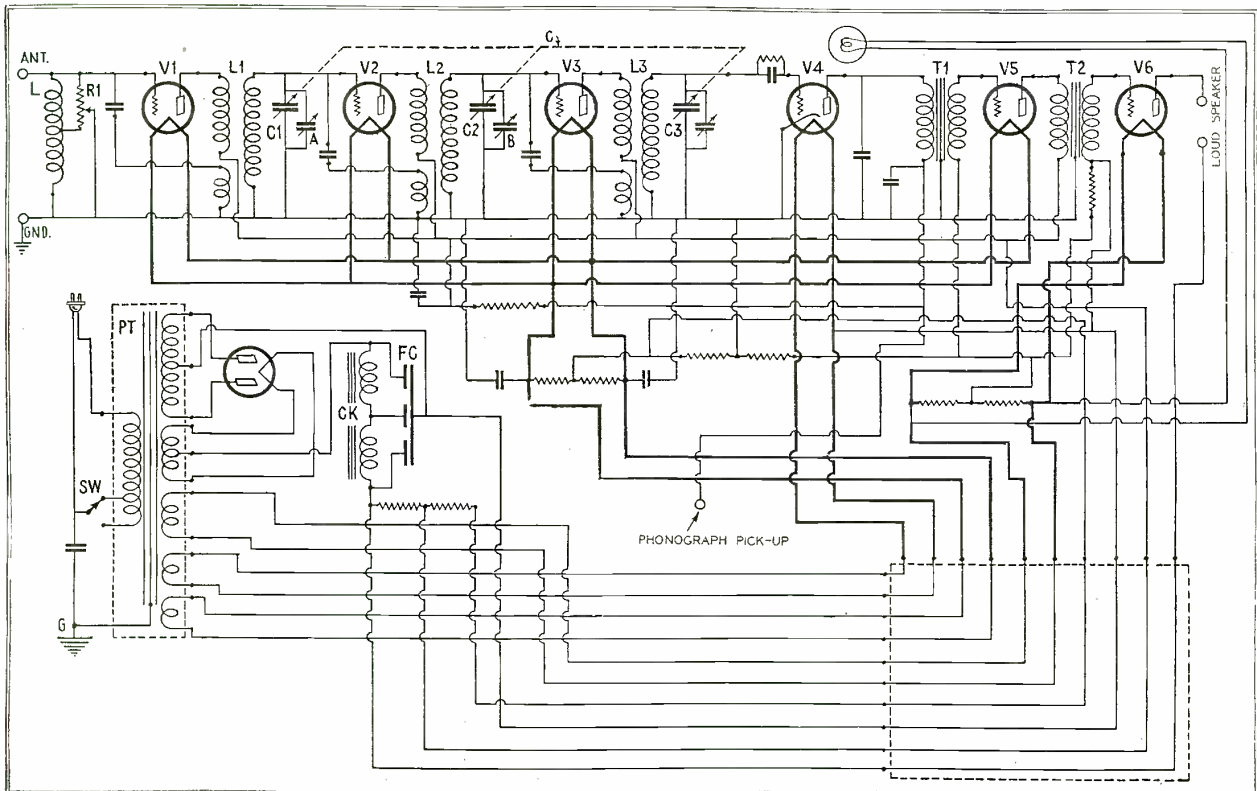

Complete schematic wiring diagram of the six-tube, all-electric receiver and built-in power equipment described on this page.

# The Radio Beginner

## A Simple "Extension" Two-Tube Receiver\*

**M**ANY persons seem to be of the opinion that the simple two- and three-tube receiving sets have gone out of style, and that practically everyone is now using an elaborate receiver employing from five to ten tubes; however, this is not the case. Correspondence which we receive from our readers proves, beyond a doubt, that there are just as many beginners today as there ever were; and a large number of these newcomers in the field are anxious to start with simple apparatus.

In connection with the frequent requests for data on the construction of simple receivers, it is interesting to note that the type of receiver desired is entirely different from the design which was popular several years ago. In the year 1923 many a broadcast fan, who contemplated the construction of a simple receiver, wished to obtain loud-speaker volume from one tube and was willing to sacrifice quality of reproduction, distance reception and selectivity in order to obtain this end. As a result there was a demand for designs of one-tube reflex receivers employing a crystal detector. At the outset the constructor understood, or should have done so, that the set would not be entirely satisfactory; but he was ready to spend his good time and money to build it in order to get the thrill of receiving broadcast music on a loud speaker.

Today conditions are very different. The beginner understands, first, that there are many stations on the air and a radio receiver must be selective enough to separate local stations, in order to assure him any

### FREE Blueprints

**T**O facilitate the work of constructors, RADIO NEWS will give away, free, complete blueprints for sets described in the constructional articles that are printed in its pages, beginning with the April issue. (Blueprints of sets published previous to the April, 1928, issue are not offered free.)

Under the new policy of RADIO NEWS, no manufacturers' names nor trade marks are given in the text pages of RADIO NEWS. For the information of those who wish to construct sets and power packs, however, and to facilitate their work, the blueprints will contain complete specifications of all the material which is used in making the complete apparatus described in the constructional article. These blueprints will be given free to readers who apply in person at the office of RADIO NEWS, between the hours of 9:00 a. m. and 5:30 p. m., daily, and until 1:00 p. m. only, on Saturday afternoons. Those who apply by mail should enclose ten cents, for postage and mailing only. Address Blueprint Department, Radio News, 230 Fifth Avenue, New York City.

degree of satisfaction from reception. Secondly, he knows that many worthwhile programs are broadcast from high-power stations within a few hundred miles and, if his receiver is sufficiently sensitive, he can derive much satisfaction from picking up these signals. Thirdly, it has been explained to him that the most desirable feature of a radio set is its ability to reproduce music without appreciable distortion; and, in this connection, he is told also that volume of signal without distortion can be obtained only by using an efficient tuner in connection with a well-designed, high-quality audio-frequency amplifier with a power tube in the last stage.

#### THE MINIMUM FOR GOOD RESULTS

As a result of the radio education which he receives by reading newspapers and magazines, and by hearing his friends talk over radio problems, the beginner no longer expects the impossible from a simple circuit. He appreciates the fact that freak circuits do not produce the results which are claimed for them, and most satisfactory results are assured by following a standard, accepted design. Also, he does not limit the set which he is to build to one tube, when he has learned from the experience of friends that at least two, and sometimes three, tubes are needed when satisfactory headphone reception is desired; i. e., in order that the set shall be selective, sensitive and capable of quality reproduction.

In addition to the points considered above, the beginner, who builds a simple receiver wishes to construct it in such a manner as to permit improvements from time to time; and he desires a set which will compare favorably, when such additions have been completed, with the best receivers available. Above all things, he wants to know that his set can be conveniently enlarged so that it will deliver ample loud-speaker volume without distortion.

The receiver described in this article has been designed in the RADIO NEWS Laboratories to satisfy the requirements of the present-day radio beginner. It is a two-tube hook-up employing a well-known standard circuit, which consists of one stage of neutralized-radio-frequency amplification followed by a regenerative detector. When properly constructed, it will be found *equally sensitive and selective with the best of four- and five-tube receivers*; though it will not deliver the same amount of volume, simply because it is not equipped with an audio amplifier, which would require the addition of two or three extra tubes. However, it is readily possible to construct such an amplifier, and connect it to the receiver externally, at any future date, and this

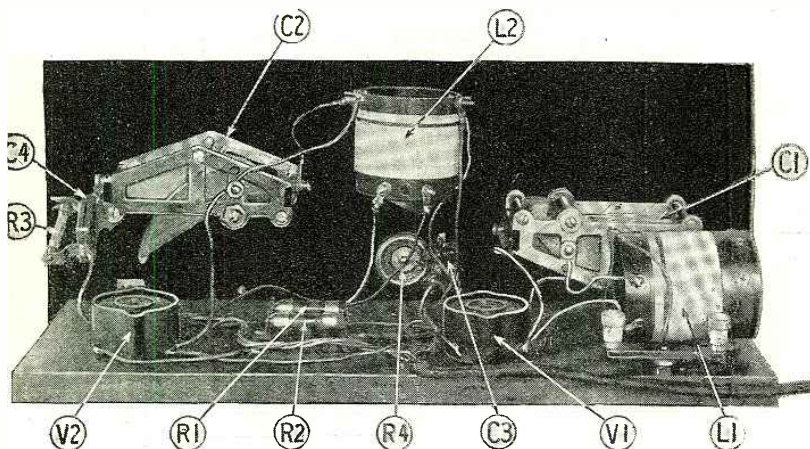

Rear view of receiver. L1, antenna coupler; L2, detector-circuit tuner; C1 and C2, variable condensers; R3, grid leak; C4, grid condenser; R4, volume control; C3, .006-mf. condenser.

\* RADIO NEWS Blueprint Article, No. 53

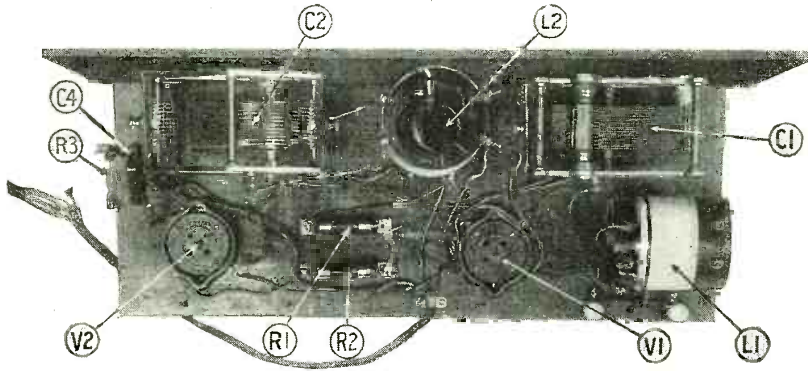

The simplicity and inexpensiveness of the parts necessary for building the two-tube receiver is an advantage. The parts are lettered alike in the illustrations and the list on page 1285.

addition will make the receiver quite the equal of any four- or five-tube set so far as performance is concerned. In short, it is a real radio receiver which anyone may be proud to own, and must not be considered a joke, or old-fashioned in any sense of the word.

CONVENIENCE OF CONSTRUCTION

Aside from the electrical features of the set, there are many practical advantages possessed by the design. A glance at the pictures will show the prospective builder the features which should require no farther discussion. First, it will be seen that the

design of the set is very compact; the panel, on which the tuning controls are mounted, is only 18 inches long and 7 inches high, and the baseboard on which the remaining apparatus is mounted is only 16 inches long and 7 inches deep. This makes it possible to place the set in a small table-type cabinet. Secondly, the mechanical arrangement of the set is very simple and very few tools are required for its construction. The tuning instruments are mounted on a bakelite or hard-rubber panel, but to mount the parts, it is necessary to drill through this panel. The baseboard is wood, 1/2-inch thick, and this makes it very easy to mount the other parts; as they may be fastened with ordinary wood screws. Of course, if the builder is mechanically inclined he may improve the appearance of the interior of the receiver by using a bakelite or hard-rubber sub-panel, and running all wires under this base. However, this is not necessary, as it would effect no improvement whatever in the electrical efficiency of the tuner.

When the receiver is constructed as shown, the wiring is very simple and also efficient. Flexible insulated wire is used and the "point-to-point" system is followed; (Continued on page 1284)

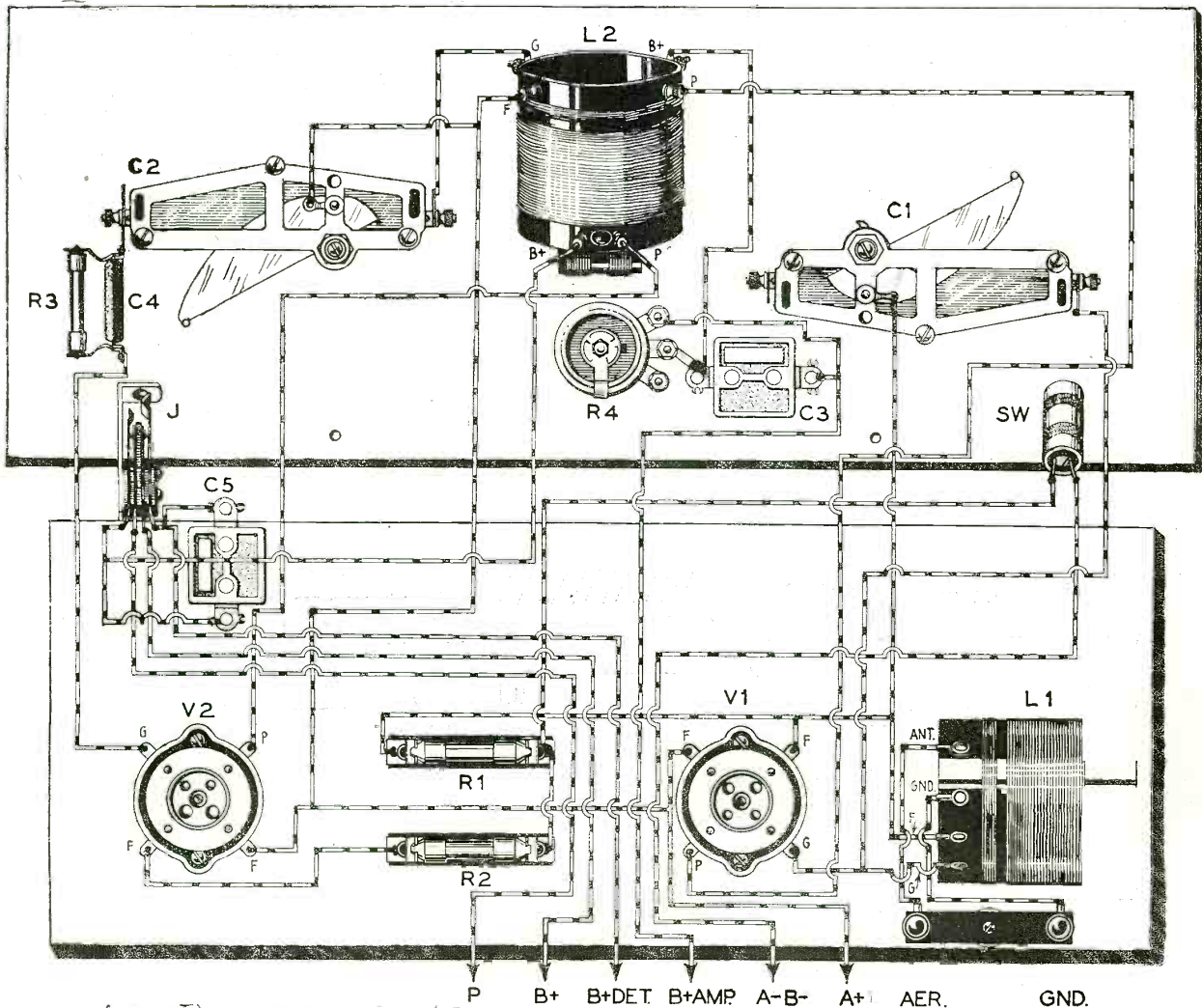

A pictorial wiring diagram of the extension two-tube receiver, showing all the necessary connections. At the top is the panel, and below the baseboard, shown sepa-

rated for convenience in following the lines. Black out with a pencil each wire on the diagram as you connect it into the set; this will aid greatly in the wiring.

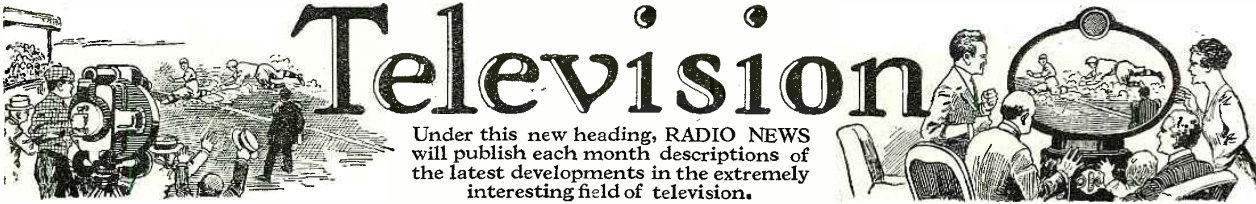

# Quartz Crystals Control Television Apparatus

Synchronizing Circuit or Radio Channel Eliminated by Utilization of Quartz-Crystal Oscillators at Both Transmitter and Receiver



By H. Winfield Secor

ONE of the greatest, if not the greatest of the problems that have worried television experimenters for many years, is the matter of establishing and maintaining perfect synchronism between the transmitter and receiver. In other words, when the revolving perforated discs at the transmitter and receiver are in operation, they must rotate in perfect step with each other. Otherwise the image reconstructed at the receiving end will be distorted, and may be not recognizable as a duplicate of the object placed before the transmitter. If accurate synchronism is not maintained between the transmitting and receiving television discs, another undesirable effect takes the form of a "drifting" of the image.

In the June, 1927, issue of RADIO NEWS the writer gave an illustrated description of the Bell Telephone Laboratories' achievement of television, as demonstrated by their experts to various engineering bodies. In that system, when the voice also was to be transmitted with the image, three channels or circuits were required; the first being used for transmission of the image-currents;

the second was necessary to carry the voice-currents; while a third circuit or wave-

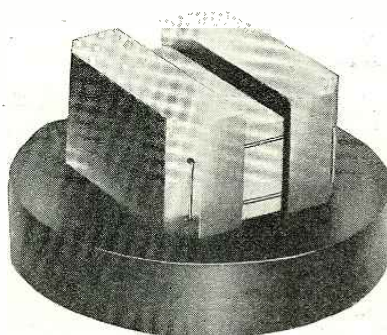

This simple quartz crystal makes it possible to synchronize a television receiver with the transmitter from which it is receiving, though there is no connection between the two, or even synchronizing radio impulses. The crystal is held in its mounting by silk threads.

channel was requisite to transmit the synchronizing current or wave from the transmitter to the receiver.

Recently, Dr. E. F. W. Alexanderson and his associate engineers of the General Electric Research Laboratories have demonstrated a simplified form of television apparatus, which comprises practically the same photoelectric cells, revolving perforated discs, etc., that are used in the Bell system, but with the advantage that the need of a synchronizing circuit or wave-channel has been eliminated. (See April, 1928, RADIO NEWS.) The synchronizing problem, in this case, is solved (or rather obviated) by utilizing an ordinary 60-cycle A.C. motor; and, whenever a variation in the motor's speed or any change in the alternating current's frequency occurs, the speed of the motor and its attached disc is corrected by simply pushing a button, which accelerates the motor. As the motor speed must be corrected continuously, this is evidently not the ideal solution of the synchronization problem in television.

### THE PROPERTIES OF THE CRYSTAL

At last, however, the famous quartz crystal has stepped out in a new spring dress

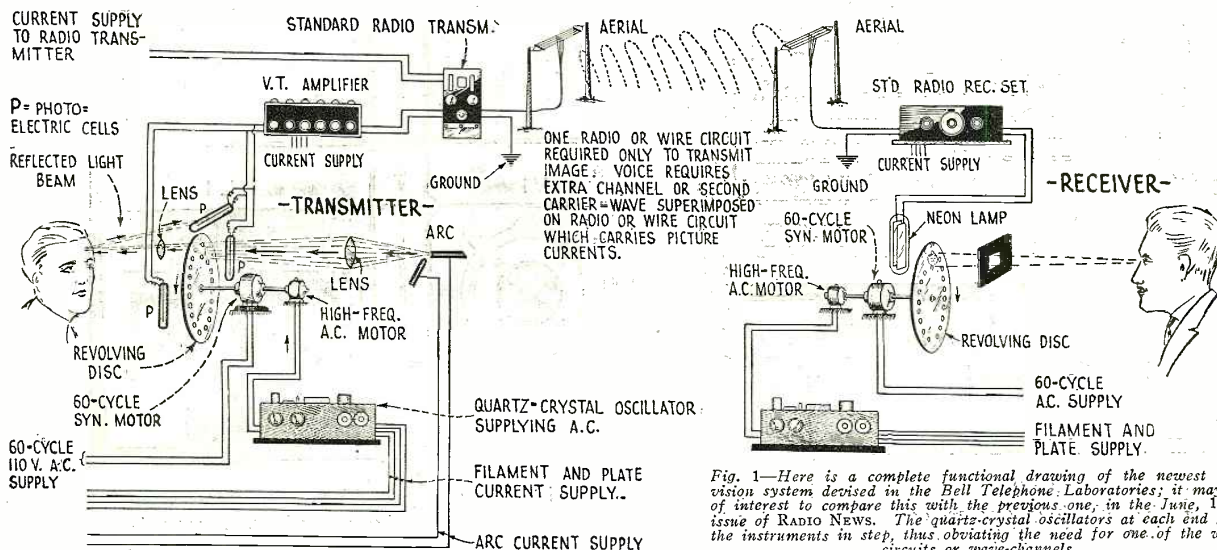
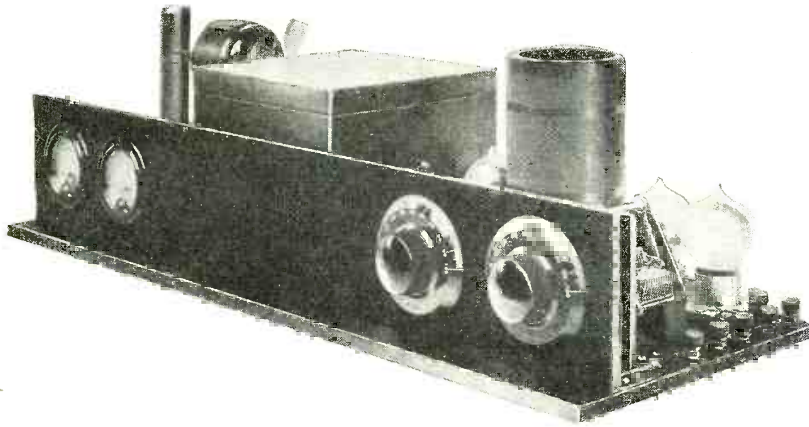

Fig. 1—Here is a complete functional drawing of the newest television system devised in the Bell Telephone Laboratories; it may be of interest to compare this with the previous one, in the June, 1927, issue of RADIO NEWS. The quartz-crystal oscillators at each end keep the instruments in step, thus obviating the need for one of the wire-circuits or wave-channels.





The appearance of one of the quartz-crystal oscillators indicated in the drawing on the opposite page; the crystal is enclosed in the large box, with apparatus keeping it at a uniform temperature.

and hat, so to speak, and has bestowed a priceless boon on the television engineers, by solving the bugaboo over which they had spent so many sleepless nights. Their endeavor to simplify and eventually commer-

cialize the "seeing over a wire" idea, first demonstrated last summer, has been facilitated by putting the crystal to work at keeping the discs revolving with *exactly the same speed at both transmitter and receiver.*

This is accomplished by the use of a quartz-crystal-controlled oscillator and a two-stage amplifier at both ends of the line.

It is a peculiar property of quartz and some other crystals, and an extremely valuable one, to have fundamental frequencies at which each responds to electrical vibrations. The effect is called "piezo-electric": the molecules of a crystal acquire, apparently, an electric charge when the crystal is twisted or pressed out of shape, without breaking it. It would seem as if the internal arrangement of a crystal is in some ways like that of a magnet. The difference between magnetized and unmagnetized metal is that, in the former, all the particles are turned with their magnetic poles in the same direction. So, also, when a crystal is twisted, the arrangement of its internal particles is disturbed, and there is a re-adjustment of their electrical charges, causing the appearance of a difference in voltage between one side of the crystal and the other.

So also, when we apply a difference of potential, or a voltage, across a crystal we cause a disturbance, of the arrangement of the crystal's particles, which slightly deforms the crystal. When we cause this volt-

(Continued on page 1281)

At the right, the television transmitter, with its "scanning" mechanism indicated in "phantom." The artist, Charles Bittinger, and the portrait he is drawing, are thus recorded with motion-picture frequency. The metal cabinet behind Mr. Bittinger contains the photo-electric cells.

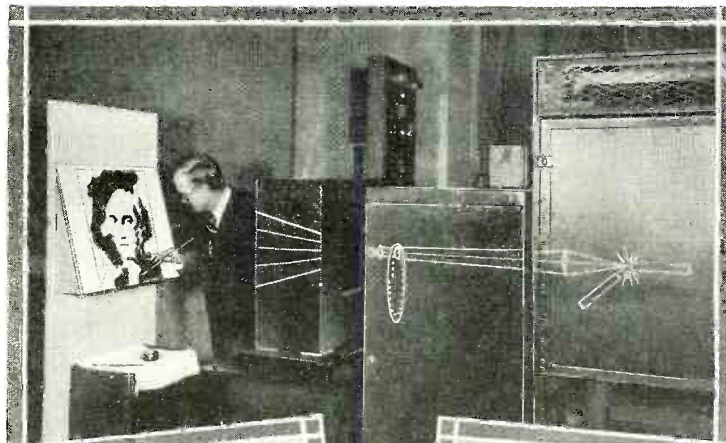

Light for the television transmitter is provided by an arc lamp, indicated at the right of the center picture; it sweeps over the moving objects in a small, brilliant spot, the strength of whose reflection governs the strength of the transmitted impulse corresponding to its position at each instant.

Below, the process of grinding the quartz crystal to the exact thickness required. This is a very delicate operation, which may be compared with work on a lens. The thickness of the crystal regulates its frequency.

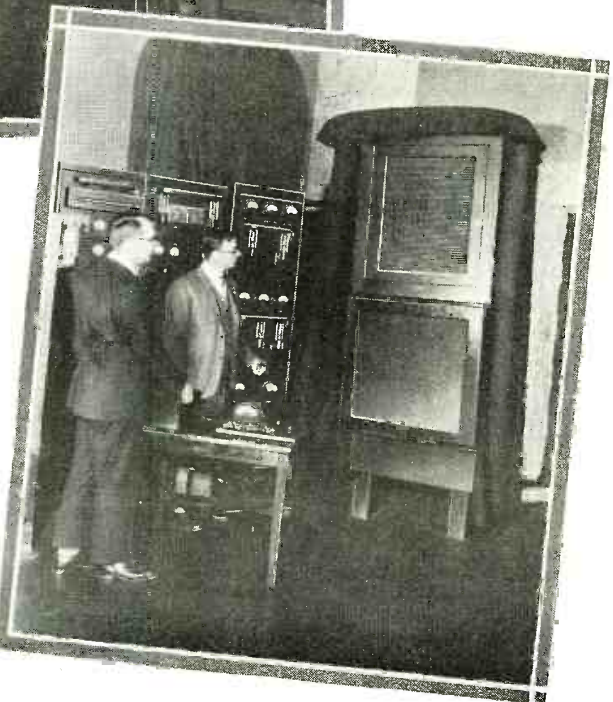

Below, the newest television receiver, with the improved luminous screen, explained on page 1282; below which appears the cloth-covered opening of an exponential-horn speaker. The amplifiers and controls are on the panels at the left.

# Seeing Across the Atlantic Ocean!



A Description of J. L. Baird's Television Experiments, During Which Images were Transmitted Over 3000 Miles by Radio



By A. Dinsdale \*

IT is less than a year since the American Telephone & Telegraph Co. successfully demonstrated television between Washington and New York, using ordinary telephone lines as the medium of transmission over a distance over 200 miles.

Shortly after that demonstration, John L. Baird, the British inventor of television, gave a successful exhibition of his apparatus between London and Glasgow, a distance of 435 miles. This distance held the record until the beginning of this year, when Baird himself shattered it by transmitting television right across the Atlantic!

Just what does this mean? It means that recognizable images of human beings seated in the heart of London were seen in New York, over 3,500 miles away!

This public demonstration, which was carried out in the early hours of the morning of February 9 (London time), turns out to be the culmination of months of secret experimenting.

On the night of the demonstration there assembled at the Baird laboratories in London a small party made up of Mr. Howe, the Associated Press representative, and Mrs. Howe, Mr. W. Fox, the Press Association representative, the writer, and one or two other privileged guests. The transmissions commenced at midnight, London time, or 7 p. m., February 8, New York time.

In order to give the watchers at the New York end an opportunity to adjust the re-

ceiving apparatus, the image of a ventriloquist's doll was first transmitted; a doll being chosen because of the need for steadiness of the image during adjustment.

The "image sound" of this doll, which was like the drone of a huge bee, was then sent over a telephone line to Baird's private experimental radio station at Coulsdon, Surrey, a few miles out of London. The station has a power of only 2 kw., and operates under the call letters 2KZ, on a wavelength of 45 meters. No doubt many readers have heard the transmissions of this station during tests, and wondered what the droning noise meant.

From this station the image sound, together with the synchronising frequency, was flashed across the Atlantic to the receiving station at Hartsdale, N. Y., which was placed at Baird's disposal by courtesy of the owner and operator, Robert Hart (2CVJ).

After amplification the signal was applied to the receiving televisor, upon the ground-glass screen of which the image appeared. This screen measured about two inches by three inches; the entire televisor occupies no more space than an average suitcase.

## "AND THERE SHALL BE NO MORE SEA"

Four watchers were anxiously gathered round the apparatus. These included the Reuter's Press representative; Mr. Hart; Mr. Clapp, one of Baird's assistants, who has been in America for some months in

charge of the preliminary experiments; and Capt. O. G. Hutchinson, Baird's business manager, who came to America especially to supervise the public demonstration.

When the image of the doll's head had been satisfactorily tuned in, Mr. Hart started up his short-wave (amateur) transmitter and called Baird's receiving station at Purley, near London. Using the Morse code, Mr. Hart asked that, instead of the doll, Mr. Baird should take his place before the transmitter. This message was telephoned from Purley to the transmitting laboratory in London.

For half an hour Mr. Baird sat before the transmitter, moving his head this way and that, until the message came through from New York that his image had come through clearly.

Mr. Fox then took Mr. Baird's place, and continued to sit before the transmitter, until word came through that his image was coming through excellently. It appeared that Mr. Fox's features are particularly striking, from a television point of view, and transmit better than those of other sitters.

The watchers in New York did not know "who" was going to be "transmitted"; but Capt. Hutchinson, who knew Mr. Fox personally, had no difficulty whatsoever in recognizing him instantly.

The next person to sit before the transmitter was Mrs. Howe, and, although her features were not recognizable at the American end, owing to atmospheric and fading of signals, there was no mistaking the fact that a woman was seated before the apparatus in London.

## CHECKING THE TRANSMISSION

Those assembled in London were able to see, on a "check" receiver, corresponding to the "monitor" of sound broadcasts, a pilot image of what was being transmitted. This image, which was full-size, showed the head of the sitter, the complete details of the features appearing in black relief on an orange-colored background. By means of this pilot before him, the transmitting operator was enabled to check the outgoing transmissions and correct any irregularities, and from his control position by means of a microphone and loud speaker beside the sitter, could give instructions to the latter as to what movements he should make to keep in focus, turn his profile, etc.

Atmospherics and other interference, and also fading of signals, at times marred the image received at the New York end, but, in spite of these disabilities, reception was, on the whole, very good. The demonstration proved quite conclusively that, if a much more powerful radio transmitter had been employed, the image could have been received in New York almost entirely free from atmospheric and other disturbances. The experiment also confirmed the state-

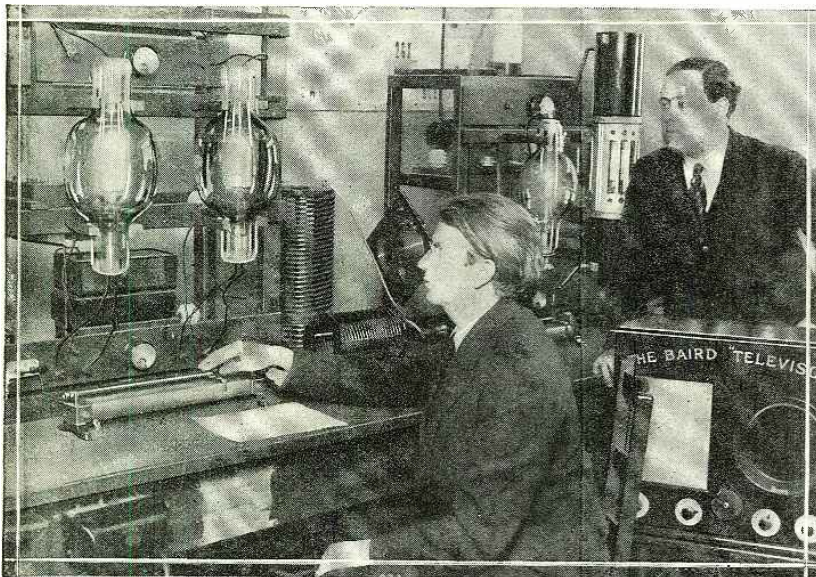

Mr. Baird seated before his 2-kw. experimental short-wave transmitter, 2KZ, which is located at Coulsdon, a few miles from London. Mr. Clapp, an assistant, is behind the television receiver.

\* Author of "Television," and Editor of The Television Magazine (London).

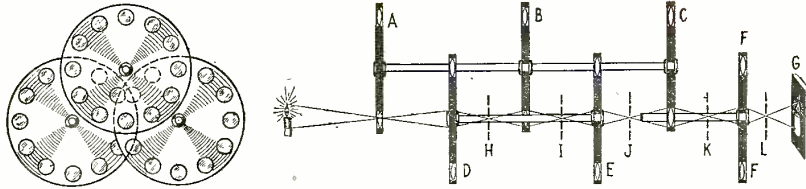

The Baird "Optical Lever" is composed of lens-studded discs on common shafts, shown in cross-section at the right, and in end-view at the left. The illuminated image cast through A is moving at an apparent speed which is doubled by the lens in D, and so on to any desired rapidity of horizontal "scanning." The focal points of the lenses are represented at H, I, J, K, L. The disc F causes the transmitted image to move perpendicularly back and forth across the window of the photoelectric cell G. (British patent 265,640.)

ment which Baird has frequently made, to the effect that the distance spanned is merely a matter of power, and that it has no dependence upon any development of the television apparatus itself.

**SMALL STAFF NEEDED**

In contrast to the A. T. & T. demonstration, which required the services of over 200 men, Baird's transatlantic demonstration required the services of but two operators to manage the television transmission, one at each end of the circuit. All told, the total number of persons employed did not exceed eight: one to control the transmitting televisor, one standing by the telephone to keep in touch with the transmitting station at Coulsdon, one standing by the telephone connecting the laboratories with the receiving station at Purley, two operators at the Coulsdon station, one at the Purley station, one at Hartsdale to run the American radio station, and one to run the receiving televisor.

The design of the television transmitter used for the demonstration closely adheres to that already described in these pages (See RADIO NEWS for September, 1926, June, 1927, and January, 1928) by the present writer. Briefly described, this consists of an image-exploring mechanism composed of three rotating discs, one of them carrying a number of lenses set in "staggered" formation near its outer edge; while the other two are simply slotted "interrupter" discs, set so that they overlap one another, and move in opposite directions at the point of overlap.

Considerable improvements have been made in the construction of this apparatus. It has been considerably enlarged, and a more perfect engineering job has been made of it; so that it runs much more smoothly, and is capable of handling a much larger image. Improvements have been made in the light-sensitive cell too, so that much less intense lighting is necessary. The sitters at the recent demonstration were bathed in flood lighting no more powerful than that employed in a photographer's studio.

**LATEST DESIGN OF MECHANISM**

In another part of his laboratory, however, Mr. Baird has erected another and more modern machine, which is at present undergoing test. This new machine makes use of the principles involved in one of Baird's latest master patents, called the "optical lever." Briefly outlined, the object of the optical lever is to increase the speed of an image passing across the light-sensitive cell, without increasing the speed of rotation of mechanical parts.

This object is achieved by mounting, on two parallel shafts, two sets of lens discs. The first pair of discs, at the end of the shaft, overlap one another and move in opposite directions at the point of overlap. The distance between the two discs is so

arranged, however, that they overlap at a point where their focal points coincide.

Further along the shafts other pairs of discs can be added, and the principle of the arrangement is such that, for every extra pair of discs, a doubling of the speed of the image is obtained.

There is no limit to the number of discs which may be added, by suitably lengthening the parallel shafts, so that there is virtually no limit to the number of image, or light impulses, which may be flashed per second upon the light-sensitive cell; and this phenomenal result is achieved without in any way speeding up the mechanism, which may rotate at any speed at all which may be prescribed by good engineering practice for the weight of revolving material concerned.

The speed difficulty in television is thus no longer limited by mechanical considerations, nor is it limited by the light-sensitive cell. The limitation now rests with the transmitting medium, which, whether it be wire or radio, will transmit only a certain definitely-limited number of impulses per second, according to the characteristics of the circuit. The only solution to this problem would appear to lie in the use of multiple light-sensitive cells and multiple transmission channels; concerning methods for the accomplishment of which Baird already has a number of patents.

**LARGER IMAGES DEMANDED**

The need for increasing the capacity of the entire system, i.e., increasing the number of impulses per second which it can handle, becomes evident when it is desired

to increase the size of the transmitted image. At present Baird transmits an image of the size of a human head only, and does so with a wealth of detail and "half-tone." This necessitates the transmission each second of a certain number of impulses which is well within the carrying capacity of an ordinary telephone line. But, in order to transmit two human heads simultaneously, with the same amount of detail, it would be necessary to transmit twice as many impulses per second.

This and many other problems in connection with television still await solution before we may expect to sit and watch, on a screen the size of the standard for moving-pictures, the full details of, say, the annual Army-Navy ball game. There is an unlimited field here for the experimenter.

Before concluding this article it is worthy of note that the amateur radio operator has contributed very considerably to the success of Mr. Baird's transatlantic television transmissions. By virtue of the great strides he has made in the development of long-distance short-wave communication by means of very low power it has been made possible to stage such a spectacular demonstration at comparatively little expense. Furthermore, it could have been done only on short waves: for it is not possible to charge up satisfactorily the enormous tuned antenna of a high-power long-wave radio station at the very high speed of signalling required in television.

**TELEVISION AT SEA**

Since this description of the first transatlantic radiovision experiments was put in type, a further demonstration has been made on the liner *Berengaria*; aboard which, a thousand miles at sea, a television image was received by radio on March 7.

The *Berengaria's* chief radio operator, Stanley Brown, was thus specially favored with the opportunity to see his fiancée, Miss Dora Selvy, who posed before the transmitter at the Baird Laboratories in London, and who was at once recognized by him. The demonstration was arranged by Capt. Hutchinson, then returning to England after conducting the reception arrangements above described for the transatlantic test.



Mrs. Howe (with hat) seated before the television pick-up, being "televized" across the Atlantic. Immediately behind her is seated the author. Note the banks of lights for illuminating the subject's face.

# Regeneration – What It Is and What It Does

A Semi-Technical Discussion of One of the Most Important Circuit Actions Known to the Radio Art; Its Theory and Application

By Fred H. Canfield

THE designer of the radio-frequency circuits of a broadcast receiver finds that the problem of regeneration is one which he must always take under the most careful consideration; whether he desires to utilize this phenomenon or to suppress it does not affect the fact that it must be reckoned with. In some instances regeneration is employed to give additional amplification in the stages affected; in others the attempt is made to gain stability of operation by eliminating, as far as possible, the effects of the regeneration which exists, to some extent at least, in practically all R.F. tube circuits. But, in any event,

annoyance. With a circuit in which regeneration is used properly, it is possible to obtain an amplification of as high as 25, which is approximately three times as great as may be obtained from an R.F. stage without regeneration. On the other hand, the existence of regeneration increases the selectivity of a circuit, and in some cases it causes the set to tune so sharp that the sidebands of a wave are excluded, resulting in badly-distorted reception. The ideal

in last month's RADIO NEWS (page 1124), as this department contains much elementary information on the subject of simple radio circuits. However, a brief summary of the facts will be given in the next paragraph.

### THE VACUUM TUBE

The ordinary vacuum tube used in radio comprises three electrical "elements"—filament, plate and grid—together with the fine wires or "leads" which run from them to the prongs set in the tube base, by which contact is made to the rest of the apparatus in a receiver.

The filament, in the center of the tube, is a thin wire of special composition, which

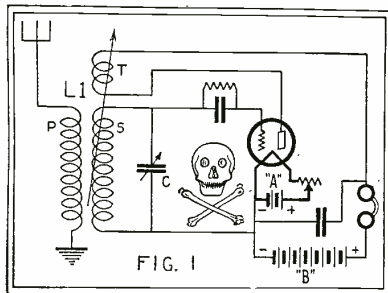

Regeneration is produced in this simple circuit by feed-back from the tickler (T) to the secondary (S). As a broadcast receiver, it is poison to nearby listeners.

to keep regeneration under positive control is the aim of every radio engineer.

It is difficult to say whether regeneration is one of the most desirable or most undesirable characteristics of vacuum tube circuits; for, when rightly employed, it is a great aid, but, when undesired, it is a great

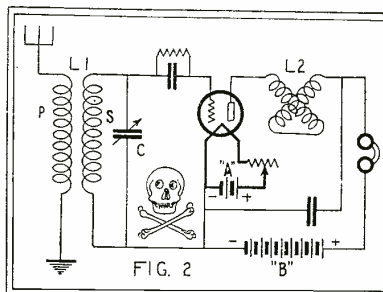

In the variometer-type regenerative receiver, feed-back takes place through the capacity between the plate and grid elements of the tube. It is deservedly obsolete.

solution to the problem would be to develop a system which would provide exactly the desired amount of regeneration on all wavelengths; but an entirely satisfactory means for obtaining this condition has not yet been discovered.

It is necessary, in order to understand the theory of regeneration in radio circuits, to have first a general understanding of the way in which vacuum tubes function in amplifying circuits. The reader will find it helpful to refer to "The Radio Beginner"

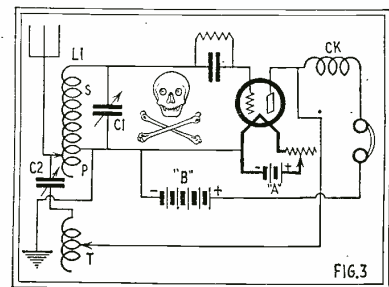

A combination of inductive and capacitive feed-back is used to produce regeneration in the Reinartz circuit, shown above. Suitable only for short-wave work.

is heated to "incandescence" or nearly so by the "A" battery, which is often a storage battery, or by special devices furnishing a low voltage.

The plate, which is nearest the bulb of the tube, is usually in the form of a thin metal cylinder surrounding the filament; between the outside wires connecting to their leads is applied the voltage from a "B" battery or power unit, with the "B+" terminal attached to the plate lead.

The grid is a coil or screen of very fine wires, close together, which is placed in the space between the filament and the plate, inside the tube. Upon the voltage which is applied to the grid depends the action of the tube, other things being equal.

When the filament is heated it gives off electrons; these are attracted by the positive charge on the plate, and there results a flow between these elements of "plate current." When the voltage on the grid (as measured from the filament) is zero, the flow of current reaches a certain value determined by the plate voltage and the "characteristic" of the tube; when the grid voltage is negative, the plate current decreases, and when the grid voltage is positive, the plate current increases up to a certain limit. It requires a very small change of voltage (and almost inconceivably little current) to cause considerable changes in the plate current, and it is this fact which enables the use of a vacuum tube as a volt-

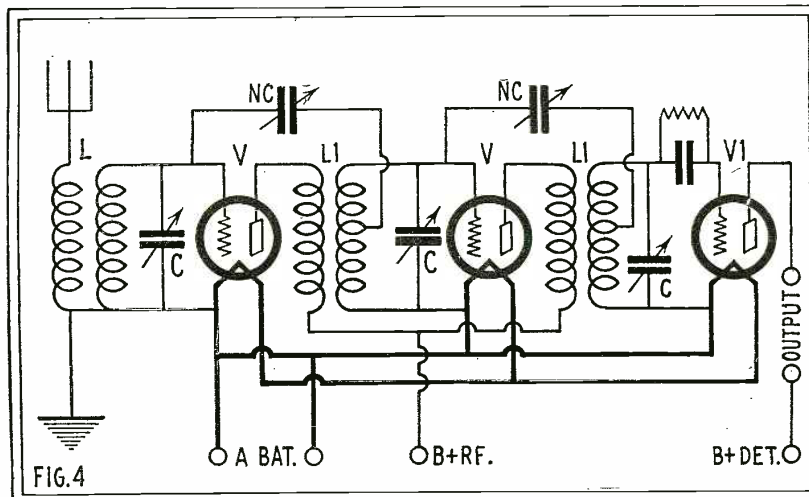

The fundamental R.F. circuit of a standard two-stage neutrodyne with a non-regenerative detector. L, antenna coupler; L1, other R.F. transformers; V, R.F. amplifier tubes; V1, detector tube; C, tuning condensers; NC, neutralizing condensers, which are small in capacity, to offset the tube capacities.

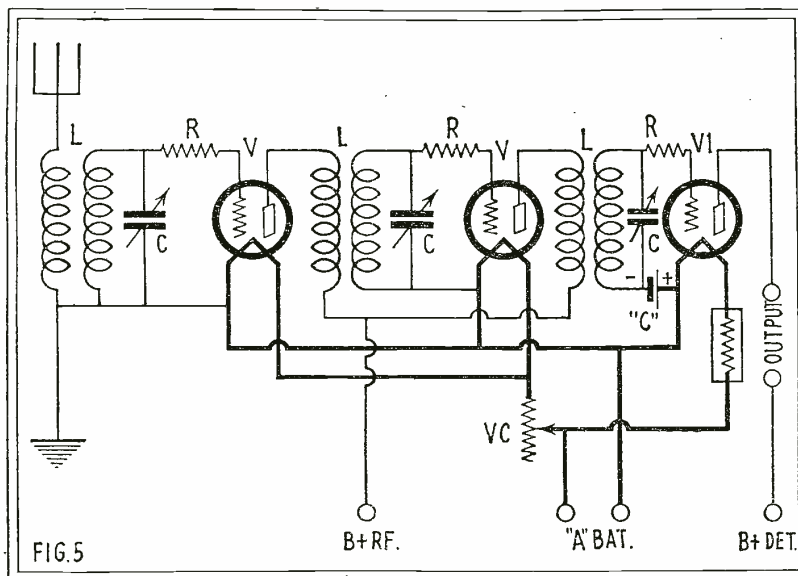

FIG. 5

Oscillation in R.F. amplifiers may be prevented by the introduction of losses; and in this circuit fixed-resistor units are used for the purpose. L, R.F. transformers; C, tuning condensers; V, R.F. tubes; V1, detector tube; VC, volume control.

age amplifier. In the case of the standard 201A-type tube the amplification factor under correct operating conditions is approximately 8; and, therefore, if the incoming oscillations cause the grid voltage or "potential" to "swing" 2 volts, the variations in the plate circuit will be eight times as great, or 16 volts.

THE "FEED-BACK"

In a regenerative circuit, the voltage variations of the grid affect the plate current exactly as they do in the usual amplifier; but the effect of voltage changes produced by the varying current in the plate circuit is returned to the grid circuit. This action is called "feed-back." As the voltage changes in the plate circuit are "in phase" with those in the grid circuit, the grid-voltage variations are increased by feed-back from the plate circuit, and in this way the amplification of the tube is greatly increased. The amount of extra amplification which may be obtained in this way is determined by two factors; first, the amount of plate-current energy which is returned to the grid circuit; and second, by the "critical point," at which the tube enters a state of self-sustained oscillation.

From the above description it is easy to see that the amplification of the circuit increases as the transfer of energy from the plate circuit to the grid circuit is increased; for, regardless of how much energy is returned to the grid circuit, this energy is again amplified by the tube with the result that the plate-current variations are increased—that is if the tube does not start "oscillating." However, the point which is difficult for the beginner to understand is that the entire operation described above takes place almost instantaneously and, as a result, under normal conditions has no effect upon the signal which is being amplified. On the other hand, when one endeavors to obtain too much amplification through regeneration the signal is distorted; but this will be discussed at greater length in another paragraph.

In order to explain the effect which regeneration has upon a circuit many authorities use the term "negative resistance"; i.e.,

they say that introducing regeneration into a circuit has an effect similar to reducing the resistance of the circuit. In many ways this explanation is very satisfactory; but it has often caused experimenters to believe that the resistance in regenerative circuits need not be considered, because it may be decreased by increasing the amount of regeneration. However, this belief is not true. Theoretically, however, when the tube breaks into a state of "oscillation," the positive (actual) resistance of the circuit has been reduced to zero by the "negative resistance."

EFFECT OF OSCILLATION

Regeneration not only produces the effect of reducing the resistance of the circuit by increasing the strength of the signals, but also greatly increases the selectivity of the

circuit. When regeneration is not present, the receiver may tune so broad that it is impossible to receive stations without interference; but, as the regeneration is increased, it will be found that the selectivity is ample for all usual requirements. Also, when the detector tube is operated on the verge of oscillation, the selectivity is often so extreme that music is badly distorted because the "sidebands" of the wave are excluded, thus cutting off the higher notes. Under these conditions the harmony will be supplanted by rough blasting tones, while the volume of the signal is often much greater than when the musical tone is preserved. After the tube enters a state of oscillation, the volume of the signal is usually greatly reduced, but the distortion remains. Music received when the detector tube is oscillating often sounds like escaping steam and is accompanied by whistling sounds.

Before continuing with the discussion on regeneration, the wiring diagram of a regenerative receiver will be considered. Fig. 1 shows the circuit of a simple "three-circuit tuner" (more properly "two-circuit") in schematic form; this represents what was once one of the simplest, most popular and most frequently-used receivers. It is easy to operate, as there are only two tuning controls, and it provides amplification which is practically equal to that of a two-stage tuned R.F. receiver with a non-regenerative detector. Of course, the overpowering disadvantage of this system of reception is that, when it is not properly operated, it will oscillate and the radiated energy from the antenna will interfere with reception in nearby receiving sets. For that reason, operation of an oscillating regenerative set is in some places punishable by law; and might be in this country under the Radio Act.

Although this circuit is no longer in general use as a first stage of broadcast reception, its operation will be considered, as it is a basic regenerative circuit and is often employed to advantage when placed after one or more stages of tuned R.F. amplification. (Continued on page 1288)

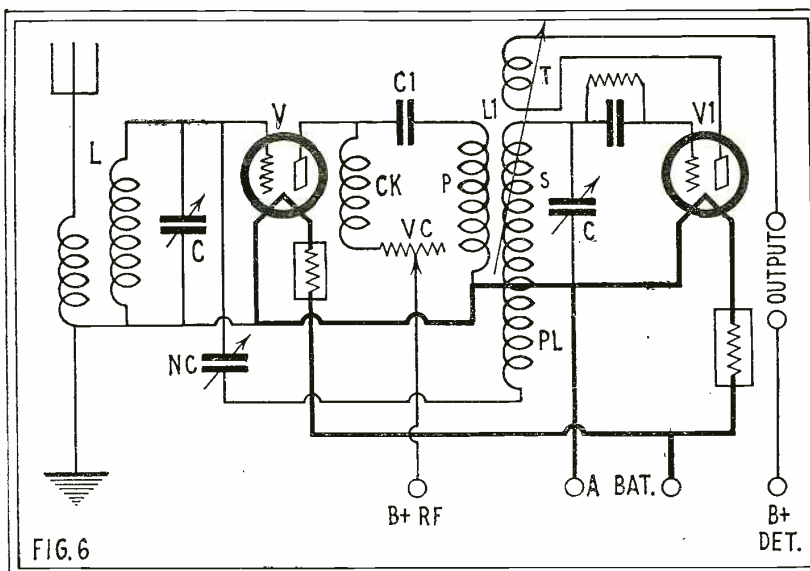

FIG. 6

High efficiency may be obtained by employing a stage of neutralized R.F. amplification, followed by a regenerative detector. L, antenna coupler; L1, detector-circuit coupler; V, R.F. tube; V1, detector tube; C, tuning condensers; VC, volume control. (See also page 1285, of this issue).

# R. F. Booster Unit Improves DX Results\*

(Awarded \$100.00 Monthly Prize for Most Useful Constructional Development)



Complete Details for Constructing A Simple Device Improving the Sensitivity and Selectivity of Any Receiver with No Wiring Changes



By David Grimes

THE greatest thrill of radio always has been, as it always will be, the reception of broadcast programs from remote transmitters. In the earliest days of radio broadcasting, the experimenter desired above all to have as comprehensive a log as possible, and local stations were little esteemed. Notwithstanding all the efforts to the contrary which have been made by manufacturers and broadcasters, that desire for distance still remains with every true radio fan.

It is well known, of course, that distant reception has been made extremely difficult in the past two years, first, by the excessive number of stations which "jam" every available broadcast channel; and, secondly, by the tendency toward the production of single-control receivers, which too often involves a sacrifice of real receiving efficiency for the sake of simplicity in operation.

The owner of the old, but efficient, three-dial receiver is now seeking relief from the congested condition of the ether; while the single-dial owner has fully realized as well the inherent shortcomings of his particular instrument. It is, further, universally understood that governmental relief, because of the many technical and legal difficulties, is not to be expected in the immediate fu-

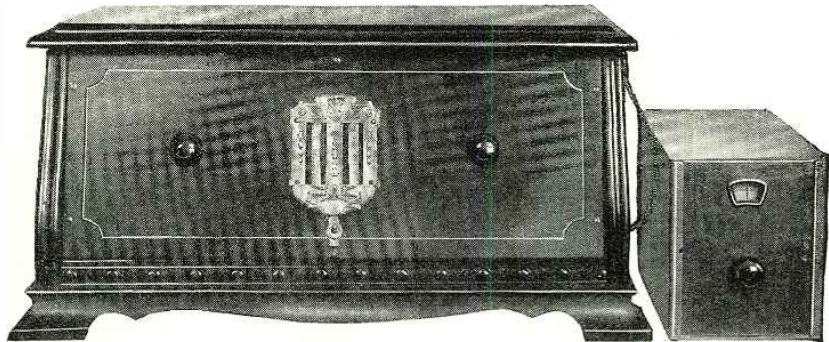

In this picture the R.F. Booster Unit is shown connected with a standard tuned R.F. receiver. In order to install the Booster Unit it is only necessary to insert a plug in the detector socket.

ture; but the entire situation calls for some remedy at once.

Many radio laboratories have been working diligently to perfect apparatus suitable to cope with present conditions, and some devices have already been offered to the public; but these are, in most instances, limited in their application to some particular

receiver or some special location. With all of these facts in mind, the writer has conducted extensive tests in the hope that some simple attachment could be designed for universal use with present sets.

An excellent solution of the problem, he is confident, has been found, and it is here presented for the first time, exclusively to the readers of RADIO NEWS. Its fundamental principle is a development of a new circuit whose peculiarities and unusual results have been under observation for over a year in his laboratory. Some of its interesting phases became generally known last fall; but each succeeding week of experiment has unfolded additional possibilities and, only recently, came the realization that the R. F. "Booster Unit" holds a universal answer for the problem of improving the receivers in present use.

The attachment has been worked out in such a way that it is necessary merely to plug it into the detector-tube socket of a set, without making other connections of any kind. *No changes of any kind are necessary in the set itself.* In this way, the device may at any time be put instantly into service, and as quickly removed from the receiver. This permits the making of an intelligent comparison, and the marked improvement will demonstrate that the small cost of construction is more than warranted by the results. Every part of the receiver is utilized without change—the R.F., detector and A.F. circuits.

The "plug-in" unit constitutes a genuine addition to the set and is in no sense a replacement. The tuning of the receiver is not changed; it is merely made sharper. There is, therefore, no need of re-logging the set except to record the new stations which will be heard after the unit has been attached.

Reference is made here to Fig. 2 which shows the functional rearrangement of a standard five-tube tuned-radio-frequency re-

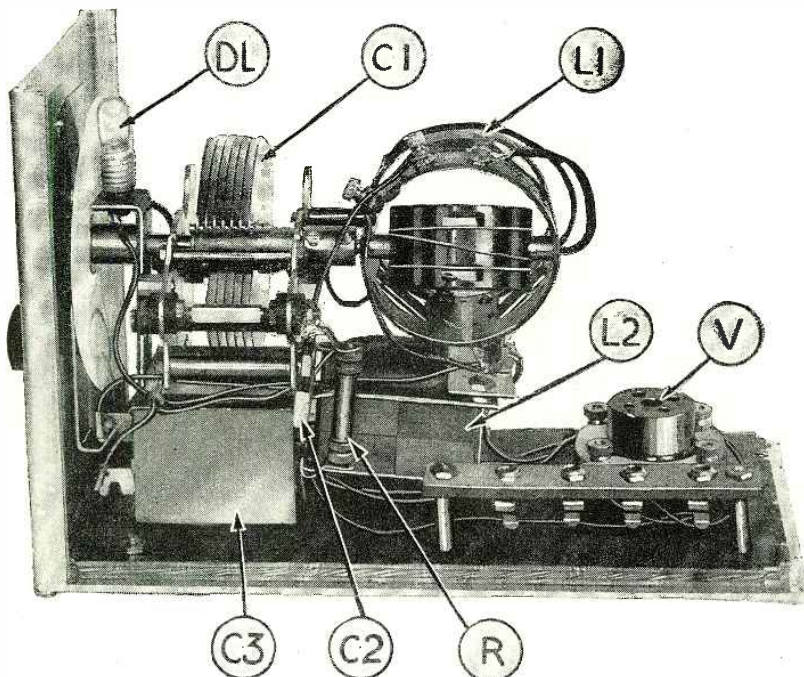

View of R.F. Booster Unit, with sides of shield-can removed. C1, variable condenser; C2, grid condenser; C3, by-pass condenser; LI, Coupler unit; L2, audio choke coil; R, grid leak; V, tube socket; DL, dial light.

\* RADIO NEWS Blueprint Article No. 54.

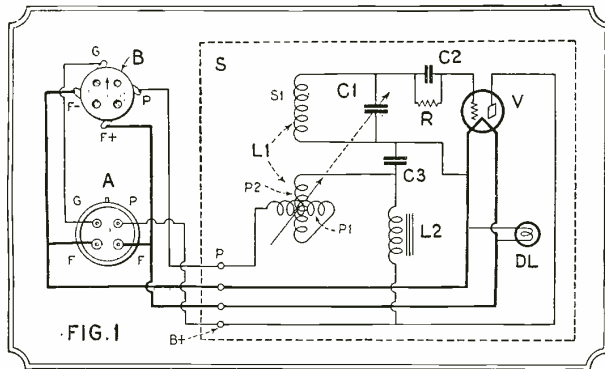
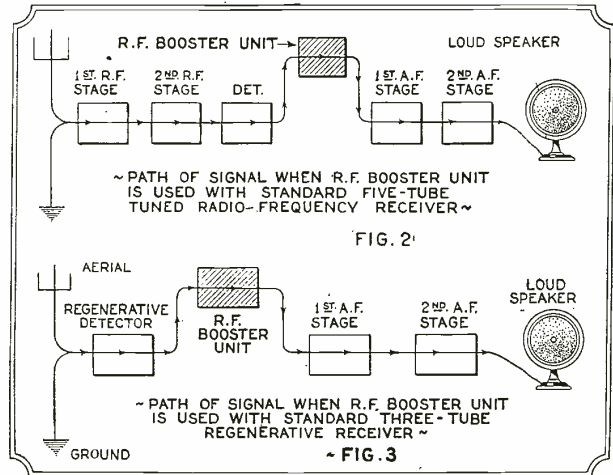

Fig. 1—Complete schematic wiring diagram of the R.F. Booster Unit described in this article. The symbols correspond to those used in the text and other illustrations. Figs. 2 and 3 indicate the location of the Unit in two types of sets.



ceiver. The unit is connected in immediately after the detector stage and immediately ahead of the first audio stage. Fig. 3 shows the comparative arrangement for a three-tube regenerative receiver. It will be noted that the "Booster Unit" is connected following the detector in the regenerative set, and the tickler coil then operates in the plate circuit of the booster stage, where it is quite as effective in its operation as it was previously. Fig. 4 is a schematic wiring diagram of the unit and the associated circuits just ahead and just after its position in the tuned radio frequency circuit. The unit wiring is shown within the dotted lines which indicate shielding; while the remaining wiring belongs to the associated circuits. Fig. 5 shows the schematic wiring diagram when the unit is connected into the regenerative circuit.

Now the theoretical considerations in this circuit are most interesting. At first glance, it appears that a second detector has been added to the circuit—and so it has! The detector circuit, ordinarily used in the receiver for the production of the audio frequencies, no longer serves this purpose; but the "by-products" or secondary functions of the detector, ordinarily wasted, are retained and utilized in this new circuit for the increase of selectivity and distance.

**RADIO-FREQUENCY COMPONENTS**

In order to appreciate fully the electrical actions taking place, one must recall that the plate circuit of a detector tube contains, not only audio-frequency currents, but

# NEW!

*M*ANY listeners have long been looking for a device of some kind which might be connected to a receiver of any type to give the increased sensitivity, selectivity and volume to be expected from another R.F. stage; but of those developed for this purpose, few have been found satisfactory. While several manufacturers have produced separate R.F. units to be inserted between the antenna and the first tuned circuit of the receiver, an additional stage of this nature introduces liability to uncontrollable oscillation.

*This article is a description of the theory and construction of a unit which will accomplish the long-desired end; it may be connected, by the simple insertion of a plug in the detector socket, to almost any radio receiver, and will improve general results in the all-around characteristics above named. The "Booster Unit" is an addition to the receiver (no parts of which does it render inoperative) of one more R.F. stage; it is simple, inexpensive and may be quickly constructed.—EDITOR.*

also radio-frequency currents of half the wavelength ("harmonics")! These are the frequencies which are brought into play upon the installation of the R.F. booster unit. So the circuit that was formerly the detector circuit becomes a radio-frequency stage and the new unit operates as a detector.

The "Booster Unit" may be used in either one of two ways: in the first, the unit operates on the original wavelength of the signal and under these conditions the detector tube functions exactly as an additional stage of tuned R.F. amplification. In the second, the Booster Unit operates on the "half-wave" or "second harmonic" of the signal, and then the detector acts as a frequency-changing circuit. Different results are obtained when the unit is used in these ways: in the first, both the sensitivity and the selectivity of the receiver are generally improved while, in the second, the selectivity is greatly improved but the sensitivity is slightly impaired. The standard unit described in these pages operates on the original wavelength of the signal; but elsewhere in this article will be found directions for making a booster unit which operates on the half-wave. Both types are satisfactory; but they accomplish different results.

The above description will cover that application of the Booster Unit which makes the detector stage an additional stage of radio-frequency amplification. A unit of this type will considerably increase the distant pick-up of the receiver and will also

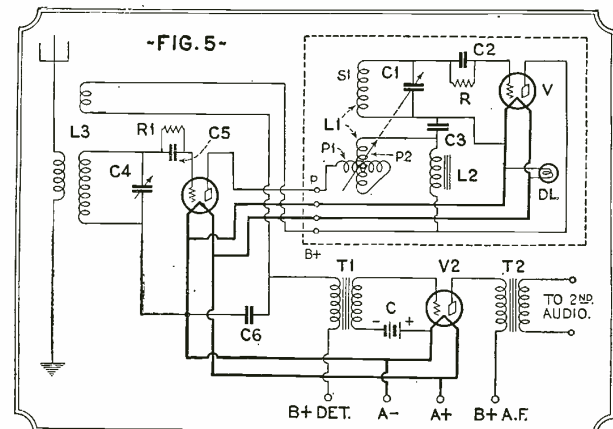
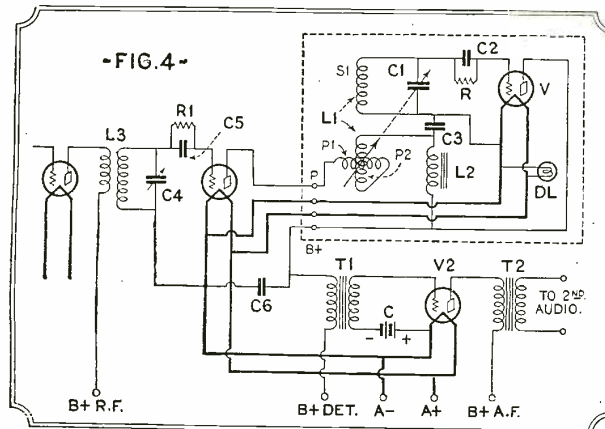

The above diagrams show in schematic form the way in which the R.F. Booster Unit is connected with two standard types of radio receivers. In Fig. 4 the Unit follows a non-regenerative detector in a tuned-R.F. set; and in Fig. 5 it is placed after a regenerative detector.

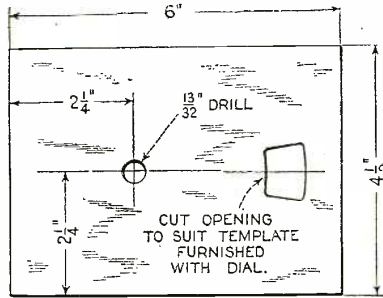

~ END WALL OF SHIELD BOX ~

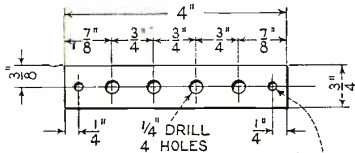

~ CORD TIP JACK STRIP ~

This drawing shows the exact location of all holes required for mounting apparatus on front of shield-can. Also, complete details of terminal strip are given.

increase the selectivity. By shortening the length of the antenna, to reduce the pick-up of the receiver somewhat, the selectivity can be still further increased.

THE POINT OF ATTACHMENT

At least half the novelty of this idea consists in the circuit arrangement, whereby no other connections are made with the exception of the insertion of the plug into the detector socket. This is the only socket into which such a unit could be plugged without disturbing the design of the radio-frequency circuit. Any attempt to connect an additional radio-frequency stage in any of the radio-frequency sockets would result in unbalancing, and cause uncontrollable oscillation. It would completely upset a neutralized or neutrodyne receiver, and would ruin the stabilization of a receiver controlled by the "losser" method.

Furthermore, the choice of the detector socket for this unit was controlled by other considerations as well. It is much easier to locate the detector than any of the radio-frequency sockets. The detector has usually a flexible socket or damping springs. The grid leak is generally mounted near this socket. With the set connected up, ready to operate, the detector tube is "microphonic;" that is, it is easy to identify by gently tapping the tubes with the finger. The tube giving the greatest noise in the loud speaker upon tapping is the tube in the detector socket. The microphonic difficulties in the average receiver were alone sufficient reason for designing this unit for plugging into the detector socket; as

*MR. DAVID GRIMES, whose name is well known to all radio students and constructors, as a radio research engineer and inventor, will be associated with Radio News during the coming twelve months as a contributing editor. Mr. Grimes' invention of the inverse duplex system of amplification is his most familiar achievement; but equal originality is shown in the interesting, as well as practically valuable, "Booster Unit" described in this article. He has been doing of late a considerable amount of research experiment, the results of which will be told in the series of monthly articles which begin in this issue and will continue for a year. Readers of Radio News, as well as its editorial staff, will welcome the addition of this distinguished radio authority to the long list of eminent writers who have made its pages the most popular radio literature in the world.—EDITOR.*

changing a standard detector circuit to a radio-frequency stage greatly reduces the microphonic hum, so troublesome when the loud speaker is placed near the receiving set.

The Booster Unit, of course, adds to the receiver one more tube. The additional

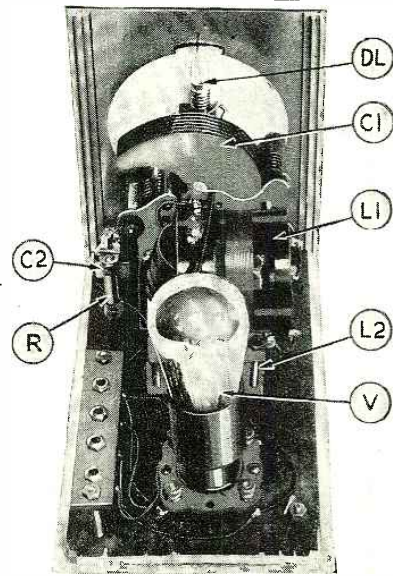

Rear view of R.F. Booster Unit, with sides of shield-can removed. Symbols correspond with those used in text and wiring diagrams.

tube is inserted in a flexible socket at the rear of the tuning unit. The tube which was removed from the detector socket is reinserted in a socket mounted in the top of the plug. (This rule applies only when a standard amplifying tube has been used as a detector; if a special detector of the 200A-type was originally used in the receiver, this tube is inserted in the socket in the Booster Unit and a standard amplifying tube of the 201A-type is placed in the socket mounted in the top of the plug.) It must be noted that the true detector circuit is now contained in the Booster Unit and a special (200A-type) tube is recommended for this circuit.

CONSTRUCTION OF THE PLUG

In Fig. 1 the method of connecting the combined plug and socket is shown. This piece of apparatus is easily constructed from an empty tube-base and the top of a flexible UX-type tube socket of the dimensions given on the next page. The cable leads consist of flexible silk-covered wire, such as that used for winding loop aeriars; this has been found to be most suitable because of its small size, mechanical flexibility and neat appearance. The free ends of this cord are soldered to cord tips to permit their easy insertion into tip jacks in the unit. This method of connection has been adopted to permit the running of the cord through a small hole in the cabinet; any permanent connection between the unit and the plug would prohibit this convenience. It would be necessary to drape the cord over the top of the set, or a hole sufficiently large to permit the passing of the entire plug would have to be drilled in the cabinet of the radio set.

There are a few minor points, about making the combined socket and plug, that should be here noted. If a new tube-base is utilized, the four brass prongs will be hollow; so that the connection wires may be brought down through and soldered at the bottom. In case an old tube-base is employed, it will be necessary to heat the brass prongs with a soldering iron to melt the solder at the end of the hollow tubes.

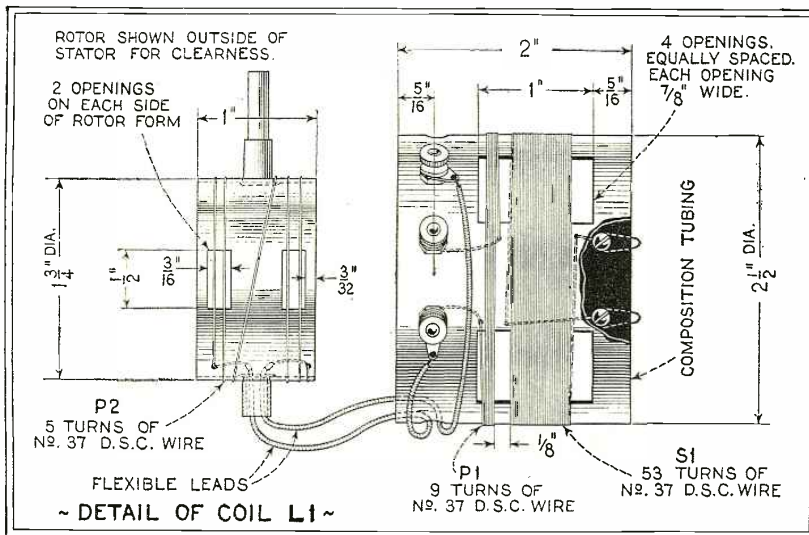

The coupler coil L1, which is used in the construction of the Booster Unit, may easily be made at home. Complete details are given in the above drawings.



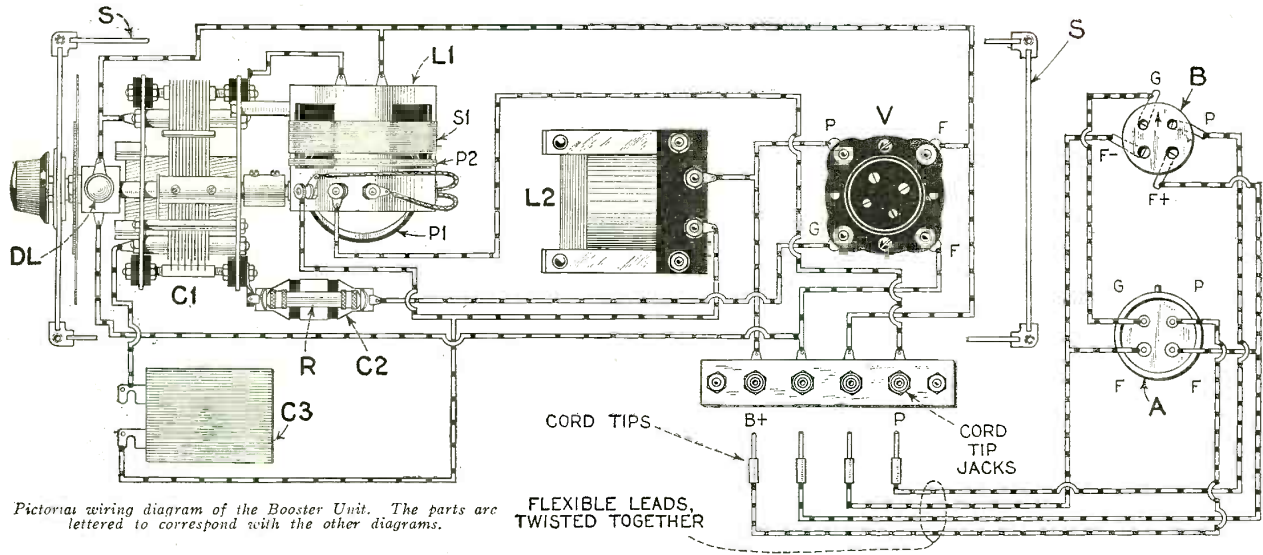

Then, the connections may be brought down through the prongs and soldered, as in the case of a new tube-base. Some care must be exercised in making the connections between the prongs on the tube-base, the terminals on the inserted tube socket, and the cable leads running out to the unit. Careful attention should be paid to Fig. 1 and the pictorial wiring diagram. The two large prongs in the tube-base constitute the two filament leads which, ordinarily, are connected to the filament of the vacuum tube cemented in the base. The two filament terminals of the socket marked "+" and "-" are connected by leads soldered into the two large prongs above mentioned. No particular care need be taken as to which prong is connected with which filament terminal, for polarity does not matter.

Hold the tube-base with the prongs down and in such a position that the small socket-pin is pointing away from you. It will then be noted that the two large brass (filament) prongs are nearest you. The small upper left prong is the grid connection; the small right prong is the plate connection. The grid spring of the socket is connected directly to the grid prong of the tube base. The plate prong is connected to one of the flexible cable wires and should be marked "B+". The plate terminal of the inserted socket is connected directly to another flexible cable lead to be marked "P." Two additional cable leads are connected to the two filament terminals of the inserted socket, but these are not labeled. The socket is then pushed down into the tube base, with the four cable wires extending up on

one side. A small hole is then drilled in the base of the plug and melted paraffin is poured in in order to hold the mechanism intact. Only a little will suffice; as too much will plug the entire inside, preventing the insertion of the tube in the socket. The four wires of the cable may then be braided together, forming a compact strand. This in no way impairs their operation; as the cable does not contain any grid wires, but merely one plate wire, one "B" battery wire and two filament wires. This cable should have a length of about two feet, although this is not at all critical. The extension springs on the socket must be sheared off to a length that will permit the socket to be inserted in the tube base, as indicated in the illustration.

(Continued on page 1268)

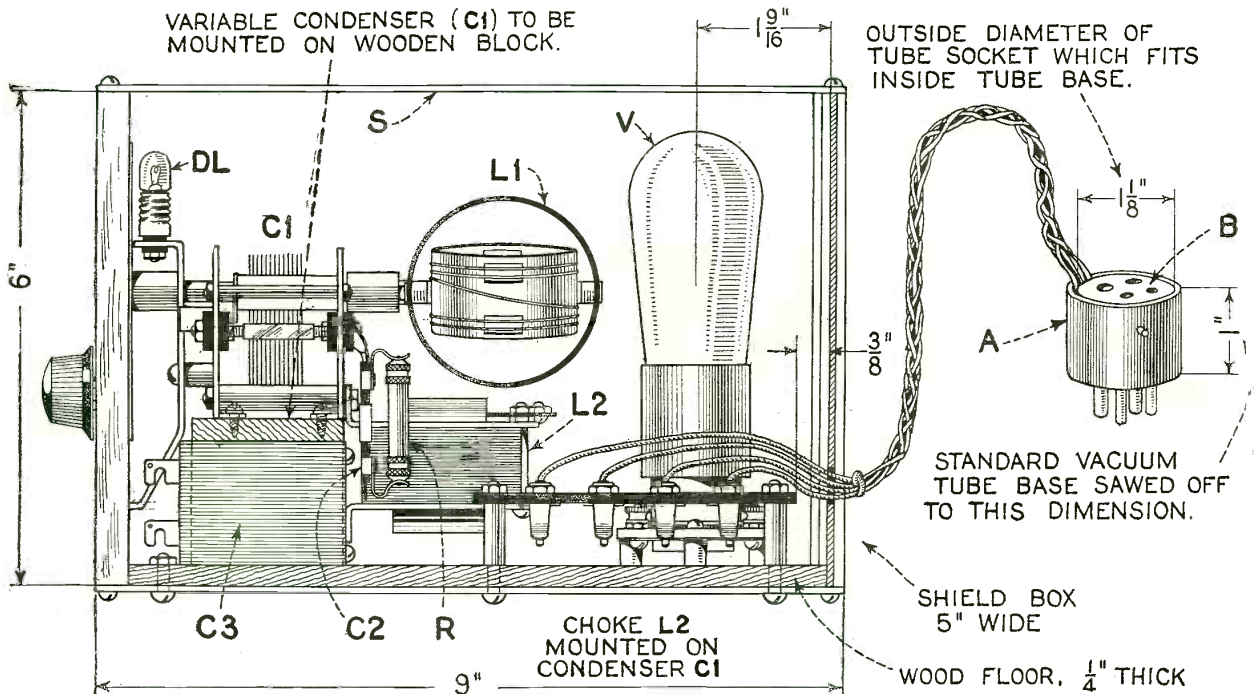

How the parts are arranged in the R.F. Booster Unit. The simplicity of construction is apparent.

# A Motor Operated by Radio or Static from the Air



By S. R. Winters

**R**ESEMBLING a spiderweb tuning coil, a tiny motor has been designed which operates exclusively from electric energy collected from the ether. The inventor, C. Francis Jenkins of Washington, D. C., merely connects this miniature motor to the usual radio aerial and ground—in a word, power by radio!

Intermittently, for twenty years this scientist has indulged in experiments, on a small scale, looking to the extraction of useful amounts of power from the air. His ambitious, if not visionary, project was given impetus by a published conclusion of the Carnegie Institution of Washington, to the effect that at any specified elevation above the earth there exists a definite electrical potential between that level and the surface of the earth. A three-year survey cruise around the world on the non-magnetic ship *Carnegie* gave conclusive proof in substantiation of this theory.

Tiring of music and speech from a broadcast station, Mr. Jenkins can simply disconnect his radio receiving set from the aerial and ground and attach the wires leading to these to the two terminals on the tiny motor. The latter whirls around as if propelled by a real dynamic force, other than the mere nothingness of the ether! Air charged with electrical disturbances tends to speed up the tiny mechanism, thus giving credence to the theory that static, harnessed in this manner, may become a benediction instead of a malediction. Storms, less electrically disposed, may have the tendency to slow down the small revolving disk.

## ELEMENTS OF THE MOTOR

The radio or static-operated motor has more than a semblance of a radio tuning coil or a variable condenser. There are well-defined stator

and rotor elements. For instance, the revolving unit consists of a thin piece of mica (M, Fig. 1) supported on pivotal points, the whole well-balanced. This mica disk has five armature sections A, of tin-foil overlapping the edges of the disk, spaced equally between five different points. Embracing this disk, also at equal intervals, are four electric field poles, each metallurgically connected with the field pole diametrically opposite by the wires marked W. On each pole is mounted a thin brush which makes a contact with the armature sections as they pass thereunder. Since there are five armature sections and only four field poles, at least one of these brushes is always in contact with an armature section.

If one pair of opposite field poles is positively charged with electricity and the other pair is negatively charged, one of the armature sections receives a charge of like sign with the field pole enveloping it. This armature section, consequently, is immediately repelled; moving away from this field pole and toward the next field pole, to which it is attracted for a similar reason. As it passes under the brush of this field pole, its charge of electricity is surrendered for one of unlike sign and is, in turn, repelled by the pole. A similar phenomenon exists at each of the other field poles and, as a result, a continuous rotation of the movable element of this radio motor is maintained, at a relatively high velocity, too.

To increase the torque, or force of rotation, a battery of armature plates is mounted on a single shaft, and all the like armature sections, in a row parallel to the

shaft, are connected together. Only one set of brushes is necessary; the latter are arranged to form contact with the armature sections only immediately after each has passed the median or intermediate end of

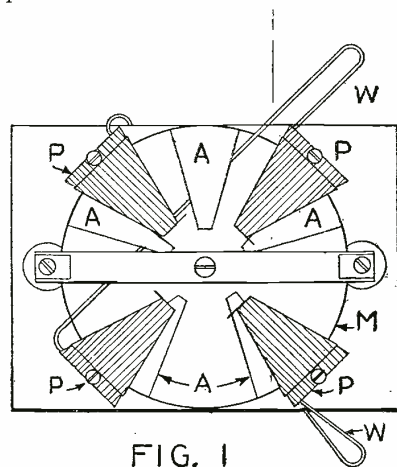

FIG. 1

M is a mica disc on which tin-foil segments, A, are fastened. The poles, P, are connected by the wires, W.

each field pole. The tiny motor, therefore, always turns in the same direction. The behavior of this motor is analogous to a simple example in the early study of electricity; a balanced wire emitting electric sparks will revolve in the opposite direction. (See page 238 of Radio News for September, 1927.)

## RADIO POWER OF THE FUTURE

Hugo Gernsback, in his book "Radio For All," pictures a group of future travelers being propelled by so-called "radio-power roller skates." Their headgear includes three-pronged metallic gadgets, which collect radio power from a nearby railing. The power is radiated through space from this rail to the three-pronged affair and then is conveyed to the skates, which are operated by small electric motors. These skates are accelerated to a speed of 15 to 20 miles an hour, and yet there is no visible connection between the wearer and the radio-power-distributing rail.

This was, undoubtedly, considered visionary when Mr. Gernsback wrote his book; but the Washington inventor who is tapping the ether for radio power staggers our imagination and prompts us to agree with Mr. Gernsback when he declared that the future of radio might be anything! Mr. Jenkins, acting upon the principle that the force of electric attraction and repulsion is in proportion to the capacities of the opposed surfaces, is constructing a motor of considerable power which, he anticipates, will be driven solely by radio or static!

(Continued on page 1298)

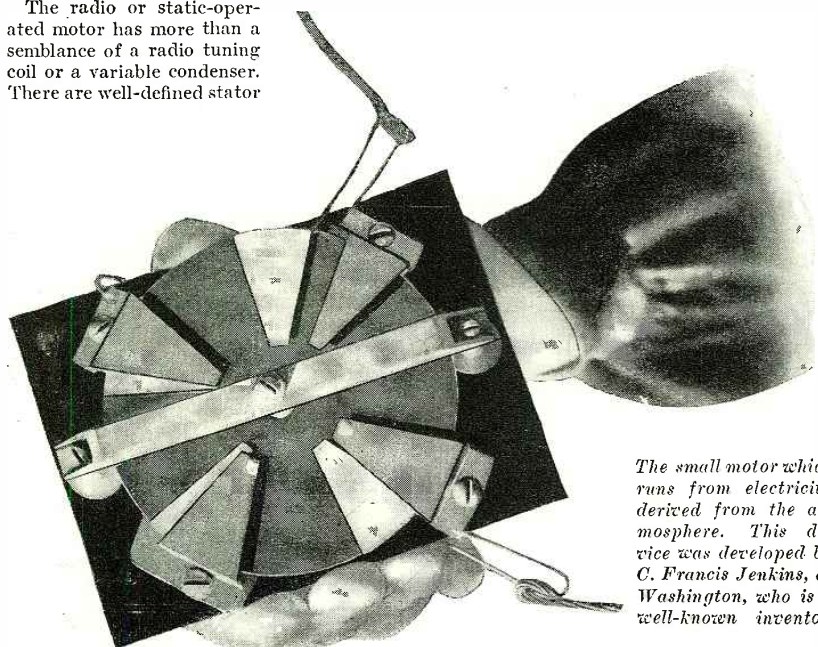

The small motor which runs from electricity derived from the atmosphere. This device was developed by C. Francis Jenkins, of Washington, who is a well-known inventor.

# From Paul Revere to Paul Whiteman

A Lover of Antiques Converts a Colonial Heirloom into a Modern Radio Receiver, and Makes Strange Discoveries

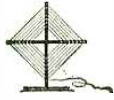

By Charles Strayer

SEVERAL years ago the writer, a radio enthusiast—and nut—as well as a lover of the beautiful, conceived the idea of building radio receivers into suitable pieces of furniture, such as old consoles, cabinets, chests and other odds and ends of household sentiment or antiquity.

In the pursuit of this plan, an old chest came into his possession through a local dealer in antiques, in the Virginias. It is made of solid golden-brown walnut, with an inlaid scroll design of satin and box-wood on the front wall, as shown in the accompanying illustration. Aside from the simple beauty of line and proportion and the rich, time-mellowed grain, there was apparently nothing unusual about this particular chest, other than attaches to many old pieces of earlier days.

The cabinet was known as a Treasure Chest in former times. In fact, it has been traced back three generations, and is well remembered by a gentleman, now living, as having been used by his grandmother for a jewel case. On the bottom, which is well worn and securely fastened with hand-forged nails, is deeply carved the date "1771".

In the writer's desire to get off the beaten path in building radio sets and in his reluctance to cover up the design on the front panel with sundry mechanical and scientific-looking discs, knobs and dials, he turned to the modern and efficient drum-control method of tuning.

### A STARTLING DISCOVERY

In the use of this method it became necessary to cut a small, rather irregular, "port-hole" in the front wall between the inlaid initials "L. R." However, no great endeavor was exercised when cutting this

that the little rectangular, panel-like design, which held the large initials "I R", was, in fact, a very real and secret panel; between which and the cabinet wall, in a pocket about an inch deep, two inches wide, and five inches long, were hidden the "docu-

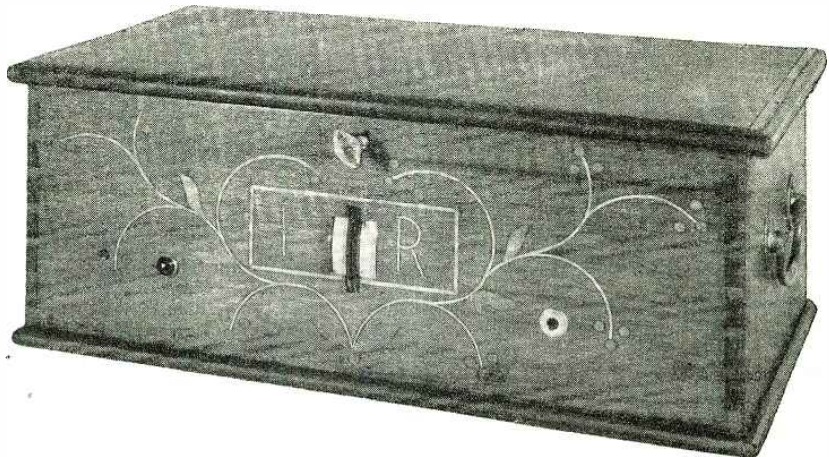

This 157-year-old chest may have held treasure; it did hold mysterious documents through a century.

opening, to preserve intact the pieces of wood which came out. So, the panel was drilled in several places, "jigged" out with a coping saw and the pieces allowed to drop rather heedlessly, until it was noticed

ments" which were subsequently mounted under the lid of the chest.

Needless to say, upon first making this discovery, stories of Captain Kidd and his (Continued on page 1277)

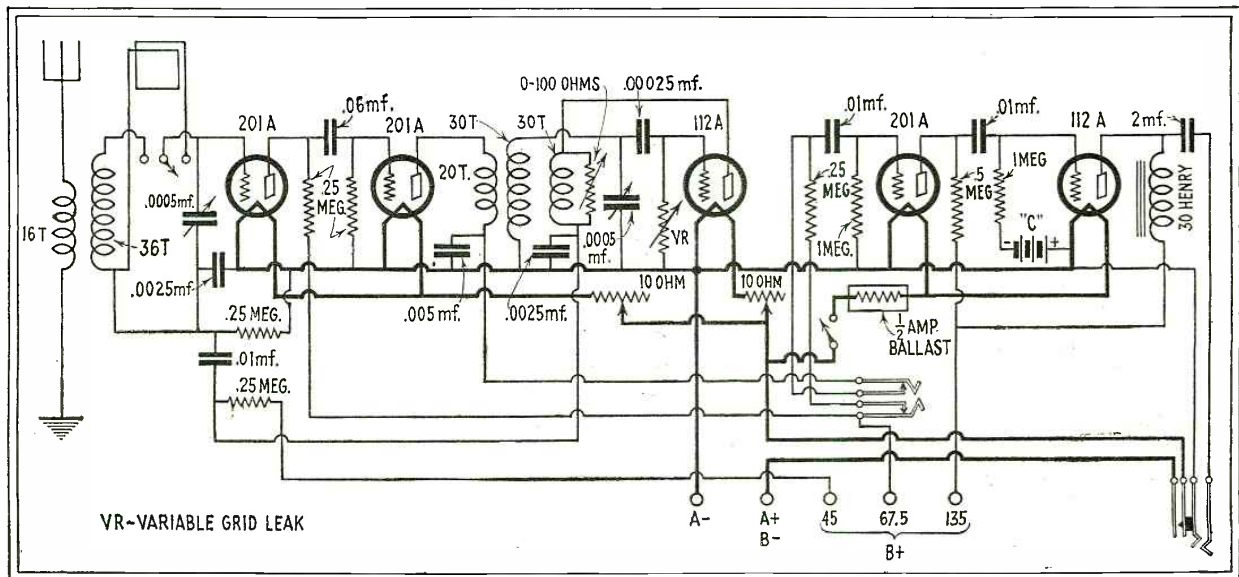

The schematic circuit of the "Treasure Chest" receiver. The R.F. transformers are spiderweb coils wound with No. 28

D.S.C. wire. When the intermediate jack is used, a bakelite plug is inserted in the output jack, to light the filaments.

# A New System of Radio-Frequency Amplification

A Circuit Interesting to Experimenters Who Would Like to Develop Into a Finished Receiver a Set Having Great Possibilities

By Arthur T. Brown

**A** METHOD of using three-element vacuum tubes for radio-frequency amplification, without the necessity of stabilizing devices, has been invented by the writer. It differs radically from any method that is in use now or, so far as the writer knows, has ever been used, both in principle and application. It is well to look at the standard methods, however, before explaining the method here published.

Present methods of using "triodes" (three-element vacuum tubes) in radio-frequency amplification have all been developed to overcome the tendency of the tube to oscillate with provoking ease—in a circuit of even a moderate efficiency. That tendency is due to the capacity between the elements of the tube. All three elements, plate, grid, and cathode (filament) act as condenser plates in relation to each other, in addition to which the leads through the base and the "mesh" of the standard tube must be added as miniature condenser surfaces. (See Fig. 1).

Now, since the reactance of a given capacity varies inversely with the frequency put across it, it is easy to see that even the small capacities in the triode (in the 201A, for example, they are of the order of 5 to 10 mmf.) become a serious factor in one-way amplification of radio frequencies. At 300 meters (1000 kc.) for example, the grid-plate reactance works out, in round numbers, at 16,000 ohms. If the plate load equals this, or is greater, as may easily be the case in tuned radio-frequency amplification, energy feeds back from the plate to the grid directly (as well as through the load) thence back to the plate, and regeneration, followed by oscillation, occurs.

### OVERCOMING CAPACITIVE FEEDBACKS

The problem, then, has been to overcome the effects of these inter-electrode capacities. Prior to invention of the neutrodyne, this was done by introducing into the circuit losses sufficient to keep the tube working so far below its maximum that oscilla-

tion did not occur; e.g., by a positive grid bias through a potentiometer. The neutrodyne method consists of feeding back, from the output tube to the grid, energy in opposite phase to that on the grid. The Hazeltine, Roberts, Rice, and superdyne methods are all ways of accomplishing this end. They, too, are "losser" methods; since they

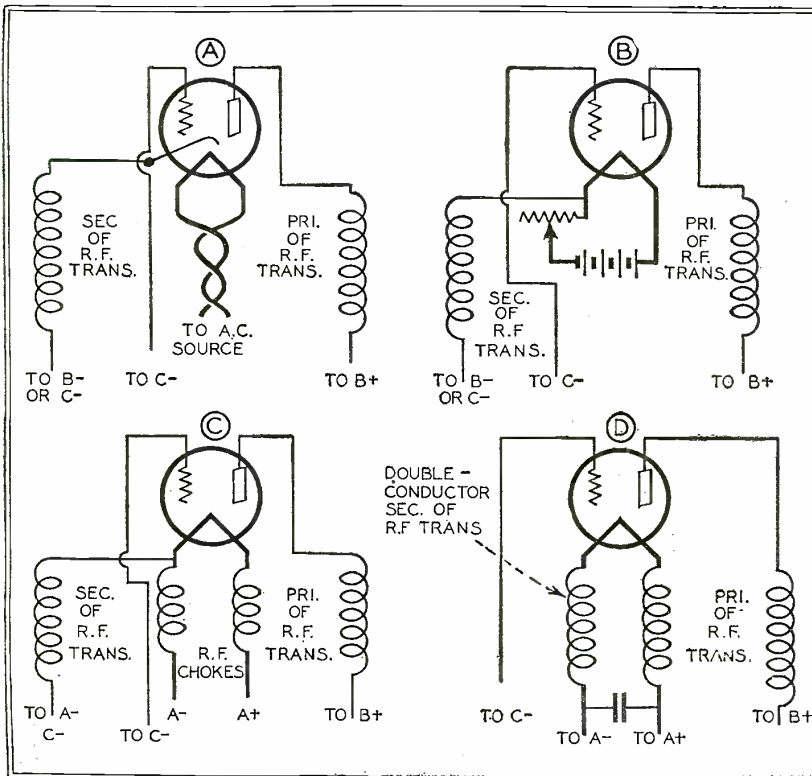
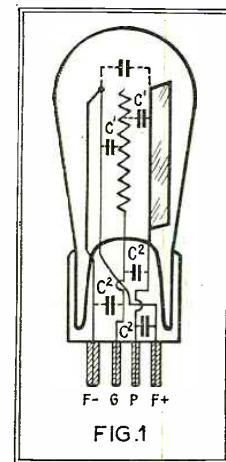

Fig. 3—The cathode of the tube must be isolated from ground potential, as regards radio frequencies. This is easily done in the heater-cathode tube shown at 3A; but in 3B a separate "A" battery must be used for each tube. In 3C, R.F. chokes are used; while the best device, a dual tuned choke, is shown in 3D.



The condensers indicated in the sketch above illustrate the capacity effects between the three elements of a vacuum tube and their leads.

use energy generated in the tube to keep the net energy down to a non-oscillating level. Even the use of variable coupling between primary and secondary of inter-stage transformers (as in the King system) is a "losser," in the sense that the input of each tube is kept low enough to avoid oscillation. And the better the inherent powers of the tube as an amplifier, the harder it is to use it in radio-frequency circuits.

If, however, we consider what happens in a triode, we shall see a way to use it so that we can employ high- $\mu$  tubes as well as low- $\mu$ , and both without the need of oscillation control.

Electrons liberated from the filament or other form of cathode, being negatively charged, are drawn to the positive plate. Their passage, however, is through the meshes of the grid. If that be positive, their progress is assisted; though some of them are captured by the grid and lost to the plate, and therefore useless for purposes of amplification. If the grid be negative, the electrons are repelled from it, and, unless they shoot through its meshes, are driven back to the cathode or its vicinity.

There is, however, in the triode problem another important consideration: the space charge between cathode and grid. This consists of countless liberated electrons

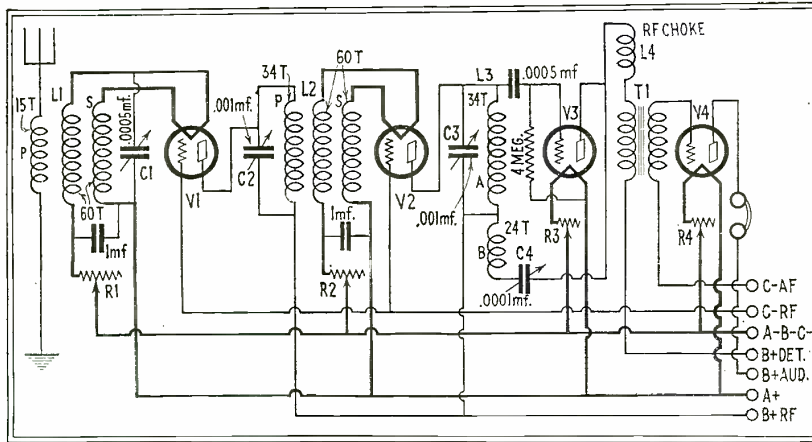

Fig. 4—Schematic diagram of receiver. No. 20 D.C. wire is used in secondaries of L1 and L2 and also A and B of L3. No. 18 D.S.C. is used on primary of L1, and No. 24 D.S.C. on primary of L2. All coils are wound on 3-inch tubing.

that, with their varying speeds, interfere with each other, and prevent some from getting very far away from the cathode, toward which (particularly its positive end, since they are negative) they are drawn. See page 897, RADIO NEWS for February, 1928, for illustration.

Now, when the grid is positive, it tends to reduce the space charge, pulling it away from the cathode, making the crowding less, and reducing the effect of the cathode on the charge. On the other hand, when the grid is negative, it tends to keep the space charge both denser and closer to the cathode, making, therefore, the flow to the plate less, and raising the impedance of the tube.

**THEORY OF A NEW METHOD**

If, now, we make the cathode the input to the tube, connect the plate in the usual way, and use the grid as a means of keeping the space charge close to the cathode, several important differences in performance will result.

Consider the action of the cathode first: As the radio-frequency alternations of potential appear on the cathode, they change, at the rate of their own frequency or frequencies, its average potential, making it slightly more positive or more negative. When the cathode is more positive, its rate of electronic liberation is decreased (thereby decreasing the plate current) while, at the same time, the space charge is drawn closer to it. When the cathode is more negative, the electronic emission is increased and the space charge driven further away. In short, the rate of the emission of electrons is conditioned by the voltages impressed on the cathode, the changes in rate being at the frequency impressed. There is thus a control, within certain limits, of the electronic stream at its source. This control in the liberation of electrons is further augmented by a control, in like phase, of the space charge. Thus a considerable portion of the total emission is controlled by impressing the radio-frequency potentials on the cathode. It is evident that the control so imposed by the cathode on the space charge is effective substantially in inverse ratio to the cube of the distance of each electron in the charge from the cathode. Hence it is important to keep the space charge close to the cathode.

**USE OF GRID**

This effect can be gained by keeping the grid of the tube at all times negative in

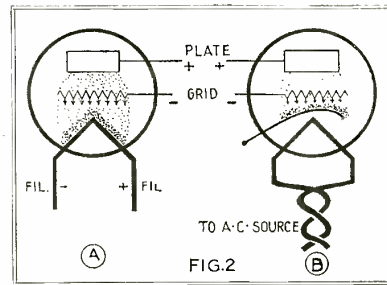

Fig. 2A illustrates the "space charge" in a D.C.-operated tube; and at B is shown the same effect when operating on A.C. The grids in each case require a negative charge to keep the space charge close to the cathode.

respect to the cathode, or any part of it. If we put a negative potential on the grid, it keeps the space charge closer to the cathode than it would be otherwise; and so aids the cathode in controlling the electronic stream. This is the only function of con-

trol which the grid has in the system here described.

The grid performs, nevertheless, another very important function when thus, in effect, grounded. Its position (between cathode and plate, its construction (a mesh with relatively wide interstices), and its connection to the point of lowest potential in the circuit of the tube, result, substantially, in grounding the inter-electrode capacities of the tube. Thus the cause of the oscillation of the triode, when ordinarily connected in circuit, is removed and, in fact, the tube used as here outlined will not oscillate easily even at high frequencies.

The basic action of the tube in this system is shown diagrammatically in Fig. 2. A shows the ordinary battery-operated tube in which the cathode consists of an electron emitting filament. B shows the heated-cathode (Y-227) type in which the filament has the sole function of heating the cathode, which thereby becomes a source of electrons. In both the electronic stream is indicated between cathode, grid, and plate. The cloud of them next to the cathode creates the space charge, kept close to the cathode by the repelling effect (shown by arrows) of the negatively-charged grid. The radio-frequency potentials induced in the cathode decrease or increase, alternately, the liberation of electrons and the closeness of the space charge to the cathode. When the charge on the cathode is more positive than its average value, the electrons are held by it, fewer fly off, and the space charge is drawn to the cathode. When it is more negative, the opposite is true—more electrons are driven off, and the space charge is pushed further away, so that more of its contents fly through the grid to the plate.

**FILAMENT-BIASING VOLTAGE**

Now, in ordinary practice, the cathode of the tube is at or near ground potential. The problem here is to keep it isolated from ground potential, so that the radio-frequency input will be effective. With the heater type of tube (Fig. 3A) the problem is a simple one. With the filament type (ordinary cathode) the problem is not so simple. Several methods are possible (Fig.

(Continued on page 1269)

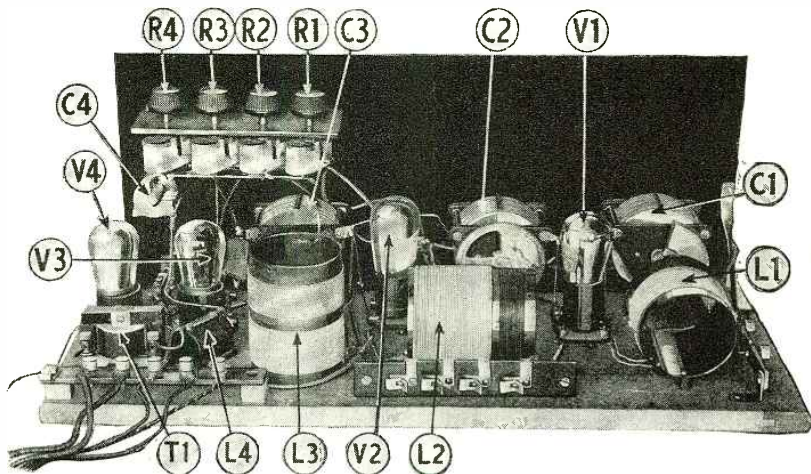

In this rear view of Mr. Brown's receiver, each part is lettered to correspond with the schematic diagram above. The capacity of C1 is .0005-mf.; of C2 and C3, each .001-mf.; and of C4, .0001-mf. L1 is an 85-millihenry R.F. choke.

# A New Receiving-Set Combination— the Neutroheterodyne



Use of High Intermediate Frequency Obviates Double-Spot Tuning and Enables Effective Use of R. F. Neutralization in the I. F. Amplifier



By Herbert J. Reich \*

**T**HE last few years have seen a marked improvement in all types of receiving sets, but practically all present-day sets make use of one of three fundamental circuits, the regenerative, the tuned radio-frequency, or the superheterodyne. Several other circuits, such as the untuned radio-frequency, reflex, and super-regenerative, have proved less satisfactory for most constructors, and hence are little used.

The regenerative circuit was for a long time the most popular because of its simplicity, cheapness, and efficiency. Its main disadvantage lies in the fact that it is usually the cause of serious annoyance to the users of other receivers for miles around. Moreover, it is unable to give sufficient amplification to operate a loud speaker on distant stations without being forced to the point of distortion.

The use of one or more stages of tuned-radio-frequency amplification, ahead of either a regenerative or non-regenerative detector, results in a fairly sensitive receiver. The main difficulty that must be overcome in such a receiver is the tendency toward oscillation as the result of interstage coupling. This may be partially overcome by neutralization and by careful arrangement of apparatus. The recent development of the shielded neutrodyne has completely overcome this defect, and resulted in a set which offers exceedingly high efficiency, good selectivity, and wonderful tone quality.

The superheterodyne circuit was developed in order to take advantage, in the reception of broadcast frequencies, of the high amplification which may be obtained at much lower frequencies without tendency

toward oscillation. This is accomplished by using an efficient low-frequency amplifier tuned to a fixed frequency between 30 to 100 kilocycles. The incoming signal has superimposed upon it in the receiver an oscillator-frequency, of such value that it produces a beat-frequency, which corre-

or beat-frequency, of 50 kc., which will pass through the amplifier. The superheterodyne has another very great advantage, namely, extreme selectivity, resulting from the sharpness of tuning of the oscillator circuit.

### SUPERHETERODYNE PROBLEMS

It has, however, one very great disadvantage. It will be noted that, in order to receive a 1000-kc. station, it is possible to tune the oscillator to either of two settings; except at the ends of the tuning range of the oscillator, there are two settings of the oscillator for every station. It is evident that the upper setting for one station will correspond to the lower setting for some other station. Thus, the 1150-kc. setting for the 1000-kc. station will also give a 50-kc. beat frequency with a station operating on 1100 kc.; and the 950-kc. setting with a third station operating on 900 kc. (See Fig. 1). The detector does not tune sufficiently sharp to eliminate the undesired station, which differs in frequency from the desired station by only 100 kc.; and hence the modulation of the undesired station produces interference. If either the intermediate amplifier, one of the stations, or the oscillator is slightly off its proper frequency the two beat-frequencies will not be exactly alike and there will result, in addition to the interference of the modulated frequencies, an audible heterodyne whistle.

If the intermediate frequency were not an exact multiple of 10-kc., but were, for example, 52-kc., then to receive the 1000-kc. station we would set the oscillator-frequency at 1052-kc. or 948-kc. It would then give a 48-kc. beat-frequency with the

*THE receiver described in this article, when demonstrated in RADIO NEWS Laboratories, proved remarkable in both its sensitivity and its quality; it went down to the "noise level," demonstrating that it gives all the power which can be used. The quality was high; cutting of side bands, which too frequently attends high selectivity, was absent. In this article the author gives the reasons which led him to design an I.F. amplifier for a frequency just below the broadcast band. The advantages of the neutrodyne and the superheterodyne are thus combined, obtaining ample distance, high amplification, and faithful reproduction, with ease of operation and elimination of the annoying double-reading effect, while the circuit is completely shielded and non-radiating. The theory is explained in this article, while complete constructional information and plans will appear in a forthcoming issue.—EDITOR.*

sponds to the tuned frequency of the amplifier. Thus we may have an intermediate-frequency amplifier tuned to, say, 50 kilocycles. To receive a 1000-kc. carrier we tune our oscillator to a frequency of either 1050 kc. or 950 kc.; giving us a difference,

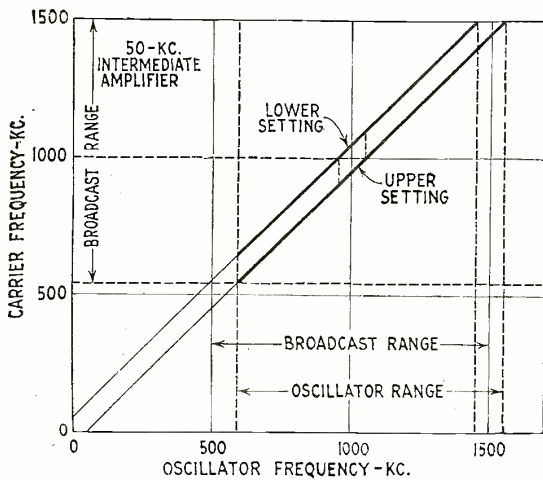

FIG. 1

In the ordinary superheterodyne, operating at say 50 kilocycles, practically every station in the broadcast band tunes in at two settings of the oscillator dial; as may be seen from Fig. 1 (left).

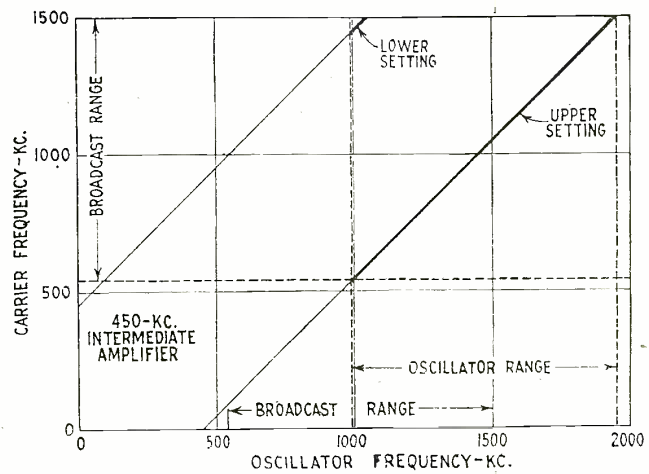

FIG. 2

If we use instead a high frequency like 450 kc., we reduce the effect to its minimum—the last six low-wave channels of the band—as demonstrated in Fig. 2. The first detector easily tunes these out.

\* Physics Department, Cornell University

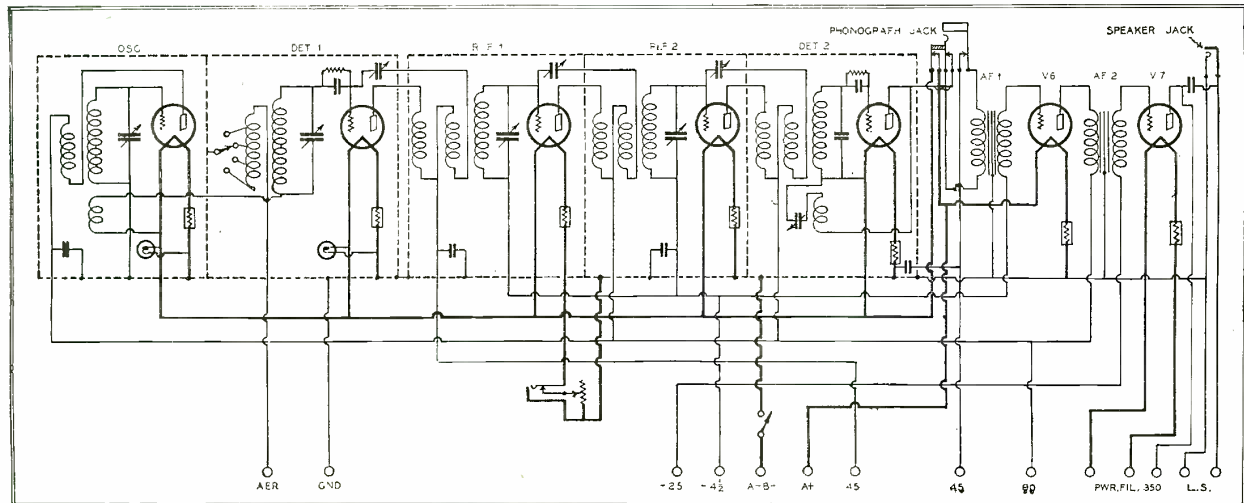

FIG. 3

In this schematic diagram of the 461-kc. superheterodyne here described, the separate shielding of the oscillator, first-detector, first and second intermediate

(R.F.), and second-detector stages is indicated. The values of parts, layout, etc., will be given with working drawings in the June issue.

1100-kc. or 900-kc. station, which would heterodyne the desired 52-kc. beat-frequency and produce a 4-kc. audible whistle. A similar effect may be caused by another station of 1150-kc. or 950-kc. acting as the oscillator for the 1000-kc. station.

In any such case, variation of the oscillator setting will change the value of both the desired and the interfering beat-frequencies, raising one and lowering the other; and so the pitch of the audible whistle will change as the set is tuned. The addition of a stage of tuned radio-frequency amplification ahead of the first detector helps somewhat in tuning out the interfering stations, but does not completely solve the difficulty; particularly in a metropolitan district where there are many powerful stations, and it adds complications.

**CHOICE OF BEAT-FREQUENCIES**

How, then, can we remedy this trouble? The obvious answer is by using such an intermediate frequency that there will be only one oscillator setting for each station, which is in itself an advantage in operation. This may be done by using an intermediate frequency of about 450-kc., as is evident from a study of Fig. 2. Only at the extreme high-frequency end of the broadcast band is it possible to find a second oscillator setting, for either the oscillator fundamental or the first harmonic. In the very short interval at the low-frequency end of the broadcast band, in which the oscillator can heterodyne two stations simultaneously, the undesired station is separated from the desired station by 900-kc., practically the entire width of the broadcast band. The detector's tuning is sharp enough to cut out completely the undesired station, and hence no interference of the type just described can take place. The same holds true for the nearest station which might act as an oscillator.

In the superheterodyne circuit just described we have gained several advantages over the tuned-radio-frequency circuit. We have retained the extreme selectivity and simplicity of control of the superheterodyne and even, though we amplify at a relatively high frequency, we amplify at just one frequency, instead of over the whole broadcast band, and therefore obtain uniform and stable amplification. It is not difficult to

build a stable amplifier tuned to 450-kc.; since the greatest difficulty in stabilizing is encountered at frequencies corresponding to the high-frequency end of the broadcast band, or higher.

There still remains possible one important improvement; substitution, for the ordinary unshielded intermediate-frequency amplifier, of the newly-developed neutralized and shielded radio-frequency amplifier, which, because of its proper design, gives as much amplification as the low-frequency amplifier ordinarily used in the superheterodyne, and is nevertheless perfectly stable.

**PREVENTION OF RADIATION**

The use of this high-intermediate-frequency amplifier makes it possible also to reduce to a negligible amount the radiation of oscillator energy. Since, in the ordinary superheterodyne, the oscillator is tuned to almost the same frequency as the first detector (see Fig. 1), a large amount of oscillator energy is radiated by the antenna. With the 450-kc. intermediate amplifier, however, the antenna circuit is tuned to an entirely different frequency from that

of the oscillator, and therefore such radiation may be almost completely prevented; providing the capacity between the primary and secondary windings of the antenna coupler is kept to a very low value.

Now let us examine for a moment the shielded neutrodyne; two important difficulties must be overcome in the design of this receiver. The first of these is the simplification of its operation; the use of two or more stages of tuned-radio-frequency amplification results in at least three tuning condensers. Unless tuning is to be broadened to an undesirable degree, this necessitates the use of either vernier condensers or some complicated system of cams, cut for the individual set after completion. None of these methods is entirely satisfactory, for obvious reasons.

The second problem is that of obtaining uniform amplification over the whole broadcast band. It is a well-known fact that radio-frequency amplifiers are much more efficient at low than at high wavelengths. To remedy this, various schemes have been adopted, such as varying the primary-to-  
(Continued on page 1279)

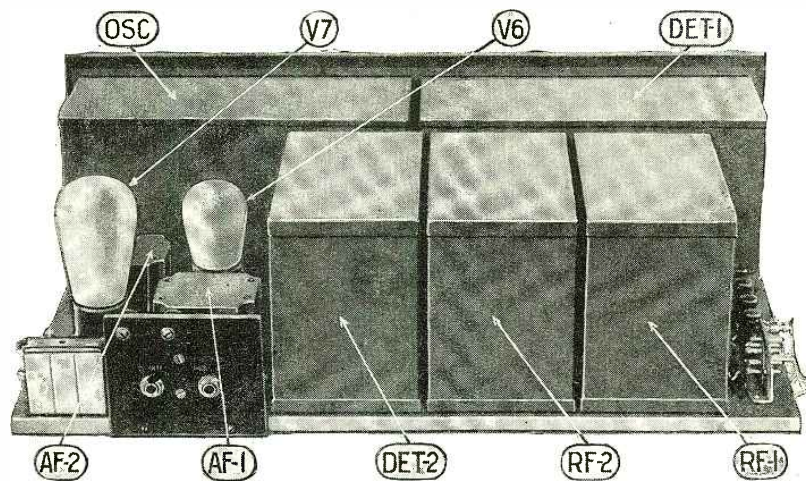

The workmanlike appearance of Mr. Reich's completely-shielded 7-tube superheterodyne, whose schematic diagram is shown above, can be seen at a glance from this picture. Complete constructional details will be given in the continuation of this article next month.

# Building a Dynamic Speaker

Directions for Constructing an Electrodynamic Cone Loud Speaker Capable of Giving the Finest Quality



By Edgar C. Nichols

**G**OOD electrodynamic cone speakers are expensive. For this reason a description of how to build one should be of interest to the home constructor. The writer gives here details of the method by which he successfully constructed one.

There are two types of cone speakers, free-edge or the inertia-controlled (ninety-degree) cone type and the fixed-edge or wave or flat-cone type. The former has been chosen as the one which will give the best results for the home speaker, inasmuch as this type reproduces all sound frequencies at any volume. In the flat-wave cone type there is a tendency to cut off the bass notes when operating at lesser volume. This type of cone vibrates within itself, reproducing the higher notes by the vibration of a small area about the center of the cone and the bass notes by vibration of the entire cone area. Therefore, unless sufficient volume is used the bass notes are lost.

In the inertial type of cone speaker the sound is reproduced by the piston action of the rigid cone, which is supported at

each end by a very flexible mounting. This type requires a baffle, separating the inner from the outer surface of the cone; so that the piston action of the cone will affect as large an air column as possible and there shall be no loss of energy, due to air slippage around the greatest diameter of the cone. This baffle is very essential for the correct reproduction of the bass notes and should be made as rigid and as large as possible, within reason; that is, from fourteen to eighteen inches square. If the speaker is put in a case, the back should be left open so that volume may not be sacrificed. This case, too, may be considered a part of the baffle.

**OBTAINING THE COILS**

To simplify as much as possible the construction of the speaker, parts from a Magnavox horn speaker, type R3, model B,

have been used. These speakers are now antiquated, but many have been manufactured and sold, so there should be no diffi-

*This illustration clearly shows the shapes into which the supporting bars are bent.*

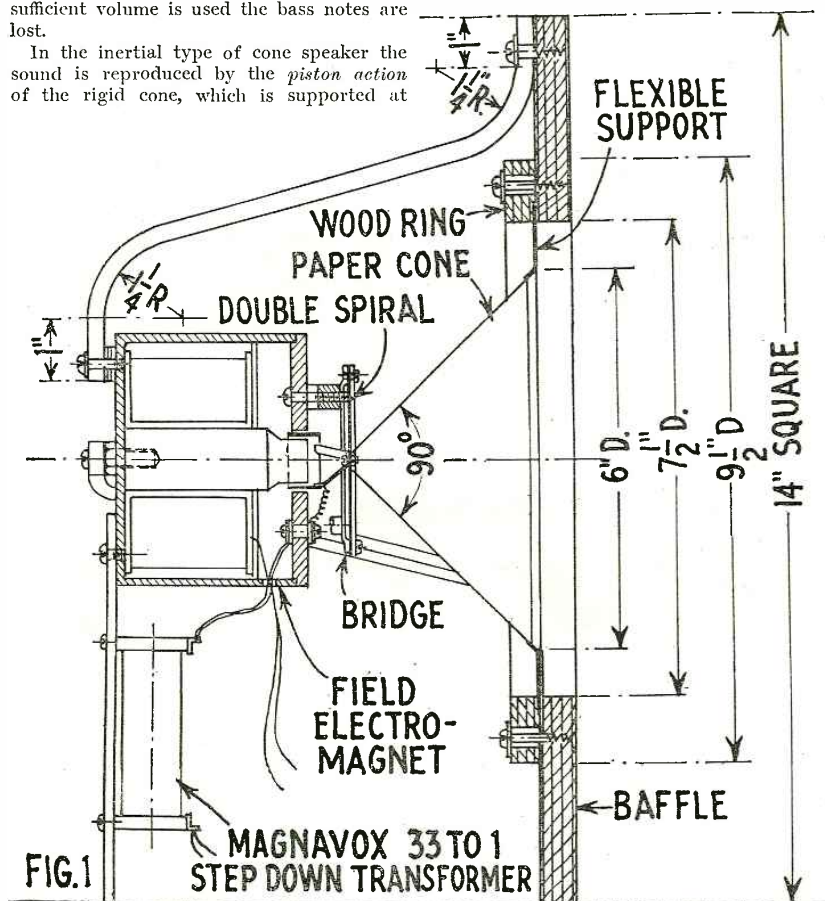
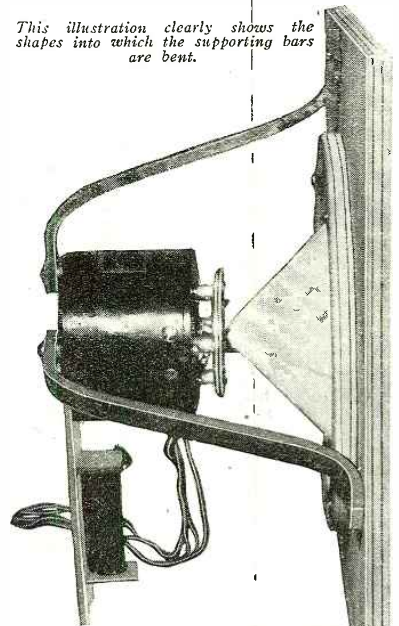

*This cross-sectional view of the electrodynamic speaker gives most of the necessary dimensions; the other details being shown on the next page.*

culty in securing one at a low cost. From this speaker we may obtain the electromagnet for the field and the armature coil for actuating the cone. To make coils of so many turns is impracticable for the home constructor. The bridge, which was used in the old Magnavox speaker to mount the diaphragm, may be used in our speaker as an adjustable mounting for the armature coil and the apex of the cone. The input transformer is used "as is" for the new speaker.

The success of the speaker depends upon the rigidity of its construction and, as the field electromagnet is very heavy, it must be well supported. This is accomplished by three 1/4 x 1/2-inch brass rods, which are bent to shape as shown in Fig. 1. The brass is annealed before bending, by heating it to a dull red and then plunging it into cold water. These rods are fastened to the electromagnet by screws at the back of the magnet. The magnet is aligned by using washers as shims under these screws; so that it is actually adjusted to the axis of the cone. There is also required a vertical leg, made of bakelite or hard rubber, for a back support. The input transformer may be mounted on this leg. The electro- or field magnet draws one ampere at six volts, for a "flux density" of approximately sixty thousand lines per square inch. This current may be supplied from the radio



CONSTRUCTING THE CONE

The next step will be to manufacture and mount the cone, which is made of a cold-pressed "water-color" paper. By many experiments this paper has proved to be the best for this purpose. The cone is six inches in diameter and the included angle is 30 degrees. (See Fig. 3 for details of this cone.) The two edges for the glued joint are "feathered" with a razor blade in order to make a smooth job. Liquid glue is used here, being put on both edges, which are then placed together with a 1/16-inch lap and protected on each side by a strip of paper. A pencil is then laid lengthwise of the joint and the whole is clamped by means of a wood clamp to a table until the joint is thoroughly set. When the cone is released the paper strips placed to protect the joint are carefully torn away. A narrow strip will remain along the joint, but this is not objectionable.

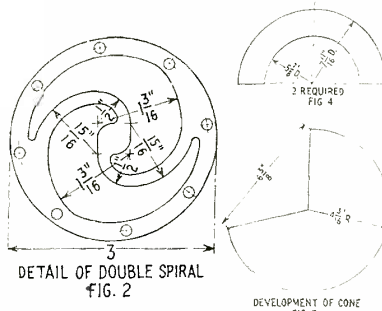
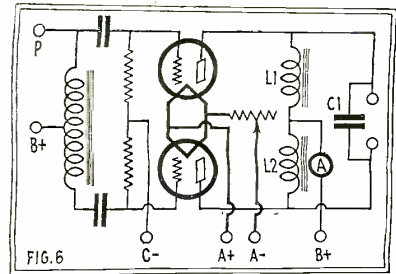

Fig. 2 shows the double spiral on which is mounted the armature coil; Fig. 3, the dimensions of the paper cone; and Fig. 4 the dimensions of cone support.

...before the wave  
...at the fine  
...broken. This  
...of arranged in the  
...may be adjusted to  
...To accomplish this  
...The center of a double  
...very thin sheet formica or  
...Fig. 2). This is done in  
...manner; the coil proper is  
...on a tripod, which in turn is  
...and cemented, with household cem  
...to the center of the double spiral.  
It is very important that the axis of the  
armature coil shall be at right angles to  
the plane of the double spiral. This double  
spiral, in turn, is clamped by the bridge  
which, in the old speaker, mounted the dia  
phragm. The old diaphragm is discarded.  
The armature coil leads are then connected  
to their terminals on the electro-magnet,  
by means of helices made of very fine ena  
melled wire. The coil is adjusted so that it  
cannot strike the poles of the electromagnet  
and the double spiral is clamped in place.



A push-pull stage of A.F. amplification will supply undistorted power to the dynamic speaker.

The larger end of the cone is supported by a flexible ring made of bookbinders "skives" of thin leather, or a support made of "gold beaters' skin" may be used. If the latter is used it must be treated with glycerine after it is mounted, to take out the rustle. Liquid glue is about the only cement which will hold gold beaters' skin to the paper cone and it must set thoroughly. The skin must be cleaned with gasoline to remove any grease, before the glue is applied. Care must be taken that the skin is not stretched tight, especially as the glycerine has a shrinking effect. If it is too tight a drumming effect will be produced, which is undesirable. (See Fig. 4 for details of this flexible support.) ("Gold beaters' skin" is a thin membrane, similar to sausage cases; and it is quite possible that a good quality of the latter, or perhaps a bladder, could be used for this purpose. "Skives" are very thin parings of soft leather, which must be made with an extremely sharp blade.—EDITOR.)

(Continued on page 1271)

# Suggestions for Power-Amplifier Current Supply

## How Batteries for a Power Tube Can Be Added to a Receiver, Increasing the Volume and Quality of Reception

IT frequently happens that the owner of a radio receiver thinks he is unable to use a power tube in the last stage of his audio amplifier, for the reason that his "B" socket-power unit is unable to supply the necessary high voltage. This is particularly true in neighborhoods supplied by direct current, and also in the case of some A.C. power units having a total output of 135 volts.

In territories where direct current only is available, operation from a "B" power unit is not entirely satisfactory, for the reason that the 110 volts usually available from the wall socket cannot be stepped up, as in the case of A.C.; and consequently, the output seldom exceeds 100 volts and, generally, is considerably less. Obviously, if the set owner is to depend on his power unit alone, it is impossible to expect satisfactory results from the use of a power tube of the 171A type, since the minimum voltage required for these tubes is 135 volts, and the maximum 180 volts. This is an altogether unsatisfactory condition of affairs; for modern standards of reception demand the use of a power tube in the last stage of the audio amplifier, if the sounds issuing from

the loud speaker are to have all the volume and realism expected of present-day radio.

The set owner may, however, enjoy the advantages of power amplification at small cost by the simple expedient of using a 45-volt heavy-duty "B" battery in connection with the power unit. In the case of D.C. "B" power units, one battery should be used for a total of 135 volts, and two batteries where 180 volts is desired, in order to secure the maximum output of which the UX-171A tube is capable.

In some cases where the original output of the power unit is around 100 volts, it is obvious that the addition of "B" batteries would make the total output voltage slightly in excess of that specified by the manufacturer of the power tubes. This should not, however, occasion concern, for the reason that the resistance of the audio transformers, impedance units or other coupling devices causes a voltage drop and, consequently, the voltage at the tube socket will not be greater than specified.

The batteries should be connected in series with the power unit in the following manner: the positive, or maximum "B+" lead of the power unit should first be dis-

connected from the receiver, and a connection is then made from this terminal to the negative post of the battery. If two batteries are to be used, the negative, or "B—" terminal of the second battery should be connected with the positive post of the first, and the positive, or "B+" lead from the receiver connected with the positive terminal of this second battery.

Where a power tube of the 171A type is used in the last stage, it is imperative that a "C" battery be used, both for the sake of high quality reproduction and for economy in operation. When the maximum plate potential is 135 volts, 22.5 volts of "C" battery should be used to secure the necessary grid-bias; and when 180 volts is used on the plate, a 45-volt "C" battery is required. In view of the fact that no current whatever is drawn from batteries for biasing the grid of a tube, the "C" battery will last as long as though it were entirely disconnected from the receiver and standing idle.

For those using the older type of receivers, in which no provision is made for the use of a "C" battery, it may be said that its inclusion can best be accomplished by se-

(Continued on page 1272)

# How to Build a Linen-Diaphragm Loud Speaker

Complete Details for the Construction of a Loud Speaker Which Furnishes Excellent Quality and

By John M. Thompson

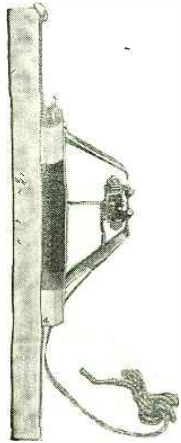

The side view of the double-diaphragm loud speaker; this shows how the drive unit should be mounted so that there will be no strain on the driving mechanism.

**B**ACK in the primitive days of radio, when it was a feat worthy of strong men and true to get a station broadcasting music fifty miles distant, loud speakers were something one read about, but seldom saw. If a newcomer wanted to listen to a program, one of the headphones was detached from the headpiece and given him and then, in a very uncomfortable attitude, each sharer of the phone stopped one of his ears with his finger and tried to follow the radio entertainment with the other.

Then came a day when someone suggested that, if a phone were placed diaphragm-down near the bottom of a bowl, music could be heard all over the room—well, heard nearly all over the room. The truth of the matter is that, as most of us were lucky to have one tube for a detector, and audio amplification was something yet to be dreamt of, it was necessary to place an ear very close to the bowl in order to hear anything at all.

Then came the simple horns to which a headset could be clamped; then the first electrodynamic speakers, using a horn and requiring lots of power to operate; then the electromagnetic horn speakers and cones,

the newer types of electrodynamic cones and, lately, the linen-diaphragm speaker.

This type of speaker, an example of which was described in the March issue of *RADIO NEWS*, has become popular over-night with experimenters, for it is something fairly simple in construction. The frequency-range and tone quality obtainable from this speaker is remarkable and, if the constructor follows the directions presented herewith, he should have a loud speaker of which he can be proud. The total cost of that built by the writer, according to the specifications below, was under \$10.

### CONSTRUCTION OF FRAME

The first operation is the assembly of

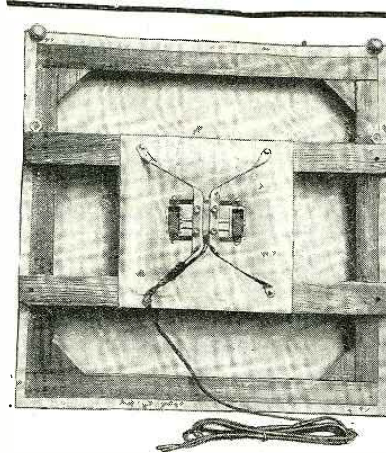

The 8-inch diaphragm and the unit, mounted in position, are here shown. Compare the frame work with the sketch below.

the wooden frame upon which the diaphragms are stretched. The frame, Fig. 1, shows the pieces of cypress or other wood which are cut and mortised together. The construction should be followed for the parts of the frame are not securely fastened.

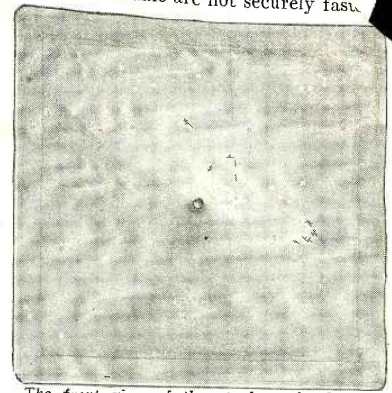

The front view of the speaker, showing the 24-inch diaphragm.

by glueing, a rattle will be introduced in the speaker that cannot be eliminated without a great amount of trouble. After the pieces A and B have been glued, the corner pieces E are attached. The pieces marked C and D are next joined and screwed to the sides B, making sure that the pieces D are centered.

While the joints of the wooden frame are drying, the two linen diaphragms are prepared. It is necessary that a hem one-half inch wide be sewed along each side of both the large and the small squares; the one being 26 inches square and the other 8 inches.

When the joints are thoroughly dried, the large square of cloth is placed over the front of the frame, tacking down one edge; be careful to place the tacks fairly close to one another, so that there will be little danger of the cloth's pulling out. When one edge has been fastened stretch the linen as tightly as possible and tack down the opposite side. This process is repeated for the other two sides. The 8-inch square of linen is fastened to the rear frame in the same manner.

### PREPARING THE DIAPHRAGM

Now locate the exact centers of both diaphragms and carefully, with the point of a compass or a sharp nail, force a hole in the linen. Be careful not to break any threads, but spread them apart until the hole is 1/4-inch in diameter. Then prevail upon one of the ladies of the family to work a button-hole stitch around these two holes.

(Continued on page 1274)

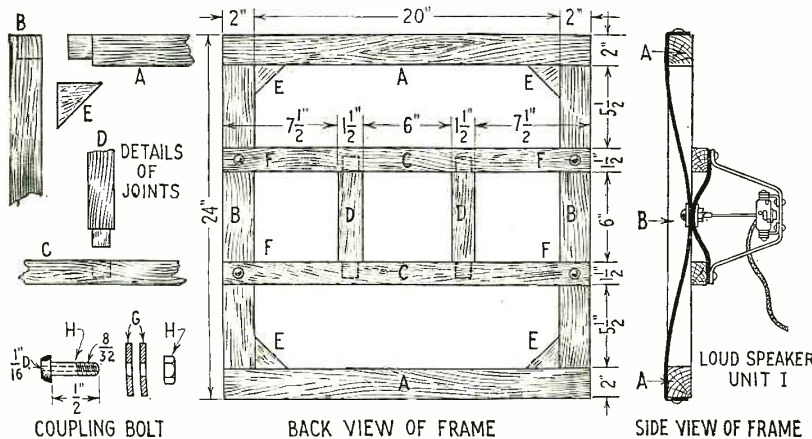

Fig. 1—The details of the construction of the wooden frames, for both the large and the small diaphragm; also, the mounting of the loud-speaker unit.

# Producing R. F. Oscillations with a Buzzer



The Theory, Operation and Construction of an Oscillator Using a Buzzer Instead of a Vacuum Tube



By Emil Reisman

**M**OST radio-frequency measurements and tests require the presence of a source of radio-frequency current. The frequency or wavelength must be known accurately at all times, and in many cases this current must be modulated at audio frequencies. Such current is required in cases when it is desired to measure the capacity of a condenser, the inductance of a circuit, the wavelength of a circuit, etc. Also, a source of radio-frequency current is often very valuable, and frequently indispensable, when adjusting or testing a radio receiver; it is desirable for balancing a neutrodyne, matching the intermediate stages of a superheterodyne, adjusting a gang condenser, etc.

In a well-equipped radio laboratory the vacuum-tube oscillator is the most usual source of radio-frequency currents. In cases where the current required must be modulated, a radio-audio-frequency oscillator is used. Such apparatus is rather complicated, but is essential when precision measurements are to be made. In reality, it comprises the elements of a small radio transmitting set, and could be used as such if it were connected to an antenna.

Although vacuum-tube oscillators are absolutely essential in a laboratory, they possess certain characteristics which make them unsuited to the requirements of the average experimenter. In the first place, vacuum-tube oscillators cannot be accurately calibrated as to wavelength or frequency, and they must be checked each time with a wavemeter before they are used. This is because slight changes in either grid or plate potentials will change the frequency of the generated current. It is therefore necessary for the experimenter to have both a wavemeter and an oscillator—rather expensive equipment for home use if the instruments are to be sufficiently accurate for measuring purposes.

**BUZZER METHODS**

The experimenter or set builder who

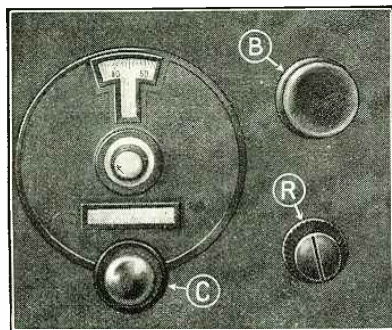

Panel view of buzzer-oscillator. B, buzzer; R, variable-resistance control; and C, control for variable condenser.

makes an occasional measurement, and who does not have the apparatus or time to set up a vacuum-tube oscillator, may use a high-frequency buzzer for providing a source of modulated radio-frequency oscillators. The oscillations generated by such a device are damped, but in most measurements, this is

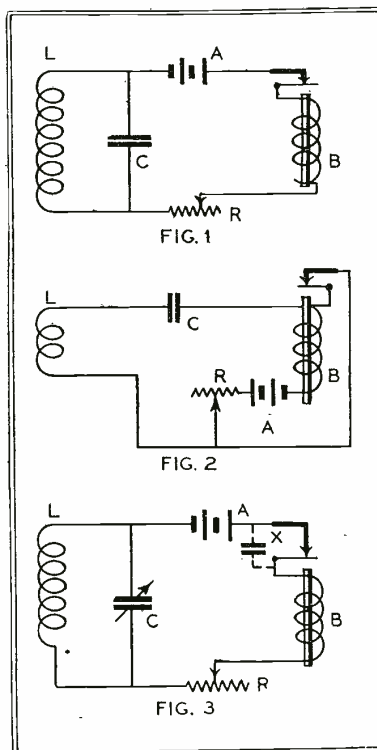

Three arrangements of a satisfactory buzzer-oscillator. Fig. 3 represents that pictured in this article.

which regulates the current passing through the buzzer. In operation, the condenser C is charged when the contacts of the buzzer B are open, closing the battery circuit; and when the contacts of the buzzer close the condenser immediately discharges through the coil L, giving rise to a train of oscillations in the circuit LC.

A careful examination of the circuit will explain the operation of the buzzer. It will be noticed that the buzzer, rheostat, battery and coil are connected in a series circuit, and that this circuit provides a path for the buzzer current. When the current starts to flow in this circuit the iron core of the buzzer becomes magnetized, because of the current flowing through the winding. The vibrator or contact arm of the buzzer is attracted to the core by the magnetic force and this opens the battery circuit. When the battery circuit is opened the iron core of the buzzer loses its magnetism and as a result the spring causes the contact arm to return to its original position. This operation allows current to pass through the circuit again and the operation is repeated. In the case of a high-frequency buzzer the contact arm of the buzzer may vibrate fast enough to produce a note having a frequency of 500 cycles.

Another form of generator for radio-frequency oscillations is illustrated in Fig. 2. A circuit of this type produces highly-damped oscillations; but the frequency or wavelength is not dependent upon the circuit LC, as in the case of the oscillator illustrated in Fig. 1. C is a fixed condenser having a capacity of 2 mf., and L is a coil of 2 or 3 turns of wire. When measurements are made with an instrument of this type the coil is closely coupled to the circuit which is to be measured and, as the oscillations in circuit LC are highly damped, the oscillator circuit coupled to L, will be

(Continued on page 1270)

not objectionable, and in many cases it is essential. With the buzzer method it is impossible to obtain the high degree of precision that may be secured with a vacuum-tube oscillator; but the accuracy obtained is usually sufficient for all practical purposes. Also, a buzzer generator is very much easier for the beginner to operate.

One of the most satisfactory methods of using a buzzer for the generation of radio-frequency oscillations of a definite frequency or wavelength is shown in Fig. 1. The tuned circuit is made up of the coil L and the condenser C, which are connected in shunt with each other; and the frequency to which the circuit is tuned is determined by the value of these two units. The buzzer is shown at B, the battery which operates the buzzer at A; and R is a rheostat

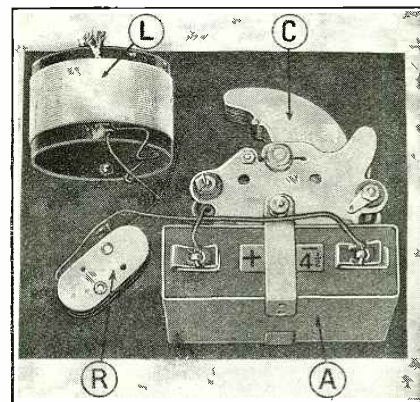

The rear view of the panel opposite. L, inductor; C, condenser; R, variable resistor; and A, 4 1/2-volt battery.

# Letters from Home Radio Constructors

## ONE A.F. STAGE ENOUGH

Editor, RADIO NEWS:

I get so many helpful pointers from your excellent magazine that I am moved to pass out a little advice which I hope may be helpful to some of your readers. Now that the attention of so many has turned to the development of tone quality and exact reproduction, it seems to me that the majority of home set builders are overlooking the most simple and most effective means of bringing out the low tones in all their fullness and the high ones without noticeable flattening.

With the advent of the power tubes the radio set came to have possibilities of becoming a real musical instrument; and for their advent may Allah be praised. I will describe the changes I have made in the last set I built; and, since the changes would not be practical in some types of sets, it will become evident to the owners of these types at once. I built a five-tube tuned-radio-frequency outfit, using the Freshman Masterpiece kit of coils and condensers. In most circuit diagrams which have come to my attention, the filaments of both the R.F. tubes and that of the detector tube are controlled by a single rheostat. I have introduced a separate rheostat to control the detector. This change is very important if the maximum clarity is to be obtained.

I provided a separate "B" battery lead for the R.F. stages, as well as one for each of the audio stages. Directions with most circuits which I have seen show 90 as the proper voltage on the R.F. tubes. My experiments have shown that a voltage of less than 45 gives the best tone quality and does not lower the volume noticeably. I use the detector voltage output on the "B" unit for both the detector and the R.F. stages. This is "change" number two.

My set is being operated in Detroit, where there are three or four high-powered stations. On such stations as WTAM, WGY, KOA, KDKA, WBBM, WCCO, WOR, etc., the voltage should go up to about sixty-seven on the R.F. stages. But change number three is the most important and is equally as simple. Having a separate "B" lead for the first stage of audio frequency, it is easy to place a CX-371 power tube in its socket and to apply 180 volts (providing you have a suitable "B" unit) to its plate. Arrangement must, of course, be made for around 40 volts of "C" battery for this tube. The second stage of audio amplification is not used, of course. And this is the last of the necessary changes.

There are certain requisites, however, which are very essential, I believe. The first is a power unit; very few would attempt to use dry batteries with such a drain, I suppose. The next requisite is a good speaker, preferably the heavy-duty type (I use the Western Electric 17-inch cone). The transformer used in my own set has a very great deal to do with its clarity, I am sure. I used the General Radio Co. combination for first and second stages of audio. The last requisite, and not the least important, is a very good ground. Again, however, if a storage battery is used for the filament supply, the use of the small 80- to 100-hour radio battery is not satisfactory. I have both the 120-hour automobile battery and this type, and have experimented with each of them. I find that the tone and volume, using a smaller battery with the arrangement described above, does not compare with that which may be had with the use of the automobile battery.

The tone quality which is obtained by this arrangement is unbeatable, I verily believe. The noises which a two-step amplifier introduces are absolutely gone. In fact, it doesn't sound like a radio at all. The same fullness and roundness of tone is there when the volume is reduced to a whisper, and the R.F. rheostat will control the volume perfectly. Curiously enough, the best tone is had on the outside stations mentioned above, and in most cases the volume is greater than the ordinary loud-speaker volume. The volume on local stations is as great as that from the ordinary two-steps without power tube, and the clarity cannot be compared. When it is desired, while tuning, to use both steps of A.F. in the set it is simple to make the required changes and they require only a second.

It is a source of much wonderment to me why home set builders as well as others with manufactured sets (where the changes are practical) are not using this arrangement; and if my experience had not shown that practically none, at least in this part of the country, use it, I wouldn't think of suggesting anything so simple.

ERROL L. GREEN,

3773 Tuxedo Avenue, Detroit, Michigan.

## MAKING RADIO DECORATIVE

Editor, RADIO NEWS:

The science of radio having now reached a stage of development where its application in the form of radio reproducing instruments is more or less standardized, the amateur begins to turn his attention to the art of radio. The cry of yesterday for "selectivity and volume" having been appeased, the demand today is for "beauty and tone quality." Here opens a new field as fascinating as the first, for those who like to make things.

It need not be difficult or costly to give almost any radio a good setting, suitable to the most discriminating. The installation depicted in the accompanying illustration was made with little effort and at small expense. To construct the front of the console compartment, two bread boards were used. The openings were cut out with a ten-cent scroll saw, and the boards were then cleated together at the rear. After the front had been sanded down and painted with lacquer a piece of green-gold silk cloth was glued across the two openings at the back. This shade of cloth gives a shadow effect that is quite inconspicuous. The silhouette of glazed black paper, which was purchased for a few cents at a store handling lampshade materials, was simply laid on the wet lacquer, where it adhered when the lacquer dried.

The console front piece was fastened to the side

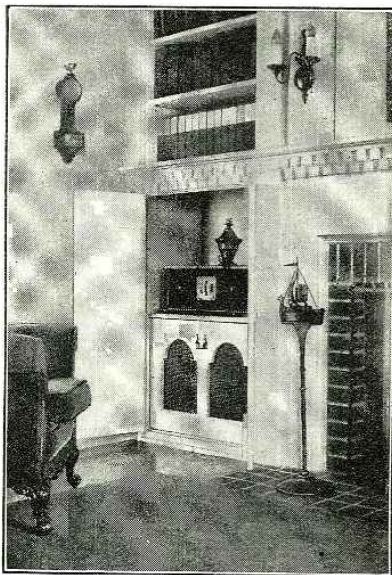

Mr. Chatterton's built-in radio set and amplifier are a delight to the eye, as well as to the ear.

walls of the cupboard with cleats; and the shelf was placed loosely above the front piece, so that the shelf board can be moved back and forth to allow of attaching the wires at the rear of the cupboard. The console compartment was lined with "Balsam Wool" to absorb echoes.

The set, in this instance, is a modified Browning-Drake employing all dry-cell tubes, with a power tube and high-quality transformer audio amplifiers. The "C" batteries are contained in the plain walnut set cabinet and the dry-cell "A" batteries are placed on the shelf at the rear of the cabinet, where they are out of sight, and yet convenient to reach for changing. The console compartment contains the heavy-duty "B" batteries and a home-made "ortho"-type horn speaker in series with a cone speaker. The upholstered chair placed in front of the installation helps to improve the tone.

When the cupboard doors are closed the whole outfit is entirely concealed from view, as well as protected from dust and molestation.

G. A. CHATTERTON,  
Labewood, Madison, Wis.

## HOW LONDON REALLY CALLS

Editor, RADIO NEWS:

I am glad to report to you that with a home-built short-wave receiver (following the circuit you published in October, 1927), London, England, is received practically every day. They do not seem to

transmit on Saturdays and Sundays. No one who has heard the real thing could be fooled in the manner of your story in the March number, "This is Station 2LO, London, England," for the announcements never include the call letters. They say simply, "London calling," or "London is calling." I set my watch by Big Ben, and so have Greenwich time direct. The program starts at 2 p. m. (E. S. T.) with chimes of Big Ben and the clock striking seven.

At times I can hear it faintly on the loud speaker; with the phones the concerts are worth listening to. Dance music seems to be reserved as an extra from Daventry from 11 to 12 (Greenwich time). I think, judging from the character of the music sent out, that Roxy's Saturnalia would last about one night.

Instead of transformers, I use three stages of resistance amplification. I find that a 200 tube is far superior to anything else as a detector.

I have read RADIO NEWS consistently and know that when any advance worth knowing is made in radio you will be among the first to publish it. For instance, you published the Everyman Circuit a year before another paper brought it out and featured it.

I thank you for the short-wave circuit, for it seems wonderful to me that I can sit down and really enjoy day by day the programs from London. I hope, though, this circuit does not become too popular, for the combined squeals and howls caused by inexperienced operators would put a blanket on "London calling."

Another thing, if a law was passed prohibiting jazz until after 11 p. m. each day, the interference problem would be solved; for a lot of stations would have to close down, having nothing to broadcast. Moreover, it should be made illegal for announcers and Roxy to laugh at their own jokes, on the grounds of using the air for false pretenses and the hollow and unnatural character of most of the laughs, or guffaws.

I had this letter in the envelope sealed, ready to mail; but opened it to tell you that the reception from London this evening (February 28) was remarkable. I put on one stage of transformer A.F. to above and the dance program from the Hotel Carlton was heard with fine volume on the loud speaker. The program finished with Big Ben striking midnight.

STANLEY C. PAGE,  
King Ferry, New York.

## PATIENCE AND PERSEVERANCE

Editor, RADIO NEWS:

I want to congratulate you on such a remarkable hook-up as the Qualitone Six. Being one of just ordinary radio knowledge, I was rather dubious about attempting it. During the time I was balancing it, I was ready to give everybody a good cussing. The instructions say twenty minutes to balance; it took me about twenty hours. Nevertheless, it is now balanced and I hear stations I never heard before.

I have had it in operation, and have logged seventy stations, among them PWX, Havana. It is a great pleasure to sit down and listen to some of these 50- and 100-watt stations. I only made one substitution, that being in the use of Amsco variable condensers. When you make a better set, let me know.

L. C. BRADFORD,  
(Kentucky)

(Unfortunately, copies of the October, 1927, issue of RADIO NEWS, describing this set, are not available, so that this office cannot supply them; and we omit Mr. Bradford's address, so that too many readers will not ask to borrow his copy.—EDITOR.)

## THE PERIDYNE MAKES A HIT

Editor, RADIO NEWS:

I have built some fifteen hundred different types of receiving sets, including the "Hot Spot 14;" but up to date, I have never built a machine that has developed such wonderful efficiency, with such simplicity in construction, with such a marked improvement over an old design, as your "Peridyne Five" has proven.

The clarity of reception that we have been able to obtain with this machine is so remarkable, and the compliments of my friends and associates, some of whom are highly developed technically in radio, has prompted me to take this liberty to write this letter of congratulation to you. And I can honestly state that this machine can be placed beside any make of radio, either commercial or amateur-built, and meet with the greatest of approval. We are now making an "ABC" power pack, to eliminate the batteries, and to operate from lighting circuit.

When this machine is put into a console cabinet

# Letters from Home Radio Set Constructors

I will try to send you a photograph of it, as I am very proud of this set. Thanking you for your publication of this set, and extending to you the good wishes of my associates and set builders, I am,

Yours very truly,  
J. G. PETTIS,  
Oholona, Mississippi.

### FROM "DOWN UNDER"

Editor, RADIO NEWS:

Last October I built the 18-1500-meter receiver described in July, 1927, RADIO NEWS, and it is "the goods." I might first state that it is the first and only set I have ever built or operated. I would have written sooner; but I wanted to give this little 3-tube a fair test in midsummer. (Mid-summer in Australia comes during the months of a northern mid-winter—EDITOR.) Instead of .00035-mf. condensers, I fitted two 17-plate Pilots; and the total cost of components was under £13 (\$65). At present I have only the one coil form, covering from 180 to 550 meters; I could not procure the standard coils specified, so made one. I have a 15-shilling British speaker unit on the

gramophone tone arm, and the volume would surprise you. I have been told that it has been heard up to 1500 yards away; and I have heard it my-

**L**ETTERS for this page should be as short as possible, for so many are received that all cannot be printed. Unless a set is made from a published description, a schematic sketch should be sent; photos can be used only to illustrate a novelty, and then only if large and very clear. Inquiries for information not given here should be sent to the constructor direct; but he should NOT be asked to furnish data already published, here or elsewhere.

This department is for free discussion to the extent that space permits; but RADIO NEWS accepts no responsibility for the opinions of readers as to the relative merits of apparatus and circuits.

self quite plainly—in fact, every word of a song, at a distance of 200 yards.

I have tuned in and clearly heard amateurs working on only 13 and 28 watts, 750 miles away. I have had one amateur on 50 watts at 600 miles, with good loud-speaker volume and excellent tone. 2YA, New Zealand, 1,700 miles and KZRM, Manila (Philippine Islands) on the phones at nearly 4,000 miles; last Saturday night I heard every round of the fights. Not bad on the broadcast band with three tubes in midsummer. I am using three Radiotrons and Columbia dry cells and find the set very economical to operate and easy to tune. I must sincerely thank your splendid journal for having offered its readers such a wonderful little three-tube set. I get better results than four- and five-tube sets. My aerial is a single strand of Belden wire, 63 feet high.

My location is central west in New South Wales, on the Western railroad near Dubbo, 280 miles west of Sydney. My nearest class A stations are 2FC and 2BL at Sydney. I trust you will be interested and wish RADIO NEWS every success.

HILTON SAUNDERS,  
"Kia Ora," Wongarbon, New South Wales, Australia.

(Continued on page 1293)

# List of Broadcast Stations in the United States

(Continued from page 1220)

Radio Call Letter	BROADCAST STA. Location	Wave (Meters)	Power (Watts)	Radio Call Letter	BROADCAST STA. Location	Wave (Meters)	Power (Watts)	Radio Call Letter	BROADCAST STA. Location	Wave (Meters)	Power (Watts)	Radio Call Letters	BROADCAST STA. Location	Wave (Meters)	Power (Watts)
WJBU	Lewisburg, Pa.	211	100	WLIT	Philadelphia, Pa.	405	500	WNOX	Knoxville, Tenn.	265	1000	WRM	Urbana, Ill.	273	*500
WJEW	New Orleans, La.	238	30	WLOE	Chelsea, Mass.	211	100	WNRC	Greensboro, N. C.	224	250	WRK	Hamilton, Ohio	265	100
WJBY	Gadsden, Ala.	234	50	WLS	Chicago Ill.	*345	5000	WNRY	New York, N. Y.	526	500	WRMU	New York, N. Y. (port.)	201	100
WJZ	Chicago Heights, Ill.	208	100	WLSI	See WDFW			WOAI	San Antonio, Tex.	500	5000		(2XAO, ship, 105.9 meters, 100 watts)		
WJD	Moonshart, Ill.	*366	100	WLTK	Brooklyn, N. Y.	256	250	WOAN	Lawsanceburg, Tenn.	240	500	WRNY	New York, N. Y.	326	500
WJES	Gary, Ind.	232	500	WLTS	Chicago Ill.	484	100	WOAX	Trenton, N. J.	240	500		(Also 30.91 meters, 500 watts)		
WJFW	Ashabula, Ohio.	208	30	WLW	Cincinnati Ohio.	428	5000	WOBR	Shelby, Ohio (portable)	204	10	WRPI	Terre Haute, Ind.	208	100
WJR-WCX	↑Pontiac, Mich.	441	5000		(Also 52.02-49.96 meters 250 watts)			WOBT	Union City, Tenn.	205	15	WRP	Dallas, Tex.	461	500
WJZ	↑New York, N. Y.	*454	30,000	WLWL	↑Kearny, N. J.	370	5000	WOBU	Charleston W. Va.	208	50	WRRS	Racine, Wis.	248	50
	(3XL, 59.96 meters, 30 k.w.)			WMAC	Cazenovia, N. Y.	225	500	WOC	Davenport, Iowa.	375	5000	WRST	Bay Shore, N. Y.	211	250
WKAQ	San Juan, Porto Rico.	322	500	WMAF	So. Dartmouth, Mass.	428	500	WOCL	Jamestown, N. Y.	224	25	WRUF	Gainesville, Fla.	203	5000
WKAR	East Lansing, Mich.	*378	50	WMAK	*Martinsville, N. Y.	545	750	WODA	Paterson, N. J.	234	1000	WRVA	Richmond, Va.	254	1000
WKAL	Laconia, N. H.	224	50	WMAN	Columbus, Ohio.	234	50	WOD	Ames, Iowa.	265	*1000	WSA	Cincinnati, Ohio.	361	5000
WKBB	Joliet, Ill.	216	150	WMAP	*Chicago, Ill.	*447	*2500	WOK	See WMBE			WSAJ	Crove City, Pa.	224	250
WKBC	Birmingham, Ala.	219	10	WMAY	St. Louis, Mo.	234	100	WOKO	Beacon, N. Y.	216	500	WSAN	Allentown, Pa.	222	100
WKBE	Webster, Mass.	229	100	WMBC	Richmond, Va.	244	100	WOL	Rochester, N. Y.	310	500	WSAR	Fall River, Mass.	213	250
WKBF	Indianapolis, Ind.	252	250	WMBA	Washington, D. C.	242	500	WOMT	Manitowig, Wis.	222	100	WSAX	Chicago, Ill. (port.)	204	100
WKBG	Chicago, Ill. (portable)	201	100	WMBB	Newport, R. I. (port.)	204	100	WOO	Philadelphia Pa.	349	500	WSAZ	Huntington, W. Va.	250	100
WKBH	La Crosse, Wis.	220	500	WMBE	Chicago, Ill.	252	5000	WOOD	Grand Rapids, Mich.	261	500	WSB	Atlanta, Ga.	476	1000
WKBI	Chicago, Ill.	218	50	WMBD	Detroit, Mich.	203	100	WOQ	Kansas City, Mo.	341	500	WSBC	Chicago, Ill.	232	500
WKBL	Monroe, Mich.	205	15	WMBE	Pecoria Heights, Ill.	205	100	WOF	↑Kearny, N. J.	422	5000	WSBF	St. Louis, Mo.	258	250
WKBN	Youngstown, Ohio.	214	50	WMBF	St. Paul, Minn.	208	10	WORD	(Also 65.4 meters, 50 watts)			WSBT	South Bend, Ind.	400	500
WKBO	Jersey City, N. J.	219	500	WMBG	Miami Beach, Fla.	384	500	WOS	↑Batavia, Ill.	252	5000	WSDA	See WSGH		
WKBP	Waukegan, Mich.	213	50	WMBH	Richmond, Va.	204	100	WOT	Jefferson City, Mo.	428	500	WSEA	Portsmouth, Va.	263	500
WKBS	New York, N. Y.	219	500	WMBI	Joplin, Mo.	204	100	WOW	Omaha, Neb.	508	1000	WSFI	Brooklyn, N. Y.	227	500
WKBT	Galesburg, Ill.	217	100	WMBJ	↑Chicago, Ill.	*263	5000	WOVO	Fort Wayne, Ind.	229	*2500	WSIX	Springfield, Tenn.	250	150
WKBU	New Orleans, La.	252	50	WMBK	McKeesport, Penna.	232	50	WPAP	(Also 22.8 meters, 1000 watts)			WSJK	Bay City, Mich.	273	250
WKBV	Brookville, Ind.	217	100	WMBL	Lakeland, Fla.	108	100	WPCH	See WQAO			WSKB	Nashville, Tenn.	337	5000
WKBW	Buffalo, N. Y.	217	5000	WMBM	Memphis, Tenn.	210	10	WPCC	Chicago, Ill.	224	500	WSMB	New Orleans, La.	297	750
WKBY	Ludington, Mich.	200	15	WMBN	Auburn, N. Y.	220	100	WPCH	↑New York, N. Y.	326	500	WSMK	Dayton, Ohio	297	200
WKCB	↑Kensha, Wd.	248	15	WMBP	Brooklyn, N. Y.	204	100	WPED	Waukegan, Ill.	216	250	WSPD	Toledo, Ohio	240	250
WKCC	Amherst, N. Y.	204	750	WMBQ	Tampa, Fla.	232	100	WPFG	Atlantic City, N. J.	373	5000	WSTO	Midletown, Ohio	236	100
WKCD	Lancaster, Pa.	252	50	WMBR	Lemoyne, Pa.	234	250	WPRC	Harrisburg, Pa.	210	100	WSSH	Boston, Mass.	388	100
WKCE	Cincinnati, Ohio	246	500	WMBW	Youngstown, Ohio	214	50	WPSC	State College, Pa. (day)	300	500	WSUI	Iowa City, Ia. (day)	476	500
WKCF	Oklahoma City, Okla.	248	150	WMC	Memphis, Tenn.	517	500	WPSW	Philadelphia, Pa.	207	50	WSUN	St. Petersburg, Fla.	517	750
WKCG	Nashville, Tenn.	225	1000	WMD	↑New York, N. Y.	207	100	WPTF	Buffalo, N. Y.	447	500	WSVS	College Station, Tex.	484	500
WKCH	Louisville, Ky.	268	*30	WME	Boston, Mass.	211	50	WQAM	Miami, Fla.	384	750	WSYR	Syracuse, N. Y.	294	500
WKCI	Minneapolis, Minn.	246	500	WMP	Lapeer, Mich.	234	30	WQAN	Scranton, Pa.	231	250	WTAD	Syracuse, N. Y.	236	*250
WKCM	Muncie, Ind.	210	100	WMRJ	Jamaica, N. Y.	207	10	WQAO-WPAP	↑Cliffside, N. J.	395	500	WTAG	Worcester, Mass.	*410	*2500
WKCN	Kansas City, Mo.	210	50	WMS	New York, N. Y.	207	100	WQB	Cleveland, Ohio	228	250	WTAT	Cleveland, Ohio	*400	3500
WKCO	Petersburg, Va.	214	100	WMCB	Boston, Mass.	461	500	WQBC	Utica, Miss. (day)	216	225	WTAQ	Bau Claire, Wis.	254	500
WKCP	Farmingdale, N. Y.	232	30	WMDA	Norman, Okla.	240	250	WQBJ	Clarksburg, W. Va.	240	65	WTAR-WPOR	Norfolk, Va.	236	500
WKCQ	East Wrentham, Ill.	288	250	WNAL	Omaha, Neb.	258	250	WQBZ	Weldon, W. Va.	250	60	WTAS	Elgin, Ill.	273	500
WKCL	↑Stevens Point, Wisc.	333	*1000	WNAT	(Also 115 meters, 50 watts)			WQCD	Raleigh, N. C.	447	500	WTAV	College Station, Tex.	484	500
WKCM	Cambridge, Mass.	231	50	WNB	Philadelphia, Pa.	288	100	WRAP	Lafayette, Ind.	208	100	WTAX	Streator, Ill.	248	50
WKCN	Chicago, Ill. (portable)	204	50	WNBX	Yankton, S. D. (day)	303	1000	WRAF	Providence, R. I.	200	250	WTAZ	Richmond, Va.	220	15
WKCO	Galesburg, Ill.	217	100	WNBZ	Forest Park, Ill.	208	200	WRAG	(Has short-wave transmitter)			WTFC	Mt. Vernon Hills, Va.	203	10,000
WKCP	Atwood, Ill.	219	25	WNC	Endicott, N. Y.	207	50	WRAM	Galesburg, Ill.	248	50	WTFS	Toccoa, Ga.	210	250
WKCR	Rockford, Ill.	248	15	WNBH	New Bedford, Mass.	261	250	WRAP	Reading, Pa.	238	100	WTIC	Atlanta, Ga.	227	200
WKCS	Crown Point, Ind.	248	50	WNBK	Knoxville, Tenn.	207	50	WRAX	Philadelphia, Pa.	213	250	WTID	Hartford, Conn.	535	500
WKCT	Mansfield, Ohio	207	30	WNBQ	Washington, Pa.	211	15	WRBC	Philadelphia, Pa.	213	250	WTIJ	Milwaukee, Wis.	294	1000
WKCU	Oil City, Pa.	294	500	WNBW	Rochester, N. Y.	205	15	WRCC	Alparaiso, Ind.	238	250	WTRF	Midland Park, N. J.	207	15
WKCV	Long Island City, N. Y.	204	250	WNBX	Memphis, Tenn.	229	100	WRD	Washington, D. C.	*468	500	WUAA	Chicago, Ill.	227	500
WKCF	Iron Mountain, Mich.	210	50	WNBZ	Elgin, Ill. (time sigs.)	35.5	500	WREC	↑Memphis, Tenn.	250	100	WWJ	Detroit, Mich.	353	1000
WKCG	Dover-Foxcroft, Me.	208	250	WNCB	Carbondale, Pa.	200	5	WREN	Lawrence, Kan.	254	750	WWL	New Orleans, La.	246	500
WKCH	Ithaca, N. Y.	248	50	WNCB	Springfield, Vt.	242	100	WRES	Quincy, Mass.	217	50	WWNC	Asheville, N. C.	297	1000
WKCI	Lexington, Mass.	216	50	WNCJ	Saranac Lake, N. Y.	232	10	WRHF	Washington, D.C. (day)	322	150	WWRW	↑Woodside, N. Y.	200	100
WKCM	See WGN			WNK	Newark, N. J.	268	250	WRHW	↑Minneapolis, Minn.	261	1000	WWVA	Wheeling, W. Va.	517	250
WKCN					(Has short-wave transmitter)										

\*Allowed higher daylight power. \*\*Standard or constant-frequency transmission. †Remote Control.

### LIST OF CANADIAN BROADCAST CALLS

CFAC	Calgary, Alta.	435	500	CHCY	Edmonton, Alta.	517	250	CJOC	Lethbridge, Alta.	268	1750	CKOC	Hamilton, Ont.	341	100
CFCA	Toronto, Ont.	357	500	CHGS	Summerside, P. E. I.	268	25	CJOR	Sea Island, B. C.	291	50	CKOW	Toronto, Ont.	517	500
CFCC	Montreal, Que.	411	1650	CHIC	Toronto, Ont.	357	500	CJRM	Moose Jaw, Sask.	297	500	CKPC	Streston, Ont.	248	8
CFCH	Toronto, Ont.	388	250	CHMA	Edmonton, Alta.	517	250	CJRW	Regina, Sask.	357	500	CKPD	Streston, Ont.	248	8
CFCN	Calgary, Alta.	435	1800	CHMI	Mt. Hamilton, Ont.	341	50	CJSC	Saskatoon, Sask.	330	250	CKSH	St. Hyacinthe, Que.	312	50
CFCO	Vancouver, B. C.	411	10	CHNC	Toronto, Ont.	357	500	CJYC	Toronto, Ont.	517	500	CKSM	Toronto, Ont.	291	1000
CFCT	Victoria, B. C.	476	250	CHNS	Halifax, N. S.	322	100	CKAC	Montreal, Que.	411	1200	CKUA	Edmonton, Alta.	517	500
CFCH	Charlottetown, P.E.I.	312	100	CHNT	New York, N. Y.	411	1000	CKBC	Vancouver, B. C.	411	1000	CKWX	Edmonton, Alta.	517	500
CFCC	Brantford, Ont.	297	50	CHRC	Quebec, Que.	341	5	CKCK	Quebec, Que.	341	23	CKY	Winnipeg, Man.	384	500
CFJC	Kamloops, B. C.	268	15	CHSC	Unity, Sask.	268	50	CKCL	Regina, Sask.	312	500	CNRA	Moncton, N. B.	322	500
CFNC	Prescott, Ont.	297	50	CHUC	Saskatoon, Sask.	330	500	CKCI	Toronto, Ont.	357	500	CNRC	Calgary, Alta.	435	500
CFHC	Kingsford, Ont.	297	20	CHUD	Regina, Sask.	312	15	CKCD	Ottawa, Ont.	435	100	CNRE	Edmonton, Alta.	517	500
CFHW	Fredericton, N. B.	248	25	CHWK	Chilliwack, B. C.	248	5	CKCR	St. George, Ont.	258	25	CNRM	Montreal, Que.	411	1650
CFQC	Saskatoon, Sask.	330	500	CHYC	Montreal, Que.	411	750	CKCV	Quebec, Que.	341	50	CNRO	Ottawa, Ont.	435	500
CFRB	Toronto, Ont.	517	1000	CJBC	Toronto, Ont.	357	500	CKCX	Quebec, Que.	341	50	CNRD	Quebec, Que.	341	50
CFRC	Kingston, Ont.	268	500	CJBD	Regina, Sask.	312	500	CKCB	Toronto, Ont.	411	50	CNRE	Regina, Sask.	312	500
CFYC	Burnaby, B. C.	411	500	CJCA	Edmonton, Alta.	517	500	CKCW	Bowmanville, Ont.	312	5000	CNRS	Saskatoon, Sask.	330	500
CFCA	Calgary, Alta.	435	250	CJCB	Calgary, Alta.	435	250	CKG	Red Deer, Alta.	357	1000	CNRT	Toronto, Ont.	357	500
CHCS	Hamilton, Ont.	341	10	CJCR	Red Deer, Alta.	357	1000	CKMC	Cobalt, Ont.	248	5	CNRV	Vancouver, B. C.	291	500
CHCT	Red Deer, Alta.	357	1000	CJCC	London, Ont.	380	500	CKNC	Toronto, Ont.	357	500	CNRW	Winnipeg, Man.	384	



# Radio News Laboratories



**RADIO** manufacturers are invited to send to RADIO NEWS LABORATORIES samples of their products for test. It does not matter whether or not they advertise in RADIO NEWS, the RADIO NEWS LABORATORIES being an independent organization, with the improvement of radio apparatus as its aim. If, after being tested, the instruments submitted prove to be built according to modern radio engineering practice, they will each be awarded a certificate of merit; and that apparatus which embodies novel, as well as meritorious features in design and operation, will be described in this department, or in the "What New in Radio" department, as its news value and general interest for our readers shall deserve. If the apparatus does not pass the Laboratory tests, it will be returned to the manufacturer with suggestions for improve-

ments. No "write-ups" sent by manufacturers are published in these pages, and only apparatus which has been tested in the Laboratories and found of good mechanical and electrical construction is given a certificate. As the service of the RADIO NEWS LABORATORIES is free to all manufacturers, whether they are advertisers or not, it is necessary that all goods to be tested be forwarded prepaid, otherwise they cannot be accepted. Apparatus ready for, or already on, the market will be tested for manufacturers free of charge. Apparatus in process of development will be tested at a charge of \$2.00 per hour required to do the work. Address all communications and all parcels to RADIO NEWS LABORATORIES, 230 Fifth Avenue, New York City.

## DRUM DIAL

The drum dial shown here has a very attractive appearance and is a neat piece of mechanical workmanship; strong, light, precise in operation and easy to install. The motion of the controlling knob at the lower end of the little front panel is transmitted to the drum through a system of four pulleys and a soft flexible cord; the vernier



ratio is approximately 1:9. The scale of the dial is approximately 1 1/4-inch wide and evenly calibrated from 0 to 200. It is translucent and illuminated from within by a small 6-volt bulb, operated from the filament-supply source.

AWARDED THE RADIO NEWS LABORATORIES CERTIFICATE OF MERIT NO. 2114.

## CONE REPRODUCER

A combination of refinement in appearance and excellence in reproduction is exemplified in the loud speaker shown here. This instrument is of the cone type and has a speaker unit of floating-armature construction. The paper cone, 7 1/2 inches in diameter, is glued to a kid-leather

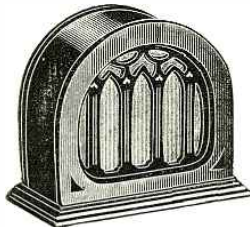

ring which is, in turn, attached to the metal frame carrying the speaker unit. This frame takes the shape of a truncated cone, and is lined with a thin felt. The speaker unit is a model of mechanical perfection and neatness; the windings are completely enclosed by the pole pieces and by two cast aluminum shells. The vibrating armature is indirectly, through a lever system, connected

to the cone. The graceful housing is of two-tone walnut, and lined with heavy felt to prevent undesirable reflection of tones; the speaker is equipped with a built-in filter.

AWARDED THE RADIO NEWS LABORATORIES CERTIFICATE OF MERIT NO. 2117.

## LOUD-SPEAKER UNIT

A detailed description of the excellent loud-speaker unit shown here was given in the April issue of RADIO NEWS (page 1149) in connection with that of the loud speaker to which Certificate of Merit No. 2278 was issued.

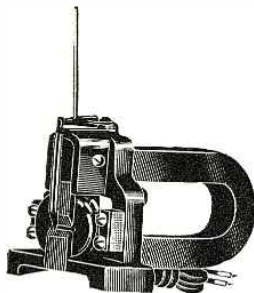

AWARDED THE RADIO NEWS LABORATORIES CERTIFICATE OF MERIT NO. 2300.

## "A-B" POWER SUPPLY

A combination of an "A" and "B" power-supply unit in one hous-

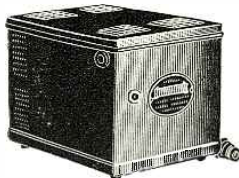

ing is shown here. The "A" unit is that described separately as No. 2304; the "B" power unit has a gas-filled full-wave rectifier tube and supplies, through the binding posts mounted on the bakelite panel inside the housing, four different voltages, one for the detector and three for the different amplifying stages. The output voltages may be varied within very wide ranges by operating the two adjustable resistors mounted on the same panel. An output of approximately 30 milliamperes at 180 volts has been measured. The iron housing is 8 x 10 x 12 inches and has a brown crystalline finish.

AWARDED THE RADIO NEWS LABORATORIES CERTIFICATE OF MERIT NO. 2302.

## "A" POWER UNIT

This "A" power supply unit is built of the components used in the

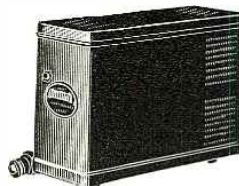

kit described below, and has the same operating characteristics. It is enclosed in an iron container, having a brown crystalline finish.

AWARDED THE RADIO NEWS LABORATORIES CERTIFICATE OF MERIT NO. 2303.

## "A" POWER-SUPPLY KIT

The assembled kit shown here operates from the 110-volt 50-60-cycle house-lighting line. It consists of a step-down transformer, a rectifier of the dry (copper-oxide) type, two large low-resistance choke coils and two dry-electrolytic condensers of extremely large capacity. The secondary of the step-down transformer is tapped, a fact which makes it possible to adjust the power unit to the different line voltages found under operating conditions. This unit has been found capable of delivering 2 1/2 amperes at approximately 5.5 volts, an output which meets the requirements of almost any commercial radio receiver; the current supplied is satisfactory in quality. A detailed description of the dry-electrolytic condensers, used in this kit, is given elsewhere in this issue; see the "What's New in Radio" department.

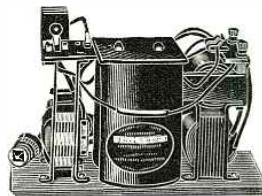

AWARDED THE RADIO NEWS LABORATORIES CERTIFICATE OF MERIT NO. 2304.

## LOUD SPEAKER

This reproducer is of the double-cone type; the paper diaphragm is approximately 22 inches in diameter.

The speaker unit is of good mechanical and electrical design; it is of the balanced-armature type and has laminated pole-pieces of silicon steel. The connection between the cone and the vibrating armature is effected through a lever system. A small condenser (approximately .05-mf. capacity) is connected across the speaker coils of the unit. This instrument has been found a very good reproducer with regard to quality and volume.

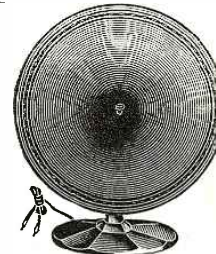

AWARDED THE RADIO NEWS LABORATORIES CERTIFICATE OF MERIT NO. 2305.

## VARIABLE CONDENSER

This condenser is of excellent electrical and mechanical design, and

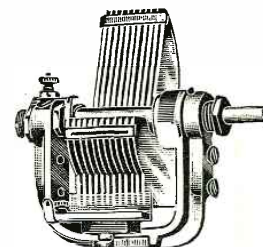

has a remarkably fine finish. It has a sturdy stator frame made of nickel-plated cast iron, which is drilled to give a choice of baseboard and panel mounting. The stator plates are soldered to the mounting and spacing bars and the plates of the rotor to the shaft and to one spacing bar. Both rotor and stator are silver-plated. The floating shaft may be removed, so that several of these condensers may be operated in gang, using a common shaft. This 23-plate condenser has a maximum capacity of approximately 450 mmf., and a minimum capacity of 25 mmf; its plates are of a shape such as to secure the most even distribution of the broadcasting stations along the dial. It is a French product.

AWARDED THE RADIO NEWS LABORATORIES CERTIFICATE OF MERIT NO. 2307.

**PHONOGRAPH PICK-UP**

The phonograph pick-up shown consists of three separate parts, the pick-up unit proper, the socket plug or adapter, and the volume control. The pick-up unit is of the conventional electro-magnetic balanced-armature type; it has a powerful horseshoe magnet and laminated pole pieces, and is enclosed in a nickle case which is very easily attached to any phonograph. The adapter fits in any standard UX socket and for operation is inserted into the socket

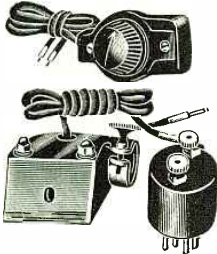

of the detector tube. The two binding posts on top of the adapter serve to connect the leads of the pick-up unit and those of the volume control to the plate and filament prongs of the detector, through a built-in 0.25-mf. condenser. The reproduction from phonograph records by means of this pick-up, when operated in connection with a well built radio receiver, has been found to be very satisfactory.

AWARDED THE RADIO NEWS LABORATORIES CERTIFICATE OF MERIT NO. 2308.

**VARIABLE CONDENSER**

This 24-plate variable condenser has a maximum capacity of approximately 490 mmf., and a minimum of approximately 22 mmf.; its characteristic curve is very close to that of the straight-line-wavelength. The stator and rotor plates are not flat,

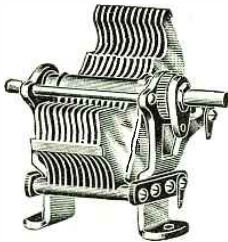

but are concentrically corrugated. This condenser can be mounted either on the front panel, through a single hole, or on the baseboard; in either case, the rotor may turn either clockwise or counter-clockwise. The condenser shaft is fastened to the rotor by a set-screw, and may be removed and replaced by a longer shaft to make possible gang mounting of several instruments.

AWARDED THE RADIO NEWS LABORATORIES CERTIFICATE OF MERIT NO. 2309.

**OUTPUT FILTER**

This output filter is designed to protect the windings of a loud-speaker unit from burning out, by preventing the flow through them of the heavy D. C. component of the plate current of the power tube used in the last stage. It consists of a choke coil and a condenser, both enclosed in a neat metallic case. The coil has an ohmic resistance of approximately 670 ohms and an inductance of approximately 29 henries

(measured at 128 cycles); the capacity of the condenser is approximately .02-mf.

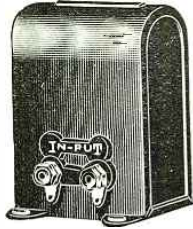

AWARDED THE RADIO NEWS LABORATORIES CERTIFICATE OF MERIT NO. 2310.

**TAPPED RESISTOR**

This small but sturdy center-tapped resistor is intended to be connected across the filament of A.C. tubes of the 226 type. It has a value of approximately 20 ohms, and is tapped in the exact center. Another resistor of similar construction, which is designed for use with tubes of the 222 type, has a value of 15 ohms and is tapped at 5 ohms to provide a negative bias.



AWARDED THE RADIO NEWS LABORATORIES CERTIFICATE OF MERIT NO. 2311.

**A.C. ADAPTER HARNESS**

The problem of how to adapt, without rewiring, a battery-operated receiver for use with A.C. tubes of the 226 and 227 types, is easily solved by the use of the A.C. adapter harness shown here. This may be used almost with any six-tube commercial receiver (except those of the superheterodyne type). Of the six adapters, four are designed for tubes of the 226 type used as radio- and audio-frequency amplifiers; one for a detector of the 227 type; and the last for a power tube of the 171 or 112 type. The adapters for the 226-type tubes are equipped across the filaments with center-tapped resistors of approximately 10 ohms. That of the power stage has a center-tapped resistor of approximately 46 ohms. The harness is formed of eight rubber-insulated leads braided together; six of these supply the heating current for the filaments at 1½ volts, 2½ and 5 volts, and the other two serve as grid returns for the direct- and indirect-heated cathodes.

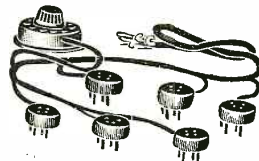

A sturdy low-resistance rheostat (approximately ½-ohm) in the filament circuit is intended to serve as a volume control.

AWARDED THE RADIO NEWS LABORATORIES CERTIFICATE OF MERIT NO. 2312.

**THREE-CIRCUIT TUNER**

The three-circuit tuner shown has two rotors, each 1½ inches long and

2½ inches in diameter; one has 24 turns of Litz wire, while the other has 16 turns tapped at the eighth. The secondary winding consists of 57 turns wound on a bakelite tube 3½ inches long and 3 inches in diameter. Its inductance is approximately 254 microhenries (measured at 600 kc.)

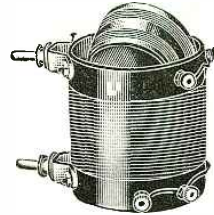

AWARDED THE RADIO NEWS LABORATORIES CERTIFICATE OF MERIT NO. 2318.

**REPRODUCER UNIT**

Unlike loud-speaker units of the ordinary type, which are permanently attached to the diaphragm of the air chamber or to the vibrating cone, the unit shown here is free and needs for sound reproduction neither a horn nor a cone. It can be operated in conjunction with any surface of suitable size and responsive to vibrations, such as a door, cupboard, or window pane; especially effective results are obtained when it is used in conjunction with the sounding board of a piano. This peculiar feature makes this unit a very useful attachment to any portable receiver. Its construction is of the conventional balanced-armature type, and it is enclosed in a japanned aluminum case. It operates in two different positions, either vertical or horizontal; in the former the unit simply rests on the vibrating surface. In the latter, it is suspended by its hook in such a way that it is pressed by its weight



against the responsive surface, with which it makes contact through the little ball at the end of the vibrating reed. It is of German make.

AWARDED THE RADIO NEWS LABORATORIES CERTIFICATE OF MERIT NO. 2319.

**VACUUM TUBE**

The vacuum tube illustrated is for A.C. operation, and made in both the direct- and the indirect-heated cathode types. The former is of 226



type and requires 1.05 amperes at approximately 1.5 volts for normal operation. Its dynamic characteristics (with 84 volts on the plate) are: amplification constant, 8.83; plate impedance, 8,500 ohms, and mutual conductance, 1025 mhos (measured value). This tube operates very satisfactorily as either an R.F. or an A.F. amplifier. The tube with the indirect-heated cathode is of the 227 type, and is designed especially to operate as a detector; its heater requires 1.75 amperes at approximately 2½ volts. The dynamic characteristics (at 44 volts) are: amplification constant, 9.12; plate impedance, 7,500 ohms, and mutual conductance, 1215 mhos (measured value).

AWARDED THE RADIO NEWS LABORATORIES CERTIFICATE OF MERIT NO. 2320.

**THREE-CIRCUIT TUNER**

The amount of insulating material used in this three-circuit tuner is reduced to almost a minimum; all three windings are supported by thin, narrow celluloid strips. The pri-

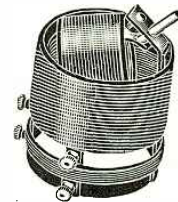

mary and secondary are each 3¾ inches in diameter, and spaced ¾-inch apart. The secondary is formed of 55 turns and has an inductance of approximately 232 microhenries. The tickler is 2¾ inches in diameter and has 40 turns.

AWARDED THE RADIO NEWS LABORATORIES CERTIFICATE OF MERIT NO. 2321.

**THREE-CIRCUIT TUNER**

The secondary winding of the three-circuit tuner shown here is constructed on the same principle as that of the three-circuit tuner mentioned above, and is supported by four thin celluloid strips, which are attached to two celluloid rings. This winding is 3 inches in diameter and consists of 55 turns of double-insulated coupled wire; it has an inductance value of approximately 220 microhenries. The primary and the tickler are wound on two slotted celluloid rings. The primary is 2¾ inches in diameter, and the tickler 1¾ inches. The coupling between the primary and the secondary may be varied within very wide ranges, by means of a specially-curved mounting bracket which attaches the pri-

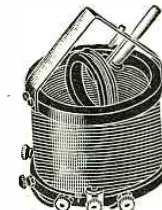

mary to the frame of this three-circuit tuner.

AWARDED THE RADIO NEWS LABORATORIES CERTIFICATE OF MERIT NO. 2322.

**R.F. TRANSFORMER**

This radio-frequency transformer is of the plug-in, low-loss type. The (Continued on page 1295)

# Radiotics

### MANUFACTURERS, PLEASE NOTICE



A boon to the overworked radio manufacturer is presented in the advertising columns of the *Philadelphia Daily News* of Jan. 27. "Electrical Pick-Up MAKES your phonograph and radio." Not so bad at all. We suggest that a few pick-ups be set turning out radio receivers; they could be made to sell very cheaply, we should guess.

Contributed by  
Benj. J. Spotts.

### VERY AUTOMATIC

In the *Western Music & Radio Trade Journal*, for Jan. 1928, is pictured an electrodynamic loud speaker "equipped with a SHUT-DOWN transformer." It may be necessary to teach these intelligent speakers when to cease playing; but doubtless the high notes of sopranos and tenors could be made to do the trick automatically.

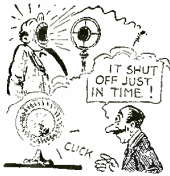

Contributed by  
William P. Bear.

### HELP! SUCCOR!! ASSISTANCE!!!



A very wet item in the *Wentworth Radio Supply Company's* catalog is a coil captioned the "DROWN-ING Drake." Mike of the Investigation Dept., ever ready to help in time of need, jumped in among the ether waves and rescued this bird—which we had hitherto thought one of the hardest to drown. Live and learn, say we.

Contributed by  
T. C. Rumney.

### DURN THEM PESKY SHOOTERS!

In the Feb. 4 issue of the *Radio World* we find, under the head of "Trouble Shooting Test Set," these remarks: "and the Double R HECKER are shown herewith." But, alas and alack, we could see no picture. After great hardships and much expense we finally obtained the accompanying portraits from the hinterland. "We hope you like it."



Contributed by  
H. B. Closson, Jr.

### PAGE SIGNOR VOLTA HIMSELF



New discoveries in the use of voltmeters set forth in the *Kansas City Post* of Jan. 28: "One of the most useful investments to have around a set is a voltmeter. With it one can tell whether the filament and plate VOLT ACID can be neutralized with ammonium hydroxide, potassium or sodium hydroxide." What can we say to anything like this?

Contributed by  
Richard E. Wiles.

### TRUTH WILL OUT

In the *Broadcast Weekly* of Feb. 12 was found this very frank description of a broadcast artist, "KFWI, 10:03 to 11 P. M. Harold Reed, entertainer; Glenhall Taylor, PAINIST." In our opinion that's rather rough on the key-pounder; but he ought to be glad he wasn't described as a *cervicodynia*. (Aw, use your own dictionary—ours is cracked.)



Contributed by  
Ralph L. Power.

### ART FOR ART'S SAKE

Aestheticism plus demonstrated in the *Vancouver Province* of Feb. 13: "Radio Inlaid MAHOGANY TUBES SPEAKER AND STORAGE BATTERY." It seems to us that this is carrying things too far. The old-fashioned glass tubes and storage batteries (whatever they're made out of) are good enough for us.

Contributed by  
Arthur W. Freeman.

### HERE'S YOUR CHANCE

Another of the well-known steps forward of Science, reported by the *Omaha Bee* of Feb. 5: "PHONOGRAPH Transmitted in 90 Seconds From WEA.F to Set 25 Miles Away." Some evening, when your radio set isn't behaving just as you want it, phone to WEA.F and they will send you canned music in short order. Simple?

Contributed by  
Lloyd Monteith.

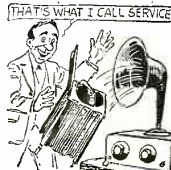

### TURN THE CRANK



Wild advertisement in the January issue of the *Citizen's Radio Call Book*: "Audio Transformers sold in sealed NETS, they are fully guaranteed in every way." In this case, ladies and gents, we have the wild Audios transformum which must be caught in its native lairs, in nets which are sealed carefully so they won't escape. Larry, do yer stuff!

Contributed by  
H. C. Heidrich.

### EXIT LOUD SPEAKERS

Another revolution forecast in an advertisement in the *Hamilton-Carr Corp.* catalog: "Wire for use as hook-up wire, bell or ENUNCIATOR wire." Let us whisper you a secret; Use this wire to connect up the next set you build and the connections will do all the singing and playing. No use for the old cone.

Contributed by  
Roy A. Jenkins.



If you happen to see any humorous misprints in the press we shall be glad to have you clip them out and send to us. No RADIOTIC will be accepted unless the printed original giving the name of the newspaper or magazine is submitted, with date and page on which it appeared. We will pay \$1.00 for each RADIOTIC accepted and printed here. A few humorous lines from each correspondent should accompany each RADIOTIC. The most humorous ones will be printed. Address all RADIOTICS to

Editor, RADIOTIC DEPARTMENT,  
c/o Radio News.

### FAMOUS PARTNERSHIP DISSOLVED



Interesting advertisement in the *Detroit News* of Feb. 17, wherein is offered a "Browning & DUKE receiver." Evidently part of the radio combination decided to get out and now we have tobacco entering the field. We'll not walk a mile to ask Dad if he found a cough in a carload and is satisfied.

Contributed by  
C. C. Whittaker.

### USE FOR OLD BATTERIES

On an instruction sheet supplied with the Westinghouse Battery charger we find this interesting caption: "Fig. 1—Method of Connecting Rectigon for charging automobile, OF radio 'A' batteries." Not for us, not even when Henry is dispensing his wares to the public at such a cheap price. Distilled water is still cheaper than gasoline.

Contributed by  
Mrs. Lawrence Davis.



### R.C.A. ENTERS NEW FIELD

From the *Bangor (Maine) Daily News* of Jan. 6 we have an advertisement which extols "RCA RADIATORS." It sure looks as if the engineers of that company were afraid that perhaps a user might get cold feet or something like that. Maybe the radiators are to be used in heating apartments or certain departments.

Contributed by  
E. L. Dobbins.



### SAY IT AIN'T SO, COMMISH!



Explanation of the present scrambled condition of the ether vouchsafed by J. P. McEvoy in *Liberty* of Feb. 25: "This is Station W.W.W. broadcasting over a BAND of 980 KILOCYCLES by authority of the Federal Radio Commission." No wonder they tell us that special apparatus is required to meet the demands of the radio public.

Contributed by  
William R. Smith.

### MATRIMONIAL OR FINANCIAL?



The *San Francisco Examiner* of Feb. 5 states: "If this does not cover the whole wavelength BOND connect a .00025 condenser in series with ANTI." It might be marital because we heard the other night a wife say to her better 99%: "Tune in and get on my wavelength" during an argument. Still, Wall Street is always a busy place.

Contributed by  
L. H. Hueter.

### YOU GOT TO CATCH 'EM YOUNG

Announcement of Conrad, in the *February Dealer's Personal Edition* of this magazine, of a diagram showing "How to Make the Tropadyme SUPERDIP," causes wonderment about this acrobatic stunt. Of course, some of these set owners tell wonderful things about what the faithful old Trope will fetch in; but we didn't think it had such versatility.

Contributed by  
Phillip Morris.

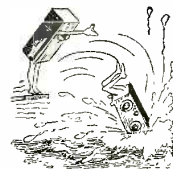

### "PAPA, BUY MIKE ONE"

Mike of the Investigation Dept. made this plea when his attention was called to this item in the *February Radio World*, viz: "If a considerable RUM is present it may be due to an open 30-ohm potentiometer." We admit that the potential of some rum we have met was rather high; so we'll keep all such potentiometers for ourself. Mike's too young.

Contributed by  
D. E. Mead.







Conducted by C. W. Palmer

**T**HIS Department is conducted for the benefit of our Radio Experimenters. We shall be glad to answer here questions for the benefit of all, but we can publish only such matter as is of sufficient interest to all. Inquiries about comparative merits of apparatus cannot be answered.

1. This Department cannot answer more than three questions for each correspondent. Please make these questions brief; if the inquiry is concerning a circuit other than a standard, published one, delay will be prevented by enclosing a diagram and other necessary information.
2. Only one side of the sheet should be written upon; all matter should be typewritten or else written in ink. No attention paid to penciled matter.
3. Sketches, diagrams, etc., must be on separate sheets. This Department does not answer questions by mail free of charge.
4. Our Editors will be glad to answer any letter, at the rate of 25c. for each question. If, however, questions entail considerable research work, intricate calculations, patent research, etc., a special charge will be made. Before we answer such questions, correspondents will be informed as to the price charge.

**COIL DATA**

(2273). Mr. A. Wedelich, St. Louis, Mo., writes:  
 Q. "Please furnish me with a chart showing the simple calculation of coil windings. I have several books on radio, but most of them give rather intricate formulas that involve algebra and higher mathematics and are too deep for me.  
 "The coils I wish to construct are for the broadcast band; the primary, secondary and tickler for radio-frequency transformers, antenna coupling coils, etc."

A. You will find below a chart of inductance coils suitable for use over the wavelength band between 200 and 550 meters with condensers of .00025-, .00035-, .0005- or .001-mf. This chart shows the size of the secondary coil for use in the coupler. The size of the primary and the distance between the primary and secondary are matters which depend upon the particular circuit in question and the size of the coil used. As an example, a radio-frequency coupling coil, to be used with a neutralized circuit when a 3-inch tube is employed, can contain 15 or more turns of wire. In a circuit which is not neutralized, this value will have to be reduced to 12 or 10 turns. In actual practice it is a simple matter to find the value which will supply the desired characteristics.

The turns on a tickler coil for use in a regenerative circuit can be figured at about two-thirds the number of turns of wire on the secondary coil. This proportion, however, does not hold true in all cases, especially when vacuum tubes such as the 199-type are used. In this case, the size of the tickler coil will have to be increased, since this tube does not oscillate as freely as the 201A-type.

The distance between the secondary and tickler coils also affects the size of the coil; and the use of resistors or condensers for controlling the regeneration also changes this value. The actual size of the tickler coil can easily be determined when the set is in operation. If the regeneration is too strong and cannot be controlled, the tickler coil should be reduced in size; while, if sufficient regeneration is not obtained, the size of the coil should be increased.

Wire D.C.C.	Diam. of coil inches	Maximum capacity (MF.) of tuning condenser			
		.00025	.00035	.0005	.001
No. 20	2	165	125	92	53
	2½	122	92	68	40
	3	90	69	54	35
	3½	76	59	46	28
No. 22	4	66	53	40	25
	2	140	105	81	50
	2½	108	82	62	38
	3	84	66	50	32
No. 24	3½	74	56	42	27
	4	60	48	37	24
	2	132	100	77	45
	2½	97	75	59	35
	3	78	62	46	29
	3½	65	53	40	26
	4	53	42	35	23

Wire D.C.C.	Diam. of coil inches	Maximum capacity (MF.) of tuning condenser			
		.00025	.00035	.0005	.001
No. 26	2	120	93	69	44
	2½	89	70	52	34
	3	72	56	45	28
	3½	61	48	37	25
	4	51	41	33	22

**FILTER CIRCUIT**

(2274). Mr. J. Blackman, Baltimore, Md., writes:  
 (Q). "I am using a double-impedance-coupled amplifier with a 'B' socket-power unit, and I am experiencing a considerable amount of 'motorboating' with this arrangement. Can you suggest some method which will help to overcome this difficulty?"

(A). There are several methods which can be used to eliminate the trouble you are having. The use of a voltage-regulator tube in the power unit will probably overcome the difficulty and, if this is not practical, a filter circuit such as that shown in Fig. Q. 2274 can be used. This filter consists

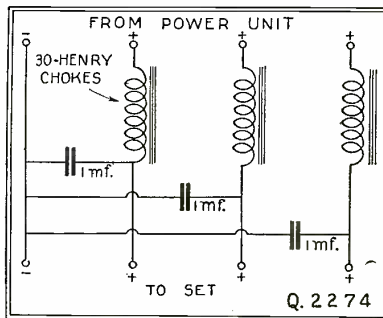

A remedy for motorboating in a resistance- or choke-coil-coupled amplifier is found in the filter diagrammed above.

of an audio-frequency choke in each of the "B+" leads, and a by-pass condenser between each of these filter coils and the "B-" terminal.  
 "Motorboating" is caused, in some cases, also by the use of incorrect "C" bias on the amplifier tubes in resistance-coupled and choke-coil-coupled amplifiers. The use of a high-resistance voltmeter to measure the output voltage of a "B" power unit is advisable; in this way, one can tell very easily what "C" bias is necessary, since the exact "B" voltage is known.

**CIRCUIT TESTING**

(2275). Mr. J. R. Lopez Sena, New York, N. Y., asks:  
 Q. "Can you furnish me with the circuit diagram and specifications for a circuit tester, which is capable of testing the various circuits in my receiver and is similar to the commercial testers

on the market. This unit does not need to be as simple in operation as the commercial products, since I would not be able to employ a multi-pole switch such as they use.

"In these units a milliammeter is arranged with series and shunt resistors to measure the plate voltage, the plate current, the filament voltage, and the comparative, plate-current values for different grid biases. The unit is equipped with a plug which is inserted in the tube socket of the set, so that the circuit can be tested while the set is in operation. The tube is placed in the unit and its operation is controlled with the various switches in this unit."

A. You will find the diagram of a tester of this type on the next page (see Fig. Q. 2275). An 0-to-1-scale milliammeter is used; and it will be necessary to obtain a shunt from the manufacturer of the meter so that it can be adapted to readings from 0 to 20 milliamperes. If desired, an 0-to-20-scale milliammeter may be purchased and the shunt removed and used externally.

The other apparatus required comprises a four-pole double-throw switch (B), a double-pole double-throw switch (D), a single-pole double-throw switch (E), a single-pole single-throw switch (C), and a multi-pole switch (A) used for testing the various voltages of the plate supply. The last may be of the ordinary panel-mounting type with an arm and switch points mounted in the panel.

It will be necessary to use also a tube socket, an old vacuum-tube base, and several fixed resistors to convert the milliammeter into a voltmeter. With a milliammeter with a scale reading from 0 to 1 milliamperes, it will be necessary to use an 8,000-ohm resistor for the 8-volt tap, an 80,000-ohm resistor for the 80-volt tap, and a 200,000-ohm resistor for the 200-volt tap. If an 0-to-20-scale milliammeter is employed with the shunt removed, it will be necessary to be sure that the milliammeter registers 0 to 1 milliamperes over the complete range, since it cannot be used if this is not true.

**Use of the Tester**

The various tests that can be accomplished with this unit are made as follows:

(1). To measure the plate voltage, turn the switch B to the voltage side and turn the switch A to the 80- or 200-volt tap; that is, to point 3 or 4. Switch C should be open and switch D should be in position 1, unless the wiring is reversed in the receiver. This can easily be determined by throwing switch A to point 2, and closing switch C. If the meter registers correctly, the switch (D) should be left in that position. If it does not register on the positive side, the switch (D) should be reversed. When measuring the voltages, switch E should be in position 1.

(2). To measure the plate current, switch B should be in the milliammeter position, and switch A should be at point 1. Switch C should be open, switch D in the positive position, depending upon the wiring of the set, and switch E on point 1.

(3). To compare the grid currents of the tube with and without bias or with a positive bias, leave the switches in the milliammeter position, and change switch E from point 1 to point 2. This places the grid return of the tube directly

on the "F-" and removes any bias which might be obtained through the set. By reversing switch D, it will be possible to place a positive bias, equal to one-half the value of the "A" battery, on the tube. While these grid measurements do not show any direct values, they are helpful in comparing the plate-current consumption of a vacuum tube under different grid conditions; and comparative values can easily be determined with tubes of known value. They will indicate whether the tube is operating correctly or not.

(4). To measure the filament voltage, switch B should be in the voltage position, switch A should be in position 2, switch C should be closed, and switch D in the position which supplies the positive reading.

(5). To use the meter and resistors in the unit separately, the external binding posts should be employed. For milliammeter readings, the negative binding post and the milliammeter binding posts are used. If a range of 0 to 1 milliamperes is required, the switch B should be open; and if a range of 0 to 20 milliamperes is required, the

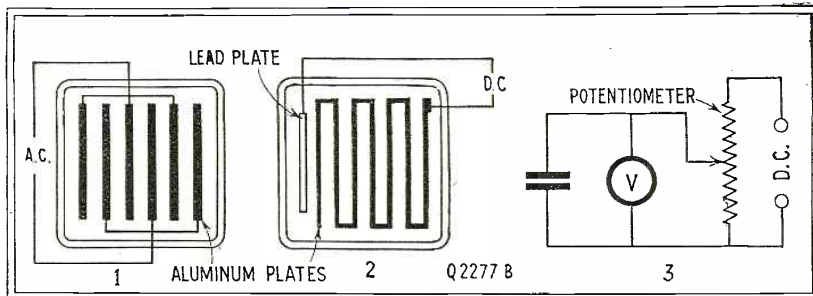

Two types of electrolytic condensers: (1) for A.C. operation contains two sets of aluminum plates; (2) for D.C. operation has one set of aluminum plates and a small lead plate for making connection to the electrolyte. Diagram 3 shows how a low-voltage condenser can be "formed."

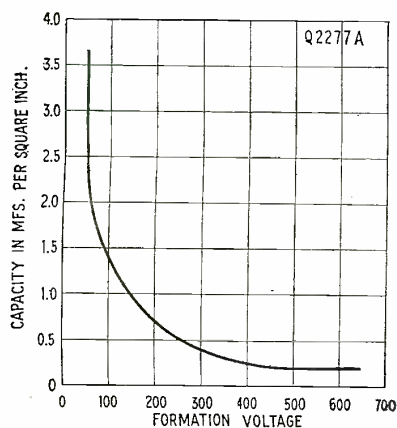

This graph indicates the approximate capacity of an electrolytic condenser, the size of whose plates and formation-voltage are known.

switch B should be closed on the milliamper side. To use the various voltage scales, the switch B should be opened and the correct voltage binding post in conjunction with the negative binding post should be used. When using the external section of the unit, the plug-in tube base should be removed from any socket in which it has been previously used.

This unit is quite useful for use in testing radio sets, vacuum tubes, etc.; and, since the meter with the resistors described above produces a voltmeter which has a resistance of 1,000 ohms per volt, the unit is also valuable for use with sets employing power units, for measuring the output of "B" power units, etc. The resistors

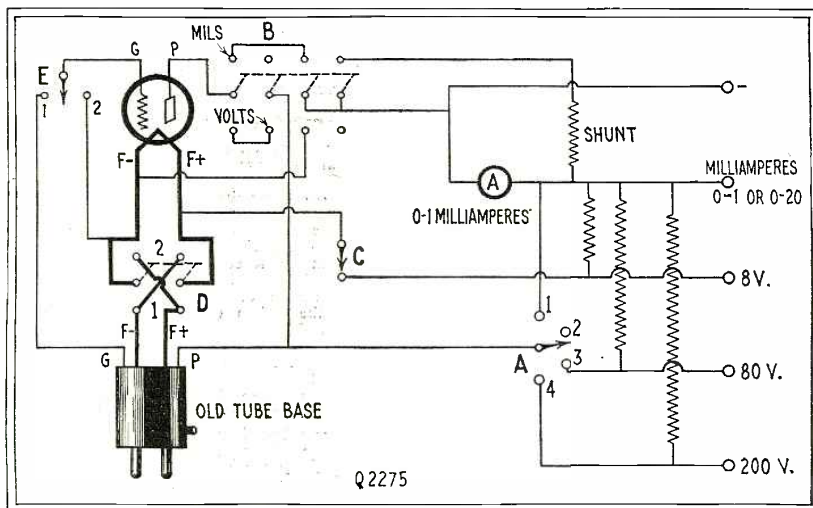

A universal set tester is shown here; its switch system allows the set to be tested while in operation. The plate voltage, plate current, filament voltage and comparative grid readings can be obtained with a unit of this type.

used in the voltmeter section of the unit should be as close to the value shown as possible. Fortunately, there have been recently placed on the market some resistors which are accurate within plus or minus one per cent. This is close enough so that the voltmeter readings will be sufficiently accurate for ordinary work. It will be necessary to recalibrate the meter; either by making comparative points equal to a given value for each of the resistors and plotting a graph of the readings, or by taking the glass front from the meter and inserting a new scale.

OUTPUT DEVICES

(2276). Mr. C. W. Hall, Philadelphia, Pa. asks:

"Is there any advantage in using an output transformer to couple the loud speaker to the receiver, other than the protection that it offers?"

(A.) If it is not possible to match the impedance of the loud speaker to the impedance of the last tube in the receiver, it is advisable to use an output transformer to compensate for the difference.

In other words, if the loud speaker has a lower impedance than the tube, a transformer with a high-impedance primary and a low-impedance secondary would be used. In this case the transformer would have a step-down ratio and the voltage of the secondary would be lower than that in the primary.

If it is necessary to use a low-resistance tube with a high-resistance speaker, the characteristics of the transformer must be reversed. That is to say, the transformer should have a small primary and a large secondary; thus producing an increase in voltage and a reduction in current.

ELECTROLYTIC CONDENSERS

(2277). Mr. R. W. Windsor, Oklahoma City, Okla., writes:

Q. "Through the columns of the 'I Want to

Know' Department, will you please give us details on how to make an electrolytic condenser suitable for heavy-duty "B" power units."

A. The theory of the electrolytic condenser is as follows: When an electrolytic cell consisting of an aluminum and a lead plate and a suitable electrolyte is connected to a direct-current line, with the aluminum plate as the positive terminal, a uniform film, without pinholes, is formed over the entire surface of the aluminum plate. This film is a very good insulator and reduces the direct current almost to zero. In this case, there is no leakage current caused by sparking, as happens when the cell is used for rectifying purposes. The small leakage current at the point where the aluminum electrode leaves the solution can be reduced to an almost negligible amount by carefully insulating the aluminum plate where it enters the liquid. A cell of this

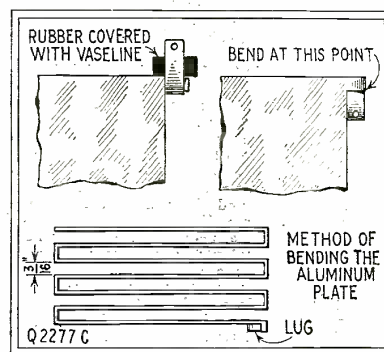

A set of plates for the condenser shown above at (2) may be made from one aluminum strip as shown.

type forms a very good high-capacity condenser, with the gaseous film acting as the dielectric.

This condenser is limited to a certain voltage at which the film breaks down, allowing current to flow again until a new film is formed. Because of this fact, the electrolytic condenser is not injured by breakdown, since it takes only a short time to form a new film. Various electrolytes have different critical voltages, and for high-voltage work some are more suitable than others. The critical voltages of some of the common electrolytes are as follows:

- Sodium sulphate, 40; potassium permanganate, 112; ammonium chromate, 122; potassium cyanide, 295; ammonium bicarbonate, 425; sodium silicate, 445; ammonium phosphate, 460; ammonium citrate, 470; sodium borate ("borax"), 480.

The critical voltage is approximately correct when aluminum plates and the electrolyte formed by a 1% solution of one of the respective chemicals shown above are used. The approximate capacity obtained per square inch of condenser plates depends upon the formation voltage. The graph (Q. 2277A) shows these approximate values.

The construction of a condenser which may be used for "B" power units can be accomplished as follows:

A piece of extra pure or No. 1 aluminum, about six inches wide, should be cut from 1/16-inch or 1/8-inch material. The length of this aluminum sheet depends upon the capacity of the condenser and the size of the container. It should be bent back and forth as shown in Fig. 2277C. A lug should be left on the end of the plate, so that a contact can be easily made to

(Continued on page 1295)

**FIVE TYPE UX222 SCREEN GRID TUBES ARE USED IN THIS ULTRA-POWERFUL BROADCAST RECEIVER, INCREASING THE RADIO FREQUENCY AMPLIFICATION AND SENSITIVITY OVER 500 TIMES**

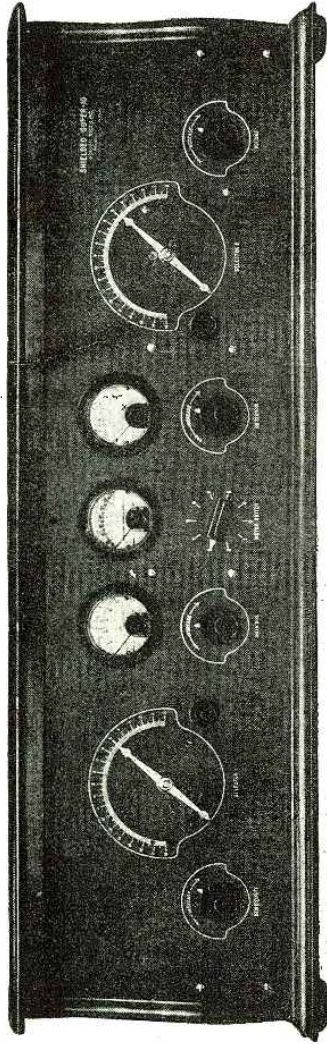

Front Panel View  
NEW ADMIRALTY MODEL  
with complete set of indicating  
meters. Panel size 9 x 36 x 3/4  
inches. Weight 45 lbs.

Licensed under Hogan Patent  
No. 1,014,002

**The New  
Norden-Hauck**

**SHIELDED SUPER-10**

**Highest Class  
Receiver  
in the World**

The new NORDEN-HAUCK SHIELDED SUPER-10 is fundamentally different, being specially designed for crowded broadcast conditions. It is a long distance concert Receiver which marks radio's final arrival at the goal of the connoisseur of performance.

Far away stations are received like locals, using only a small loop or short piece of wire for the antenna. Distance possibilities seem unlimited with this new model. Usual background noises are conspicuously absent, and an extraordinary quality of reproduction is obtained with the improved audio amplifier in the Shielded Super-10.

Smashing power with complete fidelity makes previous standards of reception pale into insignificance. There is simply nothing like it. This great 10-tube Model is so far in advance of others that its absolute superiority is instantly apparent to anyone.



Standard Shielded Super-10—Front Panel view. This model is identical with the Admiralty Model except for the indicating meters. However, it is equipped for the Weston Pin-jack Voltmeter.

**Some Exclusive Features**

1. Ten tubes. A combination of Screen Grid and Power Tubes arranged for maximum efficiency.
2. Totally shielded in accordance with latest research data. Various circuits are completely isolated.
3. Selectivity remarkable—Tunes completely through local broadcasters.
4. Either A. C. electric operation or batteries may be used as desired.
5. Simple to operate—only two main tuning controls.
6. An entirely new audio amplifier, with two power tubes handling the output.
7. Provision made for electric phonograph pickup.
8. A precision laboratory instrument. Material and workmanship conform to U. S. Navy Standards.
9. Moderately priced. Deferred terms of payment can be arranged if desired.
10. Beautiful new, and less expensive console cabinets are available.

This design and development of the Shielded Super-10 is a revolutionary achievement which has been made possible by the extraordinary "screen grid" tubes. It will be several years before any AC tube is developed that will even approach the efficiency of the "screen grid" tube as a radio frequency amplifier. This new tube raises the amplification factor thirty to forty times over that secured with the conventional 201-A tube.

Everyone can have this wonderful Receiving Set, for it is sold as a complete manufactured laboratory tested Receiver and also in a kit of parts for home construction, or for the professional set builder and dealer.

The full size genuine blue prints and instructions are so complete in every detail, that is exceedingly easy for anyone to build the Shielded Super-10. Almost everything is done for you to simplify this work.

Learn more about this remarkable Receiver. Send for attractively illustrated literature on the new NORDEN-HAUCK

SHIELDED SUPER-10, which will be gladly sent to you without cost or obligation on my part kindly send me complete attractively illustrated literature on the new Norden-Hauck Shielded Super-10.

NAME.....  
ADDRESS.....

I enclose \$2.00 for which kindly send me in duplicate the following: Blue Prints and operating instructions for the new Norden-Hauck Shielded Super-10.

Builders of the Highest Class  
Radio Apparatus in the World

**NORDEN-HAUCK, Inc., Engineers**  
Marine Bldg., Delaware Ave. and South Street, Philadelphia, Pa., U. S. A. Cables: "NORHAUCK"

# In The Bright Darkness

(Continued from page 1215)

Radio Engineering's circulation has **DOUBLED** in the past six months. There's a reason. Let us send YOU a copy. (See below.)



Not a "Fan" Magazine

## Not Sold on Newsstands

**IF** you are interested in a radio engineering magazine that is *non-biased* and authentic—

**IF** you want articles by the leading engineers of the industry—

**IF** you want a magazine that you *know* is ably edited—that includes on its staff: Muhleman, Rider, Lescarbourea, Millen, Bouck—

**IF YOU WANT ADVANCED MATERIAL ON SERVICING, TESTING, CONSTRUCTION, DESIGN—**

Send for a copy

## RADIO ENGINEERING IS NOT SOLD ON NEWSSTANDS

RADIO ENGINEERING, Inc.,  
52 Vanderbilt Ave., New York, N. Y.

Enclosed find \$2.00 for 1 year  
\$3.00 for 2 years  
subscription to RADIO ENGINEERING.  
Enclosed find twenty cents (20c.), for  
which send sample copy of RADIO EN-  
GINEERING.

Name .....

Address .....

Town and State .....

Please Check Your Classification:  
Dealer  Manufacturer  Service Man   
Engineer  Professional Set Builder   
Distributor  Anything Else

paratus, relayed from your yacht, and broadcast from your station, WROT, to the millions of radio fans, who will witness, from their own homes, what the keenest human eye could not see from this deck!"

"You have done well, Scott," approved Harold Dare. "We have only to await the arrival of the conspirators."

They seated themselves and donned the headsets of the sound reflector. Many sounds came to their ears—the sound of water sloshing against the stern of the other yacht; the hum of generators, the rattle of a chain, the clanking of metal on metal, a confused murmur of voices. Moments passed. Then in the sensitive headphones faintly sounded the hum of a motor. Gradually it grew to the full, smooth drone of a powerful engine, muffled, but working under a heavy load. Scott turned to the switch-board beside him. One by one he threw the heavy copper blades. The motor-driven cameras whirred; with a crackling sound the huge infra-red ray generators warmed to their work, sending out great waves of heat. In the head-sets the sound of the motor suddenly died. There was a churning of water and a scraping of wood against wood. Chains clanked; pulleys squeaked; there was a scuffle of feet, a rumble of heavy objects being drawn over decks, a murmur of voices. Then the idling motor rose to a roar, and a purling of water told that the launch was speeding away from the yacht.

"They have loaded the guns!" cried Scott. "Let us act!" Harold Dare scrambled over the ship's side into the speed boat, whose motor was now gently purring. With a roar the powerful launch cut swiftly across the harbor toward the yacht.

In the studio at WROT, the announcer spoke: "Friends of the air! we present tonight the most spectacular scene ever brought to the world through television—an event so dramatic, so gripping, so stirring that it might well be a scene from one of Mr. Dare's great super-specials. Dandy Diavolo, with reckless disregard of public welfare, of law, of ethics, of international relations, has planned a perfidious plot. But through the unflagging zeal and almost superhuman cleverness of Harold Dare alone it is being foiled as neatly and completely as the most critical film fan could desire. Friends, with the eye of television, you are about to penetrate the darkness of midnight, as no human eye could do. Stand by for television!"

In millions of homes, people threw the switches of their television receivers, and on millions of silver screens flashed out a long, low, rakish yacht, silhouetted against an inky-black sky. Closer and more sharply defined it grew as Scott focused the telephoto lens of the television equipment. On the deck, a man wearing headphones, sat at a large kettle-drum-shaped device, while a number of desperate appearing men lowered the last of the packing-boxes below deck. Suddenly the man at the sound detector stood up, and millions of gasping film fans recognized black Dandy Diavolo, hated villain of the Flicker Films. He turned the crank of the sound detector, listening

intently. Then he waved his arms and the listeners heard: "Overboard with everything—we are discovered!" His henchmen sprang into feverish activity. Winches clattered, as frantically case after case of guns was hauled forth and plunged overboard. As the last case disappeared beneath the waves, a streak of white flashed upon the television screen, and with a roar Harold Dare's swift boat swept alongside. The launch's searchlight climbed upward. As if before the Kliegs of Flicker Films, desperate Dandy Diavolo faced the bright beam of light and walked over to the rail.

"Avast, there! cried Harold Dare, in his best nautical manner. "Belay you! Lay to! Heave up, Dandy Diavolo!"

"What means this foolery?" snapped Diavolo.

"It means," retorted Harold Dare, "that your little plot is discovered. We command you to halt, to lay to, in the name of the United States Government, the Federal Coast Guard Service, and the Harold Dare Studios!"

Diavolo's face twisted into a fantastic sneer. "Very well, gentlemen. If you wish, come aboard."

He dropped a ladder. Dare and his men climbed aboard. The Coast Guard officer stepped forward.

"Dandy Diavolo," he said, "in the name of the Government of the United States of America, the State of California, the County of Los Angeles, and the City Governments of Los Angeles, Hollywood, and Beverly Hills, I arrest you for attempted gun-running, and for violation of the Monroe Doctrine, the Covenant of the League of Nations, and the Penal Code!"

Diavolo laughed harshly. "This time, Harold Dare, you have overreached yourself. You, my fine fellow, will suffer for causing an arrest on false charges. Think you that Dandy Diavolo would not foresee and forestall such an emergency as this? You may search the yacht from stem to stern, but not a gun will you find. Then it will be my turn to laugh. You shall rue this day—or, rather, night—Harold Dare."

Dare laughed in his turn. "Ah! Dandy Diavolo, so you have dropped the guns overboard, and propose to salvage them later with divers. You do not know that your every move in tonight's affair was betrayed by the bright darkness of infra-red light. Through radio television, your whole vile scheme has been exposed to the eyes of the world. You thought to keep your evil deeds dark; but the searchlight of justice inevitably finds out the transgressor—especially when it is an infra-red searchlight. The whole sequence of this scene is imperishably recorded on motion-picture film. A fine picture it will make—one that will entertain the stern judges in Federal Court, when the whole scene is re-enacted before their eyes, and when they inspect the cases you hurled overboard, all neatly numbered, 'exhibit A, B, C, D, E, F, G,' etc., to the end of the alphabet. It will be a picture which critics will acclaim the most realistic and thrilling of your whole career as a master-villain. How the sober judges will grip their chairs and hiss you when they see you

# WHOLESALE PRICES

for Dealers, Community Set Builders, General Repairmen and Agents!



Be sure to get this great 128-page book with net prices to the radio trade.

Radio Specialty Company is radio's oldest radio parts mail order house in the country, and the new confidential prices on standard radio merchandise are the lowest of any radio house.

We are ready now to appoint additional agents in all parts of the country. If you are contemplating making big money in radio merchandise, be sure to get in touch with us at once.

WHEN WRITING TO US, USE YOUR LETTERHEAD

New  
1928  
ENLARGED  
EDITION  
NO. 18

THIS  
128 PAGE  
RADIO  
CATALOGUE  
FREE

New 75  
HOOKUPS  
500  
ILLUSTRATIONS

Why from Radio's Oldest Mail Order House!

We are the oldest established, exclusive radio mail order house in the country. All orders are positively shipped within twenty-four hours; quick, prompt, cour-

teous service. We carry a larger variety of radio parts, radio instruments, accessories and radio findings than any other radio house in the country.

"RASCO" has it

You will find in Catalog No. 18 the largest assortment of radio merchandise in this country. Radio Specialty carries more radio parts and radio material than any other house in the country. You will find in this catalog positively the largest variety of radio merchandise.

If you are in need of certain small radio parts that other radio and mail order houses do not bother to carry, get the Rasco Catalog and you will find the small parts there, anything from a screw to copper ribbon, telephone diaphragms, as well as thousands of other small radio findings. Just to mention a few:

Lugs, nuts, jacks, plugs, all kinds of knobs, cords, panels, screws, sliders, washers, selenium, tinfoil, switches, switch points, lock washers, carbon grains, ground clamps, metal pointers, insulated tubing, low melting metal, antenna connectors, as well as thousands of other articles. We carry the Largest Variety of Small Radio Parts in the World, BUT We also carry All Standard Radio Merchandise

ANYTHING  
IN RADIO



Radio Specialty Co.



98 W PARK PLACE NEW YORK



Ten years ago Radio was in its infancy—today TELEVISION is. The possibilities of TELEVISION are every bit as great as those of Radio. And development will probably be much faster, for the basic principles of TELEVISION are closely allied to those of Radio. Much of the fundamental groundwork, therefore, has already been laid. Grow with this infant Industry—all the thrills of the experimenter are here just as they were in Radio. Learn all there is to know about this new art. This up-to-date book will give you full details on all that has been done in the development of TELEVISION. Written by the leading authorities—all theories, discoveries, and trends are fully explained and written in an easily understandable way.

### BUILD YOUR OWN TELEVISION SET

Complete instructions for building an experimental TELEVISION outfit are given in this remarkable book. Anyone can build his own. Complete apparatus can be bought very reasonably. Over 112 pages—fully illustrated. Large size 9x12 book. Mail this coupon now! Don't wait—be the first in your neighborhood. You'll get many hours of priceless enjoyment.

EXPERIMENTER PUBLISHING CO.  
230 Fifth Avenue New York, N. Y.

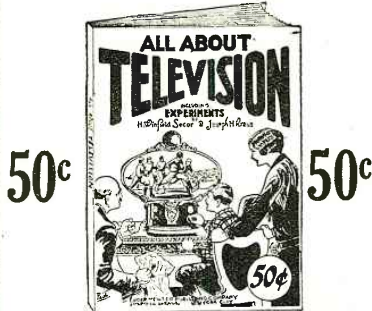

EXPERIMENTER PUBLISHING CO.  
230 Fifth Avenue, New York, N. Y.  
Gentlemen: Kindly send me a copy of TELEVISION. Enclosed is 50 cents.

Name.....  
Address.....  
City..... State.....

and your minions loading the contraband cases aboard your yacht; and how they will applaud this final scene, in which you are neatly foiled!"

Diavolo gasped. He turned wildly, but saw only menacing faces. Dare turned to the government official. "Officer, do your duty." Drawing from his pocket a set of strong steel handcuffs, the officer snapped them upon Diavolo's wrists. "At last, Diavolo, you are caught in the toils of justice. Now we must search the yacht."

Dare took the lead. They found nothing of suspicious importance until they came to the last cabin. The door was locked, but dauntless Harold Dare was not to be deterred. "Break down the door, men," he

commanded. Diavolo paled. Before the onslaught of two brawny sailors the panels splintered, the lock broke, and the men were sent flying into the room. Harold Dare stood transfixed with amazement. There was a ripple of feminine laughter—he looked into a face he knew full well.

"Rose!" he gasped.

"Harold, my hero!" cried the girl.

And, as if before the clicking cameras, Harold Dare and Rose Blush fell into a splendid, soul-satisfying clinch. And again the arch-villain, in his soul-searing despair, realized that fate holds few favors for him who flouts the forces of justice, and that to the brave alone belongs the fair.

## How Broadcast Programs Reach Broadcast Stations

(Continued from page 1213)

up-grades to maintain the minimum speed, and the brakes used when going down hill, to keep the car from going faster than 60 miles per hour.

The up-hill part of the analogy is the pianissimo minimum of a scale reading of 30 and the down-hill part is the fortissimo maximum of 60. It can be understood that, just as there are hills of different grades, necessitating either more braking or acceleration, so also there are different volumes of music-making power necessary, more or less, as the case may be, to maintain and observe the limits of 30 to 60 on the volume indicator.

This constant adjustment of the volume indicator necessitates a familiarity with the musical selections on the part of the operator at the pick-up point. He must know when there is to be a crescendo, so that he can reduce the volume at the proper time; when an incidental violin solo is in the selection he must be aware of the fact, and bring up the power so that the music will register in the loud speakers.

### AT THE CENTRAL STATION

As mentioned previously, the night club is connected by telephone lines to the central broadcasting building. Before these lines are led to the switchboard, which distributes the music to the transmitter, they go to another amplifying system, similar to the one at the night club. In addition to this is an instrument called a "pad", which also plays an important role in keeping the quality up to a high standard. This pad has the function of *reducing* the volume of the "line noises" just after the program comes from the telephone line.

It seems safe to assume that every reader of RADIO NEWS has at some time or other used a telephone and, therefore, knows that there is always a certain amount of line noise superimposed on the conversation. This happens in the land lines connecting the night club to the main building, but not to as great an extent as in most telephone circuits; for these special lines are very carefully balanced to take out as much of this noise as possible.

Now the amplifier at the night club amplifies only the music; but, by the time the signal reaches the central building, it has superimposed on it some of the land-line

noises. If this combination were amplified again and put on the air the audience would hear in their loud speakers an extra amount of noise and conclude that "the static is awful tonight." The pad mentioned above has the ability to filter out the line noises; so that when the signal is again amplified the line noises are practically eliminated and only the music is amplified.

### AT THE TRANSMITTER

At the central building there is also a volume-indicating meter, which is synchronized with the one at the night club. This is constantly observed by an operator; but the control is left entirely to the man at the pick-up point. After being again amplified, the signal comes to the switchboard, where it is routed to Bellmore, Long Island, the location of WEAJ's transmitter (and also to the different stations in the network chain) by means of plugs and jacks, such as are used in an ordinary telephone exchange.

When the land lines have finally carried the signals to the transmitting station, they are again amplified before they modulate the carrier-wave of the station; *i.e.*, before they are combined with the high-frequency current that is generated at the transmitter. It is the frequency of this carrier wave that determines the wavelength of a station. The modulated carrier current is then amplified many times and is finally led to the transmitting antenna, from which the wave leaps off into space.

Exactly what occurs between the time the wave leaves the antenna at the transmitter and the time it energizes the antenna at the receiving end is too technical to go into in this article (and, confidentially, not too well understood, even by experts). Let it suffice to say that series of electromagnetic waves are set up in the ether and these act on the receiving antenna system; so that electrical currents are set flowing in the radio-frequency amplifier of the listener's set, are detected and then amplified further at audio frequencies. These audio currents are finally turned into sound energy by the loud speaker.

### PERMANENT INSTALLATIONS

Around New York City, in some instances, there have been permanent installations

# Chemistry paves the road to Success!

Some people measure success in terms of money and others in degree of knowledge and culture. Chemistry is the one uncrowded profession today that offers both. America, always a land of amazing opportunities, is especially so now in the field of applied Chemistry. Industries have developed within eight years more rapidly than the output of trained men to conduct them. Every big industry needs chemists and there is a real demand for them immediately.

## Earn a Bigger Salary from now on

### Good Chemists Command High Salaries

Not only are there boundless opportunities for amassing wealth in Chemistry, but the profession affords congenial employment at good salaries to hundreds of thousands who merely follow out its present applications. These applications are innumerable, touching intimately every business and every product in the world. The work of the chemist can hardly be called work at all. It is the keenest and most enjoyable kind of pleasure. The days in a chemical laboratory are filled with thrilling and delightful experimentation, with the alluring prospect of a discovery that may spell Fortune always at hand to spur your enthusiasm.

### You can make yourself independent for life by unearthing one of Chemistry's undiscovered Secrets

Do you remember how the tales of pirate gold used to fire your imagination and make you want to sail the uncharted seas in search of treasure and adventure? And then you would regret that such things were no longer done. But that is a mistake. They *are* done—today and every day—not on desert islands, but in the chemical laboratories throughout your own country. Quietly, systematically, the chemist works. His work is difficult, but more adventurous than the blood-curdling deeds of the Spanish Main. Instead of meeting an early and violent death on some forgotten shore, he gathers wealth and honor through his valuable contributions to humanity. Alfred Nobel, the Swedish chemist who invented dynamite, made so many millions that the income alone from his bequests provides five \$40,000 prizes every year for the advancement of science and peace. Herman Frasch, who showed how to extract sulphur, built up a huge fortune. C. M. Hall, the chemist who discovered how to manufacture aluminum, made millions through this discovery. F. G. Cottrell, who devised a valuable process for recovering the waste from fue gases, James Gayley, who showed how to save enormous losses in steel manufacture, L. H. Baekeland, who invented Bakelite—these are only a few of the men to whom fortunes have come through their chemical achievements.

#### YOU CAN LEARN AT HOME

To qualify for this remarkable calling requires specialized training. Formerly it was necessary to attend a university for several years to acquire that training, but thanks to our highly perfected and thorough system of instruction, you can now stay at home, keep your position, and let us educate you in Chemistry during your spare time. Even with only common schooling you can take our course and equip yourself for immediate practical work in a chemical laboratory.

#### EASY MONTHLY PAYMENTS

You don't have to have even the small price of the course to start. You can pay for it in small monthly amounts—so small that you won't feel them. The cost of the course is very low, and includes everything, even the chemistry outfit—there are no extras to buy with our course. Our plan of monthly payments places a chemical education within the reach of everyone.

#### MAIL THE COUPON FOR FREE BOOK

Your name and address on the coupon will bring you by return mail our interesting free book, "OPPORTUNITIES FOR CHEMISTS," and full particulars about the course and what it will do for you. You owe it to yourself to get this book. Send the coupon right now while it is fresh in your mind. Or just write your name and address on a postal and mail to us. But whatever you do, act today.

SEIZE THIS OPPORTUNITY—MAIL COUPON NOW!

## Chemical Institute of New York, Inc.

Home Extension Division 5

16-18-R-East 30th Street

New York, N. Y.



#### Just a Few Letters From Students Who Have Taken This Course

You will probably be pleased to learn one of the lessons gave me an idea to turn my chemical knowledge to profitable account. I am now making a varnish and paint which undersells the other type products by \$2.60 a gallon, in some cases more. Have been receiving gallon orders from painters during past week which has netted me a profit of \$12.50 for my "spare-time chemical industry." Many thanks for your training thus far.

J. J. KELLY

I am but half-way through your course and am certain that I have saved my Company many times the cost of the course and raised myself in the shareholders' estimation. The knowledge obtained has its immediate practical application and I do not hesitate in saying your course and the personal attention you give is invaluable to the practical man in any business where chemistry plays a part. You may use this letter and my name and address to the furtherance of your good work.

JOHN WALTER.

I have not written since I received the big set. I can still say that it far exceeded my anticipations. Since I have been studying with your school I have been appointed chemist for the Scranton Coal Co., testing all the coal and ash by proximate analysis. The lessons are helping me wonderfully, and the interesting way in which they are written makes me wait patiently for each lesson.

MORLAIS COUZENS.

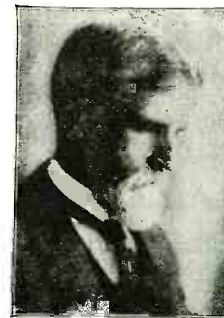

T. O'CONOR SLOANE, A.B., A.M., LL.D., Ph.D.

Noted Instructor, Lecturer and Author. Formerly Treasurer American Chemical Society and a practical chemist with many well-known achievements to his credit. Not only has Dr. Sloane taught chemistry for years but he was for many years engaged in commercial chemistry work.

#### EXPERIMENTAL EQUIPMENT FURNISHED TO EVERY STUDENT

We give to every student, without additional charge, his chemical equipment, including fifty-two pieces of laboratory apparatus and supplies, and fifty-two different chemicals and reagents. These comprise the apparatus and chemicals used for the experimental work of the course. The fitted heavy wooden box serves not only as a case for the outfit, but also as a useful laboratory accessory for performing countless experiments.

#### CHEMICAL INSTITUTE OF NEW YORK, INC.

Home Extension Division 5  
16-18-R-East 30th Street, New York, N. Y.

Please send me at once, without any obligation on my part, your free book, "Opportunities for Chemists," and full particulars about the Experimental Equipment given to every student. Also please tell me about your plan of payment.

NAME.....

ADDRESS.....

CITY..... STATE.....

R-N-5-28

## “DOUBLE-R” METERS WITH HIGH RESISTANCE

to Measure Voltages of B Eliminators, Bias Resistors, Batteries, Power Packs

0-500 volts, handsome full nickel finish, convenient portable type meter, accurate to within 2½% plus or minus, with a resistance per volt high enough to measure all “B” supplies or power packs. Fully guaranteed. To manufacture this meter requires 35 different dies. No voltmeter but a high resistance one will enable you to tell the voltages of B eliminators and across C biasing resistors. This meter is excellent for general D.C. use. It is furnished with long connecting cords. Catalogue No. 347. **\$5.50**

- No. 346, Same as above, only 0-300 volts. . . . . \$4.50
- PANEL AC VOLTMETERS**
- No. 351 For reading 0-15 volts AC. . . . . \$2.25
- No. 352 For reading 0-10 volts AC. . . . . 2.25
- No. 353 For reading 0-6 volts AC. . . . . 2.25
- PANEL MILLIAMMETERS**
- No. 350 For reading 0-50 milliamperes DC. . . . . 1.65
- No. 390 For reading 0-100 milliamperes DC. . . . . 1.65
- POCKET AMMETER**
- No. 1 For testing dry cells, 0-40 ampere DC scale pocket meter. . . . . \$1.50
- POCKET AND PORTABLE VOLTMETERS**
- No. 8 For testing A batteries, dry or storage, 0-8 volts DC scale. . . . . \$1.65
- No. 10 For testing A batteries, dry or storage, 0-10 volts DC scale. . . . . 1.65
- No. 13 For testing A batteries, dry or storage, 0-16 volts DC scale. . . . . 1.65
- No. 50 For testing B batteries, dry or storage, but not for B eliminators, 0-50 volts DC scale. . . . . 1.65
- HBH AIRPLANE CLOTH SPEAKER**
- Complete kit, including unit, 18x24-inch frame, cloth, stiffening fluid, instruction sheet. No. 999HBH. . . . . \$10.00

**GUARANTY RADIO GOODS CO.**  
141 West 45th Street, New York City

Please send me at once your new products, catalogue numbers:

for which I will pay the postman the price as advertised in *Radio News*, plus a few cents extra for postage.

Name.....

Address.....

City..... State.....

**ALL GOODS SOLD ON FIVE-DAY MONEY-BACK GUARANTY**  
R.N.-28

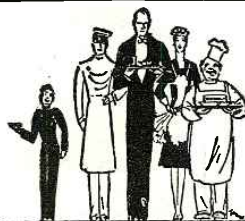

**AT YOUR SERVICE**  
**THE WHITEHALL HOTEL**  
**100<sup>TH</sup> ST. AND BROADWAY**  
**NEW YORK**

*The ideal hotel selection when you visit New York. All rooms have both bath and shower and at rates of \$5 per day for two! A perfect hotel. Ample parking space and near numerous garages.*

*Exceptional Restaurant*  
**J. J. McAULIFFE—Res. Manager**

**HOO-K-UP BOOK FREE**

Improve your reception with **CARBORUNDUM Stabilizing Detector Units, Grid Leaks and Resistors**

THE CARBORUNDUM COMPANY  
DEPT. D-1, NIAGARA FALLS, N. Y.

**EVERYTHING IN RADIO**  
AT ATTRACTIVE PRICES. SETS OR PARTS.  
Orders shipped exactly as ordered. Prompt Service.  
Write for Prices. Mail Order Only. Send Your Address.  
**ALL RADIO COMPANY, 417 North Clark St., Chicago**

made at pick-up points, such as Roxy's Theatre, The Capitol, etc., from which programs are regularly broadcast. For example, in the former theatre, as many as twelve microphones, scattered about the stage, footlights and in the orchestra pit, are sometimes used. These microphones are connected to a microphone mixing panel, where the output of each pick-up can be regulated. This is necessary for several reasons. In the first place, let us suppose that the full orchestra is accompanying a singer, and that it is desired to broadcast the combination. In the majority of cases the musical accompaniment almost drowns out the singer's voice; but when this is broadcast the output of the microphones in the orchestra pit is toned down so that the accompanying music takes its rightful place, in the background of the singer's voice. Thus, we actually hear better results over the radio than if we were sitting in the theatre.

This theatre has also a studio from which

various programs are broadcast, and it is a simple matter to switch on the microphone in the studio instead of those on and about the stage. Instruments similar to those previously described for picking up a program from some remote point are permanently installed. They are the same, with the exception of the microphone mixing panel, which is more complicated, as there are more microphones to adjust.

When a program is put on the air from one of the station's studios in the central building, the steps taken are almost identical, the only exception being that one less amplifier and operator are required. The operator controlling the volume output from the studio is situated in a room adjoining the studio, and he can observe everything that occurs therein. The output from this amplifier goes to the switchboard room where it is routed to the transmitter at Bellmore, L. I., and any other stations that are putting on the same program.

## Coming—A Program Pool?

(Continued from page 1203)

### CAN THEY GET TOGETHER?

Ignoring its commercial implications, and taking into account only the fact that the Radio Corporation is the chief owner of the National Broadcasting Co., this arrangement can be properly, if narrowly, viewed as a substantial step toward the ultimate creation of a plan under which all manufacturers would contribute to a common pool for the financing of broadcasting; and hence of one by means of which the listener would pay for programs indirectly through the purchase of receiving equipment.

As to the practical factors involved in putting such a scheme into operation, the first necessity is, obviously, that it include all those interests which profit directly from broadcasting; not only the manufacturers of receivers and such accessories as tubes, loud speakers, parts, power devices, batteries and cabinets, but also the electrical utilities (since it is well known that they enjoy augmented revenues from the growing use of power-operated receivers) together with the telephone interests, whose lines are employed in chain hookups. At first glance this would seem to present insurmountable obstacles, but closer inspection reveals that such should not be the case.

There are already national trade associations representing most of the groups affected. The Radio Manufacturers Association, the radio division of The National Electrical Manufacturers Association, and The National Electric Light Association, to mention only a few. Representing the stations, there is also the National Association of Broadcasters. So the setting up of suitable machinery, which would serve as a common medium for all, would seem to depend only on the desire of these various groups to cooperate, one which has already been demonstrated in convincing fashion. (Once the plan were well launched, too, practical pressure would virtually force in any "slackers.")

The matter of payment offers somewhat more involved difficulties. In the case of manufacturers, this could, of course, be prorated on the basis of sales; while for such

interests as the utilities it might better be estimated. Allowance, too, should be granted those radio interests which maintain stations. But the spirit of cooperation again could well be relied on to iron out the details.

### OPERATING METHODS

As to operation, whether the pool should take over stations or merely supply the bulk of programs, after the manner of the chains, presents a nice question for discussion. It would seem desirable that stations, particularly of the better sort, should be permitted some latitude for individual efforts; also that the pool's facilities be made available to non-radio organizations for programs whose quantity and character are compatible with the best interests of broadcasting. There are, too, a number of broadcasters who would, no doubt, prefer to operate independently of the pool. Once more, however, these details offer no difficulties which could not be solved.

Now as to what such a pool offers:

First: it would cause the listener to pay for programs; the very obviousness of that should not obscure its desirability. There is no doubt that leaders of the industry and fair-minded fans have agreed from the beginning that this is precisely as it should be.

Our European cousins have taken the straight line toward payment by the listener, through the licensing system previously referred to, but such an arrangement can never be put into successful operation in the United States, because of the traditional resentment at anything suggesting direct taxation. Accordingly, the fact that a pool would permit the listener to pay, and *indirectly*, should constitute the most telling argument in its favor.

### WHO IS SHIRKING?

Second: the proportional cost would probably be no greater than, if as large as that of the present system. For example, on the basis of \$500,000,000 gross sales (the volume approximated by the industry during



1927) an amount as small as 2% would yield \$10,000,000, which should go far toward paying for national broadcasting of a high order. As compared with this, it is known that some commercial broadcasters spend as much as 4% for their programs, and in addition—a third point—many of those who benefit directly from broadcasting now pay nothing toward its cost.

A moment's survey of the present situation within the industry will disclose that some of the largest, and a multitude of the smaller manufacturers, supply no broadcasting, yet reap nearly as much benefit from that furnished by others as do those paying the bills. This is obviously unfair, but, as things stand, cannot be corrected. With a comprehensive program pool in operation, however, (and, as suggested, practical pressure should make it comprehensive), each manufacturer would pay toward the total cost in proportion to the benefit derived.

Fourth: a pool of the type outlined would have the highly-desirable effect of placing broadcasting under the practical control of radio interests. Not the least grotesque phase of the present situation is the fact that a large majority of the stations are owned by non-radio interests. It is true that many of these are among the best stations on the air. But it is also true that those which are generally conceded to be contributing least, if anything, to broadcasting are, with few exceptions, owned by non-radio interests. And, as pointed out previously, broadcasting is at best of only incidental value to non-radio interests; while to the radio industry it is the thing which makes existence itself possible.

Accordingly, it is most advantageous—if not imperative—that the radio industry have as nearly complete control as possible over broadcasting; and, with a pool acting as a medium for the provision and supervision of programs, this end could be attained in a practical way, even without disturbing the ownership of stations.

Fifth: a pool would permit broadcasting to be carried on in the interests of the entire industry, and with a national perspective.

LACK OF SYSTEM

Laudable and noteworthy as have been the contributions of many manufacturers in the way of broadcast programs, it is nevertheless clear that their efforts have been inspired more by self-interest than by desire to advance the interests of the industry as a whole. This is a state of mind human enough, but one which has not made

**Station**  
**WRNY**  
**NEW YORK**  
326 METERS — 920 KILOCYCLES  
and 2XAL, 30.91 METERS

*is owned and operated by the  
publishers of this magazine  
Our Editors will talk to you  
several times every week—  
See your Newspaper  
for details*

**TUNE IN ON  
WRNY**

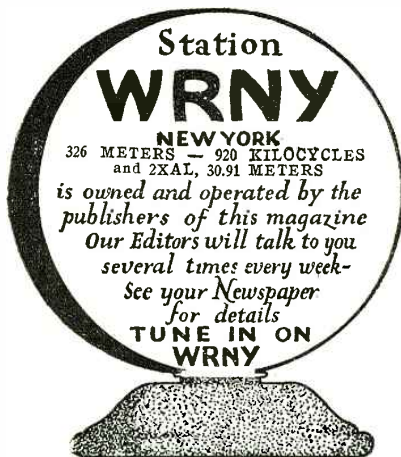

**THE AMRAD MERSHON CONDENSER**

Send for  
**YOUR FREE COPY**  
*of our new book*  
*on the*  
**MERSHON CONDENSER**

One of the most sensational devices in the history of radio engineering — the Mershon Condenser has revolutionized the building of electrical sets, B Eliminators, Power Packs, and has a score of other important uses in radio. Unaffected by moisture; tremendous capacity in small space—and lower priced than paper condensers.



*Self-Healing  
in case of  
Puncture*



We have issued a new book describing the Mershon Condenser, showing hook-ups and diagrams, and giving information about its many uses in the radio field. We will be glad to send you a copy if you will address Department 18, or use the coupon below for quick action.

The—  
**AMRAD CORPORATION**  
Medford Hillside, Mass.

J. E. HAHN *President*

POWEL CROSLY, JR., *Chairman of the Board*

**THE AMRAD CORPORATION**  
Medford Hillside, Mass.

Gentlemen:  
Please send me a copy of your new booklet describing the Mershon Condenser.

Name .....

Address .....

City.....State.....



Complete instruction course in three volumes. Every point of aviation efficiently and thoroughly treated. Subjects covered in these volumes—

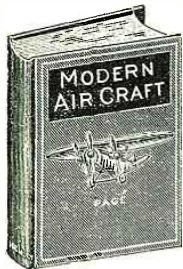

### MODERN AIR CRAFT

700 Pages  
500 Illustrations

Contents of each chapter—  
I. Aircraft Types. II. Lighter-than-Air Craft. III. Early Airplane Designs. General Design Considerations. IV. Design and Construction of Aerofoils. V. Arrangement, Fabrication and Bracing of Airplane Wings. VI. Airplane Fuselage and Landing Gear Construction. VII. Airplane Power Plant Types and Installation. VIII. Aviation Engine Design and Construction. Air-Cooled Engines. IX. Aviation Engine Design and Construction. Water-Cooled Engines. X. Aviation Engine Auxiliaries. XI. Aircraft Propeller Construction and Action. XII. Airplane Equilibrium and Control Principles. XIII. Landing, Setting Up and Aligning Airplane. XIV. Inspection and Maintenance of Airplanes and Engines. XV. Details of Modern Airships and Airplanes. XVI. Seaplanes, Flying Boats, Amphibians and Other Aircraft. XVII. Some Aspects of Commercial Aviation. XVIII. Aircraft Instruments and Aerial Navigation. XIX. Standard Nomenclature for Aeronautics Report No. 240, Part I.

This book is written in simple, understandable language.

PRICE \$5.00

### AVIATION ENGINES

This treatise, written by a recognized authority of all of the practical aspects of internal combustion engine construction, maintenance, and repair, fills the need as no other book does. The matter is logically arranged; all descriptive matter is simply expressed and copiously illustrated, so that anyone can understand airplane engine operation and repair even if without previous mechanical training. This work is invaluable for anyone desiring to become an aviator or aviator mechanic.

274 PAGES

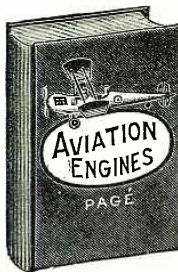

PRICE \$1.25

### A. B. C. OF AVIATION

This book describes the basic principles of aviation, tells how a balloon, or dirigible is made, and why it floats in the air. Describes how an airplane flies. It shows in detail the different parts of an airplane, what they are, and what they do. Describes all types of airplanes and how they differ in construction, as well as detailing the advantages and disadvantages of different types of aircraft. It includes a complete dictionary of aviation terms and clear drawings of leading airplanes.

PRICE \$1.25

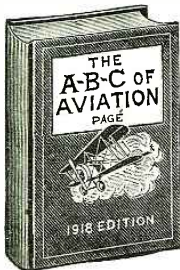

Remit by cash, stamps, check, or money order  
No C.O.D.'s

We Pay Postage On All Books

CONSRAD COMPANY, Inc.  
230 FIFTH AVENUE NEW YORK

for maximum progress, because of the obvious losses introduced by competition and duplication of effort.

Similarly, the industry has suffered on account of the lack of not only a definite national broadcasting policy, but a single agency charged with the responsibility of providing broadcasting on a national scale. One result of this has been the existence of more than twice the number of stations compatible with efficient service; another, the surfeit of broadcasting in some sections and its woeful dearth in others; a third, the general unevenness of program quality and quantity the country over.

Conceivably, the Federal Radio Commission may remedy some of these serious shortcomings, but by no means all. Had a properly-organized pool been created in 1924 or '25, there would have been no need

for such a governmental agency, no such formidable situation as now confronts broadcasting; and were a pool formed even today, there is ample reason to believe that it could do more to solve the existing tangle than any official body, since the problem is essentially one for broadcasting itself to work out.

This then is, in brief, the case for a program pool. The case against it is, as has been suggested, essentially the desire for individual rather than group action. How long this will continue strong enough to maintain the present illogical and confused conditions, remains to be seen. But certainly there is sufficient justification for anticipating that too long a time may not elapse before broadcasting will adopt some such comprehensive and logical plan for financing and directing itself. Portentous signs are already in the radio sky.

## Radio Polices A Western City

(Continued from page 1223)

atically. Similarly, the operator may turn to the Morse key, which is also on his desk, and flash the lamp signal; though this flashes all red lamps on all cars. By the selective method, with the button keyboard, however, he may attract the attention of any one or a number of patrolmen.

Having flashed this call signal, the operator may instruct the patrolman by other flashes on the red lamps, or he may wait one-half minute for adjustment of phones, and then begin speaking through one or the other of the microphones at headquarters. He thus will reach all the patrolmen through the loud speaker and the one for whom the "silent message" is intended, through his phones.

The giving of directions and orders is thus made virtually instantaneous. In case of a robbery or other crime, in an outlying part of the city, the patrolman on that beat, and others on immediately-adjacent beats, can be sent to the scene of the crime; while other patrolmen are shifted to cover the beats vacated by the men concentrated at one point. When a crime is committed in the business or industrial district, all the patrolmen can be called in if necessary, or the crime squad can be shifted from its patrol to the scene of the crime.

On at least two occasions, this radio system has been used successfully in apprehending criminals by sending one squad of officers to the scene, and throwing a second squad in behind them to close all possible avenues of escape. Fires, either in the residential district or in the center of Berkeley, have been policed in considerably less than one-quarter of the time formerly required to throw a cordon of patrolmen around the blazing structure. Patrolmen have arrived at scenes of robberies while the earth was still settling into the footprints left by the robbers—an efficiency impossible of attainment prior to the establishment of the radio system of communication with officers on patrol.

Before this time, Berkeley has had a system of controlling patrolmen by means of flashing red lamps, hung at street intersections at the center of each beat. These were connected by wire with the

central stations, and signals would be flashed over them with great rapidity; but still considerable delay was experienced, because of their ineffectiveness at times when patrolmen were driving away from the light, when they were watching houses or persons out of sight of the light, and in similar exigencies. Much time was wasted while the patrolman was driving to the nearest telephone box, even if he saw the light promptly; and during getting into and out of the car, and so on. Now the officer in charge can communicate instantly with the patrolman, start him on his way, and continue to give him instructions while he is speeding to the point at which his services are required.

So efficient has this radio control proved that Chief Vollmer has ordered a large high-speed car, capable of carrying five men, rifles and a machine gun, and equipped with both receiving and sending sets. This car will be on constant patrol, especially at night, and will be at all times in immediate and continued communication with police headquarters. It will be able to report back to the central station from scenes of crime, and thus quickly give details of the escape of criminals and the direction of their flight, their descriptions, and similar necessary information. It will be delivered sometime in 1928, and will have power enough to maintain a speed of 75 miles an hour.

### ALSO A STATIC ELIMINATOR

Recently an ad appeared in the local paper as follows: "Send us one dollar and we will tell you how to reduce your radio upkeep 100%."

Having dutifully forwarded our dollar, we received the following: "Don't use your set."—H. N. Webster.

### A TELEVISUAL TRAGEDY

A listener living at \*Belvoir  
For an artiste caught love-smitten felvoir;  
But her image he spied,  
Seized a hammer and cried  
"Base vocal decelvoir!" and smashed his  
reelvoir!

—Arthur Wolfendale (England)

\*Pronounced Beaver.

## Listener Psychology and Radio Reception

(Continued from page 1217)

which is actually quite normal will appear deficient.

This is particularly true, of course, in the case of "DX" (great distance). Here, because the signals are faint at best, acuteness of hearing is as important as the performance of the receiver itself. In fact, one individual may get good DX from a receiver while another does not, merely because the former's hearing is keener or, in psychological terms, his "attention factor" is higher. So, if your set seems below par, be sure you are at par yourself before starting to look for trouble or condemning the receiver. Often you will be surprised to find the shortcomings in your mental state.

Conversely too, volume which normally seems pleasant will often appear excessive, because you happen to be nervous or mentally irritated.

### "BUTTER FINGERS"

The mental factor also has much to do with sharpness of tuning. As suggested before, any tension or other disturbing state of mind which tends to diminish the necessary delicacy of touch may easily make it impossible for you to separate stations which lie close together on the dials. This is particularly true in the case of transmitters whose signals overlap, as many do in congested broadcasting centers. Here, if you are alert, you will be able to tune out the undesired background station merely by a mental effort. But if your reactions are sluggish, you will probably find it impossible to do so and bring in the station you want.

However, it is in the much-discussed matter of tone quality that psychology really takes the center of the stage in radio.

It is true, of course, that there is a wide difference among various receivers as regards fidelity of reproduction. It is true, too, that the excellence or deficiencies of tone quality can now be measured by scientific instruments to an astonishingly accurate degree. But in the last analysis, for all practical purposes, it is the reaction of the listener which determines whether tone quality is good or bad.

If he has been accustomed to rasping and blare, rasping and blare will seem quite normal and acceptable; and, even though he is accustomed to the finest and most faithful reproduction, there will be times when his mood makes this gratingly unpleasant. It is the same with painting and literature. To the untrained, Sargent and Conrad may appear boring, and even to the highly-trained there are times when these masters are distasteful. It is essentially a matter of emotional state.

### ARE YOU IN TUNE?

Accordingly, with all due respect to the fine work which has been done toward improving tone quality, don't forget to check your emotional condition against any impression you have of a given receiver's performance. If you are pleased, it may be that you are in such a contented frame of

# Carefree Reception

A.C.-D.C. Any Cycle

Delivers up to 100 volts on any set. Full tone, Clarity, Volume, Distance.

## Performance That Amazes At This Startling Low Price

Why put up with muffled, uneven, interrupted battery reception another day when you can equal the best tone, clarity, and volume also get the added thrill of good long-distance reception for only \$6.85? Frank H. Webster, of Cazenovia, N. Y., writes: "I have tried several high-priced eliminators and they do not equal the TOWNSEND. It is better than you claim, and I have no trouble in getting the Pacific coast on my five-tube Neurodyne. D. J. Mills, of Gonzales, Cal., writes: "I have received Japan and Australia, using your Eliminator." Convenient, dependable as your electric light. Just plug into light socket and forget it.

## SEND ONLY \$1.00

Simply fill out coupon and slip it into an envelope with only \$1.00 and mail at once. Your Townsend "B" Socket Power Unit will be sent promptly. Deposit only \$5.85 plus postage with the postman. Try out 10 days—then if not more than pleased return it, and purchase price will be refunded.

### TOWNSEND LABORATORIES

713 TOWNSEND ST. DEPT. 25

CHICAGO, ILL.

MONEY-BACK GUARANTEE

Approved and passed by the rigid laboratory tests of Popular Radio and Radio News

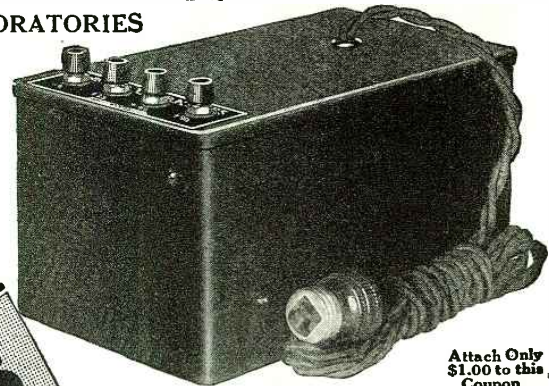

Attach Only \$1.00 to this Coupon

Complete \$6.85 \$1.00 Down Balance C.O.D.

10 Days' FREE TRIAL

Send for Literature

TOWNSEND LABORATORIES  
713 Townsend St., Dept. 25 Chicago, Ill.  
Gentlemen: Attached find \$1.00. Kindly send at once Townsend "B" Socket Power Unit, C.O.D. for \$5.85, plus postage, on guaranteed 10-day free trial.

Name \_\_\_\_\_  
Address \_\_\_\_\_  
City \_\_\_\_\_ State \_\_\_\_\_

\$75 to \$125 Weekly

Charging Batteries Starts You

Let me show you how to make big money right from the start. I've prepared a FREE book explaining all details. First week's profit pays for all equipment. You can get all the battery charging business in your community with my Service Station Charger—it's years ahead of ordinary chargers—handles 50% to 70% more batteries. I explain everything—start you in a business of your own and put you on the way to big money. Write for FREE BOOK.

C. F. HOLMES, Chief Engineer, Dept. R.N.  
Independent Electric Works  
5116 Ravenswood Ave. Chicago, Ill.

Big Profits

FREE BOOK—Just Out

"CHI-RAD"

Recommends—

Madison-Moore Super—  
Nine-in-Line Super  
Remler 115 KC Super  
and the Tyrman 70

Complete parts in stock. Dealers and set builders write for discounts.

NEW SHORT-WAVE COILS

Specially built by "Chi-Rad." Write for descriptive bulletin and catalog. Dealers and set builders please use business letterhead when writing for discounts.

Chicago Radio Apparatus Co.  
415 S. Dearborn St., Dept. RN, Chicago

## Centralab Radio Control Box Protects "AC" Tubes from High Line Voltages

ELECTRIC Radio Sets using "AC" tubes are designed to operate on a line pressure of 100 volts. Any high voltage overloads the tubes and greatly shortens their life.

In many cities the normal line pressure runs from 120 to 135 volts. In nearly all cities the voltage fluctuates with the lighting load, and at some period during the day is high enough to damage the delicate tube filaments. That is why tubes lose their pep after short service and why the new Centralab Radio Control Box is an essential and economical accessory for most "AC" set owners.

The Centralab Control Box is a manual line voltage control for "AC" sets. It can be adjusted for any set and for any local condition. It will protect radio tubes from high line voltage that would otherwise soon paralyze or burn them out. It insures longer tube life and better radio reception.

The Centralab Control Box is easily mounted within the cabinet. Adjustment is made by means of a knob, and when once set to obtain the average workable voltage need not be adjusted again. Connected as easily as plugging a lamp into a wall socket. Furnished complete with receptacle and cord. No other wiring necessary.

Price \$3.00

At your dealer's, or write us.

CENTRAL RADIO LABORATORIES  
19 Keefe Avenue Milwaukee, Wisconsin



## 90 Volt Power Unit :: \$12.75

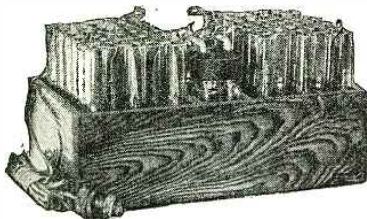

Hums, line noises, etc., positively impossible with this new advanced unit. Plug in and forget. Non-acid and noiseless. All detector and intermediate voltages plainly marked. Simpler to hook up than dry cells. Operates any type set 1 to 12 tubes. Greater volume and clearness guaranteed. If not thoroughly satisfied return after using 30 days for complete refund. Guaranteed further 2 years. For 110-120 volts A.C. 25 to 60 cycle current. 90 volts, \$12.75; 112½, \$15.25; 135, \$17.50; 157½, \$19.50; 180, \$24.00; 202½, \$26.00. Also built for D.C. current 110 and 32 volts at only \$3.00 additional, any size above. Ample stocks—same day shipments. Simply say—ship C.O.D. or write for my interesting literature, testimonials, etc.

## B. HAWLEY SMITH

334 Washington Ave. Danbury, Conn., U. S. A.

### Master the Code

Wireless or Morse—at home with the TELEPLEX Automatic Code Instructor. No better method for self instruction exists. Outfit—Easy—Thorough. Endorsed by U.S. Navy. The only instrument that REPRODUCES actual sending—messages, radio-grams, etc. Any speed. Complete Course furnished. *Picture Times* as many words as any other instrument. Avail yourself of the TELEPLEX for a quick mastery of the code. Write for booklet MR—TELEPLEX CO., 76 Cortlandt St., New York, N. Y.

mind that you would be pleased by anything; and if you are irritated, it may also be that you are in a mood which would find maddening the best symphony orchestra, heard in person. Our emotions exercise over our reactions an influence more powerful than any of us realize.

In fact, you will find it a considerable advantage to keep this whole matter of psychology in mind when you are confronted by some baffling quirk of reception. It will

not explain such things as burnt-out tubes or blown-down aerials (unless you thoughtlessly let 135 volts of "B" battery get across the filaments, or neglect to anchor your insulators properly). But, since we are all human and the human factor is always so important, it will be found to explain surprisingly many of the shortcomings you have been laying at the door of your innocent receiver or the equally innocent weather man.

## A Britisher Chats on Radio

(Continued from page 1221)

nese Empire and/or Republic and/or Commune; and that television does not come into general use and act as an arresting agency, *contra* the development of our ears.

### A NATIONAL MONUMENT

Broadcasting in this kingdom is solely in the hands of the British Broadcasting Corporation, a very British institution indeed, as I shall show later. It is as watertight as a flatiron in the Mohave Desert; as solemn as the face of a man who has burnt out all his tubes at 1:00 a. m. Sunday morning and has no spares; as correct and incorrigible as a nun; and as unalterable as the specific gravity of H<sub>2</sub>O at 60° Centigrade. Perhaps!

This B.B.C. now operates under a Royal Charter which renders it as inviolable as the grass-plots surrounding Westminster Abbey. Almost sacred! Certainly not to be trodden upon with impunity. Let not the nimble American mind cherish the notion that I write sarcastically of this institution. We believe in peace, except when we make war; and in stability and no fancy gun-work. We believe in the British policeman; if our hope in him is dashed we are a lost empire. We believe in being governed, so long as we believe our governors have got hold of the handle of the stick and know the rules of the games. So, when we let the government give the B.B.C. a Royal Charter, we mean that we want the broadcasting business to be conducted soberly, legally, decently, solemnly, slowly and surely. And, by the Lord Harry! it is so done—and right well do we know it.

More dates; The governors of the B.B.C. are as follow:

The Earl of Clarendon. (An Earl! I should smile!);

Lord Gainford, postmaster-general in 1916;

Sir J. G. Nairne, comptroller of the Bank of England;

Dr. M. J. Rendall, headmaster of Winchester College;

And Mrs. Ethel Snowden. Boys, this lady is the wife of Mr. Philip Snowden, who was chief of the Treasury during the first Labor administration of this country.

So you see clearly that this galaxy of talent is bound to give England—and those Scots, Welshmen and Northern Irishmen—just all the broadcast joy they want. They are a body well calculated to gauge the public taste in music and other forms of audio-entertainment. Well, we try to keep ourselves jolly in spite of 'em.

### THE COST OF BROADCASTS

The cost of a license for a radio receiver

in this country is about two dollars and a half per annum. Hence the revenue from radio licenses is now about \$5,889,000. The license fees are collected by our noble post office, which seizes for the cost of collection 12½%, or about \$736,125. Of the remainder, some \$5,152,875, the B.B.C. is allowed to retain 90% of the first five million dollars, and 80% of the second five million dollars, that is, about \$4,623,300; which is quite a healthy sum, either in dollars or in pounds sterling (£924,460.)

It is not known to the public just what our B.B.C. does with over four and a half million dollars per annum; though the majority of critics agree that four millions are spent on salaries, Harry Lauder, earls, and postage stamps, and the remainder on providing programmes and radio-sleuth vans for detecting—er—is "bloopers" the word, Mr. Editor? Really! a heart-rending word. Why not call them "Yoickers"? (From "Yoicks! Tally Ho!" a fox-hunting war-cry.) This slang-swapping reminds me of the newly-genteel-rich but unrefined lady who visited an Art Gallery with her daughter, aged fourteen. Said the girl (pointing to a picture), "Lumme! I don't think much of that d— thing." Said her ma: "Treen, how often have I told you it's rude to point?"

### WHAT SAID CHESTERFIELD?

The funniest joke the B.B.C. ever put over is its coat of arms. You would not expect a broadcasting enterprise to struggle along without a coat of arms, surely! What? Get the hook-ups, the ads., and the artists, and let fly? No, my restless, nervous, go-getter, you cannot hustle a British corporation like that. First the board of governors passed a resolution to set up a coat of arms; referred back by board of consultants on some point of heraldry. Confirmed by earl, lady and t'others. Committee then set up to consider design. Einstein, Epstein, and the art editor of *Punch* are called in as advisers. The dollars are flying, but no matter; the question of a C. of A. is vital. Experts evolve one design looking like a roulette board, and another so zoological that we are reminded of what we see on lifting up a big stone in the damp part of a garden. Then the whole thing is handed over to a public competition. Selection made; executed in gold, azure and crimson, on ivory; reproduced in the papers. The B.B.C. now has a coat of arms. The liberties of British listeners are secured and we can sleep at peace in our head-phones.

I am afraid that our B.B.C. is a conservative body, although its chief engineer

went to the Washington Radio Chautauqua. Somebody there must have stepped on his gas; because he came back so brisk-moving that they now have to work him on a dash-pot. I do not know the American for "dash-pot," so it's a case for an editorial footnote. (*The engineering term is the same over here, we believe—Error.*) Shall I say instead, that they have to give his grid a heavy biasing voltage and fill his pockets with leaden shot.

Conservative is too mild a term. I might with propriety say "retrogressive." For instance, the B.B.C. is singing an oratorio about what it calls its new "regional scheme" of stations. This precious scheme—it's a plot!—aims, in effect, at the encouragement of the use of the crystal detector. Fact! They say that, because the man who can afford only a crystal receiver has to pay as much for his license as the Croesus who uses 14 valves, he is entitled to the fullest benefits of the service. "Benefits" is good. However, the logic is unassailable—provided it be first postulated that users of crystal sets are not public menaces. Which is absurd!

Ah, but here I smell class warfare—a diversion unknown, of course, in your country, where even a common banker, as R. L. Stevenson called 'em, is as good as a plumber. I hope you know what I mean by "plumber." (See *plumbum*: lead; whence, "leaden-footed," especially during a severe frost.)

My point is that only our middle class and our aristocracy are poor enough to use crystal sets. When we hear a fellow (gink or guy) speak of his many tubes, we look to see the marks of labor on his hands, or ask him how the brick-laying profession is jogging along. (*Note. In America, I believe, to marry into a bricklayer's family is equivalent to finding an oil-gusher in the back yard. In England it is social suicide; unless the bricklayer be unemployed, when he is a pensioner of the State.*)

In England, the (so-called) middle class, is, as its name implies, that stratum of society which exists miserably between the upper and nether mill-stones; the "upper" being the tax-collector and the "nether," the cause of the tax-collector (i.e., the loafer.) The middle class is the milch-cow of society; too proud to apply for state relief; too respectable to beg; too stupid to steal; too idiotic to be shoved into an asylum for the insane; and too religious to wear a dirty collar. All it can do is use a crystal set, chop off kings' heads when necessary, pay national debts, and keep the country's honour clean.

In another article I hope to make you acquainted with the genuine British radio-fan, his exploits, his pretty lies, his weaknesses and his strong points. There we shall meet, I think, on common ground, and shake fins across an ocean of ignorance that has got to be mopped up. That is as fine a bit of mixed metaphor as was ever produced by a man of good will titillated by an emotion too human to heed the scruples of a grammarian.

Before I cut off the juice for this shift I will say this: When there's a millivolt lacking on the grid the whole world's akin; the wop condoes with the dago, and the squarehead (or Deutscher) with the *\*chee-chee*. Radio is the real League of Nations.

\* *Author's Note:* Chee-chee is the Anglo-Indian colloquialism for "half-caste."

# LEUTZ CUSTOM BUILT RADIO



Custom Built Universal Transoceanic "Silver Ghost" Broadcast Receiver Built for Robert B. Gable, President Wm. F. Gable Co., Altoona, Pa.

The LEUTZ organization is now entering its sixth successful year of supplying the Highest Class Radio Apparatus in the World. This year each set is being custom built to the particular requirements of each customer. We would be pleased to give you an estimate on the best radio for your requirements.

WRITE FOR NEW LITERATURE NOW

## C. R. LEUTZ, INC.

195 PARK PLACE - - ASTORIA - - NEW YORK  
Cables: "Experinfo," N. Y. - Phones: Ravenswood 4080-3670.

# LEARN THE CODE AT HOME WITH THE OMNIGRAPH

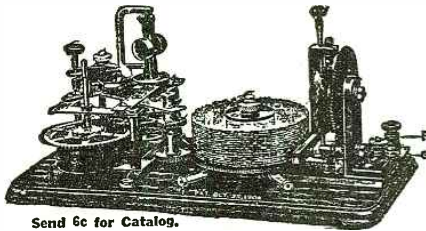

THE OMNIGRAPH Automatic Transmitter will teach you both the Wireless and Morse Codes—right in your own home—quickly, easily and inexpensively. Connected with Buzzer, Buzzer and Phone or to Sounder, it will send you unlimited messages at any speed, from 5 to 50 words a minute. THE OMNIGRAPH is not an experiment. For more than 15 years it has been sold all over the world with a money back guarantee. THE OMNIGRAPH is used by several departments of the U. S. Government—in fact, the Department of Commerce uses the OMNIGRAPH to test all applicants applying for a Radio license. THE OMNIGRAPH has been successfully adopted by the leading Universities, Colleges, and Radio Schools.

Send 6c for Catalog. THE OMNIGRAPH MFG. CO. 15 HUDSON STREET, NEW YORK CITY  
If you own a Radio Phone set and don't know the code—you are missing most of the fun

Insure your copy reaching you each month. Subscribe to Radio News—\$2.50 a year. Experimenter Publishing Co., 230 Fifth Avenue, N. Y. C.

## The Story of Chemistry

FLOYD L. DARROW

within  
your grasp!  
—interesting—

Chemistry—Floyd L. Darrow has presented this subject in a concise, simple manner.

Though a great deal of time was consumed in research work and study, the book is in such a readily grasped form, it will be nothing at all for you to obtain a good understanding of the subject.

530 PAGES—6" x 9"

The book is beautifully and sturdily bound, with a good supply of interesting illustrations.

The price is a low figure at which to gain such a complete education as it affords.

The Story of Chemistry  
**SPECIAL PRICE**  
**\$3.98**

USE COUPON BELOW

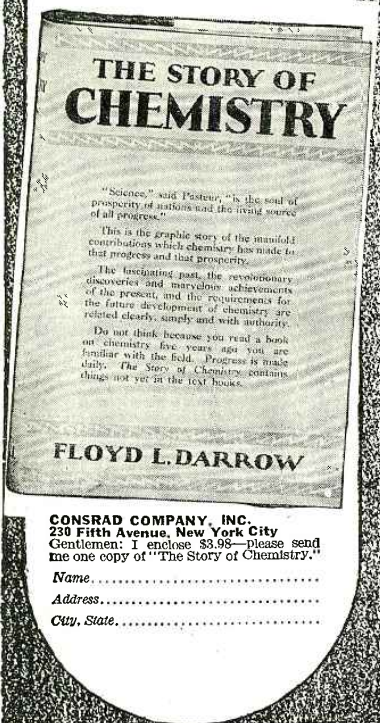

CONSRAD COMPANY, INC.  
230 Fifth Avenue, New York City  
Gentlemen: I enclose \$3.98—please send me one copy of "The Story of Chemistry."

Name.....  
Address.....  
City, State.....

## R. F. Booster Unit Improves DX

(Continued from page 1239)

### CONSTRUCTION OF THE UNIT

The wiring of the Booster Unit and the constructional details thereof are next in order. The pictorial diagram shows the wiring of the unit in detail. The circuit arrangement is not quite as simple as it first appears, for an audio choke (L2), and audio by-pass condenser (C3) confuse the issue somewhat; yet the entire arrangement is easily explained and more easily hooked up. It must be remembered that the radio-frequency component in the regular detector plate circuit of the receiver must be brought out and employed. This is done through the cabled wire leading directly from the plate terminal of the socket. This wire leads to the primary in the tuned-radio-frequency transformer (L1) in the Booster Unit. The other end of this primary must lead back to the "B" battery.

Now, the only possible manner in which to pick up "B" battery voltage by means of the plug-in unit is by means of a connection run to the plug's plate prong, which, in turn, connects to the high side of the primary of the first audio transformer. This explains the reason for the audio choke and condenser, as only the D.C. potential from this transformer is desired. The audio-frequency currents, flowing down through this winding from the plate of the new detector added in the Booster Unit, must not find their way back, nor become mixed with the audio currents set up in the plate circuit of the tube which previously acted as the detector in the radio receiver. The choke and the by-pass condenser accomplish this important task.

### COILS OF THE UNIT

The tuned-radio-frequency transformer (L1) in the Booster Unit is built in the conventional manner, with sufficient turns on the secondary to cover the broadcast range from 200 to 550 meters with the tuning condenser employed. The primary winding is wound in two sections—one, (P1) a stator winding and the other, (P2) a rotor winding. In the unit herewith presented, the transformer is 2½ inches in diameter. The secondary (S) is wound with fifty-three turns of No. 37 D.S.C. wire. The stator winding (P1) of the primary consists of nine turns of the same-sized wire, spaced ⅛-inch from the secondary. The rotor section (P2) of the primary has five turns of the same wire—two and a half turns on each side of the central axis.

For best results, the grid of the Booster's detector tube V should be connected to the end of the secondary farthest removed from the primary. The cable terminal marked "P" should be connected to the terminal of P1 which is nearest to the secondary winding. (The primary and secondary windings should be wound in the same direction.) The rotor P2 is then connected in series with the stator P1 in such a way as to oppose or stop oscillation at the short waves, with the tuning condenser C1 in its minimum position. These few rotor turns will then aid at the long wavelengths, with the condenser in its maximum position. Of course, a tuning condenser with an extended shaft will be necessary in order to connect together, mechanically, the rotor of the condenser and the rotor of the primary.

Of course, a grid leak R and a grid condenser C2 are employed in the Booster Unit, as this circuit becomes the new detector. The return from the tuning condenser should go to one side of the filament. The two filament wires coming from the set are then interchanged in the tip jacks, for best results. By reversing these two filament wires the right polarity is ascertained; so that the grid return of the new detector will be on the proper side of the filament. This polarity is not a matter of extreme importance when using the UX-200A detector; although such a tube will give best results when the grid return is connected to the negative side of the filament. If a hard (amplifying) tube is used in this detector stage, it is quite necessary that the filament wires be so connected that the grid return will be on the positive side of the filament. However, the UX-200A, or soft detector tube, is unconditionally recommended for this unit. The dial-illuminating light (DL) is merely connected across the filament posts of the tube socket in the unit.

### OPERATING THE UNIT

It is quite easy to recalibrate the tuning dial so that it will read in wavelengths, rather than in the arbitrary numbers usually found on tuning dials. This calibration will be entirely independent of that of any receiver on which the unit may be used; it depends solely upon the tuning condenser and the coil used in the unit. Thus this dial becomes a wavelength indicator and, though it is not at all critical in its tuning, gives a very good indication as to the wavelength of the station being received. In ordinary operating practice, the unit is first set at the wavelength desired, and the receiver is then tuned in the same manner previously employed. It will be found that the dials on the receiver have become considerably sharper, while the wavelength dial on the Booster Unit remains conveniently broad.

If it is desired to use the frequency-changing principle, the only change in design necessary is to remove a little more than half of the secondary turns in the Booster secondary; the number should be reduced from 53 to about 24. This unit will then tune only the second harmonic currents; which will give a 100% increase in selectivity, but reduce the distant pick-up somewhat. It is extremely easy to change your unit from one form to the other in order to determine just what is best for your particular location.

A complete list of the apparatus required for the construction of the R.F. Booster Unit follows:

- One aluminum stage shield, 5 x 6 x 9 inches;
- One wooden baseboard, 4½ x 8½ x ¾-inch;
- One variable condenser, .0003-mf., C1; extension-shaft type for tickler mounting, with ¼-inch coupling;
- One variocoupler (home-made—see text), L1;
- One audio choke coil, 30-henry, L2;
- One by-pass condenser, ¼-mf., C3;
- One mica grid condenser, .00025-mf., C2;
- One grid leak, 3-megohm, R;
- One vacuum-tube socket, V;
- Four tip jacks;
- One binding-post strip, 4 x ¾ x 3/16-inch;
- One illuminated dial;
- One 200A-type vacuum tube;
- One tube base and socket for plug, A and B.

## A New System of R. F. Amplification

(Continued from page 1243)

3B, C, D.) The separate "A" battery method (Fig. 3B) is practicable only with low-consumption tubes of the 199 type, which are not the best for the system here described. The radio-frequency-choke method (3C) is effective, but bulky and expensive. The best by all odds is that shown in 3D, in which the filament of the tube is fed through a dual tuned choke, which is, at the same time, a part of the radio-frequency transformer.

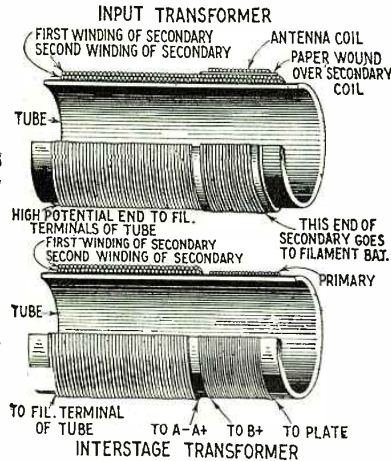

Fig. 5. L1, the input transformer, and L2, shown below it, must be carefully wound. A and B of L3 are spaced 1/2-inch apart. Use acetone and celluloid to cement the secondaries in place.

This system has been put into use by the writer with interesting results. At the time of writing the circuit which is operating the loud speaker is that shown in Fig. 4, consisting of two stages of tuned-plate-coil radio-frequency amplification, a regenerative detector, and one stage of transformer-

## 40 Non-Technical Radio Articles

every month for the beginner, the layman and those who like radio from the non-technical side.

SCIENCE AND INVENTION, which can be bought at any newsstand, contains the largest and most interesting section of radio articles of any non-radio magazine in existence.

Plenty of "How to Make It" radio articles and plenty of simplified hook-ups for the layman and experimenter. The radio section of SCIENCE AND INVENTION is so good that many RADIO NEWS readers buy it solely for this feature.

## Radio Articles Appearing in May Science and Invention Magazine

- Croydon Airplane Radio Station
- The Radio Hotel
- Freak Aerials
- Radio-Controlled Clock
- Making a Cone-Speaker Unit
- New Radio Devices
- Radio Wrinkles
- Radio Oracle
- Latest Patents

## Seattle and Australia Talk; World's Radio Phone Record

Special to The New York Times.

SEATTLE, Wash., July 2.—Radio telephone communication has been established between Seattle and Australia, setting a new world distance record. This was announced today by Frederick G. Simpson, Seattle engineer and owner of Station 7XF in the Grand Trunk Dock.

A two-hour voice conversation was held by E. J. Lesser, manager of the Simpson Radio Corporation, and J. W. Robinson, an Australian amateur. Robinson lives at Concord, about 200 miles from Brisbane. His station is 2RN.

The distance, about 8,000 miles, is the longest over which a two-way conversation ever has been conducted. It is all the more remarkable because the power was only 100 watts. Most broadcasters, with ranges of a few hundred miles, use from 1,000 to 5,000 watts. The wave length of both Seattle and Australian stations was 38 meters.

Mr. Simpson was using a Standard Item 35 as listed in Bulletin 237D. Write for your copy of this bulletin today.

## ELECTRIC SPECIALTY COMPANY

Trade "ESCO" Mark

211 South Street

Stamford, Conn., U. S. A

Makers of Motor Generators and Dynamos with the least ripple and the most miles per watt

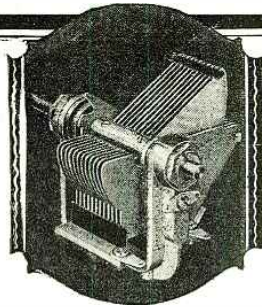

## HAMMARLUND "Midline" CONDENSER

Soldered brass plates with tie-bars; warless aluminum alloy frame; ball bearings; bronze clock-spring piston; full-floating, removable rotor shaft permits direct tandem coupling to other condensers. Made in all standard capacities and accurately matched.

Write for Folder

HAMMARLUND MFG. CO.  
424-438 W. 33rd St., New York

Canadian Representative  
WHITE RADIO COMPANY, Ltd.  
41 West Ave. N. Hamilton, Ont.

## Use the Parts Specified For Most of The Season's Featured Circuits

TAKE a tip from the experts and place your reliance in the condensers and coils they all respect—and which most of them specify for their latest circuits.

Hammarlund condensers and coils embody the best engineering skill in the field of radio. On request, folders will be sent describing Hammarlund variable condensers for every purpose; space-wound coils and couplers; R. F. coils; aluminum shields and drum dials.

If Your Dealer Can't Supply You Write Direct to Us

For Better Radio  
**Hammarlund**  
PRECISION PRODUCTS

## Tyrman 70'

Shielded Grid Amplimax USING SHIELDPLATE TUBES TYPE SP122

Absolutely New and Different The fastest selling kit on the market. Has been acclaimed "America's Greatest Receiving Set" by Radio Engineers, Designers, Editors, and Jobbers. Set Builders have been astounded by the revolutionary performance of this receiver. Write for details or ask your dealer today.

TYRMAN ELECTRIC CORPORATION  
143 West Austin Avenue Chicago, Ill.

## LIGHTING FIXTURES Ready to Hang



Direct from the manufacturer. Completely wired, including glassware. Send for new catalogue No. 29. Just Reduced Prices.

Special Proposition to Dealers.  
Erie Fixture Supply Co., Inc.  
Station R. Erie, Pa.

## The BURT Cell

A photo-electric cell without fatigue. Absolutely reproducible, instantaneous in response. Described in Bulletin 271.

## Stabilized Oscilloscope

The only visual oscillograph having a linear time axis. Gives an accurate picture of high frequency wave forms. Write for Bulletin 273.

DR. ROBERT C. BURT.  
327 South Michigan Avenue, Pasadena, California.

## FREE RADIO GUIDE

BIG NEW 1928 CATALOG—4000 items Shows the latest A-C circuits, the newest ideas in radio at startlingly low prices. Get the sets and parts you want here. Save money. The best in parts, kits, complete factory-built sets and supplies. Orders filled same day received. Write for free copy now. Standard discounts to dealers, set builders, agents Barawick Co., 123 N. Jefferson St., Dept. 805 Chicago, U.S.A.

# Needed...

## Radio Set Owners, Builders and "Hams"

The "Radio News Amateurs' Handbook" is needed by all radio set owners, builders, and experimenting "hams." This valuable magazine contains authentic information on all the latest circuits and developments of the industry. Every construction article appearing in this remarkable handbook is written by the most eminent Radio authorities. Each circuit and principle was thoroughly tested and proven before a word of constructional data that appears on these pages was prepared.

The Radio News Amateurs' Handbook is replete with accurate circuits of carefully tested apparatus. The latest, most efficient method of power supply, new approved audio systems, power amplification, all recent receiving circuits, short-wave outfits, transmitting sets—complete constructional data and information on each of these topics.

Anyone interested in Radio will find this magazine a seemingly endless source of valuable information. If your news dealer cannot supply you, mail the coupon below. Don't wait! 116 pages—fully illustrated.

Price 50c.

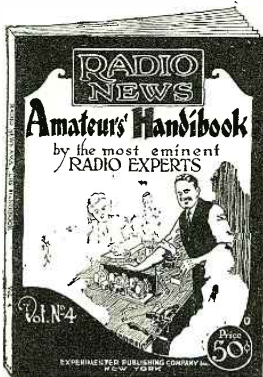

Experimenter Publishing Co.  
230 Fifth Avenue New York, N.Y.

EXPERIMENTER PUBLISHING CO.  
230 Fifth Ave., New York, N. Y.

Gentlemen: Enclosed find 50c., for which please send me a copy of the RADIO NEWS AMATEURS' HANDBOOK.

Name.....

Address.....

City..... State.....

coupled audio. The constants of the circuit are also given in Fig. 4. Details of the radio transformers, the only parts that are not standard, are given in Fig. 5.

The tubes used are standard—the high-mu type for the radio-frequency stages and the 201A type for the detector and audio circuits. Voltages in use just now are 100 for the R.F., 50 for the detector, and 150 for the A.F.; with grid biases of 7 for the R.F. and 17 for the A.F.

#### FUNCTIONING OF THE CIRCUIT

Tracing, now, the course of the signal through the receiver: Coming through the aerial-ground system, the radio-frequency impulses are sent into the cathode (here the filament) of the first tube by means of the double-conductor secondary of the input transformer. They act on the filament in the same way that, in ordinary practice, they would affect the grid of the tube. In this set each grid is grounded through the "C" battery, and controls the output only as it keeps the space charge close to the filament. It eliminates, also, the inter-electrode capacities in the tube between the leads except those in the stem and base.

The radio-frequency impulses, carried by the electronic stream to the plate, pass into the tuned primary of the interstage transformer. Its double-conductor secondary passes them on to the filament of the second radio-frequency amplifier, in which takes place a process similar to that in the first tube. From the plate of the second amplifier, the amplified impulses go into its plate load, here a straight tuned impedance; and thence via the grid condenser to the grid of the detector, and the audio amplifier. As will be seen, the detector and audio portions of the set are standard in every respect.

Though exact measurements of the tubes used in this way are not yet completed, and hence cannot be given in this article, certain general results of using them in this way can be given.

The first is, that the radio-frequency am-

plifiers, no matter what type is used, do not oscillate; even when, as in the set described, no shielding and other special precautions against feed-back are employed. The set-up shown, which is by no means the last word in design or efficiency, is sufficiently sensitive so that, on a fifty-foot antenna, strung about the moulding of a second-floor room in a section of New York pretty well shielded by fifteen-story apartment hotels, nearly all of the local stations come in with living-room intensity on the loud speaker, and even a few of the more powerful out-of-town ones, such as KDKA. As I stop a moment to see what I can get on 'phones, KYW comes in comfortably loud. The selectivity is good enough so that local stations can be separated without overhang.

The second general result is that the set does not radiate, except for such slight energy as may come from the coils associated with the detector, and even then only if it be made to oscillate.

The impedance of any triode used in this way is very high. Experiments with a variable inductive load show plainly that, the higher the impedance of the output load, the better.

One of the curious results of this system of using three-element tubes is that they amplify approximately in proportion to the "mu" figured in the usual way; though, within certain narrow limits, tubes can be made to match each other, with a given load, by varying the grid bias. But if one uses, for each tube, the optimum grid bias, output load, etc., the ear as well as instruments detect the greater value of the higher mu.

A word of caution should, perhaps, be spoken. The set described is a purely experimental affair, and gives, in fact only fair results. The time is not yet ripe to publish a "constructional article" on a set using this method. The method, however, opens possibilities for tube design as well as in the design of apparatus that may lead to something of value to radio.

## A Buzzer R. F. Oscillator

(Continued from page 1249)

shocked into oscillations at its natural frequency by the impact excitation.

#### A CONVENIENT INSTRUMENT

Probably the most valuable use of a buzzer oscillator is for the purpose of a wavemeter. When it is used thus, the frequency of the oscillations which it generates must be adjustable, and this is accomplished by substituting a variable unit for either L or C. Although it is entirely possible to use a variable inductance (variometer) and a fixed condenser, the fixed inductance and variable condenser combination is usually employed. This is because the calibrations of the latter are apt to remain fairly accurate; whereas the electrical characteristics of a variometer frequently change after it has been used a short time.

The two pictures accompanying this article show the construction of a simple, efficient buzzer-excited wavemeter which may be adjusted to all wavelengths in the broad-

cast band. The unit is mounted on a panel 6 x 7 x 3/16 inches and may be placed in a cabinet 5 inches deep. The essential parts required for its construction are: one .00035-mf. variable condenser, one coil 2 1/2 inches in diameter and wound with 60 turns of No. 26 D.C.C. wire, one high-frequency buzzer, one rheostat, one 4 1/2-volt flashlight battery and one tuning dial. The parts may be mounted as illustrated in the pictures; and wired as shown in Fig. 3.

After the construction of the wavemeter has been completed it should be calibrated. The best way to do this is to tune in a station of known wavelength on a broadcast receiver, set the wavemeter in operation and place it near the antenna coil of the set; then adjust the dial of the wavemeter until the signal of the buzzer is heard loudest in the loud speaker. The wavemeter is now adjusted to the wavelength of the station which is being received, and the dial reading should be recorded. This operation



should be repeated with several stations, until sufficient data have been obtained to plot a graph. If care is exercised in making adjustments, this method of calibrating a wavemeter is sufficiently accurate for most purposes.

In the diagram a fixed condenser is shown in dotted lines (X) connected across the contact points of the buzzer. This, often, will greatly improve the operation of the wavemeter by preventing sparking at the points of contact. The condenser should have a capacity of 1 mf. It is also possible to farther improve results by connecting a 0-200-ohm variable resistor in series with the condenser and carefully adjusting the value of the resistor until all sparking is completely eliminated.

## Building a Dynamic Speaker

(Continued from page 1247)

Before the flexible support is glued to the cone, it should be glued to a five-ply-veneer wooden ring which is 1/2-inch thick, 7 1/2 inches inside diameter, and 9 1/2 inches outside diameter. Here liquid glue is again used. After this the inner edge is glued to the cone, as explained above. The wooden ring is fastened to the baffle by four screws. The holes for these screws in the ring are made somewhat larger to allow for adjustment, washers being used under the screw heads to hold the latter from drawing into the holes.

The baffle is made of five-ply wood veneer, 1/2-inch to 3/4-inch thick. It is fourteen to eighteen inches square and has a hole in the center, 7 1/2 inches in diameter.

### ASSEMBLY

The following procedure is used in assembling the speaker: the baffle is laid flat upon a table, and the cone, mounted in its wooden ring, is placed concentrically on it with respect to the hole in the baffle. The cone is then clamped to the baffle with the four screws in the wooden ring, as explained above. The field electromagnet, with its three brackets and the armature coil mounted on its bridge, is placed in position and adjusted so that the apex of the cone comes in the center of the double spiral mounting the armature coil. Then the locations for the three wood screws, fastening the brackets to the baffle, are determined and the brackets are fastened in place to the baffle with these screws.

The speaker is then placed in its proper position and the apex of the cone is cemented to the double spiral as follows: the bolt fastening the armature coil to the spiral will extend through into the apex of the cone; and the apex and bolt and spiral should all be securely fastened together with household cement. After the cement has thoroughly set, the speaker is ready to try out. Sometimes we find that it is still necessary to make minor adjustments, because of the armature coil's striking the field magnet poles. This adjustment is accomplished by slightly loosening the clamping of the double spiral in its bridge mounting and adjusting the spiral so that the buzz is eliminated. Any adjustment of the cone for alignment at the larger end is done by loosening the four screws

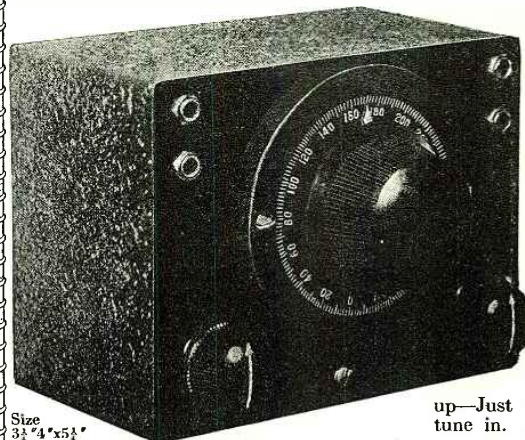

Size 3 1/2" x 4" x 5 1/2"

PHOTOGRAPH

1 Actual  
2 Size

OPERATES ENTIRELY FROM ONE STANDARD 4 1/2 VOLT "C" BATTERY CONTAINED IN THE CABINET

Receives 1000 to 1500 Miles

Take it with you when traveling—No aerial to put up—Just plug in a light socket and tune in.

## THE CUMMINGS SOLODYNE

AN AMAZING LITTLE ONE-TUBE RECEIVER WITH EXCEPTIONAL RANGE AND VOLUME

This astounding little set, located in Wichita Falls, Texas, receiving from a light socket, picked up Chicago stations nightly for six months, and in July received Havana, East Pittsburgh, Los Angeles, and four stations in Florida.

Complete, with "C" Battery, Type UX199 Tube, Dubilier Light Socket Antenna, and pair of Frost Phones, designed especially for this set—\$15.00. Less Antenna, Tube, and "C" Battery... \$12.50

CUMMINGS RADIO CORPORATION, P. O. Box 755, Southside Station, Springfield, Missouri.

## GENERAL RADIO

### Announces---

A complete line of Transformers, Rectifier Filter and Power Speaker Filters for use with the new UX 250 Power Amplifier Tube.

This tube requires equipment especially designed for it and its use will result in improved volume and quality. A folder describing a complete amplifier unit and component apparatus is yours for the asking.

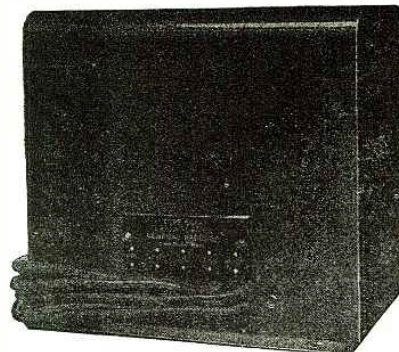

### TYPE 565-A TRANSFORMER

Rated at 200 watts, Primary designed for 105-120 volt 60 cycle A.C. High voltage secondary of 660 volts. Two low voltage secondaries of 7.5 volts each for filaments of rectifier and power amplifier tubes and one low voltage secondary of 2.5 volts for the 226 or 227 type of tube. Price \$20.00.

## GENERAL RADIO COMPANY

Write for Bulletin No. 929, describing complete line of General Radio quality apparatus  
30 STATE ST. CAMBRIDGE, MASS. 274 BRANNAN ST., SAN FRANCISCO, CALIF.

## RADIO SCHOOL

Send for Catalogue

MASSACHUSETTS RADIO and TELEGRAPH SCHOOL  
18 Boylston St. Boston, Mass.

## The ELECTRIC Radio Freshman EQUAPHASE

at All Authorized Dealers

### SPECIAL PRICES

Assembling and Wiring Scott's World's Record Ten, Nine-Inch Line and Tyrman "70" and all other kits. Send for literature.  
NORTH SHORE RADIO LABORATORIES  
ASSOCIATES I. R. E., A. A. S.  
6902 North Clark Street — Dept. A — Chicago, Ill.

AEROVOX



PYROHM RESISTANCES will carry more current without undue heating. Ask your dealer or write us for information.

AEROVOX  
70 Washington St.,  
Brooklyn, N. Y.

## 6 TUBE SUPERPHONIC Radio 16.95

FREE! 6 TUBES UX-201A Type Tested & Matched METAL CHASSIS SHIELDED COAST TO COAST RECEPTION  
An amazing value that can't be beat! Latest 6 tube tuned radio frequency circuit. Extremely selective. Send for complete descriptive circular. Value \$60.00, our price \$16.95. Write today.  
RADIO EQUIPMENT CO., 549 S. Wells St., Dept. 12E Chicago

### 6-TUBE RADIO COMPLETE

\$34.75 to \$66.66  
Licensed R.C.A. Circuits. Shielded. One Dial  
Write for catalog. Big discounts to agents  
Consumers Radio Co., Dep. 144, 4721 Lincoln Av. Chicago

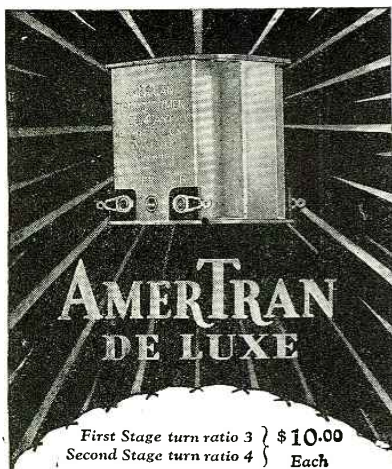

**Standard of Excellence in Audio Amplification**

AmerTran De Luxe Transformers are but two of more than 30 quality Radio Products bearing the name AmerTran, including power transformers, choke coils, push-pull systems and allied products. Each AmerTran device is designed for a specific use. Full and authoritative information will be given on any audio or power problem.

AMERICAN TRANSFORMER COMPANY  
Transformer Manufacturers for 28 Years  
140 Emmet St., Newark, N. J.

**electrify your set the easy practical Knapp way....**



No expensive short lived AC Tubes, no troublesome re-wiring, no annoying hum. Increase instead of decrease the efficiency of your set, no waiting... the

**Knapp "A" POWER KIT**

*gives you music instantly at the snap of a switch.*

**Absolutely Dry**

There is not a drop of moisture in this absolutely dry unit. The condensers are baked so that not a drop of moisture remains. The unique, fully patented, solid full-wave rectifier is absolutely dry. No water... no acid... no alkali... no tubes... no electrolytic action. Nothing to get out of order. Nothing that needs attention.

**Assemble in Half an Hour**

Everything supplied, even to the screws, wire, drilled base-board and metal cover. "B" Eliminator may be operated from the same switch.

**Big Profits for Set Builders**

Our President, Mr. David W. Knapp, is offering the set builders of America, for a limited time only, a money-saving plan which is unique in the annals of radio. Send the coupon today, before it is too late.

**KNAPP ELECTRIC CORPORATION**  
Port Chester, N. Y.

MIR. DAVID W. KNAPP, Pres., Knapp Electric Corporation  
313 Fox Island Road,  
Port Chester, N. Y.

Send me complete information regarding the Knapp "A" Power Kit and your special discount to set Builders.

Name.....  
Address.....  
City..... State.....

holding the wooden ring, then adjusting and reclamping.

The primary of the input transformer is wound with very fine wire, probably number forty, and, to avoid possible burnout, the battery current should not be permitted to flow through it. A filter circuit for accomplishing this is shown in Fig. 5. The primary impedance of the input transformer for the speaker varies directly with the load, which is applied to the secondary when the input transformer is connected to the armature coil. The impedance at one thousand cycles is nine thousand ohms. The winding ratio is thirty-three to one.

For best results with a speaker of this type, a push-pull amplifier using two power tubes in the last stage should be employed. When an amplifier of this type is used the output circuit must be slightly different, as the plates of the output tubes are not at the same potential. An output circuit which may be used with satisfaction is shown in Fig. 6. In this diagram L1 and L2 represent two choke coils, having an impedance of not less than 30 henries each at 30 milliamperes. The condenser C1 should have a capacity of approximately .001-mf.

**Suggestions for Power-Amplifier Current Supply**

(Continued from page 1247)

curing a power-tube adapter. Those desiring to make a permanent connection should couple the "C" battery into the grid circuit of the last audio tube.

If an examination of the last transformer, or double-impedance unit, is made, it will be noted that the two terminals of the secondary, usually designed by the symbol "S," or "Sec.," are marked "F," meaning filament, and "G," meaning grid. The wire connected to the terminal "F" should be disconnected from the transformer and connected to the positive, or "B+" terminal of the "C" battery. Another lead should be run from the negative, or "B-" terminal of the "C" battery to the transformer post marked "F," thus completing the circuit. In the case where single-impedance or resistance coupling is employed, the "C" battery should be connected to the grid leak at the side farthest from the grid of the tube. The negative side of the "C" battery should be connected to the grid leak, and the positive side to the ground, the original connection between these points being, of course, broken.

Because of the fact that the "B" batteries, used to boost the output voltage of a power unit, are required to serve but one tube, many months of service can be expected before the end of their useful life is reached. Where the potential applied to the plate of the UX-171A is 135 volts, the current drain, with proper "C" bias, will be 18 milliamperes; where 180 volts is applied to the plate, the drain will be about 20 milliamperes. It is thus seen that the current drain is not substantially altered in either case; and for this reason it is as economical to use two boosting batteries as one, and thus enjoy the maximum power output of the power amplifier.

The above suggestions apply equally well to "B" power units operated from alternating current, but which, for various reasons,



Learn all there is to know about loud-speakers. HOW TO BUILD MODERN LOUD SPEAKERS by Clyde J. Fitch and many other eminent authorities is a complete history of Radio acoustics. The data thus assembled is now ready to be presented to you. This is the most comprehensive treatise on the subject that has ever been compiled.

Every step forward to the goal of true tone reproduction is treated in this remarkable book. Each type of loud-speaker—The Exponential Horn—the Cone—the Piezo Electric speaker—the Roll type speaker—Power speakers—these are but a few of the many types explained.

Learn how to build your own loud speaker—the one best suited to your particular requirements. You will find full constructional information and diagrams in this valuable book. Perfect tone reproduction is the aim of every one connected with the Radio Industry today. Learn all about this important field through the pages of this book.

Get your copy now. Don't wait! Ask your newsdealer. If he cannot supply you write direct. Use this coupon.

**25c**

52 pages—fully illustrated—size 6 x 9 inches

**CONSRAD CO., INC.**

230 Fifth Ave. New York, N. Y.

CONSRAD COMPANY, Inc.  
230 Fifth Avenue, New York, N. Y.  
Gentlemen: Kindly send me a copy of "HOW TO BUILD MODERN LOUD SPEAKERS." Enclosed is twenty-five cents.

Name.....  
Address.....  
City..... State.....

do not have sufficient output voltage for the satisfactory operation of a power stage. It often happens that an A.C. power unit, particularly one of the older type which may have given good results in connection with tubes of the 201A type, fails to give the expected results when connected to a power tube. This is due to the relationship between current drain and voltage, because, as the current increases, the voltage drops rapidly. Consequently, some power units, having a rated output of 135 volts when used with 201A tubes, may have far less than that when used in connection with a tube requiring a comparatively high current. In this case, boosting batteries may advantageously be used, and should be connected precisely as in the case of the D.C. eliminator.

## The Eveready Hour

(Continued from page 1218)

WEAF with a consistent, comprehensive schedule mapped out.

How much their broadcast activities have grown since then may be realized by a comparison of the first year's radio costs, which totalled \$3,850, although the original appropriation had been \$500, while this year's appropriation which is \$400,000. Then there was but one station and a small listening public; now there are thirty-one stations and uncounted thousands tuned in.

It is true that from the start the National Carbon Company was fundamentally interested in selling batteries, and its success in that respect is contemporary business history.

With this commercial purpose of exploiting its own product in a legitimate manner, the Eveready makers wanted their radio activities to reflect that imaginative quality which, they believe, marks the successful business man or company. The Eveready Hour has been their expression of this quality, of an imaginative and mysterious character which distinguishes radio. Its purpose has been to provide the most enjoyable entertainment to the greatest number of listeners. The policy of the backers of the Eveready Hour has been: "That it may always be entertainment of the highest type, irrespective of the key or mood in which it happens to be given." So that all classes and types of listeners might be pleased, and realizing that it is an impossibility to please all the audience all the time, Eveready has presented diversified programs, has experimented in various fields and, because of the thoroughness and care with which these experimentations were made, they have many, many times been taken as a criterion by other broadcasters.

### A STORY FROM LIFE

What is generally regarded as one of the finest programs ever heard on radio is "Galapagos," with Martin ("Red") Christianson, which has already been broadcast four times.

The staging of this program is an interesting story in itself. Mr. Furness was reading a book by William Beebe, describing the author's trip to Galapagos, when he became interested in a chapter devoted to an unusual experience of the explorer.

# New SUPER MACK SPRING AERIAL

TYPE NO 20 - \$4.00

EASY TO ERECT

No. 20 for a 20 to 60-foot stretch  
No. 60 for a 60 to 126-foot stretch  
Aerials contain 350 feet of coiled wire

TYPE NO 60 - \$2.50

THE LATEST AND GREATEST IMPROVEMENT IN AERIALS FOR ALL SETS (will not rust or corrode)

One of these aerials erected in place of your old aerial will give your set greater volume, proportionate selectivity. This means your set will give you CLEARER, FULLER and LOUDER reception on stations you have been able to receive, and will also bring in stations from longer distances, likewise different directions than you have had before.

THOUSANDS SOLD AND NOT ONE DISSATISFIED CUSTOMER  
If your dealer cannot supply you—order direct by number and enclose check or money order. Mack Aerial Hour—Station WLIT—Wednesday A. M., 11 to 12 noon

MACK CO., Inc., 44 N. 4th St., Philadelphia, Pa.



**Never Wears Out**

Your first cost is the only cost. Then why not enjoy permanently the better tube performance and prolonged tube life alone offered by

## AMPERITE

REG. U.S. PAT. OFF.

The "SELF-ADJUSTING" Rheostat

Keeps filament voltage constant despite "A" battery variations. Simplifies wiring, panel design, tube control, tuning. Insist on AMPERITE. Nothing else can possibly perform as well. Unconditionally guaranteed.

Price \$1.10 with Mounting. (in U. S. A.)  
For sale by all dealers.

**RADIALL CO.**  
50 Franklin St., N. Y.

FREE "Amperite Book" of latest circuits and construction data. Write Department RN-5.

# AGENTS!

WANTED RADIO OWL AGENTS WANTED



## IT'S A WINNER

Automatic device in the form of a beautiful ornament, attachable to any radio; easy and quick to install. Turns radio off automatically any time you want to set it, from fifteen minutes up to hour and one-half. Fast seller, good profit. Write now to become distributor in your territory. Act at once!

## RADIO OWL

Desk N  
2269 E. 51st St., Los Angeles, Calif

**MUTER CLARIFIER IMPROVES TONE**

The Muter Clarifier and Tone Filter, designed to protect Speaker Units from the paralyzing effect of high "B" voltage, assures strong, full, clear tone-quality. You will be surprised at the amazing difference in reception with one on your set. Easily installed in a few moments without disturbing set. See your dealer or write for full information.

LESLIE F. MUTER COMPANY  
76th & Greenwood Ave., Dept. 827-G, Chicago, Ill.

**MEN WANTED FOR RAILROADS**

Nearest their homes—everywhere to train for Firemen Brakemen, beginners \$150-\$250 monthly. Promoted to Conductor or Engineer—\$3,000-\$4,000 yearly—highest wages on railroads. Also clerks

**RAILWAY EDUCATIONAL ASSOCIATION, Dept. D88-5 Brooklyn, N. Y.**

# DEALERS

See page 1292

## RADIO NEWS

DEALERS PERSONAL EDITION

# YAXLEY

APPROVED RADIO PRODUCTS

## RADIO CONVENIENCE OUTLETS

Wire your home for radio. These outlets fit any standard switch box. Full instructions with each outlet.

No. 135—For Loud Speaker.....\$1.00  
No. 137—For Battery Connections. 2.50  
No. 136—For Aerial and Ground... 1.00

With Bakelite Plates  
Now furnished with a rich satin-brown Bakelite plate, with beautiful markings to harmonize, at 25 cents extra. See illustration.

At Your Dealers  
**YAXLEY MFG. CO.**  
Dept. N-9 So. Clinton St.  
Chicago, Ill.



Insure your copy reaching you each month. Subscribe to Radio News—\$2.50 a year. Experimenter Publishing Co., 230 Fifth Avenue, N. Y. C.

# SKINDERVIKEN Transmitter Units

95c



Two for  
**\$ 1.75**

Have hundreds of uses. Every amateur should have two or three of these amplifiers in his laboratory.

### A FEW USES FOR THESE UNITS

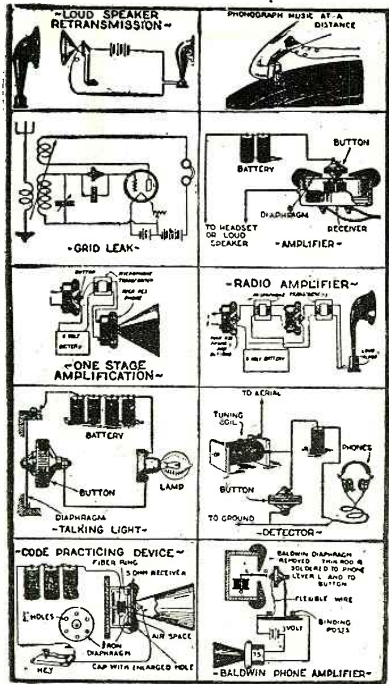

### 12 PAGE INSTRUCTION BOOKLET

containing suggestions and diagrams for innumerable uses, furnished with each unit.

**WE PAY \$5.00 IN CASH**

for every new use developed for this unit and accepted and published by us.

### P. G. MICROPHONE TRANSFORMER



A Modulation Transformer specially designed for use with the Skinderviken Transmitter Unit.

**\$2.**

### FOR SALE AT LEADING DEALERS

Or Order Direct, Using Coupon Below

**SEND NO MONEY**

Order whatever you want. When the postman delivers your order you pay him for whatever you have ordered, plus a few cents postage.

PRESS GUILD, INC.  
16-18-R—East 30th St., New York, N. Y.

R-5-28

Please mail me at once.....Skinderviken Transmitter Units, for which I will pay the postman 95c., plus postage, or \$1.75, plus postage, for 2 units. Please ship me one P. G. Microphone Transformer, for which I will pay the postman \$2, plus postage.

Name.....

Address.....

City.....State.....

It concerned a chance meeting with another adventurous soul, who had once been shipwrecked on Galapagos, but whom he had found driving a taxi in New York. The chauffeur's name was "Red" Christianson. Mr. Furness commenced a search for the man, located him through Mr. Beebe, and then Mr. Stacey arranged the famous "Galapagos" broadcast. Letters poured in from all over the country; program authorities proclaimed it to be the best thing of its kind ever done; different cities begged for visual staging of it and, whenever it has since been repeated, the reception has been similar.

The "Golden" anniversary was another popular program which was heard on this hour and represented the first actual use of the continuity idea in broadcast programs. It held the thread of a drama in which the directors introduced music that was popular half a century ago.

During 1924, while the N. B. C. was realizing how important their radio activities were, Wendell Hall was their most popular artist. That was before the time of chain-station broadcasting and the company sent this music-maker on a planned tour of all the existing stations, spreading the Eveready message. Later he came back to WEAF and, in the first radio wedding, was married to Marion Hall, a member of the *Chicago Tribune* editorial staff.

### A BUSINESS SUCCESS

WJAR, Providence, was the first station regularly added to WEAF in the Eveready broadcasts and the next was WRC, Washington. As WEAF added to the list, Eveready took them on and, since that first hour, has never had a week's break in its record. Now the program goes over the regular network of the National Broadcasting Company with a special program for

the Orange chain on the Pacific coast; while the Canadian National Carbon Company is active on individual Canadian stations, such as Montreal, Vancouver and Toronto. The eastern office alone, using twenty stations, spends \$325,000 a year.

We were anxious to learn just how definitely the National Carbon Company can trace its development to broadcasting and we asked Mr. Furness if he knew that his company obtained enough direct sales to justify the enormous expenditure which is being made this year. He agreed that it is difficult to check just what direct sales are attributable to broadcasting; but he used his company's survey of its activities in southern states as an example.

The Eveready program went on the southern stations in January of last year. The company knows definitely that its business increased more than enough to warrant its continuing. Sales territories were divided into sections, separating the zones of radio influence from that part of each territory which was not receiving the broadcast programs effectively. The business where regular reception was checked showed a big increase over that part of the south which was not being covered by Eveready programs.

Opera, chamber music, jazz, minstrel shows, vaudeville, drama, lectures and novelties have gone into the making of the Eveready Hour on the air. Four years, fifty-two times a year and never a flop! If this isn't an enviable record, then radio can't offer it. There have been degrees of success, naturally; some hours have been better than others; but, without exception, the Eveready hour has adhered to high standard of consistency in air entertainment. The public knows what it has been getting, and the coming months will but add to the general appreciation.

## Building a Linen-Diaphragm Loud Speaker

(Continued from page 1248)

The next operation should be performed either outdoors or in a room with the windows open, as otherwise the fumes from the collodion are liable to cause an unpleasant sensation. Paint the face of each diaphragm with the thin collodion and allow it to dry. Four or five coats are required; let each coat dry before applying the next one. When the last coat is dried the diaphragms will be stiff and slightly flexible and, when tapped with the finger, will sound like a drum.

The small coupling bolt is next prepared. This is an 8/32 bolt, 1/2-inch in length, through which is drilled lengthwise a small hole, just large enough to take the driving rod of the loud-speaker unit which is to be used. One of the washers is put over the bolt and the head with the washer is put through the hole in the large diaphragm, from the front. The two diaphragms are forced together until the bolt can be slipped through the hole in the smaller square, after which the other washer and the nut are put on and tightened down.

The mounting of the unit itself is left to the ingenuity of the constructor. The method employed with good results by the writer can be seen in the accompanying illustrations. It is important to remember that the unit must be so lined-up that the driving pin will come exactly in line with the hole in the bolt.

The finished speaker may be placed in a cabinet or hung from the ceiling. If it is desired to color the linen diaphragms this must be done before treating them with the collodion. The tacks should be covered over with an attractive passe-partout binder for appearances' sake.

The material needed for constructing this speaker is as follows:

- 4 pieces of cypress, 24 x 2 x 1 1/2 inches ("A, B");
- 2 pieces of cypress, 24 x 1 1/2 x 1 inch ("C");
- 2 pieces of cypress 7 1/2 x 1 1/2 x 1 inch ("D");
- 4 triangular pieces cypress 1 1/2 x 1 1/2 inches ("E");
- 2 squares of medium-weight linen, one 26 x 26 inches, and the other 8 x 8 inches;
- 4 1 3/4-inch woodscrews ("F");
- 2 1/2-inch washers ("G");
- A 1/2-inch 8/32 brass screw and nut ("H");
- A package of No. 4 cut tacks;
- A roll of passe-partout binder;
- 10 oz. collodion (Obtainable at drug store) or varnish;
- A balanced-armature loud-speaker unit with driving rod ("I").

# Editorial Policy Ballot

(See Page 1208)

Editor, RADIO NEWS:

I vote for changes in editorial policy as follows in the space given to different subjects in the pages of RADIO NEWS, as shown by the squares which I have crossed below. I am satisfied with the present policy in respect to all other subjects.

Please fill out and mail to Editor, RADIO NEWS, 230 Fifth Avenue, New York, N. Y. (U.S.A.)

**GENERAL ARTICLES**

- More Less
- Pictures of Broadcast Artists
  - Descriptions of Broadcast Features
  - Interviews with Broadcast Artists
  - Courses in Musical Appreciation
  - Pictures of Broadcast Stations
  - Illustrations of Radio Novelties
  - Editorial Talks
  - Radio Fiction—"Human Interest"
  - Radio History and Biography
  - Radio News of the Month
  - Radiotics
  - Broadcastistics
  - "The Listener Speaks"
  - Prize Contests
  - Radio Poetry
  - Radio Fiction—Semi-Technical

**TECHNICAL ARTICLES**

- More Less
- First Principles of Radio
  - Radio Work for Beginners
  - What's New in Radio
  - "I Want to Know"
  - Constructional Wrinkles
  - Correspondence from Set Builders
  - Broadcast Station Lists
  - RADIO NEWS Laboratories
  - Semi-Technical Radio Articles
  - Circuits with Constructional Layouts
  - Foreign Radio Activities
  - Short-Wave Reception Data
  - Experimental Circuits (without layouts)
  - Television and Picture Reception
  - Short-Wave Transmission (amateur)
  - Advanced Radio Theory

I would like to suggest these additional subjects for early treatment, or new departments:

.....  
 .....

If you do not wish to sign, please place an X here if you are a woman reader

(Signed).....

(Address).....

### "Television"

**T**HE debt I owe to radio,  
 I know I cannot pay.  
 And now there whispers down the wind,  
 A wonder due today—  
 It's all that television plan,  
 (Confusing, I confess);  
 I hope to see that "Magic Isle"  
 The "Wrightley Spearman" stress.

I hope the vision may be clear,  
 When Tiny "X-Ray" speaks;  
 And who can voice the charm there'll be,  
 In Clark's Hawaiian peaks?  
 Of course we'll love that Forest scene,  
 In fair "Sylvania's" wood;  
 We'll speechless gaze on "Rose Bowl" haunts,  
 Where Graham proudly stood.

We'll watch La Prade ascend the Alps,  
 And sail the Baltic sea;  
 And on Bermuda's coral strand,  
 We'll long with him to be.  
 We'll be the "observation quest,"  
 In presidential halls;  
 And cheer the "Homers" on the plate,  
 And see who fouls the balls.

We'll peep in Gen'ral Motors' plant,  
 And note which Klaxons cry.  
 We soon may follow Lindy's course,  
 And vision him on high.  
 With television on the way,  
 (Nor yet beyond its goal),  
 We hope to see our honored Byrd  
 When he o'ertops the Pole.  
 —Viva Snow.

**TRY THE SIDEBOARD AND GET CHINA**  
 FIRST RADIO FAN: "I used bicycle spokes for an aerial, and got Wheeling."  
 SECOND RADIO FAN: "That's nothing; I put my loud speaker on the bed and got Davenport."  
 Mrs. Bill Howard.

**KNOW THE SYMPTOMS**  
 Mr. JONES (to Mrs. Jones): "I've got such a strange humming noise in my left ear."  
 LITTLE BENNY JONES: "Maybe it's your batteries charging, daddy."  
 —Mrs. H. Gersten.

**NEED FOR FINESSE**  
 One of the hardest bridge problems on the radio is to keep it tuned out.—Judge.

# Achieve SUCCESS in Radio

New course gives finest instruction obtainable

You Can Learn at Home!



R.L. DUNCAN, Director, Radio Institute of America and author of several volumes in radio.

Good pay from the start, rapid advancement, and phenomenal success—a life profession of fascinating brain-work—that is what Radio holds for the man who knows his subject thoroughly. Since 1909 Radio Institute of America has trained thousands to become successful in the many branches of Radio. Are you going to plod along at a thirty-five dollar a week job when REAL MONEY is waiting for you in radio?

### New Course Finest Ever

Prominent radio men have enthusiastically greeted RIA's new course as the most complete and up-to-date offered today. All this first-quality equipment is furnished FREE WITH THE COURSE—parts for making many practical radio circuits and the Peerless Signagraph for code instruction.

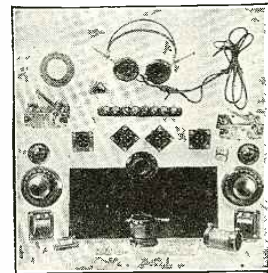

### RIA backed by RCA, G-E and Westinghouse

You get all the benefits of instruction conducted by RCA and sponsored by RCA's associates, G-E and Westinghouse. Our employment department is at the service of graduates.

### Study at Home!

Moreover you can STUDY AT HOME—when you please and as long as you please.

This new booklet describing the course is just off the press. If you want to learn more about the well paying positions in this fascinating profession send the coupon now for your copy.



**RADIO INSTITUTE OF AMERICA**  
 Dept. A-5 326 Broadway, New York City

**RADIO INSTITUTE OF AMERICA, Dept. A-5**  
 326 Broadway, New York City

Dear Mr. Duncan:  
 Please send me your new catalog. I want to know more about your new radio course.

Name.....

Address.....

# Build An efficient ONE DIAL RECEIVER Use the PERIDYNE Designed by HUGO GERNSBACK

An efficient one-dial set can now be built with a unit designed by Hugo Gernsback, well-known inventor and publisher. The Peridyne, as this unit is called, employs an entirely new principle in operation. Due to the new principle that it involves, the Peridyne assures positive, true interstage resonance and thus the

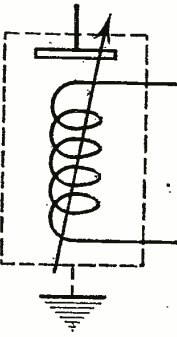

efficient one-dial receiver becomes a reality. Distance, selectivity remarkable performance under all conditions—this is what the builder of the Peridyne is assured. Note the schematic symbol used to designate the Peridyne. This symbol had to be specially designed, as there was no existing sign in radio practice that properly identified the Peridyne.

Write today for complete constructional information for the building of this remarkable one-dial receiver. A complete Conrad Pattern is available to guide you. This pattern contains: 5 full-sized blueprints—and a large magazine size instruction booklet. All the information necessary to construct the efficient Peridyne Receiver will be found in this set of plans.

Write today—do not hesitate

COMPLETE PLANS **50c** ONLY

Build this set and prove to yourself the merits of this circuit.

CONRAD COMPANY, INC.  
230 Fifth Avenue New York, N. Y.

CONRAD COMPANY, INC.  
230 Fifth Avenue, New York, N. Y.  
Gentlemen: Enclosed find 50c., for which please send me full Peridyne plans.

Name .....

Address .....

City.....State.....

## High-Frequency Magic in the Radio Laboratory

(Continued from page 1205)

at the end of a wire without any visible return circuit. Smaller standing arcs have been established on the ends of a receiving aerial several feet distant from the transmitter, showing that it is possible to transmit power currents through space.

What are the uses of a tube of this nature, besides transmitting radio signals, is difficult to judge. Will it be possible to transmit power over many miles instead of a few feet? Will this device fill some long-felt want in the medical profession? Will it

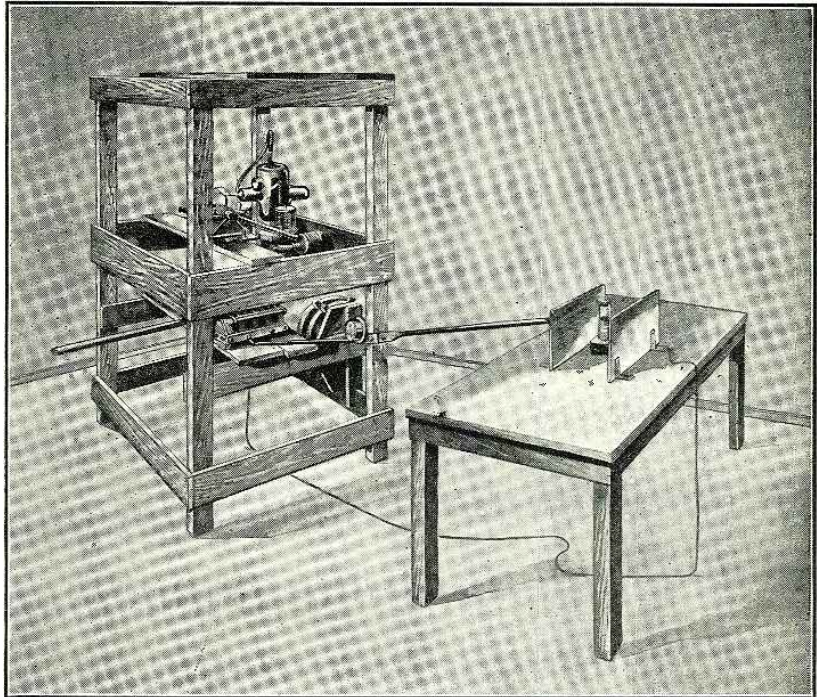

When a tube of water is placed between two parallel plates, connected to the 6-meter transmitter, as shown, the water boils after a few minutes.

Here is another most amazing plaything of scientists that astounds its beholders today, but to-morrow may seem to be as commonplace as a street-car or a balloon.

eventually replace our kitchen stoves? No one can say at this time anything except "Here is something new. Let us see how we can use it to make life easier."

## Handle Power Tubes with Discretion

WITH the increasing popularity of power amplifiers and power packs, radio has entered the power field, from the standpoint of the use of high-voltage equipment.

In many of the power packs employing rectifier tubes of the 280 and 281 types, for use with power amplifiers using the 210-type tubes in single or push-pull arrangements, the voltages supplied to the power tubes often run over 400.

In using such equipment no danger is involved either to persons or to equipment if ordinary common-sense precautions are taken in its handling. It is well to remember that, when dealing with such voltages, the current source should be turned off before any attempt is made to change tubes, equipment or wiring.

Pulling a 210-type tube out of its socket, for instance, while the current to the power pack and amplifier is turned on will cause a surge of voltage; which may be sufficient to charge the filter condensers of the power pack to the breakdown point, unless the condensers are designed to withstand very high voltages.

The usual result of a breakdown in the condensers is a decided heating in the rectifier tube, causing the tube elements to become red hot. This will ruin the rectifier tube if not discovered in time and may even result in sufficient heat to break the glass of the tube. Such heating of the tube is no fault of the tube's design, but it is a sure indication that there is something wrong in the power-pack equipment or wiring.

# From Paul Revere to Paul Whiteman

(Continued from page 1241)

buried treasure came to mind. Visions of another captain also, Captain Morgan, the most famous—or rather infamous—of all buccaneers, were recalled. Tales of the Spanish Main with buried loot and hidden pelf loomed up.

A whole afternoon and half of a night was spent gouging out the inlay outlining the small panel and then steaming it over the family teakettle, until the gas bill ran double for the month.

His patience was finally rewarded by the liberation of three separate papers carefully folded and embedded in the pocket, over which the panel had been sealed into place with glue. Some unavoidable damage was done in steaming out and opening the folded slips; but enough remained to show what purports to be an old formula in a fair state of legibility.

### A MYSTERY UNSOLVED

The date January 26, 1791, appears on one of the papers, along with some cryptic figures and letters apparently in code formation. Several other names in three different styles of handwriting, and prices of grains, etc., apparently of that date or period, make up the remaining contents of the documents. The chest and papers have been shown to a number of antiquarians and collectors, and last summer, while the writer was in New York City, it was taken to one of the museums for examination. The opinion given was that this was a very unusual and hitherto unknown method of secreting documents or messages in furniture. Further, the thought was expressed that these seemingly simple and meaningless words, formulas, etc., were, in fact, some secret message in code.

Considerable time and effort has been spent in trying to establish the original ownership and authorship of the cabinet and of the papers found; as well as in deciphering and decoding the messages, if such they be, to learn the probable motive in secreting papers in such an inaccessible place and manner that only through the building of a modern radio were they disclosed 136 years later.

As previously mentioned, ownership of the Treasure Chest has been definitely established and traced back three generations. The lady who used it years ago as a jewel case evidently little suspected that anything unusual reposed within its walls, except her own gems which adorned her person; as the chest had been completely painted over before that time, thereby totally obliterating the design on the front panel.

The name signed to the formula is that of an old and well-known family who resided in Pennsylvania before and after the American Revolution. Two brothers served in that war and later migrated to Virginia. Later direct descendants include a distinguished physician and surgeon, who practiced in the latter state and who was also an inventor of considerable note outside of his own profession. According to authentic information, one of the earlier members of this family, before or during the Revolutionary period, returned to England and all subsequent trace of him was lost. However, a descendant of the above-mentioned family, now living, believes that possibly this Tory relative of Revolutionary times may have attempted to communicate with some one in the United States in this manner. Obviously, the message never reached its destination.

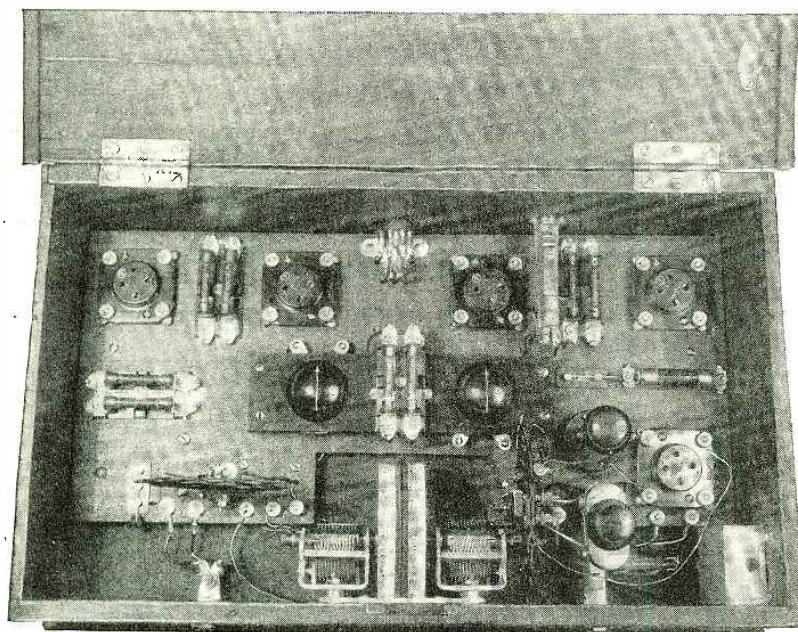

The modern radio equipment within contrasts strangely with the look of antiquity in the time-mellowed woodwork of the "Treasure Chest."

## Electrify Your Set WITH THE

# MARATHON A-C KIT

## SIMPLE AS A-B-C



Marathon AC Tubes have the standard 4 prong UX bases. No adaptors or center tap resistors.

Replace your old Tubes with Marathon A-C Tubes

The Marathon harness is universal, and can be used in any set. The "spades" slip over the projections on the tube—no thumb screws.

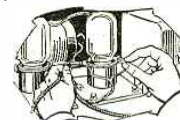

Connect the harness



Plug in the light socket —that's all there is to do

One end of the harness connects with the Marathon Transformer. All tube sockets operate on one voltage—6 volts—so there are no taps. Simply plug the transformer into the light socket.

## YOU CAN'T MAKE IT COMPLICATED



Satisfaction

Guaranteed

No need to wonder if the Marathon AC Kit will operate on your set—we guarantee it. If you have a 5, 6, 7 or 8 tube set using UX sockets and are now employing an "A" Battery (either dry cell or storage) you can use the Marathon AC Kit—perfectly. Marathon AC Tubes are guaranteed for a year. If your dealer cannot supply you use the coupon below.



The Marathon AC Kit is Complete

Nothing else to buy—everything is complete. For example the six tube kit includes 6 Marathon AC Tubes—a universal harness—a 6 volt Transformer—a volume control—and an instruction sheet. Anyone, no matter how ignorant of radio can change his set from DC to AC.

Jobbers—Dealers

Write or wire for our sales proposition. You can absolutely guarantee the operation of the Marathon AC Kit.

**NORTHERN MFG. CO.**  
NEWARK, NEW JERSEY

Northern Manufacturing Co.,  
355 Ogden St., Newark, N. J.  
Send me complete information on the Marathon AC Kit.  
Jobber..... Dealer.....  
Professional Builder..... User.....  
(Please check your classification)

Name.....  
Address.....



New York World  
Feb. 10, 1928

Def. Mas. by White House social season.

**KILLED HER BRIDGE PARTNER**  
DETROIT, Feb. 9 (A. P.)—Because her bridge partner played the wrong card and killed her, Mary Lee Bishop shot at Mrs. Rosa Lee Henderson, Mrs. Bishop was sentenced to life imprisonment.



**Don't**  
let this happen  
in your home  
**BRIDGE**  
by Whitehead  
**THE REMEDY**

Don't kill your bridge partner for making errors—give him a copy of "Bridge," by Whitehead—he'll then become a very valuable partner. Maybe the shoe is on the other foot? Maybe every time you play your life is at stake. Read this little book on Bridge, by Wilbur C. Whitehead, the renowned authority. Let this expert tell you how to play—complete instructions by a new, easy, illustrated method. Each phase thoroughly and understandingly treated. The best players can learn much from this book. The beginner could find no more able instructor. Large size 9 x 12 inch book—beautiful colored cover—100 pages.

Mail This Coupon Now—Don't Wait!  
**EXPERIMENTER PUBLISHING CO.**  
230 Fifth Ave., New York, N. Y.

Experimenters Publishing Co., Inc.  
230 Fifth Ave., New York, N. Y.

Gentlemen: Kindly send me copy of "Bridge," by Whitehead. Enclosed is 50c

Name.....  
Address.....  
City..... State.....

**50c**



A five-tube radio of rare quality has been installed in the old chest—all-resistance coupling. Now, you radio fans can appreciate just what that means: quality, supreme quality, as befits such a rare, beautiful and romantic cabinet!

While the writer has several other radio sets, he and his wife call this the T C or Treasure Chest Set, and believe it to be the most unique, romantic and truly antique-modern radio receiver now in existence. And to the antiquarian or connoisseur who is looking for something really different and not easily duplicated, the search is ended.

However, the "T C" is not for sale at any price.

**IS IT HAUNTED?**

Considerable difficulty was experienced in getting a comparatively simple hook-up to function properly, when actually placed inside the cabinet. When this circuit was tried outside of the chest, the performance was all that could be desired. But when the chassis, with its assembled wiring, was secured into position inside, a woeful succession of moans, howls and unholy screeches of an entirely new order, as of some lost or tormented soul, came forth. This persistence of sweet concord without, and rank discord within, for no apparent or known reason, almost led one to wonder if the chest were haunted.

Could it be that some irresponsible and incorrigible "Neil Gwyn" of the past had returned to protest this invasion of her jewel case? Was some vengeful Tory, loyal to the King, the sender of a message that boded ill for our colonists and balked in his efforts, long since useless, raging in impotent wrath at this etheric disturbance from modern "mikes" and jazzing bands? Or, could it be that some boon companion or confere of our nationally-revered hero of a certain famous midnight ride, torn with the spirit of those turbulent days, was grumbling at having his sesquicentennial repose disturbed by such turmoil as "Reynard Strolls," "Baked-Bean Blues," "In My Pink Heaven," and sundry other sleep-destroyers?

Now, from Paul Revere to Paul White-man is quite a stride, not to say a jump of the imagination, the reader will admit. One rode, and the other rides well his "Pegasus" Our revered Rerere knew not his radio; but we have not the shadow of a doubt that, were he here now, he would not hesitate to become a member of the modern and honorable order of dial twisters.

Music hath charms to soothe the savage breast. . . The savage breast has been soothed. Did music do it? It has soothed others even more violent. But the fact remains that peace and sweet concord now reigns supreme within the walls of the Treasure Chest.

Could those walls talk, what stories they might tell of base intrigue, of soaring ambition; of gallant cavaliers and of curtsying dames, of powdered wigs and flashing beauty!

Tonight the syncopation of Paul White-man mingles with the stately minuet of the still more stately dames of the days of Paul Revere. The lilt of the sprightly tango is blended with the more dignified gavotte of the times of Washington and Dolly Madison; symphony and fox-trot, spirituals and slumber songs; the voice of a president and the bedtime tales of a sandman—all in tune with the memories replete with action and

full of romance. The most modern of sciences is wedded to ancient craftsmanship after a century and a half of waiting.

**TECHNICAL DETAILS**

In these columns will be found the complete schematic wiring diagram of the receiver which was built in the Treasure Chest. The circuit used, in its present form, is one originally designed by the writer's good friend, J. E. Roberts, of Cleveland, Ohio, to whom much credit should be given for many helpful suggestions. In this particular case, it was necessary to modify the circuit and coil windings, type of condensers, and particularly the output device to suit existing requirements.

The receiver comprises a five-tube circuit, comprising two stages of R.F., one tuned, one untuned; a regenerative detector; two stages of reflexed A.F. and two stages of straight A.F. The reflexing, as shown in the diagram, is made through resistance units; which constitutes the unique and outstanding feature of the circuit, giving supreme quality, and the selectivity of most supers, without the harmonics of this well-known circuit, and magnificent volume.

When the interior constructional view was made, the variable resistor for controlling regeneration was attached to the detector coil. Later, as the idea developed, the writer considered that, having shown the key in its ancient keyhole, it would be quite in keeping with the general fitness of things and the artistry of the work, to devise some means whereby manipulation of the regeneration control could be effected by direct connection with the key, as shown in exterior view. Therefore, since the above interior view was taken, this variable resistor has been mounted on a small bracket just inside of the keyhole. This was accomplished by removing the knob and filing the shaft down to a driving fit to enter a hole in the key. By this means control of regeneration is effected, thus enabling one to carry out the idea of the key unlocking the melodies from the Treasure Chest.

The circuit was designed to work on either loop or outside aerial and is so constructed at present; but, at the distance the set is located from the large broadcast stations (it is at Shepherdstown, W. Va.) it functions better on the outside aerial, and the loop is rarely if ever used. Last summer, when it was operated in Brooklyn, N. Y., reception was found ample on most local stations, when using but three tubes; and Detroit, Michigan, was pulled in several times with faint loud-speaker volume on a loop with the same number of tubes.

**RADIO TERM ILLUSTRATED**



C. MOLINELLI

"Attachment Cord and Plug"



# The New Neutroheterodyne Receiver

(Continued from page 1245)

secondary coupling, using detector regeneration, etc.; but these methods are not entirely satisfactory.

How, then, can we solve these two problems? Again the obvious answer is by means of the heterodyne circuit, which makes it possible to eliminate both difficulties at once without mechanical complication, and with an actual gain of amplification. By this means we reduce our tuning controls, electrically, to two dials and, since we amplify at only one frequency, the amplification is always uniform.

## A SATISFACTORY DESIGN

Thus a careful consideration of both the superheterodyne and the shielded-neutroheterodyne circuits leads us to the same conclusion—the desirability of using a shielded tuned-radio-frequency amplifier, of about 450-kc., as the intermediate amplifier of a superheterodyne. This combines the selectivity and ease of tuning of the ordinary superheterodyne with the high amplification and excellent quality of the shielded neutroheterodyne; and at the same time it eliminates the bad features of both types of circuit. The stability of this shielded intermediate amplifier, together with the fact that the tuning of this part of the circuit is fixed, makes possible the use of regeneration in the second detector. The intermediate-frequency stages may be carefully neutralized and adjusted to resonance by means of adjustable condensers, and after that require no further attention. Only one initial adjustment of regeneration is necessary.

The only difficulty that is likely to be encountered in the design of such a receiver is the interference of code stations operating at or near 450-kc. The tuning of the first detector is not sufficiently sharp to prevent this completely. The use of a wave trap tuned to 450-kc., located in the antenna lead, together with complete shielding of the first detector and oscillator will, however, entirely eliminate this type of interference, should it occur.

The receiver developed by the writer employs a totally-shielded and neutralized intermediate-frequency amplifier tuned to a frequency of 461 kc., or 650 meters; its circuit is shown schematically in Fig. 3.

Amplification is increased to a maximum by means of fixed regeneration in the second detector. Two stages of high-quality audio amplification, with a 210-type power tube in the last, insure ample undistorted loud-speaker output. In order to prevent interference from local broadcast and code stations, and to prevent direct radiation from the oscillator, both the first-detector and the oscillator stages are shielded. Provision has been made for controlling the volume from any point away from the receiver, and for connecting a phonograph reproducer directly to the audio amplifier. The set uses seven tubes, and occupies a space of only 7 x 21 x 10 $\frac{3}{4}$  inches.

## QUALITY AND DISTANCE

It has never seemed to the writer to be worth while to build up a receiver, however good it might be in all other respects, unless the quality was such as to approxi-

mate very closely that of the original transmission. Quality was, therefore, a primary consideration in the design of this receiver. The merits of the audio amplifier here used are so well known that it is hardly necessary to dwell long on this point. Suffice it to say that the rest of the receiver has been designed to prevent any possibility of distortion. When used with a high-quality cone speaker, the receiver will faithfully reproduce all the essential frequencies of a symphony orchestra, from the highest flute to the lowest drum.

Because of the variation of reception conditions from point to point, it means very little to say that at Ithaca, New York, it is possible to bring in with good volume stations in the four corners of the United States, and in Mexico and many parts of Canada. It is always possible to get down to the noise level with this receiver; and actual comparison shows it to have an amplification at least the equal of any seven-tube shielded radio-frequency receiver or any ordinary eight-tube superheterodyne (excepting, of course, receivers using the new screen-grid tube). Practically any night, and sometimes even during the day, it is possible to get ten or fifteen outside stations with ample volume when the second radio-frequency tube is removed from the set. (Energy is then carried through the dead stage by way of the neutralizing condenser.)

The selectivity of the superheterodyne receiver is well-known, and needs little further discussion. No difficulty is experienced at Ithaca in separating any two stations that do not actually heterodyne each other. Careful testing indicates, however, that tuning is sufficiently broad to pass the requisite band of frequencies, and discloses absolutely no evidence of the cutting of sidebands. This is to be expected, since the intermediate amplifier is really a shielded radio-frequency receiver, each stage of which tunes fairly broad. In a direct comparison with a shielded radio-frequency receiver, using the same audio amplifier and loud speaker, no difference in tone quality could be observed.

The fact that there are only two tuning condensers, and that the oscillator has only one setting for each station, makes tuning extremely simple.

The hook-up, as shown in Fig. 3, differs from that of the ordinary superheterodyne only in the addition of neutralization and shielding and in that the tuning of the intermediate-amplifier stages is adjustable. The intermediate frequency is kept at the chosen value of 461-kc. by means of the second-detector circuit, which has a fixed .0005-mf. tuning condenser; and the intermediate stages are tuned to match this. The output plate choke of the power stage and the choke in the "B+" lead of the first detector are mounted on the power unit in order to keep the size of the receiver as small as possible. Also, a second-detector choke is necessary to prevent the audio-frequency component of the first detector output from feeding directly to the audio amplifier via the common "B+" lead.

Volume is controlled by a 20-ohm rho-

List  
Price  
\$6.50



## Write for Full Details of the new CeCo R. F. 22

THE "Ceco" RF-22 is of the four-element shielded grid type, and can be used to advantage only in special circuits or equipment designed for its use. Its high amplification, constant and practically negligible control grid to plate capacity make this type of tube very efficient when used properly. The RF-22 is primarily designed to be used as a radio frequency amplifier and as such is capable of a voltage amplification of from 30 to 60 per stage, dependent upon circuit design. It may also be used as an audio frequency amplifier where resistance coupling is employed. One of the several uses of the RF-22 is that of a "Space Charge Grid" tube.



Write for  
descriptive circular

C. E. MFG. CO., Inc., Providence, R. I.

Largest Exclusive, Radio Tube Mfrs. in World

OVER 3 MILLION TUBES IN USE

**FREE** WHOLESALE RADIO CATALOGUE  
*The Book they are all talking about*

**WHOLESALE  
RADIO CATALOG**

Listing thousands of items in standard radio parts, Kits, Accessories, Complete Sets, Furniture, etc. Every Set Builder and dealer should have a copy. Real wholesale prices. Send for your copy today.

**THE HARCO COMPANY**  
1257 So. Wabash Ave. Chicago, Ill.

The HARCO CO., 1257 So. Wabash Ave., Chicago.

**PATENTS** As one of the oldest patent firms in America we give inventors at lowest consistent charge, a service noted for results, evidenced by many well known Patents of extraordinary value. Book, Patent-Sense, free.

Lacey & Lacey, 631 F St., Washington, D. C. Estab. 1869

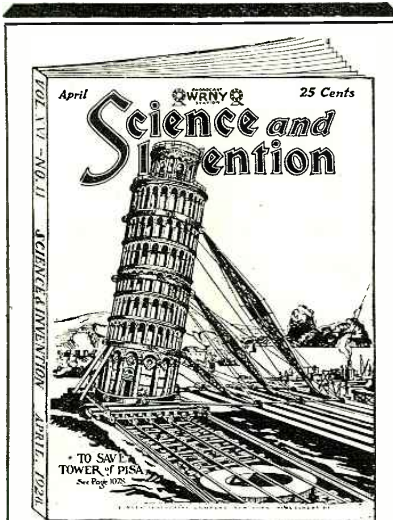

## A Review of World Progress

SCIENCE and INVENTION reflects every trend, every step forward in the world of progress. Each important development, every new invention of merit, is carefully reviewed in its pages. The readers of SCIENCE and INVENTION have learned, by years of acquaintance, to place their entire confidence in its editorial exactness.

New theories, scientific phenomena, astronomy, radio, every field of Science or Invention is thoroughly covered and unbiasedly reviewed in the pages of this remarkable magazine.

Each month you can obtain a new issue of SCIENCE and INVENTION from your news dealer. The copy, 25c. Yearly subscription, \$2.50.

Over 100 beautifully illustrated pages—large magazine size

Experimenter Publishing Co.  
230 FIFTH AVENUE  
NEW YORK, N. Y.

stat in the filament circuit of the first intermediate-frequency tube. This method makes possible the variation of volume from zero to a maximum without distortion. The jack which is mounted on the panel provides for the insertion of an external 20-ohm rheostat in place of that on the panel; so that volume may be controlled from a point away from the set. Since one side of the rheostat connects to ground, through "A—," it is necessary only to run one wire from the tip of the plug in order to vary the volume from another point in the house.

(To be continued)

## Compensating Line-Voltage Variations in an Electric Set's Power Supply

REPORTS received from the owners of receivers employing A.C. tubes of the new 226 and 227 types vary widely as to the results obtained. In most cases the tubes have given entirely satisfactory service, and the reproduction obtained from the receiver is all that could be desired. On the other hand, there have been received some complaints that the life of the new tubes is rather short, with the result that the cost of replacement has been rather heavy.

Due to the experience of a few experimenters who have found that their tubes burn out at too-frequent intervals, the rumor seems to be quite prevalent, that a large number of the new A.C. tubes are defective. However, this is not necessarily true, while investigation seems to indicate that it is false. It has been discovered that, in practically all cases where short tube-life is experienced, the trouble is due to the application of excessive voltage overloads to the tube filaments; resulting from a high line-voltage at the house lighting source, without suitable means of regulation in the power unit of the receiver.

In operation, A.C. tubes are no more critical as to filament voltage than standard tubes of the 201A type; but trouble is caused by the fact that the house-lighting circuit sometimes does not provide as constant a source of potential as does a storage battery. In the case of the latter, the maximum voltage in the filament circuit is known to be 6 volts, and it is possible to insert ballast resistors in the circuit and reduce the potential to the value required by the tubes. In this way it is possible to operate a receiver without any danger of overloading the filaments. In contrast to this, there is no definite maximum voltage of an A.C. house-lighting circuit. These circuits are usually rated at 110 volts but, during the day, the voltage may vary all the way from 90 to 125 volts in extreme cases; and for this reason some form of voltage regulator is needed in every radio power unit. Voltage variations are not as great in the large cities as in the rural districts where elaborate regulating devices are not provided; but in all cases it is wise to use some type of voltage control.

### TESTING LINE VOLTAGE

A satisfactory solution to the problem is found in connecting a power-rheostat in series with the primary (110-volt) winding of the filament-supply transformer, and with this instrument the filament potentials of all tubes may be adjusted simultaneously. After the construction of the receiver has

The water or heating pipes serve as the other line.

A second jack is provided for connecting an electrical reproducer to the audio amplifier, and automatically cuts off the filaments of all but the audio-amplifier tubes. The first detector, as well as the intermediate-frequency stages, must be neutralized; since the primary of the first intermediate-frequency transformer is in the plate circuit of the first detector, and therefore tends to produce regeneration unless the neutralizing winding is used.

been completed, the resistors in series with tube filaments should be adjusted and checked with an A.C. voltmeter until each tube receives exactly the correct voltage. When a set has been adjusted in this way an adjustment of the master rheostat in the primary winding of the transformer will bring all filament circuits back to the correct voltages, whenever the line voltage increases or decreases, as the case may be.

When operating a receiver with a master rheostat connected as described, a wise habit for the owner to cultivate will be the practice of setting the rheostat so that the filament-current adjustment is at a *minimum*, every time when he is turning off the set. If this plan is followed, the danger of overloading the filament will be greatly reduced; but it becomes necessary to increase the voltage to the proper value each time the set is used. On the other hand, if the set were not adjusted each time, there would be little advantage in having a master rheostat. It may also be suggested that a 150-volt A.C. voltmeter will be a great aid when adjusting the master rheostat; as it will remove the guesswork which is usually involved in the regulation of filament current. The increase in the life of the tubes used would probably pay the cost of the meter in a very short time.

In rural districts where the power supply is known to be very irregular, it will be wise for the radio listener to investigate conditions before deciding to use an A.C. set. In some places there are continual line-voltage fluctuations which would make it very unsatisfactory to attempt the operation of an electric radio receiver.

A RADIO QUACK

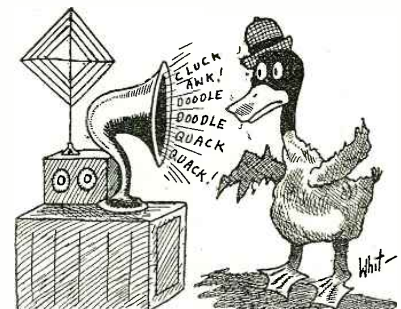

"I don't know what he's saying; but it sounds like fowl language to me!"—MAX WATSON.

# Quartz Crystals Control Television Apparatus

(Continued from page 1231)

age to alternate rapidly, we cause very slight twistings and untwistings of the crystal, and these are most effective at a certain frequency, depending on the size of the crystal. This adjustment is very critical, and renders possible a remarkable degree of accuracy in the regulation of oscillating radio circuits.

### THE INVISIBLE PENDULUM

Just as a clock's pendulum has a funda-

Europe, and compared with standard oscillators in England, France, Germany, and Italy. It was found that the accuracy of regulation obtained by the crystal is within a variation of but thirty cycles in the million; or, if it governed a clock with a million ticks a second, it would vary not more than a minute and nineteen seconds a month!

The crystal of quartz occurs, in nature, in the shape of a six-sided prism, with two pointed ends; something like the glass pen-

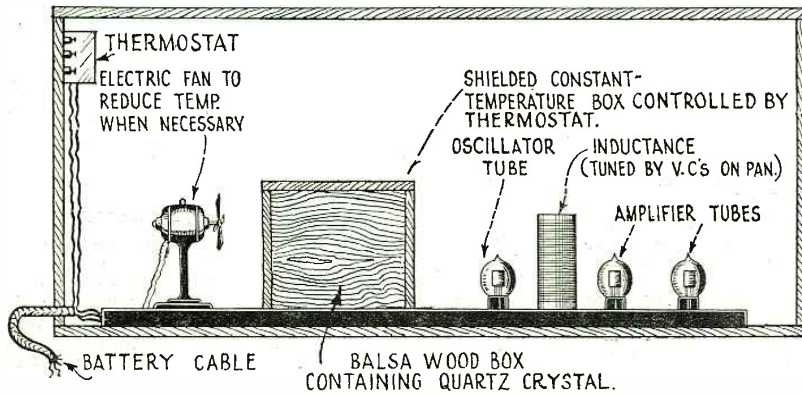

Fig. 6—Elaborate precautions are taken to keep the crystal at an even temperature, by a double system of thermostatic control. The apparatus inside the balsa-wood box is shown on page 1283.

mental frequency depending on its length, so has the crystal a fundamental frequency which depends on its size. A pendulum governs a clock by allowing the wheels to move only between intervals regulated by its natural period of swing. But in order to have a clock regulated at intervals of one one-millionth of a second, it would be necessary to have a gravitational pendulum only one twenty-five-billionth of an inch long. A pendulum of this frequency is provided by the molecules of a quartz crystal cut to a frequency of 1,000 kilocycles, under the influence of a suitably-adjusted circuit.

Such a crystal oscillator was recently built by the Bureau of Standards, taken to

dants which are often hung from chandeliers. In order to make it suitable as a "piezo-electric" governor of the frequency of electrical apparatus, it has to be cut down; the more it is reduced in size, the lower the wavelength corresponding to its fundamental frequency. The preparation of a crystal for use in this manner is shown in one illustration, and the cut-and-tested crystal, mounted for use in its oscillator, in another. The crystals are carefully ground to size on special grinding wheels, and are checked in the laboratory before being mounted.

A second important thing is that the frequency which the crystal will pass is con-

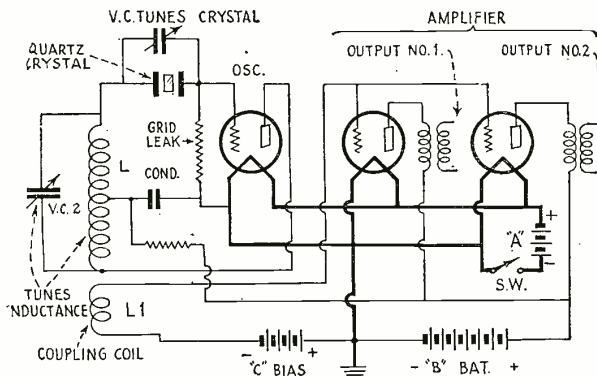

FIG. 4

The schematic hook-up of the crystal-controlled oscillator circuit and the amplifier which it regulates; the condenser, V.C. permits very slight changes in the adjustment of the oscillator's frequency. VC2 tunes the principal inductor of the Hartley circuit, which is coupled to the amplifier-tube grids through the pick-up, L1. The output is a true alternating current of very constant frequency.

## New AERO Circuits For Either Battery or A. C. Operation

Proper constants for A. C. operation of the improved Aero-Dyne 6 and the Aero Seven have been studied out, and these excellent circuits are now adaptable to either A. C. or battery operation. A. C. blueprints are packed in foundation units. They may also be obtained by sending 25c for each direct to the factory.



### AERO Universal Tuned Radio Frequency Kit

Especially designed for the Improved Aero-Dyne 6. Kit consists of 4 twice-matched units. Adaptable to 201-A, 199, 112, and the new 240 and A. C. tubes. Tuning range below 200 to above 550 meters.

This kit will make any circuit better in selectivity, tone and range. Will eliminate losses and give the greatest receiving efficiency.

Code No. U-16 (for .0005 Cond.)..... \$15.00  
Code No. U-163 (for .00035 Cond.)..... 15.00



### AERO Seven Tuned Radio Frequency Kit

Especially designed for the Aero 7. Kit consists of 3 twice-matched units. Coils are wound on Bakelite skeleton forms, assuring a 95 per cent air dielectric. Tuning range from below 200 to above 500 meters. Adaptable to 201-A, 199, 112, and the new 240 and A. C. tubes.

Code No. U-12 (for .0005 Cond.)..... \$12.00  
Code No. U-123 (for .00035 Cond.)..... 12.00

NOTE—All AERO Universal Kits for use in tuned radio frequency circuits have packed in each coil with a fixed primary a twice matched calibration slip showing reading of each fixed primary AERO Universal Coil at 250 and 500 meters; all having an accurate and similar calibration. Be sure to keep these slips. They're valuable if you decide to add another R. F. Stage to your set.

### A NEW SERVICE

We have arranged to furnish the home set builder with complete Foundation Units for the above named Circuits, drilled and engraved on Westinghouse Micarta. Detailed blueprints for both battery and A. C. operation and wiring diagram for each circuit included with every foundation unit free. Write for information and prices.

You should be able to get any of the above Aero Coils and parts from your dealer. If he should be out of stock order direct from the factory.

## AERO PRODUCTS, Inc.

Dept. 105  
1772 Wilson Ave. Chicago, Ill.

**FREE!** 30 DAY TRIAL of **Powerful 6-7 or 8 Tube Guaranteed RADIO**

Radio's most amazing "bargain direct" from big, reliable maker (9th successful year). All Electric or Battery sets. Consoles or table cabinets. Not buy unless 30 days trial proves Miraco unbeatable at 2 to 4 times the price for selectivity, distance, volume and rich, Cathedral tone. Turn 1 dial for all stations. Completely assembled, fully guaranteed sets!

**BIG DISCOUNTS to User Agents**

Free literature, users' testimony and Big SPECIAL OFFER!

**MIDWEST RADIO CORPORATION**  
Pioneer Builders of Sets  
404 Miraco Bldg., Cincinnati, O.

**RETAIL \$36.75 to \$69.75**

Your Next "B" Power Supply Had Better "B" the **NATIONAL BETTER "B"**

**NATIONAL CO., INC. MALDEN, MASS.**

# The STROBODYNE



The Greatest Super Heterodyne of the age!

# Build

the CONSRAD way

The STROBODYNE has been classed as the greatest Super-Heterodyne of the age. The Strobodine is an eight-tube circuit employing as its basic principle what is known as the "Stroboscopic Phenomenon." It is from this Phenomenon that it gets its name. Those men of the Radio Industry who are best fitted to pass judgment on the merits of any new Radio development have pronounced the STROBODYNE the greatest Super-Heterodyne ever developed.

Consrad, the famous Pattern Publishers of Radio, have assembled the entire constructional data in a new and most convenient form. The new Consrad pattern comprises four full-size blueprints and all the data required for assembling the STROBODYNE. There is a sixteen-page booklet fully explaining the principles of its construction and giving a step-by-step instruction for the efficient assembly of parts.

Write now! Don't wait!—get a Consrad pattern for this remarkable circuit. You will enjoy building this foremost set of the day. You cannot help but be pleased by the results that are sure to be yours when you build the Consrad way.

COMPLETE **50c** PLANS

THE CONSRAD CO., INC.  
230 Fifth Avenue New York, N. Y.

THE CONSRAD COMPANY, Inc.  
230 Fifth Avenue, New York, N. Y.  
Gentlemen: Enclosed is fifty cents. Kindly send me the complete Consrad Pattern for the STROBODYNE.

Name.....  
Address.....  
City..... State.....



The new screen (Fig. 3, right) contains twice as many distinct luminous points as the old one (Fig. 2, left); and therefore brings out every feature twice as sharply. The neon tube covers an area 24 x 36 inches, with the largest television image yet produced.

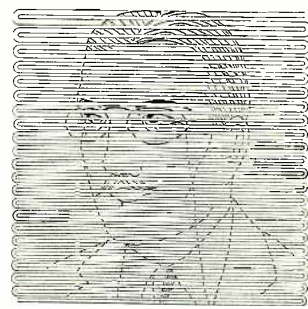

trolled by temperature changes. Therefore, as may be seen from the accompanying view of the quartz-crystal-oscillator set-up, the crystal is mounted in a wooden box, in which the air is maintained at a constant temperature by means of thermostats. When the temperature rises, say above 70 degrees, inside the crystal cabinet, thermostats cause the temperature to be lowered by connecting in circuit an electric fan, which lowers the temperature; if the temperature drops below 70 degrees, the thermostats connect electric heating coils in the circuit, and thus the air is warmed to the proper degree. The two meters at the left of the panel of the oscillator indicate the currents passing in the tube circuits; while the two dials at the right of the panel are for adjusting the efficiency of the oscillator.

#### INDEPENDENCE OF SYNCHRONIZATION

For the purpose of a television-frequency control, as the pictures and diagrams herewith illustrate, a quartz crystal is connected to a vacuum-tube oscillator, together with a suitable vacuum-tube amplifier; the "sine-wave" alternating-current output of this set-up is fed into a high-frequency synchronous motor, mounted on the disc-driving shaft beside a 60-cycle synchronous motor. As the reader will probably recollect, in the Bell television system each disc-driving shaft carries a 60-cycle synchronous 110-volt A.C. motor; and also a special high-frequency A.C. motor; the high-frequency motor is used to improve the synchronism or constancy of revolution of the disc, because a slight slippage or variation in the speed of the high-frequency motor will not be so noticeable as a corresponding variation in the case of a low-frequency motor. Between the two motors a very accurate constancy of rotation is maintained.

In fact, the writer is informed by the engineers who have perfected the quartz crystal for use with the television apparatus, that the accuracy of the speed as related to perfect synchronism has reached the order of one part in a million. This means that the discs of the transmitter and the receiver, respectively, may rotate one million times and not be out of step, during that time, more than one revolution. A correcting button, however, is placed on the television machine cabinet, so that in the event that the picture should "drift" or become distorted, once in a great while, perfect synchronism can again be established by simply pressing a button.

If no voice is to be transmitted, then a single wire or radio channel serves to carry the image-current or wave, as one of the diagrams herewith shows. If the voice is to be transmitted simultaneously with the picture image, then two two-wire circuits are to be used, requiring four wires; or, by utilizing two different carrier-currents and super-imposing these on one two-wire me-

talic circuit, both the image- and the voice-currents can be carried to the receiver; or thirdly, if radio transmission between the transmitter and the receiver is to be utilized, the voice current may be super-imposed, through a suitable filter, upon the same antenna which is radiating the image-wave. At the receiving station, for instance, the two waves are picked up and selected by a special superheterodyne or other receiving apparatus; one amplified wave is then passed on to the television part of the machine, and the other to the A.F. amplifier and the loud speaker for voice reproduction.

#### ENGINEERS IMPROVE CLEARNESS

The press reports, released from the Bell Laboratories recently, stated that their engineers have markedly improved the detail or grain of the picture at the receiving end of their television system. Inquiry of the engineers disclosed the fact that this improvement, in grain or quality of the picture, has been accomplished by redesigning the large exhibition screen, measuring 24 by 36 inches. This refinement in the screen detail or fineness of the picture, and therefore its quality, is brought about by incorporating more convolutions in the neon tube forming the "grid," on which the image is reproduced; and also by mounting a greater number of tinfoil segments along each leg of the sinuous glass grid tube. In the old exhibition-size television screen, there were 50 convolutions of the neon-gas-filled tube and, along each limb of this glass tube, there were 50 tinfoil segments. Thus, there were 2,500 tinfoil segments, in all, on the old screen; the new screen contains 72 convolutions of the neon tube, and along each limb there are 72 tinfoil segments. The total of tinfoil segments, therefore, is 5,184, or a little more than twice the number on the old screen. This gives us, therefore, twice the detail and quality in the reproduced image as compared to that projected on the old screen.

#### HOOK-UP OF CRYSTAL

In Fig. 4 we have the electrical connections of the quartz crystal, in the oscillator-amplifier hook-up used in the latest Bell television system. As will be seen, the quartz crystal, a given size of which passes only a single definite frequency at a certain temperature, is connected in series with the grid of the oscillator and the tuned inductance "L" of the oscillator circuit. In the quartz-crystal oscillator illustrated here, one of the tuning dials at the right of the panel controls the variable condenser VC2, which is shunted across the oscillator inductance "L", functioning in the well-known Hartley fashion. Of course it is understood that VC2 is so adjusted that the closed resonant circuit L-VC2 is tuned to the same frequency for which the quartz crystal has been ground. Whenever the condenser

VC2 is changed, in order to tune this circuit to a frequency in a different band, another quartz crystal, calibrated for the approximate value of the new frequency or wavelength, is placed in the temperature-controlled receptacle housing the crystal.

The second variable-condenser dial, appearing at the right of the panel, is used for the purpose of tuning the quartz crystal; and certain "plus" or "minus" corrections or adjustments in the frequency to which the crystal responds are thus made by means of this dial. In other words, the quartz crystal is ground and "lapped" in the laboratory until it is brought to the proper size, corresponding to the desired frequency. But, if it does not respond naturally to that exact frequency, it may be made to do so by carefully adjusting the variable condenser dial VC.

As the diagram shows, the output of the amplifier may be taken from either the first or the second stage. A "C" bias is placed on the grids of both amplifier tubes, as indicated; and the grid circuits of these tubes are coupled to the Hartley-oscillator inductance "L", by the coil LI.

The output of either of the amplifier stages of the oscillator set-up, is in the form of a "sinusoidal" or alternating current, the frequency of which is maintained to an astonishingly high degree of accuracy. One of the problems met, in maintaining constant the frequency with such a quartz-controlled oscillator, lies in providing a very stable and constant grid-leak resistor; for this particular circuit there has been developed a resistor of new type which will not vary as much as 0.1 per cent. Fluctuations or variations in the battery voltage are an important source of trouble; but these voltages are now maintained sufficiently constant, with a plus or minus variation of about 2 per cent. The variation in the oscillator's frequency from this cause is only about three parts in 10,000,000. It is also possible to compensate the circuit; so that variations in voltage will result in offsetting a change in frequency in one direction by setting up an equal and opposite reaction.

REGULATING THE HEAT

Referring to the detailed illustration of the quartz crystal and its mounting, the crystal vibrates along the longitudinal axis, or line of its greatest length. It is separated from the metal plates by silk threads, which also support it. Within the balsa-wood box which houses the crystal, the temperature must be kept the same at all times, within 1/20th of a degree (F.), in order to reduce frequency variations due to the heat of the crystal (and its consequent changes in size) to one part in ten million.

(The frequency of the crystal is affected also, slightly, by changes in atmospheric pressure; as explained in a paper presented to the Union of Scientific Radio Telegraphy at Washington, Oct. 13, 1927, by J. W. Horton and W. A. Morrison.)

The quartz crystal in its mounting (as shown in the picture) is placed within a steel cylinder which (see Fig. 5) has hollow walls within which mercury is placed. Whenever the temperature rises it causes the mercury to expand into a "capillary" (very fine-bore) tube which contains an electrical contact of tungsten wire. At the predetermined point, the mercury reaches the tungsten wire and operates a relay, opening the circuit through a heating coil

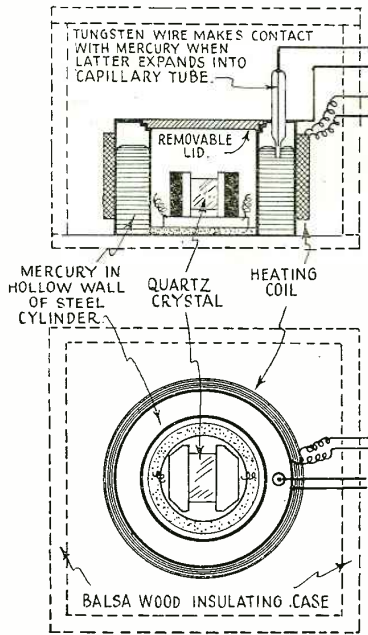

FIG. 5

The quartz crystal is kept inside a jacket of mercury; the slightest change in the temperature of which makes or breaks the electrical circuit of the heating coil, and thus keeps the temperature even.

wound around the outside of the steel cylinder. When the temperature falls sufficiently, the heating circuit is again closed. By this means the temperature in the cylinder is kept very uniform.

The cylinder with the mercury-filled wall has lids at top and bottom; and this miniature "safe" with its crystal, which may be indeed called a precious stone (it is "rock crystal," the same mineral of which many of the "diamonds" you see in cheap jewelry are composed; but the value is in its careful cutting and adjustment) is placed in a balsa-wood box for protection against external changes of temperature. The box is visible, in the panel view of the oscillator apparatus, as the square object above the panel in the center of the apparatus. (See also Fig. 6.) The entire assembly, with the oscillator-panel, inductance, amplifying tubes, ventilating fan, etc., is in turn placed within a larger closed cabinet; the air in which is regulated to a constant temperature by a thermostatic apparatus.

From Fig. 4 it will be seen that a resistor is connected in series with the "B" plate supply to the oscillator tube, to keep the plate voltage on this tube at a low value. This is for the reason that some energy is dissipated within the crystal; and the energy dissipated varies approximately as the square of the plate voltage. This phenomenon is important with regard to the system maintaining constant the temperature of the crystal when in operation; for it will now be seen why the temperature of the crystal is not exactly that of the air surrounding it.

WHY DADS LEAVE HOME

"Papa," inquired Junior, "if a bicycle is a two-wheeled vehicle and a tricycle is a three-wheeled vehicle, how many wheels has a kilocycle got?"—H. N. Webster.

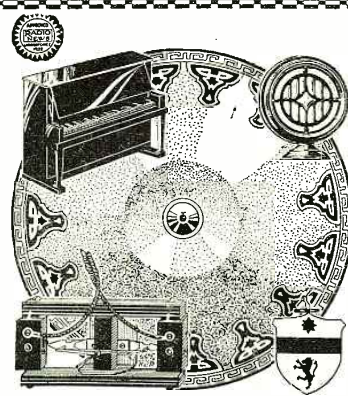

Mozart-Radioceiver Speakers and Speaker Units

FOR SEASON 1928-9

FANS who know that the Loud Speaker Unit is the very heart of any Radio, are demanding better and better performance, hence the reason for the Radioceiver Twin Balanced Armature, far outselling all others in this market.

Here indeed is true Push-Pull Tone Reproduction at a fraction of the cost it can be obtained in any other way, and with the very minimum of current consumption, and voltages ranging all the way from 90 to 400.

And for those who want a good cone unit at a lower figure, we offer our single balanced armature, which will outperform most others selling at twice its price.

Or in a complete speaker, our Mozart 26-in. Wall-Cone (not a kit) and Drum Type with these units, are guaranteed on a money-back basis to excel in appearance and performance all others in their class.

- Single Unit, 5 ft. cord (1150 ohms)..... \$4.00
- Twin Unit, 10 ft. cord (2000 ohms)..... 6.00
- 26-in. Wall Cone Speaker, Single Unit..... 8.00
- 26-in. Wall Cone Speaker, Twin Unit..... 10.00
- Drum Type Speaker, Twin Unit..... 15.00

THE FERGUS CO.

239 ELIZABETH AVENUE  
NEWARK, N. J.

DEPENDABLE "B" BATTERY POWER

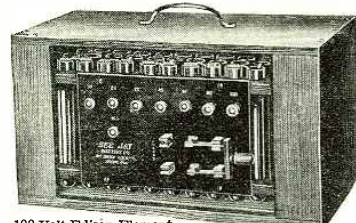

100 Volt Edison Element.  
Non Destructive, Rechargeable "B" Battery with charger. Shipped dry with solution, \$12. 140 Volt with charger, \$17. Free sample cell. See how it operates.  
SEND NO MONEY—PAY EXPRESSMAN  
Write for our Free Illustrated 28-page Booklet  
SEE JAY BATTERY CO., 915 Brook Ave., New York

FORMICA KIT PANELS

Drilled and decorated for leading kit sets are available through leading jobbers everywhere.  
THE FORMICA INSULATION COMPANY  
4614 Spring Grove Avenue, Cincinnati, Ohio

# SMATTER POPTER

The funniest comic in America, 'Smatter Pop' will keep you in stitches from the moment you open it until you have read and reread every page time and time again. Fifty full-page comics in this edition of 'Smatter Pop'—Hundreds of real laughs. C. M. Payne sure knows how to get under your skin and bring out every laugh in your system.

Meet "Pop." "Desperate Ambrose," and Pop's little family. They can make you laugh when everything else has failed. Ask your newsdealer or, if he can't supply you, fill in the coupon and mail to us. The funniest comic ever written. Don't miss it! Get your copy now! Barrels of FUN!

**EXPERIMENTER PUB. CO.**  
230 FIFTH AVE.  
NEW YORK CITY

LISSEN---'SMATTER POP IS WHAT I'M  
LOOKING FOR. 'SMATTER POP I SAY! SO  
DONT HOLD ME UP. DONT HOLD ME UP  
MAIL MY COPY NOW---NOW I SAY---  
HERE'S MY QUARTER---MY TWENTY-  
FIVE CENTS-----SO RUSH.

NAME.....  
ADDRESS.....  
CITY..... STATE.....

APOLOGIES TO C.M. PAYNE

## A Simple "Extension" Two-Tube Receiver

(Continued from page 1229)

that is, each wire is connected directly from one instrument to the next without regard to appearance. This makes possible the use of the least amount of wire, and, as a result, prevents many electrical complications. All connections should be properly soldered and, if tinned wire is used, this is very easily accomplished, even by a novice at soldering.

### COST OF PARTS

Even when the best parts are used the cost of this set is very low. The beginner is warned, at the start, not to try to save money by selecting second-class apparatus. If it is found that the total cost of the parts exceeds the amount allowed by the family budget, it will be better to save money on the decorative items, such as the dials and the cabinet, rather than on the electrical parts. Inferior parts are incapable of giving the results which may be obtained from apparatus of good quality; almost always it will be found that they are inefficient electrically or their mechanical construction is poor, and, in either case, the result is highly undesirable.

In the construction of the set there are only two semi-expensive parts required (the two variable condensers) and these should not cost over five dollars each. The coils may be home-made, if it is so desired; or factory-built units may be purchased. The remaining parts are few in number and very inexpensive.

Before explaining the construction of the set the operating features will be considered. Of course, unless the builder wishes to build or buy a power unit, batteries are required. For the filament or "A" current supply, either dry cells or a storage battery may be used. If 201A-type tubes are used in the sockets of the set, a 6-volt storage battery is needed; but, if 199-type tubes are employed, the set may be operated with three No. 6 dry-cell batteries connected in series. The set may be used with tubes of either type, provided the proper filament-

### BUILD YOUR OWN EXPONENTIAL HORN

This marvelous 17x21-in. exponential horn with a 96-in. air column can be easily built by any amateur of 14-in. soft wood, which produces the most wonderful tone quality. We furnish you with a set of **FULL-SIZED PATTERNS**, which have been accurately and scientifically worked out according to the exponential principle. Simply saw out the wood to the size and shape of the patterns and nail and glue together and you have the latest and

**MOST EFFICIENT TONE PRODUCER**

Send \$2.00 for a set of these full-sized patterns and complete instructions, or we can furnish you the **COMPLETE KIT**, which includes the wood cut to fit, the nails, the glue, our large-sized **CONCERT UNIT**, and full instructions. All complete with postage prepaid for \$11.75. Ask Your Dealer

**RADIO PRODUCER COMPANY**  
1245 Jefferson Bldg. Peoria, Ill.

## HOTEL FORT SHELBY

Lafayette and First, DETROIT

22 stories; 900 rooms; beautifully furnished; every convenience. Shopping, theatrical and financial districts practically at the door. Comfortable rooms at \$2.50, \$3, \$4 a day; also higher-priced rooms and suites overlooking city, river, and Canadian shore. Servidor throughout. Guests' cars delivered without special service charge.

J. E. FRAWLEY, Manager

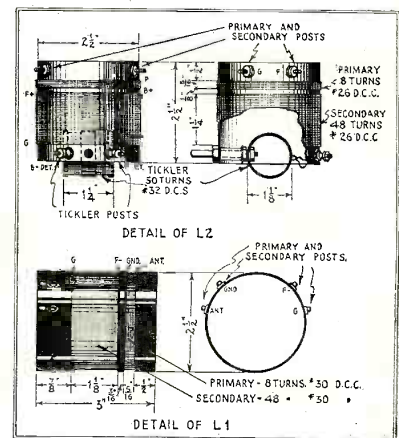

Constructional details of the antenna coupler, L1, and the detector-circuit tuner, L2.

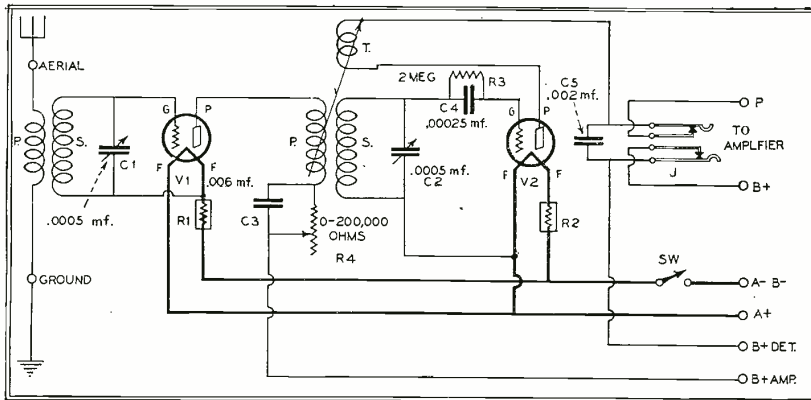

The "schematic" diagram of a two-tube receiver which may be used with any type of A.F. amplifier. Headphones also may be plugged into the jack, J.

Ballast units are used at R1 and R2 in the circuit (see above). For the plate voltage of the set, 90 volts of "B" batteries are required. As the set uses only two tubes it is not absolutely necessary to buy the heavy-duty batteries; but a large battery will be found more economical than the smaller size which is intended primarily for use in portable receivers. In addition to the batteries, the only accessories required for the operation of the receiver are

either R4 is at all critical when tuning in stations. In the lower left corner of the panel the battery switch (Sw) is located; and in the corresponding position at the right the jack for the headphones is located. Also, if the set is to be used in connection with an audio amplifier, this jack makes it possible to plug in on the detector circuit with headphones at any time.

LIST OF PARTS

A complete list of the component parts

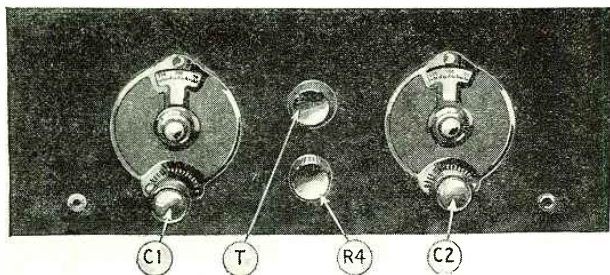

The front view of the Beginner's two-tube tuned-radio-frequency receiver. C1 and C2, condenser controls; T, tickler control; and R4, volume control.

a pair of headphones and plug, an aerial with its lead-in, a ground connection and a lightning arrester.

The actual operation of the receiver will be found very simple as there are only two dials and two knobs which will ever require adjustment. The two dials (C1 and C2) are the "wavelength controls" of the receiver, and both of these dials are set in approximately the same position when the set is correctly tuned to any station in the broadcast waveband. The knob marked T is the "regeneration control," and the knob marked R4 the "volume control." Neither

necessary for building this receiver, with their designations in the diagrams and pictures, is as follows:

- One front panel, of bakelite or hard rubber, 18 x 7 x 3/16-inches;
- One baseboard, of wood, 16 x 7 x 1/2-inch;
- One "antenna coupler," L1 (For details see text and diagrams);
- One "detector-circuit tuner," L2 (For details see text and diagrams);
- Two variable condensers, .0005-mf., C1 and C2;
- Two vacuum tubes, 201A- or 199-type, V1 and V2;

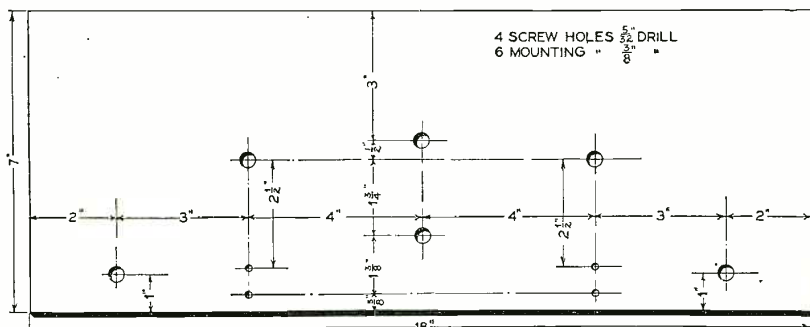

How the front panel is drilled for the condensers, switch, jack, regeneration control, and variable resistor in the two-tube receiver.

# FERBEND LEADS AGAIN!



NOW!—Lowest-Priced Quality Tube "B" Eliminator **\$18.50**

Since 1921 Ferbend Products have been famous for outstanding quality and long-life efficiency at lowest prices—prices "Within Reach of All."

The new HEAVY DUTY "B" Power Unit is no exception. In workmanship, performance, materials and appearance it is the equal of any. We INVITE comparison.

SEE YOUR DEALER, OR SEND DIRECT

Shipment will be made upon receipt of price or C. O. D. Use for ten days to convince yourself—then if not satisfied write us within that time and purchase price will be refunded. Order today.

Complete, Including Long Life Perfected 85 MIL. TUBE Delivers up to 180 volts on any set **DRY** No Liquids or Acids **10 Days' Trial**

Send for Literature.

## FERBEND ELECTRIC COMPANY

425 WEST SUPERIOR STREET CHICAGO, ILL.

# M&H

Radio's largest kit supply house

ESTABLISHED 30 YEARS

### We Have Complete Kits for All Circuits

Now appearing or which have appeared in "Radio News" and other publications

#### Set Builders

It will pay you to send for our Circuit Booklet and Catalog

Our Excellent Facilities and a Trained Technical Staff are always ready to give you the same service that has satisfied thousands since Radio became popular.

**M. & H. Sporting Goods Co.**  
512 Market Street Philadelphia, Pa.

### SAFEGUARD YOUR RADIO SET!

By placing a Radio Fuse in your set you can guard against Burnt-out Tubes, Coils and Transformers, Fire, Drained "B" Batteries and Damaged Eliminators caused by accidentally short-circuited or misconnected "B" battery or eliminator. Our Radio Fuse can be placed in the "B" circuit of any set using quarter-ampere tubes. Price, Fuse and Block, 25 cents. Extra fuses 10 cents each.

Oak Park Mfg. Co., Lock Box 524, Oak Park, Ill.

### RAISE BELGIAN HARES

MAKE BIG MONEY—We Supply Stock and pay you following prices for all you raise:

New Zealand Reds \$2 each—Flemish Giants \$3 each  
Belgian Hares \$2 each—New Zealand \$3 each  
Chinchillas \$4 each—Flemish Giants \$5 each

82-page illustrated book, catalog and contract, also copy of Fur Farming magazine, tells how to raise skunk, mink, fox, etc., for big profits, all for 10c.—Address **OUTDOOR ENTERPRISE CO., Box 73, Holmes Park, Missouri**

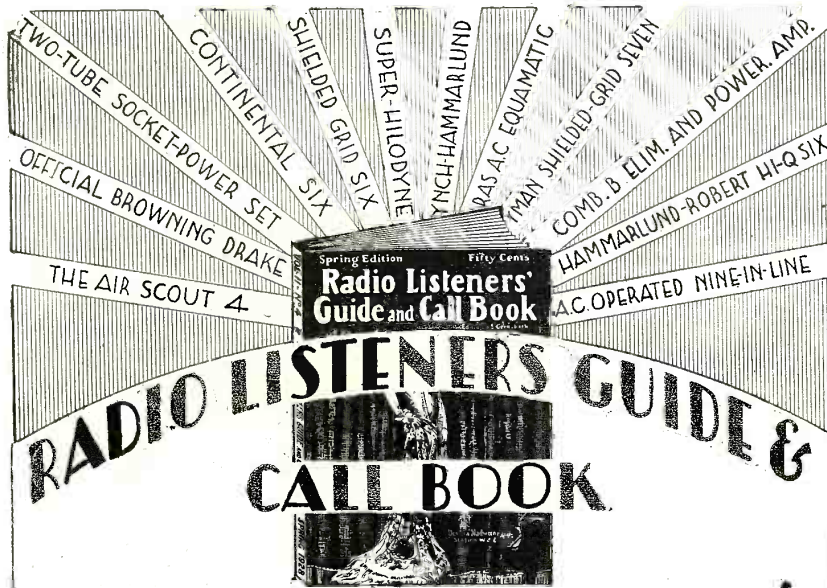

*These are the circuits to build!*  
**FULL CONSTRUCTIONAL DATA.**

Follow the trend of radio—read the **RADIO LISTENERS' GUIDE and CALL BOOK**. Full constructional data for the above circuits, also for many others. The **RADIO LISTENERS' GUIDE and CALL BOOK** is the accepted chronicle of the latest developments of the **RADIO WORLD**.

Learn how to improve your set by simple little adjustments and changes.

Besides the constructional data there is a complete and up-to-date list of all radio stations—their owners, call letters, wave length and power (watt), also their locations.

No home is complete without this accurate guide.

The **RADIO LISTENERS' GUIDE and CALL BOOK** is revised and brought up to date quarterly.

**Now!** Over 200 pages, fully illustrated  
**Price Only 50c.**  
**Mail This Coupon** If your dealer cannot supply you order direct  
*On all newsstands*

CONSRAD COMPANY, INC.  
 230 Fifth Avenue, New York City, N. Y.  
 Gentlemen: Enclosed find 50c., for which send me a copy of the latest issue of **RADIO LISTENERS' GUIDE AND CALL BOOK**.

Name.....  
 Address.....

**Balkite**  
**Radio Power Units**

Fansteel Products Co., Inc., North Chicago, Ill.

**SEND FOR FREE CATALOG**  
 From Chicago's Oldest Radio Jobbers. The most valuable Radio Catalog. Write for your copy today—**IT'S FREE!** Write for your copy today—**IT'S FREE!**  
**TELEPHONE MAINTENANCE CO.**  
 123-5 S. Wells St., Dept. 76 Chicago, Ill.

**CONDENSERS and VERITAS RESISTORS**  
 Stand up on their Jobs  
 \*Tobe Deutschmann Co., Cambridge, Mass.

**C. L. PARKER**  
 Ex-Examiner U. S. Patent Office  
 Attorney-at-Law and Solicitor of Patents  
 McGill Building, Washington, D. C.  
 Patent, Trade Mark and Copyright Law

**WRITE**  
 For Our 32 Page  
**Radio Instrument Catalog**  
 No. 15-C  
**JEWELL ELECTRICAL INSTRUMENT CO.**  
 1650 Walnut St. Chicago

**\$21 WARREN B**  
 For 1 to 10 tubes. Complete with tube. Guaranteed. Was \$35. Now **DIRECT** to you. \$21.00. Write:  
**WARREN ELECTRIC CO., Dept. R.N., Peoria, Ill**

- One mica-type grid condenser with grid-leak clips, .00023-mf., C4;
- One grid leak, 2-megohm, R3;
- Two "filament-ballast" resistors, 201A- or 199-type (depending on the tube), R1 and R2;
- One mica fixed condenser, .006-mf., C3;
- One mica fixed condenser, .002-mf., C5;
- One double-circuit jack, J;
- One volume-control resistor, 0 to 200,000 ohms, R4;
- One battery switch, Sw;
- Two vernier dials;
- Two "cushioned" vacuum-tube sockets, UX-type;
- Two binding posts marked "Aer." and "Gnd.";
- One binding-post strip;
- One roll of flexible insulated wire for connections;
- One table-type cabinet.

Before buying the parts listed above it is necessary to decide whether you wish to build or buy the two coils required. If you decide to wind the coils at home the cost of the set may be materially decreased; as suitable wire and coil forms may be purchased at much less than the cost of a manufactured set of coils. Also, the construction of the coils is very simple.

The antenna coupler is the simplest coil to make. It is wound on a composition or cardboard tube 2½ inches in diameter and 2½ inches long. There are two windings, the primary (P) and the secondary (S). The primary winding may be made by winding 8 turns of No. 30 D. C. C. wire about ½-inch from one end of the tube. After the primary winding has been completed, a space of about 3/16-inch is left vacant, and then the secondary coil is wound. The

**AMAZING STORIES** IN OUR MAY ISSUE  
**A Story of the Days to Come** (A serial in two parts), (Part II); by H. G. Wells. Now that the author has established his mechanical changes and differences, and the corresponding variation and modifications in the laws of the land, which we might well expect to find in the days of the future, he turns his attention, with equal success, to the inevitable changes in the trend and mode of human living in this age of mechanical concentration. It is an absorbing study in psychology.

**Four-Dimensional Robberies**, by Bob Olsen. If a four-dimensional forceps could extract gall stones from the human body without any operation, why couldn't it be used for other material things—banknotes and jewelry, for instance? The far-reaching effects of such a discovery as a four-dimensional instrument can hardly be foretold to any appreciable degree. Our author, by this time well known to all our readers, has proved himself the possessor of a fertile mind and a turn for good writing.

**Baron Münchhausen's Scientific Adventures** by Hugo Gernsback. The first novelty of being on Mars and the strangeness of the place wears off very quickly, and we find our friends, the resourceful Baron and his scientific traveling friend, learning all about Mars and the Martians. The Baron's periodic radio communications furnish a source of real scientific information.

**The Octopus Cycle**, by Irvin Lester and Fletcher Pratt. Every once in a while we hear, from explorers and entomologists of good repute, stories of the extermination even of human life in certain localities of the jungle, by seemingly intelligent and organized insects or animals of the smaller variety. This story, about a highly-developed mollusc, is made especially interesting because a journalist and a scientist have collaborated on it.

And Others.



secondary consists of 48 turns of No. 30 D. C. C. wire wound in the same direction as the primary. After the coil has been wound, it should be painted with collodion or some insulating varnish and it is complete.

In constructing the detector-circuit tuner, a coil wound with No. 26 D.C.C. wire is made, exactly the same as the antenna coupler; and to this is then added the tickler coil (T). The tickler coil should be wound on a tube  $1\frac{1}{8}$  inches in diameter with 50 turns of No. 32 D. C. C. wire. This coil is mounted on a shaft and is so arranged that it may be rotated by a knob located on the front panel of the receiver. The diagram, which will be found in these pages, shows the mechanical arrangement which should be followed.

#### CONSTRUCTIONAL HINTS

After all of the parts have been purchased, they should be carefully tested and inspected for mechanical defects. For example, make sure that the plates of the variable condensers do not short-circuit (touch) when they are rotated; and see that the tube makes good contact to the prongs of the socket. In the case of the dials see that there is no appreciable "backlash" and that they do not tend to slip. See that the contact arm of the volume-control resistor makes a good mechanical connection with the wire when it is rotated. Make sure that the phone plug makes good contact with the jack and see that, when the plug is removed, the contacts of the jack are fully closed.

In constructing the receiver, the first step is to drill the necessary holes in the front panel. Accompanying this article will be found a drilling layout for the panel; which will be correct if the parts used in the original model are employed. However, if different parts are employed, it may be necessary to make slight departures from the layout. If different condensers are used, a "template" which usually is supplied with them indicates the exact position of the mounting holes required.

In mounting the parts on the front panel, the detector-circuit tuner is located in the center with the tickler-coil shaft toward the top of the panel. Below the regeneration knob is the volume-control resistor; and one tuning condenser is mounted on each side of the circuit tuner, midway between the center of the panel and the edge. The jack is located in the lower right corner of the panel, and the battery switch is in the corresponding position at the left.

After this, the remaining apparatus should be mounted on the baseboard of the receiver. When looking at the receiver from the front, the apparatus on the baseboard is arranged as follows: the antenna coupler is located directly behind the tuning condenser C1, near the left edge of the baseboard toward the rear. Just behind the antenna coupler, the binding-post strip for the aerial and ground terminals is mounted.

The vacuum-tube socket for V1 is mounted at the right of the antenna coupler, and that for V2 near the right edge of the baseboard toward the rear. The two filament ballast resistors (R1 and R2) are located between the two sockets. The grid condenser with its grid leak (C4 and R3) is fastened directly to the stator terminal of condenser C2. Condenser C5 is fastened in place, with its wiring near the jack; and condenser C3 is also fastened in place, with the wiring near the volume-control resistor.

After the parts have been mounted the receiver may be wired. The pictorial and schematic wiring diagrams, which will be found in these pages, clearly show every necessary connection and as a result very little explanation is necessary. When wiring the plate and grid circuits, care should be taken to see that the wires which connect to the "P" and "G" terminals of the tube sockets are as short as possible, and that they do not come near other parts or wiring. The battery wires may be bunched together if desired. Every connection should be soldered, and care should be taken to see that the joint is strong and that the solder makes a good connection with both wires. In soldering with rosin-core solder, scrape the parts to be soldered until they are clean, and use tinned wire; and then no difficulty will be experienced.

From the pictorial wiring diagram it may be seen that the battery wires of the set are not connected to binding posts; but the connecting wires are soldered to the terminals of the various instruments and led out from the rear of the set in cable form. Label or tag the wires at both ends before cabling. This is the most convenient method; as the wires of the cable may be connected directly to the batteries.

#### OPERATING THE RECEIVER

After the construction of the receiver has been completed the set should be carefully tested before it is placed in operation. First, place the two tubes in their sockets, turn on the filament switch, and connect the negative terminal (the black one) of the "A" battery with the wire of the cable marked "A—B—." Now connect a wire to the free terminal (the positive one) of the "A" battery; and touch this wire in turn to each wire in the battery cable. The tubes should light when the "A+" wire of the battery is connected to the "A+" wire of the cable; but they *should not light* when the "A+" wire is touched to the "B+ Det." and "B+ Amp." wires. If the tubes do light when the "A+" wire of the battery is connected to the "B+" wires of the battery cable, there is a short-circuit in the set *which must be discovered and corrected before the set is placed in operation.*

On the other hand, if the test proves that the set is correctly connected, the "A" and "B" batteries may be connected with the proper battery-cable leads; the aerial and ground wires attached to their respective binding posts; and the phone plug with the phone cords attached, inserted in the jack. The set is then ready for operation and may be turned on with the battery switch.

The aerial should consist of a wire about 100 feet long, including the lead-in, strung as high as possible, firmly secured to well-braced supports at each end, and carefully insulated. The wire should be led into the house through a porcelain insulating tube, or similar device. An approved lightning arrester is a desirable attachment; this should preferably be grounded outside the house. The ground wire from the set should be made to a cold-water pipe if possible, or else to a steam pipe; the pipe should be scraped until it shows a bright metallic surface, and the wire wrapped around it tightly—securely soldered if possible—and the joint wrapped with friction tape to protect it. Upon the electrical contact obtained at this connection will depend a great deal of the results obtained with this receiver.

When you  
CONVERT  
YOUR BATTERY SET  
to AC

use  
the  
**KARAS** \$8<sup>75</sup> List

A-C-FORMER



**Karas Harmonik Transformer**  
List \$5

The Standard!

Delivers absolutely correct voltage. Needs no separate device for center tap. Has plug-in connection to "B" eliminator and wire to panel switch. No re-wiring necessary. Operates with Carter, Eby or other cable harness. Your dealer has it or writes us.

TYPE 12 — supplies up to 8  
—226, 2—227, 2—171 tubes.

Write for literature on other Karas products  
**KARAS ELECTRIC CO.**  
4038-E N. Rockwell St. Chicago

## CARTER ADAPTER HARNESS



Convert your battery set to A. C. tube operation in 10 minutes. No tools or structural changes necessary. Works with all standard transformers. Eliminates A and C batteries.

Write for complete illustrated folder

MEMBER  
**RMA**

**Carter Radio Co.**  
CHICAGO

## BIG DISCOUNTS TO SET BUILDERS

Big New 1928 Catalog—4000 Bargains—Latest A-C circuits, newest ideas in radio, at startling low prices. The sets and parts you want. Save money. Best parts, kits, complete factory-built sets, supplies. Orders filled same day. Write for free copy. *Standard discounts to dealers, set builders, agents.* Dept. 805A, Barawik Co., 129 N. Jefferson St., Chicago, U.S.A.

# Amazing Stories

## Quarterly

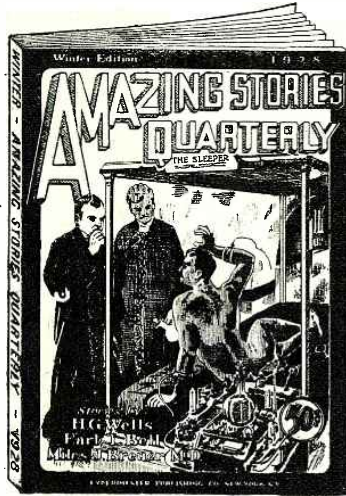

### New Big Edition

The biggest and best collection of truly "scientifiction" stories yet published. Be sure to obtain your copy of this remarkable quarterly edition of AMAZING STORIES. Tales by some of the world's most famous writers—each one written on some new, original and fantastic theme. Here are some of the renowned authors that you will find represented in this big new quarterly edition: H. G. Wells, Earl L. Bell, Miles J. Breuer, M. D., and many others equally well known.

A few of the remarkable tales in this issue of AMAZING STORIES QUARTERLY—

THE MOON OF DOOM  
WHEN THE SLEEPER WAKES

THE ATOMIC RIDDLE  
THE PUZZLE DUEL

Tales of other worlds—of other people—of queer happenings—this is what AMAZING STORIES QUARTERLY will bring to you. Yet, each story has a plausible scientific background. If you desire new fields of literature—if you want to get away from the cut-and-dried reading of the day—do not neglect to get your copy of this remarkable and truly amazing magazine.

Do not wait! Get your copy now! Ask your newsdealer, and if he can not supply you mail this coupon.

150 pages—fully illustrated—large magazine size

THE 50c COPY

EXPERIMENTER PUBLISHING COMPANY

230 FIFTH AVENUE

NEW YORK, N. Y.

EXPERIMENTER PUBLISHING COMPANY  
230 Fifth Avenue, New York, N. Y.

Gentlemen: Enclosed find fifty cents, for which please send me a copy of the AMAZING STORIES QUARTERLY.

Name.....

Address.....

City..... State.....

## Regeneration—What It Is and What It Does

(Continued from page 1235)

ation, which prevents radiation from the antenna. The essential piece of apparatus is the three-coil coupler (L1). This consists of a primary coil (P) of a few turns which is connected directly in the antenna circuit or preceding R.F. circuit, a secondary coil (S) tuned to the desired wavelength by a variable condenser (C), and a tickler coil (T). The primary and secondary coils are usually wound on the same tube form and are coupled "tightly." The tickler coil is wound on a separate tube, and the coupling between the secondary and the tickler is adjustable by rotating the tickler on its shaft. As may be seen from the diagram (Fig. 1) the secondary is connected in the grid circuit of the receiver and the tickler is connected in the plate circuit. By adjusting the coupling of the tickler the feed-back or regeneration may be increased. The construction of such a "tuner" is shown in "The Radio Beginner" on page 1284 of this issue.

### MODES OF REGENERATION

In the circuit described, the method of obtaining regeneration is called *inductive feed-back* because the energy from the plate circuit is returned to the grid circuit *inductively*; i.e., by virtue of the close proximity of the tickler coil to the grid coil. In the operation of this receiver signals are to be tuned in by adjusting the condenser C, as this governs the wavelength of the grid circuit; then, after the signal has been tuned in, its strength may be brought up by carefully increasing the coupling between the tickler coil and the secondary coil—that is, turning the tickler tube until it comes more nearly straight with the tube of the secondary.

Another popular regenerative receiving circuit will be found in Fig. 2. This type of receiver is known, properly, as the "three-circuit tuner," and in the early days of broadcasting it was almost as popular as the tickler-feed-back system just described. In this receiver feed-back is obtained through the grid-plate capacity of the tube, and this feed-back takes place when the plate circuit is tuned to approxi-

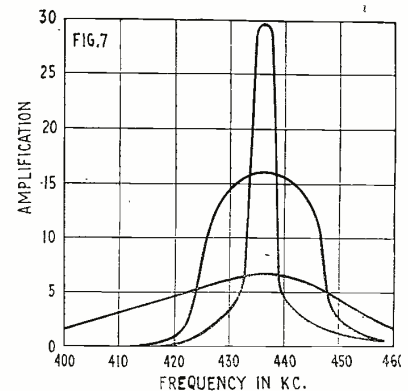

This graph clearly shows that as regeneration increases the sensitivity (height of the curve) and selectivity (sharpness of the curve) are also increased.

mately the same wavelength as the grid circuit.

From the diagram it will be seen that energy from the antenna circuit is transferred to the grid circuit in exactly the same way as in Fig. 1; that is, the primary coil (P) of the antenna coupler (L1) is connected between the aerial and ground, and the secondary coil (S) is connected between the grid and the filament of the tube. As there is an inductive relation between these coils, energy is transferred; and the condenser (C), which is connected in shunt with the secondary coil, tunes the circuit to the desired wavelength.

The "variometer" (I2) connected in the plate circuit of the tube is the interesting feature of the circuit. This unit is a continuously-variable inductance and it is equivalent to a coil of wire shunted by a variable condenser.

In operating this receiver the grid circuit was tuned to the wavelength of the desired station, and the variometer employed to control regeneration. As the wavelength of the variometer was adjusted to approach the wavelength of the grid circuit, the regeneration increased. This is because the alternations in the plate circuit were forced to return to the grid circuit through the small capacity (condenser) formed by the close proximity of the grid and plate elements of the tube. Of course, in this circuit regeneration would produce an effect upon the signal identical with that obtained by using the circuit in Fig. 1. Also, regeneration would cease and the tube breaks into oscillations when the feedback passed a certain critical value.

Regenerative circuits using a variometer in the plate circuit of the detector tube are called *tuned-plate* or *capacity-feed-back* receivers. In addition, it may be pointed out that the regeneration which is found in the average tuned R.F. receiver is usually produced by this method.

#### THE REINARTZ CIRCUIT

There are three basic ways in which regeneration may be produced in a radio receiver; the first two are illustrated in Figs. 1 and 2, and the third in Figure 3. The last is popularly known as the Reinartz circuit, as it was first introduced for the reception of short-wave "C.W." signals by the well-known amateur experimenter, John L. Reinartz. This circuit, which employs a combination of inductive and capacitive feed-back methods, has been found excellent for the reception of continuous-wave (code) signals but is not as satisfactory for the reception of phone signals as the two circuits previously described. It is only one of a number of different circuits which use this system of regeneration, but is probably the best known of its type.

In this circuit the grid and antenna circuits are arranged in much the same way as in Figs. 1 and 2; the chief difference being that the primary coil (P) and the secondary coil (S) of the coupler (L1) are coupled together conductively as well as inductively. However, the plate circuit is very different. First, it will be noticed that there is an R.F. choke coil connected between the plate of the tube and the phones. This prevents the R.F. current from being short-circuited through the phones to the filament. Next, it may be seen that there is a wire which connects the plate of the tube to one end of the plate coil (T) of the coupler, and that the other end of the plate coil is capacitively coupled to the primary and

secondary coils through the variable condenser (C2).

In this circuit the choke coil (CK) in the plate circuit prevents the R.F. current from passing through the phones and, therefore, this current follows the path of least resistance, which is to the plate coil (T). As the plate coil is both inductively and capacitively coupled to the secondary or grid circuit, feed-back takes place and regeneration is produced. In this case regeneration may be controlled in two ways; first, by changing the number of turns in the plate coil and, second, by changing the capacity of the condenser (C2). Increasing the number of turns in the plate coil and increasing the capacity of the condenser both tend to increase regeneration by increasing the inductive and capacitive feed-backs, respectively.

#### MODERN BROADCAST RECEIVERS

Thus far in this article the writer has discussed simple regenerative receiving circuits, but he does not wish the reader to consider using sets of this type for broadcast reception. It is practically impossible to operate a regenerative receiver without causing considerable interference to nearby broadcast listeners. Also, modern receivers are capable of providing much better performance. A five-tube tuned R.F. receiver may be constructed so that it costs very little more than a regenerative set with two audio stages (three tubes in all) and it has many advantages to the listener. It is simpler to operate, the quality of reproduction is much better and the sensitivity is greater.

In order to continue this discussion of the effect of regeneration in tuned, radio-frequency circuits, it is necessary to study the schematic wiring diagram of a typical tuned-R.F. circuit. Fig. 4 presents the wiring diagram of a standard neutrodyne receiver employing two stages of tuned-R.F. amplification and a non-regenerative detector. In this circuit, if the two neutralizing condensers (NC) were removed it would be the wiring arrangement of a standard tuned-R.F. set with no provision for the prevention of regeneration. Therefore, for the purpose of the following discussion, consider the condensers (NC) removed from the diagram.

In the wiring diagram I, is the antenna coupler and the two coils L1 are the other radio-frequency transformers. All three coils are the same size, and have the same number of turns on each winding. The two tubes V are radio-frequency amplifiers and V1 is the detector. The three condensers C tune the grid circuits of the three stages.

During reception the three condensers are adjusted so that the grid circuit of each stage is tuned to the same wavelength. The "signal" from the broadcast station is transferred to the grid circuit of the first tube by the antenna coupler and is amplified by that tube; then it is transferred to the second stage by the first R.F. transformer and is again amplified, and then it is transferred to the detector stage by the second R.F. transformer and "rectified" or detected by V1.

The problem in a circuit of this type arises from the fact that the condenser in the grid circuit of each stage must be tuned to the wavelength of the signal in order to obtain maximum efficiency and because the primary and secondary windings of the R.F. transformers are closely coupled to-

## Guaranteed

## Socket Power

## Unit - \$13.75



**90-Day Guarantee**

An absolutely unequalled value! We want you to test the World "A" Socket Power Unit and compare it with any other of two or three times the price. Try for ten days at our risk. Then if you are not convinced that it is unsurpassed as to quality and wonderful results, purchase price will be refunded in full. Operates on 50 or 60 cycles at 110 volts A. C. Highest quality Westinghouse electrical equipment. No hum or noise. Approved by Radio News Laboratories and other leading Authorities.

**Send Order Today** your name and address on a slip of paper—pin a one dollar bill to it and mail today. We will ship same day order is received for \$12.75 C. O. D. 5% discount for cash with order. Remember you are the judge and are fully protected—so send order NOW.

**only \$1.00 Down Balance C.O.D.**

**WORLD BATTERY COMPANY**  
 1241 S. Michigan Avenue  
 Dept. 60 Chicago, Illinois

Station W. S. B. C., owned and operated by World Battery Company

## Big 30 inch Cone Speaker

### —Build it yourself and Make Money!



Here it is at last! A real 30-inch power cone for only \$8.50. The new Excelcone is unlike the impractical knocked-down cones on the market. Easy to build. Everything furnished, nothing else to buy. Simple illustrated instructions furnished—impossible to go wrong. Beautiful, clear and natural tone 4096 per second) to the lowest bass tuba note (frequency 36 per second) without squeal, rattle, rumble, or distortion. Cone handsomely lithographed in old rose and black harmonizing colors; base in beautiful brown frostene lacquer. Has sold in stores for \$32.50 assembled. Build it yourself and sell it to your friends. Thousands of satisfied users. Send no money; shipped C.O.D., plus Express Company charge. Indicate size and model desired.

30-in. Cone, Pedestal Type.....	\$7.50
30-in. Cone, Wall Type.....	6.50
22-in. Cone, Pedestal Type.....	7.25
22-in. Cone, Wall Type.....	6.00

MONMOUTH PRODUCTS COMPANY  
 885 East 72nd Street Cleveland, Ohio

## BIG RADIO CATALOG

From the "Big, Friendly Radio House"

NEW 1928 Book offers finest, newest well-known sets, perfect eliminators, accessories at lowest prices. DEALERS WRITE FOR THIS CATALOG!

## Western Radio Mfg. Co.

126 West Lake St., Dept. 15, Chicago, Ill.

**SPECIAL PRICES ON PARTS**  
 Orders shipped same day as received. Tubes, intermediate transformers, condensers, etc. peaked and matched. Dept. A  
 NORTH SHORE RADIO LABORATORIES  
 ASSOCIATES I. R. E., A. A. S.  
 6302 North Clark Street Chicago, Ill.

# AMAZING STORIES

MONTHLY

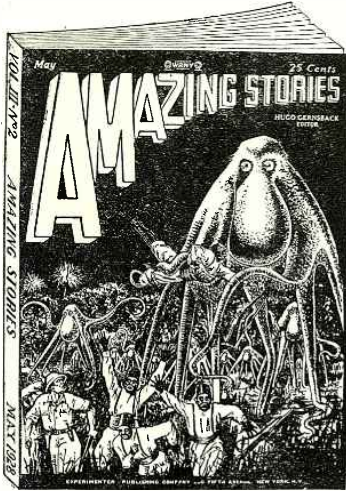

## A Magazine of "Scientifiction" by World Famous Authors

AMAZING STORIES MONTHLY contains tales as astonishing as they are novel. In it each month you will find the most remarkable narratives that you have ever read. This truly amazing book of "Scientifiction" contains stories by some of the world's best-known authors. H. G. WELLS, JULES VERNE, MILES J. BREUER, M.D., EARL L. BELL, HUGO GERNSBACK—each month you will find stories by one or more of these famous writers.

Read AMAZING STORIES MONTHLY—tales of other worlds—of other people—of queer happenings—of startling adventure. Yet every story has a plausible scientific background. This magazine is a refreshing treat for any one tired of the drab literature of the day. Each tale a gem of the imagination. Something new—something different—this is what is in store for the readers of AMAZING STORIES MONTHLY.

Get your copy now! Ask your newsdealer! If he cannot supply you mail this coupon direct to us

100 pages—fully illustrated—large magazine size

THE 25c COPY

EXPERIMENTER PUBLISHING COMPANY, 230 Fifth Ave., New York, N. Y.

EXPERIMENTER PUBLISHING COMPANY  
230 Fifth Avenue, New York, N. Y.  
Gentlemen: Enclosed find 25c.; kindly send me the latest copy of AMAZING STORIES MONTHLY

Name.....  
Address.....  
City.....State.....

### RADIO PANELS BAKELITE—HARD RUBBER

Cut, drilled, and engraved to order. Send rough sketch for estimate. Our Complete Catalog on Panels, Tubes and Rods—all of genuine Bakelite or Hard Rubber—mailed on request.

STARRETT MFG. CO.  
520 S. GREEN STREET - CHICAGO

### ACME PARVOLT CONDENSERS

Bypass and Filter Condensers in all required MFD capacities and working voltages. Filter Condensers supplied in individual units or in completely wired and housed blocks for the more important power amplifiers. Made by THE ACME WIRE CO., New Haven, Conn. Manufacturers of Acme Colatsite Wire—high insulation value, non-inflammable.

**TOWER** RADIO PRODUCTS  
ON SALE EVERYWHERE

### FREE Wholesale Radio Catalog

Dealer-Set Builders! Save Money!  
Send for this book of bargains. Everything in Radio—all the newest hook-ups. Sets, kits, parts, cabinets, consoles and supplies. If you want the best for the least money, you need this catalog.

SHURE RADIO COMPANY  
331-F West Madison St. Chicago, Ill.

### ELKAY EQUALIZORS

automatically adapt filament voltage to any tube. Elkay Suppressors tend to eliminate "R. F. boiling over." Write for prices. Langheit-Kaufman Radio Co., Dept. N, 62 Franklin St., New Haven, Conn.

**BOSCH RADIO RECEIVERS**  
AC and DC Models. Cone Type Reproducer. Power Units, and Phonographic Pick-up Device.  
AMERICAN BOSCH MACNETO CORP.  
Springfield Mass.

gether, each primary winding, or plate coil, is automatically tuned to the same wavelength as the secondary. It is, therefore, easy to see that, with the grid and plate circuit of each stage tuned to the same wavelength, the circuit will either oscillate or regenerate, as feed-back will take place through the capacities between the grids and the plates of the tubes, and all the circuits are "resonant" at the same wavelength. It thus happens that, if the circuit is otherwise efficient, it will always oscillate; and it is impossible to control these oscillations and at the same time maintain perfect efficiency.

There are two popular systems for the prevention of oscillation in tuned radio-frequency circuits; the first is known as the neutrodyne system and the second as the "losser" method. There are many different ways in which these methods may be applied; but only the two most popular circuits will be considered in this article.

#### NEUTRALIZATION

Fig. 4 shows the wiring diagram of a standard neutrodyne circuit. This circuit is exactly the same as a standard tuned R.F. receiver except that two small condensers (NC), which are known as balancing or neutralizing condensers, have been added. It is the purpose of these condensers to nullify the feed-back which takes place through the capacity between the elements of the tube. These condensers are adjusted so that their capacity is approximately equal to the grid-plate capacity of the tubes, and they are connected in the circuit so that they cause an additional feed-back between the plate and grid circuits. However, the interesting feature is that the feed-back through condensers NC is equal in value to, but 180 degrees out of phase with, the feed-back which takes place through the elements of the tube. Therefore, it is easy to see that the two feed-backs, one of which is the reverse of the other, will neutralize each other, and the result is a non-regenerative tuned R.F. amplifier.

The second system for the prevention of oscillation is shown in Fig. 5; in this circuit a fixed resistor is connected in the grid circuit of each tube. It is the purpose of these resistors (R) to introduce losses into the circuit and, in this way, prevent the tubes from entering a state of oscillation. The electrical value of these resistors is carefully selected, so that there is just enough resistance in the circuit to prevent oscillation, but not enough to prevent regeneration. Of course, there are many other methods of preventing oscillation with the "losser" method; but the circuit shown is the most popular at the present time and perhaps the most satisfactory. In all cases, however, the efficiency of the circuit is reduced just enough to prevent oscillation.

While both the neutrodyne and the "losser" systems of reception provide a satisfactory receiver for the reception of broadcasting, the "losser" system is more generally used. In a neutrodyne that has been carefully adjusted, both oscillation and regeneration have been eliminated; whereas, with the other system, regeneration has been retained. The facts explained in the early part of this article show that, when regeneration is properly controlled, it is possible to gain much useful amplification with the system. For this reason, with the "losser" system it is possible to obtain greater amplification per stage, greater selectivity, and, if the circuit has been carefully designed,

the results will be equally satisfactory from other viewpoints as well.

#### THE ROBERTS CIRCUIT

Before concluding this article, it should be pointed out that there is another entirely satisfactory method of obtaining the beneficial effects of regeneration, and known as the Roberts circuit (see Fig. 6). In this circuit a stage of neutralized radio-frequency amplification is combined with a regenerative detector of the type in Fig. 1. Only two tubes are used in the circuit, yet the results obtained usually equal those which may be secured with a three-tube circuit of the type shown in Figs. 4 and 5. This is because the full advantage of regeneration is obtained in the detector circuit and, in addition, there is the amplification of a stage of tuned R.F. Another important feature of the circuit is that, although there is a regenerative detector, the circuit cannot cause interference to nearby receivers because the regeneration is preceded by a neutralized radio-frequency stage.

After a quick glance at the circuit shown in Fig. 6, the beginner may fail to see the relationship between it and the other two circuits mentioned. However, the changes which are present are very slight and do not affect the operation of the circuit. In the circuit of the R.F. tube (V) L, C and

NC are identical with the similar parts shown in Fig. 4; and in the circuit of the detector tube (V1) L1 and C perform the same duty as similar instruments in Fig. 1. The coil PL, which is shown, is used only to avoid the necessity of a center tap on the winding of S. C1, CK and VC are employed to lead the plate voltage to the R.F. tube without passing through the primary of L1; but this is not an essential feature of the circuit. VC is a volume-control resistor, CK is an R.F. choke coil and C1 is a fixed blocking condenser.

In Fig. 7 the effect of regeneration on a circuit is illustrated graphically. The low flat curve which reaches an amplification peak of approximately 7 represents the action of a non-regenerative circuit. Notice that the amplification is low and that the circuit is non-selective, as it amplifies almost equally over the wavelengths of several 10-ke. channels. The second curve, which reaches a peak of approximately 15, shows a circuit with a moderate amount of regeneration. It may be seen that both the amplification and the selectivity are greatly increased. The third curve, which reaches a peak of 25, represents a circuit in which too much regeneration is present. The amplification is very high but the selectivity is so great that music would be distorted.

## Around the Musical World by Radio

(Continued from page 1219)

#### WHAT NATIONAL MUSIC IS

Now the distinctive music of any country can be divided into three general classes:

(1) National or folk music, which is the fundamental expression of the temperament and the lives of its masses.

(2) Works of native composers, whose music may or may not be distinctively national in character.

(3) Music by foreign composers whose work has been inspired by the general atmosphere, the folk lore, or by the indigenous music of the country itself.

The first two classifications require no explanation, but the third may. As an example of a composer in this class we might take the Russian, Rimsky-Korsakov, who wrote the *Suite Scheherazade*. This beautiful composition is filled with the throbbing melodies peculiar to Arabia, and is said to have been inspired by the *Arabian Nights*.

It is almost impossible to say, with any degree of accuracy, what was the exact nature of the music of the ancient peoples. There is every reason to believe, however, that it expressed their characters, in the same manner as that our modern music is a sidelight on our times and civilization. The compilers of *The Music Map of the World* have briefly set forth a description of the earliest music known to us, the different musical scales used and how long the countries have employed them.

Also the subject of National Music is ably treated. It is a difficult task to explain just what is meant by national music. Generally it is considered to be the folk songs and dances of the inhabitants of a particular country. In this music are reflected the social and political conditions, and the influence of the climate and the scenery of a country.

Covering the Edison Hour programs of this season, *The Music Map of the World* analyzes twenty-one programs of music, each one being devoted to the music of one or more countries. Listeners who tune in WRNY regularly are well acquainted with the Edison Ensemble, who have been on the air for two years. This group of talented musicians will broadcast these programs and those who wish to extend their musical horizon, as well as enjoy delightful concerts, are strongly recommended to tune in these Tuesday evening programs. So that these concerts may be more intelligently enjoyed, a short description of the type of music to be broadcast, and the composers whose works are to be played on each occasion, is given in *The Music Map of the World*. Every lover of music likes to have his own ideas of what the composer had in mind when he wrote the music, and so form his own musical picture. But many times the listeners' imagination is spurred on by reading beforehand something about the country and its composers; so that the music will mean much more in the end.

One of the most interesting features of the book is an inserted map of the world in attractive colors, drawn in the quaint style of the sixteenth century, and on which is indicated by a musical note the birthplace of each of the greatest composers. These composers, together with their dates and birthplaces, are listed alphabetically in the back of the book.

In order that the greatest number of people may be enabled to enjoy this series of programs to the fullest extent, a copy of *The Music Map of the World* will be sent free to anyone who writes to Station WRNY, Hotel Roosevelt, New York City, requesting a copy.

## Adds the final touch TABLE TYPE CLAROSTAT

Reg. U. S.

Pat. Off.

The ideal control for volume and tone of your loud-speaker, from soft, soothing background for conversation, reading, dining, resting, 'phoning, or dozing, to loud, crisp, snappy entertainment for center of interest. And it's always at your finger-tips—on the end-table, easy-chair arm, dining-table, davenport, sick-room table, telephone stand—anywhere, for remote control of radio entertainment. Handsomely finished in stately bronze and nickel. Felt bottom to protect finest furniture. Bakelite knob. Two cords with tips and connector block for applying to battery or socket-power set, without tools, skill, time, or trouble. Learn the new joys of controlled radio!

AND ALL FOR \$2.50 !!

Ask your radio dealer to show you the Table Type Clarostat and give you copy of "Radio Etiquette." Or write us direct for interesting data on improving your radio.

AMERICAN MECHANICAL LABS., Inc.

Specialists in Variable Resistors  
285-7 N. Sixth St. Brooklyn, N. Y.



### Guaranteed Radio Service

Largest, most up-to-date laboratory and service station in America

Completely equipped to repair and test all types of receivers and power units. Let us give you an estimate for repairing or rewiring your present receiver and incorporate all the latest developments. We will construct any special receiver or power unit desired.

Special rates for electrifying your old set. Results guaranteed.

RADIO SERVICE LABORATORIES, INC.  
506 S. Dearborn Street Chicago, Ill.

### Special Library of Information on RADIO PATENTS and TRADE MARKS

JOHN B. BRADY

Patent Lawyer

Outray Building Washington, D. C.

Cable address:  
RADIOPAT

Telephone:  
Main 4806

### SET BUILDERS BIG DISCOUNTS

Big New 1928 Catalog—Shows latest A-C circuits, newest ideas, 4000 leaders. Get sets and parts you want here. Save money. Parts, kits, complete factory-built sets, supplies. Quick service. Write for free copy. Standard discounts to dealers, set builders, agents. Barawik Co., 129 N. Jefferson St., Dept. 305, Chicago, USA.





# Dealers...

**This is your own magazine.**

**Are you making use of it?**

**WHAT** do you do with your merchandise? Do you hide it away in the back room of your store? Of course you don't. You put it up on shelves in the front, where customers can see it and buy it. You put it there because you know that it will make money for you. And yet are you doing all that you can to increase your sales? Or, is the merchandise that you have so prominently displayed moving as fast as it should? You will probably say that you are doing everything but pull the customers into your store—that you would like to see anyone do more than yourself. But, has it ever occurred to you that there are many others doing a bigger business? Why is this so? The answer is not so difficult.

There are a thousand and one merchandising tricks—little penny-savers and dollar-earners that these more successful ones have learned—sales practices that have been tried and proven, and that they will be only too glad to show you. They tell about their merchandising schemes in the pages of their own magazine, **RADIO NEWS DEALERS PERSONAL EDITION**.

Radio News itself needs no introduction—the Dealers Personal Edition contains articles written by the leaders of the industry—this is their own magazine—and your own too. Are you making use of it? Read this important trade paper, edited by the whole *Radio Trade*. Get your copy each month. Begin now to increase your sales. Mail this coupon! Don't wait 'till tomorrow! Start the sales campaign this minute. Take advantage of the special introductory rate to dealers, \$1.50 for a year's subscription—12 issues. Regular rate \$2.50. Mail this coupon and get the benefit of this low rate. You won't be sorry.

USE YOUR OWN LETTERHEAD—THIS IS IMPORTANT

EXPERIMENTER PUBLISHING CO.  
 230 Fifth Avenue  
 New York City, N. Y.

Gentlemen:

Enclosed find . . . check or . . . money order (check which) for one dollar and fifty cents. Kindly send me **RADIO NEWS—RADIO NEWS DEALERS PERSONAL EDITION** for one year beginning with the next issue.

Name.....

Address.....

City.....State.....

# The Listener Speaks

(Continued from page 1208)

and the office expense, and the dividends of the Curtis Publishing Co.—the chaps that give up a nickel a copy every Friday? They do NOT!

If the advertiser paying for a program on one of the national chains was not sure that he would get his investment back—and *more too*—from the general public through the purchase of the goods which he so advertises—how long would the present expensive programs continue on the air? *Till the contracts expired—not a minute longer!* Who's getting something for nothing? Not the listening public to which we all belong.

Then, Cuba wants stations "thick and close together"—let him come here—and try for stations below the 300-meter allocation—he'll get them thick and close together—and then some. Perhaps he has one of those selective sets which can tune out three members of a quartet and bring in the soprano as a soloist—freight that set right up to Northern Ohio and stay below 300 meters—and he can have a "cat fight" any time he turns on his set.

If he has a set so selective that it will tune out static, man-made interference, and above all, heterodyning of another station on the same wavelength (alleged) he should send the schematic diagram to **RADIO NEWS**—it would double their circulation the month it was printed and copies would be at a premium inside of 30 days. Never mind about the 1/10- and 1/15-meter variation—they don't come that close—just to show us how to get one station—clearly—without a whistle when there are five other stations in the country broadcasting on the same wave, and your set is a good "DX" receiver. Don't he know that, even in the "cleared band" above 300 meters, there are still heterodyne whistles on certain stations?

The writer has a suspicion that that set in Cuba is able to receive about a dozen United States stations—probably the big ones on the "cleared channels" and experiences no interference or heterodyning, due to inability to pick up the waves of the "little fellows" at all. Let him come here, and learn that he can't even get locals—two miles away—without a whistle from some station in Iowa on the same wave—then see how long he'll vote for stations "thicker and closer together."

The chap in Dakota *ought* to be able to get good reception—he ought not to have any kick—but let both Dakota and Cuba move to any of the first ten cities of this country (where about 50% of the country's population live) and then see if they haven't a real kick coming. They haven't an idea how fortunate they are—right where they're at.

J. E. ROBERTS,  
 1931 East 79th St., Cleveland, Ohio.

## A Call From The North

Editor, **RADIO NEWS**:

I see in the January issue a letter from an Ultradyne fan; I more than agree with him when he says it is a real receiver. In November I pulled in Sydney, 2BI, and Brisbane, 4QG, every morning for a week. Some days the static was bad, but most mornings I was able to bring them in on the loud speaker, loud enough to be heard through the house.

I had to leave on a long patrol with dogs right after that, and have not had the opportunity to work them since, except once when I picked them up as usual. I am expecting verification from them by our next mail from the south. I think all Ultradyne fans should write in and let the world know what a good receiver it is.

I did not get the November copy yet. Our mail in the fall does not get through until open water in the spring; so I did not see the other letters. I am renewing my subscription to **RADIO NEWS** through the T. Eaton Co. of Winnipeg, as I would not be without it.

L. M. LLOYD-WALTERS,  
 Corporal, Royal Canadian Mounted Police,  
 Fort Smith, Northwest Territories, Canada.

*(This letter, though not from the most distant of our readers, took twenty-one days to reach New York, perhaps by dog team to the nearest railway. It may be remarked that Fort Smith, on the sixtieth parallel of north latitude, has very little daylight in midwinter, and consequently, at some time of the 24 hours, almost complete darkness will prevail between this point and any broadcast station in the world—a fact which should facilitate reception. From Fort Smith to Sydney is 8,500 miles, almost entirely over the Pacific Ocean.—EDITOR.)*

## What's New in Radio

(Continued from page 1227)

capacity of approximately 30 mf., which is divided into three sections. After the current has been filtered, a resistor bank is used to provide the various voltages required by the tubes of the set.

Another interesting feature of the receiver is the binding post provided for connecting a phonograph pick-up unit; this makes it possible to use the set for the reproduction of phonograph records without removing the detector tube from the socket.

The installation and preliminary adjustments of the receiver are very easily accomplished. It is necessary only to connect the aerial, ground and loud-speaker wires to the necessary binding posts and then insert the tubes in the proper sockets. The

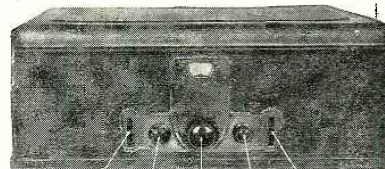

Front view of the new A.C. receiver, described above, in its attractive metal cabinet; C, wave-length control; R1, volume control; SW, switch; A and B, compensating condensers.

only adjustment to be made is for high or low voltage of the power supply; and this is accomplished by simply changing the position of the fuse in the power circuit.

### Radio-Operated Motor

(Continued from page 1210)

(In view, however, of the present vogue of selling stock in companies devoted to the development of mysterious sources of power, the investor should be cautioned that, as yet, the radio motor awaits the invention of a suitable collector of energy to make it profitable. Millions of volts could be picked up by a properly-insulated aerial a few miles above the earth; but the expense of construction would make the (literally) "overhead" cost of such power too great. Should a ray whose ionized path is conductive be discovered, it might be possible to tap the electric energy of the atmosphere; and, similarly, it is suggested that the ultra-short radio waves will make it possible to transmit power in substantial quantities without wires. This would be, not "perpetual motion," but simply exploitation of natural forces, akin to the development of hydro-electric power-generation and transmission. However, all commercial propositions depending on new scientific principles should be required to give demonstrations acceptable to engineers, before they are considered safe for investment.—EDITOR.)

### Letters from Constructors

(Continued from page 1251)

#### INTERBALANCED REGENERATION

Editor, RADIO NEWS:

A couple of months ago I built a set, using the interbalanced regenerative circuit outlined by Mr. Barbieri in RADIO NEWS for June, 1927, except that I used transformer coupling in the audio stages. This little set is one of the easiest and nicest tuning hook-ups anyone could ask for, and I have had some very good results on distant stations; having pulled in many eastern ones on the loud speaker.

I found it advisable to put a rheostat in series with the fixed resistor in the filament circuit of the R. F. tube; as I can get all the locals with plenty of volume and selectivity on the detector and audio stages. One improvement I made might help some other readers who are using this circuit. When I first built the set I used a 10,000-ohm variable resistor as recommended for the regeneration control. However, there were two things I did not like about this; in the first place, the regeneration was increased by turning the knob to the left, which did not seem natural. In the second place, the set would break into violent regeneration without any warning when nearing the oscillation point. I found an old potentiometer, of probably 400 or 500 ohms, which made a wonderful improvement over the resistor. Regeneration is now increased by turning the knob to the right; while the control is much less critical and set gives a gentle warning pop before violent regeneration starts.

RADIO NEWS is certainly a very fine magazine and I look forward to every issue.

D. C. DE HAART,  
567 Camino del Mar, San Francisco, Calif.

#### A CHANGE ON THE B.-D.

Editor, RADIO NEWS:

I have been experimenting with the Browning-Drake circuit, using the phasatrol system of neutralization, with 201A tubes and home-made coils. I find that connecting the "B+" end of the primary to ground seems to increase sensitivity, selectivity and volume. I would like to hear from some of the home set constructors who try this arrangement, and the results they get.

RALPH A. MOORE,  
215 West Clark St., Livingston, Mont.  
Designers of this circuit have already come to the conclusion, a fact unknown to Mr. Moore, who wrote. The condenser between the plate and the primary makes this possible.—EDITOR.)

#### AUSTRALIAN SUMMER

Editor, RADIO NEWS:

The short-wave receiver described in your issue of October, 1927. It delivers the goods and I can certainly recommend

it to anyone requiring a receiver easy to build and sure in results. I completed this receiver just in time to log in 5SW (Chelmsford, England) re-laying 2LO (London) last Thursday night and, although reception was not good, it was no fault of the receiver. Every night since then I have tuned in the Russian station RFN between 8 and 9 p. m. and get the most perfect reception on the loud speaker. They transmit on 60 meters, very good programs; and, as you did not include it in your earlier list of short-wave stations, I thought it worth mentioning.

Last night I had beautiful reception from PKXX, Java, using a Bremer-Tully coil of two turns. It may be of interest to know that the receiver oscillated with this coil, using the transformer secondary. I then replaced it with a 5-megohm grid leak, but found results not so good. Just in passing, I may add that I used a B.-T. coil kit, purchased Karas condensers, with which I had previous experience, and an Australian product, "Advance" transformers; and the quality of the reception is all that could be desired.

I will now make an effort to log your side of the world with your short-wave set, and I want especially to get WRNY. From 5 to 7 a. m., our time, is best; but as I am busy now, being a farmer, I will have to let it go for a while. Melbourne's 3LO transmits every Monday morning on 33.5 meters from 4 to 6 a. m. They are being well received in England, and you should log them in between 1 and 3 p. m. on Sundays.

I think RADIO NEWS is the best production of its kind, probably in the world; and any special circuit put out by it is bound to be good. I have owned or handled many sets; among them the L2 which came out in RADIO NEWS a few years ago, and will take a lot of beating today. Also, through an advertisement, the Norden-Hauk, with which I logged KDKA and KGO's long waves. It may be of interest to you to know that on this side we like RADIO NEWS circuits.

PEARSON L. SUTTON,  
Windermere, Piallmore, via Tamworth,  
New South Wales, Australia.

#### APPRECIATES HELP

Editor, RADIO NEWS:

I would like to say a good word for one of your contributors, Mr. C. A. Oldroyd of England. Some time ago I built a Browning-Drake set, winding the coils according to the specifications by Mr. Oldroyd in the December, 1926, and January, 1927, issues. I could never get it to work properly, although I wired it three times. After trying several other sources, I wrote to Mr. Oldroyd about it. Two days ago I was delighted to receive a very interesting letter from him, giving all the information I needed and an invitation to write him again as to the results.

I have been building sets since 1922, and have not missed many issues of RADIO NEWS during that time.

E. R. WILBANKS,  
5210 Acadia Terrace, Fairfield, Alabama.

#### GOOD WORK ON FIVE TUBES

Editor, RADIO NEWS:

I am using a T. R. F. 5-tube set, the Nakken autotransformer circuit; home-built of course, as this set has not been developed commercially. (RADIO NEWS for October, 1926.) All last summer I received Davenport, St. Paul, Chicago, Cleveland and New York in daytime; and the reception was so regular and so ordinary that I did not bother to get confirmations. So I cannot prove it if called upon, but yet it is true. Using this circuit, I have received with great volume and clarity a 10-watt station in Harrisburg, Illinois (WEBQ)—not in daylight, however.

My aerial and ground are, if anything, somewhat inferior to the average; as the aerial is only about 40 feet, exclusive of lead-in, and the ground a cold-water pipe, with the connection 25 feet from the ground and on the house side of the meter. Moreover, the tubes I am using are over two years old, and of the so-called "bootleg" variety.

So, figuring my handicaps, to which may be added a not very stable source for my "B" power unit, I feel very confident that there is something wrong with Mr. Woodruff's superhet.

Just last evening I listened for an hour to WWRL, a 100-watt station at Woodside, New York, for an hour; and it was as loud and good as KDKA is on most factory-built sets. I listened to KFI for two hours on the first three tubes (using phones, as the Mrs. was asleep) with no interference from WSB and no particular fading. The other—daylight—reception I speak of was all on the loud speaker.

There are times, naturally, when I would sell my set for a dime; times, even when I would pay to have it removed. But, take it on the whole, Mr. Nakken has sort of put the superhet under

## FROST-RADIO GEM RHEOSTATS



FROST-RADIO

YOU will like Frost Gem Rheostats the minute you set eyes on them. They are what you have always wanted—mighty good small rheostats. Metal frame construction, with resistance element securely wound on flexible Bakelite strip. Gem Rheostats are 1 1/2 inches in diameter. Supplied in wide variety of resistances from 5 to 50 ohms and up to 200 and 400 ohm potentiometers. Also made with filament switch at slight extra cost. Less switch, 75c. With switch, \$1.00.

#### Mail Coupon for Two Frost Booklets

Fill out and mail coupon below and we will send you FREE the two Frost Booklets: "What Set Shall I Build?" and "For Better Reception."

HERBERT H. FROST, INC.

Main Offices and Factory:

Elkhart, Ind.

Chicago

New York City

HERBERT H. FROST, Inc.  
160 North LaSalle Street, Chicago, Ill.

Please send me free your two booklets, as advertised in RADIO NEWS for May.

Name.....

Street Address.....

City.....

State.....

## \$100 WILL SAVE YOUR SPEAKER



The Craftsman Dolla Speaker Filter is Guaranteed to relieve your speaker of the DC plate current (up to 250 volts). It gives speaker a chance to operate at its best. Attached in a second. Send dollar bill NOW!

CRAFTSMAN RADIO PRODUCTS

9 Orchard St.

Newark, N. J.



Model "N" Vario-Denser

Used in

Every High Grade Circuit or Receiver Today!

#### INCLUDING

Strobodyne, Loftin-White Constant Coupled, Qualitone 6, Improved Aristocrat, Oliver Lodge, Best's Super-Heterodyne, B.-T. Power Six, Hammantund-Roberts, Daily News 4, World's Record Super, Goodwin Aperiodic Detector Circuit, Quadrafactor 6, Best's 1927, Silver's Knockout and many others.

#### MODEL "N" VARIO-DENSER

Micrometer adjustment easily made, assures exact oscillation control. Quick, easy tuning, more volume, clearness and stability. Capacity range 1.5 to 20 micro-tulero farads. Price \$1.00.



Model O MODEL "O" VARIO-DENSER

Obtains the proper grid capacity on Cockaday circuits, filter and intermediate frequency tuning in super-heterodyne and positive grid bias in all sets. Three variable capacity ranges. Price complete, with grid clips, \$1.50.



#### X-L NEW BAKELITE INSULATED PUSH POSTS

The perfect binding post at last! Convenient, simple, permanent connections. You don't have to remember to tighten them. Push down the X-L, insert wire, remove pressure. Connection is tight and will stay tight. No vibrations can loosen. Releases instantly. Standard markings, or boxed in complete sets. Price each, 15 cents.

FREE Big new up-to-date book of wiring diagrams of all leading circuits. Write today for copy! Investigate the Goodwin Aperiodic Circuit. This is applicable to any set and adds a stage without added tuning controls.

X-L RADIO LABORATORIES

2426 Lincoln Ave., Chicago, Ill.



# OPPORTUNITY AD-LETS

Follow these advertisements every month. Reliable advertisers from all over the country offer their most attractive specials in these columns. Classified advertising rate twenty-two cents a word for each insertion. Ten per cent discount for 6 issues, 20 per cent discount for 12 issues. Names and addresses must be included at the above rate. Cash should accompany all classified advertisements unless placed by an accredited advertising agency. No advertisements for less than 10 words accepted. Objectionable or misleading advertisements not accepted. Advertisements for the July issue must reach us not later than May 1st.

**CIRCULATION LARGER THAN THAT OF ANY OTHER RADIO PUBLICATION**

EXPERIMENTER PUBLISHING CO., INC., 230 Fifth Avenue, New York, N. Y.

## Agents Wanted

**Big Money and fast sales.** Every owner buys gold initials for his auto. You charge \$1.50; make \$1.35. Ten orders daily easy. Write for particulars and free samples. American Monogram Co., Dept. 133, East Orange, N. J.

**Guaranteed Genuine Gold Leaf Letters** anyone can put on store windows. Large profits, enormous demand. Free samples. Metallic Letter Co., 422 N. Clark, Chicago.

**Sell subscriptions to magazines known the world over.** Steady monthly income with absolutely no investment required. Hundreds of selling arguments every month. Start now. Full information sent free, no obligation. Agency Division, Experimenter Publishing Co., 230 Fifth Avenue, New York.

**Agents—We start you in business and help you succeed.** No capital or experience needed. Spare or full time. You can earn \$50-\$100 weekly. Write Madison Products, 600 Broadway, New York.

**Agents—90c an hour earned advertising and distributing samples to consumer.** Write quick for territory and particulars. American Products Company, 1504 Monmouth, Cincinnati, Ohio.

## Business Opportunities

**\$100 per month in your home** folding and mailing circulars. We furnish everything. Particulars and samples, 25c. Adams Mailing Service, 48 Adams St., Irvington, N. J.

**Inventions Commercialized.** Patented or Unpatented. Write Adam Fisher Mfg. Co., 278 Enright St., St. Louis, Mo.

**67 Ways to Increase Income.** 96-page book "Spare-time Money Handbook" contains 67 practical and complete plans to operate spare-time business. For everyone who wants more money. Price only 50c. Conrad Company, Inc., 230 Fifth Avenue, New York.

**Amateur Cartoonists:** Make money in spare time with new cartoon selling plan. Write Smith's Service, Wentahe, Wash.

**Free Book.** Start little Mail Order business. Hadwyl, 5A-74 Cortlandt Street, N. Y.

**Learn Collection Business.** Good income, quick results. Interesting booklet, "Skillful Collecting," free. National Collectors Ass'n, 306 Wehrle Bldg., Newark, Ohio.

## Chemistry

**Learn Chemistry at Home.** Dr. T. O'Connor Sloane, noted educator and scientific authority, will teach you. Our home study correspondence course fits you to take a position as chemist. See our full-page ad on page 1261 of this issue. Chemical Institute of New York, 16 E. 30th Street, New York City.

## Copyrighting

**Authors: Protect your stories, plays, songs, etc., by U. S. Copyright.** Get New Booklet Free! Coy C. O. Brownley Bldg., Washington, D. C.

## Correspondence Courses

**Used correspondence school courses** sold on repurchase basis. Also rented and exchanged. Money-back guarantee. Catalog free. (Courses bought). Lee Mountain, Pisgah, Alabama.

## Detectives

**Detectives Needed Everywhere.** Travel. Experience unnecessary. Particulars free. Write, American Detective System, 2100 Broadway, N. Y.

## Electricity

**Electric Fun!** Seventy stunts, 110 volts. \$1. Cooperco, Campbell, Calif.

## For Inventors

**Inventions Commercialized.** Patented or Unpatented. Write Adam Fisher Mfg. Co., 278 Enright, St. Louis, Mo.

## For Sale

**One Western Electric Microphone and Transformer.** This instrument used very little and in good condition. If interested write C. M. Mall, Clenson College, S. C.

## Help Wanted

**National Publisher, needs agents, boys and shops to help sell great national magazines.** No investment required. Big profits, sparetime work very successful. Write Agency Division, Experimenter Pub. Co., 230 Fifth Avenue, New York.

## Help Wanted, Instructions

**Earn \$25 Weekly Spare Time,** writing for Newspapers and Magazines. Experience unnecessary. Copyright Book, "How to write for Pay" Free. Press Reporting Inst., 973, St. Louis, Mo.

**Do you drive a car?** U. S. Government Chauffeur-Carrier job pays \$141-\$175 month. "How to Qualify" mailed FREE. Write, Instruction Bureau, 251 Arcade Bldg., St. Louis, Mo.

## Instruction

**Learn Chemistry at Home.** Dr. T. O'Connor Sloane, noted educator and scientific authority, will teach you. Our home study correspondence course fits you to take a position as chemist. See our full-page ad on page 1261 of this issue. Chemical Institute of New York, 16 E. 30th Street, New York City.

## Miscellaneous

**Inventions Commercialized.** Patented or Unpatented. Write Adam Fisher Mfg. Co., 278 Enright, St. Louis, Mo.

**Save Money at Home.** You can build many home necessities yourself, such as furniture, kitchen utensils, decorative material, etc., thus saving many dollars. All constructional information on hundreds of things given in 116-page book "How to Make It." Price 50c. Experimenter Publishing Co., Inc., 230 Fifth Avenue, New York.

**Send us your portrait and we will enlarge it for \$5.00.** Ben Griep, Carthage, Mo.

**Forms to Cast Lead Soldiers, Indians, Marines, Trappers, Animals, 151 kinds.** Send 10c for illustrated Catalogue. H. C. Schiercke, 1034 72nd St., Brooklyn, N. Y.

**Something new—signals one hundred cycles apart separated.** Seventy-five per cent static eliminated. Particulars. Write, Box 1116, Riverhead, New York.

## Musical

**Play Piano by Ear.** A sound system. Booklet free. Boucher's Harmony Studio, 12, Ottawa, Canada.

## Old Money Wanted

**\$2 to \$500 each paid for hundreds of Old or Old Coins.** Keep all old money, it may be very valuable. Send 10c for New Illustrated Coin Value Book, 48c. Guaranteed prices. Get posted. We pay Cash. Clarke Coin Company, 14 Street, LeRoy, N. Y.

## Patent Attorneys

**Mason, Fenwick & Lawrence,** Washington, D. C., New York and Chicago. Established 1861. Inventions protected, trade-marks registered. Information given—write promptly.

**Patents—Send for form "Evidence of Conception"** to be signed and witnessed. Form, fee schedule, information free. Lancaster and Alvine, Registered Patent Attorneys in United States and Canada, 269 Ouray Bldg., Washington, D. C.

**Patents—Send drawing or model of your invention for examination and instructions.** Advice and booklet free. Highest references. Best results. Promptness assured. Watson E. Coleman, Patent Lawyer, 724 9th Street, N.W., Washington, D. C.

**Inventors—Should write for our Guide Book, "How to Obtain a Patent"** and Record of Invention Blank. Send model or sketch and description of inventions for Inspection and Advice Free. Radio, Electrical, Chemical, Mechanical and Trademark Experts. Terms Reasonable. Victor J. Evans & Co., 822 Ninth, Washington, D. C.

**Patent Sense—Valuable book free.** See Lacey's ad, page 1273. Lacey & Lacey, 831 E. St., Washington, D. C. Established 1869.

**Wanted, Ideas.** Demand for novel devices, however small. If patentable, may be the means of your independence. Patents obtained. Sales negotiated. Advice free. INVENTORS SERVICE BUREAU, Box 1648, Washington, D. C.

## Patents

**Inventions Commercialized.** Patented or unpatented. Write Adam Fisher Mfg. Co., 278 Enright, St. Louis, Mo.

## Printing, Engraving and Multigraphing

**200 Letterheads and 100 Envelopes, \$1.10, postpaid.** OBERMAN COMPANY, Box 1268, Chicago.

## Printing Outfits and Supplies

**Print your own cards, stationery, circulars, paper, etc.** Complete outfits \$8.85; Job Presses \$11; \$29; Rotary \$149. Print for others, big profit. All easy, rules sent. Write for catalog forms, type, paper, etc. Kelsey Company, P-12, Meriden, Conn.

## Radio

**Press and public concede it to be the best ever produced.** "Radio Theory and Operating" by Mary Texanna Loomis, member Institute of Radio Engineers, Lecturer on radio, Loomis Radio College. Thorough text and reference book; 386 pages, 700 illustrations. Price \$3.50, postage paid. Used by Radio Schools, Technical Colleges, Universities, Dept. of Commerce, Gov't Schools and Engineers. At bookstores, or sent on receipt check or money order. Loomis Publishing Company, Dept. B, 405-9th St., Washington, D. C.

**Raytheon Kits \$17.75, UX 281 Kits \$25.75.** Write for diagrams and material lists. Radio Parts Sales Co., Orange, N. J.

**Phenomenal new crystal set.** Guaranteed 1,000 miles, and loud-speaker reception or money back. \$2.35, cash or C. O. D. McKay Instrument Co., Railway Exchange Building, Portland, Oregon.

**Write about our efficient power devices.** KIMBLE ELECTRIC CO., 441 E. Ferry, Buffalo, N. Y.

**Be the licensed Radio Doctor of your community.** \$7-\$10 spare time evenings. Our co-operative plan procures all the work you want. Secure franchised territory now. Write for booklet, Co-Operative Radio Doctors. Dept. N, 131 Essex St., Salem, Mass.

## Salesmen Wanted

**A paying position open to representative of character.** Take orders shoes, hosiery, direct to wearer. Good income. Permanent. Write now for free book, "Getting Ahead," Tanners Shoe Mfg. Co., 874 So. C. St., Boston, Mass.

**A Good Line:** Suitable for all or part-time. Can be sold in big cities or small towns; any place. Every business house needs envelopes in different sizes, weights and qualities. Many buy in large quantities. Our line includes stationery, and is very complete. The samples are flat, carry easily, weigh little, look good; prices reasonable. Commission liberal and paid promptly. You would like our offer. American Envelope Company, Mexico, Missouri.

## Scenery to Rent

**World's Most Beautiful settings for operas, plays, minstrels.** Amelia Grain, Philadelphia.

## Song Writers

**Song Writers—Substantial Advance Royalties** are paid on publishable work. Anyone having original ideas for songs may submit poems for examination and free advice. Walter Newcomer, 1674 Broadway, New York.

## Telegraphy

**Telegraphy—Both Morse and Wireless taught** the big salaries. Wonderful opportunities. Free chance to earn part. School established fifty years ago free. Dodge's Institute, Cour St., Valparaiso, Ohio.

## Wanted to Buy

**Full Value Paid for Old Gold, Jewels, diamonds, crowns, bridges, dental gold, silver or silver ore; magnet points, old false teeth.** Returned if our offer is not satisfactory. Smelting Works (The City), Dept. 16, Chicago, Ill.

(The ad to the same Moore when the R.F. tube arrangement was IN AUS Editor, Radio News I have just built in your issue of goods, all right



a cloud with me. Tube for tube, and not excepting regeneration, I do not believe any circuit has developed which could touch this autotransformer thing. I will except the Strobodine and Hildodine—as I have been unable, to date, to see or hear either one.

It isn't entirely a question of "how much" circuit, nor is it entirely "what kind?" There is a very great deal in this; how good are your connections, and how much excess copper is in the wiring?

I would like to know whether the lady in St. Louis did hear the song dedicated to her in Chicago. It's more than an even chance she did.

R. H. LITTLE,  
94 Millcreek Street, Uniontown, Pa.

**STANDARD-FREQUENCY TRANSMISSIONS**

The summer schedule of official standard-frequency (code) transmissions from station WWV, Bureau of Standards, Washington, D. C., follows. Readers unfamiliar with these and the methods of calibrating instruments by them may, if interested, obtain Letter Circular No. 171, with full instructions, on application to the Bureau.

Times given are Eastern Standard. Figures above, kilocycles; (below in parenthesis, approximately, meters) of the transmissions.

Hours	April 20	May 21	June 20	July 20	Aug. 20
10:00	3000	650	1500	3000	125
10:08	(100)	(461)	(200)	(100)	(2400)
10:12	3300	750	1650	3300	150
10:20	(91)	(400)	(182)	(91)	(2000)
10:24	3600	850	1800	3600	175
10:32	(83)	(353)	(167)	(83)	(1714)
10:36	4000	950	2000	4000	200
10:44	(75)	(316)	(150)	(75)	(1500)
10:48	4400	1060	2250	4400	225
10:56	(68)	(283)	(133)	(68)	(1333)
11:00	4900	1200	2500	4900	250
11:08	(62)	(250)	(120)	(62)	(1200)
11:12	5400	1350	2750	5400	275
11:20	(56)	(222)	(109)	(56)	(1091)
11:24	6000	1500	3000	6000	300
11:32	(50)	(200)	(100)	(50)	(1000)

**Radio News Laboratories**

(Continued from page 1253)

primary and secondary are supported by four celluloid rods 5/16-inch in diameter and 2-5/16 inches long; these rods are attached to two flat celluloid rings 3 inches in diameter and, together with the base which carries five small plugs, form a rigid



Frame for the transformer. The primary slides over the supporting rods, thus making possible to adjust its coupling with the secondary. The secondary is tapped at 15 turns and has an inductance of approximately 220 microhenries.

AWARDED THE RADIO NEWS LABORATORIES CERTIFICATE OF MERIT NO. 2323.

**R.F. TRANSFORMER**

The long-wave plug-in transformer shown here comprises three basket coils mounted on the same frame; one for the primary and the other two for



radio-frequency transformer long-wave reception in radio-frequency plug-in coil design three preceding items, it is

RADIO NEWS LABORATORIES OF MERIT NO. 2324.

SCOTT'S TRANSFORMER CO. 706 Erie St. Chicago, Ill. Ask for the new circuit.

**I Want to Know**

(Continued from page 1256)

this plate. The lug should be provided with a tight-fitting rubber tube generously covered with vaseline, to prevent sparking at the point where it leaves the solution. This lug can be cut as shown in the diagram; so that it will not be necessary to waste very much material in order to get this connection.

**Types of Electrolytic Condensers**

By referring to Fig. 2277B you will note that there are two general types of electrolytic condensers. The first (1) is to be used with alternating-current circuits and contains two sets of plates, arranged alternately in the electrolyte. In this case, the condenser should be "formed" with alternating current so that both sets of plates will have a film over their surfaces. The other (2) is the D.C. type and contains one set of aluminum plates and a lead plate. The lead plate serves only to make an electrical contact with the electrolyte, and should always be used as the negative terminal. This is the type of condenser to be used in "B" power units and other circuits supplied with direct current. An ordinary glass battery-jar or a large mason jar can be used as a container; although if the latter is employed it may be necessary to have more than one cell in order to obtain sufficient capacity for the circuit. When used in "B" power units, these condensers must be "formed" with voltages higher than the output voltage of the rectifier tube, so that the condenser will not break down. Because of this, the capacity obtained is not as great as that of a condenser used for low-voltage work.

To "form" the plates of the condenser, it should be placed across a suitable current supply—either D.C. or A.C., depending upon the condenser—and should be left in the circuit for about 24 hours. A forming voltage should be applied which is somewhat above the maximum voltage that is to be applied to the condenser.

When low-voltage condensers are to be made, a system such as the one shown in Fig. 2277B at (3) should be used. The potentiometer should have rather high-resistance and be capable of dissipating the heat generated through its resistance strip.

Probably the most common electrolyte used, is sodium borate, or borax as it is commonly called. A saturated solution of this chemical should be made and a small amount of glycerine should be added.

One of the main reasons why chemical condensers and rectifiers have not become more popular is because of the sloppiness and the necessity of renewing the water in the solution. At different times experiments have been made with a number of so-called "jelly" electrolytes, including fused sodium phosphate and several other chemicals. However, these jelly rectifiers have not been successful because, as the water evaporates, the jelly falls away from the electrodes; thus stopping the action.

**CAN YOU "BEAT" IT?**



—The Wireless Constructor (London)

**180 VOLT "B"**

ONLY \$12.45



Now—you can buy as good a "B" Eliminator as it is possible to build—at a price that won't cramp your purse. And you buy the PEERLESS without risk of any kind, for it is yours to try 30 days and it is

**GUARANTEED 2 YEARS** This is a 171 power tube, too—and guaranteed for two long years—at the ridiculous low price of only \$12.45.

**DOWN MAIL COUPON** Send only \$1.00. A dollar bill will do. We'll ship the PEERLESS "B" at once. Pay the expressman \$11.45 plus small express charges. Remember—you order the PEERLESS entirely at our risk. 30 days free trial. Money back guarantee protects you. Order NOW.

PEERLESS MFG. CO., 3983 Cottage Grove Ave., Chicago, Ill.

**GUARANTEE COUPON** PEERLESS MFG. CO., 3983 Cottage Grove Ave., Chicago. I enclose \$1. Send me one Peerless 180 volt "B" Eliminator and one \$4.50 Q. R. S. 85 Mill. Tube. I agree to pay expressman \$11.45 plus small express charges. It is understood I can have my money refunded if not satisfied.

Name.....  
Street.....  
Town..... State.....

**Changes Your Set Into a Short-Wave Receiver**

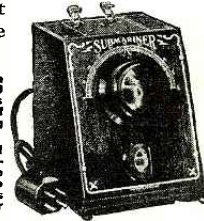

Sent postpaid anywhere in U. S. upon receipt of \$15.00 M. O., or C. O. D., plus postage, upon receipt of \$1.00 to guarantee carrying charges.

When ordering state kind of set so that detailed directions for use may be given if necessary. Also state type of tubes, such as UX195, UV195, WDX1, or 201A.

**The SUBMARINER**

Regardless of the kind of set you have, this device will permit you to listen to short-wave stations between 20 and 65 meters. Operates with sets such as T. H. F., Neutrodyne, Super-Heterodyne, regenerative sets, and many other types. No additional tubes or batteries required. No changes to the wiring of the set. A short aerial and ground is connected to the "Submariner," and a cable and plug attaches it to the set. Requires less than a minute to attach or detach. Operates as a wave changer with Super-Heterodynes, and as a detector unit with others.

**SHORT-WAVE RECEPTION**

Is practical because they penetrate better, and there is less static. There are several powerkit stations using the wave band covered by the "Submariner" for broadcasting programs. You may also learn code by listening to amateurs from all parts of the world. You will have a highly efficient short-wave receiver when the "Submariner" is attached to your set. Nothing else like it on the market. Take a trip in the low waves on board the "Submariner."

**ORDER TODAY**

We guarantee to refund if the "Submariner" fails to operate

ADDRESS  
**J-M-P MANUFACTURING CO.**  
Dept. 120 Milwaukee, Wis.



**Build LACAULT'S Latest**

ALL WAVE ELECTRIC  
Quick Shipment "R. E. L. 9" All Parts in Stock

Write for our list of "Specials" —lowest prices in country.

**R. E. LACAULT'S RADIO ELECTRIC LABORATORIES**

116 WEST 65th STREET NEW YORK CITY

**VICTOREEN**

Super Coils

Send for Folder and our Blue Print of the new A. C. circuit.

Geo. W. Walker Co.

2825 Chester Avenue  
Dept. B Cleveland, Ohio

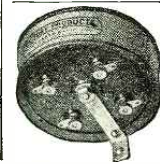

# Announcing A GREAT, NEW RECEIVER SCOTT CHALLENGES THE WHOLE WORLD OF RADIO TO ANY KIND OF COMPETITIVE TEST



**E. H. SCOTT**

The New Scott Shield Grid 9 was designed by E. H. Scott, designer of the World's Record Super 10, which prior to the advent of this new model held all records for Radio set performance.

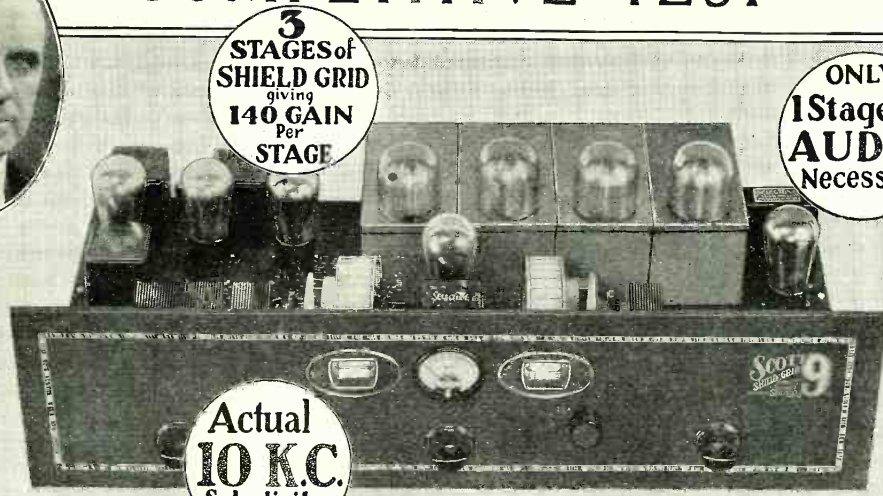

**3 STAGES of SHIELD GRID** giving **140 GAIN Per STAGE**

**ONLY 1 Stage of AUDIO Necessary**

**Actual 10 K.C. Selectivity**

**More Actual Amplification • More Distance and Volume than Any Other Existing Receiver Known to Us**

This—we believe, is the most powerful, the most selective and the finest toned receiver in existence today. We draw this conclusion from having tested and scientifically measured every other receiver which might claim itself the equal of the SCOTT World's Record Shielded Grid NINE. And there is no question but that this radically new type of receiver will maintain its position of obvious superiority for years to come, for the features of circuit engineering responsible for its amazingly better performance are far ahead of any circuit developed to date.

**UNLIMITED RANGE!** Without aerial, ground or loop, the SCOTT Shielded Grid NINE brings Pacific Coast Stations to Chicago with loud speaker volume. And so tremendous is the amplification of the shielded grid long wave amplifier employed, that it is impossible to determine a range limit for this receiver when used with a short antenna and a connection to ground.

**Shielded Grid Tubes Used in an Entirely New Way**

Standard circuits commonly in use with the new shielded-grid tubes, provide actual amplification of approximately 40 per stage. The revolutionary new circuit used exclusively in the SCOTT Shielded Grid NINE, gives a practical amplification of 140 per stage, thereby making this receiver

many times more powerful than receivers using shielded-grid tubes in a conventional manner. It is this new circuit arrangement developed and used exclusively by us which enables us to challenge the whole world of radio to any kind of competitive test with assurance that the SCOTT Shielded Grid NINE will win.

**Only One Stage of Audio Required!** The second detector output of this receiver is so heavy that concert volume and clear, undistorted cathedral tone, even on the most distant stations, is obtained with but a single stage of 2 to 1 audio frequency amplification.

**Easy to Build --- Results Guaranteed** Despite the fact that the Scott Shielded Grid NINE is one of the most elaborate receiving systems ever devised—and despite the fact that it embodies many features of circuit arrangement not known to common practice, it is a very easy set to build, and when you buy the kit of parts we positively guarantee that you will get the same results we get from our laboratory model. Both panel and sub-panel are drilled to receive each part and the shield-grid amplifier units come to you fully wired and tested—ready to be connected into the circuit just as though they were a transformer.

**Why Pay More for Less?** Why pay more than the small cost of the Scott Shielded Grid NINE when no other receiver offers you so much? Why not have a receiver which provides actual 10 Kilocycle selectivity regardless of where located? Why not have a receiver with which you can listen in on all the world—no limit to its distance range. The Scott Shielded Grid NINE is, unquestionably the finest, most powerful, most advanced receiver of the day, and is, beyond all doubt, destined to hold its position of leadership, throughout the coming years. It is the ultimate. Build it—enjoy it NOW.

**FREE**  
Circuit Diagram and Particulars

Find out all particulars of the Scott Shielded Grid NINE. Examine its circuit. See for yourself why it has unlimited range—unlimited power—perfect tone. Proof of the superiority of this great new receiver is FREE to you. Also copies of 6000 and 9000 mile reception verifications and other records made by the Scott World's Record Super 9 and the Super 10, the less powerful predecessors of the new Scott Shielded Grid NINE. Get this information now. Simply clip and mail the coupon. Mail it TODAY!

**SCOTT TRANSFORMER CO.**  
7626 Eastlake Terrace • Dept. 1  
CHICAGO, ILL.

**SCOTT**  
**SHIELD-GRID**  
WORLDS  
RECORD  
**SUPER 9**

Mail this  
Coupon!

TRA  
Dept.  
Terrace  
Send me full particulars  
Shielded Grid NINE.

Name.....  
Street.....  
Town..... State.....

*The Perfected  
Invention of  
Dr. J. Harris Rogers  
Celebrated War Time  
Naval Radio Consultant*

The eminent scientist, Dr. J. Harris Rogers is known the world over for his research work and successful accomplishments in the line of underground and underwater radio transmission and reception. His invention, the Rogers *Underground Antenna* for reception of waves within the B.C.L. band is, unquestionably, one of the most important radio advancements of the year.



*This photo shows Dr. Rogers charting the country wide success of one of his numerous underground radio tests*

**First news** of the **ROGERS**  
*Underground*  
**ANTENNA**

Made under exclusive license in accordance with patents of Dr. J. Harris Rogers Nos. 1303720, 1349103, 1349104 and pat. pend.

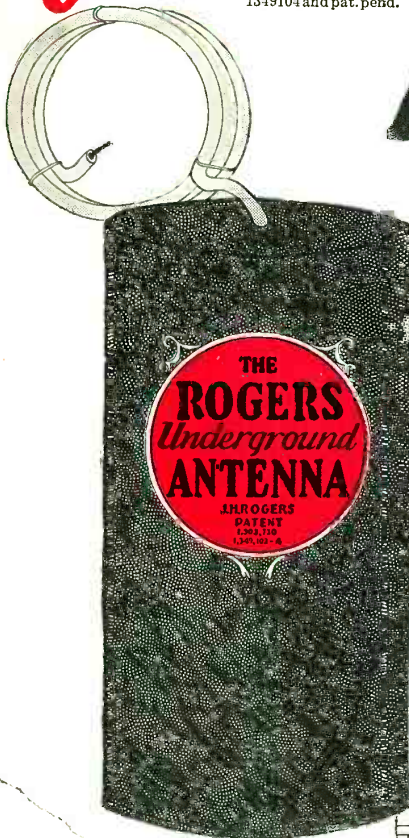

**Provides Clear, Loud Reception  
Regardless of Weather - Increases  
Distance and Volume with Any Set**

That radio waves, unspoiled by static and less affected by weather conditions, travelled thru the ground was the belief of Dr. J. Harris Rogers. Test after test proved his contention. On nights when weather made reception from distant points impossible with an antenna suspended in the air, reception was clear, steady and loud when taken out of the ground. Static has little effect upon ground-wave reception, and it was found that ground waves usually exceeded the strength of air waves even when the latter were at their best. It then remained for someone to develop a device with which these clear, strong ground waves could be intercepted and brought to the receiving set. Followed more years of research, more experimenting, more practical tests—all resulting in the Rogers Underground Antenna—developed and perfected by Dr. Rogers, himself—the product of a lifetime of study—a proved device, successful wherever used and offered to you with a positive guaranty of money back if you are not satisfied.

**Yours to Test  
FREE**

It costs you nothing to test the Rogers Underground Antenna. We will send it to you to try on your own set, and we don't ask you to pay a cent for this great radio improvement if you don't find it all that *Dr. Rogers claims* in his patents. Send the coupon now. Let us send you the startling facts of the Rogers Underground Antenna and full particulars of the FREE comparative test we want you to make. Clip the coupon. Send it today.

**EASILY INSTALLED  
IN 5 MINUTES!**

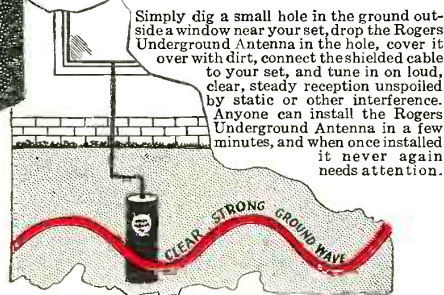

THE ILLUSTRATION at the right shows a typical installation of the Rogers Underground Antenna. As there is but little static in the ground, this Rogers unit delivers clear, strong, radio impulses to the receiver, thru the shielded connecting cable. And think! How much easier it is to install the Rogers Underground Antenna than it is to climb around on a slippery roof hanging up a wire which collects as much static as it does radio waves.

**The Underground Antenna Co.**  
4207M COTTAGE GROVE AVENUE CHICAGO, ILL.

**MAIL THIS NOW**

**The Underground Antenna Co.**  
4207M Cottage Grove Ave.  
Chicago, Ill.

Send me all the facts on the Rogers Underground Antenna. Also full particulars of FREE Test Offer and GUARANTEE.

Name.....

Street.....

Town..... State.....

# Abox

## "A" BATTERY ELIMINATOR

### A. C. OPERATION— Without Change in Set Wiring or Tubes



**6-Volt Abox  
Eliminator**

This model will operate any set using eight or less standard 6-volt tubes. Not necessary to change set wiring. Over 100,000 of this type in use.

**\$32<sup>50</sup>**



**4-Volt Abox  
Eliminator**

A new model for sets using 4-volt tubes. Fits Radiola battery compartment. Size 8<sup>3</sup>/<sub>4</sub> in. long, 4 in. wide, 6<sup>7</sup>/<sub>8</sub> in. high. Output—6 amperes, 4 volts D. C.

**\$27<sup>50</sup>**

All Prices Slightly Higher on West Coast

Changing to electric operation is a step toward convenience and dependability. By all means do it, but do not overlook the advantages of using the most sensitive tubes available.

A. C. operation using Abox is the most practical, economical and satisfactory method because it changes house current to the kind of power necessary to operate proven standard tubes.

Abox is a rectifier-filter combination adaptable to any receiver using eight 1/4 ampere tubes or less, or sixteen of the proposed new 1/8 ampere tubes. You make no changes in set wiring or tubes. Simply attach Abox and plug in. Reception is noticeably improved and consistently better. The convenience alone is worth the small investment.

Abox also makes available the many new special purpose tubes that improve radio operation and constitute the heart of practically all new custom-built circuits. A graphic comparison of the tubes possible to use with an Abox and the other A. C. type, is strikingly illustrated in the chart below, showing the superiority of Abox from every standpoint, where conversion is contemplated.

*These tubes can be operated direct from the light socket with Abox:*

UX 222 Screen Grid Amplifier	UV 199 Detector, Amplifier
UX 201B 1/8 Ampere Amplifier	UX 199 Detector, Amplifier
UX 112A Power Amplifier	UX 200A Supersensitive Detector
UX 120 Power Amplifier	UX 201A Detector, Amplifier
UX 171A Power Amplifier	UX 240 Voltage Amplifier

#### A. C. TYPES:

226 Amplifier

227 Detector

Use coupon for further information

## The Abox Company

215 North Michigan Avenue

Chicago, Illinois

THE ABOX COMPANY  
215 No. Michigan Avenue, Dept. 5, Chicago, Ill.

Please send me further information on how I can electrify my set with ABOX.

Name .....

Address .....

Check here if you are a dealer