

RADIO'S GREATEST MAGAZINE

RADIO NEWS

NOVEMBER
25 Cents

Over 200
Illustrations



Edited by HUGO GERNSBACH



"GAMBY"
Radio Star
On WJZ Chain

EXTENSIVE PUBLISHING COMPANY NEW YORK PUBLISHERS OF
SCIENCE & INVENTION RADIO LISTENERS' GUIDE SPARE-TIME MONEY MAKING GRENCH HUMOR MAZING STORIES



Cunningham RADIO TUBES

The Right Tube in the Right Socket

There are now twenty distinct types of Cunningham Radio Tubes, each expressing the correct balance in design and specification to perform a definite function most efficiently in your radio. Your dealer will tell you the correct type your radio is designed to use. Equip throughout with Cunningham Radio Tubes. By so doing you insure maximum performance in your radio.

*Twenty different types—
all in the Orange and Blue carton*

E. T. CUNNINGHAM, Inc.

New York

Chicago

San Francisco

Since 1915—Standard for all Sets

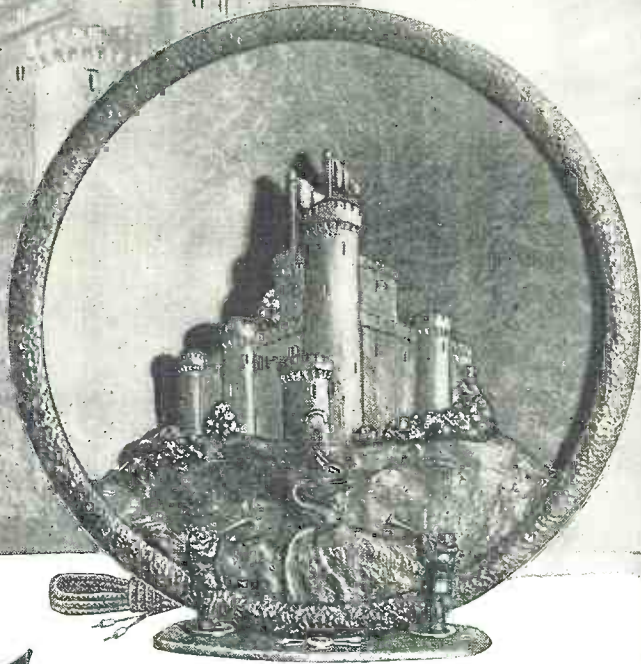
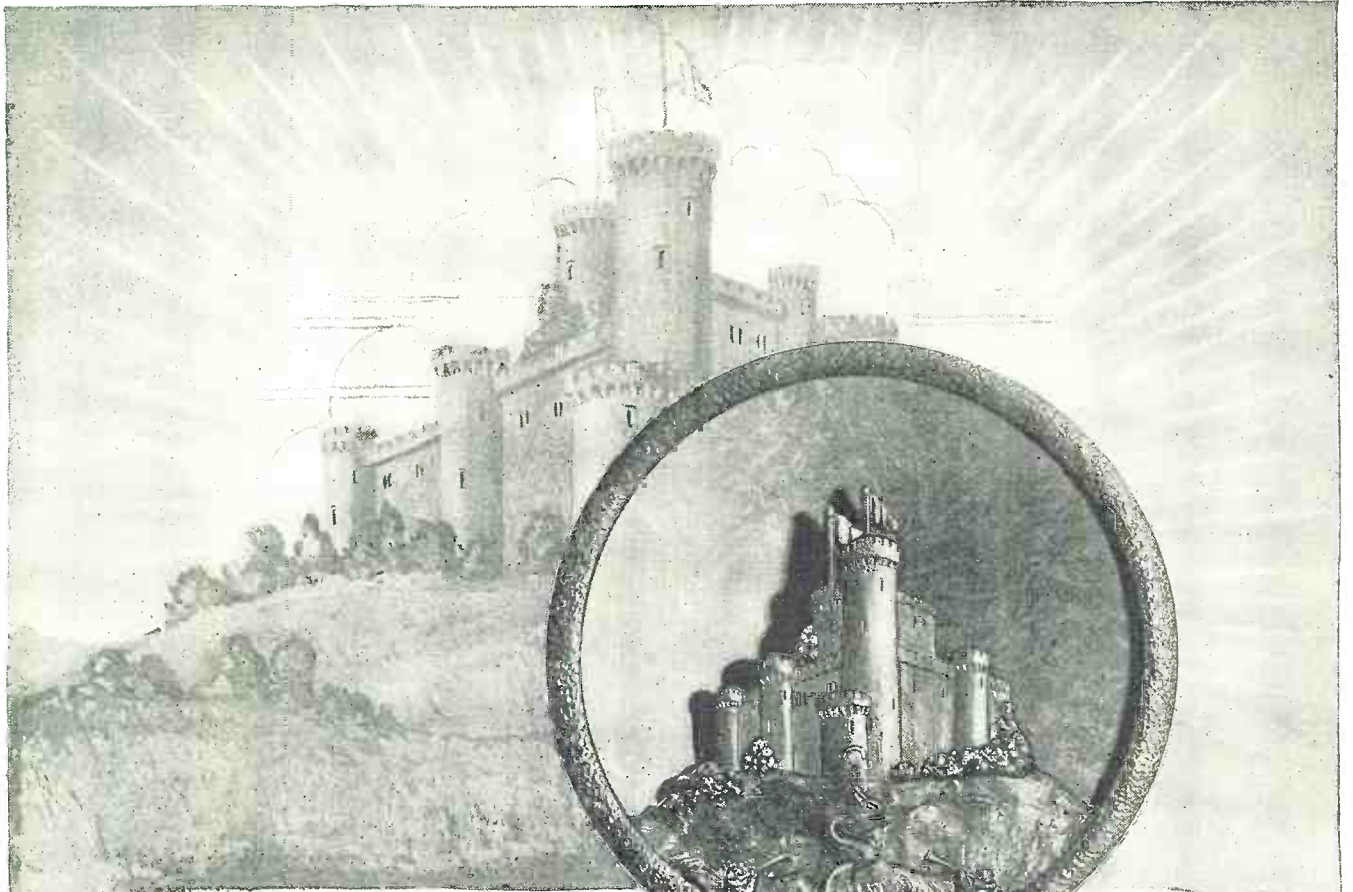

Tower Castle Cone

\$11⁹⁵

Prices Slightly Higher in the West

AN impelling example of creative art—a fine old medieval castle with embattled turrets, cast in bas-relief of two-toned bronze protecting a 17" free-edge cone. This model is equipped with a powerful armature-type unit, especially adapted for the new tubes, producing a tone quality beyond imitation.

Ask Your Dealer or Write for Illustrated Circular

TOWER MFG. CORP. 122 Brookline Ave., Boston, Mass.
MORE THAN TWO MILLION TOWER PRODUCTS NOW IN USE



MODEL "28," \$17.50

**Prices Slightly Higher in the West*



ADVENTURER, \$11.95

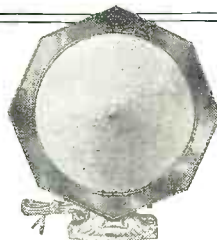

NEW IMPROVED
MEISTERSINGER, \$15

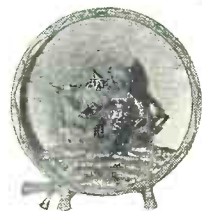

PIRATE SHIP, \$8.95

RADIO NEWS

Published by EXPERIMENTER PUBLISHING COMPANY, Inc., Publishers of "Radio News," "Science and Invention," "Radio Listeners' Guide," "Spare-Time Money Making," "Amazing Stories," and "French Humor."

H. GERNSBACK, President.

S. GERNSBACK, Treasurer.

Member: Audit Bureau of Circulations

Radio Magazine Publishers Association

Editorial and General Offices:

230 Fifth Avenue, New York City

VOLUME 9

NOVEMBER, 1927

NUMBER 5

Contents of This Issue:

The Outline of Broadcasting, By Hugo Gernsback	459	The "Peridyne" Principle, By Hugo Gernsback	486
In the Future—Intermediate- or Short-Wave Broadcasting? By Lieut. H. F. Breckel	460	The Hilograd 6 Receiver, By F. A. Jewell	488
New 50-Kilowatt Transmitter of Station WEAF, By Joseph Riley	462	How to Build a Light-Socket Receiver Using the New A. C. Tubes, By McMurdo Silver	492
Awards of the \$250 July Cover Title Contest,	464	The Super-Hilodyne Circuit, By F. A. Jewell	497
The Reflection and Refraction of Radio Waves, By Clyde A. Randon	465	The Pilot "De Luxe" A. C. Operated Set, By M. B. Sleeper	498
What's New in Radio,	466	Hook-Up Review,	502
Burnt-Out Vacuum-Tube Contest Results,	470	Radio Wrinkles—Awards of the \$50 Bi-Monthly Prize Contest,	503
The Listener Speaks,	472	The Construction of a Lattice Radio Tower, By C. W. Guyatt	504
Woman's Place in Broadcasting, By Herndon Green	477	Letters from Home Radio Set Constructors	505
"Gamby," The Girl on the Cover,	477	RADIO NEWS LABORATORIES	506
What Every Station Wants—Applause, By Earl Sowers	478	Radiotics	508
The Voice of the People, By Joseph D. Mountain and C. Sterling Gleason	479	I Want to Know	509
Broadcastastics,	480	In Lighter Vein	543
List of Broadcast Stations in the United States,	481	Progress in Radio	543
Better Volume and Quality, By H. Winfield Secor	482	The Question of Line-Voltage, By Charles Golenpaul	548
How to Use the New A. C. Tubes, By Victor L. Osgood	484	Radio Bugs	550
		New QRAs	551
		What Radio Terms Mean	553

In Forthcoming Issues:

THE "PERIDYNE" FIVE RECEIVER By Hugo Gernsback

Constructional details for this remarkable set, the distinctive theory of which is explained in this issue of RADIO NEWS.

THE CAUSE AND ELIMINATION OF FADING OF DONALD H. MENZEL

An interesting article, dealing with a subject which has forced itself on the attention of every listener, and a new idea in receiving antennas.

THE NEW "HI-Q" RECEIVER

To the "Hi-Q" circuit, one of the favorites in receiver construction, another stage of R.F. amplification and other refinements are added in this new adaptation.

RADIO NEWS is published on the 10th of each preceding month. There are 12 numbers per year. Subscription price is \$2.50 a year in U. S. and possessions. Canada and foreign countries, \$3.00 per year. U. S. Coin as well as U. S. Stamps accepted (no foreign coins or stamps). Single copies, 25 cents each. Checks and money orders should be drawn to order of EXPERIMENTER PUBLISHING CO., INC.

All communications and contributions to this journal should be addressed to Editor, RADIO NEWS, 230 Fifth Ave., New York, N. Y. Unaccepted contributions cannot be returned unless full postage has been included. All accepted contributions are paid for on publication. A special rate is paid for novel experiments; good photographs accompanying them are highly desirable.

RADIO NEWS, Monthly. Entered as second-class matter, July 12, 1924, at the Post Office at New York, N. Y., under the Act of March 3, 1879. Additional entry at Long Island City, N. Y., and San Francisco, Calif. Title registered U. S. Patent Office. Copyright, 1927, by The Experimenter Publishing Co., Inc., 230 Fifth Ave., New York. The Contents of this magazine are copyrighted and must not be reproduced in the United States without giving full credit to the publication. Translation into foreign languages must not be made unless permission is obtained from the publishers. Copyrighted in Germany. Reproduction of articles in Germany is reserved for Radio, Berlin 42.

RADIO NEWS is for sale at all newsstands in the United States and Canada, and at Eyre's, Ave. de l'Opera, Paris, France. European agents: S. J. Wise Et Cie, 40 Place Verte, Antwerp, Belgium.

HOW TO SUBSCRIBE FOR RADIO NEWS. Send your name, address and remittance to Experimenter Publishing Co., 230 Fifth Ave., New York. Mention the name of the magazine you are ordering. We also publish SCIENCE AND INVENTION, RADIO LISTENERS' GUIDE, SPARE TIME MONEY MAKING, AMAZING STORIES and FRENCH HUMOR. Write clearly.

RATES AND TERMS. The subscription rate for RADIO NEWS is \$2.50 per year (12 numbers). When remitting do so by check, money order, or registered letter if cash is enclosed. Avoid sending cash through the mail if possible. Subscriptions for less than one year are not accepted. Subscription may be made in combination with SCIENCE & INVENTION, RADIO LISTENERS' GUIDE, SPARE TIME MONEY MAKING, AMAZING STORIES and FRENCH HUMOR.

POSTAGE. We prepay postage in all parts of the United States, Mexico and island possessions. For foreign or Canadian subscriptions we require 50 cents in addition to the subscription price for additional postage charge.

CHANGE OF ADDRESS. Notify us as far in advance as possible. It requires several weeks to make an address change on our records. Always write clearly.

General Advertising Dept., 230 Fifth Avenue, New York City

ADVERTISING REPRESENTATIVES

L. F. McCLURE, 720 Cass Street, Chicago, Ill.
DAVIES, DILLON & KELLY, 15 West 10th St., Kansas City, Mo.
T. F. MAGRANE, Park Square Bldg., Boston, Mass.

HARRY E. HYDE, 548 Drexel Building, Philadelphia, Pa.
A. J. NORRIS HILL CO., 5 Third St., San Francisco, Calif.
112 West 6th St., Los Angeles, Calif.
Leary Building, Seattle, Wash.

When the ball goes 'round the end for 40 yds.

"You're there with a Crosley!"

The Crosley Radio Corporation:
Can you explain "balancing," so people can understand it? We technical people know that Hazeltine's neutrodyne principle is a wonderful thing. If you can make it understandable to laymen you're good.

Yours truly,
Noyes Bros. & Cutler Co.,
St. Paul, Minn.

Nature always puts obstacles in our way. When men begin to study a new invention or discovery they find that there are many problems to solve before a successful device can be built. This was the case with the steam engine, the printing press, the automobile, the aeroplane, and every other major invention that you can think of.

The vacuum tube is, perhaps, one of the most remarkable inventions ever made. We found that we could use it to amplify the radio signals. But when we tried to tune these amplifiers, so that they would help us select the desired signal, we found that the vacuum had a tendency to misbehave.

When a tube is used to amplify, the output voltage is much stronger than the input voltage. This is the natural result of the amplification. But there is a path back through the tube through which some of the strong output voltage can get back to the input side of the tube. This voltage is then again amplified and again returns, getting stronger each time, the result being that the tube goes wild. It becomes a miniature broadcasting station on its own hook.

If we can provide a second path from the output circuit to the input circuit, so arranged that the voltage which comes back through this second path is opposed to the voltage that comes back through the tube itself we can prevent the trouble. This is called "balancing" because the second path is adjusted so that it exactly balances the path through the tube.

The Hazeltine method of balancing (or neutralizing) this path through the tube has several unique advantages over all the other methods that have been proposed. This is why Crosley radios use the Hazeltine "neutrodyne" method.

Signal voltages leaving tube greatly amplified but some run around to entrance and crowd in with the little incoming signals.

Hazeltine divides bolshevik voltages, balancing each other by opposing each other they cause no rumpus in the tube and program signals go thru amplifier without interference.

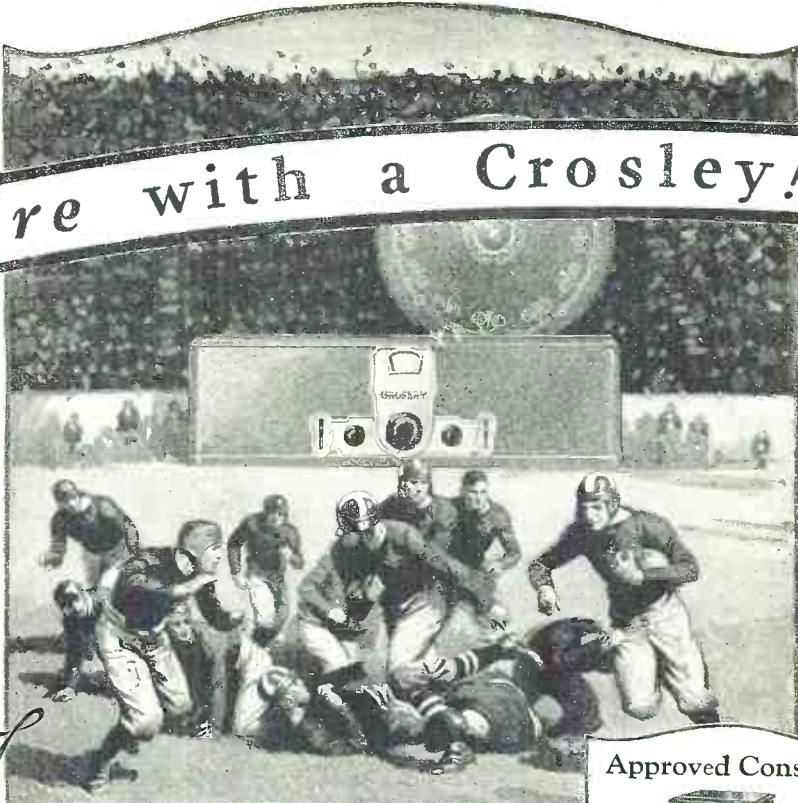

THIS new Crosley Bandbox
6 TUBE RECEIVER *de luxe*
is the national radio hit at \$55.

The "All American" radio of 1928! With license to participate in the enormous radio resources of The Radio Corporation of America, The General Electric Co., The Westinghouse Co., The American Telephone and Telegraph Co., and The Hazeltine and The Latour Corporations, the Crosley Bandbox of 1928 is an "eleven" of super-efficient features and amazing co-ordinated performance. In it are incorporated:

1. The best idea of balancing.
2. The best ideas of shielding.
3. The best ideas of sharp tuning.
4. The best idea of controlling volume.
5. The best idea of station selection.
6. The best idea of finish and color.
7. The best idea of power tube use.
8. The best idea of console installation.
9. The best idea of power supply connections by enclosing all leads in a cable.
10. The best idea of AC tube operation.
11. The best idea of converting AC current to necessary radio DC.

Operation of the Bandbox receiver from house current is possible with the AC model at \$65, which uses the new amazing R.C.A. AC tubes. Power converter costs \$60 more.

These new Bandbox receivers are now on display at over 16,000 Authorized Crosley dealers. Their faultless reception of the many wonderful events constantly on the air is proving such a startling demonstration that a national enthusiasm sweeps the country in the natural exclamation—"You're there with a Crosley!" If you cannot locate your nearest dealer write Dept. 22 for his name and literature.

Approved Consoles



Selected by Powel Crosley, Jr., as ideal, acoustically and mechanically for the installation of the Crosley "Bandbox." Genuine Musicone built in. Crosley dealers secure them from their jobbers through
H. T. ROBERTS CO.,
1340 S. Michigan Ave.,
Chicago, Ill.
Sales Agents for Approved Console Factories
Showers Brothers Company
The Wolf Mfg. Industries



IMPROVED MUSICONES
Musicones improve the reception of any radio set. They are perfect affiliates in beauty and reproductive effectiveness for Crosley Radios. A tilt-table model with brown mahogany finish stands 36 inches high, \$27.50 — 16-inch Super-Musicone as pictured above with "Bandbox," \$12.75 — 12-inch Ultra-Musicone, \$9.75.

CROSLEY RADIO

THE CROSLEY RADIO CORPORATION
Powel Crosley, Jr., Pres. Cincinnati, Ohio
Prices slightly higher west of the Rocky Mts.



Crosley is licensed only for
Radio Amateur, Experimental and
Broadcast Reception.

INDEX TO ADVERTISERS

	Page		Page		Page
A					
Abox Co., The.....	449	Crosley Radio Corp., The.	435		
Accusti-Cone Laboratories.	550	Cunningham, Inc., E. T.,			
Acme Apparatus Co.....	517	Inside Front Cover			
Acme Electric & Mfg. Co.,		Curtan Mfg. Co.....	550		
The	501	D			
Acme Wire Co.....	520	Daven Radio Corp.....	518-526		
Acme Wire Co.....	555	Deutschmann Co., Tobe...	552		
Aero Products, Inc.....	524	Dubilier Condenser Corp..	519-533		
Aerovox Wireless Corp....	530	E			
Airgap Products Co.....	562	Eby Mfg. Co., Inc., The			
Algonquin Electric Co., Inc.	564	H. H.	566		
All-American Radio Corp..	458	Electrad, Inc.,			
All Radio Co.	564	519-528-532-558-560-566			
Allen-Bradley Co.....	532	Electric Specialty Co.....	567		
Alter Co., The Harry,		Engineers' Service Co....	456		
520-532-568-572		Erie Fixture Supply Co....	557		
Aluminum Co. of America.	549	F			
American Auto & Radio		F & H Radio Labs.....	551		
Mfg. Co.....	522-	Fansteel Products Co., Inc.	455		
528-532-558-564-566-572		Ferbend Electric Co.....	541		
American Bosch Magneto		Formica Insulation Co., The	535		
Corp.	453	Freshman Co., Inc., Chas..	562		
American Hard Rubber Co.	562	Fritts Co., H. D.....	519		
Amrad Corporation, The...	553	Frost, Inc., Herbert H....	558		
Arcturus Radio Co., Inc....	447	G			
B					
Balsa Wood Reproducer		G. R. P. Products Co., Inc.	520		
Corp.	542	Gardiner & Hepburn, Inc..	557		
Barawik Co., The,		General Electric Co.....	555		
536-544-555-561-565-569		General Radio Co.....	573		
Belden Mfg. Co.....	519-534	Gold Seal Electrical Co... 512			
Benjamin Elec. Mfg. Co.	519-528	Gould Storage Battery Co.,			
Bernard Furniture Co.....	537	Inc.	559		
Bogue, B. H.....	532	Guaranty Radio Goods Co.,	538-568		
Boudette Mfg. Co.....	442	H			
Boutin Electric Co.....	568	Hamilton-Carr Radio Corp.	545		
Brady, John B.....	543	Hammarlund Mfg. Co..	519-531		
C					
C. E. Mfg. Co., Inc.....	519,	Hammarlund-Roberts, Inc..	557		
Inside Back Cover		Hampton-Wright Co.....	558		
Cable Supply Co.....	518	Harco Co.....	539		
Carborundum Co., The....	531	High Frequency Labs.....	516		
Cardwell Mfg. Corp., The		I			
Allen D	519	Independent Electric Works	549		
Carter Radio Co.....	519-564	International Resistance Co.	448		
Central Radio Labs.....	572	Interstate Sales Co.....	519		
Chaslyn Co., The.....	572	J			
Chemical Institute of N. Y.,		J-M-P Mfg. Co.....	572		
Inc.	529	Jewell Electrical Inst. Co..	557		
Chicago Radio Apparatus Co.	560	Jewell Laboratories.....	551		
Chicago Stock Gear Works	561	K			
Clark & Tilson, Inc.....	573	Karas Electric Co.....	539		
Cloverleaf Mfg. Co.....	515-576	Kennedy, Ralph M.....	537		
Conrad Co., Inc.		Keystone Products Co.....	572		
446-524-534-546-550-553-563		Kodel Radio Corp.....	521		
Copper & Brass Research		L			
Ass'n	567	Lacault Radio Elec. Labs.,			
Cornish Wire Co.....	573	R. E.	519-542		
Coyne Electrical School....	452	Lacey & Lacey.....	554		
Craftsman Radio Products.	566	Langbein - Kaufman Radio			
Cresradio Corp.....	568	Co., The	561		
D					
E					
F					
G					
H					
I					
J					
K					
L					
M					
N					
O					
P					
Q					
R					
S					
T					
V					
W					
X-Y-Z					
Radio Association of Amer-		Radio Engineering, Inc....	525		
ica	441	Radio Equipment Co.....	564		
Radio Institute of America.	568	Radio Service Co.....	573		
Radio Specialty Co.....	527	Radio Randolph Radio Corp...	454-511		
Randolph Radio Corp....	454-511	Raytheon Mfg. Co.....	445		
Raytheon Mfg. Co.....	445	Rowan Battery Supply Co.,			
Rowan Battery Supply Co.,		Walter	528		
S. R. S. Co.....	564	S			
Samson Electric Co.....	519-565	S. R. S. Co.....	564		
Schurman Laboratories....	568	Set Builders Supply Co... 526			
Shure Radio Co.....	537-541-544	Shure Radio Co.....	537-541-544		
Silver-Marshall, Inc.....	451	Smith, B. Hawley.....	536		
Southern Toy Co., Inc....	554	Sovereign Electric & Mfg.			
Co.	526	526			
Sprague Specialties Co....	568	Starrett Mfg. Co.....	565		
Starrett Mfg. Co.....	565	Steinitz Radio Co.....	565		
Steinitz Radio Co.....	565	Sterling Mfg. Co., The....	562		
Straus & Schram.....	526	Strobodyne	519		
Strobodyne	519	T			
V					
W					
X-Y-Z					
X-L Radio Laboratories,		519-538-564			
Yaxley Mfg. Co... 526-542-566		Zenith Automotive Mfg. Co. 552			

**Metrodyne
Radio Sets
are
equipped
for
BATTERY
or
ELECTRIC
Operation**

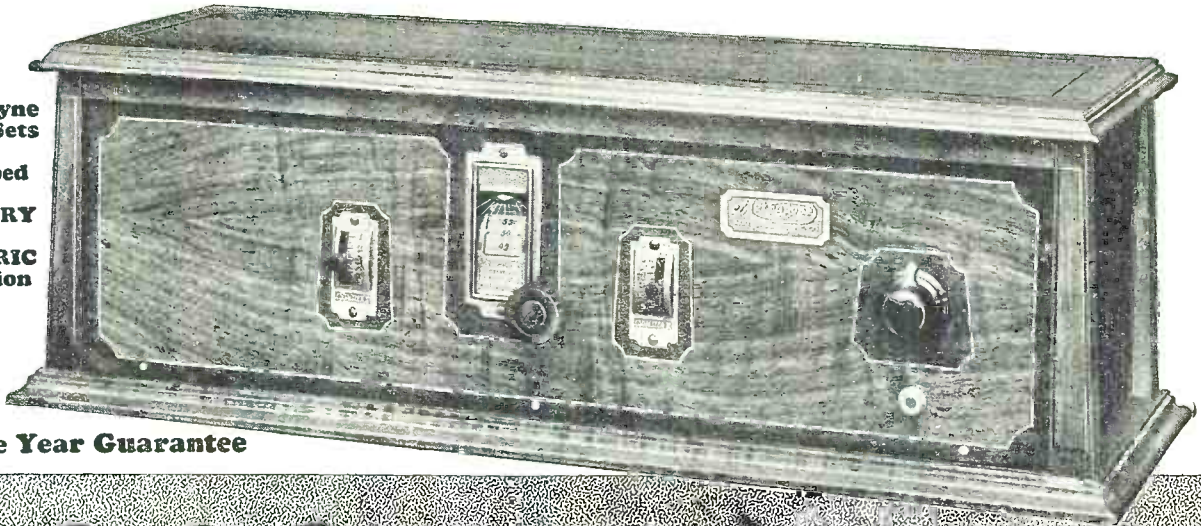

Three Year Guarantee

30 DAYS FREE TRIAL

**Super Six
6 Tubes-2 Dials
\$48.50
Retail Price
Completely Assembled
Big Discounts to Agents
and Dealers**

Metrodyne

ONLY ONE DIAL TO TUNE

**Super Seven
7 Tubes-1 Dial
\$75.00
Retail Price
Completely Assembled
Big Discounts to Agents
and Dealers**

WONDERFUL OFFER DIRECT FROM THE FACTORY!
The World's greatest radios! Electric or battery operated. Perfect working, single dial and two dial control, 6 and 7 tube receivers! And just to prove our claims, we will ship a set to your home for 30 days' free trial. Test it under all conditions. Test it for distance, volume and tonal quality—and if you are not convinced that it is the best single dial or two dial set you ever heard, return it to the factory. We don't want your money unless you are completely satisfied.

**Metrodyne Radio Sets are
equipped for Battery or
Electric operation**

**BIG
PROFITS
to AGENTS
and DEALERS**

Home agents and dealers are making big money selling Metrodynes. All or part time. Metrodyne radios have no competition. Lowest wholesale prices. Demonstrating set on 30 days' free trial. Greatest money-making opportunity!

Metrodyne Super-Seven Radio

A single dial control, 7 tube, tuned radio frequency set. Tested and approved by Popular Science Institute of Standards, Popular Radio Laboratory, Radio News Laboratory and by America's leading Radio Engineers. Designed and built by radio experts. Only the highest quality low loss parts are used. Magnificent, two-tone walnut cabinet with beautiful, gilt metal trimmings. Very newest 1928 model, embodying all the latest refinements.

Easiest set to operate. Only one small knob tunes in all stations. The dial is electrically lighted—easy to log stations, even in the dark. The volume control regulates the reception from a faint whisper to thunderous volume, 1,000 to 3,000 miles on loud speaker! The Metrodyne Super-Seven is a beautiful and efficient receiver, and we are so sure that you will be delighted with it, that we make this liberal 30 days' free trial offer. You to be the judge.

Metrodyne Owners Say:

Mrs. Wm. Leffingwell, Westfield, N. J., writes: "The Metrodyne Radio I bought of you is a wow! This is as good as any \$225 machine I have ever seen."

N. M. Greene, Maywood, Ill., writes: "My time is up and the Metrodyne works fine. I got Havana, Cuba, Oakland, Calif., Denver, Colo., Toronto, Canada, all on the loud speaker."

J. W. Woods, Leadville, Colo., writes: "Received the 7-tube Metrodyne in fine condition. Had it up and working the same day received. Was soon listening to Los Angeles, San Diego, Oakland and other California points; also St. Louis, Kansas City and other east and south stations—all coming in fine. Am more than pleased. Sure enjoying it."

We are one of the pioneers of radio. The success of Metrodyne sets is due to our liberal 30 days' free trial offer, which gives you the opportunity of trying before buying. Thousands of Metrodynes have been bought on our liberal free trial basis.



30 Days' Free Trial—3 Year Guarantee

METRODYNE SUPER-SIX

Another triumph in radio—new 1928 model. Approved by leading radio engineers of America. Highest grade low loss parts, completely assembled in a beautiful walnut cabinet. Easy to operate. Tune in your favorite station on same dial readings every time—no guessing.

Mr. Howard, of Chicago, said:—"While five Chicago broadcasting stations were on the air I tuned in seventeen out-of-town stations, including New York and San Francisco, on my loud speaker horn, very loud and clear, as though they were all in Chicago."

MAIL THIS COUPON 
or send a postal or letter. Get our proposition before buying a radio. Deal direct with manufacturer—**SAVE MONEY—WRITE NOW!**

METRO ELECTRIC COMPANY
2161-71 N. California Ave. Dept. 4 Chicago, Illinois

METRO ELECTRIC COMPANY
2161-71 N. California Ave., Dept. 4
Chicago, Illinois

Gentlemen:

Send me full particulars about Metrodyne 6 tube and 7 tube sets and your 30 days' free trial offer.

Name _____

Address _____

If you are interested in AGENT'S proposition, place an "X" in the square

BUY or BUILD with confidence and Insure Permanent Enjoyment of Your Radio Set!

USE "THE DIRECTORY OF STANDARD RADIO SETS"

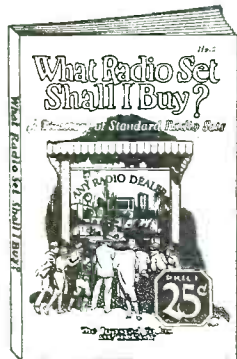

for
buying

THERE is one easy—simple way to decide on what Radio Set to buy. If you are particular as to the style of the set, the power, the sensitivity, the price, or anything that has to

do with a manufactured set you will find a complete answer in the "DIRECTORY OF STANDARD RADIO SETS."

Photographs of all standard manufacturers are shown together with an exhaustive printed description furnished by the manufacturers themselves.

This book is absolutely impartial. It is the only printed book in existence that gives you this information.

40 pages of descriptions and illustrations, size 6 x 9 inches with handsome colored cover. PRICE, 25c.

USE "HOW TO TUNE YOUR RADIO SET"

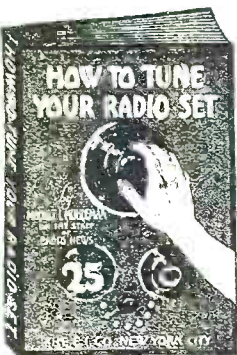

to
enjoy all
programs

RADIO Receivers know no rules of etiquette—they cannot be taught to act on best behavior when company and friends are judging them—but they can be made to act properly if the operator understands the few simple factors that effect tuning or the proper adjustment of the Receiver's controls.

Be one of those on the safe side. Don't be afraid to invite friends and show them that good tuning means good reception and enjoyable programs.

The 64-page, illustrated book on How to Tune Your Radio Set (Conrad—25c) is a carefully prepared, yet simplified, instruction book on tuning alone.

Receivers of different types, individual characteristics are handled separately. All there is to know, all that must be known before one can really say to understand the tuning of a set—is given in this book.

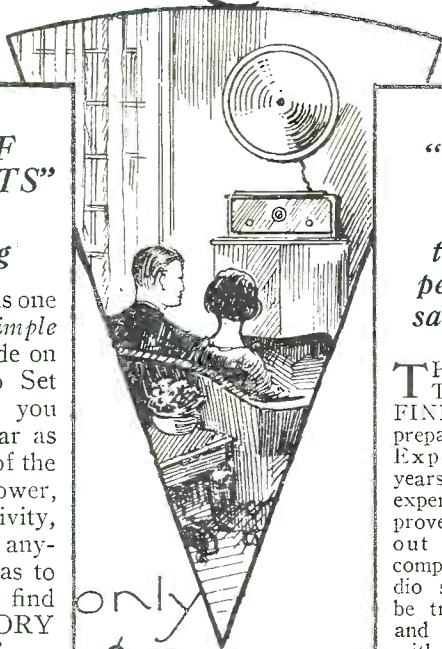

only
\$1.00

buys an entire set of these four books of vital importance to every one owning or contemplating the purchase of a radio set.

They can be bought separately if desired at

25c each

Fill out the coupon below and mail it with your remittance today.

All orders filled promptly.

USE "THE RADIO TROUBLE FINDER"

to insure
permanent
satisfaction

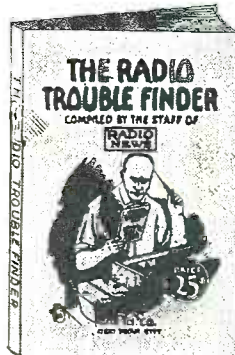

THE "RADIO TROUBLE FINDER" is a book prepared by a Radio Expert with many years of practical experience. It is a proven fact that 99 out of every 100 complaints from Radio set owners can be traced to simple

and minor troubles that a child could repair with a simple book of instructions—and only once in a lifetime the average man need pay an expert to repair his set—if he has a copy of the "RADIO TROUBLE FINDER."

This simplified 64-page book charts all troubles and how to correct them. It is the simplest thing imaginable to use it. Even the more difficult jobs of changing internal mechanism of the set can be accomplished successfully.

The "RADIO TROUBLE FINDER" contains 64 pages, many of which are illustrated. It is size 6 by 9 inches with a colored cover. PRICE, 25c.

USE "150 RADIO HOOKUPS"

for
BUILDING



THIS 68-page book of the Conrad Company is the latest compilation of Hookups in Radio. The Hookups are those that have been tried, tested and perfected by time and by thousands of Radio Listeners. This priceless book contains: 18 Crystal Detector circuits, 39 Regenerative, 21 Reflex, 23 Radio Frequency, 10 Super-Regenerative, 10 Amplifier and Oscillator, 5 Super-Heterodyne and other

valuable Hookups. All circuits are shown by simplified drawings and each is explained in detail. The book is 6x9 inches in size, illustrated, and is contained in a special attractive 2-color cover. PRICE 25c

CONRAD CO., INC., 230 5th Ave., New York.

Gentlemen, I enclose \$..... for one copy of

- Directory of Standard Radio Sets.
- Radio Trouble Finder.
- How to Tune Your Radio Set.
- 150 Radio Hookups.

Name

Address

City, State

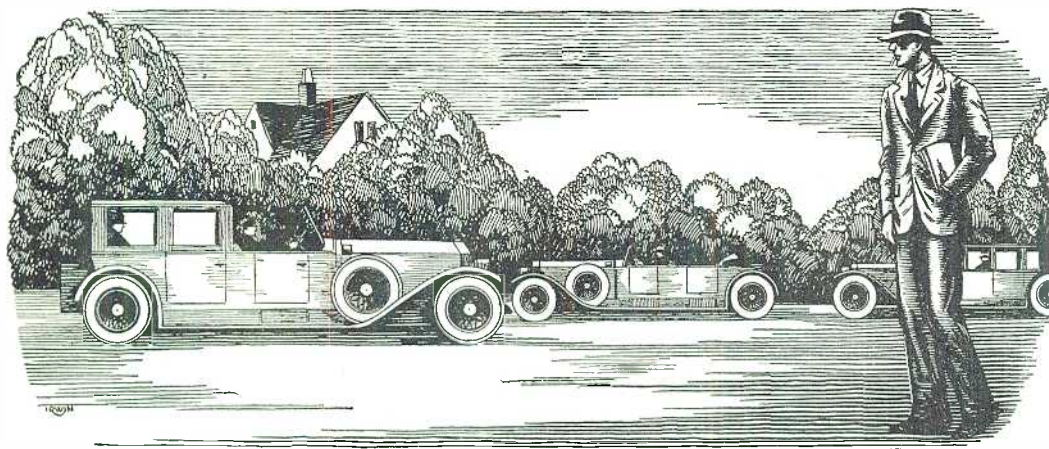

Many times in the old days, while I trudged home after work to save carfare, I used to gaze curiously at the shining cars gliding by me, the prosperous men and women within. Little did I think that inside of a year, I, too, should have my own car, a decent bank account, the good things of life that make it worth living.

I Thought Success Was For Others

*Believe It Or Not, Just Twelve Months Ago
I Was Next Thing To "Down-and-Out"*

TODAY I'm sole owner of the fastest-growing Radio store in town. And I'm on good terms with my banker, too—not like the old days only a year ago, when often I didn't have one dollar to knock against another in my pocket. My wife and I live in the snuggest little home you ever saw, right in one of the best neighborhoods. And to think that a year ago I used to dodge the landlady when she came to collect the rent for the little bedroom I called "home"!

It all seems like a dream now, as I look back over the past twelve short months, and think how discouraged I was then, at the "end of a blind alley." I thought I never had had a good chance in my life, and I thought I never would have one. But it was waking up that I needed, and here's the story of how I got it.

I WAS a clerk, working at the usual miserable salary such jobs pay. Somehow I'd never found any way to get into a line where I could make good money.

Other fellows seemed to find opportunities. But—much as I wanted the good things that go with success and a decent income—all the really well-paid vacancies I ever heard of seemed to be out of my line, to call for some kind of knowledge I didn't have.

And I wanted to get married. A fine situation, wasn't it? Mary would have agreed to try it—but it wouldn't have been fair to her.

Mary had told me, "You can't get ahead where you are. Why don't you get into another line of work, somewhere that you can advance?"

"That's fine, Mary," I replied, "but *what* line? I've always got my eyes open for a better job, but I never seem to hear of a really good job that I can handle." Mary didn't seem to be satisfied with the answer but I didn't know what else to tell her.

It was on the way home that night that I stopped off in the neighborhood drug store, where I overheard a scrap of conversation about myself. A few burning words that were the cause of the turning point in my life!

With a hot flush of shame I turned and left the store, and walked rapidly home. So that was what my neighbors—the people who knew me best—really thought of me!

"Bargain counter sheik—look how that suit fits," one fellow had said in a low voice. "Bet he hasn't got a dollar in those pockets." "Oh, it's just 'Useless' Anderson," said another. "He's got a wish-bone where his back-bone ought to be."

As I thought over the words in deep humiliation, a sudden thought made me catch my breath. Why had Mary been so dissatisfied with my answer that "I hadn't had a chance"? *Did Mary secretly think that too?* And after all, wasn't it true that I had a "wish-bone" where my back-bone ought to be? Wasn't that why I never had a "chance" to get ahead? It was true, only too true—and it had taken this cruel blow to my self-esteem to make me see it.

With a new determination I thumbed the pages of a magazine on the table, searching for an advertisement that I'd seen many times but passed up without thinking, an advertisement telling of big opportunities for trained men to succeed in the great new Radio field. With the advertisement was a coupon offering a big free book full of information. I sent the coupon in, and in a few days received a handsome 64-page book, printed in two colors, telling all about the opportunities in the radio field and how a man can prepare quickly and easily at home to take advantage of these opportunities. I read the book carefully, and when I finished it I made my decision.

WHAT'S happened in the twelve months since that day, as I've already told you, seems almost like a dream to me now. For ten of those twelve months, *I've had a Radio business of my own!* At first, of course, I started it as a little proposition on the side, under the guidance of the National Radio Institute, the outfit that gave me my Radio training. It wasn't long before I was getting so much to do in the Radio line that I quit my measly little clerical job, and devoted my full time to my Radio business.

Since that time I've gone right on up, always under the watchful guidance of my friends at the National Radio Institute. They would have given me just as much help, too, if I had wanted to follow some other line of Radio besides building my own retail business—such as broadcasting, manufacturing, experimenting, sea operating, or any one of the score of lines they prepare you for. And to

think that until that day I sent for their eye-opening book, I'd been wailing "I never had a chance!"

NOW I'm making real money. I drive a good-looking car of my own. Mary and I don't own the house in full yet, but I've made a substantial down payment, and I'm not straining myself any to meet the installments.

Here's a real tip. You may not be as bad off as I was. But, think it over—are you satisfied? Are you making enough money, at work that you like? Would you sign a contract to stay where you are now for the next ten years, making the same money? If not, you'd better be *doing* something about it instead of drifting.

This new Radio game is a live-wire field of golden rewards. The work, in any of the 20 different lines of Radio, is fascinating, absorbing, well-paid. The National Radio Institute—oldest and largest Radio home-study school in the world—will train you inexpensively in your own home to know Radio from A to Z and to increase your earnings in the Radio field.

Take another tip—No matter what your plans are, no matter how much or how little you know about Radio—clip the coupon below and look their free book over. It is filled with interesting facts, figures, and photos, and the information it will give you is worth a few minutes of anybody's time. You will place yourself under no obligation—the book is free and is gladly sent to anyone who wants to know about Radio. Just address J. E. Smith, President, National Radio Institute, Dept. OB-9, Washington, D. C.

J. E. SMITH, President,
National Radio Institute,
Dept. OB-9, Washington, D. C.

Dear Mr. Smith:

Please send me your 64-page free book, printed in two colors, giving all information about the opportunities in Radio and how I can learn quickly and easily at home to take advantage of them. I understand this request places me under no obligation, and that no salesman will call on me.

Name

Address

Town..... State.....

FREE

This Perfect Writing Instrument

THE NEW IMPROVED INKOGRAPH

Never before has any manufacturer of a standard writing instrument which is guaranteed to give perfect satisfaction, offered you so great a value. Remember, the Inkograph answers the purpose of both pen and pencil combined. Its point is shaped like a fine lead pencil point and writes with ink free and easy without a miss, skip or blur. The steady uniform flow of ink actually improves your handwriting. Won't blot, scratch, leak or soil hands.

You who already possess a standard fountain pen will find the Inkograph a most valuable addition to your writing equipment, for it will do everything any fountain pen can do and many very important things which it is impossible to accomplish with any fountain pen at any price.

HERE is your chance to get at no cost the new improved INKOGRAPH—a perfect writing instrument that operates like a fountain pen. The INKOGRAPH is guaranteed to give perfect satisfaction. It is a beautiful, finely shaped pen of exceptionally high standard of manufacture, strong, durable and handsome materials are used throughout. It is a pen that will stand “heavy duty service.” It is a pen that anyone would be proud to own. Same size and shape as regulation \$7 and \$8 fountain pens.

We offer you one of these standard regulation INKOGRAPH pens as illustrated on this page ABSOLUTELY FREE merely for getting two of your friends or acquaintances to subscribe to either RADIO NEWS, SCIENCE and INVENTION, AMAZING STORIES, or SPARETIME MONEY MAKING. All four of these magazines are more fully advertised in another part of this magazine.

Easy to Get Subscriptions

It is the easiest thing in the world to get your friends to subscribe to these magazines. Every one of them who owns a radio set will be glad to have RADIO NEWS around; SCIENCE and INVENTION tells how to save money on building things for the home, and tells all about the marvelous inventions of the day; AMAZING STORIES is the biggest, finest, and cleanest fiction story magazine now being published; and SPARETIME MONEY MAKING will help those who want to make an extra income on the side.

So you see, you have many selling arguments. Convince two of your friends, take their subscriptions and we will send you one of these beautiful pens FREE.

Save Money

Your friends can save money by subscribing. That's one of your strongest talking points. The subscription price of SCIENCE and INVENTION is \$2.50 a year. Single copies sell for 25c each, or \$3.00 a year. They save 50c. The same saving is offered to subscribers for RADIO NEWS and AMAZING STORIES. The subscription price of SPARETIME MONEY MAKING is \$1.50 per year. The price on a single-copy basis would be \$1.80 per year. And these subscription copies are delivered by mail, whereas other readers must go out and purchase their issues at the stands. Furthermore a subscriber is always sure of receiving his copy, but the single-issue buyer, unless he gets to the stand on the day the magazine is received, may find all copies sold—and additional issues as scarce as hen's teeth.

The coupon below will be accepted by us as a regular subscription order. Clip it out, check the magazines you desire, enclose the correct amount and we will enter the subscriptions at once and send you a pen immediately.

The subscription prices are as follows: Radio News, \$2.50; Science & Invention, \$2.50; Amazing Stories, \$2.50; Sparetime Money Making, \$1.50.

What Users Say Counts Most

My Inkograph is the smoothest writing instrument with which I have ever written. That is saying a lot. I am a teacher by profession. I have a \$7.00 pen and another that cost more than the Inkograph, but Inkograph is better than either. It is the greatest improvement in writing instruments since the Babylonians recorded their thoughts on clay tablets with a triangular pointed reed. John R. Atwell, Chadwick, N. C.

I wouldn't take \$5.00 for the pen I am writing this letter with. I have a good fountain pen but don't write any more with it. I am proud of the Inkograph and that I can say this to you and mean every word of it. R. H. Wilson, Beckley, W. Va.

In making out local requisitions. It is necessary to make an original and two carbon copies on very heavy paper, and the Inkograph does this twice as well as the hardest indelible pencil, and is much neater and the original is much more legible. Wm. L. Fortney, Placerville, Ia.

It sure has improved my hand writing—I never took home any medals for penmanship but I can almost read my own writing since I got this pen. M. F. Johnson, Medina, Wis.

I want to thank you for the return of my Inkograph pen, which you repaired for me. I feel rather lost without this pen in my pocket. I prefer it to any pen I ever carried principally because of the ease with which one can write with it, not having to be careful whether you slide the pen to the North, East, South or West, it flows freely in all directions. Wm. B. Brown, New York, N. Y.

Delighted: It writes bully—you have invented a pen that is perfect. It is so much more rapid than my \$9.00 fountain pen. I wish you abundant success. S. L. Carlton, Aurora, Ill.

Combines Features

of both pen and pencil, minus the weak points of both, plus improvements not found in either. The lead pencil smudges, the point breaks and its writing soon is obliterated. Most fountain pens skip, scratch, flood, clog, leak, blot, soil hands and clothing. The old stylographic ink pencil dries up, balks, blots, writes heavy, flows unevenly and is never reliable. The Inkograph feeds as fast and uniform on the 20th page as it did on the first.

Cannot Leak

Not the tiniest drop of ink will spill, although one filling is sufficient to write thousands of words. Will write on any quality of paper.

Makes 3 to 4 Carbon Copies

at one time with original in ink. Bear down as hard as you like without fear of bending, spreading, injuring or distorting its 14 Kt. solid gold point. Are you a salesman?—use an Inkograph, make out your orders in ink and retain a duplicate for your records. Do you wish to keep a copy of your private correspondence?—use an Inkograph. Do you do office work which requires clear carbon copies?—use an Inkograph. Do you make out bills or sales slips?—use an Inkograph and make a permanent original in ink with carbon copies. You can permit any one to write with your Inkograph, for no style of writing can affect the Inkograph point as it will a fountain pen.

MAIL the COUPON NOW

EXPERIMENTER PUBLISHING CO., Inc., 230 5th Ave., New York, N. Y.

Gentlemen: I enclose \$..... for 1 year (12 months) subscription to RADIO NEWS, SCIENCE AND INVENTION, AMAZING STORIES, SPARETIME MONEY MAKING. Send one "Inkograph" to me FREE.

My name is	Send	Send
.....	(Mention name of magazine)	(Mention name of magazine)
My address is	to	to
.....	Name	Name
City, State	Address	Address
.....	City, State	City, State

NOTE:—You must inclose full price for TWO subscriptions. Be sure to mention magazine or magazines desired and write plainly.



CASH IN ON RADIO Now

EARN \$75.00 a Week in your spare time

ACT AS RADIO DOCTOR

HELP YOUR DEALER

BUILD SETS FOR YOUR NEIGHBORS

Follow the Example of Thousands—Join the Radio Association—Learn Radio—Take Advantage of its Big-Pay Opportunities

Follow the Example of Thousands—Join the Radio Association—Learn Radio—Take Advantage of its Big-Pay Opportunities

THE RADIO ASSOCIATION OF AMERICA will help you make money in Radio, full or part-time. It will teach you how to build and repair sets; start you in business, if you wish.

Earned \$500 in Spare Hours

Hundreds of members earn \$3 an hour serving their communities as "radio doctors." Member Lyle Follick, Lansing, Mich., has already made \$500 in his spare time. Member Werner Eichler, Rochester, N. Y., is earning \$50 a week. Member F. J. Buckley, Sedalia, Mo., is earning as much money in his spare time as he receives from his employer.

The Association will train you to be a "radio doctor" and to build sets "tailored" to your neighborhood needs, that you can sell for less than the "ready-made" sets offered by your local dealers.

We Will Start You in Business

If you prefer a business of your own to becoming a Radio Engineer, our co-operative plan will start you in a business of your own without capital.

This plan gives the ambitious man his opportunity to establish himself in his community.

Many have followed this plan and established radio stores.

Doubled His Income in Two Months

Member W. E. Thon, Chicago, was a clerk in a hardware store when he joined the Association. The training we gave him enabled him to secure the managership of the Radio Department of a large store at a 220% increased salary.

"I attribute my success entirely to the Radio Association," he writes. "Your method of instruction is wonderful." Membership in the Association has increased the salaries of innumerable men. Some turned their extra hours into cash being "radio doctors" for their neighbors; others by accepting employment with neighborhood radio dealers. Scores of our members are now connected with big radio organizations in different capacities. Others are proprietors of prosperous stores.

From Clerk to Owner

"In 1922 I was a clerk," writes Member K. O. Benzing, McGregor, Ia., "when I enrolled. Since then I have built hundreds of sets—from 1-tube Regenerative to Superheterodynes.

"I am now operating my own store and my income is 400% greater than when I joined the Association. My entire success is due to the splendid help you have given me."

Membership Privileges

If interested in Radio as a profession or a profitable hobby, join the Association. You will receive a comprehensive and practical training in Radio that will fit you for Radio's big-pay opportunities.

You will have the benefit of proven business-building plans. Our Employment Service will be at your disposal. You will have the privilege of buying radio parts at wholesale. You will have the Association behind you in carrying out your ambitions.

ACT NOW—If You Want the No-Cost Membership Plan

Now is the time for you to join. The success of the Association was so tremendous during 1926 that we are still able to offer a limited number of Memberships that may not—need not—cost you a cent. To secure one of them, write today without fail. We will send you details and also our book, "Your Opportunity in the Radio Industry," that will open your eyes to the possibilities in Radio for you. Let us hear from you at once.

RADIO ASSOCIATION OF AMERICA
 4513 Ravenswood Avenue
 Chicago, Ill. Dept. RN-11

Gentlemen:

Please send me by return mail full details of your Special Membership Plan and also a copy of your book, "Your Opportunity in the Radio Industry."

Name.....

Address.....

City.....State.....

Only Sonochorde Gives Such Quality



Wall Model

Very attractive, hangs like a picture, has long cord and fancy tassel.

\$27

The Rear View of regular model—note protected back. The Junior also has a protected back.



Floor Standard Model

Fashioned after a floor lamp—stand is of semi-gloss mahogany finish.

\$35

Write for complete details and illustrated circular.

If you have trouble securing your Sonochorde, write us for your nearest dealer's name.

The SONOCHORDE Cones

SONOCHORDE owners enjoy an unmistakable pride of possession—a definite sense of pleasure and satisfaction in knowing they own the best.

SONOCHORDE's rich tone quality is a revelation,—the faithfulness of reproduction astonishing, it is truly a masterpiece of acoustic art.

Then, too, you'll like the silk front and the semi-gloss mahogany finished frame with its protected back.

JUNIOR MODEL



\$15

SENIOR MODEL



\$25

Both the senior model and the Junior model have semi-gloss mahogany finished frames—both have silk fronts. The regular model being larger, offers greater volume and is slightly more decorative.

Ask Your Dealer

BOUDETTE MFG. COMPANY
DEPT. A CHELSEA, MASS.

**Now! better
a bigger "B" Supply**



Compact —
5 1/2 x 6 1/2 x
9 1/2 inches.
Can be used
shown, or
vertical.
Quality un-
surpassed.

**Guaranteed
to deliver**

252 Volts at 25 Mills
233 Volts at 35 Mills
217 Volts at 45 Mills
199 Volts at 55 Mills
182 Volts at 65 Mills
165 Volts at 75 Mills
From 110 V. 60 cycle
A.C. Current, with the
improved type BH 125
M. Raytheon Tube.

from 165 to 252 volts at a
compensating milliamperage,
as the total current load varies
from 75 down to 25 mills all
the voltage you will ever need
to efficiently operate any re-
ceiving set with from one to
fifteen tubes, and a reserve
for power amplification, for
about one-half the price you
thought you had to pay for the
power you always wanted.

**Only
\$35.00
Complete
with Tube**



Buy "B" Supply for the Last Time

Some day you will want a larger radio — a larger power tube — or a power amplifier. International radio concerts are expected this season. Buy a "B" power unit now to fit your present set, and the one

you expect to purchase eventually. Authorities, engineers, laboratory tests, prove the WARREN "B" SUPPLY delivers constant "B" power of ample voltage and current needed for good reception.

Try The "WARREN" Before You Buy

Hook up the "WARREN." You can adjust the three variable voltage controls that are connected to the detector, intermediate, and amplifier taps, to suit the most critical or sensitive set according to requirements, giving exactly the correct voltage and full "B" current under all conditions. The WARREN has also a direct power tap for high power tubes, as well as reserve capacity in the filter to carry smoothly the long sustaining notes, particularly the deep tones. The modern radio owner assumes a growing pride in his radio

equipment, from points of general appearance and quality of reproduction. The "WARREN B" Model T is your greatest asset, due to its quality of construction, efficiency, compactness, neat appearance, and design. Finished in Old Gold Bronze. Fits into your console as an item of beauty and attraction to your radio equipment. The demand for "WARREN B" Supply Model T has been so great, your dealer may not have a sample unit. If not, order direct at once. Mail the coupon today. Send only \$35.00 and save express charges or we will ship C. O. D. for \$35.00 (\$37.50 West of Rockies). Do not delay. Get your "WARREN" now. You run no risk. Approval of radio laboratories, experts, and engineers, plus our money-back guarantee, is your protection. Shipped complete, including improved type BH 125M. Raytheon Tube.

Warren Electric Company, Dept. R.N., Peoria, Illinois.

Name..... State.....
 Address.....
 City.....
 Ship at once Model T "WARREN B" SUPPLY
 please M. O. for \$35 we pay express.
 Check here if you want literature.

Dealer's Name.....
 Address.....
 (Jobbers and Dealers—Take
 advantage of big demand
 for WARREN. Write
 at once.)

WARREN ELECTRIC CO.
Dept. R N. PEORIA, ILL.

Weak batteries? Never with Rectigon The Two-Rate Charger

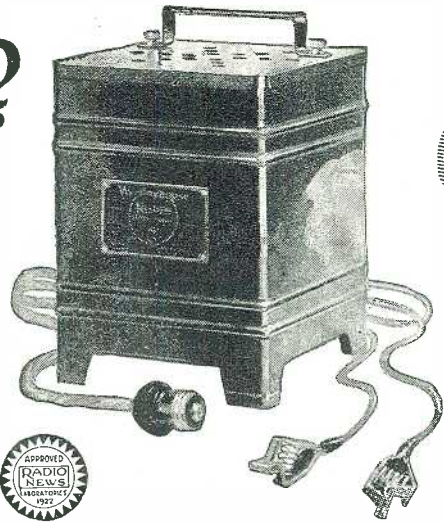

CONNECT your battery permanently to Rectigon—it will automatically “trickle in” new power to replace what you use; or if unusually long periods of set operation drain the battery faster than a “trickle will recharge, just swing the leads over to Rectigon’s high-rate terminals and bring the battery to full charge quickly and without bother.

You need only the one charger to keep

3 Ampere Rectigon

~~\$18.00~~
now

\$14.00

5 Ampere Rectigon

~~\$28.00~~
now

\$24.00

your “A” at top notch for every program. Rectigon will recharge your wet “B” just as easily.

Rectigon is made by Westinghouse—broadcasters of first radio program from KDKA, back in 1920. Rectigon is safe, compact and simple. No moving parts to break or wear out, nothing to damage the set even

if you tune in while charging. Get Rectigon at your dealer’s.

Westinghouse Rectigon Battery Charger

WESTINGHOUSE ELECTRIC & MANUFACTURING COMPANY, EAST PITTSBURGH, PA.

Offices in All Principal Cities & Representatives Everywhere

Tune in with KDKA—KYW—WBZ—WBZA

Rectox—for trickle charging only. Just attach the leads to your battery and connect Rectox to the light line. Left permanently on charge, at either 1/2 or 3/4 ampere charging rate, it keeps your “A” battery power peppy. No messy liquids, no moving parts, nothing to wear out.



Besides Rectigon and Rectox for better battery charging, Westinghouse also makes Micarta panels and tubing for better insulation, and radio testing instruments for better reception.



When you have decided to use house current for your receiver—

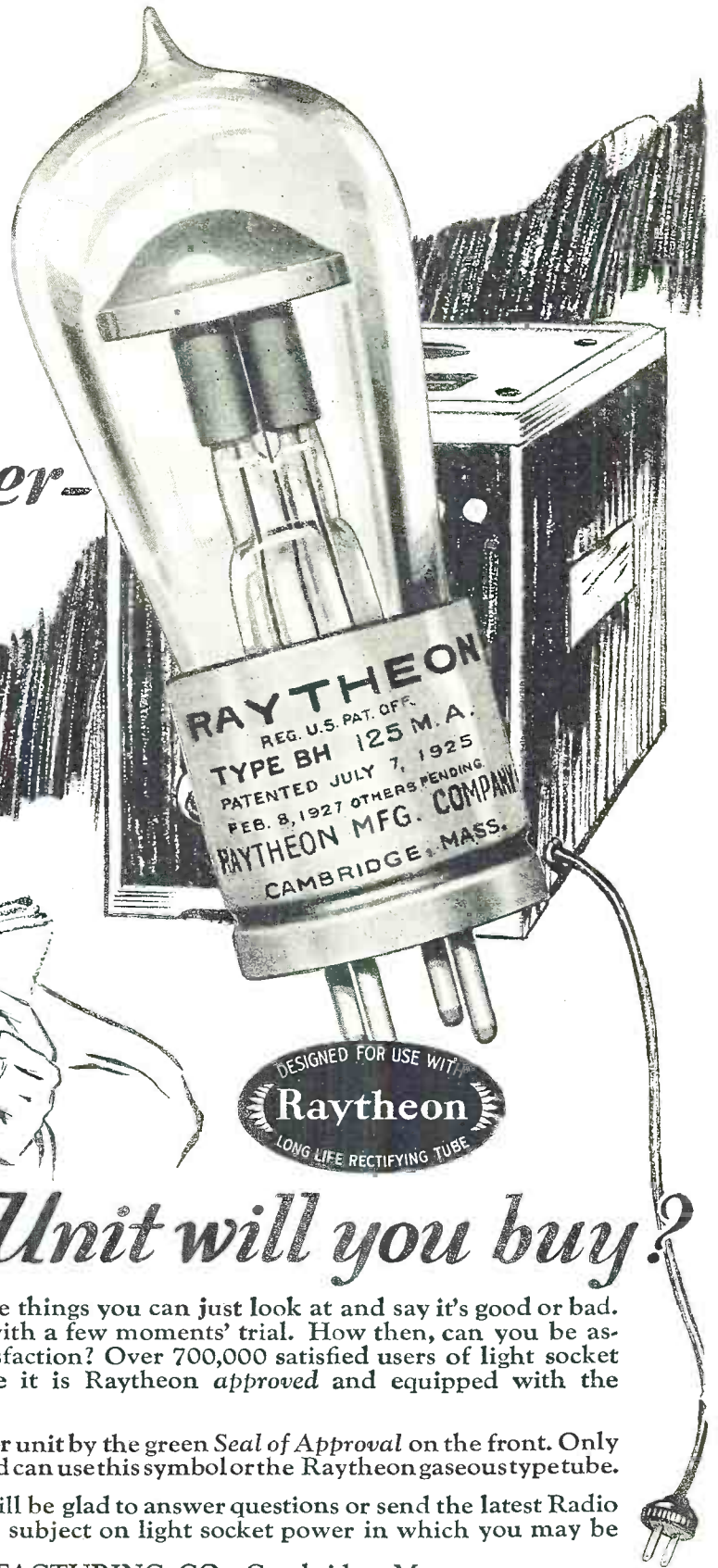
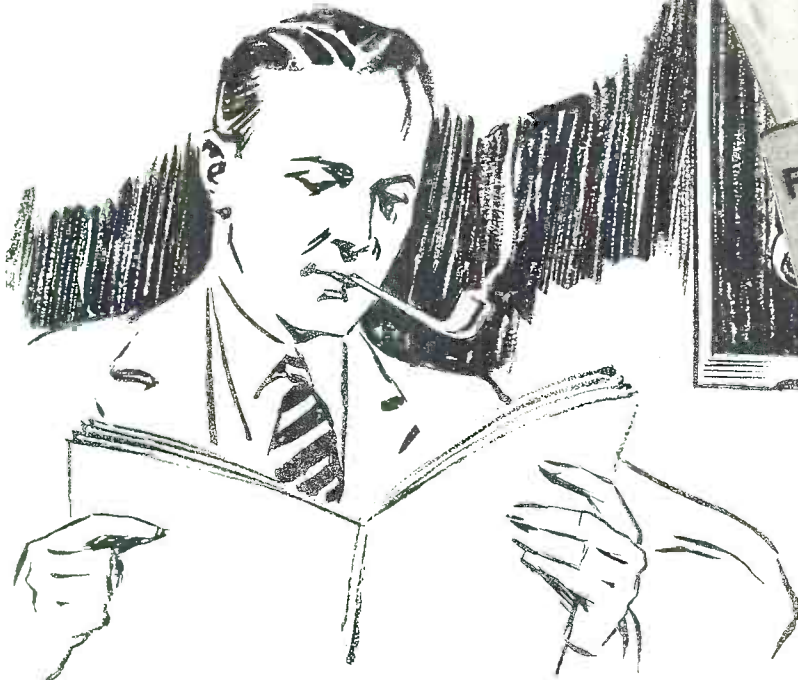

..what Power Unit will you buy?

A battery eliminator isn't one of those things you can just look at and say it's good or bad. Nor can you determine its qualities with a few moments' trial. How then, can you be assured of a reliable unit of lasting satisfaction? Over 700,000 satisfied users of light socket power units will tell you to be sure it is Raytheon *approved* and equipped with the Raytheon long life rectifying tube.

You can identify a Raytheon type power unit by the green *Seal of Approval* on the front. Only units that have been tested and approved can use this symbol or the Raytheon gaseous type tube.

Our Technical Service Department will be glad to answer questions or send the latest Radio Power Bulletin covering in detail any subject on light socket power in which you may be interested.

RAYTHEON MANUFACTURING CO., Cambridge, Mass.

Type BH
125 m.a. 300
volts

Type BA
A-B-C power
350 m.a.

Raytheon
THE HEART OF RELIABLE RADIO POWER

Type A
2½ Amps.

Type R
90 V. 60 m.a

Build the

STROBODYNE

with the *new*
improved
"Consrad"
BOOK Pattern

Price
50c
including
4
full
size
Blue
Prints

THE sensational Strobodyne circuit, the greatest of Super-Heterodyne receivers that combines the best features of every circuit and has amazed Radio, is now ready for home and community set builders.

Consrad, the greatest radio book and Pattern publishers, has printed a brand new pattern for this amazing Strobodyne circuit.

A sixteen-page, 9x12, book gives every last detail in the building up of reliable Strobodyne receivers.

In this booklet are drawings and photographs of various parts of the receivers. The few parts of the hook-up that require special attention are fully covered by special simple instructions.

FULL SIZE BLUEPRINTS

With this Strobodyne pattern come four full size blueprints. These blueprints are complete, accurate and highly simplified. Anyone can build a Strobodyne receiver, whether they have built a radio set before or not.

The Blueprints are as follows:

- No. 1. Panel layout Blueprint—Size 11x27 inches.
- No. 2. Sub-Panel Layout.
- No. 3. Wiring for Apparatus (Shown in perspective form)—
- No. 4. Underside view of Sub-Panel—Size 16x27 inches.
Size 23x27 inches.

Until you have studied the Strobodyne you are a back number in Radio—a man of the older school—the Strobodyne is not just a new circuit—It is an epoch in Radio.

50c THE COPY
USE THIS COUPON

CONSRAD COMPANY, Inc.,
230 Fifth Ave., New York.

Gentlemen: I enclose 50c for one copy of the New Official STROBODYNE PATTERN containing complete constructional information and all Blueprints.

Name

Address

City, State



Announcing
THE A. C. RADIO TUBE
FOR YOUR PRESENT SET

ARCTURUS A. C. TUBES
DETECTOR—AMPLIFIER—POWER

Four Prongs—Fits Present Sockets—For all D. C. Sets

BETTER RECEPTION
MORE RELIABLE MORE CONVENIENT
LESS EXPENSIVE

Now you can have unfailing quality reception, the convenience and reliability of A. C. Tubes, with but a few simple changes, in any D. C. Set.

Arcturize Your Present Set

No matter what set you now own it will pay you to get complete information about this latest development in radio. You will find added satisfaction in the perfect reception you get with Arcturus A. C. Tubes.

Write today for complete information mentioning make and model of your present set.

ARCTURUS RADIO COMPANY, Inc.
253 Sherman Avenue, Newark, N. J.

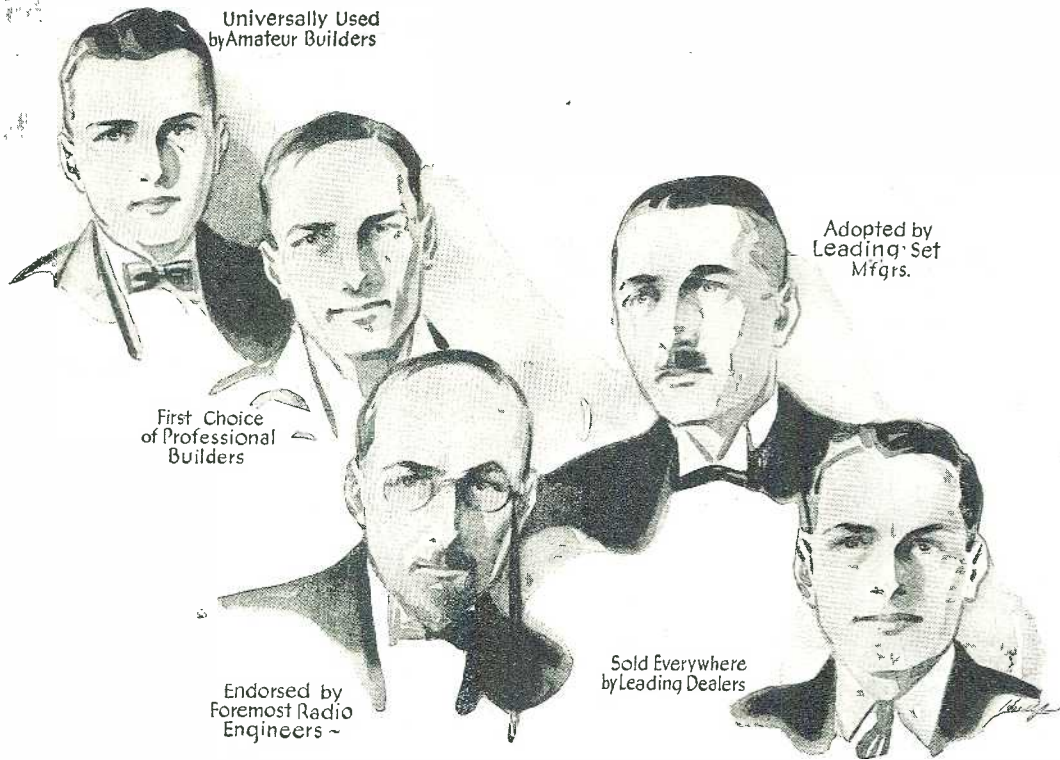

FIRST CHOICE of the Keenest Minds in Radio!



Durham standard resistors are made in ranges from 500 ohms to 10 megohms. Durham Powerohms for "B" Eliminators and Amplifier circuits are made in 2.5 watt and 5 watt sizes in ranges from 500 to 100,000 ohms.

Adopted by Leading Radio Manufacturers

Philco
Fansteel Products Co.
Kellogg-Switchboard
Western Electric
F. A. D. Andrea
Sterling Mfg. Co.
Kokomo Electric
Garod Radio Corp.
Browning-Drake
Howard Radio
A-C Dayton

FIRST CHOICE—because Durham was the first and original "metallized filament" resistor—because years of heavy production and the confidence of leading radio manufacturers have given us *time* to produce a perfect product.

Durham Resistors and Powerohms are the leaders in their field because their uniform, unfailing accuracy and absolute reliability have been proved time and time again.

This is why they are the first choice of foremost engineers, leading manufacturers, professional set builders and informed radio fans who demand quality results.

Like Durham Resistors and Powerohms, Durham Resistor Mountings are also the leaders in their field. The only upright mountings made; takes minimum space—made of high resistance moulded insulation—best quality tension-spring bronze contacts. Single and double sizes.

DURHAM

METALLIZED

RESISTORS & POWEROHMS

INTERNATIONAL RESISTANCE CO., Dept. H 2½ South 20th Street, Philadelphia, Pa.

Abox

"A" BATTERY ELIMINATOR



Slightly Higher West of the Rockies

Licensed by The
Andrews-Hammond Corporation, under Patent No. 1,637,795 and applications

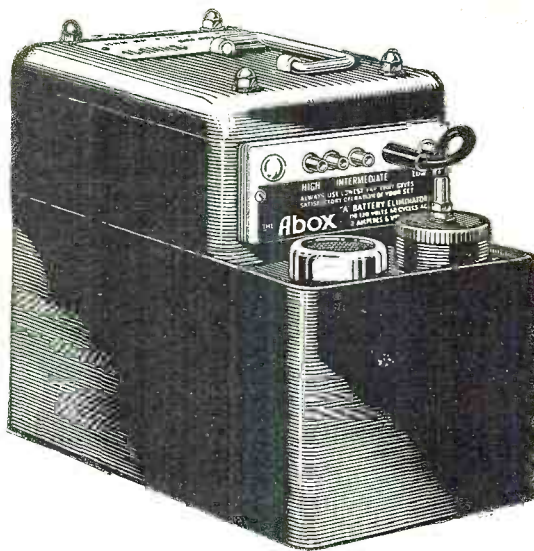

Input—110 volts, 50-60 cycles A. C. Output—6 volts direct current, 2 amperes. Shipping weight, 25 lbs.

Electrify Your Set With No Changes in Tubes or Wiring

THE ABOX "A" Battery Eliminator consists of a rectifier and the well known ABOX Filter circuit built into one compact unit. *It contains no battery.*

The ABOX takes the current direct from the light socket and delivers it to the set as hum-free, 6 volt direct current. It operates only when the set is in use. Unlike a storage battery, the current is always the same—exactly the right amount. Therefore, it permits better reception, to say nothing of the convenience of *true electric operation.*

The cost of maintenance is no more than that

of a 50 watt lamp. The initial cost is less than a storage battery and charger, which it replaces. This ABOX contains no delicate tubes or elements and entails no upkeep cost, whatever. It is adaptable to your present set without change of tubes or wiring.

The ABOX will operate eight or less tubes on a line voltage of 100 volts or over.

Ask your dealer for ABOX, the true "A" Battery Eliminator.

The ABOX Filter is an entirely different unit from the Eliminator, being the filter circuit alone in a small, compact unit. If you have a suitable charger it can be easily converted into an "A" Eliminator by substituting the ABOX Filter for the storage battery. Shipping weight, 11 lbs. Price \$19.50. Slightly higher west of the Rockies.

Send for interesting booklet,
"ABOX and The Light Socket"

The ABOX Company

215 North Michigan Avenue

Chicago, Illinois

BUILD A SHIP MODEL LOUD SPEAKER

\$12.50

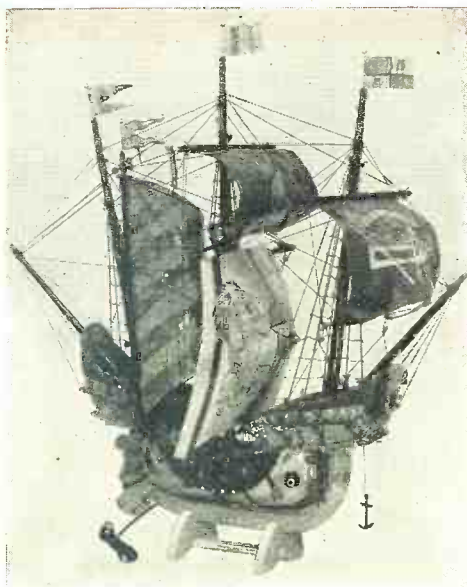

\$12.50

A combination of a beautiful ship model and a loudspeaker that is easily worth \$100. You can build it yourself in a few spare hours with no other tool than a small tack hammer.

Size: 26 inches high; 12 inches wide; 27 inches long (overall). The La Pinta, a reproduction of one of the famous Fifteenth Century ships.

The famous Melody Ship which has met with instant approval everywhere it has been shown and played can now be purchased in knock down form at the startlingly low price of \$12.50. This remarkable speaker combines

Perfect Tone - - Plenty of Volume - - No Distortion

No doubt you have often admired ship models and yearned to possess one but could not do so because the price was too high. Now it is possible to own a beautiful ship model and loudspeaker combined at a small cost. Let the WORLD'S LARGEST BUILDERS OF SHIP MODELS AND SHIP MODEL LOUDSPEAKERS supply you with all the necessary parts, cut to fit and ready to assemble from which you can build a beautiful model of the historic Mayflower, the Santa Maria or the La Pinta in a few hours. To all outward appearances the completed model is a beautiful ship model but upon closer observation a loudspeaker can be seen cleverly incorporated into the main sail.

The loudspeaker unit is of the Electro Magnet type. Power amplification is not needed to force the low tones through. They come through with perfect ease and do not interfere with the high notes, giving faithful reproduction at all frequencies. The mainmast, upon which the unit is securely fastened is seated two inches deep in a three and a half pound solid wood hull, making it impossible for counter vibrations to affect the perfect reproduction of the Melody Sail. The driving pin is attached to our super-vibrating, especially prepared, Melody Sail. The installation of the Melody Sail does not change the appearance of the model in any way. Melody ships come in three beautiful models, the Mayflower, the Santa Maria and the La Pinta, with parts cut to fit and ready to assemble. No tool needed but a small hammer.

You need not know anything about ship building or carpenter work in order to build one of these ships. No special knowledge of ship model building is necessary either. We will supply all the parts from the hull down to the smallest piece of rigging, all cut to fit and ready to

assemble. You cannot go wrong. Diagrams and plans of parts that are included with each kit tell exactly what to do with each part.

These plans show you step by step just how the model is constructed. Everything is made so simple that even a small child can build a beautiful model.

All you need is a small hammer to tap the parts into place. Here is a part of the instructions copied word for word from the diagram and instruction sheet that goes with the kits. "Take part No. 57 place it in front end of part No. 56 and tap lightly with a hammer. Next take part No. 58 and place it up against No. 57 and tap it with a hammer to bring it into place."

Easy! Nothing simpler. The instructions are like that from beginning to end. Do this and that and before you realize it a beautiful ship model has grown before your eyes.

Write for our free beautifully illustrated catalog which contains photographs of all our models together with complete details and price of each. We will send this catalog without obligation to you. Fill in the coupon below and we will act upon it immediately.

If, after assembling the model you do not think it worth many times the purchase price, return it to us in good condition and we will gladly refund your money.

MINIATURE SHIP MODELS, Inc.
3818-20-22-24 Baring St., Philadelphia, Pa.
Canadian Branch: 1485 Bleury St., Montreal, Canada
Canadian Prices Slightly Higher. Send all Canadian Orders to Canadian Office.

MINIATURE SHIP MODELS, Inc., DEPT. M
3818-20-22-24 Baring St., Phila., Pa.
Please send me complete parts, cut to fit and ready to assemble for the Melody Ship.....for which I agree to pay postman \$12.50, plus postage.

PLEASE PRINT NAME AND ADDRESS PLAINLY
Name
Street or R. F. D.....
City
State



“The Finest Tone I’ve Ever Heard” ~ and complete A. C. operation

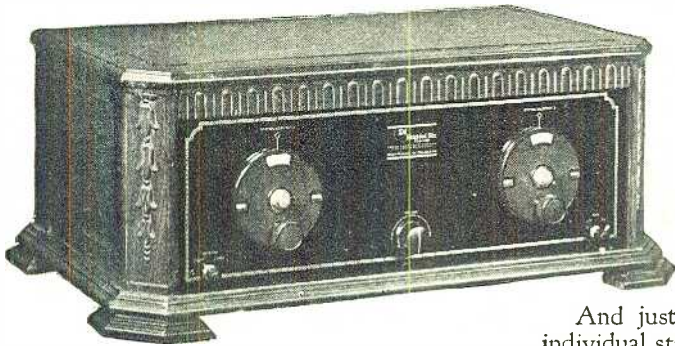

87% at 30 Cycles

At 30 cycles, an S-M 220 audio transformer in a standard amplifier circuit gives 87% of the amplification obtained at 1000 cycles, while its curve is substantially flat from 100 to 1000 cycles. Above 2000 cycles, the curve for a single stage falls off gradually, while in a standard two stage amplifier circuit, the curve is substantially flat up to 5000 cycles above which frequency it falls off rapidly to keep static, heterodyne squeals and “set noise” at a minimum.

The above paragraph sums up at once the desirable characteristics of an audio amplifier and the actual performance of S-M audio transformers. It is just this fact that has made 220's the choice of over half of the designers of the new 1927-1928 circuits, for engineers know that the short cut to the finest of quality is to use S-M audios. 220's have outsold every other transformer in their class for over a year. And S-M audios are being used in more broadcasting stations than any other types. WCAE, WBBM, WEBH, KFCR, WTAQ, KGDJ, WLBK, and many others. WCFL, the “Voice of Labor,” checks quality of all programs with them. Nathaniel Baldwin, Inc., famous speaker experts, test with 220's and 221's.

Your guarantee of quality is to use S-M 220's and 221's in every circuit you build, and you'll find that over half the popular 1927 and 1928 circuits will give you just this same guarantee.

The 220 audio is the biggest value on the market, and its performance measures up to its 4-pound size. It contains more steel and copper than any other transformer—the measure of transformer merit. Price \$8.00.

221 output transformer not only protects loud speakers against power tube plate currents, but compensates low frequencies for all loud speakers. Price \$7.50, or with cord and tip jacks, No. 222, \$8.00.

230 push-pull input and 231 push-pull output transformers are priced at \$10.00 each.



THAT'S THE STORY of the famous Silver Shielded Six in a nut-shell. Every one of the thousands who built last year's Shielded Six said the same thing —“The Six has the finest tone I ever heard.” And now the new and improved 1928 Model of this famous receiver is ready, with the same fine tone as the original, and tremendously increased selectivity and distance getting ability.

And just as last year S-M engineering led the field with the first individual stage shielding, dual control, all metal assembly features that definitely established the Six as the finest of kits, so S-M again leads. With the new A. C. tubes just out S-M offers for immediate delivery, A. C. Shielded Six Kits—before other A. C. tube circuits have even been announced, S-M engineering has been completed.

The Shielded Six may be built for operation with standard tubes, using batteries or eliminators, or it may be built with new A. C. tubes using the compact S-M 652A, ABC power plant. Or the man who wants the finest possible tone can build self contained super-power push-pull amplification, for 171 or 210 tubes right into his Six. And with its three stages of tuned R. F. amplification, plug-in coil covering all waves from 200 to 3000 meters, its all-metal assembly, individual stage shields, light socket operation, and other features, the Six can't be duplicated for less than \$250 to \$500. Above all, the Six is guaranteed to have finer tone than any other set you can buy.

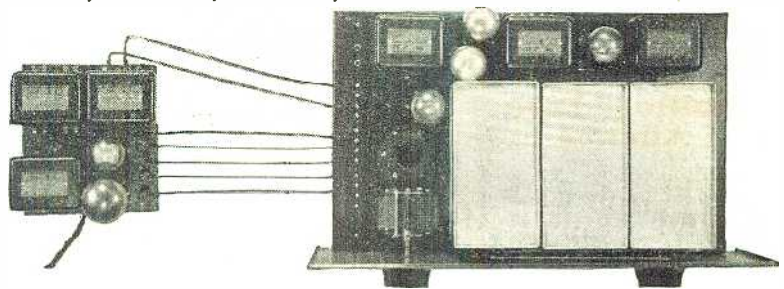

The astonishing simplicity of the light socket operated Improved Shielded Six is here illustrated. This Six (a special model with push-pull 171 power amplifier) is complete, ready for operation with all power supplied by the small unit at the left. Only a short antenna, a ground connection, and loud speaker need be added for operation.

Type 630 kit contains all parts for standard Improved Shielded Six for 5 volt tubes, for battery or eliminator operation. Price \$95.00.

Type 630 AC kit contains all parts for the light socket operated model using 4-C327, 1-CX326 and 1-CX371 A. C. tubes. Price \$99.00.

Type 652A, ABC power plant kit contains all parts for an ABC power supply for 630 AC kit or any standard receiver using A. C. tubes. Price \$36.50, or assembled, ready to use, No. 656A, price \$40.50.

Send 10c to cover postage and we'll mail you enough new dope on A. C. operation, super-quality amplification and how to bring last year's Six up-to-date to fill your reading evenings for a week.

SILVER-MARSHALL, INC.

848 West Jackson Blvd.

Chicago, U. S. A.

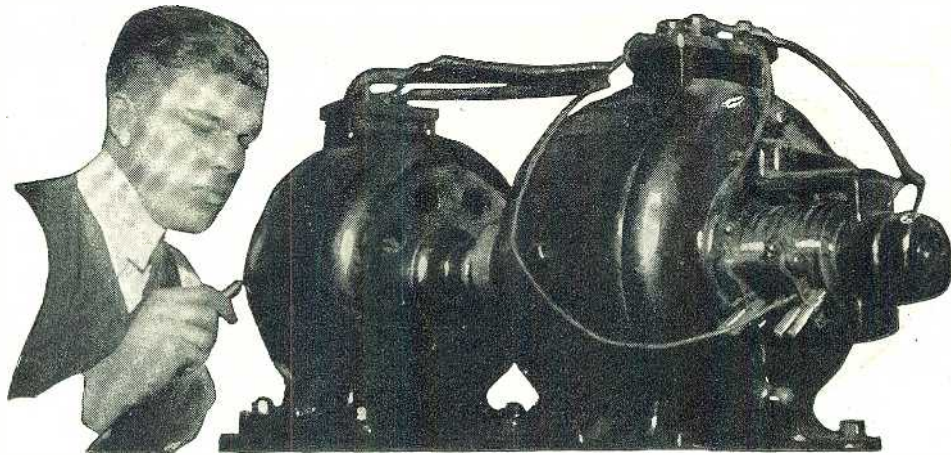

Amazingly Easy Way to get into **ELECTRICITY**

Don't spend your life waiting for \$5 raises in a dull, hopeless job. Now . . . and forever . . . say good-bye to 25 and 35 dollars a week. Let me show you how to qualify for jobs leading to salaries of \$50, \$60 and up, a week, in Electricity—NOT by correspondence, but by an amazing way to teach, that makes you an electrical expert in 90 days! Getting into Electricity is far easier than you imagine!

Learn Without Lessons in **90 DAYS**

LACK of experience—age, or advanced education bars no one. I don't care if you don't know an armature from an air brake—I don't expect you to! I don't care if you're 16 years old or 40—it makes no difference! Don't let lack of money stop you. Most of the men at Coyne have no more money than you have.

Railroad Fare Allowed

I will allow your railroad fare to Chicago, and if you should need part-time work I'll assist you to it. Then, in 12 brief weeks, in the great roaring shops of Coyne, I train you as you never dreamed you could be trained . . . on the greatest outlay of electrical apparatus ever assembled . . . costing hundreds of thousands of dollars . . . real dynamos, engines, power plants, autos, switchboards, transmitting stations . . . everything from doorbells to farm power and lighting . . . full-sized . . . in full operation every day!

No Books—No Printed Lessons

No books, no baffling charts . . . all



Prepare For Jobs Like These

Here are a few of hundreds of positions open to Coyne-trained men. Our free employment bureau gives you lifetime employment service.

- Armature Expert \$50 a Week and up
- Substation Operator, \$65 a Week
- Auto Electrician \$60 a Week and up
- Inventor Unlimited
- Maintenance Engineer \$60 a Week and up
- Service Station Owner \$60 a Week and up
- Radio Expert, \$60 a Week and up

Now In Our New Home

This is our new, fireproof, modern home wherein is installed thousands of dollars, worth of the newest and most modern Electrical Equipment of all kinds. We now have the largest amount of floor space devoted to the exclusive teaching of practical electricity in the world. Every comfort and convenience has been arranged to make you happy and contented during your training.

real actual work . . . building real batteries . . . winding real armatures, operating real motors, dynamos and generators, wiring houses, etc., etc. That's a glimpse of how we make you a master practical electrician in 90 days, teaching you far more than the average ordinary electrician ever knows and fitting you to step into jobs leading to big pay immediately after graduation. Here, in this world-famous *Parent school*—and nowhere else in the world—can you get such training!

Jobs, Pay, Future

Don't worry about a job, Coyne training settles the job question for life. Demand for Coyne men often

exceeds the supply. Our employment bureau gives you lifetime service. Two weeks after graduation, Clyde F. Hart got a position as electrician with the Great Western Railroad at over \$100 a week. That's not unusual. We can point to Coyne men making up to \$600 a month. \$60 a week is only the beginning of your opportunity. You can go into radio, battery or automotive electrical business for yourself and make *from \$3000 a year up*.

Get the Facts

Coyne is your one great chance to get into electricity. Every obstacle is removed. This school is 28 years old—Coyne training is tested—proven beyond all doubt—endorsed by many large electrical concerns. You can find out everything absolutely free. Simply mail the coupon and let me send you the big, free Coyne book of 150 photographs . . . facts . . . jobs . . . salaries . . . opportunities. Tells you how many earn expenses while training and how we assist our graduates in the field. This does not obligate you. So act at once. Just mail coupon.

Get this **FREE Book**

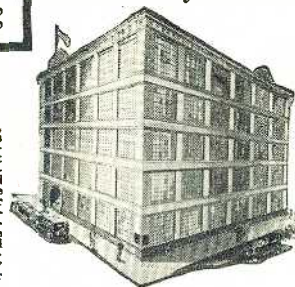

Mr. H. C. Lewis, Pres. COYNE ELECTRICAL SCHOOL, Dept. 87-77 500 S. Paulina St., Chicago, Ill.

Dear Mr. Lewis:

Without obligation send me your big free catalog and all details of Railroad Fare to Chicago, Free Employment Service, Radio and Automotive Courses, and how I can "earn while learning." I understand I will not be bothered by any salesman.

Name.....
 Address.....
 City..... State.....

COYNE ELECTRICAL SCHOOL
 H. C. LEWIS, President, Dept. 87-77
 500 S. Paulina St., Chicago Established 1899

BOSCH RADIO



Model 46—"Little Six,"
6-tube, single station selector, table type, vibration-proof aluminum chassis\$68.50

Two new models have been added to the group of Bosch Radio Receivers—they are receivers which in prices and performance make Bosch Radio outstanding in selection of models—the desirable radio line of the season for purchasers and dealers.

The Model 46 is a compact six tube receiver, but 16 inches long, with electrically lighted single tuning dial. It has the famous Bosch tonal quality. It lists at \$68.50.

The Model 87 is a seven-tube table model of unusual beauty with which an outside antenna or loop is not necessary. Single electrically lighted dial, armored and shielded with great power and Bosch tonal quality, Model 87 lists, at \$195.00.

Bosch Radio is constructed with a rigidity never before obtained in radio development—purchasers, receive Bosch Radios with the original factory settings assuring life-like tonal quality, far-reaching, satisfactory broadcast reception—without adjustment.

The Bosch Radio Line is complete—four, six-tube and two, seven-tube models. "A" power unit, "B" power unit—two loud speakers and a phonographic pick-up device.

See and hear Bosch Radio before you buy any radio—note its engineering superiority and its fine furniture.

Dealers who are in business to stay are urged to write for the new Bosch plans. Write to

AMERICAN BOSCH MAGNETO CORP.

Main Office and Works: Springfield, Mass.

Branches:

New York Chicago Detroit San Francisco

Bosch Radio Receivers are licensed only for Radio Amateur, Experimental and Broadcast Reception. They are manufactured under patent applications of American Bosch Magneto Corporation and are licensed under patent applications and patents of Radio Corp. of America and under applications of Radio Frequency Laboratories, Inc.



Model 87—Seven-tube, single station selector, table type, loop operated, wired for battery or socket power.....\$195.00

Model 87—Seven tubes, single station selector, cabinet type, concealed loop, built-in reproducer wired for battery or socket power operation. \$340.00

Model 76—Six tubes, single station selector, cabinet type, wired for battery or socket power—with built-in speaker

\$195.00

Without built-in speaker

\$175.00



Model 66—Six-tube, single station selector, table type, wired for battery or socket power.

\$99.50

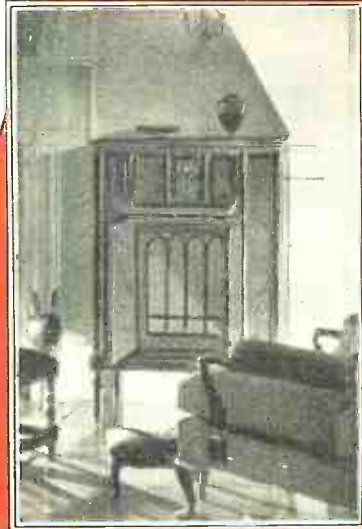

All these Bosch Models are ready for Bosch Socket Power Operation—Nobattery "A"—Nobattery "B"—both totaling \$100.

30^{DAY} FREE TRIAL

Battery or All-Electric OPERATION

HERE is the great value offer of the day. Test and try this powerful seven-tube RANDOLPH RADIO for thirty days. After it brings in stations from coast to coast with amazing clearness—with easy one-dial tuning—after it easily equals any other radio regardless of cost—after you are more than satisfied then you can buy it direct at factory prices. Every RANDOLPH must make good before it is sold.

The RANDOLPH SEVEN-TUBE CONSOLE illustrated here can be had for use with batteries or connected direct to the electric light socket—absolutely batteryless—no batteries, chargers or acids—just plug in and tune in. 100% efficient either way. Its construction and performance have been tested and approved by leading radio engineers and authorities—by leading radio publications and laboratories.

7 Tubes—Single Control Illuminated Drum

One drum dial operated by one simple vernier control tunes in all stations with easy selectivity to tremendous volume. No overlapping of stations. Illuminated drum permits operation in the dark. Volume control for finer volume modulation. This is a seven-tube tuned radio frequency receiver with power transformers and power amplification. Space wound solenoid coils. Full and completely shielded. A real receiver of the highest quality. Tremendous distance, wonderful tone quality, simple to operate.

Beautiful Walnut Console Built-in Cone Speaker

The Randolph Seven-tube Amphiphonic Console illustrated above is housed in a genuine burl-walnut cabinet with two-tone hand rubbed finish giving it unsurpassed beauty. The same expert cabinet work has gone into the making of these consoles as in the finest furniture. Has built-in cone loud speaker that compares with any on the market. Accurately reproduces complete range of musical notes from the highest to the lowest pitch.

What Users Say

I have logged more than 50 stations from coast to coast.—Lloyd Davenport, Littlefield, Texas. I have logged 52 stations from Cuba to Seattle, the set is a world beater.—J. Tampkinson, Detroit, Mich. Your set is a revelation, has all others tied to the post for distance and selectivity.—Waldo Powers, Vergennes, Vermont. On strength of its performance sold two more sets this week.—T. Scanlow, Orlando, Florida.



The **Randolph** \$ **99**
7-Tube Console
Single Control
RETAIL PRICE
 Completely Assembled



The Senior Six

Now you can have a new, modern, single-control, six-tube radio. Do not compare this set with old style 2-dial 6-tube sets selling for about the same price. The Randolph 1928 Senior Six has also been tested and approved by the leading radio engineers. Comes in a beautiful solid walnut cabinet of hand-rubbed finish. Single control. Illuminated Drum with space for logging. Absolutely dependable and very selective. Sent for 30 Days' Free Trial. You test it before you buy.

6-Tube
\$55
Retail Price
Single Control

MAIL COUPON NOW!

The Randolph Radio Corporation are pioneers in the manufacture of radios. All of its vast and unlimited resources have been used in making and perfecting of the Randolph Receivers. Because of our long and successful experience in the radio business, we are perfectly confident in sending out a Randolph Radio on trial. We know what it will do. Mail us the coupon now for the greatest radio offer ever made.

Sensationally Big Discounts to Agents

Work either full or part time and make big money. Tremendous advertising campaign helps you sell. Regardless of whether you have ever sold before, be sure to get our proposition. The Randolph sells on first demonstration. Men and women both can make money this easy way. Get your demonstration set for thirty day's FREE TRIAL.

Use This Coupon NOW!

Randolph Radio Corporation,
 711 West Lake Street, Dept. 234,
 Chicago, Illinois.

Send me full particulars about the RANDOLPH Six and Seven-Tube All-Electric and Battery Table and Console Sets with details of your 30 Day FREE Trial Offer.

Name.....

Address.....

City..... State.....

Mark here if interested in Agent's proposition.

RANDOLPH RADIO CORPORATION
 711 West Lake Street Dept. 234, Chicago, Illinois

Don't confuse Balkite "AB" with so-called radio socket powers



Balkite "A" *Contains no battery.* The same as Balkite "AB" but for the "A" circuit only. Not a battery and charger but a perfected light socket "A" power supply. One of the most remarkable developments in the entire radio field. Enables owners of Balkite "B" to make a complete light socket installation at low cost. Price \$32.50.



Balkite "B" *One of the longest lived devices in radio.* The accepted tried and proved light socket "B" power supply. The first Balkite "B," after 5 years, is still rendering satisfactory service. Over 300,000 in use. Three models: "B"-W, 67-90 volts, \$22.50; "B"-135,* 135 volts, \$32.50; "B"-180, 180 volts, \$39.50. Balkite now costs no more than the ordinary "B" eliminator.



Balkite Chargers

Standard for "A" batteries. Noiseless. Can be used during reception. Prices drastically reduced. Model "J,"* rates 2.5 and .5 amperes, for both rapid and trickle charging, \$17.50. Model "N" Trickle Charger, rate .5 and .8 amperes, \$9.50. Model "K" Trickle Charger, \$7.50.

*Special models for 25-40 cycles at slightly higher prices

Prices are slightly higher West of the Rockies and in Canada

It contains no battery in any form

The new Balkite "AB" is the greatest advance in radio power

since the early days of radio. It is made by Balkite, the pioneer and leader in the radio field. It replaces both "A" and "B" batteries and supplies radio current from the light socket. It is not to be confused with so-called radio socket powers. It contains no battery in any form, nor any of the other usual accessories. It never requires charging.

Operates only during reception

Balkite "AB" operates only during reception. Turn it on and your set operates. Turn it off and you're through. It is the most economical of all sources of radio power. There is no trickle charging when it is not in use. It puts an end forever to run-down radio power. It delivers at all times a full, even, uniform flow of current exactly as required. It always uses the least current necessary to operate your set satisfactorily. It requires no other attention than the addition of water 3 or 4 times a year. It is unaffected by standing idle.

Balkite "AB" is based on the

famous Balkite principle of electrolytic rectification. A principle so reliable that it is standard on the signal systems of most of the railroads of the country. A principle that has been responsible for nearly all the great advances in radio power. The same principle on which 2,000,000 Balkite units now in use are based. Like all other Balkite units Balkite "AB" is entirely noiseless, a permanent piece of equipment, with nothing to wear out or replace.

Makes any set electric

Balkite "AB" makes any receiver an electric set, a true instrument of pleasure. To realize the difference between Balkite "AB" and any other radio power supply, just lift the lid and look. There is no confusion of wires, nothing to go wrong. Instead a simple complete unit that means the swift passing of radio batteries and their attendant cares. Two models, to serve any set. 135 volts,* \$59.50. 180 volts, \$67.50.

Your dealer will recommend the one you need.

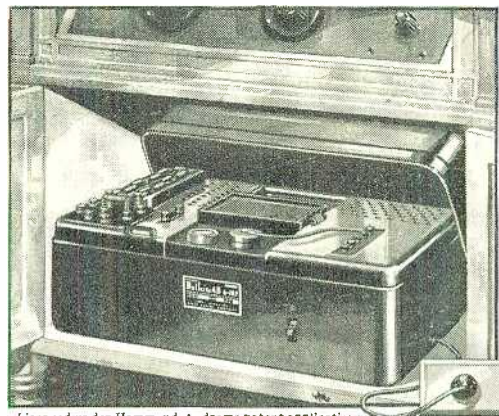

Licensed under Hammond-Andrews patent applications

Balkite "AB" *To realize the advantages of Balkite "AB," just lift the lid and look. There is no confusion of wires, nothing to go wrong. Instead a simple complete unit that means the swift passing of batteries and their cares. Particularly a boon to women.*

FANSTEEL PRODUCTS COMPANY, Inc., North Chicago, Illinois

FANSTEEL

Balkite

Radio Power Units



Enesco

THE ORIGINAL AND WORLD'S FINEST 3 FOOT SPEAKER KIT

And Now a Complete Line of "ENSCO" Models

The famous "Enesco" three foot cone has made radio history. Now we are introducing four new "Enesco" models:—two of them just like the old reliable 3 foot models but in the two foot size. And two with a beautiful polychrome pedestal, one three foot and one two foot. The new models round out the "Enesco" line and make it by far the most attractive on the market.

COMPLETE KITS

The "Enesco" Kits are complete. Every necessary part is included together with a twelve page illustrated instruction book which explains in detail just how to make six styles and three sizes of cone and roll speakers. The "Enesco" can be assembled in less than an hour.

ABSOLUTELY GUARANTEED

We guarantee the "Enesco" to be the equal of any manufactured speaker regardless of price. The "Enesco" produces the truest tones you have ever heard. After you hear your set with the "Enesco" Cone, you will wonder how you were ever satisfied with your former speaker.

AT YOUR DEALER OR DIRECT FROM US

Go to your dealer, ask him to demonstrate the "Enesco"—compare it with any speaker regardless of price. If your dealer has not been supplied send the coupon to our nearest office. Shipping charges paid. Our absolute money-back guarantee protects you.

DEALERS AND JOBBERS

Write for the "Enesco" profit making proposition. The finest cone speaker at a price anyone can afford to pay.

Engineers' Service Company

Members Radio Manufacturers Association
 25 Church Street, N. Y. 73 Cornhill, Boston
 28 E. Jackson Boulevard, Chicago
 331 Bay Street, Toronto, Ontario

ENSCO Ad. No. 240-G.V.-1927

See them at the Chicago Show

STANDARD KIT

\$10.00

WALL KIT

\$11.00



OTHER MODELS

- No. 10-24 Standard Kit in 24" size \$10.00
- No. 11-24 Wall Type Kit in 24" size \$11.00
- No. F-135-24 24" Cone with special polychrome pedestal \$13.50
- No. F-145-36 36" Cone with special polychrome pedestal \$14.50

SEND THIS COUPON

Engineers' Service Company (Send to nearest office)		U. S. Prices	Canada Prices	I am enclosing <input type="checkbox"/> Check <input type="checkbox"/> Money order <input type="checkbox"/> Cash (send registered) <input type="checkbox"/> Send C.O.D.
SEND ME		\$10.00	\$11.50	
<input type="checkbox"/>	Standard Kit	11.00	12.50	
<input type="checkbox"/>	Wall Kit	10.00	11.50	
<input type="checkbox"/>	No. 10-24	11.00	12.50	
<input type="checkbox"/>	No. 11-24	13.50	15.00	
<input type="checkbox"/>	No. F-135-24	14.50	17.50	
<input type="checkbox"/>	No. F-145-24			

Name _____
 Address _____
 City _____
 State _____
 R.D. _____

**30 Days
FREE
TRIAL
5 Year
Guarantee**

MARWOOD

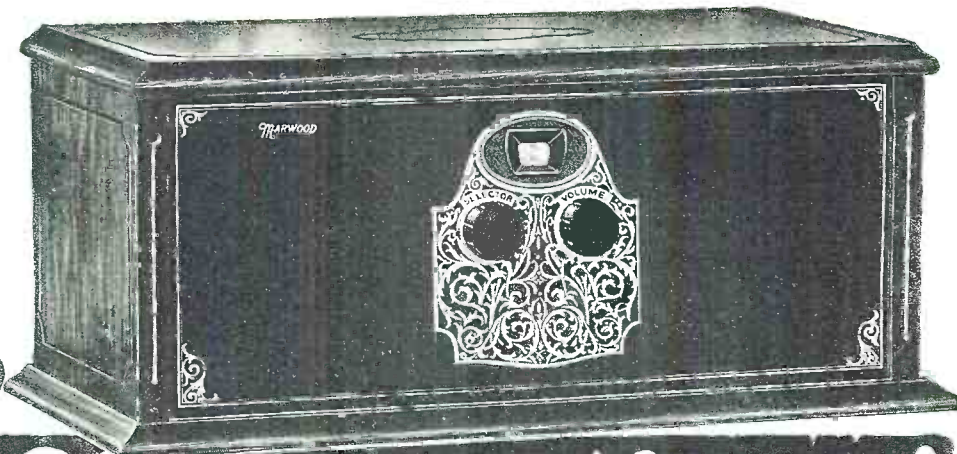

The 1928 Sensations! 8 Tube-1 Control

**All Electric
Or Battery Operation**

AGAIN Marwood is a year ahead—with the Radio sensation of 1928—at a low price that smashes Radio profiteering. Here's the sensation they're all talking about—the marvelous 8-Tube Single Control Marwood for BATTERY or ALL ELECTRIC operation. Direct from the factory for only \$69.00 retail price—a price far below that of smaller, less powerful Radios. Big discount to Agents from this price. You can't beat this wonderful new Marwood and you can't touch this low price. Why pay more for less quality? To prove that Marwood can't be beat we let you use it on 30 Days Free Trial in your own home. Test it in every way. Compare it with any Radio for tone, quality, volume, distance, selectivity, beauty. If you don't say that it is a wonder, return it to us. We take the risk.

Only
\$69 RETAIL PRICE
Big Discount
to Agents
From This
Price

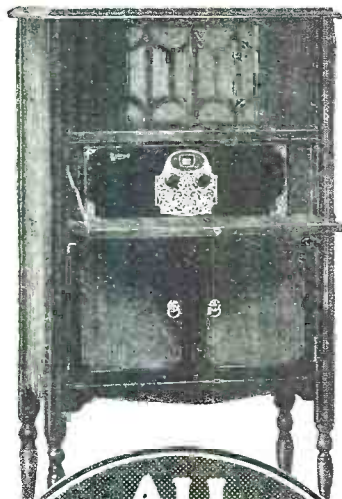

**ALL
ELECTRIC
8 Tube
1 Control
\$98** RETAIL PRICE

New Exclusive Features

Do you want coast to coast with volume enough to fill a theatre? Do you want amazing distance that only super-power Radios like the Marwood 8 can get? Do you want ultra-selectivity to cut out interference? Then you must test this Marwood on 30 Days Free Trial. An amazing surprise awaits you. A flip of your finger makes it ultra-selective—or broad—just as you want it. Every Marwood is perfectly **BALANCED**—a real laboratory job. Its simple one drum control gets ALL the stations on the wave band with ease. A beautiful, guaranteed, super-efficient Radio in handsome walnut cabinets and consoles. A radio really worth double our low price.

Buy from Factory—Save 1/2

Why pay profits to several middlemen? A Marwood in any retail store would cost practically three times our low direct-from-the-factory price. Our policy is highest quality plus small profit and enormous sales. You get the benefit. Marwood is a pioneer, responsible Radio, with a good reputation to guard. We insist on the best—and we charge the least. If you want next year's improvements **NOW**—you must get a Marwood—the Radio that's a year ahead.

**Get Our Discounts Before
You Buy a Radio**

Don't buy any Radio 'till you get our big discounts and catalog. Save half and get a Radio that IS a Radio. Try any Marwood on 30 Days Free Trial at our risk. Tune in coast to coast on loud speaker with enormous volume, clear as a bell. Let your wife and children operate it. Compare it with any Radio regardless of price. If you don't get the surprise of your life, return it. We take the risk. Don't let Marwood low prices lead you to believe Marwood is not the highest quality. We have smashed Radio prices. You save half.

6-Tube—1 Control

This is the Marwood 6-Tube, 1 Control for BATTERY or ALL ELECTRIC operation. Gets coast to coast on loud speaker with great volume. Only \$47.00 retail. Big discounts to Agents. Comes in handsome walnut cabinets and consoles. This low price cannot be equalled by any other high grade 6-tube Radio. Has the volume of any 7-tube set. If you want a 6-tube Radio you can't beat a Marwood and you can't touch our low price.

\$47
RETAIL PRICE
Big Discount
to Agents
from This
Price



**Big Discount to Agents
From this Price**

Has Complete A-B Power Unit

A REAL ALL ELECTRIC Radio with one of the best A-B power units on the market—no batteries needed—at the world's lowest price. This Marwood can't be excelled at ANY price. If you have electricity in your home, just plug into the light socket and forget batteries. No more battery trouble and expense. Costs less than 2c. a day to operate. Always have 100% volume. ALL ELECTRIC Radios are high priced because they are new. We cut profit to the bone and offer a \$250.00 outfit for \$98.00 retail price. Big discount to Agents. Don't buy any Radio 'till you get details of this sensational new ALL ELECTRIC Marwood.

AGENTS

Make Big Spare-Time Money

Get your own Radio at wholesale price. It's easy to get orders for the Marwood from your friends and neighbors. Folks buy quick when they compare Marwood quality and low prices. We want local agents and dealers in each territory to handle the enormous business created by our national advertising. Make \$100 a week or more in spare time demonstrating at home. No experience or capital needed. We show you how. This is the biggest season in Radio history. Everybody wants a Radio. Get in now. Rush coupon for 30 Days Free Trial, beautiful Catalog, Agent's Confidential Prices and Agents' New Plan.

MARWOOD RADIO CORP.
5315 RAVENSWOOD AVE.
Dept. A-5, CHICAGO, ILL.

Rush for Free Trial

Marwood Radio Corporation,
5315 Ravenswood Ave., Dept. A-5, Chicago, Ill.
Send Agents' Confidential Prices, 30 Days Free Trial,
New Catalog and Agents' New Money Making Plan.
No obligations on my part.

Name

Address

St. or RFD.....

CityState.....

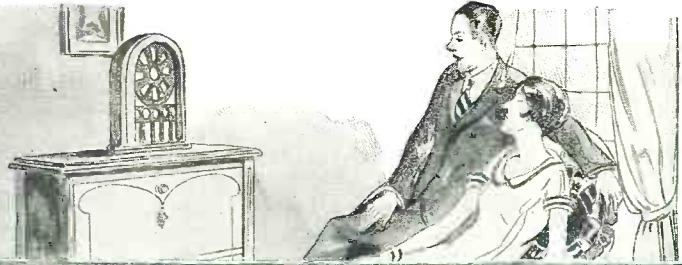
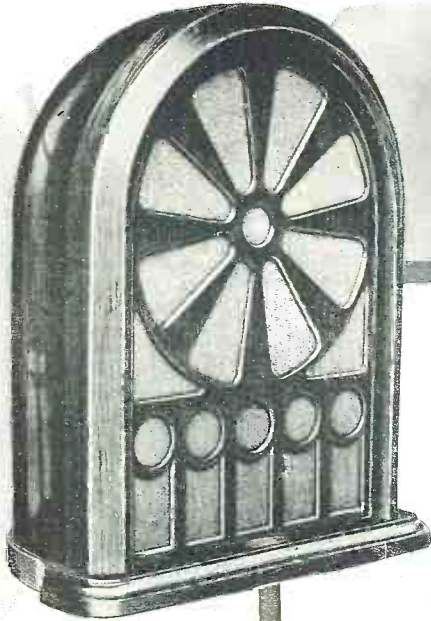

"Perfect!"
say experts



ALL-AMERICAN

TRADE MARK

REPRODUCER

MANY radio experts, hearing the All-American Reproducer for the first time, have exclaimed, "Here at last is a reproducer worthy of a fine receiver."

This splendid unit will give you greater enjoyment of radio; because it reproduces with faithful accuracy. There's no shrill harshness of the treble; no exaggeration of bass tones.

Throughout the entire amplification range—in full volume or turned down to a whisper—all the tones come rich and full.

Make this test yourself—compare the All-American Reproducer with any other, at *any* price. You'll learn instantly why the All-American is the ideal unit for getting the greatest possible enjoyment of radio. Ask your dealer about it.

ALL-AMERICAN RADIO CORPORATION

4209 Belmont Avenue
CHICAGO, ILLINOIS



ALL-AMERICAN
TRADE MARK

"B" Power

This is a compact, efficient and low priced unit. It embodies every feature of bulky and higher priced power units. Small enough to fit in any radio battery compartment. Has two controls and will deliver up to 180 volts. Price \$27.50

(Raytheon tube extra)





RADIO NEWS

HUGO GERNSBACK,
Editor and Publisher

Editorial and General Offices, 230 Fifth Avenue, New York

Vol. 9

NOVEMBER, 1927

No. 5

THE OUTLINE OF BROADCASTING

By HUGO GERNSBACK

THERE are now in this country nearly seven hundred broadcast stations. Scattered throughout the world there are, from the latest available reports, other broadcast stations enough to bring the number well over a thousand. The remarks that I shall make here will be centered, primarily, around the reason why broadcasting is done at all, and the most recent developments in the economics of broadcasting.

First, the question is often asked "Why is a broadcast station?" In America, since the Federal Radio Commission took hold, it has been freely predicted that, after even a short time, many broadcast stations will be killed off. This massacre has not been realized, for the simple reason that a broadcaster is one of the most difficult things to kill. There are hundreds of reasons why a person, a business, such as a newspaper, a church, or other institution, should broadcast. These are, usually, strictly individual and, while the reasons may be good ones, the results, in a great majority of the cases, do not warrant the maintenance of a separate broadcast station. For sentimental reasons, there may be a reason for broadcasting. A man or a firm may wish to become better known in the community, or indeed in the country, and the operation of a broadcast station often may accomplish this.

Whether it is of any dollars-and-cents value to the broadcaster himself is not always certain. A newspaper, for instance, may run a broadcast station which costs some \$200,000 to operate during the year. It is doubtful whether the newspaper can pick up sufficient additional circulation to pay for this outlay. But in good will and prestige, the \$200,000 may be well repaid. No two cases are ever alike, and what benefits one broadcaster may not benefit another. Each case should be judged on its own merits.

Some broadcasters frankly admit that they are not in the "game" from the dollars and cents standpoint directly, but expect to profit indirectly. Thus, for instance, one of our large radio corporations went originally into broadcasting simply to keep faith with the people who bought its radio sets; because a radio set without broadcasting would be the height of uselessness. Consequently, more people listening-in to radio programs meant the sale of more sets. That, however, was in the beginning. If this firm had been able to monopolize the sale of sets, then its broadcast station or net of stations would indeed have been well paid for. But this did not happen, and many independent manufacturers who sold radio sets did so really on the capital invested by others in broadcast stations.

From the economic side, one would think that the manufacturer who sells radio sets or, indeed, radio merchandise, should support the broadcaster who gives the service; but, strange to say, the set manufacturers, as well as the makers of parts and accessories, in America, while not actually hostile to the broadcast stations in general, do practically nothing to help defray the broadcaster's expenses. This situation is strange, if we contemplate the fact that, if all broadcasters suddenly shut up shop, not a single radio set, accessory or part could be sold.

There was at one time a faint hope that broadcasters could assess the radio manufacturing industry to help support the stations. Such a thing might have come about if stations in this country had not multiplied to such an extraordinary number, that the burden would be too tremendous for even the largest manufacturer to stand. Even a large sum of money, distributed over seven hundred broadcasters, would be wasted, because it could not begin to support the entire broadcasting industry adequately.

So the broadcasters who, practically one and all, with very rare exceptions, have lost huge sums on their stations, have come of late to see a new light. Even the wealthiest broadcaster will sooner or

later become discouraged, if month after month his business department shows losses piling up, from which there seems to be no escape. The average 500-watt station costs anywhere from \$100,000 per year upwards to run, if it is operated on any decent basis whereby the public gets fair entertainment. Frequently the figure is much higher, where the station has a good staff and uses good talent.

Another important change has come about lately, which may be summed up as follows: When broadcasting first started, the stations practically had to drag the talent in to the studios. I remember well the time when WJZ first started in Newark. It was the first station in this district, and not well known at the time. I had been asked to prepare a talk to deliver over the station. The station manager came over to New York in person to get me; even inviting me to dinner and having a car ready for me to go over to Newark and broadcast! Those were the good old days, when broadcasting was young.

A little later on, nearly everyone was anxious to broadcast, particularly musical artists who sought to make a name for themselves over the radio, and many indeed did so. There are many of them who have been actually "made" by radio. But of late these same artists and a host of others have come to realize that it is one thing to be a famous radio artist, and quite another to meet his rent when it comes due. Fame and publicity do not keep the wolf from the door. So the same artist, who once was glad to have the opportunity to broadcast, now has made a face-about and demands pay—and good pay at that—if the station wants to use his talents.

As for music, such as that supplied by orchestras, unions have been formed and it is practically impossible to secure any kind of an orchestra or instrumental performer, with very few exceptions, who will give services free to a radio station. There are, of course, exceptions, because there are still some artists who are not too well known.

So the broadcasters are faced with the alternative of running their stations at a huge loss, or quitting entirely. Rather than do the latter, and in order to get back the heavy investments already made, advertising over the radio has become increasingly popular lately; and it may be said that the coming year will witness a complete change in broadcasting. After the broadcasters had seen the light, and found that support was not forthcoming from the radio industry itself, they had to go sell their time to those who needed advertising. And it may be said here that *advertising over the air is possibly the cheapest kind of advertising and the most economical.*

It is doubtful whether an advertiser can secure the same results in any other way than over the radio, providing it fits his particular class of business. When it comes to making a name for a certain class of merchandise, and to popularize it quickly, there is possibly nothing quite as efficient as radio, because it immediately reaches a large class of people who are in a receptive mood. On the other hand, there should be no direct advertising over the air; that is, so-called "sales talk." It has been found that such methods are usually fruitless, because the listener becomes annoyed and tunes out the offending station. But few listeners object to a "sponsored program;" that is, a musical program sponsored by an advertiser. In such a case, not more than two dozen words of advertising are given, which is not at all offensive; because the listener knows that the entertainment comes to him free anyhow, and he is not likely to complain.

Strange as it seems, the radio advertiser has not as yet been educated to this fact, and often insists on long-winded, foolish advertising talk, which gets him nowhere. Another, and most important part, that most radio advertisers frequently forget, is that even the best of sponsored programs, if given only once or twice, are of no use whatsoever. Only those programs that run week in and week out, stretching over a year and more, bring the greatest results.

... In which the Editor dips back into ancient history, and recalls the earliest days of broadcasting—when the question of its support was less troublesome than it is today—how the broadcaster has been faced by continually increasing costs of good entertainment—why paid advertising must be relied upon to provide programs of quality that is attractive to critical listeners—and why radio advertising must not be of too direct a nature if it is to be really profitable to its purchasers.

Mr. Hugo Gernsback speaks every Tuesday night at 9.30 P. M. from station WRNY on various radio and scientific subjects.

In the Future—Intermediate- or Short-Wave Broadcasting?

By Lieut. H. F. BRECKEL

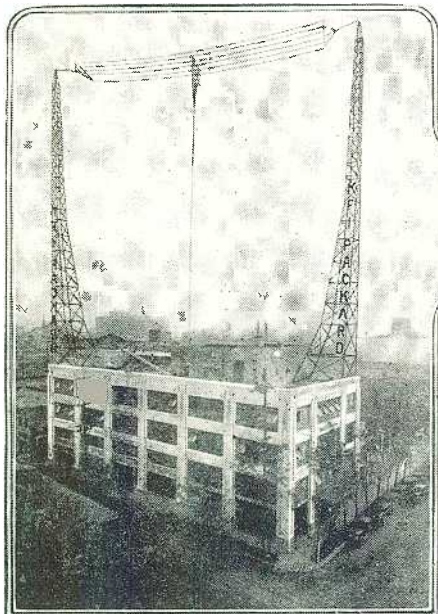

At the left is the elaborate antenna of a station using a wavelength of 468.5 meters and at the right is the simple vertical antenna of a transmitter operating on 32.77 meters.

Photos by courtesy of Earle C. Anthony, Inc., and General Electric Co.

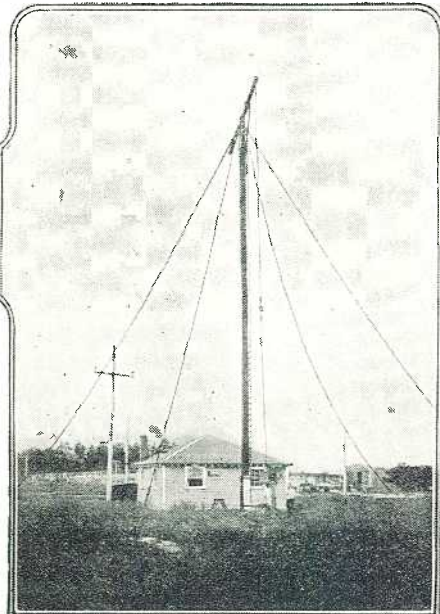

THE increased use of shorter waves (higher frequencies) for commercial broadcasting has led to considerable discussion by the average listener, as well as by those actively engaged in this field, whether or not this system of transmission will eventually displace that in general use at present.

In view, therefore, of the widespread general interest displayed in the subject, an analysis of the relative merits of the *intermediate* waves (as those between 200 and 550 meters, used in American broadcasting, will be called here, to distinguish them from the really *long* waves used in ship and commercial radiotelegraphy and transatlantic telephone work, etc., which range up to 30,000 meters or so) and the short waves, in their practical application to broadcasting, is in order; and will prove interesting to the owners of broadcast stations, as well as to the average listener.

Taking for first consideration the intermediate-wave system now in general use for broadcasting (see Fig. A), this type of station radiates waves which, generally speaking, spread more or less equally in all directions and can be heard best at close range. (The meaning of the latter statement will

become apparent when the short-wave system is discussed.) However, because of the relatively high absorption losses incurred in this form of transmission, particularly in the daytime, it is necessary to use high-power transmission to cover any considerable distance. During darkness, owing to greatly-decreased absorption losses, much greater ranges can, of course, be obtained with a given power.

For example, in the case of a modern 5,000-watt broadcast station, the average day range over which a *good, understandable* program can be heard will approximate 250 miles, at a generous estimate. At night this same station may be heard over ranges of 1,000 to 3,000 miles, varying with the atmospheric conditions and the season of the year. It can, therefore, be seen that, if considerable distances are to be covered reliably with this form of transmission, it is necessary to utilize high power. This, of course, means higher costs; not only in the original installation, but in the maintenance of the equipment, which involves power, replacement of tubes and other parts of the equipment, additional personnel, and other items of general upkeep, such as care of station grounds, residential buildings, towers, etc.

To give the reader some idea of the expense involved in erecting a modern 5,000-watt remote-controlled (*i. e.*, located outside the immediate city limits to avoid local interference) broadcast station, it may be stated that the station shown in Fig. A cost in the neighborhood of \$200,000 to install; and the total cost of maintenance and operation is in excess of \$100,000 annually.

Judging from the present trend of the more progressive broadcasters in the direction of greatly-increased power, such figures will be enormously increased in the future, unless there is devised a more economical

arrangement capable of accomplishing the objective of the broadcasters—which is to have their programs reach as many listeners as possible throughout as great an area as can be covered. In this connection, it may be pointed out that one station, WGY, has been carrying on experimental radio broadcasting work.

Fig. A. A remote-controlled broadcast transmitter of 5000 watts power, used on the present assigned band of intermediate frequencies.

Photo by courtesy of Station WLW (Crosley Radio Corporation).

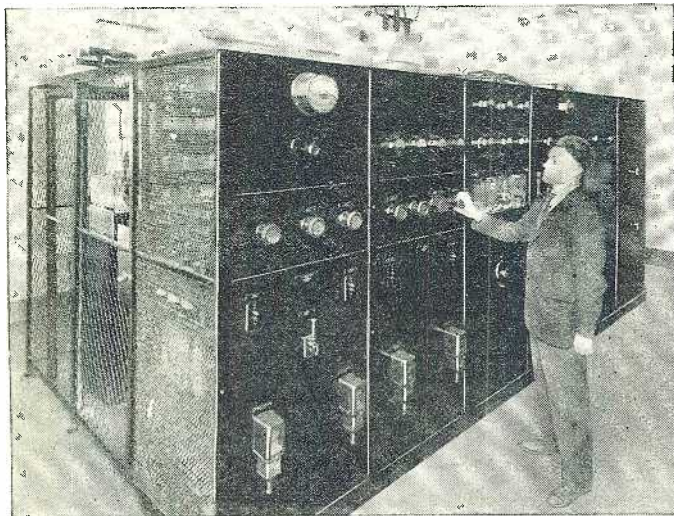

with a power of 100,000 watts; while another station, WEAJ, is actually using in regular service 50,000 watts. The use of equal power is contemplated by at least two Ohio stations in the near future.

Of course, it may be said that the use of 100,000 watts in the first-mentioned transmission is primarily experimental at present; but it undeniably indicates that the trend, in the matter of power used by the leading broadcasters, is "up." Also, there can be no denying that programs *do "come through"* on these higher powers on the present generally-used intermediate waves, even during the summer weather and its associated static disturbances. However, as mentioned, the cost of erecting and maintaining such an installation is also "up" and very much so; being (so the writer is informed) in the neighborhood of \$160,000 for the bare transmitter alone! And this does not include any of the necessary adjuncts, such as buildings, towers, power lines, etc., etc.! Not many broadcasters can afford to install and maintain equipment of such power and cost. So much for the present type of intermediate-wave transmission.

DISTANT RECEPTION OF SHORT WAVES

Let us now consider the advantages of the (comparatively) recently-developed short-wave system of transmission and its practical application to broadcasting. A typical installation (more or less experimental) is shown in Fig. B. In the short-wave system of transmission a form of wave-propagation results which is somewhat different from the system of intermediate-wave transmission previously described. This difference lies essentially in the fact that, while the intermediate waves follow the earth's curvature (being, so to speak, "earth-bound" and subject to absorption losses), the short-wave system propagates its waves "skyward" at a critical angle. They rise to a height varying, with the different conditions prevailing, from fifty to a hundred miles or more, until they reach what is termed the "Heaviside layer," a conductive stratum existing in the earth's atmosphere. This, as illustrated in another article on page 465 of this issue, possesses the property of reflecting the short waves again to earth,

where they react in the normal way on the listener's receiving aerial and apparatus, provided the latter is so designed as to respond to their wavelength. (The average receiving equipment today in general use for listening to the intermediate waves will not respond to the short waves unless a special device is used in connection therewith. Short-wave reception equipment can, of course, be obtained by the listener desiring to listen to the short-wave programs, or an attachment which is suitable for use in connection with his present equipment. With such apparatus, either short- or intermediate-wave programs may be heard, as desired.)

SMALL POWER NECESSARY

To get back to the main subject, the short waves, after being reflected earthward, come down at great distances from their source, even though very small power is used. The range of short-wave transmission is enormous, because it is capable of traveling through the conductive medium without suffering the absorption losses which are incidental to intermediate-wave transmissions. Thus the short waves reach out farther and arrive at the listener's aerial with comparatively little loss of energy. The range obtainable with the same power but using the intermediate waves is, by reason of the high absorption losses previously mentioned, much shorter.

For example, the short-wave transmitter shown in Fig. B (located in Cincinnati, Ohio) uses a power of only 250 watts, but is consistently heard in England on a small three-tube set, and has been received also in such other far-distant countries as Australia, New Zealand, Africa, and others. This transmitter is located in the same building with the 5,000-watt intermediate-wave transmitter shown in Fig. A and both transmit the same program simultaneously and under the same climatic conditions. Yet it is only rarely that the intermediate-wave transmitter can be heard in Australia; while the transmission of the short-wave unit is heard and actually re-broadcast at that far-distant point!

THE SKIP DISTANCE

However, the short-wave system of transmission possesses one feature objectionable from the standpoint of the broadcaster; there exists what might be termed a "dead spot" adjacent to the station, in which area the program cannot be heard by the listeners. In the case of the transmitter shown in Fig. B, this dead area prevails throughout a radius of some seventy miles around. In other words, a listener must be at least seventy miles distant before the program can be intercepted. After this point is passed it can be clearly and loudly heard. Thus, it can be seen that the disadvantage exists that a broadcaster could not reach his local listeners were this method alone used.

The technical term for this peculiar characteristic of short-wave transmission is "skip distance," *i. e.*, the waves skip over a certain distance of the area adjacent to the transmitting aerial before coming again to earth. Therefore, a station using this system and desiring to serve the local listeners would have to be located some distance away from the immediate territory it is desired to serve! This would surely suit a lot of fans whose receivers are located in the immediate vicinity of some of the high-powered transmitters, would it not?

ADVANTAGES AND DISADVANTAGES

Weighing, then, the respective merits of each type of transmission, we may sum up as follows:

The intermediate-wave system (200-550 meters) can serve listeners throughout the total area surrounding the station; is adaptable to transmission throughout the present assigned broadcast band of frequencies; can

serve listeners possessing receivers capable of responding to the present broadcast frequencies only, thus protecting their investment; can cover greater ranges, if desired, through augmentation of the power used, *i. e.*, replacement with higher-powered equipment.

On the other hand, the disadvantages are the limited number of available transmitting channels capable of simultaneous use without causing interference due to heterodyning of stations; high initial and maintenance costs in erecting and operating a modern station of reasonable power; the greatly-limited day ranges, because of high absorption losses; the high power necessary to cover distant ranges, thus causing "blanketing" of local listeners; and the costs thus entailed by the necessity of locating the high-powered transmitter outside areas of congested population, to minimize interference with the listeners in the immediate vicinity.

The short-wave system (100 meters and lower) can serve listeners at very distant points (provided receivers are of short-wave design); can cover great distances consistently, with comparatively moderate power; requires relatively low initial and maintenance costs; has increased day range by reason of very low absorption losses; makes possible an increased number of transmitting stations by reason of greatly-augmented number of available channels; reduces interference due to heterodyning because of wider separation of channels; reduces "blanketing" interference to local listeners by reason of reduced power (this being also possible by reason of the "skip distance" characteristic previously mentioned). "Local" listeners, in the case of short-wave transmission, would mean those residing in the area where the programs are first capable of being heard.

Unfortunately, however, the short-wave system cannot reliably serve listeners residing in the "skip-distance" area, *i. e.*, the local listeners (this undoubtedly constitutes a major objection for the broadcaster). It cannot provide service to the listeners unless a special short-wave receiver or an attachment for the present intermediate broadcast band receiving set is purchased. It may be mentioned that, even though such an attachment is obtained, its operation will increase

the number of tuning operations necessary on the part of the listener.

USE OF BOTH PROBABLE

Thus we see that each system has its advantages and disadvantages, and what would be best from the standpoint of the broadcaster might not fit in so well from the angle of the listener. While the use of the short-wave system would provide a possible remedy for the congestion in the broadcast field today, the disadvantage of making the listener's receiving equipment obsolete is formidable; as well as the area of "skip distance." The latter prevents the serving of local fans by the broadcaster, unless, of course, the station is remote from the local area it is desired to cover, which would occasion, for various reasons, higher costs.

Weighing the evidence, as it were, the future trend would seem to be toward the simultaneous use of both systems, in view of the advantages available, as in the case of the station illustrated; it being thus possible to provide a high quality of service to both local and far-distant listeners. If this type of service is developed further, there can be little doubt that the average listener will provide himself with both short- and intermediate-wave receiving equipment, and thus take advantage of the benefits of both systems. That is, if he wants great distance, he will use the short-wave system; and, on the other hand, should he or she find the local program pleasing, the equipment is available to listen to them. The present tendency toward "chain-station" programs and the general willingness on the part of the average listener of today to listen to the local station, if the quality of the program is satisfactory, are other factors, however, which will undoubtedly influence the future.

Yet the listener may desire to listen to a distant station which is blanketed by the local station, because its program cannot be heard on a local link of the chain system. Now, if this same program were being broadcast simultaneously on short- and intermediate-wave systems, it would be readily possible for the listener equipped to receive the short wavelengths to tune in and get the program desired.

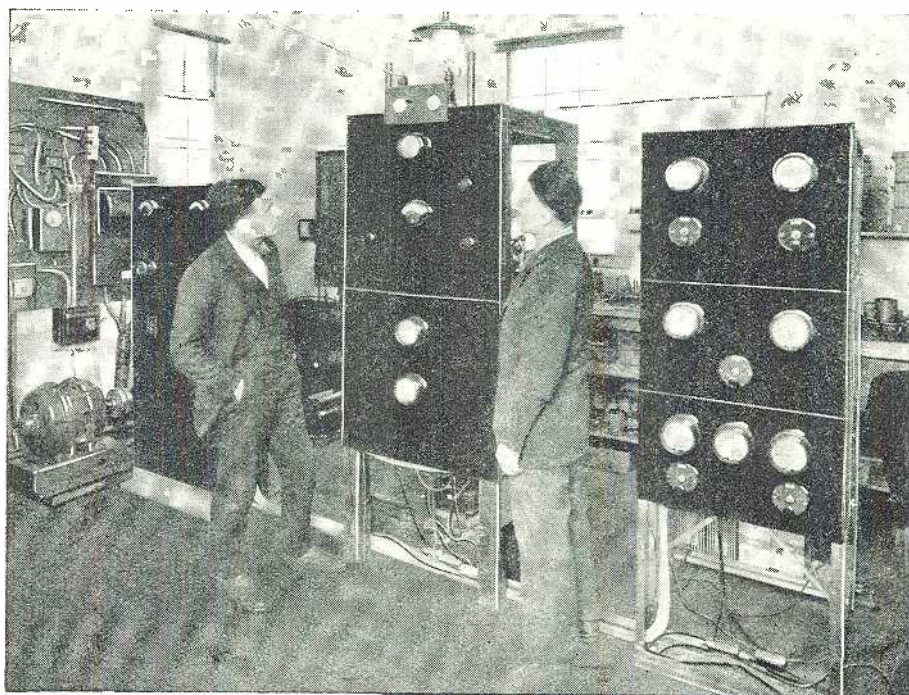

Fig. B. An experimental remote-control 250-watt transmitter, shown above, which operates on a wavelength of 52.2 meters, has been heard in all parts of the world.

Photo by courtesy Station WLIV (Crosley Radio Corp.)

New 50-Kilowatt Transmitter of Station WEAF

A Complete Description of the World's Most Modern Broadcast Installation

By JOSEPH RILEY

THE visitor to the new 50-kilowatt transmitter of Station WEAF at Bellmore, Long Island, in his thirty-mile journey from the heart of New York City, follows a course roughly paralleling the cable which connects the plant to its metropolitan studio. This cable passes through three telephone exchanges where, at each point, telephone "repeaters" are inserted to keep the signal strength well above that of disturbances. The course of the wires is partly underground and partly in overhead cables. A telephone cable, consisting of a bundle of conductors within a lead sheath, is a far more reliable means of communication than the open wire on cross-arms, which is a familiar sight along railroad tracks. Even if a pole should fall, the cable is sufficiently strong to support its weight. In this way interruptions to program service are guarded against.

The steel towers of the station are 300 feet in height, and visible for a considerable distance over the flat terrain of Long Island. When one comes close to the eight-acre plot completely occupied by the installation, the aerial becomes visible. It is merely a single 3/8-inch wire suspended between the towers, with the downlead in the middle, forming a T-shaped aerial of great mechanical strength. The horizontal section of the wire is 250 feet long, affording ample clearance from the towers, which are spaced 600 feet apart. The towers are supported on heavy, glazed

THE recently-opened 50-kilowatt transmitter of WEAF, which is the key station of the extensive "Red" network, is without question the most complete and modern broadcast installation in the world. It represents the efforts of the best radio engineering brains in the United States and a total investment of approximately half a million dollars; so, we are sure, our readers will be interested in the description of its outstanding features.

—EDITOR.

porcelain insulators and, in normal radiation, remain insulated from the earth. This type of antenna has a great effective height and radiates efficiently in all directions. Incidentally, the natural period of the aerial is well above 600 meters, necessitating the use of a series condenser to tune the system to 491.5 meters (corresponding to the frequency of 610 kilocycles assigned to the station. At night the towers are flood-lighted,

for the guidance and protection of airplane traffic, of which there now is a great deal over Long Island.

THE TRANSMITTER BUILDING

The station building is a one-story-and-basement stucco structure, set about midway between the towers. It makes an attractive picture on the landscaped grounds and fits neatly into its suburban surroundings. The architecture might be described as a compromise between the residential and the style more usual in power plants. The effect is one of simplicity and harmony.

Entering the station from the front, one passes through the engineer's office to a control room on the right, where the broadcasting circuits from the New York City studios terminate. Here are located the input and "monitoring" panels and the preliminary amplifiers of the station. The latter, in their last stages, include tubes more powerful than the largest found in most broadcast stations.

The monitoring and switching panels comprise apparatus such as small amplifiers and volume indicators, used in measuring the strength of incoming currents; equalizers, to correct for the loss of high musical frequencies along the line; signal lights, showing the condition of various circuits; and a compact oscillograph which indicates the depth of modulation of the carrier. Besides

Right: The arrow in the lower right compartment points to piezo-electric crystals which maintain a stabilized frequency of 610 kilocycles for the 50-kilowatt transmitter. Only one crystal is used at a time, the remaining two being held for emergency. They are kept in an atmosphere regulated all the time to a constant temperature, to insure that their fundamental frequency will not change.

Photos by courtesy of National Broadcasting Co.

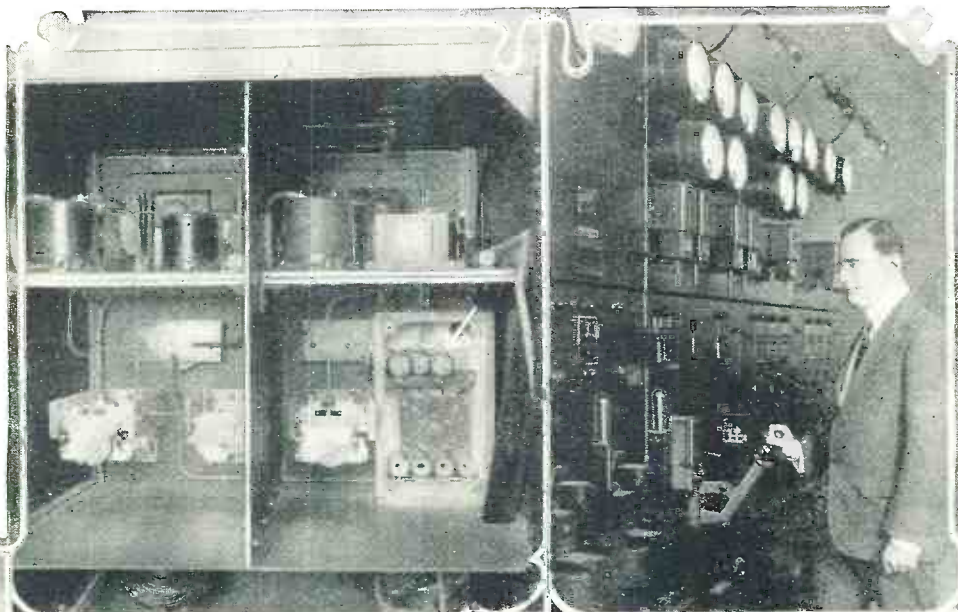

Left: Dr. A. N. Goldsmith, chairman of the National Broadcasting Company's board of consulting engineers, throws the switch which puts the new 50-kilowatt transmitter of station WEAF on the air. This station, heard all over the world from its former location in the heart of New York City, is now thirty miles out to permit use of tenfold greater power and to escape the absorption effects which were occasioned by its location in the city, as well as to minimize interference to listeners.

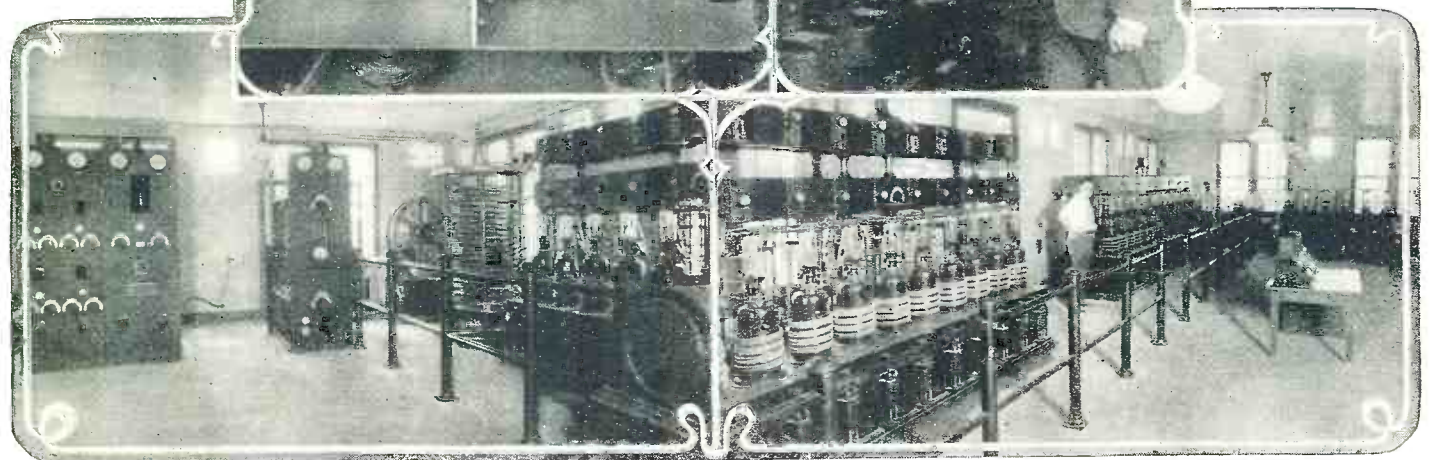

In the corner of the room above may be seen the huge R.F. tuning condenser and the tuning coils. At the left are the R.F. amplifier units, including the crystal-control apparatus.

A general view of the 32 high-power radio tubes (rated at 20 kilowatts each) used in the new WEAF transmitter. The control table is shown at the right.

these visual checks there is a high-quality cone loud speaker fed from a radio-frequency rectifying system, used for monitoring the output of the station. (This means simply that the operators on duty listen to the program just as do other members of the audience at more remote points. On these panels there are also jack panels and switching facilities for conveniently changing lines, connections, etc.)

The first speech amplifier in the actual broadcasting circuit within the station building is a tube with a 50-watt oscillator rating. (As ampli-



its full capacity) would be sufficient to supply all the power for a normal 500-watt broadcast station. This does not take into consideration the power of over one kilowatt (52 amperes at 22 volts) required to heat the filament of each unit. In broadcast practice the tubes are run at inputs below the allowable figure, in order to prolong their life and minimize interruptions.

PRECAUTIONS

In the 50-kilowatt, 610-kilocycle amplifier which follows the intermediate power stage, ten 20-kilowatt

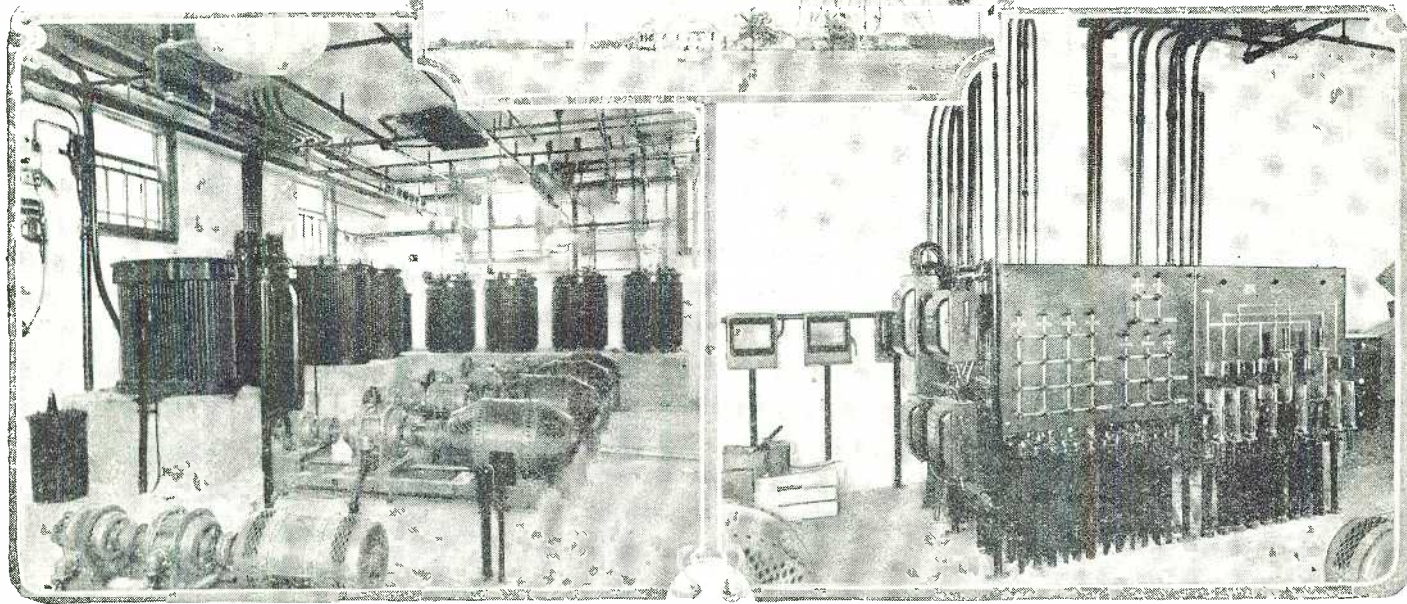

Top: The lead-in of the aerial drops to a small tuning house, from which a R.F. transmission line runs to the station house proper. Left: Transformers, plate reactors and half of the motor generators in the

basement of the WEAF building. Right: Filament motor-generator control switchboard in another corner of the same basement. Notice how all the connecting cables disappear through the floor.

fiers, tubes have a much lower power rating than as oscillators; but it is customary to give the oscillating output as a measure of the size of the tube.) This is resistance-coupled to another tube of the same size. The next unit is a one-kilowatt air-cooled tube which "swings" the grids of the modulator tubes, the connection being effected through a low-capacity cable. These three vacuum tubes derive their filament supply from a storage battery, while the plates are fed from generators large enough to supply a 500-watt broadcast station. The audio amplifier, consisting of the two 50-watt and one 1000-watt tubes, is mounted in a metal case about seven feet in height, with suitable meters mounted on the panel and doors giving access to the tubes. It is provided in duplicate, with a power-control and change-over panel set between the two amplifier units.

The main transmitter room of the station contains the following units: main power switchboard; crystal-controlled low-power amplifier; intermediate power amplifier; 50-kilowatt power amplifier; modulator for 50-kilowatt amplifier; rectifier; tuning apparatus; operator's control desk. The apparatus is placed along the walls, with access to the open high-tension sections barred by a wooden railing. The operator's control desk is placed in the middle of the floor. With all this apparatus, the room, 70 by 30 feet in size, is by no means crowded.

The radio-frequency (610 kilocycles) portion of the circuits begins with the quartz crystals, of which there are three, housed in a box whose temperature is thermostatically controlled. Any crystal may be selected by means of a switch. These crystals act as oscillation governors to keep the station rigidly

on its assigned frequency. Their natural operating period varies slightly with changing temperature; therefore the heating current is kept on day and night, whether the station is on the air or not, in order to maintain perfectly constant physical conditions for this delicate equipment. The first tube controlled by the crystal is of 7.5 watts rating, a size commonly found in the output of high-quality amplifiers and radio receivers. It is radio-frequency-coupled to a second tube of the same size, which in turn is followed by stages employing one and then two 50-watt tubes. At the next stage the power level becomes formidable and a one-kilowatt tube is required to handle it. Up to this point the tubes have been air-cooled, *i.e.* cooled by radiation of heat from the glass. But now a single 20-kilowatt tube, as the next stage in the radio-frequency chain, constitutes the intermediate power amplifier, and this requires water cooling. It is also a separate unit with its own panel, meters and controls.

These water-cooled tubes are built with the "anode" or "plate" (which in smaller units is actually a plate or small rectangular sheet of metal) in the form of a closed hollow cylinder, housing the grid and filament. The amount of energy conveyed to this "anode" may be of the order of 30,000 watts, at a voltage of perhaps 15,000. The efficiency of the device is between 60 and 70%, so that some 20,000 watts may be withdrawn in the form of useful oscillations, leaving 10,000 watts dissipated at the plate, in the form of heat. This energy warms the water circulating through the hollow cylinder at the rate of two or three gallons a minute. The inescapable loss of plate energy in one such power tube alone (if that unit is run at

tubes are employed; but only eight are in use at any given time, the remaining two acting as "spares." This unit, about 20 feet long, is built in open fashion. Most conspicuous are the ten water-hose coils wound on insulating cores into which the anodes of the tubes themselves fit. These coils insure a water stream sufficiently long to insulate the plates, with their 10,000-15,000-volt potential, from ground. Below each coil there is a pressure-actuated relay which prevents voltage from being applied to the plates of the tubes when water is not flowing at a safe rate. With twenty-seven water-cooled tubes in use, in the absence of such automatic protection an operator's mistake might cost the station upward of \$10,000 in a few seconds. The superstructure of the 50-kilowatt amplifier carries meters, individual choke coils, indicating relays, switches, and other paraphernalia required in the operation of large vacuum tubes.

Each of the big tubes is rated at 20 kilowatts; but they are considerably underloaded, their life being increased by such treatment.

The modulator, which governs the amplitude of the 50 kilowatts of radio-frequency energy in accordance with the speech or music of the program, is in appearance a similar unit. It contains 16 tubes, 12 in use and 4 "spares." These are connected and disconnected in groups of two. The grid bias may, however, be individually adjusted. The biasing voltage is provided by a pair of small generators which are, nevertheless, large enough to supply electric power for a residence. The biasing voltage is not much below 1,000.

(Continued on page 560)

Awards of the \$250 July Cover Title Contest

THE Contest Editor is a DX fan. When he checked over the returns from RADIO NEWS' latest \$250.00 prize cover title contest, it was easy to see that Sydney, Australia, was the best distance logged for a reply, with Otatau (South Island), New Zealand, not far behind. As between Durban, South Africa, and Rangoon, Burma (on the road to Mandalay), it was necessary to take down the globe to decide. From the latter city a letter came hurrying by air mail via Basra and Cairo, passing another from the telegraph station at Mohammeran, Persia. Tsingtao in China and Yokohama in Japan; Cape Town, South Africa, and Pitufquen, Chile, are the homes of other entrants in this tourney. Compared with these, residents of Europe and of other countries in South America are "locals:" while Point Barrow, Alaska, is the Arctic home address of one communication, the letter was mailed in Seattle. Canadian readers, as usual, are among the promptest and not the least successful in every contest—as the prize list will show.

The problem of naming the picture, again reproduced in miniature on this page, presented unusual difficulties in its very simplicity; a retired safe-cracker has turned to radio as his hobby, and is seen enjoying the performance of his new receiver—one which brings up pleasant memories of old times. His son, also deeply interested in radio, has slipped into the sitting room with the firm purpose of borrowing a "gadget" for his own use, but finds unexpected difficulty in carrying out his purpose.

WHAT DID YOU SUGGEST?

Now then, how would you sum up the situation—if you have not already done so? Hundreds of our readers, as if moved by one impulse, immediately exclaimed "Safe and Sound!" Nearly as many commented "Money Talks," and "Fool Proof," "Tool Proof," "Ham Proof" and "Monkey Proof," vied also in popularity.

"Shielded from the Son and Heir," "No Pick-Up" and "High Resistance" were the theme of many variations. With the preceding cover contest and its results in mind, many readers worked on the idea of "A Cunning Ham;" but lightning does not strike twice in the same place. One of the previous prize-winners, however, again has made a hit: should he do so a third time, it may be necessary to bar him as a professional from future contests.

Many entries contained similar ideas to the prize-winners; and were carefully weighed in the semi-final and final selections by the judges, to determine which best expressed the thought most wittily. Many extremely good replies, very little inferior to the best, passed the first stages of elimination successfully, and finally failed of being winners only because the supply of prizes had been exhausted.

WITTY SUGGESTIONS

We have now the pleasure of sharing with our readers the enjoyment of the humor in the winning replies. The ingenuity shown and the double meanings will appeal to all the old-timers of radio; and the tears of laughter should soon be streaming down their faces, as pun after pun takes effect. Incidentally, we suppose all our readers have familiarized themselves sufficiently with modern detective stories to appreciate that "soup" is the crackman's trade name for that opening course, nitroglycerin.

Many of the replies, as usual, were popular sayings; some were thumbnail essays on the merits of radio, without special reference to the picture. Other ideas or expressions repeated many times are as follows:

"No Losses;" "A Metal Resistor;" "In-

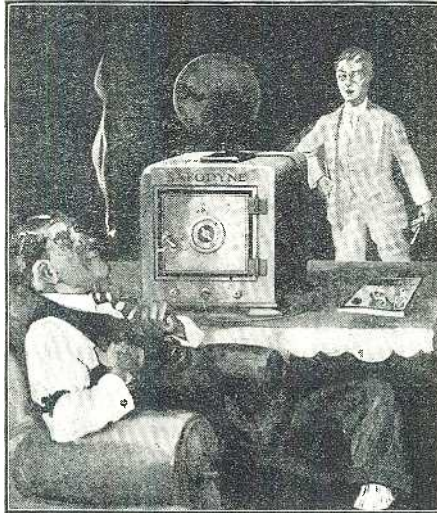

Awards of the \$250.00 Prize Title Contest

First Prize\$75.00

"S-O-N'S OPENING SELECTION
POSTPONED FOR SAFE
REASONS"

STEWART HOPKINS, Newark, Delaware.

Second Prize\$50.00

"A NEW SET USING THE OLD
CROOKES TUBES"

F. I. ROSE, 2907 Burnet Ave., Cincinnati, Ohio.

Third Prize\$35.00

"WAITING FOR THE OPENING
NUMBER"

AUDIE ROBERTSON, Box 143, Alex., Oklahoma.

Fourth Prize\$25.00

"THE OLD SOUPER SCORES AGAIN"

N. J. MATHESON, Marconi Beam Station, Drummondville, Quebec, Canada.

Fifth Prize\$13.00

"ONE OF THE CONSTRUCTIVE
IDEAS OF A BIG STEAL MAN"

FRANK G. DAVIS, P. O. Box 428, Springfield, Ohio.

Sixth Prize\$10.00

"TURN TO THE RIGHT AND PLAY
SAFE"

AARON LEE CARTHAGE, Box 791, City Hall Sta., New York City.

Seventh Prize\$7.50

"THE BCL BUILDS A STRONG CASE
AGAINST THE AMATEUR"

LOUIS ATWATER, Box 783, Bridgeport, Conn.

Eighth Prize\$7.50

"THE WISE CRACKER PLAYS SAFE
IN MORE WAYS THAN ONE"

ROLLA FLORA, 10912 Landale St., Lankershim, Calif.

Ninth Prize\$7.50

"JUST A CRACKER WITHOUT SOUP"

C. L. ARMSTRONG, 1492 Columbus Ave., Hazelton, Iowa.

Tenth Prize\$7.50

"THE IMPROVED NO-LOSS SHIELD
QUENCHES A FRESH YOUNG
SPARK"

W. E. BAKER, 247 Ann Street, Belleville, Ontario, Canada.

Eleventh Prize\$5.00

"A SHIELDED RECEIVER AND A
CRACKING GOOD OPERATOR"

WILLIAM ROBINSON, Box 312, Nat. Military Home, Leavenworth, Kansas.

Twelfth Prize\$5.00

"A SAFE BET AND NO TAKER"

HAROLD MORRIS, Box 124, Elkton, Virginia.

terference Eliminator;" "Eliminating Hand Capacity;" "A Total Eclipse of the Sun;" "Heir Trouble Apparent;" "Heir Full of Static;" "An Heirtight Receiver;" "A Closed Circuit;" "Poor Selectivity;" "Noc-turne in A Flat;" "Better Safe than Sorry;" "A Good One on the Heir;" "No Interference;" "Hard Combination to Beat;" "A Sound Investment;" "There's Money in Radio;" "One-Dial Control;" "One Man's Set;" "Ohm, Sweet Ohm;" "Not a Portable;" "A Dialogue."

"Safe at Home;" "One Out;" "Capital and Labor;" "The Treasure Chest;" "The Nitrodyne;" "End of a Perfect Day;" "Like Father, Like Son;" "When a Feller Needs a Friend;" "A Lock-Out;" "Dyne Might Wreck It" (ouch!); "Father's Day;" "Checkmate;" "Old Ironsides;" "Ask Dad, He Knows;" "A Scotchman's Set;" "Dyin' to Get In;" "Try and Get It;" "Curing a Ham;" "Time to Retire;" and "Ham and Yegg" are also among the numerous variants.

HONORABLE MENTION

In the following list of replies much ingenuity is expressed; and honorable mention is hereby extended to the contestants who submitted them:

"A Case of Pop Bubbling Over"—H. H. Daniel, St. Louis, Mo.

"A Fixed Resistor for Armstrong Regeneration"—Robert J. Higgins, Philadelphia, Pa.

"A Fresh Cracker Meets a Hard-Boiled Egg"—W. Ivan Mangus, Jamestown, Ind.

"A Tinkerer's Dam"—John Voliva, Indianapolis, Ind.

"A Tough Set to Break In"—Fred A. Thompson, Detroit, Mich.

"An Arrested Case of 'Son' Stroke"—L. C. Harrison, Walhalla, S. C.

"An Output Transformer"—Averill P. Boomer, Las Animas, Colo.

"An Unpickable 'Pick-Up' Device"—Martin M. De Arce, Madrid, Spain.

"Better Safe than Dyne Only"—Anna E. Pinesneault, Red Lake Falls, Minn.

"Bungler Insurance"—E. L. Winston, Brownfield, Texas.

"Closed-Coupled with Reject Heir Stage"—Sylvester Hopkinson, Toronto, Canada.

"Dad Has Stolen His Stuff"—Ashley N. Chandler, Toledo, Ohio.

"Dad Now 'Dynes' in Peace"—W. Curtis Snow, Sioux City, Iowa.

"Dad Thus Bars Son's Altering Bus Bars"—E. C. Dymond, Jackson, Minn.

"Dad's Not Raising His Son to Be a Solder Boy"—Stewart Hopkins, Newark, Delaware.

"Former High-Frequency Experience Eliminates a Troublesome Local Carrier"—W. E. Baker, Belleville, Ont., Canada.

"Guess It's Up to the Ham to Crack the Egg"—Hildegard Wanous, Glencoe, Minn.

"Ham and Yegg, a Touching Combination"—Moses Schleicher, White Plains, N. Y.

"Hard-Boiled Yegg Eliminates Ham's Interference"—Helen Peters, Denver, Col.

"Heir Trouble Is A Parent"—Mrs. Hayne Jones, Walhalla, S. C.

"Hooked Up and Eyed"—L. C. Harrison, Walhalla, S. C.

"In Case of Fire, Tubes are Safe from Burnout"—Walter Kirstuck, Chicago, Ill.

"Loss of Selectivity"—Averill P. Boomer, Las Animas, Colo.

"Needed! One Condenser and Dad's Absence and Experience"—Forrest G. Smith, Washington, D. C.

"No (w)Rest from the Wicked"—Hilary Doerfler, Colledgeville, Minn.

"OM Causes QRM on Ham's Crave-Length"—Cecil A. Haase, Roanoke, Va.

"Playing Safe after Making a Steal"—Frank G. Davis, Springfield, Ohio.

"Pop Prefers a 'Single Circuit'—Jack Bender, Evansville, Ind.

"Program from SAFE Will Be Opened Tonight by 'Soup'—Pierson W. Banning, Los Angeles, Calif.

"Putting 'A' Would-'B' Eliminator at 'C'—W. E. Baker, Belleville, Canada.

"Rather Awkward: Dad's Idea Outwits Needy Experimenter with Screwdriver"—(acrostic)—A. B. Cuthbertson, Langford, B. C., Canada.

(Continued on page 564)

The Reflection and Refraction of Radio Waves

How Electromagnetic Waves Bend Round the Earth

By CLYDE A. RANDON

IN the early days of radio, scientists were astonished that Marconi was able to send radio waves across the Atlantic ocean. They argued that these waves, if they traveled in straight lines, would not be able to reach a distant point because of the curvature of the earth. This is logical; but at that time little was known about the refraction and polarization to which electric waves are subjected. The scientists did not know that the upper regions of the earth's atmosphere could refract radio waves, much as light waves are refracted or bent in passing through substances having different refractive powers.

IONIZATION

Above the earth at a considerable distance, the atmosphere is very rare and thus easily remains in a state of *ionization*, in which the air molecules are broken up into their component parts. Molecules of air collide with one another and the resulting free electrons do not recombine again with the molecules as easily, perhaps, as at the lower levels where the molecules are much closer together and thus reunite much oftener. Electrons shot out from the sun collide with the molecules of air and aid this process of ionization; therefore, it is evident, more ionization exists on that side of the earth which is exposed to the sun. There is much more ionization in the daytime than at night.

Ionized air has the property of bending radio waves, much as light is bent in passing through air of different densities. A star on the horizon always appears to be higher than it actually is; because the light is bent before it reaches the observer. (This is shown in Fig. 1.) The star appears to be in the direction from which light enters the eye, so that it seems higher than it actually is. For the same reason the sun is visible after it is actually below the horizon.

Radio waves undergo bending as they pass into the upper atmosphere, and some of the waves are bent to earth again. At present it is known that, the longer the wavelength, the sooner are the waves bent to earth.

In Fig. 2 are shown a transmitting and a receiving station, at a considerable distance apart on the earth's surface. If radio waves were not bent, a tremendously high transmitting tower would be necessary to cover long distances. The maximum distance at which a transmitter could be heard in this case would be limited by the height of the receiving and transmitting antennas, and a ray *tangent* to the earth would determine the range of the transmitter (see Fig. 2). Note that the waves traveling into the atmosphere are bent back to earth and that some of them (those traveling beyond a certain *critical angle*) travel out into space, never to return to earth.

SKIP DISTANCES

The waves, especially the longest, are refracted to earth again, but some are bent so that there is a space between the transmitter and receiver, when they are separated a certain distance, into which no waves reach. The distance skipped by the waves before reappearing at a distance is known as the "skip distance" and this is greater as the wavelength is shorter. It is interesting to note that, although a station may not be heard at a certain distance, an observer at a much greater distance might obtain good reception.

Since the ionized condition of the atmosphere causes the refraction, and ionization is greater in the sunlight, as has been explained,

the waves will return to earth much sooner in daylight than at night. In the daytime the "depth of ionization" is much greater, the waves are bent much more rapidly, and they thus return to earth sooner; at night the sunlight is not present, there is comparatively little ionization, and the waves travel high into the atmosphere before they are

comparatively short distances and DX work is not good.

Another explanation of the return of radio waves to earth is furnished by supposing a "Heaviside layer" above the earth. This layer is assumed to act much as a mirror does, to ordinary light waves, and thus reflect the radio waves back to earth again. The refraction theory is the more reasonable, although the Heaviside layer also accounts for the same phenomena. At night the layer is much higher than in the daytime, and waves travel to greater heights at night before becoming reflected; this accounts also for the greater distances over which radio waves are heard. A combination of reflection and refraction may also account for the behavior of the waves.

FADING

A transmitter sends out both a "sky-wave" and a "ground-wave"; the former traveling into the atmosphere and the latter remaining in contact with the ground. The ground-wave is rapidly absorbed and does not reach great distances. It is possible to have a receiver so located that both the ground and sky waves reach it. In a case like this, there is very likely to be "fading," since any passing clouds or electrical disturbances may diminish the intensity of the received signal from either of the components reaching the receiver. For example, if both are of the usual intensity, and one is suddenly diminished in intensity, the received signal will suddenly "fade"; and when the disturbance is removed (when a cloud has passed, for example) the original intensity will be restored. Fading might also be produced if only one of the components were reaching the transmitter and the sun set suddenly, changing the condition of the ionization in the atmosphere. Reception, for this reason, is usually not very consistent at sunrise or at sunset.

Storms between the transmitter and receiver have often peculiar effects on radio waves. Observers have studied the direction from which the waves appear to come,

(Continued on page 554)

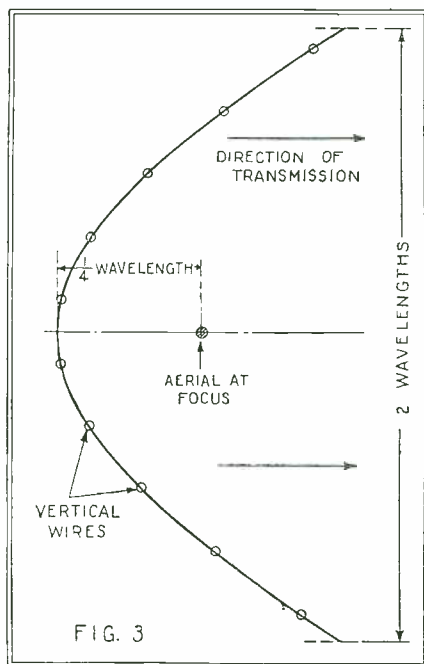

If a transmitting antenna is located at the focus of a suitably-proportioned parabolic reflector, the radio waves will be sent out in a beam, instead of radially, or in all directions.

refracted sufficiently to return to earth. This accounts for the better distance work at night, when the waves travel longer distances before they return to earth. In the daytime, the waves reach the earth again at

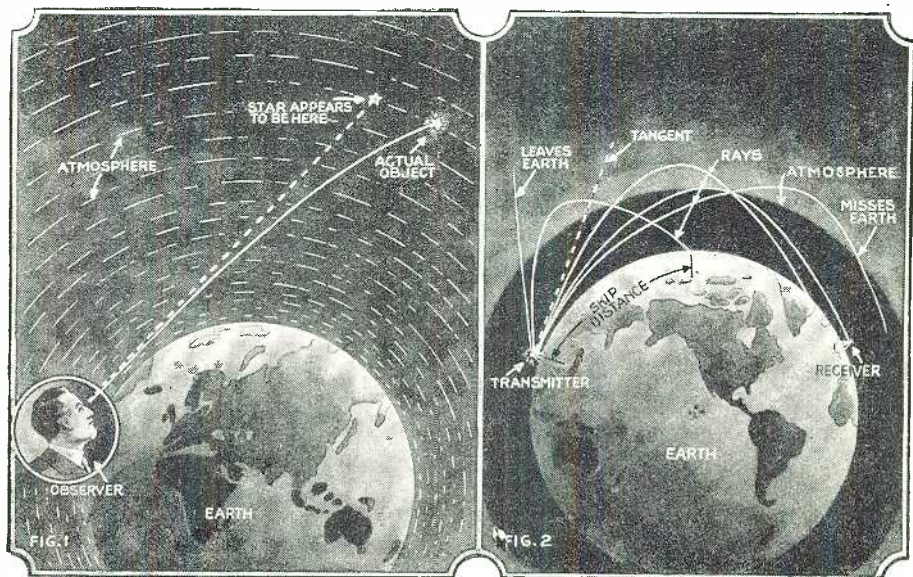

In Fig. 1 is illustrated the manner in which light waves are bent in the earth's atmosphere, causing an object to be visible, even when it is below the true horizon. Fig. 2 shows how radio waves behave when they come in contact with the upper atmosphere and Heaviside Layer, and why there are zones of silence.

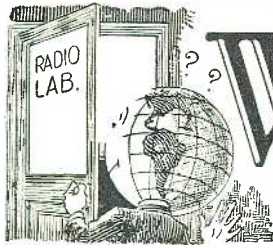

What's New in Radio



STRONG CONSTRUCTION MARKS NEW SIX-TUBE RECEIVER

A NEW six-tube single-control receiver has recently been placed on the market. It is pleasingly housed in a metal cabinet, finished in a brown crystalline enamel, and because of its ease of operation should be particularly popular with radio fans this winter. The metal cabinet is 17 inches long, 5½ inches high and 8 inches deep.

The antenna circuit of the receiver is aperiodic, with a fixed coil between aerial and ground and across the grid circuit of the first tube. The tuning is accomplished by three variable condensers coupled together by a band arrangement to the single tuning dial. On the front panel are the tuning dial, volume control, filament switch and the tuning compensators. The tuning dial is illuminated and is of the vernier type.

set is not affected by the varying antenna conditions to which the instrument is likely to be submitted, as the entire antenna circuit (including the grid circuit of the first R.F. tube) is of the untuned or semi-aperiodic type. A tapped, fixed inductor, functioning as an autotransformer, transfers the signals picked up by the aerial to the first tube; and, since it is not adjusted to any particular frequency in the broadcast band any slight increase or decrease in its period of response will be of no consequence.

This feature enables the manufacturers of the set to match the three tuned circuits in the rest of the R.F. amplifier with a high degree of accuracy, and to couple the variable condensers together under the control of one knob.

The battery terminals are brought out in a seven-wire cable; binding posts are provided

consisting of a metal sub-base and a metal control panel. The various parts of the receiver are mounted on this chassis and insulation is used where necessary to prevent short circuits. The set is wired with flexible insulated wire under the sub-base. The battery terminals are brought to a connecting strip to which in turn is fastened the battery cable. The band control for the three variable condensers will be seen in the illustrations on this page; these show also the underside of the sub-base and the control panel.

The receiver is very strong mechanically because of the all-metal construction. The small front panel, with its tuning and volume controls, serves merely as a decorative front for the working instruments, which are supported by the rigid metal chassis. The brown crystal finished cabinet is made in three sections: the sides and front, which serve to shield the set as well as to afford protection for the instruments; the top, which can be removed to allow access to the tubes; and the base, which is screwed into place and protects the delicate wiring and the instruments.

To install the set, the battery cable should be connected to the various specified batteries or socket-power units, the tubes inserted in the sockets, the aerial and ground connected and the loud speaker terminals connected to the binding posts provided for them. The filament switch should then be turned on and the volume control adjusted to a position about halfway across the scale. The tuning dial should then be turned until a station is heard, and the compensators on the left and right then be adjusted until the signal is loudest. The volume control is next adjusted until the required volume is obtained. To tune in other stations, it is necessary only to adjust the tuning dial. For distant reception, it may be necessary to vary the compensators slightly, to obtain maximum results.

The receiver is designed for use with an outside aerial, which may consist of a single wire from 50 to 150 feet in length, with the lead-in connected to either one end or to the middle. To the "ground" post should be connected a wire running to a water or steam pipe, or (in country districts) to a metal plate buried in one or two feet of soil.

The remarkable compactness and simplicity of tuning obtained in this six-tube set should make it very popular with radio fans, especially those who want an efficient receiver that can be installed in a small space, can be operated easily and does not mar the appearance of the room.

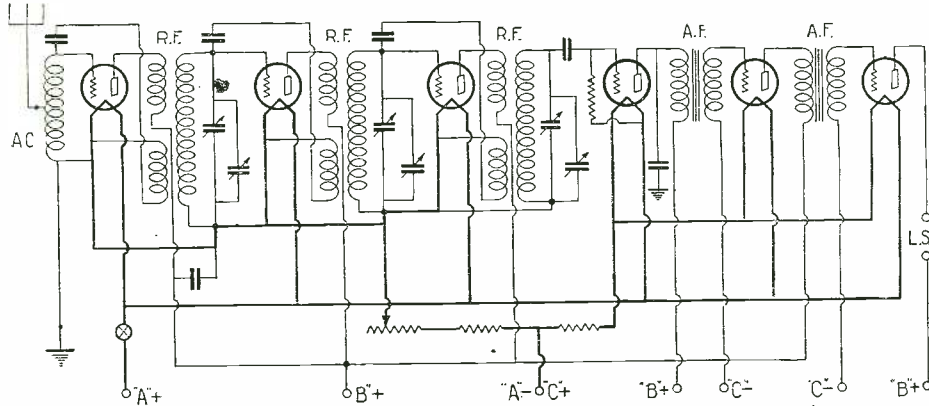

Complete schematic hook-up of the six-tube receiver. The R.F. amplifier is of the neutrodyne type, comprising two tuned and one untuned stages; while the A.F. portion uses regular transformers. AC, antenna coil; R.F., radio-frequency transformers; A.F., audio transformers; L.S., loud-speaker posts.

The circuit used in this receiver is of the neutrodyne type. The neutralization is accomplished by means of small condensers and coils coupled to the radio-frequency transformers. The set uses three stages of radio-frequency amplification, (one untuned, two tuned) and two stages of transformer-coupled audio-frequency amplification, with a power tube in the last. The various parts of the receiver are completely shielded, the condensers occupying one shield and the radio-frequency transformers separate shields. The shielding of the tubes is accomplished by the grounded metal case.

The operation of this receiver as a one-dial

for the aerial, ground and loud speaker. Five 201A-type tubes are used in the radio-frequency, detector and first audio-frequency stages, while a 171 tube is used in the last stage. A "B" battery voltage of 180 and a "C" bias of 40 volts are required for the power tube. The radio-frequency and first audio-frequency stages use 90 volts of "B" current and 4½ volts "C" bias.

The filament-current control for the radio-frequency section of the receiver is obtained by a rheostat; the detector and audio-frequency sections are controlled by a fixed resistor.

The receiver is built on a metal chassis

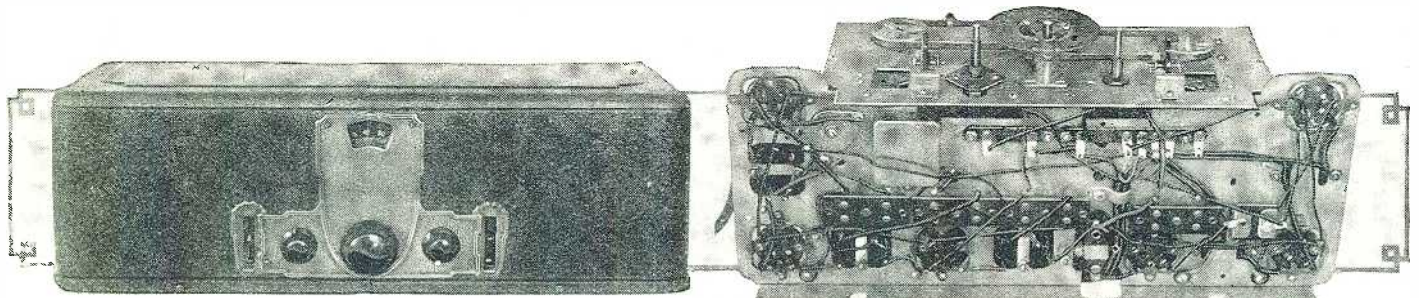

Left: The receiver as it appears in its metal cabinet. The main tuning knob may be seen in the lower center of the panel plate, being flanked by the auxiliary compensating controls and the battery switch.

Right: View of the under and front sides of the receiver unit proper, with the cabinet, panel-plate and control knobs removed. The framework is made entirely of metal.

Illustrations courtesy Crosley Radio Corporation.

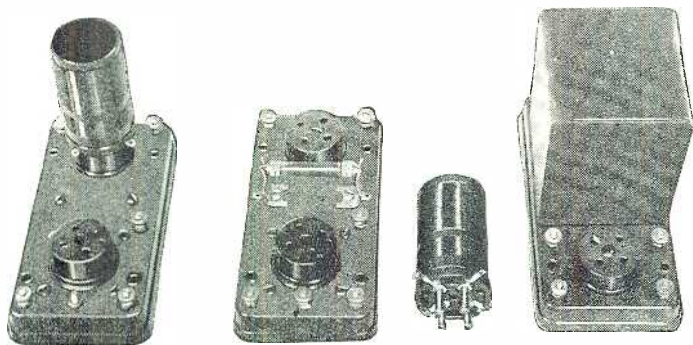

Left: R.F. unit, showing coil in place; center, detector unit, with coil alongside; right, A.F. unit. Each, with the addition of a tube, is a completely self-contained stage of a receiver. Illustrations courtesy Pilot Mfg. Co.

NEW DIALS AND SET UNITS FOR THE EXPERIMENTER

A WELL-KNOWN Brooklyn manufacturer has brought out a new line of radio parts which will appeal to all constructors. One of these instruments is a new drum-control unit made in the single- and double-dial types. The single-dial unit has a 4 3/4-inch drum and the front plate measures 3 3/4 x 4 3/4 inches. To accommodate this dial a piece measuring 1 3/4 inches wide and 2 3/4 inches high will have to be cut out of the panel. Two controls are provided; one gives a direct drive on the condenser and the other, seen at the side, gives a three-to-one "vernier" reduction. The picture shows one of the double-dial units. The metal front plate is attractively finished in an ornamental design and will enhance the appearance of any radio set.

In the double dial the metal front plate measures 4 1/2 inches square. To accommodate this dial on the front panel, a hole 3 3/4 inches long and 2 3/4 inches high will have to be cut. The double-dial unit is fitted with

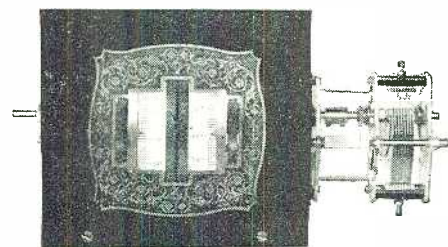

A double-drum dial mounted on a section of a panel, to show its general appearance.

two vernier controls. The front plates of both of these dials are held to the panel by four small bolts. These drum dials give an efficient and accurate control which can be smoothly regulated at all times.

The three oblong units shown herewith are made by the same manufacturer. They are available in three types; radio-frequency, detector and audio-frequency. The radio-frequency unit is 5 inches long, 2 1/2 inches wide and 1 1/2 inches high. It is completely wired, has a tube socket and a coil mounting, and needs only a .00035-mf. variable condenser to make a complete tuned-radio-frequency stage. The radio-frequency coil is equipped with a standard UX base so that it may be plugged into a standard tube socket. The coil itself is 2 1/2 inches high and 1 1/4 inches in diameter, making the unit four inches high when complete. The radio-frequency unit may be seen in the illustration at the extreme left.

The detector unit, which is shown next to the radio-frequency one, is of exactly the same size, but contains a grid leak and condenser. The radio-frequency coil, which is wound with enameled wire upon a bakelite tube, may be seen beside the detector unit.

The audio-frequency unit, shown at the extreme right in the photograph, is 5 inches long, 2 1/2 inches wide and 4 1/4 inches high. This unit includes a transformer and a tube socket and is completely wired, ready for use.

The audio-frequency transformer is completely encased in a black metal shield.

With the advent of these units, the experimenter and amateur constructor will find the assembling of sets an easy job, inasmuch as the instruments are completely wired and ready for use; it is necessary only to attach a few wires to the binding post and the set is practically finished. All of the units are made of black bakelite and the coils are wound upon a bakelite form, thus bringing electrical losses through poor insulation to a minimum and, at the same time, adding greatly to the appearance of the unit and consequently to that of the completed radio set.

NEW COILS FOR TUNED-RADIO FREQUENCY SETS

A MATEUR constructors who desire to experiment with tuned radio-frequency circuits, without resorting to the labor of constructing the coils, will find the inductors illustrated here of great convenience. These units are solenoid-wound inductances, supported by bakelite strips. They are made in two types; one, for use in the antenna circuit of a tuned-radio-frequency set, is equipped with an adjustable primary so that the selectivity of the set can be controlled. This adjustable primary coil also serves to compensate for the differences in antennas, permitting the use of gang-condenser control. The secondary coil is 2 1/2 inches in diameter and 3 5/8 inches high. This coil is designed to be tuned with a .0005-mf. variable condenser. The primary coil is one inch in diameter and mounted on a hinge so that it may be pushed into or swung out of the secondary coil. It is equipped with two flexible wires for connection to the rest of the circuit. The complete coil is 5 1/2 inches high, when the primary coil is all the way out, and 3 7/8 inches when this is entirely within the secondary coil.

The other type of coil is very similar to the antenna coupler, with the exception that the primary coil is at the bottom of the secondary coil and is not adjustable. This primary coil is wound on a slotted bakelite tube which just fits inside the secondary coil. The terminals from this coil are brought out to the bakelite base. These coils are also bakelite supported, like the antenna coupler, and are designed to be tuned by a .0005-mf. condenser. The insulation on the wire of these coils is green cotton, and no adhesive is used to bind the coils together. They are supplied in kits of four and are adaptable to



A set of four of the new upright R.F. transformers. The second from the left is fitted with a variable primary coil. These are self-supporting, low-loss coils of high efficiency, and facilitate set construction. A high degree of uniformity is obtained in their manufacture. Illustration courtesy Aero Products, Inc.

the usual forms of radio frequency amplifier circuits, as well as to special arrangements of the experimenter's own design. In the illustration, the antenna coupler is second from the left; it will be seen that the primary is entirely disengaged from the secondary.

NEW CONE SPEAKER IS WATERPROOF

THIS new cone speaker is so arranged that it will fit into a cabinet 15 inches in diameter and seven inches deep. It is especially arranged with two tone chambers; one is designed to reproduce the high alto and soprano notes, while the other takes care of the low notes of the tuba and bass viol. One of the features of the speaker is its resistance to dampness. This is known to be an important factor in the operation of loud speakers using paper cones. Because of the special preparation of this speaker, it can be completely submerged in water, yet its operation will be unaffected in any way afterward.

While most cone speakers are able to reproduce the low notes well, many are unable to reach the higher tones. The special arrangement of the cones used in this speaker permits it to cover both the highest and the lowest tones used in radio broadcasting.

The cabinet is strikingly finished in Chinese lacquer of black and gold and is decorated with raised Chinese figures. It is mounted on two uprights and so arranged that it may be swung to adjust its acoustical properties to that of the room. This speaker is available both in completely assembled

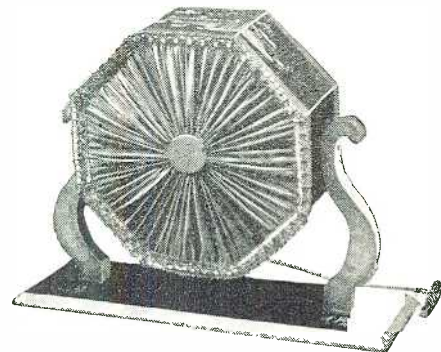

The cone speaker as it appears in finished form. Illustration courtesy Miniature Ship Models, Inc.

form and in knockdown kits for those who wish to construct their radio reproducers. The kit may be assembled in a few hours without much difficulty.

The loud-speaker driving unit used is powerful enough to operate a 72-inch cone. This assures long service, plenty of volume and a minimum of distortion.

The front and back of the cabinet have silk covers mounted on wire frames to permit easy removal. This enhances the appearance without affecting the operation. Because of the large unit used in this speaker, it is particularly well adapted for use with receivers having power tubes and using high "B" battery voltages. This speaker should be attractive especially to those experimenters who wish to construct their own and still obtain the results achieved with factory-made appliances.

TWO AMPLIFIER COMBINATIONS IN TEN-TUBE SET

THE radio set illustrated on this page is an efficient instrument employing ten tubes with a minimum number of controls. It employs in its design numerous electrical and mechanical refinements representing the great advances made in broadcast receiver construction during the past few years. It comprises a two-stage radio-frequency amplifier, a three-stage infradyne amplifier, and two stages of transformer-coupled audio-frequency amplification with a power tube in the last. The arrangement of the components has been carefully balanced, and the resulting receiver is one of pleasing appearance, as well as efficient operation.

The various details of the set are shown in the illustrations and wiring diagram on this page. It is built upon a pressed-iron chassis, which is supplied completely drilled for the convenience of the home constructor. The totally-shielded single-dial, tuned-radio-frequency amplifier and detector (R.F.) can be seen on the left. This unit is supplied completely assembled by the manufacturer and is a one-dial radio set complete in itself. By means of a switch on the control panel, the infradyne amplifier and oscillator can be switched out of the circuit and the amplifier and radio-frequency unit used as a complete one-dial, five-tube radio set. The switch controlling this change-over feature is marked

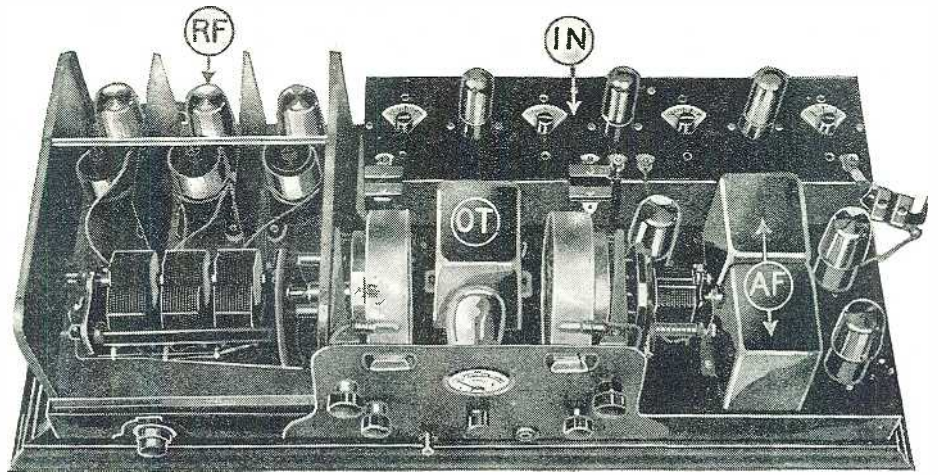

General view of the receiver, with the cabinet removed. R.F., two-stage tuned R.F. amplifier unit, with top shield removed; IN, Infradyne amplifier unit; A.F., audio transformers; O.T., output transformer. The variable condensers are controlled by illuminated dials of the edgewise-drum type.

variometer and a switching arrangement.

The set is supplied in kit form, the kit containing the tuned-radio-frequency amplifier, the infradyne amplifier, and the various parts for the rest of the receiver. The small parts are enclosed in envelopes numbered and labeled, so that it is necessary only to follow in order the construction details given

tion, as the rest of the amplifier is carefully balanced at the factory before shipment. A cam arrangement is used to keep the primary coupling constant on all wavelengths. Four switches are also enclosed in the amplifier, so that resistors may be placed in the grid circuits of the tubes, if the tuning is found to be too sharp. By carefully balancing these resistance combinations, an arrangement will be found which will give good volume, selectivity, and ease of control.

When the five-tube receiver is working satisfactorily, the control switch should be turned to distance and the infradyne amplifier should then be balanced. This is accomplished by tuning in a fairly-distant station and carefully adjusting the compensators until the best results are obtained. The oscillator condenser is equipped with a shunt semi-variable condenser, so that the tuning of the two selector dials may be balanced. This is done so that stations at the point of about 100 on the left dial come in also at about 100 on the right-hand dial. When this is done, the two dials will be matched within ten degrees on all wavelengths.

The complete metal sub-base and control-panel assembly is mounted on an ornamental wooden base, and entirely enclosed in a brown crystalline-finished metal cabinet, 26 3/4 inches long, 12 inches deep, and 8 inches high. The cabinet is cut out to fit around the control panel, antenna compensator, and the battery terminal strip in the back. With the cabinet in place, the receiver presents a very neat appearance. In the back, on the left-hand side, will be found the binding-post panel. This contains aerial and ground binding posts, a jack for the loud speaker and the battery cable. A jack on the control panel, in the front, permits the operator to plug a headset into the first audio-frequency amplifier stage, so that distant reception can be more easily accomplished.

A carefully-designed plan of construction has been worked out by the manufacturer, so that almost anyone can assemble this receiver. First, the tube sockets are mounted on the metal sub-base with screws taken from envelope No. 1. Next, in rotation, the various fixed condensers, choke coils, amplifying transformers, rheostats, etc., are taken from their respective envelopes and mounted according to the simple instructions. The next procedure in building the receiver is the construction of the wiring cable. A carefully designed template is provided for this purpose. It is placed on a board and brads are driven into the specified points on the template. Next, the varied colored wires provided by the manufacturer are fastened around the nails in the template (according to the instructions. After all the wires are in place, the cable is fastened with string. It is then removed from the template and put into position on the underside of the metal sub-base. The wires are pushed through

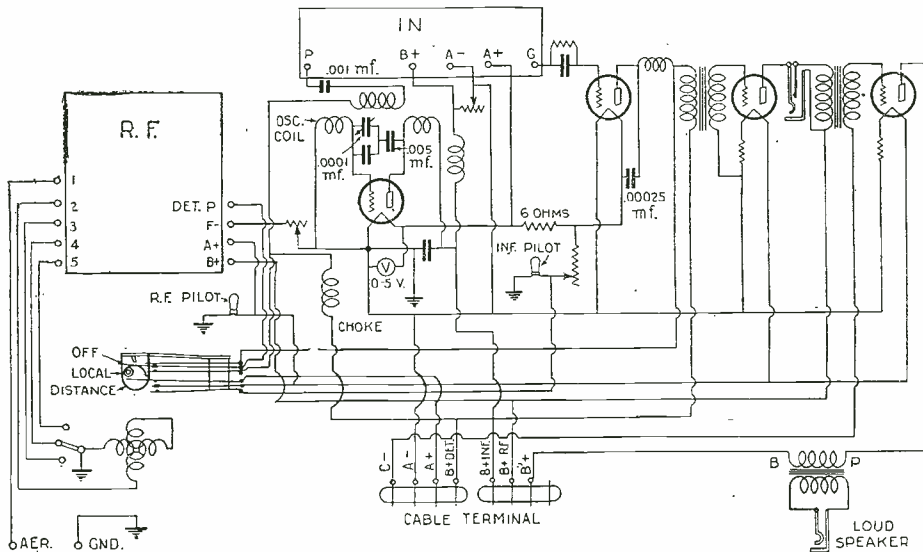

Schematic layout of the ten-tube receiver. When the switch at the left is in the "local" position, the R.F. amplifier (R.F.) alone feeds into the A.F. amplifier; in the "distance" position, the Infradyne unit (IN) is thrown into action, and all ten tubes are used.

"local" for the five-tube set, and "distance" for the ten-tube combination. At the rear can be seen the infradyne amplifier (IN) mounted on the iron base, and connected to the various other components of the set under the base. In the front, on the right-hand side, can be seen the audio-frequency amplifier A.F., with its transformers and tubes, while in the center front will be found the oscillator tube, the controlling condenser and the output transformer of the set. On the control panel are placed the two tuning dials, a volume control, a sensitivity control, the change-over switch, a voltage regulator for the 199-type tubes and a voltmeter. On the left of the control panel can be seen the antenna compensator, which consists of a small

in the book accompanying the kit to assemble the receiver. All of the wiring is arranged in cable fashion, making even the underside of the set remarkably neat. Illuminated drum dials are used in this receiver and are equipped so that they may be calibrated either directly in meters or according to station call letters. When the switch is turned to the "local" position, the right (oscillator) dial light is automatically extinguished and the only controls used are the left-hand selector and volume control.

When the set is first completed, the switch should be turned to the "local" position and the five-tube receiver should be balanced. To do this, it is necessary only to adjust the antenna balancing condenser for the best posi-

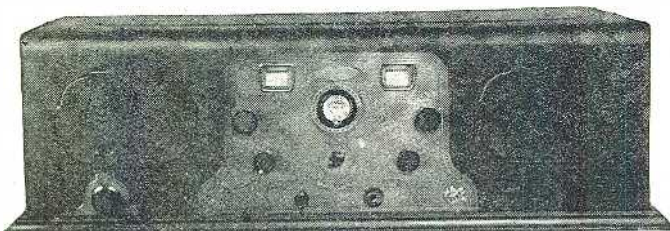

Panel view of the completed set. The cabinet is of copper, attractively finished with a crystalline effect.

Illustration courtesy Gray & Danielson Mfg. Co. (Remler Division)

the holes provided for them, or are soldered to specified pieces of apparatus on the sub-base. The infradyne amplifier is next fastened on the upper side of the sub-base, and the various wires protruding from the sub-base are fastened to the terminals on the amplifier. The radio-frequency amplifier, the inner section of the control panel, drum dials, oscillator condenser, driving arms for rheostats, phone-jack and change-over switch are next mounted and wired into place. Finally, the antenna compensator is mounted and the outer control panel placed in position.

NEW "B" POWER UNIT

THIS plate-supply unit has been placed on the market after an extensive survey of the needs, both engineering and merchandising, in the plate-supply line. The results of this survey were carefully compiled, after which a unit was designed to meet the conditions. Fixed controls are used, with separate voltage taps, giving ample range as well as enabling the user to know definitely the voltage he is getting. The rectifier is a full-wave system and will supply enough current to operate a ten-tube set. It obtains the necessary current from a 110-to-120-volt, 60-cycle A.C. line and is designed to use the 213- or 313-type of rectifier tube. The manufacturer has found that, by producing every part in quantity, he was able to supply an efficient power unit at a low price.

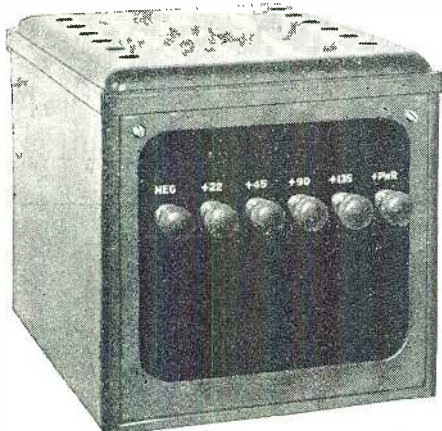

The simplicity of the "B"-power unit is evident from this illustration. There are no variable controls on the panel.
Illustration courtesy Leslie F. Muter Co.

Special high-voltage test condensers are used to insure constant service without a chance of breakdown. The unit will supply 40 milliamperes of current at 150 volts and is equipped with a 180-volt tap for the 171-type power tubes. The other taps supply 135, 90, and 45 volts for the remainder of the set. The unit supplies also 22½ volts for operating a detector tube. The device is entirely enclosed in a metal case, 6½ inches wide, 7 inches high, and 8½ inches long. The case is highly finished with brown enamel, and has a bakelite front panel to hold the binding posts. The unit weighs approximately fifteen pounds.

ACCESSORIES SIMPLIFY A.C. TUBE OPERATION

REALIZING the necessity for special transformers, tube sockets and resistors for use with the new A.C. tubes, a Massachusetts radio manufacturer has recently developed some apparatus to cover this need. For several years the trend of commercial and amateur experimenters has been toward the complete elimination of batteries. Many satisfactory plate-supply units, operating from alternating current, have been developed; but filament operation from an A.C. source has presented more of a problem, because of the larger currents required, and increased expense in the filter and rectifier

A group of accessories designed for the new A.C. tubes. Left, heavy-duty rheostat, wound with brass wire. Center, filament-lighting transformer. Right, five-prong socket for the heated-cathode type of tube. Foreground, tapped resistor.

Illustrations courtesy General Radio Co.

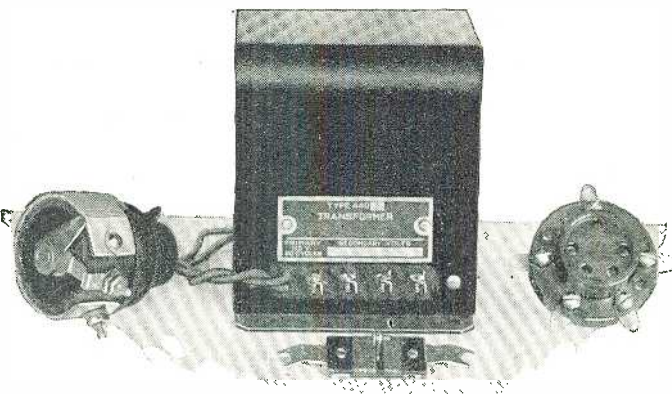

units. The newly-announced A.C. tubes offer an excellent solution of this problem.

These alternating-current tubes require a source of low voltage capable of delivering high current. The various types of tubes, also, require several different voltages. The transformer illustrated herewith supplies voltages for all the popular tubes and sufficient current for ordinary receiver requirements. It is housed in a black enameled iron case, 3½ inches long, 3 inches wide, and 4 inches high. Filament supply is provided for A.C.-filament, separate heater, power-amplifier and rectifier tubes.

The following voltages and current are available: the primary is designed to operate from 105-125 volts at 60 cycles.

Secondary: 2 volts, 10 amperes; 3.5 volts, 5 amperes; 5 volts, 2.5 amperes; 7.5 volts, 2 amperes.

All the new A.C. tubes, with the exception of the 227- or 327-type detector tubes, have a standard UX four-prong base. The 227-type detector tube, however, has a separate heating element and, consequently, a five-prong base which requires a socket especially designed with five-prong contacts. One of these sockets is shown in the illustration on this page.

To control the new A.C. tubes correctly, a low-resistance rheostat capable of carrying appreciably more current than those designed for D.C. tubes is required. The rheostat shown here is wound with brass wire, tightly wrapped on a special fiber strip, and mounted on a bakelite form. By constructing the rheostat in this manner, it will stand considerable heating without damage. These rheostats, designed for the new A.C. tubes, are supplied in two resistance values. The first has a resistance of 0.5 ohms and will carry 3.5 amperes of current. The other one is rated at 1.5 ohms and will handle two amperes of current.

The new tubes for alternating-current operation require a resistor with a center tap across the filament or heater. In the A.C. filament type of tube, the center tap provides a point of connection for the positive grid and negative plate potential source. The special resistor shown here is designed to mount directly on the prongs of the tube socket, thus saving space and facilitating the wiring.

Because of the heavy currents drawn by the filaments of the new alternating-current tubes, the filament circuits should be wired with a size considerably heavier than that used for the ¼-ampere tubes. Before installing the A.C. tubes in an existing set or in a new one, the constructor should consult a wire table and, with its aid, select a gauge of wire that will carry the current safely.

OPERATION OF "A" CHARGER IS AUTOMATIC

AN automatic "A"-battery charger employing a rectifier of the new "dry" type is the latest product of a prominent New England manufacturer. It is entirely enclosed in a steel case, 9 inches long, 3

inches wide, and 5½ inches high. The metal case is coated with a pleasing, brown crystalline finish. The unit is of the trickle-charger type, designed to charge the battery at 0.75 amperes; and is equipped with a series relay, so that it starts charging automatically when the set is turned off. When the set is switched on, the charger is automatically disconnected and the "B" power unit commences operation. Once the set is switched off again, the charger comes into action at a rate sufficient to keep the battery always at maximum efficiency. These advantages makes it a real trouble-saver. In addition to its automatic switching, it is absolutely noiseless in operation and, once installed, keeps the "A" battery in good condition.

The manufacturer attributes a large part of the credit for this development to the extensive and fruitful research of one of the most celebrated American electrical laboratories. The principle of rectification employed represents one of the most advanced

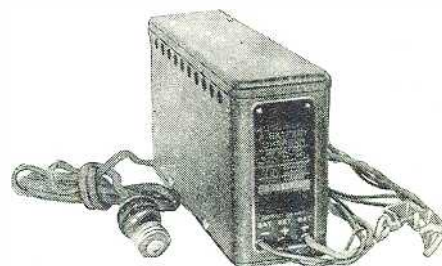

The complete charger as it appears ready for service.
Illustrations courtesy Apco Mfg. Co.

scientific principles evolved. The efficiency is very close to the ultimate in A.C.-to-D.C. rectification standards, and long life of the unit is guaranteed.

There are three wires coming from the unit. Two of these are equipped with battery clips and are fastened to the "A" battery terminals, while the third is connected to the "A+" battery terminal on the receiver.

The advantages of this charger will appeal to the radio fan who has experienced the annoyance that comes from forgetting to switch his charger on or off, not to speak of the irksome necessity of fussing with switching-attachment plugs and improvised light-socket arrangements.

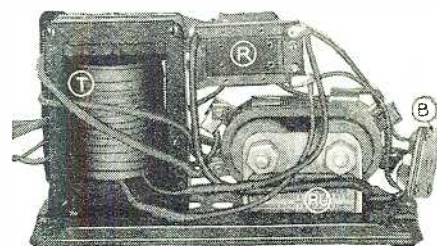

The insides of the charger. T, step-down transformer; R, switching relay; RU, rectifier unit; B, receptacle for "B" supply unit.

Burnt-Out Vacuum-Tube Contest Results

Many Interesting Uses for Discarded Tubes Entered in Contest

ALMOST every need of the constructor, so far as parts are concerned, may be supplied out of the box of old tubes, by the exercise of some deftness and ingenuity; as may be seen by the ingenious wrinkles produced by competitors in this RADIO NEWS prize contest. While the competition was not limited to radio parts, most of the successful entrants availed themselves of the mechanical convenience of base-and-socket connections. The ideas here presented will be valuable, not only in their illustrated forms, but in the practical suggestions they should offer to the set builder.—EDITOR.

as the most useful suggestions, submitted. It was unnecessary for contestants to use the burnt-out tubes for radio purposes; these might be adapted to anything which the resourceful fan desired. And to put the matter shortly, they were.

SOME STRANGE STUNTS

For example, one lady suggested that doll faces be painted on old tubes, hair placed on their tops, and that they be mounted as ornaments in a boudoir lamp. Someone else made a suggestion which greatly appealed to our Military Editor; it was to use old

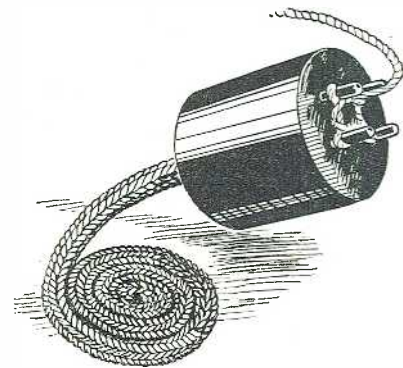

Miss Bernice Vanderburg was awarded fifth prize for her knitter, made from a tube base, as illustrated.

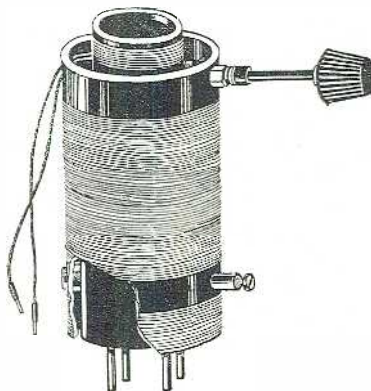

Third prize was given to the designer of this efficient three-circuit tuner, which can be plugged into a vacuum-tube socket.

vacuum tubes that had outlived their usefulness in the realm of radio instead of clay pigeons in trap-shooting. Another "gun crank" presented a sketch of a revolving target in which tubes were placed and, after they had been hit, could be replaced by pulling a lever. Another inventive enthusiast proposed that a musical instrument be made by drilling holes in the bases of tubes and

A dial light, for mounting on the front panel, was ingeniously constructed from a tube base, a piece of bus bar and a miniature electric lamp. The bus bar is coiled to form the lamp socket. A sectional view is given here of this device, for which fourth prize was awarded.

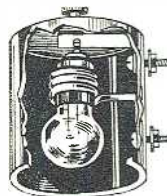

filling them partly with water. A number of these could be thus prepared and tuned, by varying the amount of water in them, so that melodies could be played when they were struck with a felt-covered mallet. Another fan turned radio back in its flight and converted a tube grid into two multi-contact "cat whiskers."

Few entries of these types were received, however, the majority being generally up-to-date and practical. Those to which were awarded the prizes were judged the best of their respective types; but the contestants who submitted somewhat similar ideas will perhaps feel less disappointed when it is explained that it was indeed a difficult task for the judges to decide upon the prize-winning entries.

WALL OUTLET FOR "A" AND "B" BATTERIES

The first prize of \$25.00 was awarded to George Harvey of Lebanon, Ind., for a wall outlet for batteries. Mr. Harvey's description is as follows:

"An inexpensive outlet for 'A' and 'B' bat-

teries can be made from an old UX-tube base, a UX-tube socket, a toggle-switch plate, and a block of wood.

"First take a round file and enlarge the hole in the plate, so that the raised part of the socket will fit in it closely.

"Then reverse the binding posts so that the nuts are on the bottom side of the socket. Drill two holes in the plate so that the socket may be fastened to the plate. Extra taps may be placed between the plate and the socket, so that the screw-heads of the binding posts will not touch the plate.

Sixth prize was awarded to the designer of this unique ashtray, which was constructed from a UV-type tube base. The bottom is weighted with lead, so that the tray will not tip over easily.

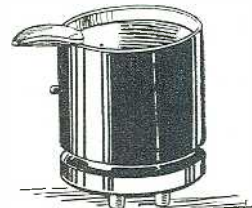

"A wooden plug may then be cut from an old curtain pole or something of the sort and the end rounded off; a hole is bored in the center and it is fitted into the tube base.

"The 'A+' and 'B-' are attached to the same prong."

RADIO-FREQUENCY TRANSFORMER FOR LOW WAVES

The winner of the second prize of \$15.00 was J. G. Vickery of Pensacola, Fla., who describes the construction of his plug-in coil as follows:

"Prepare tube base for its new use by removing solder and tube connections. Using a hacksaw, make two cuts parallel with prongs, downward from top to within 1/4 inch from bottom. Place in vise with bottom of cuts slightly below vise jaws and break



Two vacuum-tube bases provided the prongs used in this cable connector, which won seventh prize.

out material between cuts. Smooth with file to fit curve of coil.

"Cut slot 2 inches long by 1/4-inch wide, in one end of 3-inch tubing. Cover tubing with heavy paper to facilitate removal of finished coil. Use heavy D.C.C. wire, wind one turn

MANY people suppose that, when the filament of a vacuum tube has been burned out, no further use can be made of the tube. As may be seen from the illustrations and descriptions in this article, this pessimism is far from being justified. This contest was devised mainly to test the ingenuity of radio fans

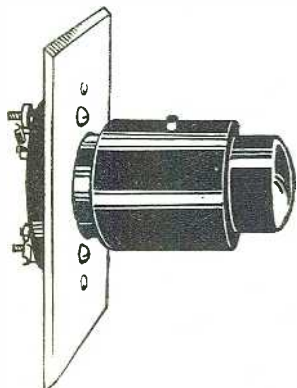

The wall outlet for batteries, which won first prize for George Harvey.

and, from the large number of entries submitted, it is certain that its purpose has been fulfilled.

In the rules of the contest, which was announced in the July, 1927 issue of RADIO NEWS, it was stipulated that the prizes would be awarded for the cleverest, as well



This self-supporting, interchangeable inductance, mounted in a tube base, was awarded second prize.

more than necessary for primary and secondary over slot and wrap that portion with silk thread and treat with collodion. The coil may also be treated to make more rigid. Remove coil from tubing, cut the extra turn between primary and secondary on side opposite from silk wrapping, and bend the four ends close to wrapping. Insert ends through hollow prongs, pull tight and solder.

"Although this is described as a radio-frequency transformer, it is used by the writer as the secondary and tickler in a short-wave receiver."

AN EXCELLENT TUNER

Charles Kelly was awarded the third prize of \$10.00 for his plug-in three-circuit tuner. A vacuum-tube base was emptied of its compound and all connections were removed. A piece of bakelite tubing, 1 3/4 inches in diameter, was mounted on the base by means of two machine screws, as shown in the accompanying illustration. A primary and a secondary, of 18 and 76 turns of No. 26 D.S.C. wire, respectively, were wound on the tube.

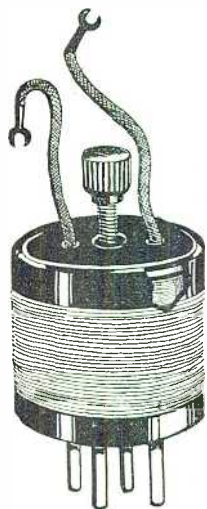

The ends of these coils are brought down to the four prongs of the tube base and soldered at the tips. The tickler coil, of 24 turns of the same wire, is wound on a 1-inch tube through which have been drilled two 1/8-inch holes to take the shaft and the leads from this coil. The shaft of 1/8-inch brass rod is fastened to the rotor by means of two collars, held in po-

Eighth prize was awarded to T. Shimizu for his plug-in flexo-coupler.

sition by means of set-screws. This rod is fastened to the outside tubing by means of two nuts and is held from slipping by means of a spring and collar.

HANDY PANEL ATTACHMENT

A radio panel dial light was submitted by Robert J. Williams, who was awarded the fourth prize of \$5.00. This ingenious little accessory is made by first removing the prongs from an emptied vacuum-tube base. A strip of 1/8-inch brass is bent in an L-shape, long enough to reach from the side of the base to just a little past the center of the end, and fastened to the side of the base by a nut and bolt. In the middle of the end a hole is drilled through the base and brass strip, and threaded to take a small machine screw, which acts as a switch for turning on and off the light. The socket of the miniature lamp is made by coiling a piece of No. 18 or 20 bare wire and bending it so that it will be directly in the center of the base. This is held in position by means of a bolt and nut, such as holds the brass strip. These bolts are left sufficiently long, so that they may be brought through the panel and the light fastened above the dial which is to be illuminated.

ODD, BUT SERVICEABLE

Bernice Vanderburg, 13 years old, of Kalamazoo, Mich., received fifth prize of \$5.00

Awards of the \$100 Burnt-Out-Tube Contest

- First Prize, \$25.00—WALL OUTLET FOR BATTERIES. GEORGE HARVEY, Cason-Neal Bldg., Lebanon, Indiana.
- Second Prize, \$15.00—PLUG-IN INDUCTANCES. J. G. VICKERY, Naval Radio Station, Pensacola, Fla.
- Third Prize, \$10.00—THREE-CIRCUIT TUNER. CHARLES KELLY, 382 First Avenue, New York City.
- Fourth Prize, \$5.00—DIAL LIGHT. ROBERT J. WILLIAMS, 1118 Wolfram St., Chicago, Ill.
- Fifth Prize, \$5.00—SPOOL KNITTER. BERNICE VANDERBURG, 1415 Bank St., Kalamazoo, Mich.
- Sixth Prize, \$5.00—ASH TRAY. SALVADOR FOLEY, JR., 19 Hackensack St., E. Rutherford, N. J.
- Seventh Prize, \$5.00—CABLE CONNECTOR. HAROLD J. CLARK, 43 Watchung Ave., No. Plainfield, N. J.
- Eighth Prize, \$5.00—FLEXO-COUPLER. T. SHIMIZU, 519 Towne Ave., Los Angeles, Calif.
- Ninth Prize, \$2.50—DOUBLE JACK. J. V. MORAN, 2117 Nob Hill Ave., Seattle, Wash.
- Tenth Prize, \$2.50—PLUG-IN A. F. TRANSFORMERS. JOHN G. MARINAC, c/o Bell Telephone Laboratories, Room 1102, 463 West St., N. Y. C.
- Eleventh Prize, \$2.50—ILLUMINATED PRICE SIGNS. HERMAN R. WALLIN, 693 Watkins St., Brooklyn, N. Y.
- Twelfth Prize, \$2.50—BALANCING CONDENSER. A. W. J. SCHAEFFER, 35 Eldon Road, Lordship Lane, Woodgreen, London, England.
- Thirteenth Prize, \$2.50—PLUG-IN VOLT-METER. HARVEY HAM, JR., Box 161, Fergus, Ontario, Canada.
- Fourteenth Prize, \$2.50—COMBINATION HORN-CONE SWITCH. LEE GUNN, Nickerson, Kansas.
- Fifteenth Prize, \$2.50—THREE-IN-ONE SWITCH. WILLIAM RICHARDSON, 3663 Sacramento St., San Francisco, Calif.
- Sixteenth Prize, \$2.50—SOCKET. ALVIN PORTER, 1119 Twelfth St., Highland, Ill.
- Seventeenth Prize, \$2.50—INTER-CHANGEABLE SWITCHES. S. BAYMAR, 7 Darlington St., Manchester, N., England.
- Eighteenth Prize, \$2.50—BINOCULAR R. F. TRANSFORMER. W. E. KINDSCHI, 1826 Maple Ave., Madison, Wis.

for her children's spool-knitter (or should we call it a tube-knitter?). The first step in the construction of such a device is the drilling of a 1/4-inch hole in the center of the end of the tube base, from which the contents have been removed. If the tube is of the UV type, the short peg should be removed from the side of the base. It will be found that this knitter is an efficient one.

HANDY ASH TRAY

One of the unique entries submitted in the contest was an ash-tray entered by Salvador Foley, Jr., of East Rutherford, N. J., using the metal base of an old-style UV-type tube. After removal of the contents, the base was partly filled with lead. This metal was put also on the under side of the base and, as the prongs in this type are short, the danger of tipping over the ash-tray is almost nil; it will rest at several angles. In order to furnish a rest for the cigarette a piece of bronze exactly the size of a penny was curved and soldered to the top side of the weighted base.

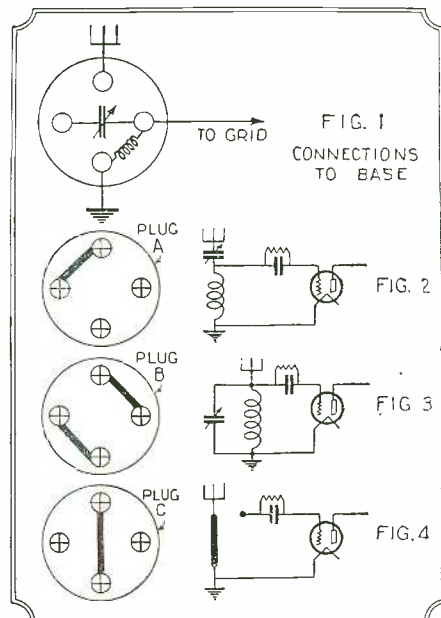

How the three plug-in switches of Mr. Baymar will effect, respectively, changes in the tuning circuit.

This "experimenter's friend" was awarded sixth prize.

A DUPLEX PLUG

Harold J. Clark of North Plainfield, N. J., submitted a cable connector which was awarded seventh prize. As may be seen from the illustration, two vacuum-tube bases are so cut that there is about 1/8-inch of bakelite left above the prongs. A hole is drilled, in the center of each piece, large enough to accommodate an 8/32 machine screw. These two sets of prongs are fastened by these screws to the ends of a strip of bakelite 4 inches long, 1 1/4-inches wide and 3/16 inch thick. The ends of the strip are rounded off to match the bases, and in the middle of the strip is fastened a knob so that the connector can be easily handled. Two vacuum tube sockets are screwed to the rear of the cabinet and the various leads are brought out to the terminals of these sockets, the bat-

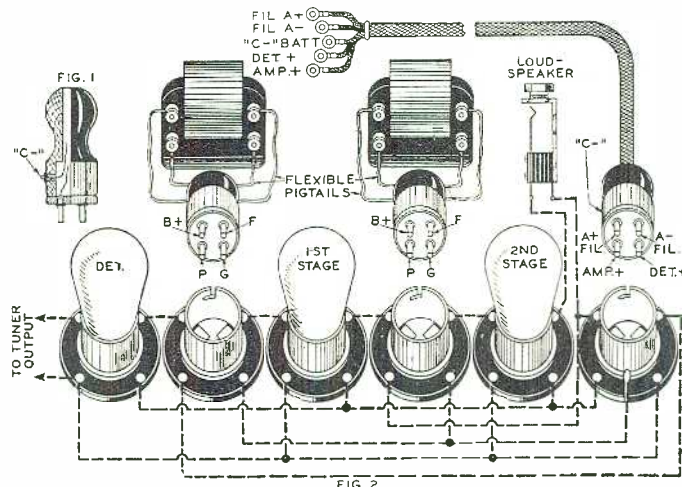

Scheme for testing different A.F. transformers by connecting them to plugs made from tube bases. A comparison can readily be made in this manner.

teries being wired to the eight prongs of the connector that has just been described. (Continued on page 562)



NOT TOO MUCH KITCHEN

Editor, RADIO NEWS:

Thought I'd drop a line and tell you that we women get tired of eternally listening to cooking recipes. Give us a little variety. I like to sit down and enjoy about one or two recipes, then probably a few suggestions on how to do this or that about the household or probably a short talk on fixing our lawns or gardens. Then top it off with a little music.

We get tired, too, working around the house, and we could have a glorious rest while listening to the music and then we'd be able to work with renewed energy after. That's the best way I can write this out, and it's my idea of what I and many more would like.

MRS. TERESA BEST,
No. Dartmouth, Mass.

ENJOYS TRAVELOGUES

Editor, RADIO NEWS:

The daily round of housework leaves so little time for reading that the radio is a real delight when there is a good travel talk being given. At present I have no opportunity of gratifying my desire to see some other parts of the world but it is a true pleasure to hear some one else describe their trip.

When the speaker makes his talk as glowing and as interesting as a railroad folder, then I have an evening's entertainment indeed. Through force of circumstances I have a stay-at-home body, but I have a gad-about mind. A vivid account of a trip to Greenland's icy mountains, to India's coral strand, or to anywhere between, is what I want to hear on the radio. Less jazz and more travel is my radio slogan.

MRS. ADDIE BRENTON,
Baltimore, Md.

IN THE GREAT OPEN SPACES

Editor, RADIO NEWS:

"Der Turm bau zu Babel"—a peculiar way of starting a letter, I'll admit. But, after reading so many articles on how the Radio Commission has cleared the broadcast situation, I'm ready to throw my hat in the ring, or turn on the loud speaker, with a loud and emphatic "Nay!"

What's the matter with broadcasting, anyway? Well, I will admit that everything is the matter with it. I'm telling you that it does not make a bit of difference with me, whether static is terrific or reception is good; it's all the same. The closest approach to it is a fox in a chicken house containing several hundred thousand hens. Noise, whistles, squeaks and a babel of voices that beats a Jewish peddler, an Irish bagpiper and an amateur jazz band having an interference contest—a veritable Witches' Sabbath. If that keeps up, Old Man Static is bound to lose out.

I admit that the location, with us, is ideal for interference; every station comes in at about the same distance, so it seems. The only trouble is heterodyning, cutting of sidebands, so many stations on the same wavelength. Somebody was taking a record of it, but the same record took on Mendelssohn's Wedding March and "Tires for Sale." Happily it was the last tire. But, alas, the next shipment was a carload, which was too much

for such a frail instrument. It died peacefully, by strangulation from the high C of a compromising soprano.

Alas! "Es war so schön gewesen aber es hat nicht sollen sein." You know, I have been wondering why the commissioners do not send some of these stations on a vacation, or better still, as missionaries to the African savages. I believe they would cause an interference in the natural process of digestion; for not even a cannibal is able to digest high Cs, cutting of sidebands, balloon tires, and political campaigning in general. It is wonderful how some of these stations find ways and means to make themselves heard and hated.

Yet, in spite of all this, money invested in

THIS page belongs to the readers of RADIO NEWS. It is theirs for the purpose of discussing fairly and frankly the needs of broadcasting from the standpoint of the great public who listen in. The letters represent, not necessarily the editorial opinion, but that of the writers; who are, in the editorial belief, fairly typical of groups of opinion among the radio public. Make your letters concise and offer constructive criticism when you can; remembering always that there is something to be said for the other fellow's side.

Address The Editor, RADIO NEWS, 230 Fifth Avenue, New York City.

a radio set is a splendid investment. For instance, late in the night, some belated friends stay in spite of yawns, glances toward the clock, gentle suggestions of sleepiness, etc. Turn on the radio, and presto, begone! Well, another mark for broadcast stations. Do you know what I enjoyed in the International Tests last year? The silence!

A READER,
Hague, South Dakota.

(Our correspondent, whose name is given, of course, as an evidence of good faith, is evidently cheerful in his contest with too much sensitivity and not enough selectivity, well removed as he is from the centres of urban broadcasting. The Radio Commission has already done much with the difficult task of separating the numerous stations; but has officially and unofficially expressed the opinion that an ideal arrangement cannot be obtained with the present number of stations, at the same time that it has taken the position that it is not clothed with authority arbitrarily to close down existing stations for the benefit of others. At present the problem remains unanswered, of restricting a station's interference range to the limits of its service range. However, the evolution of broadcasting progresses, along the economic and scientific lines discussed in both editorial and technical articles in this issue. —EDITOR.)

VALUE OF MOTHER'S HOUR

Editor, RADIO NEWS:

A motherhood hour over the radio, with helpful suggestions to the young mother on the proper care and rearing of the child, would be a feature welcomed by many women listeners. Lectures on proper physical development, intelligent child training, good home influence, instructions on children's diet, will find many interested listeners. A "Motherhood Hour" means a movement toward greater health and happiness in the homes of the future.

Weekly lectures by experts on better homes might include advice to the bride on the furnishing and conduct of the new home on a modest budget, how to make kitchen work easier, menus for special occasions, etc. These hours would be most helpful to the homemakers.

MRS. E. M. ANDERSON,
Berkeley, Calif.

ROSES, NOT RASPBERRIES

Editor, RADIO NEWS:

Everytime I read one of these "Correspondence from Reader's columns, it seems that everyone has some big axe to grind or is hiding a big stick behind his back. I, for one, want to say that if the listener who pays fifty odd dollars for a radio set would stop to consider that the trouble may lie in his set, not with the artist broadcasting or in the broadcast station, we might hear fewer complaints about the "rotten" sopranos on the air.

Another thing that gets my "nanny" is to hear so many complaints about the "rotten" programs on the air. Before you take a crack at anyone, just sit down and make up what you think is a good program; and before you get through you'll be wondering where in the name of time the program directors of these stations manage to corral all the features they do manage to get. Then remember that this is a regular job for them, 365 days a year. The best argument to give a chronic kicker is to let him try and improve things himself.

For me, I say three cheers for the fellows that think up the daily programs, and three more for the fellows that broadcast!

HENRY CAMPBELL,
Bayonne, N. J.

ASKS CLEARER ANNOUNCEMENTS

Editor, RADIO NEWS:

So many of the broadcast stations have announcers who mumble so that they cannot be understood, that I should like to voice to them this request through your pages:

"Mr. Announcer, will you please tell me what station you are operating?"

"You do not need to consume quite so much time in elaborating on the wonderful artist whom you are about to display on the air. I, perhaps, will be able to hear his tom-toms, tin pans, and his Jewsharp without being pulverized with oratory. I do not charge any fees for hearing your troubles, therefore, will you please tell them to the doctor or a good lawyer?"

(Continued on page 518)

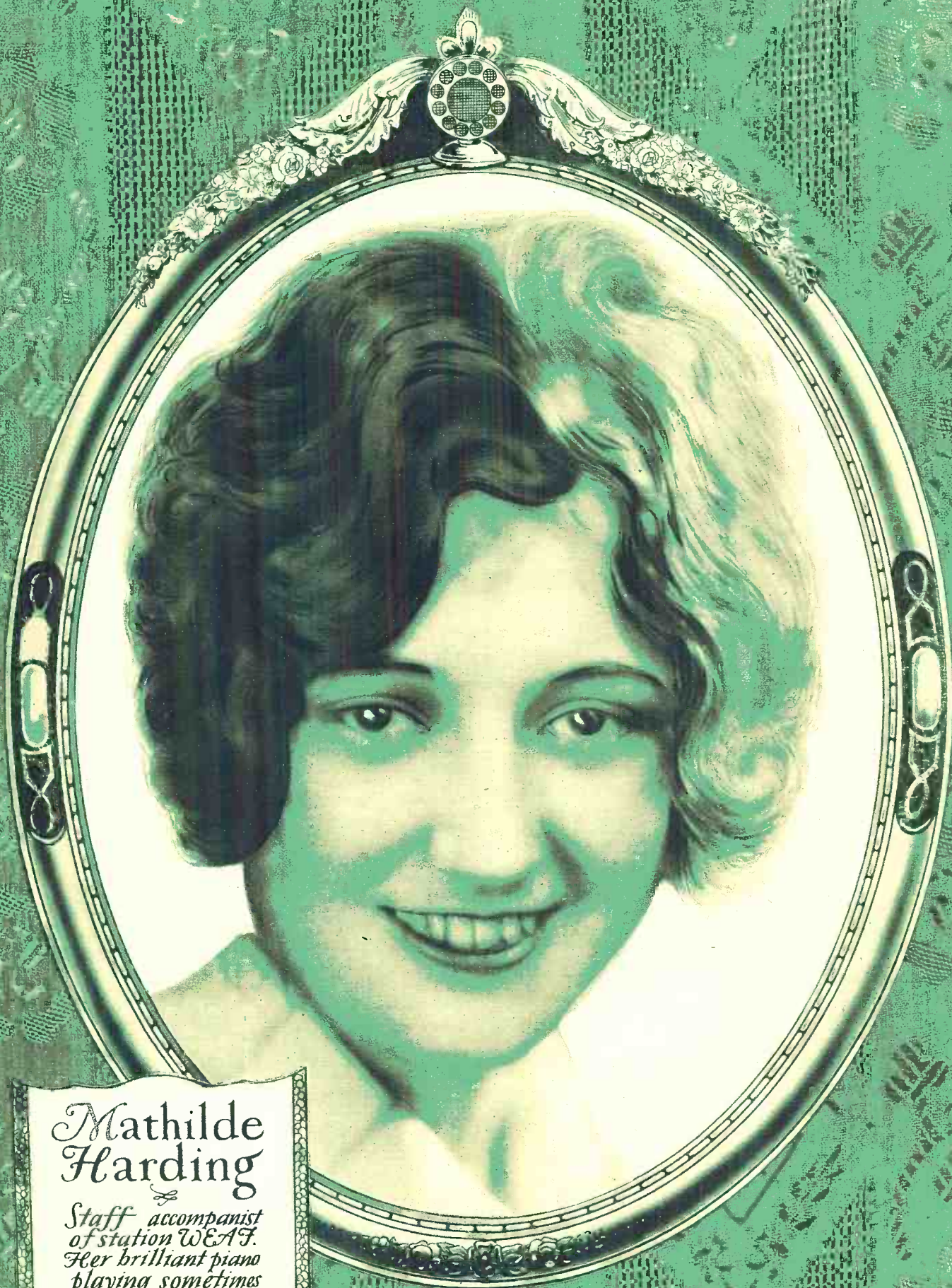

Mathilde Harding

*Staff accompanist
of station WEAZ.
Her brilliant piano
playing sometimes
draws more comment
than the efforts
of the soloist she
accompanies . . .*



*Betty
Lutz*

*Betty is hostess
of the beautiful
WEAF studios
in New York and
also announces the
morning programs
of that station
occasionally ...*



*The Ponce
Sisters*

∫

*Ethel is only 17
and Dorothea 20,
but they have
been featured on
important programs
at WJZ and other
big stations . . .*

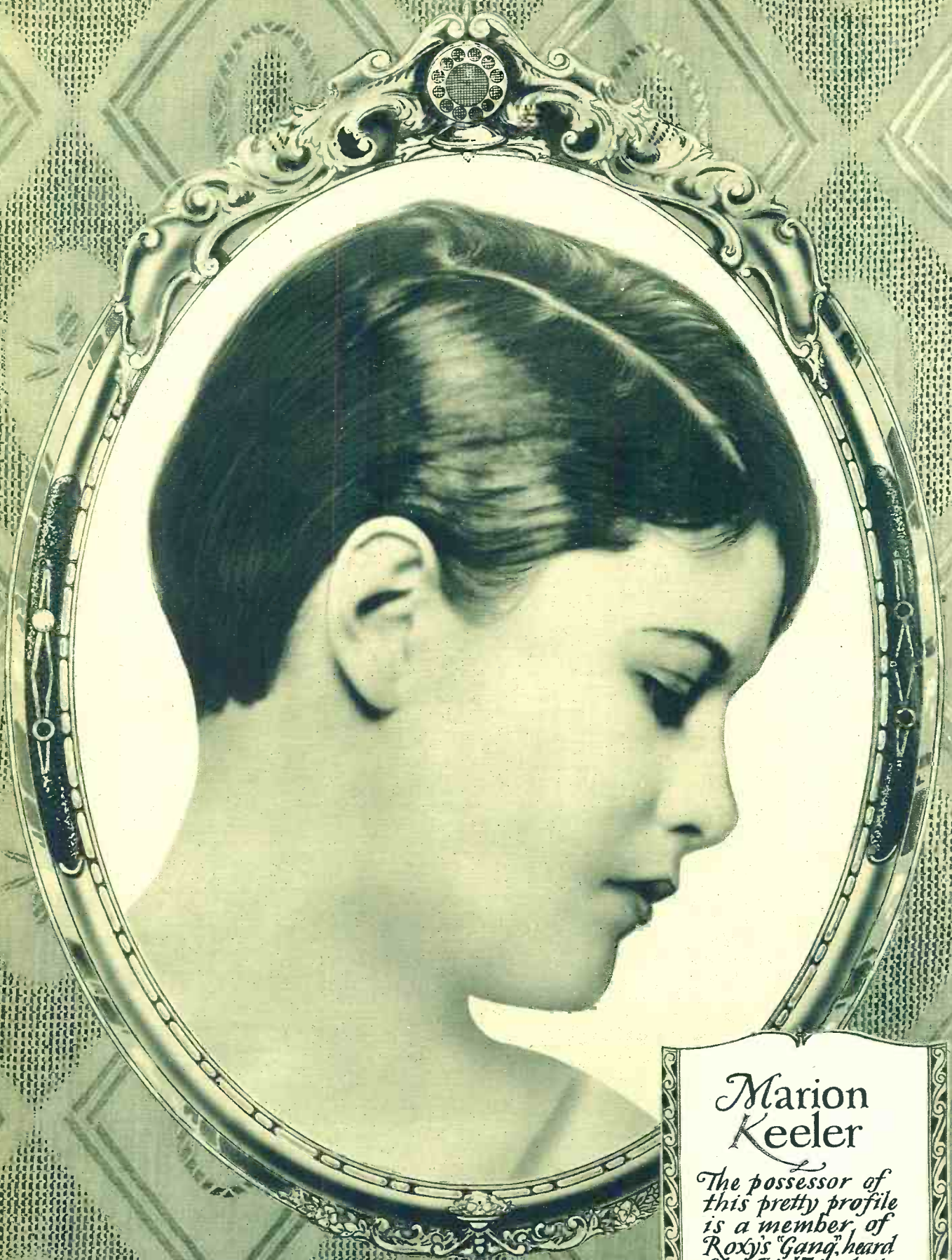

*Marion
Keeler*

*The possessor of
this pretty profile
is a member of
Roxys' Gang, heard
from WJZ and its
associated stations.
She is a soprano.*

What Is Woman's Place in Broadcasting?

How Bertha Brainard Has Proved Ability and Application the Keys to Success

By HERNDON GREEN

WOMEN in commercial life are usually pictured in the roles of personal department heads, advertising copy writers and artists, and in other positions where a knowledge of the feminine viewpoint and temperament may assist them in the conduct of their duties. They are rarely found in occupations where a knowledge of mechanical devices is essential to the proper achievement of their tasks, nor are they often pioneers in a new industry. For the most part, they allow men to develop projects to a certain stage, and then step in and give a refining feminine touch to the undertakings.

A notable exception to this rule is the case of Miss Bertha Brainard, who is the actual manager of WJZ, the "key station" of the country-wide "blue" network and one of the most powerful broadcast installations in the world. Not only is Miss Brainard one of the real pioneers in the radio-broadcast industry, but she is thoroughly versed in all its branches. She is the only member of her sex who occupies such a high position in the

impression is quickly dispelled when the visitor moves closer to the desk, and discovers, after about two minutes of conversation and observation, that the manager of WJZ is a business executive of distinctive ability, manifesting, by her decisiveness in speech and action, perfect fitness for the important position she occupies. The observer will say without hesitation that his hostess possesses personality; if he cared to express himself further he might remark that she also possesses what Elinor Glyn designates briefly as "It."

The state of New Jersey produced both Miss Brainard and the great broadcast station, whose activities she directs. She was born in South Orange and graduated from the South Orange High School and the Montclair Normal School. During her school days she was interested in theatrical work and took part in many amateur performances. At the outbreak of the World War she enlisted in the motor-ambulance section of the American Red Cross, serving with her unit for many months during the hostilities.



field; but, as she herself points out, there are numerous opportunities in broadcast work for women who possess ability in any one of half a dozen directions, and who are not afraid of work. She stresses particularly this last point; for a job in a broadcast station is not the sinecure many women seem to think it is.

People who do business for the first time with WJZ are rather surprised to learn that

Miss Brainard is really the "boss" of the works, and that the entire operation of the busy station is under her personal supervision. A visitor entering her spacious office sees a beautiful, red-headed woman seated at a daintily-decorated desk; and his first impression is that he is about to meet one of those soft-voiced females who direct you to tables in tea rooms and who do other work of equally weighty nature. However, this

After the Armistice, she turned to literary pursuits, securing a position with the Fairchild Press.

FIRST BROADCAST WORK

When WJZ first came into being, back in 1921, Miss Brainard immediately realized the potentialities of broadcasting. She realized, too, the opportunities which would be open
(Continued on page 537)

"Gamby," The Girl on the Cover

MILLE MARIA GAMBARELLI, or "Gamby," as she is better known to most radio listeners in North America, is the young lady whose picture adorns the front cover of RADIO NEWS this month. She has been with "Roxy" (S. L. Rothafel) and his famous "Gang" for more than three years; broadcasting first from the Capitol Theatre through the WEAF chain, and now from Roxy's own "Cathedral of the Motion Picture," through the WJZ network. Both theatres are in New York.

Gamby is of Italian descent. As a very little girl she was so attracted to dancing that her mother took her to the Metropolitan ballet school; where, after she had practiced for some time, she was entered in the ballet and before long was engaged as a solo dancer for the opera. Her instructress there was Madame Cavalazzi. She made her debut at the Metropolitan at the age of fifteen, having the distinction of being the youngest première danseuse to appear at the grand old opera house. She also appeared as prima ballerina with Kosloff and Anna Pavlova, while they were touring the country. She has been soloist and ballet mistress for Roxy for a number of years, and is now première danseuse of the new Roxy Theatre.



Radio broadcasting is a side-light for Gamby. To the question, how she began broadcasting, she replied: "My first attempt was very unexpected, and flustered me considerably. It was quite some time ago that I went secretly up to the broadcasting room in the Capitol Theatre and taking a tiny stool into an obscure corner, I enjoyed all that the artists were doing. Suddenly, like a bolt from the blue, I heard Roxy say: 'Well, there's little Gamby; come here, Gamby.' Needless to say, I turned from pink to red and from red to scarlet when I realized I was discovered. Although I can't remember what I did that first night on the radio, the fans seemed to like it, and from that time on I have broadcast regularly, singing Italian songs and reciting little poems. Playing announcer of the stations is one of the things I like doing best."

The Italian "patter" songs which Gamby sings are given in a tiny, appealing voice and have formed a unique feature of Roxy's radio programs. They are quite different from anything else heard over the air, and are full of genuine sparkle. As Gamby explains it: "The weekly radio broadcast has been a source of great delight and inspira-
(Continued on page 537)

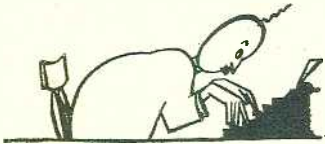

What Every Station Wants - Applause

By EARL SOWERS



HERE is a million-dollar idea. Though it is not a new one by any means, there is a growing necessity, as the author points out, for broadcasters to know who, and how many, are listening to them. They are willing to pay handsomely for any plan that can be evolved whereby paid advertising over the air can be justified, in the same measure that magazine or newspaper advertising can be justified, by known circulation.

Here, then, is a big idea, and RADIO NEWS would like to hear the opinion of its readers. What are your thoughts on this subject?

—EDITOR.

study to the subject. So far no satisfactory solution has been found.

DOLLARS AND CENTS

This is the point: What incentive is there for the operation of a broadcast station, furnishing free entertainment of the highest caliber available, unless there is some appreciation of it? How can the owner or the station manager know that his program is really entertaining, or that there is anyone listening on his wave, unless he is told so?

There are many angles to this subject, but just a few are all that need be considered here. Station WXYZ cost from \$50,000 to \$75,000 for its erection; its operation and maintenance entail an expense of probably \$20,000 annually, unless the programs are bought, and then you can go as far as you like. It is owned by a commercial establishment or an institution rendering a semi-public service, such as a newspaper, for instance. Is it profitable?

feels at perfect liberty to roast the ether program, and of course that is a good thing. Otherwise there is no telling what hideous programs we might be asked to put up with. However, the parallel is there. We could, and ought to, show our appreciation.

You say that the entertainment isn't free; that you bought your radio set, buy a few tubes occasionally and have a nominal maintenance charge; therefore, "how come" this free stuff? All right, but wait a minute.

SOMEBODY PAYS THE BILL

You bought an automobile, and you buy tires occasionally with a nominal expense for gasoline and oil. Now, when they build hard-surfaced roads that you may really enjoy your car, do they do that for nothing? No! They issue bonds which you repay or help to, and you pay the interest, or else they levy a special tax on your gasoline. Perhaps they do both; some states do. Doesn't your pleasure cost you something more than the first outlay? Is your radio pleasure costing you in the same way? Of course the answer is obvious; but, since we cannot expect to get something for nothing, why should we be so opposed to giving a little radio applause?

However, people always have been, and no doubt always will be, looking for something for nothing. No doubt that explains the popularity of certain broadcasters in the early days of the 1,000-watter; when something was wrong on Saturday nights if all manner of prizes were not being offered for the best slogan, the first listener from a state to report, or any number of other come-ons. I fell once and contributed forty cents to the Western Union. Who hasn't?

That brings to mind a specific incident. At a certain station, operated by the manufacturers of a commodity used in daily life by most men, and now by a steadily increasing number of women, there was a discussion as to whether anyone was really listening to them. It was just in advance of one of their anniversary nights and the program manager inveigled the owners, in a spirit of wager, to offer a sample of their brand to every listener who would write in.

(Continued on page 558)



TAPPING the till for a million dollars might not be such an easy thing, even in this day of billion-dollar deals; but that is just about what one idea would be worth to the radio broadcast stations of the United States.

Produce an idea that will solve this simple little everyday problem and you can write your own check. It sounds easy, and maybe it will be to you or someone else who, one day, will be struck with a beautiful thought that will make golden dreams come true. Think about it. This might be your Lucky Day. It certainly isn't mine.

The million-dollar idea? Here it is:

Find the formula that will make Mr. and Mrs. Broadcast Fan write each evening to Station WXYZ and say "We heard the Eveready Twins and they are good to the last drop."

Before we proceed, let me warn you that this is one of the big problems, possibly the largest when all is said, that station managers have confronting them. They have tried all manner of schemes to get the all-desired "applause." Experts have given long

"What incentive is there for the operation of a broadcast station, furnishing free entertainment of the highest caliber available, unless there is some appreciation of it?"

Actually, the American radio public is going in on passes, and occupying a front-row seat every night, in a manner of speaking. So accustomed to this has the average listener become, however, that he has ceased to be appreciative, though the old-fashioned rider of a free pass boosted the show to his friends. The broadcast fan

The initial outlay and annual operation is a considerable item, any way you figure it, and all that can be hoped for is good-will building, unless the rankest sort of advertising is resorted to. Good will is an intangible thing at best and clear-thinking business men are quite likely to ask to be shown that radio is really producing. Can that be done unless the listening public comes across?

"Since we can not expect to get something for nothing, why should we be so opposed to giving a little radio applause?"





The Voice of the People

By JOSEPH D. MOUNTAIN and C. STERLING GLEASON



YOU will be mightily interested in this story; not only because it is, in our opinion, excellent in itself, but the science in it is unusually correct, as well. There is no question at all that the scientific statements made by the author are correct in every respect, and that such effects as he describes can be readily obtained.

Some time ago, at station WRNY, Mr. Hugo Gernsback, editor of RADIO NEWS, tested the sensitivity of the hearing of the radio audience by means of an audio-frequency oscillator. The oscillator used produced audible vibrations from a frequency of about 100 up to some 30,000 cycles (per second). Beyond 15,000 most people could hear nothing; but it was reported by several listeners that beyond this range effects could be noted on various animals. So, while the loud speaker was silent to human beings, it was noisy enough for animals to be disturbed. This is in line with the theme of this story, which we recommend heartily to our readers.

—EDITOR.

TO that palatial Hollywood mansion where Harold Dare, hero of a thousand Flicker Films, lay ill with an insidious, undiagnosed disease, came the world's foremost specialists, who made examinations, held consultations, stroked their beards, and went away baffled. For four weeks the great actor had lain still as

if in sleep or death; but the stethoscopes told that in his manly breast still fluttered the heart to whose beats those of many millions of film-fans had long pulsed synchronously.

What was the mysterious malady which had paralyzed the brain of the film idol? None of the doctors could say. Conference after conference revealed nothing. There could be found no germ, no diseased condition, no symptom which might have indicated any ordinary sickness. Harold Dare had been in perfect health; he had gone to bed at his usual hour, and, so far as could be learned, had been feeling exceptionally fit. But in the morning, he could not be awakened. Dr. Fredericks, Dare's personal physician, had been summoned; and he had tried every known restorative, but without success. Then specialists had been called in. For hours they had worked over Dare with their instruments. For hours they had discussed the case, pro and con, back and forth, without reaching a conclusion.

"To me," said Doctor Rott, a famous bone specialist from Vienna, "the case seems to be characterized by a severe flexo-torsional displacement of the sphenoid. That would account for the incipient metabolism which seems to be developing into internal katabolism."

"Sir," retorted Doctor von Lump, the great German blood specialist, whose name is well known on both sides of the Atlantic, and even better on the Pacific, "are you not aware of the fact that metabolism and katabolism occur simultaneously only when complicated by osmosis? The treatment of this case does not lie in your field; this patient's symptoms show unmistakable signs of haemophilia, perhaps complicated by lymphocytic diathesis, for the polymorphonuclear and eosinophilic leucocytes show distinct signs of contact with mesoblastic, discoid

lymphocytes and platelets. Do you not think so, Dr. Fredericks?"

"Yes," agreed Dr. Fredericks. "The symptoms show the patient to be suffering from an abnormal condition, which may or not be pathological."

"Perhaps you are right," admitted Doctor Rott, with what, in a lesser man, might have resembled professional jealousy: "You blood specialists always get the best words, anyway."

The conferences went on. The doctors still disagreed. Other specialists were summoned. A muscle specialist from Cologne, a lung specialist from Boulogne, a heart specialist from Bombay, and a spine specialist from Bagdad,—all came, and all were completely baffled. At length, they presented their report: "The symptoms indicate the patient's condition to be a most extraordinary complication of pathological morbidity."

"That confirms my original diagnosis,"
(Continued on page 564)

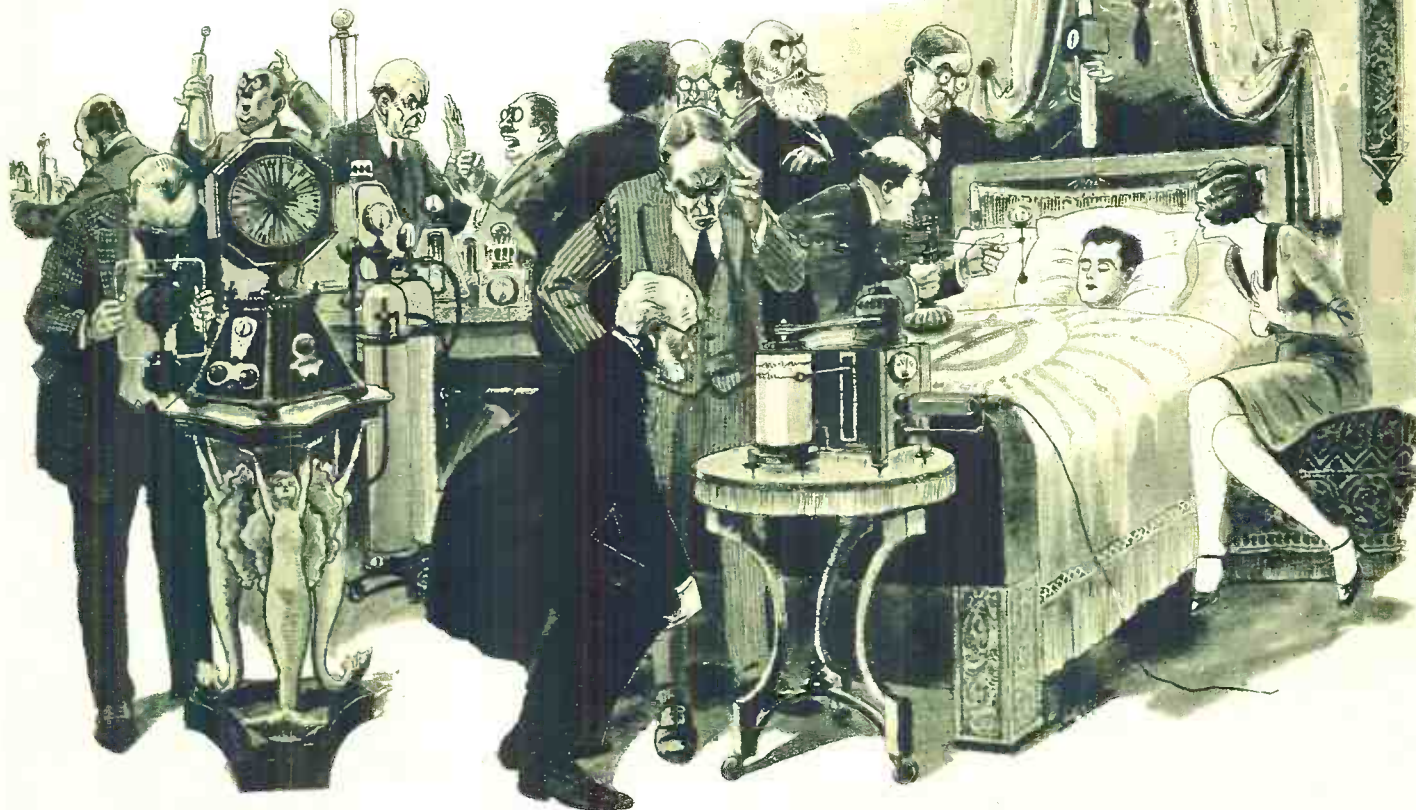

"With skilled hands the doctors prepared their instruments for the test. With sphygmomanometers, pneumatometers, stethometers, manometers, neurometers, and even haemoglobinometers, they prepared to record the most minute change in Dare's condition."



COLLEGIATE WIT

RADIO FAN: "I picked up WGY last night."
AUTO FAN: "Huh, wouldn't she give you her full name?"

TUNING IN F-O-O-D

HE: "Now there's quite a difference between a neutrodyne and a superheterodyne. Do you want me to explain?"
SHE: "Oh, don't bother. It's the when-we-dine and the where-we-dine that interest me."
 —*Gleason Pease.*



OBSERVANT YOUTH

Young radio enthusiast at the opera, as tenor introduces a particularly trilly bit: "I say, dad, he's heterodyning, isn't he?"
 —*Punch.*

THE RETORT COURTEOUS

HENPECK: "Does the loud speaker of our radio annoy you?"
MRS. NEXTDOOR: "Is that what it is? I thought it was your wife."
 —*J. J. O'Connell.*



SELECTIVITY PLUS!

BANKS: "Can you cut out interference with your radio set?"
BINKS: "Can I? Why, when I put the earphones on, I can't hear a word my wife says."

PERSONAL

Young man with one pair headphones, five tubes, two condensers, two tuning coils, wishes to meet a young lady with some "A," "B" and "C" batteries, two transformers, some bus bar wire and a panel. Object: matrimony and a complete set.



NEXT TO RINGSIDE

MIKE: "Scotty, you said you would take me to the boxing matches to-night."
SCOTTY: "Aye, Mike. The room next to mine has a swell radio."



THE BLESSINGS OF RADIO
 Intelligent appreciation of fine art in the West was displayed in a letter to WCCO from a "Constant Listener."
 "And the classical music is so appealing. Grandmother sleeps so peacefully through it all every evening that I do not have to stay with her but can go down for a game of pool."

THIS page is devoted to humor of purely radio interest; and our readers are invited to contribute pointed and snappy jokes—no long-winded compositions—of an original nature. For each one of this nature accepted and printed, \$1.00 will be paid. Each must deal with radio in some of its phases. Actual humorous occurrences, preferably in broadcasting, will be preferred. Address Broadcastastics, care RADIO NEWS, 230 Fifth Avenue, New York City.

THE FAN'S PROGRESS
*How well I remember
 My first crystal set;
 The fun I had with it
 I'll never forget.*

*My newest receiver's
 Both gorgeous and stable;
 My wife often tells me
 It makes a great table.*

—*C. R. Dowd.*

THE COMPLEAT ANGLER

A medical writer mentions the case of a man with elastic arms. When television comes in he should be a useful performer for broadcasting fishing stories.
 —*London Opinion.*



TIME TO RETIRE

DAD: "Has that sap of a suitor gone?"
DAUGHTER: "No, papa, he has not."
DAD: "Then turn on the radio and tune in the time signals."

HARD TO MATCH 'EM

A. NEWFAN: "The dealer told me to light the tubes, or the set wouldn't operate. Now where is the wick?"
 —*William Rudaitis.*



AN "SOS" FROM THE BUSH

An Australian broadcast station recently received the following letter: "I have a kow that is going to hav a carf soon and i wood like u tu broadcast a a-peel for a name becorse i want two kerlect stampps fore mi boi who is krazy on kerlecting them."

IN GOOD CONDITION

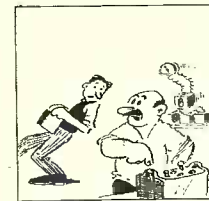

SERVICE STATION PROPRIETOR: "Was there much deposit on Jones' battery?"
BRIGHT ASSISTANT: "None at all—Mr. Jones just said to charge it."

WHAT OF THE SOPRANOS?

The Federal Radio Commission is considering halving the broadcast stations. Personally we would even go farther. The tenors should be quartered and the announcers minced.—*The New Yorker.*

"LOCAL INTERFERENCE"

BONES: "What does your radio bring in?"
FONES: "The installment collector."
 —*Harry Epstein.*



RADIO RHYMES



TO-DAY THIS FAN'S RECENER BRINGS A TALK ON HEALTH AND KINDRED THINGS.



HE'S EVIDENTLY LEARNING MUCH OF MICROBES AND DISEASE AND SUCH!



BUT HARK!—WHAT DO WE NOW BEHOLD! OUR LEARNED SPEAKER HAS A COLD!



IT'S OBVIOUS AT JUST A GLANCE OUR HERO'S TAKING NO CHANCE!

Better Volume and Quality

Are You Supplying the Loud Speaker with the Proper Amount of Energy?

By H. WINFIELD SECOR

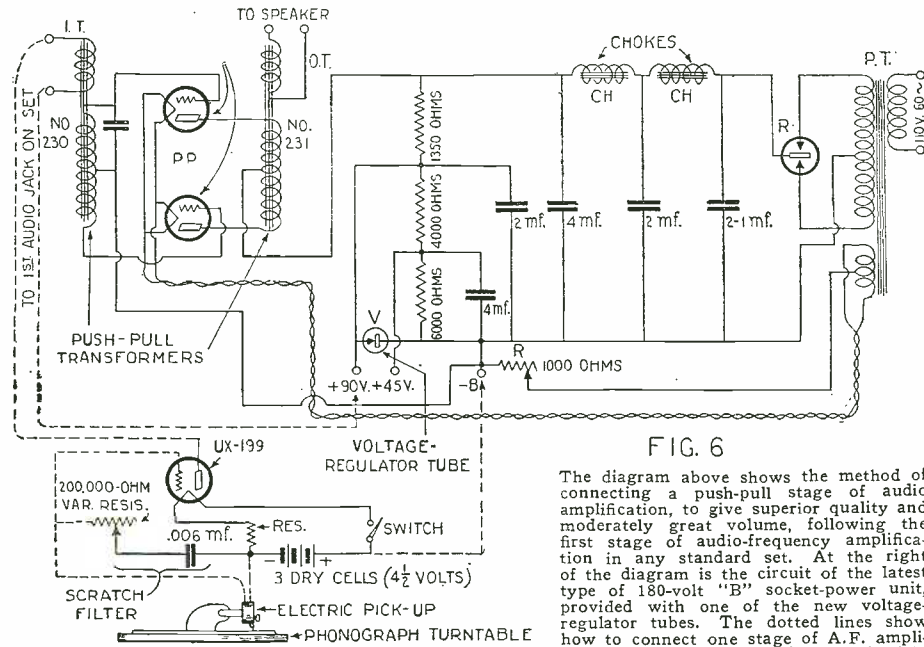

FIG. 6

The diagram above shows the method of connecting a push-pull stage of audio amplification, to give superior quality and moderately great volume, following the first stage of audio-frequency amplification in any standard set. At the right of the diagram is the circuit of the latest type of 180-volt "B" socket-power unit, provided with one of the new voltage-regulator tubes. The dotted lines show how to connect one stage of A.F. amplification with an electric phonograph pick-up. The two push-pull tubes may be either UX-201A, UX-112 or UX-171.

THE question of combining volume with quality is now uppermost in the minds of the radio listening public. There are in this problem many factors which have an important bearing on the association of high quality with good volume, so far as radio receiving sets and loud speakers are concerned. The readers of some radio advertisements are apt to think that the purchase of some single piece of apparatus, featured in a certain write-up, will cure all their ills, and give them both quality and volume in the highest degree. The writer has been making an extensive search for better quality and volume, and gives below a few hints which may lead to some worth-while results; which you have not, perhaps, experienced before in radio reproduction.

A few weeks ago the writer gave a radio talk from station WRNY, in which he covered briefly some of the points dwelt upon in this article. At the close of the talk, several musical test notes were broadcast, in order that those listening in could get a

fair idea as to whether their sets and loud speakers were capable of reproducing these

FIG. A. The picture at the right shows one of the latest push-pull power-packs, complete with a 180-volt "B" power unit and voltage-regulator tube. This compact unit is operated from the first stage of audio-frequency amplification of any standard receiving set. Photo by courtesy of Siler-Marshall, Inc.

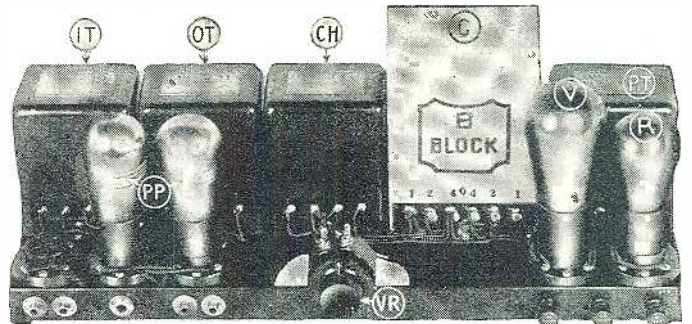

musical tones with anything like real fidelity. Each note was struck three times on the studio piano; the first being the lowest E on the piano, equivalent to 40 cycles (per second); the second, A below middle C, or

106 cycles; the third note struck was middle C, 256 cycles; the fourth was the second C above middle C, 1024 cycles; fifth, the note corresponding to 2048 cycles, or the first C above "high C," was struck; and, finally, the uppermost note on the standard piano keyboard, which is its highest C, 4096 cycles, was sounded.

In an exhaustive article entitled, "What is the Best Loud Speaker and Why?" (which appeared in the March 1927 issue of RADIO NEWS), the writer explained with curves and description the reason why a 72-inch orthophonic horn can render faithfully all the notes in the musical scale, from approximately 100 cycles up to 5,000 cycles. Notes lower than 100 cycles are seemingly heard by virtue of the harmonics of the fundamental tone; in the same way that a small 18-inch loud-speaker horn enables you to hear, after a fashion, the lower bass notes, which may have a wavelength in air of 20 feet or more. Such a horn or other speaker, of course, cannot reproduce notes which the set does not deliver to it.

CHARACTERISTICS OF THE RECEIVER

In considering any radio receiving set with respect to the frequencies which it will pass, the first thing we find is that the various radio and audio-frequency stages constitute a series of frequency filters. It is not our purpose that these amplifiers should act as filters to musical frequencies between, say, 40 cycles and 5,000, or even higher; but,

whether we like it or not, such is the fact, due to the inherent design of the receiving set as we know it to-day. In a conversation with one of the physicists connected with the Bell Telephone Laboratories, he stated that, by actual tests in their laboratories, it had been found that the average five-tube set of the neutrodyne type has quite a sharp cut-off on frequencies transmitted through the radio-frequency stages. He stated that one such set, which had been tested, did not pass any frequencies below 350 cycles per second through the R. F. stages. Therefore, it is important that the R. F. stages in a set should be well designed. If any receiver has a well-designed audio-frequency amplifier, this part of the set will usually pass frequencies covering the piano-keyboard range, as indicated in one of the illustrations (Fig. B.)

According to the claims of the resistance-coupling enthusiasts, this form of coupling will pass practically all frequencies necessary to good musical reproduction. If poorly-designed or very cheap transformers are used for two stages of transformer coupling in the audio-frequency stages, then without a doubt a restricted band of frequencies will be transmitted through these transformers.

One of the latest improved forms of audio-frequency amplification involves the use of

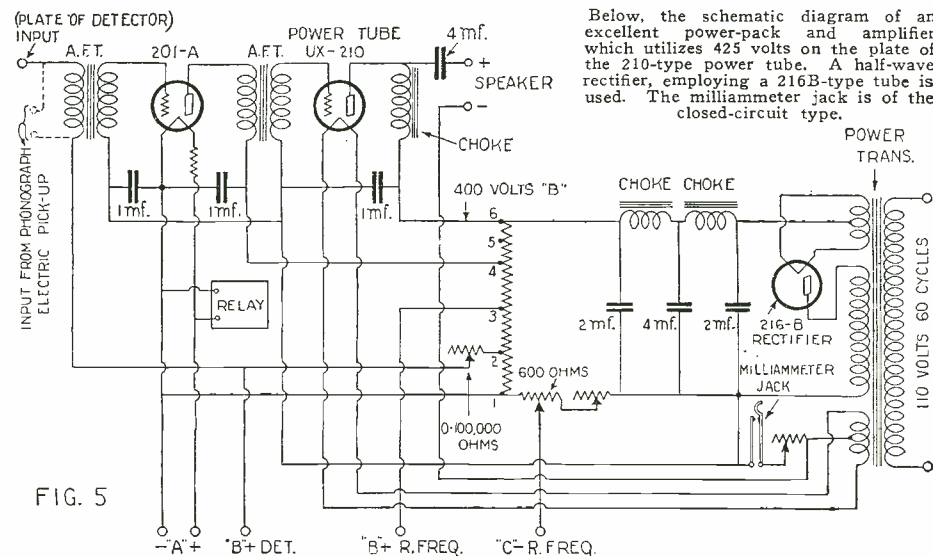

FIG. 5

Below, the schematic diagram of an excellent power-pack and amplifier which utilizes 425 volts on the plate of the 210-type power tube. A half-wave rectifier, employing a 216B-type tube is used. The milliammeter jack is of the closed-circuit type.

dual-impedance coupling; and, when the impedance coils used have a good flat curve of resonance or frequency-response, they will give thorough satisfaction. Broadcast stations use impedance coupling, to a large extent, in the voice-amplifiers at the station.

If constructors use two stages of transformer coupling with some of the modern, well-designed transformers, they will find that these transformers, as their makers guarantee, will give excellent results; for some transformers have practically a flat curve over a frequency range of from 40 cycles up to 6400 cycles. (See Fig. B, illustrating frequencies with reference to the piano keyboard.)

If you are fortunate enough to have a vacuum-tube oscillator capable of producing frequencies corresponding to the piano scale, or say from 100 cycles to 5000 cycles, you can test the audio-frequency amplifier in the manner shown in Fig. 1; the vacuum-tube oscillator may be inductively coupled

cheaper, poorly constructed paper cones, are very faulty reproducers of the spoken word. Of course, if the loud speaker cannot reproduce the voice clearly and naturally (with strong emphasis on the last word), then of course it is out of the question for such a loud speaker to give anything like faithful and pleasant reproduction of the singing voice.

POWER TUBES NEEDED FOR GREATER VOLUME

One of the greatest conundrums to the average broadcast listener is the why and wherefore of the power tube. Everybody today is talking about power tubes, and the average man expects nothing less than wonderful volume, as soon as he spends five bucks or so for a husky-looking power tube. The clerk who sold him the tube specifies that he must use a good stiff "C" battery with it, and, if the purchaser had been using 90 volts, he is told to raise the "B" potential to 135 or somewhat more. Imagine the

outburst of sufficient volume to rattle the windows. Usually the head of the house and the rest of his family are not startled by the tremendous increase in power after one of the lower-priced, small-sized power tubes. (Continued on page 528)

UNDISTORTED POWER OUTPUT		.5		1.0		1.5		2.0		2.5		3.0		3.5		4.0		4.5		48	
ONE 201 TUBE AT 425 VOLTS	BY																				
ONE UX 171 TUBE	AT .80 V.T. B																				
TWO UX 171 TUBES IN PARALLEL	IN PUSH-PULL CIRCUIT																				
ONE UX 112 TUBE	IN .95 WATT																				
TWO UX 112 TUBES IN PARALLEL	TWO UX 112 TUBES IN PUSH-PULL CIRCUIT																				
ONE 201-A TUBE	IN .055 WATT																				
TWO 201-As IN PARALLEL	IN .110 WATT																				
TWO 201-As IN PUSH-PULL CIRCUIT	IN .171 WATT																				

The graphic chart at the left will show at a glance the relative output, in watts, of undistorted power which the various types of vacuum tubes yield, used singly, in parallel or in push-pull arrangement. This chart makes it manifest that a 201A-type tube is quite inadequate for the second stage of audio-frequency amplification, and shows the reserve of power which makes other tubes capable of giving all frequencies evenly on strong signals.

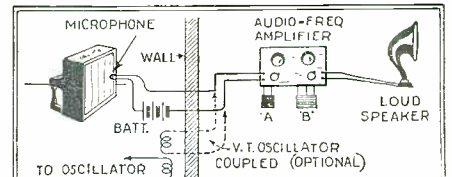

FIG. 1

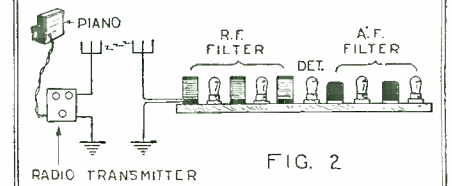

FIG. 2

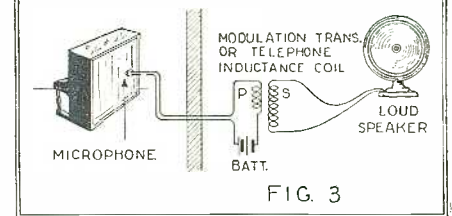

FIG. 3

In Fig. 1 above is shown a method for testing the frequency range of your A.F. amplifier. A microphone picks up the notes from a piano, while someone plays up and down the scale. Fig. 2 shows how to make a frequency-range test on the complete receiving set, the sounds being transmitted actually by radio to the receiver. Fig. 3 explains testing of a loud speaker alone for frequency range.

to the input circuit of the amplifier as shown. As such apparatus is usually not available to the average student of the subject, another way to make a fairly good test, is to procure a good microphone and place it behind a piano. (Connect microphone as shown in Fig. 1.) Have the piano in a separate room or in another house, so that it cannot be heard by the person listening in front of the loud speaker. By listening while someone strikes the notes up and down the scale, you can get a pretty good idea how faithfully the A. F. amplifier being tested, together with the loud speaker, is reproducing the notes corresponding to the desirable frequencies.

TESTING THE R. F. AMPLIFIER

This is all right for the audio-frequency amplifier; but, owing to the peculiar operating conditions in the radio-frequency stages, a thorough tone test cannot be carried out quite as simply as this. When you want to check up the whole receiving set, including the R. F. as well as the A. F. stages, you will have to listen for test notes from a broadcast station, or else broadcast the notes from a miniature radio transmitting set, as shown in Fig. 2. Here a piano and microphone can be used to modulate a small radio transmitter, fitted with a 201A-type tube for instance. To avoid transmitting waves to any distance, which would be illegal without a government license for a transmitting station, the waves may be transmitted from a loop. The radio waves are picked up on the usual aerial, or preferably on a loop connected to the receiving set.

From what has been said so far, it will be seen that it is frequently the case that the loud speaker is often "starved," so far as supplying it with the full band of musical frequencies is concerned. With regard to volume, particularly great volume, something will be said about this directly. The diagram, Fig. 3, shows a piano and a microphone being used, together with a modulation transformer and telephone induction coil, for trying out the musical range and quality of a loud speaker. This test for a loud speaker can and should be also carried out by a person speaking into the microphone. It will be found that many loud speakers, particularly some of the class of

surprise of the average radio set owner when, after he has reached home and feverishly downed his evening meal, he proceeds to insert a nice, new shiny power tube in the last audio stage, and waits expectantly for an

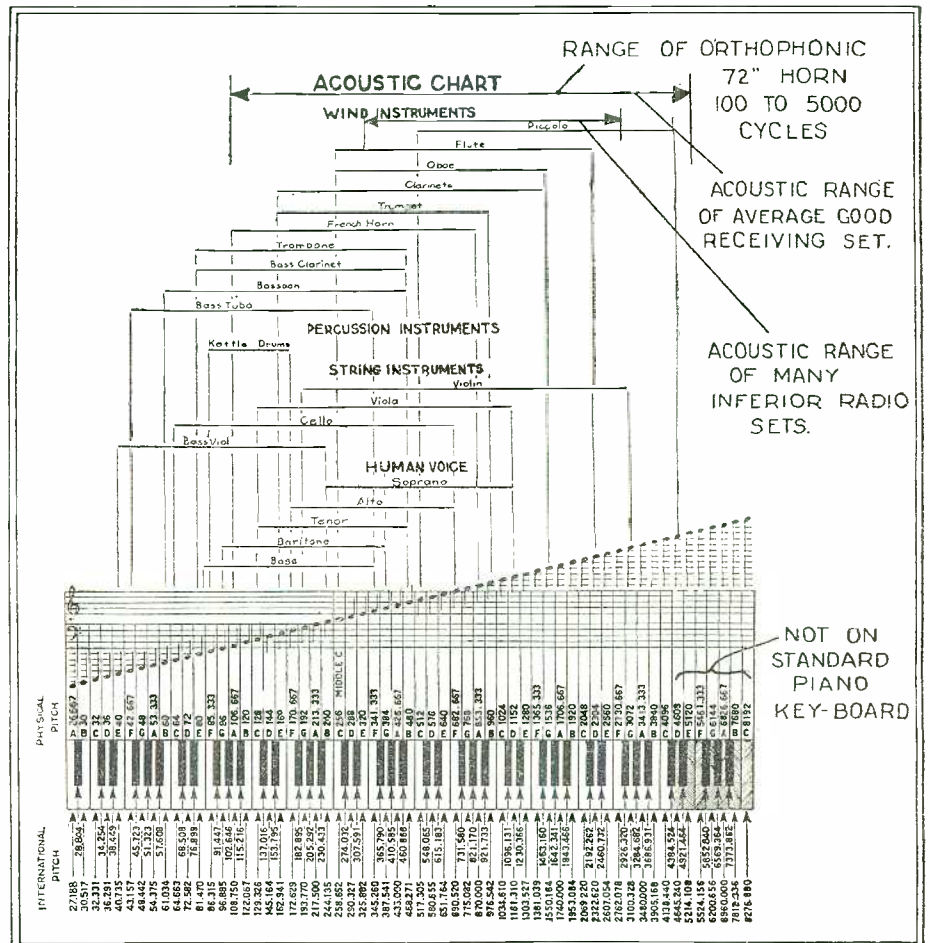

Fig. B. This remarkable chart shows the frequency range in tones and in cycles (the figures at the bottom) of the various musical instruments, also the different ranges of the human voice. The acoustic range of a good receiving set, as well as that of the average set, is indicated. Courtesy Wacovsky Music Products Co.



How to Use the New A. C. Tubes



Advice on the Adaptation of Receivers to Use These Latest Products of Radio Design

By VICTOR L. OSGOOD

“WHY can't I simply replace my old tubes with the new A. C. type (the UX-226 or CX-326), attach a transformer secondary to the filament binding posts, and thus have an electric power set?” This question, while perhaps not exactly the same in words, is quite prominent in the minds of a multitude of set owners today. “And why do I have to have for the detector a different tube using a five-prong base?” is another question puzzling the aforementioned portion of the American public.

It is not a difficult question to answer, as those who try it will quickly find out; the deafening roar from the loud speaker that will greet the experimenter will more than suffice to demonstrate the impracticability of this method of remodeling. But a study of the information contained in this article will show that it is not a difficult job to adapt the set to the new tubes—if the owner has had any experience whatever in following schematic circuit diagrams.

An explanation of the causes of hum will be timely here, with the method of reducing each to a minimum to follow. It will probably be a surprise to those who have had little experimental experience to know that there are two “kinds” of hum. That is, two separate frequencies exist independently of each other; one being equal to the frequency of the A. C. current and the other being double the first, though not because of harmonics, as will be seen.

THE 60-CYCLE HUM

The chief cause of the fundamental-frequency hum (let us say 60-cycle, 110-volt power is being used) is what is called the grid-and-plate effect. By this is meant the effect of the A. C. filament voltage upon the plate and grid respectively when the grid return and “B—” are connected to one side of the filament, as shown in Fig. 1. S is the low-voltage secondary of a transformer supplying the current necessary to heat the filament. This supply is alternating and therefore voltages at the filament terminals, A and B, are constantly alternating, plus and minus. Since the average voltage of the filament is one-half the applied voltage, then C, the center of the filament, is at a constant potential with respect to the terminals collectively. For when C is negative with respect to B, it is positive with respect to A, and *vice versa*: always by the same amount.

Both the grid and plate have the effect of operating directly on the center of the filament. Consequently, if alternating current is applied to the filament, it is evident that one alternating voltage will be on the grid and another on the plate; each equal to one-half the voltage applied to the filament. These

voltages are naturally treated by the tubes as a signal voltage and are amplified accordingly.

USE OF POTENTIOMETER

From the above it may easily be seen that a grid-and-plate return to the center of the filament will eliminate this source of hum. But we cannot get to the center of the filament, because it is enclosed in the tube. True, but if we find a point outside whose potential is the same, we have an equivalent connection. This is known as a bridge effect, from the “Wheatstone bridge” circuit shown in Fig. 2A, and may be accomplished by connecting across the filament voltage a small potentiometer and adjusting it to the proper position as shown in Fig. 2B.

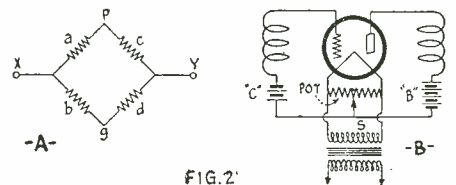
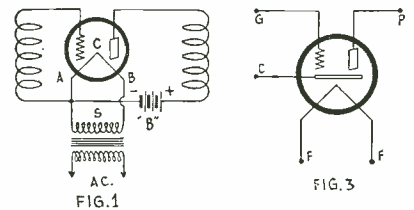
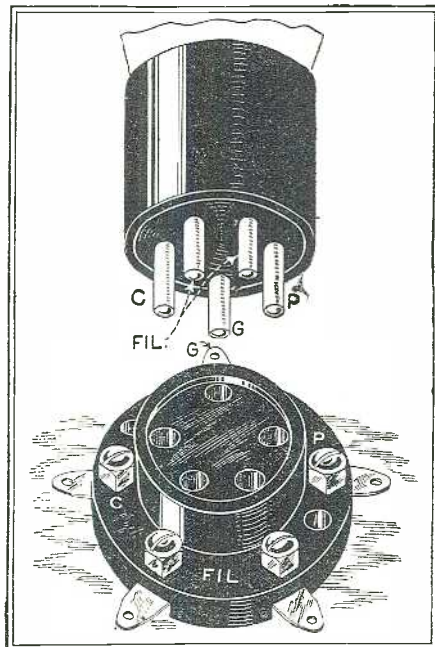

Fig. 1 is a circuit which will let through the A. C. hum. In Fig. 2A is a Wheatstone bridge, illustrating the principle of the circuit in 2B which remedies this fault. Fig. 3 illustrates the elements of the A. C. tube.



The base of a heated-cathode tube of the new A. C. type, and the special five-prong socket into which it fits. The contact marked C is for the cathode, or source of the electrons.

voltage and inserting the “C” battery shown in Fig. 2B we have a quiet tube operating on A. C. This accounts for the fact that the UX-226 or CX-326 tube is designed to burn at 1.5 volts.

THE 120-CYCLE HUM

But why the heavy current that is used to heat the filament? The answer is, to eliminate the cause of the 120-cycle disturbance. It is well known that a small piece of metal will cool much more quickly than a large piece; also that the more cubic contents the metal has per unit of radiating surface, the more slowly will it cool. A small “ribbon” filament heated by A. C. has a decided tendency to allow its heat to fluctuate with the current value in it; and this current value is constantly changing, being at zero 120 times a second and also at maximum at an equal frequency. There is a consequent variation of plate-filament resistance, which modulates the plate current and produces a note in the speaker. This is especially noticeable when a strong signal is being received. The radio-frequency signal is being modulated with 120 cycles, thus creating more amplification of the disturbance than when it originates in the audio tubes.

A heavy filament of circular cross-section will obviously be the remedy for this trouble; since its circular form reduces its ratio of surface to cubic volume, and the increased size reduces heat variations. Since the cross-section of the filament is larger, its resistance will be less and naturally more current will flow. But from a viewpoint of watts (which is the expense factor) there is but very little increase in the new tube over the old quarter-ampere, five-volt tube. (Watts are equal to the product of volts and amperes.)

There is another source of hum known as the “stealing effect,” from the fact that one end of the filament, when positive, attracts electrons from the other end, thereby depriving the plate of that amount. This applies especially to the inverted-V type of filament, because the ends are close together; but is easily remedied by simply making the filament straight. The reduction in the voltage used also helps to cure this source of trouble.

PROBLEMS OF THE DETECTOR

Up to this point the solution has seemed very simple, in view of the fact that millions in

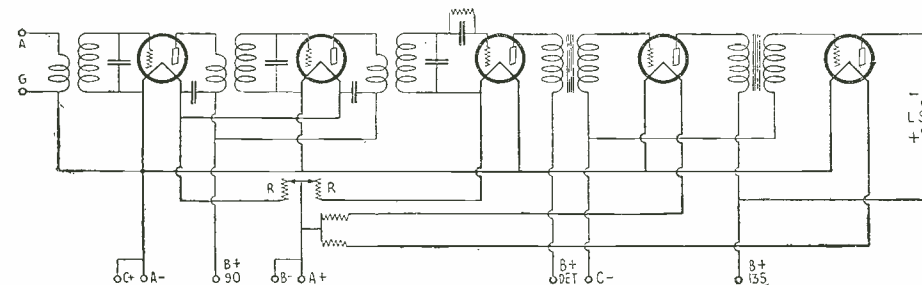

FIG. 5

A typical five-tube receiver which is wired for ordinary five-volt tubes; and which is shown rewired for A. C. tubes in Fig. 6.

time and money have been spent during the past five or six years to arrive at it. And it really is very simple, now that it is understood; as is so often the case. But, when we try to apply these ideas to the detector tube, we run into some serious complications. Not that it is impossible to light the detector on

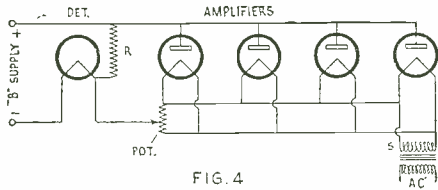

FIG. 4

Using the plate-supply of the amplifier tubes for heating the filament of a 199 detector tube. The grids are omitted, for simplicity.

A. C. without a disagreeable hum, but other drawbacks enter that make this impractical.

The grid condenser and leak, since they offer extremely high impedance to low-frequency alternations, isolate the detector grid and make it very susceptible to any stray 60-cycle electric fields. If it is shielded from these hum sources, a positive voltage must be applied to the grid to get the most sensitivity; and this will bring out a hum which the negative bias eliminated, as mentioned in the first part of this article. Consequently either hum elimination or sensitivity must be sacrificed if A. C. is applied directly to the filament; and neither of these alternatives is to be preferred to the two methods explained below.

The new UY-227 detector is known as the "heater-cathode" type. For those who are unfamiliar with this type, which has become quite popular of late, a few words of explanation will be timely here. Current is needed in filaments for but one purpose; *viz.*, its heating effect. A gas flame could be applied to a filament and enable the tube to operate. Since heat is the only requirement, then the problem boils down to working out the best method of applying heat. If we heat one body and a second is close by, conduction of heat from the first will heat the second body. So if one filament is heated by A. C., and another strip of metal is placed alongside and heated by thermal conduction, the latter may be used as the cathode in a vacuum tube, corresponding to the filament in other types. This is shown by Fig. 3, in which F-F is the filament to which the heating voltage is applied; C, the cathode to which the plate and grid returns are attached; G, the grid, and P, the plate connection; thus making necessary the five prongs that are found on the UY-227 tube.

UTILIZING THE PLATE CURRENT

Another method of detection is to use a UX-199 tube and heat its filament with the plate current of the other tubes, adding what additional current is needed to make up 60 milliamperes by connecting a resistor, R, in the "B" supply, as shown in Fig. 4. This method should not be employed except when a "B" socket-power unit is used; and then only when the user is absolutely sure it will deliver the 60 milliamperes at the voltage required without being ruined by the load.

The chief difference between the two methods is in the amount of time required after turning on the switch before the set will function. In the case of the heater-cathode tube about forty-five seconds will elapse; while the UX-199 heats immediately, as though connected to a battery.

REWIRING A SET

The changes necessary to install the new tubes are not numerous. The grid and plate returns are shifted, a few condensers are inserted and the filament wires enlarged by replacing with new wire; and two additional

leads are connected to the detector socket. This socket must be changed to accommodate the five-prong tube. Let us say Fig. 5 is the circuit to be changed over, for it is typical of the five-tube sets in use today. Fig. 6 is the same circuit re-wired.

The two rheostats (R—Fig. 5) may be converted into potentiometers (P—Fig. 6) by making a connection to the open end, thereby saving the price of these devices and avoiding the removal of the rheostats from the panel. If it is necessary to buy new potentiometers, they should not be over 20 ohms in rating, and should be of a physical size that will permit them to be installed in place of the rheostats, thereby avoiding any open panel holes. The potentiometers will not need constant adjustment; but setting them at the center is the way to eliminate the hum once the change-over has been made. The two extra binding posts shown are for the detector-heater leads; or these may extend clear to the transformer without installing these binding posts at all.

Since each tube draws 1.05 amperes, the four in parallel will draw 4.2 amperes. Ex-

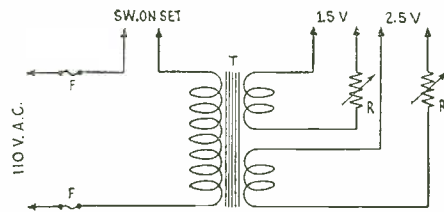

FIG. 7

Two rheostats marked R are placed in the A.C. mains, leading to the tubes in the set, to regulate the voltage.

amination of the wire chart below will show that No. 16 should be used to carry this current. Remove old filament wires (or disconnect only if in cable form) and put in new wire; remembering to twist every pair of leads carrying A. C. and to keep them all well away from the detector grid and plate.

WIRE CHART

Gauge (B&S)	Current Capacity (amperes)
12	20
14	11
16	6
18	3
20	1.5

Of course, the switch is disconnected from the old battery line and put in the A. C. primary circuit. Fig. 7 shows the power supply as it should be hooked up. Quarter-ampere fuses will answer for F-F very well when the load is no more than that just discussed.

The rheostats R shown in Fig. 7 should be used to get the proper voltage at the tube terminals. It should be read with a good A. C. meter and, after once adjusted, forgotten. Do not try to operate the set with one tube out, for in that case the others will be overloaded and their lives decreased. The rheostats must be capable of carrying the current used, and should be about 1/2-ohm in value. Many good transformers designed

specifically for use with the new A. C. tubes are now on the market.

It will be noticed that the two grid returns in Fig. 6 run to opposite sides of the filament voltage (that is, through the by-pass condensers), as do also the plate returns (through the "B+" by-pass condensers). This is advised, though not necessary when the capacity in the by-pass condenser is not over .006 mf. These condensers should be of at least that size.

"B" AND "C" SUPPLY

Those having a "B" socket-power device, which delivers sufficient voltage and a little to spare, may eliminate the "C" battery also, if desired, and thus have a completely electrified set. This is done by inserting in the "B—" lead resistors, which set up a voltage drop of the proper polarity to provide a negative bias on the grid. Fig. 8 shows the way to connect in these resistance units, and the method of determining how much to use is given below.

The plate current of the four amplifier tubes returns to "B—" through R and R1 and sets up a voltage drop whose numerical value is equal to the product of the current in amperes multiplied by the resistance in ohms. Or, reversing the operation, the amount of resistance to be used is the quotient obtained when the voltage value is divided by the current value. For example, if 135 volts is used on the audio plates, using UX-226s throughout as amplifiers, and 90 volts on the radio amplifier plates, by consulting the data sheet supplied in each tube carton it is found that each audio tube is drawing 7.5 mils (.0075 ampere) and each radio tube 3.7 mils; a total for the four tubes of 22.4 mils. At 90 volts on the plate the tube should have 6 volts on the grid. Therefore, R in Fig. 8 is equal to 6 divided by .0224 or 268 ohms (250 to 280 ohms tolerable); and, as we need 6 more volts to make up the 12 required for the grids of the audio tubes, another resistance unit exactly like the above will suffice for R1. The two 6-volt drops, being in series, are added

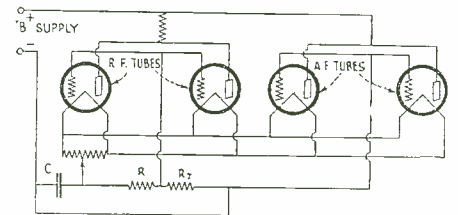

FIG. 8

The filament circuit of the R.F. and A.F. amplifiers. The values of the resistors are given in the accompanying text.

together and supply the bias of 12 volts to be used with a plate voltage of 135.

This voltage is "stolen" from the output of the "B" supplying device, it must be remembered. That is, if 135 volts is the maximum output of the device, the amount left to apply on the plate is only 123 volts; but here

(Continued on page 551)

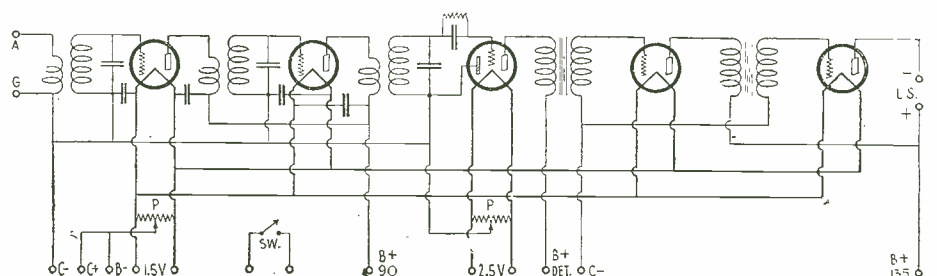

FIG. 6

The set shown in Fig. 5, opposite, is here re-wired for A.C. tubes.

The "Peridyne" Principle

A New System of Variable-Shield Tuning

By HUGO GERNSBACK

Member, American Physical Society; Member, American Association for the Advancement of Science.

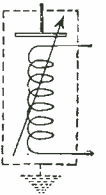
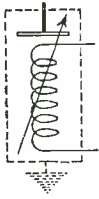

THE "Peridyne" receiver, first disclosed here, is rather revolutionary, because it embodies an entirely new principle in what we have named the "Peridyne" method of shield-tuning.

A new radio symbol, the "Peridyne" character, had to be created by the author, as no symbol for this arrangement is provided in the present radio practice.

We predict great commercial possibilities for this invention; which for the first time, it is believed, makes it possible to bring a single dial set into perfect inter-stage resonance and conse-

quently, to operate it at the maximum possible efficiency.

The first installment explains theoretically, the distinctive features of the "Peridyne." The second article will include the constructional data of the "Peridyne 5," a five-tube set, by means of which the author in New York receives Pacific Coast stations several times during the week, even during the summer.

The "Peridyne 5" we believe, is the greatest 5-tube DX set that has ever been described, anywhere.—
EDITOR.

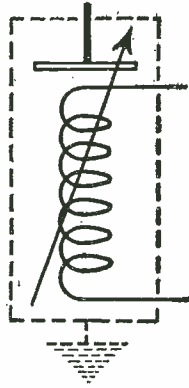

WHEN reviewing the trend of progress of radio receiving sets during the past few years, the careful observer is most impressed by the fact that receivers are being simplified, so far as the controls are concerned.

Time was, when as many as twenty controls were on the panel. This we consider in these latter days, a monstrosity. I believe I was the first to point out, as early as 1922, that the single-control set would prevail in the future. This has indeed proved to be the case, and wherever possible today the preference of all constructors is for the single-control idea.

Several years ago, when the three-dial sets first came into vogue, it had already been realized that the three manually-controlled condensers could very well be placed on one shaft, using but one hand to tune instantaneously the three circuits with their three respective condensers. Theoretically, it should be possible to do this with ease but, practically, it is more difficult. It will be

found that, with most good 3-dial sets, the settings of all three dials for different stations (particularly DX stations) never are the same. Thus, for instance, on a certain station the setting of dial 1 might be 50; of dial 2, 51; and of dial 3, 51 3/4, etc. Several years ago, it was found advantageous to place balancing condensers in parallel with the main tuning condensers, in order to compensate the small differences of capacity; but at best this gave us only an approximation, which was more theoretical than practical.

The reason is that no two circuits tune exactly alike over the entire broadcast scale between 200 and 545 meters; even the best precision condensers do not do the trick. The reason is that the difference is found, not only in the condensers, but in the inductors as well. It is almost impossible to make two inductors exactly alike. The slightest difference in diameter, winding, spacing of the wire, etc., makes changes which multiply discrepancies quickly when the coil becomes

part of a radio-frequency amplifier. Consequently, even the best single-tuning-control sets of today invariably include compensators of some kind, usually midget variable condensers, in parallel with the main tuning condensers.

HARMONIZING THE R.F. STAGES

Fig. 1 shows this graphically; here we have at A the diagram of a three-dial tuned-radio-frequency set. The same set is shown at B, stripped of its unessentials. In other words, is an electrical skeleton of the circuit A. The same letters are used throughout for the same symbols. Thus, in A, we have the letter R, which is the internal resistance of the vacuum tube. This is shown in B, as a simple resistance. R1 stands for the resistance of inductance L2; while this resistance is slight, still it exists.

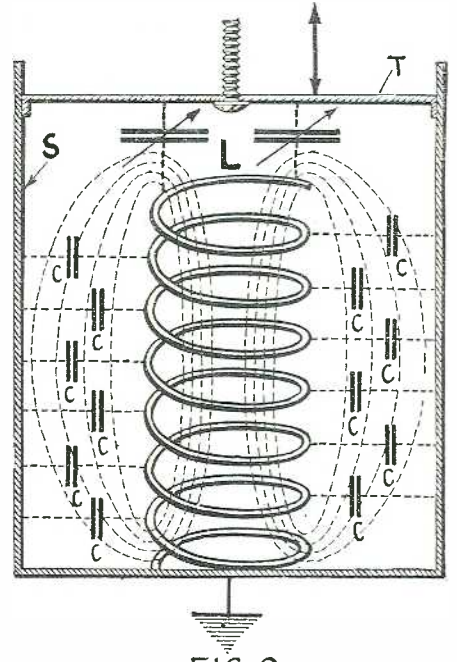

FIG. 2

If the sides and particularly the ends of a shield are too near the enclosed coil, there results a capacity effect (indicated by the small condensers) reducing the efficiency of the shielding enormously. If the top of the shield can be slid up and down, this effect, however, can be turned to good account.

The three condensers on one shaft, C1, C2, and C3, tune the inductors L2, L4, and L6. In order to compensate for the differences of readings between the condensers, when used with their inductors, the small condensers Ca, Cb, and Cd, are used.

Some condensers have these small compensators affixed in such a way that they need, supposedly, to be balanced but once, and then left in this condition. This, however, is not found satisfactory, because the setting does not remain the same for all wavelengths. For that reason, most sets have extra controls on these small balancing condensers, so that they may be adjusted, particularly for DX tuning. It is admitted that on local tuning this is not necessary, because usually the tuning of the local stations is broad anyhow, so that exact correspond-

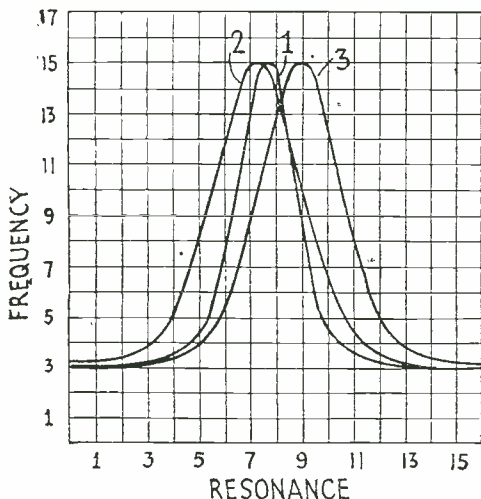

FIG. 5

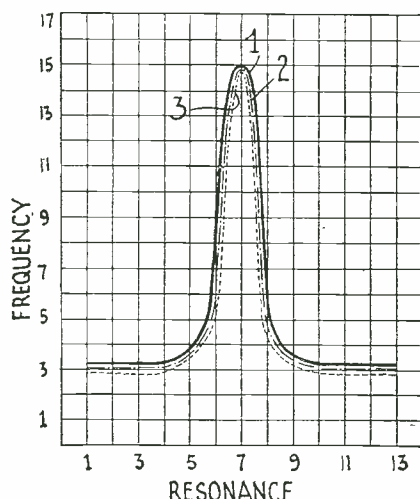

FIG. 6

The curves in Fig. 5 represent the operation of three R.F. transformers at a given frequency; in Fig. 6 is shown the mean of the three curves. It will be noticed that they are practically coincident, after each has been adjusted by means of the Peridyne shield, regulating the inductance.

ence is not required here. But, for the man who lives out in the country, anywhere from 50 to 300 miles away from the nearest broadcast station, it is a matter of prime importance; and for him, as well, it becomes a matter of manual dexterity to tune the set to bring in the distant stations.

If we now refer back to Fig. 1, illustration C, we find a graph, or plotted curve of the results of the tuning, which is not strictly orthodox, but is given simply to show the results graphically. It will be seen that the resonance curves, providing the small compensating condensers are not used, will be something like 1, 2, and 3. Each curve has a different resonance peak; and in order to make all three peak at exactly the same frequency, let us say value 14, each of the peaks would have to coincide at this point. If they do not, it simply means that the three transformers would not be in resonance with each other, and would therefore tune only approximately; thus we would obtain only average results, which may be satisfactory for local stations where powerful signals are received, but are not for distant stations.

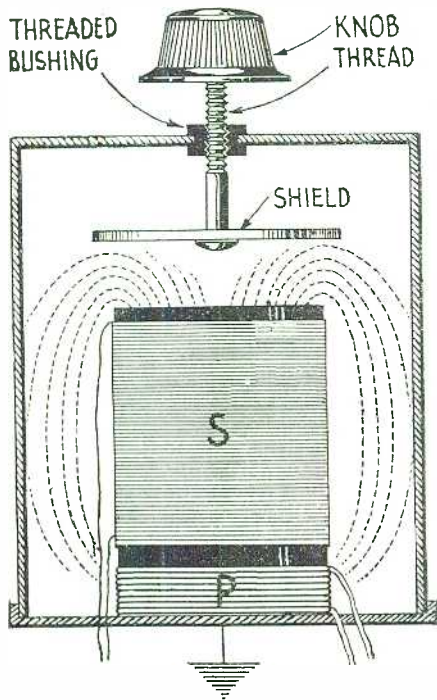

FIG. 4

The "Peridyne" tuning shield; its distance from the coil's high-voltage (grid) end is varied by the knob which is attached to a screw having a fine pitch, capable of producing very fine variations in this critical distance.

In order to rectify this we might use the compensating condensers Ca, Cb, and Cd, which then would bring the circuits into resonance with each other. In this way, the receiver would be brought to its highest efficiency, and the distant station could be received; always providing, of course, that the signal was actually in the aerial.

CHANGE OF INDUCTANCE BY SHIELDING

I have always been struck by the fact that the use of these balancing condensers in parallel with the main tuning condenser is, at best, only a makeshift—a crutch, so to speak—something that would not be used if we had something better. So far, we have had nothing better, so the makeshifts were used.

During the past year or so, however, a new wrinkle came along. I refer to shielding in general. It was found that, to protect most effectively the stability of a receiving set, not only from certain electro-

Two beneficial effects can be combined by varying the shield's top; it becomes a compensating condenser and it matches the inductance of the enclosed coil to that of the others in the receiver.

magnetic as well as capacity effects, arising from components within the receiver, but from various disturbances from outside the set—it was good practice to shield certain parts of the receiver. By shielding completely the inductors, for instance, many advantages are immediately obtained in the set, which may be summed up as follows: the set can be made to tune sharper, the parts may be brought closer together, stray leaks may be eliminated. Most important of all, however, a tuned-radio-frequency transformer, or, for that matter, any inductor in any receiving set, must always be thought of as a pick-up coil. If we disconnect the aerial and ground from a set which is not shielded, it is still possible to receive signals from nearby stations, simply because the coils themselves, acting as loop antennas, pick up enough energy. Shielded inductors show no such sensitivity and no signals can be received with a well-shielded receiver.

In referring to Fig. 2, we have, first, an inductor L, and a shield S, surrounding the inductance. It has been found in actual practice that if the sides, and particularly the top, of the shield come too close to the inductor, we lose more than we gain; for the simple reason that the inductor does not work efficiently unless it is sufficiently distant from the shield. The inductor has its

field of magnetic flux and, if a shield cuts this flux to any considerable extent, losses are immediately incurred, and the over-all efficiency of the receiver is cut down. It has been realized for a long time that, if shields are used at all, they should be proportioned in such a manner that the walls and top are far enough away from the inductor so that they do not influence the magnetic field seriously.

If the shield is brought too close, the condition indicated by the dotted lines of the equivalent condensers occurs; because the turns of the coil may be considered as a series of small condenser plates, each in capacitative relation to the shield. This effect can be nullified to a great degree, as just explained, if the shield is kept far enough away from the inductor. This effect, it should be pointed out at once, is not so

(Continued on page 534)

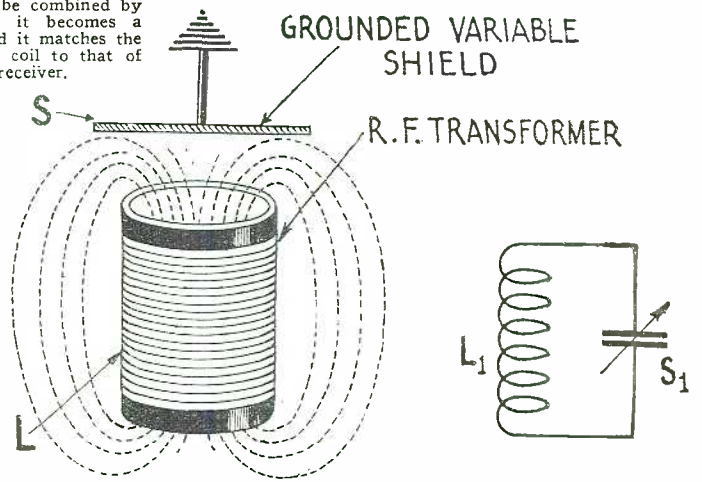
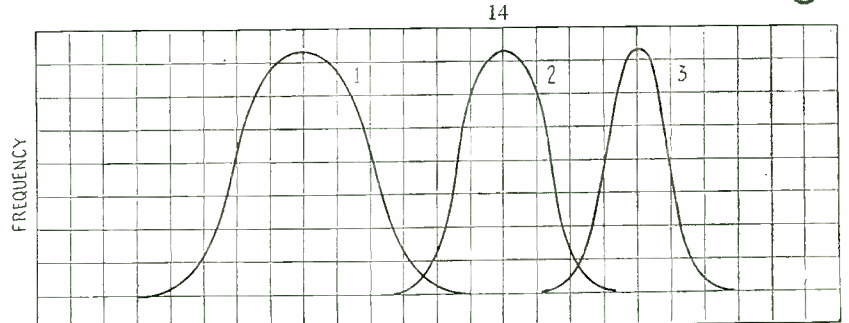
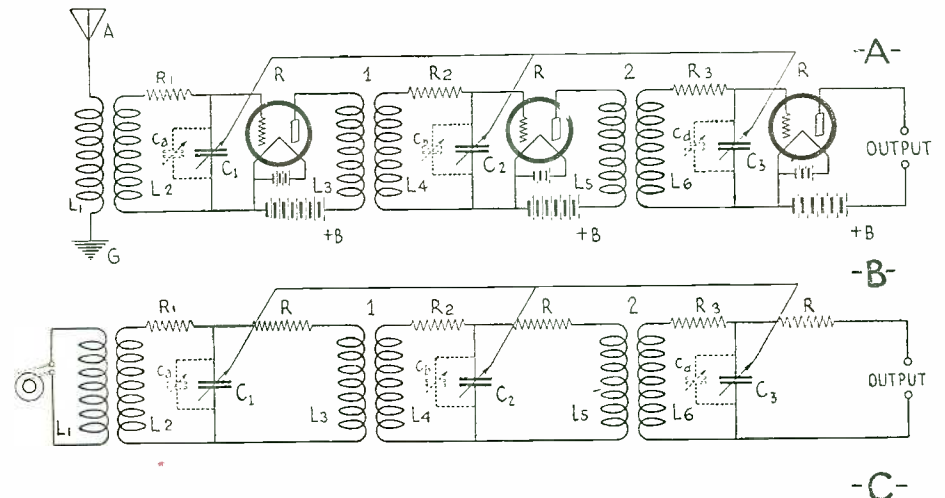

FIG. 3

FIG. 3-A



RESONANCE
FIG. 1

Above, 1A, the diagram of a three-dial tuned radio-frequency set. 1B shows this circuit stripped of its unessentials. The three curves of 1C are the resonance curves of the above set whose transformers are untuned.



The Hilograd 6 Receiver

Constructional Details of a New Tuned R. F. Set Giving Equal Amplification Over the Broadcast Wavelength Band



By F. A. JEWELL

an important role in the adjustment of the R. F. amplifier.

PRINCIPLE OF THE CIRCUIT

Let us assume that the circuit L1-C1 is tuned

IN the receiver described in the accompanying article, the novel two-stage radio-frequency amplifier is so designed that it gives equal amplification over the entire wave-band between 200 and 550 meters. The three-stage audio-frequency amplifier is of the dual-impedance-coupled type, which has been found excellent, especially when used in conjunction with a faithful loud-speaker. We can recommend this receiver to our readers as one which has embodied in it a new principle of compensation and which should give excellent results if properly built.—EDITOR.

L1 is the tuning coil, to which is inductively coupled a second coil or tickler T, which is

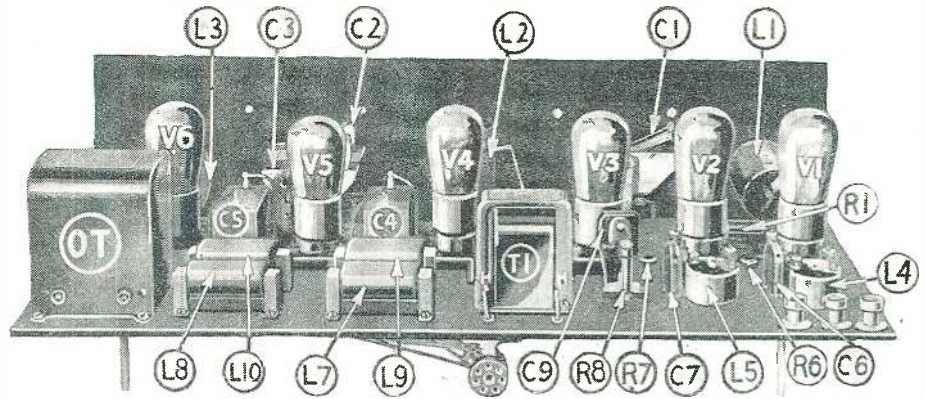

In the rear view of the Hilograd 6 Receiver, above, C1 is the variable condenser tuning the antenna circuit; C2 and C3, the variable condensers tuning the R.F. stages; L1, antenna coupler; L2 and L3, R.F. transformers; C6 and C7, .001-mf. fixed condensers; V1 and V2, R.F. amplifiers; V3, detector; V4, V5, and V6, A.F. amplifiers; L4 and L5, R.F. chokes; L7, L8, L9 and L10, A.F. impedances; T1, A.F. transformer; and OT, output transformer. The receptacle for the battery-cable plug will be seen underneath the sub-panel in the center.

WHEN a new circuit is mentioned in a group of radio fans, some will inquire as to its DX-getting properties: others will want to know about the quality of reproduction, and others will show their interest in the details of tuning and the relative difficulty of construction. In order to anticipate as many as possible of these queries, the writer will explain the principal points of interest about the receiver before describing its construction.

Let us first consider the radio-frequency amplifier, which is of the greatest interest, because in that end of the circuit we have what is most important in a tuned radio-frequency set.

A uniform degree of regeneration is obtained in this part of the circuit by using a combination of two methods, of getting regeneration in any circuit of this kind. The first method is that of permitting feed-back from the plate to the grid circuit through the inter-electrode capacity of the vacuum tube. The other method is one most familiar to every fan who has experimented with a three-circuit tuner; that of a plate-circuit tickler coil feeding energy back to the grid circuit.

In the schematic diagram of the receiver,

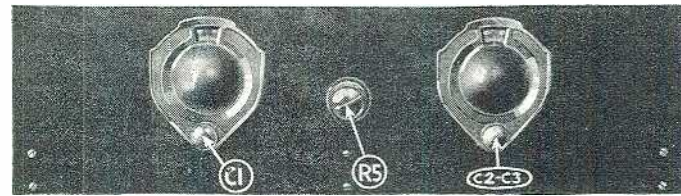

At the left is a view of the front panel of the Hilograd 6 Receiver. The left dial, C1, adjusts the condenser in the antenna circuit; the right hand dial, C2-C3, adjusts the condensers of the R.F. stages, and the center knob, R5, is the combined filament switch and volume control.

in series with a condenser C6 and a radio-frequency choke coil, L4; the last being also connected, in turn, to the plate of the tube V1. Also in the plate circuit of V1 we have the primary of the radio-frequency transformer, L2. A variable resistor, R6, is connected between the 90-volt "B"-battery tap and the combination just mentioned. It may be said in passing that this resistor plays

to a high wavelength, in the neighborhood of 500 meters; remembering that if the radio-frequency choke, L4, is short-circuited the system will oscillate over the whole wavelength band. When the tuning condenser C1 is in this position the feed-back from the plate to the grid circuit is less than when the condenser is adjusted for the shorter wavelengths, or higher frequencies. Now if the resistor R6 is varied, a point will be found where the oscillations begin. We will note the value of the resistance at this point. Since R6 acts as a partial short-circuit around the feed-back coil in series with the main coil, by increasing this resistance it is made less of a short circuit. This may be considered in another way; there are two paths in the plate circuit through which the feed-back current may flow. One of these is through the choke coil L4 and the condenser C6, and then to the tickler coil; while the other path is through R6 direct to the filament. The feed-back current passing through the resistor produces regeneration, mainly through the plate-to-grid capacity of the tube. This feed-back is small at low frequencies (high wavelengths); so that it has little effect on the regeneration. However, if the resistance of R6 is increased, the potential of the point at the connection of the primary of L2 with R6 is increased, with respect to the negative side of the filament of V1. In this way feed-back current is forced to flow through L4 into the tickler coil. In short, on the longer wavelengths the lack of feed-back through the tube is compensated by the tickler feed-back.

Now, let us assume that the condenser C1 is set for a wavelength of about 250 meters. At these higher frequencies the feed-back

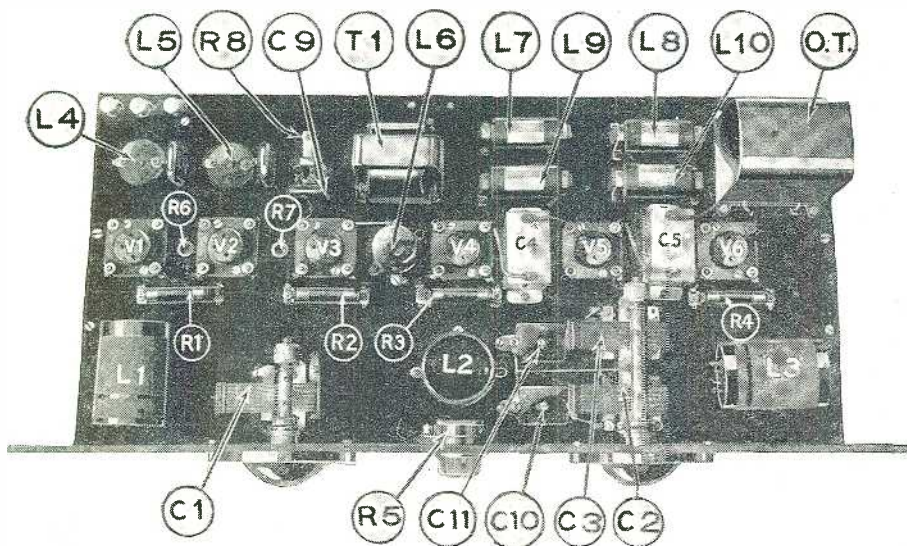

The symbols in this illustration correspond to those in the views above. R1, R2, R3 and R4 are amperites; R5, volume control and filament switch; R6 and R7, resistors in the R.F. circuit; R8, grid leak; L6, R.F. choke; C4 and C5, coupling condensers; C9, grid condenser; and C10 and C11, compensating condensers.

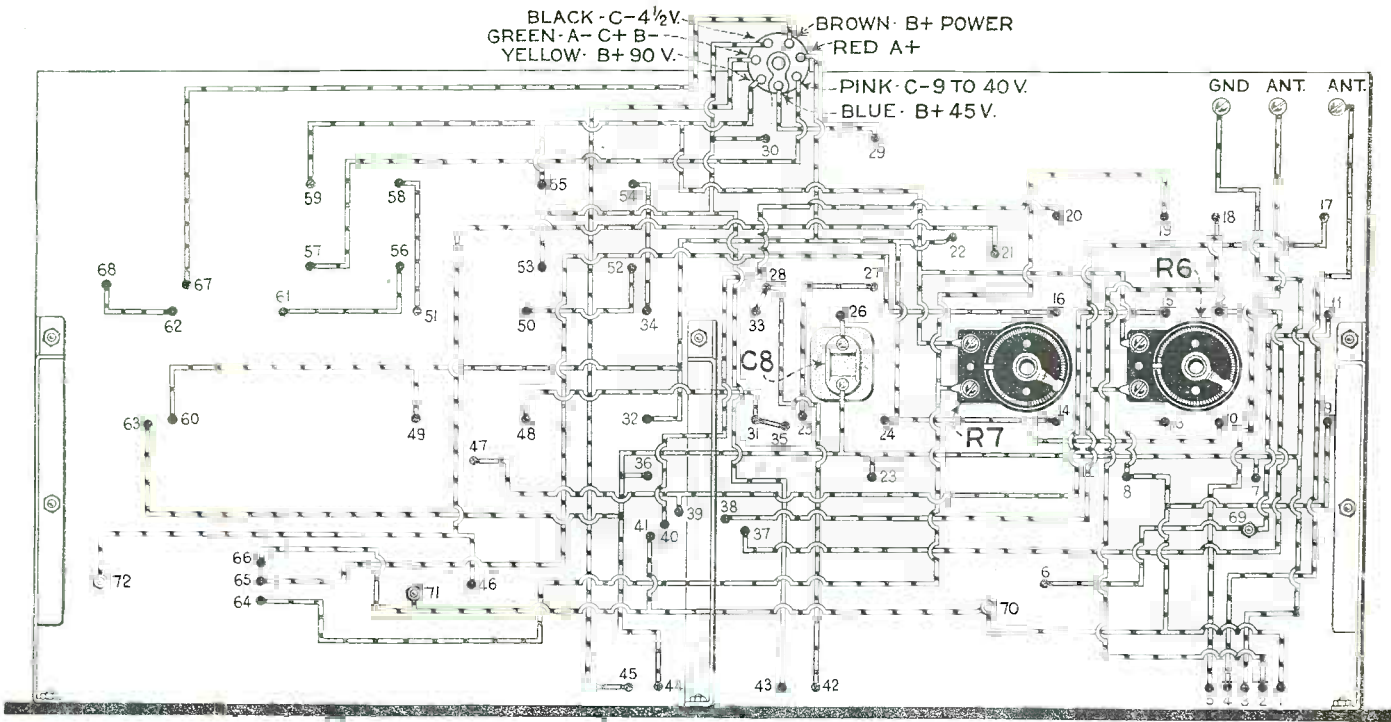

Most of the connecting wires of the Hilograd 6 are run beneath the sub-panel. R6 and R7, the variable resistors in the R.F. circuit, are mounted on the under side of the sub-panel and are adjusted from the top by means of a screwdriver.

through the tube is fairly strong, but when the resistor R6 is set for a high value this current is not able to pass through R6 and produce the regeneration which we want. Therefore, when C1 is tuned to higher frequencies, R6 is decreased gradually until oscillations start once more. The setting of R6 is again noted. It will be found, by

following these directions, that somewhere, midway between these two points on the resistor, there is a point where the regenerative effect will be uniform over the entire waveband.

DETERMINING THE PROPER CHOKE
The value of the radio-frequency choke

coil, L4, is important in the action of this part of the circuit. If the choke coil is too large (has too many turns) it may be impossible to make the circuit oscillate on the longer wavelengths by increasing R6, because the feed-back current will not flow in the tickler coil. However, this condition can be remedied by removing turns from the

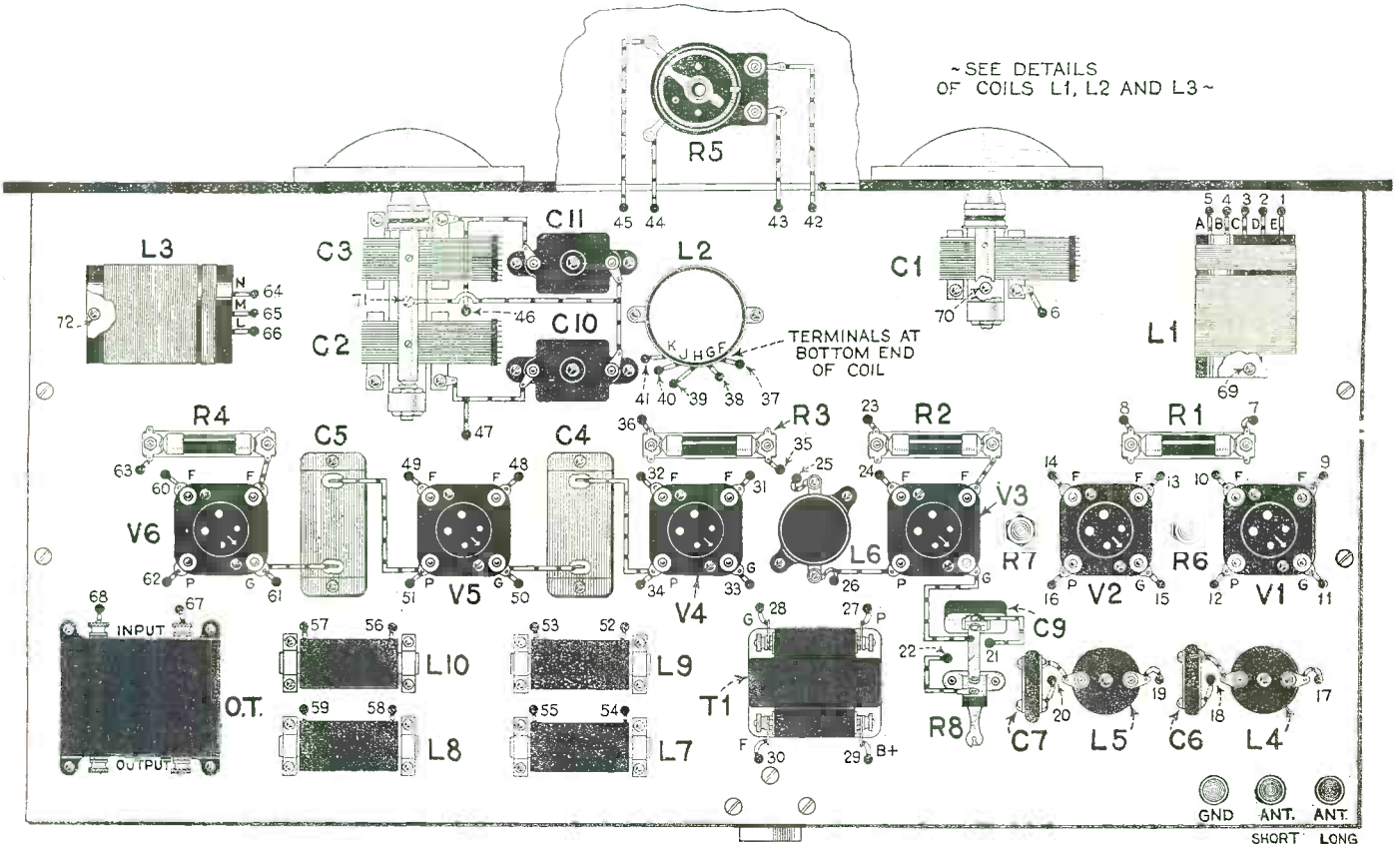

It will be seen that every hole is numbered in the above wiring diagrams; so that the connecting of the instruments is made relatively simple for the constructor. The "output" terminals of O.T., the output transformer, are used for connecting the loud speaker to the receiver.

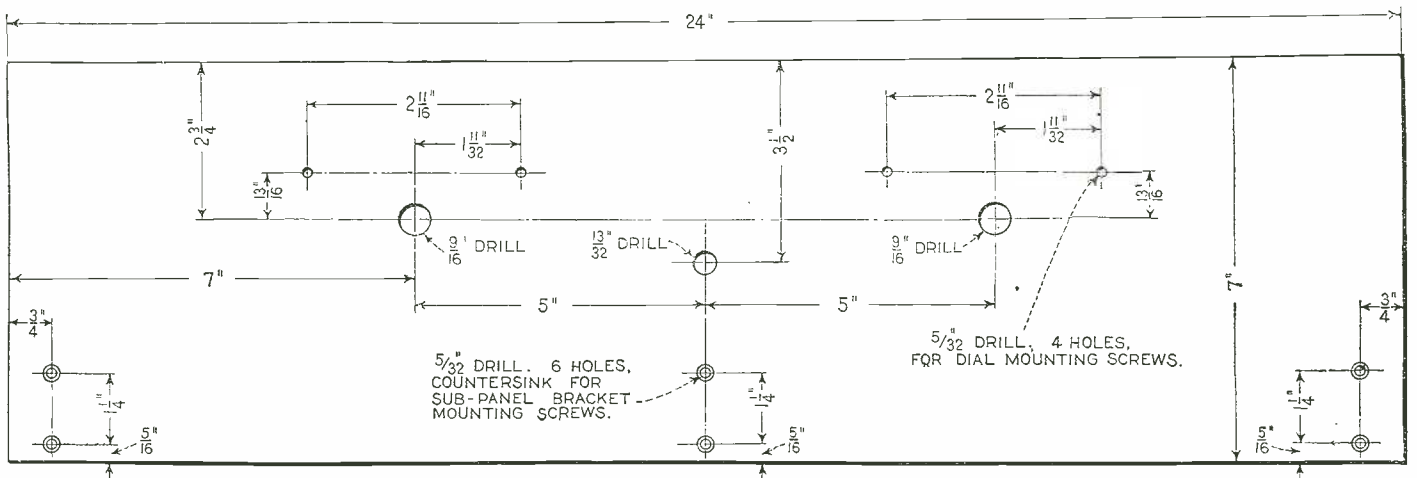

The details for drilling the front panel of the set are given in the above sketch. Because of the amount of apparatus that is mounted on the sub-panel, which is 23 inches long, a center bracket also is used to support the weight.

choke coil and making the resistance adjustments as mentioned above.

When the choke has been reduced sufficiently, so that the circuit will oscillate on the longer wavelengths, it will be found that it will oscillate but feebly on the shorter. This is because the resistance of R6 must be increased so much, to make the circuit oscillate at the longer wavelengths, that little feed-back through the tube capacity is possible.

As the value of the R. F. choke L4 is decreased more and more, it will be found that it becomes correspondingly easier to create oscillations at both ends of the frequency scale. When the choke coil is of the correct size it will be found that the two above-mentioned points on the resistor will be brought together; and, just before we reach this condition, we have the amplifier

working at its highest efficiency. The regeneration, and therefore the R. F. amplification, is the greatest possible over the whole scale, when the amplifier is operating just below the point of oscillation.

It is inadvisable to make the choke coil any smaller than its critical value; because, if we do so, it will be found that the two regions overlap and no satisfactory adjustment of the amplifier can be made. It is advised that the constructor follow as closely as possible the directions for making the parts for this receiver, as the values must be exactly correct in order to get the optimum results.

THE A. F. AMPLIFIER

The audio-frequency end of the circuit is also quite interesting. The writer, after experimenting with a number of circuits, has

developed that shown in the schematic diagram as the most efficient in many ways. A combination of the straight transformer and dual-impedance types of coupling is employed.

As this system was described in detail by the writer in the May, 1927, issue of RADIO NEWS, it is necessary only to state that the plate coils, L7 and L8, have values of 200 henries each, while the grid coils, L9 and L10, have values of 2,000 henries. The question may, perhaps, be raised as to the desirability of these high values; but, if the reader will stop to consider, were both these sets of coils 200 henries, they would be in resonance. Then we would have a perfect condition for audio-frequency oscillations. However, with 1,800 henries difference between the plate and the grid coils, there is no chance of this condition arising.

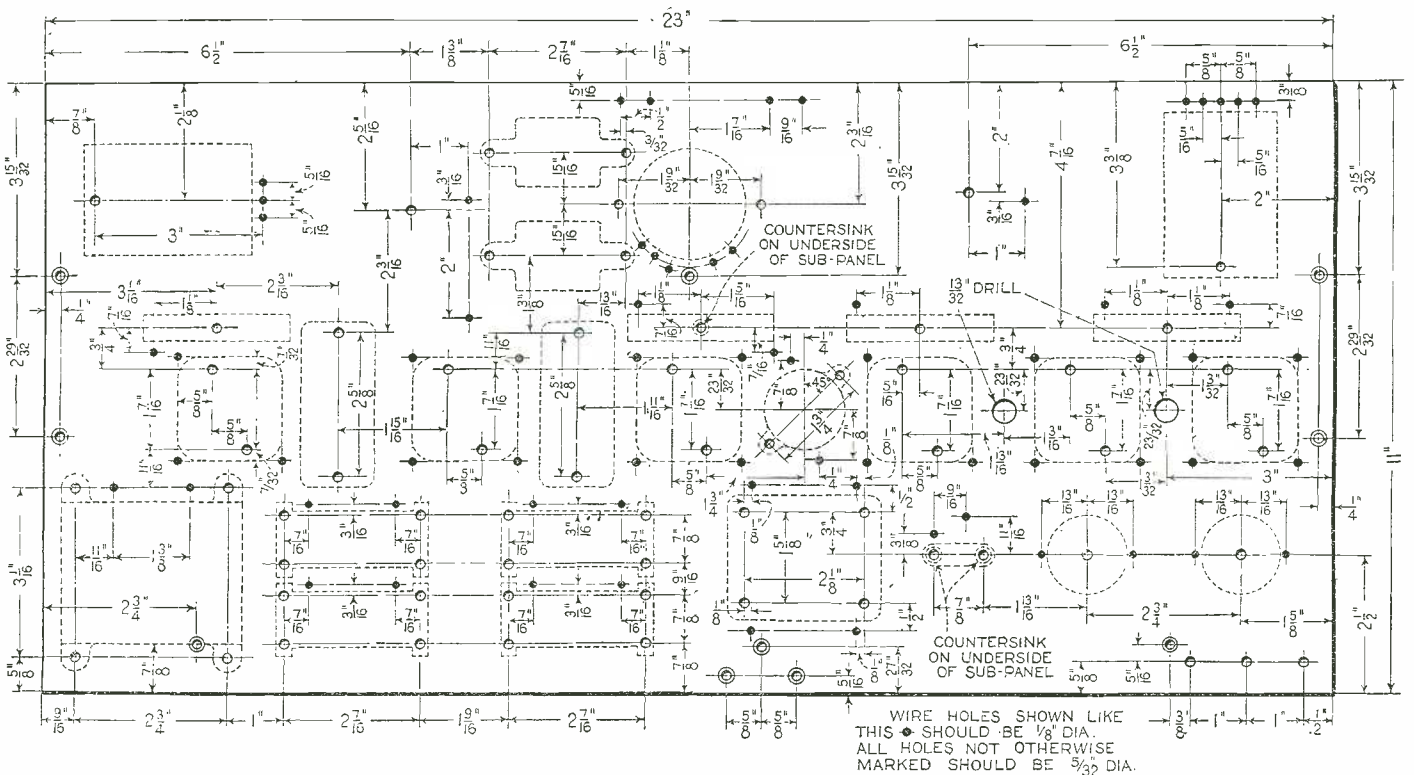

The various pieces of apparatus are shown in dotted outline in the above drilling diagram for the sub-panel of the Hilograd 6 Receiver, making it very easy to locate each part.

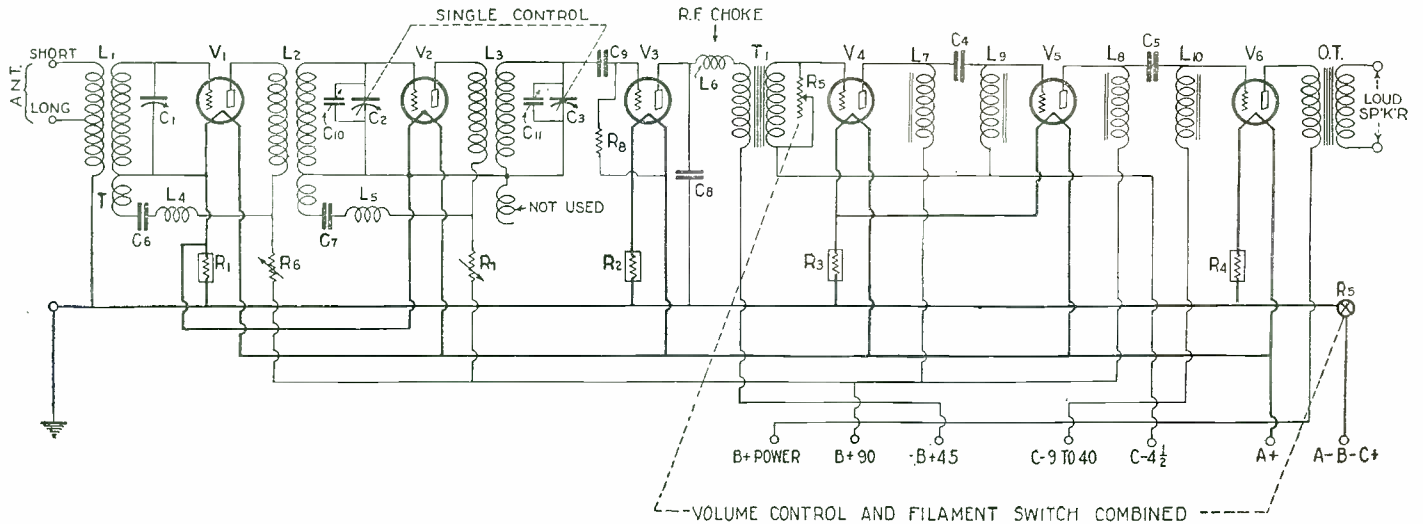

The schematic diagram of the Hilograd 6 Receiver, which consists of two stages of radio-frequency amplification, a detector, and one stage of transformer-coupled and two stages of impedance-coupled audio-frequency amplification.

It will be noted that there are a radio-frequency choke coil L6 and a condenser C8 in the output of the detector tube. This is to prevent radio-frequency currents from entering the primary of the audio-frequency transformer, T1. It will be seen also that an output transformer O. T. is in the plate circuit of the power tube, V6. This transformer has a 1:1 ratio and is included in the circuit to keep the high voltage from the windings of the loud speaker. Across the secondary of the transformer T1 is shunted a variable resistor, R5, which operates as a volume control. In connection with this variable resistor is the filament switch.

CONSTRUCTION

The radio-frequency transformers, L2 and L3, are wound on insulating forms, which are 2 inches in diameter. No. 24 D. C. C. wire is used, the primary having 12 turns and the secondary 84 tapped at the tenth turn. L1 has 24 turns on the primary and 84 on the secondary. The radio-frequency choke coils, L4 and L5, are wound on a form specially designed, and have 325 turns of No. 30 D. S. C. wire. These coil dimensions will be seen in the drawing on page 514.

The six tube sockets are placed in a row across the center of the sub-panel. Between V1 and V2, and between V2 and V3, are located the resistors, R6 and R7. Between the sockets V3 and V4 is placed the radio-frequency choke coil L6, behind which is the transformer T1. To the left of T1 are the grid condenser, C9, and the grid leak, R8, which is placed in a vertical mounting.

The battery cable of seven strands is used, instead of binding posts, to connect the various batteries to the receiver. Three binding posts are employed for the ground and two antenna connections, which are shown in the schematic diagram. The jack into which the cable plug fits is located under the sub-panel. This, together with the two variable resistors, R6 and R7, is the only apparatus that is placed beneath the sub-panel.

As may be seen from the illustrations, the only apparatus mounted on the front panel is the variable condensers, C1, C2 and C3, and the combination volume control and filament switch, which is placed in the middle of the panel. The three radio-frequency transformers, L1, L2 and L3, are mounted on the front portion of the sub-panel and are placed at right angles to each other, thus minimizing feed-back between them. The radio-frequency choke coils, L4 and L5, after the correct number of turns has been determined, are placed within the small round cases and mounted behind the first two tubes,

V1 and V2. The condensers, C6 and C7, which are in series with these chokes, are mounted immediately beside them in a vertical position.

At the right side of the sub-panel are placed the two pairs of audio-frequency chokes, each pair being lined up behind its coupling condenser. In the extreme right corner of the set is placed the 1:1 ratio output transformer. The secondary termi-

nals are so located that they can be used as binding posts for the loud-speaker leads.

The sub-panel is fastened to the front panel by means of three brackets; one being placed in the middle of the sub-panel, so that the weight of the apparatus mounted thereon will cause no undue strain.

Vacuum tubes of the 201A type may be used in the first five sockets; but, in order (Continued on page 514)

SYMBOL	Quantity	NAME OF PART	REMARKS	MANUFACTURER *
C1	1	Variable condenser	.00035 mf.	1
C2, C3	2	Variable condensers	.00035 mf. each twin unit	1
L1, L2, L3	3	R. F. transformers	Matched	2 1
L4, L5	2	R. F. chokes	Special	2
L6	1	R. F. choke	85 millihenries	1 7, 18, 25, 31
L7, L8	2	Plate impedances	200 henries	2
L9, L10	2	Grid impedances	2,000 henries	2
T1	1	A. F. transformer	Ratio 3:1	3 19, 20, 21, 22, 23, 24, 25
R1, R3, R4	3	Amperites	5 volts, 1/2 ampere	4
R2	1	Amperite	5 volts, 1/2 ampere	4
	6	Sockets	UX type	5 3, 21, 23, 25, 26, 27, 28, 29, 30
C4, C5	2	Fixed condensers	Heavy duty, 1 mf.	6 9, 11, 23, 28, 29, 31, 32, 33, 34, 7
C6, C7, C8	3	Fixed condensers	.001 mf.	7 3, 11, 23, 28, 29, 32, 33, 34, 50
C9	1	Fixed condenser	.00025 mf.	7 9, 11, 23, 28, 29, 32, 33, 34, 50
	5	Binding posts		8 15, 23, 27, 28, 33, 36
R5	1	Variable resistor	0-500,000 ohms with filament switch	9 10, 11
	2	Vernier dials		12 3, 15, 18, 23, 25, 28, 33, 39
R6, R7	2	Variable resistors	5,000 ohm; for sub-panel mounting	9 11
	1	Cable and plug		13 15, 29, 35, 37, 38, 49
	3	Brackets		5 15, 18, 23, 28, 39, 40
R8	1	Grid leak	2 megohms	14 6, 7, 9, 23, 28, 29, 31, 32, 33, 26, 51
	1	Leak mounting	Vertical type	14 7, 50
	1	Panel	7 X 24 X 3/16 inches	15 39, 45, 46, 47
	1	Sub-panel	10 X 23 X 3/16 inches	15 39, 45, 46, 47
	50 ft.	Hook-up wire		16 23, 37, 38, 48, 49
V1, V5	5	Vacuum tubes	201-A type	17 23, 31, 41, 42, 43, 44
V6	1	Vacuum tube	112 or 171 type	17 23, 31, 41, 42, 43, 44
O. T.	1	Output transformer		7 3, 19, 49, 23, 25
C10, C11	2	Compensating conds.		7 1, 6, 21

NUMBERS IN LAST COLUMN REFER TO CODE NUMBERS BELOW.

1 Hammarlund Wfg. Company	2 Jowell Laboratories	3 All-American Radio Corp.
4 Radjall Company	5 Benjamin Electric Company	6 Dubliner Condenser Corp.
7 Leslie F. Muter Company	8 W. L. Radio Laboratories	9 Electro, Inc.
10 Central Radio Labs.	11 Carter Radio Company	12 Pure-Vac Company
12 Howard S. Jones	14 International Resistance Co.	15 Micro-Fabricators, Inc.
16 Ralden Mfg. Company	17 E. T. Cunningham, Inc.	18 Sanson Electric Company
19 Thorndarson Elec. Mfg. Co.	20 Duncan Elec. Mfg. Co.	21 Kellogg Switchboard & Supply Co.
22 Reichman Company	23 Electrical Research Labs.	24 Jefferson Elec. Mfg. Co.
25 Bremer Tube Mfg. Co.	26 Patent Electric Company	27 H. H. Eby Mfg. Co.
28 Pilot Elec. Mfg. Co.	29 Babco Products Company	30 Hark Products Co.
31 Daven Radio Corporation	32 Federal Radio Corporation	33 Hart & Hegeman Mfg. Co.
34 Tobe, Deutschmann Company	35 Yarkley Mfg. Company	36 Ineson Products, Inc.
32 Rome Fire Company	38 Cornish Fire Company	39 Frank H. Morse Company
40 General Mfg. Company	41 G. E. Mfg. Company	42 Van Horna Co., Inc.
43 Magnavox Company	44 Patka Labs., Inc.	45 American Hard Rubber Co.
46 Insulating Company of America	47 National Vulcanized Fibre Co.	48 L. S. Branch Mfg. Company
49 Acme Wire Company	50 Aerovox Wireless Corp.	51 Allen Bradley Company
52	53	54

* THE FIGURES IN THE FIRST COLUMN OF MANUFACTURERS INDICATE THE MAKERS OF THE PARTS USED IN THE ORIGINAL EQUIPMENT DESCRIBED HERE.

If you use alternate parts instead of those listed in the first column of manufacturers, be careful to allow for any possible difference in size from those originally used in laying out and drilling the panel and sub-base.

How to Build a Light-Socket Receiver Using the New A.C. Tubes*

The Improved Shielded-Six Redesigned for A.C. Tubes and Utilizing a Compact "A-B-C" Power Unit

By McMURDO SILVER

THE new Shielded Six is the first set intended for home construction that has been designed specifically for the new alternating-current tubes. The excellent features of its R.F. and A.F. amplifying systems are already well known to radio experimenters; to these must now be added the convenience afforded by a complete "A-B-C" power unit occupying less room than many "B" socket-power devices alone.—EDITOR.

IT has been said that complete light-socket operation of broadcast receivers will be to radio exactly what the self-starter was to automobile development. The self-starter lifted the automobile out of the technical-hobby class and made it a public utility; and today it is a necessity. It is easy to understand this when it is realized that the self-starter has adapted automobiles to use by women, under varying climatic conditions, and in urban surroundings; this would have been utterly impossible if each and every car had to be cranked every time it was started.

And, as one looks at the first illustration of this article, showing a six-tube, tuned-R.F. receiver whose entire "A-B-C" power plant is a small unit less than seven inches square, absolutely dependable in operation and entirely free of servicing troubles—light-socket operation looks absurdly simple. But let it be remembered that this final simplicity has been achieved only after years of laboratory work and that at this writing, the receiver to be described is the only light-socket operated set, using the new A.C. tubes, which is available to the home builder. The milestone it represents along the road of progress is an important one indeed, for it marks the end of servicing trouble, acid-laden storage batteries, liquid chargers, dying "B" batteries and the necessity for the knowledge involved in the care and operation of such paraphernalia.

The new Improved A.C. Shielded Six is in itself an unusual and excellent receiver, for it incorporates one of the few designs of

sufficient merit to have enjoyed public popularity for over two years, though each year it has been improved and developed. This past popularity assures the builder that it is a thoroughly dependable receiver from which all "bugs" have been thoroughly eliminated. The Improved Shielded Six consists of three stages of tuned-radio-frequency amplification, a detector and two stages of audio amplification with a push-pull power output stage. The entire assembly is made upon a pressed-steel chassis, to the front of which is attached a beautifully-decorated bronze panel carrying the two vernier tuning controls, the volume-adjustment knob, an antenna-adjustment switch, and the small control switch which serves to turn on and off all power.

QUALITY OF OUTPUT

The performance of the receiver is a revelation in tone quality, for the Shielded

while locals are on, and with an aerial only twenty to fifty feet in length. Ordinarily, it will deliver more volume than is necessary on practically all stations heard.

The use of the new A.C. tubes has been so carefully worked out that only a very low whisper of A.C. hum is heard in the loud speaker—so low that the head must be placed very close to the speaker to detect it at all. In operation, this low hum is less than that ordinarily heard with average "B" socket-power units, and is never loud enough to interfere with reception, even with volume turned well down. One of the features of the whole design is that the "A-B-C" power unit may be placed in the same cabinet with the set, only a foot or so away from the left end of the receiver.

This simplicity attained through complete light-socket operation is the direct result of the development of the new A.C. tubes recently announced by tube manufacturers. However, the A.C. tubes in themselves are not sufficient to replace batteries, chargers, and the accessory equipment forming an

At the right is the A.C. Operated Shielded Six Receiver, mounted in its cabinet. The left dial controls the variable condenser which tunes the antenna circuit. The right-hand dial operates the link motion that turns the three remaining condensers simultaneously. The switch S1 is at the left and S2 at the right is the "Off-On" switch.

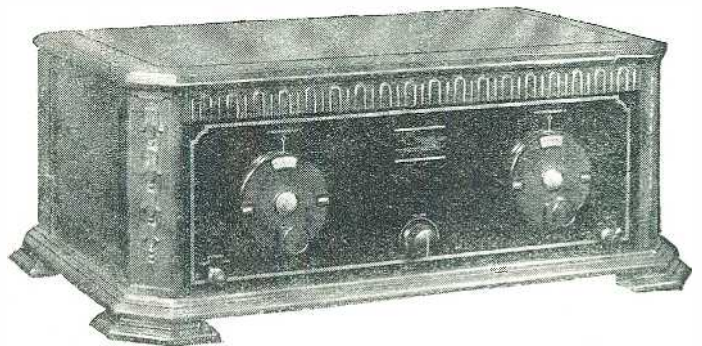

Six provides a fidelity of reproduction which has pleased thousands of builders with its reality and life-likeness. Its operation is simplicity itself, for there are only two tuning controls to adjust, with a small auxiliary knob to regulate volume and sensitivity. The tuning is not critical, but is truly sharp. The Shielded Six will not only separate local stations in such cities as New York and Chicago, but if at all favorably located, it will bring in distant out-of-town stations

essential part of every radio installation up to now. In order to use these new A.C. tubes circuit designs must be very carefully evolved and worked up around them; for they cannot be put into any receiver without modification and expected to operate satisfactorily. It is probable that many fans will endeavor to do exactly this, and to convert their older receivers to complete light-socket operation, by employing A.C. tubes of special types and power units, which are certain to be advertised in tremendous quantities in the first few months by the get-rich-quick fraternity. With the full realization that such a course is certain to lead to trouble and grief, the entire design of the Improved Shielded Six receiver has been developed around the new A.C. tubes; so that, between the two models available (one for battery or socket-power unit operation and standard tubes, and one for light-socket operation) there are marked differences in circuit design. The points of difference have to do only with the different operating powers required for the new tubes; and, in actual performance, a Shielded Six, whether built for battery operation or for light-socket operation with A.C. tubes, will operate in exactly the same fashion so far as actual results are concerned.

ELEMENTS OF THE R.F. CIRCUIT

Electrically, the A.C.-operated Shielded Six comprises three low-resistance, low-loss tuned-R.F. amplifier stages and a detector; each containing a space-wound radio-frequency transformer, the primary and secondary windings of which are held on a molded bakelite form in such fashion that they are practically air-supported. The grid circuits

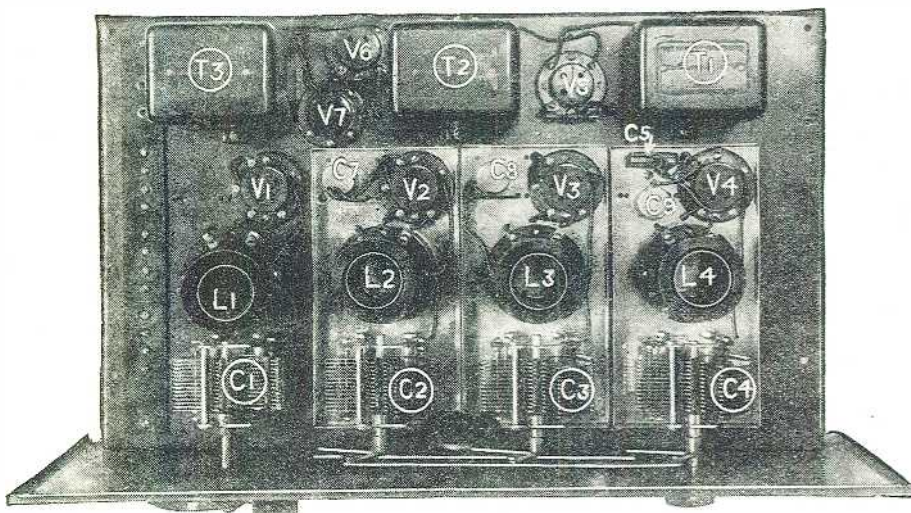

C1, antenna condenser; C2, C3 and C4, R.F. tuning condensers; L1, antenna coupler; L2, L3 and L4, R.F. transformers; T1 and T2, A.F. transformers; T3, output transformer; V1, V2 and V3, R.F. tubes; V4, detector, V5, V6 and V7, A.F. amplifiers.

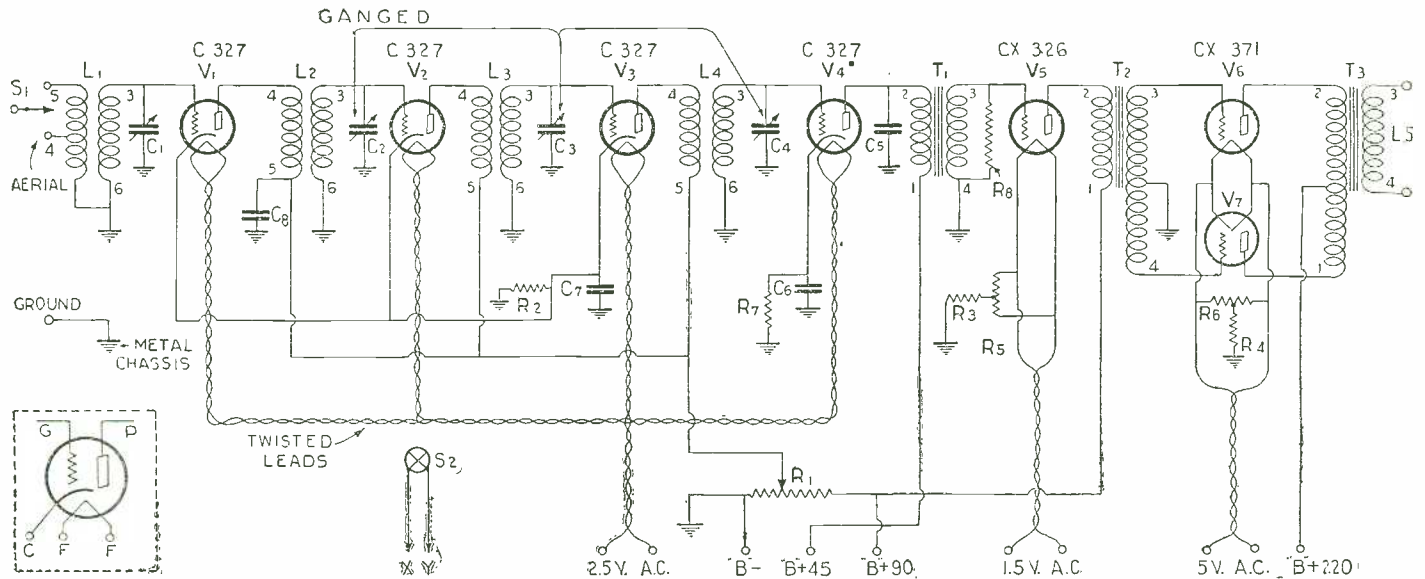

The schematic diagram of the Shielded Six Receiver. The diagram of the socket-power unit is on page 494. In the left corner the cathode or electron emitter is marked C.

of all four transformers are identical, as are the characteristics of the four modified-S.L.-F. tuning condensers employed with them. As a result, the tuning adjustments of the second, third, and detector stages being identical, all are operated by a single-control dial simultaneously adjusting the three condensers through the agency of a mechanical link which is free from back-lash. Since antenna characteristics cannot be definitely pre-determined and will vary with every installation, the antenna stage of the Six is tuned by a separate control; and in order to accommodate varying lengths of aerials, a tap-switch is provided, allowing the use of part or whole of the antenna transformer's primary coil.

The design of the three R.F. transformers is very interesting, in that the primaries are spaced out under a large portion of the secondary windings instead of being bunched in a small slot at the filament end of the secondary, as recently advocated. The reason for primary spacing is that maximum energy-transfer results from maximum coupling, and maximum coupling for a given value of primary inductance is obtained through spacing the primary beneath the secondary. Were the primary bunched to obtain the same value of R.F. amplification, many more primary turns would have to be used and the oscillation tendency, due to the tuning effect of the primaries in the tube plate circuits of the receiver would be greatly increased. The

R.F. amplification factor of the receiver is quite high, averaging better than 10 to 12 per stage, and the amplification is comparatively uniform at all wavelengths. However, no endeavor has been made to obtain absolutely uniform amplification at all wavelengths; as, were this done, the high efficiency of the receiver at certain wavelengths would have to be cut down to the level of its performance at other waves. Also, for the

being little point in shielding it to prevent a coil-socket pick-up which would be far lower than the degree of energy intentionally fed to this first coil from the antenna. The problem with the three other tuned circuits is entirely different; and each is individually shielded in an aluminum housing, to prevent interaction between stages and pick-up of external interference, which has not passed through the filtering process imposed by the preceding stages. The wavelength range of the receiver with a set of standard coils is 200 to 550 meters; while by means of two additional sets, of four coils each, it may be extended up to 3,000 meters, thus rendering it adaptable to all classes of broadcast reception throughout the world.

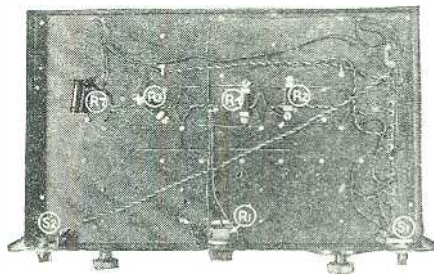

The under side of the sub-panel showing the positions of the resistors and the two switches.

AUDIO AMPLIFICATION

The audio-frequency amplifier consists of two stages employing large, heavy transformers which provide excellent low-note reproduction with a 5,000-cycle cut-off; resulting in the elimination to a great extent of background noise, heterodyne squeals, and interference. An output transformer is employed, not only to protect the loud-speaker windings from the high plate current of the last power tube, but also to compensate for poor loud-speaker performance at low frequencies. It is a well-known fact that the average loud speaker is far less efficient at very low frequencies than it is through the middle register. It is just this deficiency

same reason, automatic regeneration control is not employed and, instead, a small manual sensitivity adjustment allows the receiver to be operated at optimum efficiency at every wavelength.

The first R.F. stage is unshielded; there

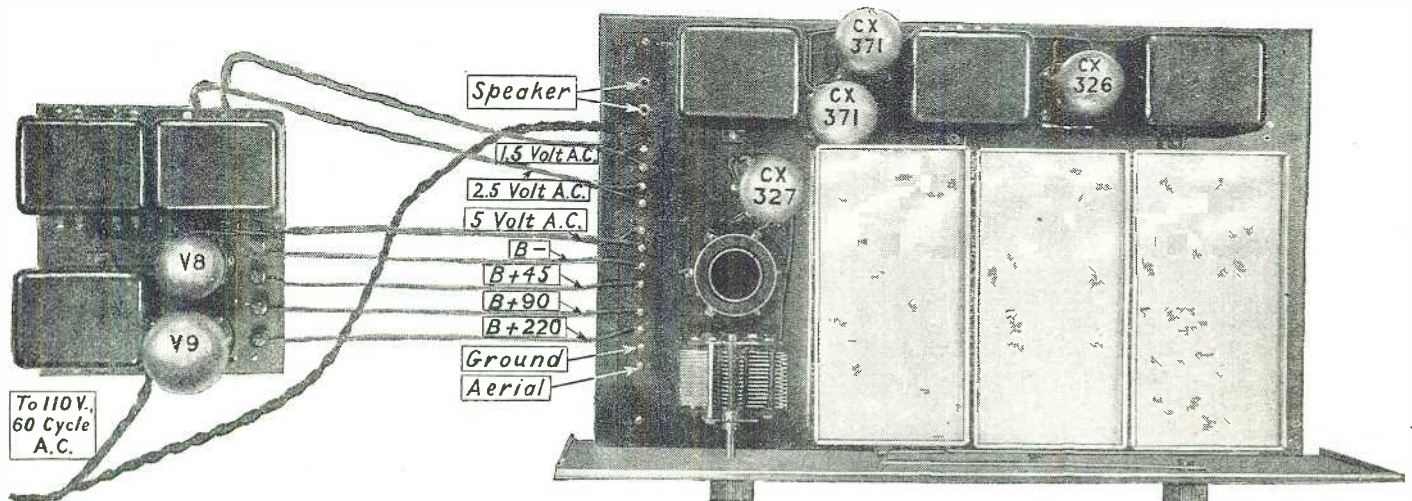

The power unit is here connected to the receiver. The connecting leads should not be more than four feet in length and may be of No. 14 lamp cord. V8 is the rectifier and V9 the voltage regulator tube.

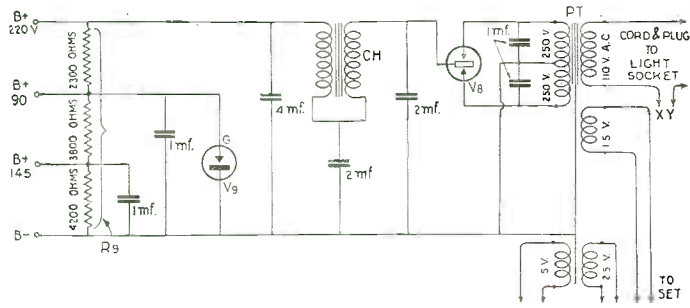

At the left is the schematic diagram of the power unit which supplies "A" and "B" current for the receiver's A.C. tubes. "C" bias is obtained through the use of suitable resistors in the set.

T.R.F. sets, which are sold in large quantities at prices of from forty to sixty or seventy dollars. However, in an extremely sensitive amplifier with a manual sensitivity control capable of obtaining maximum performance from the R.F. amplifier, the raw-A.C. tubes introduce too high a value of hum; and therefore they do not lend them-

that the special output transformer compensates.

THE A.C. TUBES

Four CY-327 (heater-type) tubes are employed in the three R.F. stages and as a detector. These tubes are used because the standard CX-326 (raw-A.C.) amplifying tubes are unsuited for use in an extremely

At the right is the layout for the drilling of the front panel. Very few holes are necessary for the mounting of the apparatus.

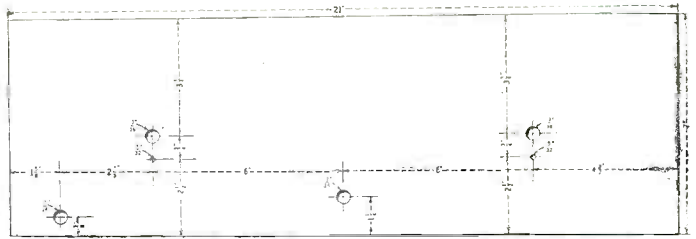

sensitive radio-frequency amplifier; though the latter are well adapted to many of the comparatively insensitive "loss-controlled"

selves to such amplifiers. On the other hand, the five-prong CY-327 "heater" tubes, with isolated filaments heating an electron-emitter

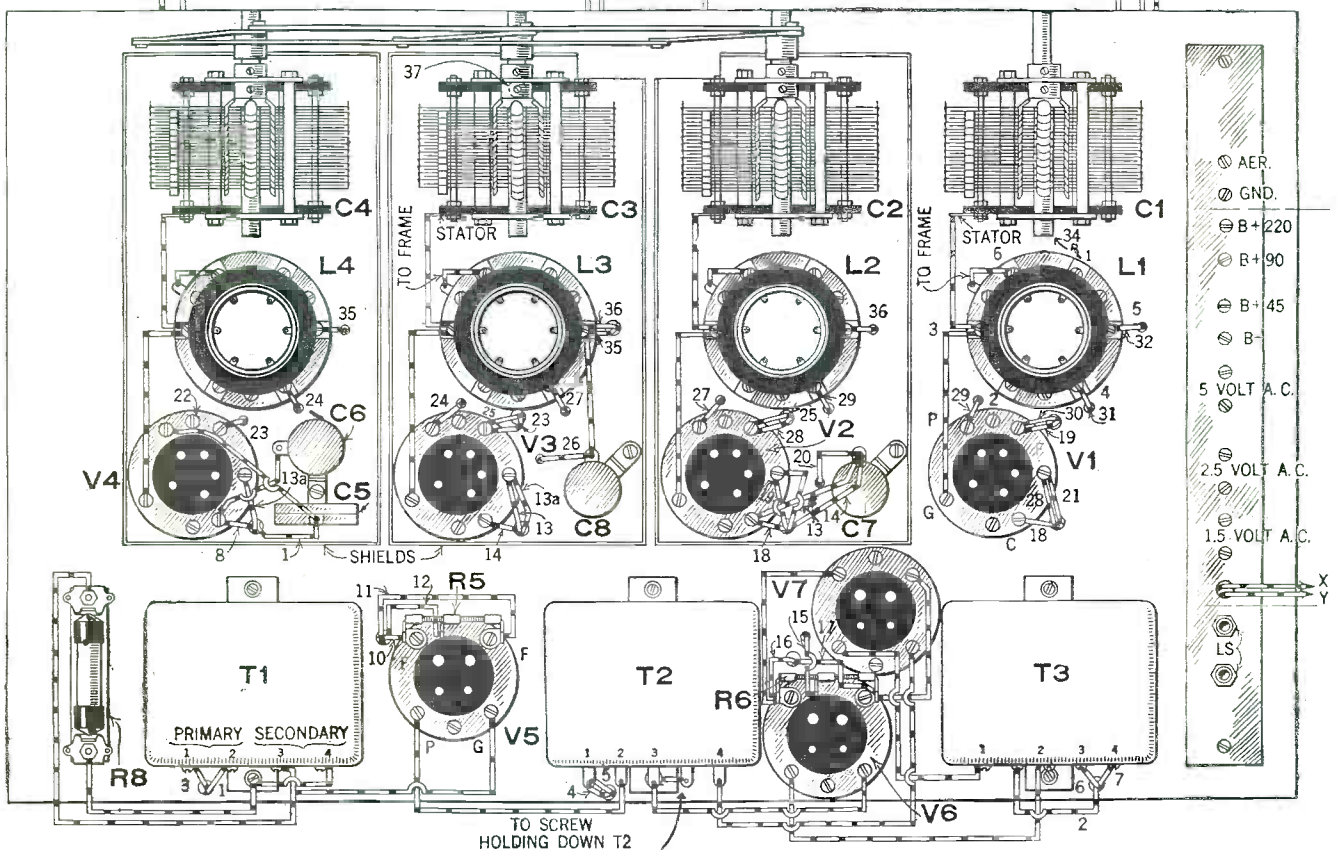
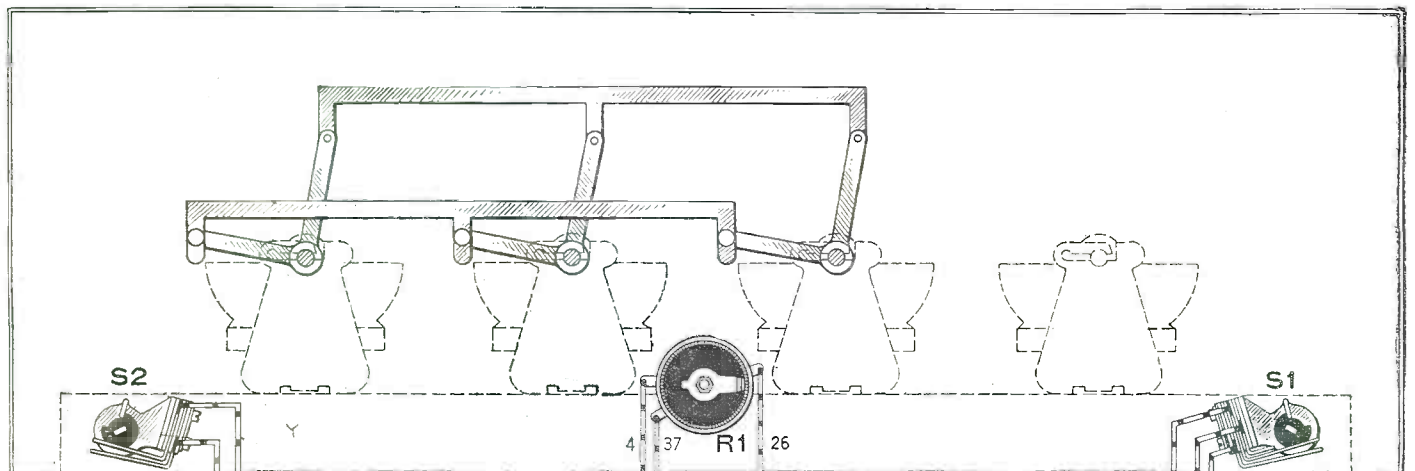

How the connections are made to the pieces of apparatus that are mounted on top of the sub-panel. The components are lettered to correspond with the other illustrations and list of parts. The link connectors for the condensers are illustrated to aid the constructor.

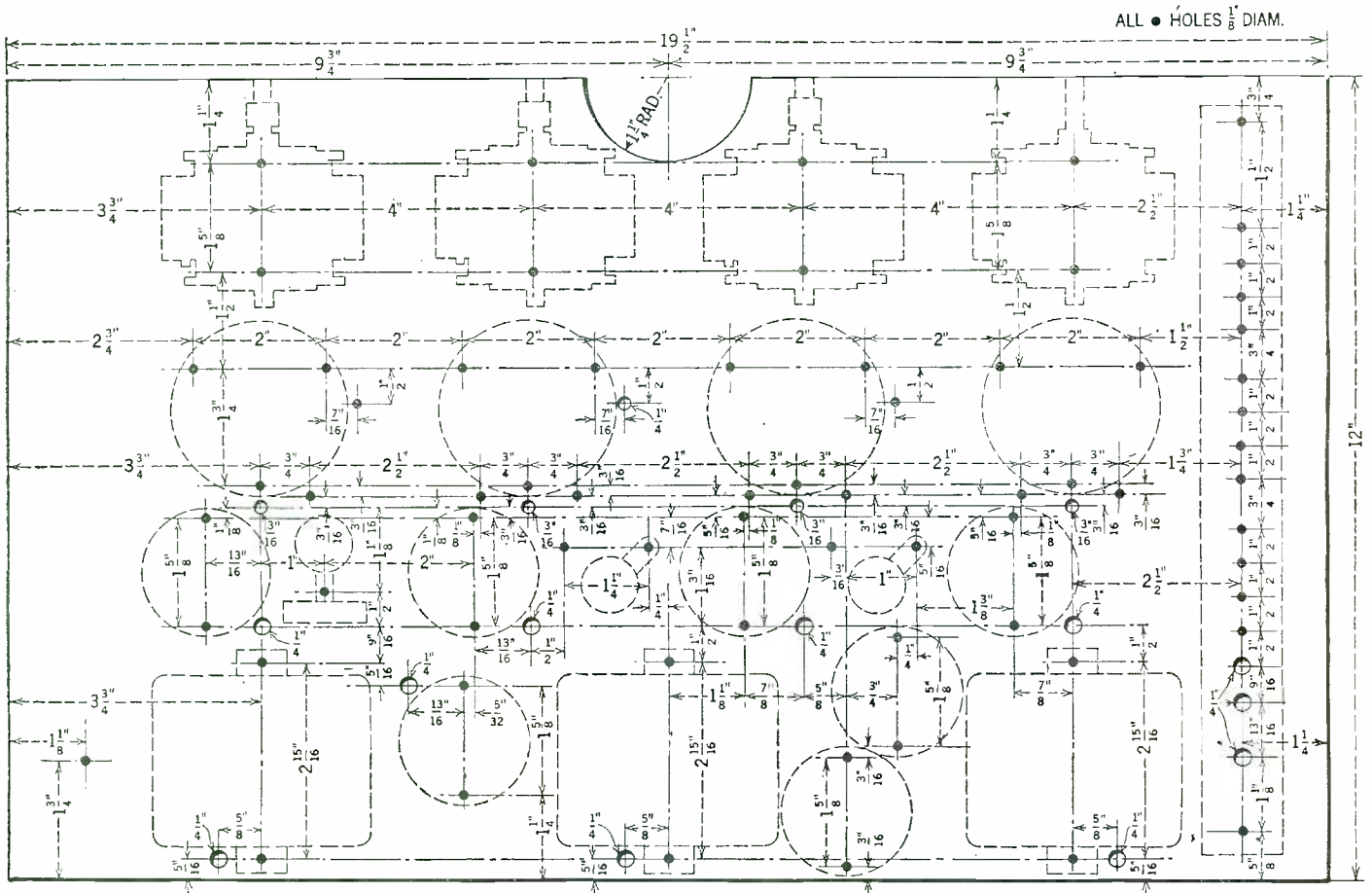

The drilling layout for the sub-panel. The different instruments are shown in dotted outline. Each hole is numbered in the wiring diagram below.

(cathode), are admirably suited to ultra-sensitive R.F. amplifiers and hence are employed in the Shielded Six.

The first audio amplifier is a CX-326 raw A.C. tube, which is entirely suited for first-stage audio work. The second audio stage

consists of two CX-371 power tubes in a push-pull amplifier circuit capable of delivering considerably more undistorted power out-

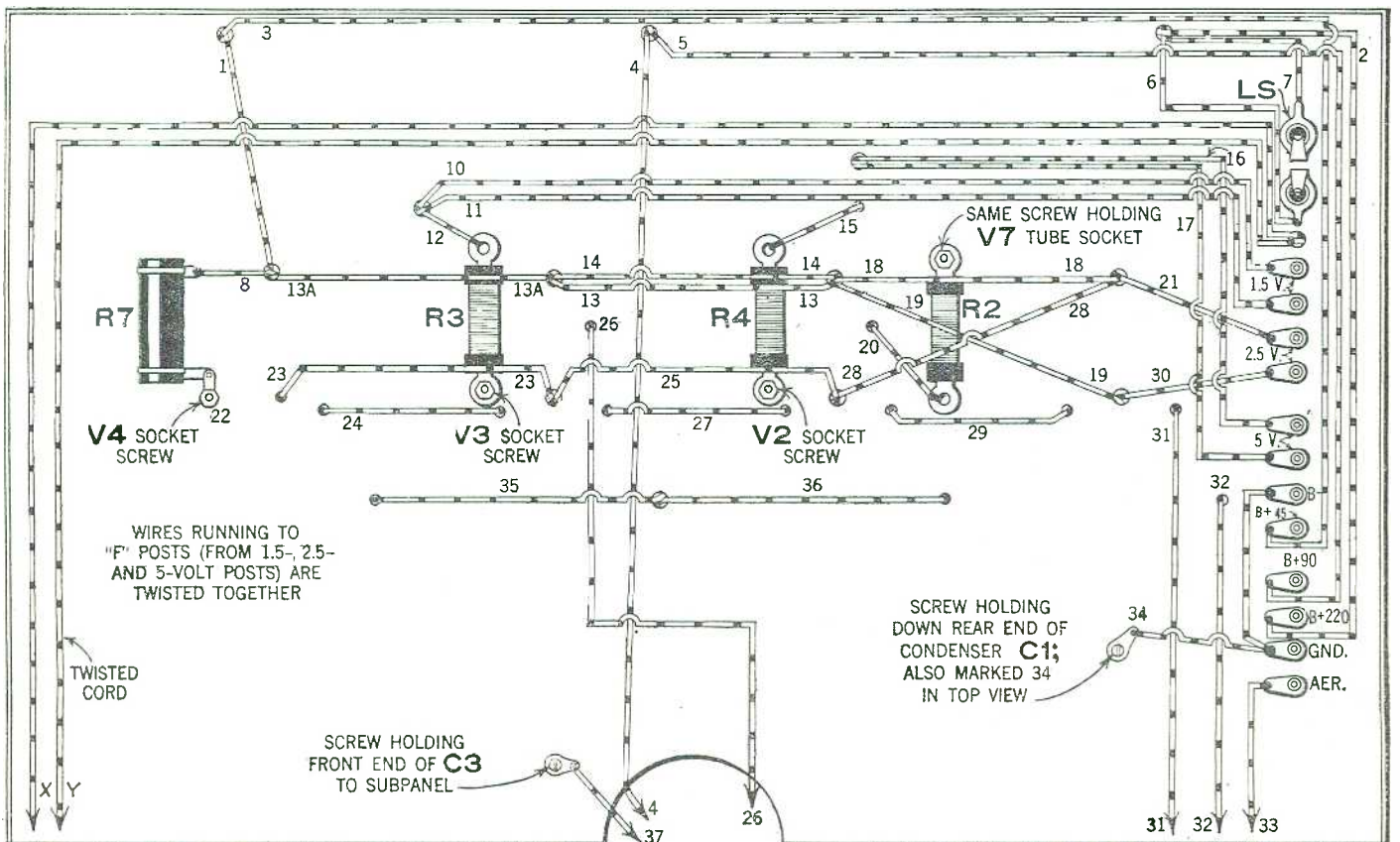

The wiring diagram for the under side of the sub-panel. The holes are numbered to correspond with those in the diagram on the opposite page.

put than will the average 210 power pack employing only one amplifier tube. The CX-371s are not strictly A.C.-type tubes, but are entirely suited for last-stage audio work with direct A.C. excitation of the filaments. The push-pull feature is optional, and the receiver as available in kit form is provided with a

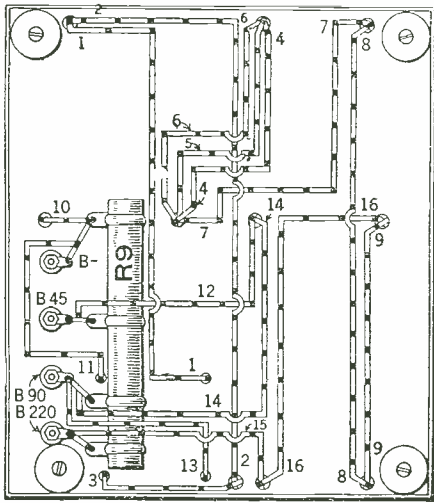

The greater part of the wiring of the socket-power unit is run beneath the sub-panel. The only apparatus on the under side is the tapped resistor, R9.

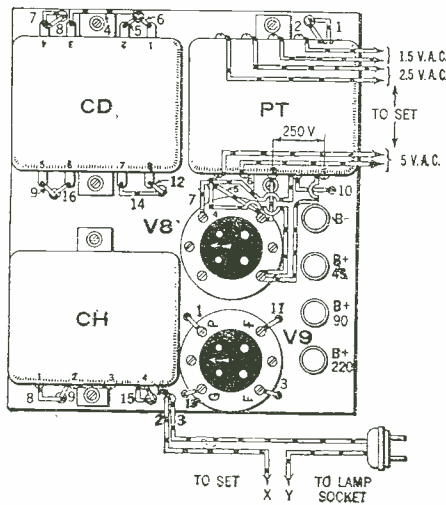

CD is the filter condenser; PT, the power transformer; CH, the choke; V8, the rectifier and V9, the voltage-regulator tube.

straight 171 power output stage which delivers ample volume for the majority of homes. The set illustrated herewith uses the push-pull arrangement.

SOCKET-POWER UNIT

Power for the receiver is obtained through a power-supply device, which is essentially

a very carefully designed "B" socket-power unit incorporating automatic voltage regulation by a glow tube and a special selective filter circuit for extreme freedom from hum, required in such a set as the Shielded Six. This power unit consists of a step-up transformer carrying two 250-volt windings, and

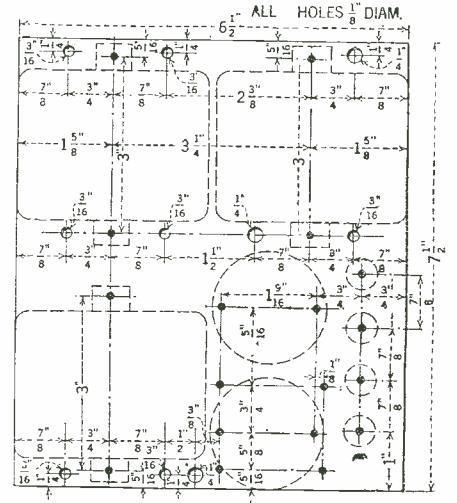

The drilling layout for the sub-panel of the socket-power unit. In the other diagrams on this page the holes are numbered, correspondingly, to facilitate wiring.

an 85-milliamperere full-wave gaseous rectifying tube. The output of this tube is filtered through a single double-section choke coil and a special combination of condensers providing a selective circuit resonant at 120 cycles—the fundamental ripple of the rectified output. The filter delivers to the voltage dividing resistor a total of 220 volts at approximately 82 milliamperes. Of this, a portion is drawn by the glow tube, to be given up to the receiver under the instantaneous demand imposed by strong signals; the remainder goes directly to the plates of the power output tube.

Filament excitation is obtained from three separate filament-lighting windings carried by the power transformer. One winding of 2.5 volts lights the four CX-327 heater tubes; another winding of 1.5 volts lights the CX-326 first audio-stage amplifier; and the third winding of 5 volts lights the CX-371 power output tubes. "C" potential for the various circuits is obtained by means of four resistors inserted in the common grid and plate returns; the voltage drop developed in operation serves to bias the various tube grids to the proper value. The by-passing of these resistors and other portions of the circuits has been very carefully considered and worked out; and, in constructing the receiver, it is vitally important that specifications be adhered to exactly, in order that the maximum results from the circuit design be realized.

In operation, the power unit is connected to the receiver terminal strip by means of three twisted pairs of wires for the three A.C. filament circuits, and four high-voltage connecting leads. Thus a total of ten wires to the power unit and receiver are all that are necessary, plus a short length of twisted lamp cord, which is run from the "on-off" switch to one side of the 110-volt cord of the power-supply unit. These leads may be cabled and the power unit placed either a few inches away from the left end of the receiver with short leads, or beneath the set on the floor, or on the bottom of a console cabinet. The leads from power unit to receiver should, preferably, be not over three to four feet long. Since there are no batteries to wear out, the receiver is practically free from servicing trouble other than the occasional replacement of a tube, at intervals varying from three to four months to a year or more.

(Continued on page 522)

SYMBOL	Quantity	NAME OF PART	REMARKS	MANUFACTURER *
C2-C3	2	Variable condensers	Type 316A	1
C3-C4	2	Variable condensers	Type 316B	1
L1	1	Tuning coil	Type 116A	1
L2-3-4	3	Tuning coils	Type 116A (matched)	1
	4	Coil sockets	To accommodate plug-in coils L1-4	1
V1-4	4	Tube sockets	For five-pin tubes	1, 13, 14
V5-7	3	Tube sockets	For standard four-prong tubes	1, 13, 14
T1	1	A. C. transformer		1
T2	1	A. C. transformer	Push-pull type; output model	1
T3	1	A. C. transformer	Push-pull type; output model	1
	1	Triple link motion	Connects condensers C2, C3 and C4	1
C5	1	Fixed condenser	.002 mf.	2, 7
C6-7-8	3	Fixed condensers	.5 m.f. each; special round type #105	2
R1	1	Potentiometer	Model HW6000 (6000 ohms)	2
LS	2	Tin jacks	For loud speaker	2, 15
R2	1	Fixed resistor	Model HW600 (600 ohms)	2
R3-R4	2	Fixed resistors	Model HW200 (1000 ohms)	2
R5-R6	2	Tapped resistors	Model FT64	3
R7	1	Fixed resistor	5000 ohms	4
	2	Vernier dials		5
	1	Terminal strip	With terminals #63; AC	1
	1	Front panel	Brass, drilled and engraved 7" X 27"	1
	1	Steel chassis	12" X 19 1/2" X 1 1/2"	1
S1	1	Antenna switch	Single pole, double throw type	2, 15
S2	1	On-off switch		2, 15
	1	Connection wire	With screws, nuts and lugs	6
	1	Resistor sockets		7
R8	1	Fixed resistor	250,000 ohms	7
PT	1	Power transformer	Type 322A	1
CH	1	Choke coil unit	Type 331	2
CD	1	Filter condenser	Type 511	2
	2	Tube sockets	Standard four-prong type	1
R9	1	Tapped resistor	Type 659	1
	1	Steel base	7" X 7" Type #654	1
V1-4	4	Vacuum tubes	A.C. heated cathode type #326	8, 10, 11
V5	1	Vacuum tube	Full A.C. type #327	8, 11, 11
V6-7	2	Vacuum tubes	371 type	8, 10, 11
V8	1	Rectifier tube	Full-wave filamentless type	9, 11, 12
V9	1	Voltage regulator tube		9, 10, 12

NUMBERS IN LAST COLUMN REFER TO CODE NUMBERS BELOW.

1 Silver-Marshall, Inc.	2 Carter Radio Company	3 H. E. Frost, Inc.
4 C. E. Mountford Co. (Kroblak)	5 Martin-Copeland Co. (Mar-Co)	6 Kellor Switchboard & Supply Co.
7 Polymet Mfg. Company	8 E. F. Cunningham, Inc.	9 QRS Music Company
10 Radio Corporation of America	11 C. E. Mfg. Co. (CeCo)	12 Ravinham Mfg. Company
13 General Radio Company	14 Benjamin Electric & Mfg. Co.	15 Yaxley Mfg. Company
16	17	18

* THE FIGURES IN THE FIRST COLUMN OF MANUFACTURERS INDICATE THE MAKERS OF THE PARTS USED IN THE ORIGINAL EQUIPMENT DESCRIBED HERE.

If you use alternate parts instead of those listed in the first column of manufacturers, be careful to allow for any possible difference in size from those originally used in laying out and drilling the panel and sub-base.



The Super-Hilodyne Circuit

A Description of a New Tuning System Incorporated in a 9-Tube Receiver



By F. A. JEWELL

THE TUNING CIRCUIT

Let us consider the path followed by a signal picked up in the antenna circuit. This signal is passed from the antenna inductance L1 to the secondary L2. C1 is a variable condenser and tunes this input circuit. The signal charges the grids of the tubes, VT1 and VT2, negatively and positively, alternatively. However, the grids of these tubes are connected in opposing potential relation to each other (push-pull): and when the grid of VT1 is negative, causing a drop in the plate current of that tube, the grid of VT2 is positive, causing an increase in the plate-current flow of this tube in about the same proportion as the drop of current in VT1. Therefore, if the coil, L3, is completely short-circuited by the resistor, R2, the flow of current at the point, X, will always be the same, as the plates of VT1 and VT2 are in parallel just opposite to the input circuit. No matter how carefully the signal is tuned in the circuit, L2-C1, the variation of the current at the point X would

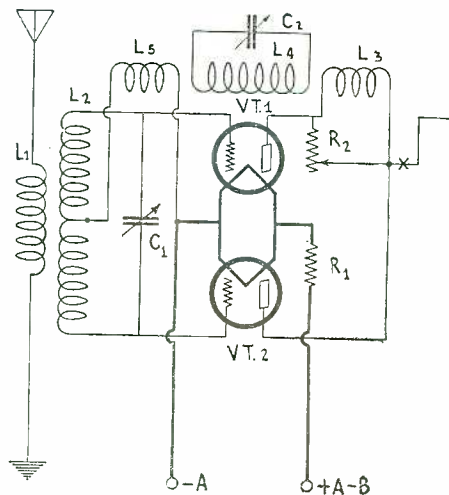

FIG. 1

The tuning circuit of the Super-Hilodyne uses two vacuum tubes in push-pull as shown in the above diagram. Only two variable condensers, C1 and C2, are used for tuning the receiver.

ONE of the most interesting circuits that has been brought to our attention in some time is described in the following article. The tuning system is an innovation and the method of controlling the regeneration in the intermediate radio-frequency amplifier is one which has considerable merit. According to the theoretical aspect of the circuit it would seem as if this arrangement should appeal to the DX hunter, as well as to the man who would be willing to sacrifice distance for quality of reproduction, if necessary. Constructional details of this receiver will be published in a forthcoming issue of this magazine.—EDITOR.

MUCH has been done in the development of radio circuits since the days of the old regenerative single-circuit tuner, but up to the present time the designing engineers admit that they are still some distance from the coveted goal

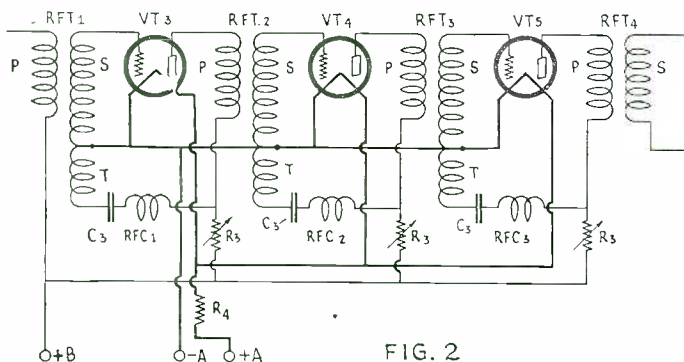

FIG. 2

Here is shown the intermediate radio-frequency amplifier of the Super-Hilodyne circuit. The system of maintaining these stages just under the point of oscillation is the Hilograd, described elsewhere in this issue. (See the article, "The Hilograd 6 Receiver," on page 488.) Once the three variable resistors are properly set, no further adjustment is necessary.

variable signal flowing in this coil if the resistor, R2, is opened.

THE SUPER-HILODYNE THEORY

The trap circuit, L4-C2, is tuned to the frequency which we desire to receive, L4 being in inductive relation to L3. The particular frequency to which L4 and C2 are tuned is picked up by the coil, L5, and is conductively coupled to the grids of VT1 and VT2 through the coil, L2. The current flowing in L5 charges the grids of the two tubes in phase just opposite to that of the current picked up in the antenna coil. Therefore, the grid of VT1 is reinforced by the current transferred from L3 to L5 through L4, while the grid input of VT2 is balanced out, thus causing no current flow from the plate to the point X, no matter to what frequency L4 is tuned. A correspondingly greater current flows in the plate circuit of VT1. Therefore, an amplified current, at whatever frequency is by-passed by L4, flows in the primary of the radio-frequency transformer, while all the other signals are cancelled out.

(Continued on page 552)

of the perfect radio receiver. These Knights of the Laboratory are still striving diligently and the resulting circuits that are being produced show that they are progressing more and more toward their goal.

The qualifications for a perfect radio set may be said to be as follows: quality of faithful reproduction; absolute selectivity; ample volume; unlimited range; stability of operation; simplicity in tuning and elimination of undesirable interference. We will endeavor to show that the Super-Hilodyne receiver approaches very closely to these qualifications.

In Fig. 1 is illustrated the tuning portion of the receiver. Only two variable condensers are needed to obtain a high degree of selectivity without danger of cutting off any sidebands. This circuit functions as a wave-trap which completely cancels all signals except the frequency which we desire to receive. Because of this fact the set is able to operate below the static level; as only the static on the particular frequency that is to be received is passed, the remainder being cancelled out. Incidentally, the set is also able to work with no interference under the towers of a broadcast station and in congested districts, as well as in locations where interference from local sources is very pronounced.

No claim is made that this circuit eliminates static and all other interferences; but it does confine such interference to the one frequency that is received by cancelling out the rest.

be zero. This circuit is then neutralized, as signals of all frequencies are balanced out.

This circuit would be absolutely worthless as a receiver if we were to allow it to remain in its present condition; but let us consider it a bit further. A variation of current exists between the plates of the two tubes and the point X. By connecting L3 in series with the plate of VT1, we have a

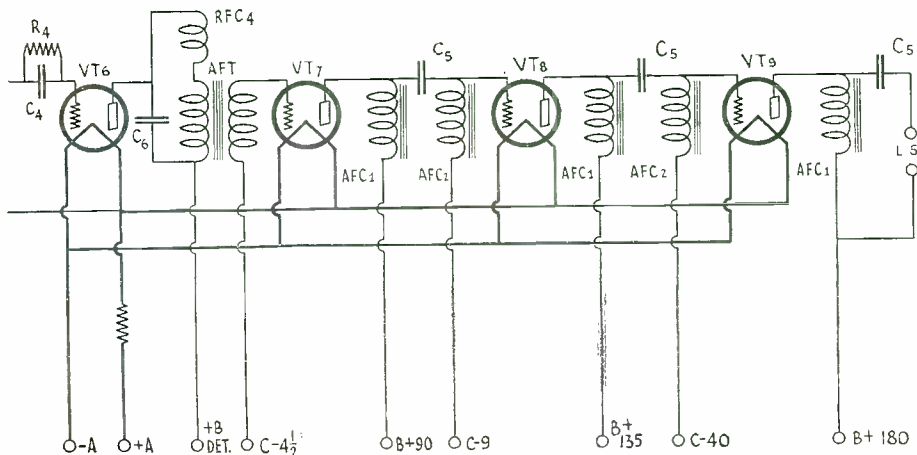

FIG. 3

The detector and audio-frequency amplifier. In the latter the dual-impedance system of amplification is employed, thus insuring excellent quality of reproduction.

The Pilot "De Luxe" A.C. Operated Set

Geloso Circuit Makes Socket-Power Set Simple and Inexpensive

By M. B. SLEEPER

THE receiver described in this article will appeal even to the less-experienced radio-set constructor, because its assembly involves only a small amount of labor. The R.F., detector, and A.F. units are factory-built products, supplied in ready-wired form. The constructor need only mount them in place, and run a few connecting wires, to produce a complete receiver. The set works on alternating house current, without batteries of any kind.

—EDITOR.

WHEN you study the outstanding features of the Geloso circuit, which is used in the new Pilot De Luxe A.C. Receiver, you will wonder why such difficult methods have been used in the past to accomplish results which Geloso achieves in such a simple manner. By way of explanation, John Geloso won his spurs as an engineer and manufacturer of precision electrical instruments in Italy.

The plan behind the development of the Geloso circuit was to produce high-grade results with a much lower expenditure for equipment than has been possible in previous practice. Without going into the faults of other systems, let me review the actual accomplishments in this new circuit.

SMALL CURRENT REQUIREMENTS

Laboratory tests have shown that the combination of 199-type tubes, with a 171-type in the power amplifier, produces ample sensitivity and sufficient amplification for all requirements of radio entertainment in the home. This was an important step, because it showed that the expense of power-supply circuits to handle 201A-type tubes is not necessary.

Now, about filament control for the 199-type tubes; circuits which have used these in series have always required a variable high resistor in series with the tube. Practical experience shows the difficulty of producing a dependable rheostat of 3,000 ohms, capable of carrying 60 milliamperes, at any reasonable cost. Therefore, set builders have resorted to various substitutes.

Incandescent lamps have been used as resistors; but they are most unsatisfactory, because they give a current adjustment more

often either above 60 milliamperes—thus reducing the life of the filament—or else below 60 milliamperes, reducing the efficiency and volume. Rheostats have been employed; but the wire-wound types usually

across the series of four tubes. Therefore, the rheostat carries the excess current only; about 10 milliamperes.

The 3,000-ohm rheostat can handle considerably more than 10 milliamperes, so that it is not overloaded. The resistance is constant, since the rheostat is wire-wound, and provides an accurate current control.

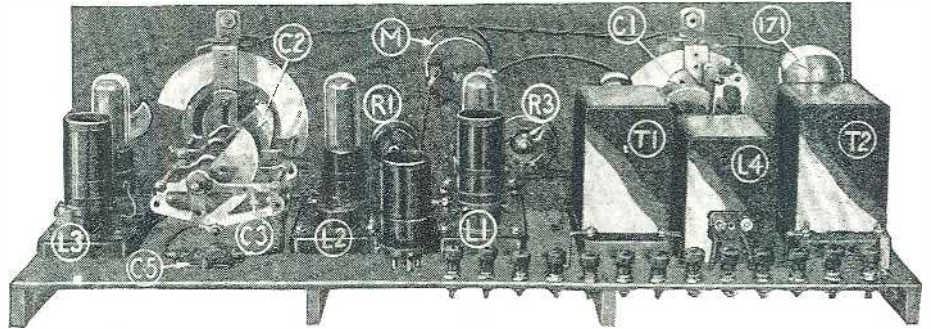

Back view of the completed receiver showing how the various R.F. and A.F. units are placed along the sub-panel, C1, C2, C3, tuning condensers; L1, L2, R.F. units; L3, detector unit; T1, T2, audio units; R1, volume control; R3, filament rheostat; M, milliammeter; L4, output choke; C5, fixed condenser; 171, power tube.

break down from overheating, while the compression types generally fail to remain constant.

The Geloso circuit solved this problem in the simplest manner possible. If 199-type tubes are connected in series, the voltage

Everyone who has had experience with 199-type tubes knows that a negative grid return must be used on the R.F. tubes, and a positive return on the detector tube. If you have tried to accomplish this with any of the standard circuits, and at the same time used a double condenser for tuning the second R.F. and detector stages, you know that the circuit is greatly complicated by by-pass condensers and is altogether quite unsatisfactory.

All that is due to the old ideas about the order in which the series filaments should be connected. Geloso exploded this policy by using a new arrangement for the filament connections, and obtained the correct grid returns, with the proper bias on the first audio tube—a very important factor in the circuit—in the simplest possible manner, doing away with all the complications found in other hook-ups. The Geloso hook-up,

translated into physical set design, is quite in keeping with the cleverness displayed in the electrical circuit.

PREPARED UNITS OF ASSEMBLY

The important feature of the design is the use of certain new complete-stage units called "Redi-Blox"; these are made for R.F., detector, and A.F. circuits. Both transformer- and resistance-coupled units are available for the audio circuits; but the transformer type was chosen for this set.

Each audio unit comprises a heavy A.F. transformer and a tube socket, mounted on a base of the dimensions given in the next paragraph.

The important thing about these units is that the internal wiring is done by the manufacturer. Therefore, there is no chance that the set builder will leave any loose grid connections or let any soldering paste get where it will make trouble around the tube socket; for the wiring is done with strips in a very solid and substantial manner. All units have bases of the same size, measuring $2\frac{3}{8} \times 5$ inches, and only $5\frac{1}{4}$ inches in height from the bottom of the base to the top of a 201A-type tube. These units are adaptable to circuits of all types and can be readily changed from one to another in a few moments. Terminals are arranged so

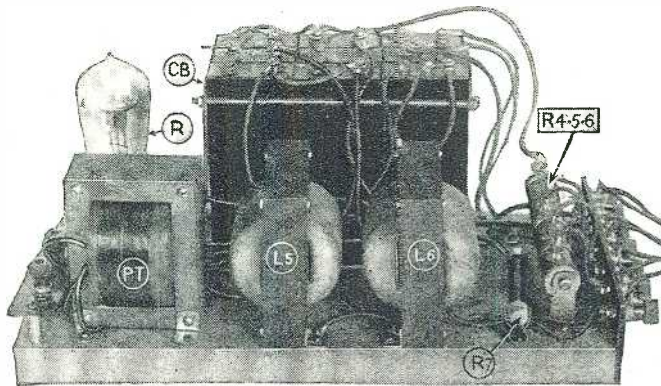

The power unit which furnishes the "A", "B" and "C" power for the receiving set. PT, power transformer; R, rectifier tube; CB, condenser bank; L5, L6, filter chokes; R4, 5, 6, 7, fixed resistors.

applied would be high enough to put about 70 milliamperes through the tubes, if no current control were employed. Accordingly, Geloso used the 3,000-ohm rheostat connected

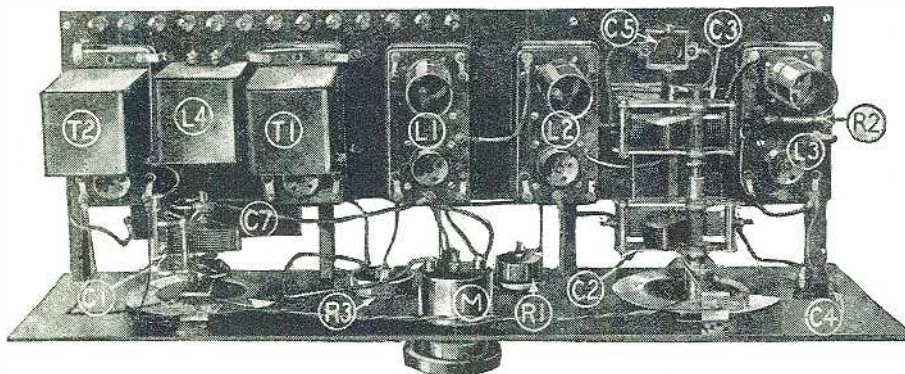

How the De Luxe A.C.-Operated set appears when viewed from above. The symbols on the various parts correspond with those shown in the back view, also printed on this page. R2 is the grid leak; C4 the compensating condenser connected across the variable condenser C3.

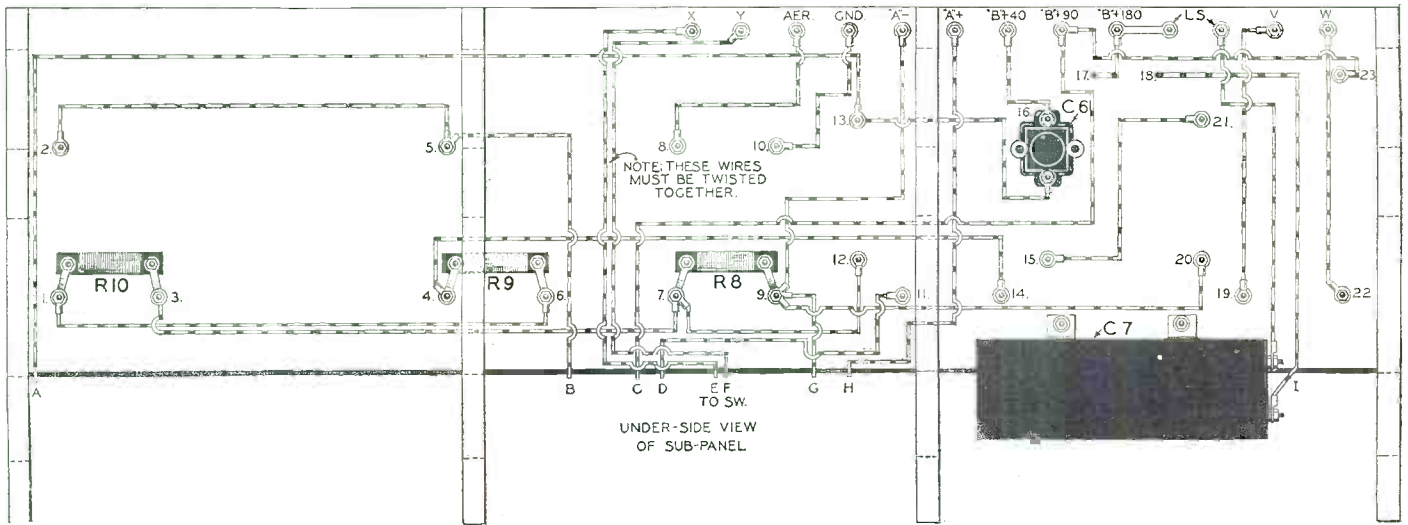

The fixed resistors R10, R9 and R8 are fastened by the same screws that hold the units L3, L2 and L1 to the sub-panel. All the numbers and letters in this under view correspond with those shown in the

wiring diagram below. Condenser C7 is held by two separate little L-shaped brackets, soldered to its case.

that any storage-battery or A.C. tube can be used, and connected in either series- or parallel-filament systems.

This De Luxe set is assembled on a front panel 7x24 inches, and a sub-panel 6x23 inches, of sheet micarta.

You can go through the assembly of the set with a speed that will leave you astonished. The wiring is done with flexible leads fitted with lugs, thereby eliminating all soldering, or bus bar may be used. Since the panels can be obtained ready-drilled and engraved, no toolwork is required.

SIMPLE ASSEMBLY

The accompanying drawings show the rear

of the front panel, the top and the bottom of the sub-panel, as well as the power unit on its baseboard, with the parts and wiring as they appear in the finished set. In addition, there are patterns for those who prefer to drill their own panels, a list of parts, and the following special instructions. The drawings are planned for use by inexperienced constructors, so that anyone can follow them with ease.

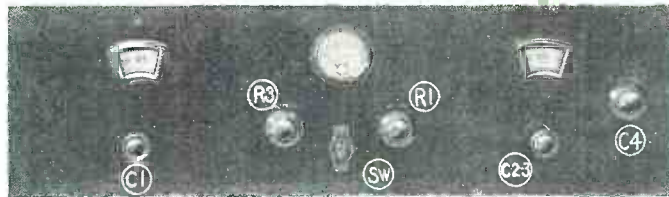

Panel view of the De Luxe receiver. C1 and C2-3 are the main tuning controls. R1, volume control; R3, filament rheostat; SW, switch; C4, midget condenser.

The drilled and engraved front panel, which is made up for the De Luxe A.C. set, is of walnut-finished micarta, although undrilled blank panels can

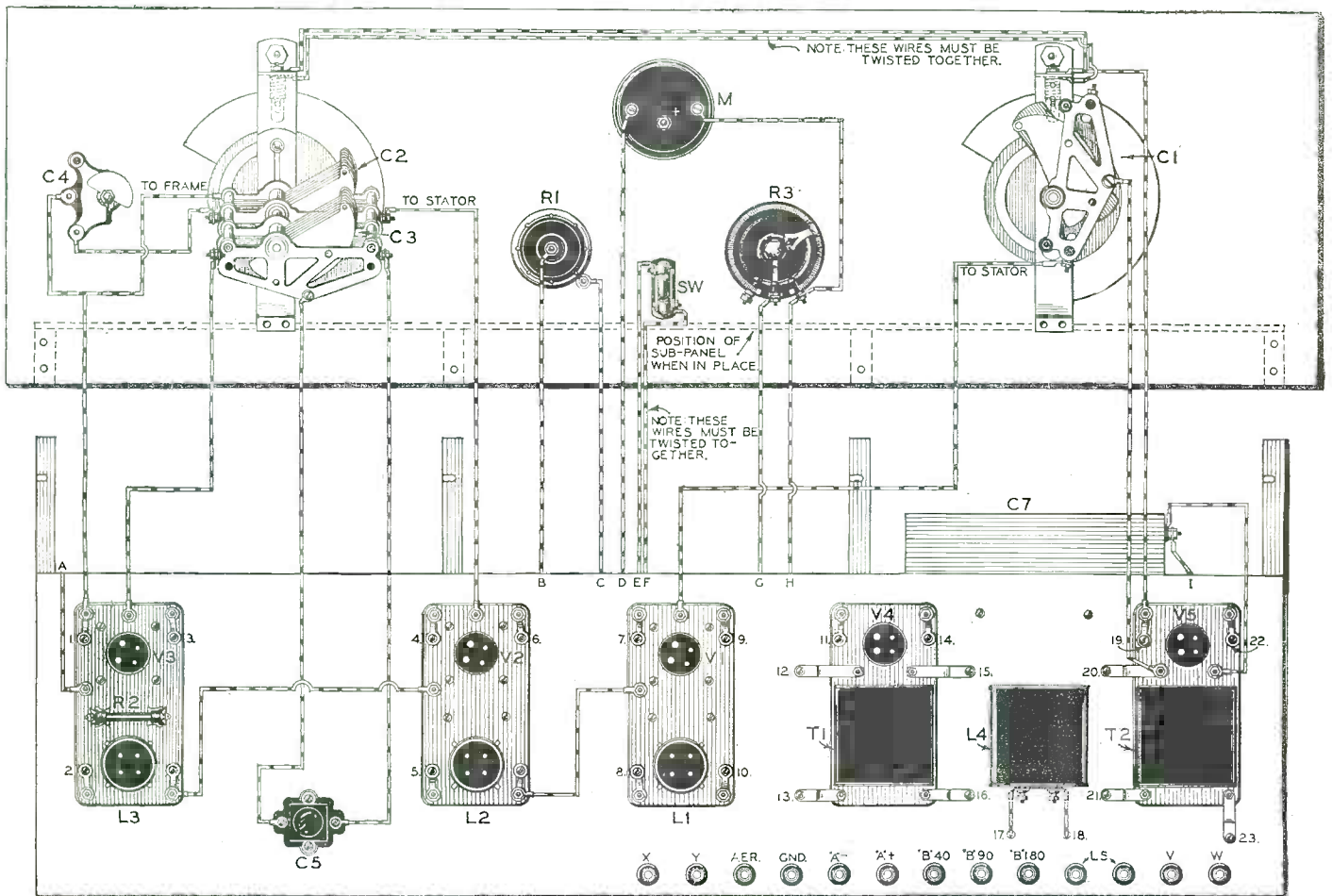

This pictorial wiring diagram, together with the one at the top of this page, will enable even the most inexperienced radio fan to wire the De Luxe A.C.-operated receiver. As each wire is put in place, a

pencil mark should be drawn along the line representing it in the drawing. When all the lines have been blackened, the constructor will know he has finished the wiring.

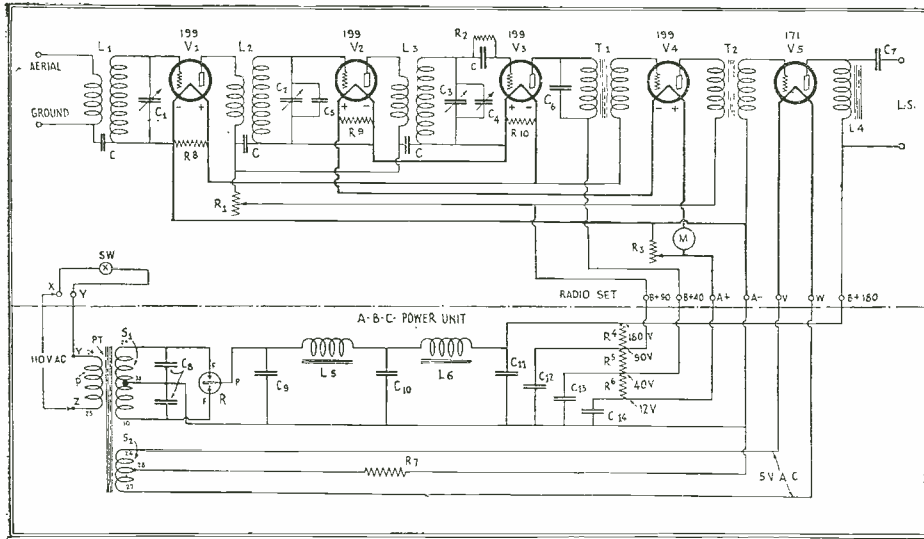

Complete schematic diagram of the De Luxe A.C. Operated radio set and its accompanying power-supply unit. The fixed condensers marked C are contained in the assembly units L1, L2 and L3, and are already wired properly inside these. The small numbers on the power transformer PT correspond to those in the pictorial layout, below and to the right.

be obtained if preferred. The parts should be mounted on the panel in the order listed mounted on the panel in the order listed.

PANEL MOUNTINGS

Mount the 7-plate midget condenser (C4) at the left end (looking at the set from the rear) of the front panel. This is held in place by a large nut at the front of the panel. Put the knob on so that the arrow is up when the condenser plates are intermeshed half-way.

Next comes the double condenser (C2-C3); mount the vernier dial as shown in the instructions which accompany it, and fasten the double condenser to the dial. With the latter is furnished a slotted piece, which should be fastened by a screw through the slot, going into a threaded bushing on the dial frame just above the condenser shaft. The other end of the piece must be fastened to the condenser by a screw going through the slot and into a threaded bushing on the condenser end-plate.

Put the variable resistor (R1) in place, clamping it firmly with the nut which goes on the front panel. Have the binding-post arm, between the resistor cover and the front panel, pointing downward.

Fasten the toggle switch (SW) in place by the two screws provided; putting them through the indicating plate, the front panel, and into the switch itself. You will notice that the switch is stamped "On" at one end. This marking should be at the top of the switch when it is in place. Mount the meter (M) in the large hole in the center of the panel.

The 3,000-ohm rheostat (R3), controlling the tubes, also, is made for center-hole

mounting. Looking at the rheostat from the rear, the center and right-hand terminals are used, and the left terminal unused. Turn the

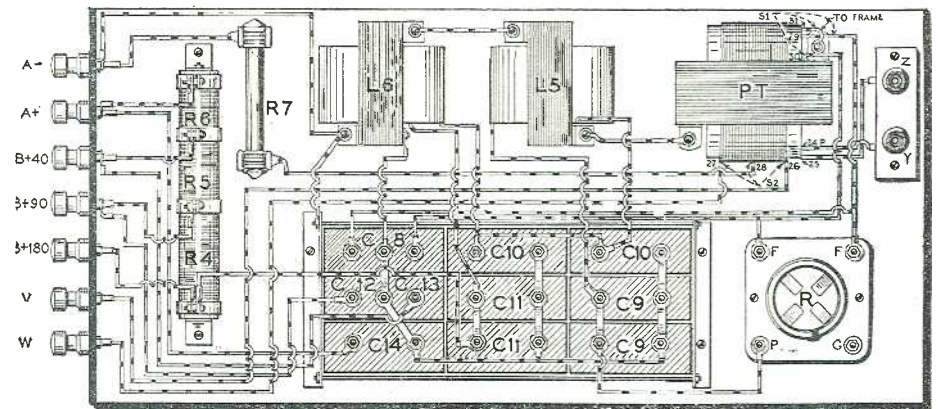

The wiring of the "A-B-C" power unit is simple, and can be followed with the aid of this picture diagram. PT, power transformer; R, rectifier-tube socket; C8-C14, condenser bank; L5, L6, filter chokes; R4, R5, R6, R7, fixed resistors. The 110-volt A.C. supply is connected between post Z (on this unit), and post X on the set.

contact arm all the way to the right and put on the indicating knob so that the arrow points toward the bottom of the panel.

Mount the single condenser (C1) with its vernier dial at the right-hand end of the panel, in the manner already described. Be sure that the light bulbs are in place.

SUB-PANEL ASSEMBLY

For the sub-panel, black micarta is used. It can be bought already drilled, or you

can drill your own according to the accompanying diagram. Mount the parts on the sub-panel in the order listed.

The detector unit (L3) is mounted with four 1/4-inch round-head screws and nuts. Be sure to have the spring tube socket toward the front of the set. Put a 2-megohm grid leak in the clips provided. Connect the 850-ohm by-pass resistor (R10) across the front-corner binding posts of the detector unit. Fasten the .0002-mf. fixed condenser (C5) to the sub-panel with 1/2-inch round-head screws; and with 1/2-inch screws fasten the lugs to the threaded terminals.

Fasten the four 1-inch sub-panel brackets to the base panel, using 1/2-inch oval-head screws. Do not use longer screws, or you will crack the brackets. The nuts are held in place by the recesses in the brackets, which must be mounted before the other units are put in place, for they cover some of the screws.

The second R.F. unit (L2) must be fastened in place with 1/4-inch round-head screws and nuts also. Put a lug under the heads of the mounting screws. Then put corresponding lugs on the corner binding posts, to make connections to the underside of the sub-panel. Fasten the 1,200-ohm by-pass resistor (R9) across the front-corner binding posts of the R.F. unit.

The first R.F. unit (L1) is mounted like the preceding; the same remarks concerning

the lugs on the mounting screws apply. Fasten the 650-ohm by-pass resistor (R8) across the front-corner binding posts of the R.F. unit.

Before the first A.F. unit (T1) can be mounted, the .002-mf. fixed condenser (C6) must be put in place. This is held by 5/8-inch round-head screws, which also hold the soldering lugs to the terminals of the condenser.

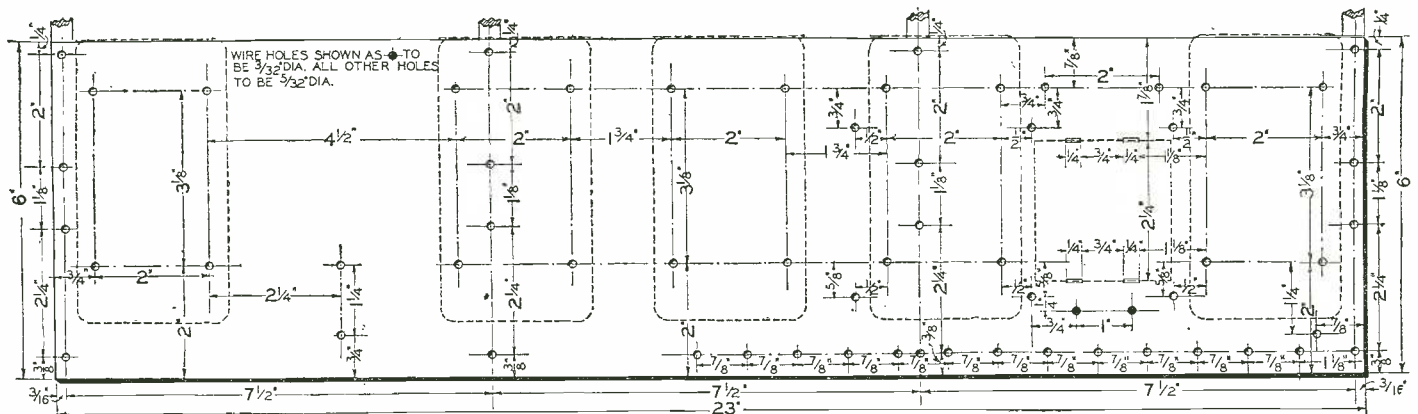

Drilling layout of the sub-panel, showing the exact location of every hole. This panel should be drilled and the fit of each part carefully tested before the instruments are mounted permanently upon it. The

dotted lines show the outline of the parts designated as L3, L2, L, T1, L4 and T2 (viewed from left to right).

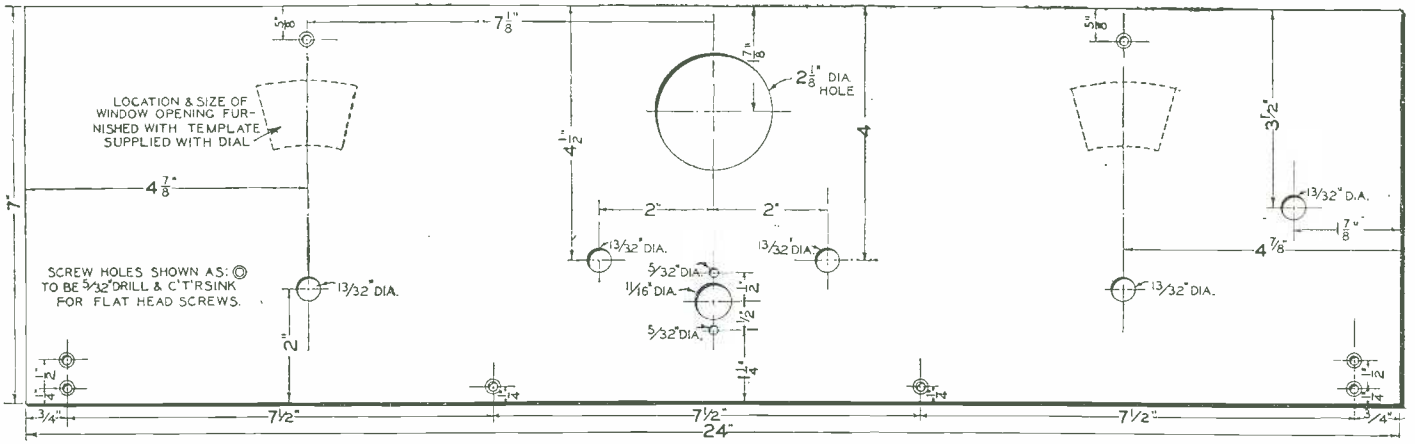

This working drawing, laid out to scale, shows the locations of all the holes in the front panel. In marking the panel, before drilling, the

constructor should be careful not to scratch or otherwise mar the surface.

For the first A.F. unit (T1) use 1 1/4-inch round-head screws, as before, for mounting. You will see that there are four 1/2-inch screws going through the sub-panel, with lugs above and beneath, for interpanel connection purposes.

The output impedance L4 is placed between the audio units T1 and T2, while the filter condenser C7 is mounted on the under side of the sub-panel; so that it is just under and behind variable condenser C1. Make sure that the binding posts of C7 face to the extreme right (looking at the set from the rear). These devices are easy to install and connect, and will give the constructor no trouble.

The second A.F. unit (T2) is mounted like the other units. There are three screws going through the sub-panel, with lugs above and below, for connections to the binding posts on the unit.

There are 13 engraved bakelite binding posts to be put in place. Be sure that you get them in the correct order. Otherwise, you will make mistakes in connecting the set to the power pack. In the screw of each binding post there is a hole to take connecting wires. When you tighten the binding post in place, put a small nail through the hole to keep the screw from turning while you tighten the nut underneath.

This set is designed for use with plug-in coils, which, with the condensers provided, cover approximately from 190 to 550 meters.

TESTING

Plug the coils into the fixed sockets, put the 171-type power tube in the left-hand unit and 199-types in the others. Make the necessary cross connections to the socket-power unit, and push the toggle switch up. Adjust the rheostat until the meter reads exactly 60 milliamperes. The light bulbs on the dials can be turned on or off at will.

Tune in a station by adjusting the two dials. If it is weak, you can bring the station up to full strength with the midget condenser (C4). Volume can be regulated by the resistor (R1). This control will affect the meter reading slightly. If it brings the needle down below 60 milliamperes, readjust the rheostat.

POWER UNIT

The illustrations show also the simple construction of the Gelsco power-supply unit, which operates with a 125-milliamper full-wave rectifier tube, and incorporates a power transformer (PT) and chokes, as well as a filter condenser. It will be noticed that the latter is made up of individual units clamped together. The gang clamp accommodates up to nine 2-mf. sections. It is necessary only to cut off the threaded rods at the sides, to fit the clamp to any number of condensers.

This arrangement is not intended particularly to allow the renewal of broken-down sections; for good filter condensers do not break down readily. However, this method has the advantage of permitting any combination of capacities. If the condensers were put together in a solid block, they might

be found unsuited for the various new socket-power circuits which are brought out from time to time.

If the filament current drops off, after a year or so of operation, it may be that the rectifier tube needs replacement. Other than this, there should be no difficulty of any sort.

SYMBOL	Quantity	NAME OF PART	REMARKS	MANUFACTURER *
L1-L2	2	R.F. tuning units	Special (include tube sockets)	1
L3	1	Detector unit	Special (include tube socket)	1
L4	1	Output choke	In plate circuit of power tube	1 9, 11, 35, 36, 37
L5-L6	2	Filter chokes	30 henries each; in power unit	1 9, 10, 11, 35, 36, 37
C1	1	Tube socket	For rectifier tube	1 3, 9, 10, 14, 16, 22, 23, 25, 29, 23
C1	1	Variable condenser	.00035 mf., S.L.F. type	1 3, 8, 9, 10, 11, 13, 14, 22
C3-C5	1	Variable condenser	Twin unit; .0025 mf. each section	1 3, 8, 9, 11, 13, 14, 22
C4	1	Midget var. cond.	Seven plates	1 8, 9, 10, 14
C5	1	Fixed condenser	.0002 mf. capacity	1 14, 17, 19, 20, 21, 26, 27, 28
C5	1	"	.002 mf. by-pass	1 14, 17, 19, 20, 21, 26, 27, 28
C7	1	"	2 mf.	1 17, 19, 20, 21, 26, 44
C8	1	Buffer condenser	Twin unit, 1 mf. each section; 100 volt	1 17, 19, 20, 21, 26, 44
C9-10-11	3	Filter condensers	4 mf. each; 300 volts working voltage	1 17, 19, 20, 21, 26, 44
C12-13	2	By-pass condensers	1 mf. each; 160 "	1 17, 19, 20, 21, 26, 44
C14	1	"	4 mf., 160 "	1 17, 19, 20, 21, 26, 44
R1	1	Variable resistor	Universal range type	1 13, 45
R2	1	Grid leak	2 megohm	2 3, 14, 18, 19, 20, 21, 25, 40, 41
R3	1	Rheostat	3,000 ohms (or potentiometer)	1 11, 14, 23, 29
R4	1	Fixed resistor	1,200 ohms	1 3, 17, 18, 21, 28, 39
R5	1	"	725 ohms	1 3, 17, 18, 21, 28, 39
R5	1	"	470 ohms	1 3, 17, 18, 21, 28, 39
R7	1	"	2250 ohms (for grid bias)	3 17, 18
R8	1	"	650 ohms; filament by-pass	1 17, 28
R9	1	"	1,200 ohms "	1 17, 28
R10	1	"	850 ohms "	1 17, 28
M	1	Milliammeter	0-80 milliamperes range; 2 1/2" diameter	4 9, 12
ST	1	Switch	117 volt type	1 13, 17, 22, 28, 29
	2	Dials	Illuminated vernier type	1 31
	1	Panel	7 X 24 X 1/8 inches	5 32, 38
	1	Sub-panel	5 X 23 X 1/8 inches	5 32, 38
	3	Brackets	To hold sub-panel	1 10, 22
	22	Binding posts		1 3, 8, 25, 28, 29, 33, 34
PT	1	Power transformer	550 volt & 5 volt tapped secondaries	1 9, 10, 11, 35, 36, 37
	1	Baseboard	13 X 6 X 1 inches wood; for power unit	
	1	Binding post strip	4 X 2 X 1/8 inches for power unit	
	3	Vacuum tubes	132-type	6 42, 43
	1	Vacuum tube	171-type	6 42, 43
R	1	Rectifier tube	Filamentless type	7 42, 43
T1-T2	2	A. F. units	Special (include sockets & transformers)	1 1

NUMBERS IN LAST COLUMN REFER TO CCDE NUMBERS BELOW.

1 Pilot Electric Mfg. Company	2 Tridet Electric Company, Inc.	3 Amaco Products, Inc.
4 Jewell Electrical Instrument Co.	5 Micarta Fabricators, Inc.	6 E. T. Cunningham, Inc.
7 Raytheon Mfg. Company	8 Homarlund Mfg. Company	9 General Radio Company
10 Silver-Marshall, Inc.	11 Sanson Electric Company	12 Weston Electrical Instrument Co.
13 Central Radio Laboratories	14 Debur Products Company	13 United Scientific Lab. (U.S.L.)
14 Cutler-Hammer Mfg. Company	15 Carter Radio Company	14 Electro-Ed, Inc.
15 Dabiller Condenser Corp.	16 Tube Deutschland, Inc.	15 Aerovox Electrical Corp.
16 Benjamin Electric Mfg. Co.	17 Precision Mfg. Corporation	16 Electrical Research Lab. (E.R.L.)
17 American Radio Hardware Corp.	18 Polomat Mfg. Corporation	17 Micacold Radio Corporation
18 Yaxley Mfg. Company	19 Harbert H. Frost, Inc.	18 Gray & Danielson Corp. (Remlar)
19 Martin-Copeland Co. (Mar-Co)	20 American Hard Rubber Co. (Radion)	19 X-L Radio Lab.
20 H. H. P. Mfg. Company	21 Acme Apparatus Co.	20 Thorntons Electric Mfg. Co.
21 American Transformer Co.	22 Formica Insulation Co.	21 War-Learner Electric Co.
22 International Resistance Co.	23 Arthur H. Lynch, Inc.	22 G.E. Mfg. Company (DeCo)
23 QRS Music Company	24 Inrad Condenser & RA-19 Co.	23 American Mach. Lab. (Alloparat)
24	25	24

* THE FIGURES IN THE FIRST COLUMN OF MANUFACTURERS INDICATE THE MAKERS OF THE PARTS USED IN THE ORIGINAL EQUIPMENT DESCRIBED HERE.

If you use alternate parts instead of those listed in the first column of manufacturers, be careful to allow for any possible difference in size from those originally used in laying out and drilling the panel and sub-base.



Hook-up Review



STARTING with this number, RADIO NEWS will contain each month a department devoted to short reviews of radio receivers and auxiliary equipment which have already been described elsewhere. The purpose of the new section is to familiarize our numerous readers with some interesting sets and apparatus they might not otherwise see or hear about; and to acquaint them with the electrical and mechanical features of the instruments.—EDITOR.

THE "WORLD'S RECORD" SUPER TEN

TWO stages of straight tuned R.F. amplification are combined with a superheterodyne in the "World's Record" Super Ten to produce a receiver of unusual sensitiveness and selectivity. As with many other multi-tube sets, such a combination does not indicate complexity, for this receiver is a two-dial instrument which is easy both to build and to operate.

The two-stage R.F. amplifier, feeding into the first detector, is tuned by a triple condenser, which is controlled by an illuminated drum dial on the panel. Following the first detector and its associated oscillator tube is the intermediate-frequency amplifier, composed of three stages. This works into a non-regenerative second detector and a two-stage, transformer-coupled A.F. amplifier. The loud speaker is connected to the last tube

through an output transformer, which keeps the heavy D.C. of the plate supply out of the delicate speaker windings.

A second illuminated control drum on the panel turns a single variable condenser, which tunes the oscillator circuit.

The following parts are used in the Super Ten:

One "Selectone" antenna coupler, type B-530; two "Selectone" R.F. transformers, type B-520; one "Selectone" oscillator coupler, type B-540; four "Selectone" I.F. transformers, two type B-500; two type B-510.

Two Thordarson A.F. transformers, type R-200; one Thordarson output transformer, (Continued on page 512)

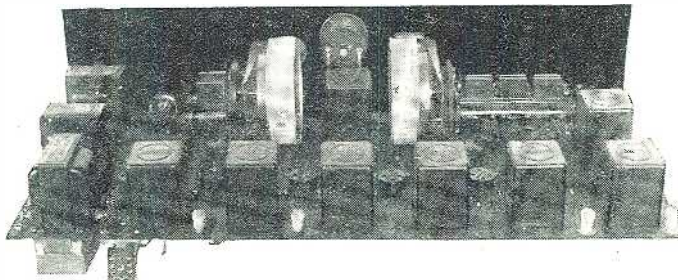

Left: The inside of the Super Ten, showing how the various R.F. and I.F. transformers are spaced over the baseboard.

Below: Complete schematic hook-up of the set.

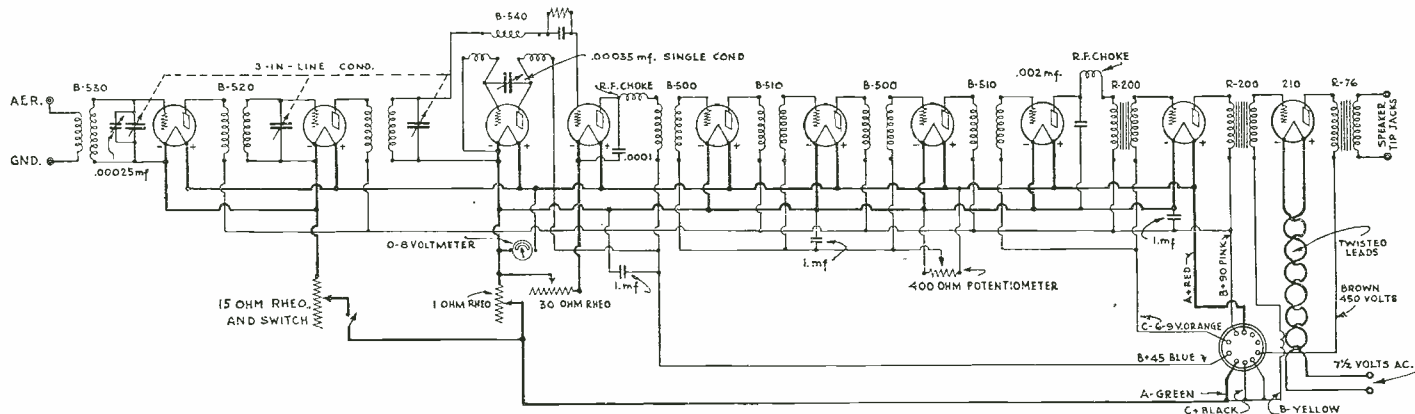

THE KARAS TWO-DIAL EQUAMATIC

THIS receiver represents an advance in design and construction over the well-known three-dial Equamatic, which has enjoyed great popularity among radio constructors because of its automatic coupling-control feature. It embraces two stages of tuned R.F. amplification, a non-regenerative detector, and two stages of transformer-

coupled A.F. amplification, with an output filter to protect the loud speaker. The R.F. circuit is substantially the same as that used in the original model, with the addition of two balancing condensers and two R.F. chokes. The variable condensers tuning the second R.F. and detector circuits are linked together, and thus controlled by a single dial. The second dial operates the condenser across the secondary of the antenna coupler.

The parts for this excellent receiver are

available in convenient kit form. The front panel and the sub-panel, as supplied, are completely drilled and engraved. The complete list of components is as follows:

Two Karas audio transformers, type 28; one Karas output filter; three Karas variable condensers, type 17; three Karas "Equamatic" coupling coils; two Karas "Micrometric" dials, 0-100; three Karas sub-panel brackets; one Karas control system, including complete hardware; two Karas R.F. chokes, 100-millihenry; one bakelite front panel, engraved and drilled; 7x24x1/8 inches; one bakelite base panel, drilled, 9x23x1/8 inches; two Carter rheostats, one 10-ohm, one 20-ohm; two Carter filament-control resistors, one type H2, 2-ohm, one type H4, 4-ohm; one Yaxley interstage switch No. 69-B; two Carter tip jacks, No. 10; one Sangamo grid condenser .00025-mf., with grid-leak clips; one Amsco or Lynch grid leak, 2-megohm; one Yaxley cable plug; five Benjamin cushion sockets; two Samson variable neutralizing condensers, range 0 to .0007-mf.; five mica fixed condensers, two .0001-mf.; one .006-mf.; two .001-mf.; two 4 1/2-volt "C" batteries; three 2-foot lengths insulated sleeving; nine 2-foot lengths round bus-bar wire (tinned); one "X-L" aluminum binding post with "antenna" marker.

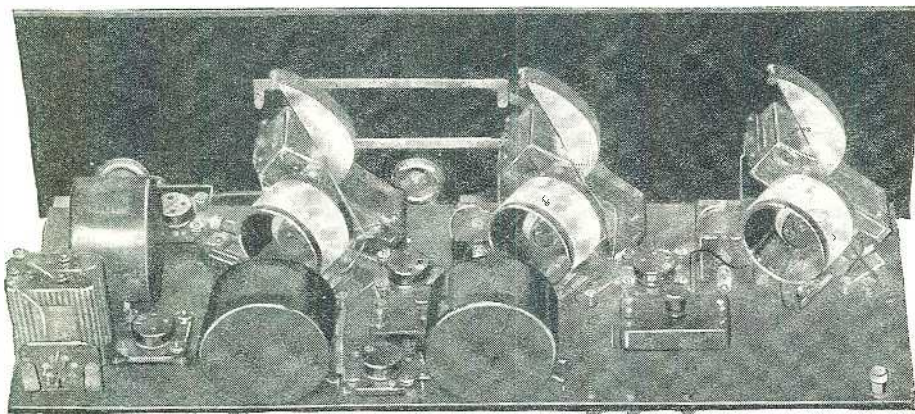

Rear view of the Two-Dial Equamatic. The two variable condensers on the left are linked together to turn as one. The round black cans are the audio units.



First Prize

CHARGER-POWER-UNIT RELAY

By H. R. Ringold

IN this device, the magnet consists of a 1/4-inch round-headed stove bolt 1 3/4 inches long, with two fiber washers, each 1 inch in diameter with a 1/4-inch hole drilled in the center. In the lower washer drill one 3/32-inch hole near the center hole and another of the same size near the edge for the end of the winding. Wind evenly 6, 8 or 10 layers of No. 22, 24 or 20 D.C.C. wire as shown, according to the number of tubes in the set. It is best to wind the spool nearly full of wire so that the magnet will have more pulling power. The coil may be inserted in the "A+" lead and tested before completing the assembly.

The base consists of a wooden board 3x4 x 3/4 inches, drilled as per model. The 1/4-inch hole for the magnet is drilled 1/8-inch from one end, on the center line. The contacts are Ford coil parts. The contact for No. 3 (see diagram) was the upper contact of the Ford coil, and removed from its mounting by drilling with a No. 2 drill the three rivets that held it.

This relay may be adapted to control the "B" socket-power unit by merely omitting the No. 5 assembly; and likewise for the trickle charger by reversing the contact on No. 4 and omitting contact No. 3. These may be added at any time. The support used for the contacts was a ground clamp bent to the required size. This is a simple little device, and one that any one can make and connect with very simple tools; while it is something that everyone who has a trickle charger "B" power unit is in need of.

Second Prize

A RUBBER MULTIPLE PHONE CONNECTOR

By Philip Sussman

AN easily made and efficient multiple phone connector can be made from an ordinary five-cent eraser, having dimensions 1 3/4 x 1 1/4 x 3/8 inches. This size is not imperative, but it should be considered a minimum. Six holes are drilled, using a 3/32-inch

Prize Winners

First Prize \$25 CHARGER-POWER-UNIT RELAY

By H. R. RINGOLD
600 Parkwood St., N. E.,
Grand Rapids, Mich.

Second Prize \$15 A RUBBER MULTIPLE PHONE CONNECTOR

By PHILIP SUSSMAN
113 State St., Seneca Falls, N. Y.

Third Prize \$10 A WIRING KINK

By WILLIAM WRIGHT
324 Nelson Ave., Nelson, B. C., Canada

All published Wrinkles, not winning prizes, will be paid for at the rate of two dollars each.

The next list of prize winners will be published in the January issue.

drill, about the size of a phone tip. Insulated stranded wire, scraped bare for about 6 inches from the end, is used to connect the block to the set. Starting beneath the eraser, each wire is laced through three holes on the

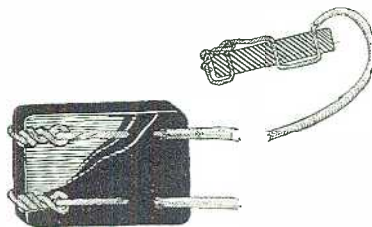

By threading bare wire through an eraser, an efficient phone connector can be easily made.

same side. The ends of the wire are fastened by pulling them over the ends of the eraser and tying them to the wire on the other side.

At the left are details for building the charger-power-unit relay which was awarded first prize in the Radio Wrinkle Contest. In the upper left corner will be seen the details for constructing the coil, which is wound on a bolt. Below it is the layout of the apparatus on the wooden baseboard. In the upper right corner is diagrammed the manner in which the relay is connected in the circuit of a receiver and its various power-supply units. Below the diagram are the connections for the unit itself.

At the right, in A, is a back view of an alarm clock on which is installed the simple mechanism for turning on a radio receiver at any given time. B and C are sketches showing clearly how the parts are installed.

This connector is wired for three pairs of head-phone tips; but, if a larger eraser is used, more connections can be made to it. It will be found that the eraser is better than a wooden connector; as the rubber holds the tips securely in place, making a better contact. This eraser can be used also as a loud-speaker or headphone extension cord; and, if so desired, a hole may be drilled in the center of the eraser, through which it may be screwed to the wall.

Third Prize A WIRING KINK

By William Wright

WHEN wiring a radio set, it is often difficult to hold the wire to be soldered in place until the soldering iron comes along. Also, at times, it is hard to estimate the length of a certain piece of wire. By means

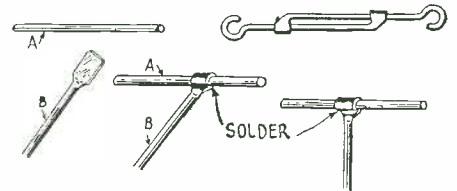

Try this simple little trick the next time a set is being wired and see how much time is saved.

of this kink, it is possible to make all leads as short and direct as possible. The approximate length of wire is figured out, and one end is placed on the edge of an anvil. (In this particular case, the side of an iron plane was used.) The wire is hit squarely where it crosses the edge of the anvil. When it is flattened sufficiently, trim and bend with a round-nose pliers. The loop is then placed around the wire to be soldered and slid along until the correct position is found. A nip with the pliers will make the "dry" joint. The connection is now ready to be soldered. Hammer, anvil and wire must be bright, or difficulty will be encountered when soldering.

The writer has used this kink for a number of years for switchboard and radio work and has found it indispensable when neatness and convenience is required. It also does away with the necessity of an extra hand, so often experienced.

A TIME SWITCH FOR THE RECEIVER

HERE is an easy way to make a time switch out of an alarm clock. It can be used for turning on the radio set, as well as for an electric alarm bell.

First fasten a short strip of bakelite or hard rubber by one end to the top edge of the clock, letting the other project. (Continued on page 516)

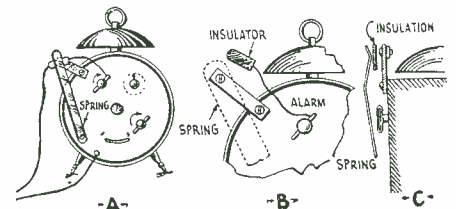
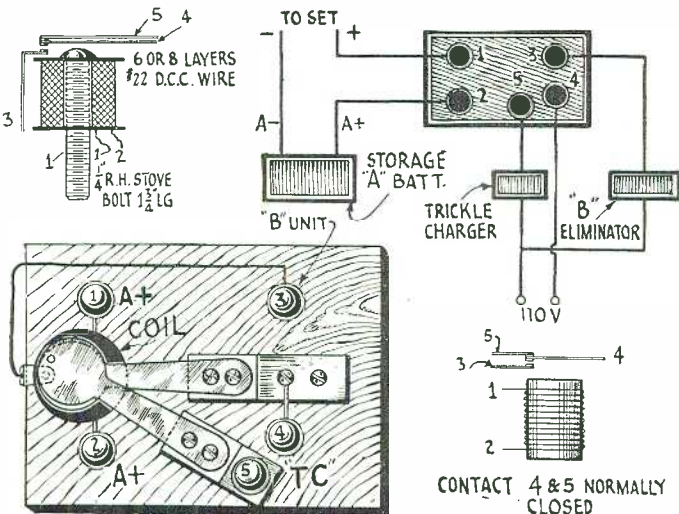

The Construction of a Lattice Radio Tower

An Attractive and Substantial Support for an Aerial

By C. W. GUYATT

THE wooden tower has a number of advantages over the straight wooden or steel pole, chief among which are its great rigidity and strength. Few guy wires are needed; which is an advantage in both convenience and appearance. It does not obstruct the yard and does not absorb from the antenna field as much energy as does a steel pole or a wooden mast with many guys.

The type of tower built at station 2CXE (Bogota, N. J.) was designed to hold an extremely heavy aerial and at the same time withstand very heavy wind storms, to which the location of the station is subject. This tower has been up nearly four years and during that time has required no attention

plank; 290 feet No. 10 galvanized wire; six bolts $\frac{1}{2}$ x10 inches with washers; three bolts $\frac{1}{2}$ x8 inches with washers; six bolts $\frac{1}{2}$ x6 inches with washers; eighteen strain insulators; a pulley; a gallon of marine paint; rope for pulley, and a quart of tar.

Raising apparatus: A pole 20 feet high and good tackle, about 1 to 4 ratio.

CONSTRUCTION

Begin by bolting two of the two-by-fours together with three bolts, using a $2\frac{1}{2}$ -foot lap; and then bolt on a four-by-four, using a 3-foot lap. Repeat this process, thus forming the two main uprights of the tower, each of which is $54\frac{1}{2}$ feet long. It is highly advisable, before making any joints,

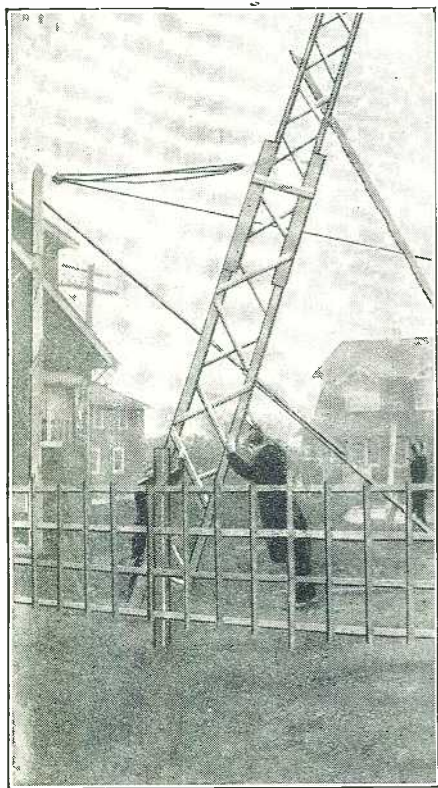

Fig. D. Erecting the mast. This shows the gin-pole and the tackle required.

except the application of a coat of paint. It can be climbed without danger and its appearance is such as to permit its erection in suburbs.

It will be noted that the described tower has only two uprights, in contrast to the usual four—this departure from the usual resulting in a number of advantages. A tower erected for the purpose of holding an antenna is subjected to a major strain in only one direction. Why build it equally strong in all directions? The two-legged tower is just as strong as the four-legged tower, when considering aerial strain, and is sufficiently strong to withstand wind strain in all directions. This means that the two-legged tower costs half as much to build, is much easier to construct, and finally, is somewhat easier to raise.

The general view of the tower is shown in Fig. A. This particular one happens to be 55 feet high; but, of course, the same design can be used for any height to about a hundred feet. For a 55-foot tower the following material will be needed:

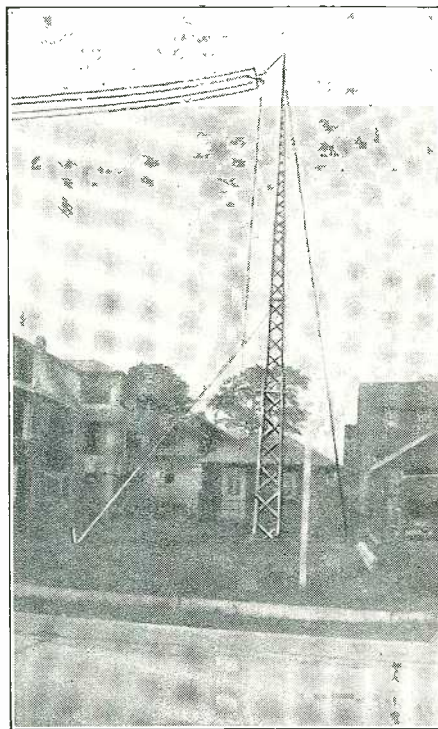

Fig. A (above). Here is shown the completed tower, which is 55 feet high.

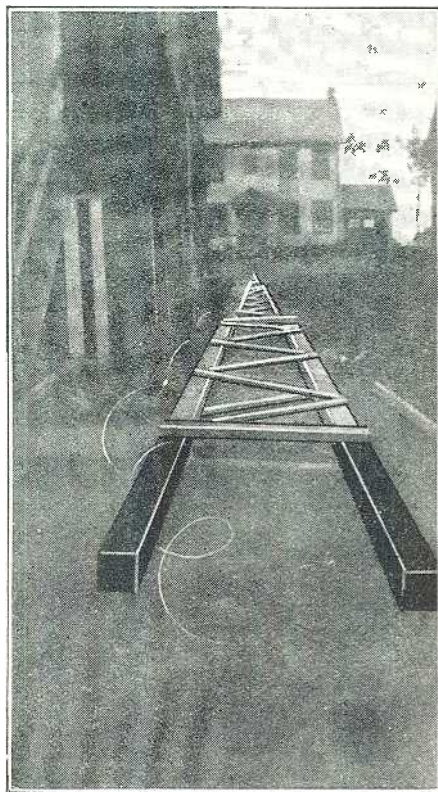

Fig. B. The uprights are laid on the ground and braces nailed to them, as shown.

Two 20-foot 4x4-inch fir timbers; four 20-foot 2x4-inch fir planks; 140 lineal feet 1x2 in. spruce strips; one 6-foot 2x4-inch fir

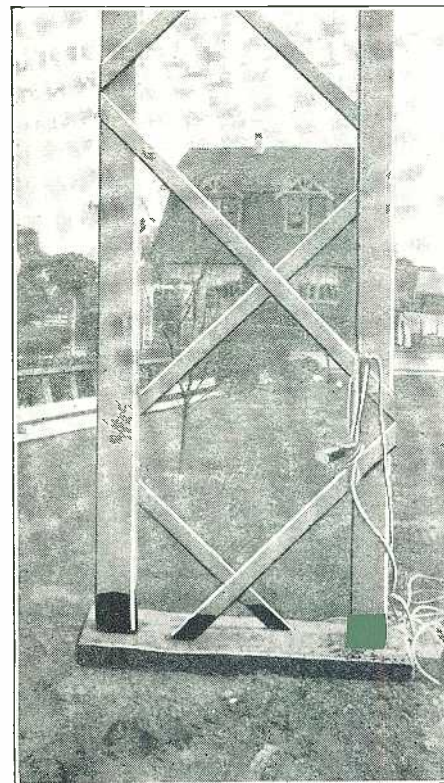

Fig. C. The 2-inch spruce strips are nailed between the uprights in this fashion.

to give each piece a thorough coat of paint. Now select a stretch of flat ground (a sidewalk is excellent) and lay the two legs down so that the 4x4 in. ends are three feet apart. About five feet up, nail a piece of 2x4 in. on each side to act as spacers. The other ends of the legs should be bolted together with the six-foot piece of fir between them; allowing it to project four feet. It is on top of this projection that the pulley should be fastened, by means of wire. The two uprights are now in the form of an isosceles triangle and should be kept firmly that way by means of spacers placed about 20 feet apart. These spacers can be easily seen in Fig. B.

The next step is to put in the diagonal bracing—one side at a time. Starting at the bottom spacer, begin putting on the 1x2-inch strip at an angle a trifle less than 45 degrees. At least three nails should be used at the end of each brace—always being sure to see that each joint is coated with paint or tar before nailing. The arrangement of this bracing can be seen in Fig. C.

(Continued on page 557)



Radio News Laboratories

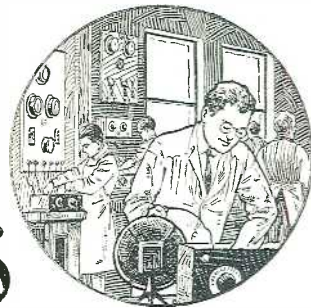

RADIO manufacturers are invited to send to RADIO NEWS LABORATORIES samples of their products for test. It does not matter whether or not they advertise in RADIO NEWS, the RADIO NEWS LABORATORIES being an independent organization, with the improvement of radio apparatus as its aim. If, after being tested, the instruments submitted prove to be built according to modern radio engineering practice, they will each be awarded a certificate of merit; and a "write-up," such as those given below, will appear in this department of RADIO NEWS. If the apparatus does not pass the Laboratory tests, it will be returned to the manufacturer with suggestions for improvements. No "write-ups" sent by manufacturers are pub-

lished in these pages, and only apparatus which has been tested in the Laboratories and found of good mechanical and electrical construction is described. As the service of the RADIO NEWS LABORATORIES is free to all manufacturers, whether they are advertisers or not, it is necessary that all goods to be tested be forwarded prepaid, otherwise they cannot be accepted. Apparatus ready for, or already on, the market will be tested for manufacturers free of charge. Apparatus in process of development will be tested at a charge of \$2.00 per hour required to do the work. Address all communications and all parcels to RADIO NEWS LABORATORIES, 230 Fifth Avenue, New York City.

FULL-WAVE RECTIFIER

The "Speed-Type Hyvolt" rectifier tube shown, submitted by the Cable Supply Co., 267 Douglas St., Brooklyn, N. Y., is of the full-wave gas-filled rectifier type, and designed for use in "B" power-supply units operating from the A.C. house line.



Tested in connection with several commercial "B" power-supply units, this tube gave very satisfactory results.

AWARDED THE RADIO NEWS LABORATORIES CERTIFICATE OF MERIT NO. 1968.

ANTENNA LOADING COIL

The "Resonator" shown, submitted by the F. & H. Radio Laboratories, Fargo, N. Dakota, is an inductance unit intended for use in connection with a radio receiver having an aerial of the common type, in order to increase the selectivity of the set and thus eliminate interference due to powerful local stations. The in-

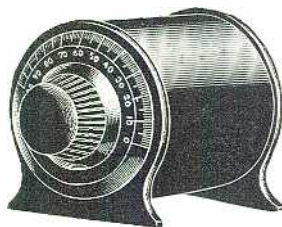

ductor, which is housed in a hard-rubber tube 3½ inches long and 3½ inches in diameter, is of the toroidal type and has 220 turns of enameled wire each 3 x ¼ inches in cross-section; it has a maximum inductance of approximately 150 microhenries. The variation of the inductance is obtained by sliding a contact spring, of the rheostat type, along the edge of the coil.

AWARDED THE RADIO NEWS LABORATORIES CERTIFICATE OF MERIT NO. 2115.

BATTERY CABLE

The battery cable shown, submitted by Eugene A. Hagel, 37 W. Van



Buren St., Chicago, Illinois, is 5 feet long and is formed of seven stranded rubber-insulated wires of

different colors, all braided together in one cable; one end of each is soldered to the split contact tips of the plug. The receptacle plug which carries the tip jacks is fastened to an L-shaped bracket of bakelite, which allows easy baseboard mounting.

AWARDED THE RADIO NEWS LABORATORIES CERTIFICATE OF MERIT NO. 2121.

THREE-CIRCUIT TUNER

The three-circuit tuner shown, submitted by the Birnbach Radio Co., 234 West 31 St., New York, N. Y., is of the conventional one-hole-mounting type. The stator uses a bakelite tube 2½ inches long and 2½ inches in diameter; while the rotor (tickler) is made 1½ inches long and 1½ inches in diameter. The inductance of the secondary is approximately 178 microhenries, and it will cover the broadcast waveband, in connection with a .0005-mf. condenser. A stop-pin on the shaft

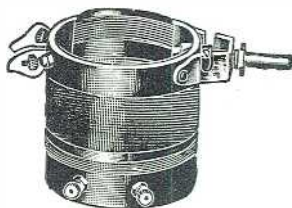

carrying the tickler permits only 180° rotation; thus guarding against strain on the ends of the tickler winding.

AWARDED THE RADIO NEWS LABORATORIES CERTIFICATE OF MERIT NO. 2123.

"A" POWER SUPPLY

The "Unipower" (A.C. type 6-K shown) submitted by the Gould Storage Battery Company, Inc., 250 Park Ave., New York, N. Y., is a combination of a 6-volt storage battery and a trickle charger. The trickle charger operates from a 110- to 125-volt house-lighting line. 60- to 25-cycle; it uses an electrolytic rectifier, which is in the same case

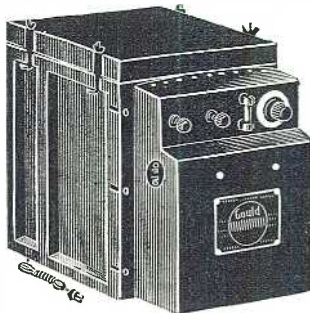

as the storage battery. An automatic-relay switch, which is operated by the filament switch of the receiver, controls the "on" and "off" positions of the trickle charger and "B" supply unit. The device regu-

lating the charging rate is enclosed in a metallic box attached to the rubber case. The "Unipower" is a very convenient method of obtaining filament current of a high degree of purity, and minimizes the attention required by the battery.

AWARDED THE RADIO NEWS LABORATORIES CERTIFICATE OF MERIT NO. 2124.

THROW-OVER SWITCH

The throw-over switch shown, sub-

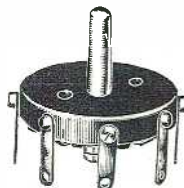

mitted by the Deutsche Radio-Werkstätten G.m.b.H., Schönebergerstrasse 6, Berlin S.W. 11, Germany, is a well-designed instrument. It has a base made of hard rubber of good quality; the phosphor-bronze springs provide perfect contact.

AWARDED THE RADIO NEWS LABORATORIES CERTIFICATE OF MERIT NO. 2125.

WIRE STRIPPER

The wire stripper shown, submitted by the Pyramid Products Co., 117 No. Dearborn St., Chicago, Illinois, is a very useful tool for the radio builder, especially when rubber-insulated wire is being used. It operates like ordinary pliers; by

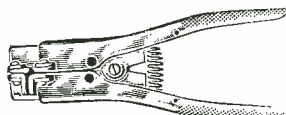

pressing down the handles of the stripper, the wire is held tightly between two gripping jaws, which slide lengthwise; the insulation is then removed by the movement of two sharp stripping jaws. This operation is effected very quickly, and neatly, without injury to the wire.

AWARDED THE RADIO NEWS LABORATORIES CERTIFICATE OF MERIT NO. 2126.

BY-PASS CONDENSER

The fixed condenser shown, submitted by the Aerovox Wireless Corp., 70 Washington St., Brooklyn, N. Y., is of the paper type. Its capacity element is mounted and sealed in a compact metal container equipped with lugs for baseboard or panel mounting. 100% pure linen paper is used as the dielectric. This condenser is intended for use as a



by-pass and is rated at a D.C. operating voltage of 200.

AWARDED THE RADIO NEWS LABORATORIES CERTIFICATE OF MERIT NO. 2130.

A. F. TRANSFORMERS

The audio-frequency transformer (type 3-30 shown) submitted by the Tyrman Electric Corporation, Chicago, Ill., is completely enclosed in a stamped heavy iron shell which reduces the interstage-coupling effect. The terminals of this transformer are so disposed as to permit the use of a Kurz-Kasch (Flewelling) capacity-strip connector. This transformer is very well designed and affords good reproduction of music and speech when used in an audio-frequency amplifier.

AWARDED THE RADIO NEWS LABORATORIES CERTIFICATE OF MERIT NO. 2131.

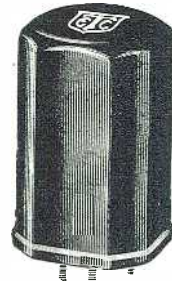

The A.F. transformers (types 3-50 and 3-51), manufactured by the same company, are similar in construction to the type 3-30 shown above. They are designed for use in the last stage of an audio-frequency amplifier, as a push-pull combination. An A.F. amplifier using those transformers, in conjunction with the 3-30 type in the first stage, gave excellent results in quality and volume.

AWARDED THE RADIO NEWS LABORATORIES CERTIFICATE OF MERIT NO. 2132.

AERIAL KIT

The "Belden" aerial kit shown, submitted by the Belden

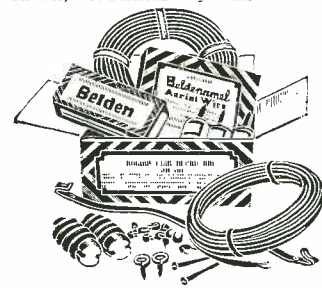

Manufacturing Co., 2300 So. Western Avenue, Chicago, Ill., contains 100 feet of 7-strand 22-gauge enameled aerial wire, 50 feet of 7-22 rubber-covered lead-in wire, 50 feet of heavy rubber-covered single wire, one lightning arrester, one ground clamp, one lead-in strip, insulators, screws, and other miscellaneous re-

quisites for an antenna installation. All the parts of this kit are of the best quality and provide for the construction of a perfect antenna.

AWARDED THE RADIO NEWS LABORATORIES CERTIFICATE OF MERIT NO. 2134.

VARIABLE CONDENSER

The variable condenser shown, submitted by the United Scientific Laboratories, Inc., 80 Fourth Ave., New York, N. Y., is of the low-loss one-hole mounting type. The maximum capacity of this condenser is 348 mmf., and its minimum is very low, approximately 7 mmf. The rotor plates are of almost circular

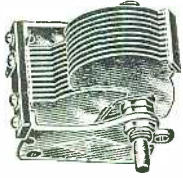

shape and the characteristic curve of the capacity changes of this condenser differs slightly from that of a straight-line-frequency type. This condenser is light and of good mechanical and electrical construction. Mounting feet on the end stator plates provide for baseboard mounting. The rotor shaft is hollow, and so constructed that several condensers can be operated from the same shaft.

AWARDED THE RADIO NEWS LABORATORIES CERTIFICATE OF MERIT NO. 2135.

GRID LEAK

The "Puremetal" grid leak shown, submitted by the Polymet Mfg. Corporation, 599 Broadway, New York, N. Y., has a resistance element made of a glass tube 3/16-inch in diameter, covered with a metallic deposit in the shape of a thin narrow



spiral. This element is hermetically sealed within another glass tube, 3/8-inch in diameter. The resistance value of this grid leak is steady and does not vary with use, provided too heavy loads are not applied.

AWARDED THE RADIO NEWS LABORATORIES CERTIFICATE OF MERIT NO. 2136.

AUDIO OUTPUT FILTER

The "clarifier" and output transformer shown submitted by the Leslie F. Muter Co., 76th St., and



Greenwood Ave., Chicago, Ill., consist of a specially constructed dual-choke coil and by-pass condenser of large capacity, both in one metallic container. The object of this device is to prevent the flow of direct current from the plate through the windings of the loud speaker; and thus avoid continuous pull on the

diaphragm or the armature of the unit and, at the same time, lengthen the life of the coils and magnets. The voltage drop across the choke coil is very small, as its resistance is low—approximately 320 ohms.

AWARDED THE RADIO NEWS LABORATORIES CERTIFICATE OF MERIT NO. 2137.

SMALL JACK

The "Universal Midget" jack



shown, submitted by the Pilot Electric Mfg. Co., Inc., 323 Berry St., Brooklyn, N. Y., is compact and very useful in building portable receivers or in any set where little space is available. This jack is very well built and its springs are provided with silver contacts which assure a perfect connection. This device may be used for a load speaker or to cut in phones.

AWARDED THE RADIO NEWS LABORATORIES CERTIFICATE OF MERIT NO. 2138.

R. F. TRANSFORMERS

The radio-frequency transformer (types 4A and 4D shown), submitted for test by the Precision Coil Company, 209 Centre St., New York,



N. Y., is very efficiently built. The primary and the secondary which are, respectively, of double-silk-covered stranded and enameled single wire, are wound on a threaded bakelite tube. The spacing between the adjacent turns of the windings is very even as it is regulated by the thread and therefore identical coils can be wound with a very high degree of precision. Indeed the uniformity and precision is so high that it has been found, after a test of two sets of three coils each, that the difference between the inductance of each coil and the average of the six is only a fraction of one per cent. This coil has an inductance of approximately 280 microhenries, and will cover the broadcast band when tuned with a .0005-mf. condenser.

AWARDED THE RADIO NEWS LABORATORIES CERTIFICATE OF MERIT NO. 2139.

The "3B Junior Tuning Unit" shown, submitted by the same company, is a three-circuit tuner of the conventional type. The primary and secondary are wound in the manner

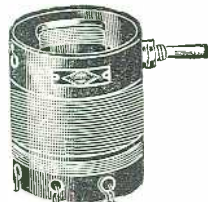

previously described (i. e. on a threaded bakelite tube); the tickler winding is lodged within two grooves of the rotor. This tuner is of the

one-hole mounting type. The rotor shaft is equipped with a stop pin, which prevents the ends of the tickler winding from being twisted and frayed.

AWARDED THE RADIO NEWS LABORATORIES CERTIFICATE OF MERIT NO. 2140.

VARIABLE CONDENSER

The variable condenser shown, submitted by the Superior Radio Sales, 6121 Sansom St., Philadelphia, Pa., is of the rotary, one-hole mounting type. This condenser, however, differs considerably in construction from the usual rotary type. The stator and the rotor have each two sets of plates; insulated from each other; each stator-plate set is connected through a flexible spiral spring to one of the rotor-plate sets.

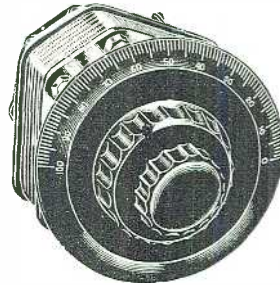

The rotor plates move between those of the stator. In the position where the rotor plates are turned into the stator sets to which they are connected by a spiral spring, the capacity of the condenser is minimum. The maximum capacity is obtained when each rotor set is turned into the stator plates from which it is insulated. The rate of variation in the capacity of this condenser places it in the group of straight-line-frequency types. This condenser is electrically and mechanically well constructed, and equipped with a very fine vernier arrangement, having a ratio of 1:200. This vernier is operated by a thin rod passing through the hollow main condenser shaft.

AWARDED THE RADIO NEWS LABORATORIES CERTIFICATE OF MERIT NO. 2142.

A. C. TUBE SOCKETS

The "Y" socket shown, submitted



by the Benjamin Electric Mfg. Co., 847 W. Jackson Blvd., Chicago, Illinois, is of the spring-suspension type and is constructed on the same principle as the "Cle-Ra-Tone" socket of the same company. This socket is designed for use with A.C. vacuum tubes of the UY-227 type.

AWARDED THE RADIO NEWS LABORATORIES CERTIFICATE OF MERIT NO. 2143.

BY-PASS CONDENSER

The fixed condenser shown, submitted by the Aerovox Wireless Corp., 70 Washington St., Brooklyn, N. Y., is of the paper type and is designed for by-pass work in receivers, amplifiers and power units where the voltage does not exceed 200. The capacity unit of this condenser is hermetically sealed with non-hygroscopic wax in a molded bakelite shell, and is therefore perfectly protected against moisture which might



cause internal breakdown and leakage. This type of condenser is available in different capacity values, up to 1 mf.

AWARDED THE RADIO NEWS LABORATORIES CERTIFICATE OF MERIT NO. 2144.

FIXED MICA CONDENSER

The fixed condenser shown, submitted by the Leslie F. Muter Co., 76th St. and Greenwood Ave., Chicago, Ill., uses mica as the dielectric. The capacity element of this con-



denser is molded in solid bakelite. The soldering lugs or the bus-bar wires of the circuit are attached to the condenser by means of screws passing through the two threaded brass tubings.

AWARDED THE RADIO NEWS LABORATORIES CERTIFICATE OF MERIT NO. 2145.

PHONE PLUG

The automatic shock-proof phone plug submitted by the same com-



pany, permits easy insertion of the phone tips into the shell of the plug, where a perfect contact is made with the elements of the latter. The release of the tips is caused by an outward pull on the cord. As the phone tips are completely enclosed in the plug shell, the possibility of their coming in contact with the higher voltages while operating the plug is eliminated.

AWARDED THE RADIO NEWS LABORATORIES CERTIFICATE OF MERIT NO. 2146.

PANEL BRACKETS

The radio panel bracket shown, submitted by the Ex-El Specialty Co., 2226 Rockton Ave., Rockford, Illinois, is made of two members of cast aluminum held together by screws. A circular slot in that intended to carry the front panel permits the latter to take different in-

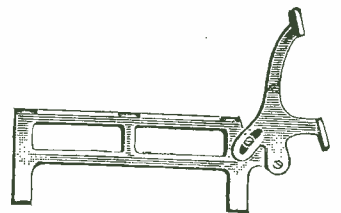

clinations in regard to the sub-panel. Although light, this bracket is strong and insures rigidity to the receiver.

AWARDED THE RADIO NEWS LABORATORIES CERTIFICATE OF MERIT NO. 2147.

Letters from Constructors

(Continued from page 505)

was attached to the phone diaphragm with a cork, as in the original article. Volume and clarity are excellent and, up to a certain input, just as good as a Western Electric cone. By the way, I use a three-stage resistance-coupled amplifier with a power tube in the last stage, and an output filter. My Western Electric cone will, of course, carry much more power than the roll speaker; but, for an ordinary room, one is as good as the other. I

have an old Amplion horn Speaker, a four-year-old concert model, which sounds louder in a room than either the cone or the roll because of the directional properties of the horn.

I am engaged in building the Strobodyne and will let you know later how this works; I have built from your magazine several sets and all have been very good. G. RIVERS WOODVILLE, Broadlake, Willaston (near Birkenhead), ENGLAND.

BUILDS WINNING SUPER CIRCUIT

Editor, RADIO NEWS: I have read with a great deal of interest the article describing the winning super-regenerative set, and inasmuch as you have solicited comments, I would like to hand you mine. In the first

place, super-regeneration has been my "mania" for about three years, and I venture to say that possibly very few amateurs have done as much experimenting with it as I have. However, I don't claim any very satisfactory results therefrom, and probably the only things I have gotten out of it so far have been a vile disposition and a permanent grouch. Like Perry though, I "don't give up the ship."

Immediately on seeing the hook-up of Dr. Koteschweller's set in RADIO NEWS, I proceeded to build a similar one myself. I just finished it last week and unhesitatingly pronounce it the best super arrangement it has been my pleasure to handle. As you stated, it has absolutely no hand (Continued on page 539)

Radiotics

INSTALLATION SIMPLIFIED



Progress reported on set installation, in the September issue of RADIO NEWS magazine; in which Crossley's advertisement states that "a woven TABLE," containing vari-colored rubber-covered leads, makes installation and hook-up easy for the veriest novice." If you can't get this at a radio store, why, just ask grandma to knit you one.

Contributed by Gordon Moran.

AND THE LAST STATE SHALL BE WORSE—

Dubious advice from July-August Popular Radio: "If you have a good plate supply system and a set with the new AC tubes and one or two UX-171 power tubes in the last STATE, the H-67 AmerTran is ideal." When we come to think of it, there ought to be a big demand for sets that can utilize moribund vacuum tubes.

Contributed by John W. Heineman.

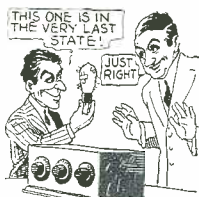

MR. WATERMAN, PLEASE NOTE

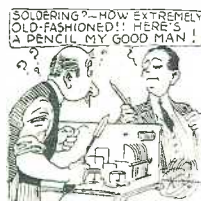

This gem is found in the 1926 Barawik radio catalog, above a description of a simple method of wiring a receiver: "Easy to WRITE." Evidently this set can be quickly connected up by using a pen or a pencil, instead of the more conventional wire and soldering iron.

Contributed by Walter Hawkins.

CHARGED FOR ONE GRAND

This from the Danville (Illinois) Commercial News of January 13: "Free Log Books—batteries recharged, \$1,000." Off hand it strikes us that the advertisers could well afford to give away log books for nothing, if they can get any such price as this for pepping up the storage battery. We'd buy a crystal set first.

Contributed by Harry H. Shuler.



MARK ANTONY STARTED IT



In Radio World of August 13 we have this startling description of a soprano: "with three EARS training under G. S. DeLuca, Myra Bender is able to demonstrate a soprano voice well adapted to broadcasting." We wonder whose car Myra borrowed to practice her vocal training for the radio.

Contributed by O. Jaus.

OPTICAL ILLUSION

Far-sighted radio receiver advertised for sale in the Montreal Daily Star of August 13 in this fashion: "Radio for sale, 3 LENS, complete \$40.00." Mike of the Investigation Dept. reports that this set has great distance-getting possibilities; it will bring in the moon, on a clear night.

Contributed by Muriel McCulloch.



OO! OO! OUCH!



Gold-finding novelty described in the New York Herald-Tribune of July 31 incorporates "an apparatus for recording the DEFLATION of directional waves." Perhaps the real cause of "fading" is that Old Man Static has sneaked up behind the wave of our favorite DX station, and painfully punctured it, to collapse somewhere in the Alleghenies.

Contributed by J. H. Farrington.

GUILTY OR NOT GUILTY?

Characteristics of a Hertz antenna thus revealed in Radio Broadcast for September, 1927: "This relation is INDICTED by the curve." Perhaps this is one of these unauthorized transmitters that the Federal Radio Commission has turned over to the tender mercies of the Department of Commerce and the Grand Jury.

Contributed by Mrs. J. R. Brooks.



WATCH THE BIRDIE



This from the Pittsburgh Press of August 15: "The Stromberg-Carlson Company had equipped all its new receivers with PHOTOGRAPH jacks." Those of you who do much traveling will be glad to know that it is no longer necessary to carry a camera about with you. Just use your portable radio set for taking pictures.

Contributed by Stanley W. Jencka.

REMOTE CONTROL

A startling item from the San Francisco Call of August 5: "U. S. Radio HEAD in East Africa." (This line appeared over an article telling about an American station that was picked up in Kenya Colony about 12,000 miles from Cincinnati.) We thought at first that Uncle Sam had been attacked for some of the things that had been sent out over the air, and had to take to the woods.

Contributed by Clyde A. Randon.



WATER, WATER EVERYWHERE



Moist advertisement from the Hamilton-Carr Radio Corporation's 1927 catalog: "tubular grid LAKE, 10c." Now it would appear that the latest radio engineering practice is to use a lake for a resistance in the grid circuit. This will be a hardship to those radio fans living out in the desert.

Contributed by Loyt L. Lathrop.

YOU CAN KEEP THEM

From the catalog of the Western Radio Mfg. Company comes this: "rated at 85 milliamperes continuous duty without HEARING, it will furnish double this current for reasonable periods." We do not think this much of a recommendation for a power transformer; for it ought to be their function to let a little music go through, now and then.

Contributed by Paul F. Edwards.

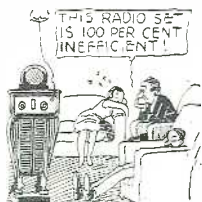

QUICK, WATSON, THE MICROSCOPE

The craze for miniature radio sets may be carried too far, as witness this trouble-shooting information in the Buffalo News of August 20: "This is invariably due to a MICROSCOPIC tube." It's all right to go ahead and build a superhet that you can carry in your watch pocket; but you must expect to have a little trouble now and then making the finer adjustments.

Contributed by Rogers Crosby.

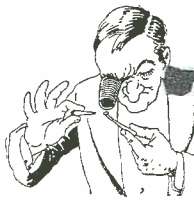

SOUND YOUR A

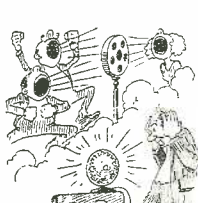

Candid news item from the New York Herald-Tribune of August 17: "Away for a YELL earned vacation, the National Grand Opera will be replaced to-night by a grand opera concert organization on WEAF." We trust that none of these singers have strained their voices during the season, as this item seems to insinuate.

Contributed by William Lenkin.

"THAT IS THE QUESTION"

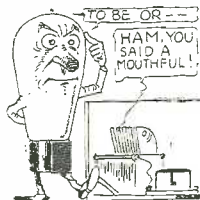

Shakespearean motif evidenced in an advertisement in the Detroit News of August 19: "brand new 301A TO BE\$ 69c." Evidently there is a shortage of Shakespearean actors, when managers have to get their supply from radio manufacturers. This is indeed Hamlet brought up-to-date.

Contributed by C. C. Whittaker.

ARM CHAIR SOLDERING

New soldering device mentioned in the advertising columns of RADIO NEWS Magazine, August, 1927, issue: "Bruno drum TINGING control." Discoveries come thick and fast in radio but this has everything beat so far. It must be some sort of an automatic gadget that connects up your set and is controlled by a drum arrangement.

Contributed by H. Brown.

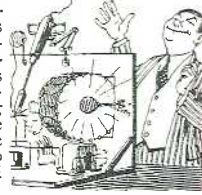

A PERFORMANCE MURDERED

In Vol. XI, No. 7 of Radio Doings we find the following blood-thirsty announcement: "among the numbers to be SLAYED will be 'Argentine Nights' and 'Mio Vida.'" "Forewarned is forearmed," as the genuine lovers of music will say, when they get a straight tip like this.

Contributed by Robert S. McNaughton.





THIS Department is conducted for the benefit of our Radio Experimenters. We shall be glad to answer here questions for the benefit of all, but we can publish only such matter as is of sufficient interest to all.

1. This Department cannot answer more than three questions for each correspondent. Please make these questions brief.
2. Only one side of the sheet should be written upon; all matter should be typewritten or else written in ink. No attention paid to penciled matter.
3. Sketches, diagrams, etc., must be on separate sheets. This Department does not answer questions by mail free of charge.
4. Our Editors will be glad to answer any letter, at the rate of 25c. for each question. If, however, questions entail considerable research work, intricate calculations, patent research, etc., a special charge will be made. Before we answer such questions, correspondents will be informed as to the price charge.

POWER TRANSFORMERS

(Q. 2245.) Mr. F. P. Potter, Philadelphia, Pa., writes:

Q. I would like to build a transformer for use with a Raytheon 85-milliamperer, rectifier tube, to supply the "B" current for my set. Will you please give me the necessary data for constructing this transformer?

A. Such a transformer contains a primary wind-

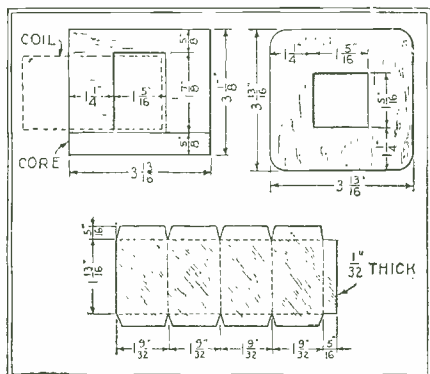

FIG. Q 2245

The layout for the transformer spool is shown below; bend the fiber on the dotted lines. Above: right, end-pieces of spool; left, how the iron core is fitted into the windings.

connected to the 110-volt A. C. house line, two high-voltage, secondary windings giving 250 volts for the "B" supply, and a secondary winding for the filament supply of the power tube in the last A. F. stage. The construction of such a transformer begins with the winding form. Out of fiber 1/32-inch thick, cut a piece of the dimensions shown in the illustration above and, with the aid of a block of wood 1-9/32 inches square and 2 inches long, bend the fiber as indicated by the dotted lines. Glue to the side the 5/16-inch flap, and when it is dry remove the wooden block. Two pieces of fiber 1/16-inch thick are then cut as shown, to form the end pieces of the spool. Bend up the four flaps on each end of the form and glue these outside of the end pieces.

Winding the Transformer

The primary winding is put on first and consists of 550 turns of No. 22 D.C.C. wire. At the 500th turn, a tap is taken off and the two ends of the wire and the tap are brought out through holes drilled in the spool ends.

Before putting on the next winding, place three layers of empire cloth over the primary winding. The next coil is the secondary; this consists of two coils of No. 30 enameled wire. Wind 1350 turns over the primary, bringing the leads out as before. Insulate this with three layers of empire cloth and wind 1350 turns more of the same wire. Place the beginning of this winding through the same hole as the termination of the first secondary winding; connect these two together to make the center tap. Over this winding, place three more layers of empire cloth, and then wind the filament secondary; for this use No. 16 D.C.C. wire. Wind 25 turns of this wire; it will make just one layer, if wound evenly.

If a rectifying tube of the 213 type is to be used, it will be necessary to wind another filament secondary. This also will consist of 25 turns of No. 16 D.C.C. wire, with a tap at the center. Wrap several layers of tape over this winding and the coil is finished.

The Core

The laminations of the core are cut from .014-inch laminator iron. Be sure that the iron is lacquered, at least on one side. The core pieces are of two types; one consists of rectangular pieces 3 13/16 x 5/8 inches. The other pieces are

U-shaped, and cut to the dimensions shown in the illustration. Ninety pieces of each size will be required. These laminations can be cut with tin shears, then hammered flat; or may be cut to size by the dealer from whom they are purchased. Each piece should be filed so that no sharp points or edges are exposed.

The core laminations are then put in place in the coil form. They are staggered; one "U" piece is placed from the right, with the "I" piece at the end; and then the next "U" piece is placed from the left with the "I" piece at the right, and so on. When all the core pieces have been put into position, two brass clamps are made to hold the core firmly in place. A case for the transformer may be made from sheet brass or tin, to protect the windings.

T.R.F. TROUBLE SHOOTING

(Q. 2246.) Mr. A. Silverman, Dayton, Ohio, asks:

Q. Please tell me the reasons for a tuned-radio-frequency set having high and low dial settings for the same station; seemingly acting on the same principle as the oscillator dial on a super-heterodyne?

A. The phenomenon you describe is a very unusual one as far as T.R.F. circuits are concerned. It probably is not due to any action in the receiver itself, but rather to re-radiation on the part of the broadcast stations in your vicinity or to the existence of strong harmonics of the waves to which the transmitters are tuned. Under some conditions it may be caused by too close coupling between the primaries and secondaries of the R.F. transformers, but it is more likely the fault of the transmitters.

ANTENNA CONNECTIONS FOR SUPER-HETERODYNE

(Q. 2247.) Mr. H. E. Edwards, Trenton, N. J., asks.

Q. If possible, I would like to change my 8-tube loop-type superheterodyne for use with an outside aerial. Will you give me the necessary instructions for the coils and condensers which will be required?

A. The equipment necessary for this purpose consists of a variable condenser of .0005-mf. capacity and a loading coil, of 100 turns of No. 24 D. C. C. wire on a 2 1/4-inch tube, or a 100-turn honeycomb coil. It will also be necessary to construct a coupling coil to be used in place of the loop antenna. The rotor (primary) of the coupler may be wound on a 1 1/4-inch tube and should have not more than 20 turns of No. 24 or No. 26 D.C.C. wire. The secondary may be wound on

a 2 1/4-inch tube with 70 turns of No. 24 or No. 26 D.C.C. wire, a tap being taken out at the 35th turn. The coupling between the rotor and stator should be very loose, to prevent the tuning from being broad. When the rotor has been adjusted, the antenna tuning is accomplished entirely with the antenna series condenser, which will have a low capacity setting for the short waves, and will be set at practically full capacity at the higher waves. See Fig. Q. 2247.

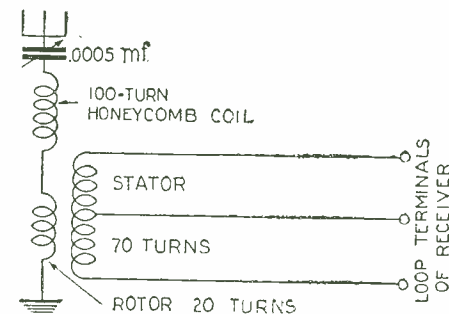

Q.2247

The method used to couple a loop-type super-heterodyne to an outdoor aerial is shown here. The honeycomb coil is used for loading purposes and the antenna tuning is accomplished with the .0005-mf. condenser.

AUTOFORMER AMPLIFICATION

(Q. 2248.) Mr. J. Brisbain, Salt Lake City, Utah, writes:

Q. If possible, I would like to obtain the circuit and constructional data for building an audio-frequency amplifier of the Thordarson autoformer type. I have heard a lot about this amplifier, and recently obtained three of these autotransformers, and I would like to try them out.

A. You will find the circuit diagram of this amplifier on this page. The auto transformer is particularly adapted for A.F. amplifiers, since a greater amplification is obtained than with either the resistance or single-choke-coil-coupled amplifiers, yet without loss of quality. The coupling condensers are not critical as to their value but, with capacities near 1 mf., they allow the unobstructed reproduction of the lowest notes. A greater volume limit can be obtained by reducing this capacity; but smaller capacities have a tendency to reduce the amplification of the bass notes.

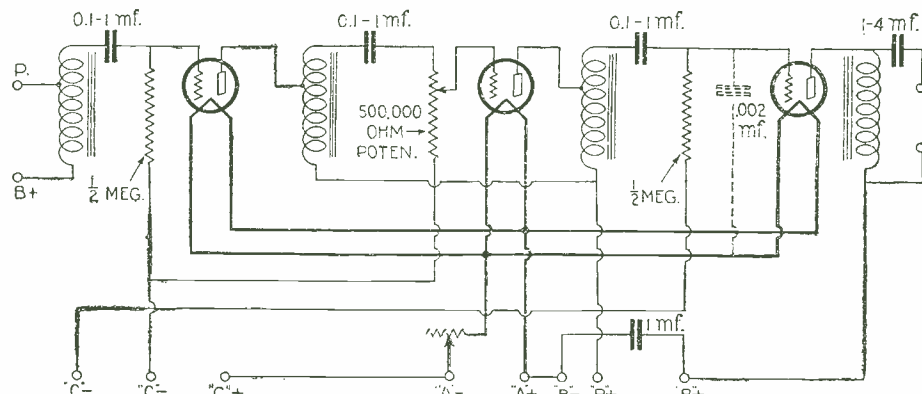

Q. 2248

The circuit of the "Autoformer" type of audio amplifier is shown above. The 500,000-ohm potentiometer in the grid circuit of the second tube is used to control the volume. The .002-mf. condenser in the last grid circuit is desirable to stabilize it.

A 1-mf. condenser should be used between "B+" and "B-," and a .002-mf. condenser should be placed between the grid and the negative filament of the last tube, if any feed-back is present in the amplifier. It will also be helpful to ground the autotransformer cases to prevent interaction between the stages.

While the volume of auto-transformer A.F. amplification per stage is not as great as that of regular transformer-coupled amplification, the increased clarity, and the uniform amplification of all notes the human ear can detect, far more than compensate for this. Three stages of autotransformers will usually give more amplification than the customary two stages of A.F. transformer coupling, and more volume than is required under normal conditions for home loud-speaker reception. It is usually advantageous to connect a 500,000-ohm potentiometer in place of the second grid leak, so that volume can be controlled successfully.

LABORATORY OSCILLATOR

(Q. 2249.) Mr. A. Miller, St. Louis, Mo., writes:

Q. We would like to obtain information regarding the construction of a laboratory oscillator which we can build and which will be comparatively accurate.

A. An oscillator consists, essentially, of a vacuum tube with an inductance and a variable condenser. It generates an oscillating current of a frequency determined by the setting of the variable condenser. For satisfactory use, which should be free from hand-capacity effect, its range should extend over the entire wave band. It ought to be easily portable, flexible and, above all, should be permanent in calibration. The circuit of an oscillator which meets these specifications will be found in these columns. (Fig. Q. 2249.)

The various parts may be either home-constructed or factory-built. The grid coil requires 8, 17 and 45 turns of No. 26 D.S.C. wire for the several corresponding wave bands (50-110, 90-210, and 190-550 meters); and the plate coil 8, 17 and 35 turns respectively, all wound on 1/2-inch tubing. The smaller coils should be space-wound with thread between turns. All coils should be made rigid with shellac or heavy varnish.

The number of turns required for the longer wavelengths are as follows:

Wavelength Meters	Grid Coil Turns	Plate Coil Turns
8000-20000	2000	1000
3500-8500	900	700
1500-4000	400	250
500-1800	125	100

The first three pairs of these coils may be lump-wound with No. 32 S.S.C. wire. The last is wound with No. 30, as described for the short-wave coils. The choke coil can be wound with No. 32 S.S.C. in "slab" fashion with paraffine binder. Together with the by-pass condenser, it isolates the tube from the "B" battery. All of these coils are available in stock, the Silver-Marshall 111 (types A, B, C, and E) being typical. The condenser should be a .00035-mf. variable, preferably of the straight-line-frequency type. It should be rugged in construction with heavy plates and bearings, with provision to take up the minor wear without altering the plate spacing or position. It should have vernier control and be smooth in operation, and the dial should be provided with a permanent hair-line indicator.

Other necessary minor parts are self-evident from the circuit diagram. The grid condenser should not exceed .00005-mf. in value; as it is necessary to keep the tube capacity low in relation to the circuit capacity, to insure permanency of calibration. For the same reason, the negative filament line should be clear of anything except the permanent and unchanging wire connections.

When this oscillator is used for the calibration of an unknown new receiver the experimenter first tunes in a station on a known receiver, and adjusts the oscillator dial until a strong squeal is heard. He disconnects the old set, connects the new, and turns the dials until the same squeal is

heard from the oscillator. This locates the point for receiving that station on the new receiver. This process can be repeated until enough stations have been logged to enable a curve to be drawn. Many other uses will suggest themselves to the owner of this handy instrument.

ANTENNA OPERATION FOR GOMEZ SUPER

(Q. 2250.) Mr. G. Robinson, Newark, N. J., writes:

Q. I have constructed the Gomez Super-Reflex receiver (described in RADIO NEWS for September, 1927), and have had excellent results with it. If it is possible, I would like to adapt this set for use with an outside aerial. Will you publish the necessary data for doing this?

A. A coupler for adapting the Gomez reflex receiver for use with an aerial can be made as follows: On a 3-inch tube wind 90 turns of No. 26 D.S.C. wire, tapped at the 60th turn. This coil should be spaced like the coil L2 in the original receiver. The beginning of this coil should connect to the No. 1 terminal on the receiver; the 60-turn tap to No. 2, and the far end of the coil to No. 3. A rotor coil, which will connect to the antenna and ground, is wound on a 3/4-inch bakelite tube with 15 turns of No. 24 D.S.C. wire. This coil is arranged so that it can be rotated at the No. 1

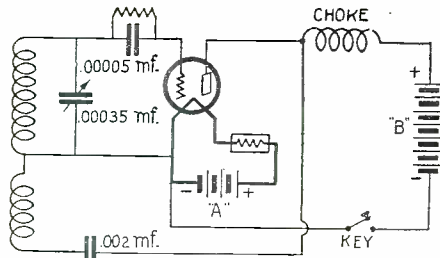

Q. 2249

The circuit of the laboratory oscillator described at the left is shown here. By coupling a small coil to the grid inductor, and then connecting an aerial and ground to this coil, the oscillator may be used as a small transmitter.

end of the secondary coil. Of course, the Gomez receiver has been made as compact as possible and it will be necessary either to use a larger panel to accommodate the new coil, or to connect it outside of the cabinet. By rotating the primary coil in the antenna coupler, a point will be found at which the selectivity and volume are best. When this point has been found, the primary coil need not be turned again, all the tuning being accomplished with the tuning condenser.

"B" UNIT WITH IMPEDANCE AMPLIFIER

(Q. 2251.) Mr. Chas. Leslie, Miami, Fla., writes:

Q. I have built an impedance-coupled amplifier, but when I use it with my "B" power unit I am troubled with a humming noise and sometimes loud squeals. Three stages of impedance-coupled amplification are used and a "BH"-type rectifier tube is employed in the "B" unit. Can you help me to overcome this difficulty?

A. In some cases considerable trouble has been experienced when a receiver with an impedance-coupled amplifier is operated from a "B" power unit. The usual indications are a squeal, a hum, or no response but a periodic pop. The cause of the squeal or hum may be a feed-back through the filter condenser of the "B" unit. The remedy for the squeal or hum is a system of audio-frequency choke coils and by-pass condensers. An A. F. choke is inserted in each positive "B" lead from the unit; and a fixed condenser of 1- to 2-f. capacity is used to by-pass each choke coil. That

is, between the negative "B" wire and each of the positive leads, a condenser is placed. The chokes and condensers should be placed near the receiver. If the output voltage is too high, there may result a periodic popping noise which can be remedied by using lower values of grid resistors in the receiving set. Feed-back may be caused also by the effect of long connecting wires between the receiver and source of power. The arrangement described above serves to isolate the receiver from such feed-back action.

SUPERHETERODYNE OSCILLATOR

(Q. 2252.) Mr. R. Koch, Montreal, Quebec, asks:

Q. What is the law governing the number of turns, size of wire and closeness of coupling of the grid and plate coils of an oscillator in a superheterodyne? Is there any relation between the sharpness of tuning of the oscillator dial and the intermediate amplifier?

A. The sharpness of tuning on the oscillator dial is, practically, controlled entirely by the characteristics of the intermediate amplifier. If your oscillator settings are broad, it is due, not to any inherent broadness of the oscillator itself, but to the selectivity of the intermediate amplifier. If your intermediate transformers have a very flat "amplification characteristic" and the filter circuit tunes broadly, then the oscillator settings will likewise be broad, and the set will not be selective. If, on the other hand, your intermediate transformers have a fairly definite "peak" at a certain frequency, and the filter is well designed, with a sharp maximum at the same frequency as the transformers, then the oscillator-dial settings will probably be very sharp.

The usual oscillator circuit consists of a grid coil tuned with a variable condenser, the number of turns on the grid coil being designed to work over the broadcast band with the particular type of condenser used. The plate coil is not tuned, and has sufficient inductance so that the tube will oscillate at all frequencies within the broadcast range. An oscillator coil of this type may be made by winding 90 turns of No. 24 enameled wire on a 2-inch tube, for use with a .00035-mf. variable condenser, and 45 turns of No. 30 silk-covered wire, wound double-jumble fashion at the filament end of the grid coil, for the plate inductance. The coupling coil is wound on a 1-inch tube placed inside the oscillator, and consists of 25 turns of No. 36 silk-covered wire. This coil is usually placed in series with the secondary coil of the first detector and serves to couple the oscillator with the detector.

MADISON-MOORE WITH "A-B-C" POWER SUPPLY

(Q. 2253.) Mr. R. W. Wilson, Phila., Pa., asks:

Q. Please furnish a circuit diagram for the Madison-Moore superheterodyne with series filament connections, so that I may use the set in connection with an "A-B-C" power-supply device.

A. The circuit that you requested will be found on this page. All the apparatus used is standard, and may be obtained for the ordinary Madison-Moore circuit. In order to obtain proper volume control, it will be necessary to shunt the primary of the second intermediate transformer as shown, with a 50,000-ohm variable resistor. The use of the filaments in series, so that they may be supplied from a power unit, necessitates the use of one of the new 350- or 400-milliamperer rectifier tubes. The constructional data for such a unit will be found in the June, 1927, issue of RADIO NEWS.

DETECTOR TUBES FOR REFLEX SET

(Q. 2254.) Mr. A. Duckwell, Chicago, Ill., writes:

Q. Is it possible to use the UX-200A tube as a detector in my reflex set, or would you suggest that I use the 201A type? If you suggest the 200A, please explain how to get the greatest efficiency from it.

(Continued on page 557)

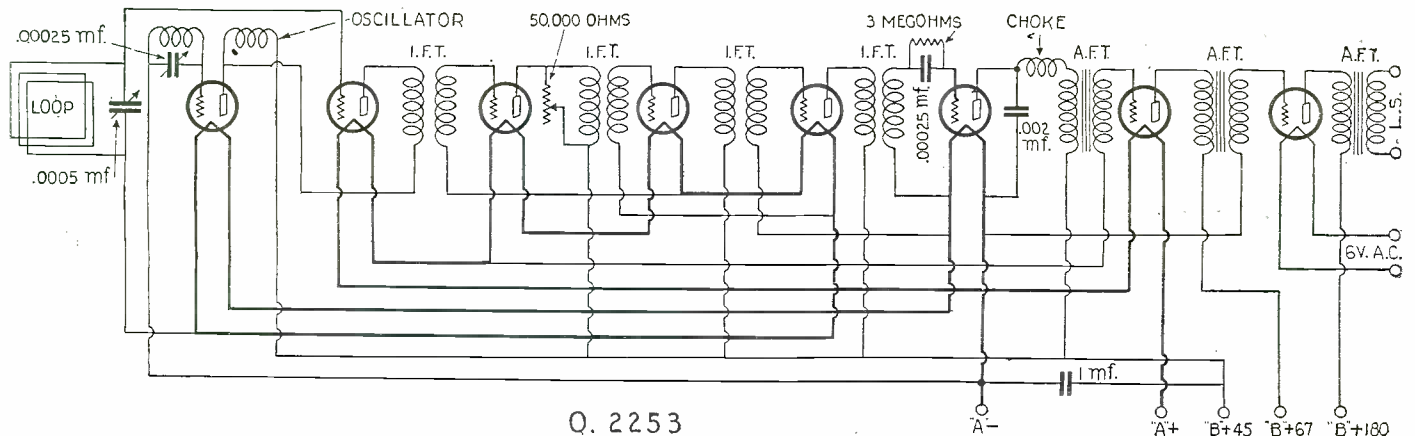

Q. 2253

This circuit shows how the Madison-Moore Superheterodyne may be adapted for use with an "A-B-C" socket-power unit. For this purpose the filaments are connected in series and a tube of the 350-milliamperer type is used to supply both the plate and filament currents. The 500,000-ohm variable resistor in the second intermediate-frequency stage is used to control the volume of the set. The filament of the power tube is operated directly from the A. C. lighting source.

All Electric Radio

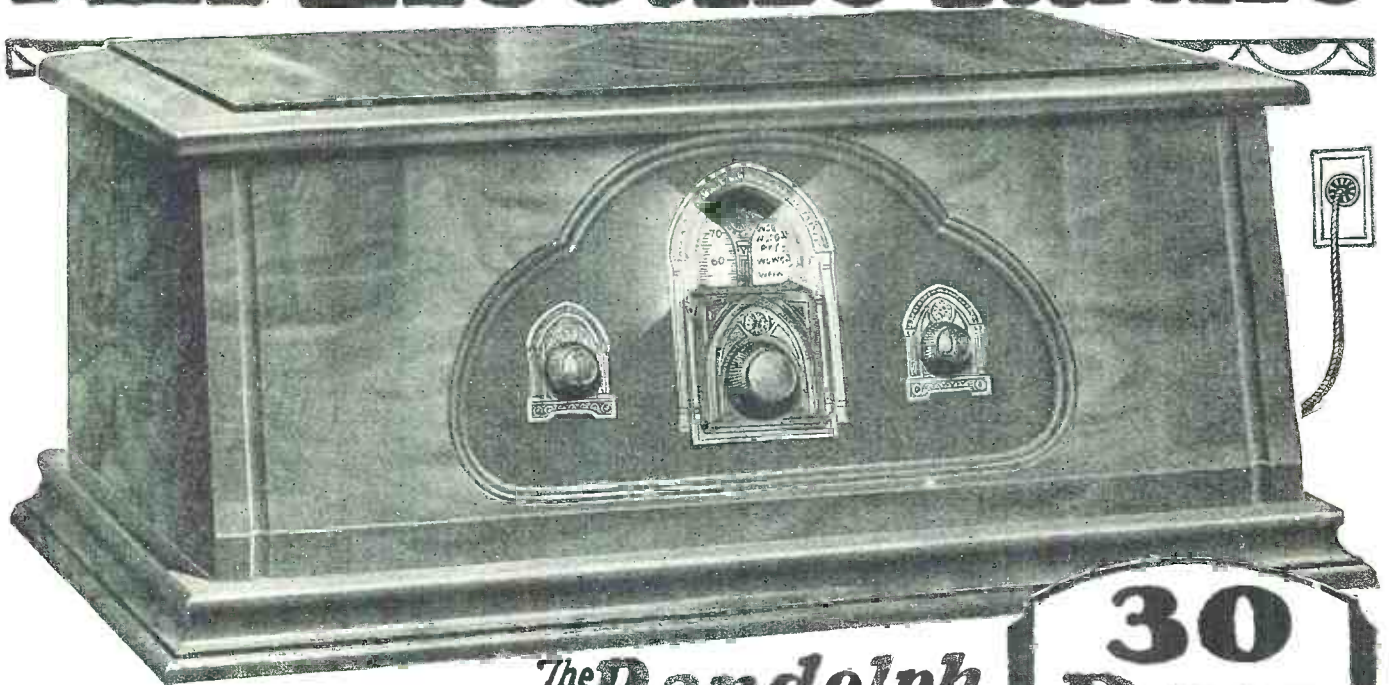

The **Randolph**

7 Tubes-Single Control

JUST plug this Randolph Radio into the electric light socket—and tune in. A powerful, selective radio that gives dependable coast to coast reception. **No batteries, chargers, eliminators, acids or liquids.** Here is complete radio satisfaction whenever you want it. The easy tuning with one control brings on all stations. Illuminated drum allows you to operate the radio in the dark and has space for logging stations. Every detail of the Randolph is modern and perfected—it is the utmost in radio—unsurpassed regardless of price. It is this wonderful radio that you test and try for 30 days FREE before you buy. Listen to it in your own home. When it convinces you by actual performance it is the ideal radio—the one you have always hoped for—you can buy it direct at factory prices. Be sure you write for free descriptive literature today.

Beautiful Ampliphonic Console



Illustrated here is one of the beautiful Randolph Seven Console Models—made of the finest carefully selected heavy solid walnut, hand-rubbed and with burl finish. Has built-in genuine large cone speaker that compares with any on the market. Assures unlimited reception of high notes and low notes clear as a bell. Completely electric—uses no batteries of any kind. Be sure you send for fully illustrated, full color folder giving complete details.

Genuine Walnut Cabinets

The finest of heavy, genuine, solid burl finish walnut is used in the making of all Randolph cabinets. No picture can do them justice. You must see them to appreciate them.

6-Tube Radio

New, modern, single-control, six-tube radio. Do not compare this set with old-style, 2-dial, 6-tube sets selling for about the same price. The Randolph 1928 Senior Six has also been tested and approved by the leading radio engineers. Comes in beautiful solid walnut cabinet of hand-rubbed finish. Single control. Illuminated drum with space for logging. Absolutely dependable and very selective. **Send for 30 days free trial. You test it before you buy.**

All Sets Guaranteed

30 DAYS FREE TRIAL

6 Tube \$55 Retail Price

Biggest Discounts To Agents



Biggest Discounts to Agents

Work either full or part time and make big money. Sensationally big discounts to agents. No experience required. Randolph All-Electric Sets sell on first demonstration. Tremendous advertising campaign helps you. Men and women both make big money this way. Demonstrating set sent on 30 Days TRIAL. **WRITE NOW for proposition.**

USE THIS COUPON TODAY!

Randolph Radio Corporation
711 West Lake Street, Dept. 256
Chicago, Illinois

Send me full particulars about the RANDOLPH Six and Seven-Tube Electric and Battery Table and Console Sets with details of your 30 Day FREE Trial Offer.

Name.....

Address.....

City..... State.....

Mark here if interested in Agent's proposition.

RANDOLPH RADIO CORPORATION
711 West Lake Street Dept. 256 Chicago, Ill.



**Best tubes—
Best reception**

New broadcast developments make it necessary to have the latest types of tubes for fullest enjoyment of your receiving set.

Bring it up to date with a complete installation of the new Gold Seal radio tubes—specially developed for modern reception. You will be delighted with the improvement.

You can make the changes yourself—no trouble. Our new booklet tells you all about it. Send today for your copy—it is free. Use coupon below.

All Standard Types

Gold Seal Electrical Co., Inc.
250 Park Ave., New York

Send me copy of the new booklet.

Name _____

Address _____

R. N. 11-27

**Gold Seal
Radio Tubes**



Hook-Up Review

(Continued from page 502)



type R-76; nine 201A-type tubes; one 210-type tube; one Remler "three-in-line" variable condenser, each section, .00035-mf.; one Remler single .00035-mf. variable condenser; two Remler R.F. chokes; two Remler drum dials (left and right hand) illuminated; one Jewell 0-8 voltmeter; one Carter 15-ohm rheostat with filament switch; two Carter rheostats, one 1-ohm, one 30-ohm; one Carter 400-ohm potentiometer; three Parvold

1-mf. by-pass condensers; three Sangamo fixed condensers, one each .002-mf., .0001-mf., .00025-mf.; one Silver-Marshall .000025-mf. midget condenser; ten Benjamin tube sockets; one battery cable, 10-wire; one Formica panel, 12x26x $\frac{1}{8}$ inches; one Formica sub-panel, 10x25x $\frac{1}{8}$ inches; two Benjamin sub-panel brackets; four X-L push posts; one 2-megohm grid leak; two phone tip jacks.

THE TYRMAN TEN-TUBE SET

THE Tyrman Ten is a ten-tube super-heterodyne of the most advanced type. However, in spite of the imposing appearance of its hook-up, it is a remarkably simple set to assemble, for the various parts are so carefully laid out that only a few short connecting wires are necessary. The wiring operation is also simplified by the use in the receiver of a patented "capacity-connector" strip (described in detail by E. T. Flewelling, its inventor, in RADIO NEWS for August and September, 1926). This strip runs under the sub-panel for the full length of the latter, covering more than thirty different connec-

able tuning condensers, the latter being controlled by a double-vernier dial of the edge-wise-drum type. The sub-panel holds the rest of the parts, which are listed in detail as follows:

Two Tyrman R.F. transformers, type 8-70; one Tyrman R.F. transformer, type 8-71; four Tyrman R.F. transformers, type 8-80; one Tyrman audio transformer, type 3-30; one Tyrman power input transformer, type 3-50; one Tyrman power output transformer, type 3-51; one Tyrman vernier drum, double; ten Tyrman shielded sockets; one Kurz-Kasch capacity connector; one bakelite front panel, drilled and decorated, 7x26

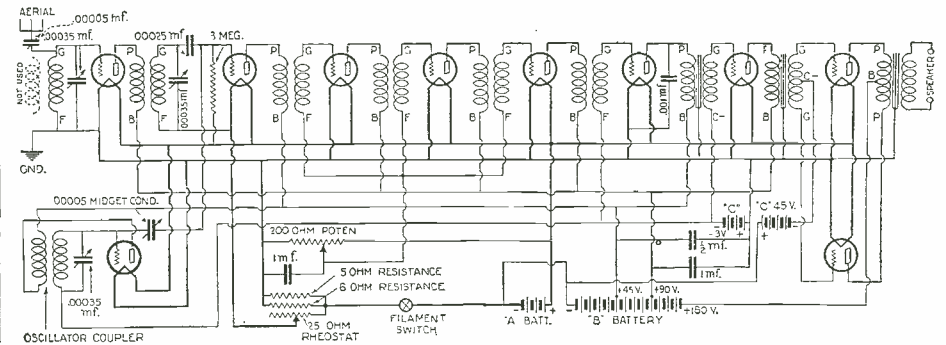

The complete hook-up of the Tyrman Ten. The set uses one stage of straight R.F. and three of intermediate-frequency amplification. The locally-generated oscillations are transferred to the "mixing" circuit of the first detector (the second tube from the left) through the .00005-mf. midget condenser.

tions and saving the constructor several hours of labor.

The ten tubes are arranged to act as follows respectively: straight R.F. amplifier; oscillator; first detector; three intermediate-frequency amplifiers; second detector; A.F. amplifier; two in push-pull, as A.F. amplifiers. A feature of the receiver is the fact that each tube is equipped with an individual metal shield, completely surrounding it.

The components of the set are mounted on panels of bakelite. The front one holds a combined filament rheostat and filament switch, a potentiometer, and the three vari-

ables; one ivory bakelite sub-panel, 7x26 inches; two Benjamin brackets; three Carter by-pass condensers, two 1-mf., one 0.5-mf., two Carter fixed mica condensers, one .00025-mf., one .001-mf.; one Yaxley cable connector, complete, No. 669; one resistor with mounting, 3-meg.; two Yaxley filament resistors, one 6L type, 1 $\frac{1}{2}$ -amp. 5-volt, one 5L type 1 $\frac{1}{4}$ -amp. 5-volt; one Yaxley 200-ohm potentiometer; one 50-mmf. midget condenser; one Yaxley 25-ohm rheostat with switch; two binding posts; one Camfield condenser, type 351, .00035-mf.; one Camfield two-gang condenser, type 352, .00035-mf.

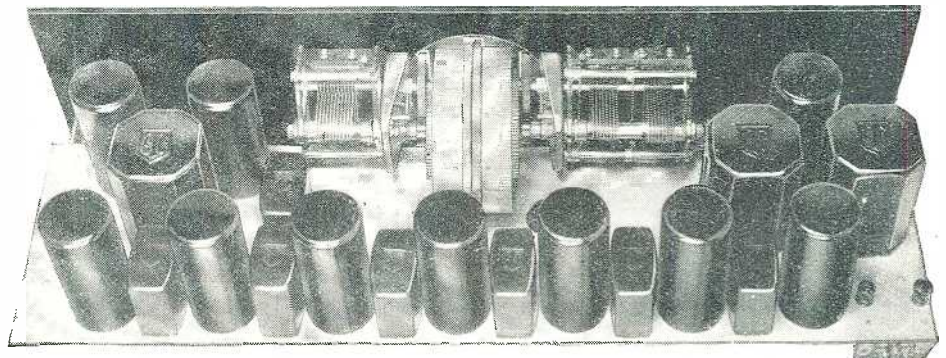

Rear view of the Tyrman Ten. The upright cylinders are individual metal shields for the tubes. The parts are so arranged that all the connections are very short and direct. The Flewelling "capacity connector" is used, eliminating most of the wiring and much of the task of the constructor.

... Modern

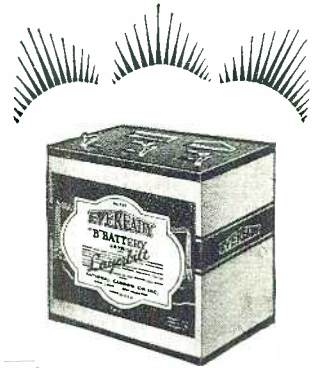
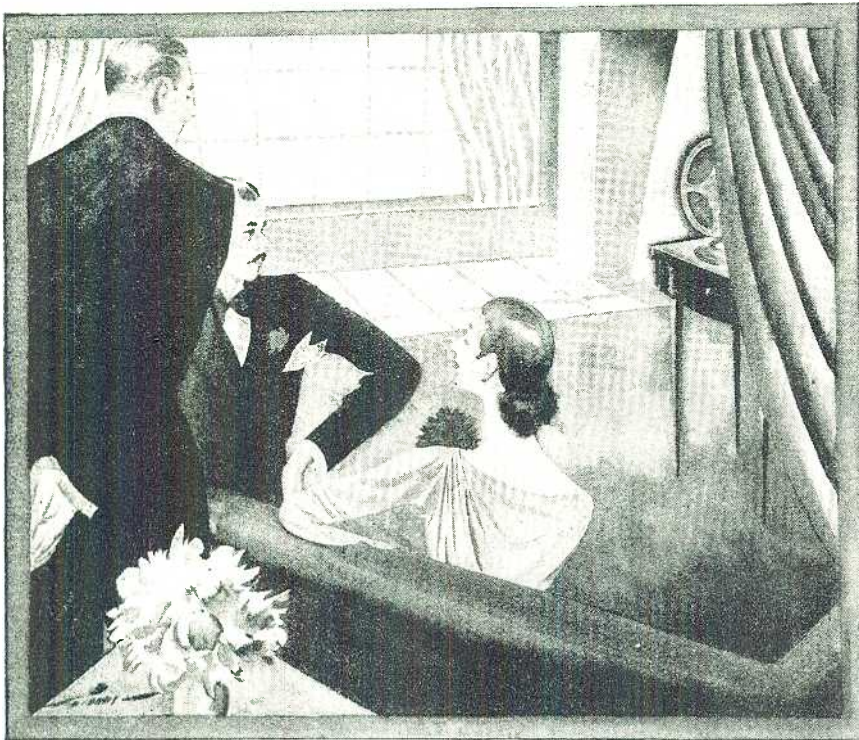

Here is the Eveready Layerbilt "B" Battery No. 486, Eveready's longest-lasting provider of Battery Power.

Radio is better with *Battery* Power

NOT because they are new in themselves, but because they make possible modern perfection of radio reception, batteries are the modern source of radio power.

Today's radio sets were produced not merely to make something new, but to give you new enjoyment. That they will do. New pleasures await you; more especially if you use Battery Power. Never were receivers so sensitive, loud-speakers so faithful; never has the need been so imperative for pure DC, Direct Current, that batteries provide. You must operate your set with

current that is smooth, uniform, steady. Only such current is noiseless, free from disturbing sounds and false tonal effects. And only from batteries can such current be had.

So batteries are needful if you would bring to your home the best that radio has to offer. Choose the Eveready Layerbilt "B" Battery No. 486, modern in construction, developed exclusively by Eveready to bring new life and vigor to an old principle—actually the best and longest-lasting Eveready Battery ever built. It gives you Battery Power

for such a long time that you will find the cost and effort of infrequent replacement small indeed beside the modern perfection of reception that Battery Power makes possible.

NATIONAL CARBON CO., INC.
New York  San Francisco
Unit of Union Carbide and Carbon Corporation

Tuesday night is Eveready Hour Night
—9 P. M., Eastern Standard Time

- | | |
|------------------|------------------|
| WEAF—New York | WOC—Davenport |
| WJAR—Providence | WCCO—Minneapolis |
| WEEL—Boston | WEEI—St. Paul |
| WFI—Philadelphia | KSD—St. Louis |
| WGR—Buffalo | WDAF—Kansas City |
| WCAE—Pittsburgh | WRC—Washington |
| WSAI—Cincinnati | WGY—Schenectady |
| WTAM—Cleveland | WHAS—Louisville |
| WWJ—Detroit | WSB—Atlanta |
| WGN—Chicago | WSM—Nashville |
| | WMC—Memphis |

- Pacific Coast Stations—
9 P. M., Pacific Standard Time
- | | |
|-----------------------|-----------------|
| KPO—KGO—San Francisco | KFI—Los Angeles |
| KFOA—KOMO—Seattle | KGW—Portland |

EVEREADY
Radio Batteries
—they last longer

The air is full of things you shouldn't miss

Finally—the Perfect “A” Eliminator For Your Present Set or the Set you eventually buy

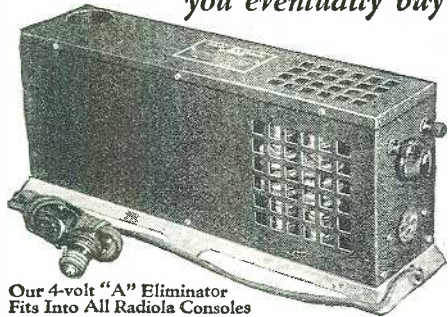

Our 4-volt “A” Eliminator Fits Into All Radiola Consoles

Silver Beauty POWER

Replaces “A” storage battery and charger; has full wave “dry” rectification; maintains required voltage in uniform, constant flow; operates automatically by moving a switch; economical—uses minimum amount of current (about 1-10 cost of using electric iron); has rheostat control for additional refinement in voltage and reception; gives maximum power to radio tubes and lengthens their life; no acids to test or spill. Satisfactory results guaranteed.

Its principle is simple and correct!

The 110 volts Alternating Current is scientifically reduced with the famous “Silver Beauty” transformer coil to deliver the proper voltage to an especially developed dry, noiseless rectifier, which transforms the electricity to direct current. This current of exact voltage, is then transmitted through a patented special filter which clarifies the current, eliminating all foreign noises caused by rectifier or generator.

The Silver Beauty “A” Eliminator is endorsed by prominent radio engineers—adopted by leading distributors and dealers—approved by thousands of users. These are sufficient reasons for making Silver Beauty your choice.

\$39⁵⁰ \$43⁵⁰ \$39⁵⁰
 6-volt; 2 amp. 6-volt; 3 amp. 4-volt; ½ amp.
\$2 Higher West of Rockies

Silver Beauty “B-C” UNIT

Does away with “B” and “C” batteries

Embodies every up-to-date refinement and principle, insuring smooth, unflinching reception. As beautiful as it is efficient.

No. 450
180 Volts—40
Milliamperes
\$45

No. 460
135 Volts
\$35

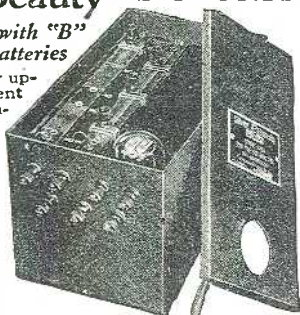

Individual adjustment adapted to all sets.

Silver Beauty CHARGERS

Employing an entirely new method of rectification. Two models—with or without bulbs.

See Your Dealer or Jobber



Triple-A-Specialty Company
 Manufacturers of the famous Silver Beauty Chargers
 312-316 South Hamilton Ave., Chicago, Ill.



The Hilograd 6 Receiver

(Continued from page 491)



to take full advantage of the power in the dual-impedance audio-frequency amplifier, one of the 112- or 171-type should be used in V6. It may be well to remind the constructor that suitable negative grid bias must be supplied to this tube, in order that the quality of reproduction may be satisfactory. Either a short or a long aerial can be used, as two binding posts are provided, to suit whichever type is desired.

ADJUSTMENT

After all the apparatus has been mounted and the wiring, which is for the most part beneath the sub-panel, has been checked, insert a tube in each of the sockets in turn to see that the filament lights in every case. The “B” and “C” batteries should next be connected and a tube tried in each socket. If everything is satisfactory, the next thing is to adjust the two resistors, R6 and R7.

These adjustments are made as follows:

a station operating on a high wavelength, say 490 or 500 meters, is tuned in and the resistor R6 varied until there is no howl in the loudspeaker. The resistor is then moved back slightly towards its original position until the howling, or oscillation, just starts. It is then set forward again until it just stops. In other words, the receiver must operate just under the point of oscillation. This operation is then repeated with the second resistor, R7.

A station which operates on a short wavelength, in the neighborhood of 200 meters, is then tuned in. The same adjustment of the two variable resistors is once more made. It will be found that between the two points (i.e., that for the high and that for the low wavelengths) an adjustment of each resistor can be made so that the set will operate just under the oscillating point. Once made, these adjustments need not be touched until a change is made in the tubes, etc.

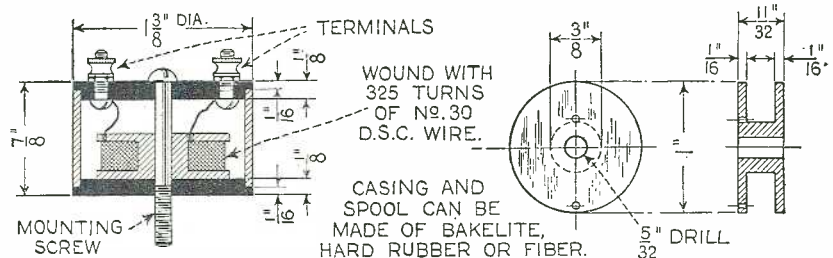
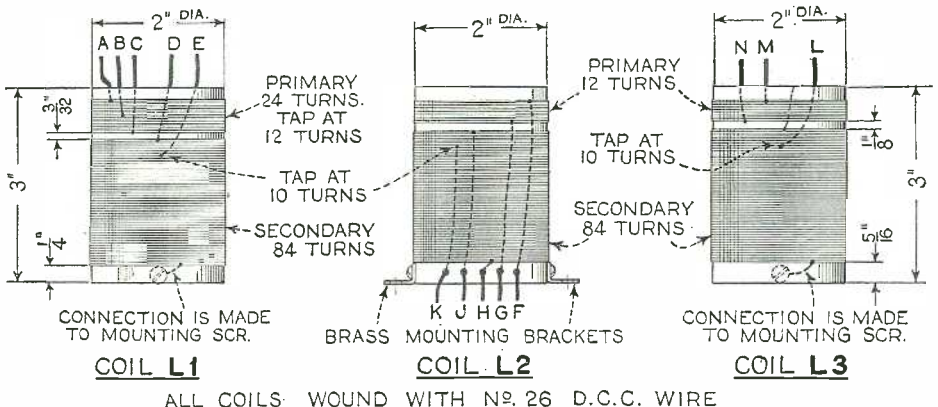

~ DETAILS OF CHOKES L4 AND L5 ~

The constructional details for the radio-frequency coils and chokes. It is very important that these specifications be followed very closely.

ANTIPODEAN SHORT WAVES

STATION 3LO, Melbourne, Australia, has recently been conducting short-wave experiments with a 29.8-meter transmitter, and requests reports from readers on this side of the earth. The hours of these test transmissions early in September were from 9:45 a. m. to noon and from 2:00 to 3:00 p. m., E. S. T.

Station 2FC, Sydney, has also been in operation on 32 meters. An English correspondent, Mr. E. T. Somerset, states: “He was received from 1800 to 2100 G. M. T. (1:00 to 4:00 p. m. E. S. T.) with the utmost clarity at strength R4 to R6, with telephones in the second audio stage. You will see the very real need for a satisfactory third audio stage with these enormous distances; and, should your laboratory experiment in this direction, I shall be enormously indebted to you if you will be so good as to advise me of their success, if any. I shall also be most interested to learn if you have received Radio Malabar, Java, as I cannot find him on the ether any more.”

The latter experimental station, built to work with Holland, is said to have used two kilowatts power, on its 17.4-meter wave, and was heard regularly in Europe. The experiments, we are informed, were prompted by the fact that static is so violent that even a local could not be heard on the normal intermediate broadcast wavelength at times, in the equatorial East Indies.

RADIO INTEREST IN PORTO RICO

DEMONSTRATING a willingness to aid in the development of better broadcasting in Porto Rico, a number of the leading radio enthusiasts of the island are forming a radio club to contribute financially toward this end. An initiation fee of \$2.00 and dues of \$1.00 per month indicate that this is taken seriously.

Porto Rican listeners, also, are uniting in a proposition to obtain rebroadcasts of programs transmitted from the short-wave stations in the United States, such as WGY, KDKA, WLW, WRNY, etc., through their local station, WKAQ at San Juan, P. R.—Santiago R. Rodriguez.

new
advanced
TYPE
180 volt
"B"
Eliminator

**Uses Q. R. S. or
 Raytheon
 85 Mil. Tube**



**For
 110 Volt
 60 Cycle A. C.**

Brand new—radically different in design—obviously better—and guaranteed for years! The first "B" Eliminator ever offered at a reasonable price which combines high power output with real long life. Delivers every volt required by the modern multi-tube set, 5-8-10 tubes—it makes no difference. Plenty of pure, smooth, hum-free power for any set. And we let you try it free before you buy.

**A Real High Quality Lifetime
 "B"—at a Price that
 Stagers Comparison**

Do not confuse this new, advanced type "B" unit, with chemical rectifier types or with cheap eliminators having only a single filter choke or employing short lived single paper filter condensers. The Cloverleaf Lifetime "B" is all that its name implies. It is the true lifetime unit; good for long years of dependable service, even under heavy load. Only the very finest quality materials go into the Cloverleaf Lifetime "B"—two oversize filter chokes—the very finest grade high voltage heavy duty filter condensers that money can buy—the best, longest lived, newest type of thoroughly dependable wire-wound voltage control resistances that experts could design. Every part, every bit of workmanship is the best. Yet, the Cloverleaf Lifetime, high voltage "B" costs only half what others of equal capability cost you.

**Operates "171" and "210"
 Power Tubes**

Many "B" eliminators costing more than the Cloverleaf will test at 180 volts on a meter. But what YOU must have is high voltage under load. The Cloverleaf Lifetime "B" provides plenty of voltage and plenty of current for all the ordinary demands of the set—then it supplies ample voltage for the proper operation of either a "171" or a "210" power tube.

Heretofore you have had to pay a really exorbitant price for an eliminator that would do what the Cloverleaf does. Read our FREE TRIAL OFFER. Then send the coupon.

**ONLY
 1/2
 THE PRICE
 OF
 OTHERS**

We want you to try the Cloverleaf; to put it to any test you can. Hook it on to 8 or 10 tubes. Make it drive a power tube. Compare it with any "B" eliminator at any price. Compare its performance—compare its many detailed advantages such as the absence of exposed binding posts and many other important refinements. Make this test at our risk under our FREE TRIAL GUARANTEE OFFER. Then decide why, if at all, you should pay more for a "B" eliminator than the ridiculously low price at which the Cloverleaf Lifetime "B" is sold. Mail coupon at once for full particulars of this great new "B" and for details of our FREE TRIAL GUARANTEE OFFER and 2 YEAR GUARANTEE.

**Users
 Anxious
 to Spread
 Praise for this
 Great, New, Better
 Eliminator**

"I purchased a Cloverleaf "B" eliminator from you on the strength of the wonderful performance of your other product—Subantenna. The Cloverleaf "B" is, in every sense of the word, all you claim for it. I have it hooked up to an eight tube set. It not only operates the set in beautiful style but also operates my power amplifier which has two Western Electric power tubes in it. No "B" eliminator ever made my set perform like the Cloverleaf does."—L. M. P., Chicago.

"I have tried several "B" battery eliminators on my superheterodyne but they all caused 'motor-boating.' The Cloverleaf works perfectly. No 'bubbling' sounds, and no hum. I am well satisfied."—W. J. S., Cadott, Wis.

"The Cloverleaf "B" received and it works fine. Other eliminators all failed when the A. C. line voltage fluctuated. The knob on the front of the Cloverleaf certainly takes care of that condition nicely.

"Several of my friends have seen the Cloverleaf at my house and said they were going to order eliminators for their sets. I gave them your name and address."

F. E.,
 Watervliet, Mich.

**Get Ready
 for
 WINTER**

CLIP AND MAIL AT ONCE!

**CLOVERLEAF MFG. CO.
 2712-G Canal St., Chicago, Ill.**

Tell me more about the Cloverleaf "B" Eliminator and particulars of your FREE TRIAL OFFER.

Name.....
 Town.....
 State.....

Made by the makers of Subantenna the underground antenna whose remarkable performance has placed the Cloverleaf Mfg. Company in the enviable position of being known as makers of reliable radio apparatus

lifetime
Cloverleaf
"B" ELIMINATOR

**Cloverleaf Manufacturing Company
 2712-G Canal Street Chicago, Ill.**

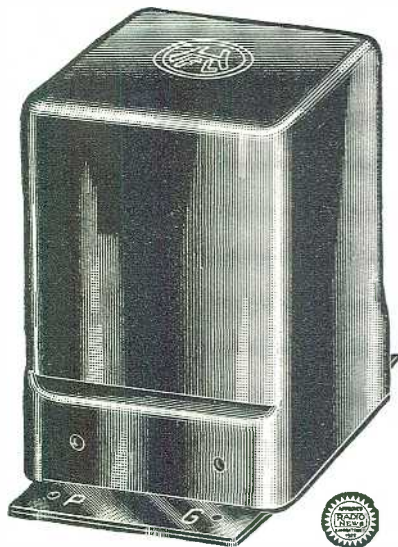

H.F.L. Transformers

H.F.L. C-16 Audio Transformers and C-25 Output Transformer—New Companions of a Great Circuit

H.F.L. C-16 is the most efficient Audio Transformer built. It carries signals at highest volume and lowest amplitude without blasting or developing harmonics. Operates with all power tubes as well as standard tubes.

H.F.L. C-25 Output Transformer handles the voltage output of power amplifying tubes, at the same time matches the impedance of the average speaker to the tubes. Protects loud speaker unit without reducing plate voltage.

Mechanical features of these two transformers are: A coil designed and treated to exclude moisture and withstand heavy electrical surges without breaking down—complete magnetic shielding to avoid interstage coupling—terminals brought out so as to insure short leads.

Endorsed by America's Leading Engineers—Guaranteed by the Manufacturers

The new C-16 and C-25 Transformers will work in any circuit and will improve any Radio Set.

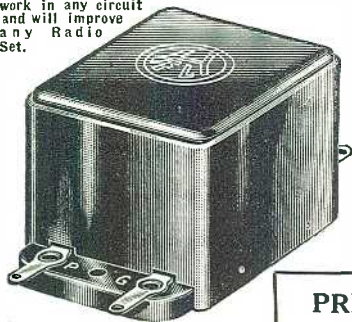

Set Builders and Dealers

If your jobber cannot supply you with H. F. L. Transformers, write us for name of nearest jobber.

PRICES	
H-210 Tran.	\$8.00
H-215 Tran.	8.00
L-425 R. F. Choke ...	5.50
L-430 R. F. Transform.	5.50
C-16 Transf.	8.00
C-25 Output Transform.	8.00

High Frequency Laboratories

133 NORTH WELLS STREET CHICAGO, ILL.



Radio Wrinkles

(Continued from page 503)

jecting end must have a screw and nut to form one terminal. The other terminal is the body of the clock.

Now get a strip of spring steel or tin and solder one end to the back of the clock, letting the other end rest on the screw at the end of the piece of bakelite. All that is needed now is a little piece of some insulating material fastened by a short piece of string to the winder of the alarm spring.

To set the clock, it is wound up and the piece of insulation is put between the end of the spring and the screw. When the clock goes off the winder turns round as the spring unwinds and, of course, pulls the insulation from its place between the contacts; and so turns on the set.

—Contributed by R. Dove.

A SIMPLE FILAMENT BALLAST

OLD rheostats of the wire-wound variety may be utilized as filament ballasts for vacuum tubes, by removing the resistance unit and using various lengths for different types of tubes. These home-made resistors are very satisfactory for use in the audio-frequency stages, where the filament current is not critical.



STRIP OUT OF OLD RHEOSTAT

A filament-resistance strip can be obtained by taking apart an old rheostat.

After the strip of insulation has been removed from the rheostat, it may be cut to the proper length or the wire rewound on another strip more convenient in size. For a 201A tube about 4 ohms (two-thirds of a 6-ohm-rheostat strip) will be sufficient. Holes may be drilled in the ends of the strip, so that the resistor can be mounted on the terminals of the socket.

—Contributed by Jack Behrns.

INEXPENSIVE OUTPUT FILTER

IT is possible to construct an impedance-type output filter using nothing more than a burnt-out old-style A.F. transformer and a 4-mf. output filter condenser which has been specially designed for this work. The secondary of the transformer is used as the inductance, or choke, in the filter, as shown.

Since the transformer required will generally be on hand, or procurable for almost nothing, the only outlay is for the condenser.

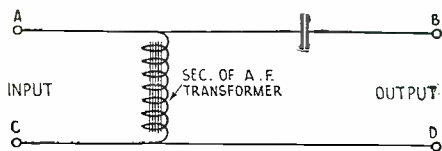

If an A.F. transformer with a burnt-out primary is in the junk box, it can be put to good use in a filter system to protect the loud speaker from high plate current.

An old-type low-impedance transformer has about the correct secondary impedance to match the power tubes generally used. The primary binding-posts are used as the output connections, thus eliminating the need for extra binding-posts, and making the unit cost still less. A base can be used to mount the transformer and condenser; or the parts may be built right into the receiver, if there is room in the cabinet.

The transformer is adapted to its new

function by removing the primary winding connections from the primary binding-posts. A connection with No. 18 insulated wire is then made from the bottom of one primary post to the adjacent secondary; this is C-D on the diagram. The other primary post is connected to one side of the condenser, the other side of which is connected to the remaining secondary post. These connections should be made under the lock-nut portion of the binding-posts, so that the tops will be free for external circuit connections, if possible.

This unit is very easily installed in a receiver. The output connections of the receiver, usually connected to the loud speaker, are led to the input terminals of the filter. The output terminals of the filter (which were the primary binding posts before adapting the transformer) are connected to the loud speaker.

—Contributed by H. R. Lubcke.

MAGNETIZING A SCREWDRIVER

MUCH time is certainly lost by many while trying to place a screw in an inaccessible place of the receiving set, and although some devices have been placed in the market for filling this need this way of doing it incurs no further expense. The scheme is this: Magnetize your screw-driver so that the screws will stick to it while you put them in their right place in the set. This can be done in several ways, but the two most efficient are by friction with a permanent magnet, or by using a solenoid in connection with a battery; e.g. the electro-magnetic way.

If using the first method, be sure that you rub your screwdriver along the permanent magnet, always in the same direction, until

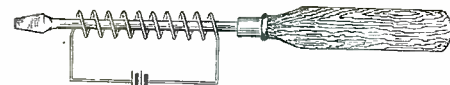

Small steel or iron parts can easily be picked up from inaccessible places by this magnetic screwdriver.

the screwdriver becomes magnetized. In the other case, wind a layer of No. 24 D.C.C. wire around your screwdriver and connect it to a set of batteries. If the screwdriver is rather short, two or three layers of wire may be needed.

—Contributed by Gonzalo Velásquez.

BATTERY-CABLE TAGS

THESE tags are easily and quickly made and are very neat. Aluminum is the best metal to make them of; zinc is good; and copper or tin can be used. Cut pieces of the metal 1 inch long and 1/2-inch wide. Make two cuts half the length of the strip, forming three tongues which are bent out slightly while the lettering is being done.

The lettering is done with a pen and India ink; the metal must be free from grease and dirt. After the ink has dried, go over the letters with a light coat of clear varnish to keep the ink from rubbing off.

One tongue (in the center) is bent around the wire in one direction, and the other two in the other direction; thus fastening the tag securely. See the sketch.

—Contributed by J. Thomas Scott.

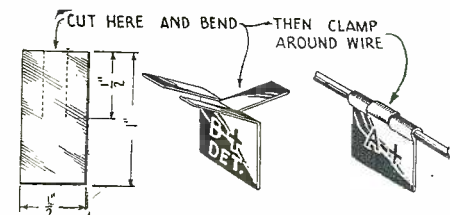

Cable leads can be tagged conveniently with these easily constructed homemade markers.

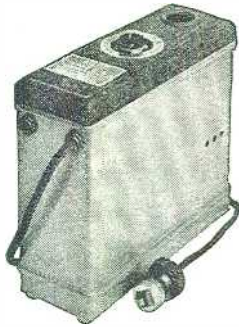

ACME E-4 B-Power Supply
\$35.00

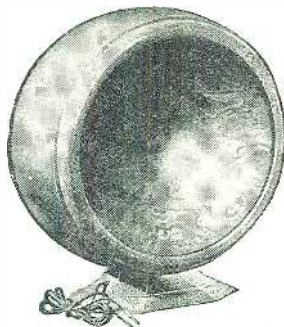

ACME K-1A SPEAKER
\$25.00

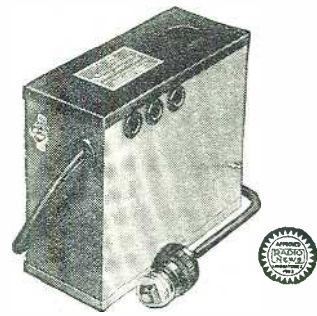

ACME PA-1 Power Amplifier
\$14.50

Give Your Present Set a Square Deal

Any Good Dealer Will Be Glad to Have You Try ACME APPARATUS on a Money-Back Guarantee

YOU can go to the nearest radio store and hear any one of a number of loud speakers that sound wonderful there. But perhaps your own old speaker at home sounds mighty good, too. Perhaps the actual reception in your old set is a great deal better than any previous speaker you've ever tried has been able to demonstrate. The conditions in your home and in the store are never the same. No two sets are exactly alike. The thing that counts is how the speaker sounds on your own particular set—in rooms the shape of yours—and how well it goes with the rest of your furniture.

But never until you hear the marvelous new Acme K-1-A double free-edge cone speaker—and hear it in your own home—can you possibly realize

the tremendous strides that have been made in radio reproduction since your loud speaker left its factory! It took five years and 320 experimental models to make this speaker.

This new K-1-A gives your old radio set a real square deal—shows how genuinely good your reception has been all along.

For the B Power Supply that has been proved absolutely sound—and

NEWSPAPERS in principal cities carry his newsy column telling of the biggest forthcoming radio programs each week.

As radio programs become better and better, the importance of supplementing your set with the farthest-advanced loud speaker becomes greater and greater.



A K M E E
The Speaker of the House

proved by longer experience on the market than any other B Power Supply of this type . . . demand Acme B with Raytheon tube. It was the first on the market, three years ago. We said it would stand up and work—thousands of users now know we were right.

Acme now offers a single stage power amplifier to add to any set. All you have to do is connect your set, your B supply and your speaker to the amplifier, put in a power tube, plug into the lamp socket, and your radio enjoyment increases a hundred fold. No additional A battery current and no C battery to add, both of these supplies are included in the unit.

Acme has two booklets. (Amplification without Distortion) telling how to improve any radio set; and (Power Supply for Radio Sets) telling the story of Lamp Socket operation.

Fill in the coupon below for the one you want.

ACME

-for amplification

ACME APPARATUS CO.
Dept. R.N.-2 Cambridge, Mass.
Gentlemen: Please send me a copy of the booklet checked below. I enclose 10 cents for each copy.

Amplification without Distortion
Power Supply for Radio Sets

Name
Street
City State

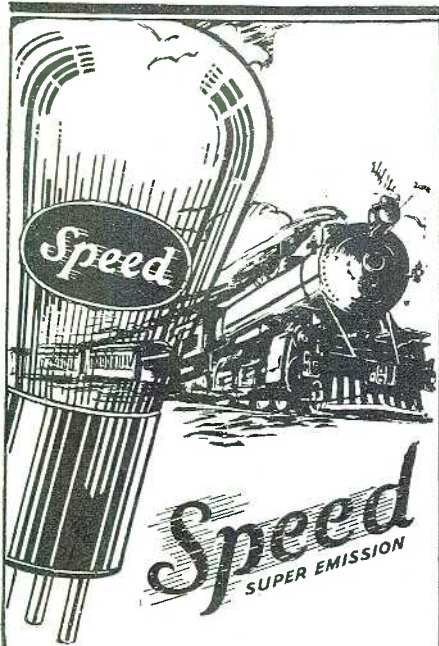

RADIO TUBES

THE MODERN FLYER—symbol of twentieth century progress—typifying the speed of this golden era in which we live.

And in SPEED Super-Emission Radio Tubes you will find the true culmination of all that marks progress and advancement in that great modern science and popular amusement art—RADIO.

No matter how good your set, reception is bound to improve when you use SPEED Super-Emission Tubes, for SPEED Tubes run so uniformly that they require no balancing—no matching.

SPEED Tubes are absolutely interchangeable—brothers in performance!

Here's protection! Thirteen inspections—one after each manufacturing operation, followed by seven rigid tests for characteristics—twenty guarantees of perfect results in your set.

If you cannot secure SPEED Tubes locally, write to the address below, giving us the name of your dealer and we will see that you receive complete information

CABLE SUPPLY CO., INC.
MANUFACTURERS

Executive Offices: 31 UNION SQUARE
New York, N. Y.

The Listener Speaks

(Continued from page 472)

I am trying to log the stations whose programs I am pleased to receive and I find it quite difficult when some umpire starts up a deep, guttural, smart, flat, froggy, stomach growl that is impossible to understand on evenings when receiving sets are snapping with static. He makes it sound as though he is trying to sponge me off with his confidential affections; and, without warning, he snaps on his inspiring highbrow jazz with no intimation as to where his stroke of paralysis is coming from.

T. DELOS MULLINS,
Mena, Ark.

WORLD-POWER STATIONS

Editor, RADIO NEWS:

Your editorial in the September issue of RADIO NEWS (suggesting a group of stations of power in an order many times higher than that now in use, in order that American programs might be heard all over the world) is laudable. The idea expressed is feasible from the technical point of view; but there is one objection which you yourself point out, and that is a financial one.

To be sure, such a project as you outlined would require much capital. We already have super-power stations in the order of 50 kilowatts, and find them expensive to run. Much more would be the cost of running ultra-power stations, in the order of 25,000 or 50,000 kilowatts. But the unquestioned good effects of such an undertaking would, no doubt, more than pay for it indirectly, at least.

When we stop to consider the millions of horsepower, available from natural sources, which are not being utilized today, and consider that the minimum equivalent of all five stations would not total more than 167,600 horsepower, the practicality of your idea, in the immediate future, looms up more forcefully.

JOHN HENRY MEREDITH,
New Haven, Conn.

AN EX-DX-ER SPEAKS

Editor, RADIO NEWS:

I note that you have published (in the September issue of RADIO NEWS) very interesting letters in regards to my challenge in the July issue. To all the type of deluded ("DX") radio fans, I only wish to say, go to it; for some day you will get out of your heads those childish ideas about DX making a radio receiver.

My basement is full of two-, three-, and four-tube sets that were and still are howling successes on DX, both literally and figuratively speaking; for in between squawks, scratches and howls, I have heard all of the DX stuff mentioned by most of the DX hounds—with the possible exception of some of those mentioned by Mr. H. S. Smith. His letter, though written in a spirit of comedy, is very little worse than some written in all due sincerity.

To go on with the story, as my basement filled up with marvelous relics and my pocketbook emptied, I decided (with the able assistance of my wife) that a radio receiver is designed primarily for faithful reception of something one wants to listen to; and, as the same howls and squawks prevailed in my wonder sets when I attempted to listen to local stuff, I began to cast around for a receiver I could turn on when I wished the company to stay, instead of when I wished them to leave. After adding considerably to the collection in the basement, I finally ran into the haven of rest for any disillusioned fan who has the idea that DX alone makes a receiver.

If there are any radio fans who have hesi-



Make your
LAST change

Radio fans spend thousands of dollars every year changing Resistors and Grid Leaks—needlessly! Make your last change now—replace your resistors with

GLASTOR

THE TRANSPARENT RESISTOR

with the complete knowledge and confidence that the resistor will be the value the label says it is—that it will be absolutely noiseless—that it will be permanent. Daven Glastors will not change in value while the glass remains intact. The resistance material is not on the inside of the glass—it is *in* the glass itself.

The DAVEN BALLAST

Won't Burn Out!

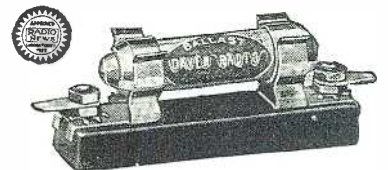

The Daven Ballast, the standard filament control, will not burn out, or change its characteristics no matter what the service.

Replace your filament control with Daven Ballasts and forget them—they will perform perfectly, *for the life of the set*. Made in ¼, ½, ¾, 1 and 1½ amperes. Supplied with or without special mounting as illustrated.

Free Catalog

The new Daven Catalog describing the complete line of Daven Products, will be sent **Free** upon request. Your copy is ready, address

The Sine of Merit
DAVEN RADIO CORPORATION
TRADE MARK "Resistor Specialists" REG. U.S. PAT. OFF.

141 Summit Street Newark, N. J.

BUILD THE STROBODYNE

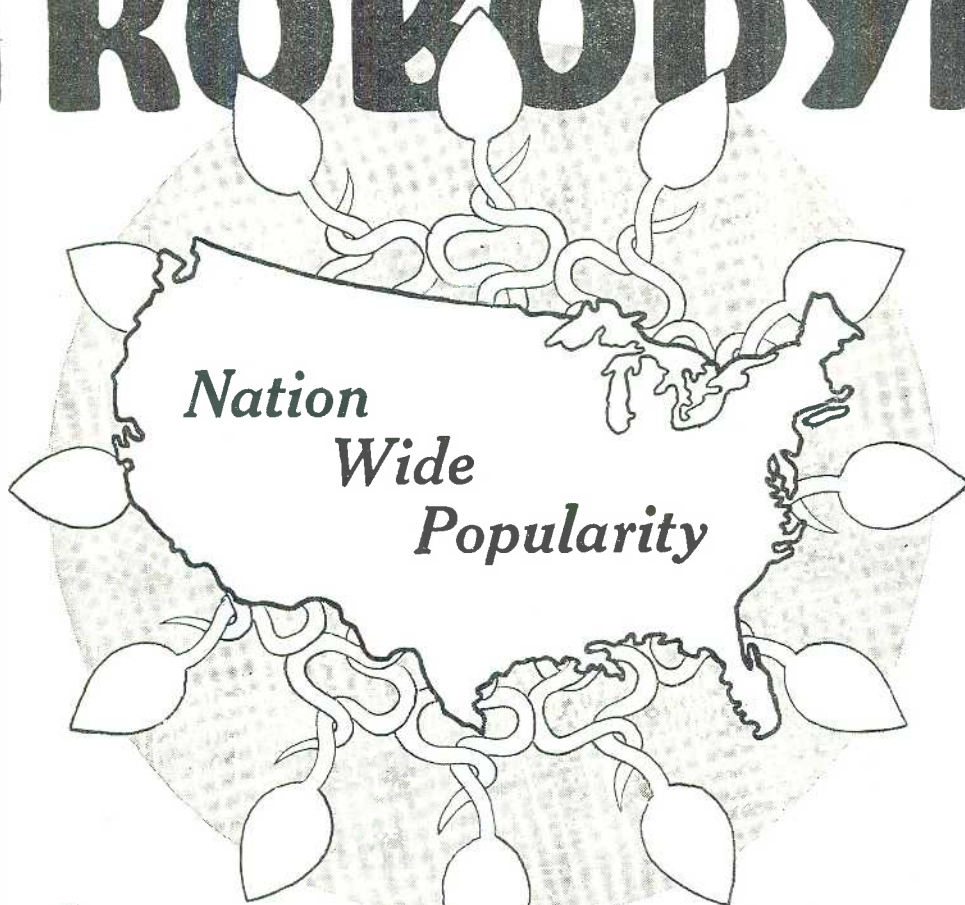

The Greatest of All Circuits for Performance

The designer of the "Strobodyne" called it, not a new Radio circuit, but an EPOCH in Radio.

Results by hundreds of Strobodyne builders have confirmed his prognostication. Strobodyne builders are at work in every state of the Union—it has swept the country.

Strobodyne gives:

1. Extreme selectivity enabling you to tune out interference.
2. The ability to receive distant stations as a matter of course, rather than as an event.
3. Unusual tone quality due to the precision and quality of the apparatus used.
4. All the volume you want—undistorted.
5. Extreme simplicity of tuning and adjustment.
6. Easy to build and every product fully guaranteed.

USE THIS OFFICIAL LIST OF PARTS

- 2 Hammarlund Variable midline condensers .00035 mf.
- 1 Set Hammarlund Strobodyne coils
- 3 Hammarlund Shields
- 2 Hammarlund Equalizing Condensers
- 1 Hammarlund Brass Shaft 10 1/4 inches long
- 2 Samson Symphonic Transformers
- 1 Samson No. 85 Choke
- 4 Radio Electric R.F. Units Type F
- 5 Radio Electric Fixed Matched Condensers
- 1 Micarta Fabricator Panel 8" x 21" x 3/16"
- 1 Micarta Fabricator Sub Panel 12" x 25 1/2" x 1/4"
- 1 Interstate Sales Output Filter
- 3 Carter No. M-20 Midget Rheostats 20 ohm
- 1 Carter No. M-100 Midget Potentiometer 400 ohm
- 1 Carter No. 1 Short Jack Open Circuit

- 1 Carter No. 2A Short Jack Closed Circuit
- 1 Carter Imp Battery Switch
- 1 Cardwell Balancer Type 618A
- 4 Dubilier By-Pass Condensers .5 mf. Type 907
- 1 Dubilier Fixed Condenser .002 mf. Type 601
- 8 Benjamin Sockets UX Type 9040
- 12 X-L Binding Posts
- 2 National Co. Dials
- 4 Radiall Amperites Type 1A
- 1 Radiall Amperite Type 112
- 1 Electrad Royalty Variable Resistance Type B
- 2 25 ft. coils Heiden Colorubber
- 7 CeCo Vacuum Tubes Type 201A
- 1 CeCo Vacuum Tube Type 112
- 1 Pritts Cabinet for Panel 8" x 21" x 12 1/2"

OFFICIAL CONSTRUCTION BOOK NOW READY

"STROBODYNE"
230 Fifth Ave., New York

I enclose 50c. for one copy of the official construction book, giving all data on the STROBODYNE, and all supplementary information.

Name

Address

City

State

Address all inquiries to "STROBODYNE," 230 Fifth Ave., New York

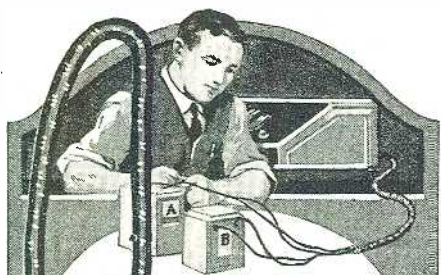

ACME

Celatsite Battery Cable

A rayon-covered cable of 5, 6, 7, 8 or 9 vari-colored Flexible Celatsite wires for connecting batteries or eliminator to set. Plainly tabbed; easy to connect. Gives set an orderly appearance.

Stranded Enameled Antenna
Best outdoor antenna you can buy. Seven strands of enamelled copper wire. Presents maximum surface for reception, resists corrosion; this greatly improves the signal. Outside diameters equal to sizes 14 and 16. (We also offer solid and stranded bare, and stranded tinned antenna.)

Loop Antenna Wire
Sixty strands of No. 38 bare copper wire for flexibility, 5 strands of No. 36 phosphor bronze to prevent stretching. Green or brown silk covering; best loop wire possible to make.

Flexible Celatsite for sub-panel wiring
A cable of fine, tinned copper wires with non-inflammable Celatsite insulation. Ideal for sub-panel or point-to-point wiring. Strips easily, solders readily. Nine beautiful colors; sold only in 25 ft. coils, in cartons colored to match contents.

Acme Celatsite Wire
Tinned copper bus bar hook-up wire with non-inflammable Celatsite insulation, in 9 beautiful colors. Strips easily, solders readily, won't crack at bends. Sizes 14, 16, 18, 19; 30 inch lengths.

Spaghetti Tubing
Oil, moisture, acid proof; highly dielectric — used by leading engineers. Nine colors, for wire sizes 12 to 18; 30 inch lengths. (We also make tinned bus bar, round and square, in 2 and 2½ ft. lengths.)

Send for folder
THE ACME WIRE CO., Dept. D
New Haven, Conn.



ACME WIRE
MAKES BETTER RADIO

tated to hop my challenge because of lack of confidence in their sets' DX abilities, let them not hesitate longer; for they need not pull in reception from outside the state of Iowa to demonstrate their receivers against mine. If they enjoy listening to the kind of reception we all know we get from freak distances, I can give them that, too.

F. C. STAVES,
Des Moines, Iowa.

(It appears that some misunderstanding arose about the original challenge; all of those who wrote to this office concerning it being of the impression that Mr. Staves had in mind DX as the first requisite of a receiver; as have so many who find it a most engrossing hobby. However, if the DX'er does not bloop, there is room in the ether both for him and for the fan who prefers the stronger and less-faded nearby signal. As a matter of fact, the real radio experimenter, and perhaps every member of his family, should have a set for each special need. Set builders, like "gun cranks," have long been discussing the ideal equipment, which shall be developed in every way to the highest possible extent; but the sportsman has an armory proportioned to his purse, and so has the real radio fan more than one good receiver in commission, as a rule.—EDITOR.)

SPAIN ASKS FOR REPORTS

Editor, RADIO NEWS:

May I ask of you the favor to inquire how many of your readers, who have long-range sets with a sufficient number of tubes, have heard the transmission of *Radio Catalana*, of this city, whose wavelength is 462 meters (649.35 kilocycles) and power 1 kilowatt? This station, whose call is EAJ-13, broadcasts from 9 to 12 p. m. (Greenwich time, corresponding to 4 to 7 p. m., Eastern Standard time.) At the beginning and end of each program, the announcer introduces the station in English, as well as Spanish, Catalan, Italian, French and German. The program includes concerts and solos of all kinds; the high character of the modulation of the station has been commented upon. It has several times been heard across the Atlantic; and we hope that readers of RADIO NEWS who do so will write. Of the magazines which we receive, this is the best, and its diagrams, especially, the most perfect.

CARLOS GIMINEZ,
Manso 48, Barcelona, Spain.

HIS OWN CLARIFIER

Editor, RADIO NEWS:

We wish to let you know of an experience, perhaps phenomenal, which we had about six months or so ago. While it is not altogether in improving radio reception, it does, however, muffle the noises.

It was by accident we happened to cup our ears with the palms of both hands during reception on our receiver when "static" was unusually bad. To our surprise, the noises were "filtered" greatly, and the talk which was on came through audible. We have repeated this many times since, and have even placed a finger tip in each ear cavity with even better result. We listened in for several days on the basketball games played in this state; and, while the "mike" was in the open room, the announcer could not be heard distinctly at times on account of the excessive noises; but the little stunt above mentioned helped in following the game through.

Also, sometime passed, while listening in on the receiver we happened to stroke the back of our dog (a Doberman Pinscher) with a pair of pliers, which were used to tighten up a few nuts on the batteries, and this created static electricity which was heard in the receiver, or rather it was picked up by the receiver.

J. A. PANKRATZ,
Garrison, N. D.

G. R. PENN'S NEWEST

Only speaker designed by and now being made under G. R. PENN'S Direct Supervision

G·R·P 3-FOOT Cone Speaker

"Assemble It Yourself"

ABSOLUTELY NEW!

—quicker, easier way to build a better 3-ft. Double Cone Speaker

A finer speaker than you thought possible—truer reproduction, finer tone quality, greater sensitivity and ability to reproduce a wider range of frequencies, high and low, than speakers have had heretofore... Can be compared only with very high priced speakers.

Assembled Flat!

G. R. Penn's latest invention lets you assemble this speaker FLAT. Cones shape themselves. Success certain. Any cones—even if you never have built anything—can assemble a perfect G.R.P. 3-foot Cone Speaker. Illustrated, easily understood Assembling Instructions.

At Reliable Dealers

Ask your dealer for G.R.P. 3-foot Cone Speaker Kit—the Double Cone for \$13.50 or the Single for \$10.50. If he hasn't them, and will not get them for you, refuse imitations; we will supply you direct, f. o. b. N. Y. C., on receipt of price.

G.R.P. 3-foot Double Cone Kit

Complete in every detail—absolutely nothing else to buy; decorated, marked genuine Fonotex; G.R.P. Unit, G.R.P. Back Ring (pat. pend.) Ambroid, Unit Mountings, braid, \$13.50 etc., etc. Complete! in one package

G.R.P. 3-foot Single Cone Kit

Finest Single Cone Speaker you can build; complete in every detail with unit \$10.50 and wall frame

"How to Build Seven Practical 3-foot Speakers", price 50c. For a limited time sent for 10c, coin or stamps. Write today.

G.R.P. PRODUCTS CO., Inc.

104 Fifth Ave. Suite 2397 New York City

HARRY ALTER'S NEW LOWER PRICES WILL AMAZE YOU!



Again Harry Alter challenges all competition by smashing prices that were already the lowest known in radio. Staggering values in sets and parts of standard quality. Get my new November catalog. Write for it NOW. We sell to retailers only.

The Harry Alter Co.

1786 Michigan Avenue CHICAGO

BIG RADIO CATALOG

From the "Big, Friendly Radio House"

NEW 1928 Book offers finest, newest well-known sets; parts, eliminators, accessories at lowest prices. Set-builders, dealers, agents —WRITE for this CATALOG!

Western Radio Mfg. Co.

126 West Lake St., Dept. 18, Chicago, Ill.

New Metal Is Revolutionizing Radio

THE most revolutionary development in radio has been the development of direct lamp radio power, with the use of batteries, acids, charging bulbs, liquids and the inconveniences that were so common in the old days of electrolytic devices. Almost overnight, the public demand for dry, light socket radio power, swept from coast to coast.

This tremendous demand was met with the discovery of Kuprox, a new metallic element in which the atomic structure was rearranged. Prof. S. J. M. Allen, Ph.D., College of Engineering, University of Cincinnati, a scientist of world-wide repute, discovered this marvelous new metal when experimenting with metals in molten temperatures.

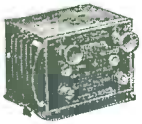

The Replacement Unit, a series of simple Kuprox metal discs, riveted together.

Kuprox makes light socket radio power as easy, as safe and as certain as an electric sweeper, toaster or iron—just the touch of a switch. There is no watering, no acid fumes or holes in rugs, no discomforts of run-down batteries to be charged or replaced. Kuprox is the ultimate in radio power development.

Kuprox lasts indefinitely. Once connected to the light socket Kuprox Radio Power Devices may be forgotten, for they require no attention, no adjustments, no replacements. Kuprox is permanent, ever-lasting radio power and it cannot be improved upon. Radio reception has at last solved one of its most perplexing and annoying problems.

In addition to its use in complete A, B, and C electric radio power devices, Kuprox is also being manufactured in an ingenious device that brings to an end all the bother and trouble experienced heretofore with all electrolytic trickle chargers.

With this device, known as the Kuprox Replacement Unit, and retailing for only \$4.50, it is possible to convert any standard wet trickle charger or power unit into a dry rectifier that requires no attention. It is easy to attach. Simply disconnect the present jar of acid and throw it away. Install the Replacement Unit in its place by two simple binding post connections. Besides eliminating all the watering and attention, the new replacement delivers about twice the former charging rate, resulting in much higher efficiency of the battery to which it is attached.

Kuprox makes light socket radio power as easy, as safe and as certain as an electric sweeper, toaster or iron—just the touch of a switch. There is no watering, no acid fumes or holes in rugs, no discomforts of run-down batteries to be charged or replaced. Kuprox is the ultimate in radio power development.

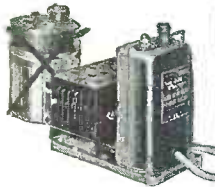

How the Kuprox Replacement Unit replaces the acid jar on trickle chargers.

Dry, Permanent! Radio Power!

No Acids, Liquids or Charging Bulbs

No watering or other attention!

RADIO is truly electric, at last! KUPROX Radio Power Devices have supplanted all the old wet acid-filled power units with completely dry, electric operation.

No more of the bother and worry . . . none of the troublesome watering and attention. KUPROX is all-metal . . . absolutely dry . . . it can't wear out . . . needs no attention of any kind. Install KUPROX Devices on your set and forget them.

See the complete line of KUPROX Radio Power Devices at your nearest radio dealer's.

KUPROX

RADIO POWER DEVICES



KUPROX "A" TRANSIFIERS—Batteryless, noiseless, electric "A" power. Dry, dependable, needs no attention. Operates any receiver. 4-volt or 6-volt. \$28.50 and up.



KUPROX A & B TRANSIFIERS—All radio power from a single unit. Controlled from set switch. Absolutely dry, requires no attention. \$57.50 and up.



KUPROX "B" TRANSIFIERS—Dry, permanent, free of hum. Models for all sets and circuits, \$14.50 and up.



KUPROX Replacement Unit—For replacing acid jar on all standard trickle chargers and power units. \$4.50

KUPROX Trickle Chargers—1-amp. rate. Large model gives 2½-amp. booster charge. \$10.50 and \$18.50.



WRITE FOR FREE BOOKLET—"The Secret of Successful Battery Elimination" describing KUPROX Radio Power Devices.

THE KODEL RADIO CORPORATION, 501 E. Pearl St., CINCINNATI, O.

© 1927 K. R. Corp.

See the World FREE!



Taste Romance and Adventure In the Far Lands of the Earth

How often you've longed to see for yourself the awe of Egypt's pyramids—the beauties of the gorgeous Mediterranean sunset—the squalor of China's ancient cities!

Spend a few years, or the rest of your life, tasting high adventure on the seven seas and in all the world's great ports—roving the earth's highways and byways! You can do it FREE—all your expenses paid—and earn a good salary besides!

Only one profession will carry you around the world at will, traveling like a gentleman, but that's the most interesting and pleasant work there is—Radio Operating! Easily and quickly learned, there's no other profession like it for the man who wants the experiences and pleasures of world-travel. Radio operators are needed—all sea-going ships like the one shown here must carry from one to half a dozen or more.

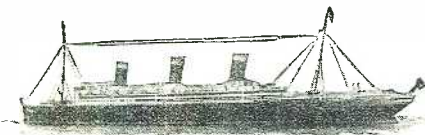

Take a Look Beyond the Skyline Without a Penny's Expense

Radio operators aboard ocean liners live luxuriously—they rank as officers of the ship. Meals, a private cabin, all other living needs are furnished free, and besides the operator draws a good salary. You can learn quickly and easily at home in your spare time to be a Radio operator through our practical training methods. Take a look at the FREE BOOK which tells how—mail coupon below.

This U. S. Government-recognized school has been training successful operators since 1914. Our graduates are all over the world. We maintain an Employment Department to put you on your own ship. The world-famous NATROMETER, our own patented invention, obtainable only by students of this Institute, is recognized as the best and easiest way to learn the Radio code. A few short months, with the aid of the famous Natrometer and our quick home training, and you too can be a fully qualified Radio operator, sitting in your cabin like the one shown above, bound out for Liverpool or Nagasaki!

Read the Free Book that tells all about this fascinating profession and our practical Government-recognized methods of training you for it. Send coupon TODAY—no obligation. Special tuition offer now on, includes world-famous Natrometer free of extra cost with your course! Act at once.

NATIONAL RADIO INSTITUTE WASHINGTON, D. C.

SPECIAL OFFER COUPON

National Radio Institute, Dept. OB-99, Washington, D. C. Gentlemen: Without obligating me in any way send me your free book and information about your offer of Natrometer with course.



World-Famous Natrometer

Name.....
Address.....

A Light-Socket Receiver

(Continued from page 496)

BUILDING THE RECEIVER

The parts used in constructing the A.C.-operated Shielded Six are listed elsewhere in this article. The principal components listed and specified should be used with no thought of substitution; for unlike that of a battery-operated receiver, the design of an A.C.-tube set depends upon an exact co-ordination of all parts, and substitution in even a small item may wreck the entire performance of the outfit. It is safe to change only such things as binding posts, sockets, and dials; while, of course, a choice of tubes is possible.

Should the builder desire to construct the receiver without the push-pull amplifier feature, the following substitutions should be made in the list: the push-pull transformers should be replaced by a 220 and a 221 standard transformers; one four-contact tube socket may be omitted entirely; and one of the 1000-ohm resistors should be changed to a 2000-ohm type. No other changes than these should be made.

Before the constructor begins the assembly of the receiver, all parts should be very carefully examined and inspected to make sure that they have suffered no damage in transit. Tubes particularly should be tested in the sockets for good spring contact; the R.F. transformers tried in their sockets; and the variable condensers most carefully scrutinized. All resistors should be tested with headphones and battery to make sure that they are not open-circuited. (The ¼-meg-ohm grid leak will give only a very faint click in headphone test.)

To assemble the receiver, all parts should be mounted upon the chassis exactly as illustrated in the various pictures and diagrams, using 6/32 machine screws and nuts. The four coil sockets should be lifted above the chassis by means of ¼-inch hollow mounting studs and long screws. The three shield pans are placed as illustrated; but, before they are inserted in their place, two of them, as well as the two shield tops, must be cut away to make room for the rather large 6,000-ohm volume-control potentiometer. This potentiometer, using insulating washers to insulate it thoroughly from the front lip of the chassis in which it is mounted, should be slipped into position before attempting to fasten down the shield pans. The two central shield pans must have their adjacent front corners cut away slightly with a pair of heavy shears or tin snips in order that they may not touch the 6,000-ohm potentiometer. Similarly, the adjacent bottom front corners of the shield pans must be clipped away. This can be done with a pair of scissors, simply by cutting out a triangular section from the corner of each one; so that, when slipped into place, they will not short-circuit upon the volume-control resistor.

WIRING

If all parts are mounted, the receiver should be wired with fabric-insulated hook-up wire. The fixed resistors R2, R3, R4 and R7 are mounted on the inside of the chassis with one end terminal of each grounded to the chassis and the other end terminals bent up free and clear of the chassis. The mounting screws of the sockets at convenient points are used to hold these resistors. The drawings show the exact location of these resistors. If desired, the wiring on the underside of the chassis may be left somewhat longer than is necessary, but grouped along common paths so far as possible so that all wires can be laced into one or two groups or cables after all wiring is completed.

Before the panel is put in place, the link



The nation's strength is the nation's health

Buy

Christmas Seals and help preserve it

THE NATIONAL, STATE, AND LOCAL TUBERCULOSIS ASSOCIATIONS OF THE UNITED STATES



RADIO WHOLESALE

Write for my Big 1928 Radio Catalog—just off the press. Thousands of marvelous bargains in nationally advertised goods. All the LATEST IN RADIOS and equipment. Lowest wholesale prices. Agents Wanted.

FREE

DEALERS NEW 1928 CATALOG

It's a regular encyclopedia on Radio. All about trouble finding. **FREE Log and Call Book** and Catalog. Get your copy today. Send postcard now! American Auto & Radio Mfg. Co. HARRY SCHWARTZBERG, PRES. Dept. 103 American Radio Bldg., Kansas City, Mo. 3

BIG WEEKLY ISSUES

of *The Pathfinder*, America's liveliest, most unique, most entertaining weekly magazine. Full of wit, humor, information, news events, pictures, special features, best fiction. Once you read *THE PATHFINDER* you will never do without it. Send your name and 10 cents IMMEDIATELY!

THE PATHFINDER, Dept. G-88 WASHINGTON, D. C.



Look for this Pilot window display! It signifies a dealer who handles products of the world's largest Radio Parts Plant. "Utmost value for every radio dollar!"

Again Leading the Way in RADIO PROGRESS

Redi-Blox Detector Unit. Spring mounted tube socket takes all UX and UV tubes. Positive or negative grid return. Plug in coils for 180 to 3000 meters. Designed for .00035 mfd. tuning condenser.

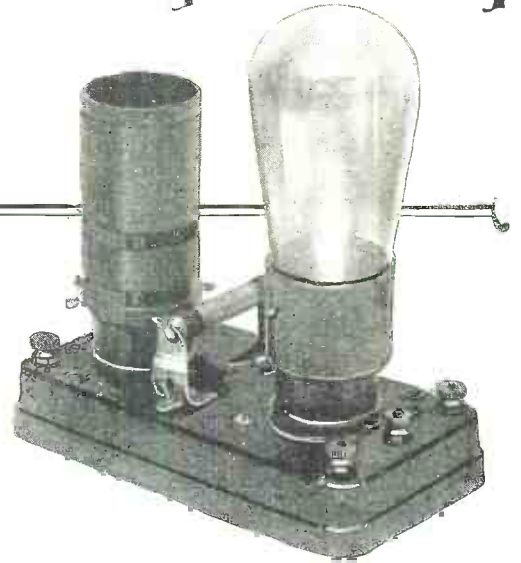

M.B. Sleeper's REDI-BLOX WIRED RADIO UNITS



Redi-Blox R.F. Unit. Construction similar to detector unit. Wired for battery or eliminator circuits with series or parallel filaments. Genuine Bakelite base, as used in all Redi-Blox units.

Redi-Blox Radio Wired Units is the application of the sectional book-case idea to radio construction!

To the experimenting set builder, Redi-Blox offers the key to countless combinations. With Redi-Blox Units any circuit is built in minutes instead of hours.

The man with fair technical knowledge, who wants to build a real good set, at minimum cost and labor, finds Redi-Blox the solution to his problem.

For instance, to build a Five-tube R.F. set, simply hook up two R.F. Redi-Blox, one Detector Redi-Blox and two Audio Redi-Blox.

No soldering! Completely wired! Simply connect the various Redi-Blox Units just as you'd hook up a couple of dry cells!



Redi-Blox A.F. Unit. Equipped with new Pilot Giant Audio Transformer in handsome steel case which also acts as shield. Takes all power tubes including 210.

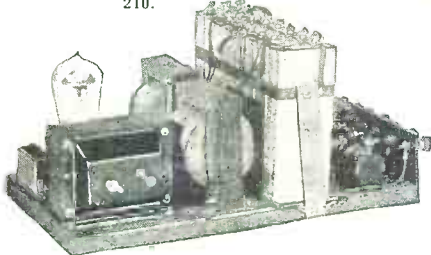

Socket-Power Radio is the passport today! With the Pilot ABC Eliminator you can easily change your present battery set to a dependable trouble free A-C operated receiver. If you are building a new set, it will be electric, of course!

PILOT Vernier Drum Dials

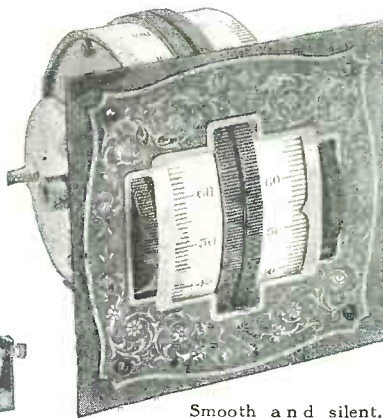

Smooth and silent, the PILOT vernier drums can be revolved singly or together with the pressure of your thumb, and set to hair-line accuracy with the individual verniers. Made with single or double drums. Single drum takes condensers on both sides. Fits all condensers.

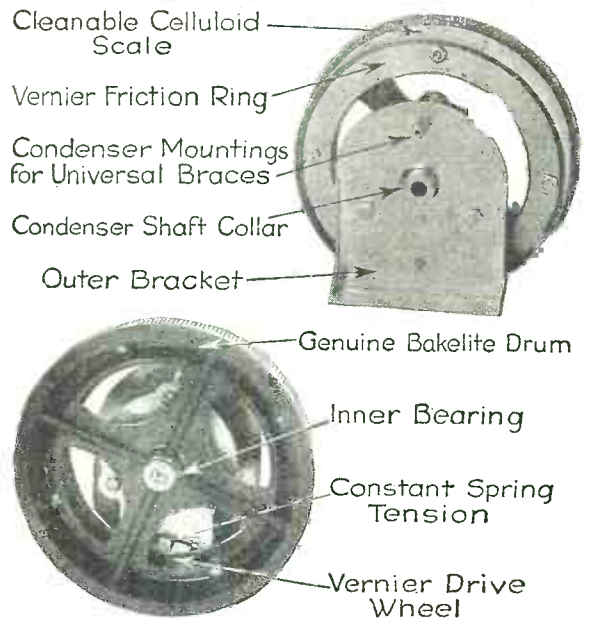

PILOT
ELECTRIC M'FG. CO., INC.
323 BERRY ST., BROOKLYN, N.Y.

A BIG 25c WORTH!

Send 25c. coin or stamps for four issues of "RADIO DESIGN" chockful of advance radio information. Shows how to build latest socket-power sets and super-hets at half usual cost. Edited by M. B. Sleeper, Chief Research Engineer, Pilot Electric Mfg. Company, and nationally known authority on radio design.

NAME

ADDRESS

RN 11-27

ARGENTINA
AUSTRALIA
BELGIUM
BRAZIL
CANADA

DENMARK
ENGLAND
FINLAND
FRANCE
GERMANY

HOLLAND
INDIA
ITALY
JAPAN
MEXICO

NORWAY
PORTUGAL
SOUTH AFRICA
SPAIN
SWEDEN

New AERO Circuits worth Investigating

The Improved Aero-Dyne 6 and the Aero 7 and Aero 4 are destined to be immensely popular this season!



AERO Universal Tuned Radio Frequency Kit

Especially designed for the Improved Aero-Dyne 6. Kit consists of 4 twice-matched units, adaptable to 201-A, 199, 112, and the new 240 and A. C. tubes. Tuning range below 200 to above 550 meters.

This kit will make any circuit better in selectivity, tone and range. Will eliminate losses and give the greatest receiving efficiency.

Code No. U-16 (for .0005 Cond.)... \$15.00
Code No. U-163 (for .00035 Cond.)... 15.00



AERO Seven Tuned Radio Frequency Kit

Especially designed for the Aero 7. Kit consists of 3 twice-matched units. Coils are wound on Bakelite skeleton forms, assuring a 95% air dielectric. Tuning range from below 200 to above 550 meters. Adaptable to 201-A, 199, 112, and the new 240 and A. C. tubes.

Code No. U-12 (for .0005 Cond.)... \$12.00
Code No. U-123 (for .00035 Cond.)... 12.00



AERO Four Kit

An exceptionally efficient kit for use in the Aero 4 and other similar circuits. Consists of one Aero Universal Radio Frequency Transformer and one Aero Universal 3-Circuit Tuner. Uses 201-A, 112, 199 and new A. C. tubes.

Code No. U-95 (for .0005 Cond.)... \$8.00
Code No. U-953 (for .00035 Cond.)... 8.00

NOTE: All AERO Universal Kits for use in tuned radio frequency circuits have packed in each coil with a fixed primary, a twice matched calibration slip showing the reading of each fixed primary AERO Universal Coil at 250 and 500 meters; all having an accurate and similar calibration. Be sure to keep these slips. They're valuable if you decide to add another R.F. Stage to your set.

A NEW SERVICE

We have arranged to furnish the home set builder with complete Foundation Units for the above named Circuits and for the Chicago Daily News 4-Tube Receiver and the Aero Transmitter Set, drilled and engraved on Westinghouse Micarta. Detailed blueprints and wiring diagram for each circuit included with every foundation unit free. Write for information and prices.

You should be able to get any of the above Aero Coils and parts from your dealer. If he should be out of stock order direct from the factory.

AERO PRODUCTS, Inc.

1772 Wilson Ave. Dept. 105 Chicago, Ill.

motion should be attached to the three right-hand condensers, in such a fashion that, as one condenser is turned, the other two rotate with it. Care should be exercised to leave a space of at least 3/32- to 1/8 inch between the lock collars of the link motions and the variable condenser shafts; for in this space the stage-shield edges fit. The front panel is fastened to the chassis by means of the battery switch and antenna switch and the shaft bushing of the 6,000-ohm volume resistor; this last being insulated away from the chassis and panel with suitable insulating washers. The vernier dials are fastened upon the condenser shafts in such a fashion that they read zero with the condensers entirely unmeshed.

So far no connections have been made to the battery switch; though a 6-foot length of twisted loop cord should have two ends connected to its terminals, the cord running across the chassis and up through a hole in the bakelite terminal strip adjacent to the speaker tip jacks. The two free ends of this cord should later be spliced into one wire of the twisted pair joining the power transformer to an attachment plug, which must be inserted in a home-lighting socket. Thus the battery switch on the receiver panel serves to break one side of the lighting line to the power transformer and, with a single flip of the switch on the receiver front panel automatically turns on or off all power for the set.

POWER UNIT CONNECTIONS

The assembly of the power unit itself is very simple and is well illustrated in the accompanying view. The power transformer and condenser bank should be mounted upon the steel base, together with the two tube sockets and four binding posts; using insulating washers to insulate these posts from the steel chassis. All wiring should then be put in place, leaving three leads for connection to the choke-coil unit, which

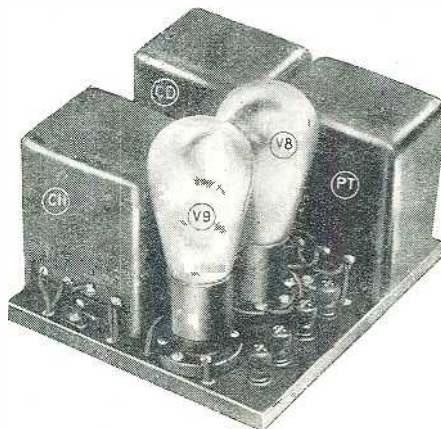

Complete power unit of the A.C.-tube light-socket receiver, showing its compactness.

is put in place last to avoid interference with connections 5, 6, 7, and 8 of the condenser bank. The voltage-dividing resistor is mounted by having its four lugs soldered to the ends of binding-post soldering lugs underneath the chassis. Care should be taken to see that the proper resistance values fall between the different binding posts. Four rubber feet are provided to raise the chassis from the table and prevent the scraping and marring of furniture.

To operate the receiver, it is necessary simply to connect the four binding posts of the power unit to the four similarly marked posts of the receiver terminal strip, and to connect the three filament windings of the power transformer to the six properly-marked filament binding posts on the receiver terminal strip. These connections should be made by means of a twisted No. 18 lamp cord; though, if the receiver is to be located more than two feet from the

Modern Air-Craft

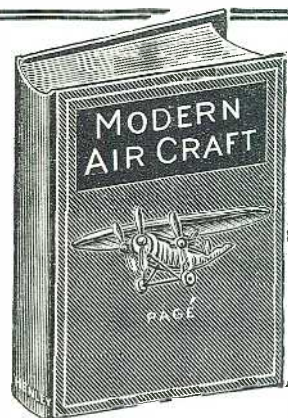

THE AGE OF AVIATION —IS HERE—

Learn Design, Construction, Operation and Maintenance

Contents of each chapter—1. Aircraft Types. 11. Lighter-than-Air Craft. 111. Early Airplane Designs. General Design Considerations. IV. Design and Construction of Aerofoils. V. Arrangement, Fabrication and Bracing of Airplane Wings. VI. Airplane Fuselage and Landing Gear Construction. VII. Airplane Power Plant Types and Installation. VIII. Aviation Engine Design and Construction. Air-cooled Engines. IX. Aviation Engine Design and Construction. Water-Cooled Engines. X. Aviation Engine Auxiliaries. XI. Aircraft Propeller Construction and Action. XII. Airplane Equilibrium and Control Principles. XIII. Uncrating, Setting Up and Aligning Airplane. XIV. Inspection and Maintenance of Airplanes and Engines. XV. Details of Modern Airships and Airplanes. XVI. Seaplanes, Flying Boats, Amphibians and Other Aircraft. XVII. Some Aspects of Commercial Aviation. XVIII. Aircraft Instruments and Aerial Navigation. XIX. Standard Nomenclature for Aeronautics, Report No. 240, Part I.

This book is written in simple, understandable language.

**700 Pages : 500 Illustrations
Price, \$5.00**

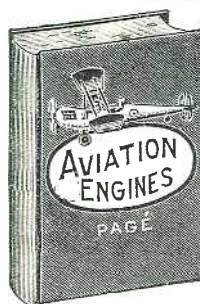

AVIATION ENGINES

This book describes the basic principles of aviation, tells how a balloon, or dirigible is made and why it floats in the air. Describes how an airplane flies. It shows in detail the different parts of an airplane, what they are and what they do. Describes all types of airplanes and how they differ in construction; as well as detailing the advantages and disadvantages of different types of aircraft. It includes a complete dictionary of aviation terms and clear drawings of leading airplanes.

274 Pages. Price, \$1.25

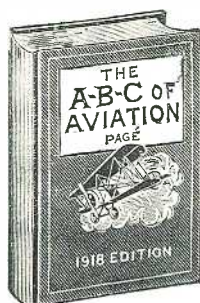

A. B. C. OF AVIATION

This treatise, written by a recognized authority on all of the practical aspects of internal combustion engine construction, maintenance and repair, fills the need as no other book does. The matter is logically arranged; all descriptive matter is simply expressed and copiously illustrated, so that anyone can understand airplane engine operation and repair even if without previous mechanical training. This work is invaluable for anyone desiring to become an aviator or aviation mechanic.

Price, \$1.25

CONSRAD COMPANY, Inc.
230 Fifth Avenue New York



Send for sample copy. See coupon below.

FOR THE PROFESSIONAL RADIO MAN

Custom Set Builders, Advanced Experimenters, Engineers, Manufacturers, Service Men and Technicians

RADIO ENGINEERING

has been published for seven years exclusively for the professional men of the radio industry and trade—for custom set builders—for experimenters who “know what it’s all about.” It includes each month a complete review of important construction developments together with carefully selected articles on technical and semi-technical subjects prepared by leading engineers of the industry exclusively for Radio Engineering.

NOTE—An information service covering technical, engineering and construction problems is available without charge to subscribers.

THE EDITORIAL STAFF IS HEADED BY MR. M. L. MUHLEMAN, FORMERLY TECHNICAL EDITOR OF RADIO NEWS. ASSOCIATE EDITOR, MR. JOHN S. RIDER, FORMERLY ASSOCIATE EDITOR OF RADIO DEALER

A non-biased, impartial source of accurate technical information

RADIO ENGINEERING IS NOT SOLD ON NEWS-STANDS

RADIO ENGINEERING, Inc.,
52 Vanderbilt Avenue, New York, N. Y.

Enclosed find { \$2.00 for 1 year } subscription to Radio Engineering.
 { \$3.00 for 2 years }

Enclosed find twenty cents (20c) for which send sample copy of Radio Engineering.

PLEASE CHECK YOUR CLASSIFICATION

- Dealer Professional Set Builder
- Engineer Service Man
- Manufacturer Distributor
- Anything Else _____

Name _____

Address _____

Town and State _____

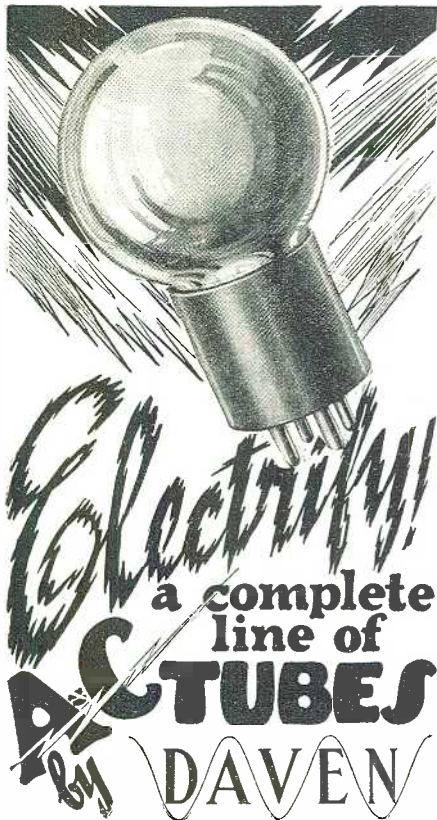

YOU as a Radio Fan know what that means—a complete line of tubes tested and perfected in our laboratories, not a half-baked product tried on the fans.

The new Daven AC Tubes will not hum, are non-microphonic, and give the same superb tone which has always featured Daven Products. If you have used Daven Products you know what you can expect—the new Daven AC Tubes are up to the Daven standard of perfection in every way. One outstanding refinement is the use of a specially coated PLATINUM filament which is instrumental in eliminating tube noises and prolongs life. A cheaper filament could be used and give average performance—but Daven performance demands Platinum. Four Prongs—fit any standard socket.

**Daven AC-1
Radio and Audio Amplifier**

Made for use in all radio frequency sockets and for the first audio stage where transformers are used.

1½ volt—1.05 Ampere—Platinum Filament

**Daven AC-15
High Mu Audio Amplifier**

The AC-15 should be used in the first two stages when resistance or impedance audio is used. Amplification factor 15.

1½ volt—1.05 Ampere—Platinum Filament

Daven AC-D1 Special Detector

For use in all circuits. Due to special construction filament currents are distributed in such a way as to reduce AC hum to a minimum.

1 volt—1 ampere—Platinum Filament

Daven AC-10 Power Tube

Should only be used in the last audio socket. The AC-10 is a real power tube operating on 400 volts. Delivers 2.5 watts of undistorted power output.

7½ volt—1.25 Ampere—Platinum Filament

Daven AC-R1 Rectifier Tube

A single wave rectifier which delivers 65 milliamperes at 400 volts. Silent, perfect power from your "B" Eliminator. Exceptionally long life.

7½ volt—1.25 Ampere—Platinum Filament

Modernize your Receiver with Daven AC Tubes—the proper AC Tube for every socket.

FREE Catalog containing full description of these and other new Daven Products on request.

"The Sine of Merit"

DAVEN RADIO CORPORATION
TRADE MARK "Resistor Specialists" REGISTERED

142 Summit St.

Newark, N. J.

power unit, the connections of the 2.5-volt circuit should be of No. 14 lamp cord.

To operate the unit, the power transformer plug should be inserted in the home-lighting socket and the rectifier tube placed in the inner socket of the power unit. If the voltage-regulator tube is placed in the outer socket, it should glow with a pinkish or purplish glow. The receiver tubes should be inserted in their sockets, the four CY-327 tubes in the five-prong sockets of the R.F. circuits, the CX-326 in the right rear socket, and the CX-371s in the left rear sockets adjusted to the output transformers. All of these tubes should light; and, as they are successively inserted, the glow-tube brilliancy should vary somewhat as the filament control is turned from left to right. After current is turned on with all tubes inserted, it will be from 30 to 60 seconds before the receiver is ready for operation; for it takes this length of time for the heater tubes to come up to proper operating temperature. When they do, a considerable hum will be noticed in the loud speaker. Some of this hum should disappear with a ground connection attached to the proper receiver binding post; though it should still persist with the volume control turned half-way or fully around to the right.

The next step is to connect a wire to one side of the 2.5-volt heater lighting circuit; the other end of this wire is to be touched successively to the "B—," "B+45," and even "B+90" binding posts of the set. If this is done, hum will noticeably decrease and will practically disappear with one connection, which should be made permanent. Preference should be given to the connection between the 2.5-volt heater winding and "B—" or "B+45." If, however, the hum does not entirely cease, an FT64 balancing resistor should be connected to the two 2.5-volt binding posts of the receiver and the center tap of this resistor connected to "B—" or "B+45." This done, the hum will be reduced to a value too low to interfere with reception.

OPERATION

The receiver may be operated by the connection of an aerial lead to the proper binding posts; the aerial itself may be anything between 20 feet of indoor wire around a picture moulding and a 50- or even 80-foot outdoor antenna. Stations are tuned in by using the two large tuning dials, with volume adjusted by the volume-control knob.

If the volume knob is turned too far to the right, the receiver will oscillate and squeal; and in operation it should always be kept just to the left of the oscillating point. The set is most sensitive with the volume control adjusted to just below the oscillation point; though it may be, of course, turned all the way to the left to decrease the volume, as desired.

There are practically no trouble-shooting suggestions to be offered; for the receiver, if properly assembled and wired, will work without any difficulty. However, if any question arises, the power-unit voltage should be checked with a high-resistance voltmeter, and should show approximately the voltages marked on the binding posts, having from 200 to 220 volts maximum output with the receiver in operation. The glow tube should not extinguish in operation, though it will flicker as strong signals are received. The heater tubes will hardly glow at all when lit; though the small rods projecting through the internal assemblies will heat to about a cherry-red color after 30 or 40 seconds of operation. The 371 tubes should light to fair brilliancy; while the filament of the 326 will glow a dull red after 5 to 10 seconds of operation. If the tubes are believed to be defective, they may be tested, most satisfactorily by a dealer or service station. There is no reason, however, for anticipating even as much trouble with A.C. tubes as may be experienced with standard storage-battery types; for the electrical nature of the former is very much more rugged.

SOVEREIGN

A-C TUBES and KITS MODERNIZE YOUR RADIO!



Build your own battery-less receiver or convert your present set with Sovereign equipment.

No More "A" Battery

No more hum—microscopic noises—clearing units or "A" Battery Eliminators,

BUT INSTEAD

Clear—Clean Cut—Truthful Reproduction.

Sovereign A-C Kit, 110 or 220 Volts—60 cycles. Price \$8.75

Sovereign A-C Kit, 110 or 220 Volts—25 cycles. Price \$9.75

Sovereign A-C Tube. Price \$5.00

Sovereign A-C Power Tube for last audio stage. Price \$6.00

If your dealer cannot supply you, we will ship C.O.D. direct to you.

We have prepared a comprehensive pamphlet on A.C. tubes and receivers. Write for your copy today.

SOVEREIGN ELEC. & MFG. CO.
125 N. Sangamon St. - - - Chicago

IMMEDIATE DELIVERY ON IMPROVED SHIELDED SIX and

IMPROVED LABORATORY RECEIVER



SEND your order to us—immediate shipments on the improved Silver Shielded Six. Both the A.C. model (described in Radio News) and the regular 5-volt tube models are ready. All parts laboratory tested, matched and guaranteed. Thousands

have proclaimed the Six as "the finest receiver they've ever heard"—and it's just that—and for quality it can't be equaled at any price.

Complete parts with detailed instructions on the 630 A.C. Shielded Six light socket model \$99.00, or for the regular 5-volt tube 630 model, \$95.00. Complete parts for the 652A, ABC power supply for the light socket operated Shielded Six \$36.50 or completely wired (less tubes) \$40.50.

Immediate shipments can also be made on the famous Improved Laboratory Receiver—the eight tube receiver which is taking the country by storm—the most selective, sensitive and powerful set you can build. Complete parts—tested, matched and guaranteed—\$39.45. If shielded oscillator and first detector is desired add \$4.00 for individual stage shields.

Complete literature available—send for it and let us save you money on all standard apparatus.

SETBUILDERS SUPPLY COMPANY
512 South Peoria Street Chicago, U. S. A.



Selected for

Karas Two-Dial Equamatic

No. 660 Cable Connector Plug.....\$3.00
No. 416 Pup Jack.....25c. per pair
No. 69B Two Stage Switch.....\$1.25

Insure correct set construction and enduring reliability in set operation by insisting on Yaxley parts for these vital places.

At your dealer's

YAXLEY MFG. CO.

9 So. Clinton St. Chicago, Ill.

HOME FURNISHINGS FREE ON CREDIT - Catalog

Over 1400 bargains in living room, dining room and bedroom furniture, rugs, dishes, etc. A year to pay. 30 days trial. Write today for free catalog.
STRAUS & SCHRAM Dept. 3578 Chicago, Illinois

Insure your copy reaching you each month. Subscribe to **RADIO NEWS**—\$2.50 a year. Experimenter Publishing Co., 230 Fifth Ave., N. Y. C.

WHOLESALE PRICES

--- for Dealers, Community Set Builders, General Repairmen and Agents ---

Be sure to get this great 100-page book with net prices to the radio trade.

Radio Specialty Company is radio's oldest radio parts mail order house in the country, and the new confidential prices on standard radio merchandise are the lowest of any radio house.

We are ready now to appoint additional agents in all parts of the country. If you are contemplating making big money in radio merchandise, be sure to get in touch with us at once.

WHEN WRITING TO US, USE YOUR LETTERHEAD

1927
Edition
No. 17
500
Illustrations
NEW
Enlarged
Edition



THIS
100 PAGE
RADIO
CATALOGUE
FREE
75 HOOKUPS

ALL GOODS SENT PREPAID IN U.S.A.

BUY!!
from Radio's Oldest
Mail Order House

WE are the oldest established, exclusive radio mail order house in the country. Our motto is "Quick Shipment." All orders are shipped within 24 hours. Quick, prompt, courteous service. We carry a larger variety of radio parts and findings than any other radio house in the country.

"RASCO HAS IT"

If you are in need of certain small radio parts that other radio and mail order houses do not bother to carry, get the Rasco parts catalog and you will find them there, anything from a screw to copper ribbon and telephone diaphragms, as well as thousands of other small radio findings. Just to mention a few:

Lugs, nuts, dials, vernier dials, jacks, plugs, every kind of knob, cords, panels, screws, sliders, washers, selenium, tinfoil, switches, crystals, ear nuts, Litz wire, cord tips, brass rods, resistances, name plates, spring binding posts, switch parts, metal ribbon, carbon balls, binding posts, all types, switch points, switch levers, lock washers, carbon grains, ground clamps, metal pointers, insulated tubing, low melting metal, antenna connectors, bus bar wire, as well as thousands of other articles.

We carry the Largest Variety of Small Radio Parts in the World.

BUT We also carry ALL standard radio merchandise.

ANYTHING IN RADIO



RADIO SPECIALTY CO.

**98W PARK PLACE
NEW YORK CITY, N. Y.**

BENJAMIN

Cle-Ra-Tone Sockets

are specified for

Most of the Leading Circuits

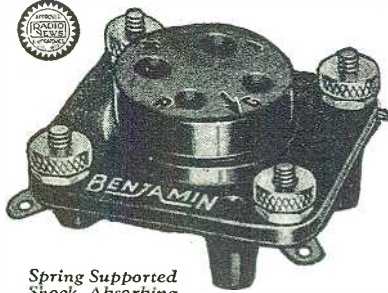

Spring Supported Shock Absorbing

Tube holding element "floats," independently of the base, on four perfectly balanced springs. Positive tube to terminal connections. Shock absorbing feature is not affected by stiff bus wiring.

Non-Microphonic. The greatest aid to the non-noisy operation of the set. Gives longer life to the tubes.

The choice of experts and amateurs for practically every prominent and successful circuit for several years.

Among the most recent circuits for which Cle-Ra-Tone Sockets have been specified are: Strobodine 8, Magnaformer 9-8, Camfield Super-Selective 9, Lynch Suppressor Circuit, H. F. L. Nine in Line, World's Record Super 10, Melo-Heald Fourteen, St. James Super, Two-Dial Equamatic, Knickerbocker 4, Hilograd Receiver.

Push Type, on Mounting Base:
Benjamin Cle-Ra-Tone Sockets, 75c each
Without Mounting Base 50c each

New Y Type Socket

Specially designed, for use with 5-pronged A. C. Radio Detector Tubes:
For direct attachment to panel . . . 90c each
For mounting on top of panel . . . \$1.20 each

At all Radio Jobbers and Dealers

Made by

Benjamin Electric Mfg. Co.
120-128 S. Sangamon St., Chicago

247 W. 17th St.
New York

448 Bryant St.
San Francisco

Manufactured in Canada by the Benjamin Electric Mfg. Co., Canada, Ltd., Toronto, Ontario

Volume and Quality

(Continued from page 483)

tubes has been inserted in the last audio stage. The purchaser of such a tube is probably mystified for a while, until he finds that he is supposed to listen, not for deafening power from one of these small tubes, but instead for greatly improved quality, which is the usual result of inserting a small power tube, such as a 112-type in the last stage of audio.

If you have had a great deal of radio experience, you have probably noticed that, when strong notes come through the ordinary set, there is liable to be *blasting* as the singer sounds a strong note; this is due to grids being temporarily overloaded. Not only this, but the current-carrying capacity of the tube between the plate and filament is less, in a 201A-type (all-purpose) amplifier tube, than in a power tube. The latter is constructed with sufficiently large internal members, suitably spaced from one another, so that the tube is capable of carrying a much greater load in both the grid and plate circuits.

The accompanying graphic chart, Fig. 4, provides a clear example of just why a power tube is essential when we demand real volume from a receiving set. When the dealer tries to sell a power-pack, utilizing a 210-type tube to the average broadcast listener the latter will frequently reply that he has no use for such a device; as he is getting all the volume he needs from a 201A-type tube in the last stage of audio. There is really just one logical answer to such a statement; and that is, the set or rather the tubes, are being forced or overloaded in order to produce the volume that the set owner claims he is getting with the simple line-up of 201A-type tubes.

It is frequently found that, for a small room, a 201A-type in the last audio stage will give sufficient volume, without overloading or rushing the tube; but, for a fair-sized room, a 112- or 171-type power tube should certainly be used in the last stage of audio-frequency amplification. A glance at Fig. 4 shows just what happens when you exchange one of these power tubes for a 201A-type in your last stage of audio.

In the first place, as you will see, the latter tube has an undistorted power output of only .055 watt. If you select a 112-type power tube, you have increased by four times the undistorted power output available for actuating the loud speaker. But if you use instead a 171-type power tube, you will increase the undistorted power output of your last stage, with respect to the loud speaker, by a factor of *fourteen*.

In other words, you now have *fourteen times the energy* previously available for operating your loud speaker. It should be noted that the 171 tube, for instance, has a lower amplification than the 112. Thus, you might notice that with the same plate voltage the 171 does not seem to give quite as much volume as the 112 but the former will give better tone quality, because it has *more reserve energy available in the output*. It should be taken into consideration that a loud speaker really demands, after all, a suitable amount of power, expressed in watts; and this is where the power tube comes to the rescue. When the listener is located quite a distance from the nearest broadcast stations, it is frequently advisable to use a 112-type tube in preference to a 171; but where the receiving set is situated, possibly but a few miles from local stations, with a consequent strong signal to be picked up by the set, then the 171-type will fill the bill best.

This analysis shows what happens when

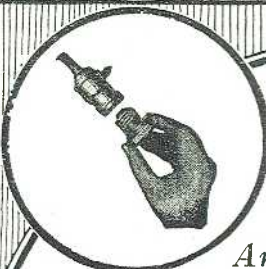

Listed by Underwriters Laboratories

Every Outlet An Aerial

ELECTRAD

Lamp Socket Antenna

\$1.00

No need bothering with aerials, inside or outside, if you have this antenna.

Screws in any light socket, uses no current. Efficient, neat in appearance and SAFE. Tested at 2500 volts A.C.

At your dealer's or write

Dept. 51A, 175 Varick Street
New York, N. Y.

ELECTRAD



THE RADIOMAN'S BUYER'S GUIDE

WALTER ROWAN
BATTERY SUPPLY CO.

Free!

Free!

To Set Builders and Dealers

Write today for this big new Catalog. It's yours for the asking without obligation. Contains everything worth while in Radio, including all popular kits described in this and other leading publications. We carry in stock a complete line of parts, accessories, consoles and cabinets.

Buy Direct

from the largest Jobbing house in the middle west and save money on all radio equipment. Try us for quick, accurate service. No delays, no substitutions.

WALTER ROWAN
BATTERY SUPPLY CO.
227 N. Peoria St. Chicago, Ill.

BIG NEW CATALOG FOR RADIO BUILDERS

FREE

LATEST RADIO CIRCUITS



My big 1928 Radio Catalog, Call Book and Trouble Finder. 132 pages about Radio. Check full of newest circuits—kits, transmitter parts, short wave outfits, eliminators and speakers. Thousands of bargains at lowest wholesale prices. A regular Radio Encyclopedia—Free. Write today.

American Auto & Radio Mfg. Co.
HARRY SCHWARTZBERG, PRES.
Dept. 103 American Radio Bldg., Kansas City, Mo.

Insure your copy reaching you each month. Subscribe to RADIO NEWS—\$2.50 a year. Experimenter Publishing Co., 230 Fifth Ave., N. Y. C.

SUCCESS

from

CHEMICAL INSTITUTE OF NEW YORK
16 East 30th Street, New York City.

Mountoursville, Pa.

Gentlemen: I must tell you the success I have had since taking your chemistry course. My salary has been increased several times, and different industrial plants are coming to me for a little advice on different things, netting me a fair side income.

I am only sorry that I did not make my whole life study of the wonderful science.

(signed) *M. E. Van Sickle.*

CHEMISTRY

NOW
is the Time to Study
Chemistry

Not only are there boundless opportunities for amassing wealth in Chemistry, but the profession affords congenial employment at good salaries to hundreds of thousands who merely follow out its present applications. These applications are innumerable, touching intimately every business and every product in the world. The work of the chemist can hardly be called work at all. It is the keenest and most enjoyable kind of pleasure. The days in chemical laboratory are filled with thrilling and delightful experimentation, with the alluring prospect of a discovery that may spell fortune always at hand to spur your enthusiasm.

Easy Monthly Payments

You don't have to have even the small price of the course to start. You can pay for it in small monthly amounts—so small that you won't feel them. The cost of our course is very low, and includes everything, even the chemistry outfit—there are no extras to buy with our course. Our plan of monthly payments places a chemical education within the reach of everyone. Write us and let us explain our plan in full—give us the opportunity of showing you how you can qualify for a highly trained technical position without even giving up your present employment.

CHEMISTRY has no equal as a profession in the modern world. There is mystery, romance and fortune awaiting the man in the laboratory.

Millions have been made by the discoverers of the chemical formula of dynamite, bakelite and many other world known chemical products.

Opportunities in the chemical profession abound on every hand—and as modern business and competition progresses the chemist will play an important part.

Profit by the experience of Mr. Van Sickle and many others, resolve to study chemistry NOW.

YOU CAN LEARN AT HOME

To qualify for this remarkable calling requires elaborate specialized training. Formerly it was necessary to attend a university for several years to acquire that training, but thanks to our highly perfected and thorough system of instruction, you can now stay at home, keep your position, and let us educate you in Chemistry during your spare time. Even with only common schooling you can take our course and equip yourself for immediate practical work in a chemical laboratory. Dr. Sloane gives every one of his students the same careful, personal supervision that made him celebrated throughout his long

career as a college professor. Your instruction from the very beginning is made interesting and practical, and we supply you with apparatus and chemicals for performing the fascinating analyses and experimental work that plays such a large part in our method of teaching, and you are awarded the Institute's official diploma after you have satisfactorily completed the course.



T. O'CONOR SLOANE,
A.B., A.M., LL.D., Ph.D.

Noted Instructor, Lecturer and Author. Formerly Treasurer American Chemical Society and a practical chemist with many well known achievements to his credit. Not only has Dr. Sloane taught chemistry for years but he was for many years engaged in commercial chemistry work.

Special 30 Day Offer

Besides furnishing the student with his Experimental Equipment, we are making an additional special offer for a short while only. You owe it to yourself to find out about it. Write today for full information and free book "Opportunities for Chemists." Send the coupon right now while it is fresh in your mind. Or just write your name and address on a postal and mail it to us. But whatever you do, act today before this offer is withdrawn.

DON'T WAIT—MAIL COUPON NOW!

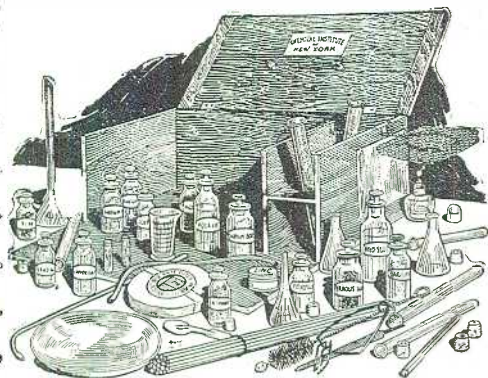

EXPERIMENTAL EQUIPMENT FURNISHED TO EVERY STUDENT

We give to every student without additional charge this chemical equipment, including forty-nine pieces of laboratory apparatus and supplies, and forty different chemicals and reagents. These comprise the apparatus and chemicals used for the experimental work of the course. The fitted heavy wooden box serves not only as a case for the outfit but also as a useful laboratory accessory for performing countless experiments.

Chemical
Institute
of
New York

Home Extension
Division 11
16-R—East 30th St.
New York, N. Y.

CHEMICAL INSTITUTE OF NEW YORK
Home Extension, Division 11
16-R—East 30th Street, New York City.

Please send me at once, without any obligation on my part, your free Book "Opportunities for Chemists," and full particulars about the Experimental Equipment given to every student. Also please tell me about your plan of payment and your special 30 day offer.

NAME

ADDRESS

CITY STATE.....
R.N. Nov. '27.

MAGNAVOX (electro dynamic) Power Cone Speaker Units

Built under exclusive patents on electro dynamic principle made famous by Magnavox. Recognized by technical experts and music critics as the one method of construction for perfect reproduction.



R-4 Unit

Type R-4 for 6 volt $\frac{1}{2}$ ampere field. Type R-5 for A. C. radio or phonograph circuits using field as the choke in filter pack. Unit designed for easy installation in radio and phonograph cabinets. Each type, unit only, list \$45.



Beverly Cabinet

Beverly cabinet speaker complete with R-4 unit, cords, switch \$60. Requires 6 volt A battery for power supply.



R-50 Unit

Type R-50 unit is R-5 with built-in power amplifier and B supply using one 216 and one 210 tube. List \$110. Easily installed in your radio or phonograph cabinet.



Loboy Cabinet

Loboy cabinet speaker, complete with R-50 unit, cords, etc. \$160.

Order through nearest dealer or write us for special bulletin about electro dynamic and permanent magnet type speaker units.

THE MAGNAVOX CO.

Oakland, California

Chicago Sales Office 1315 So. Michigan Ave.

a power tube is inserted in the last audio stage, utilizing the average "B" socket-power unit producing 130 to 180 volts, and of course using the proper "C" batteries, as specified for the particular tubes being used.

At present radio concerns are advocating the push-pull amplifier, and a very fine quality of reproduction is produced by this form of balanced-amplifier circuit. The graph, Fig. 4, shows the increase in undistorted power output from two 112-type power tubes, as well as that from two 171-type power tubes, when used either in parallel or in a push-pull circuit. The undistorted power output for the two tubes in parallel is approximately that of one tube multiplied by two; for two tubes in a push-pull circuit it varies between 2 and 3.12 times the output of one tube. The factor 3.12 was used in the computation of Fig. 4.

Looking at the graphic chart, once more, we note that the 210-type power tube has the remarkably-large undistorted power output of 1.54 watts. If you have a desire for great volume in the musical reproduction from your loud speaker (particularly where the radio music is used for dancing in a large ball room or dance hall), you will need either a 210-type tube with a suitable power-pack supplying 450 volts to the plate, or a pair of 171-type tubes hooked up in, preferably, a push-pull circuit.

VALUE OF A POWER UNIT

The writer has been using for sometime a power-pack utilizing a 210-power tube with a 216B rectifier tube. The undistorted power output of the 210 tube is approximately thirty times the output of a 201A-type; and from this it may be seen why the power tube has come to stay. For, if a listener can bear a 210-type tube with its 1.54 watts operating a cone or horn speaker in a house, it stands to reason that one using a 201A tube, with only one-thirtieth of the power, is not realizing any really strong musical or vocal reproduction on his loud speaker. Why a listener is often completely deceived, as to the strength of the musical reproduction from his loud speaker and set, lies in the fact that, though the music may sound quite loud, it is killed very quickly by the shuffling feet of a few couples dancing about the floor. This shows that the music does not have any real timbre or character; and it may also indicate that the bass notes are not being reproduced very well by the set and the loud speaker. It is important to remember that far more energy is required to reproduce bass and baritone notes than for the higher notes of the musical scale. Here again the reason for power tubes is made manifest.

As an example of what the power-pack, with 450 volts on the plate and utilizing a 210-type power tube, together with a six-foot orthophonic horn, can do, the writer wishes to say that this volume is just about right for dancing, though it should be cut down somewhat for ordinary requirements. If it is desired to reproduce the music with something that sounds like a full dance orchestra right in your home, then the 210-type tube and power-pack just mentioned will give what you are looking for.

The accompanying diagram (Fig. 5) shows in schematic form the construction and arrangement of a well-known power-pack. This high-duty audio-frequency amplifier is especially designed for the operation of a 210-type power tube with 425 volts on the plate. This power-pack supplies the filament current for the 216B rectifier tube and the 210 (7½-volt) power tube, together with the "C" bias for the tubes in the amplifier and the receiving set used with it. The plate current also for the tubes in the receiving set can be taken from this power-pack.

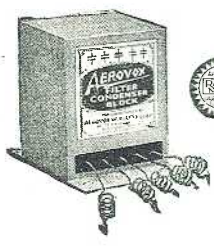

Eternal Life

We cannot guarantee eternal life, but we do guarantee the AEROVOX FILTER CONDENSER when properly used to outlast all the other equipment used in conjunction with it.

WHY???

Because—

each section of a block is individually sealed and impregnated against moisture absorption.

the safety factor used in manufacture, testing and rating will permit indefinite continuous operation at the rated working voltage without injury.

For all eliminators

AEROVOX

"Built Better"

70 Washington St., Brooklyn, N. Y.

TELEVISION is Here!!!

Radio Fans! Mechanics! Scientific Men!—Everybody!—Build a TELEVISION SET. The greatest and most amazing development of the 20th Century

HERE, friends, is the first book to be published giving you the history of TELEVISION, from the first crude experiments at the beginning of the 20th Century—to the comparatively, perfect machines just put into daily operation. From this book you can build your own, workable television set that will serve as a fundamental apparatus for hundreds of tremendously interesting and amazing experiments.

Get in now on this new development. You may be fortunate enough to discover some improvement to Television that will be worth many thousands of dollars. Start with a copy of this new book today. 116 Pages, 9 x 12 inches, illustrated.

50c ON ALL NEWSSTANDS
OR USE THIS COUPON

EXPERIMENTER PUB. CO., Inc.
230 Fifth Ave., New York, N. Y.

Gentlemen: I enclose 50c. for one copy of "ALL ABOUT TELEVISION."

Name

Address

City

State

Six New Precision Radio Products

By the Makers of the Famous



(1)

Illuminated DRUM DIAL

Makes single-control of multiple circuits practicable. Two circuits tuned as one, or individually. Translucent wave length scales illuminated from back. Beautifully embossed, oxidized bronze escutcheon plate gives distinction to panel.



(2)

Flexible COUPLING

Permits coupling condensers in tandem without exact alignment. Bakelite insulation makes the two sides electrically independent of each other. Tough spring phosphor-bronze with brass bushings and hardened steel set screws.



(3)

EQUALIZER

For neutralizing R. F. circuits or equalizing multiple tuning units. Small size fits limited space. Bakelite base, mica dielectric, phosphor-bronze spring plate.

HAMMARLUND "Midline" CONDENSER

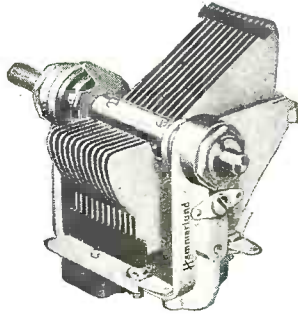

Write for Folders

Radio-Frequency CHOKE COIL



(4)

Special winding and impregnating gives minimum distributed capacity for a given inductance and provides extremely high impedance to all broadcast frequencies. Distinctive Bakelite case. Two sizes: 85 and 250 millihenries.

The Improved "HAMMARLUND, JR"

A new, high-ratio midget condenser with all the distinctive Hammarlund features—plus sturdier, simplified construction. Has new locking device for fixing rotor plates in any position. Knob included.

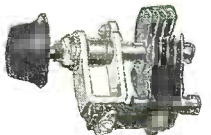

(5)

HAMMARLUND MANUFACTURING CO.
424-438 W. 33rd St. New York

For Better Radio
Hammarlund
PRECISION
PRODUCTS

New AUTO-COUPLE

Specified for Hammarlund-Roberts HiQ Six Receiver. Essentially the same as previous model, but designed for use with the new Hammarlund Drum Dial.

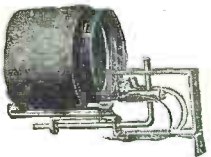

Quietness The Carborundum GRID-LEAK



SLIP a Carborundum Grid-Leak into your set and you will notice an improved reception instantly.

Carborundum Grid-Leaks are quiet. They are dense solid rods of Carborundum that provide for an uninterrupted flow of current.

No chance for the creation of minute noisy arcs—no glass tube. They can't disintegrate. They are unbreakable.

All standard values, both Grid-Leaks and Fixed Resistors.

The Grid-Leaks are tested for values at 5 volts—the Resistors at 90 volts.

No. 77 Carborundum Grid-Leaks, values 0.25, 0.50, 1 to 10 Megohms, each \$0.50
No. 79 Carborundum Resistors, values 2500 and 5000 Ohms, each 1.00
No. 79 Carborundum Fixed Resistors, values 12,000, 25,000, 50,000, 75,000 and 100,000 Ohms, ea., .75

THE CARBORUNDUM COMPANY, NIAGARA FALLS, N. Y.
CANADIAN CARBORUNDUM CO., LTD., NIAGARA FALLS, ONT.

Sales Offices and Warehouses in
New York, Chicago, Boston, Philadelphia, Cleveland, Detroit, Cincinnati, Pittsburgh, Milwaukee, Grand Rapids
The Carborundum Co., Ltd., Manchester, Eng. Deutsche Carborundum Werke, Dusseldorf, Ger.

Carborundum is the Registered Trade Name used by The Carborundum Company for Silicon Carbide. This Trade Mark is the exclusive property of The Carborundum Company.

From
your dealer
or direct

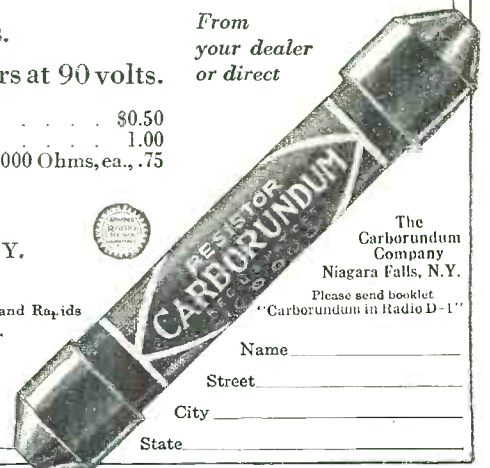

The
Carborundum
Company
Niagara Falls, N.Y.

Please send booklet
"Carborundum in Radio D-1"

Name _____

Street _____

City _____

State _____

POWER-PACK AND SET ON A. C.

If it is desired to operate the receiving set used with this power-pack from the A. C. mains, without any storage battery, the new A. C. tubes with a suitable step-down transformer can be connected to the 110-volt, 60-cycle lighting circuit, and in this way complete freedom from batteries is obtained. Another way in which this power-pack can be arranged to operate the receiving set as well as the power-pack from the A. C. lighting circuit, is to connect a set of 199-type tubes in series with the plate-return wire in the power-pack set. Adjustable resistors are shunted across each tube to regulate the individual voltages.

A PUSH-PULL POWER PACK

A new low-voltage type of power-pack, utilizing the famous push-pull circuit, is shown in another diagram (Fig. 6). In this power-pack the two power tubes, of the 112 or 171 type, have their filaments lighted by raw A. C. supplied from a low-voltage winding on the power transformer. A voltage-regulator or ballast tube of the neon or "glow" type is connected across the voltage-dividing resistance; and a full-wave rectifier, of the gaseous type and rated at 85 milliamperes, supplies the plate circuit for the tubes in the push-pull circuit. These power-packs make ideal amplifiers also for electric-phonograph pick-ups, and a very good circuit is shown in Fig. 6. The high-power loud-speaker outfits now on the market utilize a 210-type power tube with approximately 400 volts on the plate; and this accounts for the tremendous intensity and surprising quality of the reproduction given by these instruments. It is very important to utilize a choke-coil-and-condenser filter, or else a transformer-type filter, when using any form of power pack, in order to keep the plate current out of the speaker and to minimize any blasting effects. It will be noted that in the push-pull power-pack a transformer with a separate winding is provided for the loud-speaker output; while in the power-pack formerly mentioned a large and thoroughly capable choke-coil-and-condenser filter is provided.

In using such a power-pack which utilizes a 210-type power tube with 425 volts on the plate (if it is built as shown in the accompanying diagram, incorporating a first stage of A. F. amplification, in which a 201A- or 112-type tube is used) the input lead to such a power-pack is connected to the plate terminal of the detector tube. The author has tried operating this type of power-pack without the first stage of audio, utilizing in this instance only the second power stage with only the 210 tube, but it does not give very great volume. He has also tried the power-pack of this type with a 210 power tube in the second audio stage, with an electric phonograph pick-up, and the volume in this case was about equal to an average phonograph of the old small-horn type. The plug (fitted on the end of the cord from the electric pick-up) was inserted in the first audio stage of the power-pack. In this case all of the amplifier operation was carried on from the 110-volt A. C. lighting circuit, thus obviating the use of any batteries.

It is surprising what a difference the addition of a first stage of A. F. amplification in such a high-voltage power-pack makes; and the volume given from the loud speaker is tremendous when a phonograph pick-up is used, as also when any ordinary receiving set has its detector-plate terminal connected to the input post of the power-pack.

The volume from the loud speaker with one of these modern power-packs is so great that the voice can be heard easily a quarter of a mile away. As mentioned before, the musical reproduction from a loud speaker

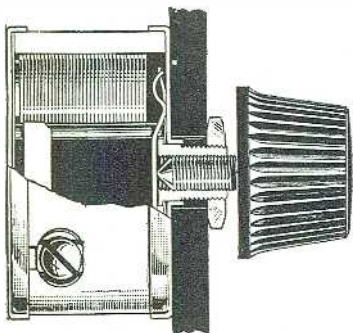

Bradleyohm-E
PERFECT VARIABLE RESISTOR

The graphite disc principle, utilized in the construction of Bradleyohm-E assures noiseless, stepless regulation of plate voltage when used in B-Eliminator hookups.

By turning the bakelite knob, the plate voltage output of the B-Eliminator can be adjusted, without steps or jumps, to the precise value for maximum volume. That is why prominent B-Eliminator manufacturers have adopted Bradleyohm-E.

Ask your dealer for Bradleyohm-E in the distinctive checkered carton.



Bradleyunit-A
PERFECT FIXED RESISTOR

This is a solid, molded fixed resistor that does not depend upon hermetic sealing for accuracy. It is not affected by temperature or moisture and can be soldered without disturbing its rating.

For resistance-coupling, grid leaks, and other applications, ask your dealer for Bradleyunit-A in any desired rating.

Allen-Bradley Co.
ELECTRIC CONTROLLING APPARATUS

287 Greenfield Ave.  Milwaukee, Wis.

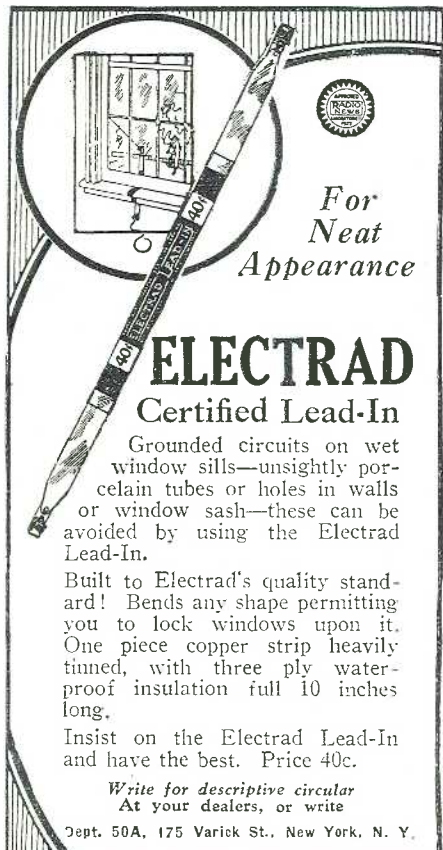

For Neat Appearance

ELECTRAD
Certified Lead-In

Grounded circuits on wet window sills—unsightly porcelain tubes or holes in walls or window sash—these can be avoided by using the Electrad Lead-In.

Built to Electrad's quality standard! Bends any shape permitting you to lock windows upon it. One piece copper strip heavily tinned, with three ply waterproof insulation full 10 inches long.

Insist on the Electrad Lead-In and have the best. Price 40c.

Write for descriptive circular
At your dealers, or write
Dept. 50A, 175 Varick St., New York, N. Y.

ELECTRAD



Harry Alter's **RADIO BOOK**
NOVEMBER 1927
Dealers Only

DON'T WAIT

You wonder how certain other radio retailers are selling at prices so much lower than yours. Learn why without delay. You will find that as customers of the Harry Alter Co., America's largest jobbers of radio goods, they pay less.

Write For Radio's Greatest CATALOG Filled with sensational values. We sell only to radio retailers. Send now.

The Harry Alter Co.
1788 Michigan Avenue CHICAGO



6 TUBE RADIO

One Dial Latest advanced circuit. All steel chassis totally shielded. Balanced parts of best quality. Marvelous power and selectivity. Gets the long range stations as clear as a bell. One dial single control. An unsurpassed value—just one of our many mighty bargains.

FREE Log and Call Book and **Big New Catalog**—just off the press. Full of Radio Bargains. Send for your free copy now!

American Auto & Radio Mfg. Co.
Harry Schwartzberg, Pres.
Dept. 102, American Radio Bldg., Kansas City, Mo.

You can be quickly cured if you

STAMMER

Send 10 cents for 288-page book on Stammering and Stuttering "Its Cause and Cure." It tells how I cured myself after stammering 20 yrs. B. N. BOGUE, 6973 Bogue Bldg., 1147 N. 111 St., Indianapolis.

capable of handling the output can be compared only to that of the original orchestra. The author, in one of the tests made before writing this article, connected one of the high-voltage power-packs to a 72-inch orthophonic horn fitted with an orthophonic loud-speaker unit. This combination worked very well and gives about the closest resemblance to the original studio reproduction that can be imagined.

ADVANTAGES OF PUSH-PULL

The writer has discussed the matter of the desirability of using push-pull, as compared with a simple one-time stage of power audio amplification, with several well-known radio engineers; and they generally recommend the push-pull system, as being capable of producing the highest quality, and also giving a greater gain in undistorted power output in the loud speaker, when compared to the results obtained when two power tubes are simply connected in parallel.

Authorities differ as to the actual increase in the output of undistorted power, in watts, when two power or other tubes are connected; in parallel, in the first case, and in the second, in push-pull arrangement. As you will see from the graphic chart (Fig. 4) showing the increase in power obtained from connecting two tubes, in parallel and in push-pull relation, a factor of two has been used to multiply the output in watts of one tube, in order to find the output of two tubes connected in parallel. It should be stated, as several engineers pointed out, that if the two tubes are to be connected simply in parallel, then they should have exactly similar characteristic curves; or else they will not be working in synchronism or unison on all loads, filament emissions, biases and plate voltages. In order to realize a true 100% gain in power output by connecting two tubes in parallel, it is necessary that both have the same characteristics. When this is not the case, the power output gain is slightly less than doubled.

It may be considered, from a practical point of view, as some authorities have stated, that the amplifying factor for two tubes in push-pull, as compared to that of one tube, may be taken as about two or somewhat more. In an ideal case—if the push-pull transformers are accurately designed and built, with relation to the number of turns in the tapped windings on the transformers, and the matched impedances of the windings, and also the two tubes used have exactly the same characteristics and everything is in perfect balance—then the power output of the two tubes in the push-pull circuit may rise as high as 1.56 times the undistorted power output possible with two tubes connected simply in parallel. The voltage-amplification constant of the latter combination is only that of one tube.

THE RÔLE OF THE LOUD SPEAKER

Providing you have a receiving set of good design which passes a fairly wide band of frequencies, it may be that a good deal of the trouble in poor vocal or musical reproduction lies in the loud speaker itself. It is advisable at this point to refer back to the previously mentioned article by the writer, "What is the Best Loud Speaker and Why?" which appeared in the March issue of *RADIO NEWS*. At present quite a number of the better-class radio receiving sets are being equipped with horns from 40 to 85 inches in length. When fitted with a good loud-speaker unit, these speakers give results indeed excellent; particularly if the horn is designed according to the exponential equation, which gives the curve followed in building the famous orthophonic horns.

In the selection of a speaker, care is necessary to see that it will handle the full output without distortion or rattling. While some are adapted to the 210-type tube, many are not adequate even for a 171-type.

When Static Ruins Good Programs-Switch Over to a



Dubilier LIGHT-SOCKET AERIAL

Just connect this neat little device to your set, plug into the nearest light-socket—and listen to the difference! It takes only one program to convince you that crazy poles, loose wires, lead-ins, etc., are not only unnecessary, but downright inefficient when compared to the Dubilier Light Socket Aerial. Works perfectly on AC or DC, totally

eliminates the lightning hazard and uses absolutely no current. Sold at all good radio stores on a 5-day money-back basis. Price \$1.50.

Used in the Power-Units You Consider Best

Dubilier Condenser Blocks are the choice of manufacturers whose battery eliminators are known for reliability and long life. In building your own unit remember that the condenser blocks are the most expensive and important elements in the circuit. Make sure that yours will stand heavy loads and long hours of service by insisting on Dubilier. Diagrams upon request.

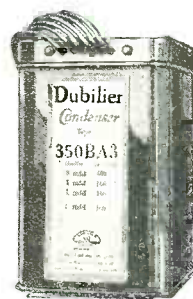

Dubilier Micadon

The Standard Fixed Condenser of Radio in a new case of moulded Bakelite, shaped to meet the newest type of receiver construction. Terminals adapted to either screwed or soldered connections. All standard capacities. Priced from 45c to \$1.50.

Dubilier Metaleak

Accurate resistance ratings and extremely quiet performance make these tubular grid leaks popular with amateurs who build with great care. They are small, but highly important items in the construction of any type of receiver. All standard resistance—prices—75c and 50c.

DUBILIER CONDENSER CORP., 4377 Bronx Blvd., New York

Dubilier

CONDENSERS



Use an Aerial Kit to get Matched Parts

Every part of your aerial installation should be of uniformly high quality, because one poor unit will affect the entire job.

For complete satisfaction year in and year out, buy a Belden Aerial Kit with Beldenamel Aerial Wire and the well-known Belden Lightning Arrester. Don't take a chance with a poor antenna system. Ask your dealer for a Belden Aerial kit.

Belden Manufacturing Co.
2314-A S. Western Ave., Chicago

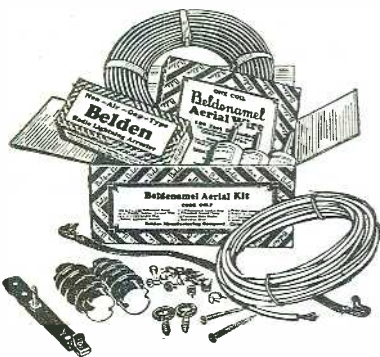

Specify
Belden
Aerial Kit

The Peridyne Principle

(Continued from page 487)

important at the sides of a radio-frequency transformer as at the high-potential end of the inductor, which is usually located at the top. Here the effect of the shield becomes tremendously important; so important, as a matter of fact, that if the shields are not correctly proportioned much more is lost than gained.

To use a homely analogy, it is as if you were trying to use a live spring, and then loaded it down with such heavy weights that there would be no elasticity left to uncoil the spring.

THE "PERIDYNE" ACTION

I noted, about a year ago, when working with shields—and the same thing must have been observed by many others—that when I moved a can up and down above an inductor in a set that was actually working, at certain positions the set would bring in stations at a tremendous volume; while, in other positions of the shield, the reception of certain signals was practically impossible. The explanation is simple; the shield, if not placed right, will displace the resonance points of the radio-frequency transformer, tremendously. The logical idea, therefore, was to make the shields variable in such a way that the various radio-frequency stages could be matched to a very fine degree by bringing the respective inductors into absolute resonance with each other.

Referring back again to Fig. 2, T (the top of the shield) is made movable, so it can be slid up and down. It was found immediately that this solved most of the difficult problems that had been hitherto encountered. The effect is also diagrammatically shown under Fig. 3. Here we have an inductor L and a movable grounded shield S. It will be seen that, as it is moved towards the radio-frequency transformer, the shield cuts the magnetic lines of force. Electrically, we have the system analyzed in Fig. 3A, where L1 is the inductor and S1 the shield; which, it should be noted, now becomes a variable condenser and thereby can be made to affect the period of response of the radio-frequency transformer L1. It will be seen, therefore, that the movable shield performs two functions: first, the shield is a variable condenser, a compensating condenser, in effect; secondly, it is used to match its accompanying coil with the other coils in the receiver. It has been found in actual practice that the variable shield, from an electrical standpoint, is far more effective than an external compensating condenser; because the variable shield, once set in its most advantageous adjustment, can be left in this position, and the inductor will then work with the same efficiency over the entire broadcast range. This it actually does, strange as the fact may seem.

While I have experimented with ungrounded shields, I soon discarded them because they become entirely too critical and too easily affected by hand capacity and temperature changes; so the grounded tuning shield actually works out better in practice. Even here very slight changes of the tuning shield will bring in stations that otherwise could not be received at all. Thus, for instance, when using a 5-tube set and employing the principles explained here, I could not bring in station KFI (Los Angeles) over 3,000 miles distant, unless the tuned shields were adjusted carefully. But it was easy to bring the station in several times during the week, after the system had been once brought to the highest peak of efficiency.

FINENESS OF ADJUSTMENT

A motion of less than 1/64 of an inch, toward or from one of the radio-frequency

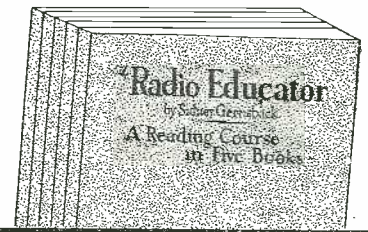

A COMPLETE "RADIO EDUCATION" IN 5 VOLUMES

Theory, Design, Construction, Operation and Maintenance

THESE five component parts of a complete Radio Instruction Course are outlined in five volumes that contain not merely the essentials as so many books do, but more, they contain all that any modern up-to-the-minute textbook on any subject would cover. They are in themselves a COMPLETE radio education teaching every possible portion of Radio science. Size of each book 6 by 9 inches, handsomely bound and illustrated with charts, diagrams, descriptions of equipment, etc. Each volume 52 pages.

SEND NO MONEY

for these books. Just forward your name and address. We send you the books at once. On receipt of same you pay the postman \$1.97 plus a few cents postage and then they are yours.

Published and Distributed by
THE CONSRAD COMPANY, Inc.
230 Fifth Ave. New York, N. Y.

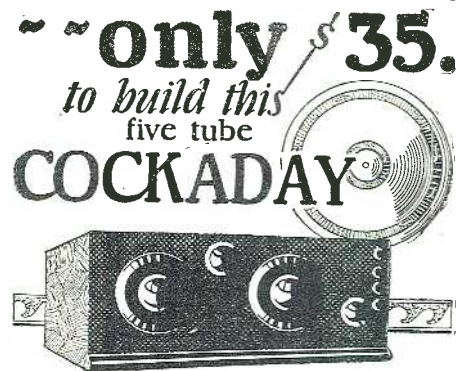

Invest 50c in the Popular CONSRAD PATTERN and Save 1/2 on Your Set

Radio's most popular "Home Built" circuit, Powerful and easily built. Used by the thousands everywhere. Parts cost only \$35 if you use the Consrad Pattern. Two full sized blueprints given with fully illustrated instruction booklet. All measurements full size.

Panel layout and Wiring diagram simplified so that anyone can understand them. Save NOW on your Radio—Buy one of these patterns.



Price 50c

Consrad Co., Inc.
230 Fifth Ave., New York City, N. Y.
Enclosed 50c for one copy of your pattern, "How to build the 5-tube 'COCKADAY'."

Name
Address
City State

transformers, is sufficient to throw out the distant station. In practice I have used a shielded inductor termed a "Peridyne," as shown under Fig. 4. The word "Peridyne" is derived from the Greek *peri*, meaning "on all sides," and *dynamis*, "force"—alluding to the complete enclosure of the coil by its tuning shield.

In Fig. 4 we have an inductor, and a round metallic can in two parts. We have an adjustable shield which is moved up and down by turning the central knob. The thread may be either 6/32 or 8/32. Even a single turn of this fine thread, as explained before, will throw a distant station in or out.

It should be noted, by referring to Fig. 4, that the radio-frequency transformer has its highest-potential side nearest to the shield, and it should also be noted that the "Peridyne" tuning shield does not act as a "losser." It would become such only if the shield came very close to the inductor, which, in practice, it never does. As a matter of fact, the best results are obtained when the shield is at least one inch away from the inductance. It then becomes a corrective device to bring the entire system to the exact resonance.

Graphically this is shown under Figures 5 and 6. In Fig. 5, the three curves represent the operation of three radio-frequency transformers in an average set that may be termed fairly sensitive. We have also, it will be noticed, in Fig. 6, the mean for the three curves. In even the best of sets heretofore constructed, these three curves rarely coincided exactly. One of the transformers might work at its best peak, but the other two would not. You could, therefore, get only an approximation of the best results supposedly inherent in the set; which, however, in practice could never be realized unless corrective measures, such as compensating condensers, were used. In a "peridyne" set, however, after the shields have corrected the entire system to perfect inter-stage resonance, you will have the result shown in Fig. 6, where all three curves fall into practically one exact curve. In other words, all three radio-frequency transformers, with their condensers, automatically come up to the same resonance peak, and the set therefore works at its highest possible efficiency over the entire broadcast range, without manual setting of correcting instrumentalities.

With the "Peridyne" system, therefore, it is possible to get from a set the last fraction of efficiency which would not be available otherwise.

OTHER ADAPTATIONS

I once more wish to emphasize the point, because it is quite important, that in a correctly designed "Peridyne" shield practically no losses whatsoever are observed; because in no case does the shield come close enough to the inductor. The "Peridyne" shield, in fact, is not used as a true lossy, but only as a compensating device. For reasonably-matched radio-frequency transformers, it is never necessary to bring the "Peridyne" shield closer than one inch, at the nearest, to the top of the inductance. Frequently the distance is much greater than this, the average being from 1½ to 2 inches; although, when the set oscillates violently, this distance may sometimes, but rarely, be reduced to three-quarters of an inch. When the shield is so close, it does absorb a little energy.

It should be noticed that the utility of the "Peridyne" idea is not restricted to matching independent radio-frequency transformers in a tuned-radio-frequency circuit; but it can be used for many other purposes, which will immediately become apparent to the radio technician. It even becomes possible to do away entirely with the usual tuning

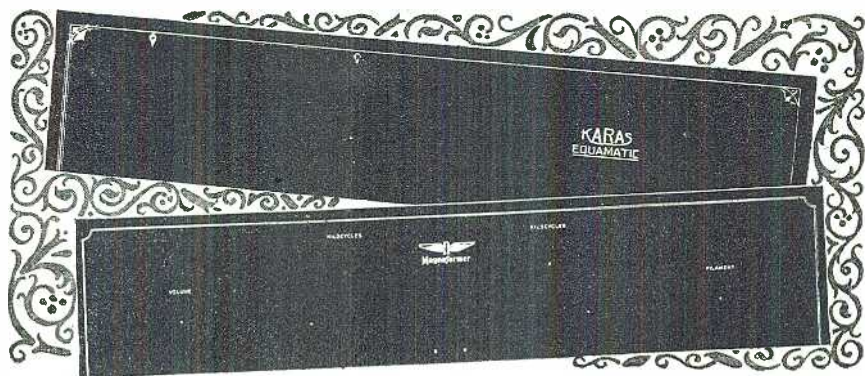

Panels for Magnaformer and Other Kits

Formica is supplying handsomely decorated and drilled front and sub-panels for the Magnaformer Circuit; also Tyrman front and sub-panels, H.F.L. new hook-up; Karas new hook-up; World's Record Ten, Camfield Nine and Camfield Seven.

Other kits for which Formica panels are available are Madison-Moore; Melo-Heald, Victoreen, St. James and Infradyne.

These panels enable the home constructor to build a set equal in appearance and efficiency to the best manufactured receivers.

Sold by leading dealers and jobbers everywhere.

THE FORMICA INSULATION COMPANY

4618 Spring Grove Avenue

Cincinnati, Ohio

Any parts dealer or jobber can get Formica panels for you.

FORMICA

Made from Anhydrous Bakelite Resins
SHEETS TUBES RODS

Formica has a complete service on insulating parts for the radio manufacturer.

RADIO NEWS

NOVEMBER BLUEPRINTS

You can obtain a complete set of Blueprints for these receivers direct from RADIO NEWS.

THE HILOGRAD RECEIVER Radio News Blueprint Article Number 34	\$1.50
THE A. C. SHIELDED SIX Radio News Blueprint Article Number 35	\$2.25
THE "PILOT" A. C. DELUXE Radio News Blueprint Article Number 36	\$1.50

Order Direct from RADIO NEWS

230 FIFTH AVENUE, NEW YORK, N. Y.

MENTION NAME OF RECEIVER AND ARTICLE NUMBER

Enjoy LOUD SPEAKER OPERATION from a CRYSTAL

NO "TUBES" - NO "B" BATTERIES - NO COSTLY "ELIMINATORS"

THE SKINDERVIKEN TRANSMITTER BUTTON

Simple microphone button provides a most effective and inexpensive way to satisfactory speaker operation. Easy to build and operate circuit.

FOR several years our English cousins have been able to purchase on the open market a radio amplifier of the microphonic type, which enables one to operate a loud speaker from a crystal detector, thus obviating the use of vacuum tubes, "B" batteries, etc.

Everybody can do this now with a Skinderviken Button.

The Skinderviken Button is fastened to the diaphragm of the speaker unit. It will act as a "microphonic relay." Every time an incoming signal actuates the diaphragm, the electrical resistance of the microphone button will be varied correspondingly and the current from the battery, in series with the button and the loud speaker, will fluctuate accordingly.

Thus the problem of securing sufficient power to actuate the Loud Speaker is simply and adequately solved.

The results from this very novel and simple unit will astound you.

The expense of this hookup is trifling compared to elaborate tube circuits that give no greater actuation of the speaker.

Besides this there are many other valuable uses in Radio Circuits for this marvelous little button. Every builder of Radio sets should have a few on hand.

LISTENING THROUGH WALLS

This Unit makes a highly sensitive telephone, the real thing—you listen through walls with ease. Plenty of fun and real detective work too.

CONDUCTING SOUND THROUGH WATER

Make yourself a miniature submarine signaling apparatus like those used during the war. Simple circuit with this microphone unit gives splendid results.



**95¢ EACH
TWO FOR \$1.75**

FREE 8-page circular fully explaining these and many other uses for these units sent with each order.

PRESS GUILD,
16R E. 30th St., New York, N. Y.

Enclosed find \$.....for.....Microphone Units as advertised above.

Name

Address

City-State

condenser and tune solely by moving the "Peridyne" shield to or fro; although this can be accomplished only within a rather narrow range.

I have even found it possible to use the "Peridyne" shield as a regeneration control in connection with a regenerative tuner. Fig. 7 shows the arrangement.

Then too the "Peridyne" shield can be used admirably for matching the intermediate transformers of a superheterodyne, to peak them and bring all of them to their highest point of efficiency. In some circuits, notably the Tropadyne, it will be remembered that the intermediate transformers are shunted by a small variable capacity in order to bring the intermediate transformers into

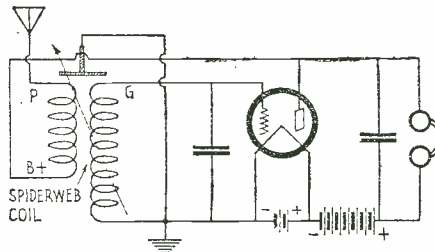

FIG. 7

The Peridyne principle applied to control of regeneration. The shield, as shown, can be employed to regulate the amount of feed-back and keep it below the point of oscillation. The shield can also be used to actually tune over a narrow wave band.

resonance with each other. By means of the "Peridyne" shield the intermediate transformers can now be matched quite easily and far more efficiently; because, when they are once set, the setting will not have to be changed.

I, personally, would advocate the use of the "Peridyne" shield only in connection with air-core intermediate transformers. Another use for the "Peridyne" shield is in wave traps, doing away entirely with the tuning condenser. I have found, for instance, when using a spiderweb or honeycomb coil, that an almost micrometric adjustment of the shield will easily throw the wave trap in or out of tune.

Summing up, therefore, the "Peridyne" idea of tuning by shielding opens a new era in extraordinarily fine electro-mechanical balancing systems, not possible heretofore. By means of the "Peridyne" shields, a number of radio-frequency transformers in a set can be brought into perfect resonance with each other and, once adjusted, the set will remain at its highest efficiency over the entire broadcast range (200 to 545 meters).

While it is possible to use the "Peridyne" shield without encasing the inductor completely, it is best to use it inside of such a surrounding shield, for practical considerations.

In the December issue of RADIO NEWS, the "Peridyne 5," a 5-tube radio-frequency set completely "Peridyne'd," using the above-described principle, will be illustrated, and full instructions given for its construction. This set has been used by the author since November, 1926, and has purposely been withheld by him from publication heretofore out of a desire to be certain that he could present something worth while and quite out of the ordinary. The "Peridyne 5" has been tested under all manner of conditions, and has proven to be a DX set par excellence, surpassing even some of the best superheterodyne sets. Yet there is only a single tuning knob.

The set is extraordinarily simple, far simpler to build than anything that has been shown heretofore for a set of this effectiveness, and will bring in stations two and three thousand miles away, if atmospheric conditions are only fair.



BUILD THE SENSATIONAL STROBODYNE

Complete kits for this popular circuit, as used by designer on hand.

READY FOR DELIVERY

THE HILOGRAD RECEIVER

The set with equal amplification over the entire waveband. Price of Kit Upon Request

THE A. C. SHIELDED SIX

The perfection of the modern Radio A. C. operated and ingeniously shielded. Price of Kit Upon Request

THE "PILOT" A. C. DE LUXE

The "Easy to Build" Receiver. All parts sold in ready made units. Price of Kit Upon Request

We have complete kits for all constructional articles appearing in this Magazine

M & H SPORTING GOODS CO.
512 Market St. Philadelphia, Pa.

90 Volt Power Unit :: \$12.75

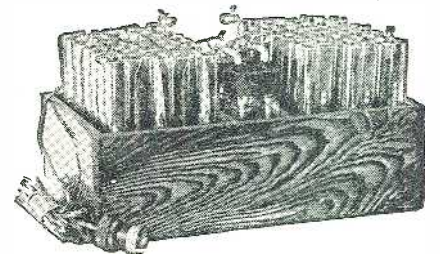

Hums, line noises, etc., positively impossible with this new advanced unit. Plug in and forget Non-acid and noiseless. All detector and intermediate voltages plainly marked. Simpler to hook up than dry cells. Operates any type set 1 to 12 tubes. Greater volume and clearness guaranteed. If not thoroughly satisfied return after using 30 days for complete refund. Guaranteed further 2 years. For 110-120 volts A.C. 25 to 60 cycle current. 90 volts, \$12.75; 112½, \$15.25; 135, \$17.50; 157½, \$19.50; 180, \$24.00; 202½, \$26.00. Also built for D.C. current 110 and 32 volts at only \$3.00 additional, any size above. Ample stocks—same day shipments. Simply say—ship C.O.D., or write for my interesting literature, testimonials, etc.

B. HAWLEY SMITH

334 Washington Ave.,

Danbury, Conn., U. S. A.

C. R. LEUTZ, Inc.

6th and Washington Aves.
LONG ISLAND CITY NEW YORK



Big New 1928 Catalog—4,000 Items
Standard discounts to dealers, set builders, agents. Write for free copy. The Barawik Co., 129 N. Jefferson St., Dept. 111, Chicago.

"GAMBY," the Girl on the Cover.

(Continued from page 477)

tion to me, because of the kindly and generous response of the radio fans. I hope some day that they will be able to broadcast the dance; until that time the only means of entertaining my radio friends is by singing. At least that is what some people call it; Roxy says: 'As a singer, you are an excellent dancer.'

Woman's Place in Broadcasting

(Continued from page 477)

to those who entered the radio entertainment field at the outset. Accordingly, she decided to gain some first-hand knowledge of broadcasting. At that time, WJZ was a small station in the experimental stage, operated in the Newark factory of the Westinghouse Electric and Mfg. Company. It was one of a mere handful of broadcast stations in the United States. With her experience as a writer serving as her card of introduction, Miss Brainard obtained an interview with the manager of the station and suggested to him a weekly radio review of current Broadway plays.

Old-timers among broadcast listeners may remember these weekly theatrical chats, which were entitled "Broadcasting Broadway." Preparing and presenting them entailed a great deal of work, for which she received no compensation other than a thorough knowledge of the broadcast methods then in use. She showed such efficiency in her work, however, and became so popular with the radio audience, that the management of WJZ soon asked her to serve the station in another capacity.

WJZ needed a representative in New York City. The studios were then located in Newark, while most of the entertainment talent was drawn from Manhattan. It was necessary that some responsible person, with a knowledge of the theatrical and musical fields and the abilities of various artists, handle the booking of entertainers to be heard over the air. Miss Brainard was given the position and proved from the outset her qualifications for the job. And it was a job in those early days, for performers of real ability were not hammering on the doors of radio stations for the opportunity of donating their services. Through her contacts, however, Miss Brainard was able to bring many artists of the theatrical, operatic and concert stages to the Newark studios. Her broadcast features were soon listed among the outstanding attractions of the station.

TO THE TOP

In 1923, when WJZ's studios, offices and transmitters were moved to the old Aeolian Building in New York City, Miss Brainard was made assistant manager of the station. She inaugurated a broadcast hour devoted especially to the interests of women, and, under her guidance, the period became immediately and widely popular. In the fall of 1926 the management of WJZ was taken over by the National Broadcasting Company, and she was made full manager. Today she is one of the most outstanding women, if not the first, in the radio field and the only woman managing a station of the size, power and importance of WJZ.

"Broadcasting is not different from any other business," said Miss Brainard, in answer to a question about woman's place in broadcasting which was put to her by the writer during a recent interview. "Only re-

A HIGH-POWERED 10-TUBE MODEL FOR 1928

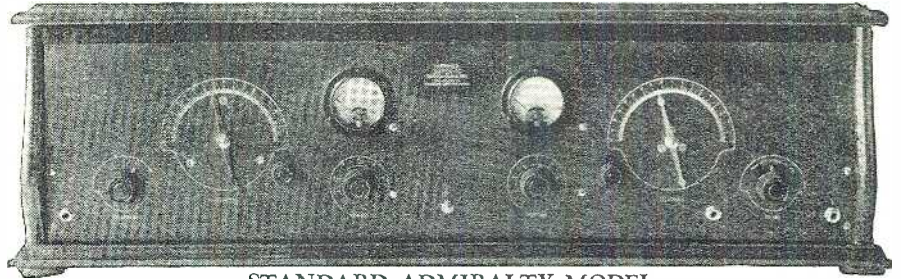

STANDARD ADMIRALTY MODEL

NORDEN-HAUCK IMPROVED SUPER-10

LICENSED UNDER HOGAN PATENT 1,014,002

"Highest Class Receiver in the World"

This new and advanced design brings to you all the luxury and performance you could possibly desire in a radio receiver. Absolutely nothing has been omitted to provide supreme reception—a new standard previously unknown.

The up-to-the-minute engineering principles found exclusively in the improved Super-10 are comparable to the high compression head and super charger in an automobile engine.

In the Norden-Hauck Improved Super-10 you have

- Wonderful Selectivity
- Faithful Reproduction with any Degree of Volume
- Signals received at only one point
- Two major tuning controls for all wave lengths
- Wave band 200/550 meters (adaptable down to 18 and as high as 6000 meters with removable coils)
- Material and workmanship conform to U. S. Navy specifications.

The improved Super-10 is sold complete as a manufactured receiver, or we are glad to furnish blue prints and all engineering data for home construction.

Upon request, new attractive illustrated literature will be promptly mailed to you without cost or obligation on your part.

Tear off and mail today—

Your correspondence or inquiry for further information is cordially invited

Write direct to

NORDEN-HAUCK, INC.
ENGINEERS

"Builders of the Highest Class Radio Apparatus in the World"

MARINE BLDG., PHILA., PA., U. S. A

Cable: Norhauck

NORDEN-HAUCK, INC.,
MARINE BLDG., PHILA., PA.

Gentlemen:

- Without obligation on my part send me complete literature on the new improved Super-10.
- I enclose \$2.00, for which send me, postpaid, complete Blue Prints and operating instructions for the new improved Super-10.
- I enclose \$1.00, for which send me Blue Prints of the Model 500 B. C. Power Unit.

Name.....

Address.....

FREE Wholesale Radio Catalog
Dealer-Set Builders! Save Money!
Send for this book of bargains. Everything in Radio—all the newest hook-ups. Sets, kits, parts, cabinets, consoles and supplies. If you want the best for the least money, you need this catalog.
SHURE RADIO COMPANY
333C West Madison St. Chicago, Ill.



WALNUT FINISH RADIO TABLE \$3.95

This most extraordinary value is offered radio fans for a limited time only. Full size, 13 x 27 inches with battery shelf. Table is knocked down for convenient and safe shipping. Sent postpaid on receipt of \$3.95 plus 25c. for parcel post charges.

BERNARD FURNITURE CO. 38 So. 2nd Street, Philadelphia, Pa.



\$25

Kennedy Utility Saw

Will rip, cross cut, sand, and grind. With extra attachments you can plane, groove, tongue, plough, miter, bevel, bore, rabbet, mortise, joint, make mouldings—extremely efficient for building radio cabinets, tables, etc.

Ball Bearing Pat. 1622237

RALPH M. KENNEDY
111 N. 7th St., Philadelphia, Pa.

EUGENE G. WILE

Complete Kits for **STROBODYNE** **WORLD'S RECORD SUPER TEN**

and for all constructional articles appearing in all radio magazines.

Set builders—write for our prices first
7 North 10th Street **PHILADELPHIA, PA.**

Insure your copy reaching you each month. Subscribe to Radio News—\$2.50 a year. Experimenter Publishing Co., 230 Fifth Avenue, N. Y. C.

BLUEPRINTS OF INEXPENSIVE DX RECEIVERS

THE FIVE-TUBE DIAMOND OF THE AIR, a very selective circuit of thrilling tone quality, that brings in distant stations to the great delight of the fans, is easily built, in fact can be constructed in a couple of hours. The authorized blueprints that make this speed and efficiency possible are just off the press and will be shipped at once, together with a booklet of full textual exposition of construction, including winding of coils, how to connect coil terminals, what values of condensers and resistors to use, etc. If you want a tone quality set that will give you great enjoyment, be sure to build this five-tube Diamond of the Air. The receiver consists of a stage of tuned radio frequency amplification, a specially sensitized detector, first stage of transformer audio and next two stages of resistance audio. It is easily adapted to playing phonograph records on your speaker. Get acquainted with this NEW delight.

THE FOUR-TUBE DIAMOND

represents the most that is obtainable from four tubes. A stage of tuned radio frequency amplification, a specially sensitized detector, and two stages of transformer coupled audio. Follow the diagrams as shown in the blueprint and you can't go wrong. You will be amazed at the results. Build the set from parts that you have. Full instructions cover utilization of such apparatus. Thousands are eager to build an economical set and this one is the most economical in cost of construction and upkeep, where one considers the surpassing results. Works splendidly from batteries, with either type 99 or type 01A tubes, and can be used with A and B eliminators, power packs, etc., with great success.

Look Over Both of These

blueprints and read the text in both cases before choosing the receiver you are to build.

SEND NO MONEY!

Just fill out the coupon below, and note what you get FREE!

Guaranty Radio Goods Co.

141 West 45th Street, New York City
Please send me one newly-printed official blueprint of the 5-tube Diamond of the Air, one newly-printed official blueprint of the 4-tube Diamond, and the textual data giving full directions for constructing these sets. I agree to pay the postman 75 cents on delivery. Also, you are to send me, without extra cost, one Auto Strop Safety Razor, one blade and one automatic razor strop.

Name
Address
City State

sults count; sex is immaterial. If a woman is willing to start at the bottom and work hard all day—and sometimes during the night, too—she will make her way to the top. Any woman who thinks broadcasting offers an opportunity to earn an easy livelihood has no conception of the business."

"Must a woman have any special training to enter the broadcasting field?" Miss Brainard was asked.

OPPORTUNITIES FOR WOMEN

"This is an age of specialization," she replied: "A woman should be able to specify the work she is capable of doing, and then the station manager to whom she applies for a position will be able to inform her whether she can be employed profitably. If a woman came to me and asked for a job, merely because she thought a broadcast station was just the place for a nice, genteel person, I would tell her to get a job as a nursemaid."

"What positions in a broadcast station can a woman fill?" was another query.

"Practically any a man could fill," said Miss Brainard. "Of course, there are always stenographic jobs, from which many successful executives in other departments have risen. Women can do publicity work, write continuities, book programs and even announce over the air. They must be ready to work hard; for the important programs and presentations which they prepare during the day are broadcast during the evening; to make sure that everything is going properly, they must therefore be willing to spend a little extra time listening to them and seeing them through.

"At any event, radio broadcasting is the most interesting game in the world," she continued. "One never does the same thing twice. One night we have visiting celebrities, the next an operatic diva. There is no monotony, but instead a constant succession of interesting experiences and interesting people. Of course, life in a broadcast station does not always flow smoothly. We have our troubles, but we treat them with common sense and they usually iron themselves out. And the opportunities we have for helping others are a source of continual happiness."

THE MODERN KID

CRAWFORD: "Has that youngster of yours learned to let your watch alone?"

CRABSHAW: "Yes. I just caught him trying to take my radio set apart."—J. J. O'Connell.

RADIO TERMS ILLUSTRATED



AN EFFECTIVE LEAD-IN

Better Reception Through Better Aerials

LIGHT, sturdy Premax adjustable steel radio masts go up easier, safer, cheaper—fit any roof and ends or sides of buildings. Two sizes, 7 and 10 ft., telescoping to a 4 ft. section for easy erection.

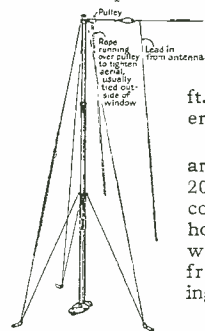

10 ft. 3-section Mast complete with all attachments, \$3.00 each. Mast \$2.00 each, \$1.00 per pair, parcel post prepaid.

20 in. 2-section outrigger arm. White porcelain insulator on end, 75 cents each; weight 1 1/2 lbs.

Through dealers or direct from
Niagara Metal Stamping Corp.
Dept. RN-3 Niagara Falls, N. Y.

PREMAX Parkerized Rustproof Metal Specialties

Self-Adjusting!

For best performance your tubes require a variable filament control to supply the definite current they need, despite "A" battery variations. AMPERITE is the only self-adjusting and automatic filament tube control that does this. Takes the "guess," inconvenience and unsightliness out of panel rheostats. Simplifies wiring, panel design, and tuning. Prolongs tube life. Order by name. Accept nothing else. Price \$1.10 mounted (in U. S. A.). For sale by all dealers. Write for FREE "AMPERITE BOOK" of season's best circuits and latest construction data. Address Dept. RN-11.

RADIALL COMPANY
50 Franklin St., New York

AMPERITE
The "SELF-ADJUSTING" Rheostat

XL Products

Pep up Your Set!
Tune quickly—adjust accurately—eliminate distracting noises—get correct tube oscillation—with X-L VARIO DENSENSERS in your circuit. Designers of all latest and best circuits specify and endorse X-L Vario Densers and Binding Posts.

MODEL "N" VARIO DENSER Micrometer adjustment easily made, assures exact oscillation control in all tuned radio frequency circuits: Neutrodyne, Roberts 2-tube, Browning-Drake, McMurdo Silver's Knockout, etc. Capacity range 1.8 to 20 micro-micro farads. Price \$1.00.
MODEL "G" Obtains the proper grid capacity on Cockney circuits, filter and intermediate frequency tuning in super-heterodyne and positive grid bias in all sets. Capacity range: Model G-1 .00002 to .0001 Mfd. Model G-5 .0001 to .0005 Mfd. Model G-10 .0003 to .001 Mfd. Price complete with grid clips \$1.50.
FREE Big, new 16 page book of wiring diagrams of popular circuits including the LOFTIN-WHITE constant coupled radio frequency circuit, Stroboddyne, etc. sent free on request.

X-L RADIO LABORATORIES
2426 Lincoln Avenue Chicago, Ill.

Letters from Set Constructors

(Continued from page 507)

capacity, and is absolutely stable throughout its entire range. The arrangement I used was a conventional three-circuit one with the tickler coil wound with 75 turns of No. 22 D.C.C. wire and tuned with a .0005-mf. condenser, instead of the coil itself being movable. I found, however, that, in spite of the fact that a condenser was used to handle regeneration, in addition to this the position of the coil with regard to its distance from the secondary was exceedingly important.

In my own case, I used a regular radio-frequency coil shunted with a .0005-mf. condenser for the tuning element and the tickler coil was held at a distance of about 1/2-inch from the secondary by means of a couple of strips of wood run through both coils. It took considerable experimenting to find the point or distance of the tickler from the secondary at which regeneration would retain its entire strength over the entire range. A variable grid leak was also found of great assistance; same being used in conjunction with a .00025-mf. grid condenser.

Another thing which I have found to be of great value, and which I have always used, is a variable resistor across the 1500-turn coil of the oscillator (I am using the regulation 1250 and 1500-turn coils). With the coils placed in conjunction with each other, this variable resistance serves the same purpose of varying their capacity as when the coils themselves are placed in coupled relationship with each other. This variable resistor is 50,000 ohms; gives a much smoother control than could otherwise be had, and of course, obviates the necessity of any cumbersome arrangement for coupling the coils.

45 volts on the plate is used for the oscillator and 90 volts for the detector, both tubes being the 201A type.

I have an indoor antenna hidden behind the molding of my living room, being two strands of bell wire with a total length of probably 55 feet. The ground is the usual one. Most articles I have seen on super-regenerative sets seem to take it for granted that such a set can be used only with a loop; but I have always used mine with an antenna and ground, and the results are certainly worth it. In the case of the set I have just finished building, I find the volume on local stations entirely too much for the earphones, and actually have to detune the set somewhat to make the volume comfortable. Right now is the rainy season here and static conditions are of the worst. However, in spite of it, I have several times been able to bring in KDKA with plenty of volume, and also a few stations in the southern states. I might mention here that the volume with the ground wire attached to the antenna post, and the antenna omitted, seems to be about the same. However, as I live one flight up in an apartment, the exposed part of my ground wire has plenty of distance to pick up static, so I don't see any improvement on that score.

Let the above suffice for the present set so that I may now give you a little of my past experience. In November 1924 there was published in "Radio Broadcast" an article by Mr. Roberts on the theoretical construction of a reflex super-regenerator using the Roberts circuit. Having had so much experience with the little old single-tube "flivver," I thought this would be a good stunt to try. I tried it all right, and if anybody's set ever got out of hand, that one certainly did for me. One minute it would work like a house afire, and the next be as dumb as a doorknob. For a little while I had it working fine, and I want to say right here that if such a set is finally perfected, it will unquestionably be the peer of any set now in existence, superheterodynes and all.

As you would probably guess, the main trouble with it was body capacity. One couldn't stand within five feet of it and make even a slight movement without the set howling or going out of adjustment. By standing right still with the hand on the antenna post, station after station from the States could be tuned in. I forgot to mention that this was done in the town of Tampico, Mexico. You will probably think I am stretching it when I say that with no other antenna than the body itself, station WBZ at Springfield, Mass. was brought in with just about as much volume as the earphones could stand. Similarly other stations in the far northern states were easily brought in with remarkable volume.

As stated, though, it was so erratic and thoroughly uncontrollable that the writer gave it up in disgust, and finally went back to his "flivver." In case you do not have the data on Mr. Roberts' "theoretical" set, it consisted of a stage of tuned radio frequency; the regulation single-tube super-regenerator, and a stage of audio-frequency amplification, this last being reflexed through the first radio-frequency tube. This made only two tubes in all.

Later, I tried another arrangement with an autodyne first detector and a super-regenerative intermediate amplifier operating on approximately 100 meters. This worked fine as far as it went, but I could never somehow attain the proper size of oscillator. The tuning was very sharp, but stations appeared at three places on the dial, and I was never able to eliminate this bad feature.

Going back to the Doctor's set, it is, of course, not different, theoretically, from the old-style super with separate oscillator. However, it is so much

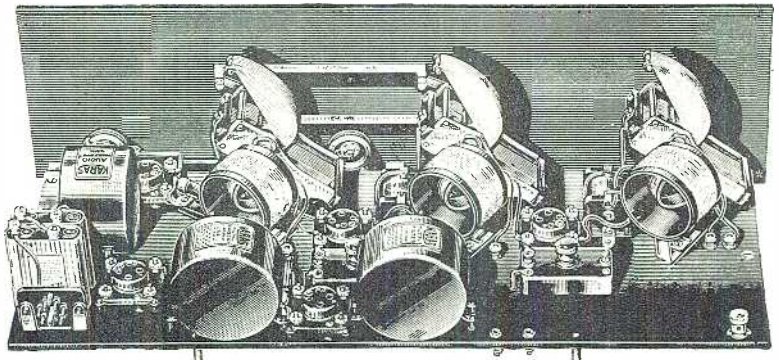

Two Sensational Karas Successes!

"KNICKERBOCKER 4" THE WONDER SET

AND THE NEW

2-DIAL KARAS EQUAMATIC 5-TUBE RECEIVER



For the Karas 2-Dial Equamatic you will need 2 Type 28 Audio Transformers, each \$8.00.



1 Karas Output Filter, price \$8.00, is used in the 2-Dial Equamatic Receiver.

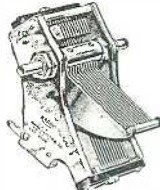

3 Karas S. F. L. Removable Shaft Type 17 Variable Condensers, each \$5.25 are used in the 2-Dial Equamatic.



2 Karas Micrometric Vernier Dials, each \$3.50 are used in both the 2-Dial Equamatic and in the Knickerbocker 4.

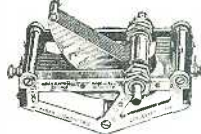

2 Karas Orthometric Extended Shaft .00037 in. Variable Condensers, each \$7.00, are used in the Knickerbocker 4, (shown at right.)

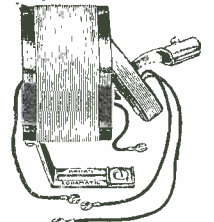

3 Karas Equamatic Inductance Coils, \$12.00 per set of 3, are used in the 2-Dial Equamatic.



2 Karas Harmonik Audio Transformers, each \$5.00, give the Knickerbocker 4 its tremendous volume and purity of tone.

No other transformer made has enjoyed the tremendous popularity of the Karas Harmonik.

Mail the Coupon for Blue Prints, Full Information, Everything About These New Karas Sets and Parts. You will want blue prints of both the KNICKERBOCKER 4 and of the 2-Dial Karas Equamatic—can obtain them free by using the coupon. This coupon also brings the new Karas Catalog, full, complete information about these two sets and ALL Karas parts. Sign and mail the coupon NOW.

KARAS ELECTRIC CO.
4038-K No. Rockwell St., Chicago

KARAS ELECTRIC CO.,
4038-K No. Rockwell St., Chicago
Send me, in addition to your complete parts catalog and other Karas literature, the following:
() Complete, easy-to-read blue prints and diagrams on the KNICKERBOCKER 4.
() Blue Prints and full information on the 2-Dial Karas Equamatic 5-Tube Receiver.
Name
St. Address
City State

Selectone Transformers
TESTED — MATCHED — GUARANTEED
Designed by E. H. Scott, whose famous receiver the WORLD'S RECORD SUPER established FOUR world's records for long distance reception.

HIGHEST AMPLIFICATION
—FINEST TONE QUALITY
SELECTONE TRANSFORMERS cut through the local stations with ease, and their tremendous amplification brings in the distant stations with great volume.

They are supplied in perfectly matched sets, insuring maximum amplification and the finest tone quality. **FREE**—Send for illustrated literature describing Selectone Transformers and tests they undergo.

SCOTT TRANSFORMER CO.
7620B Eastlake Terrace, Chicago, Ill.

WHOLESALE RADIO CATALOGUE
FREE
The Book they are all talking about
WHOLESALE RADIO CATALOG
Listing thousands of items in standard radio parts, Kits, Accessories, Complete Sets, Furniture, etc. Every Set Builder and dealer should have a copy. Real wholesale prices. Send for your copy today.
THE HARCO COMPANY
1259 So. Wabash Ave. Chicago, Ill.
The HARCO CO. 1259 So. Wabash Ave. Chicago.

Insure your copy reaching you each month. Subscribe to Radio News—\$2.50 a year. Experimenter Publishing Co., 230 Fifth Avenue, N. Y. C.

Use Any Circle Size of Half Dollar



**WIN
\$500!**

How Many Times Can You Write the Letter A in the Circle?

Try it! See how easy it is to win! Takes little time—no work—just play—and it may win you a fortune! No red tape! No complicated rules! Neatness and fine handwriting do NOT count!

No Subscriptions to Sell! No Second Puzzle to Work!

You will not be required nor asked to get any subscriptions! No other puzzle to solve! Qualify yourself! Put in the A's and send in your circle! If you can't use this paper draw a circle the size of a silver half-dollar on any kind of cardboard or paper. Use only capital A's. Use pen or pencil. Don't let any A touch another. That is all the rules to remember. And if you put in more than anyone else you get the \$500.00 in cash right away after Dec. 30th, 1927, which is the closing date for this contest.

200 Other \$2.50 Prizes! 1000 More 50c Prizes!

If you don't win the first prize you can surely win one of the 1,200 other prizes! And there is no catch or trick to this. We make this wonderful offer as a means of advertising the Inkograph, the amazing new writing instrument. Everybody who uses it is amazed at the ease with which it writes. Read about the amazing Inkograph elsewhere in this ad! Then mail in your circle and the coupon below and you are qualified to win. In the event of a tie each contestant will be awarded the full amount of the prize tied for.

READ WHAT USERS SAY!

"I am a teacher. The Inkograph is better than any \$7 fountain pen."
—John R. Atwell, Chadwick, N. C.
"I wouldn't take \$5 for this Inkograph. I mean every word."
—R. H. Wilson, Beckley, W. Va.
"The Inkograph makes two carbon copies of my requisitions twice as well as the best indelible pencil."
—Wm. L. Fartney, Placerville, Ia.
"It sure has improved my handwriting."
—M. F. Johnson, Medina, Wis.

SEND NO MONEY!

MAIL THIS COUPON

CONSRAD CO., Dept. R,
230 Fifth Avenue, New York City.

I hope to win \$500.00. I have put A in the circle this many times..... as per my solution attached. Please send me one Inkograph on 10 days' free trial for which I will pay the postman the regular price of \$1.50, plus the few cents postage charges. You are to refund my money if I don't like the pen.

NAME

STREET

P. O.

This Amazing New Pen



This amazing new kind of fountain pen writes on any kind of paper—on cheap news-paper or wrapping paper as easily and smoothly as on the finest bond, without scratching, clogging, blotting, leaking or soiling hands. Never misses, skips or blurs. Answers as both pen and pencil. Makes 3 or 4 carbon copies! Bear down as hard as necessary! You won't bend, break or spread its 14-K. solid gold point! Salesmen, business men, and farmers use it to keep carbon copies of letters, orders, sales bills, etc. Holds enough ink for 20,000 words! Refills itself in 2 seconds! Uses any ink! Get one! Try it 10 days and if you are willing to part with it just send it back and we will refund your money! We make this offer because we know you wouldn't take \$10 for it if you couldn't get another.

simpler than no trouble at all was experienced in getting it to function. Its excellent stability and lack of hand capacity leads me to believe that it would function quite well indeed in the reflex arrangement that I mentioned above, and I would suggest that you folks work something out for us amateurs along that line. Maybe when I get an extra streak of ambition I'll go back and try it again myself, but memories of my former misadventures along that line are still too recent to allow my enthusiasm to get unduly worked up. I don't suppose I should feel much discouraged about my own unsatisfactory results in the past, after seeing the results brought out by the contest.

D. A. LAWSHA,
Apartado 1363, Mexico, D. F., Mexico.

ANOTHER VOTE FOR THE ROLL

Editor, RADIO NEWS:

This note is inspired by the thrill I am getting out of the "Eveready Hour" via WWJ. Why should I be writing you about it? Well, I am a regular reader of Radio News, and I saw the article "A Simple Roll-Type Speaker" in the July issue; and sceptical though I was, I tried it—gingerly, I admit.

Spool a perfectly good unit glueing it up? Not I! I used a cheap headphone and a piece of "detail" (drafting) paper about half the size specified—and got a big surprise, to hear a deeper bass note than I could ever get on a horn with the same unit or any other. I then tried it the specified size, then with my Tower phonograph unit, using elastic bands to hold the cork against the diaphragm. I finally glued it and made a wooden frame like a letter H; the cross piece being two heavy pieces of board about 3 inches wide, notched to hold the unit. I made it 18x22 inches, with a sheet 22x30 inches, two inches wider than the article shows.

I had some difficulty getting rid of a harsh "skirt" in the high notes. I remedied it by getting the best adjustment of the unit, tried several sizes of corks, and finally shunted a .002-mf. condenser across the speaker terminals, after trying all the way up to .008-mf. The larger ones suppress the high frequencies too much, dulling the violins, piccolos, soprano voices, etc.

I'll put this speaker up against any \$35 speaker, and then some. It delivers everything from the organ contra-bass up to the top note of the piano, with almost perfect fidelity. The neighbors utter exclamations when they hear it, and are of my opinion. I was asking myself how low a note it would reproduce, when (since I began this letter) the bass in the Eveready brass quartet answered for my by going down the scale to C—32 cycles, almost the bottom note of the piano. I followed him by sounding each note softly to be certain. And that bottom note was loud and strong and only slightly lacking in depth, if at all. I use five dry-cell tubes, 4 199s and a 120, including one stage of impedance and two of resistance coupling, with 0.1 and 0.25-mf. coupling condensers.

The same unit on the phonograph horn gave several times as much volume, but the quality of tone did not compare with the roll speaker. I should like to know if a heavier paper would increase the volume, as that I use is much lighter than speaker paper. I appreciate your magazine immensely.

M. L. WALKER,

5508 Lakepoint Ave., Detroit, Mich.

P. S. Since writing the above, I have obtained a somewhat stiffer paper with a harder finish. I note no increase in volume, and the quality of the music is about the same. The speaker, though entirely undecorated, looks anything but unsightly hanging on the wall in the parlor. It is just a cream-yellow paper, with a semi-glossy finish.

AERIALS AND THE SEASONS

Editor, RADIO NEWS:

I am glad to see that the DX men are active still even in summer as evidenced by the many distant-reception letters appearing in RADIO NEWS. Early this summer I hauled down my aerial for inspection and repairs and substituted therefor an underground aerial consisting of a roll of ordinary aerial wire inserted in a hole in the ground to a depth of about two feet; the coils being separated by thin layers of earth and sufficient of the wire being left above ground to form a lead-in. I expected no DX from this but intended it merely for local reception during the summer. It turned out to be rather good on DX but poor on the locals with a few exceptions.

A number of New York stations which came in clearly on the other aerial could not be located at all but here are some of the distant stations which I logged via the underground during the summer: KDKA, Pittsburg; KFAB, Lincoln, Neb.; KFKX, Hastings, Neb.; KFNE, Shenandoah, Iowa; KFUO, St. Louis; KMA, Shenandoah, Iowa; KMMJ, Clay Center, Neb.; KMOX, St. Louis; KOA, Denver; KOIL, Council Bluffs, Iowa; KTNT, Muscatine, Iowa; KVOO, Oklahoma City; KWKH, Shreveport, La.; WCCO, St. Paul; WFHH, Clearwater, Fla.; WHB, Kansas City; WHO, Des Moines; WIQD, Miami, Fla.; WIAX, Jacksonville, Fla.; WLW, Cincinnati; WMC, Memphis; WNOX, Knoxville; WNRC, Greensboro, N. C.; WOC, Davenport, Iowa; WREO, East Lansing, Mich.; WSMB, New Orleans. Some of these stations, notably WCCO, WIAX, and WOC, came in with the strength of locals.

During the winter KFI, Los Angeles, was received on numerous occasions and at times with loud-speaker volume; but it refused to travel via a buried aerial though I tried to coax it on several occasions. All that I could hear were faint,

protesting groans. The underground aerial made tuning sharper and more difficult, though it did reduce static considerably; and I do not believe I could have had this reception with the overhead aerial in summertime.

However, I do not hold that the underground equals the other for winter DX reception, as I have logged upwards of 300 stations during the last two seasons; among them being stations located in Maine, Florida, California, Washington, Oregon, Alberta, Manitoba, Mexico, Cuba and Vancouver.

MICHAEL LONERGAN,
32 East Harwood Terrace, Palisades Park, N. J.

A SIXTEEN-FOOT HORN!

Editor, RADIO NEWS:

I enclose a sketch of the constructional details of a loud speaker which I have installed in my own

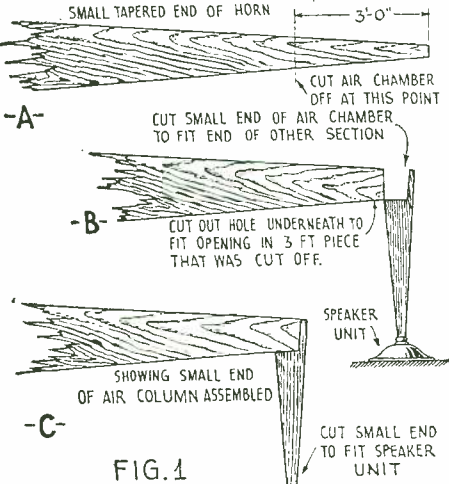

The throat of Mr. Wheaton's horn. This has a straight, not a curved air chamber; the foundation material is two 16-foot boards, 16 inches wide, which are ripped diagonally to make four sides. These are assembled, overlapping at successive sides, and the small end is cut as shown.

home, and which has the goods for putting out the real stuff—honest-to-goodness sweet and mellow music.

I have had twenty "hams" out here inspecting it, and they all claimed it is far better than anything they ever heard before.

But there is one drawback! You have to tear your house down, at least in part, to install it. But it is surely worth the trouble, time, profanity, etc., to make one like it, if you want to hear real reproduction.

The bell of this horn comes down through the ceiling, level with the plaster. The opening is covered with a grating, similar to a cold-air register, and artificial flowers are entwined in the grating.

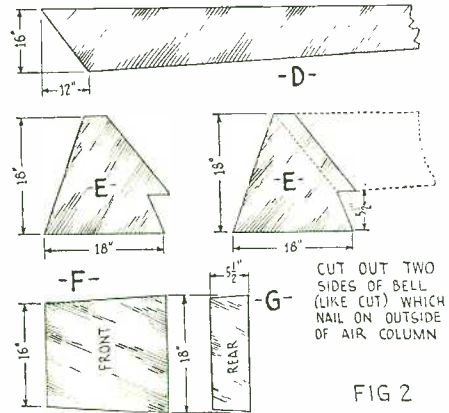

Here we have the "bell" of the horn, if it may be called such. End pieces are cut for the mouth of the air duct, and we have the final assembly as shown on the next page. The deepest notes will be transmitted through this combination.

All joints, cracks, etc., are puttied and covered with white lead to make it airtight.

And, believe, me, a pipe organ comes over this speaker in its natural mellow tones. I know you will agree with me that organ music in its natural mellowness is hard to get, except with a speaker similar to my "Whizbang," or the large orthophonics.

RUSSELL E. WHEATON,
R. F. D. 9, Jackson, Michigan.

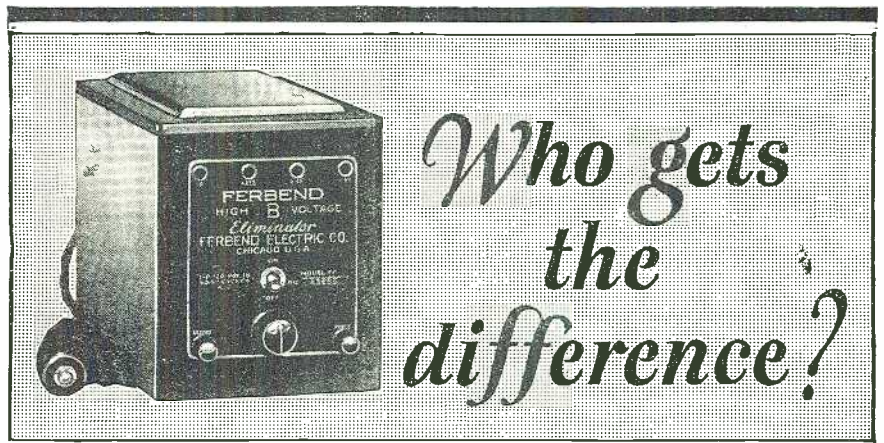

Who gets
the
difference?

Why do other good "B" Eliminators sell for as much as \$65.00—while the Ferbend sells for \$12.50? ❀ ❀ ❀

Generally accepted in the minds of the radio public is the fact that "B" Socket Power is best from every standpoint—convenience, lasting satisfaction, better reception. There remains only the question of price. Of the best "B" Eliminators, many are as high as \$65.00, while the Ferbend—which is equal to any, not only in operation, but in quality, durability, workmanship and appearance—sells for only \$12.50.

Original cost less than half of any equipment of similar quality; lowest maintenance cost. Sooner or later you will change to "B" Socket Power. Why pay the difference?

Model III for all sets using 90 volts, \$12.50. Model IV for extremely large sets and sets using power tubes; delivers up to 180 volts, \$17.50.

Tested and approved by the Rigid Laboratory Tests of Radio News and Popular Radio.

See Your Dealer or Send Direct

Shipment made direct on receipt of price, or C. O. D. if preferred. Use for 10 days to convince yourself—if unsatisfactory, write us within that time and purchase price will be refunded. Send Coupon TODAY.

FERBEND ELECTRIC COMPANY
425 W. Superior St., Chicago, Ill.

Your Proof of Lasting Satisfaction

"I have used your B Battery Eliminator for two years. Being an electrician, I wish to inform you that your Eliminator has given perfect satisfaction in every way."
S. O. Stives, Beaver Falls, Pa.

"Have been using Ferbend B Eliminator for over a year and am more than satisfied with same."
J. W. Reites, New Orleans, La.

"Your Eliminator has been in use now almost two years and still works great."
W. T. Henwood, Boulder, Colo.

The first Ferbend B Eliminator is still in use and giving good service.

FERBEND ELECTRIC CO.,
425 W. Superior St., Chicago, Ill.

.....Send \$12.50 Model.
.....Send \$17.50 Model.
.....Send at once. Payment enclosed.
.....Send C. O. D.
.....Send Literature.

Name.....
Address.....
City.....State.....

FERBEND
"B" ELIMINATOR

Build this set

without fail. Build it at once and enjoy that exclusive thrill that can only come through the proud possession of the finest and greatest radio set ever designed. The MAGNAFORMER 9-B, Commander-in-Chief of the Air, is fully two years ahead of the field. Outstanding feature is its True-Tone Quality, which is utterly marvelous, amazing beyond description. Musicians especially are enthusiastic in their praise of its wonderful fidelity of tone. The new scientifically designed and precisely matched and sealed Magnaformer Intermediate Long Wave R. F. Transformers are the cause. A truly beautiful job. Changes from 9 to 8 or 9 tubes instantly. Greatest distance getter. Non-critical. Super-selective. A world of volumes; quiet operating; easy to tune; easy to build. Prominently featured by G. M. Best, L. M. Cockaday, Call Book and other leading radio authorities and magazines. All standard parts. NO AFTER-SERVICE. The ideal set to build for yourself or others. Every one who hears or tunes a Magnaformer 9-B decides to own one immediately. Send now for free descriptive literature. RADIART LABORATORIES COMPANY 19 S. La Salle Street Dept. 18, Chicago

free Wholesale Radio Catalog

Send today for it

1928 Catalog Dealers, set builders—make this your biggest radio season. Shure's great wholesale catalog insures the best in quality at lowest prices.

This wonderful book is jammed full of the newest offerings of Nationally known radio parts, kits, sets, accessories, table and console cabinets, etc. Also contains short wave sections showing the finest electrical apparatus for short wave receiving and transmitting. Your request brings out book of a thousand bargains, price lists and discount sheet. Write for a copy today.

2000 Items

Big Values

Shure Radio Company
131C West Madison St., Chicago, Ill.



Josh Billings once said—"Success don't konsist in never makin' blunders, but in never makin' the same one twict"—let me help you get the best results from your next set; two heads are always better than one.



We have all the specified parts for the latest circuits including the new—

STROBODYNE and the latest H-I-Q-6

Mr. R. E. Lacault will give free authoritative advice on how to build the latest and best circuits.

The use of specified parts is very important in obtaining GOOD PERFORMANCE, therefore do not substitute to save a few cents and spoil your set. We sell only high grade guaranteed parts.

Send For New Handbook—It's Free

R. E. LACAULT
RADIO ELECTRIC LABORATORIES

116 West 65th St., New York City
Only firm having exclusive services of
Mr. R. E. Lacault, E.E.

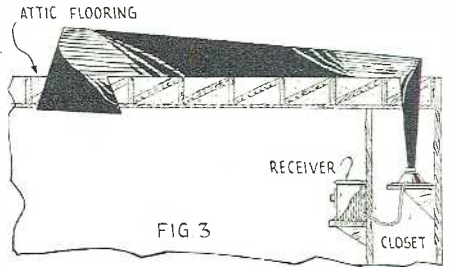
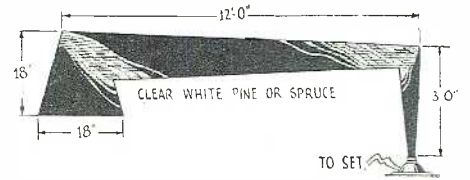
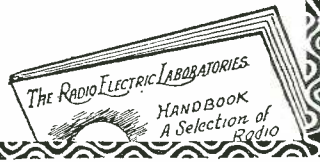

Mr. Wheaton's "Whizbang," a straight 16-foot conical horn, as built into his home. Fellow fans will envy his ability to rearrange his surroundings to suit.

AN OLD STAND-BY

Editor, RADIO NEWS:

It was interesting to read F. C. Staves' letter in the July issue about his Victoreen and T. F. Mann's challenging the Victoreen with his Browning-Drake. Now, I would like to challenge them both with my Superheterodyne.

This set is the old Haynes-Griffin 1923 seven-tube circuit, home constructed and built especially for the Buffalo, N. Y., radio show of 1924, when I captured first prize and \$100.00 in the amateur set-building contest.

During the last International Broadcasting tests in 1925 I logged six foreign stations and I have verifications from all six. During 1925 and 1926, when the verification-stamp fad came out, I collected 214 stamps for the year—sixteen of them foreign.

I still use this set and expect to use it for five years more at least, as I have it modernly equipped with socket-power units and other adjustments that bring it up to date.

Having been an experimenter and set builder for the past seven years, I feel safe in stating Mr. Staves' Victoreen, if properly constructed, far surpasses Mr. Mann's Browning-Drake; and I have to be shown the circuit or set in existence today that will pass the superhet—this with all due respect to the Browning-Drake and all others of equal merits.

The set is loop-operated and has a distance record of 5000 miles for Rio De Janeiro, South America.

J. H. PERAN,
210 East 7th St., Oswego, N. Y.

TWO ULTRADYNE FANS

Editor, RADIO NEWS:

I will make no claims to have the most sensitive receiver or champion DX-getter; but I am well satisfied with my Ultradyn, model L2, designed by R. E. Lacault, and first made known to me through the Radio News Superheterodyne Book. I built this the first week in July, and did not erect an aerial, as there are so many on our roof and other houses nearby that they look like barbed wire entanglements.

So, with a cheap loop, I have received, besides all locals, up to August 23, KDKA, KYW, WPG, WOO, WIP, WFL, WLIT, WRC, WSM, WSB, WCAZ, WTAM, WSUI, WGN, WBBM, WJR, WLW, WEBB, CNRO and WGY. I consider this remarkable summer reception, as all were received with good volume on the loud speaker. All except WSUI and WBBM were received before 11:30, as I have never sat up till 2:00 or 3:00 a. m. I am anxiously waiting to see what this set will do in the winter, and can recommend it to anyone. I thank RADIO NEWS for publishing this circuit, and Mr. Lacault for inventing it.

NEIL E. KENNEDY,
206 West 122 Street, New York, N. Y.

Editor, RADIO NEWS:

I have been reading your Correspondence from Readers, and decided I would let the boys all know that I also have the only radio set. I have an L2 Ultradyn that I believe, will do more howling and squeaking and squalling, make more static, entice more radio waves in and lead them over the bus-bar trail, and make more pretty music than any radio set that ever punished a loud speaker.

I will put this set against any other. Here is what it will do: It will bring KFI on the loud speaker on the first stage most any night, summer or winter, with a small loop. With a small loop I can get 500-watt stations on the west coast (2000 miles). I have heard KGU (Honolulu) many times—when using an aerial and ground. It is very selective because it is a "one-spot" super; only three or four stations come in on more than one setting.

WILLIAM G. MARTIN,

Glenview (Lookout Mountain), via Chattanooga,

Tenn.
(Let us hope Mr. Martin's nearest radio neighbor is not too close; since he may not enjoy the squeaks so well.—EDITOR.)

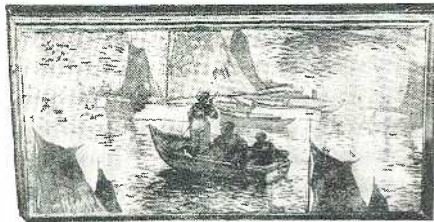

Above illustrates one of the four attractive Lata Balsa Reproducers.

Nature's Sounding Board

Radio reproduction has been perfected by the use of the Lata Balsa Reproducer which uses as a diaphragm a wide expanse of carefully selected and treated Lata Balsa Wood.

The appearance of this reproducer, a model of which is illustrated, is such as to make it a real work of art and an adornment which fits into the furnishing scheme of any tasteful home.

Its remarkable, non-resonant characteristics, its ability to reproduce any frequency in the musical scale combined with beauty and its decorative possibilities have gained for this speaker immediate acceptance among radio enthusiasts.

Illustrated booklet on request.

Balsa Wood Reproducer Corporation

331 Madison Avenue
New York City

Wirthmore Radio Cabinets

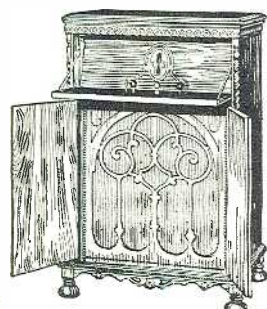

SAVE MONEY

Right in your own city are many people who have saved money by buying Wirthmore Cabinets direct.

You too can buy a Better Cabinet and save Money. A Complete Line of Consoles equipped with Newcomb-Hawley Speakers.

Get Your Catalog

THE WIRTHMORE COMPANY
910 Wirthmore Street, Rockford, Ill.



Selected for

Knickerbocker 4

- 2 No. 120 K Rheostats.....Each, \$1.35
- 1 No. 10 Midget Battery Switch, Each, .50
- 2 No. 416 Pup Jacks.....Per Pair, .25
- 2 No. 2L Resistance Units.....Each, .15
- No. 669 Cable Connector Plug with two extra contacts\$3.25

At your dealer's

YAXLEY MFG. CO.

9 So. Clinton St. Chicago, Ill.

Insure your copy reaching you each month. Subscribe to RADIO NEWS—\$2.50 a year. Experimenter Publishing Co., 230 Fifth Ave., N. Y.

IN LIGHTER VEIN

EPITAPH FOR A DX HOUND
*Here lies interred Josephus Byrd,
 Who passed, from joy, away:
 The station call that he last heard
 Was 7BY (Bombay).*

—Joseph Riley.

WHERE ALL HOURS ARE ALIKE

The teacher had been explaining longitude and time, with illustrations from broadcasting.

BRIGHT PUPIL: "If you went to the North Pole, would you get all stations at the same time?"—*Popular Wireless.*

FOR A HOBODYNE

TRAMP: "Lady, would you give a poor man an old tube?"

LADY (flivver owner): "Why—er, will an old 30 x 3 do you?"

TRAMP: "No, ma'am, me radio is a portable an' takes a UX-199 fer dry cells."

GOOD NEWS

MOTHERS: "Come, Bobbie, you will be late for school if you don't hurry."

BOBBIE (age 7): "There won't be any school today, Mother."

MOTHER: "Why, certainly there will be school."

BOBBIE: "Well, Father said last night that the primary was all burned out."

ANOTHER VERSION

ELIZA: "Where am dat man what used to holler 'bout trains at de deepo, Mandy?"

MANDY: "Why, dat man am de mos' grandiferous radio pronouncer what are."

A STANDING BUY

TEACHER: "If your father bought a sixty-dollar radio set on the installment plan and paid off two dollars a week, how long will it take him to pay it off?"

JIMMY: "Ten years."

TEACHER: "Sit down, you don't know the lesson."

JIMMY: "You don't know my father."

NO MORE ENCORES

SON: "Pa, it says here that WROT was broadcasting phonograph records, but they won't do it any more."

PA: "Why not?"

SON: "It says that last night they broke all the broadcast records."

A BRITISH VIEW

"Everything," says a writer, "will soon be done by wireless." Cats are now eagerly awaiting the advent of the wireless canary cage.—*Sunday Pictorial.*

WRONG ETHER, PERHAPS

Calling up a friend by radio will soon be as easy as calling him up on the telephone. The only difference will be that instead of getting the wrong number, we shall get the wrong wave-length.—*Even.*

PROGRESS IN RADIO

STRAIGHT-LINE CONDENSER

THE number and variety of tuning condensers is becoming legion. In the model shown in the diagram the interleaving plates A and B are mounted on two converging arms C and D, pivoted at E and F. The arms are brought together against a spring S by means of a pair of links mounted on a slide. The latter is moved up or down a screw-threaded spindle by the usual control control knob.

The angular displacement of the arms C-D for a given movement of the slide increases as the slide moves downwards; so that the



Outstanding Characteristics of the

MUTER B Power Unit

FIXED CONTROLS used with separate fixed voltage taps, giving ample range and definite knowledge of voltage received.

CAPACITY ten tubes or seven with a power tube.

RATING 40 mills at 150 volts. Will deliver 130 volts for new type 171 power tube.

CONDENSERS. Muter filter condensers of ample capacity and acknowledged quality ensure long life and uniform output.

Uses Standard Cunningham or Radio Corp. Full Wave Vacuum Rectifying Tube because of long life and stability. Used on 110 to 120 volt, 60 cycle A. C. current only.

No Noise—No Vibration



\$24.50

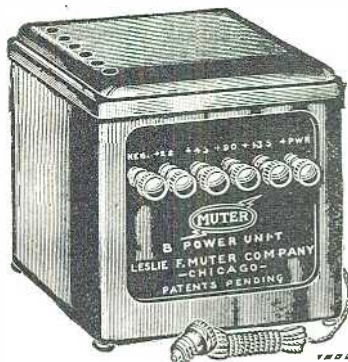

millions may now enjoy the thrill of improved reception with MUTER B POWER

When your favorite radio hour is at hand! That's the time to settle back at ease and appreciate the real joy of clear, true, uninterrupted reception with the new Muter B Eliminator. The Muter Policy of "Dependable quality at a popular price" has brought this enjoyment within the means of every set owner. Convince yourself of the pleasure that can now be yours by an early try out on our liberal guarantee of satisfaction. Model 3000 for 280 or 213 Tube, \$24.50, model 3050 for Raytheon B. H. Tube, \$26.00.

Ask Your Dealer or Send Coupon

Prompt shipment, postpaid will be made upon receipt of price—or C. O. D. plus postage, if you prefer. Make this moderate investment with perfect assurance that of all the enjoyment Radio offers you will find none greater than the difference in reception with Muter "B" Power.

LESLIE F. MUTER CO.

76th and Greenwood Ave., Dept. 827-PX. Chicago, Ill.



*The complete Quality Popular Priced Line
 Send for Comprehensive Catalog*

LESLIE F. MUTER CO.

76th and Greenwood Ave., Dept. 827-PX, Chicago, Ill.

- Send \$24.50 model for 280 or 213 Tube.
- Send \$26.00 model for Raytheon B. H. Tube.
- Payment is inclosed. You pay postage.
- Send C. O. D. plus postage.
- Send me complete Muter Catalog.

Name

Address

City State

Special Library of Information
 on
RADIO PATENTS
 and
TRADE MARKS

JOHN B. BRADY

Patent Lawyer

Ouray Building Washington, D. C.

Cable address:
 RADIOPAT

Telephone:
 Main 4806



Every new radio development is shown in this big catalog, including such hook-ups as the Tyman Ten, 9 in Line, Camfield, Silver-Marshall, Karas, Carter, Aero Coil and numerous others. All nationally advertised radio parts and accessories are listed and described. Everything worth while in Radio now in stock and ready for shipment. Orders filled and shipped same day they are received. Lowest prices given to SET BUILDERS AND DEALERS. Write today for this catalog. WHOLESALE ONLY. Miller-Welles Co., 18-M W. Kinzie St., Chicago, Ill.

Insure your copy reaching you each month. Subscribe to Radio News—\$2.50 a year. Experimenter Publishing Co., 230 Fifth Ave., N. Y. C.

FREE The Greatest RADIO CATALOG

Every community set builder and agent needs this book. Every live dealer in radio sets, parts, accessories, supplies, etc., should have a copy of this bargain wholesale catalog. You will be amazed at the thousands of money-saving radio items illustrated and listed in this store-house of everything you could possibly need in radio.

Radio's Newest Products

The book contains all the latest and most popular kits—all the famous, nationally known radio parts, accessories and supplies—the very newest types and designs of table cabinets and consoles—everything at prices that mean bigger profits for you.

New Radio Kits

We can supply complete kits for any of the popular circuits described in the national Radio magazines; such as, The Stroboddyne, Silver-Marshall Laboratory Model Super, Nine-in-Line, Tyrman 10, Remler Infradyne, Karas, Aero, and many others. In fact our special Radio Kit Book which is combined with our Vest Pocket Edition contains the largest selection of radio kits offered by any wholesale house in the country.

Silver Marshall AC Parts in Stock

630A Kit, Retail Price \$99.00. 652A Kit, Retail Price, \$36.50. Liberal discounts to the trade.

Short Wave Section

Our catalog contains a section devoted to a showing of the highest grade short wave receiving and transmitting apparatus. Also the finest electrical appliances for use in the home.

Large Stocks—24 Hour Service

Tie up with a house that carries large, complete stocks—that gives you the highest quality radio parts—that insures speedy shipments and 100% satisfactory service. Tie up with Shure. Our wholesale vest pocket price list and discount sheet, together with the 1928 bargain catalog will be sent to you on request. **WRITE AT ONCE!**

**Dealers!
Make More
Money**



SHURE RADIO COMPANY

339-C West Madison Street

Chicago, Ill.

**A
Dependable
Dry
Battery Charger**

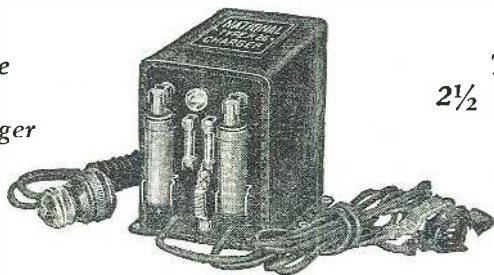

**Gives
Two Rates
2½ or 5 Amperes
At Will**

The NATIONAL R-26 Battery Charger uses two Raytheon "A's" and gives a choice of charging at 2½ or 5 amperes. Now equipped with indicator lamp

and fuses and special resistance. Price, complete with two Raytheon "A's," cord and plug, rubber-covered battery leads and clips, \$19.00.

NATIONAL R-26 BATTERY CHARGER

rate of overlap of the plates A-B is accelerated as the plates approach the closed

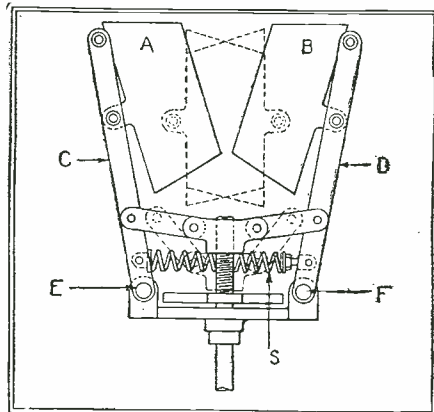

This toggle-joint mechanism is used to obtain straight-line-frequency tuning from rectangular plates in a British condenser.

position. This gives a "straight-line frequency" response in tuning, according to the rule that, as the capacity in the circuit grows larger, the rate of increase for equal angular movements of the operating knob must also increase. This model is covered by British patent 270,020.—*Wireless World*, London.

RECEIVING WITHOUT A "B" BATTERY

A BRITISH patent, No. 270,486, which is a variation of the numerous circuits designed to dispense with the plate "B" battery, has recently been granted to William West Sparey of Warminster, Wiltshire, England. Two tubes are employed, of which the first has its plate connected through a circuit tuned to the frequency of the incoming oscillations to the positive pole of the "A" bat-

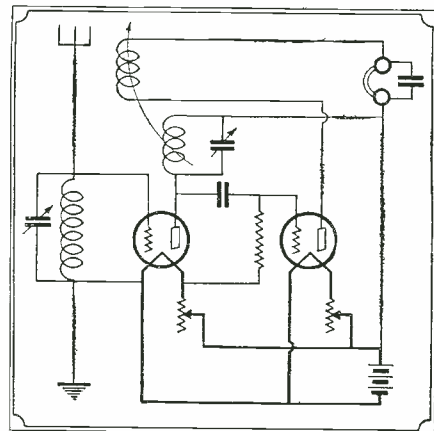

Any three-element vacuum tubes can be used in this circuit, which requires no plate ("B") battery for them.

tery. The second tube has its grid connected to the plate of the first tube through a condenser and to the positive end of the filament of the first tube through a grid leak; its plate is connected to the "A+" through an inductance magnetically coupled to the tuned circuit connected to the plate of the first tube.

This arrangement eliminates the usual plate battery without the use of special tubes; any ordinary three-electrode tubes being employed.—*Wireless Trader*, London.

A FILAMENTLESS TUBE

This invention forms the subject matter of a British patent, No. 266,480, recently granted to Arthur Thomas Masterman, of London. The object of the invention is to provide a form of tube for radio transmission and reception, consisting of electrodes enclosed in a hermetically-sealed receptacle, preferably of glass, containing gas or air

Big FREE RADIO
PARTS, HOOK-UPS, SETS and
Catalog & Guide
BIG NEW 1928 CATALOG—4,000 ITEMS.
Standard discounts to dealers, set builders, agents. Write for free copy.

Barawik Co., 129 N. Jefferson St., Dept. 111, Chicago, U. S. A.

**SAVE 25% TO 60%
on every book you buy**

Write for

**BOOK BULLETIN No. 5
CONSRAD CO.**

230 Fifth Avenue :: New York

under suitably reduced pressure. In these respects this tube resembles the three-electrode tube of usual design, but differs therefrom by the absence of a filament and its "A" voltage supply, and also in the absence of a grid in the usual form.

It is well known that, in a partial vacuum, an electric discharge can be produced between two electrodes, the amount of current and intensity of discharge being determined by the nature of the surrounding gas or gases, the applied electromotive force and strength of the current and the shape and nature of the two electrodes. It is also known that such a continuous discharge can be employed to take the place of the electrons set free from the filament in a two-electrode or rectifying tube; thus making it possible to dispense altogether with the filament and the "A" supply.

Such an electric discharge can be employed, with a suitable device in lieu of the third electrode or grid, for the purpose of rectification and amplification; the device sometimes taking the form of a coil, with or without a soft iron core, suitably located and wound in such a manner as to produce an electrostatic or magnetic field between the two electrodes.

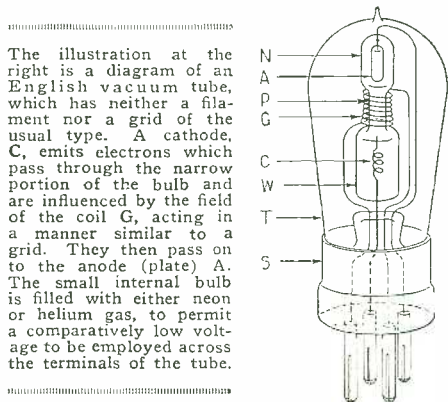

The illustration at the right is a diagram of an English vacuum tube, which has neither a filament nor a grid of the usual type. A cathode, C, emits electrons which pass through the narrow portion of the bulb and are influenced by the field of the coil G, acting in a manner similar to a grid. They then pass on to the anode (plate) A. The small internal bulb is filled with either neon or helium gas, to permit a comparatively low voltage to be employed across the terminals of the tube.

In the illustration, the glass receptacle is of dumb-bell shape, with a narrow end N containing a tubular aluminum or other anode (plate) A, and a wider cathode end W containing a pointed cathode C. These two ends are joined by a narrower portion P, around which is wound the coil G, functioning as a grid. The whole of the structure is contained in an outer tube or envelope T, which is exhausted, and through the base of which the leads from the coil and the plate-voltage leads are joined to a base S, and pins of usual type. This outer envelope is not essential, but serves the purpose of insulation and of preventing access of moisture through the covering of the coil G. The interior of the tube contains neon gas, exhausted to a pressure which for the length of the spark gap selected gives optimum results. The length of spark gap is mainly determined by the size and nature of the coil which it is required to use, according to the function of the tube.

One end of the coil G connects either with the aerial or with the plate of the preceding tube and the other end is connected to ground or to the suitable terminal of the plate-voltage supply, according to its function. The effect of the variations in the electrostatic field and consequent variations in the conductivity of the gas is to vary the plate current and thereby to impress upon the last the modulations of the first. This coil may, of course, form a portion of the aerial circuit, either in series or in parallel, and its effect can be greatly enhanced by regeneration.

By using in the bulb inert gases, such as helium or neon or a mixture of the two, it will operate by means of an applied potential of 150 to 200 volts. By the employment of sodium, potassium or both, for "flashing," a considerable reduction in the voltage re-

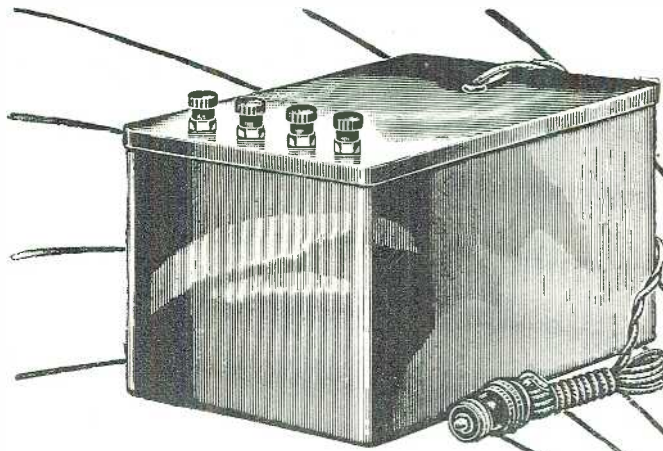

it's the Value behind the price that counts!

Because every part in the Townsend "B" Socket Power Unit is made and assembled in our own factory we can give you a high grade instrument at a surprisingly low price. Now everyone can enjoy wonderfully improved reception, uninterrupted by screeches of fading batteries.

Reports from hundreds of satisfied users prove that the Townsend "B" Socket Power is the most remarkable value in Radio today.

Money Back If Not Delighted

Sold on real guarantee of money refunded if not satisfied. Delivers up to 100 volts on any set, on D, C or A. C.—any cycle. Full tone, clarity and volume.

Approved and passed by the rigid laboratory tests of Radio News and Popular Radio

SEND ORDER TODAY

Simply fill out the coupon and slip it into an envelope with only \$1.00 and mail at once. Your Townsend "B" Socket Power Unit will be sent promptly. Deposit only \$5.85 plus postage with the postman. Try out for 10 days—then if not amazed and delighted with improvement in reception, return it to us and purchase price will be refunded.

Townsend "B" Socket Power

TOWNSEND LABORATORIES
713 Townsend St. Dept. 25
CHICAGO, ILL.



HERE'S YOUR PROOF

Asheville, No. Car.
Your "B" Eliminator is real good, in fact it works better than a \$65.00 Eliminator a neighbor has. Have tried them side by side.

E. V. Stewart.

Havana, N. Dak.

Please send at once one Townsend B Eliminator. Would state this is the third B Eliminator ordered from you and I have given them a very thorough trial. You will note I have returned none. I have used these Eliminator for about seven months, also having three others hooked up ranging in price from \$19 to \$35 and your make has given less trouble and as good satisfaction as any. Without doubt I will order more. You are at liberty to use this letter. I did not write it as a recommendation, simply stated the facts as I found them. I believe it is the best investment the radio fan can make.

C. L. Winn.

Raton, N. Mex.

I have been using your Eliminator every day for about four months. It has been giving perfect service. I have tried several other makes and like yours best.

Jas. D. Smith.

Ankeny, Iowa

I have been using your Eliminator for just six months on 110 volt 25 cycle current and have found results satisfactory

Frank G. Snyder, Jr.

complete
\$6.85
\$1.00 Down
Balance
C.O.D.

Attach Only \$1.00 to this Coupon

TOWNSEND LABORATORIES

713 Townsend St., Dept. 25, Chicago, Ill.

Gentlemen: Attached find \$1.00. Kindly send at once Townsend "B" Socket Power Unit, C. O. D. for \$5.85, plus postage, on guaranteed 10-day free trial.

Name.....
Address.....
City..... State.....

Beautiful 136 Page Wholesale Radio Catalog
FREE to Dealers—The greatest book of radio values ever published. Just off the press. Fully illustrated in colors. **Battery and All-Electric Sets.** New low prices on nationally advertised kits, parts, loud speakers, cabinets, and all accessories. **Sensationally low prices on high quality "A" and "B" Eliminator.** Wholesale only. **Write for this book today.**
HAMILTON-CARR RADIO CORP.
711 W. Lake St., Dept. 175 Chicago, Ill.

New Models of World Record Supers
This receiver has brought in coast to coast reception consistently for thousands of fans. You, too, can secure these marvelous results. Get complete parts and build this receiver according to the Call Book layout. Simple to build. Write for our big catalog describing this and other popular hookups. All parts in stock—ready for shipment.
THOR RADIO CO.
817 Crilly Bldg. Chicago

\$ ONLY 8 (EIGHT)

BRILLIANT NOVELS in Book Form

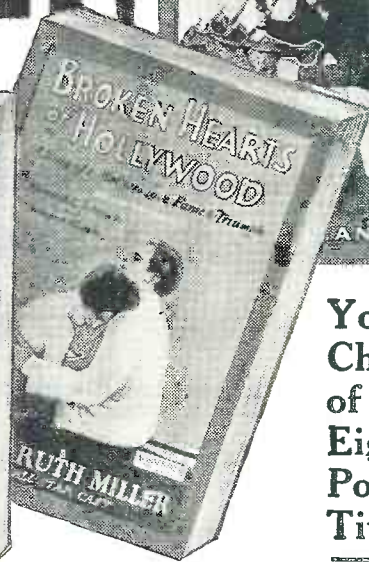
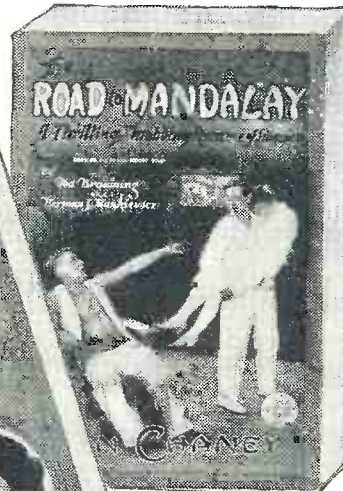

Your Choice of Eighteen Popular Titles

SENSATIONAL BOOK OFFER

EACH story or novel complete in a 144 page 5½x8 book set in large, readable type and profusely illustrated with scenes from the film. Greatest book value ever.

If you have seen the pictures, the fast moving, brilliantly written stories will thrill you. If you read the books first, you will find greater pleasure still in seeing the characters live for you with your favorite stars. Here are many delightful reading hours for \$1.00, for these are not tiny booklets, but large, readable, library volumes.

Below are given 18 titles of which you may choose any 8. Clip the coupon below and enclose \$1.00, mentioning the books you desire, and we will send them to you at once postpaid.

This is the most sensational book offer this season. It may never again be repeated. We expect thousands of requests for these books. Place your order now to insure prompt delivery.

HERE ARE THE TITLES:

- | | | |
|-------------------|-------------------------|----------------------------|
| 1. New York | 7. The Dixie Flyer | 13. The Road to Mandalay |
| 2. Campus Flirt | 8. The New Klondike | 14. Tracked by the Police |
| 3. Almost a Lady | 9. Forbidden Waters | 15. Tell It to the Marines |
| 4. The Love Thief | 10. Sensation Seekers | 16. What Happened to Jones |
| 5. Les Miserables | 11. The Rambling Ranger | 17. The King of the Jungle |
| 6. That's My Baby | 12. Don't Tell the Wife | 18. The Cat and the Canary |

Place Your Order While the Supply Lasts.

True Thrilling Novels and Wondrous Romances of the MOTION PICTURES

AMAZING OFFER

Send your Order in now. Order Books by number.

CONSRAD CO., INC.
230 Fifth Avenue
NEW YORK, N. Y.

CONSRAD CO., INC.,
230 Fifth Ave., New York, N. Y.

Gentlemen: I enclose \$1 for books Number.....

Name

Address

City, State

quired can be effected. The form and shape of the electrodes can also be selected with a view to reducing the pressure, while their material, to give the best results, should be aluminum or magnesium.—*Wireless Trader*, London.

NEW SINGLE-TUBE CIRCUIT

John Stafford Northcote, of 3, Fitzwarren Gardens, London, N. 13, has recently obtained a British patent, No. 268,866, on improvements in connection with the standard single-tube receiving circuit.

The circuit is illustrated in the accompanying drawing, in which V denotes the detector tube. In accordance with the invention, and as shown in the diagram, the ground end of

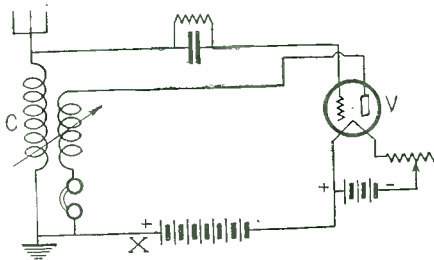

The "B+" is connected to the aerial coil, and thus also grounded. This circuit is said to be more efficient than a standard single-tube regenerative hook-up.

the aerial tuning coil C, instead of being connected to the filament F of the tube is connected to the positive terminal of the plate ("B") battery by the lead X and thence to ground. It is claimed that the efficiency of this circuit is much greater than that of the standard single-tube circuit and the signal strength is exactly the same as that of a detector tube having one radio-frequency (tuned plate) stage.—*Wireless Trader*.

A VACUUM-ENCLOSED AERIAL

A NOVEL form of aerial forms the subject matter of an invention upon which a British patent (No. 271,331) has recently been granted to Charles Edward Thomason, of De Beauvoir Town, London, N.1. It is a solid glass rod with four short arms of glass, fused to each end, similar and approximately of the same length, at an angle of 90° to the rod and from each other. These short arms are serrated for spacing purposes.

In the drawings, Fig. 1 is a plan of the device, and Fig. 2 an end elevation. One complete length of copper wire, covered or bare, is wound over the short glass arms, alternately with the corresponding glass arms at the opposite end. Both ends of this copper wire have to be left protruding at the same end of the glass rod. The unit when completed is inserted into a glass bulb just large enough to accommodate it. The glass bulb has at one end a two-way glass joint. The two protruding ends of copper wire are passed, one through each joint, and fused solidly to the glass, leaving enough wire outside the bulb to make connections. The other end of the glass bulb is then drawn down, exhausted of air and finally sealed.—*Wireless Trader*, London.

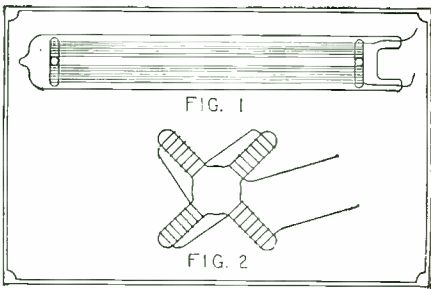

A plan view, Fig. 1, shows the aerial in its evacuated glass tube. Below is an end view of the glass supports for the aerial wires.

What Kind of Voice Has Your Loud Speaker?

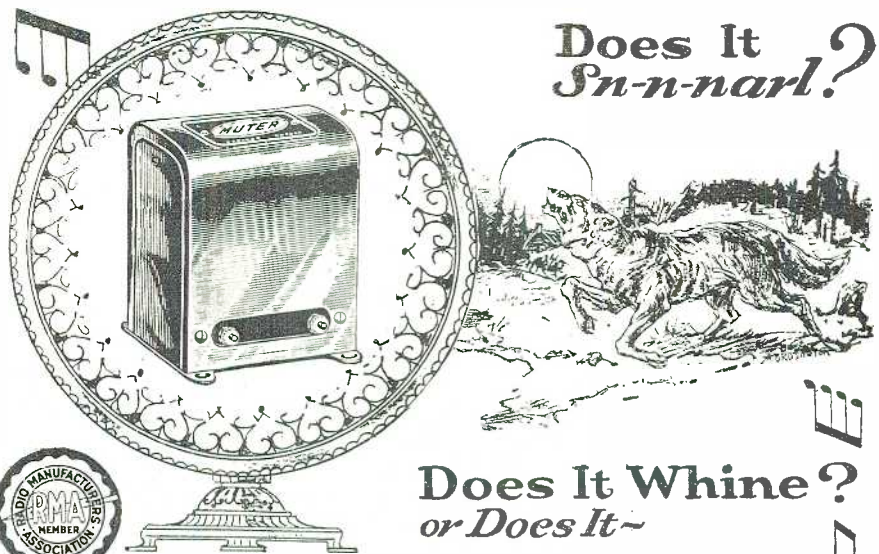

Register Clear, Natural Human Tones? The Muter Clarifier [NEW OUTPUT TRANSFORMER]

on your set will astonish and delight you by immediate, almost unbelievable improvement in reception. In nine cases out of ten that weak, distorted voice issuing from the speaker unit is suffering paralysis from high "B" Voltage. The Clarifier protects Speaker coils from this shattering current, assuring longer life as well as strong, full tone, clarity and volume. If your speaker is one of the great majority that fail to respond properly to the output of the set—you need a Muter Clarifier. It's the only thing that will remedy the cause. Easily attached in a few seconds without disturbing set. Try it out to your own satisfaction on our liberal guarantee—you won't recognize your set!

SEE YOUR DEALER—or SEND DIRECT

Dealers can easily secure Muter Products for you from leading Jobbers. If, however, you have any difficulty in obtaining from your dealer, mail coupon direct to us. Prompt shipment will be made upon receipt of price or C.O.D. if preferred. Give your speaker a chance to produce its utmost. Mail coupon today.

LESLIE F. MUTER CO.

76th & Greenwood Ave., Dept. 827-P CHICAGO, ILL.



DEPENDABLE PRODUCTS

The complete Quality Popular Priced Line
Send for comprehensive catalog



Use This Coupon!
LESLIE F. MUTER CO.
76th & Greenwood Ave., Dept 827-P
Chicago, Ill.

- Send Muter Clarifier at once, postage prepaid. \$5.00 is enclosed.
- Send C. O. D.
- Send complete Muter Catalog.

Name.....
Address.....
City..... State.....

LEARN THE CODE AT HOME

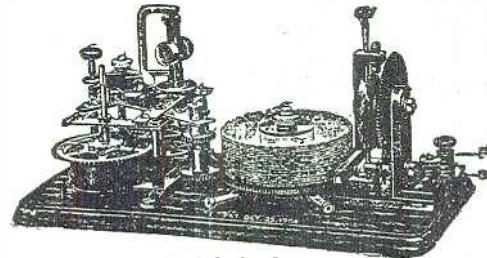

WITH THE OMNIGRAPH

THE OMNIGRAPH Automatic Transmitter will teach you both the Wireless and Morse Codes—right in your own home—quickly, easily and inexpensively. Connected with Buzzer, Buzzer and Phone or to Sounder, it will send you unlimited messages at any speed, from 5 to 50 words a minute.

THE OMNIGRAPH is not an experiment. For more than 15 years, it has been sold all over the world with a money back guarantee. The OMNIGRAPH is used by several Depts. of the U.S. Govt.—in fact, the Dept. of Commerce uses the OMNIGRAPH to test all applicants applying for a Radio license. The OMNIGRAPH has been successfully adopted by the leading Universities, Colleges and Radio Schools.

Send 6c for Catalog
THE OMNIGRAPH MFG. CO.
15 HUDSON STREET, NEW YORK CITY
If you own a Radio Phone set and don't know the code—you are missing most of the fun

Insure your copy reaching you each month. Subscribe to Radio News—\$2.50 a year.
Experimenter Publishing Co., 230 Fifth Avenue, N. Y. C.

The whole COUNTRY

is

praising

AMERICA'S FIRST RADIO ENCYCLOPEDIA



\$2

A place in every home, every library, every laboratory

S. GERNSBACK'S RADIO ENCYCLOPEDIA is the only standard work ever published in America attempting to classify alphabetically the countless words used in the highly specialized science of RADIO. The ENCYCLOPEDIA is written in plain English so that everybody can understand the definitions and descriptions.

No expense has been spared, covering over two years in compilation, to make it worthy a place in your library.

It is published in one volume—168 pages—size 9x12 inches, nearly an inch thick and nicely accommodates the beautiful illustrations and the large, easy to read type.

Every page is replete with illustrations—to make the text easily understandable.

REMEMBER THIS IS A REAL ENCYCLOPEDIA—NOT A DICTIONARY.

The book contains as a supplement a classified cross-index designed to bring together radio references under one heading having relations in common.

All circuits new and old are described by word and picture.

The work contains 1,930 definitions, 549 photographs, drawings and diagrams.

SEND NO MONEY—Just forward your name and address. We will send you the Book at once. You pay postman \$2, plus postage on delivery.

Order Direct from
S. GERNSBACK
230 Fifth Ave., New York

NEW YORK, N. Y. . . . It is the best work of the kind we have ever seen and shows considerable painstaking and laborious effort.—*Telegram*.

NEW YORK, N. Y. . . . The volume amounts to practically a compact review of all that has been done in radio up to this date.—*Radio*.

WASHINGTON, D. C. . . . It presents a complete classification of the latest authoritative data in radio.—*Evening Star*.

SAN FRANCISCO, CAL. . . . A book that will be of value to all that are interested in practical radio work.—*Examiner*.

PITTSBURGH, PA. . . . Many radio fans will be interested in the new Radio Encyclopedia by S. Gernsback.—*Sunday Post*.

PHILADELPHIA, PA. . . . It is a complete classification of the latest authoritative data in radio.—*Philadelphia Record*.

PHILADELPHIA, PA. . . . Mr. Gernsback is author of other volumes on radio and his encyclopedia may be recommended as authoritative.—*Daily Press*.

CHICAGO, ILL. . . . S. Gernsback has aimed to provide not merely a dictionary of radio terms but an actual ready reference encyclopedia.—*Herald and Examiner*.

ST. LOUIS, MO. . . . S. Gernsback's new radio encyclopedia holds all needed facts.—*St. Louis Star*.

ST. LOUIS, MO. . . . This book of radio information is S. Gernsback's radio encyclopedia.—*Globe Democrat*.

MACON, GA. . . . Gernsback's radio encyclopedia fills a demand that has been made by every radio fan as well as technical expert since the industry has started.—*Telegraph*.

DALLAS, TEXAS. . . . This encyclopedia is readily understandable to anyone who reads English and is thorough and readable.—*Sunday News*.

LOS ANGELES, CAL. . . . Its references cover every item of importance relative to the radio industry.—*Sunday Times*.

OTTAWA, CANADA. . . . It is an encyclopedia in the true sense of the meaning and not a mere dictionary.—*Journal*.

NEW YORK, N. Y. . . . The volume amounts to practically a compact review of all that has been done in radio up to this date.—*Radio*.

NEW YORK, N. Y. . . . It is the best work of the kind we have ever seen and shows considerable painstaking and laborious effort.—*Telegram*.

NEW YORK, N. Y. . . . The volume amounts to practically a compact review of all that has been done in radio up to this date.—*Radio*.

NEW YORK, N. Y. . . . It is the best work of the kind we have ever seen and shows considerable painstaking and laborious effort.—*Telegram*.

NEW YORK, N. Y. . . . The volume amounts to practically a compact review of all that has been done in radio up to this date.—*Radio*.

NEW YORK, N. Y. . . . It is the best work of the kind we have ever seen and shows considerable painstaking and laborious effort.—*Telegram*.

NEW YORK, N. Y. . . . The volume amounts to practically a compact review of all that has been done in radio up to this date.—*Radio*.

NEW YORK, N. Y. . . . It is the best work of the kind we have ever seen and shows considerable painstaking and laborious effort.—*Telegram*.

NEW YORK, N. Y. . . . The volume amounts to practically a compact review of all that has been done in radio up to this date.—*Radio*.

NEW YORK, N. Y. . . . It is the best work of the kind we have ever seen and shows considerable painstaking and laborious effort.—*Telegram*.

NEW YORK, N. Y. . . . The volume amounts to practically a compact review of all that has been done in radio up to this date.—*Radio*.

NEW YORK, N. Y. . . . It is the best work of the kind we have ever seen and shows considerable painstaking and laborious effort.—*Telegram*.

NEW YORK, N. Y. . . . The volume amounts to practically a compact review of all that has been done in radio up to this date.—*Radio*.

NEW YORK, N. Y. . . . It is the best work of the kind we have ever seen and shows considerable painstaking and laborious effort.—*Telegram*.

NEW YORK, N. Y. . . . The volume amounts to practically a compact review of all that has been done in radio up to this date.—*Radio*.

NEW YORK, N. Y. . . . It is the best work of the kind we have ever seen and shows considerable painstaking and laborious effort.—*Telegram*.

The Question of Line Voltage

By CHARLES GOLENPAUL*

WHAT is the line-voltage of your house-lighting system? Why 110 volts, of course! But, is it really 110 volts? Have you tried an A.C. voltmeter on that electric supply of yours? If not, then you may be surprised to know that your so-called 110-volt current is anything but 110 volts.

The failure of some radio power units to deliver satisfactory results, particularly in the matters of volume and quality, either part time or full time, may often be traced to deficient line-voltage. Instead of 110 volts or better, the actual voltage available may be only 100 volts, or less. Especially is this true in rural districts, where the transmission lines are long and the voltage is not as carefully regulated as in the more populated sections.

Recently, in order to learn more about the input end of radio power units (and that is the real starting point of socket-power operation), the writer made a survey of various districts around New York. In the cities, he found the voltage usually better than 110 volts, and often as high as 120 and even 122; although during periods of heavy load, such as "dark spells" during the day or again in the early evening when the lights are turned on, the voltage dropped as low as 105. In suburban districts, especially northern Westchester County, the voltage during the day was found as low as 92 on some occasions, but generally hovering around 100, with an increase to 102 or 104 in the early evening, and up to 108 late at night as the lights are turned off in the many homes.

COMPENSATING DEVICES

Now it goes without saying that such voltages are inadequate when operating transformers designed for 110 volts or better. The secondary voltage is very much reduced, because of the step-up ratio of 1 to 3 or 4 and even higher in the case of high-voltage radio power units. Many transformer manufacturers and radio power unit manufacturers fully appreciate the low voltage of most A. C. supplies, and are accordingly providing transformers which operate satisfactorily on lower voltages than the so-called 110. Others, aiming to take care of a variety of voltages that may be encountered, are providing their primaries with several taps, to compensate for lower voltages. Others, again going a step further, employ lower-voltage primaries with a variable resistor in the circuit, to reduce the current if necessary when the line-voltage runs high. A still greater refinement is presented in certain radio power units that are provided with a ballast tube for automatically regulating the input current, irrespective of the voltage.

It will be noted that the usual glow-tube or regulator tube, while it does compensate for fluctuating line-voltage and fluctuating drain on the output end, by holding the 90-volt and the 45-volt taps steady, does not take care of the 135-volt and maximum-voltage taps which supply the amplifier tubes and the power tube. When "C" batteries are employed for the amplifier and power tubes, the wide fluctuation caused by line-voltage variation is sufficient to introduce marked distortion; and even when the grid biasing is incorporated in the socket-power end, there is a tendency to unbalance the amplifier, with subsequent distortion.

AUTOMATIC AND HAND REGULATION

All of this means that the input current should be controlled to compensate for fluctuating line-voltage. The logical place for

* American Mechanical Laboratories.

S. GERNSBACK 230 FIFTH AVE., N. Y.

Send me 1 copy of your Radio Encyclopedia. I will pay postman \$2 plus postage on delivery.

Name

Address

City

State

altering the radio power units to meet various voltage conditions is in the primary, or input end. This may be accomplished by means of a ballast tube, which does the work automatically in maintaining the performance at a fixed standard, or again by an adjustable resistor. The former method has its good points, notably in the automatic-regulation feature. However, there are times when the radio listener prefers to adjust the output voltages as a group for more or less power; in which event the variable-resistor method is preferable.

Many radio power unit manufacturers are now incorporating variable resistors in their products for line-voltage regulation. However, even in the existing radio power unit, without line-voltage regulation as a built-in feature, it is quite practicable to introduce this feature. All that is necessary is to place the variable resistor in one side of the input circuit; and this may be easily done by cutting the conductor cord and inserting the resistor in one lead. A 25-500-ohm power-type resistor is usually employed for this application. While it may be that the existing radio power unit is designed for 110 volts and not much less, still, there is a definite advantage in having a control for line-voltage; since it thus becomes possible to set the output-resistance values for a slightly lower voltage and then regulate the input when it is desired to strike the necessary balance.

In the case of the "A-B-C" radio power unit, the line-voltage regulator should consist of a 0-10-ohm power resistor, shunted by a 4-ohm fixed resistor of the wire-wound, heavy-duty type.

Until the not-distant future, when all radio power-unit manufacturers will probably incorporate a line-voltage-control device in their assemblies, the progressive radio set owner can improve his results and the stability of his outfit by including a noiseless and reliable gradually-variable resistor in the input side of his socket-power device.

THE OLD TIMER

BILL: "Have you had a radio long?"
 BELL: "I've had one so long I remember when we used candles instead of bulbs."

CASABIANCA UP TO DATE

*The boy stood on the sinking wreck;
 He didn't want to go.
 He'd caught a new one on his set;
 Its letters he must know.*

*His father called; he would not flee.
 The water reached his ears;
 And, as he sank, he cried with glee,
 "By Heck, I had Algiers!"*
 —Popular Wireless.

A RADIOPTIMISTAKE



Note the Aluminum Shielding

At the Radio Shows

THIS year's Radio Shows will demonstrate that Aluminum has been adopted for shielding by more of the leading manufacturers than ever before.

This metal is especially effective at radio frequencies and has been accepted as standard by many of those whose names mean progress in Radio.

Aluminum has more applications in radio than any other metal, and is rapidly becoming a mark of quality quickly recognized by the layman.

You will be interested in the exhibit of the Aluminum Company of America, at Chicago, Booth No. CCI.

ALUMINUM COMPANY OF AMERICA

2467 Oliver Building, Pittsburgh, Penna.

Offices in 18 Principal American Cities

"ALUMINUM IN EVERY COMMERCIAL FORM"

\$75 to \$125 Weekly

5 Down Charging Batteries Starts You

Let me show you how to make big money right from the start. I've prepared a FREE book explaining all details. First week's profit pays for all equipment. You can get all the battery charging business in your community with my Service Station Charger—it's years ahead of ordinary chargers—handles 50% to 70% more batteries. I explain everything—start you in a business of your own and put you on the way to big money. Write for FREE BOOK.

C. F. HOLMES, Chief Engineer, Dept. R.N.
 Independent Electric Works
 5116 Ravenswood Ave. Chicago, Ill.

FREE BOOK—Just Out

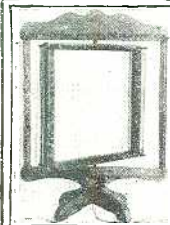

Tune Out With
 SUPER TUNER
VARILOOP

Directional Allocating

Complete and Positive Control
 ELIMINATES All "The Undesireable"

Cuts out undesired stations without changing dial settings. Can be used either as loop or in connection with outside aerial, affording strong signal strength of long antenna with sharp tuning characteristics of loop. For ALL SETS — no changes whatever necessary. Antenna, Tuner and Eliminator combined. Unconditionally guaranteed, order today, \$15 prepaid.

Write for Circular
 FROM YOUR DEALER OR DIRECT
PALMER & PALMER
 404 WEST UTICA ST. BUFFALO, N. Y.

Amazing New Aerial Eliminator

Gets Everything But Static



Fans everywhere are replacing their troublesome and static-gathering aerials with the marvelous new Aer-O-Liminator. Radio Engineers and a myriad of users testify that Aer-O-Liminator brings greater volume without distortion, better long distance reception and freedom from outside noises through the use of Ground Waves.

Says "Cuts Out Static"

R. Curtis of Ill. says "There's no such thing as static trouble since I got my Aer-O-Liminator. I got stations I never got before—so loud and clear I would almost swear they were in the next room." Others report marvelous sweetness of tone, greatly increased volume, surprising selectivity and wonderful freedom from static and winking noise. Simple and easy to install. Takes but a few moments.

Free Trial Make Thrilling Test at Our Risk! Get an Aer-O-Liminator. Leave your aerial up and compare the two any time, connecting first one and then the other. If you are not thrilled and delightfully surprised by the enormous improvement in reception you get with Aer-O-Liminator, the test costs you absolutely nothing. Fill in the coupon and mail at once for complete description and details of Guarantee. Scientific Proof and remarkable Free Trial Offer.

SEND COUPON TODAY!

CURTAN MFG. CO.
154 E. Erie St., Dept. 827-P
Chicago, Illinois

Rush This Important Coupon

Curtan Mfg. Co.,
154 E. Erie St., Dept. 827-P
Chicago, Ill.

Please send me at once complete description of Aer-O-Liminator with details of guarantee, Scientific Proof and FREE TRIAL OFFER.

Name

Address

City

State

Radio "Bugs"

OUR artistic readers have sprung to their pens in answer to our call for sketches of the creatures of Radioland. Not all of them have confined themselves to the elements of the schematic diagram, however; the attempts at pictorial illustration have usually been unhappy, but this illustration

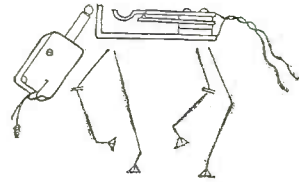

by Clarence Day of San Leandro, Calif., at once commands attention and wins first place in this column.

The shambling resident of This Equine World, explains the illustrator, "is not a jackass; it is just an old plug." The reader's imagination will quickly supply the rest.

We have asked for "personality" in these drawings; if still life can be said to have such a thing, this picture of "My 'Ohm"

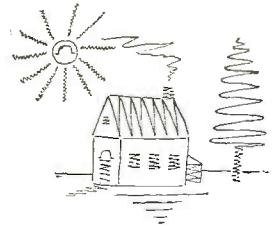

possesses it. We forgive James Hough, of Kittanning, Pa., the pun; and that is extreme leniency on the part of an editor who has just aided in judging any radio title contest and groaned at least five hundred times at the endeavors to rope in the name of the late Prof. Georg S. Ohm.

Many of our radio entomologists have endeavored to portray the features of Ann Tenna, but we have hitherto been always disappointed. However, when we set eyes upon the sketch below, we exclaimed "Tis she!" Here is that coy, studious, retiring spinster in person. Don L. Hale of Phoenix, Ariz., caught the light that lies in her shell-rimmed specs.



"A Detector"

"A Detector," following in the footsteps of the fiendish Dandy Diavolo, or some other great criminal, can be seen here. He does not, however, seem to be gas-filled—unlike some whom we have met. Hugh McBee of Cleveland, O., plays Watson to the Radio Sherlock.

The classic dancer who is striking such a dainty pose is, perhaps, the Spirit of Fading or her impersonator. He, or she, as the case may be (we decline to pronounce authoritatively) is the creation of Fred L. Lipton of Seattle, Wash. A hop and a skip carry us across the country to Norfolk, Va., where W. G. Bailey has noted the appearance of this radio acrobat. The

WORLD'S GREATEST LOUD SPEAKER

UNEQUALLED TONE QUALITY

The ORIGINAL ACCUSTI-CONE

3 FT. DOUBLE CONE SPEAKER

HERE IS THE MOST POPULAR 3-FT. DOUBLE CONE SPEAKER IN THE COUNTRY—You can build it in less than fifty minutes.

We furnish everything in Kit form with free instructions and blue prints. Everybody is building one you can do it, too! and at such a low price. With this the ACCUSTI-CONE original 3-ft. Cone speaker you hear ALL the tones. It brings out the true depth and beauty of orchestral and instrumental music. Truly unequalled in tone quality and the greatest speaker in Radio today. BUY this wonderful speaker, which works on any set, under our "absolute Money back if not fully satisfied guarantee." You will admit after hearing it that it equals any speaker selling today for \$75 or more. Imitators only imitate shape, but not ACCUSTI-CONE quality.

24-inch Accusti-Cone Speaker Kit \$11. Accusti-Cone Speaker Unit Adjustable \$7. Life-time Guar. Speaker Cement 30c. and 50c., Apex Fittings 25c. FON-O-TEX 38 x 38, Alhambra Cone paper 75c., and many other items illustrated in our new free Catalog. Write for one.

SEND CHECK OR MONEY ORDER TODAY
Dealers and Jobbers—Write for Accusti-Cone Attractive Profit-Making Proposition

ACCUSTI-CONE LABORATORIES,
Dept. N
11 N. 7th Street, Philadelphia, Pa.

THE SPEAKER THAT SATISFIES

GREATEST VALUE IN RADIO TODAY

PRICE \$12.50
STAND \$3.00 EXTRA

Before You Buy a Radio Receiver Consult this Book!

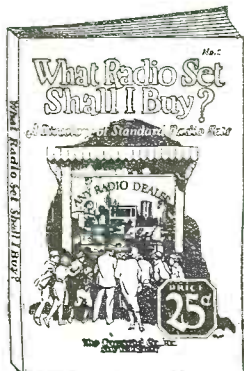

THERE is one easy—simple way to decide on what Radio Set to buy. If you are particular as to the style of the set, the power, the sensitivity, the price, or anything that has to do with a manufactured set you will find a complete answer in the "DIRECTORY OF STANDARD RADIO SETS."

Photographs of all standard manufacturers are shown together with an exhaustive printed description furnished by the manufacturers themselves.

This book is absolutely impartial. It is the only printed book in existence that gives you this information.

40 pages of descriptions and illustrations, size 6 x 9 inches with handsome colored cover.

PRICE 25c

Sold On All Newsstands

CONSRAD CO. INC., 230 Fifth Ave., N. Y.

balancing, we would say, is critical, and there is liable to be a spillover.

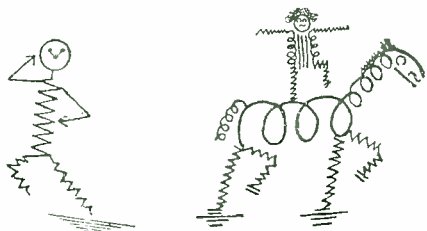

There is still opportunity to send in a few more "Bugs;" but they must be good ones, to appear on these pages—there must be something of life about them, and preferably some humorous turn. For each one printed, \$1.00 will be paid. Address the Jingle Editor, RADIO NEWS, 230 Fifth Ave., New York City.

How to Use A. C. Tubes

(Continued from page 485)

a matter of a few volts up or down will not make a serious difference. The condenser, C, in Fig. 8, is very necessary and should be of at least 1 mf. capacity. The plate current drawn by the detector tube has been disregarded entirely, due to its small value.

Detailed specifications obviously cannot be given here, because of the large number of sets in use; therefore, the judgment of the constructor must be relied upon to a large extent. But, for those following the advice and directions given herein, there will be returns in the way of convenience and reduced operating expense sufficient to pay for the trouble involved.

New QRAs

- 5ADL, W. E. Ivey, Greenland, Ark. 40 meters, 201A.
 - 6DHR, 6DKD, Albert Good, Jr., 212½ West 58th St., Huntington Park, Calif. 40 meters, 15 watts.
 - 6BDO, 6SR, AV3, Ernest R. Cady, Chief Op., Hq. 143rd. F. A., Calif. Nat. Guard, 674 23rd St., Oakland, Calif. 40 meters.
 - 9CBO, C. A. Jenkins, Hazelton, Iowa. 40 meters, 15 watts.
 - 9CGP, Edward A. Timm, 612 N. Walnut St., Plymouth, Ind. 80 and 40 meters, 7½ watts.
- Foreign Calls Heard
- 9APY, F. J. Hinds, 3337 Oak Park Ave., Berwyn, Ill. (August); eg-2K2; nr-2FG; nq-8LO; nm-JJ; oa-2HM, 2SX, 2YI; on-3DAZ (?); REB.

RADIO TERM ILLUSTRATED

A
CRYSTAL
RECEIVER.

W. LENKIOW

Write for Our
Special Proposition
Whereby You
Can Make
**OVER \$100
PER WEEK**
in your spare-time
as our representative
in your locality

Due to the patent situation, now is the time for the Professional Set Builder to make some real money. Write us for our liberal proposition.

A Complete Kit of Parts for the SUPER-HILODYNE CIRCUIT COSTS YOU NOTHING!

If you will build this set according to our instructions and after you have tested same, send us a complete report, with a verified list of Broadcast Stations that you received, we will reimburse you accordingly. Write for complete details now!

The Jewell Laboratories desires to conduct a field test on 100 of these receivers in various sections of the country under actual receiving conditions, for the purpose of obtaining accurate data and logs. This information is very valuable to us and we will be glad to pay you for this service, which should more than reimburse for the cost of the Kit of parts.

This is a bona-fide proposition, with no catch to it. We desire to compile a composite report on 100 of these sets to be used in our laboratories by our engineers, for research work and to prove conclusively that the "Super-Hilodyne" is without doubt the greatest Radio Receiver in the world to-day.

THIS OFFER IS FOR A LIMITED TIME AND IS RESTRICTED TO ONLY ONE SET IN EACH LOCALITY.

<p><i>Six-Tube Hilograd T.R.F.</i></p> <p>Automatic electrically controlled — giving maximum sensitivity and selectivity over the entire broadcast band, unequalled quality of reproduction with all the volume that could be desired.</p> <p>Complete kit with working diagrams \$72.50</p>	<p><i>Nine-Tube "Super Hilodyne"</i></p> <p>True single control with perfect selectivity, unlimited range, unequalled quality of reproduction and all the volume that can be desired. The main feature of this circuit, that puts it in a class by itself, is its ability to work far below the so-called static level.</p> <p>Complete kit with working diagrams \$147.50</p>	<p><i>Jewell Dual Impedance Audio Amplifier</i></p> <p>This amplifier will positively not "Motor boat" even when used with a socket power supply. Its perfect quality of reproduction and tremendous volume without any grid blocking makes it the supreme Audio Amplifier.</p> <p>Complete kit with working diagrams \$27.50</p>
---	---	--

FORWARDED PARCEL POST, PREPAID ON RECEIPT OF REMITTANCE

JEWELL LABORATORIES

"Constructors of Super-Fine Custom-Built Radio Receivers"

126 West 73rd Street New York, N. Y.

"When a station is hard to get, and it is a distant hit, Use a REESONATOR"

Equip your radio with this new instrument. The Reesonator will boost your volume from three to twenty times on distant stations, making it possible to cut thru interference and bring in stations that were infinitely out of your reach before. Made especially for single and two dial radios; Can also be used to great advantage on three dial tuned radio frequency receivers. Decreases A and B battery consumption and can be installed by anyone in less than a minute. **WE GUARANTEE SATISFACTION.**

Try one for three days at our risk; if not thoroughly satisfied your money will be cheerfully refunded. Sent complete and postpaid on receipt of \$4.75 or send C.O.D. Dealers inquiries solicited.

Pat. Pending
IMPROVED MODEL
\$4.75

REFERENCES:
First and Fargo National Banks

F & H RADIO LABORATORIES

Fargo North Dakota

Spartanburg, S. C.

Six or eight weeks ago I bought from you a Reesonator—I just want to tell you that your device is everything you claim. As a matter of fact it would be hard to get along without it. It makes it possible to get stations under the most trying conditions. (Signed) Name on request.



Trademark Reg'd
U. S. Pat. Office

CONDENSERS

Recognized radio engineers have for a long time known the excellence of Tobe Condensers. They have the quality of continuing to function perfectly over long periods of time. Now the Tobe No. 662 high voltage B Block has been selected exclusively by McMurdo Silver for use with the new Silver-Marshall UNIPAC and Mr. Silver has written us the letter reproduced here. Send for price list N-11.

Tobe Deutschmann Company
Cambridge, Mass.

SILVER-MARSHALL, Incorporated



RADIO EQUIPMENT
846 WEST JACKSON BLVD
Chicago, U. S. A.

June 21, 1927.

Mr. W. J. Halligan,
Tobe Deutschmann Co.,
11 Windsor St.,
Cambridge, Mass.

Dear Mr. Halligan:

It is indeed a pleasure to inform you that upon completion of our tests we find that the condenser blocks which you have submitted have proven exceptionally satisfactory and, insofar as we can determine, superior to all other banks which we have tested.

We are particularly glad to be able to standardize upon Tobe Condensers for our future requirements and to recommend them to our customers for, as we believe you are aware, we have had very considerable difficulty in connection with condenser banks manufactured for us by _____ We feel confident, however, that due to the generous rating of your condenser banks that we need anticipate no condenser trouble whatsoever in connection with the various models of Unipac amplifiers which we are now marketing.

Yours very truly,

SILVER-MARSHALL, INC.,

W. J. Halligan

S:0

The Super Hilodyne Circuit

(Continued from page 497)

THE INTERMEDIATE R. F. AMPLIFIER

The object of the radio-frequency amplifier is to magnify any signal that is picked up by the antenna and passed through the tuner, no matter how weak the signal may be. The Hilograd system of untuned radio-frequency amplification (see Fig. 2) is employed in this circuit because of its excellent characteristics, which have been covered in the September, 1927, issue of RADIO NEWS. The advantage of this system of amplification is that there is little danger of cutting any of the side-bands, thereby causing distortion. The amplifier is untuned and performs at maximum efficiency over the whole waveband of broadcast frequencies. Obviously any signal sufficiently strong to actuate the grids of the first tubes will come through with ample intensity to provide a proper amount of current to the detector.

In Fig. 2 the radio-frequency transformers RFT-1, 2, 3 and 4 are untuned and give a high degree of amplification between 220 and 300 meters. Inasmuch as these transformers would have the same resonance frequencies if the resistors, R3, were not in series with the primaries, this amplifier would oscillate and therefore be useless. However, the resistors, R3, are increased to a point just below oscillation; so that the amplifier will operate at maximum efficiency between 220 and 300 meters. As the amplification factor begins to drop off, above 300 meters, part of the current of the plate circuit is fed back to the grid circuits through the radio-frequency chokes, RFC-1, 2 and 3. This current is forced through these chokes and the condensers, C3, to the coils, T, and to the filament or ground. This is true because these chokes have a lower impedance than R3 at the lower frequencies, or higher wavelengths.

It is a well-known fact that the impedance of a choke coil drops as the frequency is lowered; therefore more current will be fed back to the grid circuit in proportion to the drop in frequency. As the coil, T, is coupled through the secondary of the radio-frequency transformer, we have an electrically automatic form of regeneration that compensates for the drop in amplification on the higher wavelengths (the lower frequencies); and thus keeps the amplification factor at its highest point of efficiency over the entire waveband.

Let us consider a signal of 250 meters flowing in the primary of RFT. This signal is led into the secondary, amplified and passed on to the next radio-frequency transformer. As these transformers are in resonance the tube would oscillate but for the resistor, R3, which is increased to a point below oscillation at this frequency. Practically no current is forced back to the grid circuit, as the impedance of the radio-frequency choke is too large to allow a frequency of over a million cycles (a 300-meter wavelength) to pass through it. When once the proper adjustments have been made on R3 and the amplifier is operating at peak efficiency, no further adjustments are needed on this portion of the circuit.

THE A. F. AMPLIFIER

As the detector circuit is conventional we will pass on to the audio-frequency amplifier, in which is employed the dual-impedance system of coupling developed by the writer. This type of amplifier has several notable features. One of these is that, by the combination of the transformer in the first stage, where the signal is the weakest, with the impedances in the succeeding stages, a distortionless and stronger signal is the result. It has been found that the quality

SEND FOR FREE CATALOG

From Chicago's Oldest Radio Jobbers
The Most Valuable Radio Catalog

GREATER BETTER VALUES

WRITE FOR YOUR COPY TODAY SEE WHAT YOU SAVE

WHOLESALE ONLY

New Fits Featured include:
Aero—Bodine
Camfield—Citizens
H-F-L—Infradyne
Karas—Melo
Heald—Scott's
Silver Marshall
St. James—Tyrman
Etc.

Everything new and desired—all under one roof. You don't need to look elsewhere. Complete stock carried.

Est. 1918

TELEPHONE MAINTENANCE CO.
123-M South Wells Street Chicago, Illinois

CHICAGO'S OLDEST RADIO HOUSE

Prompt Efficient Dependable Service

100 AMP. GUARANTEED 2 YEARS

FROM FACTORY TO YOU NO MIDDLEMAN'S PROFIT NO DELAYS NO GRIEF SEND NO MONEY

This is a real 100 Amp. Radio Storage Battery—honestly built of best materials by pioneer battery builders. Solid rubber case—not wood—(nonleakable). Will operate the average 5-tube set from 3 to 4 hours daily for a month to six weeks.

NO DEPOSIT OR ADVANCE PAYMENT REQUIRED

Simply order—and we will ship by express at once and you can examine battery at your express office to your heart's content. If you agree with us that it's the biggest offer ever made—pay the expressman the cost of the battery plus express charges and the battery is yours.

NEW YORK STORAGE BATTERY CO., Inc., 633 West 47th Street, New York, N. Y.

STORAGE BATTERY 6 VOLT - RUBBER CASE

OTHER SIZES IN STOCK

6 volt 60 amp.....	\$6.95
6 volt 80 amp.....	7.95
6 volt 120 amp.....	9.95

Auto Batteries in solid rubber cases. Guaranteed 1 year, but will last 3 years if properly taken care of.

6 volt 11 plate.....	\$9.95
6 volt 13 plate.....	11.95
12 volt 7 plate, Dodge	13.95

IF YOU PREFER TO REMIT WITH ORDER— DEDUCT 50¢

You run no risk as we replace any defective battery during the life of the guarantee. APPROVED by Radio News Laboratory.

ZENTOLA Leads the World in Quality

ZENTOLA is the lowest-priced high quality radio receiving set on the market. Remarkable tonal volume and clarity. Coast to coast reception with unusual selectivity. Cabinet models, 6 and 7 tube, \$29.50 up. Console models, \$42 up. Highest grade walnut cabinet consoles only \$19.50 up. ZENTH "A" Batteries, \$6.95. ZENTOLA quality and price is the big sensation of the radio world. Write for free circulars and our special money-making discounts to dealers and agents.

ZENITH AUTOMOTIVE MFG. CO.
A. S. Sinclair, Mgr. Dept. R, 4416 Olive St., St. Louis, Mo.

Cabinet Model \$29.50 up

of reproduction obtained with an amplifier of this type closely approaches the goal of perfection. The low and high frequencies are amplified with equal intensity for two reasons; first, the use of large condensers and large impedances; and second, as the inductances of the plates and grids are staggered, one being very high and other low, there is little danger of audio oscillations or "motor-boating," even when a "B" socket-power unit is used.

It will be noticed that, in the plate circuit of the detector tube (See Fig. 3), there is a radio-frequency choke coil, RFC4 and a by-pass condenser, C6. These are incorporated in the circuit to keep radio-frequency currents from entering the primary of the audio-frequency transformer, AFT. In the output of the last tube of the audio-frequency amplifier, VT9, is a similar A.F.-choke system, which is employed to keep the high "B" voltage from the windings of the loud speaker.

The volume control is the variable resistor R2 in the tuning circuit (Fig. 1). This serves to regulate the volume of the loud speaker's output and also to control the balancing of the tuner. This system of control prevents any overloading of the radio-frequency amplifier and detector, as well as in the rest of the circuit.

The construction of the receiver employing the Super-Hilodyne circuit is simple, requiring no shielding, delicacy in the placing of the apparatus, or balancing of circuits. It is stable in operation and, after the set is once adjusted, no further demands are made of the constructor.

What Radio Terms Mean

TO bring about greater accuracy in their use, various familiar terms have been accurately defined by the standard-making body in the National Electrical Manufacturers Association ("NEMA"). A recent definition is one covering "distortion."

This is defined as "a change in waveform, as in passing through a circuit or transmission medium. A wave-form may be distorted by (a) the presence in the output of components having frequencies not present in the original wave, due to circuit elements having non-linear characteristics; (b) a change in the relative amplitude of the component frequencies, due to variation in transmission efficiency over the frequency-range involved; (c) a change in the relative phase of the component frequencies. Two or more of these forms of distortion may exist simultaneously."

"Fading" is defined in the NEMA standards as "the variation of the signal intensity received at a given location from a radio transmitting station, as a result of changes in the transmission path."

"Swinging" is defined as "the variation in intensity of a received radio signal, resulting from changes in the frequency of the transmitted waves."

"Attenuation" is "the reduction in power of a wave or a current, with increasing distance from the source of transmission."

"Interference" is "the confusion or reduction due to strays, undesired signals or other causes, also that which produces the confusion."

In the transmitter section of the new edition of the NEMA Radio Standards, a "radio channel" is defined as "a band of frequencies or wavelengths of a width sufficient to permit its use for radio communications. The width of the channel depends upon the type of transmission."

A "band of frequency" is "a continuous range of frequencies extending between two definite frequencies."

A "uni-directional radio finder" is "a radio receiving device which permits determination of the direction (without 180 de-

The AMRAD MERSHON CONDENSER

A thoroughly tested product. It has been used extensively during the past six years by expert radio amateurs for filtering plate supply in their transmitting equipment, which is a very severe requirement. The Mershon Electric Condenser is even better adapted for smoothing "A" and "B" filter circuits used in conjunction with radio receivers.

Made in copper cans of four different sizes, namely, 1½ inch, 1½ inch, 2 inch and 3 inch diameters. The three smaller sized cans are of the single anode type. The 3 inch can is produced in double, triple or quadruple anodes having a maximum capacity of 80 mfd. containing two 25 mfd. and two 15 mfd. units.



Of the several uses the most important are as follows:

1. Connection to any "B" eliminator for improving tone quality of reproduction.
2. For preventing "thumping" or "motor-boating" of "B" eliminators.
3. As the basic unit of capacity in building a super "B" eliminator.
4. For constructing an "A" and "B" power unit.
5. For "smoothing" the plate supply current for amateur transmitters.
6. For greatly prolonging the useful life of ordinary dry cell "B" batteries.
7. For protecting receiving sets from punctured parts or insulation breakdowns when using "B" eliminators.
8. Mershon Electric Condensers may be connected in series, to withstand higher voltages at lower capacity, or in parallel, for larger capacity.
9. For eliminating A.C. "hum."
10. Acts as a reservoir to store energy.
11. To take the "ripple" out of a D.C. Motor-generator.

It is self-healing. If the dielectric should be broken down by accidental over-voltage, a re-application of direct current will shortly restore it. Economically this is of great importance, as when other forms of condensers are punctured, they are useless and must be thrown away. Write for descriptive folder.

The **AMRAD** Corporation
MEDFORD HILLSIDE, MASS.

LEARN RADIO — at Home

"Radio Educator Course" gives complete schooling in Radio—complete in 5 volumes

Want to learn the Theory, Design, Construction, Operation and Maintenance of Radio? These five component parts of a complete Radio Instruction Course are outlined in five volumes that contain not merely the essentials as so many books do, but more; they contain all that any modern up-to-the-minute textbook on

any subject would cover. They are in themselves a COMPLETE radio education teaching every possible portion of Radio science. Size of each book 6 by 9 inches, handsomely bound and illustrated with charts, diagrams, descriptions of equipment, etc. Each volume 52 pages.

SEND NO MONEY

for these books. Just forward your name and address. We send you the books at once. On receipt of same you pay the postman \$1.97 plus a few cents postage and then they are yours.

Published and Distributed by

THE CONSRAD CO., Inc., 230 Fifth Ave., NEW YORK

Better by Far

Than any fixed leak in the detector circuit is the

BRETWOOD VARIABLE GRID LEAK

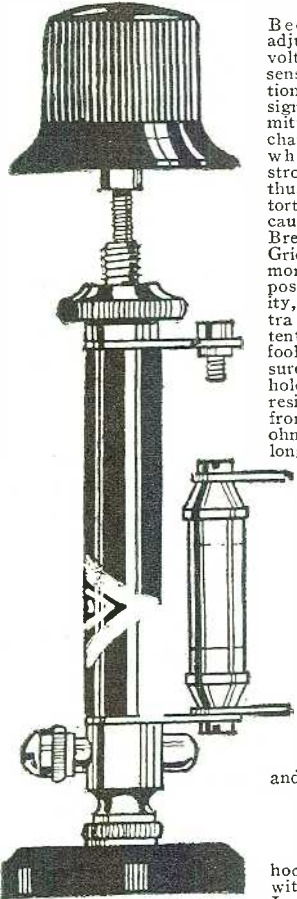

The New Bretwood De Luxe Variable Grid Leak with Condenser Attached

Because it allows adjustment of grid voltage to maximum sensitivity for reception of far - distant signals, while permitting faster discharge of electrons when receiving strong local stations, thus preventing distortion from this cause. Therefore a Bretwood Variable Grid Leak means more miles plus best possible tone quality, without any extra tubes. A patented plastic and foolproof plunger insure permanence in holding any desired resistance setting from .25 to 10 megohms, as well as very long life of the leak itself. As no grid leak can function any better than its grid condenser, be sure that you use a leak-proof Bretwood Bullet Condenser, of mica dielectric, and of .00025 mfd. capacity (another precision product, accurate to plus or minus one per cent.). Get these two parts and also get our

FREE

hookups, supplied with each purchase. Just fill out and mail the attached coupon.

Don't Send a Solitary Cent!

The Bretwood Leak may be baseboard or panel mounted. Works the same in any position. No fluid used.

North American Bretwood Co.,
141 West 45th Street, N. Y. City.

Please mail me at once one New and Improved 1928 Model De Luxe Bretwood Variable Grid Leak (price, \$1.75) and attach one Bretwood Bullet Condenser (50 cents extra), for which I will pay the postman \$2.25 on receipt. Both must be the genuine Bretwood articles, imported from England.

NAME

STREET ADDRESS

CITY..... STATE.....

N-11

grees ambiguity) of waves as received from a transmitting station."

A "radio beacon" is "a radio transmitting station in a fixed geographic location, which emits a distinctive and characteristic signal for enabling mobile receiving stations to determine bearings."

"Observed radio bearings" are "the angular deviation from an arbitrary fixed line, such as the earth's geographical meridian or the fore-and-aft line of a ship, of the direction of the incoming wave as determined by a radio direction finder (without calibre direction."

"Corrected radio bearings" are "an observed radio bearing to which the calibration correction has been applied."

"True radio bearings" are "the angular deviation from true north, at the point of observation, of the chord of the great circle passing from the observer to a given transmitting station."

WHAT IS BROADCASTING?

The layman may find considerable amusement in the fact that the radio industry has recently adopted standards defining the *raison d'être* of practically the entire industry—namely, broadcasting! "Broadcasting" is defined by the NEMA as "the transmission of music, news, entertainment or other intelligence intended for general reception."

The use of socket-power devices is considered also in the new edition of the NEMA Radio Standards, in the battery and socket-power section. Among other standards are these two:

"It shall be standard to mark socket-power devices plainly with the name of the manufacturer, the rating of the primary supply or input in volts, frequency, and amperes or watts. The secondary output rating shall be stated in the accompanying instructions or on the device. It shall be standard to provide an installation diagram or instructions with socket-power devices."

The Reflection and Refraction of Radio Waves

(Continued from page 465)

by using a very sensitive receiver and a loop aerial. The received signal has been tuned-in for its maximum response on different occasions, and sometimes the best results were obtained when the loop aerial was turned at a considerable angle from the position which normally gave best received signals. Upon investigation it has been found that the reason was usually due to a storm between the transmitter and receiver.

RADIO MIRRORS

It is possible for radio waves to be reflected from the surface of conductors; a wave may strike the earth and pass into the atmosphere again and thus again undergo refraction and return to earth. That radio waves are reflected is well known. It is possible to construct a *parabolic* reflector for radio waves of any definite wavelength. The focal distance of the parabola is usually made one-fourth of a wavelength, and the aperture about one and a half, or two wavelengths. The construction of a parabolic reflector is shown in Fig. 3. At the longer wavelengths the size of the necessary parabolic reflector becomes too enormous for practical construction. A 300-meter wave, for example, would require an aperture, or opening in the reflector, of about 600 meters for good directional reflection; 600 meters corresponds to about 1970 feet.

With the shortest waves, in the vicinity of 5 meters (an amateur wavelength), reflectors become quite easy to handle and many of the short-wave enthusiasts are using them for experimental purposes. The reflector



PRECISION Diamond Cut COILS

Type 3B Accurate Because—

1. Spacing between wires always the same.
2. Winding so carefully spaced that lowest distributed capacity is available.
3. The rigidity of the bakelite form assures you that the inductance will be the same five years from now.
4. Each coil is tested individually to within one per cent of the rated inductance, most of them are even more accurate.

Send for new catalogue

PRECISION COIL CO., Inc.

207 Centre St., New York, N. Y.

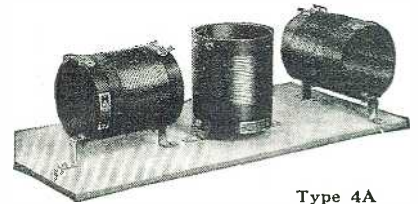

Type 4A

At \$6.00 this famous Cabinet has no equal!

The Blue Ridge Mahogany or Walnut Finish

Dimensions	Prices
7x18x10.....	\$6.00
7x21x10.....	6.50
7x24x10.....	6.75
7x26x10.....	7.25
7x28x10.....	7.75
7x30x10.....	8.25
7x18x12.....	7.50
7x21x12.....	8.00
7x24x12.....	8.25
7x26x12.....	8.75
7x28x12.....	9.25
7x30x12.....	9.75

The Blue Ridge Cabinet is made from best grade birch, noted for the quality and the beautiful finish it takes. Specializing for years in wood-working craftsmanship we are especially equipped to produce cabinets famous for quality of construction and lustrous finish. The Blue Ridge, finished either in gleaming Mahogany or rich Walnut has full length nickeled piano hinge and nickeled lid support, rubber anti-vibration feet and free, non-warping baseboard. Send us your order today. It will be on its way within 12 hours of receipt.

C.O.D. half price with order

All Prices f.o.b. Hickory

12 hour service factory to you

Southern Toy Co. Inc.
Manufacturers Hickory N.C.

A QUALITY CATALOG from a Quality House.

"Good Apparatus Pays"

1928 Catalog listing newest in radio at lowest prices. Cash in on the experience of the engineer-owners of this Recognized Radio House. Dealers, set-builders, agents—write today!

NATIONAL RADIO CO.
6 No. Wells St. Dept. 47 Chicago

PATENTS As one of the oldest patent firms in America we give inventors at lowest consistent charge, a service noted for results, evidenced by many well known Patents of extraordinary value. Book, Patent-Sense, free. Lacey & Lacey, 631 F St., Washington, D. C. Estab. 1869

consists of vertical wires arranged in a parabolic cylinder with the aerial, a single vertical wire, at the focus. The action of the waves is such as to cancel the energy at the rear of the reflector and reinforce it toward the direction of transmission. It is possible, also, to use a reflector for reception and thus build up the received energy, perhaps thousands of times, before applying it to a receiver.

REMARKABLE SHORT-WAVE WORK

With the short-waves, the skip-distance is often thousands of miles and amateurs using small receiving tubes in their transmitters have been able to communicate over tremendous distances. It is evident that the best time of day to receive from a distant point is that hour at which the waves are refracted, down to the receiver, to the best advantage. Amateurs have studied the receiving conditions at various times and have thus been able to determine at which hours there is the greatest possibility of having their transmitters heard in a given community. By using the best hours, communication has been accomplished with very small power; often no more than is radiated from poorly-operated broadcast receivers in the course of receiving a program.

A radio wave consists of vibrations, in two directions at right angles. In its course through the atmosphere, one component may pass more readily than the other and the result is that the wave arriving at the receiving set may be vibrating only horizontally. Amateurs have found, on the short waves, that, if a horizontal aerial is used, much better response is obtained than from a vertical one, even though the original transmitter employed a vertical aerial to send out the wave.

A man on the Pacific coast has heard several European broadcast stations on an ordinary three-tube regenerative set. He used several long horizontal wires, all connected together at their centers, and this lead was brought to the set. In view of the fact that the distance is well over 6000 miles, this is exceptional reception. It is probable that such results are obtained, under the most favorable conditions, when the waves are refracted down in the immediate vicinity of the successful listener.

There is so much research to be done in the study of electric waves yet, that no one can say what the future will reveal; but it is better so, for the radio listener can proceed with hopes that he too will discover some interesting phenomena.

Radio Articles Appearing in NOVEMBER Science & Invention

every month for the beginner, the layman and those who like radio from the non-technical side.

SCIENCE & INVENTION, which can be bought at any newsstand, contains the largest and most interesting section of radio articles of any non-radio magazine in existence.

Plenty of "How To Make It" radio articles and plenty of simplified hook-ups for the layman and experimenter. The radio section of SCIENCE & INVENTION is so good that many RADIO NEWS readers buy it solely for this feature.

Rôle of Wavelengths in Modern Theories of Radiation.

By Prof. F. K. Richtmeyer, Cornell University.

Radio-Frequency Currents Guide Planes to Landing Fields.

Radio "Guard" Watches Water Supply. By Walter E. Burton.

Pacific Fliers Guided by Radio Beacon. Making a Loop Speaker.

By Herbert C. McKay. Static and Thunder Storms—Results of Tests by Bureau of Standards.

Radio Oracle—Questions and Answers.

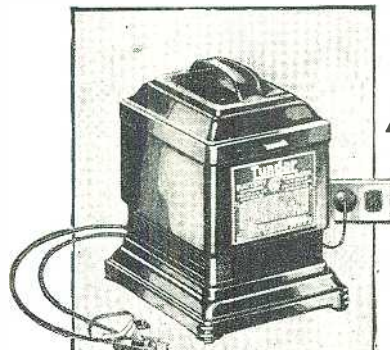

2-ampere Tungar



5-ampere Tungar

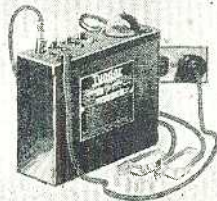

G-E Trickle Charger

New Low Prices (East of the Rockies)

2-ampere Tungar . now \$14

5-ampere Tungar . now \$24

G-E Trickle Charger now \$10

Tungar causes no radio interference. It cannot blow out tubes. An overnight charge costs about a dime. It is a G-E product developed in the Research Laboratories of General Electric. The 2- or 5-ampere Tungars charge 2-, 4- and 6-volt "A" batteries, 24- to 96-volt "B" batteries in series, and auto batteries, too. No extra attachments needed.

Merchandise Department
General Electric Company
Bridgeport, Connecticut

Battery Chargers
made and guaranteed
by

General Electric
now \$10 - \$14 - \$24

When you buy a General Electric battery charger for your radio batteries, you get a thoroughly tested and proved product.

The Tungar [the name of the General Electric battery charger] was developed by a staff of technical experts in the experimental and testing laboratories of the world's greatest electrical organization.

More than 1,000,000 Tungars are in use today. For Tungar long ago established its reputation for dependable, trouble-free economical service.

Just turn on a Tungar at night . . . in the morning your radio storage batteries are pepped up and ready for active duty.

Your dealer can help you. Ask him to show you the popular 2-ampere Tungar that gives both trickle and boost charging rates. It charges "A" and "B" radio batteries and auto batteries, too.



Tungar—a registered trademark—is found only on the genuine. Look for it on the name plate.

GENERAL ELECTRIC

PARVOLT
WOUND CONDENSERS

Stand The Surges
The ACME WIRE CO., New Haven, Conn.

FREE RADIO GUIDE

BIG NEW 1928 CATALOG—4000 items

Shows the latest circuits, the newest developments in radio at startling low prices. Get the parts you want here and save money. The best in parts, kits, complete factory-built sets and supplies. Orders filled same day received. Write for free copy now.

Standard discounts to dealers, set builders, agents.
Barawik Co., 129 N. Jefferson St., Dept. 111, Chicago, U. S. A.

Interested in—

Aviation, Biography, Economics, Education, Engineering, Fiction, History, Mathematics, Languages, Music, Radio or Science

We have hundreds of books covering these fields at actual price reduction ranging from 25% to 60%. Latest up-to-date editions. Regular bindings. All complete and identical to those sold at any bookstore.

Write for Big Book Bargain Bulletin No. 5

EXPERIMENTER PUBLISHING CO., Inc. 230 Fifth Ave., New York, N. Y.

What is a COOKOO NUT?

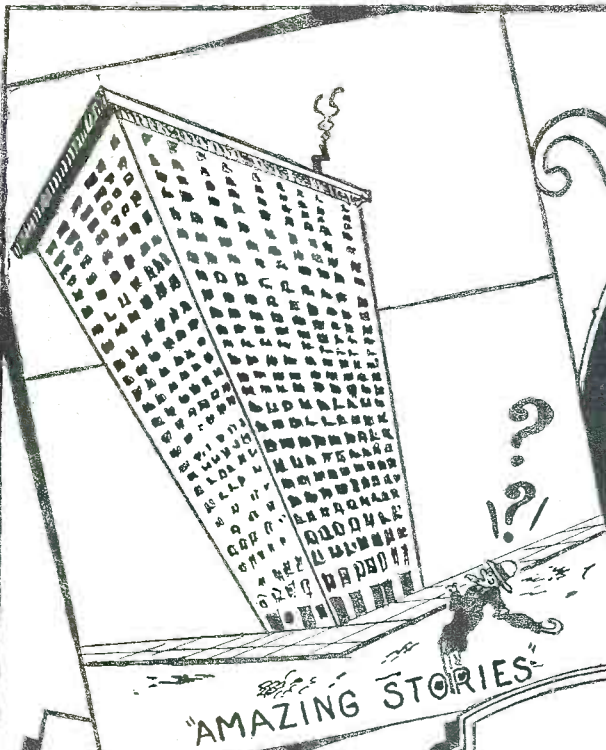

A COOKOO NUT is a new wrinkle to pass away your time. Far more interesting, more entertaining and more humorous than a cross-word puzzle. The COOKOO NUT illustrates an ordinary, well-known saying in a distinctly new manner. Study the examples on this page. The test of a COOKOO NUT is that there must be no question as to the correctness of the description. The quotation must absolutely fit the COOKOO NUT, otherwise it does not go. Cover up the captions of the COOKOO NUTS on this page, and make your friends guess what each COOKOO NUT stands for. An exciting new game is to play COOKOO NUTS at parties where everyone is asked to make up an original COOKOO NUT. The most mirth-provoking one gets the party prize. The best COOKOO NUT printed in FRENCH HUMOR gets a weekly prize of \$5.00. For every other one accepted FRENCH HUMOR pays \$1.00.

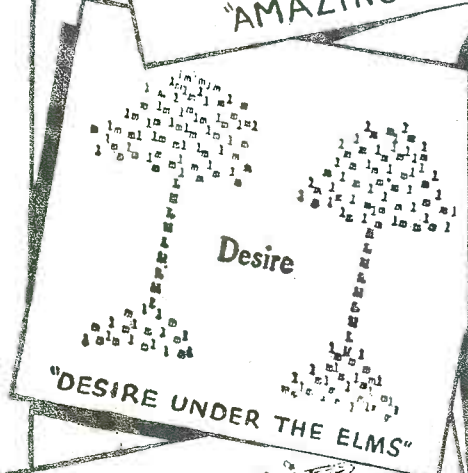

"DESIRE UNDER THE ELMS"



"A SOCK IN THE EYE"



"SWEETIES"

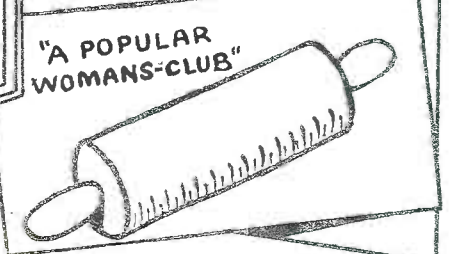

"A POPULAR WOMANS-CLUB"

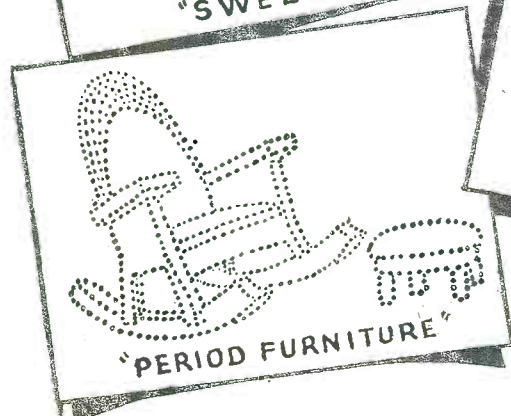

"PERIOD FURNITURE"

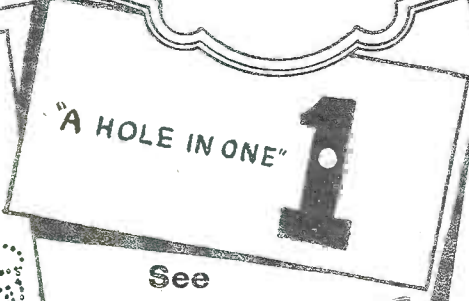

"A HOLE IN ONE"

See

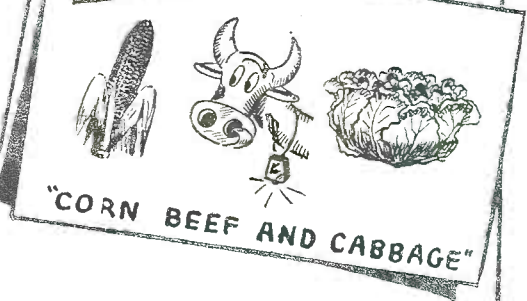

"CORN BEEF AND CABBAGE"

FRENCH HUMOR

France, that magic land of humor, wit, and keen, Knife-edged "parlay," offers humor-loving Americans, its choicest, finest humor through the new weekly magazine, "FRENCH HUMOR." Your first copy of "FRENCH HUMOR" will prove what we

say—hundreds of choice jokes and original illustrations by French Artists, with all the illustrated jokes printed first in French and then in English. It's the funniest, wittiest and most entertaining magazine you have ever read.

10c WEEKLY ON ALL NEWSSTANDS

I Want to Know

(Continued from page 510)

A. Of the vacuum tubes now available for use as detectors in reflex receiving sets, the UX-200A and similar types are the most sensitive. Compared to these the UX-201A tube is not so sensitive when used as a detector tube; although the latter is suitable for local reception and is desirable because of the good quality of sound reproduction that is obtained.

The UX-200A and similar vacuum tubes require a rather exact adjustment of filament and plate ("B" battery) voltage. Should either of these adjustments be incorrect, the tube will be insensitive. Except when there is available a "B" power unit which has a continuously-variable plate voltage at the "detector" tap, it is best to use a tapped "B" battery for the detector tube. (This battery will be referred to as the "D" battery for convenience.) Several voltages, usually varying from 16 to 22.5 volts by 1.5 volt steps, are available by the use of this device.

A UX-200A tube may be adjusted in the following manner: using the lowest "D" (plate) voltage available, adjust the filament of the detector tube by means of its rheostat until a seemingly-distinct hissing sound is heard from the telephone receivers or the loud speaker. If the hissing sound is not heard, the next higher plate voltage should be tried. When the hissing sound is heard, the rheostat should be turned back just enough to stop the hissing. In this connection, the brilliance of the filament of the detector tube is of no significance. The next step is to tune the receiving set to a somewhat distant broadcast station, and then make a final adjustment of the filament by means of the rheostat, being careful not to pass the hissing point as that will result in poor quality. The next step is to raise the "D" (plate) voltage slightly (in the case of the dry battery this minimum change is usually 1.5 volts) and readjust the filament voltage, using the rheostat as before, with reference to the hissing point. Now listen to the broadcast station again and, allowing for fading, observe if the signal strength and quality are improved, or the reverse. In the same manner try all of the "D" voltages available and use the one giving best results. Do not try to make a fine adjustment when listening to very strong signals.

Remember that while many combinations of filament and plate voltages will permit the detector to function to some extent, only one combination will give maximum results and, as the sensitivity of the detector tube controls the sensitivity of the whole set, it is worth while to make these experimental adjustments with care.

When both the filament and the plate voltages are properly adjusted, an increase of either the filament or the "D" (plate) voltage will cause the characteristic hissing sound to be heard. When the proper "D" (plate) voltage for a detector tube has been found no further adjustment of that voltage will be necessary. The detector circuit can then be controlled by adjusting the filament rheostat as the "A" battery (filament) voltage varies. About five minutes after first adjusting the filament voltage for a UX-200A tube, the final readjustment should be made. After this the detector tube will require no attention during the period of listening, except when the "A" voltage is low. This usually indicates that the battery should be recharged.

When a "B" power unit is used the filament voltage for a UX-200A tube should be set at about 5 volts and the "D" (plate) voltage varied until the characteristic hissing sound is heard. Then a final adjustment is to be made as described.

The best average grid condenser value is .00025-mf., and the best average grid-leak value is 1 megohm; although it is worth while to try different grid leaks up to 2.5 megohms.

When a UX-201A tube is used as detector the characteristic hissing sound described above will not be heard. The lowest filament voltage available will be sufficient and a "D" (plate) voltage of from 20 to 30 volts will give best results. With this type of tube, grid leaks varying from 2.5 to 5 megohms should be tried.

The Construction of a Lattice Radio Tower

(Continued from page 504)

The lower end of the tower should be coated with three heavy coats of tar to a height of seven feet. The rest of the tower should be given two coats of paint, allowing the first to dry thoroughly before applying the second. The tower is now ready to be erected.

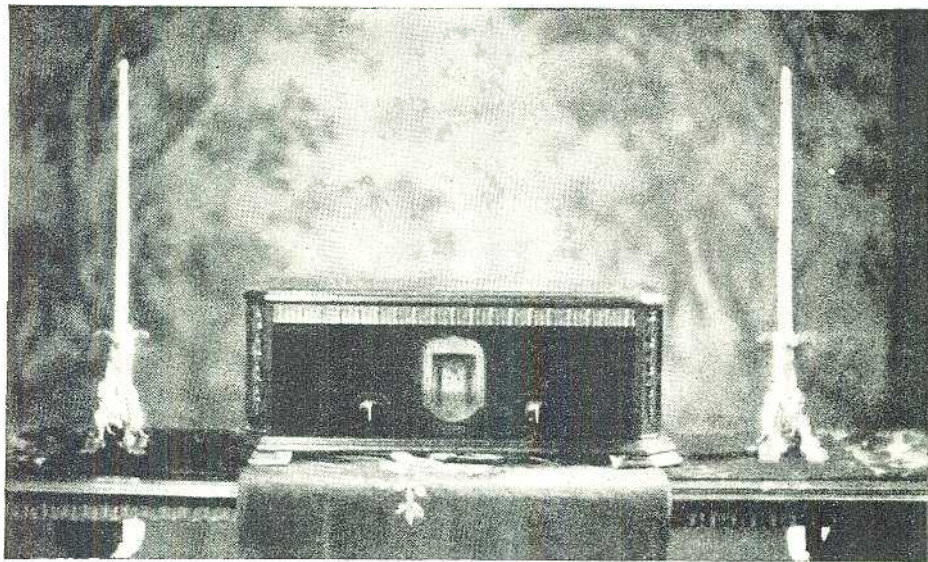

The New Improved Hi-Q Six—the creation of ten foremost American Radio Engineers—a receiving instrument that is far in advance of its time.

Exclusively CUSTOM-BUILT From Our Simple Instructions and at Great Savings!

NO ordinary standards can be applied to this latest improved Hammarlund-Roberts Receiver, for it is the result of a determination to produce America's very finest instrument—absolutely regardless of cost!

Every modern constructional feature has been incorporated. Each part is the most efficient known to radio science, and the entire group has been purposely selected for perfect synchronization.

Complete isolation of four tuned circuits plus Automatic Variable Coupling effects maximum and uniform amplification over the entire wave band. Distortion is totally eliminated. Oscillation is utterly absent. Symphonic transformers

ASSOCIATE MANUFACTURERS
Acme Wire Co. (Parvot)
Benjamin Electric Mfg. Company
Carter Radio Company
H. H. Eby Mfg. Co.
Hammarlund Mfg. Co.
International Resistance Company (Durham Resistors)
Radial Company (Amperite)
Sanston Electric Company
Sungamo Electric Co.
Yarley Mfg. Company
Westinghouse Micarta

and a power tube faithfully reproduce the full musical scale. Selectivity, even in crowded areas is something to marvel at. *And tonal quality simply MUST be heard to be appreciated!*

Such a set, factory made, and sold through usual channels, would cost \$250.00 to \$300.00, but through following our simple instructions you can purchase all parts for only \$95.80 (less cabinet) and build this supreme receiver yourself—a CUSTOM-BUILT set which gives you CUSTOM-BUILT results at a saving of \$100 to \$150.

Get the complete Hi-Q Instruction Book from your dealer—or write us direct. Price 25 cents.



Completely drilled panel and sub-panel are foundation for easy building.



HAMMARLUND-ROBERTS, INC., 1182 Broadway, New York City

LIGHTING FIXTURES
Ready to Hang
Direct from the manufacturer. Completely wired, including glassware. Send for new catalogue No. 28. Just Reduced Prices.
Special Proposition To Dealers.
Erie Fixture Supply Co., Inc.,
Station R. Erie, Pa.

MASSACHUSETTS RADIO AND TELEGRAPH SCHOOL
Trains for the Merchant Marine and positions of importance in Radio
WRITE FOR CATALOGUE
18 Boylston St., Boston, Mass.

JEWELL WRITE
For Our 32 Page
Radio Instrument Catalog
No. 15-C
JEWELL ELECTRICAL INSTRUMENT CO.
1650 Walnut St. Chicago

IMPROVED TURN-IT
Variable Grid Leak (Non-Evaporating)
.5 to 12.6 megohms. \$1.00
If your dealer can't supply you write direct
GARDINER & HEPBURN, INC.
611 Widener Bldg. Phila., Pa.

Insure your copy reaching you each month. Subscribe to Radio News—\$2.50 a year. Experimenter Publishing Co., 230 Fifth Avenue, N. Y. C.

Radio Fans are mailing this coupon



NOW!

—and orders follow by the hundreds!

Hampton-Wright
128 Darmody Building
Indianapolis, Ind.

Gentlemen: I'm interested in this new catalog of unusual radio bargains. Mail one today to:

Name _____
Address _____
City _____ State _____

Everyone interested in radio—dealers, set builders and fans—are finding a wealth of bargains in radio equipment in this new

1927-28

HAMPTON-WRIGHT
FREE CATALOG

of
RADIO PARTS AND
ACCESSORIES

Enthusiastic buyers endorse our merchandise and service. They're finding the best in radio equipment, made by the world's best-known manufacturers, at a price surprisingly low. If you want to see this "Book of a Thousand Radio Bargains," mail this coupon **Now!**

"Keeping Pace with Radio"

HAMPTON-WRIGHT
RADIO PARTS AND ACCESSORIES
DARMODY BUILDING * * * INDIANAPOLIS

FROST-RADIO

De Luxe Apparatus
Frost De Luxe
Variable High
Resistances

Have continuously variable resistance adjustment of liquid-like smoothness. The unique Frost roller contact arm eliminates friction and reveals no wear after tests of more than a million revolutions. Highly polished Bakelite shell, transparent

Bakelite cover, hand-buffed nickel plated metal parts. Two or three terminal type, less switch, \$1.75. With switch, \$2.10. Your dealer has them—see him today.

HERBERT H. FROST, INC.
Main Offices and Factory: Elkhart, Ind.

ERECTION

Fasten three guys at the top joint, and three more at a point a little more than half-way up. The guy wire should be separated every 15 feet by strain insulators. It is best to fasten the wire to the tower by actually wrapping the wire around the legs, rather than by using hook-eyes, which have a tendency to cut the wire. The wire will last much longer if it is coated with some heavy oil to prevent premature rusting.

The tower is raised by using a 20-foot gin-pole and tackle. This pole must be thoroughly guyed and anchored at a point at least six feet away from where the tower is to rest. The tackle should be fastened to the tower at a distance from the bottom equal to the height of the gin-pole plus the depth of the hole. At least eight assistants should be secured for the lifting job; in fact, the more, the better. Have several hold the side guys to prevent the tower from swinging as it goes up. At least two should be at the base to guide the tower into the six-foot hole. It is advisable, during the process of erection, to keep a prop under the tower as it is going up, to prevent a sudden fall if the tackle breaks. When the tower is nearly perpendicular the guys should be fastened all around, and then adjusted so that the tower is perpendicular. Fig. D shows this part of the erecting job. The hole may now be filled with concrete or a mixture of stones and earth. When the base is firm it will be found that the tower will stand without guys; but leaving off the guys is undesirable. The guys should be anchored to a firm support and tightened. After everything is firm the tower may be climbed and the tackle removed.

MAINTENANCE

If the construction of this tower has been properly performed it will be found that very little care will be needed. Every now and then, the guys should be tightened and watched for deterioration. If the rope for the pulley is boiled in raw linseed oil, or coated with tar, it should last for many years. An occasional coat of paint on the tower will improve its appearance and, at the same time, will help to preserve it.

What Every Station Wants—Applause

(Continued from page 478)

There was no prior announcement of the offer and it was made only after every series of numbers on the program. The night wasn't especially good, and the station did not get out as well as it often did; but the offices were swamped with mail for the next ten days. The cost of the samples ran into the thousands.

Of course the satisfaction the owners gained was worth the price, at least for once a year, but not every night. Yet that station would like to know, every morning, just how many people listened to them the night before and what they really thought of the program. It would be helpful in balancing the entertainment if for no other reason.

DOES IT PAY?

Now we come to a different class of station. It is one selling time on the air—a perfectly legitimate undertaking—either for profit or for actual cost, to the end that desirable features may be obtained. When the commercial manager goes to the head of the city's largest department store and offers him the air, at say \$400 an hour, what kind

Exclusively Licensed by Technidyne Corporation under U. S. Patent No. 1593658, July 27, 1926.

Specified by Experts

ELECTRAD

ROYALTY VARIABLE HIGH RESISTANCES

To obtain the best results from your set, insist on the Variable High Resistances of proven accuracy and dependability.

Electrad Royalties are the choice of radio experts because of such superior, exclusive features as:

- 1—Contact made positive by metallic arm on wire-wound strip.
- 2—Same resistance always obtained at the same point.

A range for every purpose—11 in all. Type E \$2.00. All other types \$1.50.

Write for Free hook-up circular

Dept. 48B, 175 Varick Street, New York, N. Y.

ELECTRAD

Pure Tone

The ingenious TELEVOCAL SUPPORT eliminates squeals and rasping noises and prevents shorting in Televoctal Quality Tubes. Tested, balanced and proven perfect by technical experts before leaving the factory. A Televoctal tube for every radio need—each backed by our unconditional guarantee.

If your dealer cannot supply you, write us, sending his name.

TELEVOCAL CORP'N
Televoctal Bldg.
Dept. A-3, 588-12th St.
West New York, N. J.

TELEVOCAL QUALITY TUBES

RADIO AGENTS

Make Big Money

EASY to sell American Radios and Supplies. Nationally advertised, high quality merchandise at wholesale. Big profit on every sale. No capital to invest. No stock to carry. Order direct from my huge warehouses as you sell.

Get My Liberal Offer and also Big New 132-page Catalog and Guide—"How to Sell Radios"—Free. Full of Bargains—all latest in Radio. Write today.

AMERICAN AUTO & RADIO MFG. CO.
HARRY SCHWARTZBERG, PRES.
Dept. 106 American Radio Bldg., Kansas City, Mo.

BIG BARGAIN CATALOG

Insure your copy reaching you each month. Subscribe to Radio News—\$2.50 a year. Experiment Publishing Co., 230 Fifth Ave., N. Y. C.

of audience can he guarantee? As it is, he cannot make any guarantee. He can only say that there are 250,000 listeners in the area that he serves with dependability. Therefore, his sales are fewer and those that are made come only after the greatest effort.

Suppose you were offered time on the air. Would you hurry to buy a "cat in a bag" out of your fixed advertising appropriation? I don't think so. Remember that, after you buy the time from the station, you must buy your entertainment and, before you get through with it, there is real money gone into the venture. And if you go on the air weekly, when the end of the year comes you will have used quite a sizable appropriation.

Given definite figures as to the audience and furnished with so many thousand expressions from your listeners after each program, you would feel that radio is worth while. Then you would provide the best entertainment that you could find, lest there be any reflection upon your organization. There is where Mr. and Mrs. Broadcast Fan will profit. More and better programs!

NATION-WIDE ENTERTAINMENT

Then there is the time-seller of the United States Broadcasting Co., which either owns or controls a chain of twenty stations and feeds programs out through the gold and silver networks. He calls on Mr. Sanford, president of the Super-Eight Motor Co.

"Mr. Sanford, I'd like to offer you the facilities of our stations in a way that, I believe, will put sales of your motor cars three jumps ahead of the Royal Flier," says the time-seller.

"I can furnish you an audience of five million every time you go on the air and everyone is a potential customer. Radio is in the best homes, where they spend money. They own motor cars and are always buying them. Create through the radio the right atmosphere for your car and your sales are made."

"Well, I have been thinking of using radio," Sanford replies. "I have given it much thought, but have become dubious. You will have to convince me otherwise. You'll see I have been studying the question. How do you know how large your audience is? How do you know they listen to you every night? Are your stations popular? Why—I have a neighbor who is always complaining about Station WXYZ muddling up the air and spoiling his reception."

"I would like to take a chance with you, because I've always had a hankering for the thing, but I'm not convinced. I won't buy time on the air unless I know what I am getting. When I place advertising in newspapers and magazines, I insist on the A. B. C. circulation reports; and we key our copy to check the response. We know what we get, beyond any doubt. Can you give me that sort of service with radio?"

Station
WRNY
NEW YORK
309 Meters—970 Kilocycles
is owned and operated by the publishers of this magazine
Our Editors will talk to you several times every week—
See your Newspaper for details
TUNE IN ON WRNY

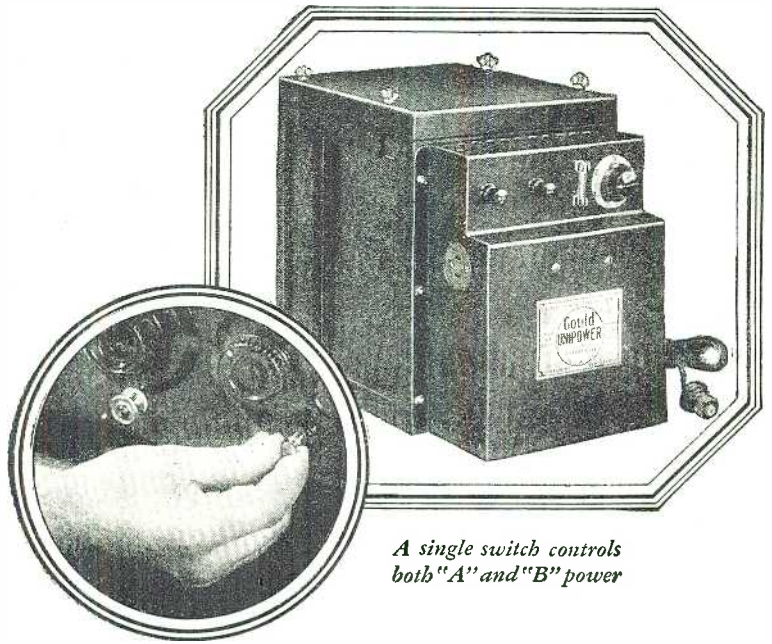

A single switch controls both "A" and "B" power

The Last Word in light socket "A" power

The main difference between a costly batteryless set and your old radio equipped with a new Unipower is the cost—and that's in favor of Unipower.

THE new Gould Unipower puts the convenience of the most expensive batteryless set within reach of all—at a fraction of the cost. It supplies rich, unfailing "A" power that is automatically replenished from the light current.

Time-tested principles of design are embodied in the new Unipower. But in addition it contains a striking advance in battery practice that makes this economical form of "A"

power equal in most and superior in some ways to costly batteryless sets. This new exclusive feature of Unipower is the Gould Kathanode assembly. With it, care is reduced to a minimum; service expense is practically eliminated; and richer, smoother power is attained. There are no tubes to replace, and it is practically fool-proof.

A demonstration at your dealer's will show how the new Gould Unipower brings your set up-to-date, equal in convenience and performance to costly batteryless models. The Gould Storage Battery Company, Inc., 250 Park Avenue, New York City.

The New
IMPROVED **Unipower** Price \$35
A GOULD PRODUCT Upwards

1000 HOURS---of the Best Fun You Ever Had—Get Your Copy of

SAM LOYD'S TRICKS and PUZZLES

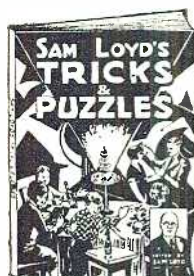

The year's most unique book, contains 120 pages that are crammed full of all kinds of tricks, puzzles, games, conundrums, etc.

Size 9 x 12 inches—illustrations on every page. Fun for every member of the family.

50c On All Newsstands

EXPERIMENTER PUB. CO., INC.
230 Fifth Avenue New York, N. Y.

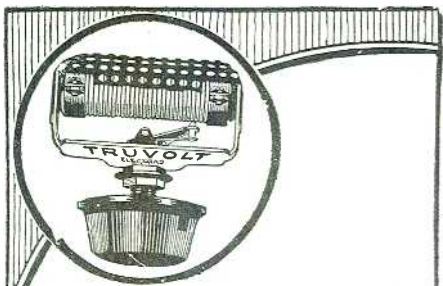

Constant Accuracy!

TRUVOLT

An All-Wire Variable Voltage Control

Install Truvolt in your B-Eliminator and vary your voltage exactly. A new type wire variable high resistance kept cool by its greater radiation surface—like an air cooled motor.

Develops but 1/2 the temperature of other resistances of like size; hence is permanently accurate and lasts indefinitely. Positive metallic contact always, and 30 exact readings of resistance.

Eight stock types with resistances up to 50,000 ohms. All rated at 25 watts. List \$3.50 each. At your dealers.

Also a full line of Wire Fixed Resistances

Dept. 12B, 175 Varick Street
New York City

Write for free circular

"This is an Eliminator Year"

ELECTRAD

TRANSMITTING APPARATUS

A Complete Stock at "Chi-Rad"

In addition to our regular broadcast apparatus we carry a very good stock of transformers, chokes, grid leaks, high test condensers, etc., for transmitting purposes.

NEW SHORT-WAVE COILS

Specially built by "Chi-Rad." Write for descriptive bulletin and catalog. Dealers and set-builders please use business letterhead when writing for discounts.

Chicago Radio Apparatus Co.
415 S. Dearborn St., Dept. RN, Chicago

And of course the commercial manager of the United States Broadcasting Co. is up against it. He can say that, one night last week they offered a big feature and as a result received 15,000 pieces of mail; that their average daily mail is possibly 1,500 letters. But that isn't sufficient. The buyer of time wants more for his money, and he wants to know, day by day, what he is getting.

ENCOURAGING THE SPONSORS

That brings us back to the million-dollar idea. If someone can evolve a system by which the listener-in can be persuaded to drop a postal card every morning to those stations he enjoyed the evening before, then that idea ought to be worth the million and the possibilities that will be opened are almost unlimited.

The system must be clean, of high standard, and not linked up with any general distribution of prizes. Anyone can buy applause if he is willing to pay the price; but that would not bring the really sincere report that is desired by the broadcaster and advertiser alike.

If Mr. and Mrs. Broadcast Fan can be brought to feel that they owe the station an obligation to write, after enjoying the evening's entertainment, the problem would be much simpler. As yet, however, that has not come about; but it is what I would like to see.

If Mr. and Mrs. Broadcast Fan would only stop a moment and reflect! Applause means air time is "pulling" and commercial stations will have something of a known value to sell. Big organizations will be scrambling to get time and outdo each other in the lavishness of their entertainment to win popular approval.

With such competition the listener will always be assured of the best that can be given him—all on the twist of a dial at the arm of his favorite easy chair.

New 50-kw. Transmitter of WEA F

(Continued from page 463)

At one side of the transmitter room the rectifier, which supplies plate power for all the three-element tubes, is located. This is a relatively small frame, mounting six water-cooled rectifying tubes; but it is capable of delivering 12 amperes direct current at 15,000 volts, corresponding to a power of 180 kilowatts.

The power board of the station is similar to that of a good-sized electric substation, with the same circuit breakers, meters, relays, signal lights and controls. The equipment for starting and stopping the various machines and energizing the different frames is located here.

OPERATING CONTROL

Once the station is running, however, it may be taken off the air instantly by a small tumbler switch on the operator's control unit, which is placed on a table in the middle of the room. This table holds also the 600-meter receiver and a loud speaker always in service on marine wavelengths. An operator always sits at the table; and, should an "SOS" call be picked up, he immediately takes the station off the air after a covering announcement. If a modulator or amplifier tube should break down in operation, the operator is also in a position to remove it from the circuit and energize a spare unit by throwing two tumbler switches on the control unit. These actuate large solenoid-operated switches which perform the operations required. Such automatic controls, while complicated and costly, insure the con-



The 4th and Greatest edition of RADIO NEWS AMATEURS' HANDBOOK

HERE is the greatest Radio Handbook ever published! Right up to date—a brand new edition of the very finest selected articles that have appeared in RADIO NEWS, Radio's Greatest Magazine, this year.

All new Radio—Plenty of latest model circuits with blueprint diagrams, ready for building. This is the most popular Radio Book ever printed. The past three editions were completely sold out.

—And now we offer the biggest and best edition of them all—116 pages of 1927 Radio complete with elaborate circuit diagrams and illustrations and parts. Size 9x12 inches.

Copies are going fast, get your order in now—or see any news-dealer.

50c ON ALL NEWSSTANDS

If your newsdealer cannot supply you use coupon below.

EXPERIMENTER PUBLISHING Co., Inc.
230 Fifth Ave., New York

EXPERIMENTER PUB. CO., Inc.
230 5th Ave., New York, N. Y.

Gentlemen: I enclose 50c. for one copy of the new 1927 AMATEURS' HANDBOOK.

Name

Address

City, State

tinuity of service which is vital in such a plant.

Near the radio-frequency amplifier, in one corner of the room, is located a huge, hollow-plate condenser standing well above the height of a man's head, and variable by means of a motor. This, in conjunction with an equally large pair of flat spiral inductances, constitutes a 610-kilocycle "tank" circuit which delivers the modulated radio-frequency energy to a transmission line, running some 30 feet out to a small tuning house directly under the antenna downlead. This line operates at a potential of 5,400 volts, but is designed for a 610,000-cycle carrier, with its two program-bearing sidebands, instead of the usual 60-cycle current of commercial power circuits. The line is terminated in some further tuning equipment (variable from the main power board of the station) to effect the transfer of the radio-frequency energy, with its burden of music and voices, to the antenna, which flings it into space.

In the basement of the new WEA-F transmitting plant are found the transformers which step up the 2,300-volt power supply to the high voltage required to feed the rectifiers, the "reactors" which smooth out undesired variations, the speech reactor coupling the 50-kilowatt amplifier with its modulator, and the rotating machinery of the station. The latter includes the three 25-kilowatt filament motor generators, four 3-kilowatt plate motor generators, two 0.55-kilowatt biasing motor generators, and, in a separate room, the pumping equipment for the water-cooling system. There is also a storage-battery room, heating equipment, and a vault for spare tubes. The basement of the station, with its heavy cement blocks and ponderous machinery, looks like a power plant—and sounds like it. The transformers emit their characteristic threatening drone, and the generators run with a higher-pitched and louder noise. It is hard to realize that here energy in its primitive form is being converted into the subtle and intricate inflections of human thought and emotion, in instantaneous and accurate obedience to the performance in the studios, thirty miles away.

CONSUMPTION OF POWER

The amount of energy used to light the filaments of the tubes in the transmitter would supply enough current to operate the filaments of 200,000 199-type tubes, or approximately 50,000 of the average dry-battery receiving sets now in use.

The amount of electrical energy used to supply the plate circuit of this transmitter would provide sufficient plate current for 550,000 199-type tubes.

4,000 gallons of distilled water pass through the tube-cooling system during each hour of operation.

The plant is, perhaps, the only one of its kind in the country to hold a license for the operation of a "still," which is used to distill the water for the tube-cooling system.

The programs from the Manhattan studios of WEA-F travel to the new transmitter via the New York telephone circuits, passing through three "repeater" (amplification) points, the Prospect, Jamaica and Lynbrook exchanges.

The two antenna towers are painted in 12-foot bands of alternate black and yellow. Both towers are illuminated by flood-lights, principally to serve as a beacon for aviators.

Specifications for the entire plant were drawn up by Dr. Alfred N. Goldsmith, chief broadcast engineer of the Radio Corporation of America; Dr. E. F. W. Alexanderson, consulting engineer of the General Electric Company, and Frank Conrad, consulting engineer of the Westinghouse Electric and Manufacturing Company.

The floors, ceilings, walls and windows of the entire plant building are double-shielded with built-in copper screening.

The entire installation represents a cost of approximately half-a-million dollars.



RADIO ACME UNITS

"ACME" means that you receive PEAK PERFORMANCE from the day you start to use one of these POWER UNITS



"A & B" Socket Power Unit

The Acme "A & B" Socket Power Unit delivers 180 to 200 volts at 60 to 80 milliamperes! It operates with and improves the reception of any set made.

It's all in one compact cabinet—always ready at the touch of the switch. No hum—no distortion—giving you that strong flow of constant, dependable A & B Power.



B Power Unit

As safe as it is satisfactory to use—a permanent servant that will save you all the trials and disappointments of the past. Very simple to install.



Acme Automatic Control Switch \$3.75

TYPE AB-1-R, 40 mills. at 180 volts, only \$67.50 East of the Rockies. Built for six to eight tube sets and Radiolas.

TYPE AB-2-R, giving 60 to 80 mills. at 180 to 200 volts, only \$72.50 East of the Rockies. Very efficient on sets with any number of tubes.

Ask your Acme Dealer why the Acme Line gives such Peak Performance. He will tell you it's due to the exceptionally fine Engineering Skill back of the entire Acme Line! Big Value—Permanent Operation.

Sold by leading Jobbers and Dealers throughout the country.

ESTABLISHED IN 1917

NEW ACME PRODUCTS

Ask us about the new Acme PEARL-O-CONE SPEAKER. Lists at \$17.50. See your dealer on our special B Unit using the new UX 280 Tube, and our A & B Unit, 180 volts Dry Rectifier with new UX 280 Tube. Also our new dry Automatic Charger with relay at \$17.50.

COUPON

I AM INTERESTED IN YOUR

- A & B Socket Power Unit
- Automatic Control Switch
- Pearl-O-Cone Speaker
- Universal B Power Unit
- New Special B Unit
- Acme Trickle Charger and Control Switch
- New A & B Unit 180 v. Dry Rectifier
- New Dry Automatic Charger

Send me prices and the name of your nearest dealer.
Name
Address

Our New Literature is ready—send for it

THE ACME ELECTRIC and MANUFACTURING COMPANY.
1412 Hamilton Avenue
Cleveland, Ohio

GEARS

All kinds—Small -

The most accurate made and prices reasonable. We carry a complete line of gears in stock for immediate shipment. Can also quote on special gears of all kinds. Send us your inquiries. Write for Catalogue 40 Chicago Stock Gear Works 105 South Jefferson St., Chicago



Lucas Spring Binding Post

A Spring Binding Post unequalled for service and simplicity, requiring but a press of the finger to make necessary connections giving you satisfaction unexcelled. Seven posts to a slab. Marked or plain. Single 10c. Double 15c. Manufacturers, Dealers and Jobbers write for prices.

JOHN LUCAS & SONS
654 N. Talman Ave., Chicago, Ill.



ELKAY EQUALIZERS

and Suppressors are made by The Langbein-Kaufman Radio Co. (Dept. N), 62 Franklin St., New Haven, Conn. Write for prices and tables of values.



FREE RADIO GUIDE

Big New 1928 Catalog—4,000 Items Gives special hook-ups with illustrations. Shows big savings on standard radio parts, complete sets, kits. Be sure to get this thifty book before you buy. Write letter or postal NOV. Standard discounts to dealers, set builders, agents. Barawik Co., 129 N. Jefferson, Dept. 111, Chicago, U. S. A.

LATEST HOOK-UPS

FRESHMAN EQUAPHASE

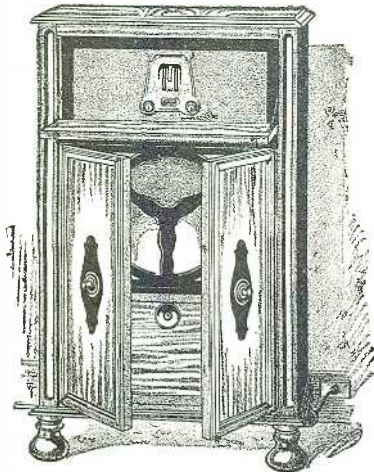

THE ELECTRIC RADIO

Always Ready
Always Right

10 acids
trouble
batteries
water
excuses
makeshifts

Model G-7, genuine mahogany cabinet, large built-in cone speaker, a handsome piece of furniture
\$185
Complete—ready to operate

Sold on Convenient Terms by
Authorized Freshman Dealers

The AIRGAP SOCKET

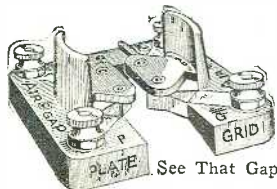

"It gets that last mile"

See That Gap?

THE GAP has the effect of omitting the socket entirely; it creates a higher resistance path between grid-plate terminals, decreasing high frequency losses, preventing feedback and intercoupling through and over the socket body, making the circuit more easy to stabilize and control, cause your set to go into oscillation more smoothly and not "spill" over until maximum results are obtained.

At Your Dealers or Direct
Postpaid 60c

Dealers and Jobbers write us

AIRGAP PRODUCTS CO.

56 Clinton St.

Newark, N. J.

Burnt-Out-Tube Contest

(Continued from page 471)

A flexo-coupler, such as called for by the Interflex circuit, built into the base of a vacuum tube and submitted by T. Shimizu of Los Angeles, Cal., was awarded eighth prize. The contents were removed from the base of a tube and a single-layer coil wound on the outside. The base of another tube was cut off, $\frac{1}{8}$ -inch from the end, and the prongs removed. A coil was wound on this (bunch-winding) and secured in four places by wrapping wire around it. Two bakelite pegs were inserted in the upper part of the base for use as guide rods for the second coil to slide upon; these pegs passing through two of the holes in which the prongs fitted. A screw passing through the center of the top piece adjusts the position of the movable coil with respect to that on the outside of the tube. Leads from the inside coil are brought out through the holes made for the prongs in the upper tube base.

SIMPLE TESTING DEVICES

The double jack which won the ninth prize was submitted by J. V. Moran of Seattle, Wash. His description is as follows: "The lower third of a tube base can be used as a double jack. The prongs serve as lugs and the phone cord tips will fit snugly inside of the prongs. This can be used for testing any circuit, by removing the tube and inserting this jack in the socket."

The tenth prize was awarded to J. G. Marinac of New York City, who illustrates it himself. His description follows:

"My idea shows the use of the first two burnt-out vacuum-tube bases used with flexible leads attached to any transformers for testing them quickly without any change in the wiring; and the third or last burnt-out base is used for a cable-connector plug, replacing the customary binding-posts as shown in Fig. 2.

"Fig. 1 shows the typical section of the three burnt-out bases used in this amplifier in conjunction with the sockets. The drawing shows the way the base would go into the socket from the top of the socket. All the leads in the last burnt-out base or cable connector plug go to the prongs of the burnt-out base with the exception of the "C—" lead which is soldered on the inside of the base shell (as shown in Fig. 1) through the hole in the wooden handle used to insert the base in the socket."

AN ADVERTISING DEVICE

Herman R. Wallin of Brooklyn, N. Y., who was awarded the eleventh prize, thus explains his idea:

"A very neat and novel illuminated price sign can be made from old tube bases. The bases are cleaned after removing the bulbs and a small 6-volt or 110-volt bulb soldered to the 'F' terminals.

"Circular celluloid pieces are cut to fit the tube openings. The figure or symbol is first painted, on the back preferably, and then tinted red or some other color. This will prevent the bulb from showing and only the number or symbol will be visible when illuminated. The celluloid is fastened by pressing or glued in place. A frame or box is used for the stand. Tube sockets are fastened to this and then the 'F' terminals connected to a battery or 110-volt line."

VARIABLE CONDENSER

A. W. J. Schaefer of London, England, was given the twelfth prize for his balancing condenser. After removing the contents of a vacuum tube base a metal disc was cut so that it would fit in the bottom of the base and insulated from the prongs. Another of the same size was fitted into the top of the base through which was drilled a

\$28.50

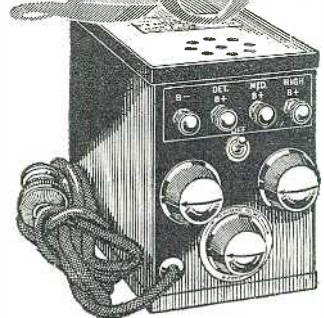

Model R-81

NOW you can buy a Sterling "B" Socket Power (Raytheon approved) for as little as \$28.50 complete. There's no longer any reason why you should put off enjoying the advantages of full radio power and better tone. Simply "light-socket" your set the Sterling way.

A Sterling Demonstration will be a revelation—
Ask your dealer.

Sterling B Socket Power Unit

THE STERLING MANUFACTURING CO.
2831 Prospect Avenue :: :: Cleveland, Ohio

Build Any Set
but use
ACE
Hard Rubber
PANELS

Their high insulating values insure the utmost protection against leaks and losses which often cause poor reception.

Made with Crackle or plain Polished Surface in all regular sizes:

- 7 x 10, 7 x 12, 7 x 14
- 7 x 18, 7 x 21, 7 x 24
- 7 x 26, 7 x 30 inches.

Low prices at all dealers or write to

AMERICAN HARD RUBBER CO.
11 MERCER STREET
NEW YORK, N. Y.

Makers of famous RADION PANELS

Insure your copy reaching you each month. Subscribe to RADIO NEWS—\$2.50 a year. Experimenter Publishing Co., 230 Fifth Ave., N. Y. C.

hole to take a screw. The end of this screw was soldered to a movable disc, forming the variable plate of the condenser. The stationary plate of the condenser (i. e., the bottom one) is connected to one of the prongs and the top plate, connected through the screw to the movable plate, is also connected to another prong.

HANDY MOUNTING FOR VOLTMETER

The thirteenth prize of \$2.50 was awarded to Harvey Ham, Jr., of Fergus, Canada, for the idea of a plug-in voltmeter. He describes his device as follows: "The pieces of flexible wire are soldered to the filament prongs of a vacuum-tube base, these wires being at least 3 inches long. The other ends of the wires are each soldered to a tip-jack, and these are placed upright in the base as far apart as possible. The space around the two jacks is then filled with sealing wax, allowing the ends of the jacks to project above the wax. The voltmeter can then be plugged into the tip jacks and the voltage reading taken when the device is plugged in a socket." A similar idea for the use of an ammeter seemed somewhat less desirable.

MISCELLANEOUS SUGGESTIONS

Lee Gunn of Nickerson, Kansas received the fourteenth prize for a switch for a horn-cone combination. Three vacuum-tube sockets are so connected that, when bases are plugged in the sockets, different combinations of the speakers can be made and their tones thus compared.

A three-in-one switch was submitted by William Richardson of San Francisco, Cal., who was awarded fifteenth prize. This switch, which is made from the base of a tube, takes the place of a filament switch and two jacks and plugs. Phones and a loud speaker can be switched on, using this arrangement.

Sixteenth prize was awarded to Alvin Porter of Highland, Ill., for a UX-type socket made by drilling in the bottom of a base two pairs of holes to fit the prongs of the tube. Contacts are made to the prongs by bending thin 1/4-inch brass straps, and attaching them to the base's sides with nuts and bolts.

S. Baymar of Manchester, England, submitted the idea for which was awarded seventeenth prize. The diagrams show how the bases of burnt-out vacuum tubes may be used for effecting changes in the tuning circuit of a receiver.

A BASKET-WEAVE COIL

W. E. Kindschi of Madison, Wis., is awarded the eighteenth prize for his plug-in radio frequency transformer, illustrated here, and stated to be very efficient. The form for basket-weave winding was made by marking off two 1 1/2-inch circles on a board 3x6

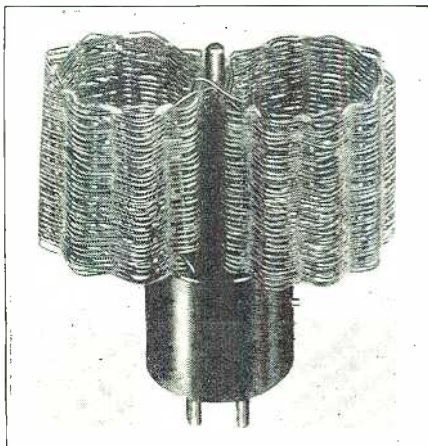

A plug-in R.F. transformer mounted on a tube base.

Tone reproduction

That no one even thought was possible~

New delights—beyond your fondest dreams—are realities in this new speaker—the sensation of the radio world. Now for the first time in your life hear radio as you never heard it before! No harsh notes—no grating—no slurring at the bottom of the scale. The marvelous tone quality of the Temple Air Column Speaker is finer than anyone thought was possible.

Not a Cone
—but a long compensated exponential air column type matched with a new Temple Unit.

The TEMPLE Air Column Speaker
has given the world a new appreciation of Radio



Console Cabinet Model No. 65, containing the same tone chamber as drum type model No. 18. Beautifully finished in walnut Spanish design.

TEMPLE SPEAKERS are selling like wildfire all over the country. New enthusiasts by the thousands are now hearing radio in a new and better way. Eddie and Fannie Cavanaugh, the Gaelic Twins of KYW, Chicago, say: "We have tried many speakers but none have the wonderful tone quality and volume of the TEMPLE."

Ask your dealer for a demonstration on the Temple Comparator. Make this test: Close your eyes as you hear different speakers. You'll pick the Temple every time because of its unflinching purity and richness of tone reproduction.

Console Cabinet Model No. 65—priced at \$65.00; west of Rockies, \$75.00
Drum Type Model No. 13, 13 inch—priced at \$29.00; west of Rockies, \$32.00
Drum Type Model No. 18, 18 inch—priced at \$48.50; west of Rockies, \$55.00

If your dealer cannot supply you write us for complete information and name of nearest Temple Dealer.

TEMPLE, INC.

213 South Peoria Street, Chicago

LEADERS IN SPEAKER DESIGN

LIMERICK RHYMING DICTIONARY
Prepared with a special article on LIMERICK WRITING FOR PROFIT

Written and compiled especially for the use of Limerick Enthusiasts
By E. W. WILSON

Price 50 cents

Published by
THE CONSRAD CO., Inc.
230 Fifth Ave.
New York City, New York

CASH from LIMERICKS

Fatten Your Bankroll on Limerick Contests—Learn How Winners are Picked and What Makes Them First Choice

LIMERICKS can be manufactured with tremendous success by studying the construction of last lines, by studying the special kinds of rhyming words that are most effective and by learning the "inside dope" on how limericks are judged.

This book gives the first and only specially prepared *Rhyming Dictionary* of words especially fine for Limericks and the similar words that rhyme with them. It is prepared by one of America's leading authorities who had much experience in how limericks are judged.

Sixty-eight pages of instruction, large-sized book 6 by 9 inches, the only book of its kind. Price 50c.

50c HELPS YOU WIN BIG PRIZES

THE CONSRAD CO., INC.
230 Fifth Ave. New York, N. Y.

All Metal Chassis Shielded

6 TUBE SUPERPHONIC RADIO KIT COMPLETE

Only \$16.95

FREE! 6 TUBES UX 201-A TYPE Tested and Matched

Can be built in 2 hours

COAST TO COAST RECEPTION

Latest 6-tube tuned radio frequency circuit. Extremely selective, marvelous sensitivity. 2 stages of radio frequency, detector and 3 audio amplifiers for improved tone quality. 2 dial control. All metal chassis. Shielded. Clear and realistic reception guaranteed. Beautiful ornamental design on front panel, crystalline finish. Metal panel and sub panel; all holes drilled making mounting of parts very simple. No special tools needed. Vernier dials for fine tuning. New type UX sockets. All hook-up wire and colored battery cable included. Value \$60.00. Our price \$16.95.

Complete Set of Simple Plans and Directions to Build

Very easy to build this set with the plans and instruction we furnish. No complicated drawings. Can be built in two hours. Instruction for operation also included. Make money by building these sets in your spare time and selling them to your friends.

MAKE MONEY IN YOUR SPARE TIME

SEND NO MONEY

Just write your name and address on a post card and ask us to send you this great kit together with 6 tubes. We will ship them right away. When they arrive, pay only \$16.95 plus a small delivery charge.

RADIO EQUIPMENT CO.

Dept. N 549 S. Wells St. CHICAGO, ILL.

REMOTE CONTROL

Mechanical Model \$18.00
Electrical Model \$60.00
(Add 10% west of Rocky Mts.)
Write for illustrated descriptive circular

Imagine the pleasure of tuning your radio without having to get up once all evening! Turn set "on" or "off," tune, regulate volume—from your easy chair! Easily attached to any single removable dial receiver in a few minutes.

ALGONQUIN ELECTRIC COMPANY, Inc.
245 Fifth Avenue, New York City

The NEW **Algonquin**

Trade Mark Reg. U. S. Pat. Off.
REMOTE CONTROL RADIO TUNING UNIT

RADIO ACCESSORIES at WHOLESALE

Radio Sets, "B" Eliminators, Chargers, Tubes, Kits, Parts—everything new in Radio at lowest wholesale prices. Thousands of nationally advertised bargains. All listed and illustrated in my Big New Catalog and FREE Call Book. 132 Pages of valuable Radio information—trouble finding, set building—Radio knowledge of all kinds. Write today. **HARRY SCHWARTZBERG PRES.**
AMERICAN AUTO & RADIO MFG. CO.
Dept. 104 American Radio Bldg. Kansas City, Missouri

FREE BIG BARGAIN CATALOG

RADIO—SETS—PARTS
Eliminators at amazingly low prices
Write for latest money-saving literature
S. R. S. CO., N-427 16th St., New York City

inches, touching each other. A 3/16-inch hole was drilled at the common point, and equally-spaced 1/8-inch holes, eight around the rim of one circle and nine around the other. A 3/16 center pin of bakelite or fiber, and nails for the 1/8-inch holes are inserted into these holes as spacers, and the coils wound, the primary first; then the secondary. Long leads are left to make the connecting easy. Fifteen primary and sixty secondary turns of No. 22 D. S. C. wire were used.

The coil is tied together, with good waxed string, and painted with collodion at cross-over points, before removing it from the winding form. The tube base is thoroughly cleaned, and a 3/16-inch hole drilled in its center, between the prongs, to receive the centre pin, which should fit tightly. The coil should be a little above the top of the base. The leads are threaded temporarily into the proper prongs; and the coil is adjusted to the condenser, by removing turns as needed, from the primary until it tunes sharply, and from the secondary until the dial settings cover the range desired. This coil was designed for use with a .0005-mf. condenser. Coils to cover ranges between 40 and 900 meters may be made in this fashion and used interchangeably.

Awards of the Cover Title Contest

(Continued from page 464)

- "Safe Always For Old Dad; You'll Never Enter"—(acrostic)—Wm. T. Axton, Glens Falls, New York.
- "Safe, Forays (for rays) of the Son Can't Penetrate."—Fred C. Harrell, Hot Springs, Ark.
- "Segurodad"—(Spanish)—James McIntyre, Hartford, Conn.
- "Shades of Jimmy Valentine, I Hear You Calling Me"—W. J. Sosnowski, Cayey, Porto Rico.
- "The Home Radio Commissioner Has Barred an Operator"—G. W. Dockery, Oteen, N. C.
- "The Inevitable, Forgotten Detail—The Cone"—W. H. Burrows, Rochester, Minn.
- "The Loss Rectified by a Cunningham and a Metalized Resistor"—Cecil A. Haase, Roanoke, Va.
- "The Safodyne Makes a Sonomyne Squeal"—Oscar M. Hawkins, Rockingham, N. C.
- "The Set He Loved to Touch"—A. A. White, Lakewood, N. J.
- "The Wise Cracker Passes Up the Soup"—C. L. Armstrong, Hazelton, Iowa.
- "This Set Limits the Output"—Hugo W. Dahlstrom, New Orleans, La.
- "Tool Late!"—Ralph Gluck, Waukon, Iowa.
- "When Programs Come Through Safe"—A. L. Franklin, Ninnekah, Okla.
- "Where the Son Does Not Shine"—Mrs. Lamont E. Close, Emporium, Pa.
- "WHO WILL KUT KSD KOIL?" ("Who Will Cut Cased Coil?")—(station call letters)—Louis Atwater, Bridgeport, Conn.
- "Working Right Now, Youngster"—(acrostic)—J. F. Stettiner, Maple Heights, Ohio.
- "Young Man's Electromotive Force About to Meet Resistance"—Albert J. Duquet, Worcester, Mass.

The Voice of the People

(Continued from page 479)

sadly nodded Dr. Fredericks; "but what is the remedy?"
"There is none," gravely replied the specialists: "If the patient does not recover, he will die."
Dr. Fredericks bowed his grey head in despair.
By Harold Dare's bedside still sat Dorothy Golden, the great film star's secretary. Ever since the fatal day, she had sat there, practically without food and drink. Haggard from want of sleep though she was, her brave heart still held a spark of hope for her beloved employer. She achieved a wan smile when Dr. Fredericks entered.
"Never mind," Doctor," she murmured,

World "A" Socket Power Unit

\$13.75

Save 50%

No better "A" Socket Power Unit can be obtained even at twice this amazingly low price. Combines all the efficiency of plate current with the undoubted convenience of socket power. No bothersome hauling around of batteries to be charged. No hum or noise. Highest quality Westinghouse electrical equipment. Operates on 50 or 60 cycles at 110 volts A. C. Thousands of satisfied users prove the worth of World Power Units. Approved by rigid tests of Radio News and other leading Laboratories.

Send No Money Just name and address; and we will ship day order is received by express C. O. D. subject to examination on arrival. 5% discount for cash in full with order. NOW is the time to do it.

WORLD BATTERY COMPANY
1219 So. Wabash Ave., Dept. 60, CHICAGO, ILL.
Station WSBC owned and operated by World Battery Company

CARTER

New Vitreous Enamel Resistors

Wire wound, protected with hard glassy enamel. Enamel and wire have same rate of expansion, permitting safe operation at high temperatures. Cannot oxidize. Guaranteed permanently accurate within 5% of rated value.

In Canada: CARTER RADIO CO., LTD., Toronto
Offices in principal cities of the world

Carter Radio Co. CHICAGO
2611-E.

New! GENUINE BAKELITE INSULATED X-L Push Post

At last a perfect Push Post. Convenient, simple, permanent connections. You don't have to remember to tighten X-L Push Posts. Just push down, insert wire, remove pressure. Connection is tight and will stay tight. No vibrations can loosen; releases instantly. All standard markings or boxed in complete sets for all popular circuits. Price each 15c. If your dealer can't supply you, write direct.

FREE big, new, up-to-date book of wiring diagrams of all leading circuits, write today.

X-L RADIO LABORATORIES
2426-B Lincoln Ave., Chicago, Ill.

EVERYTHING IN RADIO
AT ATTRACTIVE PRICES. SETS OR PARTS.
Orders shipped exactly as ordered. Prompt Service.
Write for Prices. Mail Order Only. Send Your Address.
ALL RADIO COMPANY, 417 North Clark St., Chicago

Insure your copy reaching you each month. Subscribe to **RADIO NEWS**—\$2.50 a year. Experimenter Publishing Co., 230 Fifth Ave., N. Y. C.

with an assurance she did not feel: "He will be better. He has always been well. At any moment he may wake."

"Brave girl!" said Dr. Fredericks. "I wish I could believe it. But the specialists have agreed that they can do nothing, and what their skill cannot accomplish, nothing can. If Harold Dare does not wake soon, he will die of starvation. See how pale he is already."

"He must live!" cried Dorothy, with a little choke in her voice. "I know he will live. His public needs him, and he will not fail them. He has never yet failed them!"

"Perhaps you are right," sighted the Doctor. "At any rate, all we can do is to hope."

* * *

The strange illness of Harold Dare had been a severe shock to the public. Men wore crepe in their buttonholes; women dressed in black. Thousands of feminine film fans were prostrated. The motion-picture industry was practically at a standstill. In the Flicker Film studio, through which are released the powerful Harold Dare pictures, high officials sobbed in the privacy of their offices, and seasoned accountants occasionally let fall a tear upon their ledgers; for while Harold Dare lay sick and still, there could be no more of the gripping Dare superspecials which meant so much to the world, and to the credit side of the ledger. Out of respect to the great actor, they had put the whole studio staff on half-pay until Dare should return. Throughout the great studio, electricians, camera-men, and even hardened directors gathered in sad little knots and bewailed the plight of their chief; and on the doors of theatres, throughout the United States, hung crepe.

From the Dare broadcasting station, WROT, were issued hourly bulletins regarding the actor's condition. In millions of homes, the radio receivers remained in operation all day long, while many people awoke in the night and rushed to their sets to hear the latest news of their film idol. Employers found it necessary to install radio receivers in offices and factories, for the benefit of their employees. DX fans sat helplessly by their receivers, the dials stationary at the setting of the nearest station which relayed the bulletins, themselves fearful to reach out for distance lest they should miss important news. In this emergency, many radio dealers found profitable business in the sale of second sets calibrated to the wavelengths of the various stations in all parts of the U. S. which relayed the Dare bulletins; these made it possible for the DX fans to fish for far-off stations without danger of missing any announcement.

The blood-pressure and pulse count of Harold Dare became as common figures as the box scores. Many a film fan fainted or wept to hear the heart-beats of Harold Dare picked up by a sensitive microphone and relayed to the millions. In churches all over the land, people prayed day and night for the recovery of Harold Dare. The picture palaces were practically deserted, for no one could bear to see the pictures of any other actor while the greatest of them all lay at the point of death. Only one thing saved the exhibitors from ruin; the projection of news reels showing Harold Dare as he lay in his Hollywood home, the doctors in consultation, and devoted Dorothy Golden keeping her incessant watch over the bedside of her employer.

It was in this crisis that a member of the Dare radio-engineering staff conceived a brilliant idea. He suggested that in every motion picture playhouse in the country, a radio microphone be placed, and that each playhouse should be connected by direct telephone wire to a nation-wide broadcasting chain; then, at a signal given by radio and received in each picture palace, the audience should join in singing "We Want You, Harold Dare," a new song which was tre-

"The human ear could not detect further tone improvement"

GAIN-TRANSMISSION UNITS

FREQUENCY - CYCLES PER SECOND

Engineers told us this as Samson Symphonic Transformers were tested in famous laboratories. Musicians confirmed it frequently.

The curve above shows audible music is amplified with remarkable evenness from lowest to highest frequency. This frequency characteristic of the Symphonic Transformer is more uniform than that of the average broadcast station or any loud speaker in common use. Samson power units will supply dependable A, B and C current for the above.

"Audio Amplification," a book, rich in highly practical, original information for bettering quality of reproduction sent on receipt of 25c.

Learn how to get supreme coil efficiency from new "Inductance Units Bulletin." Send 10c. to cover mailing.

How to apply RF and AF Chokes to 17 popular circuits, or your own, is illustrated in Make-Em-Better Sheet. Send 5c. to cover mailing.

Samson Parts Specified for EQUAMATIC CIRCUIT and KNICKERBOCKER FOUR

Samson Electric Co.

MANUFACTURERS SINCE 1882

CANTON :: :: :: MASS.

Steinite RADIO

ELECTRIC-NO-BATTERY

ONE COMPLETE SYNCHRONIZED UNIT.
No Chemical Rectifiers, Acids or Liquids of Any Kind

Licensed under Radio Corporation of America Patents for Radio Amateur, Experimental and Broadcast Reception

Dealers are Interested

Production must be limited to 100,000 sets—
76,000 are already contracted for.

WRITE OR WIRE

GENERAL SALES OFFICE **CHICAGO, ILL.**
506 So. Wabash Ave.

Steinite Radio Co. Atchison, Kans.

Manufacturers Famous Steinite Laboratory Products
Largest Exclusive Radio Factory in the West

RADIO PANELS

OF GENUINE BAKELITE

Cut, drilled and engraved to order. Send rough sketch for estimate. Our Complete Catalog on Panels, Tubes and Rods—all of genuine Bakelite—mailed on request.

STARRETT MFG. CO.
520 S. GREEN ST. - - CHICAGO

FREE RADIO GUIDE

BIG NEW 1928 CATALOG—4000 items

Shows the latest circuits, the newest developments in radio at startling low prices. Get the parts you want here and save money. The best in parts, kits, complete factory-built sets and supplies. Orders filled same day received. Write for free copy now.

Standard discounts to dealers, set builders, agents.
Barawik Co., 129 N. Jefferson St., Dept. 111, Chicago, U. S. A.

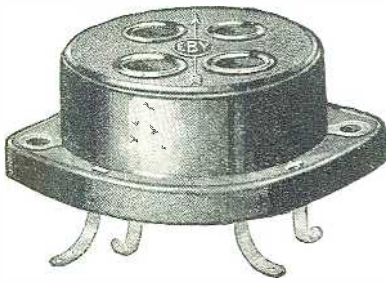

The Latest and Best in Socket Design

Not more than two, and in many cases not any, cushion type sockets are used in most of the better factory built receivers. You can check this up yourself.

Improvements in tube design and manufacture enable the rigid type socket to give performance equal to any other socket—at a considerably lower cost.

The New EBY Socket has a 3 point wiping spring contact—the most scientifically perfect type of contact known. On all counts, the EBY Socket is the most efficient rigid socket made.

Easy to mount above or below bakelite, metal or wood. List price 40c.



The H. H. Eby Mfg. Co., Inc.
4710 Stenton Ave., Philadelphia, Pa.



Cable Connector Plug

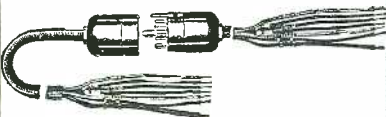

Just take this Cable Connector Plug in your hands but once and you will be completely sold on its many merits. It will enable you to turn a messy maze of battery connections into one neat, compact, good looking cable, instantly connected or disconnected. Has polished Bakelite plug with phosphor bronze contact springs that assure positive contact at all time.

- No. 660—Cable Connector Plug, Complete \$3.00
- No. 670—For Binding Post Connections, Complete. \$3.50

YAXLEY MFG. CO.
Dept. N, 9 So. Clinton St.
Chicago, Ill.

MUSIC IN THE AIR!



This wonderful new invention makes it possible. A high grade radio loud speaker in a beautiful tapestry picture, handsomely framed. Does away entirely with old style speakers—and beautifies your home.

YOUR OWN FREE!

Write today! Let us show you how to get your own WALART Speaker absolutely FREE by introducing it in your community. Act NOW!

WALART SPEAKER CO.
619H So. Tenth Ave. Maywood, Ill.

mendously popular. The idea caught the public fancy, so much so that arrangements were made for the interlinking, and the date set for July 15.

Dorothy Golden heard the news of this project with intense interest.

"Oh, Dr. Fredericks!" she exclaimed; "it is touching to see the concern of Harold's film following. I cannot help feeling that their devotion will help him pull through."

"Yes," agreed the doctor, "it is indeed touching. I fear, however, that devotion can do no more than the utmost skill of medical science. If it could, you would have had him well long ago."

"Dr. Fredericks," said Dorothy, her voice suddenly low: "I believe that if Harold could hear a nation calling him, he would not fail to answer. If anything could bring him back to us, it would be the voice of his people."

Startled, the doctor looked at her. "I fear not, Miss Golden," he replied, but his voice had a strange note of uncertainty. The idea plainly fascinated him.

"The voice of the people is to be broadcast, is it not?" continued Dorothy. "Then, why can it not be received right here? There, in the corner, is Harold's own set. I believe that if he could hear it, he would come back to us. It could be arranged, could it not?"

"Yes, it could be arranged," agreed Dr. Fredericks. At least, he thought, it might make her happy. "When the time comes, we can turn on the set and try it. It can do no harm. We have come to the point when we may try anything."

July 15 was at hand. The Dare engineers had worked out the details of the nationwide interlinking. Standard remote-control equipment was suitable. Upon the stage in each theater was to be placed a receiving set, and connected to it, a pair of head-phones for the director who was to lead the singing. A loud speaker could not be used, for its output would mingle with the sound of the voices, and, being fed back through the microphones, would cause a regenerative action like that of the well-known "telephone howler," thereby detracting from the quality of transmission. Before the singing, the sound of a metronome was to be broadcast from WROT, over the chain, clicking for two measures in order to set the tempo of the song for the directors in the theaters.

The interest of the public was at a high pitch. Those who could not go to the theater hovered about their radio sets. The news had gotten out, somehow, that the singing was to be received in the room where lay Harold Dare, and speculation ran rife as to the effect upon the sick actor.

At five minutes before the time set for the national demonstration, eight o'clock, the engineers sent the final test over the chain. Every circuit was in perfect order. The whole nation held its breath while the hands of the clock edged slowly toward the mark. Then, as the hour struck, in a million loud speakers was heard the click of the metronome. One, two, three, four, one, two, three, four—and a torrent of voices thrilled the world! "We Want You, Harold Dare!"—the appeal thundered in a mighty cry which echoed through the vastness of the ether and swirled up to the very stars!

In Harold Dare's room, Dorothy Golden sat silently waiting for the song. The receiver was turned very low, lest the shock of a loud noise prove disastrous to the film star.

The metronome ticked, the singing began. Dorothy and the doctor stared at the face of the actor, as if, by the very intensity of their gaze, they would bring him back to consciousness. The song continued. They were singing the second verse now. Another century passed, and yet the actor did not stir. The verse came to a close, and a voice said, "For the last verse, let everyone west of the Mississippi whistle, and the rest sing." The whistling increased the volume.

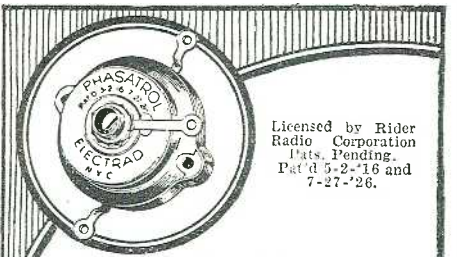

Licensed by Rider Radio Corporation
Pat. Pending.
Pat. d. 5-2-16 and 7-27-26.

Banish Oscillation Squeals

PHASATROLS

Reg. U. S. Pat. Off.

A True Balancing Device for All Radio Frequency Amplifiers

PHASATROLS are Electrad's latest triumph! They stop oscillations and let distance come in smooth and clear. Leading radio engineers endorse them. Easily installed in any set—tuned, untuned or reflex.

PRICE \$2.75

AT GOOD DEALERS.

Write for hook-up circular for any set or circuit

Dept. 45B, 175 Varick Street,
New York, N. Y.

ELECTRAD



Standard parts and equipment at money-saving prices, with discounts that show you a real profit. Electrical phonograph—pick-ups—latest kits. New A. C. tubes and transformers—parts for any circuit—power audio equipment—short wave supplies—they are all in our big new 1928 Catalogue. Write for it today, with discount sheet. 12-hour shipment guaranteed.

Van-Ashe Radio Co.
210 North 10th St. ST. LOUIS, MO.

\$1.00 WILL SAVE YOUR SPEAKER

The Craftsman Dollar Speaker Filter is Guaranteed to relieve your speaker of the DC plate current (up to 250 volts). It gives speaker a chance to operate at its best. Attached in a second. Send dollar bill NOW!

CRAFTSMAN RADIO PRODUCTS
9 Orchard St. Newark, N. J.

Radio on Terms

Play While You Pay!

A marvelous set for distance, tone, selectivity, 8 tube—1 dial (aluminated). Beautiful cabinet. Easy monthly payments while you enjoy nation-wide programs. FREE Log and Call Book and Big Catalog containing thousands of Radio Bargains. Write today for copy.

AMERICAN AUTO & RADIO MFG. CO.
HARRY SCHWARTZBERG, PRES.
Dept. 107 American Radio Bldg., Kansas City, Mo.

\$9.85 PUTS IT IN YOUR HOME

Dr. Fredericks stepped to the receiver to turn down the rheostat; but even as he turned, Dorothy suddenly rose and stood transfixed, staring at the face of Harold Dare. The doctor whirled and gasped. Dorothy sank into the chair and fainted. For the eyelids of Harold Dare were fluttering like a pinioned bird, and the lips were trembling as if to speak. For a long moment the doctor stared, then the music ended. Harold Dare lay still as death.

* * *

It was a long conference that kept the lights burning in the parlor of Harold Dare's mansion that night; and not until dawn did the group of specialists that had been hastily summoned come to a decision. Some of the doctors attached little importance to the strange behavior of Harold Dare; but the earnestness of Dr. Fredericks convinced them that the incident merited investigation, at least. In one thing, all finally agreed; that the only way to test the effect of the theory was to repeat the broadcast.

There was no difficulty in arranging a repetition of the event, for July 17. It had been a tremendous success. The spectacular nature of the proceeding, the idea of hearing a whole nation sing, thrilled the world. Telegrams from every country were pouring into the studio of WROT, and had it not been for the tragedy which hovered over Hollywood, it would have been an occasion for general rejoicing. As it was, when the news of Harold Dare's possible rally went forth, nothing could have prevented a second broadcast. A thrilled citizenry, inspired with new hope, rose to a frenzy of anticipation. Upon Dorothy Golden was showered the gratitude of a people. Meanwhile, there was, for the group of doctors upon whom the responsibility rested, a time of feverish research into works dealing with the therapeutic properties of musical sounds. And, meanwhile, Dorothy Golden had slept twelve hours.

At eight o'clock on the evening of July 17, the room in which lay the sick Harold Dare was the scene of silent but intense activity. With skilled hands the doctors prepared their instruments for the test. With sphygmomanometers, pneumatometers, stethometers, manometers, neurometers, and even haemoglobinometers, they prepared to record the most minute change in Dare's condition. An engineer from WROT was setting up an oscillograph near the loud speaker, in order to record the exact nature of the music. With intense interest, Dorothy watched every move of the experts. Sleep has dissipated the haggard look about her eyes, and the sure, swift movements of the doctors filled her with new hope for the recovery of her beloved Harold Dare.

All was in readiness. At five seconds before eight o'clock, the engineer started the oscillograph. There came the eight ticks of the metronome, then swelled the sound of a million voices. "We Want You, Harold Dare!" The pen of the oscillograph quivered. Dorothy Golden's gaze was riveted upon the face of Harold Dare; but there was no movement, no sign that he had heard. Through the whole first verse the actor lay motionless.

"Let those west of the Mississippi whistle, the rest sing," said the announcer.

The pen of the oscillograph increased its beat. Fascinated, Dorothy saw Harold Dare's forehead furrow. He appeared puzzled. "On the third verse, everyone will please whistle." The pen of the oscillograph swept to the extremes of its arc, tracing a smooth, sinuous curve.

"Nearly a sine-wave," muttered the engineer to himself.

Dorothy gasped. The doctors started, then scribbled frantically. Harold Dare's lips moved feebly. A frown furrowed his forehead. Dr. Fredericks sprang to the receiving set and twisted the knob of the volume

Write today
for your copy of
"Copper Shielding for Radio"

This new book shows how to improve the reception of your set. There is no charge.

Copper shielding means greater selectivity and sensitivity.

COPPER & BRASS
RESEARCH ASSOCIATION
25 Broadway, New York

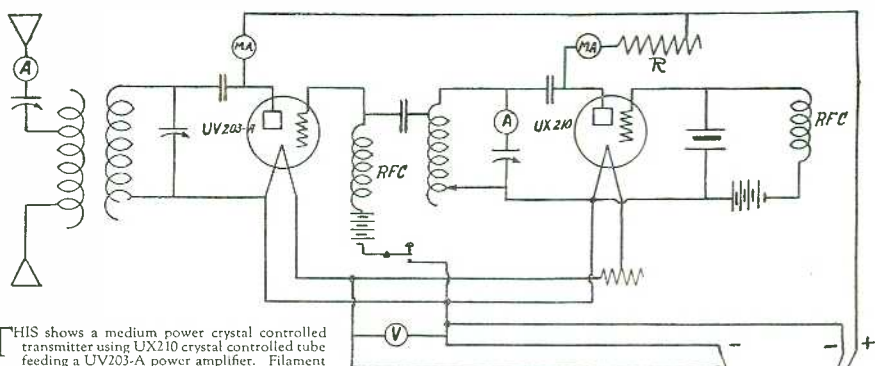

THIS shows a medium power crystal controlled transmitter using UX210 crystal controlled tube feeding a UV203-A power amplifier. Filament and plate voltages are to be obtained from Item 34, operating from either DC or AC house mains. The voltage to the filament of the tubes is variable, either by the field rheostat in the filament generator circuit (not shown) or by the resistance in the filament circuit of the UX210 tube. Keying is done in the bias circuit of the 203-A power amplifier. As the amplifier is NOT neutralized, the power amplifier must work on some harmonic of the crystal tube (preferably the second), for all operations in the 20, 40 or 80 meter bands. A crystal having a fundamental of 160 meters will allow operation in all bands with best output in the 80 meter one. An 80 meter crystal is best for 40 meter operation and in like manner the 40 meter crystal would be best for 20 meter operation. Forty meter crystals are hard to get and blow up easily, so for 20 meters the 80 meter crystal is used again. Both tubes obtain plate supply from the plate end of Item 34, the UX210 being supplied with not over 350 volts through resistance R, and the 203-A taking the full 1000 volts.

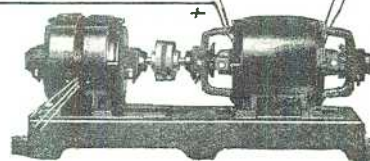

ELECTRIC SPECIALTY COMPANY

211 South Street

TRADE "ESCO" MARK

Stamford, Conn., U.S.A.

Manufacturers of Motors, Generators, Motor-Generators, Dynamotors and Rotary Converters for Radio and other purposes

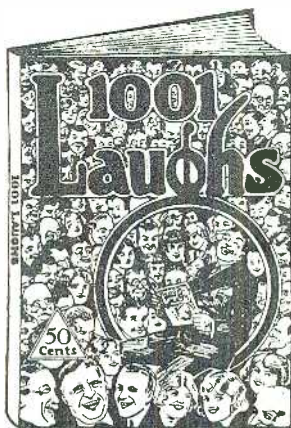

**LAUGH—an hour a day
for the rest of your life!**

1001 LAUGHS

Did you ever pick up a French, German or Spanish joke magazine and wonder what their specially good jokes were?—Here's a brand new laugh book with hundreds of the best Foreign jokes and illustrations translated into English for you, together with plenty of good American humor and cartoons. Altogether this is the greatest, funniest, most uproarious book of jokes and funny illustrations ever presented to Americans. Each leaf of this book is one merry round of pleasure. Every joke is a winner. Relax from your daily grind, spend an hour a day in good old-fashioned laughter. It's a healthy recreation. "1001 Laughs" is an extra-large size book, 9 x 12 inches, with over 300 illustrations.

**50c EVERYWHERE — OR ORDER DIRECT
EXPERIMENTER PUB. CO., 230-5th Ave., N.Y.**

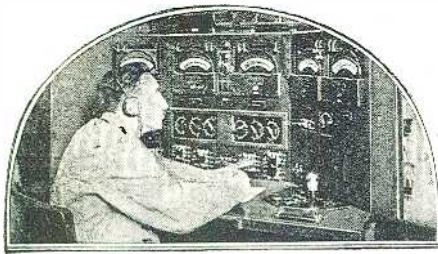

Learn Radio and command a worth while salary

Study at Home . . . Radio Institute of America has for the last eighteen years offered the finest radio instruction obtainable—qualifies you to pass the U. S. Government Commercial or Amateur License Examination. The low cost of the course makes it a real investment that pays dividends in higher wages. Study at home! Send the coupon now for full information.

Radio Institute of America
324 Broadway, New York City

RADIO INSTITUTE OF AMERICA
324 Broadway, New York City

□ Please send me full information about your Home Study Course of code and technical radio instruction which qualifies for the U. S. Government Commercial or Amateur Radio License.

□ Please send me full information on your technical course for radio dealers, jobbers and salesmen.

Name

Address

DUO-POWER B CURRENT SUPPLY



\$29.50—Slightly higher west of the Rockies. Sturdily constructed and dependable in operation. Embodies all the latest improvements in B Power Unit manufacture. Adaptable to any receiver requiring up to 180 volts at 60 mils. Easy to install. Fixed resistances insure selection of proper voltages for any set.

BOUTIN ELECTRIC COMPANY
724 So. 4th St. Minneapolis, Minn.

A. R. R. L. Members and Service men—User agents wanted. Write for very attractive agency proposition.

BUILD IT TO FIT

Make that Exponential Horn to fit your present cabinet or Victrola.

Booklet giving Exponential Horn formulas and directions for making horns at home cheaply. Make it from materials around house. Send one dollar for booklet. Nothing else to buy.

SCHURMAN LABORATORIES
1316 Maple Street Detroit, Mich.

control. The whistle intensified. The group of watchers looked on as Harold Dare struggled to awake. Dorothy Golden sat at the foot of her hero's bed, silently weeping into her handkerchief. After what seemed ages of suspense, the whistled verse came to an end and again Dare lay still. Everything was exactly as before. But now, the voice of the people was imperishably recorded upon the tape of the oscillograph. Thus the experiment could be gone over again and again by the scientists.

For hours the doctors conferred, trying to draw some conclusion from their data. Busiest of all, however, were the men who were consulting every available work upon the therapeutic effect of musical sounds, in an effort to explain the strange effect of the whistling upon Harold Dare. Dorothy Golden believed that Harold Dare was responding to the call of his public; but the great scientists had learned to look beneath every mystery for the inexorable laws of science, which, if understood, explain everything. The engineer, who was a recognized authority on musical sounds, was comparing the musical score to "We Want You, Harold Dare" with the oscillographic record.

At length the doctors had to admit defeat. Their data was insufficient to interpret the strange behavior of the sick film star. All depended upon the significance of the music. What mystic power did the voices of a million people have over the man who had long been their servant in the realm of film art?

The engineer had completed the charting of the song. Yet, he appeared perplexed. Slowly he rechecked his analysis. Still he seemed puzzled. At length he spoke. "What did you hear between verses?" he demanded.

Startled, the doctors searched their memory. "The announcer," said one of them, at last.

"Was there nothing else?" persisted the engineer.

There was a silence. No one could remember having heard anything else.

"Why do you ask?" inquired Dr. Fredericks.

The engineer pointed to the oscillogram: "Here is the end of the first verse; here the announcer spoke; and here began the second verse." The doctors gathered round. Between the points indicated was traced a delicate, curiously symmetrical shading, where the pen had oscillated very lightly and with incredible swiftness. "And here ended the second verse; here the announcer spoke; and here began the third verse." Between the points, the pattern repeated itself again and again. "Then, see the moment of silence at the very first of the oscillogram and at the end of the song."

The pattern was identical. "What a high pitch that sound must have had!" exclaimed Dr. Fredericks.

"Yes, very high, indeed," replied the engineer. He picked up a hand lens, and with a fine metal pointer counted the lines between two of the cross divisions which gave a rough indication of the pitch of a sound. "Very near twenty thousand cycles—a pitch that comparatively few can hear, for the human ear drum cannot easily follow such rapid variations of intensity."

"Is that the only peculiarity of the oscillogram?" asked Dr. Fredericks.

"Apparently," affirmed the engineer: "Nothing out of the ordinary."

"Then," said the Doctor, "that may well contain the explanation of the mystery!"

"It well may!" agreed the engineer thoughtfully.

"Then," continued Dr. Fredericks quietly, "who knows but what that mysterious sound or combination of sounds is still audible in the room where Harold Dare lies? Of course, it might be merely some little peculiarity or defect of the set itself; but, on the other hand, at this very moment it may be sounding in the ears of Harold Dare! Who knows?"



SPRAGUE MIDGETS are built to carry maximum loads. A new process of triple impregnation and a special waterproof asphalt wrapper insures constant capacities.

The new .1 M. F. D. is truly a condenser revelation. Order it from your dealer or send one dollar for sample complete with mounting bushings.

SPRAGUE SPECIALTIES CO.
Dept. N
Quincy, Massachusetts



YOU NEED THIS BOOK

Just Out HARRY ALTER'S New Radio Book



You, as a retailer need the extra profit that is figured for you in our plan of selling at rock-bottom prices. Fourteen thousand dealers are sharing in the advantages of our overnight service.

JUST OUT! WRITE TODAY! for your copy of this—the most famous of all radio catalogs. No matter what your customer wants we have it for you. Get your copy quick.

Note: We sell only to radio retailers.

The Harry Alter Co.
1774 Michigan Ave. Chicago, Ill.

25 Cent Brings ALL THIS!

One Official Blueprint of the Five-Tube Diamond of the Air One official booklet describing in detail how to build this famous set, wind coils, etc.

Act Now! Send That Quarter to **GUARANTY RADIO GOODS CO.** 141 W. 45th Street, New York City

A Laboratory Product

CRESCENT LAVIE RESISTANCES

For Distortionless Amplification Used in 75 big broadcasting stations. 12,000, 48,000, 50,000 and 100,000 ohms. \$1.50 each. Other special resistances made to order at \$2.50 each. We can supply resistances from 3,000 ohms to 10 megohms.

Cresradio Corp., 166-32 Jamaica Ave., Jamaica, N. Y.

"Who knows, indeed!" chorused the doctors, excitedly. But the engineer had rushed into Harold Dare's room, and in a moment reappeared, bringing a strip of tape from the oscillograph. "See!" he cried: "The mysterious vibration! It is still in the room with Harold Dare!"

A thrill ran right through the doctors. Was Harold Dare under the sinister influence of some insidious vibration, perhaps a thought wave or other unknown power, from which he could be released only by the imploring voices of a million human beings? It was a perplexing possibility, a dangerous possibility. How could it be combated?

Seized with an inspiration, Dr. Fredericks rushed into Harold Dare's chamber. He stood listening intently. Dorothy Golden had fallen asleep in her chair. There seemed to be no sound, save the soft regular breathing of the girl and the slow respiration of the actor. Yet, in some remote corner of his brain, he seemed to hear the echo of an illusive soft music, a single insistent tone, so high it seemed almost a rustle. Was it merely his imagination? In vain he tried to concentrate his attention on it; still it eluded him. The voice of the people! . . . How could it cure a disease, especially a disease so subtle as to baffle the best specialists of the world? . . . A psychological problem? . . . Psychology could not supersede the absolute concrete facts of physiology; yet, no abnormal physiological condition had been found. . . .

He turned on the radio set, and passed aimlessly over the scale. The song of the people had not affected Harold Dare; the whistle had. . . . He came upon a flute solo, and tuned it in.

A slight sound startled him. He turned. Dorothy Golden had roused.

"I didn't mean to wake you," he said softly. Then his heart jumped, for Dorothy Golden stood staring aghast at the face of Harold Dare. The doctor followed her gaze. The eyelids of Harold Dare were struggling to open! For a moment the doctor stood stupefied; then he rushed to the oscillograph and set it in motion. For two minutes he let it record; then he snapped the switch and turned to Dorothy.

"How did you happen to fall asleep?" he demanded.

"Perhaps I was a little drowsy. Then it seemed to me that I heard a sound like the song of a canary, far, far away—just too far away to be heard. Then, before I knew it, I was asleep; and in my dreams I could hear it better. It sounded like a snake crawling through the grass, a soothing but sinister sound. Then I heard a bird singing near by and I woke up."

"It was the flute you heard," said Dr. Fredericks. He ripped the strip of paper from the oscillograph. Insidious, cabalistic, the mysterious design ran through the whole record. But the smooth curves of the flute had changed the form from a rhythmic, even pattern to a jagged and irregular scribble. . . .

In a blinding flash, Dr. Fredericks saw the answer to the mystery. With an exclamation he flew into the room where his colleagues still conferred.

"Gentlemen," he cried, "Harold Dare is not sick; he is hypnotized!"

Hypnotized? The doctors shook their heads. How could anyone have entered the carefully-guarded residence of Harold Dare without being detected and ejected before he had had time to work his foul designs? Besides, who could find it in his heart to work evil against the universally-loved hero of the films?

"Gentlemen," continued Dr. Fredericks, "there is one person who would stop at nothing to inflict injury on Harold Dare. For years he has used every means within his power to obstruct Harold Dare's plans, in real life as well as in every scenario of the Flicker Films. He would stop at nothing. His name is Dandy Diavolo. He, and

Victoreen

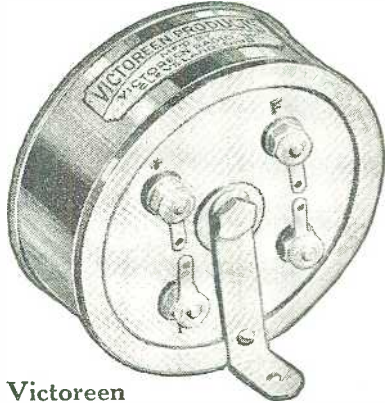

Victoreen Radio Frequency Transformers

No. 170 for Storage Battery Tubes
No. 171 for Dry Battery Tubes

The very heart of the Super Circuit! These units are instruments of great precision, being matched and tuned to within one-third of one per cent and eliminating the necessity of tube matching. Due to their peculiar construction, stray fields are eliminated, enabling the Transformers to be placed in close relation to each other. Inter-stage oscillation is prevented in this efficient instrument.

PRICE \$7.00

The GEORGE W. WALKER Co.
MERCHANTISERS OF VICTOREEN RADIO PRODUCTS
2825 CHESTER AVENUE CLEVELAND OHIO

Dependable Standardized Super Parts

ACCEPTED AS THE BEST IN RADIO

If you want the ultimate in radio reception—if you are one of those who demand range, clarity, volume and selectivity, then you will appreciate Victoreen supremacy in the super field! Victoreen has gained the confidence of those whose radio experience is based on scientific knowledge. They accept the new products of Victoreen, knowing that a progressive step has been made in Radio—one that has passed the experimental stage and arrived at the point of the utmost in satisfactory results.

Send today for 1928 Blue Print of Victoreen Circuit



For Your "B" Battery Eliminator Ask Your Dealer for Guaranteed



Q·R·S
Trade Mark Registered

Gaseous Rectifier Tubes

Are Better

60 MILLIAMPERES

\$450

85 MILLIAMPERES

\$450

400 MILLIAMPERES

With Ionizer 300 Volts for A, B and C Eliminators with Charts and Diagrams

\$700

Manufactured by **The Q·R·S Company** CHICAGO

Established 1900. References: Dun, Bradstreet or any bank anywhere.

C. L. PARKER

Ex-Examiner U. S. Patent Office

Attorney-at-Law and Solicitor of Patents
McGill Building, Washington, D. C.

Patent, Trade Mark and Copyright Law

Send for Latest RADIO CATALOG and GUIDE

Big New 1928 Catalog—4,000 Items
Standard discounts to dealers, set builders, agents. Write for free copy. The Barawik Co., 129 N. Jefferson St., Dept. 111, Chicago.

Try this!

Save Big

You Can
Now, for the First
Time, Order Three Different
Magazines SENT TO THREE DIFFERENT ADDRESSES and Still Get the Very

Lowest Wholesale Prices on Best Magazines!

THIS is News! Big news for magazine readers of all classes! By special arrangement with a number of publications, we are able to offer you **wholesale** prices on the best of the standard magazines. Buy your magazines **now** under this great offer and you will save half or more than half the price at the single copy or newsstand rate. And you will save almost half in nearly every instance over the regular yearly subscription rates. Furthermore, we shall be glad to send each magazine to a different address if you direct, or all to one, as you wish.

Never Before Such An Offer!

Never before have magazine clubs been offered in this way. Always heretofore all magazines in the club had to be sent to one person. We have changed all that! You can now have all the magazines sent to yourself, or only one or two to yourself and the other ones to different persons.

Go In With Your Neighbors

Show this offer to your friends, relatives or neighbors. Give them the advantage of wholesale price on their favorite magazine! For instance, you'd like "Radio News," one friend wants to renew his subscription for six months to "Review of Reviews," and another one would like "Illustrated Monthly." Separately the price would be \$6.00; but you can buy them now for only \$2.99! Less than half!

Every Magazine for a Full Year

Every magazine (except two) subscription will be for one full year. "French Humor" will be 26 issues or six

months. And "Review of Reviews" may be had for six months if full year is not desired. If subscriber is already taking any magazine and present subscription is not yet expired, mark that name with an X on the coupon order and subscription will be added on to present one.

Three Excellent Xmas Presents

What would please friends and relatives more—What would remind them of your thoughtfulness so many times during the year, as a subscription to a nice magazine! What three presents could you buy for so little money that would look so big? A dollar or so apiece wouldn't buy much of a gift, but think what it buys here. If you will mark "Xmas" on the Coupon Order we will send the first copy of each magazine to reach the name given just be-

fore Christmas and will also send a beautifully engraved Christmas Card announcing it as your gift.

How to Order—Read Carefully

Before the name of each magazine is a number. Order by number only. If you want "Radio News," "Illustrated Monthly" and "Success" sent to you, order numbers 1, 2 and 29. If you want "French Humor" (26 issues) and "Illustrated Monthly" and "Success" order 5, 2 and 29. If you want these three sent to three addresses, indicate by number which magazine is to be sent to the respective name. Be sure to send order coupon properly filled out and don't fail to enclose remittance—your check will be acceptable. Order NOW. We will be rushed later. Get in early and get quick service.

CONSRAD CO., 230 Fifth Ave., New York

References: Equitable Trust Co., New York City; Experimenter Publishing Co., or the publisher of any of the magazines quoted.

GIVE THEM FOR CHRISTMAS

Money On Quality Magazines

SELECT FROM BARGAINS BELOW:

All Magazines Are for One Year Each, Unless Otherwise Mentioned. Order at Once.

THESE PRICES NOT GOOD IN CANADA NOR ELSEWHERE OUTSIDE UNITED STATES

	(1) RADIO NEWS (2) Illustrated Monthly and any magazine below.		(3) AMAZING STORIES (2) Illustrated Monthly and any magazine below.		(4) SCIENCE & INVENTION (2) Illustrated Monthly and any magazine below.		(5) FRENCH HUMOR-6 mo. (2) Illustrated Monthly and any magazine below.	
	REGULAR	OUR PRICE	REGULAR	OUR PRICE	REGULAR	OUR PRICE	REGULAR	OUR PRICE
(6) American Boy	\$6.00	\$3.99	\$6.00	\$3.99	\$6.00	\$3.99	\$5.50	\$3.69
(7) American Magazine	6.50	5.01	6.50	5.01	6.50	5.01	6.00	4.51
(8) Better Homes & Gardens	4.60	2.79	4.60	2.79	4.60	2.79	4.10	2.49
(9) Boy's Life	6.00	3.76	6.00	3.76	6.00	3.76	5.50	3.39
(10) College Humor	7.00	4.16	7.00	4.16	7.00	4.16	6.50	3.89
(11) Collier's Weekly	6.00	4.66	6.00	4.66	6.00	4.66	5.50	4.39
(12) Cosmopolitan	7.00	5.01	7.00	5.01	7.00	5.01	6.50	4.69
(14) Delineator	7.00	4.98	7.00	4.98	7.00	4.98	6.50	4.69
(15) Etude	6.00	4.01	6.00	4.01	6.00	4.01	5.50	3.66
(16) Everybody's Magazine	6.50	4.28	6.50	4.28	6.50	4.28	6.00	4.09
(17) Golden Book	7.00	4.01	7.00	4.01	7.00	4.01	6.50	3.69
(18) Good Housekeeping	7.00	5.01	7.00	5.01	7.00	5.01	6.50	4.73
(19) Hunting & Fishing	4.50	2.98	4.50	2.98	4.50	2.98	4.00	2.62
(20) McCall's Magazine	5.00	3.14	5.00	3.14	5.00	3.14	4.50	2.86
(21) Modern Priscilla	6.00	3.56	6.00	3.56	6.00	3.56	5.50	3.29
(22) Motion Picture Magazine	6.50	4.48	6.50	4.48	6.50	4.48	6.00	4.19
(23) Open Road for Boys	5.00	2.69	5.00	2.69	5.00	2.69	4.50	2.46
(24) People's Home Journal	4.50	2.71	4.50	2.71	4.50	2.71	4.00	2.48
(25) Pictorial Review	5.50	3.75	5.50	3.75	5.50	3.75	5.00	3.54
(26) Review of Reviews	8.00	4.98	8.00	4.98	8.00	4.98	7.50	4.76
(27) Rev. of Reviews (6 mo.)	6.00	2.99	6.00	2.99	6.00	2.99	5.50	2.74
(28) Screenland	6.50	3.48	6.50	3.48	6.50	3.48	6.00	3.29
(29) Success Magazine	6.50	3.79	6.50	3.79	6.50	3.79	6.00	3.58
(30) Woman's Home Comp'n.	5.00	3.49	5.00	3.49	5.00	3.49	4.50	3.31
(31) Youth's Companion	6.00	3.69	6.00	3.69	6.00	3.69	5.50	3.47

Special Combinations

	REGULAR	OUR PRICE
(29) Success and (12) Cosmopolitan	\$9.50	\$6.01
(23) Open Road for Boys, (19) Hunting and Fishing, (8) Better Homes and Gardens	6.60	3.65
(20) McCall's, (8) Better Homes and Gardens, and (24) People's Home Journal	6.10	3.49
(28) Screenland, (10) College Humor, and (20) McCall's	10.50	5.99
(32) Popular Science and (33) Scientific American	10.00	7.49
(34) Woman's World, (8) Better Homes and Gardens, (24) People's Home Journal and (35) Needlecraft	6.10	3.69

Please be careful to mention numbers. We positively will not break combinations. These offers not good in Canada or elsewhere outside the U. S.

SPECIAL OFFER COUPON!

Please Cut Out Along Broken Lines and Mail This Coupon with Remittance.

CONSRAD CO., Dept. R, 230 Fifth Ave., New York City.

I enclose \$..... for following subscriptions:

Send Magazine No.....to	Send Magazine No.....to
.....
Send Magazine No.....to	Send Magazine No.....to
.....

Send me Magazine } My Name.....

No. } Address

disappeared a double lamp-cord, which was connected at one end to the set. "The oscillator," breathed the engineer.

But meanwhile, Dr. Fredericks had hastened to Harold Dare's room. From his instrument case he snatched a long rubber tube, one end of which he connected to a stethoscope and the other to the oscillograph. Dorothy Golden sensed the triumph in his manner.

"Can I help?" she begged, with excitement.

"Watch the pen of the oscillograph and tell me when it makes a darker line!"

He approached Harold Dare's bed.

"Darker!" breathed Dorothy.

He placed the stethoscope against the wall and moved it slowly toward the head of the bed.

"Darker!" repeated Dorothy.

He continued.

"Darker and darker—oh, it's making a big black smudge!"

But Dr. Fredericks's keen eye had caught a little black button in the center of one of the flowers which ornamented the wallpaper. He tapped the wall.

"Oh," cried Dorothy, "it's making a blot on the paper!"

But the doctor's hand had gone through the thick, parchment-like wallpaper. Behind was a cavity, from which shone the nickel of a loud-speaker unit and the glint of a little bright rod. Dr. Fredericks tore the unit from the wall, breaking the wires which held it in place. He flung it in a corner, then turned to the bed where lay Harold Dare.

"Sec, Dorothy!" he called.

Then Dorothy Golden caught her breath, and her heart seemed to stop. For upon the white pillow, Harold Dare's head turned ever so slightly. His eyes opened, and in a voice little louder than the rustle of a breath, he murmured—"Dorothy!"

ANOTHER BRICKBAT

"Owing to lack of space, the radio program is postponed until next week."—*American Paper.*

The American ether is a bit overcrowded.—*Popular Wireless, London.*

IN OUR NOVEMBER ISSUE



TREASURES OF TANTALUS (Conclusion) by Garret Smith. Though Professor Fleckner's telephonscope bids fair to act for the public good, because of its ability to look into the most secret hiding places and so unearth a gigantic criminal trust, villainy, with the help of newer and cunning devices, throws the world into panic and a veritable reign of terror. The well-known author makes the most out of the plot and gives us a tremendously interesting conclusion.

THE ASTOUNDING DISCOVERIES OF DOCTOR MENTIROSO, by A. Hyatt Verrill. Our well-known author is delving into the realm of time in this most absorbing story, and before you get through reading it your head will be in a whirl. What is the past? What is the present? Can we step into the future? Can you witness something now that happened yesterday, and can you actually see something that is going to take place tomorrow? Dr. Mentiroso shows you how it is done. Don't fail to read this story.

A STORY OF THE STONE AGE, by H. G. Wells. Our famous author has gone back to the stone age and develops a picture before your eyes that is most astounding to our present-day experience. If you ever wanted to know what your great-great-ancestors were doing in their day, read this story.

THE MACHINE MAN OF ARDATHIA, by Francis Flagg. If the human being continues to progress, mechanically, at the present rate of speed there is no reason to doubt that we might eventually evolve into veritable "machine men." What such an existence might be like, is graphically told in this story. Whether such a life would please you, is another question.



CORWICO



"BRAIDITE"

A New and Better Hook-Up Wire

To make a soldered connection, it is not necessary with Braidite, to strip back the insulation. The braid is simply pushed back while the soldering is done and then replaced, thus making the neatest possible connection. Braidite is made from either solid or stranded tinned copper wire, covered first with a cotton wrap and then with a cotton braid. Braidite is impervious to moisture and possesses the highest insulation qualities. Made in red, green, yellow, brown and black.

If your dealer cannot supply you with Braidite, order from us direct. 25 ft. of one-color with solid copper core per carton—30c—with stranded core, per carton, 35c.

"Corwico" Radio Wires are sold by all leading dealers. Write for free booklet on radio wires and their uses.

"Corwico" Radio Wires

"Best from the Ground Up"

- Antenna Wire (Solid, Stranded and Braided)
- Complete Aerial Kits
- Magnet Wire
- Battery Cable
- Bus Bar Wire
- Hook-up Wire
- Lead-in Wire
- Annunciator Wire
- Loop Aerial Wire
- Litz Wire
- Flexible Wire

CORNISH WIRE COMPANY

30 CHURCH ST., NEW YORK CITY

4 Adjustable "B" Voltages in Any Combination

from 0 to 180

Also Adjustable "C" Voltage from 0 to 50

Type 445 Plate Supply, Price \$55

The New

GENERAL RADIO PLATE SUPPLY

Embodying new and distinctive features in plate supply design

1. Adjustable wire wound resistance with sliding taps which control voltages so that any combination of voltages from 0 to 180 may be taken from the four positive "B" terminals. This method of voltage control is superior to the use of several resistances with exterior knob controls. It has the advantage that once the sliding taps are adjusted to the proper operating voltages of the tubes, they are tightened in place by thumb screws and voltages will remain constant, but are immediately available for readjustment whenever the unit is used with a different set.
2. Adjustable "C" voltage for power tube.
3. High voltage test condensers in filter circuit.
4. Uses UX-280 or CX-380 rectifier tube which has maximum output of 100 milliamperes, thereby providing sufficient current for sets of the multi-tube type.
5. Automatic cut-out switch breaks the 110 volt A. C. circuit when cover is removed for adjusting voltages or connecting wires to taps, thereby making unit absolutely safe even in the hands of persons not familiar with electrical apparatus.
6. Designed to meet the specifications adopted by the National Board of Fire Underwriters.
7. Absolutely guaranteed against mechanical and electrical defect upon leaving the General Radio factory. Cost, which has been a secondary consideration to over-all efficiency, has been kept as low as peak performance and production economies permit.

Price from your dealer, or direct from the factory if your dealer cannot supply you:

Type 445 Plate Supply Unit.....	\$55.00
Type UX-280 or CX-380 Rectifier Tube for above.....	\$5.00

Licensed by the Radio Corporation of America only for Radio Amateur, Experimental and Broadcast Reception. Under terms of R.C.A. license unit may only be sold with tube.

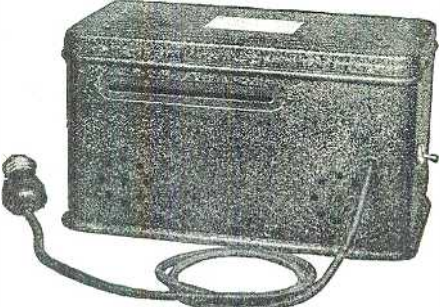

GENERAL RADIO CO. Cambridge, Mass.

DEALERS!

Complete stock of nationally known parts and accessories. Send for illustrated catalog and discount sheet.

Radio Exclusively Since 1921

CLARK & TILSON, Inc.

122 CHAMBERS ST. New York

The Nationally Known House

IRELAN WONDER STATION FINDER

More distance—Volume—More Selectivity
—Tone Quality. Save tubes and batteries.
Improves any set.

No extra wiring.....\$1.25

If your dealer cannot supply you write to us direct.

RADIO SERVICE COMPANY

603 West Erie Avenue
PHILADELPHIA, PENNA.



Insure your copy reaching you each month. Subscribe to Radio News—\$2.50 a year. Experimenter Publishing Co., 230 Fifth Avenue, N. Y. C.

All Electric Radio

Single Dial 7 Tube Set - 30 Days Free Trial

**Agents!
Dealers!
Big Profits!**

Make Big Money taking orders for Metrodynes—all or part time. Metrodyne All Electric Radios are in a class by themselves. Unequaled for quality, performance and price. Demonstrate at home and take orders. Lowest wholesale prices. Your Demonstrating Set on 30 days' FREE trial. Mail the coupon below for complete details.

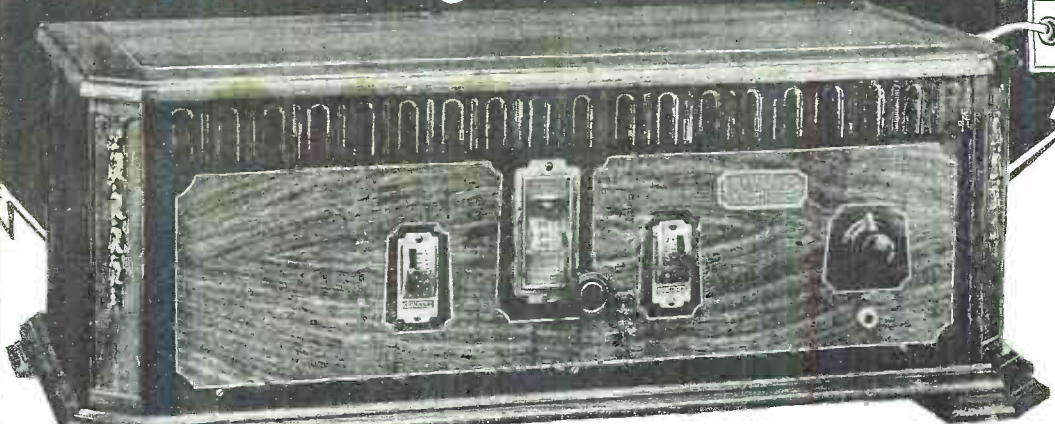

Three Year Guarantee

Metrodyne

ALL ELECTRIC RADIO

"Simply press the switch button and it's on"

NOW! A real electric radio set! Costs less than most battery sets. No batteries—no chargers—no eliminators—no acids—no liquids! Shipped direct from our factory at rock bottom prices and on 30 DAYS' FREE TRIAL.

At last! The radio you've dreamed about! If you have electricity in your home you can now really enjoy coast to coast radio reception without the care, bother and muss of batteries, chargers, eliminators, etc. The Metrodyne All Electric is a real, genuine batteryless radio set. Simply insert the plug in the socket, press the switch button and "tune in."

You could not possibly buy a better radio set than the Metrodyne All Electric, no matter what price you paid.

COSTS LESS THAN MOST BATTERY SETS

Do not confuse the Metrodyne All Electric radio with ordinary light socket sets, because the Metrodyne is truly an all electric radio—consumes less than 2c worth of electricity a day. Comes to you direct from the factory. Its low cost brings it down to the price of an ordinary battery set. We are so confident that you will be delighted with this wonderful, easy-to-operate batteryless radio that we offer to ship it to your home for thirty days' free trial—you to be the judge.

~~NO~~
~~A-Batteries~~
~~B-Batteries~~
~~C-Batteries~~
~~Eliminators~~
~~Chargers~~
~~Acids~~

30 DAYS FREE TRIAL

We are one of the pioneers of the radio. The success of Metrodyne is due to our liberal 30 days' free trial offer, which gives you the opportunity of trying before buying. Thousands of Metrodynes have been bought on a liberal free trial basis—Write to us...

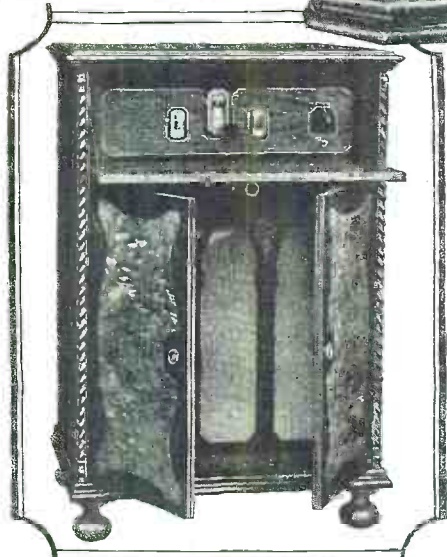

GORGEOUS CONSOLE ELECTRIC RADIO

Here is the Metrodyne All Electric Console Radio—a gorgeous, genuine walnut cabinet, in a beautiful two-tone finish. Has a built-in genuine Metro-Cone large size speaker. Brings in programs with great volume, reproducing the entire range from the lowest to the highest notes with remarkable clearness and distinction. All metal parts are finished in old gold. Wonderful electric radio, in a cabinet that will beautify the appearance of any home.

**BEAUTY — EFFICIENCY
DEPENDABILITY**

The Metrodyne All Electric table model Radio is a 7 tube, single dial set. Only the highest quality low loss parts are used throughout. Solid walnut cabinet, beautiful two-tone effect, with handsome gilt metal trimmings. Size of cabinet, 28 inches long, 13 inches deep, 10 inches high. Has electrically lighted dial—easy to log stations, even in the dark. Only one dial to tune in all stations. Excellent tonal qualities—wonderful volume—selective.

METRO ELECTRIC COMPANY
2165 N. California Ave. Dept. 604 Chicago, Illinois

Mail This Coupon

Learn all about the marvelous Metrodyne All Electric Radio before buying any radio set. Let us send you the proof of quality. Read the letters from thousands of enthusiastic owners. Get our rock bottom direct-from-factory prices and our liberal thirty days' free trial offer.

FREE TRIAL COUPON

METRO ELECTRIC COMPANY
2165 N. California Ave., Dept. 604
Chicago, Illinois

Gentlemen:
Send me full particulars about Metrodyne All Electric Radio and your thirty days' free trial offer.

Name _____

Address _____

If you are interested in AGENT'S proposition place an "X" in the square

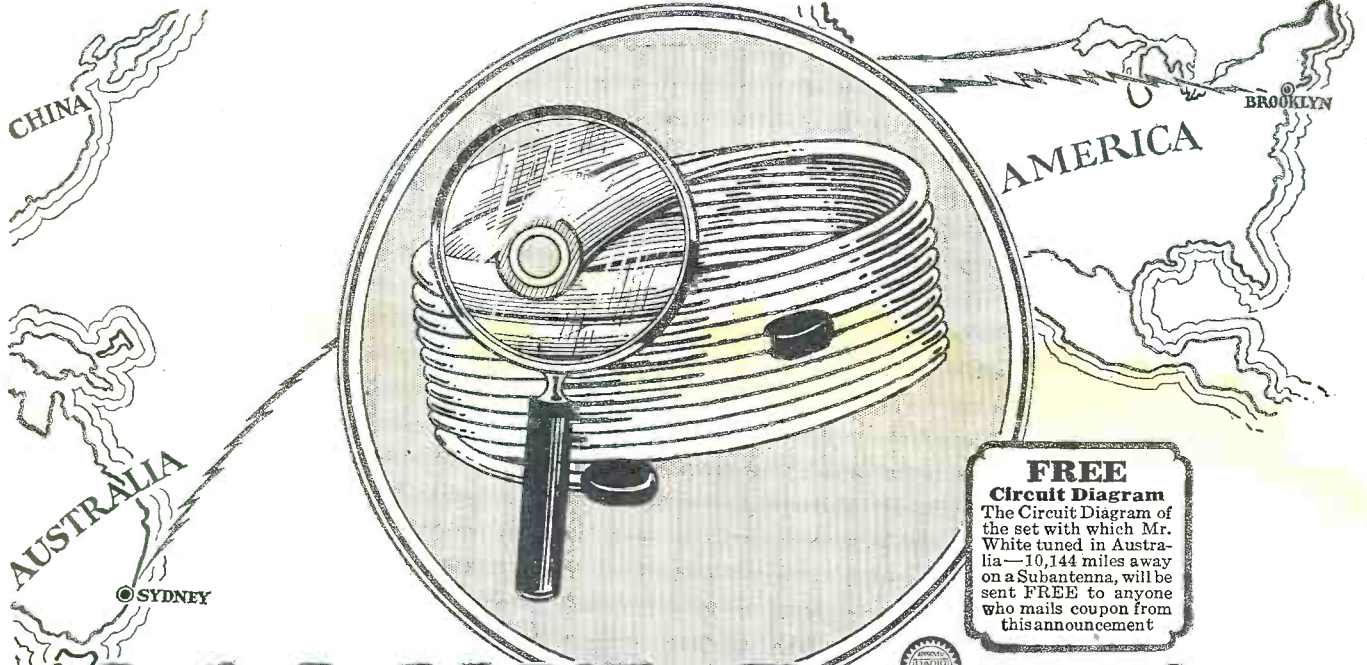

FREE
Circuit Diagram
 The Circuit Diagram of the set with which Mr. White tuned in Australia—10,144 miles away on a Subantenna, will be sent FREE to anyone who mails coupon from this announcement

10,144 Mile Reception with a SUBANTENNA



Mr. JOHN WHITE of Brooklyn, N. Y.—who tuned in Australia with 6 tube set and a SUBANTENNA

10,144 miles—and the music came in loud and clear! Mr. J. O. White residing at 217 Wyckoff Ave., Brooklyn, New York, established the world's distance record for reception within the B.C.L. band of 200 to 550 meters by tuning in 2FC and 3AR Australia with a simple six tube tuned radio frequency set—and a Subantenna. Think of it!

Confirmation letter from 2FC, Sydney Australia

Mr. John White,
 217 Wyckoff Avenue,
 Brooklyn, N.Y., U.S.A.

Dear Sir:

We have to acknowledge your letter of the 16th of February, which only arrived here by today's mail.

We have pleasure in settling the amount that you are quite correct in stating up Station 2FC Sydney.

Yours faithfully,
 FARRER & COYNE, LIMITED
 Broadcasting Manager

Confirmation letter from 3AR, Melbourne, Australia

Associated Radio Co. of Australia Limited

Mr. John White,
 217 Wyckoff Avenue
 Brooklyn, N.Y.

Dear Sir:

We are very pleased to get your letter dated March 20th and we are pleased to say that we can confirm your item.

I may state that the power we were using at that time was only 1000 watts dissipation and I think that your reception, considering our power, was excellent.

Yours faithfully,
 Associated Radio Co. of Australia, Ltd.
 J. C. COOPER,
 Chief Engineer

GROUND WAVES are Practically STATIC-FREE—That's Why Subantenna Gives Greater Distance and Clarity

The same radio waves that you have always taken out of the air, also travel through the ground. The only difference between the air and ground components of the broadcast wave, is that the latter is practically static free, while the air component is always accompanied with static or noise of one kind or another. Scientists have long recognized this fact, and knew that if some device could be perfected for the reception of ground waves, clear, loud, long distance reception would be a reality for the owner of the modest three or four tube set as well as for the possessor of the larger, more powerful set. Subantenna is the answer—tried, tested and proved by thousands of owners of all kinds of sets, and recommended to you by such leading radio laboratories as Radio News, Popular Radio, Radio Digest, and others.

TRY IT ON FREE YOUR SET FREE

Install Subantenna. Leave your old aerial up. Select a bad night when DX is almost impossible with the ordinary aerial. Make a comparison station for station, connecting first your aerial, then Subantenna. If, from stations that are just a mess of jumbled noise with the old aerial, you don't get reception that rivals local in sweetness and clarity the instant you switch to Subantenna, this test won't cost you even a single penny. Obtain a Subantenna from your dealer or send coupon at once for scientific explanation of Subantenna and for particulars of GUARANTEE and FREE TRIAL OFFER. SEND COUPON NOW!

Other users get greatly increased distance

Cuba—also South America

"To show you that I received a program from Station PWX in Havana, Cuba, I enclose herewith a verification card from that station. On January 28th I received a program on my set broadcasted from Buenos Aires, South America, at 10:15 in the evening. Many other long-distance stations have been heard on my set after installing the Subantenna. I never could receive such distance on my outside antenna."—W. C. F. Chicago

More Stations—No Static

"I get plenty of stations with my Subantenna, on the loud speaker, that I have never been able to reach with my outside aerial. It absolutely cuts down interference to the minimum, cuts static out too—not just partly out—but ALL out."—H. S. M., North Carolina.

Results—Almost Unbelievable!

"After years of testing aeriels I at last found the master in the Subantenna. The first night I used it was a very

hot summer night. Static was very bad on my outdoor aerial. I connected my Subantenna and one could hardly believe the results. It was wonderful."—F. L. C., Massachusetts.

Says "Static Is No More"

"I have received the Subantenna. My grandson installed it. STATIC IS NO MORE. Am well satisfied. I can tune in stations I never could coax out of the air even though I had a long aerial."—A. E. F., Kansas

CLOVERLEAF MANUFACTURING CO.
 2713-F Canal Street - - CHICAGO, ILLINOIS

CLIP AND MAIL AT ONCE

CLOVERLEAF MFG. CO.
 2713-F Canal Street, Chicago, Illinois

Tell me about SUBANTENNA, your unqualified, unconditional guarantee and your Free Trial Offer.

Send me FREE Circuit Diagram of the set used by Mr. White in tuning in Australian Stations. (Check here if you want Circuit Diagram)

Name.....
 Address.....
