

RADIO NEWS

REG. U.S. PAT. OFF.

NOVEMBER

25 CENTS



**"POLICE RADIO ROUTS
THE RACKETEER"**

By RALPH L. PETERS

Guaranteed QUALITY..!
...that reduces service calls!



HOW often the service calls that follow a sale overbalance the money you've made on it! TRIAD quality stops this dangerous leak in your profits. When you sell a TRIAD Tube, you're sure of the satisfaction it will give. You're sure also that it will still be giving the same trouble-free performance long months afterward. TRIAD quality is insured! A printed certificate, accompanying each tube, guarantees a minimum of six months' perfect service—or a satisfactory adjustment will be made. *Cut your service calls to a minimum*—stock TRIAD trouble-free tubes! They sell faster and easier, they assure customer satisfaction and dealer protection. They represent your greatest profit opportunity!

TRIAD MANUFACTURING CO., INC.
PAWTUCKET, R. I.

Call your jobber or write us direct for complete TRIAD information.



Tune in on the TRIADORS every Friday evening, 8 to 8:30 P.M. Eastern Standard Time, over WJZ and associated NBC Stations.

TRIAD
INSURED
RADIO TUBES

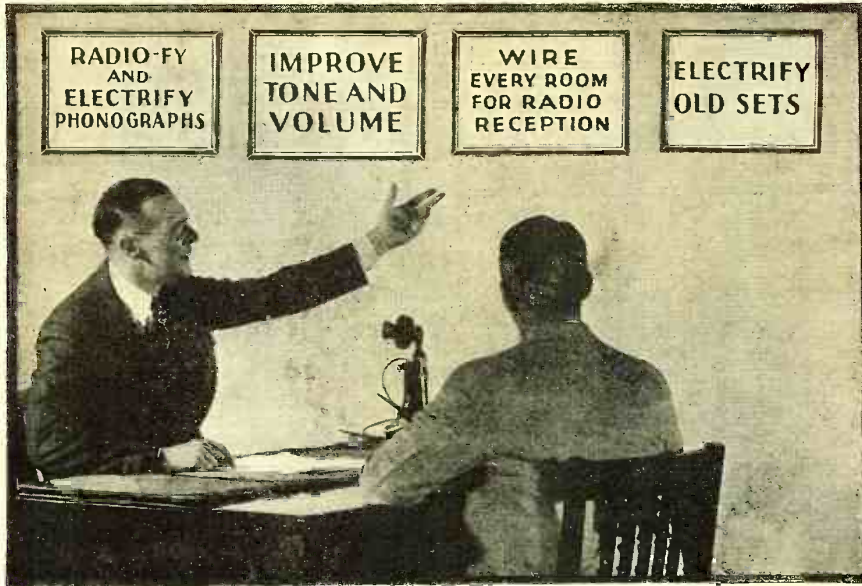

"That's But the Third of the 40 Easy Ways

— to make \$3⁰⁰ An Hour Spare Time In Radio"

Wiring rooms for Radio—as usual, our members are among the first to cash in on it, because the Association was on the job in advance of the trend, preparing its members for this newly developing easy way to make money in radio. It is but one of the many easy ways by which Association-trained men are making \$25 to \$75 a week in spare time, \$50 to \$200 a week full time—easy ways you, too, can follow.

Join with 100,000 Ambitious Men—Cash in on Radio Now

Join the Radio Training Association and take advantage of the proven ways by which you can make \$3.00 an hour upwards from the day you join. Our members are cleaning up on them and at the same time preparing for the \$10,000 to \$25,000 openings in Radio. The Association is helping men start businesses without capital, finance inventions, increase their pay, pass licensed operator's examinations, get better positions. No matter what you want out of Radio, the Association can help you get it easier and quicker. Learn what the Association has done for others and can do for you.

Act NOW...for No-Cost Membership!

A limited number of these memberships now available! Write for one today! It need not—should not—cost you a cent. Write for the inspiring story of what the Association has

done for other ambitious men. Learn how it can help you make more money now and later. Fill out and mail in the coupon now—right now—without fail.

RADIO TRAINING ASSOCIATION OF AMERICA
4513 Ravenswood Avenue ▲ ▲ Chicago, Illinois

Do You Know That —

- 20,000,000 sets are waiting to be modernized?
- over \$200,000,000 will be spent on them by their owners?
- every phonograph owner is a prospect for the services of an Association member?
- our Free Radio Hand-book will open your eyes?

Mail Coupon for FREE Radio Hand-book



In 2 Months Made Factory Manager at 300% Pay Increase

H. L. Schweber, Ill. — "After graduating I secured a position with a large Radio manufacturer. In two months I was given complete charge of a factory. My income has increased 300% since I joined the Association."

Clears \$3,000.00

Frank J. Deutch, Pa. — "Since joining the Association I have cleared nearly \$3,000.00. I don't see how a man can fail, no matter how little education he has, if he follows your easy ways of making money."

\$1,100.00 In 6 Weeks

J. R. Allen, Calif. — "Have done over \$1,100.00 worth of business in the last 6 weeks. Next month I'm going to open a store. Never knew money could come so fast and easy."

\$32.00 In 2 Days

F. G. Gentner, Pa. — "I thought I was doing well last month in spare-time work, but the first two days of this month I have made \$32.00. Since joining I have started a bank account."

Radio Training Association of America
Dept. RN-11, 4513 Ravenswood Ave., Chicago, Ill.
Gentlemen: Please send me full details of your special No-Cost Membership Plan, and a copy of your Radio Handbook.

Name _____
Address _____
City _____ State _____

Radio News

Vol. XI

CONTENTS FOR NOVEMBER, 1929

No. 5

JOHN B. BRENNAN, JR.
Technical Editor

ARTHUR H. LYNCH, Editorial Director
W. THOMSON LEES
Managing Editor

EDWARD W. WILBY
Associate Editor

In Radio News Next Month

WITH the tremendous swing to all a.c.-operated receivers, the dweller in city areas where the house lighting supply is direct current has been distinctly out of luck. The receiver which will be described in next month's RADIO NEWS is an answer to that problem. Free from tricky dodges, easily constructed from standard parts, it gives the d.c.-dweller quality reception without batteries at the turn of a switch.

THE boating season is still on, in Southern waters; while for Northerners next Spring is just around the corner. If you're a cruiser enthusiast, don't miss the account of the work of the RADIO NEWS Floating Laboratory—in this issue and in the issues to follow.

AUTOMATIC volume control—short-wave developments—trade news—band-pass filters for superheterodynes—new equipment available for the serviceman and experimenter—how to install speech amplifier systems . . . these are only a few of the many subjects scheduled for the December issue of RADIO NEWS.

	PAGE
Cover—From a Painting by Howard V. Brown	
Frontispiece: Dr. Hugo Eckener, Pilot Extraordinary	388
Editorial: Ballyhoo and Bunk!	396
A Ham Set DeLuxe	398
<small>LESTER SPANGENBERG'S 200-Watt Crystal-Controlled Transmitter is a real outfit.</small>	
Police Radio Routs Racketeers	400
<small>RALPH L. PETERS describes Detroit's radio-equipped police cars and what they have accomplished in a year's service.</small>	
Practical Pointers on Sound Amplifier Installations	404
<small>S. GORDON TAYLOR, in this fourth article of his series, gives some valuable hints to the serviceman.</small>	
A Push-Pull Short-Wave Tuner Circuit	407
<small>THOMAS A. MARSHALL gives constructional details of the unique circuit which gets down to as low as seven-meter wavelength.</small>	
RADIO NEWS Tribute to Dr. Eckener	409
The Symphony in Brass	410
<small>P. H. W. DIXON presents—with the aid of Artist Ricca—highlights in the career of EDWIN FRANKO GOLDMAN.</small>	
An Experimental Small-Boat Receiver	412
<small>The Floating Laboratory gives an account of its work.</small>	
Television Abroad	416
<small>DR. ING. WALTER REISSER gives an account of the Television system of von Mihaly, as compared with the Baird system.</small>	
The Band-Pass for Tuned Radio Frequency Circuits	419
<small>JOHN RIDER, in this second article of his series, gives the theory as well as constructional data of t.r.f. band-pass filters.</small>	
Handling 54 Messages an Hour on the World's Fastest Liner	422
<small>By WILLIAM H. MATTHEWS.</small>	
A Short-Wave Transmitter That Fits the Average Home and Purse	424
<small>LIEUT. WILLIAM H. WENSTROM shows how to construct a low-cost transmitter that takes little space.</small>	
"Public Interest, Convenience and Necessity?"	428
<small>How well has the Federal Radio Commission done its job?</small>	
High Quality at Low Cost	430
<small>The Technical Staff gives full constructional details on a single-stage push-pull 71A and "B" supply.</small>	
Why the Baffle?	432
<small>JAMES MARTIN describes its functions and how it should be designed and installed.</small>	
The Calculation and Design of Voltage Dividers	435
<small>JOSEPH CALCATERRA shows how to take the mystery and guesswork out of B-power calculations.</small>	
What the Screen-Grid Tube Means to Volume Control	438
<small>By JAMES MILLEN and GLENN H. BROWNING.</small>	
The Junior Radio Guild	440
A Complete A.C.-Operated Short-Wave Receiver	442
<small>By H. S. KNOWLES.</small>	
Some Refinements for the S-W Four	443
The Radio Forum	444
<small>A meeting place for the experimenter, serviceman, and short-wave enthusiast.</small>	
The Trade Announces	449
<small>New equipment and manufacturing trends.</small>	

Published Monthly by the Experimenter Publications, Inc., at 184-10 Jamaica Ave., Jamaica, N. Y.

Member: Audit Bureau of Circulations

B. A. MACKINNON, President

H. K. FLY, Vice-President and Treasurer

Entered as Second-Class Matter at Jamaica, N. Y., under Act of March 3, 1879.

Executive and Editorial Offices, 381 Fourth Ave., New York, N. Y.

RADIO NEWS is published monthly, on the tenth day of each month preceding that of date. Entered as second-class matter at the postoffice, Jamaica, N. Y., under the act of March 3, 1879. Copyrighted 1929 by Experimenter Publications, Inc.; title

registered U. S. Patent Office. Subscription price \$2.50 a year; \$3.00 in Canada and foreign countries. Single copies, 25 cents each. The contents of RADIO NEWS are indexed in the Industrial Arts Index.

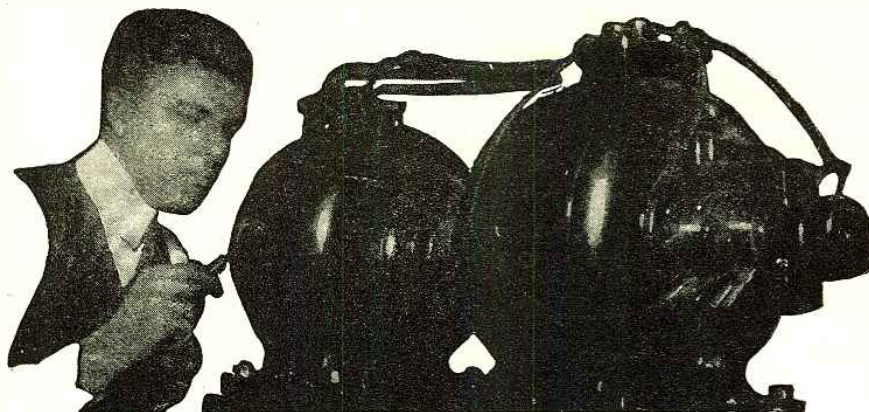

Amazingly Easy Way to get into ELECTRICITY

Don't spend your life waiting for \$5 raises in a dull, hopeless job. Now . . . and forever . . . say good-bye to 25 and 35 dollars a week. Let me show you how to qualify for jobs leading to salaries of \$50, \$60 and up, a week, in Electricity—NOT by correspondence, but by an amazing way to teach, that makes you an electrical expert in 90 days! Getting into Electricity is far easier than you imagine!

Learn Without Lessons in 90 DAYS

Lack of experience—age, or advanced education bars no one. I don't care if you don't know an armature from an air brake—I don't expect you to! I don't care if you're 16 years old or 48—it makes no difference! Don't let lack of money stop you. Most of the men at Coyne have no more money than you have.

Railroad Fare Allowed

I will allow your railroad fare to Chicago, and if you should need part-time work I'll assist you to it. Then, in 12 brief weeks, in the great roaring shops of Coyne, I train you as you never dreamed you could be trained . . . on the greatest outlay of electrical apparatus ever assembled in any electrical school . . . costing hundreds of thousands of dollars . . . real dynamos, engines, power plants, autos, switchboards, transmitting stations . . . everything from doorbells to farm power and lighting . . . full-sized . . . in full operation every day!

No Books—No Printed Lessons

No books, no baffling charts . . . all real actual work . . . right here in the great Coyne school . . . building



Prepare for Jobs Like These

Here are a few of hundreds of positions open to Coyne-trained men. Our free employment bureau gives you lifetime employment service.

- Armature Expert, to \$100 a Wk.
- Substation Operator \$60 a Week and up
- Auto Electrician \$110 a Week
- Inventor Unlimited
- Maintenance Engineer up to \$150 a Week
- Service Station Owner up to \$200 a Week
- Radio Expert up to \$100 a Week

Now in Our New Home

This is our new, fire-proof, modern home wherein is installed thousands of dollars' worth of the newest and most modern Electrical Equipment of all kinds. We now have the largest amount of floor space devoted to the exclusive teaching of practical electricity in the world. Every comfort and convenience has been arranged to make you happy and contented during your training.

real batteries . . . winding real armatures, operating real motors, dynamos and generators, wiring houses, etc., etc. That's a glimpse of how we make you a master practical electrician in 90 days, teaching you far more than the average ordinary electrician ever knows and fitting you to step into jobs leading to big pay immediately after graduation. Here, in this world-famous *Parent school*—and nowhere else in the world—can you get such training!

Jobs—Pay—Future

Don't worry about a job, Coyne training settles the job question for life. Demand for Coyne men often exceeds the supply. Our

employment bureau gives you a lifetime service. Two weeks after graduation, Clyde F. Hart got a position as electrician for the Great Western Railroad at over \$100 a week. That's not unusual. We can point to Coyne men making up to \$600 a month. \$60 a week is only the beginning of your opportunity. You can go into radio, battery, or automotive electrical business for yourself and make up to \$15,000 a year.

GET THE FACTS

Coyne is your one great chance to get into electricity. Every obstacle is removed. This school is 30 years old—Coyne training is tested—proven beyond all doubt—endorsed by many large electrical concerns. You can find out everything absolutely free. Simply mail the coupon and let me send you the big, free Coyne book of 150 photographs . . . facts . . . jobs . . . salaries . . . opportunities. Tells you how many earn expenses while training and how we assist our graduates in the field. This does not obligate you. So act at once. Just mail coupon.

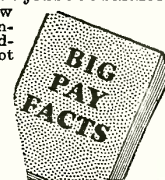

Get This FREE Book

Mr. H. C. LEWIS, President
COYNE ELECTRICAL SCHOOL, Dept. 89-27
500 S. Paulina St., Chicago, Ill.

Dear Mr. Lewis:
Without obligation send me your big free catalog and all details of Railroad Fare to Chicago, Free Employment Service, Radio, Aviation Electricity, and Automotive Courses, and how I can "earn while learning."

Name.....
Address.....
City..... State.....

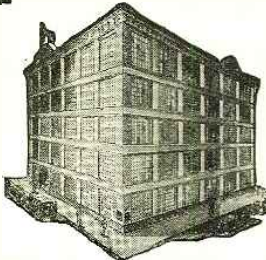

COYNE ELECTRICAL SCHOOL
H. C. LEWIS, Pres. Established 1899
500 S. Paulina Street • Dept. 89-27 • Chicago, Illinois



© International

DR. HUGO ECKENER, after the completion of his record-breaking feat in piloting the *Graf Zeppelin* around the world, attending the Aeronautical Exposition at Cleveland, Ohio.

Just prior to the gallant commander's departure from these shores, RADIO NEWS had the honor to present him with the original painting from which our August 1929 cover was reproduced (See page 409).

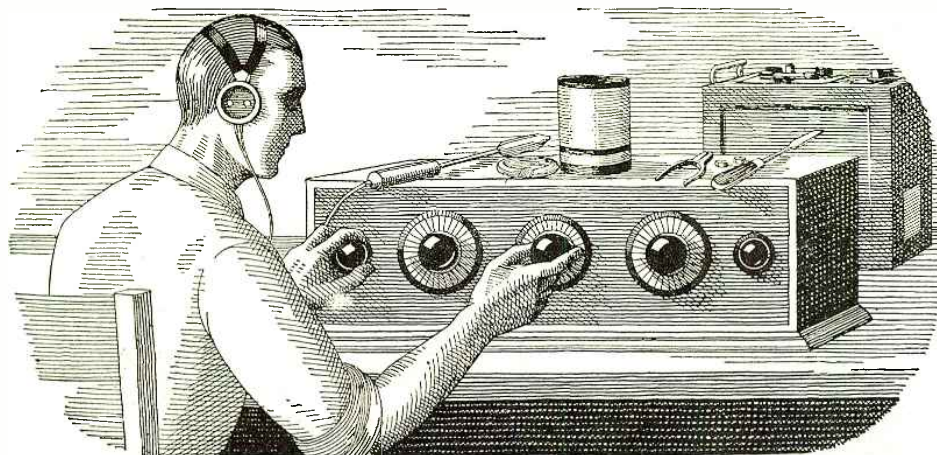

If all the Radio sets I've "fooled" with in my time were piled on top of each other, they'd reach about halfway to Mars. The trouble with me was that I thought I knew so much about Radio that I really didn't know the first thing. I thought Radio was a plaything—that was all I could see in it for me.

I Thought Radio Was a Plaything

But Now My Eyes Are Opened, And I'm Making Over \$100 a Week!

FIFTY DOLLARS A WEEK! Man alive, just one year ago a salary that big would have been the height of my ambition.

Twelve months ago I was scrimping along on starvation wages, just barely making both ends meet. It was the same old story—a little job, a salary just as small as the job—while I myself had been dragging along in the rut so long I couldn't see over the sides.

If you'd told me a year ago that in twelve months' time I would be making \$100 and more every week in the Radio business—whew! I know I'd have thought you were crazy. But that's the sort of money I'm pulling down right now—and in the future I expect even more. Why only today—

But I'm getting ahead of my story. I was hard up a year ago because I was kidding myself, that's all—not because I had to be. I could have been holding then the same sort of job I'm holding now, if I'd only been wise to myself. If you've fooled around with Radio, but never thought of it as a serious business, maybe you're in just the same boat I was. If so, you'll want to read how my eyes were opened for me.

WHEN broadcasting first became the rage, several years ago, I first began my dabbling with the new art of Radio. I was "nuts" about the subject, like many thousands of other fellows all over the country. And no wonder! There's a fascination—something that grabs hold of a fellow—about twirling a little knob and suddenly listening to a voice speaking a thousand miles away! Twirling it a little more and listening to the mysterious dots and dashes of steamers far at sea. Even today I get a thrill from this strange force. In those days, many times I stayed up almost the whole night trying for DX. Many times I missed supper because I couldn't be dragged away from the latest circuit I was trying out.

I never seemed to get very far with it, though. I used to read the Radio magazines and occasionally a Radio book, but I never understood the subject very clearly, and lots of things I didn't see through at all. So, up to a year ago, I was just a dabbler—I thought Radio was a plaything. I never realized what an enormous, fast-growing

industry Radio had come to be—employing thousands and thousands of trained men. I usually stayed home in the evenings after work, because I didn't make enough money to go out very much. And generally during the evening I'd tinker a little with Radio—a set of my own or some friend's. I even made a little spare change this way, which helped a lot, but I didn't know enough to go very far with such work.

And as for the idea that a splendid Radio job might be mine, if I made a little effort to prepare for it—such an idea never entered my mind. When a friend suggested it to me one year ago, I laughed at him.

"You're kidding me," I said.
"I'm not," he replied. "Take a look at this ad."

HE pointed to a page ad in a magazine, an advertisement I'd seen many times but just passed up without thinking, never dreaming it applied to me. This time I read the ad carefully. It told of many big opportunities for trained men to succeed in the great new Radio field. With the advertisement was a coupon offering a big free book full of information. I sent the coupon in, and in a few days received a handsome 64-page book, printed in two colors, telling all about the opportunities in the Radio field, and how a man can prepare quickly and easily at home to take advantage of these opportunities. Well, it was a revelation to me. I read the book carefully, and when I finished it I made my decision.

What's happened in the twelve months since that day, as I've already told you, seems almost like a dream to me now. For ten of those twelve months, I've had a Radio business of my own. At first, of course, I started it as a little proposition on the side, under the guidance of the National Radio Institute, the outfit that gave me my Radio training. It wasn't long before I was getting so much to do in the Radio line that I quit my measly little clerical job and devoted my full time to my Radio business.

SINCE that time I've gone right on up, always under the watchful guidance of my friends at the National Radio Institute. They would have given me just as much help, too, if I had wanted to follow some other line of Radio besides building my own

retail business—such as broadcasting, manufacturing, experimenting, sea operating, or any one of the score of lines they prepare you for. And to think that until that day I sent for their eye-opening book, I'd been wailing "I never had a chance!"

NOW I'm making, as I told you before, over \$100 a week. And I know the future holds even more, for Radio is one of the most progressive, fastest-growing businesses in the world today. And it's work that I like—work a man can get interested in. Here's a real tip. You may not be as bad off as I was. But think it over—are you satisfied? Are you making enough money, at work that you like? Would you sign a contract to stay where you are now for the next ten years—making the same money? If not, you'd better be doing something about it instead of drifting.

This new Radio game is a live-wire field of golden rewards. The work in any of the 20 different lines of Radio is fascinating, absorbing, well paid. The National Radio Institute—oldest and largest Radio home-study school in the world—will train you inexpensively in your own home to know Radio from A to Z and to increase your earnings in the Radio field.

TAKE another tip—No matter what your plans are, no matter how much or how little you know about Radio—clip the coupon below and look their free book over. It is filled with interesting facts, figures and photos, and the information it will give you is worth a few minutes of anybody's time. You will place yourself under no obligation—the book is free, and is gladly sent to anyone who wants to know about Radio. Just address J. E. Smith, President National Radio Institute, Dept. 9YTT, Washington, D. C.

**J. E. SMITH, President
National Radio Institute
Dept. 9YTT, Washington, D. C.**

Dear Mr. Smith:

Please send me your 64-page free book, printed in two colors, giving all information about the opportunities in Radio and how I can learn quickly and easily at home to take advantage of them. I understand this request places me under no obligation, and that no salesman will call on me.

Name

Address

Town State.....

Occupation

THE FINE THINGS ARE HAND MADE



SCOTT CUSTOM

**NATION WIDE
FROM A SEED PLANTED FOUR YEARS
LISHED THE WORLDS RECORD FOR**

E. H. SCOTT

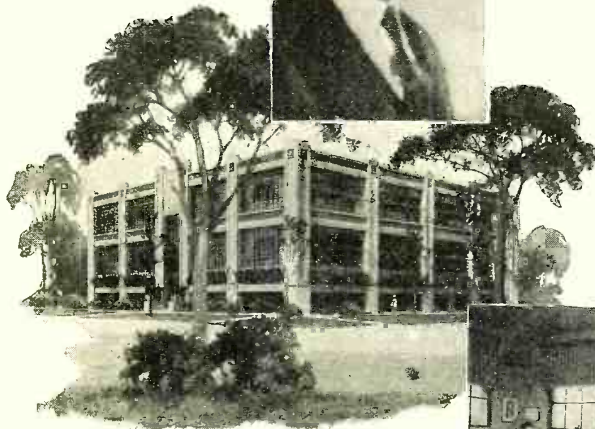

Corner of Studio

FOUR years ago, in the early days of the application of mass-production methods to radio manufacturing, E. H. Scott assumed an attitude diametrically opposed to current thought. He contended that the best product of factory methods could *never even approximate* the performance possible to obtain from a receiver custom-made in the laboratory. He gave his thought material form and the resulting instrument, which was destined to become known as the Scott World's Record Receiver, established the world's record for distant reception and the Scott records stand unapproached and uncontested to this date. 117 programs, all 6,000 to 8,000 miles away were received during the thirteen week test period. All were verified.

The idea of custom-built radio made an instant appeal to people who wanted what the best of the "ordinary" sets could not give them—and these people were will-

The World's Records Held by Scott Radio

We repeat our challenge to ANY Radio Manufacturer to show a better *verified* DX record than that listed below.

1—A better record for a number of broadcasting stations heard from 6000—8000 miles distant.

- 6—Stations heard—*distance 6000 miles.*
- 7—Stations heard—*distance 7000 miles.*
- 6—Stations heard—*distance 8000 miles.*

2—A better record for number of programs heard from stations distant 6000 or more miles over a period of from one to three months.

- 19—programs from stations *8000 miles away.*
- 19—programs from stations *7000 miles away.*
- 79—programs from stations *6000 miles away.*

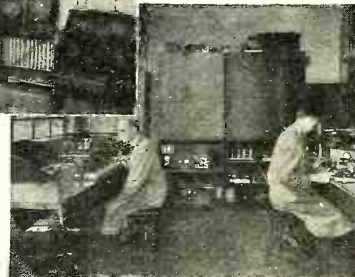
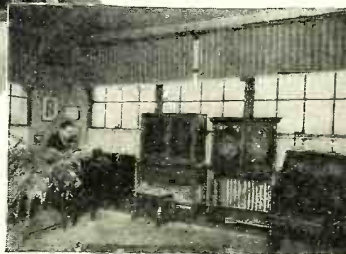

Research Laboratory

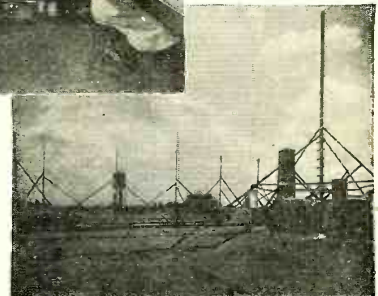

Experimental Laboratory

SCOTT TRANSFORMER COMPANY,

BUILT RADIO

INSTITUTION WHICH HAS GROWN AGO WHEN E.H. SCOTT ESTAB— RADIO RECEIVER PERFORMANCE

ing to pay for the comparatively costly laboratory method necessary to duplicate the performance of the *original* Scott World's Record Receiver. And they are still willing to pay for Scott laboratory precision—more willing than ever before. They are *eager* to pay for Scott custom-building when they experience the tremendous power, the exact selectivity and the tonal perfection made possible thereby. In fact, the market for Scott Custom-Built Radio has grown to such proportions that the Scott Laboratory, where Scott Receivers are laboratory-made, has become the greatest institution of its kind in the world.

One of the seven thousand qualified Scott sales and service representatives scattered throughout the nation will gladly discuss Scott Radio with you. The price range is between \$300 and \$8,000.

*Write for name of nearest
Scott Representative*

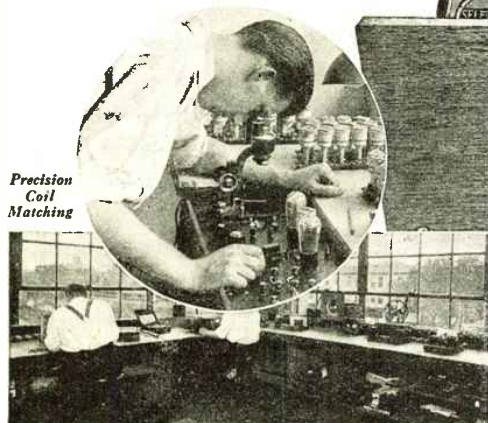

Precision
Coil
Matching

Airtest
Room



*Custom-Built
Period
Cabinets*

To exactly suit the acoustical and mechanical requirements of the Scott Custom Built Chassis, there are fifteen especially designed period cabinets. All are custom-made to the very highest standards of furniture craftsmanship and present a range of design variation adequate to suit every taste. Such fine cabinet work has never been shown in the field of radio furniture before.

Below are sketched a few of the Scott Custom-made consoles which constitute the first line of radio furniture made to the same high standard as your other home furnishings.



CORTEZ



ABBEY



NAPIER



MILFORD

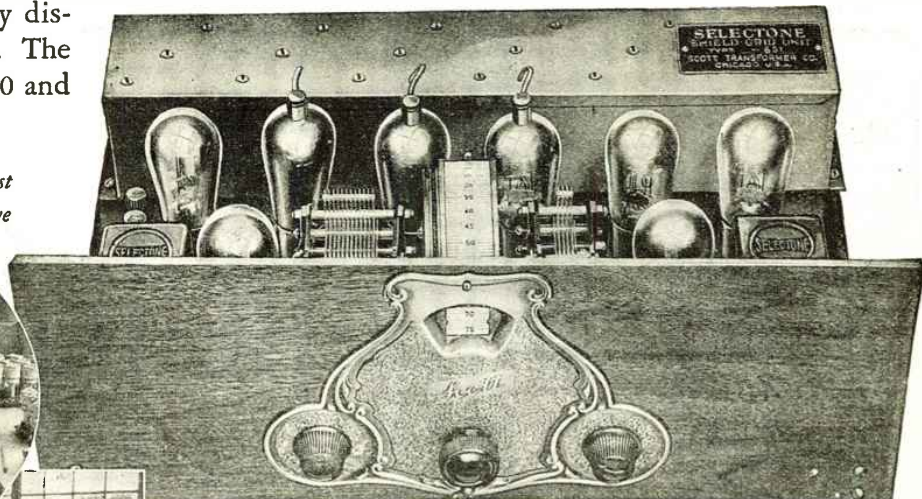

THE SCOTT A. C. SHIELD-GRID 10

The newest model of Scott World's Record Custom-Built Radio combines the advantages of world's record performance with the convenience of direct A-C operation. "All the world" is on the single dial of the SCOTT A. C. SHIELD GRID 10 and it is certain that you will not only be pleased, but thrilled and amazed at the realism of its tone.

A limited amount of unfranchised territory is still open. If you are interested in selling the best there is in radio and in operating in a protected market, write at once for qualification blank

SHORTWAVES

The World at Your Fingertips With a *Baird* Shortwave Converter

This converter, together with all other apparatus shown on this page, is the development of years of intensive experimental work by our chief engineer, Hollis Semple Baird, B.Sc.; Fellow of the Television Society of Great Britain; Member of the Television Society of America and Associate Member of the I. R. E. In offering our new models and additions to the public we honestly believe that we have done everything humanly possible to build the finest and most efficient apparatus ever offered. Get the thrill of tuning in foreign stations in the daytime. We have authentic and verified reports of customers who tune in G5SW, Chelmsford, England, PCJ Holland, etc., with consistent loud speaker volume. (These letters are on file for public inspection at any time.) To operate simply remove the detector tube from your receiver, plug the converter in its place, put a detector tube in the converter, connect your aerial to the converter and you are ready to tune in by simply operating the dial on the converter and *Baird* not tuning your receiver at all. The shortwave converter is an improvement in many ways over any other converter which has so far been offered to the public. Some *Baird* of its advantages are: .00015 SLF special variable tuning condenser, which spreads your signals over the whole dial range. *Baird* special antenna tuning condenser allows for efficient use with any type of aerial. Special volume control to prevent the usual awful squealings when tuning in a station. Cushion socket to eliminate microphonic troubles. A four-foot flexible lead for the plug in allowing ample working space. By special patent applied for method A. C. hum is entirely eliminated from A. C. models. Compact, size being only 9 1/2" x 5 1/2" x 4". 100 to 1 ratio vernier dial. Equipped with complete set of 4 OCTOCOILS, the finest and most efficient coils on the market, with a wavelength range of 16 to 225 meters.



Judge Fabyan of Brighton, Mass., logs G5SW and KGO practically every night. John Tee of Denver listens to Europe and South America. Ronald W. Brown of Stoneham, Mass., gets Australia occasionally. We do not guarantee that you will get consistent reception over five or ten thousand miles, but we do claim that with patience and careful tuning greater distances can be obtained with the shortwave converter than ever can be had with the ordinary broadcast receiver. If you have not the patience to tune carefully, systematically and patiently, do not buy this converter, as you will be disappointed. An 8-page instruction booklet, together with the latest revised list of shortwave stations all over the world, furnished with each converter.

Baird
Shortwave Converter

Complete with Four OCTOCOILS \$25.

Wavelength Range 16 to 225 Meters

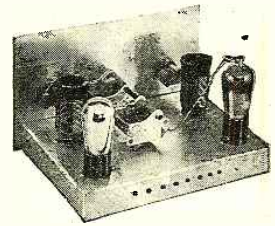

The No. 1-T Kit is a complete assembly of parts for the construction of a one-tube shortwave receiver. Can be assembled in 30 minutes. The chassis is all aluminum and the finest parts obtainable are included in this assembly. One complete set of 4 OCTOCOILS furnished with each kit. *Baird* Shortwave Kit No. 1-T. Complete with 4 Coils..... 2950



The No. 2-T Kit is a tuned antenna circuit, making it extremely desirable and simple to operate. It brings only single-dial control. Will tune unbelievable distances and pull in stations one can never hope to get with the regular broadcast receiver. Remember that the stations you can get actually give you the same quality and type of entertainment as you can get on the long waves, with the difference that you might be listening to England or Holland or even further. This kit is composed of an all-metal chassis and panel and all the component parts are of the highest quality and fully guaranteed against defects. Simple to construct and can be built in one hour. Two complete sets of ten OCTOCOILS furnished with each kit.

Baird Shortwave Kit No. 2-T. Complete with 10 Coils, 3950 16 to 550 Meters.....

Baird International Shortwave Kit No. 4-T

The *Baird* International No. 4-T Kit is composed of a detector, one stage of tuned screen grid radio frequency and two stages of audio amplification, using either 112 or 171 in the last stage. Will operate satisfactorily with loud speaker volume on practically any signal that can be pulled in. Get the thrill of hearing the chimes of Big Ben in your home every evening. All necessary parts for complete construction are included in this kit. Can be built in less than two hours. This kit is of all-metal construction. Two complete sets of ten OCTOCOILS furnished with each kit.

Baird International Shortwave Kit No. 4-T. Complete with 10 OCTOCOILS, 16 to 5950 550 Meters.....

OCTOCOILS

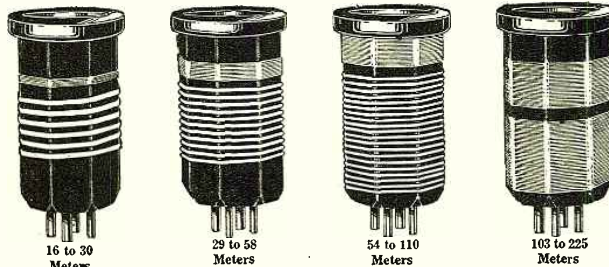

OCTOCOILS are unquestionably the finest, most rugged and most efficient shortwave coils ever designed and have been built to a standard of efficiency and appearance seldom if ever attained in commercial production. The actual size of these coils is 3 1/2" high and 1 1/2" in diameter. With OCTOCOILS and the proper receiver or converter, distance means nothing in tuning your stations. Everything worth while has been done, even Byrd in the Antarctic (from Schenectady, New York). We furnish diagrams gratis for one-tube shortwave receiver and converter and two-tube shortwave receiver and converter with screen grid radio frequency, simply for the asking. The circuit is ideally simple for the fan who wishes to build his own shortwave receiver or converter. Within an hour he can be ready to tune in anything anywhere. OCTOCOILS are made in four distinctive colors, green, brown, blue and red, on genuine bakelite moulded forms and wound with Nos. 12, 14, 16 and 25 enameled wire. Will plug into the ordinary tube socket and has a rugged rim to grasp coils so that they will not break. If you are not satisfied with their appearance and performance, we will gladly refund your money. Packed in individual boxes of the same color as the OCTOCOILS with wavelengths printed on each box. The entire set is in a special attractive container. Broadcast coil also furnished, list price \$1.25 each. These coils will also cover the 10 to 80-meter amateur bands if used with our special No. 5 condenser, list price \$1.25.

Set of Four OCTOCOILS Wavelength Range 16 to 225 Meters \$5 Per Set of Four

For those who desire the ultimate in a shortwave receiver we offer our No. 20 Super, which is composed of one stage of screen grid tuned radio frequency with power amplification for either battery or A. C. operation. This is a complete unit in itself, is built into a beautiful metal cabinet finished in green and gold and is equipped with National Illuminated vernier drum dial. Not only will this receiver work on the aerial which you now use using for your broadcast set, but it will work at the same time on the same aerial without any interference. This is a single-dial control receiver and uses the screen grid tuned antenna circuit, which is accepted by leading engineers as the method of giving the greatest possible amplification of a signal. For those who want loud speaker reception on shortwave signals with wonderful quality and simple tuning, we sincerely recommend the No. 20 *Baird* Super Shortwave Receiver.

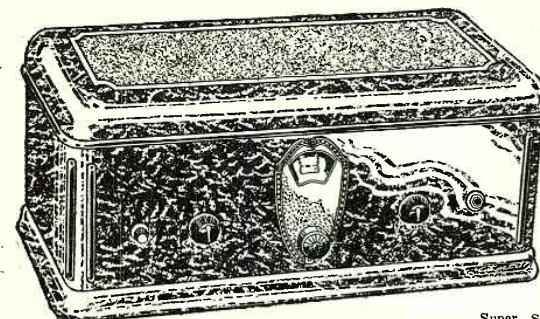

Baird Super Shortwave Receiver Battery Model, Less Equipment \$88.
Baird Super Shortwave Receiver A. C. Model, Less Tubes \$135.

TELEVISION

WATCH FOR OUR ANNOUNCEMENT IN A FORTHCOMING ISSUE OF OUR NEW TELEVISION RECEIVER—THE ONLY COMMERCIAL PRACTICAL UNIVERSAL TELEVISION RECEIVER EVER OFFERED THE PUBLIC. For further information, write.

Mfd. by **SHORTWAVE & TELEVISION LAB., Inc.**
18,000 Sq. Feet Devoted to the Manufacture of Shortwave and Television Apparatus
70 Brookline Avenue, Dept. 11
Boston, Massachusetts

TELEVISION

Shortwave & Television Laboratory, Inc.
70 Brookline Ave., Dept. 11, Boston, Mass.

Please send me

for which I enclose \$.....

as 25% deposit or \$....., which is in full payment for merchandise selected.

Name.....

St. & No..... City..... State.....

WHOLESALE PRICES



FREE RADIO CATALOG

✓ HIS new "1930"-148 page radio catalog is now ready, with all the latest radio improvements and all at wholesale prices. Hundreds of specials at remarkable figures, including the new

SCREEN GRID RADIO

From the first page to the last this book is crowded with values that will please and astound you—every radio need and requirement fulfilled in this greatest of all Radio Books.

**Standard Sets as low as
\$15.95**

Marvelous offerings in new, Humless, Screen Grid A. C. all-electric and battery operated sets; a wide range of beautiful consoles, from the small table model types to the most ornate and artistic of radio furniture; dynamic speakers of tremendous volume and richest tone; accessories, parts and kits in wide variety—in fact, everything that is standard, as well as everything that is new, in Radio. Get this book *today!* Supply your every Radio need at rock-bottom wholesale prices, and pocket the saving. Such startling values have never before been offered at like prices.

Write for This Catalog Now!



The New Screen Grid Receivers

The outstanding Screen Grid Receiver of the year featuring advanced engineering practices and a new perfection in circuit design—that is establishing a new standard in radio performance.

Humless

The use of the new heater type tubes assures freedom from hum and all extraneous noises assuring unusual tone quality.

A. C. Operated

Practical A. C. operation assures consistent performance operates directly on 110-125 volt. 50-60 cycle A. C.

Power Detector

A tuned detector stage in keeping with modern radio engineering imparts unusual power to the receiver.

"245" Push Pull

The use of two "245" super power tubes assures faithfulness in reproduction without danger of overloading.

Screen Grid Tubes

Three screen grid tubes in this famous chassis assure extreme sensitivity and remarkable distance range.

Super-Sensitive

Power detector coupled with Screen Grid R. F. efficiency imparts unusual sensitivity to the circuit assuring extreme distance range.

Dynamic Tone

Two stages of audio frequency the last employing two "245" power tubes with oversize transformers assures finest tone quality.

Tremendous Volume

Perfection in audio circuit design makes possible tremendous undistorted volume from a whisper to the full blare of an orchestra.

CHICAGO SALVAGE STOCK STORE
World's Largest Radio Store
509 So. State St. Dept. 127 Chicago, Ill.

SM

Opening Now the All-Electric Era in Short-Wave Reception

Two-Hundred-Dollar Results—\$74.75

As trim and stylish-looking a one-dial set as was ever built to "sell on looks"—yet embodying such extreme performance as only Silver-Marshall can build into a set with three screen-grid tubes, band-selector tuning, and even screen grid power detection—five times as efficient as '27 power detection. Four tuned circuits—highly shielded—an audio amplifier combining resistance coupling and 245 push-pull—complete built-in ABC power unit—chassis only 18 $\frac{3}{8}$ " by 9 $\frac{1}{2}$ "—all at the price of \$74.75 net, less tubes and cabinet, in the S-M 722 Band-Selector Seven. Tubes required: 3—'24, 1—'27, 2—'45, and 1—'80. Component parts total \$52.90 net. For use with any 90-120 volt d. c. electro-dynamic speaker. Ideal for mounting in any of the cabinets mentioned below.

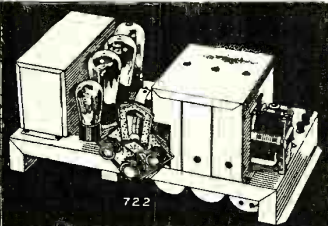

Up-To-The Minute Cabinets

S-M 707 metal shielding table cabinet in beautiful crystalline brown and gold for 722 or 735, \$7.75 net. Three beautiful console cabinets, adapted especially for mounting S-M 722, 735, or 712 with 677 by the I. A. Lund Corporation, are available from leading supply houses: see the new S-M Fall Catalog.

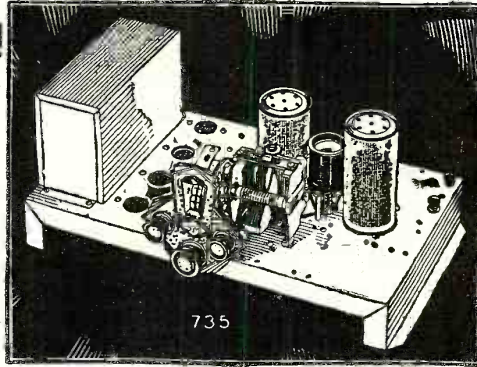

SHORT-wave reception has become the thrill-producer of modern radio—in spite of batteries and ungainly receivers with difficult control. Now, with the new S-M 735 Round-the-World Six bringing every marvel of the low-wave bands within the perfect convenience and unsurpassed neatness of installation suggested in the illustration—no one who really enjoys distance reception should be without the all-electric 735. A 224 a. c. screen-grid tube, so connected as to produce 2 $\frac{1}{2}$ times greater amplification than the '22, and a two-stage S-M audio amplifier (245 push-pull)—free from hum, even in distance reception. Four plug-in coils cover from 16.6 to 200 meters. Two extra coils (cost \$1.65) cover the broadcast band, with an altered connection built into the coil so as to greatly increase selectivity.

Yet the 735 is low-priced—\$64.90 net, wired complete with built-in power unit; the component parts total \$44.90 net. Tubes required are: 1—'24, 2—'27, 2—'45, and 1—'80.

735DC, for battery use only, \$44.80 net less tubes and cabinet. Tubes required: 1—'22, and 4—'12A. Component parts total \$26.80 net.

Either set fits perfectly in any of the cabinets referred to below.

Surpassing the Famous Sargent-Raymont Seven

You know the Sargent-Raymont Seven—universally found to be the most sensitive broadcast receiver ever developed. Here, in the new 712 Tuner, is every feature of the 710 Sargent-Raymont—the five tuned circuits, the ultra-perfect shielding—the extra-fine r. f. coils—all built into an all-electric strictly single-dial tuner, with band selector tuning and power detection. Tubes required: 1—'27, 3—'24. Completely wired in satin-finish metal shielding cabinet, less tubes, \$64.90 net. Works into any audio amplifier.

Component parts, including shielding cabinet, total \$40.90. Fits beautifully (with controls central) in any cabinet with space 18 $\frac{1}{2}$ by 9 $\frac{1}{2}$ by 7 $\frac{3}{8}$ -inch high.

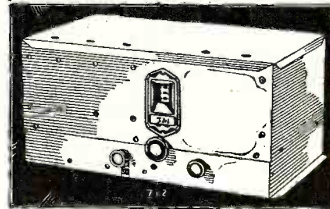

New 677 Amplifier

An ideal audio amplifier for the 712 is the new S-M 677. Fully equipped with the famous Clough system (in push-pull) the 677 takes radio or phonograph input; supplies all ABC power required for the 712 (2 $\frac{1}{2}$ volts a. c., 180 volts B). Tubes required: 1—'27, 2—'45, 1—'80. Completely wired less tubes, \$58.50 net (or for 25 cycles \$72.50). Component parts total \$43.40.

Over 3000 Authorized S-M Service Stations are being operated; many are proving highly successful and profitable. The nearest one is ready to serve you if you want a custom-built set; write us for address if you do not know it. If you build professionally and do not have the S-M Service Station franchise—write us.

Complete circuit diagrams of the 722 and 735 were first published in the RADIOBUILDER for August. Valuable suggestions on building and servicing are to be found in every issue. Use the coupon.

SILVER-MARSHALL, Inc.

6405 West 65th St., Chicago, U. S. A.

Silver-Marshall, Inc.
6405 West 65th Street, Chicago, U. S. A.
...Please send me, free, the new fall S-M Catalog; also sample copy of the Radiobuilder.
For enclosed..... in stamps, send me the following:
... \$06 Next 12 issues of The Radiobuilder
... \$1.00 Next 25 issues of The Radiobuilder
S-M DATA SHEETS as follows, at 2c each:
...No. 3. 730, 731, 732 Short-Wave Sets
...No. 4. 255, 256, etc. Audio Transformers
...No. 5. 720 Screen Grid Six Receiver
...No. 6. 740 "Coast-to-Coast" Screen Grid Four
...No. 7. 675 ABC High-Voltage Power Supply
...No. 8. 710 Sargent-Raymont Seven
...No. 9. 678 PD Phonograph-Radio Amplifier
...No. 10. 720 AC All-Electric Screen-Grid Six
...No. 12. 669 Power Unit
...No. 14. 722 Band-Selector Seven
...No. 15. 735 Round-the-World Six
...No. 16. 712 Tuner (Development from the Sargent-Raymont)
...No. 17. 677 Power Amplifier for use with 712

Name.....
Address.....

There Is No Substitute for QUALITY

Insist on ELECTRAD Voltage Controls And Be SURE of the BEST

Back of every ELECTRAD product is a world-wide reputation—a reputation gained through superior quality and service, plus right prices.

The strongest endorsement of ELECTRAD Resistances and Voltage Controls comes from radio engineers, manufacturers, and custom-set builders who *compare* before they buy.

No better proof of ELECTRAD supremacy could be found than the willingness of these men to stake the reputation of *their* products upon ELECTRAD performance.

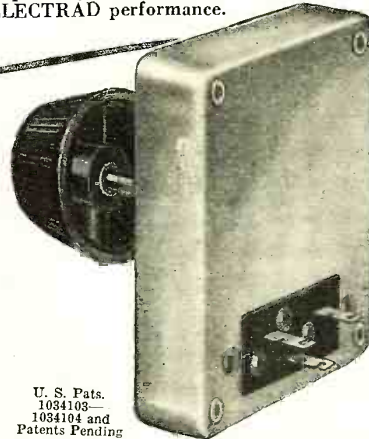

The SUPER-

The ELECTRAD heavy-duty volume control which has set new standards of efficiency and long life.

Easily dissipates 5-watts without breaking down or varying in resistance.

The resistance element is fused at high temperature to the surface of an enameled metal plate. Its pure silver floating contact of new design has an astonishingly smooth and positive action

U. S. Pats.
1034103—
1034104 and
Patents Pending

TONATROL

which *improves* with use. Laboratory tests approximating 10 years' average service amply prove its long-lasting qualities.

Metal cover, firmly riveted, aids rapid heat dissipation. Bakelite insulation.

7 types for every volume control purpose, including control of output from electrical phonograph pickups. \$2.40 to \$3.50.

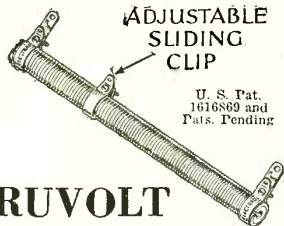

ADJUSTABLE
SLIDING
CLIP

U. S. Pat.
1616869 and
Pats. Pending

TRUVOLT

All-Wire Resistances

The SAFE resistance for eliminator and power pack use owing to its unusual stability, generous margin of safety and long life.

Patented method of open winding gives cooler operation. Nichrome resistance wire is first wound around an asbestos covered copper core. This is then wound around a fire-clay tube. The sliding clip, an *exclusive TRUVOLT feature*, enables quick adjustment of resistance value. All usual sizes.

TRUVOLT VARIABLES have same distinctive construction plus knob control and metal shield. Less wear owing to endwise travel of contact over wire. 22 stock sizes, \$2.50 each.

ROYALTY Variable High Resistances

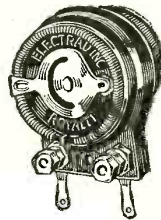

U. S. Pats.
1598658—
1034103-04

Licensed by
Technidyne
Corp.

A quality-built voltage control with many distinctive features, widely used in circuits requiring variable resistors with low self-inductance. Due to its unique patented construction, contact is more positive and absolutely free from variations due to wear.

Entire resistance range covered with one turn of the knob. 11 types, with all usual resistance ranges and ratings. Potentiometer types, \$2.00. Other types, \$1.50.

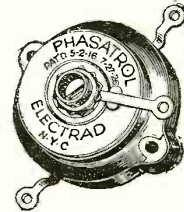

U. S. Pats.
5/2/16—
7/27/26
and Pats.
Pending

PHASATROL The Universal R. F. Balancer

A PHASATROL to each stage of R. F. amplification effectively controls oscillations and greatly simplifies balancing any radio frequency circuit, tuned or untuned. Completely eliminates R. F. distortion.

Handsome Bakelite case. Easily mounted anywhere on panel or sub-panel. Can be quickly installed without experience. Instructions for installing in different circuits packed with each PHASATROL. Price \$2.00 each.

175 Varick Street, New York, N. Y.

ELECTRAD INC.

ELECTRAD INC. Dept. RN11, 175 Varick Street, New York, N. Y.

Please Send data on the following products: Super-TONATROL TRUVOLTS ROYALTY PHASATROL All Products.

Name

Address

Ballyhoo and BUNK!

MANY a radio listener has been greatly surprised and disappointed to find that his broadcast receiver did not have a day or night three thousand-mile range. Overzealous sales folks and advertisers have made claims for this, that and the other receiver which have been "optimistic"—to use a charitable word.

Some rather ludicrous as well as some serious disputes have followed sales made on foolish claims. Similar claims are still being made. At a recent radio show in Boston, a jobber's salesman, mistaking me for a dealer and a prospect, gave me a very illuminating discourse on a new model of a really good receiver. Among other things, I learned that it was "absolutely impossible for two stations, even if working on the same wavelength, to be heard at the same time;" there was "absolute freedom from static and a station could be heard with full volume at every division on the tuning dial."

The fellow who gave me this sales talk really believed it himself and invited me to return to witness the demonstration to be held the next day. He had not heard the receiver perform. I had. It was a very good one. One of the best. It would not do the things he was claiming for it. He was building a lot of grief for himself

AT Cleveland, a few days ago, I ran into a similar circumstance. In the office of a friend of mine who is a large radio distributor, a salesman sent out by a prominent factory was dilating upon the wonders of a new short-wave receiver which had just been added to his line—a good receiver and a good line. Before the road agent was finished there was little left that this new marvel would not accomplish.

The jobber was an old-timer and knew what short-wave receivers would and would not do. He asked a few technical questions and the answers were truly wonderful. Quite obviously he was laughing up his sleeve at the new radio technique he was learning. When the interview was finished he ordered three receivers. If he had not been given a "high-powered sales talk" he would have ordered three dozen. He told me so later.

And the purpose of telling you of these two incidents is to warn you against the broadside of bunk you may expect from the ambassadors of short-wave reception during the present season.

SHORT-WAVE receivers really do some very remarkable things. They really bring Japan and Australia to your own living rooms. They offer one of the greatest opportunities for radio thrills we have, and do it at a very small cost. They open a new vista of radio utility and offer all sorts of pleasant surprises for the curious, as well as all manner of opportunity for research. Short-wave reception is subject to certain vagaries, however, which are rarely mentioned. For instance, your Japanese or English program may be accompanied by sounds which, in music, correspond to hash in food. There is so much real pleasure to be had from short-wave work that we hope the sales efforts made for them will be reasonable and not based on unsound and unwarranted claims which do more harm than good.

Arthur H. Lynch

EDITORIAL DIRECTOR

You Fellows Who Want BIG PAY Get Into

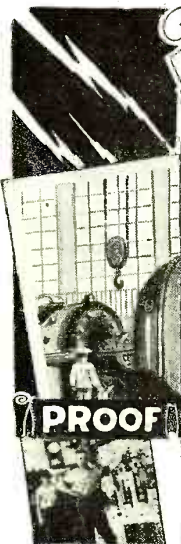
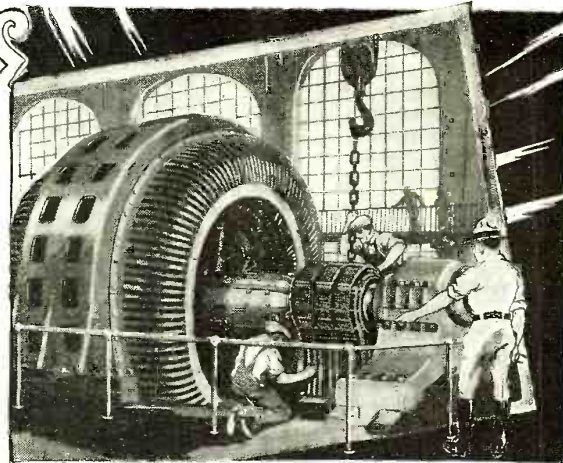

PROOF

GETS \$12,000 JOB
Dear Mr. Cooke: Since finishing your Course I have been doing very well in my own electrical business. But recently I was offered the job of Chief Electrician for a Big Coal Mine. I took the job, at \$12,000 a year.
W. E. HUGHES
1656-2nd Avenue
Terre Haute, Ind.



MORE PROOF

\$65 A DAY
Dear Chief: If it wasn't for your wonderful course I wouldn't now be making as high as \$65 a day. It makes me proud to have your Diploma, and believe me I am a booster for your Course.
JACOB L. ENYER
1223-1st Avenue
Hillsboro, Oregon



MORE PROOF

\$150 A WEEK
Dear Mr. Cooke: My new shop is going strong, paying me now over \$100 a month above expenses. I must thank you again for my success, because it was your wonderful course and method of instruction that put me where I am.
W. E. FENCE
Box 921, Palo Alto, Calif.

**6 BIG
OUTFITS
TOOLS-APPARATUS
GIVEN**



WHY earn \$15 or \$20 or \$30 a week, when in the same six days as an Electrical Expert, you can make \$60 to \$100—and do it easier—not work half so hard. Why, then, remain in a small-pay, no-future job that offers no chance for big promotion—no chance for big income? Fit yourself for a real job. **Get into Electricity.** That's where the big money is being made, and always will be made.

Electricity — The Big Pay Field
Today even the ordinary Electrician—the "screw driver" kind—is making money—big money. But it's the trained man—the Electrical Expert—who makes the really big money—\$10 to \$20 a day—\$60 to \$100 a week. Be a Big-Pay man, yourself. Get in line, now, for one of these "Big-Pay" Jobs.

I'll Train You At Home
I'll train you at home—in your spare time. You work just as you are working now—at your same job. My now famous "Work-Sheet and Job-Ticket" method guarantees you simplified, practical training along work-shop lines. In a few short months you can step out of your old job into a new job—into electrical work where you can be a Big-Pay man in this Big-Pay field.

You Earn As You Learn
To learn Electricity my way you don't have to be a College man, or even a High School graduate. You can read. You can write. That's enough. With me, you get experience as you go along and make good money while learning. I'll show you how—and I'll give you, without extra cost tools and apparatus to work with—6 Big Outfits in all.

Money Back If Not Satisfied
That's what I agree to do. And back of me in this agreement stands the Chicago Engineering Works, a \$2,000,000 Illinois Corporation. There's nothing like "Cooke" Training, anywhere. It's the Training that Big Electrical men are praising; it's the Training that employers recommend; it's the Training that one of our greatest Engineering societies, has endorsed 100 percent. **It's the Training for you.**

If You're Earning Less Than \$70 A Week — Investigate
Don't wait a minute! Find out today why "The Cooke Trained Man is the Big-Pay Man", everywhere! Find out how "Cooke" Training will help you boost your pay! Mail coupon right now for my Big FREE Book of Facts. See the Six Big Working Outfits I give you without extra charge. See the hundreds of pictures, the proofs, the Big-Pay letters of other "Cooke" Trained Men. Get this great free Book. Send for it today. Clip, sign, and mail coupon RIGHT NOW!

L. L. COOKE, Chief Instruction Engineer
**L. L. COOKE SCHOOL
OF ELECTRICITY**
Dept. 408
2150 Lawrence Avenue
Chicago, Illinois

ELECTRICITY

*Hundreds of Men
I have trained are
now earning*

**\$60 to \$100
A WEEK**

Why don't you?

**If you
earn less
than \$70
a week—
INVESTIGATE**

**ACT
NOW**

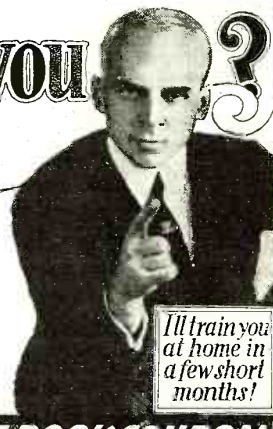

*I'll train you
at home in
a few short
months!*

Use this FREE BOOK COUPON

L. L. COOKE, Chief Instruction Engineer,
Dept. 408, 2150 Lawrence Avenue, Chicago, Illinois
Send me at once without obligation your big illustrated book "The Secrets of Success in Electricity" and complete details of your Home Training Course in Practical Electricity, including your outfit and employment service offers.
Name _____
Address _____
City _____ State _____
Residents of Canada may send coupon to R. A. Farrow, Special Representative, 7 Medbury Lane, East, Windsor, Ontario, Canada.



The "Cooke" Trained Man is the "Big Pay" Man

A Ham Set

*Lester Spangenberg's
Controlled
Is a Real*

Below is a rear view of the transmitter unit, showing the various pieces of apparatus of the several sections, while to the left is a rear view of the power-supply rack

The photographs on this page of Mr. Spangenberg's 200-watt crystal controlled short-wave transmitter give sufficient detail of the mode of construction employed to enable the experienced and more advanced short-wave enthusiast to adopt some of the excellent ideas embodied in this outfit.

Above is shown the front view of the transmitter proper, illustrating the three shelves or sections, one for each of the frequency changes and the push-pull amplifier. To its right is shown the front view of the power-supply rack.

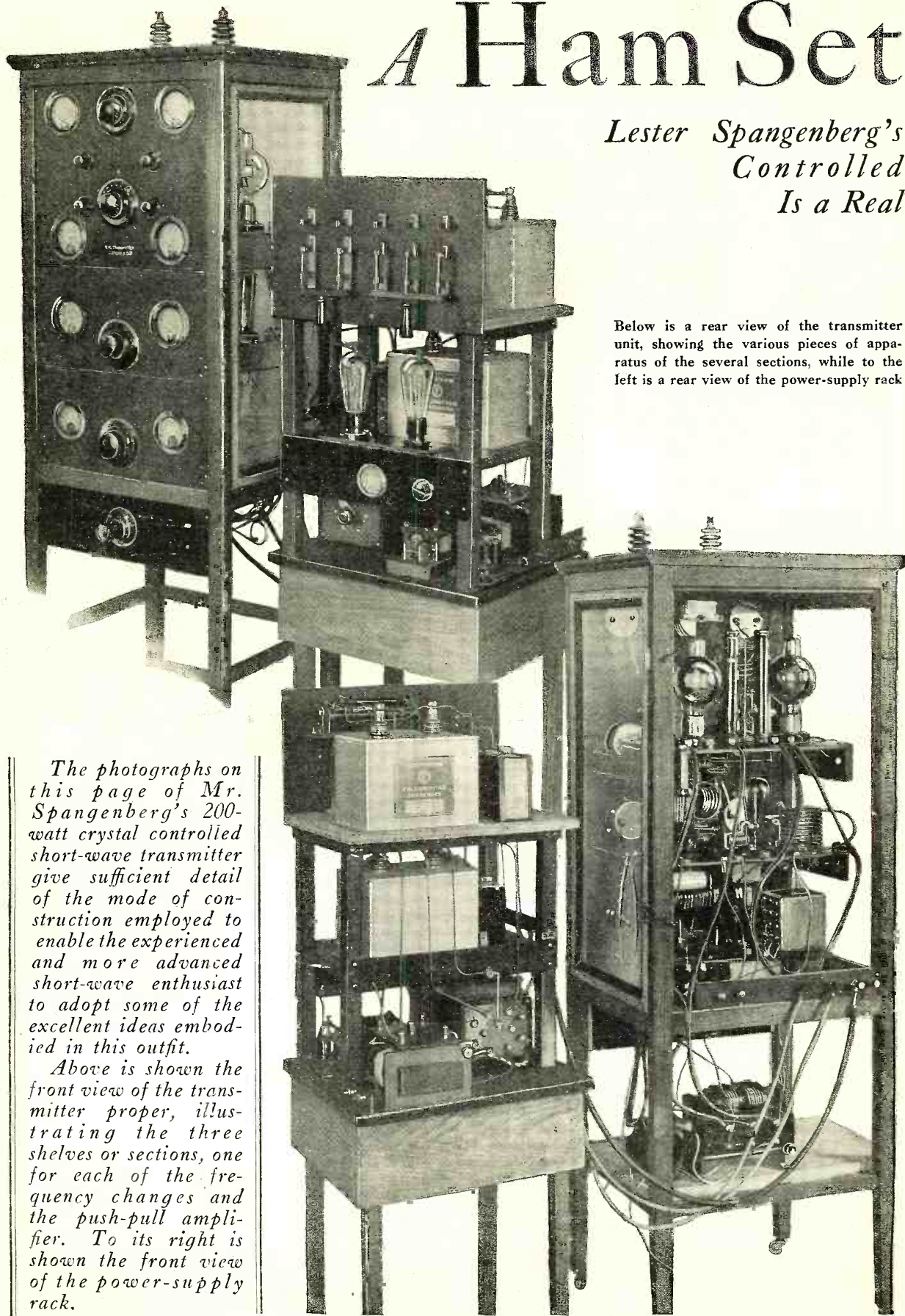

De Luxe

200 Watt Crystal Transmitter Outfit

THERE are few amateurs who have had the experience and the facilities for research at their disposal which Mr. Spangenberg has crowded into his excellent transmitter. In a single unit we have the result of many years' experience. All the experimental work has been done and here we have a finished transmitter that really works.

Mr. Spangenberg may well be ranked as one of the old-timers in amateur radio. He became a "ham" in 1906 and has been plugging along at it ever since. Lester, as most of the old timers know him, operated a station when there was little known and less published about radio; when a ham had to do some real experimenting and when carrying on a chat with a fellow in the next town was a great accomplishment. He had been a member of the American Radio Relay League from the time it started and during the war was a Radio Inspector for the U. S. Naval Radio Aircraft Section with headquarters at the Bureau of Steam Engineering, Washington, D. C.

As early as 1919 Spangenberg was operating a broadcasting transmitter, one of the first in the vicinity of New York. He is a member of the Institute of Radio Engineers and the Radio Club of America.

In the transmitter shown here, Mr. Spangenberg has incorporated everything a modern short-wave, C.W. transmitter should comprise. This transmitter is far and away ahead of the self-oscillating set of last year. And one of the unique features is the frequency doubling circuit which really came to be used because Mr. Spangenberg had two sets—one for the 7,000 kc. and one for the 14,000 kc. band, which have been combined and improved.

Consideration of the use to which the transmitter was to be put was worked right into this job and it is useful for the rapid handling of traffic as well as operating over long distances.

Experiments Leading Up to the Final Selection of Tubes

One circuit tried out by Mr. Spangenberg in designing his transmitter was made with a UX-210 tube in the 3,500 kc. band, controlled by a crystal. The frequency was doubled by the use of a 203A tube in the 7,000 kc. band which was to control the two UX-852 tubes in a push-pull circuit in the 14,000 kc. band.

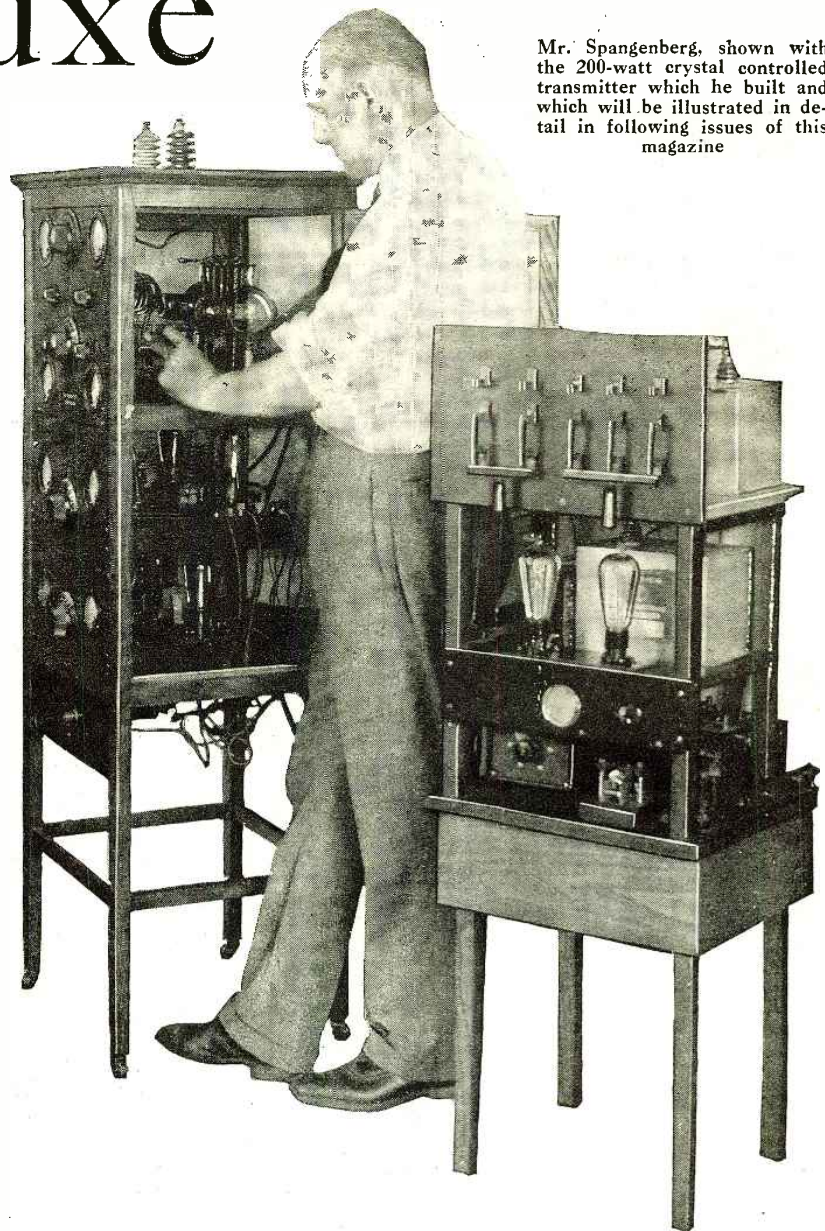

Mr. Spangenberg, shown with the 200-watt crystal controlled transmitter which he built and which will be illustrated in detail in following issues of this magazine

After a lot of experimenting it was found that the UX-203A tube would not push the two UX-852 tubes in the push-pull circuit and double the frequency at the same time. So the final arrangement which is shown here was worked out. The circuit now in use is as follows: The UX-210 tube is employed in the 3,500 kc. band and is controlled by the crystal. This frequency is fed into the next 210 tube and its accompanying frequency doubling circuit, bringing the frequency up to 7,000 kc. The second 210 feeds into the 203A in a second frequency doubling circuit and the final 14,000 kc. is then fed into the two 852 tubes in the push-pull, power-amplifier circuit, which is coupled to the antenna circuit.

Only the two frequency changers and

the push pull power amplifier are mounted in the main frame. For a clear concise understanding of the method of construction employed it is only necessary to refer to the several photographs accompanying.

Each of the above three units are mounted individually on its own shelf and is readily removable without disturbing connection to the other units.

The apparatus comprising the power supply, together with the various switches, key relay, etc., is mounted as shown as a separate unit.

This transmitter is to be the basis for a series of articles by Mr. Spangenberg, in which he will give all the details necessary for the construction of a transmitter of similar design.

At the right—Ready to step on the gas the instant an alarm is received

The illustration below shows the installation details of "A" and "B" batteries and the receiver partly removed from its case

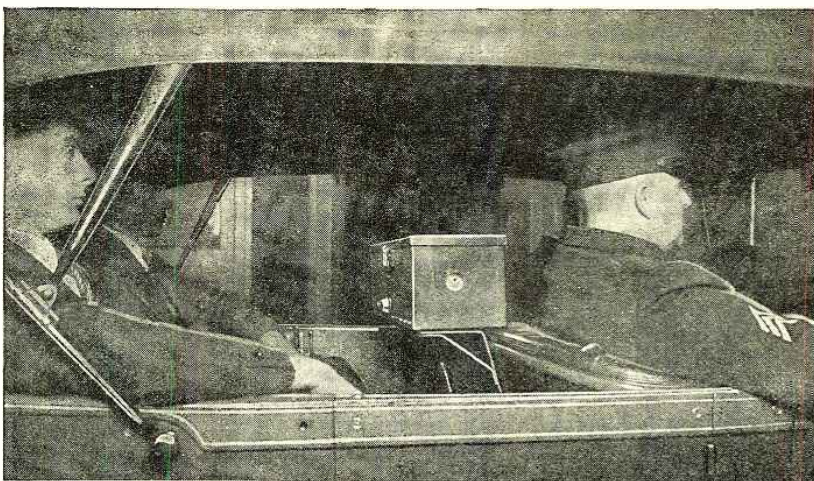
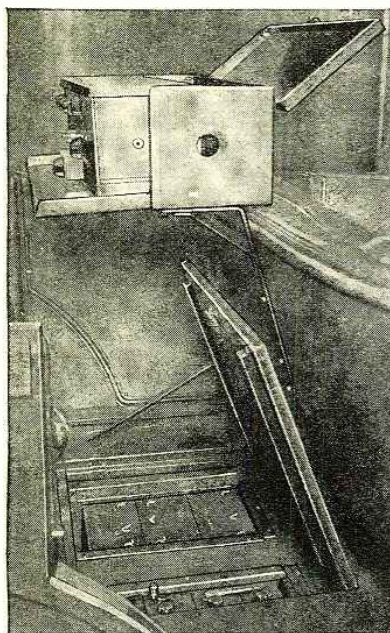

Police Radio *Routs* RACKETEERS

*A Year's Experience Proves the Value
of Detroit's Radio Police Cars*

By Ralph L. Peters

RADIO'S use as a swift and efficient police weapon in the never-ending battle against crime and the criminal has been demonstrated in an uncanny, almost unbelievable fashion during the last fifteen months by the Detroit Police Department.

Police officials predicted for years that some day radio would prove itself a valuable police ally. That day is here. Snaring criminals in a radio network woven by the police radio station and swift, powerful police automobiles equipped with receiving sets and loud speakers, has become a matter of split seconds.

The perfecting of the radio system has enabled the Detroit police to achieve arrests less than 30 seconds after the report of a crime has been given the police dispatcher.

Eight hundred arrests, at an average time of less than 90 seconds each, have been made by the radio-equipped automobiles of the Detroit police in the past fifteen months. More than 15,000 messages have been given the cars and more than half of these have been direct orders to proceed to the scene of some actual or reported crime. The balance of the messages have been descriptions of wanted and missing persons, license numbers of stolen cars, and other police information.

Burglars have been trapped in homes they were looting. Bandits have been captured or killed as they fled from hold-ups; hit-and-run drivers have been overtaken, arrested and returned to the scene where they had left hapless victims lying in the street.

Bad-check passers; "shovers" of counterfeit money; apartment-house mail-box robbers; annoyers of women; car thieves and racketeers of various sorts have all

A GROUP of men without respect for law, life or property; bent only upon "getting theirs," and getting it without work, and—if possible—without being caught at it. That is "Gangland."

An alarm reaches headquarters, of a hold-up or a burglary or other crime; in many cases, while the trail is still hot; in some cases, even while the perpetrators are still on the scene. Meanwhile, scattered about the city are squads of officers trained to handle just such a situation. By the time headquarters, in the average city, communicates the alarm to one or more of these squads, the trail is cold.

Not so, in Detroit. In that city, an alarm to headquarters is instantly conveyed to every one of the police cars which constantly patrol their routes; enabling the nearest of these cars to speed instantly to the scene.

What radio offers, as a weapon against modern Gangland, Detroit will bear witness; not in a spirit of half-baked enthusiasm, but by pointing to the actual record.

been caught by the crews of police cruisers sent speeding to the scene by orders transmitted broadcast by radio.

Small wonder that criminals of all sorts have come to view the police use of radio with fear. Seconds count with the criminal, so narrow is the margin of escape or capture. With the radio enabling the police to reach the scene while he is still engaged in a crime, or even before he actually attempts a crime, the chances of escape become poorer every day.

Four to six seconds after a report of a major crime reaches the Detroit police

every radio-equipped police automobile in the city has received the warning simultaneously—a city-wide alarm in a matter of split seconds. One or more of the cars, depending on their location at the time and the seriousness of the crime, speed off to the scene of the trouble.

The police dispatcher, seated before the switchboard at Police Headquarters, plugs in on the radio station as soon as he has received the first flash of a crime. The radio station is located miles across the city on Belle Isle, Detroit's island park in the Detroit River.

When the dispatcher thus plugs in on

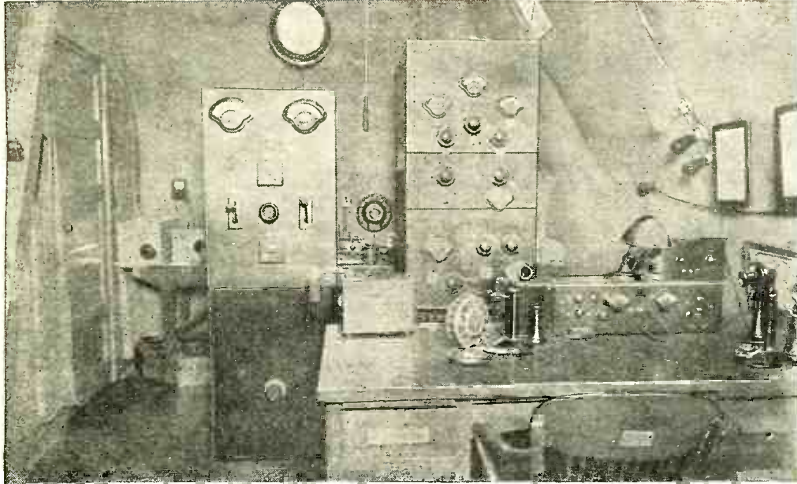

of the scene of some crime when warned by radio to proceed there. Possibly they are farther away, but the chances are that one or more of them will be within 60 to 90 seconds' running time of the crime. It wasn't so before the advent of radio. Then, it was possible to communicate with the cruisers and scout cars only when one of the members of the crew called in to report. Now, all of them receive the flash at the same instant.

At least two arrests have been made in "nothing flat." These were achieved by the No. 7 cruiser. A citizen called Police Headquarters early one morning and reported having seen two men ransacking a grocery store. No. 7 cruiser received the report at the very instant when it was turning into the street on which the store was located, just nine doors from the store itself. Before the radio operator had ceased repeating the message, the members of the cruiser crew

the switchboard, he automatically puts the station on the air. He repeats the message twice and it is then reiterated by the radio operator, to doubly insure its receipt. The messages come in clearly and succinctly to the crews of the radio-equipped cars. As they are speeding to the address given, any additional details obtainable as to the nature of the crime, the license number of the escaping car, descriptions, etc., are flashed to them.

Two types of automobiles are used. The cruisers are high-powered seven-passenger touring cars manned by a crew of four officers armed with automatic pistols, revolvers, shotguns and tear-gas bombs. The others are termed scout cars and are light cars manned by a crew of two. In between radio-flashed orders they patrol the streets of their respective districts.

The receiving sets are of the six-tube type, mounted on a steel chassis. They are tuned in on the police radio station, locked in position and then padlocked in a metal cabinet.

The crews of the patrolling automobiles have access to the volume control but can not tune the set to any other station but the police station. The aerials are mounted in the tops of the cars, being either of wire or copper screen. Both types are in use. All of the sets are built in the workrooms of Station WCK, the police radio station, by members of the radio staff. A "trouble-shooting" car is ready at a minute's notice to service the sets. Extra receiving sets are always ready for installation and the substitution is effected within a few seconds, one set being slid out of the cabinet and another slipped into position. The sets of all cruisers are tested every eight hours, and half-hourly test calls enable the crews to know whether or not their sets are working after the tour of duty has begun.

Since the department has its own station, there is no delay in putting the alarms on the air. Nothing but police work is done by the station: it has no entertainment programs. It is operated on a low wavelength, where there is less chance that any but the police sets will receive the messages.

Sometimes the cars are within a block

Over the microphone, above, go the broadcast alarms which have succeeded in gumming up the "get-aways" of Detroit's gangsters

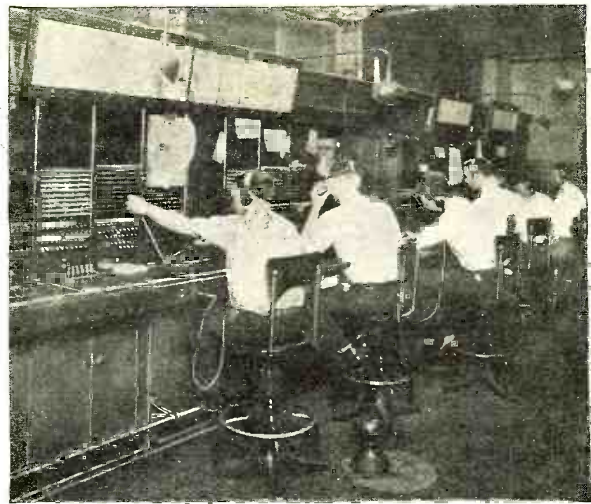

At the right the switchboard at police headquarters in Detroit. The dispatcher at the left of the illustration is plugging in on the police radio station. The act of plugging in automatically puts this station on the air

Below—William T. Rutledge, Commissioner of the Detroit Police Department, who says "Radio Communication to Police cars is the greatest development of modern times, in the prevention of crime and the apprehension of criminals"



Patrolman Robert Batts, designer of the receivers, and Sergeant Walter Vogler, in charge of the Police Radio Station at Detroit

Below—This shows how the specially designed radio receiving set is installed in the back of the front seat of the "cruiser" type of police car

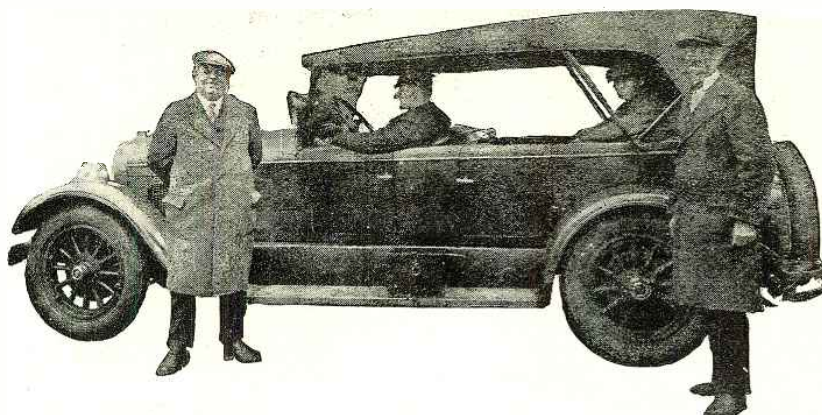
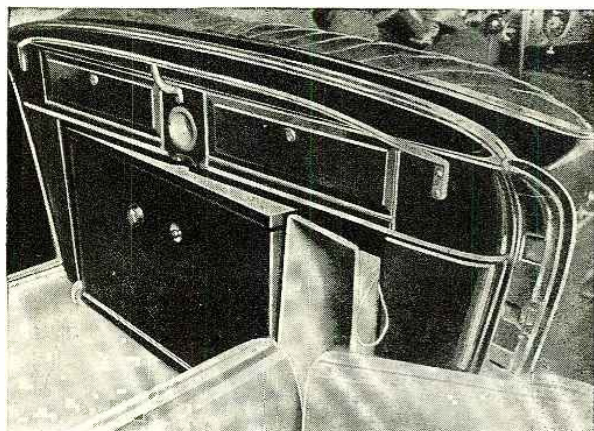
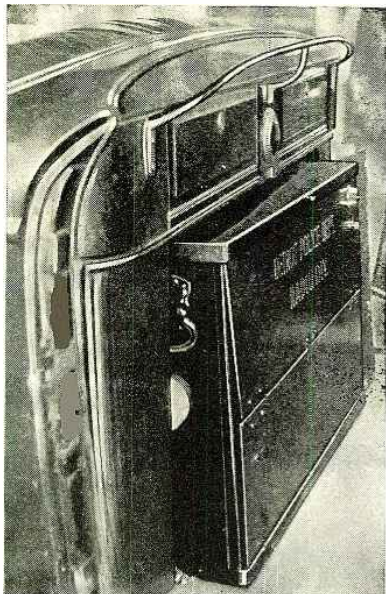

rested the man several blocks down the street in another store.

Sometimes the cruisers run a race to the scene of some crime. No. 9 and No. 7 cruisers staged such a race recently.

No. 9 picked up a report a prowler was in a house. The cruiser headed for the address at once. No. 7 cruiser was within a few blocks of the address and also headed for the scene. No. 7 made the run in 90 seconds and trapped the prowler in the house. No. 9, having been at the far end of its territory at the time the alarm was sounded, reached the house

These cars cover regular territories in various parts of the city and are ready for instant dispatching to any point by means of the centralized radio communication

still refused to halt. No. 9 reached the scene in 90 seconds, but there was nothing left to do but take the wounded man to the hospital.

Even more spectacular was the round-up of five store burglars by the crews of the No. 5 and No. 7 cruisers. Four minutes before midnight, an excited citizen called Police Headquarters and reported he had seen three men in a grocery store near a certain street intersection, three blocks from the corner. He did not have the address of the store nor did he designate which corner it was near.

The dispatcher ordered No. 5 to the scene. Arriving there, the crew separated, one man going to each corner. One of the four found the rear door of a store open. Inside the store he saw three dark figures. It was one man against three, but in he went. One of the three was captured. The others leaped through a front window and fled.

The officer reported at once to the radio station, asking that all cruisers be notified to be on the watch for two youths with cut and bleeding hands and faces. He also had obtained a brief description of the pair. The alarm was sounded. A few minutes later a taxicab sped past No. 7 cruiser. Suspicious, the cruiser crew set out in pursuit. The cab was overhauled and forced to the curb. Inside were two youths. Their hands and faces were cut and bleeding. In their pockets was a quantity of small change. They admitted having escaped from the store and named two other youths that had been implicated with the three of them in other store burglaries. These two also were arrested.

Crimes actually are prevented by the speed of the radio-dispatched cruisers. Recently No. 9 was given an alarm a man with a gun had been seen entering a drug-store. The cruiser reached the store in 30 seconds and arrested the suspect. He was armed but had not yet held up the store.

Three men in a large sedan were seen parked in front of a grocery store recently. Their actions aroused the suspicion of an alert shopkeeper, who called

At the left, note how the loud-speaker horn is placed in this "cruiser" installation. In the scout type car shown at the beginning of this article, the loud-speaker is placed overhead

had surrounded the store and captured the prowlers.

Not many weeks ago, No. 5 cruiser was dispatched to a coal office that had been held up. The run was made in 90 seconds but the bandit had fled. The cruiser crew quickly obtained a description of the man and started circling the block. The bandit was sighted running down an alley. Off sped the cruiser in pursuit. The bandit was ordered to halt. He attempted to clamber over a fence as the officers opened fire. He fell lifeless. In his pockets were found a revolver and the money taken in the hold-up.

It was No. 5 cruiser, also, that apprehended a bad-check worker within three minutes after the police had been told of his attempts to defraud several storekeepers. The cruiser crew obtained a description of the suspect from the storekeeper who had called the police and ar-

rested the man several blocks down the street in another store.

No. 9 and No. 8 cruisers participated in a similar case recently. No. 8 was given a report a man was attempting to enter a house. The run was made in 90 seconds, but the prowler had gone. The crew began a search of the neighborhood. A few minutes later No. 9 cruiser was given a report of a prowler. The new address was only three blocks from the first.

No. 8 cruiser raced off to the new address, arriving there in 30 seconds. A man slipped from between two houses. The cruiser crew ordered him to halt. He broke into a run, stopped and reached for his hip, warning the officers not to follow him.

Two officers opened fire. He renewed his flight. The men in the cruiser sped after him and shot him down when he

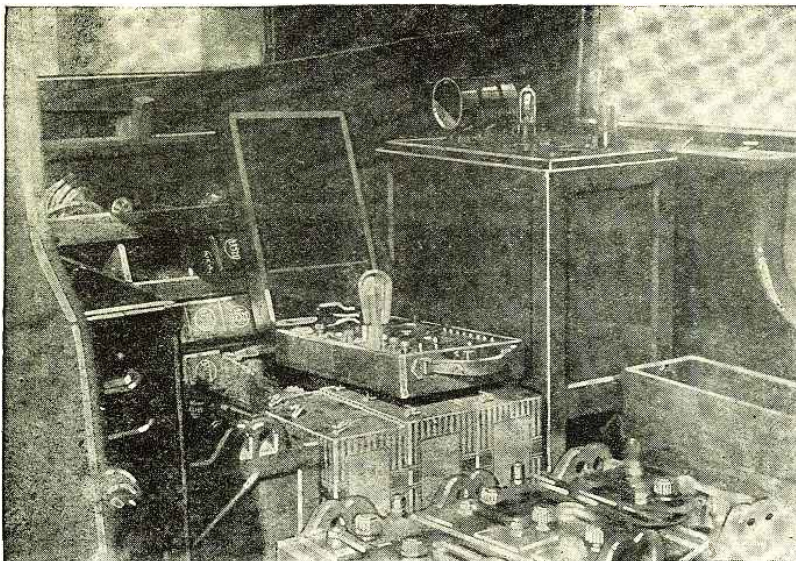

Below—A busy corner of the workroom at Station WCK, the Detroit Police Department Radio Station. All of the police sets are built in the workrooms of the station by members of the radio staff

Half hourly test calls enable the crews to know whether or not their receivers are functioning, and the sets are given a test every eight hours; extra receiving sets being always ready for substitution, which is a matter of only a few seconds

the police. No. 15 cruiser went roaring off to the scene. The cruiser crew spotted the three suspects less than two minutes after getting the message. The trio was parked in front of a store, scrutinizing its interior at length. They drove on down the street, parked in front of another store and repeated their actions. One of the three turned and saw the cruiser slipping down upon them. The suspects' car sped off with the cruiser in headlong pursuit.

As the fleeing trio swung around a corner, one of them tossed an automatic pistol from the car. Less than a block farther on a revolver was flung from the car. Still the pursuit continued. The car was forced to the curb. The three leaped from their car and attempted to flee but found themselves facing the weapons of the cruiser crew. They were identified later as gasoline station bandits. The car they had been driving had been stolen several weeks before.

All of these are actual instances taken from the log book of Station WCK. The list might be continued indefinitely, but those cited will explain why Commissioner William P. Rutledge, of the Detroit Police, a pioneer and prophet in the police use of radio, spoke as he did recently before the annual convention of the International Association of Chiefs of Police, meeting at Atlanta, Ga.

"Radio communication to police cars is the greatest development of modern times in the prevention of crime and the apprehension of criminals," he said. "It is the most forward step taken since I entered the profession thirty-five years ago."

The results in Detroit were not obtained overnight. Ten years of experimentation, trial and disappointment lay behind the present record. Ten years ago police officials all over the country were talking about and experimenting with radio. Bit by bit the enthusiasm waned and in most cities died entirely.

The Detroit police had a station and one cruiser in operation in 1921. The station was operated intermittently and with varying success down to the spring of 1927, when Commissioner Rutledge

Above—The interior of the troubleshooting car which services the Detroit Police radio-equipped scout and cruiser cars

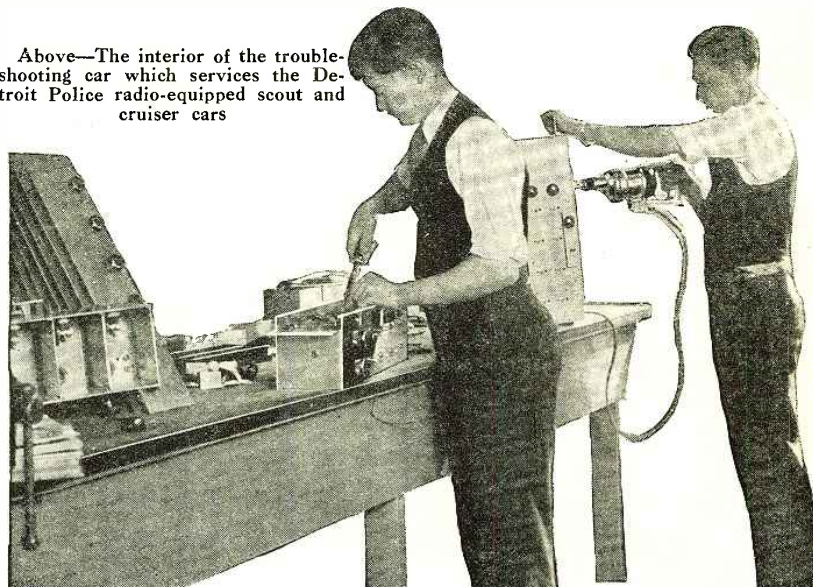

ordered it closed because the results had been unsatisfactory. He was disappointed but not ready to give up. When some one suggested the equipment be sold he refused, saying he would find some one who would achieve the results he wanted.

In the fall of 1927 a patrolman by the name of Kenneth Cox, attached to the traffic violations bureau, asked for permission to try his hand at the radio system. He was given the opportunity with the assistance of a capable staff. Patrolman Robert Batts designed a new type receiver for the police cars. Patrolmen Bernard Fitzgerald and Walter Vogler tore down and rebuilt the station's transmitter. The station was reopened in April, 1928. The rest is police history. Cox was made a sergeant and later given leave of absence to go to Chicago to perfect the Chicago Police Department's radio system. He was succeeded in Detroit by Sergt. Vogler.

The success obtained in Detroit has led other cities to renew their interest in

the police use of radio. Even Scotland Yard has sent a letter of inquiry to the Detroit police for details. Additional police radio systems have actually been placed in operation or are contemplated in Chicago, Cleveland, Buffalo, Berkeley, Cal., Highland Park, Mich., and other points.

Commissioner Rutledge and other police officials now vision the day when the police use of radio will be nation-wide. Commissioner Rutledge also predicts it will not be long before every patrolman walking a beat will be equipped with a receiving set. Perhaps that day is not so far distant.

At this moment, having proved the efficiency of radio-equipped and dispatched automobiles, the Detroit Police Department is experimenting with a compact receiving set designed for the use of the individual patrolman. When it is perfected instantaneous communication with every police officer in the city will be possible.

PRACTICAL POINTERS ON

Sound Amplifier

The Radio Serviceman Needs to Supplement His Knowledge by a Study of Telephone Practice, and of Manufacturers' Data Sheets

IN the installation of sound amplifier systems there are certain technical considerations involved, which are not encountered in ordinary radio work except in rare instances. A microphone may be employed, for instance, where it is desired to reproduce music or speech direct. Also, there may be long leads, both at the input and the output of the amplifier, which call for special attention to prevent the pick-up of interference from nearby electric and telephone lines, etc. These and other points will be taken up for consideration in this article.

Amplifier installations may be used for the amplification of radio programs, phonograph selections or microphone input. In many installations all three types of inputs are provided for. No special discussion need be devoted to radio inputs here because every radio man is familiar with the usual radio receiver and audio amplifier arrangement.

The phonograph input requires some special consideration if best results are to

At the right is a well-planned school installation, at the Choat School, Wallingford, Conn., employing Stromberg-Carlson equipment, and capable of operating from 70 to 400 speakers

Directly below is part of the Graybar public address installation at the Palace Hotel, San Francisco. The smaller illustration below shows the phonograph and amplifier equipment used at Pine Island Park, Manchester, N. H.



be obtained. It is not advisable, where high quality and high power amplifiers are used, to connect the phonograph pick-up directly to the input of the amplifier, or to connect it into the detector socket of a receiver, which amounts to the same thing. The reason for this is that the impedance of the average pick-up unit is quite different from that of good audio transformer primaries and when the

two are connected directly together the maximum transfer of energy cannot be obtained.

For this reason the pick-up should be connected to the amplifier through a special impedance-matching transformer. Such transformers are available in the open market and can, therefore, be obtained without difficulty. Some of them are arranged with three or more primary terminals to provide a

Installations

By

S. Gordon
Taylor



(Photo Courtesy of "Radio Contractors")
Above—a corner in one of the apartments of the Lake Lane apartment hotel, equipped for radio reception from a central receiver

choice of several different impedance values so that one transformer can be used with any one of the popular pick-up units. This is a wise arrangement because the pick-up units on the market do not all have the same, or even approximately the same, impedance and the ability to try out different pick-ups without having to change transformers is a convenience.

A volume control should by all means be connected in the output of the pick-up unit, even though the amplifier with which it is to be used may also include a separate volume control. This will aid materially in obtaining best tone quality. Such a volume control should be of the constant impedance type rather than a straight potentiometer arrangement.

Where a microphone is to be employed a number of new considerations are brought in. First, there is the selection of the best type of microphone for the purpose it is to serve. This is an important consideration because high grade microphones such as those employed in broadcast studios are not only expensive but delicate and should be used only where quality and wide frequency range are required.

If a microphone is to be used only for announcements a small hand or desk microphone will often serve the purpose nicely. However, for the reproduction

of music, either vocal or instrumental, the regular broadcast microphones should be used if truthful reproduction is to be obtained. In some cases it may be necessary to employ two or more microphones at one time, especially in picking up music from a large orchestra. Wherever possible, it is better to use only one because otherwise complications are likely to be encountered, particularly in obtaining proper phase relations, both electrical and physical (sound).

A speech amplifier, usually consisting of two stages, is required between the microphone and the audio amplifier. This is made necessary by the fact that the



Large exponential horn used at Pine Island Park, Manchester, N. H., to provide public concerts from phonograph records

microphone output is only a small fraction of that obtained from a phonograph pick-up or from the detector output of a radio receiver. This amplifier is much like an ordinary two stage audio amplifier, the only difference being that the input transformer must be a microphone transformer instead of an audio transformer, with its primary impedance matching the impedance of the particular type of microphone used. Also, the tubes employed may both be of the -01A type, a power output tube not being required in this type of amplifier. If the speech amplifier is to be operated from the a. c. lines both tubes should be of the -27 type.

It is best practice to keep the speech amplifier as close to the microphone as practical, and to keep it well away from the power amplifier, unless both are thoroughly shielded. Keeping the two amplifiers well separated reduces the possibility of interstage coupling and the importance of this source of trouble will be realized when it is remembered that the speech amplifier plus the power amplifier really amount to a four or five stage amplifier. Locating the speech amplifier close to the microphone serves two purposes. First, the microphone output is so extremely small that the losses resulting from the resistance of long leads in its output cannot be tolerated. Second, interference from local sources such as nearby a. c. lines, telephone lines, etc., picked up by this line may easily be of the same order of energy as the microphone output and will, therefore, be amplified to the same intensity. With a short line between microphone and speech amplifier there is little chance for outside interference to get into the line and the interference picked up in the line between the speech amplifier and the power amplifier would be of a much lower order than the speech amplifier output energy, with the result that interference is much less likely to be troublesome.

It was stated earlier in this article that special considerations must be given to long lines frequently employed in sound amplifier installations. In the

THIS is the fourth of a series of articles by Mr. Taylor on sound amplifiers. In preceding discussions, he has outlined the immense field for equipment of this type, of the opportunities open to radio servicemen; given data on some of the installation and servicing problems; and described the construction of a compact, flexible amplifier adapted for radio, phonograph and microphone pick-up.

The present discussion gives some practical pointers of value to the radio serviceman. Succeeding articles will give detailed descriptions of typical installations, as well as business hints designed to help the radio man make more money.

ordinary radio installation in the home there are no long leads other than perhaps those from the antenna and ground. In commercial amplifier installations, on the other hand, there may be several hundred feet of wiring employed between the amplifier and the loud speakers; or between the speech and power amplifiers, if a microphone is used. Long leads in the input circuit of the amplifier, and particularly in the input to the speech amplifier, are frequent sources of trouble. Perhaps the most common trouble encountered is the pick-up of hum from nearby a. c. lines.

In hotel installations a good deal of trouble has been encountered where two or more channels are employed to provide a choice of two or three programs to each guest room. Unless proper precautions are taken the program in one

channel may cause interference when the headphones or loud speakers are plugged into another channel. This is due to the loud speaker lines of one channel picking up the program from another channel by induction.

The extent of the precautions to be taken to avoid this undesirable pick-up will depend upon the length of the lines and their location with relation to one another and to other lines, such as telephone, signal or lighting lines. There are two simple precautions that should be taken in all but the smallest and most simple installations. The first is, to use twisted pair for all audio lines, whether they be input or output lines. Where the two wires of a line are twisted together the pick-up in each wire will be the same and the two will cancel out to a very large extent. The second precaution is to employ low impedance lines in circuits which are normally of rather high impedance. If the output transformer in the power amplifier is designed to work into magnetic type speakers, for instance, its normal impedance will be around 2000 ohms. By employing an output transformer designed to work into a 500 ohm (impedance) line, or by employing a separate impedance adjusting transformer having a 500 ohm output impedance, between the amplifier output and the line, the tendency toward pick-up in the line will be reduced. To carry out this scheme it will of course be necessary to use a similar impedance adjusting transformer between the line and the speakers, or else connect the speakers, where several are to be used together, in a parallel or series-parallel arrangement so that their total impedance will equal that of the line.

Telephone engineers seem to agree that the most practical impedance value for lines carrying audio currents is 500 ohms and it is therefore logical to follow their experience by employing lines of this value for the loud speaker circuits.

In cases where interference pick-up is likely to be especially troublesome it is sometimes necessary to take further precautions than the two mentioned. In one large hotel installation, for instance, it was found advisable to shield each twisted pair with a metallic braid covering which was grounded. This was found necessary in order to eliminate cross-talk between the three output channels. Such

a precaution is rarely necessary in loud speaker lines, but where it is necessary to have even a moderately long line between a microphone and its speech amplifier it is advisable to shield the twisted pair composing this line. A lead-sheathed cable is often used for this purpose.

Wherever practical, the wiring in walls and even exposed wiring on the walls should be inclosed in conduit. This does not mean a separate conduit for each loud speaker lead, because the wiring for all loud speakers operating from the same amplifier may be inclosed in the same conduit. If the amplifier installation for a hotel, hospital or other building is being planned before the building is erected, provision for the amplifier and loud speaker wiring should be made by instal-

(Continued on page 456)

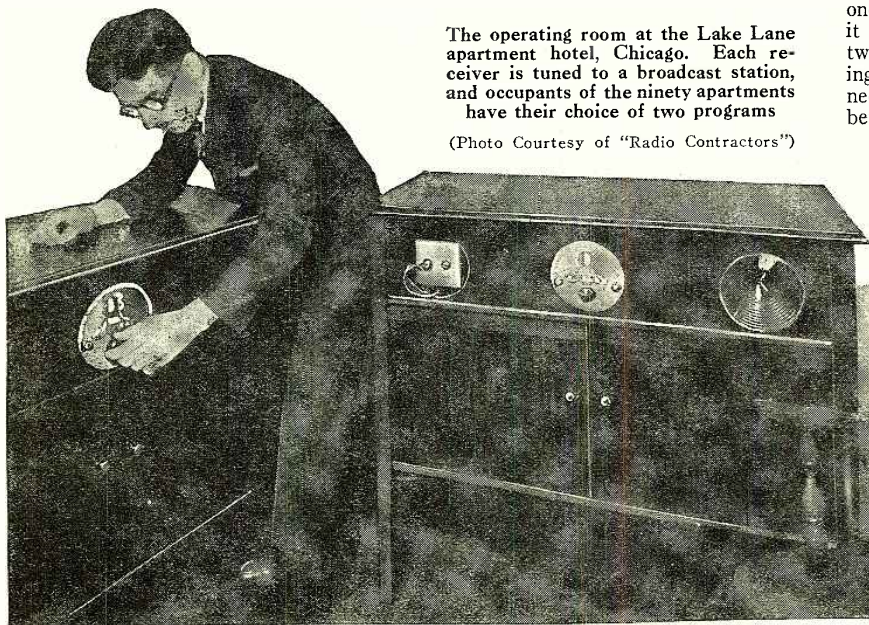

The operating room at the Lake Lane apartment hotel, Chicago. Each receiver is tuned to a broadcast station, and occupants of the ninety apartments have their choice of two programs

(Photo Courtesy of "Radio Contractors")

A PUSH - PULL Short Wave Tuner Circuit

Circuit Details and Pointers on the Construction of this Unique Receiver

By Thomas A. Marshall

THIS is the receiver with which Mr. Marshall conducted experiments on ultra-high frequencies; with such success as to cause the U. S. Navy to adopt the circuit. Working on board the *U. S. S. California*, and co-operating with the Naval Research Laboratory, at Bellevue, D. C., this receiver was successful in picking up signals of excellent strength at a distance of 2,000 miles, on wavelengths as low as 7.5 meters.

Among the advantages cited by the author for this short-wave circuit, he stresses the stability of oscillation control, even at 5 meters wavelength; the higher ratio of inductance to capacity; perfect neutralization of feedback conditions within the tubes, due to the balancing effect of push-pull connection; and electrical symmetry of the loop input circuit, important in directional work.

For the serious experimenter, this is decidedly a circuit "worth playing with."

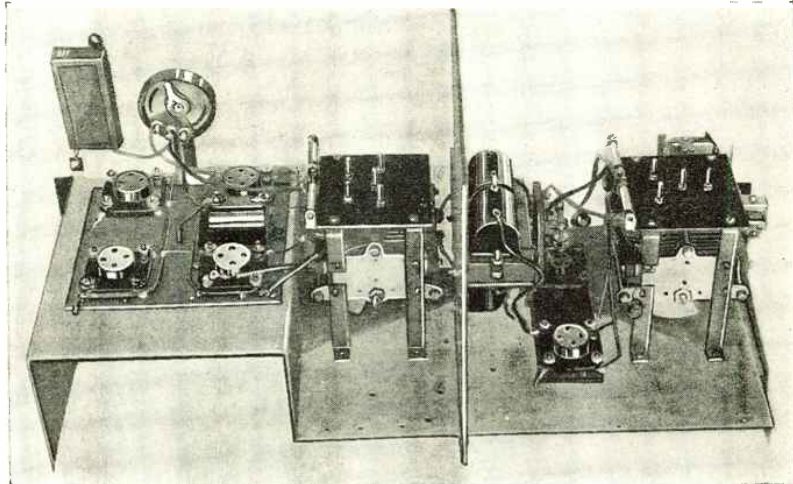

How the inside of the Marshall receiver looks. The metal base is specially formed as shown, with a compartment wall to shield the r.f. tuner from the detector circuit

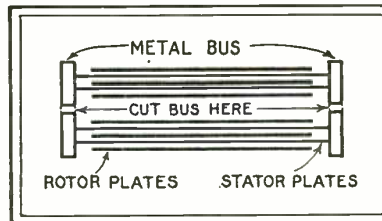
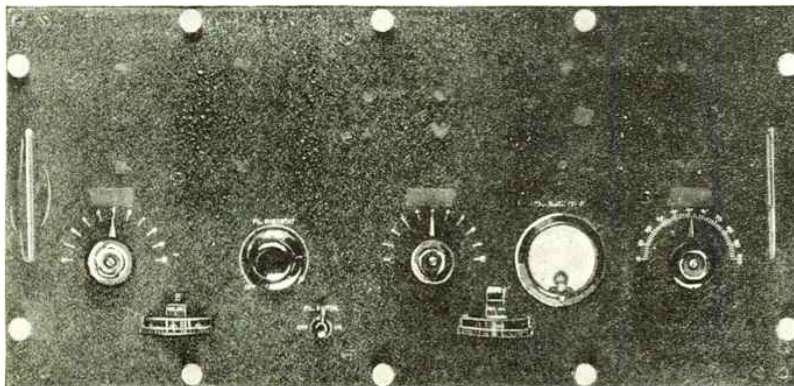

Fig. 1—Making one condenser do the work of two. In the push-pull circuit the stator sections of the tuning condensers are altered as shown

The panel layout (below)



MANY readers have written to me for additional information on the Marshall push-pull receiver, as described in RADIO NEWS, for July, 1929. For this reason, I have prepared the following diagrams, etc., which will enable the reader to construct this receiver, which will give really wonderful results and please the most exacting radio experimenter. The receiver will enable the radio constructor and experimenter to explore the short-wave band from 7 to 125 meters. More and more experimenting is being conducted on these short-wavelengths. Of course at present there are not many broadcast stations within this band, but to my mind the time is not far distant when broadcasting stations will be using the short wavelengths extensively.

General Considerations

In order to obtain selectivity and sensitivity, it is necessary to completely shield the r. f. stage and the detector circuit. The arrangement of the shielded compartments (see photograph) is such as to produce a satisfactory over-all shielding and to obtain proper neutralization of the r.f. stage. The shielding recommended should be 3-16" in thickness, in order to eliminate all microphonic noise.

It will be noticed that subpanel wiring is used. This results in a neat appearance and at the same time greatly increases the shielding effect.

Plug-in coils are used in each of the tuned circuits, arranged so as to cover a definite wavelength range. L, L1, L6

COIL #	1°	2°	3°	4°	5°	6°	7°	8°	9°	10°
1										
2	38.1	41.7	43.3	45.3	47.5	50.3	53.6	57.3	60.5	62.0
3										
4										
5										
6										
7										
8										
9										
10										

Fig. 2—The preparation and use of a chart such as that shown facilitates greatly the tuning in of desired stations

and L7 are wound upon bakelite forms, which are recommended from a lowloss standpoint. The losses are further reduced by use of proper diameter-to-length ratio and by the use of spaced windings. Care should be exercised in winding each coil system, making sure that the

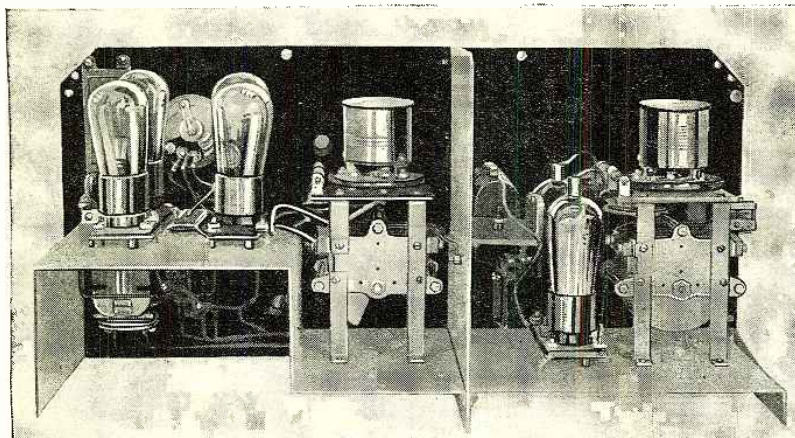

Practically every constructional detail is clearly indicated in the above photograph. Note that the specially formed metal base shields the audio channel and also serves as the base for the detector and audio amplifier tubes

turns are wound exactly as specified in Table I.

Cardwell straight-line frequency condensers (type 169-E) are used in order that maximum ease in tuning may be experienced in the short-wave bands. These condensers are also recommended due to the arrangement of the stator plates which enable two condensers to be made from one. This is done by cutting the bus-bar at the center as shown in Fig. 1. The middle stator plate is removed, thus leaving four stator plates and six rotor plates. This combination makes possible two condensers with one common set of rotor plates. The total tuning capacity across the coil is approximately .0008 mfd. In order to tune short-wavelengths, it is necessary to use a high ratio vernier dial, such as a National VV. With the condensers bottom side up as shown, the coil mounts are secured to the condensers by means of sup-

port brackets as shown in the illustrations. The dial is so arranged as to read kilocycles, starting at the lowest value at the left, increasing as the dial is rotated. Fig. 2 shows arrangement of the chart for calibration of the coil systems. This is new to the tuning art and will be extremely valuable in locating short-wave stations.

Circuit Constants

C1, C2, C7 and C8 are Sangamo .0001 mfd. condensers. See Fig. 4. These condensers are mounted directly underneath the coil bases so as to reduce the length of the grid leads. R1 and R2 are 1 megohm grid leaks. R4 and R5 are 1/2 megohm grid leaks. Durham or Lynch metallized grid leaks are recommended. C3 is a 1 mfd. condenser. C12 is a 2 mfd. by-pass condenser. L2, L3, L4, and L5 are Sampson No. 125 r. f. choke coils. L2 and L3 are mounted on a stand as shown in Fig. 5 while L4 is mounted vertically and directly underneath the junction point of L2 and L3. C10 and C11 are neutralizing condensers. R6 is a Centralab 500,000 ohm variable resistor. V1 and V2 are UX222 shield grid tubes. V3 and V4 are UX201A

center. C4 and C5 are 50 micromicrofarad condensers. About 30 mmfds. should be used. Increased coupling will cause unstable oscillations within the detector circuit due to inter-action between the two stages. C9 is a 1 mfd. by-pass condenser. R7 is a 200 ohm potentiometer. R8 is a 10 ohm rheostat. R3 is a 20 ohm rheostat. R3 is adjusted to 3.3 volts on the UX222 tubes when R8 is adjusted for 5 volts on the detector tubes. A1 is a Thordarson 5-1 ratio audio transformer. A2 is a S. M. 256 transformer. This combination is recommended in order to obtain the best audio amplification. V5 is a UX112A tube, V6 is a UX171A tube.

Oscillations are controlled by R6. This method of control permits maximum regeneration without changing the calibration of the receiver. R7 permits the proper adjustment for good detection. When the proper bias is used the detector should go in and out of oscillations without any "hang over" effect.

Operating Notes

After the filaments have been adjusted to the proper voltages, insert coil No. 3 in the detector circuit and adjust R7. It will be necessary to adjust R7 so as to cause the circuit to go in and out of oscillation. After this adjustment is perfected, set C4 and C5 at about 30 mmfds. and insert No. 3 r. f. stage coil. Adjust C10 and C11 to about 3/4 inch

TABLE I
Coil Winding Data

Coil No.	Wave Band	L	L1	L6	L7	Dia. in inches
1	80-125	10	41	8	41	2
2	75	6	21	6	21	2
3	40	4	12	6	12	2
4	30	4	7 3/4	4	7 3/4	2
5	22	3	5	4	5	2
6	18	2	3 3/4	3 3/8	3 3/4	2
7	12	2	4	4	4	1
8	10	2	3	4	3	1
9	8	2	2	4	2	1
10	7	2	2	4	2	3/4

apart. Tune the r. f. stage to resonance with the detector circuit. If the latter stops oscillating, detune the r. f. stage until the detector oscillates. Adjust C10 and C11 and tune the r. f. stage condenser until it is possible to set the detector stage at maximum regenerative point (just barely oscillating) and be able to pass through resonance with the r. f. stage without causing the detector to

tubes. It is not necessary to have matched tubes for this circuit since the grid coil has no center connection which enables the circuit to find its own electrical

Fig. 3—A drilling template for the parts employed and described by the author in the text

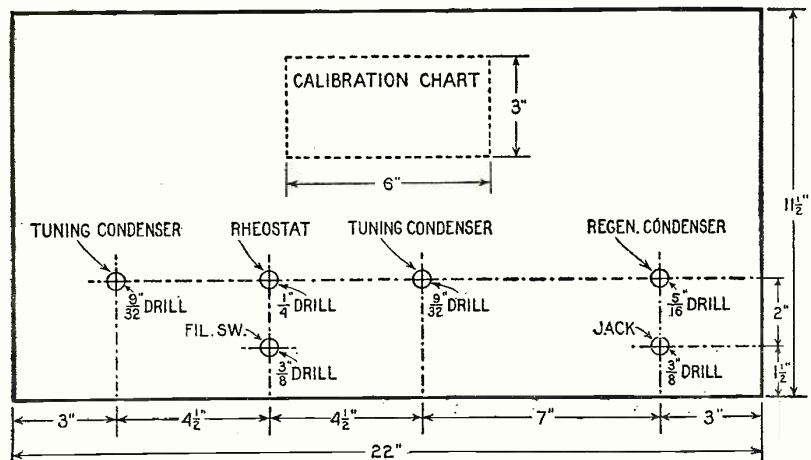

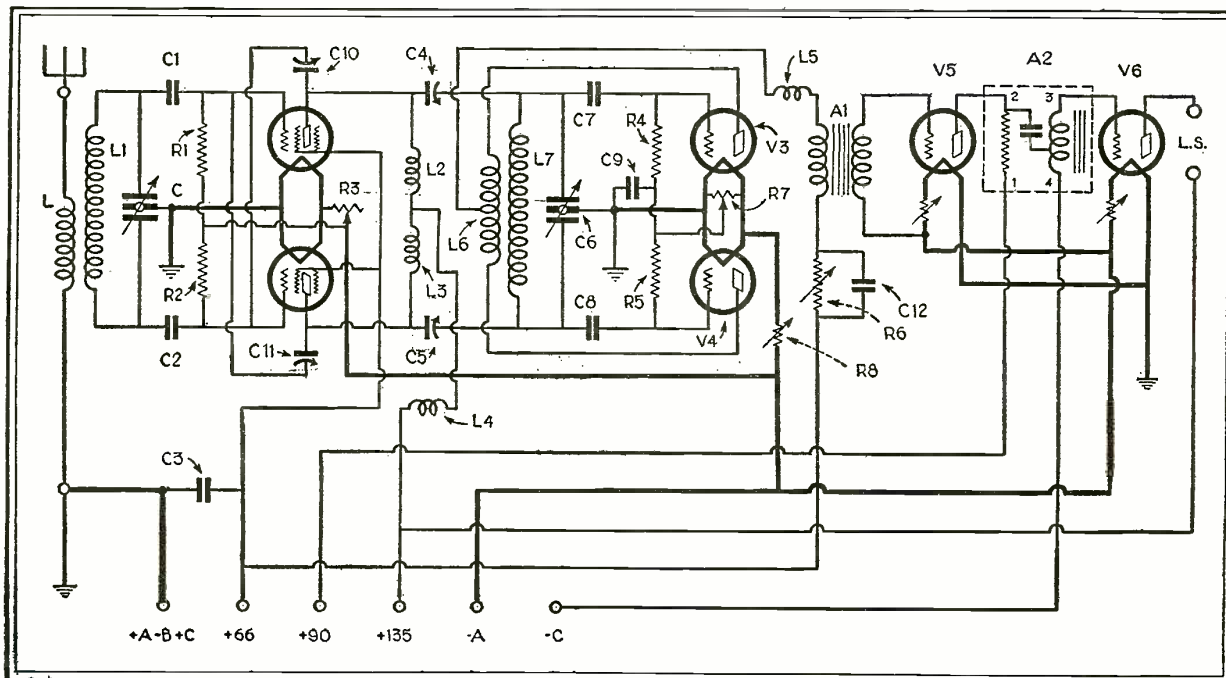

Fig. 4—The complete circuit diagram of Mr. Marshall's push-pull short-wave receiver. The coils L-1 and L6-L7 are of the plug-in type, allowing change of tuning in the wavelength bands

stop oscillating. When R7, C4, C5, C10 and C11 are properly adjusted there should be no interaction between the detector circuit and the r. f. stage, when both circuits are tuned to resonance. If this condition is obtained, the circuit is ready for calibration.

Do not make any changes in C4, C5

C10, C11 or R7 after the coils are calibrated.

Do not make any changes in C4, C5,

inclusive are wound 18 turns to the inch with No. 22 enamel covered wire. Tickler coils No. 1 to No. 6 inclusive are wound with No. 28 enamel covered wire. Coils No. 6 to No. 9 inclusive are wound with No. 22 D. S. C. wire. Windings are close together so as to concentrate the fields.

Radio News' Tribute to Dr. Eckener

Radio played a large part in the success of the record-breaking trip around the world of the dirigible *Graf Zeppelin*. It played a large part in all of the voyages of the giant airship. In fact, it is not too much to say that, without radio, aerial navigation could not have reached its present state of development.

When the *Graf Zeppelin* made its second trip to America, it so happened that the date of its arrival at Lakehurst coincided almost exactly with the appearance on the newsstands of the August issue of *RADIO NEWS*. This, in itself, would have had scant significance, except for the fact that the editors of *RADIO NEWS* had shown their faith in Dr. Eckener's project by commissioning Howard V. Brown to paint, as the cover design for that particular issue, a scene showing the *Graf Zeppelin* arriving at dawn over New York harbor. The painting is reproduced here in black-and-white; the original, of course, being in full color.

It also happened—not by accident, but

by design, and because of enthusiastic interest in the dirigible's ambitious plans—



that Arthur H. Lynch, editorial director of *RADIO NEWS* and its sister publications, was among the first to greet the *Graf* on her approach to these shores, last August. Flying in a Stimson-Detroit owned by the Pilot Radio & Tube Corporation, it was his pleasure to wave a cordial greeting to Dr. Eckener, some fifty miles at sea, off Barnegat.

What more natural, then that the thought of presenting to the man pre-eminently responsible for the *Zeppelin's* success, the original painting, suitably framed, from which the cover of August *RADIO NEWS* had been reproduced?

On September 10, therefore, the day of Dr. Eckener's departure on the *S.S. New York*, Mr. Lynch journeyed to the Sherry Netherlands hotel. There, without ceremony, he made the presentation, in the name of the publishers and editors of *RADIO NEWS*.

With it, go the sincere admiration and hearty good wishes of the entire staff.

The Symphony in

The future band leader was a cornet addict at the early age of nine

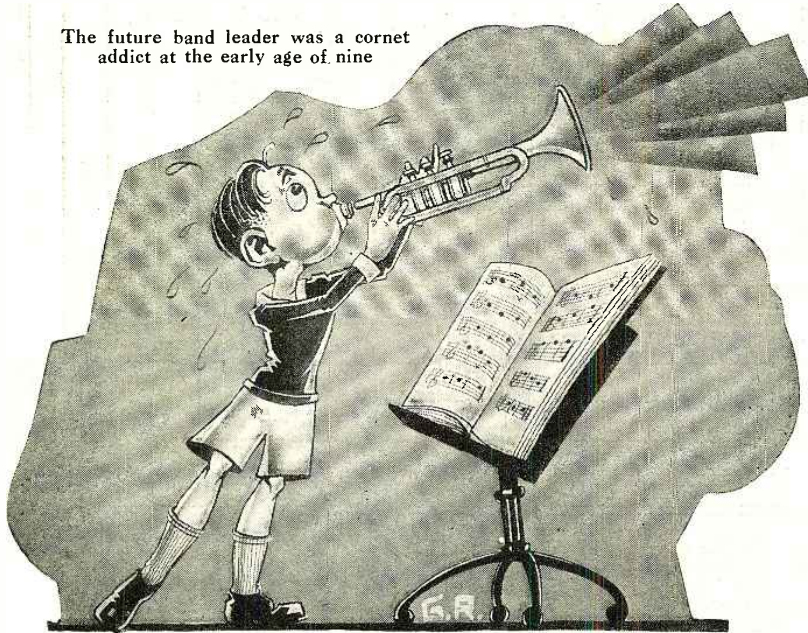

*Edwin Franko
created a new*

Meeting him, the shock of white hair is the most noticeable physical characteristic. His face is keen, alive. His eyes sparkle and he grins a lot when he talks. His body is small, compact and gives the impression of wiry strength. When he walks he strides. He seldom sits still and even when talking to some one he continually jumps up from his chair and paces up and down, throwing back sentences over his shoulder.

He has his peculiarities and admits them. He doesn't like to see women smoke, but knows of no moral reason why they shouldn't. He refuses to play bridge and isn't interested in card games of any kind.

He dislikes hats and only wears them because he doesn't like to be conspicuous. He hasn't time for hobbies but takes long walks whenever he has any spare time—which isn't very often.

He is a great hand-shaker and holds impromptu receptions after every concert or broadcast. He doesn't mind shaking the hands of three or four hundred people in an evening and claims to have evolved a technique which avoids wear and tear on his fingers.

Goldman was born in Louisville, Kentucky, in 1878. His musical ambitions began before he can remember and despite parental ridicule and open disapproval he was able to toot a cornet with some degree of skill before his ninth birthday. About this time his family moved to New York—a move highly appreciated

GOLDMAN is happily married and has two children, a son and a daughter. The boy, Richard Henry Goldman, was music critic of "The Spectator," Columbia University publication, last spring. Both the son and daughter have musical inclinations which the maestro is making no attempt to influence. He is a strong believer in letting young people work out their own destinies, he says.

While the exact amount of Goldman's income is not known, he is reported to be receiving an income that runs into six figures annually. His Pure Oil contract pays him well; he has other concert engagements and there is a steady stream of checks from royalties on marches he has written. He says he is too busy to dabble in the stock market or other money-making enterprises than the music business.

NO one has referred to Edwin Franko Goldman, radio band leader, as "that chap with the white hair." This despite the fact that Goldman's shock of silvered locks can be seen before any other part of him becomes distinguishable. Goldman's personality is the answer to this situation. His is the personality of a young, dynamic man—nothing white-haired about it at all. He injects his personality into his musicians—it flows from his baton as he conducts his musicians and even an interview with him is a strenuous proposition, for he leaves those he talks to with a restlessness and an urge to accomplish something immediately.

Versatility is one of the popular band leader's greatest assets

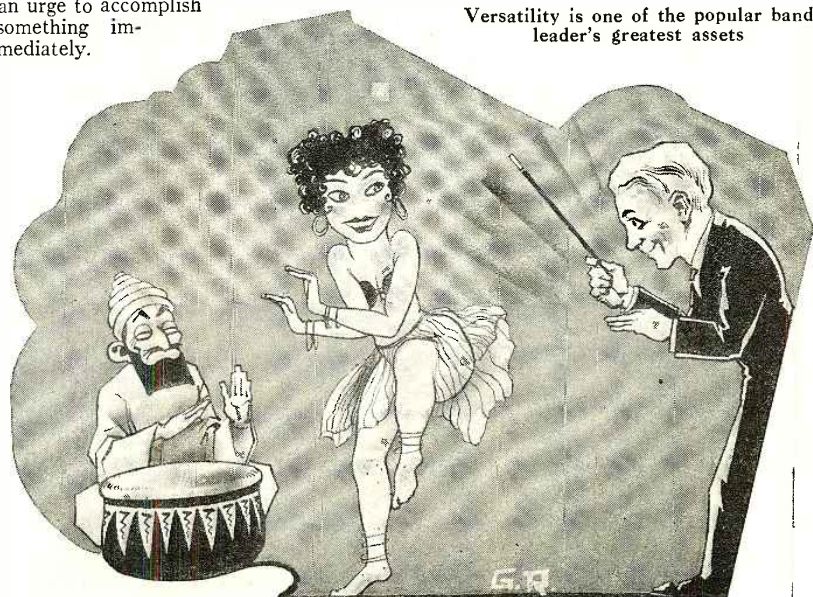

Brass

*Goldman, who
band technique*

By P. H. W. Dixon

Illustrations by
Gaspano Ricca

(Courtesy of the National Broadcasting Company)

by the neighbors of the young cornetist, according to Goldman.

The boy continued his struggles with the cornet and against parental opposition and was recognized as a professional musician by the time he was 15 years old. Soon after his seventeenth birthday he was playing in the orchestra and was solo trumpeter for the Metropolitan Opera House. He was the youngest musician to have played with the orchestra up to that time.

The young musician went west, not in search of adventure but because the Metropolitan orchestra went on tour. In San Francisco he found more than his share of excitement, for the earthquake and fire swept that city while he was playing there. He escaped injury but says he will never forget the experience.

For a number of years he played with symphony orchestras in the winter and with bands in the summer. The sharp contrast between the methods of the two different musical groups gave him an idea. Volume, rather than quality, seemed to be the main idea back of band music in those days, according to Goldman, and his symphonic training made the result little short of awful to his critical ear. So the young man organized his own band and conducted it with the



An artist's character study of Edwin Franko Goldman



Mr. Goldman is a great hand-shaker and holds impromptu receptions after each concert

technique he had learned in symphonic playing. Band men held up their hands in horror at this radical move, but Goldman went quietly ahead with his plan, made his own arrangement of marches and added numerous selections from his own musical pen to the library of band music. People laughed and spoke of "Goldman's kindergarten."

In 1918, on the green of Columbia University, the radical bandmaster showed what he had done. His organization immediately was termed "a symphony in brass" and the result was that his concerts attracted audiences of from 15,000 to 20,000 persons at every summer concert. His reputation and his place in the world of music were achieved.

Goldman's career as a radio bandmaster began with broadcasting itself. He made his radio debut from Station WJZ in 1921, when that famous transmitter was just an experimental station located at Newark, N. J.

Since that time he has been continuously associated with broadcasting and has actually been heard around the world. Some of the most enthusiastic fan letters have come to him from radio listeners in Central American countries where band music is considered one of the highest forms of musical expression.

Until last winter radio listeners looked forward to the summer time as the time when Goldman's band could be heard; (Continued on page 454)

Radio News Floating *Experimental*

By

W. Thomson Lees
Managing Editor

and

John B.
Brennan,
Jr.
*Technical
Editor*



A rear view of the experimental receiver, with top and back removed. Above—using the trouble finder in making interference tests on board

WE had no illusions about time, when we took over the RADIO NEWS FLOATING LABORATORY, last month; hence the very conservative promise that, in this issue of RADIO NEWS, we expected to have "some worthwhile reports!" of progress toward a real radio receiver for the small boat. As a matter of fact, we progressed farther than we expected, though not as far as we should have liked.

Just as, in preparing a rabbit stew, it is first necessary to have a rabbit; so, in conducting experiments aboard a cruiser, it is essential to have the cruiser. As mentioned in last month's article

(RADIO NEWS for October, page 309) the Elco Boat Company of Bayonne, N. J., alive to the importance of the work, loaned us one of their 26 ft. cabin cruisers.

Fortunately, in addition to radio and editorial experience, there was enough nautical and piloting experience among our group to assure the Elco management that we would not pile the boat on the rocks. So, with little formality, we started out from the Bayonne works about noon on Saturday, August 10.

The trip from Newark Bay, through the Kill von Kull, out to the Narrows, was uneventful, except for the small detail that we had made no provision for lunch; expecting to get away early enough to have lunch at one of the beaches. The "small detail," however, became acute by the time we had spent an hour or two in visiting the Coast Guard base (Squadron No. 2) at Staten Island, where Lieutenant E. B. Smith, engineer officer, and Charles Moffatt, warrant officer, machine section, not only showed us around, but gave us some helpful pointers.

Putting in at Brighton Beach, Coney Island, about 4:30, we remedied the food omission, and then proceeded to the Sheepshead Bay Yacht Club. Here, through the courtesy of the board of governors, we were given a mooring to serve as our base of operations. The following day, Sunday, real work began.

On the initial run, experiments with the trouble finder (a compact, portable outfit equipped with both loop and pick-up coil for locating interference) had shown that ignition disturbance was a strong

Laboratory Tries Out An *Small-Boat Receiver*

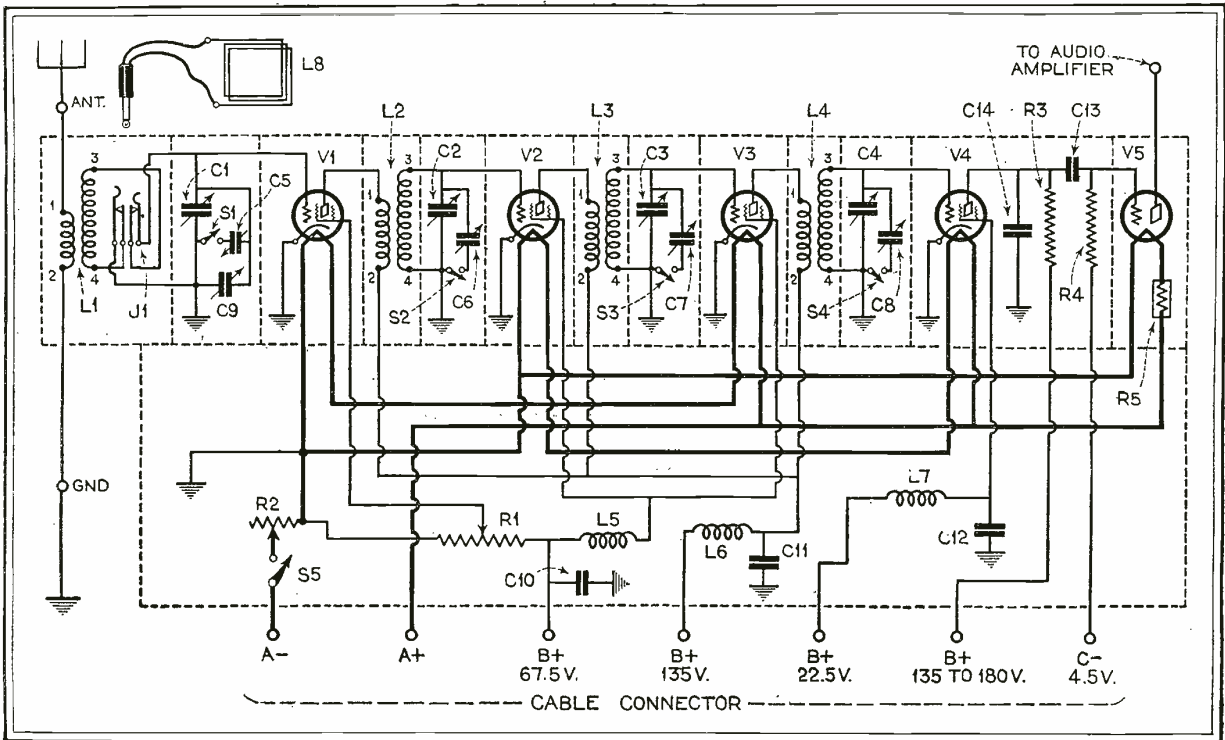

The circuit employed in the experimental receiver. Note the use of a.c. heater-type tubes in a novel filament circuit arrangement for 6-volt filament supply

factor. At the extreme bow of the boat, this man-made static was at a minimum, but still perceptible and destructive of real quality radio reception. This then, was one of the things which must be solved.

Borrowing a leaf from the note-book of aviation experience, we got in touch with Walter Kidde & Company, Inc., manufacturers of the Hahn shielded spark plugs. Various delays, and the fact that week-ends constituted the only available time for work afloat, prevented completion of the ignition shielding until the Labor Day week-end.

In the meanwhile, in addition to the troubler (which, in an emergency, proves itself a very handy broadcast receiver) we had brought on board two custom-built radio sets which, under ordinary conditions in our laboratory, gave more than ample volume. These, primarily, were to give us a check on the pick-up efficiency of an antenna system.

Right here, we learned two things: first, that while a single stretch of wire from bow to masthead, to stern theoretically should be as efficient as any, practice proves otherwise; second, that the antenna pick-up efficiency on a small

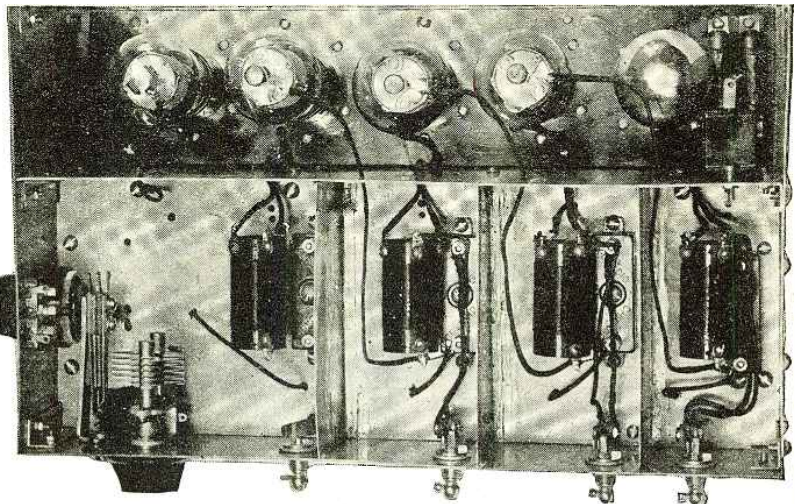

Looking down on the experimental receiver, with top removed; showing the arrangement of coils and switches for cutting in extra capacity to cover the higher wavebands

boat is woefully low, in comparison to even the average home installation. In fact, a receiver which, in our laboratory, was capable of blasting a really good balanced-unit cone speaker with its volume, proved a sad disappointment on board; only the more powerful locals

came in with volume enough to be heard at all.

Various dodges were tried, before we settled upon a form of antenna which would be more efficient without being too cumbersome or conspicuous. The installation finally adopted recommends itself

on several counts: it is more efficient than any but an impractically elaborate network; it does not in any way detract from the appearance of the boat; it is both inexpensive and simple to install; it lends itself readily to practically any type of small or medium size cruiser.

Briefly, this antenna consists of a single length of rubber-covered wire of No. 14 gage, strung from the center of the rear of the cockpit canopy, to the port side of the same stanchion, then upward over the port yard-arm, down (forward) to a spreader attached to the forward flag-staff; across to the other side of the spreader, and back on the starboard side in the same fashion, until it once more reaches the starting point. The lead-in is taken from either end of this aerial, the other end being left open.

With this antenna, reception was materially better than with a singlewire aerial strung over the top of the mast and reaching from bow to stern. Glass insulators were used of course, at each of the six points of support; with a seventh glass insulator where the lead-in

A bottom view of the experimental receiver assembly. Below is a diagram of the brass case and its compartments

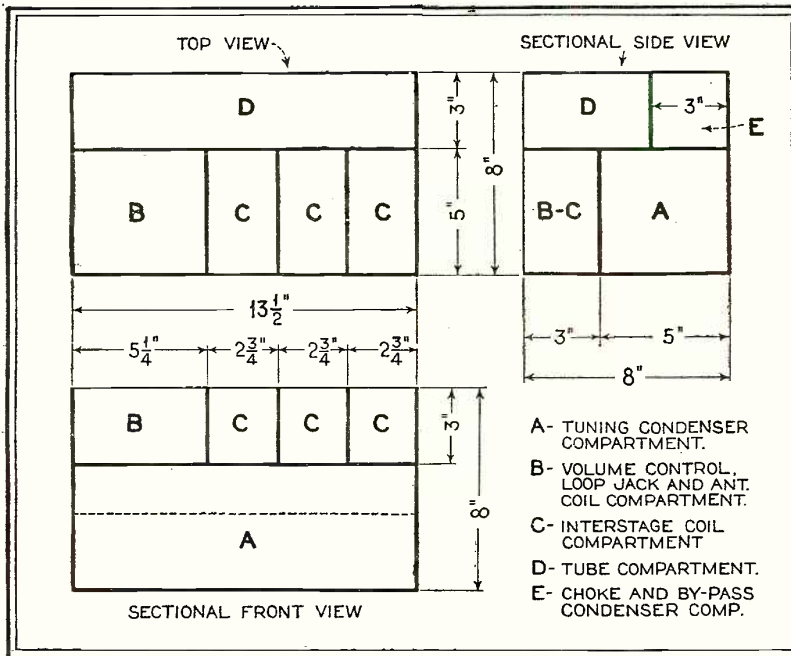
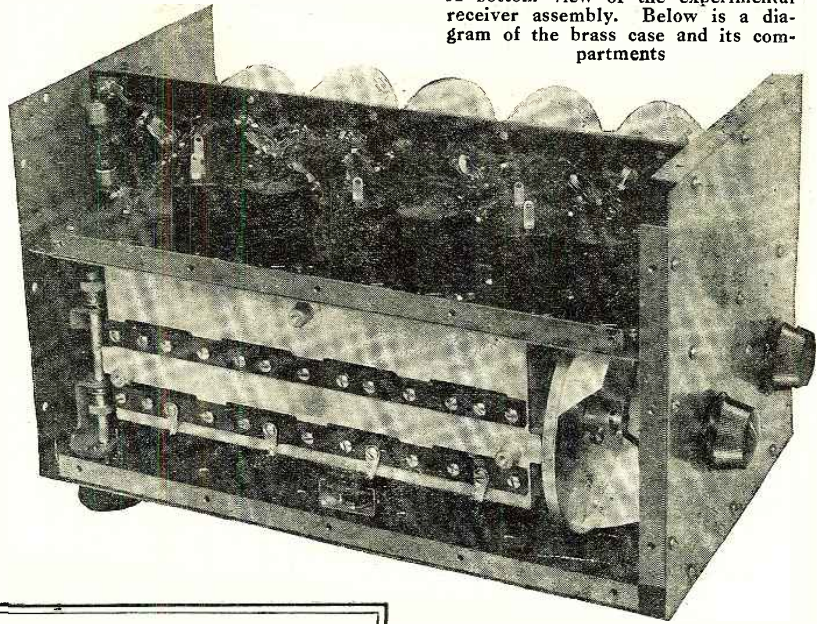

on the port side, about 18 inches astern of the cabin; the best location for the B-batteries was at the extreme aft end of the cabin, starboard side; while the radio set, for accessibility, needed to be located near the top of the cabin, not far from the bulkhead supporting the wheel. Also, since provision was to be made for loop reception (for direction-finding), the power-supply box was provided with antenna and ground connections and loop binding posts, and was so located as to permit short, protected leads to the loop, up above.

This "junction box," about three inches deep, and five inches square was provided with a bakelite front, carrying binding posts, respectively, for A-, A+; B-1, B-2, B-3, B4; two loop terminals; antenna, and

end and open end came, at the rear center of the cockpit awning, astern.

Another job that occupied an unconscionable amount of time—but one that is well worth the attention of any boat owner who plans to make a ship-shape radio installation—was the installation and wiring of a centrally-located power-supply box. The filament supply, or A-battery, in most cases, will be the regular lighting and starting storage battery; which, usually, is located close to the engine. The B-supply, in the case of small boats, will consist of heavy-duty dry batteries. The latter, usually, cannot be placed near the storage battery; but they should be put in an out-of-the-way place that is protected and free from the incursions of bilge-water.

In the case of the 26-footer on which we have been working, this meant that the A-battery was under the engine hatch,

Details of installation of the antenna, aboard the Floating Laboratory



A front-panel view of the receiver. Below, at the right, details of the coil construction

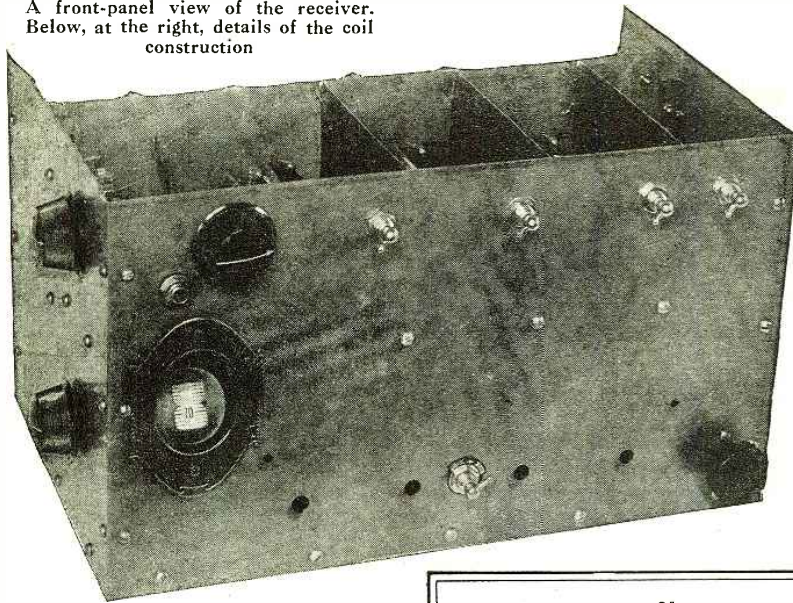

learn the following day that fisherman a few hundred yards away had caught an 8-foot hammerhead shark. Another memory that will stay with all of us for quite some time is the night when we anchored in a supposedly sheltered cove, only to find that nature had prepared a special reception in the way of a rough sea which made sleep utterly impossible for the night. These things and many others helped to make life interesting, but they are aside from the main point.

Our third week-end aboard was devoted primarily to securing some photographs and to making tests which would crystallize our ideas of the kind of receiver which should be built as an experimental model. In doing this we had in mind the fact that the Labor Day Holiday would afford a three-day period for exhaustive tests. At this time we had already commenced work in our home laboratory on the construction of this experimental model, and by dint of night work and
(Continued on page 471)

ground. The latter was provided, simply for possible experiment with outside filament supply, as the boat storage battery already has one side grounded to the engine.

To assure trouble-proof operation, and avoid a tangle of loose wiring, lead-sheathed cable was used throughout, in wiring from the antenna lead-in, ground, and batteries, to the junction box.

All of this installation work sounds fairly simple in the telling, but in the doing it required hours rather than minutes. Interspersed with the installation work, most of which was done at the anchorage, we made short runs out to Rockaway, over to Staten Island and along the Coney Island beaches. On these runs various tests were made of the antenna pick-up quality and of variations in signal strength at different times of day and evening. All of this was more in the nature of preliminary work to test out some of the theories we had already arrived at as to the type of circuit which would be required in order to accomplish what we set out to do. Even with a receiver not designed for the purpose, earphone reception was easy to obtain from all of the local stations. This in itself, with a loop-operated receiver would have made a very useful adjunct to navigation, but it neglected entirely the truly satisfactory entertainment factor.

Needless to say, although there was enough to keep us more than busy, there was also occasional diversion enough to liven the hours. In fact it would be only too easy to fill several pages with some of the side issues which formed a part of our experience. For example, on our first run, when we anchored at Brighton Beach, decidedly hungry and somewhat tired, we failed to notice that the dinghy was anything but water tight; with the consequence that before the two of us who went ashore for food had come any where near the shore line, said dinghy had just as much water inside as outside. On another run, when we went out along Ambrose Channel way into deep water, three of us refreshed ourselves with a very enjoyable swim; only to

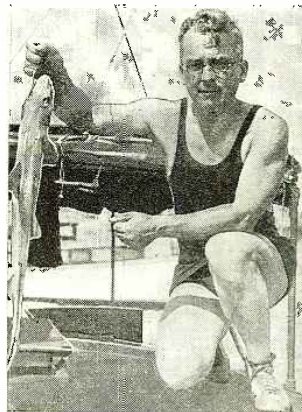
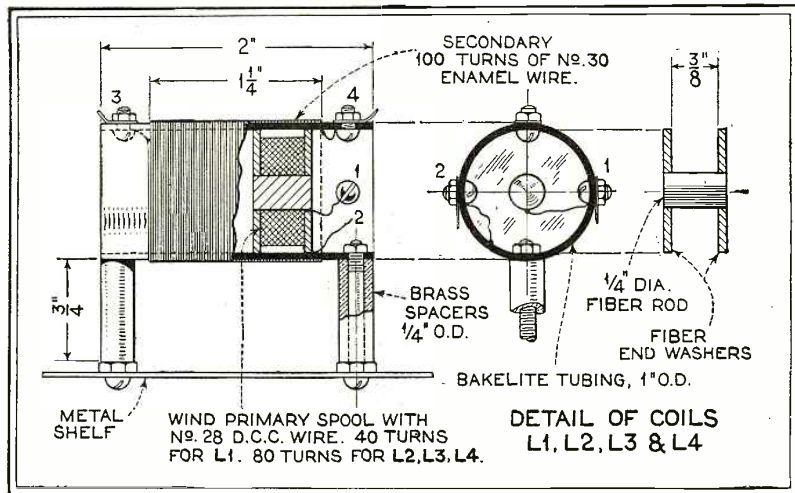

Above—evidence of better "pick-up" qualities



At the right—applying shielding to the ignition wires, to conquer interference with radio reception

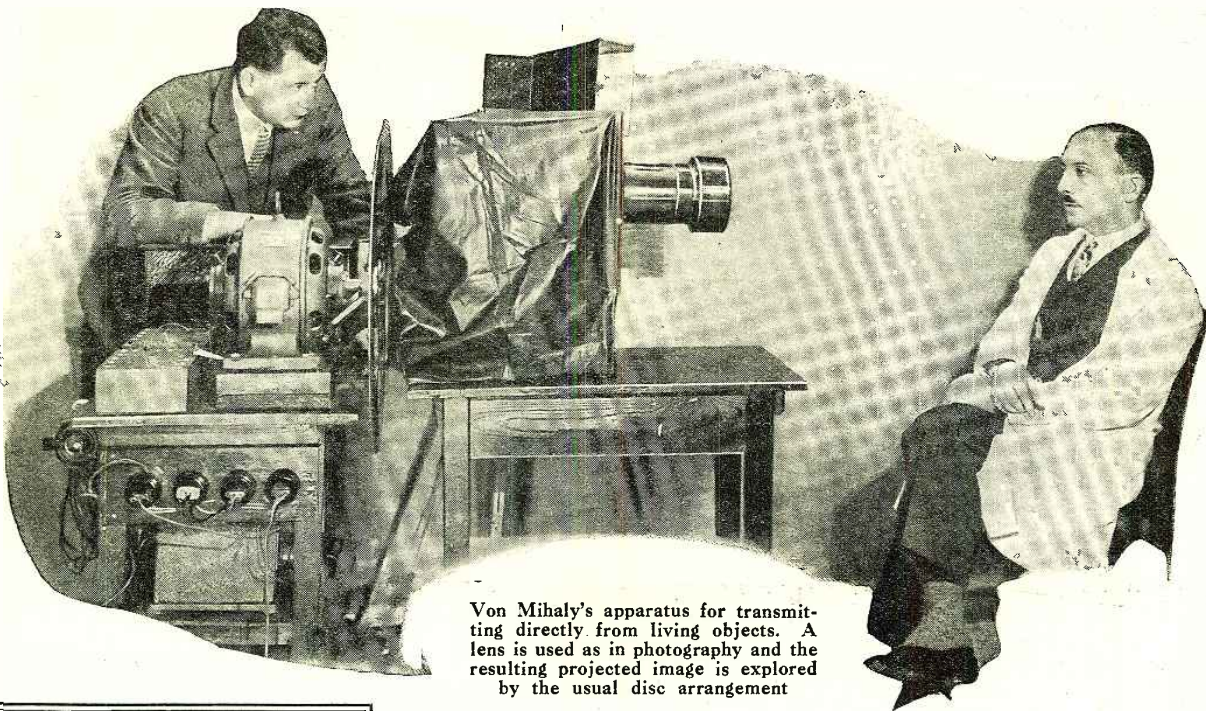

Von Mihaly's apparatus for transmitting directly from living objects. A lens is used as in photography and the resulting projected image is explored by the usual disc arrangement

While the first dashing announcements of television and its wonders have left many radio-minded folks in a state of temporary collapse a great deal of work is being done by the more serious investigators. There remain a great group of scientists who believe the problems can be solved. There are a number of large corporations here and abroad which are backing this view with the tremendous financial investment television experimentation involves. They hope some day to reap a rich harvest. No doubt they will, if not through television as we are aiming at it today, through some by-product of the art developed from television research.

In the accompanying review we have a direct comparison of two European systems, written by a man who has witnessed demonstrations of both and who should be in a position to judge them.

Television Abroad

*A Comparison of the BAIRD and the
VON MIHALY Systems*

By Dr. Ing. Walter Reisser

Chief Engineer, Government Broadcasting Company (Reich-Rundfunk Gesellschaft, Berlin)

IN assessing the value of a Television process, and especially of the possibilities of its technical exploitations, it is not sufficient to consider it alone as such, but it must be considered in conjunction with the whole technology with which it will have, most probably, to operate. In the following, therefore, the process is considered first of itself and then in its relation to broadcasting, which it will probably exclusively effect.

First of all, generally speaking, what does television set out to accomplish? Its object is to render visible, at the moment of their occurrences, motion-comprising events, at distances only limited by the range of the means of transference applied; in other words, to increase the range of vision to an extent beyond that

obtained by the aid of the best telescopes, unhindered by intervening objects of all kinds, such as walls, mountains, dense fogs, etc. Electric waves form such a means of transference, which are also applied in a large degree for the distant reproduction of sounds. It must thus finally be demonstrated under what conditions the electric wave is capable of solving the above problem.

Broadly stated, the problem runs: taking a pictorial impression, converting this into electrical oscillations suitable for modulating a broadcast transmitter, conveying the modulated high frequency to the receiving station, and converting back into optical impressions which, taken together reconstruct the picture at the transmitter.

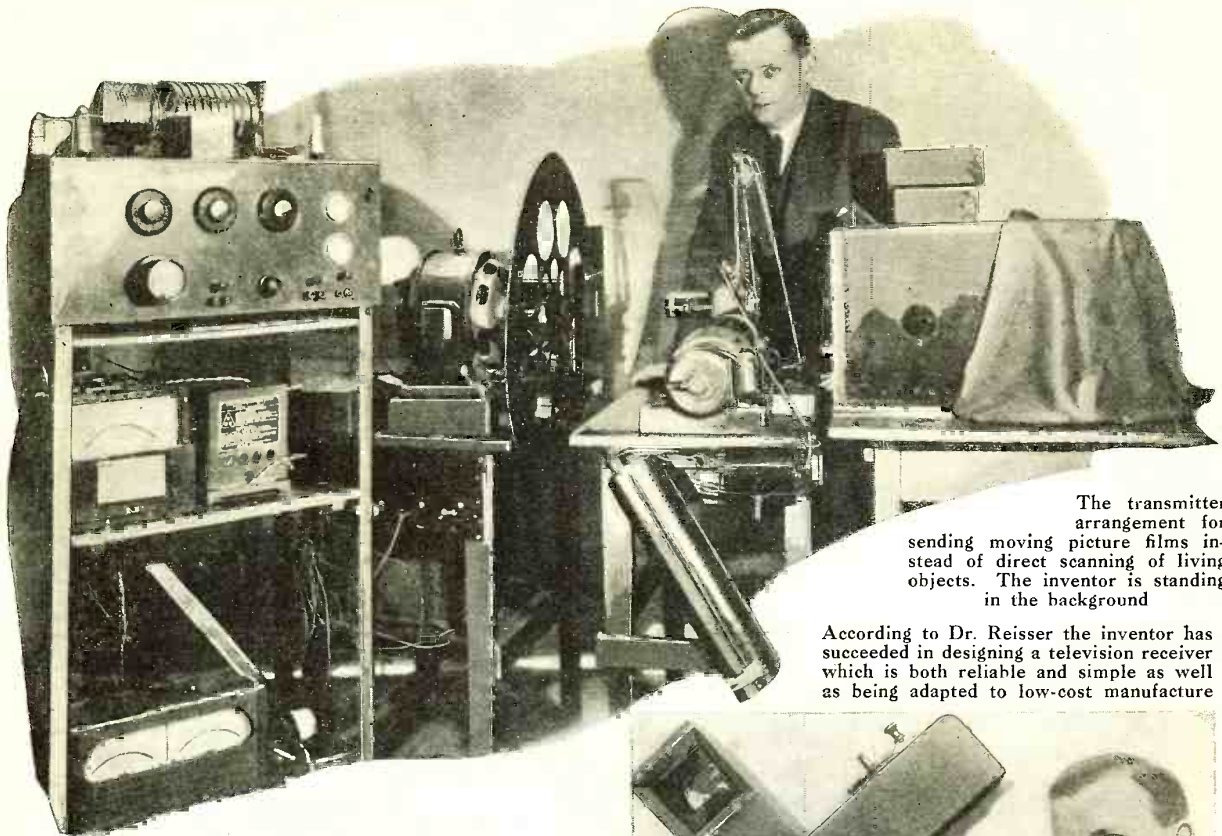

The transmitter arrangement for sending moving picture films instead of direct scanning of living objects. The inventor is standing in the background

According to Dr. Reisser the inventor has succeeded in designing a television receiver which is both reliable and simple as well as being adapted to low-cost manufacture

What method has von Mihaly adopted for this purpose? First of all, he does not start, up to the present, with the object itself in motion, but from a kinematographic film. This appears so far desirable in that, in my opinion, it is not only an intermediate step on the way to actual television, but it will, also certainly later on find an important application in the introduction of such processes into broadcasting. There are a large number of events which cannot be transmitted at the moment of occurrence for reasons of time and on other grounds.

Fundamentally, the same problems have here to be solved as in actual direct television, only with the difference that with the film the intensity of the available illumination can be increased to almost any desired degree, so that during the developmental stages a number of difficulties can be avoided, for the overcoming of which, however, the theoretical foundations appear to have been laid.

Von Mihaly utilizes, for breaking up the pictures to be transmitted, the so-called Nipkow discs. These are discs carrying spirally-arranged holes by means of which, on rotating the disc, the picture is utilized in a similar way by nearly all new television processes, and appears to represent the most promising method of reaching a wide circle of television receivers. The mirror wheel, used for example with the "Karolus" system, is too costly to allow of its being incorporated in a popular receiver. Baird also, who is to my knowledge the only serious competitor of Mihaly's, uses the Nipkow disc. Such a disc is inserted in the path of

the light rays, which, passing from the picture to be submitted, are led to a photo-electric cell. The latter has the property of changing its resistance according to the intensity of the light which impinges upon it, so that a more intense illumination corresponds to a stronger current, and a less intense illumination to a weaker current. This conversion of variations of optical intensity into variations of electric current forms the essence of the transmitter. The photo-electric cell must not only cause the greatest possible difference in current, when the illumination changes from light to dark (intense to weak), but must be able to follow the necessarily very rapid variations without lag. An experiment shown to me by Herr von Mihaly demonstrated that the sensitiveness to light variations of the cell used is quite good, on account of a special switching arrangement. It may be concluded, from demonstrations which have since taken place, that the behavior of the cell is throughout favorable even at the high frequencies necessary for the transmission of pictures.

The difficulty of passing from films to directly moving objects is, ultimately, a question of amplifier technique, of which, however, von Mihaly is, in my opinion, eminently qualified.

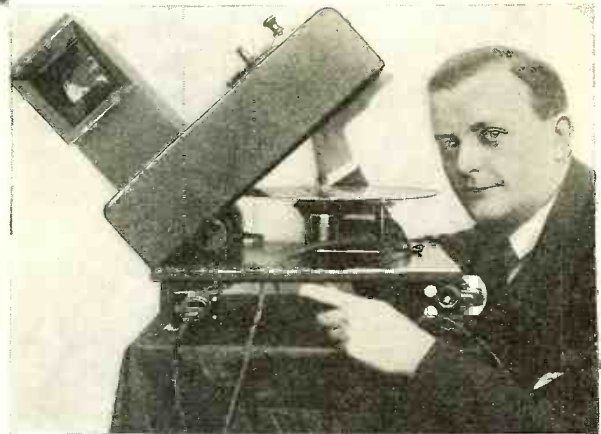

The Englishman Baird is at the moment ahead of Mihaly in so far as he starts with directly moving objects. For this purpose, however, he uses a procedure which, in my opinion, has no great practical value. That is to say he places the person to be seen (the view obtainable extends only to the head and shoulders by this procedure) in a room which is either completely dark or illuminated only feebly with red light, and then explores him with a wandering beam of light, produced by a fairly complicated arrangement of rotating lenses. (See Dinsdal's "Television.") One or two heads can be transmitted in this way. According as this beam of light traverses a light or dark portion of the object, more or less light is reflected, and this, corresponding in intensity with the illuminating power of the point to be transmitted, acts upon a series of photo-electric cells arranged opposite to the object. A Nipkow disc is not used in this transmitter.

On my visit to Baird in London in

December of last year, a boxing match was indeed shown to see, transmitted by means of another receiver, which was stated to be capable of transmitting from an illuminated room. In contrast to the other demonstrations, however, the acoustic effects were not transmitted simultaneously on the one hand, and on the other hand he declined to show me the transmitting room. I am therefore in doubt as to whether the transmission was made from actual objects or whether the original was really a film.

In comparing Mihaly's and Baird's processes, it must not be forgotten that Baird uses a considerably greater number of points in the picture than does Mihaly, who based his arrangements from the start on the circumstances attending broadcast waves. Further, Baird's transmission took place over wires, whilst Mihaly's was carried out by wireless through the Berlin-Witzleben transmitter. Also, last but not least, Baird has had fairly considerable means available for some years, whilst Mihaly has had relative freedom of movement for only a short half year.

On enquiry, Herr von Mihaly informed me that he had since solved the problem of transmitting directly from living objects. For this purpose an objective is used as in photography, and the picture projected by this explored by the usual disc arrangement. As a preliminary arrangement, there is said to be still required an extraordinarily high degree of illumination of the object to be transmitted, corresponding approximately to that used in cinematography. Such strong illuminations, however, soon becomes unpleasant, and experiments are at present in progress with the object of reducing the necessary intensity of illumination, so that it should already be possible to make exposures in well-lighted rooms. Such a procedure has the advantage over the above-described Baird procedure, which takes place in a dark room, that on the one hand the free movement of the object to be transmitted is unhindered, and on the other hand that it is naturally more pleasant to work in an illuminated room than in a dark one.

Further, Mihaly has, according to his statement, already developed a daylight-exposure process which he claims to have rendered independent of variations of the intensity of the sun's light by means of an automatically operating photo-electric cell.

Flickering has been reduced to the minimum by special shaping of the holes (in the discs) at

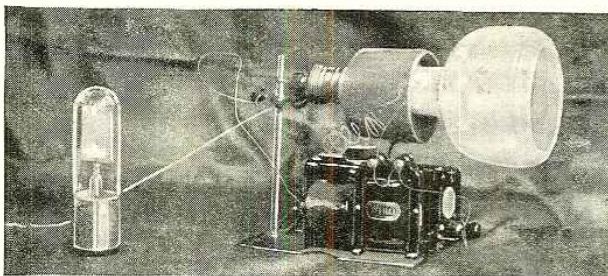
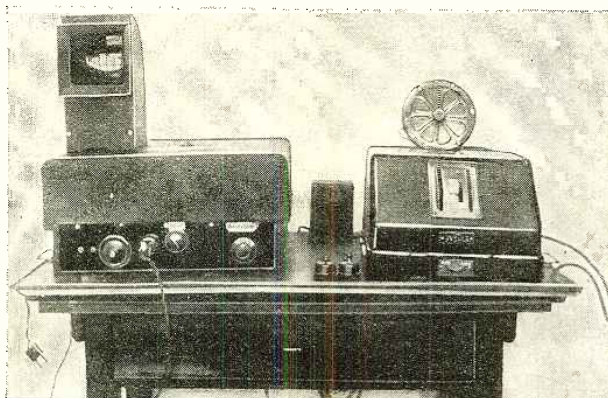

The upper illustration shows, at the left a television receiver, and at the right, a sound receiver, while the illustration immediately below is of the "super-frequency" lamp which, according to description is considerably more efficient than the average

the transmitting and receiving stations.

For the comprehensive broadcasting of television, the production of the receivers is of course of the utmost importance. These machines must not only be so cheaply manufacturable as to be available to the majority of radio listeners, but must be throughout reliable and simple in operation. Von Mihaly appears, in my opinion, to have fulfilled these conditions very well.

The condition of greatest possible cheapness is fulfilled in that no special motor is necessary, the Nipkow disc of the receiver being operated by a fully balanced, horizontal, point-supported "phonic wheel." This has the advantage

A demonstration with the large receiver. If this illustration is to be taken at face value, the received image is both larger and brighter than what television enthusiasts in this country have been accustomed to

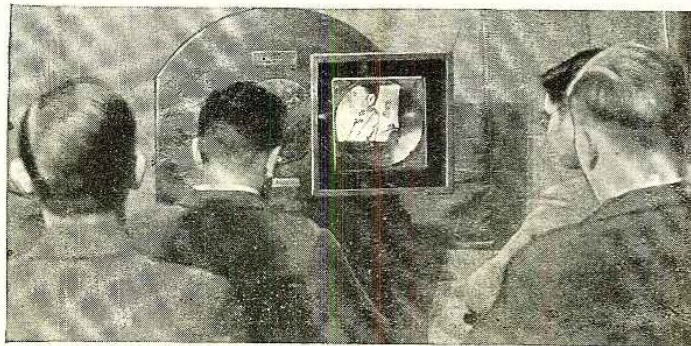

of being considerably cheaper than the usual shunt-wound motor. The latter costs about 26-marks, whilst the phonic wheel can be produced for about M. 6.-. As, apart from the very slight friction at the point of suspension, only air resistances has to be overcome, 5 milli-amperes are sufficient to maintain the phonic wheel in rotation; i. e., approximately the current produced by the broadcast receiver. In contrast to this, Baird, who uses a special motor, requires in addition a local synchronizing arrangement, with which the effect of variations in temperature can become noticeable. During visits to England and demonstrations of the Baird procedure it was in fact determined that frequent readjustment of the synchronization was necessary. As it is not sufficient merely to maintain synchronous rotation, but also to maintain the arrangement in phase, the latter being only possible by variation of the rate of rotation, the procedure is not very simple. The phonic wheel, on the other hand, when once brought into phase (which is effected by manual operation) remains permanently in phase, so that the necessity for further readjustment is eliminated.

In Mihaly's latest procedure, the synchronization problem is solved in the most ingenious manner. That is to say, the synchronization impulses are superimposed on the actual picture impulses in such a way that the actual picture is not distorted, and no special transmission channel is required for these synchronization impulses. Herr von Mihaly even indicated the possibility of transmitting speech on the same wave as the picture and synchronization by utilizing the other sidebands of the carrier wave. This at present, however, is still theory, and in addition, slight alterations to the transmitter would be necessary.

An important part of the receiver is the glow lamp (vacuum tube) necessary for illuminating the picture field. This is produced in conjunction with the scientific laboratories of the Osram Company. The lamp is so constructed that it can be operated with a few *milli-amperes*, instead of requiring excessive power. Baird uses therefore under all conditions a power amplifier, whilst the power required for operating Mihaly's lamp is that generated in an ordinary receiving set giving weak loud-speaker reception.

At present, Mihaly uses lamps filled with neon or argon, which give a reddish light. Lamps filled with helium, and giving a white

(Continued on page 458)

The Variably-Tuned BAND-PASS

By John Rider

Second of a series of practical articles on the design and construction of R. F. Filter Circuits

EVERY indication points to the abundant use of band pass filters in the radio-frequency amplifiers of future radio receivers. A few modern radio receivers make use of such systems at the present time and one of the reasons that other receiver manufacturers have not incorporated these systems is that sufficient time has not yet elapsed to permit most economical design and application. Many radio receivers, to be announced next June, will undoubtedly employ some sort of a band pass arrangement to provide the required side-band characteristics in the radio-frequency part of the receiver.

We are interested primarily in the design and application of these units so that the many radio receiver owners who build their own receivers, may construct such systems and utilize them to good advantage. However, we must announce that the subject is not as simple as we would like it to be; that is, its presentation as a technical subject to technically minded men is much easier than its presentation to men who are not in possession of a thorough grounding in radio technique. This does not mean that the average reader will not comprehend what is to follow. We believe that if he reads conscientiously the subject will be clear. To simplify matters, certain data must needs be secured by test rather than by computations, because the involved computations necessary to eliminate the test are quite complex and, to some extent, confusing. However, for the benefit of the man who is not in a position to conduct the test in order that he secure the required amount of data, we shall supply this data in definite form, so that he who wishes to do so may apply this data and continue with the design of the unit.

We made mention in the August issue (page 140) that one of the characteristics of band pass filters used in radio-frequency amplifiers and tuned to a band of radio frequencies is that the band width is not constant; that the width of the frequency band passed, when the initial computation for design is made on some wavelength of frequency lying midway between the upper and lower wavelength or frequency limits of the filter system, increases as the frequency is increased (wavelength reduced) and decreases as the frequency is decreased (wavelength increased). This fact will not be evident in the progress of calculation used in this dissertation, because we have chosen the simplest method of presenting the subject.

We recall making mention of how the interpretation of the linking or coupling medium used in band pass filters, in the form of coupling reactances, illustrates or rather explains why the width of the frequency band pass varies over the whole frequency range, and we refer the reader to part 1 of this series. In this installation we consider the coupling medium as an inductance, which remains constant irrespective of frequency. The results are sufficiently accurate to permit the construction of a very satisfactory band

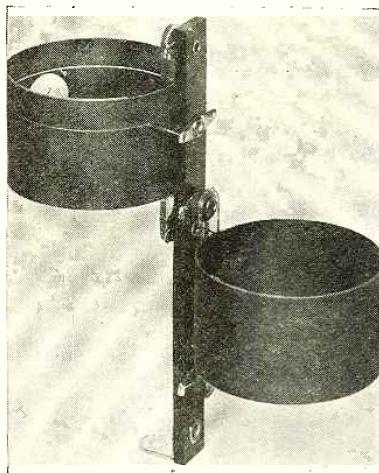

A typical band pass filter coil assembly as used in the prominent Hammarlund-Roberts receiver

pass filter. As a matter of fact, we quote the electrical constants of two such filters designed for use in conventional radio-frequency amplifiers.

Hi-Q Uses Inductively Coupled System

One of the simplest yet very effective band pass filters is the inductively coupled system employed in the Hammarlund-Roberts receivers. We make particular mention of this system because it lends itself to home construction without very extensive changes in the radio receiver. Each radio-frequency amplifying stage, consisting of the primary of the radio-frequency transformer and the secondary of the same radio-frequency transformer, constitutes a band pass stage, the primary winding connected into the plate circuit of one tube consti-

tuting one of the tuned circuits of the filter network, and the secondary of the same transformer being likewise tuned and connected to the grid of the succeeding tube, constituting the second tuned circuit of the filter, as shown in Fig. 1. As is evident, the coupling between the primary and secondary winding is inductive.

Since energy is transferred from one circuit to the other, it stands to reason that the two circuits are coupled to each other; that a linking medium is present between these two circuits. In other words, a certain amount of mutual inductance couples the two circuits. For the purpose of review we will again repeat that two tuned circuits can be arranged to operate independently of each other and respond to the same frequency or may be so arranged that when tuned to the same frequency they will nevertheless respond to frequencies other than those to which they are tuned, and the original tuned frequency lies within the limits of the other two frequencies. The latter is due to the degree of coupling between the two circuits; that is, the degree of reaction between the two circuits due to the presence of the coupling medium. If the coupling medium is great, the circuits are closely coupled; if the coupling medium is small, the circuits are loosely coupled. Furthermore, closely coupled circuits will respond to two frequencies far apart, whereas too loosely coupled circuits will respond to two frequencies which are close together. If the coupling is sufficiently loose the two circuits will respond to one and the same frequency.

Since our filters must respond over a band of wavelengths extending from 200 meters to 550 meters, we shall select 350 meters as the value used in the design. This wavelength is equivalent to a frequency of 857,100 cycles,

$$(F = 300,000,000)$$

w

Now we reach the first snag. Having two coils in a certain position, how can we determine (1) the mutual inductance between the two coils and (2) the coupling coefficient "k" between the two coils? These values may be determined by computation, but this work is quite complicated and for the benefit of the men who are in possession of measuring equipment we will suggest a simple means of determining the above-mentioned values. (We will give exact values for a filter after this exposition is

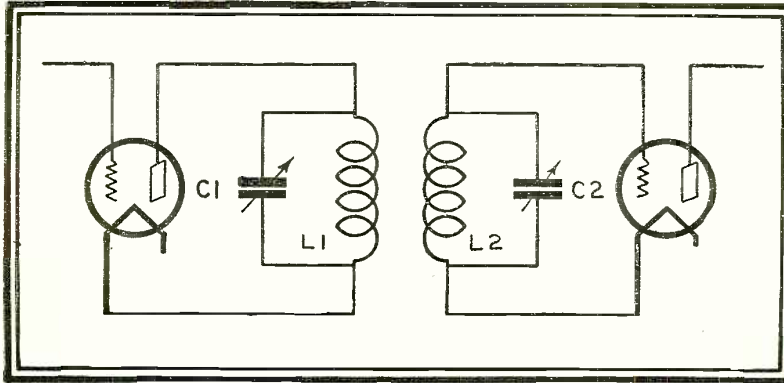

The elements comprising a complete section of band pass filters. Separate condensers tune both the primary and secondary circuits to resonance with the received signal

completed.) To proceed we must assume that the coils at hand have been designed for use with a certain condenser to respond over a certain predetermined wave-band. Hence the coils are of 240 microhenries each and the tuning condensers are of .000354 mfd. each.

Since the average radio-frequency band pass filter is designed for a band width of 10,000 cycles, 5,000 cycles each side of the carrier and the carrier frequency, as we have mentioned, is 857,100 cycles, it stands to reason that the coupling between the two coils need not be very great, since the band width of 10,000 cycles is a very small fraction of the carrier frequency. In other words, the value of mutual inductance required to cause the band width to extend from 852,000 cycles to 862,000 cycles will be small. Hence we must so place our coils that the coupling between them is small. This may be accomplished in several ways, but since these coils must be incorporated into the receiver, it is necessary to consider space and mounting. Hence we select an arrangement where the coils are on a parallel plane but in a certain position, as shown in Fig. 2, with the ends of the respective windings on line with each other and the coils separated about 1/4". (This form of construction is similar to the H-R Hi-Q system. Incidentally, the writer carried out some experimental work upon such forms of coupling in 1924-5. See N. Y. Sun Laboratory Scrap Book.)

A Typical Example

The coils are mounted. . . . What now? . . . How can we determine the coupling between the two coils without extensive calculation. The mutual inductance between such windings may be additive or subtractive, depending upon how the coils are arranged and wired, i.e., the way the current is caused to flow through the respective winding. By determining the total inductance of the two coils in various wiring arrangements we can determine the mutual inductance. With the mutual inductance known, we can determine the coefficient of coupling and determine the frequency response of the filter. To determine the total inductance it is necessary that the inter-

ested individual possess a good wavemeter and a calibrated condenser. Since we intend to quote constants for a filter we shall assume that the above equipment is at hand and the reader follows in line with what is mentioned in the text.

Under normal conditions, the inductance of two coils in series is equal to the sum of the individual inductances, provided that coupling does not exist

The mutual inductance between two coils as illustrated here depends upon the physical coupling of the two in the peculiar position in which these are shown

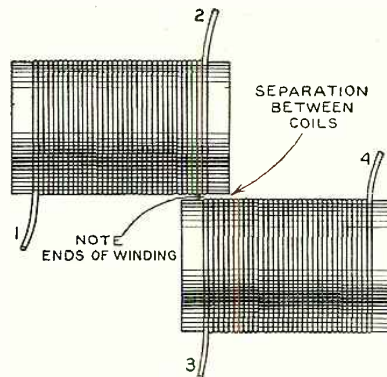

between the two coils. If this were true the total inductance of the two coils, when connected in series would be 240 + 240 or 480 microhenries. We proceed to wire the two coils in series by connecting lead 2 to lead 3 and to measure the inductance at 350 meters by tuning the

combined inductances with a calibrated variable condenser. We find that it is 495 microhenries, which is equal to

$$(1) L_a = L_1 + L_2 + 2M = 495 \text{ microhenries}$$

It is evident that the mutual inductance is additive.

We now connect the inductance so that the mutual inductance is subtractive by connecting lead 4 to lead 2 and remeasure. The inductance of the combination is now found to be 465 microhenries, or

$$(2) L_b = L_1 + L_2 - 2M = 465 \text{ microhenries}$$

The mutual inductance is now subtractive Now

$$(3) L_a - L_b = 30 \text{ microhenries} = 4M$$

and

$$(4) M = \frac{L_a - L_b}{4}$$

$$(5) \text{ or } M = \frac{30}{4}$$

$$(6) \text{ or } M = 7.5 \text{ microhenries}$$

To prove the above, the sum of the two inductances in series without coupling should be equal to

$$(7) L_1 + L_2 = \frac{L_a + L_b}{2}$$

$$(8) \text{ hence } L_1 + L_2 = \frac{495 + 465}{2} = 480$$

With the value of mutual inductance known we can make further progress. (Let it be known that this value of mutual inductance is actually high for conventional band pass filters and the separation between the two frequencies will be excessive. Small values are used in practice, as will be shown later.)

The next step is the determination of

In this circuit coil "M" has been added. "M" is designed to possess a certain value of inductance so that when included in the circuit it will provide a coupling coefficient

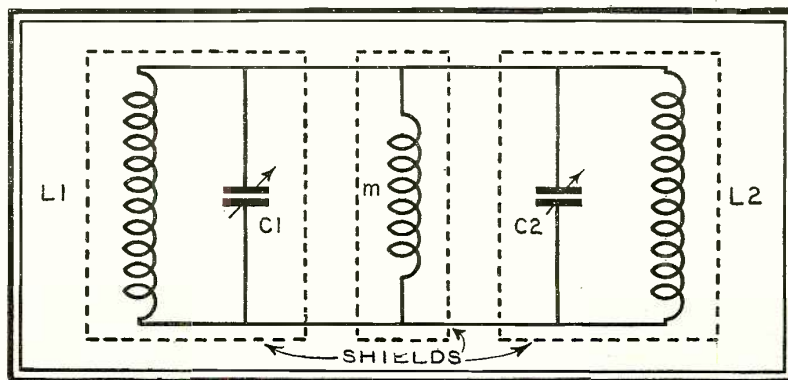

the coefficient of coupling, which is

$$(9) \quad k = \frac{M}{\sqrt{L1 \times L2}}$$

which, because the inductance values of L1 and L2 are alike, is

$$(10) \quad k = \frac{7.5}{240} \text{ or}$$

$$(11) \quad k = .0312 \text{ or } 3.12\%$$

We now have two values, the mutual inductance and the coefficient of coupling.

When we have two circuits like those shown in Fig. 1 the frequency of response is governed by the degree of coupling. If the coupling is very loose so that there is no reaction between the circuits, the frequency of response is

$$(12) \quad F = \frac{1,000,000}{6.283 \sqrt{L \times C}}$$

with L in microhenries and C in microfarads. Substituting, we have

$$(13) \quad F = \frac{1,000,000}{6.283 \sqrt{240 \times .0001435}}$$

The value of .0001435 mfd. is the value of capacity required to tune the inductance of 240 microhenries to a wavelength of 350 meters or to a frequency of 857,100 cycles, which are the values used in design as the response values when the circuits are very loosely coupled to each other; hence

$$(14) \quad F = 857,000 \text{ cycles.}$$

However, we have a certain amount of coupling, in which case we will secure response at two frequencies. The first is with the mutual inductance additive or

$$(15) \quad F1 = \frac{1,000,000}{6.283 \sqrt{(L + M) \times C}} \text{ or}$$

$$(16) \quad F1 = \frac{1,000,000}{6.283 \sqrt{(240 + 7.5) \times .0001435}}$$

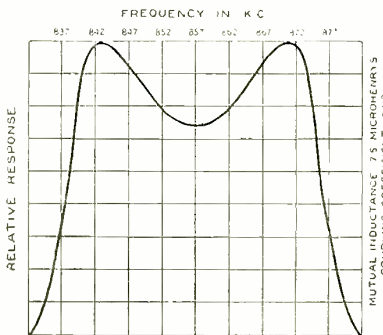

The curve herewith shows the band pass filter characteristic with a coupling coefficient of .0312 (3.12%) and a mutual inductance of 7.5 microhenries

The subject of radio frequency band-pass filters is one which has not received the recognition which its importance merits. In addition to the present series by

$$(17) \quad F1 = 844,000 \text{ cycles (Approximate. Slide rule calculation.)}$$

$$(18) \text{ and } F2 = \frac{1,000,000}{6.283 \sqrt{(L - M) \times C}}$$

$$(19) \quad F2 = \frac{1,000,000}{6.283 \sqrt{(240 - 7.5) \times .0001435}}$$

$$(20) \text{ or } F2 = 871,000 \text{ cycles (Approximate. Slide rule calculation.)}$$

According to the above, the band width is around 15,000 cycles each side of the carrier, which, of course, is excessive and is due to the high degree of coupling between the tuned circuits. In conventional circuits of this nature the usual coefficient of coupling is .0075 or .75%, which with the above value of inductance (240 microhenries) would make the value of mutual inductance about 1.8 microhenries, because

$$(21) \quad M = k \sqrt{L1 \times L2}$$

If the reader desires to know the wavelength band covered by the filter and the wavelength peaks in the filter discussed, it is necessary to apply the following:

$$(22) \quad \lambda 1 = \lambda \sqrt{1 + k}$$

where λ is the wavelength to which the circuit is resonant without coupling between the circuits, i.e., 350 meters.

Substituting, we have

$$(23) \quad \lambda 1 = \lambda \sqrt{1 + .0312} = 355 \text{ meters and}$$

$$(24) \quad \lambda 2 = \lambda \sqrt{1 - .0312} = 345 \text{ meters}$$

It is evident that the 30,000-cycle band width is equivalent to a wavelength band of 10 meters, 5 meters each side of the carrier wavelength of 350 meters. This band is of course excessive and has been used to illustrate the design of the system.

A Practical Application

The exact constants for a band pass filter suitable for use with a .000356 mfd. variable condenser over the normal wave band is as follows:

Inductance of primary, 240 microhenries.

Inductance of secondary, 240 microhenries.

Diameter of winding, 2 inches.

Number of turns, 80 (40 per inch).

Size of wire, No. 26 d.c.c.

Coils located as shown, with the ends of the windings on line. This form of coupling is critical and the mounting should be so arranged that variation is possible until the best result is obtained, after which the coils are to be rigidly fastened into place.

Mr. Rider, which in next month's RADIO NEWS will show the application of this principle to superheterodyne receivers, we have arranged for several informative

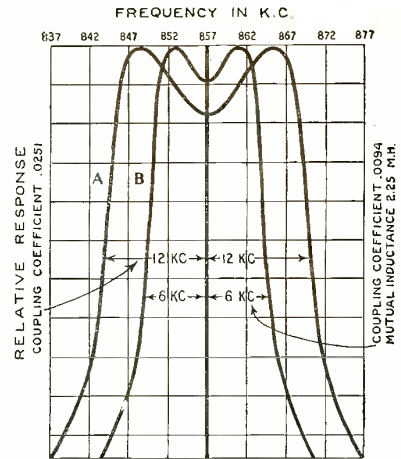

These curves illustrate the band pass filter characteristic of an inductively coupled filter with curve A having coupling coefficient of .0251 (2.5%) and B with a coupling coefficient of .0094 (.94%) and mutual inductance of 2.25 microhenries at 350 meters

The Hammarlund-Roberts band pass filter coils used in the Hi-Q receivers consist of 78 turns of No. 28 s.s.c. on a winding form 1 1/8 inches in diameter and the pitch of the winding is 70.

With respect to the band pass filters employed in certain receivers wherein the coupling medium is a special coil, we find a different situation. To describe the basic analysis it would be necessary to quote reactance figures and to show reactance wiring diagrams. However, we wish to avoid the above because it complicates matters greatly and a thorough comprehension of parallel and series resonance is required for an understanding of what is said. Experiments upon such filters have shown that analysis in the form described in connection with inductive coupling is satisfactory. Under the circumstances repetition of what has been said is unnecessary. However, certain pertinent facts must be mentioned. Examine Fig. 3.

The coils and condensers are identical to those used in Fig. 1. The coil M is the coupling coil, which is designed to possess a definite value of inductance and when connected into the circuit to provide coupling coefficient. Since the correct condition is obtained with a coefficient of coupling between .5 and 1%, the equivalent value of mutual inductance should be between 1.2 and about 2.2 microhenries. In order that the coupling between L1 and L2 be limited to M, it is imperative that all circuits be fully shielded; that is, an individual shield used for L1C1, an individual shield used for L2C2 and an individual shield used for M. M consists of about 3.5 turns of No. 26 d.c.c. wire on a 1-inch spool.

The design of band pass filters suitable for use in superheterodyne receivers will follow in the next instalment.

articles by Dr. F. K. Vreeland, the originator of the band-pass filter system. The first of these noteworthy articles will appear in an early forthcoming issue.



Handling 54 Messages an Hour On the World's Fastest Liner

By William F. Matthews

THE German Trans-Atlantic Liner *Bremen* has made its complete round trip between Germany and the United States and left the world a-talking. High-speed, geared turbines, streamlined funnels, bulbous under-water bow and rakish lines in general are features which have come in for wide discussion. But the radio installation on this new queen of the seas has been acclaimed by engineers as being of the acme of design. With radio, among other things, the Germans have done an extremely good job.

Not only does the speed record attained by the *Bremen* offer something for other ocean liners to shoot at, but the radio record has made new history on the high seas. During the four and one-half days' voyage on her maiden trip, no fewer than 1,725 radio messages were sent and received, an average of 350 per day, 270 of which were handled during the last five hours of her voyage. Altogether, more than 50,000 words were radioed by the six operators comprising the *Bremen's* radio staff. Moreover, during the last two days of its voyage, the *Bremen* communicated simultaneously with three American stations of the Radiomarine Corporation carrying on a two-way exchange of messages with each station. It was the first time in history that a passenger vessel could and did work three radio transmitters and their respective receivers, and copy press reports, all at the same time.

In addition to the transmission of commercial messages, talks by the ship's officers about the performance of the *Bremen* on its maiden voyage were transmitted on short waves. These talks were intercepted and rebroadcast to German and other European listeners over stations at Lengenber, Hamburg, Bremen, Berlin and other cities, and reports from Germany state that the reception was very clear and uniform. And not content with

"doing all the talking," the radio officers during spare moments tuned in on broadcast programs emanating from Germany, England, France, the United States and other countries. In a word, the *Bremen's* maiden voyage was somewhat radio complete.

All of the radio equipment on board the *Bremen* was made and installed by The Telefunken Company of Germany.

The German steamship Bremen, newest speed queen of the seas, is startling evidence of the place which radio has come to assume on shipboard.

With four transmitters reaching as low as fifteen meters and as high as 3,600 meters, the ship carried a staff of six operators on her maiden voyage, and expected to add two more shortly because of the heavy volume of radio traffic.

The ship has four transmitters, one an 800 watt short-wave 15 to 90 meter c. w., i. c. w. and phone transmitters; a 3 k. w. set for 500 to 3,600 meter waves; one 500-watt installation for 175 to 900 meters and a spark transmitter of 500 watts power for emergency operation on 600 to 660 meter wavelengths. The 175 meter wave is the special set aside for the North German Lloyd Steamship Company's

coastal station. All transmitters are rated in power according to their output in "watts in the antenna," which is the European standard of power designation. In addition to regular telegraphic work, all the transmitters except the spark emergency set can be connected with microphone installations for voice broadcasting.

The complementary receiving sets also stand out as the latest in marine radio. The 10 to 150 meter receiver has five tubes (2 radio frequency, 1 detector and two audio frequency) which are operated from storage batteries. The second receiver, for 120 to 1,200 meter waves, has six tubes, the extra tube being employed in the audio system. A third, for 400 to 4,000 meters, has six tubes and another six-tube set tunes from 3,000 to 25,000 meters. A special super-heterodyne set capable of covering a wide range of from 10 to 40,000 meters is also a part of the radio equipment. In all this receiving equipment no screen-grid tubes are used.

"By means of special tuned filter which selects the wavelength before the signal is allowed to enter the receiver proper we suffer no interference whatever from the ship's transmitters," declared Chief Radio Officer Paul Schuch. "This is not the case with other ships which must stop sending messages to copy press. At present we have six radio men and they are all kept busy. Three operators on watch in the radio room operate freely in their individual channels of communication on the different wavelengths without causing interference in the least to a fourth operator engaged in copying press bulletins. Indeed, the radio traffic was so heavy that I expect we will have to carry two more radio operators on our next trip to New York.

According to Officer Schuch marine radio telephone communication will also be established on the *Bremen's* second

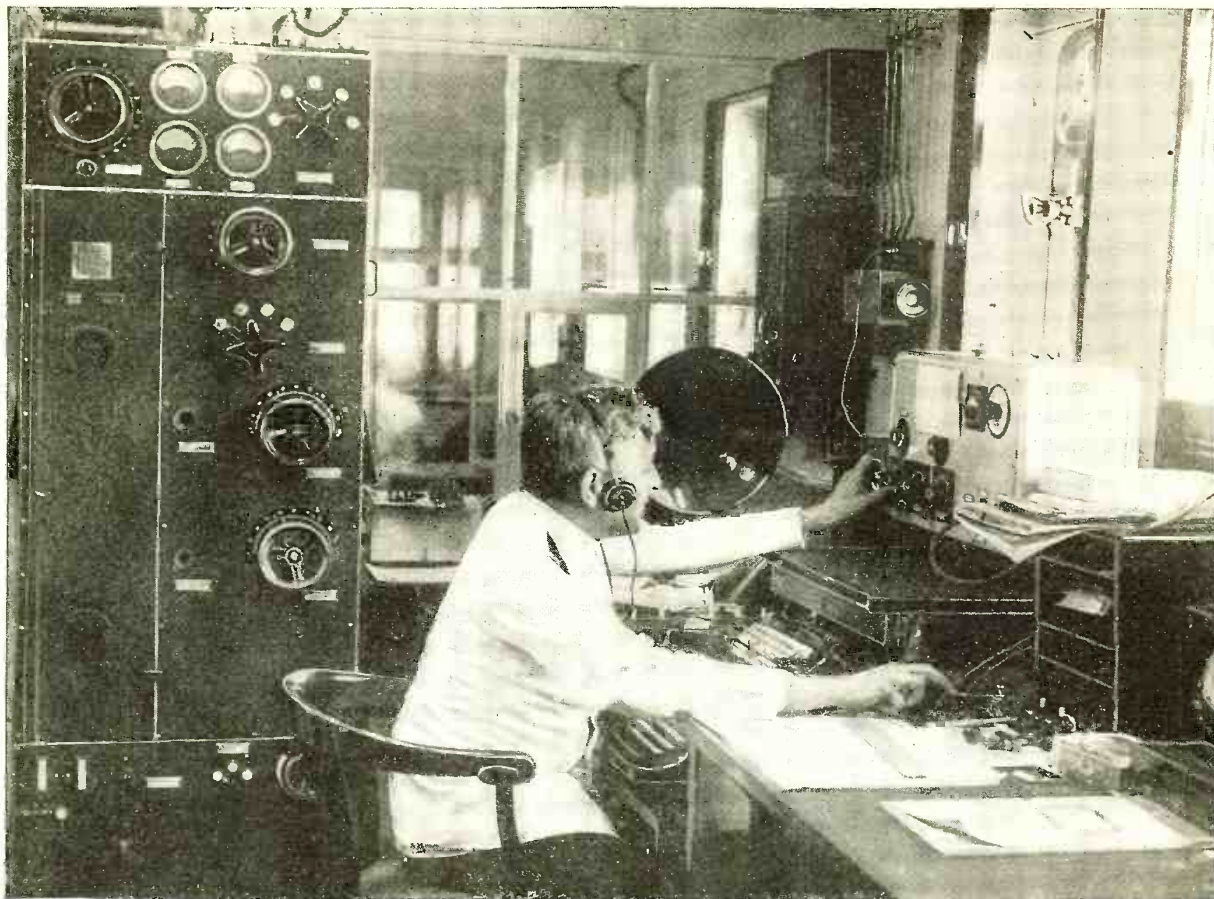

Trans-Atlantic voyage. It will then be possible for passengers to lift their receivers from the hooks of their phone installations and communicate directly by means of beam radio to anyone in the world who enjoys telephone communication—by radio to the nearest land station and then over the land wires to a subscriber's office or home. There is also a sizeable "pay station" for telephonic communication just across the aisle from the main radio room.

Seven separate antennas are employed on the *Bremen*. Two of these are for long waves and five for short wave communication. One antenna—that used for press—utilizes a special duplex aerial system resembling the cage or sausage types which have had a wide use. Stretched in the center of this sausage-shaped cage is a wire which is used for receiving the press, the outer wires being grounded so as to form a shield to shut out the signals from the ship's transmitters.

Above, operating the short-wave receiver. The 800-watt short-wave transmitter being visible in the background

At the right, Paul Schuch, Chief Radio Operator, inspecting the tubes of the 3 k.w. medium and long-wave transmitter

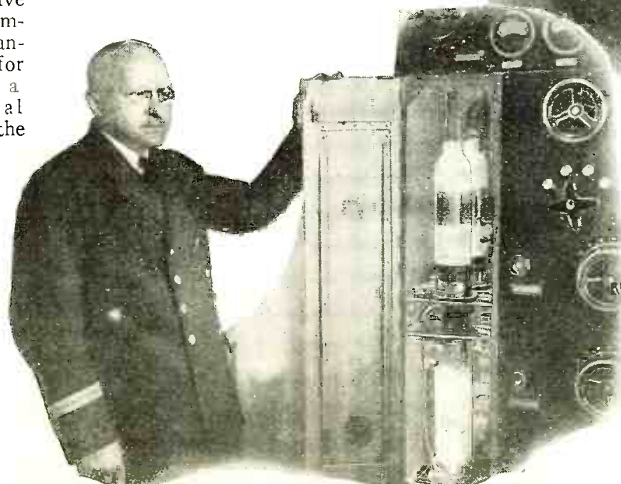
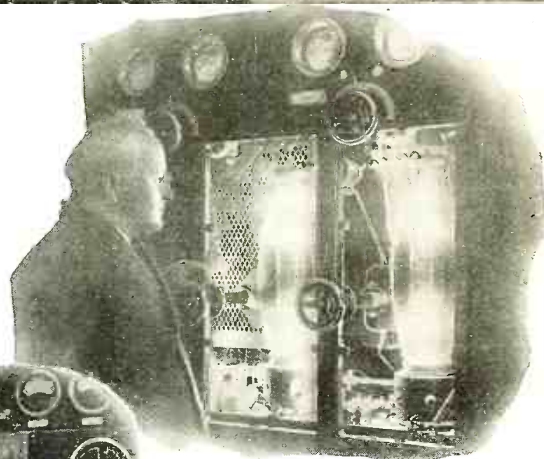

Tubes of the 800-watt short-wave transmitting equipment for other than phone or c.w. transmission

The radio room, as may be expected, is ideally laid out. It contains all the transmitting and receiving apparatus with the exception of the transmitter and receiver used for press, which are in a small room adjoining. In another room, separated from the main room by a glass partition, are motor-driven tape sending and receiving devices which are coupled with the transmitters and receivers respectively. All sending and receiving is done via typewriters, the message to be sent being typed in code which then travels through and actuates the transmitter. Likewise, when a message comes in, the automatic receiver records it on another tape. There is nothing about either the transmitters

(Continued on page 456)

A Short Wave Transmitter

that fits the

Average Home and Purse

By Lieut. William H. Wenstrom

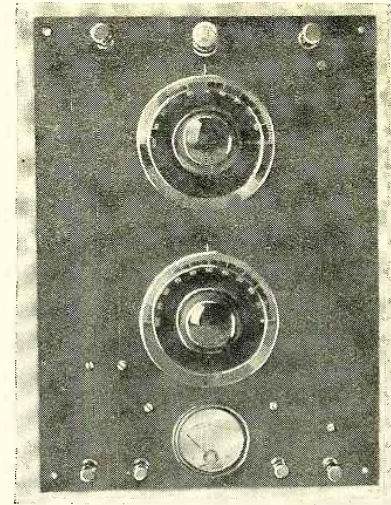

Front of transmitter panel. For neatness and compactness all parts are mounted directly on a 10 by 14 bakelite panel

IN the last issue we touched on the elementary knowledge required of a transmitting operator; in this article we survey a more specific problem—the design and construction of a short-wave transmitter that will fit into the average home. Too often has enthusiasm for radio and electricity blossomed forth in a rambling and apparently endless maze of wiring, fascinating perhaps to the enthusiast when he can remember in more lucid moments which wire goes where, but decidedly inconvenient for those who happen to share the same house. Loose wires running more or less at random with occasional sparks, short circuits and other fireworks; oddly assorted pieces of radio apparatus crowding over tables and shelves until they do battle for space with the very necessities of existence; chemical rectifiers crouching in dark corners ready on the slightest provocation to sputter electrolyte over nearby rugs—these sights have turned away many potential transmitting operators, to say nothing of innumerable fathers and wives whose vetoes were final. Needless to say, in this year of grace, these things are not

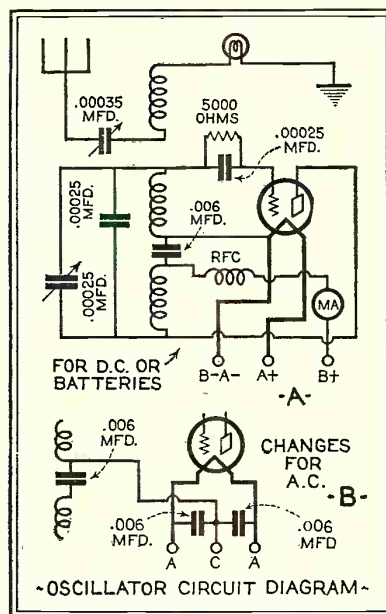
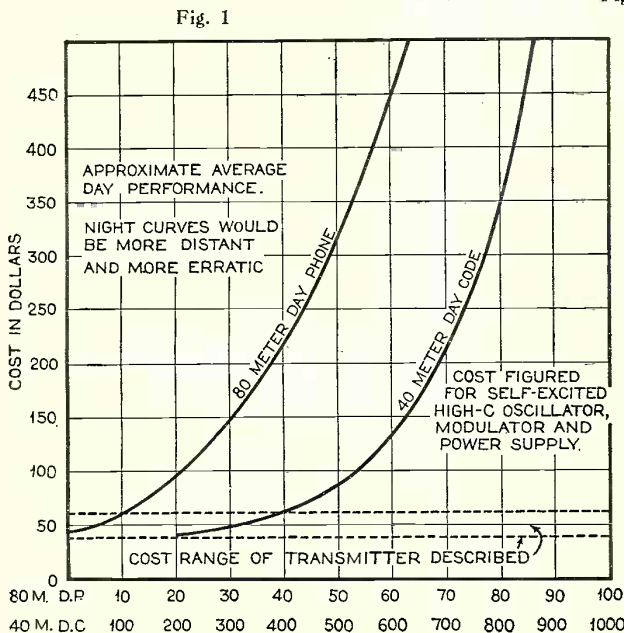

Fig. 2

necessary in transmitting, any more than they are in receiving. It is possible to arrange the apparatus so that it intrudes very little on the other interests of life. But before we consider placement, let us come to some decisions as to what the equipment itself will be.

General Design

The first question is quite properly one of cost. A man buying an automobile does not take demonstrations indiscriminately in Fords and Cadillacs; he usually has a fairly definite idea of the amount he can invest and the results he expects in return. It might be well to approach radio transmitting with something of the same level-headed attitude. The curves in Fig. 1 give a fair average idea of the performance to be expected from various investments in transmitting apparatus, assuming the same general design in each case and current mail order



prices. By performance we mean a clear, steady signal, readable at the given distance under average operating conditions. The shape of the curves is interesting. As in all other branches of human activity more money, representing as it does accumulated man-power of the past, produces more results. But we notice that around fifty dollars a slight increase in money means a considerable increase in performance; while above the "knee" of the curve, say around two hundred dollars, relatively great money increases cause little change in performance. Most of us are not ready to invest all our resources in a transmitter to the exclusion of such necessities as food and transportation, so that we would probably in any case hold the expense below a hundred dollars. But in addition, for all such who are not millionaires, the curves have a message of cheer; they show conclusively that for around fifty dollars we can get the most miles per dollar—the highest actual value from our investment. This is because parts and accessories cost about the same for a UX-210 as they do for a UX-112A. For these reasons the transmitter here described is held within very reasonable limits; and if the cost seems at all high, it must be remembered that the estimates are for average prices on complete equipment: oscillator, modulator, tubes, power supply.

The next consideration is the choice of transmitting circuits. Anyone will admit that crystal control and master oscillator—power amplifier circuits will in general produce steadier signals than self-excited oscillators. But by using high capacities across the tube elements and loose antenna coupling (or detun-

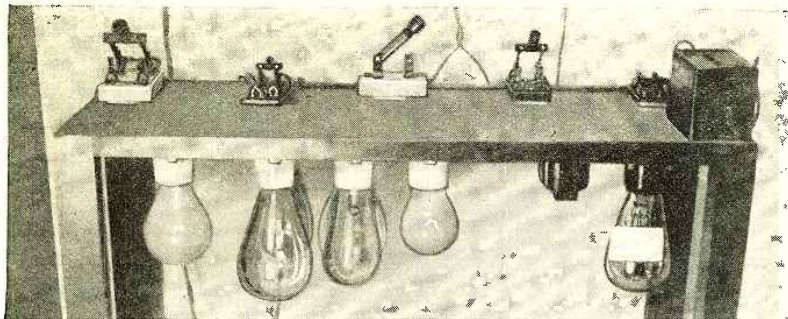

ing the antenna if coupling is fixed) the self-excited oscillator signals can be made steady enough for practical purposes.

There are several oscillator circuits, notable among them being the Hartley, Colpitts and tuned grid-tuned plate. The last is efficient and popular, but requires two tank circuit controls for tuning. The Colpitts is ideal for any one band, and was used in the portable transmitter described in the July issue of RADIO NEWS. The Hartley, economical of apparatus and long the old stand-by, has had movable inductance clips in its usual form, but in this series Hartley design we do away with the clips and lead in the plate supply at a point of low radio-frequency potential. All coils for any one wave-band plug in as a complete unit; and the tank capacity, directly across the grid and plate, is variable only between 250 and 500 mmfd. This condenser is, in effect, a single control for changing the oscillator wavelength, though for actual transmission the antenna is tuned as well.

For some reason radio telephone does not appeal greatly to most amateurs. There is even some resentment at times against phones in the 80 meter band, usually when the latter are operating below their allotted sub-band. But while code with its far greater range and certainty will always remain the major interest, phone has its uses, such as talking to nearby friends or experimenting with voice transmission. A Heising modulation system, as good in principle as that of a broadcasting station, means only another tube, a choke, a transformer and a microphone; and we include it in this design so that our transmitter, simple though it is, will realize the fullest usefulness.

General Arrangement

After the determination of the transmitting circuits, we come to the problem of constructing and mounting them. Probably the most common arrangement places the transmitter, either panel or breadboard mounted, on one or two tables with the receiver and controls, while the power supply reposes on the floor. Though this scheme does make an imposing display of equipment, it usually monopolizes most of the space of one room, making it practically useless for anything else and very difficult to clean. Such profusion of apparatus is justifiable enough in an electrical laboratory, but it is out of proportion in the home.

It might seem at first that the solution is to be found in the other extreme—a transmitter, or both the transmitter and receiver, built into a console worthy in

Close-up of local control switches, lamp bank and modulator. The upper side of the top shelf may well be used for local control transmitter switches, while its under side and lower shelf carry the modulator parts, batteries and transformers

If you have always hankered to "get into the amateur game," this article by Lieut. Wenstrom will be exactly your meat.

The amateur transmitting set does not require a lot of loose or trailing wires and a generally unfinished looking ensemble. Nor does the outfit require that the furniture be moved out, or the attic ripped to pieces, in order to install it.

Fig. 3

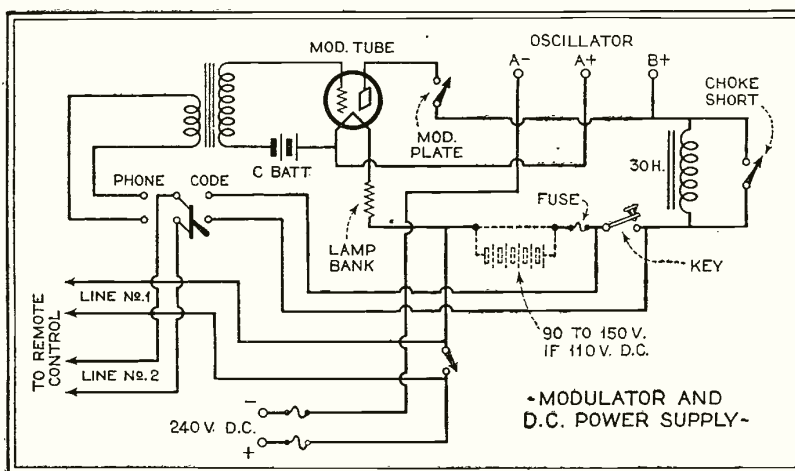

appearance to take its place in living room or study. But at the start this conception entails serious difficulties. Some form of arm rest is a practical necessity for continued key work, and scarcely less so for the delicate and rapid receiver tuning which two-way communication demands. In these respects, at least, the time-honored table is right in principle. Another possibility would be to mount the transmitter and receiver in a well-finished cabinet based on a living room table. This project breaks down because we must have a key and several control switches screwed tightly to the table for effective work. And both of these arrangements have other drawbacks, surmountable only at great sacrifice of efficiency. A transmitter cannot be crowded into any available space like a receiver, in which the relative placing of apparatus means little. The fields surrounding the transmitter are so much more intense that losses would be prohibitive; and the transmitter must be readily approachable for testing, measuring wavelength, or observing plate color—problems which never arise in the case of a receiver. In addition the antenna leads must be short, reasonably straight, and away from walls or other partial conductors.

Our reasoning thus seems to lead to an impasse, but there is a way out of the difficulty—remote control. We will take

The transmitter panel is held out from the bedroom wall by four wooden sticks; the whole being hung by two wires. The modulator and power supply is placed under the transmitter

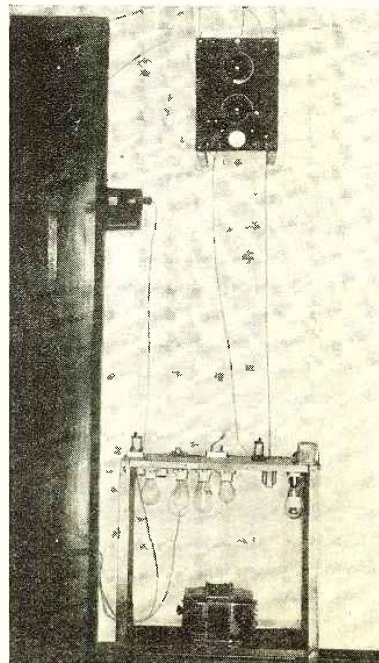

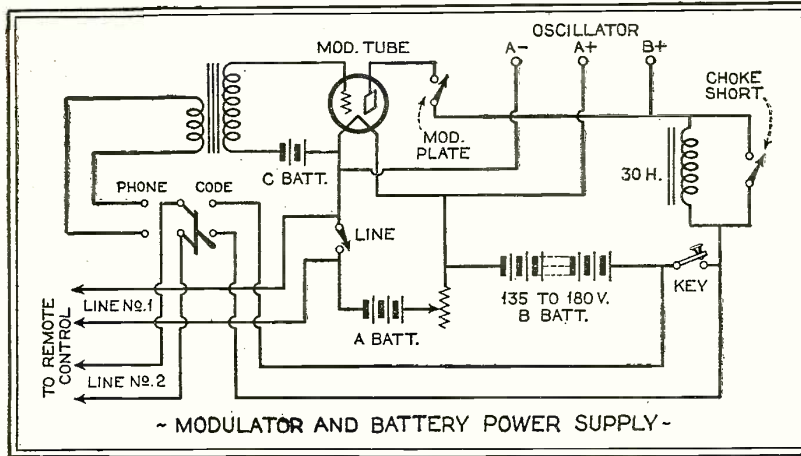
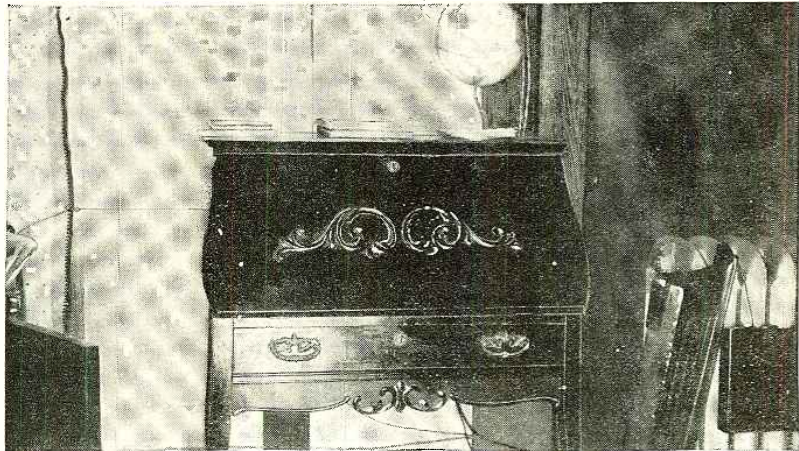

Fig. 4

this transmitter which is so particular about its field space and its antenna connections, and put it where all its whims can be indulged—high up on the wall of a spare bedroom or a covered back porch. For neatness and compactness all parts can be mounted directly on a 10" x 14" bakelite panel, held out from the wall by four wooden sticks, one inch square and one foot long, the whole being hung by two wires and hooks for ready removal. The modulator and power supply can be placed anywhere the constructor likes—down cellar if there is one, but in the writer's installation they are mounted on a two-shelf affair similar to a small bookcase, directly under the transmitter. As the latter is well up towards the ceiling, the modulator and power supply unit covers very little additional horizontal area. The upper side of the top shelf may well be used for "local control" transmitter switches, while its under side and the lower shelf carry the modulator parts, batteries and transformers. The placing of the receiver and controls is the best of all. Waiving all

claims to originality, we might say that the idea was suggested to us four years ago by 5AKY, Mr. W. F. Kitchens of El Paso. It is nothing more than mounting the receiver, key, microphone, trans-

mitter remote control switches, "Q" signal chart and all other devices which the operator needs immediately before him, in a small folding desk. With the front down, the necessary writing, keying and tuning table is at hand; with it up, the casual visitor sees only an ordinary desk. And even if the experimenter likes to show friends his transmitting equipment, how much more startling is this display in its suddenness, like the presto change act of a magician! If all these advantages were not enough, remote control has others. Throwing switches on the transmitter itself, keying on the same table, and moving about in the vicinity—all are likely to produce vibration of the transmitter parts or changes in its field detrimental to steadiness of signal. It will work best when off by itself with no one putting around it or jarring it. Then too, with a low power set thirty feet or more from the receiver the latter can be used (without antenna) for listening to one's own signal. And break-in, the ideal form of telegraph operation, is easy.



Remote control desk in living room—closed. The casual visitor sees only an ordinary desk

Fig. 5

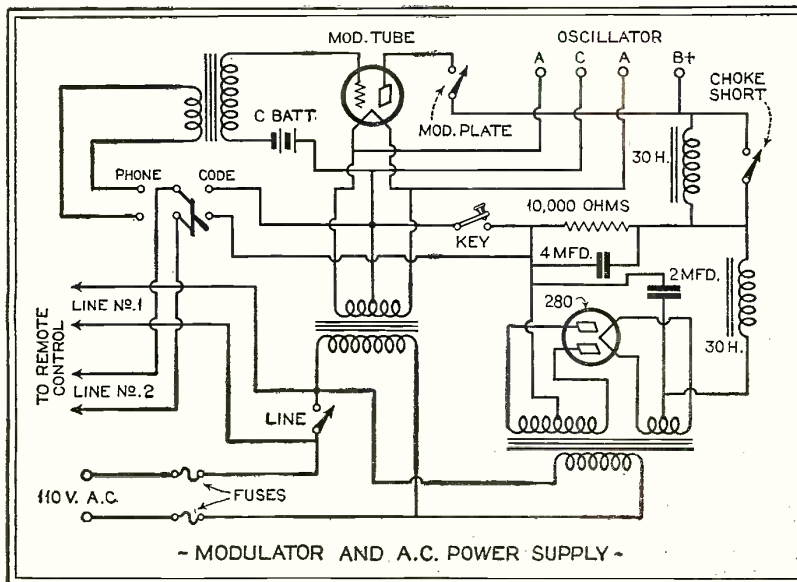

Transmitter Construction

The whole transmitter assembly is based on a 10" x 14" bakelite panel, one fourth inch thick. The photographs and panel drilling diagram, Fig. 7, clearly indicate the layout and placement of parts. Experimenters may wish to vary the arrangement, but the design has been carefully worked out for greatest electrical efficiency, convenience and neatness, and may well be exactly followed. The controls and indicators are mounted along the panel center line. At the bottom is the millimeter, a fairly expensive instrument, but an absolute necessity, as it protects an equally expensive tube and tells many things about the transmitter operation as well. Next are the tank circuit tuning condenser (which happens to be double spaced), controlling the oscillator wavelength, and the antenna tuning condenser. These are old style Cardwells, obtainable very cheaply at many stores, and as good electrically and mechanically as anyone could want. It will be noted that a fixed condenser is shunted directly across the tank circuit tuning condenser. By thus always keeping the total tank capacity high, we achieve an absolutely steady signal.

At the top of the panel is the antenna current indicating bulb. Here we have a chance to spend over ten dollars for a radio-frequency ammeter, but on the whole the bulb does just about as well.

The exact antenna current is not very important in short-wave operation anyway, and the bulb resistance is low compared to the total antenna resistance. If one wishes the last ounce of signal strength, the bulb can be shorted by a switch. The bulb size will vary with the power used. For the average set a 12 volt 3cp auto bulb, with a normal current of .3 amps., a cold resistance of 6 ohms, and a white-hot resistance of 40 ohms, is the best size. For battery sets a 6 volt pilot bulb, as used in the Portable Transmitter, would be better; higher voltage a. c. installations will require a 6 volt 3 cp auto bulb (normal current .6 amp., cold resistance 2 ohms, hot resistance 10 ohms).

We have now accounted for all the major parts except the tube and the coils. The tube socket is mounted on the right

For the 40 meter band: antenna coil 5 turns; plate coil 3 turns; grid coil 3 turns. The 20 meter band could be reached, if desired, with a smaller fixed tank capacity, a plate coil of 2 turns and a grid coil of 1 or 2 turns, but it is best to begin with the lower-frequency bands. No filament voltmeter is included in the transmitter, as this voltage can be checked with a portable meter, and usually remains fairly constant.

The following parts went to make up the writer's transmitter:

- 1 Cardwell variable condenser, 350 mmfd.
- 1 Cardwell variable condenser, 250 mmfd.
- 2 Sangamo fixed condensers, 250 mmfd.
- 1 Sangamo fixed condenser, 6000 mmfd.
- 1 Benjamin spring socket.
- 1 Weston millimeter, No. 506, 0-200.
- 1 Ward Leonard resistor, 5000 ohms.
- 2 Dials, 4" bakelite, plain.
- 1 RFC (100 turns No. 28 on 1/2" dowell).
- 1 Socket and bulb, auto.

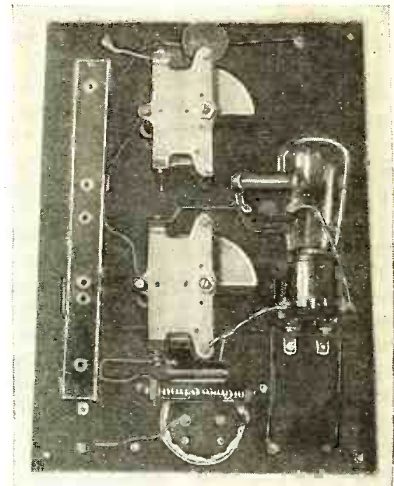

Back view of the transmitter with coils removed. The above photograph and panel layout in Fig. 7 clearly indicate the layout and placement of parts

- 1 Panel 1/8" x 10" x 14" bakelite.
- 3 Strips 3-16" x 1" x 10 1/4" hard rubber.
- 12 General Radio plugs, No. 274-P.
- 6 General Radio jacks, No. 274-J
- 6 Eby binding posts.
- Inductance coils (see text).

Tubes and Testing

For our tube combination we have chosen the UX-210 as oscillator and the UX-250 as modulator. A UX-112A and UX-171A will do fairly well for low voltage battery power supply; but in general, even for battery and d. c. power, it is worth while to install these husky tubes and work them underloaded, rather than to overload receiving tubes. The plate currents in oscillator and modulator will run about the same—around 30 to 60 mls, depending on the voltage and circuit adjustments. The modulator operates much like the last stage of an audio-frequency amplifier with which most people are familiar. The oscillator is much like a regenerative detector in principle, and should not give any trouble if a few common sense principles are ob-

(Continued on page 460)

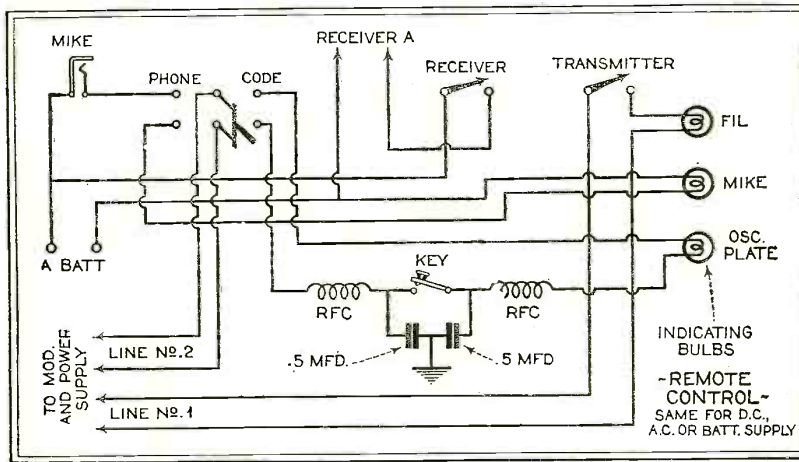
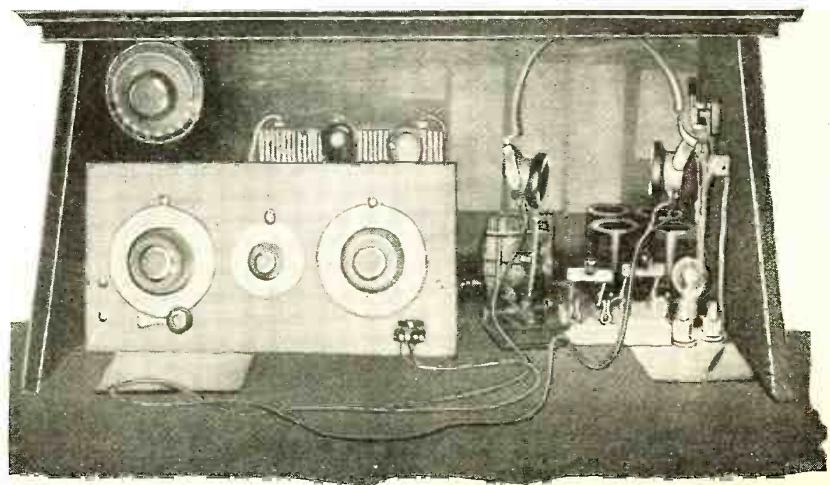

Fig. 6

of the condensers (viewed from back of panel), far enough out to clear the rotors. It happens to be an old style spring socket so that all types of transmitting tubes will fit it, but a new push-in socket would do just as well. The plug-in coils are worthy of some notice. Manufactured transmitter coils are available, but none of these proved adaptable to this circuit and general design, adopted after a process of elimination. The coils are therefore easily and cheaply homemade from 1/8" copper tubing, first pulled out straight and polished, then wound tightly and tied overnight on a bottle or other form, then looped at the terminals and screwed to the strip by the beautiful little General Radio plugs, obtainable directly from that company at Cambridge, Mass. In a similar strip permanently mounted back of the front panel is a corresponding line of G. R. jacks (all three strips are drilled together), so that the coil assembly for one wave-band plugs in as a complete unit in practically one motion. The strips are 3-16" hard rubber, and the coil diameter is 2 1/2 inches. For the 80 meter band we use: antenna coil 10 turns; plate coil 7 turns; grid coil 7 turns.

Below—a close-up view of the remote control apparatus, as installed within the ordinary writing desk. Note that the receiver occupies the lion's share of the space, and that there is no crowding of apparatus



The present Federal Radio Commission. Left to right: Major General Charles McK. Saltzman (Fourth Zone); Judge Eugene O. Sykes (Third Zone); Judge Ira E. Robinson (Second Zone); Harold A. Lafort (Fifth Zone); William D. C. Starbuck (First Zone)



“PUBLIC

MILLIONS of American citizens now use and have access to radio receiving sets. Each day and night they enjoy their choice of splendid programs with a clarity of reception unexcelled by the radio reception of any country in the world. But it is doubtful if more than a relatively small portion of them possess any comprehensive idea of the part played by the Federal Radio Commission in making possible such ideal radio conditions.

Following the Radio Act of 1912, all regulation of radio rested with the Secretary of Commerce. Although he had authority to allocate frequencies to applicants for broadcasting as well as transcontinental and transoceanic licenses, he did not have sufficient authority because of defects in the wording of the law, to settle disputes, revoke licenses, refuse applications for licenses and limit the licenses to specific frequency assignments. His lack of authority became accentuated by the court ruling of the well-known Zenith case, and the result was the creation, by Congress, of the Federal Radio Commission, empowered by a stronger law to regulate radio in the public interest, convenience and necessity. The new Federal Radio Commission was empowered to issue all licenses for broadcasting, communication and other services within the United States and from the United States to foreign countries and ships at sea. Under the 1927 law, all previous radio licenses were vitiated. Accordingly it devolved upon the new commission to re-license all existing stations, considered to be operating within the meaning of the “public interest, convenience and necessity” clause of the new radio act.

Obtaining the services of one of the government's foremost radio engineers and competent legal counsel, the Commission prepared to attack its major problem. A survey of the entire situation was made, thousands of questionnaires were sent out and the information so obtained was promptly applied to the decisions of the Commission in renewing licenses. By the allocation of new fre-

quencies, or wavelengths, the congestion was reduced to the minimum possible consistent with the number of stations in existence.

The International Convention and Reg-

The author of the accompanying article, preferring to remain anonymous, presents a strong case for the Radio Commission.

We have heard so many and such bitter complaints, to the effect that the Commission had “spinelessly botched its job,” that we are glad to present, here, the Radio Commission viewpoint.

We shall be equally glad to present in subsequent issues, the suggestions and comments of those who hold opposite views; especially those who have some practical, constructive ideas to back up their criticism.—

THE EDITORS.

ulations drafted in Washington during the fall of 1927, contained the proviso that it should be put into effect beginning January 1, 1929. The Federal Radio Commission was confronted with the task of recalling and reissuing all outstanding licenses in all fields except broadcasting, in order to make the services covered by these licenses conform to the service bands established by this Convention.

The Convention provided that for certain frequencies, where world-wide inter-

ference would not prevail, regional agreements could be made between nations in certain geographical areas. In conformity with this, the United States entered into such a regional agreement with Canada, Cuba, and other North American nations, providing that the so-called Continental Band, i.e., the band between 1,500 and 6,000 kilocycles, be set aside for certain specific services which were subdivisions of the main headings, “Fixed and Mobile” services. These special services include ship and coastal; aircraft and aeronautical; portable, including police and geophysical; railroad rolling stock and railroad harbor and tug; fixed point to point; amateur, visual broadcasting, general experimental, and agriculture. In addition to these divisions of the Continental Band by services, this regional conference set aside a number of specific general communication channels for the exclusive use of the various nations involved.

These agreements imposed many additional responsibilities on the Commission.

During the time spent on the stabilization of broadcasting, the Commission handled the periodical renewal of more than two thousand ship licenses, all point to point, transcontinental and transoceanic licenses, all airplane and experimental licenses, held hundreds of hearings in cases where applications were denied and relicensed the broadcasters quarterly.

So rapidly had successful experiments been performed and new apparatus been designed for more perfect commercial communication with radio, that the Commission soon became besieged by a host of newly formed corporations for grants to use frequencies in the continental band. Elaborate communication systems both in the United States and internationally were proposed and the keenest sort of competition for the valued frequencies ensued.

The continental band has been allocated and assigned after careful study and

INTEREST, CONVENIENCE and NECESSITY?"

That one phrase has been the big stick with which the Federal Radio Commission has taken radio out of chaos and insured for the American people the best radio regulation in the world.

That phrase is the life or death of all broadcasting and communication stations.

extreme consideration for the public interest. The assignment of its frequencies will have a most important bearing upon communications of the future not only in America but throughout the world. That responsibility which is now almost completely discharged was a tremendous one.

Without codified radio laws and in the almost total absence of judicial precedents, the Federal Radio Commission is blazing a new trail. While some of its rulings and decisions have fallen upon individuals with severe precision, the Commission's entire regard has been for the interest, convenience and necessity of the American public.

No other government Commission has yet been called upon to decide such a multiplicity of questions, involving moral and property rights, without definite judicial precedents for guidance. On this account the Commission's problems have often been grave but it has solved them with fearless zeal.

Another complicating factor has been the physical limitations by which radio communication is confined. The spectrum is not elastic and cannot be increased. The United States has definite bands of frequencies for definite radio services. The number of frequencies is small when compared to the number of applicants who have sought them.

Those industries regulated by other Commissions do not bow to such extreme physical limitations. There remains considerable ground for the building of railroads, the installation of telephone and telegraph lines and the operation of interstate motor transportation systems. If the fields of radio operation were equally abundant, its regulation would be materially facilitated.

(Continued on page 464)



The Honorable Herbert C. Hoover, as Secretary of Commerce, in one of his early talks over the radio

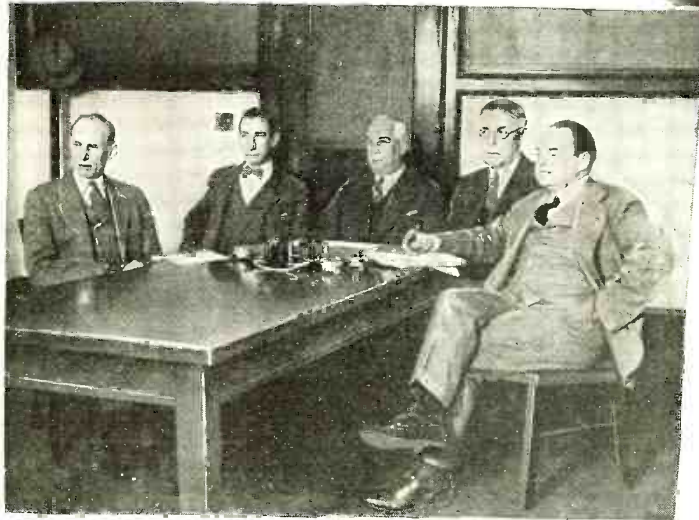

The original Federal Radio Commission, of which but one member (Judge Sykes) is still serving



At the right are shown Henry F. Bellows, Judge Sykes and Orestes H. Caldwell, three members of the original Federal Radio Commission who bore the brunt of the active work of reallocating the broadcast wavelength

HIGH Quality at LOW

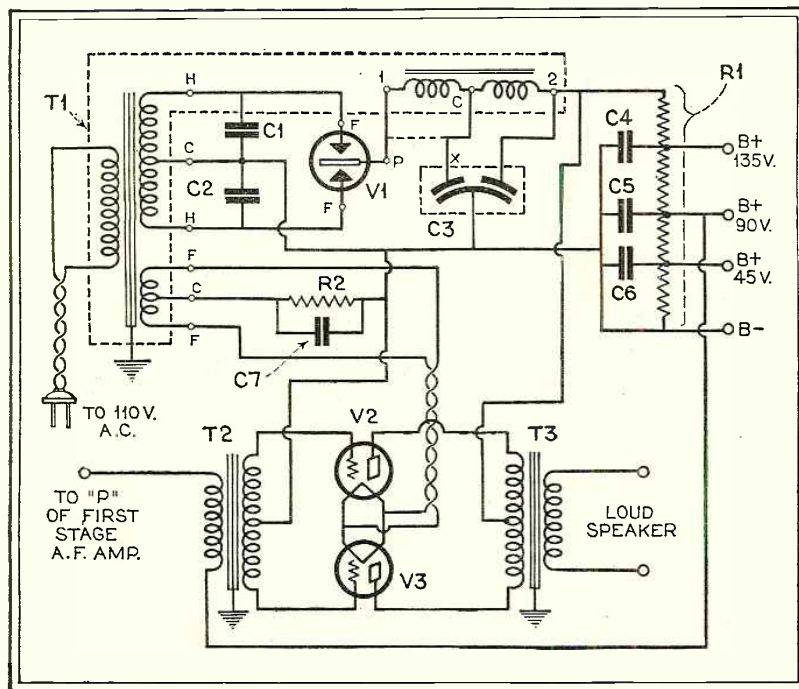

An Easily Constructed Audio Amplification

IN the quest for good quality reproduction in the home, the set builder is often in a quandary as to just what type of power tube he shall choose for his power amplifier. So important has this problem become that Mr. James Martin, one of RADIO NEWS' regular contributors and now well known to readers of RADIO NEWS for his instructive and enlightening articles, made this topic the subject for one of his articles, which appeared in the August issue of RADIO NEWS.

In this article, Mr. Martin made the statement "power outputs up to about 0.3 or 0.5 watts will give fairly low room volume, about 1.5 watts gives very good room volume; up to about 3 watts give loud room volume and 5 to 10 watts give auditorium volume." He showed the rating of the various types of amplifier combinations which can be employed to

provide different outputs, and from his table it will be observed that the 171A tube used in push-pull will very easily meet the requirements for "loud room volume" without the necessity for employing a type of audio channel which uses the more expensive types of amplifier tubes and their attendant power supply.

Use a Power Stage for Good Quality

The single-stage power amplifier-power supply device described here has been designed chiefly to meet such requirements. It will deliver exceptionally good quality, have ample room volume, and above all is economical in construction.

It comprises the final or power output stage of an audio channel and is intended for use either with a receiver already containing a first audio stage, or to replace the final audio stage of a receiver of the old style which does not contain power audio amplification. In addition, it provides the plate potential, not only for the two push-pull tubes in the power stage, but also the "B" voltages for the other tubes in a radio receiver proper.

Circuit Is Simple

The circuit for the amplifier is shown in Fig. 1. It consists of an input push-pull transformer, T2, connecting to the grids of the two 171A power tubes arranged in push-pull fashion, and a push-pull output transformer, T3, having its primary connected to the plates of these two power tubes. Input and output connections are made to these two transformers respectively. Filament supply for the two tubes is obtained directly from a winding on the power transformer, T1. In the power supply circuit this transformer is enclosed in a metal can which also contains the two filter chokes. The secondary of the transformer supplies the high voltage which is rectified by the BH type of rectifier, V1, and passed along to the filter unit comprising the two before-mentioned chokes and two Mershon electrolytic capacitors, each one of 8 mfd. capacity.

It will be noted from the circuit that there are two ways in which the Mershon electrolytic filter condensers may be con-

Fig. 1—Above, the circuit diagram, and below, rear and top views of the completed amplifier and "B" supply

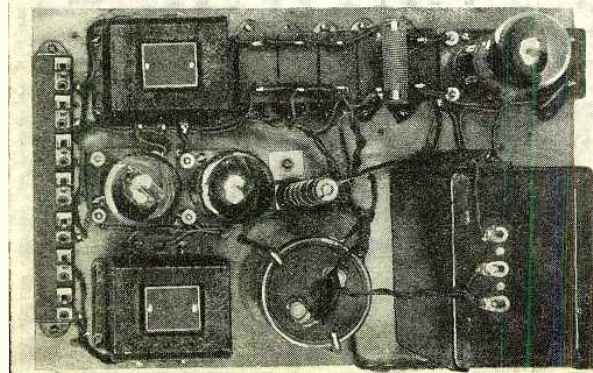
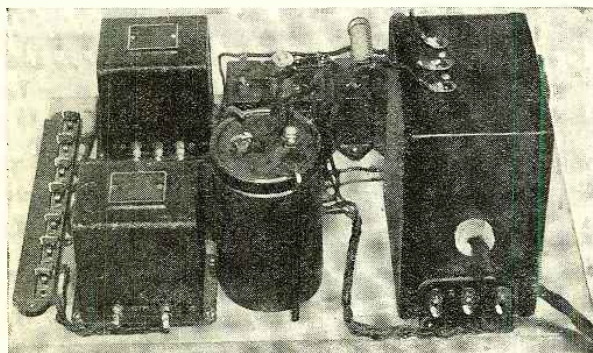

Cost

Push-Pull Stage of With B-Supply

By the
Laboratory
Staff

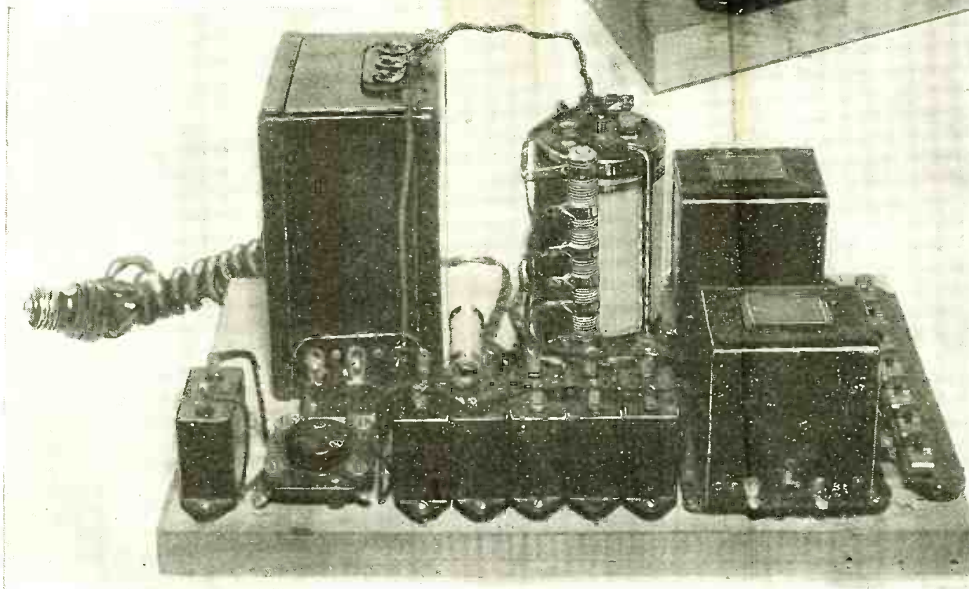
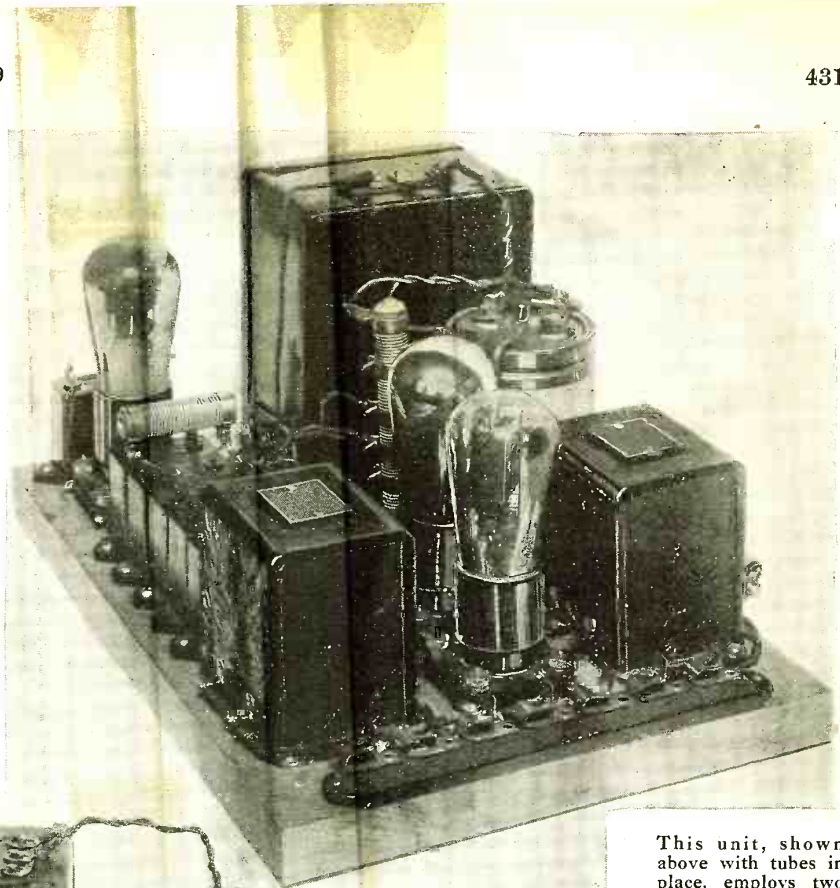

This unit, shown above with tubes in place, employs two 71A type tubes in push-pull, and a gaseous rectifier. In addition to furnishing an output giving ample volume without distortion, it supplies plate voltages for the entire receiver

voltages for the receiver proper.

PARTS LIST

Audio Amplifier

T1, T2—National push-pull input and output transformers. No. P59 and P10 respectively.

Two sockets.

One box Corwico braidite.

Power Supply

T3—Radax or Thordarson 171 power compact.

C1, C2—Aerovox or Polymet .1 mfd. 450-volt condensers.

C3—Mershon electrolytic filter condenser D8, 8 mfd. per section.

C4, C5, C6, C7—Aerovox or Polymet bypass condensers, 1 mfd., 450-volt type.

R1—Electrad voltage divider, C130S.

R2—Electrad truvolt wire-wound resistor, type B—25, 1,000 ohms.

V1—Eveready-Raytheon rectifier, type BH.

One terminal strip.

One box Corwico stranded braidite.

One socket.

nected. In the way in which they are shown in the circuit diagram in solid lines, the 60-cycle a.c. supply with its harmonic are less apt to be passed through than with the method shown by the dotted line connection. In the latter case, its advantage lies in the fact that by changing the connection X from the center tap C to point 1, an increased voltage output will be obtained. Either way may be tried. In addition, the use of the Mershon condenser permits the employments of a comparatively high capacity at both these places in the filter circuit without requiring a great deal of space. At least not as much as would be required if the same amount of capacity were to be employed in the paper type of condenser.

Another advantageous feature about the use of these electrolytic condensers is that should the voltage applied to the in-

put of the filter circuit rise beyond normal value for any reason and puncture the condenser, it will not be permanently injured because of its self-healing properties. The voltage divider, a simple wire-wound resistance, is employed to "drop" the output voltages to values suitable for powering the tubes which are employed in the radio and first stage audio channels of the receiver.

From the photographs accompanying, it will be seen that the construction of this push-pull output stage of amplification is simplicity itself. The amplifier parts are mounted from front to back along the right-hand edge of the baseboard, while the power supply equipment takes up the remainder of the space available to the left of the amplifier. At the extreme right edge of the baseboard is mounted a terminal strip providing the various "B"

Why the BAFFLE?

*Its Function, Its Size and
Its Composition Are Some
of the Points Explained*

By James Martin

DYNAMIC loud speakers really consist of two major parts, the chassis or unit and the baffle—although we are prone to refer to the unit as though it were the complete loud speaker. Such it certainly is not. This we can readily prove to ourselves by listening to any dynamic unit without a baffle and noting the complete absence of all the low frequencies. This one fact will perhaps serve to indicate the importance of correctly installing the loud speaker unit. Obviously the matter of proper installation is closely associated with the larger problem of good quality—in which we are all interested. The problem of obtaining good reproduction from a radio set does not end with the purchase of good parts. Just as essential is their proper utilization.

Probably no factor has more effect on the proper operation of a dynamic loud speaker unit than the "baffle." A baffle is necessary for the following reason:

The Function of the Diaphragm

When a loud speaker is producing sound the diaphragm of the unit is in vibration—that is, first it might move in the direction A, Fig. 1, and then the next moment it is moving in the direction B. If the current flowing through the moving coil has a frequency of 60 cycles then 60 times every second the cone moves in the direction A and 60 times every second the cone moves in direction B. Now every time the cone moves in direction A it compresses the air in front of the diaphragm—we might say it crowds the air together. At the same time the air in back of the diaphragm is decompressed—rarefied, because the cone has moved forward and there is more space in back for the air to fill. These differences in pressure—more pressure in front and less pressure in the rear—tend immediately to equalize each other and figuratively what happens is that the extra air in front begins to run around the edge of the cone to the rear where there isn't sufficient air. But sounds are produced due to the differences in air pressure and if these pressures succeed

Celotex, a comparatively light but satisfactory material is widely used nowadays as a baffle

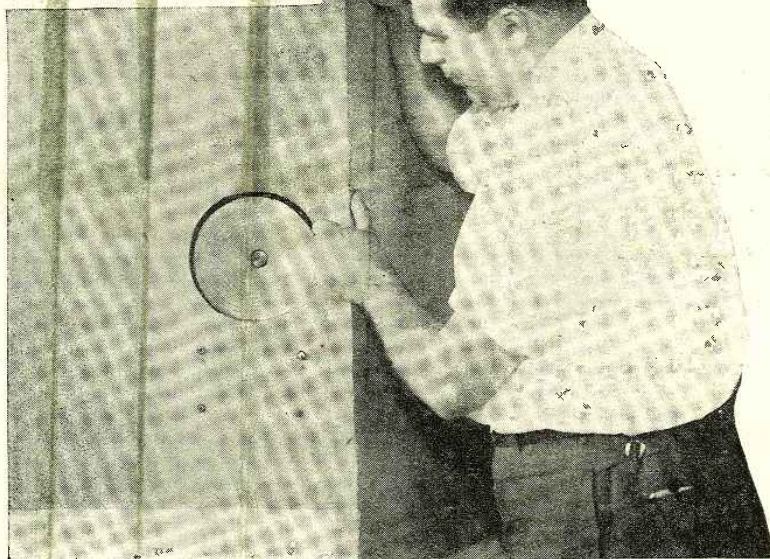

in completely equalizing each other no sound will be produced. If they partially equalize each other, very little sound will be produced. So we must do something that will prevent the air from getting from the front to the back of the cone. This we accomplish by placing the cone in a baffle which may take either of the forms indicated in Fig. 2. By means of the baffle we have made the air distance from the front to the back of the cone very much longer and this long path prevents any considerable amount of air from getting from the front to the back of the cone in time to equalize the pressure.

The Baffle and Quality Reproduction

The baffle is most essential at low

frequencies. Here's why. The current flowing through the moving coil is a. c. and it has the familiar form as indicated in Fig. 3. Since the cone follows the variations in the current the air pressure curve will have the same form. Therefore in terms of air pressure in front of the cone we can decide that from A to B the pressure is increasing above the normal value. From B to C the air pressure is gradually decreasing to normal. From C to D the air pressure is gradually decreasing below normal. And from D to E the air pressure is gradually increasing to normal. The air pressure therefore goes through four changes during each cycle. If the current had a frequency of 30 cycles then there would be 30 times 4 to 120 changes in pressure per second. Now sound waves travel about 1100

feet per second and in the case of 30 cycles during any one change in pressure (each of which takes place in 1-120 of a second) the sound pressure wave will therefore travel 1100 divided by 120, or about 9 feet. Consequently if we make the path from front to back about 9 feet long the air pressure wave from the front will not be able to get around to the back of the cone in time to equalize the pressure. If the total length of the path is to be 9 feet then the distance A in Fig. 2

Fig. 1

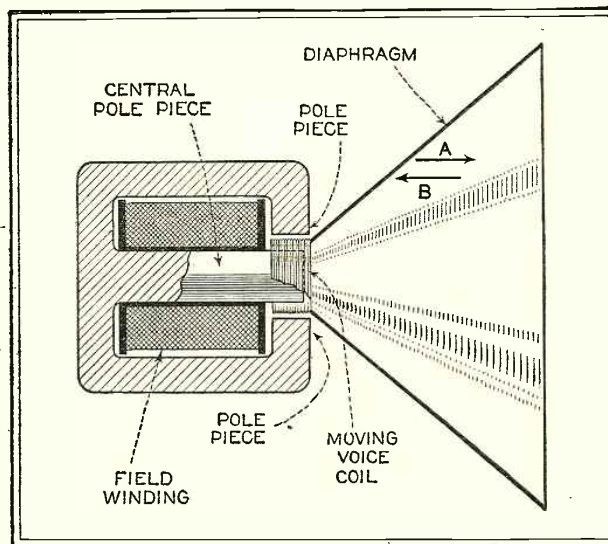

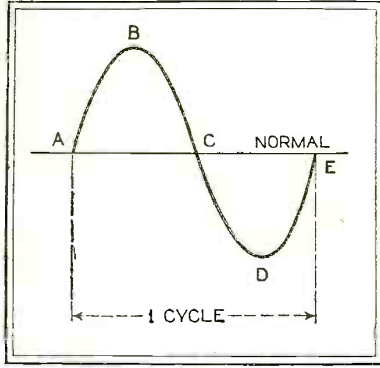

Fig. 3

must be about $4\frac{1}{2}$ feet, so that the total distance B will be 9 feet. If the calculations are carried out at 60 cycles we find that the total length must be about $4\frac{1}{2}$ feet. Tabulated, these results become

Lowest frequency desired	Length of air path
30	9 feet
60	$4\frac{1}{2}$ feet
100	$2\frac{3}{4}$ feet
200	$1\frac{1}{2}$ feet
1000	$3\frac{1}{4}$ inches

The important point to notice in the above table is that the required length of the air path decreases as the frequency goes up. At 1000 cycles, for example, the air path need be only $3\frac{1}{2}$ inches. Since the average distance from the center of the front to the center of the back of an ordinary 10 inch diameter cone is something like 6 inches it follows that the cone *itself* is an effective baffle at high frequencies. Therefore the baffle we place around the cone is only important at low frequencies and its size should be determined by the lowest frequency we desire to reproduce. If we want to reproduce down to 60 cycles we must have an air path of $4\frac{1}{2}$ feet; (see table above) if 30 cycles is the lower limit then the air path must be 9 feet.

The dynamic unit is only part of a good sound reproducing device. It is fastened to the baffle at the rim of the cone

(Photographs courtesy of United Reproducers Corp.)

The Baffle's Size, Shape and Composition

It makes no difference how this length of air path is obtained. Using square baffles such as are indicated in A of Fig. 2 the side of the baffle should equal the length given in the above table. The figures for square baffles are therefore as given in Table II. In the case of cabinets such as are indicated in B of Fig. 2 any number of sizes are possible. For example, suppose that we wanted the front of the cabinet to be 2 feet square. If the lower frequency limit was to be 60 cycles, then the sides would have to be of such a length that the distance A plus B plus C plus D was equal to at least $4\frac{1}{2}$ feet. In all cases the effective baffle length is equal to the *shortest* distance from a point in the center of the front of the cone to a point in the center of the rear of the cone. Using as a basis the examples we have given, it should not be difficult to calculate any specific case.

The fact that a baffle is slightly smaller than the size required to reproduce a particular frequency does not mean that frequency will be *completely* suppressed—it simply means that notes of this frequency will be *somewhat* suppressed, the

AS a cone diaphragm vibrates, it produces alternate compression and decompression of the air, both in front of and in back of the diaphragm; but at any given moment air pressure conditions in front are exactly opposite to those in back of the cone. On the higher frequencies, the area of the cone itself is sufficient to prevent the air from rushing around the edges to equalize the pressure (and thus neutralize sound production); but on low tones, with their slower rate of vibration, the air has time to do exactly that, thus damping out the low-frequency sound vibrations.

That, in brief, is the reason for employing a baffle. How to calculate its proper size, shape, and how it should be employed, Mr. Martin explains in the accompanying article.

extent of the suppression being determined by how much smaller the baffle is than the correct size. For example, a baffle giving an air path of 4 feet will permit the reproduction of 60 cycles

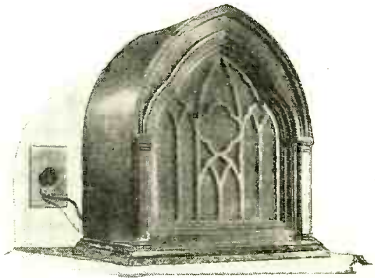

Heavy, massive construction of the loud speaker cabinet is identified with the cabinet type of baffles as shown here

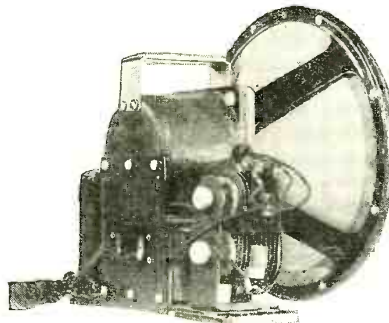
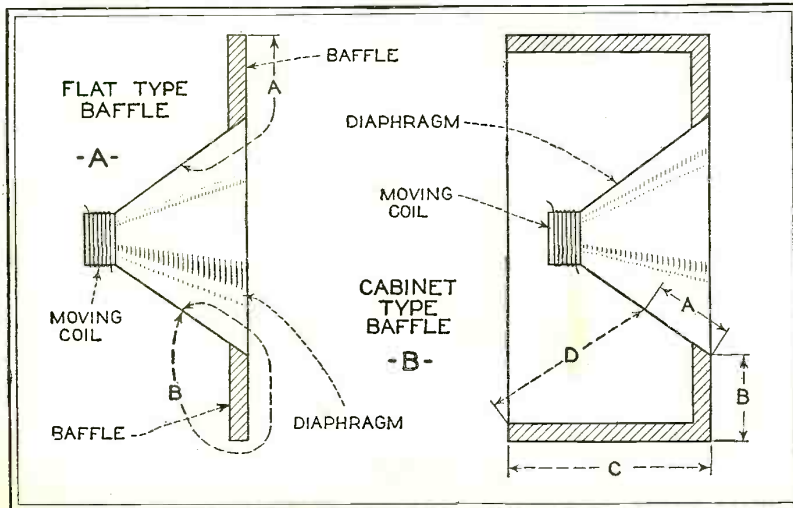

Fig. 2



notes although notes of this frequency will not be quite as loud as they might be were the baffle to have an air distance of $4\frac{1}{2}$ feet. It is the writer's personal opinion that baffles giving an air distance of about 4 feet are entirely satisfactory—this gives a lower frequency limit of about 70 cycles, which means that essentially satisfactory reproduction will be obtained down to at least 60 cycles.

No matter what type of baffle is used or of what material it is composed it should be understood that it has only one purpose—to prevent two air pressures from equalizing each other. The baffle material should be such that it will not vibrate under the influence of the movements of the diaphragm of the dynamic unit. If the baffle does vibrate it will seriously affect the quality. Therefore for the baffle use good, solid wood—flat baffles should be made of stock at least $\frac{3}{4}$ inches thick. Another good material for baffles is Celotex, which can be obtained from the Celotex Company in large, flat $\frac{3}{4}$ -inch-thick sheets ideally suited for use as baffles. The same considerations apply to cabinet type baffles. Use heavy stock or some material such as Celotex. If you have on hand a wooden cabinet that you want to use but which is not constructed heavily enough, it can be lined with a layer of Celotex to make it satisfactory.

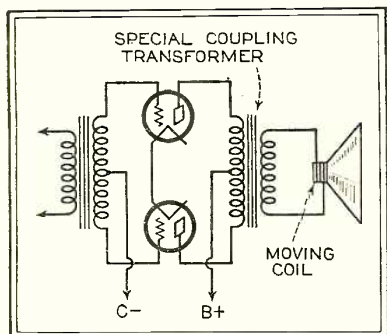

Fig. 5

Flat Baffles versus Cabinet Baffles

Flat baffles are probably the best types to use but their large size and ungainly

Table II

Lowest desired frequency	Length of side of square baffle
30	9 feet
60	4½ feet
100	2¾ feet

appearance hardly make them suitable for the living room. Cabinet type baffles are for this reason more generally used. Sometimes a separate cabinet is used for the loud speaker unit but more frequently a single cabinet houses both the loud speaker unit and the radio receiver. All manufacturers' sets, except table models, fall into this class.

When a dynamic unit is operated in a cabinet two factors need attention. In the first place the material of the cabinet must be heavy enough so that it will not vibrate. Secondly, the possibility of cabinet resonance must be avoided, for if cabinet resonance occurs certain low frequencies will be accentuated and give the reproduction of boom-boom quality. Cabinet resonance will not be bothersome provided the back of the cabinet is left almost entirely open so that the air is not confined inside of the cabinet. If the cabinet is thin, or if the back is partially enclosed, it will be worth while to line the cabinet with Celotex or other sound absorbing material.

If the radio receiver is in the same cabinet with the unit the entire system may break into continual oscillation due to feedback from the unit to the detector tube. The remedy is to wrap the detector tube in felt or to weight it down with a metal cap so that it cannot respond to the vibrations produced by the loud speaker.

These then are the important considerations covering the use of baffles: Make the baffle of a size determined by the lowest desired frequency, construct it of heavy material; in the case of cabinets be sure the back is left open and if necessary line the cabinet with sound absorbing material.

The Coupling Transformer—Another Essential

Now let us take up another important consideration in the operation of dynamic loud speakers—the coupling transformer.

This is the transformer which is connected between the output circuit of the radio receiver and the moving coil of the loud speaker. Its function is to adapt the impedance of the output or power of the radio receiver tube to that of the loud speaker, so that high efficiency and good quality can be obtained. The problem shapes up something like this. The impedance of a moving coil might have an average value of, say, 30 ohms over the audio frequency range. A tube might have an impedance of about 2000 ohms. If the moving coil were to be connected directly to the tube (no coupling transformer) about 99 per cent. of the power would be lost in the tube! A coupling transformer must always be used.

The coupling transformer consists, like an audio transformer or a power transformer, of two coils of wire wound on an iron core. The characteristic of the coupling transformer of major interest at this point is its turns ratio for it is this factor that determines how well

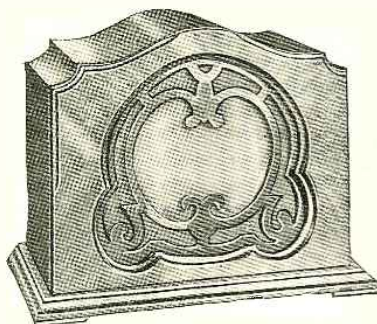

Variation in the design of baffle cabinets is allowable so long as the air path dimensions, as explained in the text, are closely observed

the transformer will succeed in compensating the inequalities of the tube and moving coil impedances.

The turns ratio of the coupling transformer is determined by the square root of the ratio of the plate impedance of the power tube to the impedance of the moving coil. If the power tube has a plate impedance of 2000 ohms and the moving coil impedance is 10 ohms, then the required turns ratio of the coupling transformer is equal to

$$\sqrt{\frac{2000}{10}}$$

or approximately 17. Serious results are not encountered however if a coupling transformer of not exactly correct ratio is used. If we were to carefully analyze the characteristics of the circuits we would find that a coupling transformer designed to make a moving coil function satisfactorily with a 5000 ohm tube (a 210 for example) would also be satisfactory for a 2000 ohm tube (such as the 245) although a transformer satisfactory for a 2000 ohm tube would not be very satisfactory for use with a 5000 ohm tube. It is these considerations that have caused practically all the loud speaker manufacturers to design the coupling transformer to give optimum results from a 5000 ohm tube knowing that such apparatus will be satisfactory with 2000 ohm tubes. Not that slightly greater efficiency might not be obtained by using the proper transformer in each case. One manufacturer—Silver - Marshall—uses a tapped transformer so that optimum conditions can be obtained under any condition.

This settles the first point regarding the coupling transformer. The transformer is used to obtain efficient operation of the circuit and its ratio is determined by the ratio of the plate impedance to the moving coil impedance.

Special Output Transformers

Because coupling transformer ratios are not critical it is safe to say that any dynamic loud speaker unit may be satisfactorily connected to the output of any receiver. In some cases, however, somewhat more efficient results can be obtained by the use of a special transformer. Take as an example the case of a push-pull amplifier. If we connect our unit to the output of such an amplifier the circuit will look as indicated in Fig. 4. There are two transformers between the tubes and the moving coil. By purchasing a special output push-pull transformer designed to work directly into a moving coil we can eliminate one of the transformers and then the circuit will be as indicated in Fig. 5. The elimination of one transformer will slightly increase the efficiency and may improve the

(Continued on page 477)

Fig. 4

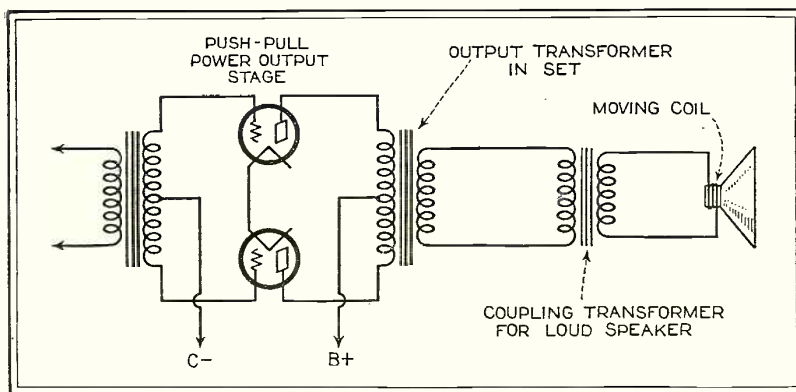

The Calculation and Design of VOLTAGE DIVIDERS

Taking the Mystery and Guesswork out of B-Power Construction

By Joseph Calcaterra

FOR some unknown reason, the principles involved in the design of power units and voltage dividers have been shrouded in considerable mystery and the usual method of tackling the problem has been the very unsatisfactory "cut-and-try" system, using the most convenient power transformer and filter unit which came to hand, with an assortment of variable resistors to form the elements of the voltage divider.

Yet the design of a power unit and a suitable voltage divider system is a very simple proposition which involves no more than the possession of an ordinary working knowledge of Ohm's Law and the use and observance of a simple chart which gives the plate voltage, plate current and grid bias characteristics of the tubes used in a receiver.

A Starting Point

The most logical point at which to start in the design of a power unit is at the receiver. Unless the voltage and current requirements of a receiver are known, it is impossible to design a suitable power supply unit or voltage divider system.

Charts giving the average characteristics of the popular vacuum tubes are available from the various tube manufacturers. The characteristics which are necessary in designing a voltage divider and power unit are given in Fig. 1. This chart shows the filament terminal voltage, the filament current, the plate voltage and the corresponding grid bias voltage, the plate current and undistorted power output of the various types of receiving tubes now on the market and in popular use.

Since this article is not concerned with the factors which enter into the design of receiver circuits, it will be taken for granted that the receiver circuits have been designed with due consideration to the correct plate voltages, grid bias voltages, etc., which will give most efficient operation in the receiver.

This article will concern itself merely with the matter of designing the voltage divider to provide the required plate voltages, grid bias voltages and necessary current capacity to satisfy the conditions under which the tubes are called upon to operate.

Once the receiver and amplifier circuits have been designed and the plate and grid bias voltages required have been determined, it is a simple matter by referring to a tube chart to find the current which will be drawn by each tube in the circuit, at the plate and grid bias voltages which have been decided upon as the best points of operation for the tubes.

A glance at the chart shown in Fig. 1 will show the current drawn by any given tube with any given combination of plate voltage and grid bias voltage. It is important to note that the grid bias voltages for the 112A, 171A and 210 have been given both for d.c. and a.c. operation of the filaments. In d.c. operation the positive terminal of the "C" bias supply is connected with the negative terminal of the filament, which point is 2.5 volts negative with respect to the centerpoint of the filament. In a.c. operation of the fila-

ment, the positive terminal of the "C" supply source is connected to the electrical center of the filament winding, equivalent to a connection to the centerpoint of the filament, so that an additional negative bias of one half the terminal voltage of the filament must be added to the "C" bias source.

FIG. 1—The chart below shows the current drawn by any given tube with any given combination of plate voltage and grid bias voltage

TUBE	FILAMENT TERMINAL VOLTS	FILAMENT CURRENT (AMPS)	DETECTOR		AMPLIFIER				
			"B" VOLTS	PLATE CURRENT (MA)	PLATE VOLTS	GRID BIAS VOLTS	PLATE CURRENT (MA)	MAXIMUM UNDISTORTED OUTPUT (MILLIWATTS)	
CX-12 UX-12	1.1	.25	22.5 TO 45V.	1.5	90.0	4.5	2.5	7	
					135.0	10.5	3.5	35	
CX-299 UX-199	3.3	.063	22.5 TO 45 V.	1.5	45.0	1.5	1.0		
					67.5	3.0	1.7		
					90.0	4.5	2.5	7	
CX-220 UX-120	3.3	.132			90.0	16.5	3.2		
					135.0	22.5	6.5	110	
CX-322 UX-222	3.3	.132	SCREEN-GRID VOLTAGE +45		90.0	1.5	1.5		
					135.0	1.5	1.5		
					135.0	3.0	1.0		
CX-300A UX-200A	5.0	.25	45	1.5					
CX-301A UX-201A	5.0	.25	45	1.5	45.0	1.5	.9		
					67.5	3.0	1.7		
					90.0	4.5	2.5	15	
					135.0	9.0	3.0	55	
CX-340 UX-240	5.0	.25	135	.3	135.0	3.0	.2	*	
			180	.4	180.0	4.5	.2	*	
CX-326 UX-226	1.5	1.05			90.0	6.0	3.5	20	
					135.0	9.0	6.0	70	
					180.0	13.5	7.5	160	
C-327 UX-227	2.5	1.75	45	2.0	90.0	6.0	3.0		
					135.0	9.0	5.0		
					180.0	13.5	6.0		
C-324 UX-224	2.5	1.75	SCREEN-GRID VOLTAGE +75		180.0	1.5	4.0		
CX-112A UX-112A	5.0	.25			90.0	D.C. 4.5	A.C. 7.0	5.5	30
					135.0	9.0	11.5	7.0	120
					157.5	10.5	13.0	10.0	195
					180.0	13.5	16.0	10.0	300
					90.0	16.5	19.0	10.0	130
CX-371A UX-171A	5.0	.25			135.0	27.0	29.5	16.0	330
					157.5	33.0	35.5	18.0	500
					180.0	40.5	43.0	20.0	700
					250	18.0	22.0	12.0	340
CX-310 UX-210	7.5	1.25			350	27.0	31.0	16.0	925
					425	35.0	39.0	20.0	1540
					180	34.5	26.0	750	
CX-345 UX-245	2.5	1.5			250	51.5	32.0	1600	
					250	45.0	28.0	900	
					300	54.0	35.0	1500	
CX-350 UX-250	7.5	1.25			350	63.0	45.0	2350	
					400	70.0	55.0	3250	
					450	84.0	55.0	4650	

* WHEN USED IN RESISTANCE COUPLED AMPLIFIER WITH .25 MEGOHM PLATE RESISTOR.

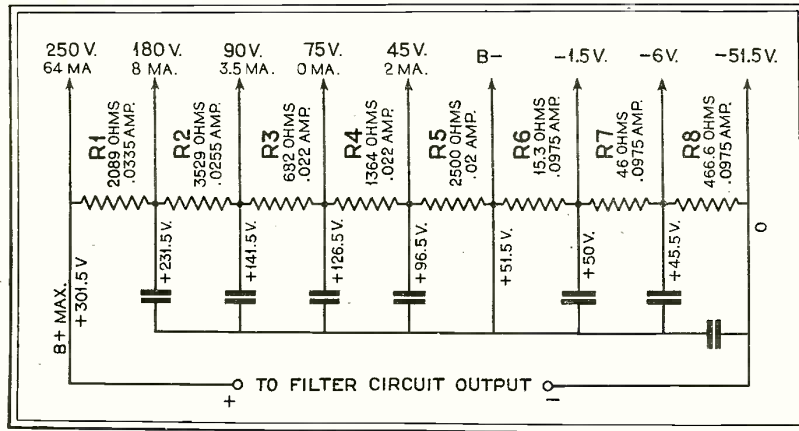

Voltage and Current Requirements

We may now take any combination of tubes and determine the plate voltages, grid bias voltages, and in the case of the screen-grid tubes, the screen-grid voltage which the voltage divider must provide. Once these voltages are known, it is a simple matter to find the current which will be drawn at each voltage tap of the divider by finding the number of tube plate circuits which will be supplied at each tap, and then consulting the chart shown in Fig. 1 to find the plate current which is drawn by any particular tube at such plate and grid bias voltages. The current drawn at each tap will be equal to the total of all the plate currents drawn by the tubes whose plate circuits are fed from those particular taps.

For the sake of illustration, let us assume that we have a receiver which employs two 24 type tubes, one 27 type tube, one 26 type tube and two 45 type tubes in push-pull arrangement.

The plate voltage required for the 24 type tubes is 180 volts. The plate voltage for the 27 type tube is 45 volts; that for the 26 type tube is 90 volts and that for the two 45 type tubes is 250 volts. The control grid bias required for the 24 type tube, with a plate voltage of 180 volts, is -1.5 volts. The voltage required for the screen-grid is +75 volts. No grid bias is necessary for the 27 type detector when used with grid condenser and leak. The grid bias required for the 26 type tube at 90 volts plate voltage is -6 volts. The grid bias required for the two 45 type tubes with a plate voltage of 250 volts is -51.5 volts.

A glance at the chart shows that under the conditions of plate voltage and grid bias mentioned, the 24 type tube plate circuits will draw 4 milliamperes each, or a total of 8 milliamperes for both tubes at the 180 volt tap. The 27 type detector tube plate circuit will draw 2 milliamperes at the 45-volt tap. The 26 type tube will draw 3.5 milliamperes at the 90-volt tap while the 45 type tubes will each draw 32 milliamperes or a total of 64 milliamperes for both tubes.

The current drawn at the 75-volt tap, by the connection of the screen-grid terminals of the screen-grid tubes at that point, is so small as to be negligible.

The requirements imposed on the volt-

Fig. 2.—Above is shown the method generally used for supplying plate and grid bias voltages for d.c. tubes whose filaments operate on a d.c. source of supply

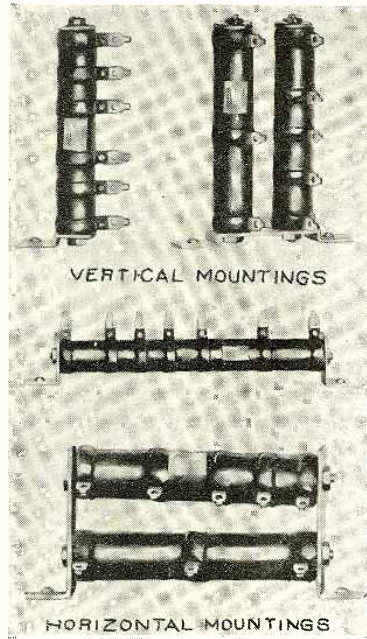

Some typical voltage divider resistances with fixed taps, designed to work with a predetermined load

age divided by the receiver in question can be summarized as follows:

TAPS	CURRENT DRAIN
250-volt tap	64 ma.
180-volt tap	8 ma.
90-volt tap	3.5 ma.
75-volt tap	0 (practically)
45-volt tap	2 ma.

77.5 ma. total for receiver

GRID BIAS TAPS

- 1.5 volts for the 180-volt tap
- 6.0 volts for the 90-volt tap
- 51.5 volts for the 250-volt tap

The maximum total voltage required from the power unit is 250 volts for the plate supply and 51.5 volts for the maximum grid bias, giving a total output voltage required of 301.5 volts to take care of these operating requirements. The total current required by the receiver is 77.5 milliamperes, but to this must be added the bleeder current drawn by the resistance of the voltage divider, which is connected across the output of the filter circuit. The current drawn by this resistor will depend on the terminal voltage across the output of the filter circuit.

Good regulation can be obtained either by using a regulator tube between the 90-volt and "B—" terminals or by designing the voltage divider to provide a high bleeder current. The higher the bleeder current, the better the regulation of the unit will be.

When a regulator tube is not used, at least 10 and preferably as high as 20 milliamperes should be allowed as bleeder current. This bleeder current represents an additional drain on the power unit and should be added to the current drain of the receiver and amplifier which the power unit is called upon to supply.

If we allow 20 milliamperes in the instance we now have under consideration, the total current drain on the power unit will be 77.5 milliamperes for the receiver and 20 milliamperes for the bleeder, making a total of 97.5 milliamperes.

The power unit will therefore be called upon to supply an output voltage of 301.5 volts at a current drain of 97.5 milliamperes.

For the present we shall consider that

Fig. 3.—The method of obtaining plate voltage and grid bias voltage for a.c. tubes operating on filament windings of power transformers is shown below in contrast to Fig. 2

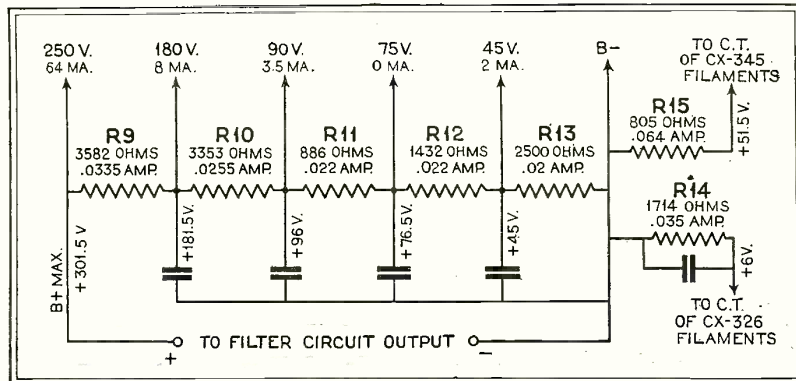

the power transformer and filter circuit is properly designed to give these characteristics at its output and will proceed to the design of the voltage divider.

If no current were to be drawn at the various taps, practically any resistance of fairly high value could be connected across the output and the taps could be calculated by simple proportion. The fact that current is drawn at each tap, however, changes the problem considerably, although the solution is no more involved.

Two Practical Voltage Dividers

There are two general methods which are used to obtain the plate and grid bias voltages from the output of a power supply unit.

One method, shown in Fig. 2, is generally used to supply plate and grid bias voltages for d.c. tubes whose filaments are energized from a d.c. source, such as batteries or "A" eliminators.

The other method, shown in Fig. 3, is generally used in connection with receivers employing a.c. tubes whose filaments are energized from an a.c. source by means of filament windings on power transformers.

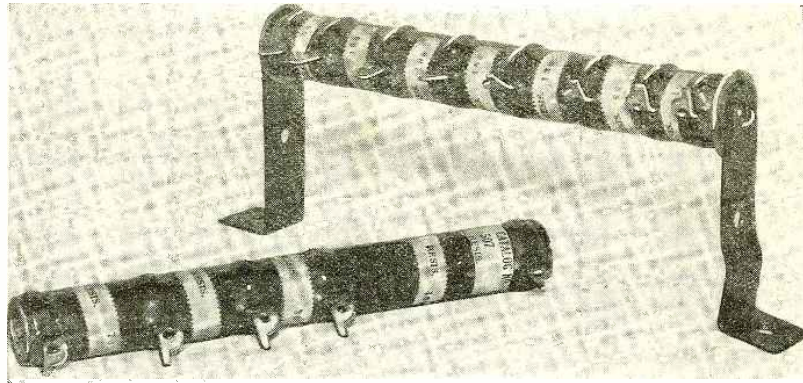

These voltage divider resistors, as are those on the preceding page, are made in a variety of styles to meet the requirements of different combinations of receiver and amplifier tubes

The circuit diagram below shows the application of the voltage divider circuit of Fig. 3 as incorporated in a completely a.c. operated receiver with push-pull output

while those on the left are shown as measured from the negative terminal of the filter circuit output.

In the case of the voltage divider shown in Fig. 3, the voltages at the right are shown as being measured between the centerpoint of the filaments of their respective tubes, while those on the left are the voltages measured between the negative terminal of the filter circuit output and the taps.

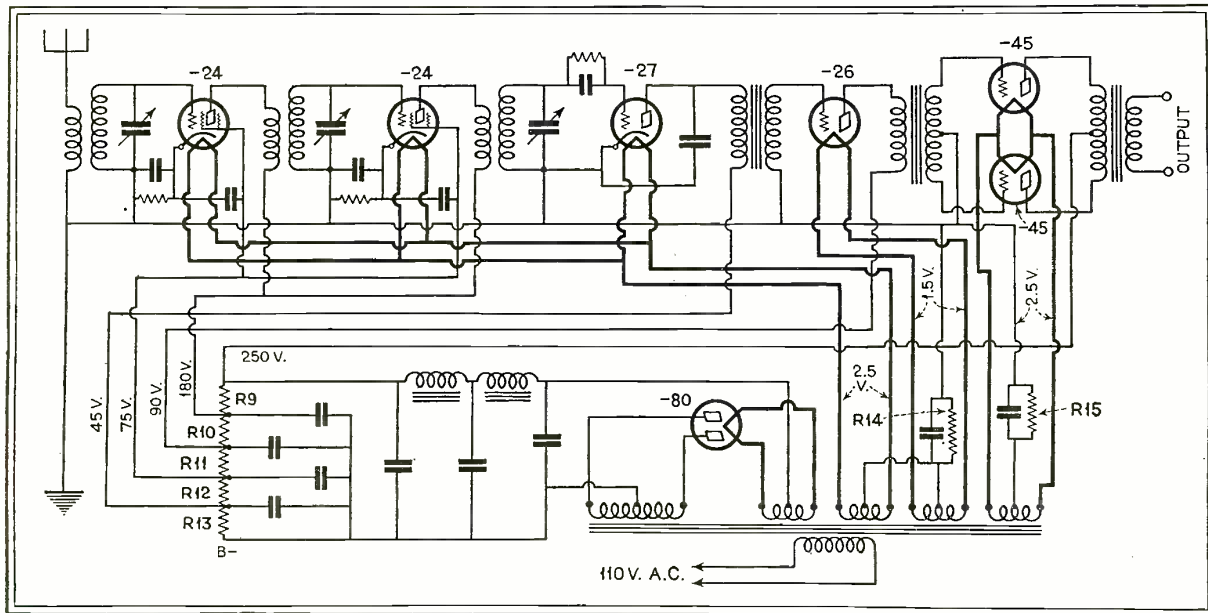

Combinations of both of these forms are sometimes used in instances where both d.c. and a.c. tubes are used, as for instance when a d.c. receiver is used with an a.c. power amplifier.

Combinations are also sometimes used when several tubes are used for different purposes, such as for r.f. amplifiers and a.f. amplifiers, all similar tubes being operated from the same filament windings

but requiring different plate and grid bias voltages.

The voltages measured at the various taps, depend of course on which terminal is considered the "negative" terminal for the measurements.

In the case of the voltage divider shown in Fig. 2, the voltages at the right are shown as being measured from the "B—" terminal as the reference point,

It should be noted that in both cases the negative terminal of the filter circuit output is the most negative point of the system. In the case of the arrangement shown in Fig. 2, the -51.5 terminal is more negative than the "B—" terminal. When using this type of voltage divider circuit with either d.c. or a.c. receivers, the filaments of the tubes are connected to the "B—" terminal of the voltage divider and the grid returns of the various tubes are connected to the respective grid bias taps of the voltage divider.

The plate current of each tube originates in the rectifier, travels to the respective taps on the voltage divider and thence through the plate circuits of the tubes to the filaments; thence to the "B—" tap to which the filaments of the

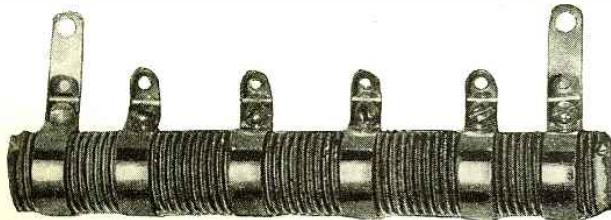

A type of voltage divider resistance which permits of setting the individual taps in accordance with requirements of the particular receiver which is to be operated

(Continued on page 474)

What the SCREEN GRID Tube Means to Volume Control

By James Millen and Glenn H. Browning

IN the design of a radio receiver, the volume control is one of the features which may in many cases determine the success or failure of the set, yet the engineer usually considers this problem after all other design questions have been settled, and in many cases gives the volume control the least amount of thought and effort.

The ideal volume control would be one which smoothly and uniformly controls the sound emitted from the speaker from a whisper to a maximum intensity. The control should not allow any of the tubes in the set to overload, and in fact it should not change the electrical characteristics of any part of the receiver in any way. As far as the writers know, the ideal volume control is yet to be found, but by a careful study of the various methods which might be used, it is possible to pick the one which most nearly approaches the much-striven-after goal in the particular receiver being designed. Volume controls which are placed after the detector tube will not be considered, for they allow the detector or audio-frequency amplifier tubes to overload on strong local stations, thus impairing the quality of the signals on just the stations which should be received the best. Let us consider a number of systems which are operative

Behind the tube is shown the variable resistor used as a volume and regeneration control on the National Thrill Box Receiver

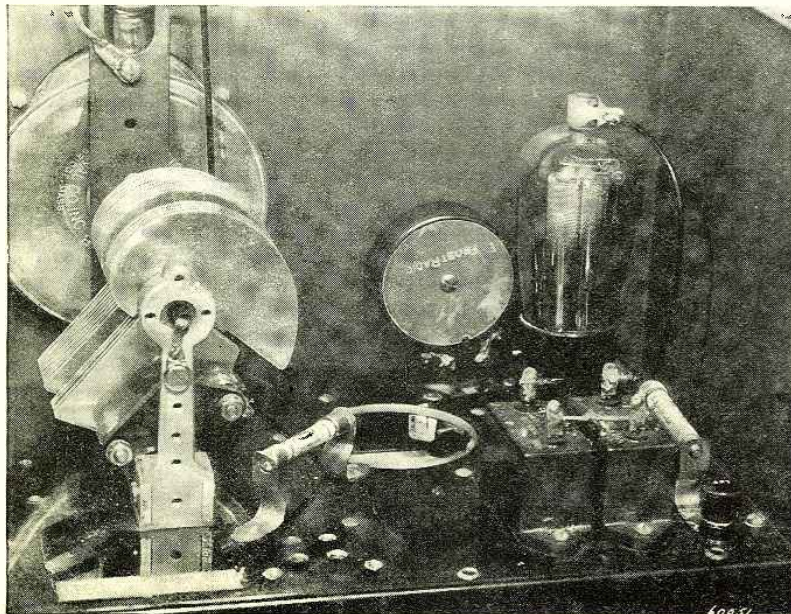

before the detector tube and which will more or less effectively control the volume on modern a.c. receivers.

A Resistance in the Antenna Circuit

Fig. 1 shows a variable resistance in series with the antenna-ground, on the first radio-frequency tube. By varying this resistance more or less voltage is placed across the grid filament of the tube and consequently the volume is varied. On receivers which do not have too much r.f. gain or on those where sufficient shielding is employed, this is an excellent method, for it controls the amount of signal which passes through the entire set. Thus, no overloading on any of the tubes can occur. Moreover, varying this resistance does not alter, in a large degree, any of the electrical characteristics. However, in many sensitive sets

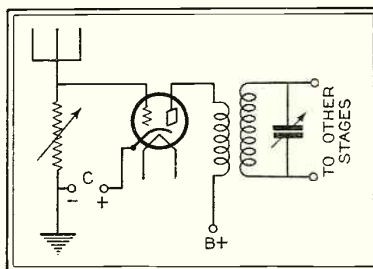

Fig. 1

located close to powerful broadcasting stations, cutting this resistance down to zero does not lower the volume sufficiently, and consequently some other method or an additional method must be employed.

Volume Controls in the Radio Amplifier

Fig. 2 shows a variable resistance of some 100,000 ohms placed in series with the "B" supply. This controls the volume

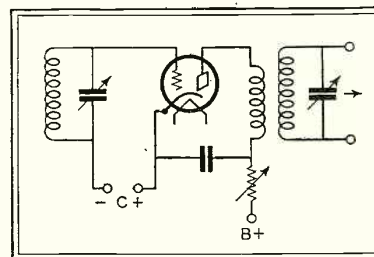

Fig. 2

on one or more of the radio-frequency amplifier tubes by lowering the plate voltage. This system has little to be said in its favor, for as the resistance is changed, the plate current in the tube is varied as well as the actual voltage applied to the plate. If too low a voltage is applied to a radio-frequency tube, it becomes a detector and consequently distortion takes place. Thus, this control may be discarded in most types of tuned radio-frequency amplifiers.

Fig. 3 shows another system somewhat similar to the preceding one, except in this case the resistance is in parallel with the primary of the radio frequency. This gives a smoother control of volume, but in addition to the disadvantages of two, the tuning of the secondary of the radio-frequency transformer is dulled when the volume is reduced. This is because of the increase of load on the secondary when the primary is partially or totally short circuited. This effect, however, may be an advantage if the other tuned circuits are sufficiently sharp so that no interference is experienced on local stations, for the broader the receiver within limits, the better the quality on the higher audio frequencies.

Fig. 4 is a control very similar to 3, and in many cases either of the two are satisfactory.

Fig. 5 shows a potentiometer placed across one of the tuned circuits of the receiver, and the volume is changed as more or less voltage is applied to the

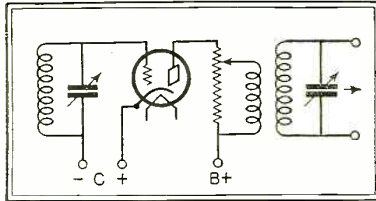

Fig. 3

grid-cathode of the following tube. This method gives an excellent control of volume but difficulties due to the construction of high-resistance potentiometers are encountered. For instance, the writers know of no potentiometer commercially built which does not have at least 8 mmfd. capacity across its terminals. This means that besides a resistance being placed across the tuned circuit, a capacity is also added. In the case where a number of tuning condensers are being run from the same shaft, as is the case in single-control receivers, the tuning of this circuit would be thrown out and small capacities would have to be placed across all the other variable condensers for exact alignment. Of course, this is not an insurmountable difficulty, but simply one which would impede quantity production. It might seem to some of the readers that placing a resistance across a tuned circuit would decrease the selectivity to a marked degree, but this is not the case if a potentiometer of 500,000 to 1,000,000 ohms is employed.

The above methods are applicable to d.c. or a.c. sets with the exception that 2 and 3 cannot be employed if filament type (27 type) tubes are used as radio-frequency amplifiers. This is because on this type of tube the a.c. hum becomes objectionable when the plate current is reduced below a certain amount.

There are many modifications to the above systems and in the case of d.c. sets operated by a storage battery, there is the rheostat controlling the temperature of the filaments which should be added, however, outside of screen-grid tubes

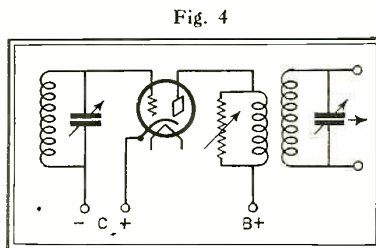
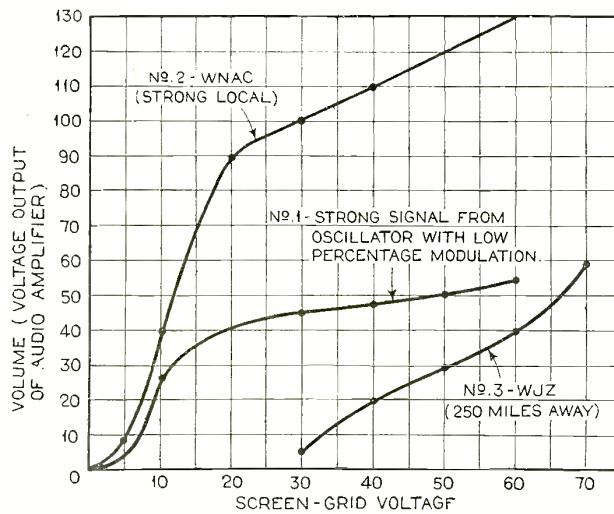

Fig. 4

those considered are the main systems. The screen grid in the screen-grid tube offers another solution to the volume control problem which in many ways is superior to any of the former methods. The system is shown in Fig. 6, and consists essentially of a potentiometer whose setting determines the voltage applied to the screen grid. It should be understood that the screen grid is merely an electrostatic shield so positioned that there is a much smaller feedback of high-frequency current from plate to grid, than in the ordinary three-electrode tube. The reason for connecting this shield to 46 to 67 volts positive potential is to raise the mutual conductance of the tube, otherwise the screen grid is not directly connected to any of the electrical circuits on the receiver. However, by varying its voltage, volume may be made as great or as



small as the operator desires. The reason for this is that the higher the voltage of the screen grid, the lower the plate resistance and within reason, of course, the higher the resultant signal. The reader will immediately say that this system of varying plate resistance is comparable to the method of volume control shown in Fig. 2. In many ways the effect is the same, but the plate impedance of the screen-grid tube in the first place is much higher than the 27 type by a ratio of about 4 or 5 to 1, so that the variation of load on the secondary of the tuned transformer is not at all serious, while the effect of detection in the radio-frequency screen-grid amplifier tubes is taken care of by the automatic bias system used. That is, the bias on the tube is obtained by a resistor in such a manner that the higher the plate current in the tube the greater the bias. This method of volume control in the case of the screen-grid tube has several marked advantages, and consequently has been chosen by a number of manufacturers of tuner kits and manufactured receivers.

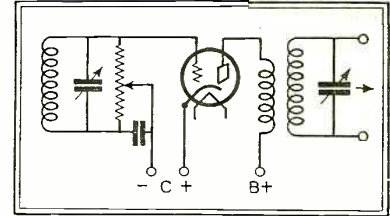

Fig. 5

First, the volume may be controlled through the widest range possible, *i.e.*, from no signal at all to as much volume as the set and audio amplifier are capable. Second, the control is very smooth. Third, the control is effective whether the set is located close to a powerful broadcasting station or not. Fourth, the taper on the potentiometer may be such that rotating it through a given angle any place on the scale increases the volume a given amount. Fifth, if there is any tendency for the receiver to oscillate, due to the variation in the screen-grid tube, it may be readily controlled in this manner, thus making a combined regeneration and volume control in one. Sixth, the length of leads necessary to place the volume control wherever convenient on the receiver are not at all critical. In fact the potentiometer might be placed across the room from the set, if such an arrangement proved to be convenient.

The screen-grid a.c. tube has come to stay; in fact, the writers believe that by next season most radio-frequency amplifiers will have one or more of these tubes, which, because of their inherent high amplifying characteristics, might be named "radio frequency power amplifiers." Thus, the shield-grid tube not only makes possible more radio-frequency gain, does away with the problem of neutralization, but also adapts itself readily to a simple, convenient volume control which is superior in many ways to any of the methods previously open to the radio designer.

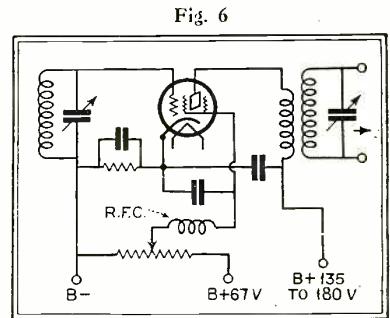

Fig. 6





The Junior RADIO Guild



What Is a Radio Frequency Amplifier?

Lesson IV

TO refresh our minds on what has gone before, we will briefly summarize the preceding lessons. Lesson Number One told how broadcast transmitters and receivers worked, gave an explanation of radio symbols and told how they were used in the preparation of radio circuits and diagrams; Lesson Number Two told you what a detector was and explained the construction of the

BROADLY TUNED DETECTOR CIRCUIT.
MORE THAN ONE STATION
HEARD AT A TIME.

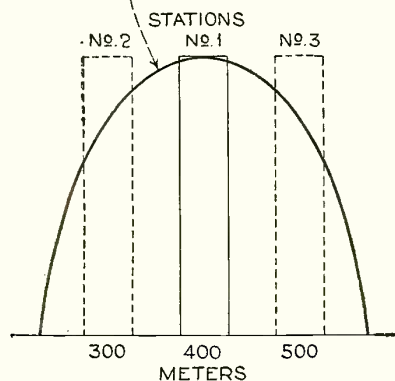

FIG. 17

The curve above shows the tuning response which is obtained when the tuning circuit is very broadly tuned. Note that stations No. 2 and 3 are received with about $\frac{3}{4}$ the volume of Station No. 1 to which the circuit is tuned. This is called a broadly tuned circuit

detector unit of a complete five-tube receiver; Lesson Number Three told you what an audio amplifier was and also gave the instructions for adding a two-stage audio frequency amplifier to the detector unit already built. This brings us up to date.

This Lesson Number Four will tell you what a radio frequency amplifier is, how it is used, and how to add a two-stage radio frequency amplifier to the three-

This lesson is the last of the series actually concerned with the construction of a complete five-tube radio receiver. The next lesson, Number Five, describes how you can build a simple short-wave adapter which may be used with your present receiver to tune-in on the signals being transmitted on short waves. If you learn the Continental Code, you can listen in then on messages originating in Europe, South Africa and Australia and can also hear the radio operators of Commander Byrd's Antarctic Expedition, now in the Bay of Whales, in Antarctica, communicating with stations throughout the United States.

Many broadcasting stations are also broadcasting their programs simultaneously on the regular broadcast channels and the short-wave channels, and remarkable distances are being covered in short-wave reception. Then there are television signals, too, which can be tuned in on the short-wave lengths.

The fifth lesson will describe short-wave reception and "how to build a short wave adapter."

tube section of the receiver already built.

If the tuning system provided by the detector were entirely sufficient for all our needs—that is, if it could tune in stations near and far alike, or if it could tune in one station at a time without hearing another station in the background,

then there would be no need to describe how and why a radio amplifier should be added. However, such is not the case. Our tuning system can be greatly improved, as you will see.

It is reasonable to believe that a man fifty yards away from a target can aim a gun at it and hit a bull's-eye more readily than if he were, say, a mile away from the target. To a certain degree,

SHARPLY TUNED R.F. CIRCUIT.
ONLY THAT STATION HEARD
TO WHICH CIRCUIT IS TUNED.

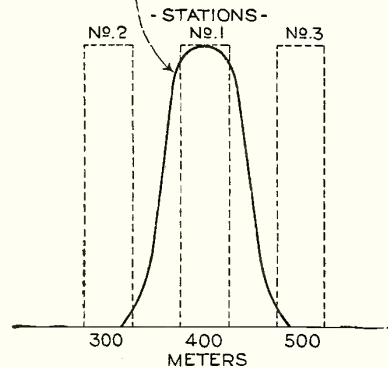

FIG. 18

Here is given the curve for a sharply tuned circuit. The response from stations No. 2 and 3 is so weak in comparison to that obtained from station No. 1 as to be negligible. This is a desirable characteristic curve

the same comparison can be employed to explain how two stations, each of equal power, one ten miles away from a receiver, can be heard more readily than the other one, which is 1,000 miles away. If the receiver were farther away from the second station, say 1,500 miles, then the signal received would be weaker than if the station were only 1,000 miles away. Naturally, if a weak signal is received it will not be amplified by the audio amplifier so that it will be as loud as the signal from the station only ten miles away. How, then, can we make

the weak signal strong enough so that it will be of sufficient loudness? The answer is in the employment of a radio frequency amplifier which will increase the sensitivity of the receiver to weak signals coming from distant stations.

If you will reread Lesson Number Three you will remember how the vacuum tube can

Here is shown the base view of the complete five-tube Junior Guild receiver. It consists of two stages of radio frequency amplification, a regenerative detector and two stages of audio frequency amplification, all described in the previous lesson, unit by unit

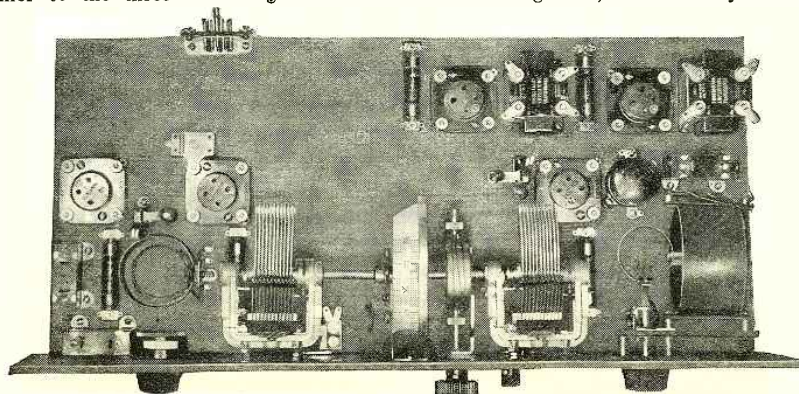

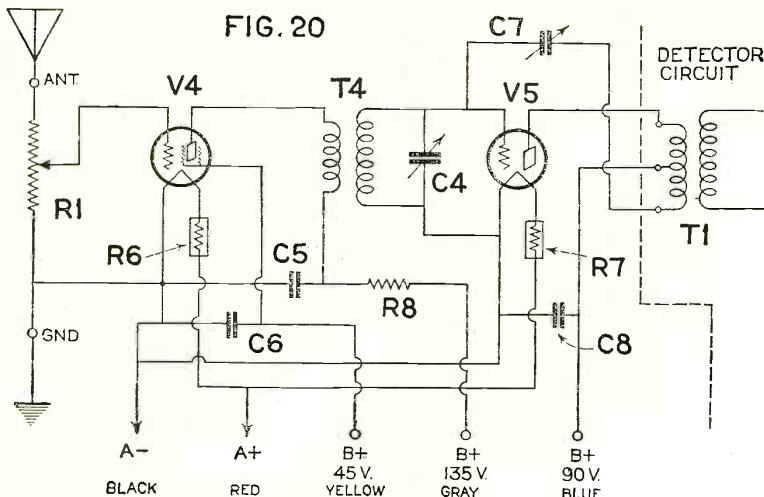

enlarge or amplify an alternation or vibration many times. Use is made of this principle in the radio frequency amplifier also. The only difference between the audio and the radio amplifier is that in the former we are amplifying audible vibrations, while in the latter we are amplifying inaudible vibrations. Naturally different apparatus is required for each of these two kinds of amplifiers. In the audio amplifier we are dealing with tones or vibrations varying between 100 and 5,000 or 8,000 cycles which can be amplified quite satisfactorily by a suitable audio frequency transformer. In the radio frequency amplifier, however, it is necessary to use a tuning system similar to that used in the detector circuit, one complete tuning system being required for each stage of amplification employed, unless it is of special design. In other words, when we attempt to amplify radio frequency vibrations it is first necessary to use a tuning system consisting of a transformer coil and variable condenser so that the desired signal may be tuned in, to the exclusion of all others.

With this equipment the signal, as absorbed by the antenna, is amplified many times, much in the same manner as the signal which is amplified by the audio amplifier. It is not necessary at this time to repeat the process of amplification. Brush up on this by again reading the third lesson.

Now, considering that with the radio frequency amplifier we can amplify weak signals sufficiently to be heard on the loud speaker after passing through the detector and audio frequency amplifier, it is easy to understand how the addition of such an amplifier will make the receiver as a whole more sensitive. Naturally, signals from local stations will also be amplified many more times than if the amplifier had not been used. But then, with the aid of a volume control located in the antenna circuit the amount of signal received from the "locals" can be adjusted so that they will not be too loud.

Besides increasing the sensitivity of a receiver as explained above, the addition of a radio frequency amplifier does one other beneficial thing for a radio receiver. It will be apparent from the following.

Perhaps you have noticed, in operating the detector and audio amplifier, that it

Herewith is given the circuit diagram for the radio frequency amplifier which is described in this, the fourth lesson. The screen grid tube, V4, is used as a coupling medium between the antenna and tuned radio frequency amplifier circuit employing the tube V5. In this way, single control tuning from both of the tuning condensers in the receiver is obtained

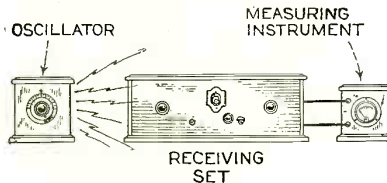

FIG. 19

A radio frequency oscillator which is nothing more than a miniature transmitting station, is helpful in determining the sharpness of tuning of a circuit, as indicated in Figs. 17 and 18

was not always possible to listen to the program coming from one station without hearing in the background the broadcasting from another station. This type of "interference" is quite bothersome, especially if you have tuned in to some very enlightening speech only to hear mingled with the speech the warbling of some soprano being broadcast from another station. Perhaps you have noticed, too, in trying to get rid of the "interference," that when you turned the dial slightly away from the station to which you wished to listen the other station's broadcast was received more loudly and that it was not possible by any manner of dial turning to get rid of this interfering station.

In reality the one station is not interfering with the other, for if it were the Federal Radio Commission would soon put a stop to it. The fault lies entirely with the receiver. Do not get the idea that the fault is purely one that is connected with the particular JRG apparatus you are using. It is a fault that may be attributed to any simple detector circuit when the detector alone is used as a tuning system for the receiver.

Supposing a detector tuning system were adjusted to a certain wavelength setting, say 400 meters; then near it was placed an instrument used in radio work and known as a radio frequency oscillator (simply a miniature transmitting station); then connected to the detector was a suitable measuring device which would indicate how much energy was being received by the detector from the r. f. oscillator. See Fig. 19. Now, with this set-up imagine the r. f. oscillator having been adjusted to 300 meters. The de-

(Continued on page 465)

The actual wiring of the parts of the radio frequency amplifier is shown here. For a clear idea of the circuit connections, this figure should be compared with that of the schematic circuit shown in Fig. 20

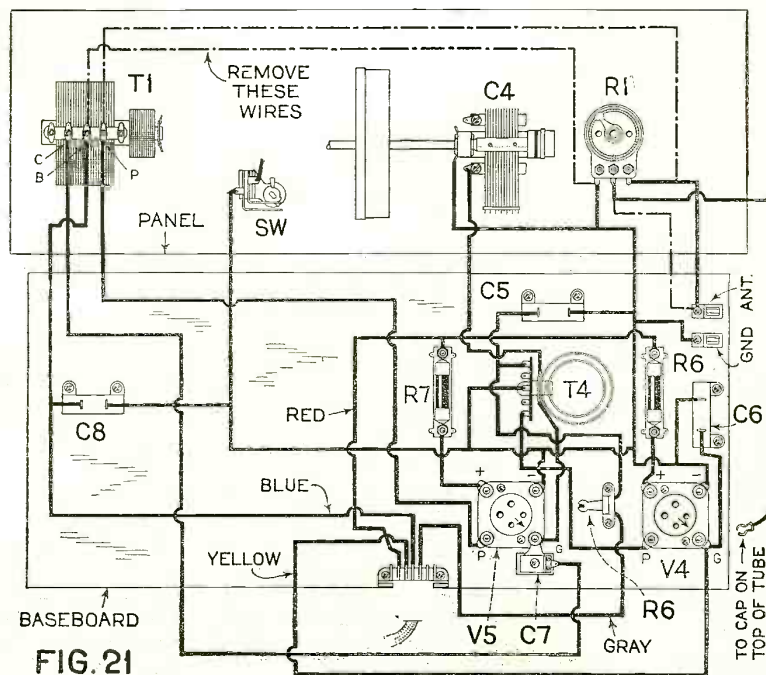

FIG. 21

A Complete A.C. Operated SHORT WAVE Receiver, With PUSH-PULL Output

By H. S. Knowles

ALTHOUGH a number of short-wave adaptors that have been intended for a. c. receivers have been announced at various times, to the best of our knowledge no complete a. c. short-wave receiver has been described. The problem of making such a receiver which is reasonably free from a. c. modulation when receiving short-wave phone signals (that is, in a non-oscillating condition) is only slightly more difficult than that of a standard broadcast receiver. The difference arises largely from the fact that power line and rectifier disturbances are more pronounced at high frequencies. The design of a full a. c. operated short-wave receiver, which may be operated in an oscillating condition and with a value of a. c. modulation which is sufficiently low to permit real DX reception, is a much more difficult one.

Five tubes Employed in A. C. Short-Wave Circuit

The receiver uses a choke-coupled screen-grid stage followed by a 227 detector and 227 first a. f. stage and a pair of 245 tubes arranged in a push-pull power outfit stage. An inspection of the

schematic wiring diagram in Fig. 1 does not, as might be expected, disclose any unusual circuit arrangement. With the exception of the two chokes, which are in series with the plates of the 280 rectifier tube, the by-pass condensers from the heater circuit to ground and the .1 mfd. condenser, which is tied into one side of the line, the circuit is perfectly conventional. Experience with the circuit precautions necessary in high gain screen-grid tube circuits at broadcast frequencies have brought out the necessity of using a separate ground return for each circuit to which all of the returns for that particular circuit are connected. All of the leads are as short and direct as possible with the exception of the one to the regeneration condenser which was, however, laid out so the loop it formed did not introduce any a. c. hum. It will be noted that although the rotor is at ground potential, the return lead is run all the way from the midget condenser to the common ground of the detector circuit.

Receiver Employs Novel Design Features

It was found that a large percentage of the interference from power line distur-

ances could be filtered out by placing radio-frequency chokes, which had a uniformly high impedance to the frequency range that the receiver covered, in series with the plate leads of the 280 tube.

The .1 mfd. condenser which is connected to the ungrounded side of the 110 volt a. c. line is the first condenser of what is, in fact, a complete r. f. and a. f. filter. The first condenser in the plate supply filter is the terminating condenser in the r. f. filter.

Stability in Operation Obtained By Choke Input

Although the possibility of using a tuned input to the 224 tube was considered, in order to improve the amplification, it was found that the greater amplification of this 224 tube resulted in quite a marked improvement over the usual d. c. receiver using the 222 tube with an untuned input. Although the effective grid-plate capacitance of the 222 tube is only .025 mmfd. this capacitance is very appreciable at the high frequencies at which a short-wave receiver is normally used.

At these high frequencies the 224 tube by virtue of its lower effective grid-plate

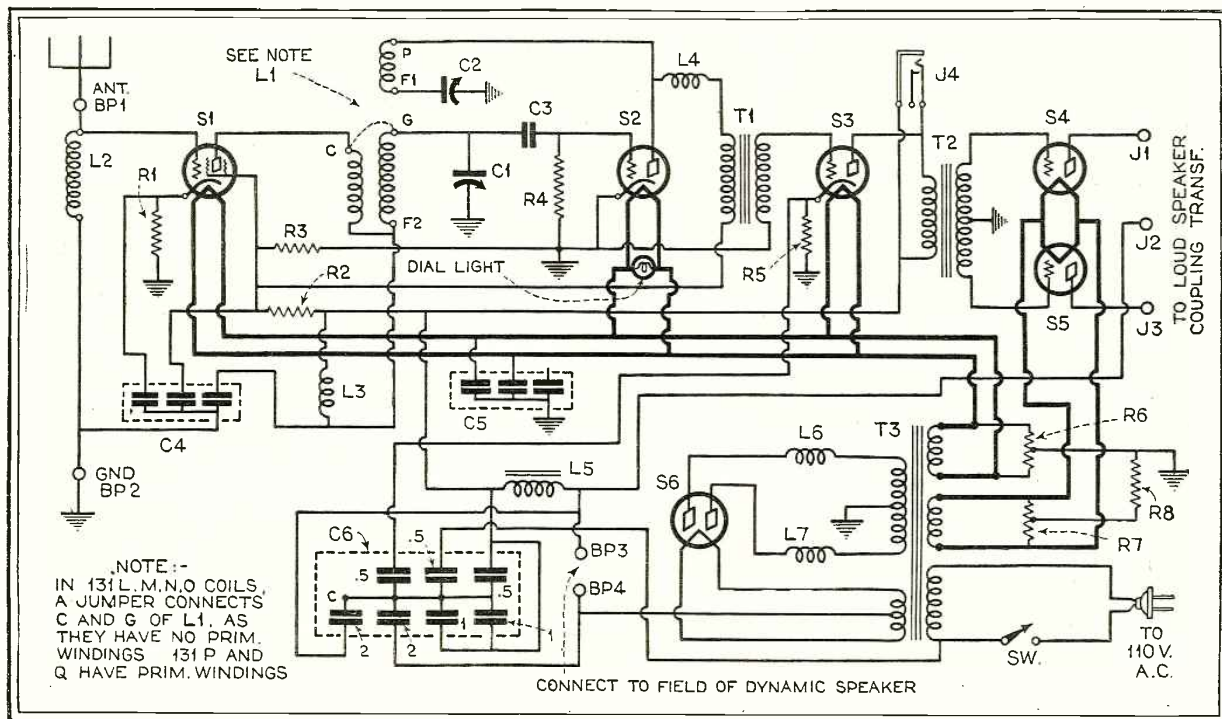

capacity permits about $2\frac{1}{2}$ times the gain with the same stability. Even this extremely low value of effective grid-plate capacitance is high enough, however, so that there is no improvement in gain at the very high frequencies and the slight increase in selectivity which may be obtained under certain conditions is more than offset by the difficulty of tuning this extra circuit.

Although the alignment could be preserved between the two tuned circuits of one, or possibly two of the ranges covered, it is impossible to make the two circuits "track" with all of the sets of coils required to cover the range of from 17 to 650 or even 17 to 215 meters. There is also the added disadvantage of having to change two dissimilar coils instead of only one, for each range.

Condenser System of Regeneration Found Satisfactory

Although rheostat and potentiometer type regeneration controls were tried, these were rejected in favor of the conventional condenser method when it was found that the frequency variation with regeneration setting could be minimized, the "drag" in the control almost eliminated, and the a. c. modulation reduced to a lower value than was otherwise possible. The regeneration control is used as a volume control since in the reception of phone signals it was found that a sufficient change in gain could be effected. On very loud signals the speaker may be used in the first stage jack where a head set is normally used for DX. Because of the high selectivity of the receiver in

the oscillating condition when used for the reception of CW and even ICW signals and due to the fact that broadcast stations are not placed on adjacent channels 10 kc. apart at high frequencies, the selectivity did not need to be increased above the values obtainable with a single tuned impedance-coupled stage below 200 meters (above 1500kc.). At broadcast frequencies the selectivity of a single tuned impedance stage is inadequate for local reception. In the two coils which cover the broadcast band an inductively coupled primary is used; the necessary change in circuit is taken care of by a jumper in the short-wave coils.

At broadcast frequencies the receiver may be used where moderate gain and selectivity are required.

(Continued on page 452)

Some Refinements for the S-W Four

PROOF of the fact that the S-W Four, the short-wave receiver described in the August issue of RADIO NEWS, is meeting with wide acclaim and popularity will be apparent from reading the letter which the editors of RADIO NEWS have received from the designer of the receiver, Mr. Samuel Egert.

Questioned further, Mr. Egert has furnished us with additional information concerning the operation of the S-W Four, which undoubtedly will be of interest to readers of RADIO NEWS.

DEAR MR. EDITOR:

No doubt you have been interested in knowing the response which resulted from the publication of the article on the S-W Four, described in August RADIO NEWS. Interest in short waves has been increasing by leaps and bounds, and the S.W. Four has been another incentive for the radio fan to realize its possibilities. Almost everyone wanted to know of the possibilities of hearing Mr. Nicholson's voice direct from the Graf Zeppelin. The Columbia Broadcasting system distributed five of these sets along the Atlantic Coast, working on schedule time with Mr. Nicholson.

One item of interest is the inquiries that have been arriving. They have come from almost all over the world. I am sure that you can appreciate the worth of a short-wave set located in some part of deep Africa or in the frozen North where communication with human beings is an impossibility without the proper type of short-wave equipment. The interest shown from these distant parts, seems to be greater than that shown here in the United States. This is possibly due to the fact that men in foreign lands are in need of and want something which they believe will produce results.

We have made a series of experiments in various parts of the city and suburbs to determine the exact possibilities of this set working under these different conditions. We have found that reception on shortwaves in the city is far inferior to

that in outlying sections. The steelwork that exists in the structure of urban buildings hampers the reception of short waves to a great degree; and the results obtained

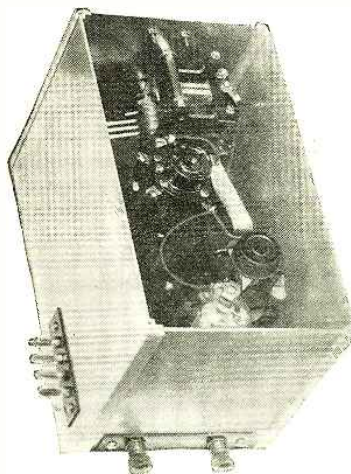

both in reception and volume were greatly decreased when compared to results obtained in the suburbs. Another thing that we have found to our delight is the adaptability of this set to broadcast reception. Local stations come in with fine volume and most certainly afford as good entertainment as the most modern electric receiver. There is one more discovery we made while testing the receiver and that was its complete lack of hand capacity. This is probably due to the excellent shielding it employs. All in all we had a great time while checking the receiver. We stayed up two or three nights until about 4 in the morning and aside from the reception we received on short-wave broadcast, which included voice and music reception from France, England, Holland, Germany and Australia, we received code reception from every continent in the world, checking Byrd as well.

One rather serious criticism of the operation of the receiver was the way in which

the dials tracked, or rather their lack of tracking. This was due to the difference in the characteristics of the two tuned circuits and the tubes to which they inputted. To overcome this tuning discrepancy the following remedy will prove quite satisfactory. Merely shunt across the first tuning condenser, a midget of the 3.2 mmfd. size. The accompanying photo shows how this is done. Then, with the midget adjusted, the main dials will read alike and will track together.

Here are a few reports from some of the people who have built the S-W Four: The first comment invariably is upon the ease with which one can construct the set. Most of the men who have built this set are not amateur radio operators who are interested in code, but who are vitally interested in getting good broadcast reception on short waves. This is the first time that they have owned a short-wave set, and the results they are obtaining are highly encouraging. Most of them have already succeeded in getting foreign broadcast reception on short waves, despite their unfamiliarity with a set of this type. This speaks well for the ease of tuning, which we have always claimed was one of the features of the receiver. We have also received a report from a gentleman in New York State, who is using a B-eliminator for his B supply with very fine results. We have tried the short-wave set with various B-eliminators at different times and have found that excellent results are obtained on some while very poor results are obtained on others. This, of course, is due to the efficiency of the eliminator. In other words, if one wants to use an eliminator, he must use a good one. One of our customers is employing a 210 tube in the last stage successfully.

We have also had a number of comments as to the quietness of operation. As you know, we employed the use of seven by-pass condensers in the design. They seem to be functioning very well, as the quietness of operation depends on these by-pass condensers. Another thing

(Continued on page 452)

The Radio Forum

*A Meeting Place for Experimenter, Serviceman
and Short-Wave Enthusiast.*

The Experimenter

Audio-Frequency Amplification in Europe

It is a very remarkable fact, writes Mr. R. Raven-Hart of Paris, France, that, in the three greatest radio countries of Europe, Great Britain, Germany and France, audio-frequency amplification has developed along three entirely different lines. A comparison of these, either in diagram form as given in this article, or preferably, in "flesh and blood," is well worth the while for any serious experimenter who likes to try things out for himself. The diagrams are drawn for d.c. tubes, but of course the same principles hold good when a.c. tubes are used.

To begin with the least interesting, the French type (Fig. 1); the least interesting because on the whole similar to old-fashioned American practice, except for the fact that as a rule (though there are, thank Heaven! exceptions) the transformers are not up to U. S. standards; and that voltages are kept low, this largely due to the little use made of plate supply units.

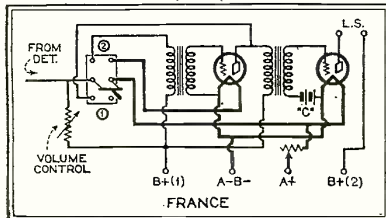

Fig. 1

The particular circuit shown cuts out the first audio-frequency tube for loud signals; quite a number of French sets, however, use the far less satisfactory switching whereby the *power* tube is cut out, leading to almost inevitable overloading.

Regular French practice would be to use 80 volts on the last tube, "B plus (2)"; and 40 volts on the other tube and on the detector, "B plus (1)." This low voltage explains the absence of polarization for the first audio tube. However, there is a tendency of late to use higher voltages, with, of course, the necessary polarization.

Tubes here would be of the -01A type for detector and first audio, semi-power type for second audio. A.c. tubes are very seldom used in France.

The German maker has settled down quite definitely to resistance-capacity amplification (Fig. 2), almost invariably without any switching devices at all.

Values in this case would be: R1, 200,000 ohms; R2, 3 megohms; R3, 2 megohms; R4, 3 megohms; C1 and C2, 0.01 microfarads (10,000 picofarads) each.

Tubes would be: Detector, -01A type or similar a.c. tube (-27); first audio, a high-resistance, high magnification type; and second audio, a semi-power tube. In this case, the voltages would be around 50 volts on the detector and 150 on the two audio tubes.

A rheostat in the positive "A" lead has been shown, but it is a matter of fact

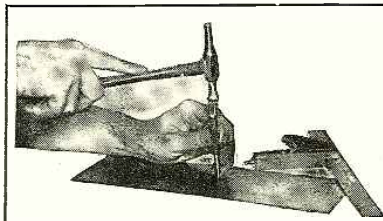

There's a right and a wrong way to use a center-punch when laying out panels, etc. The above photograph, a combination of both, is instructive in that it shows how the punch should be guided with the fingers but note also that instead of being held truly vertical it is slanted, a feature which is not so good since it will possibly produce an incorrectly placed punch hole

standard German practice is to run all the tubes direct off the "A" battery (four volts), or at most to use a rheostat with the detector.

No volume control is shown; in German sets this is usually obtained by decoupling the antenna, or by other pre-detector control: incidentally, a far more satisfactory

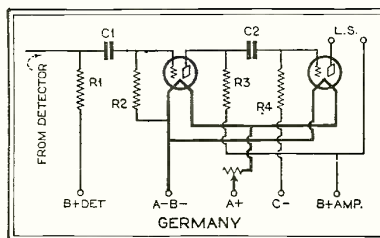

Fig. 2

means than that used in the French amplifier.

The most interesting of the three is undoubtedly the British type (Fig. 3), where one stage of resistance-capacity is followed by a transformer-coupled stage.

The values here would be something like: R1, 20,000 ohms; R2, 2 megohms; with voltages of perhaps 80 to 100 on the detector, the same on the first audio tubes, and 150 or more (in fact, all available)

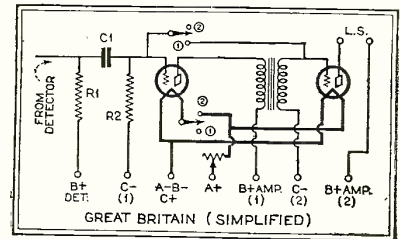

Fig. 3

on the last tube. Tubes of the -01A type in the first two stages and a power tube in the final stage would probably be used, or a semi-power tube might appear in the first audio stage.

It should not be overlooked that there is a definite difference between German and British practice as regards resistance-capacity amplification, the German tending to use high plate coupling resistances (even after a grid detector), with the result that the actual voltages on the plates are low, and the British to use much lower plate resistances and consequently higher effective anode voltages.

However, Fig. 3 tells only half the story: Fig. 4 is much more representative of modern British practice. Here

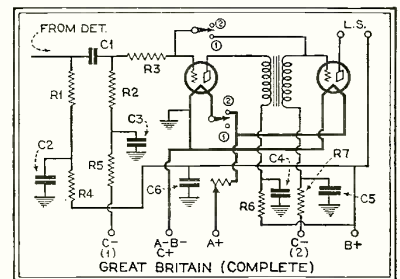
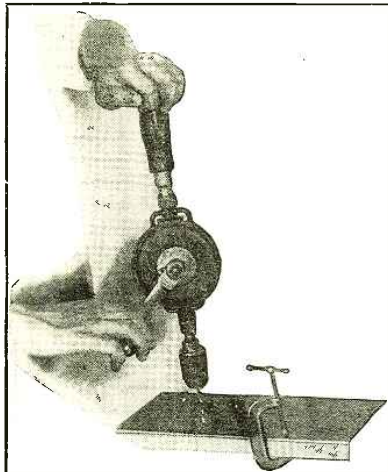

Fig. 4

the additional resistances R4, R5, R6, R7 and the condensers C2, C3, C4, C5, associated with them, are the so-called "decoupling" filters, preventing feedback due to the presence in several plate or grid circuits of a common resistance in the form of "B" or "C" batteries or (more especially) of a power unit of one sort or another. The important fact is that the presence of these filters (those in the

plate circuits being the more vital) not only prevents motorboating and similar unpleasant phenomena, but also does quite definitely improve the frequency characteristic of the audio-frequency amplifier as a whole.

The four condensers may be of one or two microfarads each; C6 of two or four microfrads, since there is here no de-



The wrong way to hold a drill. If the panel or material to be drilled is of any considerable thickness, holding the drill away from the vertical will produce a hole running diagonally through the panel and thus throw off the alignment of units to be mounted in those holes

coupling resistance to force audio-frequency currents to ground through it. It should be noted that, although the condensers C2, C3, C4, C6 are shown conventionally as grounded, it is desirable to connect them directly to the negative filament terminal of the tube they belong to—C2 to the detector, C3 and C4 to the first audio tube, and C6 to the last tube. R5 and R7 can be of almost any value, from 20,000 ohms to one megohm, for example: as no grid current flows, they have no effect on the "C" battery volt-

ages. R4 and R6, however, have a double task: they not only act as decoupling resistances but also reduce the total "B" voltages to values suitable for the tubes used. Their calculation is a simple matter of applying Ohm's law, knowing the voltage to be dropped across them and the plate currents.

Thus, for example, with a -01A type tube as a detector (grid leak and condenser), and with a total "B" voltage of 150, R4 would be something like 20,000 ohms. On the other hand, if the same tube were worked as a "power detector," and this is more standard British practice, R4 might remain at this value (because such detectors work better with higher voltages), but R1 might be put up to 150,000 ohms or so, with enormously increased amplification.

In the same way, R6 can be of 30,000 ohms or so if the first audio tube is a -01A; but if a semi-power tube is used it can advantageously be reduced to 10,000 ohms or even less (though its "decoupling" effect is of course reduced proportionately).

R3 is intended to keep radio-frequency currents out of the audio side; 250,000 ohms is a suitable value. (It is of course understood that a radio-frequency choke with its by-pass condenser already exist in the detector itself, so that all the work is not thrown on R3.)

The particular switching shown is not really characteristic—as a rule none exists—but it is well worth adding. As can be seen, with the switches in the position "1" (a two-pole switch is of course used), there remains one stage of resistance-capacity amplification, but using an impedance (the secondary of the audio-frequency transformer) instead of the more usual grid leak.

No volume control is shown; as a rule, this is of the logical pre-detector type, or perhaps R2 may be a potentiometer with R3 connected to the slider.

It has already been stated that the last tube would of course be a power tube. As a matter of fact, it would most likely be a triple-grid audio-frequency tube ("pentode"), this type having taken the British market by storm. So much is this

the case, in fact, that there is a tendency to suppress the first audio stage altogether, not only after a "power detector" but even after a grid detector, since the pentode develops about as much power as it can handle (and as much as anyone normally needs) with one transformer-coupled stage.

Since, however, at the moment of writing it is understood that this tube is

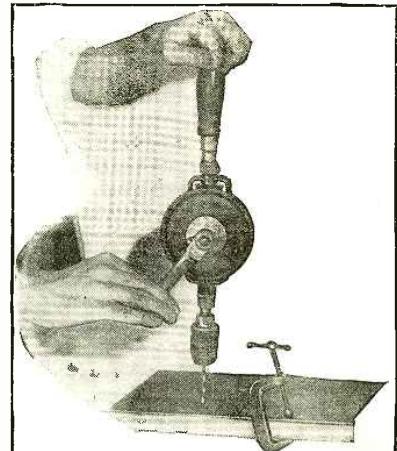

The correct way to hold the drill. Here the top of the hole is directly above the bottom of the hole and correct placement results. Note also that the work to be drilled should be clamped firmly to a bench or table so as to prevent slipping, etc.

not available in America (very regretably), the two-stage amplifier shown is more practical, because it can be realized with American materials at little cost.

It is exceptionally interesting to make up all three of these amplifiers, or at any rate the German and the British versions, and test them in turn after the same detector and tuner. I would particularly like to recommend this experiment to radio clubs, as the discussion on the results, as compared with a standard American amplifier, is likely to prove unusually animated and interesting.

The Serviceman

An A.C. Tube Tester

Mr. M. R. Shaffer, of Kokomo, Ind., has designed for his own use when servicing tubes an excellent tester which he here describes so that other servicemen may construct such a tester for use in their everyday work.

It is sturdy, made up of standard parts, portable and easy to build. The cost is considerably less than one can be bought for, of equal merit.

Here is what it will do:

- Test the emission of any standard tube.
 - Test power and rectifier tubes.
 - Show shorts in standard tubes.
 - Test for continuity, in some circuits.
 - Test for shorted condensers in power packs.
 - Test for open condensers in power packs.
- The diagram (Fig. 1) explains itself. The transformer, in the one described, is

home-made. Unless the serviceman is familiar with this kind of work we suggest



Keep your tubes shipshape. A tube rack, such as that illustrated, is of immeasurable aid, especially to the serviceman and experimenter, since it helps him to keep tubes classified according to their type. Also they are always readily available for use

one be bought and remind you the Kresge Stores sell one, made by the Pilot people, for \$5.00.

A 3-ply wood panel, to fit carrying case, will be all right for this purpose and will cut the cost.

The 110-volt 10-watt lamps are held in standard receptacles. One pair, as will be noted, being in series and a tap taken off from the center for 50-volt plate supply.

The milliammeter should be any of the favorably known makes.

The knife switch should be of strong construction, as it will see much service.

The two pup jacks are to be used in connection with leads for different kinds of test work. The lamps light up when circuits is completed. Keep in mind they will glow through any good condenser of ample size.

To test tubes, place tube in correct socket, throw knife switch to short position and look to see if tube lights up,

even faintly; if so, it should be discarded as defective.

After testing for shorts, throw knife switch to emission position and press button to read emission. A chart can be made up, of different types of tubes to show good, fair and bad tubes. At the new low price of tubes, it hardly pays to use any but the best tubes, and you may save your customer much trouble and yourself a free service call by discarding tubes you might have used when they sold for \$6.50 for a 201.



Mr. Shaffer's handy tube tester, ready for immediate use, in its carrying case

Herewith is chart showing test of power and rectifier tubes. When placed in proper socket, the 110-volt 10-watt lamps will show as follows:

INDICATIONS OF GOOD TUBES
POWER AND RECTIFIER

CX210	Grid side of socket—	Dull red
	Plate “ “ “	Dull orange
CX313	Grid “ “ “	Both sides dull orange
	Plate “ “ “	orange
CX316B	Grid “ “ “	Dark—no light
	Plate “ “ “	Dull orange
CX350	Grid “ “ “	Dull red
	Plate “ “ “	Dull orange
CX381	Grid “ “ “	Dark—no light
	Plate “ “ “	Dull orange

A.C. Voltage Booster

When line-voltage taps are not provided and the line voltage is consistently low, say around 105 volts, receivers designed for operation at 115 to 120 volts will not give satisfactory service. On many occasions, says Mr. D. A. Brown, of Marion, Ohio, the power company will not co-operate with the set owner in remedying this trouble, so it is up to the serviceman, if he wishes to keep the receiver sold, to provide satisfaction according to the customer's viewpoint, which, of course, is all within reason.

By using a heavy-duty bell-ringing transformer, the voltage may be boosted in steps of six, twelve, or in extremely low voltage cases, 18 volts. Connecting a device of this sort is extremely simple, as will be seen in Fig. 2. The double-pole, double-throw switch controls the re-

ceiver voltage between “light and heavy load periods.” When the line load is light, as in the daytime, the switch is

thrown to the normal position “N” and the set is connected direct to the power line. During the evening hours, when the line load is heavy, the switch is placed in the booster position “B” and the receiver obtains its correct operating voltage from the booster.

In some locations, a low-voltage condition will exist at all times. The booster then, of course, can be adjusted to suit this particular condition. In other locations, where the voltage is low only at night, precaution will have to be taken that the switch is not in the booster position during daylight hours, as this position

experiments that a marked improvement may be obtained in the selectivity and volume by the use of 70 volts, which may be obtained by a slight rearrangement of the voltage dividing system as shown in

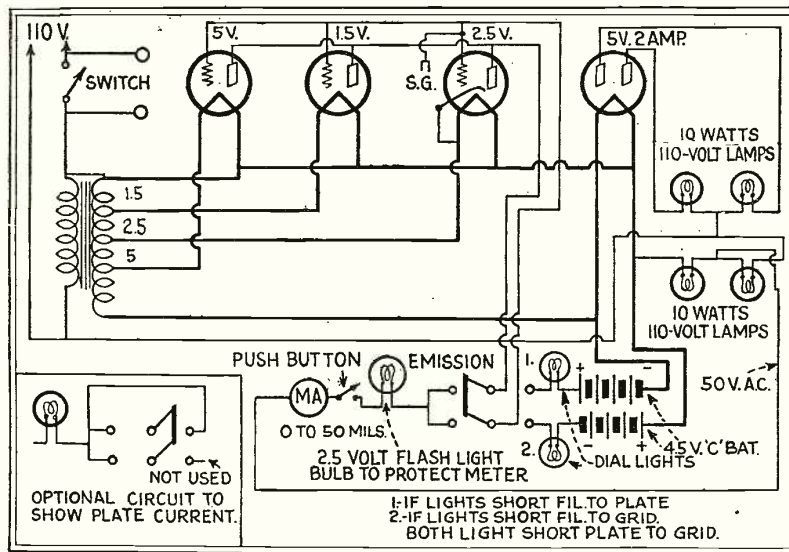

Fig. 1

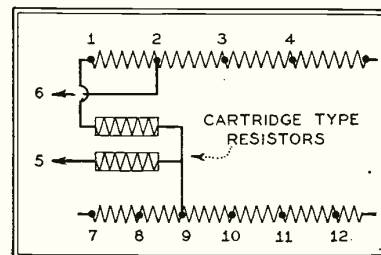

Fig. 3

Fig. 4. Here it will be seen that the terminal 6 is connected to terminal 1 in place of terminal 2, while the terminal which was originally connected to terminal 1 is now connected to terminal 7. Terminals 7 and 9 are shorted. These changes are extremely simple and are well worth while.”

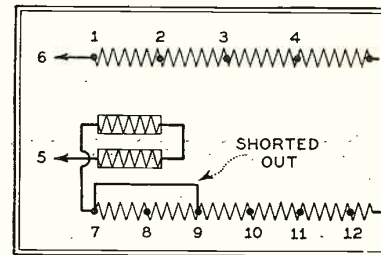

Fig. 4

A suggestion from Mr. R. F. Townsley, of Emison, Indiana, which will undoubtedly be of interest to servicemen who are frequently called upon to improve the selectivity of an old style set of the six-tube Neutrodyne type or of a similar

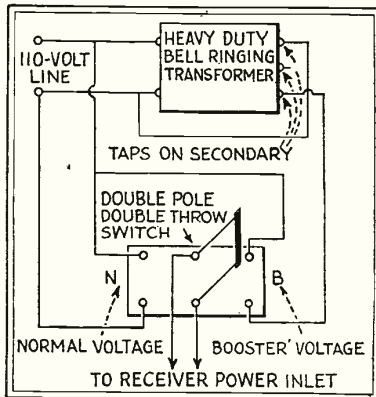

Fig. 2

will materially decrease the life of the tubes, due of course to the increase in voltage above the safe operating rating of the tube. With the above described method, I have remedied a number of low-voltage troubles, providing my customers with satisfactory service.

“Although tube manufacturers recommend 70 volts on the Screen Grid of the new 24 type a.c. screen-grid tube, a number of sets that I have had repair work on,” says Mr. A. Lauratis of Mas-

circuit arrangement. This usually is a more or less dreaded job and is often turned down completely, when one thinks of rewinding coils, preventing oscillations, etc.

The following tip is simple and may be used on any set having an untuned r. f. stage, to prevent aerial characteristics from affecting the tuning of the receiver. In many of the older battery sets, it is noted that the selectivity is increased more in proportion to the signal strength when the r. f. rheostat is advanced. That is, the set will tune sharper on a weak station when the volume is on full than when on a strong local station with the r. f. rheostat turned back to where the volume is the same as on the more distant station. This proves that the selectivity improves as the amplifier is used near its point of maximum efficiency.

Now why not let the r. f. amplifier run at its maximum efficiency and use some other method of volume control? That is the precise thing to do and the most logical place for the volume control is in the antenna circuit, which in most cases can be a 0 to 100,000 ohm variable resistor directly in series with the antenna. This type of volume control cuts down the volume without reducing the selec-

tivity of the receiver and since most good sets are run below their maximum volume on most stations, a great deal more selec-



Sparking, dirty commutators on converters, motors and generators often cause considerable man-made static. A piece of sandpaper (not emery) held against the revolving segments corrects this fault in a jiffy

tivity can be obtained or to be more exact, sharper tuning will result. Often times after this type of volume control

is installed in place of the r. f. rheostat and an automatic filament ballast used for these tubes, ten kilocycle selectivity is obtained at room volume whereas before the change was made, the same station at equal volume would spread over five or six degrees on the dial.

This is also largely why all electric sets are more selective than the older battery sets of the same number of tubes and a similar circuit design. This type of volume control is suitable for all sets having an untuned r. f. or so called "blocking" stage ahead of the first tuned r. f. stage. Another advantage is that the length of the antenna may be doubled or tripled without decreasing selectivity for a given volume and when local stations are off, the DX ability of the set is greatly improved, due to the increased antenna pick-up.

Occasionally, although very rarely, this modification causes the set to oscillate. If this happens, try a potentiometer across the antenna and ground, but as a rule the series resistor seems to give the best results. Since this does not carry an appreciable amount of current, it is better to use a variable resistor of the carbon compression or the wire-wound graphite-paper type resistor.

On Short Waves

Audio Amplifiers

The strength of the radio signal after being rectified by the detector tube can be tremendously amplified by use of an efficient audio channel.

An audio amplifier consists of one or more vacuum tubes with the necessary coupling devices between them. This amplifier is connected between the detector



Better home-wound coils can be made when using some sort of winding jig, as shown. There is better chance of duplicating coils for matching purposes than if they were hand wound

stage and the sound-converting unit, namely, earphones or loud speaker. The audio amplifier differs from the radio amplifier in that the latter feeds into the detector while the audio channel is fed from the detector.

There are three well-known methods of audio amplification. Named, as to promi-

nence, they are transformer, resistance and impedance coupled, with of course the possible combinations of any of these methods. Of these three methods, only the transformer-coupled amplifiers can be termed as having a voltage step-up. Two types of transformers may be employed. The first and more commonly used is the transformer with separate primary and secondary, followed by the auto-transformer, whose primary and secondary form a continuous winding. Both types of transformers employ secondaries whose turns are greater than the primary turns, resulting in a step-up voltage ratio, increasing or amplifying the incoming voltage impressed on the primary of the transformer. It will then be readily realized that the amplification of the audio transformer is dependent on the turn ratio. Theoretically, the output amplification constant of a five-to-one transformer should be five times the input voltage; this amplification holds good only when a transformer is operated at one frequency. In the audio amplifier the transformer is required to operate from approximately 50 to 5,000 or 6,000 cycles, therefore the theoretical amplification does not hold true. Let us, therefore, before going too far, mull over just what is necessary for good transformer design. If few turns are employed on the primary of the transformer, resulting in low impedance, the lower frequencies from 120 cycles down, which should of course be amplified along with the higher frequencies, pass through the low impedance without having much effect on the secondary. The low impedance does not allow current changes to magnetize the core nor transfer the energy to the secondary winding; providing little or no amplification. The impedance of the transformer pri-

mary winding, theoretically, should be about equal to the output impedance of the plate circuit of the preceding tube. In practice, however, it will be found necessary to have a primary impedance about twice as great as the preceding tube output resistance in order that the lowest frequencies may be fully amplified. This means, of course, that the primary im-

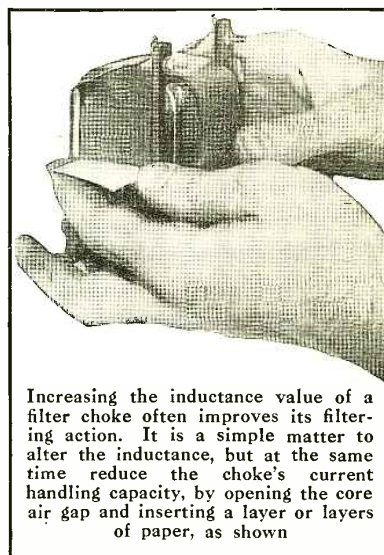

Increasing the inductance value of a filter choke often improves its filtering action. It is a simple matter to alter the inductance, but at the same time reduce the choke's current handling capacity, by opening the core air gap and inserting a layer or layers of paper, as shown

pedance be measured under operating conditions; that is, the secondary connected to a tube as in Fig. 1. There are two ways of increasing the primary impedance—increasing the primary turns or increasing the cross-section of the transformer core. Increasing the number of turns on the primary of the trans-

former is easily accomplished, but by so doing another difficulty arises, this being that a large number of turns produces a large distributed capacity which tends to by-pass the higher frequencies, reducing the amplification constant in this portion of the frequency band. Thus a transformer designed with a large number of primary turns amplifies the low frequencies but discriminates at the higher fre-

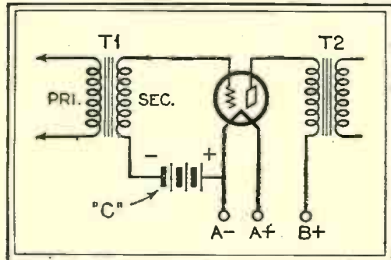

Fig. 1

quencies. It is, therefore, necessary to use a transformer where the balance between the lower and higher frequencies produces a reasonably flat amplification curve over the desired frequency band.

It is generally recognized that a vacuum tube is a voltage operated unit, in that it is the voltage change applied to the grid of the tube that produces a change of current in the plate circuit. Therefore, the voltage applied to the grid controls the current and power in the output or plate circuit. The current in the plate circuit of the tube flows through the coupling unit in this case, the primary of T1, Fig. 1, producing a voltage change in the secondary of transformer to which the grid of the following tube is connected. The grid voltage change of the tube is impressed on the plate of the same tube and one step of amplification is complete. As the transformer coupling, as mentioned above, has a step-up ratio between the primary and secondary turns, this method produces the greatest ampli-

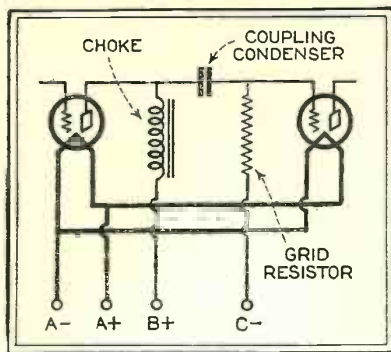

Fig. 2

fication. An example of this type of audio amplification is illustrated in Fig. 1.

Next in efficiency to the transformer-coupled audio amplifier is the impedance-coupled type of amplifier as in Fig. 2. Many variations of the method of amplification are employed. The best known is with a choke coil of the audio type in the plate circuit, a coupling condenser, and either a resistor or a second audio choke in the grid circuit. Although in this type of amplifier, the voltage step-up ratio is not as great as in the transformer-

coupled, it is, however, remarkably free from distortion and frequency discrimination. The ideal choke for use in plate circuit in impedance method of audio amplification should consist of pure inductance, without either distributed capacity or resistance. A choke of this type of course is an impossibility, but there are at present some manufactured chokes which come reasonably close to this ideal. As the plate resistance of the 01A type tube is about 10,000 ohms, we will require a choke of 125 henries to pass the 50-cycle frequency band at 97 per cent. efficiency or 250 henries for 25-cycle at the same efficiency. It must be remembered that the coupling condenser should have a very low reactance, as the alternating or audio-frequency current passing through it must reach the grid of the next tube. This means the coupling condenser should be at least 1/10 mfd. with a very high resistance factor. If by any chance the dielectric insulating the electrodes of the condenser is faulty, then some of the plate positive voltage will be applied on the grid of the tube producing a positive bias and distortion. As a general rule a grid resistor of 250,000 to 500,000 ohms is employed. If this re-

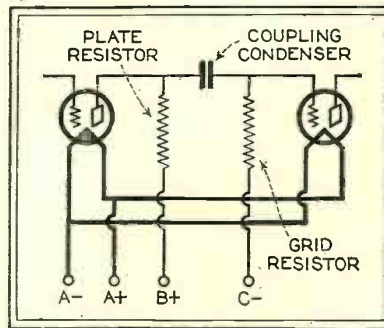

Fig. 3

sistor is of too high a value, the negative grid charges cannot leak off fast enough and the tube will block up. When a very low grid resistor is used, the effect will be a reduction of the effective impedance of the choke in the plate circuit, as the grid resistor is practically in parallel with the impedance of the choke.

Undoubtedly the resistance-coupled audio amplifier will come into its own niche when television is placed in universal use. This form of audio amplification has not the amplifying qualities of either the transformer or impedance-coupled amplification but has as a redeeming feature a practically uniform frequency curve, discriminating neither the low nor high ends of the musical range. The action taking place in a resistance amplifier is similar to that taking place in the impedance type, in that the flow of plate current through the plate resistor produces a voltage drop across this resistor. The changes in voltage across the plate resistance being of alternating or audio frequency are carried through the coupling condenser to the grid of the next tube. The coupling condenser here, as well as in the impedance amplifier, stops the positive plate voltage from the grid, preventing blocking of the tube. The grid resistor allows the negative charges to leak off from the grid of the tube. If these negative charges were allowed to accumulate,

they would finally place such a negative charge on the grid of the tube as to cut off the plate current, blocking signals entirely. The usual resistance-coupled audio amplifier consists of three or four stages, with plate resistors of 100,000 ohms each, the grid resistors of 1,000,000 ohms in the first tube, half that value for the second, one-quarter that value for the third and one-tenth, namely 100,000 ohms, for the

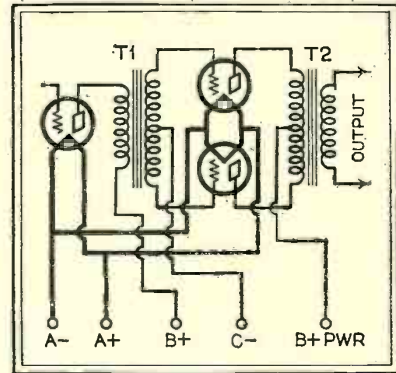

Fig. 4

fourth tube. Blocking condensers are not extremely critical; the values may be from .001 to .5 mfd. Most higher plate voltages are necessary for successful operation of this type of amplifier than for either the transformer or impedance-coupled types. However, the current drain on a four-stage resistance amplifier is approximately the same as for a two-stage transformer amplifier. A resistance-coupled circuit is shown in Fig. 3.

A refinement of transformer coupling has been used for some time in what is known as push-pull amplification (Fig. 4). The purpose of this method is to obtain great output volume without overloading the tubes. In push-pull audio circuits two tubes are employed in each stage. These tubes are not, as commonly imagined, connected in parallel, but are used with transformers of special design,

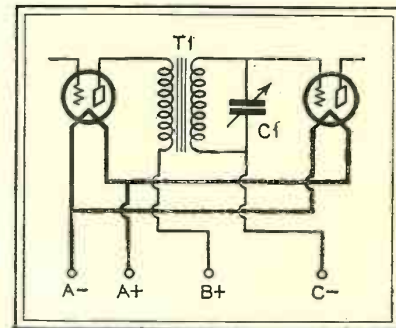

Fig. 5

so that one of the tubes amplifies one-half of the signal voltage, while the other tube amplifies the other half.

In Fig. 5 is shown a method of tuning the secondary of an audio transformer so that enormous amplification over a very narrow frequency band may be obtained. While this method is of real advantage to the short-wave amateur, it is of little or no use to the short-wave broadcast enthusiast, as it will eliminate all of the

(Continued on page 479)

A Familiar Name

WORKRITE

Since 1909

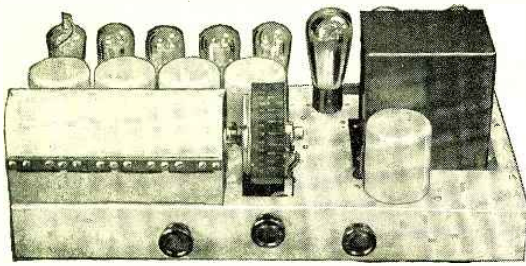

Front View

An attractive arrangement of especially selected parts showing engineering skill, forethought and experience. Sizes of chassis.

Designed by George W. Walker

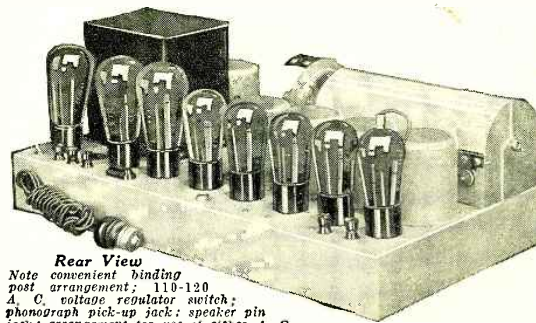

Rear View

Note convenient binding post arrangement; 110-120 A. C. voltage regulator switch; phonograph pick-up jack; speaker pin jack; arrangement for use of either A. C. or D. C. dynamic speaker. Convenient Straight-Line Tube arrangement.

Performance — It Means Everything!

The Name WORK-RITE Is Your Guarantee

20 years of manufacturing experiences, 8 years of which are in Radio, permit the production of this chassis at a price within reach of all. A comparison with other receivers selling at more than double our price will only convince you further of the value each Workrite chassis represents. We doubt whether a better chassis is possible to produce.

Performance was the primary consideration in the design of this chassis by George W. Walker. Costs of material were secondary. All the latest features known to the radio field are incorporated in this unusual receiver.

A WORD TO THE WISE

The inexperienced radio dealers and agents are flocking to purchase cheap and inferior quality receivers—swayed by the many alluring advertisements offering receivers revolutionary in performance at given-away prices. Some manufacturers are striving to substitute parts and accessories entirely unfit for long life and satisfaction—merely to meet this cheap competition.

Nothing will destroy confidence more quickly than a dissatisfied customer. Nothing will destroy the future of Radio and its possibilities more quickly than encouragement to purchase questionable radio merchandise. To avoid replacing receivers to collect payment; to avoid exhausting your profit in free service work; to avoid a loss in keeping cheap merchandise sold—to avoid GRIEF—buy a certified radio chassis. Certified by the trade mark established in 1909—WORKRITE—Cleveland's first radio receiver manufacturer. Pay more for your chassis—a WORKRITE is worth a few extra dollars. Insure yourself a reasonable profit and a satisfied customer. Establish good-will in your business and profit thru future transactions. Remember, the WORKRITE chassis is built to perform—not to a price.

Order a sample. Examine closely the parts used in the WORKRITE chassis; inspect the efforts of skilled workmen; note the fidelity in tonal quality; the selectivity in cutting thru powerful local interference; the ease in tuning far distant stations—then compare this chassis to the highest priced receiver in the market. If it is not all that we claim, return it to our factory—your money will be refunded immediately. You risk nothing.

SELECTIVITY

The conditions under which most receivers are operated today require absolute resonance in the R. F. circuit. Only with the most efficient circuit, plus carefully balanced components, are we in position to assure you maximum selectivity without distortion.

VOLUME

Only a single volume control is necessary in this chassis. Either great volume or a whisper, without distortion, is a feature pleasing to the particular radio public.

TUBES

Two 245 type tubes are used in the push-pull audio circuit, one 224 type screen-grid tube in the first R. F. and four 227 type tubes in the balanced R. F. detector and first audio circuits. A 280 type tube is used as a rectifier.

TONAL QUALITY

The utmost care in the selection of only the highest quality audio transformers, which contain twice the number of turns generally used, results in unequalled fidelity of tone and reproduction.

DIMENSIONS

Chassis size—20 inches long, 10 inches deep, 8 inches high. These measurements will permit use of all standard size consoles. Chassis pan is Udyllite processed insuring a rust-proof and attractive finish. Weight 35 pounds.

ADDITIONAL FEATURES

Other desirable features are the use of either A. C. or D. C. Dynamic speakers; Phonograph plug-in pick-up arrangement; Freedom of objectional A. C. hum; Line voltage regulator switch to safeguard against the destroying of tubes or any damage to chassis; accessibility to tubes due to rear straight line arrangement, making unnecessary the removal of the chassis from the console cabinet. Unusual sensitivity. The quality of materials used insures you a chassis free of grief and future trouble. Remember, each Workrite chassis must please and satisfy.

YOUR OPPORTUNITY

The wise public will quickly take advantage of this combination method of purchasing a complete radio receiver. By merely using the attached coupon you will acquaint yourself with an opportunity of buying chassis, speaker, tubes and console cabinet—directly from the manufacturers at surprising discounts. Dealers and agents throughout the country should write immediately for complete details and discount sheets on the Work-Rite Chassis, Furniture, Tubes and Dynamic Speakers. Become one of our thousand specially selected sales representatives. Associate yourself with a manufacturer of 20 years' experience. Cleveland's oldest radio receiver manufacturer.

Prices

This 8-tube A. C. latest design chassis (including knobs and beautiful escutcheon plate). Either Model No. 24 or 27 without tubes \$89.50.

Model 24 uses Screen-Grid tube in first R. F. stage
Model 27 uses a 227 type tube in first R. F. stage

SATISFACTION GUARANTEED

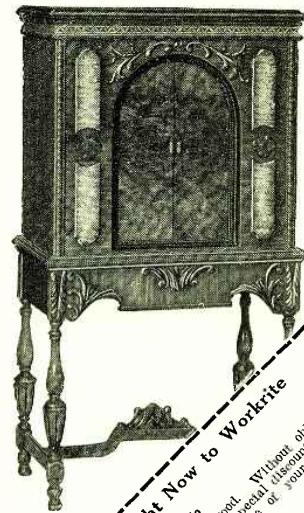

Write Right Now to Workrite
WORK-RITE RADIO CORP.
1105 E. 30th St., Cleveland, Ohio
Conditions: You may send good mail order for complete details and discount sheets to specially selected sales agents.
My Name _____
My Address _____
City _____
State _____
Without obligation to
PRINT NAME AND
ADDRESS PLAINLY

Work-Rite Radio Corp.

1836 East 30th St.

Cleveland, Ohio

Performance

WORKRITE

Means Everything

A Familiar Name

WORKRITE

Since 1909

A Radio Utility and Entertainer

George W. Walker "MULTI-UNIT"

A Device with a Dozen Uses

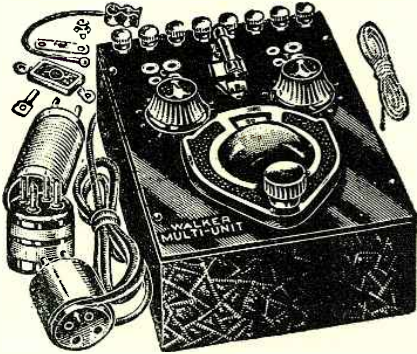

- SHORT WAVE RECEIVER
- SHORT WAVE ADAPTER
- REGULAR BROADCAST RECEIVER
- SCREEN-GRID PRE-AMPLIFIER
- R. F. OSCILLATOR
- EXTRA STAGE OF R. F. OR "BOOSTER"
- RADIO "EXPERIMENTAL" UNIT
- CRYSTAL RECEIVER
- WAVE TRAP
- WAVEMETER

One of the most unusual radio instruments ever devised. Will perform any individual function of a complete receiver, and in addition may be used for calibrating, testing or checking. Makes a wonderful broadcast receiver, short-wave receiver or transmitter. Oscillates violently over the entire scale range from 550 meters down to 15. Uses all tubes 199 to 210 and all voltages, A.C., D.C., or rectified. Nothing like it ever placed on the market before.

The Radio Fan has at his disposal a device which will provide him with something to tinker with for an entire season without performing the same experiment twice. Become acquainted with all the circuits and the way tubes perform under particular conditions.

The Dealer and the service man require this most valuable instrument for adjusting radio-frequency circuits to resonance, providing a beat note or constant frequency oscillation for determining wavelength of a particular condenser setting, calibrating a receiver disposing of trade-ins and obsolete sets by making them up to date by the addition of an R. F. amplifier.

NO ANTENNA-GROUND NEEDED

When using the Multi-Unit with most any receiver as an R. F. Booster (extra stage T. R. F.), the sensitivity increase is sufficient to make unnecessary the use of outside antenna. Tone quality is immediately improved. Less external electrical interference assured.

SHORT-WAVE CONVERTER (15-95 Meters)

Enjoy the novelty of short-wave experiments by converting your present receiver to tune to the low waves. Utilizing the audio amplifier in your own receiver serves a dual purpose and increases volume and range. Plug the unit adapter into the detector socket of your set. No change in wiring or extra tube required. The Multi-Unit will function with either A. C. or D. C. receivers.

R. F. PRE-AMPLIFIER

Uses same type tube as in the R. F. stages of your present receiver. 199, 201-A, 222, 224, 226 or 227 tubes may be used. Either A. C. or D. C. Extreme selectivity, if you prefer. Tune in stations you never heard before. This efficient circuit reduces static and other interference. Greater clarity results as the additional volume makes over-loading of tube filaments unnecessary.

SCREEN-GRID R. F. BOOSTER

Increase the range and volume of your present receiver to equal the latest improved Screen-Grid Receiver. Merely insert unit adapter plug in socket of your receiver. No change in receiver wiring. Adaptable to either A. C. or D. C. receivers.

SHORT-WAVE RECEIVER (15-95 Meters)

Experiment with the fascinating short waves. Tune to stations thousands of miles distant. Reception of short-wave foreign stations has been verified. Ideal all-year-around reception. Warm weather in Australia and New Zealand is winter in this country. Hundreds of short-wave stations throught the world are listed.

SINGLE TUBE RECEIVER

Ideal for either short-wave or regular broadcast band.

SHORT-WAVE R. F. BOOSTER

Connect the unit ahead of your short-wave set and hear stations with greater volume. Uses screen grid or 201-A type tube.

R. F. OSCILLATOR

Check your receiver for wavelength and calibration. Determine resonance of circuits, test tubes for oscillation and regeneration, neutralizing receivers, balancing condensers, laboratory measurements, short distance transmission and generating a beat frequency for superheterodyne.

There are numerous additional uses, a few of which are wavemeter, Loop R. F. Amplifier and growler for measuring efficiency of shielding material. By the time an experimenter has exhausted the possibilities of this instrument he will be qualified for a radio engineer.

Consists of the essential parts of an oscillatory circuit, and in addition are plug-in coils, adapter cord and plug, bridging connections, and extra wires along with well detailed instructions for many major experiments. Entire unit contained in box 7 1/2 inches by 5 inches by 3 1/2 inches. Price **\$16.00**

THE WORKRITE RADIO CORP., 1836 E. 30th Street, CLEVELAND, OHIO

SERVICE MEN—DEALERS—JOBBER—AGENTS WANTED

Wide Furniture Selection for Work-rite Chassis



Consoles—Combinations— Table Models

All Radio Furniture Shown in Our Free Folder Is Arranged Especially for the Use of the Work-rite Chassis

Carefully Selected Lumber, Skilled Craftsmanship, and Artistic Designs Are Embodied in This Line of Cabinets Selling at Amazingly Low Prices

Console AR-4 (at left), List \$50.00

Console AR-9, \$37.50

Height 50 1/2"; Width 27 1/2"; Depth 16 1/2"

Write for Our Complete Booklet of Furniture Showing the Latest Design Consoles—Combinations—Table Models

Attractive Discounts to Dealers and Agents

Write for Special Discounts

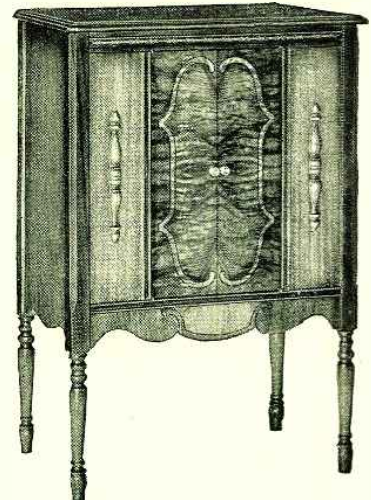

The Akrodyne Radio Mfg. Co.

Perkins and East 30th Street, Cleveland, Ohio

Performance

WORKRITE

Means Everything

For Beauty and Distinction Put Your Radio Chassis

in an *EXCELLO*
Radio Console

THESE rare examples of fine furniture are designed with expert care to best accommodate your chassis, speaker, eliminator, or power-pack.

With quality and refinement of design, materials and craftsmanship, Excello Consoles incorporate unusual technical skill in meeting all conditions contributing to excellence of reception.



(Style R-68)



(Style R-54—Open View)
Combination Phono-Radio Console



(Style R-61)

THE exclusive use of American walnut and fine cabinet woods combined with panels and doors of native matched Madrone burl veneer or rare imported inlays, expertly finished and hand rubbed to satin smoothness, acclaims Excello quality.

Reasonableness of price and perfection of appearance will be a revelation to you.

Write today for Free catalogue illustrating and describing fully our complete line of many models

EXCELLO Radio Consoles

Excello Products Corporation

4832 West 16th Street

Cicero (Chicago Suburb), Illinois

Barawik - the Old Reliable

RADIO SERVICE

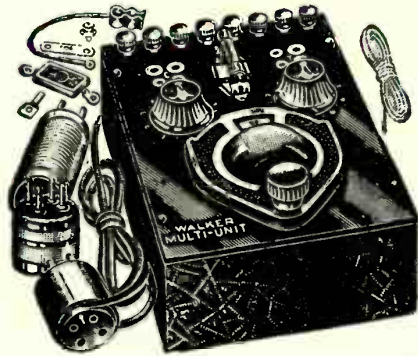

Geo. W. Walker's Multi-Unit
This 12-in-1 radio wonder, complete as described in this issue. 3R4800—List price **\$16.00**
ATTRACTIVE DISCOUNT



Special 8 Tube Chassis
Specially shielded metal chassis ready to mount in cabinet or console. Panel size 8 x 20 in. Depth, 10 in. Complete with essential parts, wired, ready to operate. Super size power pack. Three stages R. F. and detector.
1R11494—Chassis only—List price \$89.50.

ATTRACTIVE DISCOUNTS
Big line other models quoted in our catalog.

R-61 Excella Console

De Luxe model of American and Oriental Walnut, selected Japanese ash overlays. Beautiful hand-rubbed finish. Sliding panels. Battle in speaker compartment.
List price \$125.00. **\$73.50**
Our Special price



Diatron Radio Tubes
Fully guaranteed high quality tubes at very low prices. 245 Lower Amplifier. List \$3.50, net \$1.72.



New Erla Phonograph Pick-up
One of the finest made. 3R3081 — With volume control built in—List \$15.00, net \$8.82. 3R3082—Model T81 without volume control—List \$13.50, net \$7.94.

Oxford Dynamic Speaker

For 110-volt A.C. current, complete with rectifier. 8-inch cone. List \$39.50. Our special price \$23.23. Same for 110-volt, D. C. List \$31.50, net \$18.52. For 6-volt Storage Battery—List \$29.50, net \$17.35.



List \$5.00, net \$1.47. 201A General Purpose Tube. List \$1.25, net 62c. 222 D. C. Shield Grid Amplifier. List \$4.50, net \$2.20. 171 Power Amplifier. List \$2.25, net \$1.11. 226 A. C. Amplifier. List \$1.75, net 86c.

Send Us Your Order for Geo. W. Walker MULTI-UNIT

Headquarters for Walker's Multi-Unit

We are official wholesale distributors for George W. Walker's Multi-Unit and the equipment required to operate completely the receiver featured in this issue. In order to save money on your purchases, be sure to send your orders to us for Walker's Multi-Unit, chassis, etc. Order direct from this page. Note our low prices.

Thousands of other Bargains

The active radio season has started. With the opening of another history-making year in radio, Barawik has had the pick of the bargains and is opening the season with a huge stock of quality goods at bargain prices. A large, carefully selected line in the newest models of factory-built sets, A. C., Screen-Grid, etc., complete parts for circuits and hook-ups, accessories, parts, kits, etc., are described and listed in our new fall catalog.

The new Barawik Radio Guide presents some of the most outstanding bargains you have even seen. Your money goes far here. You'll be pleased with many new things contained in our new catalog.

Another Big Bargain Book Ready for You

This big new Radio Guide tells how to take advantage of the new things in radio. It shows how to get the best results from A. C. and D. C.

Screen-Grid sets and tubes, how to use remote control, how to get reception on front or back porch and lawn, while playing bridge, etc.; how to save money on tubes, speakers, supplies; how to make radio-phonograph combinations and public address systems, etc. Many new ideas with pictures, full descriptions and new low prices on anything you want in radio—sets, kits, parts and supplies

—besides hundreds of necessities for your auto, for home, camp and outdoor use. Fill in the handy coupon below. It will bring you the latest edition. Be sure to send at once. Get the facts before you. Write today—NOW!

MAIL THIS COUPON FOR FREE COPY

BARAWIK CO., 20 Canal Station, Chicago, U. S. A.
You may send me, free, the big new Radio Guide, set-builder's encyclopedia and catalog of Walker's Multi-Unit, complete receiver and newest radio sets, kits, parts, supplies and accessories, showing illustrations, descriptions and giving me advantage of new low prices.

Name.....
Address.....
City..... State.....

The Barawik Co.

20 Canal Station

Chicago, U. S. A.



FREE BOOK

The Trade Announces:

New Equipment and Manufacturing Trends

Cornell Cub Condenser

A UNIT mounting condenser suitable for use as a grid condenser or coupling capacity in resistance coupling units, is the new product of the Cornell Electric Mfg. Company, Inc., of Long Island City, N. Y. (Fig. 1). This condenser, known as the "Cub," is supplied in capacities ranging from .0001 to .006 mfd. It is self-mounting and can be used to advantage with the carbon type grid leak or any of the pig-



Fig. 1

tail type of leaks. Pure linen paper of .0005 inches of three thicknesses, provides a d.c. flash-over rating of 1500 volts. The condenser is of the wound type and is non-inductive. Terminal contacts are rigidly fastened to a vacuum dried and impregnated mandrel, consequently have no possible chance of loose ends and noisy contacts. The capacities are held very accurately to their specified percentages.

A Soft Rubber Phone Cap

From Frank Walter, of Los Angeles, Calif., comes the announcement of a new soft rubber cap suitable for earphones. This cap (Fig. 2) is novel in its design in that it prevents sweating on the thin metal diaphragm, thus eliminating replacements of

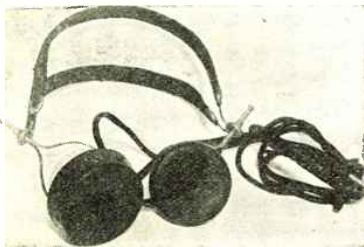

Fig. 2

the diaphragm. The cap is threaded so that it may be screwed on the earphone in place of the hard rubber cap usually provided. These caps are of real advantage to fans who use earphones for any length of time as they relieve ear strain.

Operadio Power Amplifier

A new high quality power amplifier is the announcement of the Operadio Mfg. Company of St. Louis, Mo. This unit (Fig. 3) uses a 226 tube in the first stage and two

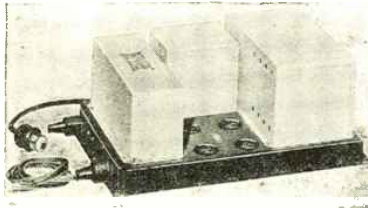

Fig. 3

210's in push-pull as an output stage. A 381 tube is employed in half-wave rectification. The apparatus, consisting of transformers, chokes, condensers, etc., is mounted on a steel chassis. Shielding cans are employed to prevent magnetic coupling as well as providing a guard against dust and breakage. Voltage taps are also provided for the r.f. amplifier and detector portions of the radio receiver. The amplifier may also be used in conjunction with an external pick-up.

Radio Receptor Powerizer

Despite the wide variety of applications for power amplification, such as in the home, club, theatre, auditorium and outdoors, ingenious engineering and design have succeeded in producing four new Powerizers which meet every requirement, according to the Radio Receptor Company, of 106 7th Ave., New York City.

In Figure 4 is the PYP-245 Powerizer and is typical of the present line of power amplifiers for every purpose. This powerizer is a three stage amplifier employing two stages of 227 amplification and a power stage with two 245 tubes in push-pull and provides a 5 watt undistorted output for use in extra large living rooms, club rooms and small auditoriums.

Similar are the powerizer PX-245 comprising one 226 stage and one 245 stage with a 280 rectifier and an output of 1.5 watts, and the powerizer PXP 245, with one stage of 226 and a power stage of two 245 tubes in push pull, with a 280 rectifier and an output of 5 watts.

For large auditoriums and outdoor applications, there is the powerizer PXP-250, comprising two units in steel cabinets with one stage of 227, one semi-power stage of 171-A in push pull, and a high-power stage of two 250 tubes to-

Fig. 4

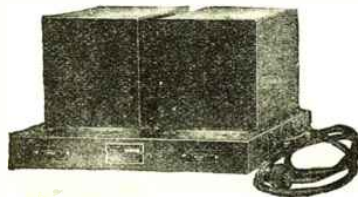

gether with one 280 and two 281 rectifiers and an output of 15 watts.

Corwico Lightning Arrester

As a safeguard for radio receivers, Cornish Wire Company, Inc., of New York City, offer the Corwico Vulcan Lightning Arrester. This lightning arrester (Fig. 5), according to the manufacturer, is designed not only to protect the radio receiver against damage from lightning but also to dissipate static charges accumulated in the



Fig. 5

antenna. To accomplish this, materials are used which result in minimum voltage breakdown and at the same time offer maximum resistance under operating conditions. The Cornish Wire Company, Inc., include with the arrester a guarantee up to \$100 for a receiver damaged by lightning when protected by a Vulcan Arrester.

Hahn Shielded Spark Plug

A spark plug for use in motor cars, motor boats and airplanes when radio



Fig. 6

equipped is announced by Walter Kidde & Company, Inc., of New York City. (Fig. 6). This spark plug is totally shielded and when used in conjunction with copper braid on the high tension wires eliminates ignition sparking interference. Mr. Hahn, designer of the spark plug, advises in cases where ignition interference is extremely bad, use of copper shielding boxes covering the distributor head and ignition coil. The head of this shielded spark plug is of brass while the center electrode is of a special composition metal having a very high arc resisting surface. Mica insulation is used throughout. A brass clamp is provided at the head of the spark plug for the grounding of the copper braid.

The World Beater Crystal

Of interest to crystal detector enthusiasts is the announcement of William A. Talley, of Beaudry, Arkansas, in the perfecting of a galena crystal and its asso-

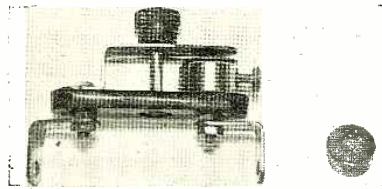

Fig. 7

ciated mounting. The crystal is mounted in a special low melting metal which insures low resistance connection to the crystal. A brass angle arm provides contact with the crystal. A threaded screw with a control knob varies the tension of the arm with the crystal. Nickel plated brass angles provide an easy method of mounting the unit in any desired position.

The Furnell Die Cast Condenser

According to the Furnell Mfg. Corporation, Newark, N. J., an important step forward has been made in condenser design in perfecting the design of their new die cast variable condenser. Simplicity of operation, accuracy, dependability,

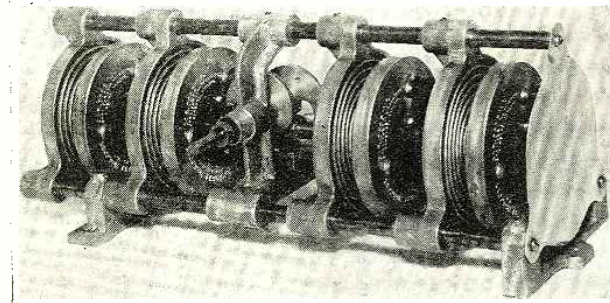

Fig. 8A

compactness and precision are all obtainable through careful design of the condenser (Figs. 8A and 8B). The stator and slider units are cast in aluminum alloy and are of

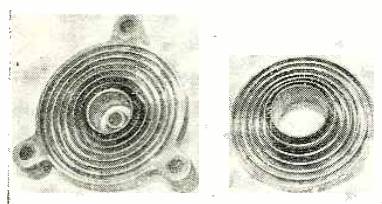

Fig. 8B

sufficient thickness to prevent distortion irrespective of heat and tension strains. A dial movement of 360 degrees eliminates the use of a vernier dial as well as avoiding crowding on the lower wavelength stations. The air-dielectric spacing of this condenser between the stationary and moving plates is approximately .02 inches at maximum and .05 inches at minimum capacity, providing a maximum of 500

mmfd, and a minimum of 21 mmfd. A high grade of bakelite insures one hundred percent insulation and mechanical strength. Resistance losses are minimized by the die-casting process and the elimination of soldered connections. Due to its ruggedness, simplicity and sturdy construction, the Furnell die cast condenser provides a high degree of accuracy, permitting ganging of condensers without the use of small trimming capacities.

Electrad New Layer-Wound High Resistance Units

This addition to the Electrad's Inc. line of radio resistances and voltage controls is recommended particularly for the use as a plate resistor, multiplier for voltmeters and is accurate enough for general laboratory use (Fig. 9). The finest grade of Ni-

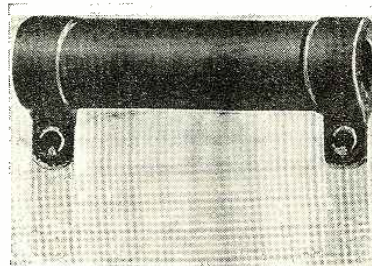

Fig. 9

chrome resistance wire is wound on insulated layers around a refractory tube. The entire unit is covered with a heavy coating of moisture-proof enamel of unusual elasticity, baked on at 400 degrees to prevent loosening of connections and fractured wire. Contact bands and soldering lugs are of Monel metal. Lugs are soldered up for easy soldering. The overall length of the units is 2 inches, with maximum outside diameter of 5/8 of an inch. Standard resistance ratings of from 10,000 to 250,000 ohms are obtainable.

Radio Set Analyzer With Tube Merchandizing Case

A new 4-instrument set analyzer with a tube merchandizing case is announced by the Jewell Electrical Instrument Company, 1650 Walnut Street, Chicago, Illinois.

The new kit has two compartments size 4 1/4 x 1 1/4 x 5 1/8 inches and a drawer size 11 1/4 x 10 3/8 x 2 1/4 inches, for the purpose of carrying tools and replacement tubes.

In this case, Jewell has made it easy for service men to make an additional profit from servicing through the sale of replacement tubes. The convenient method provided for carrying tubes is also a big time saver (Fig. 10).

The Pattern 408, as the new analyzer is called, contains the same four Jewell instruments and all test equipment pro-

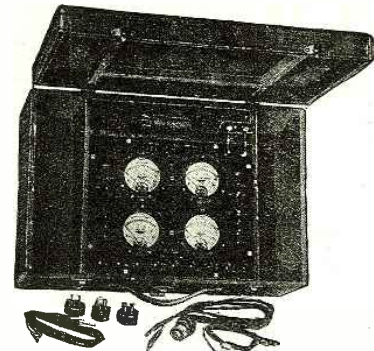

Fig. 10

vided in the Jewell Pattern 409. It gives plate voltage, plate current, filament, and grid voltage readings simultaneously and makes every other desirable test.

J. H. Bunnell & Company, New York City, has purchased the recording equipment business for telegraph and submarine cable service, which was formerly owned by A. A. Clokey Company, Rutherford, N. J. This includes the single, double and multiple pen direct writing recorders, and also the motor-driven tape pullers and tape reels.

These instruments are in general use by the telegraph and cable companies throughout the world, and will tend to round out more broadly the lines of telegraph, precision and mechanical instruments manufactured by J. H. Bunnell & Company. The direct writers and tape pullers will be manufactured at the new Bunnell plant in Brooklyn, N. Y.

Dynamic Speaker Unit

A dynamic speaker unit intended especially for use with the exponential type of horns has been announced by the Racon Electric Co., Inc., 18 Washington Place, New York City. (Fig. 11.) This unit is made in several styles, each employing speaker coupling transformers which are especially designed to work out of one of the various types or combinations of power tubes which are now available. Also, special coupling connectors are made so that the unit can be used with various types of exponential horns now on the market.

Fig. 11

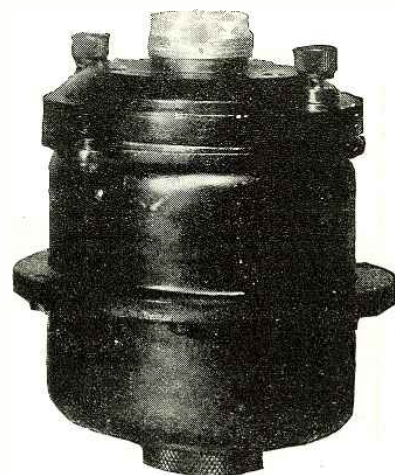



Radio Inspectors
\$2000 to \$4500.

Radio Repair Mechanic
\$1800 to \$4000 a year!

Radio Operators
\$90 to \$200 a month
(board free).

Open!

THOUSANDS OF RADIO JOBS like these!

Pick the job you want—
see what only 9 months
training will do!

TELL us where to send your copy of this free book. See how thousands of men just like you easily make big-money in Radio. It's a big pay business. Salaries from \$2,000 to \$25,000 a year are common. So why worry along on a poor salary? Why put off another day the success that can now so easily be yours?

These World-Wide Opportunities are Calling to You!

Share in the glorious future of this gigantic industry. Broadcasting stations and manufacturers all over the country are eagerly seeking trained men . . . Thousands of ships require experienced operators...and now, nation-wide radio telegraph service, telephony, television, photoradiograms open up thousands of new opportunities for you.

Easy to Learn at Home With This Magnificent Laboratory Outfit

There's no need for you to know a thing about radio. The Radio Corporation of America sponsors this marvelous, simplified home training course . . . by means of which you can now prepare for suc-

cess in every phase of Radio . . . You learn by actual experience with the remarkable outlay of apparatus given with this course . . . learn how to solve every Radio problem . . . such as repairing, installing and servicing fine sets. That's why you, too, can easily have the confidence and ability to hold a big-money Radio job like thousands of our other students.

Only Course Backed by Radio Corporation of America

The progress of Radio is measured by the accomplishments of the great engineers in the huge research laboratories of the Radio Corporation of America. This gigantic organization set the standards for the entire industry . . . and sponsors every lesson in the course. That's why graduates of this school are posted in newest up-to-the-minute developments in Radio. That's why they are always in big demand.

Money Back if Not Satisfied

This marvelous home-laboratory training practically

insures your success by preparing you thoroughly in every phase of Radio manufacturing, servicing, broadcasting and airplane radio equipment. As a student you will receive an agreement signed by the president of this school assuring you of complete satisfaction upon completion of your training—or your money refunded.

READ THIS FREE BOOK

The young men in Radio today will be the industrial leaders of tomorrow . . . that's what happened in the automobile business . . . in aviation . . . and in every other essential industry . . . Get in on the ground floor and climb with this tremendous industry!

FREE...everything you want to know about Radio... 50 fascinating pages . . . each one packed with pictures and descriptions about the brilliant opportunities in this fast-growing profession. See for yourself why R.I.A. training has placed thousands of men in well paid positions—usually from 3 to 10 days after graduation. Mail this coupon now and receive your **FREE BOOK**.



RADIO INSTITUTE of AMERICA,
Dept. EX-11, 326 Broadway, New York, N. Y.

Gentlemen: Please send me your **FREE** 50-page book which illustrates the brilliant opportunities in Radio and describes your laboratory-method of instruction at home.

Name.....

Address.....

RADIO INSTITUTE OF AMERICA

SPONSORED BY





EVEREADY RAYTHEON TUBES FOR TALKING PICTURES AND TELEVISION



ARE DEFINITE CONTRIBUTIONS TO THIS NEW SCIENCE

EVEREADY RAYTHEON is at the front in television . . . with both transmitting and receiving tubes of proved dependability and performance.

The Eveready Raytheon Foto-Cell is a long-life transmitting tube for talking pictures, made in several standard types. Also used in television. Foto-Cells to special specifications will be made at reasonable prices.

The Eveready Raytheon Kino-Lamp for television reception is the first tube developed commercially which will work with all systems. Its glow is uniform over the entire plate. Its reproductive qualities are perfect, without the need of mirrors or ground glass. The performance of each tube is carefully tested in our laboratories.

Correspondence is invited from every one interested in television and talking pictures.

NATIONAL CARBON CO., INC.
General Offices: New York, N. Y.

Unit of
Union Carbide **UCC** and Carbon Corporation



A Complete A. C. Operated Short-Wave Receiver (Continued from page 443)

PARTS LIST

One Potter condenser block, No. 674C.
Two Potter by-pass condenser blocks, No. 30B.
One Polymet small moulded bakelite condenser, .00015 mfd.
Four A. C. sockets.
Three D. C. sockets.
Three Yaxley insulated tip-jacks, No. 422.
Two Yaxley center-tapped resistors, 40 ohm, No. 840C.
One on-off a. c. switch.
One Durham onewatt resistor, 2,000 ohm (White).
Two Durham two-watt resistors, 10,000 ohm (Green).
One Durham one-watt resistor, 2 megohm (Red).
One Carter resistor, 400 ohm, No. RU400.
One Carter closed circuit jack, No. 2A.
One Ohio carbon five-watt resistor, 300 ohm (Green).
One cord and plug.

Four moulded binding posts.
One set of hardware and hook-up wire.
AND THE FOLLOWING SILVER MARSHALL PARTS
One pierced metal chassis and power unit case, No. 721.
One Escutcheon, No. 812.
One illuminated drum dial (Right), No. 810R.
One variable condenser, .00014 mfd. No. 314.
One Midget condenser, .000075 mfd., No. 342B.
Four plug-in coils, 131L, 131M, 131N, 131O.
Two tube shields, No. 636.
One audio transformer, No. 260U.
One push-pull input transformer, No. 270U.
One power transformer, No. 336U.
Two R. F. chokes, No. 275.
Three R. F. chokes, No. 277.
One filter choke, No. 338.
Two wood knobs, No. 817.



Some Refinement for the Short-Wave Four (Continued from page 443)

that has been commented on is the application of the removable caps to replace the various coils. We mentioned the advantage of these caps in the August article and it appears that in the application of the short-wave receiver they are an important item.

Very truly yours,
SAMUEL EGERT,
of Wireless Egert, Eng. Co., N. Y. C.

* * *

Making the Dials Read Alike

Recapitulating the suggestions in Mr. Egert's letter, for improving the receiver, first, it is simple to overcome the lack of similarity in the dial readings for both of the tuned circuits. The disparity in the dial readings was due to the difference in the characteristics of the two tuned circuits and the tubes to which they in-putted. To overcome this tuning discrepancy the following remedy will prove useful. Merely shunt across the first tuning condenser a midget of the 32 mmfd size. The accompanying photograph shows how this addition has been made.

Screen-Grid Volume Control

The variable resistance, R5, which was incorporated in the original receiver as a control of regeneration, has to some extent been used also as a volume control but sometimes with a sacrifice in selectivity and sensitivity. Therefore the addition of the screen-grid volume control is advisable, especially where it is desired to cut down volume from a nearby local short-wave transmitter. Simply connect the center arm of a 100,000 ohm potentiometer to the screen-grid of the first tube and the two outer terminals one to B—, the other to B+ 45 battery terminal.

The Short-Wave Wavemeter

In tuning short-wave sets it is almost invariably the case that the exact frequency to which the set is tuned is unknown, and when the listener wants to get a certain station the frequency of which he knows, the best that he can do is to tune his set and say, "It ought to be somewhere around here." While this condition is practically universal at the present time, there is no reason for its continuance, for a short-wave frequency meter with the numerous coils calibrated in terms of wavelength or frequency can very easily be employed to determine the dial position of the desired station. The photograph accompanying shows a wavemeter which has been designed by Wireless Egert Engineering, Inc., 179 Greenwich Street, New York.

This wavemeter is mounted in a beauti-

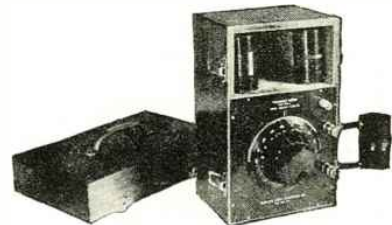

fully finished solid walnut cabinet, and is arranged and wired so that it may be used either for transmitters or receivers. When used with a transmitter the meter is loosely coupled to the oscillator; the bulb in the wavemeter will indicate resonance as the tuning is varied. When used with a receiver, the "click" method is used. The instrument is now available complete with tested coils. A full set of curves is also included, each meter having been separately calibrated.

Ready Now! the New "HiQ-30" The PERFECT Custom Built RADIO

9 TUBES INCLUDING
"AMPERITE" AUTOMATIC
VOLTAGE CONTROL

COMPLETE
UNITS
Factory-wired
and Tested
—
ASSEMBLED
and
OPERATING
PERFECTLY
in
TWO HOURS

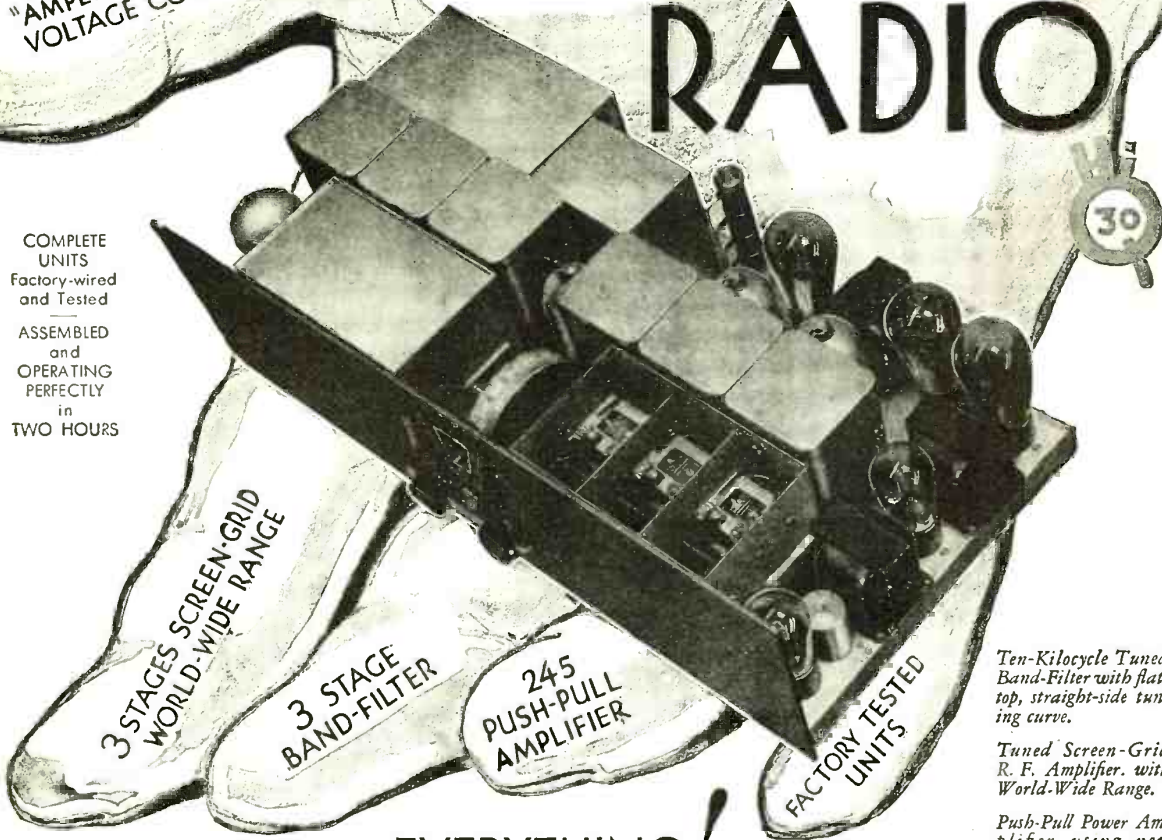

3 STAGES SCREEN-GRID
WORLD-WIDE RANGE

3 STAGE
BAND-FILTER

245
PUSH-PULL
AMPLIFIER

FACTORY TESTED
UNITS

IT HAS EVERYTHING!

Ten-Kilocycle Tuned
Band-Filter with flat-
top, straight-side tun-
ing curve.

Tuned Screen-Grid
R. F. Amplifier. with
World-Wide Range.

Push-Pull Power Am-
plifier, using new
"245" tubes.

Tremendous volume,
with a rich, vibrant
tone that is revolu-
tionary in radio.

One-Dial Operation.

Choice of Finest Cabi-
nets and Speakers.

Completely-Shielded A.
C. and Battery Models,
with Cadmium-plated
metal chassis.

THE new Hammarlund "HiQ-30" caps the climax of five years of custom-radio designing with two years of Screen-Grid development. Its epoch-making "Band-Filter" Circuit, originated and used exclusively by Hammarlund the past year, is the most advanced obtainable. Its parts are the finest—precision-designed especially for this truly great receiver.

The distance-getting ability of the "HiQ-30" is amazing. Stations do not merely "roll" in—they "SNAP" in, one at a time, free from cross-talk and background noises. No hum, no buzz—nothing but the crystal-clear program with startling realism and rare richness of tone.

A connection is included for reproducing phonograph records through the amplifier—as you have never heard them before.

Here is engineered radio perfection, clothed with beauty that delights the most fastidious. And all so easily acquired by either assembling it yourself with factory-tested units, or having it installed by your local custom-radio builder—at a price far less than any factory-built receiver that even approaches the "HiQ-30" in quality.

Don't buy or build any radio at any price until you get all of the "HiQ-30" facts. The 48-page "HiQ-30 Manual" tells the story. Use the convenient coupon.

HAMMARLUND - ROBERTS, INC.
424-438 W. 33rd Street, New York

COMPLETE
(less tubes)
\$139.50 to
\$1175.00

MAX COUPON AND 25¢ FOR "HiQ-30" MANUAL
HAMMARLUND-ROBERTS, INC., Dept. RN/1, 424-438 W. 33rd St., N.Y.
Enclosed 25c (Stamps or Coin) for the "HiQ-30" Manual.
Name _____ Address _____

KOLSTER

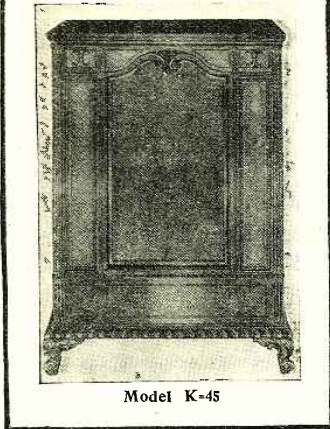

Model K-45

... another leader
who standardizes

on DURHAM RESISTORS and POWEROHMS

KOLSTER!—another great name in radio—another leader who has set the pace in quality receivers for many years—another leader who has long recognized the superiority of the metallized principle upon which DURHAM Resistors and Powerohms are manufactured. Yes, KOLSTER is another who standardizes on Durham resistance units . . . because they are unfailing in accuracy and uniformity. DURHAMs may cost slightly more than average resistances, but their aid to quality reception is well worth the slight difference in price. Furthermore, their presence in a receiver is a guide to the quality of other parts.

Write for engineering data sheets, samples for testing and complete literature. Please state ratings in which you are interested.



DURHAM Metallized RESISTORS and POWEROHMS are available for every practical resistance purpose in radio and television circuits, 500 to 200,000 ohms in power types; 1 to 100 Megohms in resistor types; ratings for all limited power requirements; standard, pigtail or special tips.

THE LEADERS STANDARDIZE ON

DURHAM

METALLIZED

RESISTORS & POWEROHMS

INTERNATIONAL RESISTANCE CO.
2006 Chestnut Street, Philadelphia, Pa.

The Symphony in Brass

(Continued from page 411)

the broadcasts from the bandstand in Central Park being a part of the National Broadcasting Company's summer program schedule. In the fall of 1928 it was announced that the popular bandmaster would not confine his radio work to summer concerts but would be heard every week in a concert broadcast from the NBC studios at 711 Fifth Avenue. The Pure Oil Company agreed to sponsor the concerts and the series has become one of the most popular and best known on the air, being heard every Tuesday night through a national network of stations associated with the NBC.

A March Composition That Surprised Its Composer

Goldman, unlike many musicians, doesn't believe that a band leader is the best judge of what the public wants in the way of music. He cites his now nationally famous march "On the Mall" as an example of "you never can tell."

The march was written several years ago and was to have had its premiere at the dedication of the Elkin Naumberg memorial band stand in Central Park. Goldman wrote the march, listened to it in rehearsal and thought it awful. He worked on it intensively and rehearsed it again and again. The selection still was sour to him.

"I considered the march the worst piece of music I had ever written," he said. "I finally decided not to play it at the dedicatory concert.

"In the meantime, a music publisher had taken the march and had printed thousands of copies of it. Several weeks after the dedication of the bandstand I decided I'd try the piece out on an audience. Usually at the Central Park concerts, a boy holds up a placard with the name of the selection the band is to play. This time I motioned him to keep the placards out of sight and brought the march in as an encore.

"The musicians all were laughing as they played "On the Mall," for I was directing with one hand and the other hand held my nose to express my disgust for the march. As my back was to the audience they couldn't see the gesture.

"Then I almost fell off the stand when the applause roared out at the end of the selection. It was the greatest reception any piece had had that season. So we played it again, and you can bet that this time I had the boy hold up the placard with the name of the march on it.

"Since that time 'On the Mall' has been played at virtually every concert I have given. It is by far the most popular composition I have ever written or directed. And I still have my doubts about its musical merit."

The Symphonic Possibilities of Every Melody

Goldman has some interesting ideas on music. He believes that there is the foundation of a symphony in every melody, and that skilled treatment will

develop that symphony. Even the notorious Babylonian strain—more commonly known as "hoochie-coochie" music—has symphonic possibilities. Every musical selection has a climax, he says, and the good conductor must handle his composition as a good theatrical director handles a drama—everything must lead to a climax.

The man is thoroughly in love with his own work. He has faith in the brass band and believes it to be one of the most misunderstood of musical units. The band, according to this leader, has too long been associated with circuses, marching regiments and picnics. It is a symphony orchestra in every respect but one—and that is that stringed instruments are not used.

Goldman carries out his theory in the way he places his musicians in the studio. He groups his reed instruments—the saxophones, clarinets and oboes—close in and almost under his hands. The brasses—trumpets, trombones and bass horns—are further back, away from the director and the microphone. This is contrary to the accepted practice, which was to have reeds at the conductor's right and the brasses at his left. Thus Goldman has his reeds where the light strings are, in the symphony orchestra, and his heavy-toned instruments back in the places usually held by the cellos and bass violins. This method, he says, enables him to hear the reeds clearly and the brasses do not drown out the more melodious reeds.

Goldman is said to be one of the first band conductors to use the works of Wagner, Beethoven, Tschaikowsky, Puccini and Brahms as band music. He has made special arrangements of many of the works of these classic composers and is said to have done much in popularizing them.

Composer as Well as Band Leader

He is the composer of a number of internationally known selections, among them being "Sagamore," "On the Campus," "Sunapee," "Star of the Evening," "In Springtime," "On the Farm," "The Chimes of Liberty" and "On the Air."

He recently received a decoration from the French government in the form of a citation and a medal. The citation conferred upon him the designation of Officer of Public Instruction—an award given because of his broadcast concerts, it was explained.

He has a room full of trophies as testimonials of public approval. Medals, gold watches, testimonial scrolls, loving cups and all the other things that people give to outstanding public figures have been heaped upon him. In addition his radio admirers have sent him everything from boxes of home-made fudge to elaborately carved clocks.

Mr. Goldman expects to continue in radio work and now declares it to be the most important part of his many activities.

LEVI F. WARREN JUNIOR HIGH SCHOOL, WEST NEWTON, MASS., PAM EQUIPPED

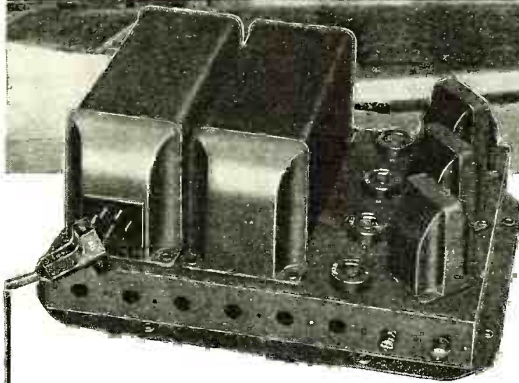
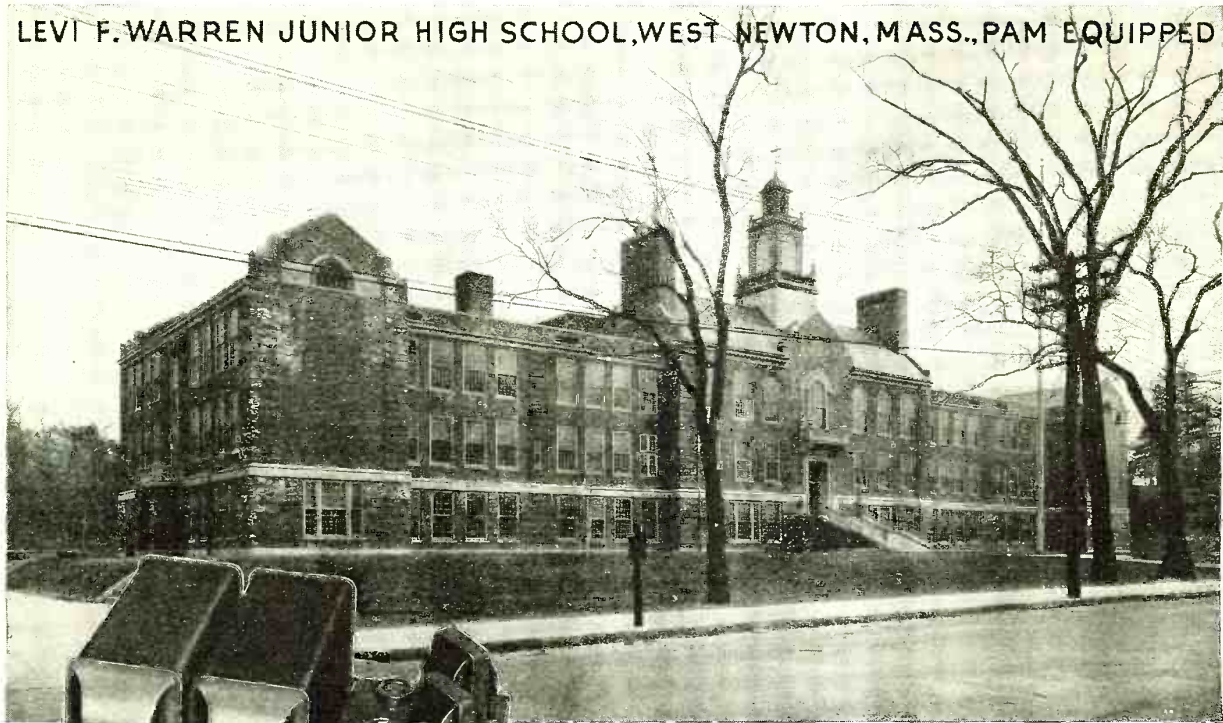

PAM 16

PAM

the new educator

WALTER DAMROSCH and other famous educators are instructing thousands of children in our schools through radio and PAM installations.

The voice of the educators or music received by radio or from phonograph record is amplified by PAMS for loudspeakers in classrooms and assembly halls.

The PAM equipment installed for educational purposes is admirably suited to furnish music for class

parties or other school social functions.

Many fine installations, such as that at the Levi F. Warren Junior High School, West Newton, Massachusetts, shown above, can be sold by wide-awake radio dealers.

A new 16-page bulletin giving mechanical and electrical characteristics, representative installations and many new PAM amplifiers will be sent upon receipt of 10 cents in stamps to cover postage. When writing ask for bulletin No. RN 4.

Main Office:
Canton, Mass.

Samson Electric Co.



Manufacturers Since 1882

Factories: Canton and
Watertown, Mass.

A NEW Edition

Thoroughly revised — greatly enlarged and offering a wealth of new up-to-the-minute information.

THE RADIO MANUAL

Revised Edition

Complete new chapters on aircraft radio equipment; Practical Television and Radiomovies with instructions for building a complete outfit; radio interference; 100% modulation; latest equipment of the Western Electric Co.; the Marconi Auto-Alarm System; and many other developments of the past year. All this information is added in the new edition and, besides, the entire book has been brought right up to date with much new material. The *Radio Manual* continues to be the one complete and up-to-the-minute handbook covering the entire radio field.

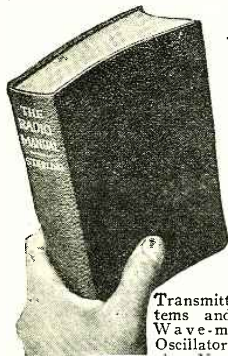

A Complete Course in a Single Volume

20 big chapters cover: Elementary Electricity and Magnetism; Motors and Generators; Storage Batteries and Charging Circuits; The Vacuum Tube; Circuits Employed in

Transmitter, Modulating Systems and 100% Modulation; Wave-meters; Piezo-Electric Oscillators; Wave Traps; Marine Vacuum Tube Transmitters;

Radio Broadcasting Equipment; Arc Transmitters; Spark Transmitters; Commercial Radio Receivers; Marconi Auto-Alarm; Radio Beacons and Direction Finders; Aircraft Radio Equipment; Practical Television and Radiomovies; Eliminating Radio Interference; Radio Laws and Regulations; Handling and Abstracting Traffic.

An immense amount of information never before available including detailed descriptions of standard equipment is presented.

Prepared by Official Examining Officer

The author, **G. E. Sterling**, is Radio Inspector and Examining Officer, Radio Division, U. S. Dept. of Commerce. The book has been edited in detail by **Robert S. Kruse**, for five years Technical Editor of QST, the Magazine of the American Radio Relay League. Many other experts assisted them.

Free Examination

The new edition of "The Radio Manual" has just been published. Nearly 900 pages. 369 illustrations. Bound in Flexible Fabrikoid. The coupon brings the volume for free examination. If you do not agree that it is the best Radio book you have seen, return it and owe nothing. If you keep it, send the price of \$6.00 within ten days.

Order on This Coupon

D. Van Nostrand Co., Inc.,
250 Fourth Ave., New York

Send me the Revised edition of THE RADIO MANUAL for examination. Within ten days after receipt I will either return the volume or send you \$6.00, the price in full. Radio News 11-29

Name

St. & No.

City and State

Sound Amplifier Installations

(Continued from page 406)

ling rigid conduit in the walls, just as rigid conduit is installed for telephone and lighting lines. With this arrangement the wiring may be drawn through the conduit after the construction work has been completed. It is a noteworthy fact, in this connection, that most of the hotels and hospitals being erected today are providing rigid conduit lines for this purpose. Even where there is no intention of making immediate radio installations, the architects are aware that sooner or later radio wiring will be just as necessary in these buildings as is the telephone wiring today.

In wiring part or all of standing buildings it is frequently impractical to employ rigid conduit because of the difficulty of installing it after the building is once up. Flexible metallic conduit can readily be used in such cases, and can be run through and within walls, just as is done in wiring old buildings for electric light service. In other cases it may be permissible to run the amplifier wiring on the surfaces of the walls, for which purpose metal moulding may be used. When painted the same color as the walls this moulding is inconspicuous but at the same time it provides effective shielding and adequate protection against injury to the wires.

This emphasis is laid on the use of some form of metallic conduit for several reasons. It provides a safeguard tampering with or physical injury to the wiring, and it protects against moisture. What is more, the Underwriters' rules definitely require such protection in most cases. Also there is the consideration that inclosing wiring in conduit makes for a

more workmanlike and professional appearance.

Before closing this article on the technical installation considerations it would be well to call the attention of installation men, and those interested in this field, to the wealth of information on the subject now available from the manufacturers of equipment. Such manufacturers as Samson, Yaxley, Amplion, General Radio, Carter, Jensen, Silver-Marshall, Amertran, Centralab, and numerous others either have booklets containing information useful to the installation man, or literature on their products which contains interesting and useful data on various parts and devices intended for commercial sound amplifier use. Many manufacturers of amplifiers are not only willing but glad to cooperate with installation men in planning specific installation. Some are prepared to supply complete specifications for a proposed installation, including the amplifier power required, the number and type of loud speakers, etc.

In the articles to follow this, a detailed description of several typical installations, with photographs and diagrams, will be given. Also there will be some business suggestions for the installation man which should help him to widen his field of activity. Some novel uses have been made of sound amplifiers in connection with advertising stunts, sound effects for theatres and so on. Ordinarily one thinks of sound amplifier as a vehicle for entertainment, but actually they are finding more and more use in other fields, as will be disclosed in the following articles.

Handling 54 Messages an Hour

(Continued from page 423)

or receivers" to connect it up with the "radio shack" of other and perhaps more romantic days.

Power for the radio plant of the *Bremen* is derived from nine motor-generator units which are capable of being started and stopped by small switch-levers on the operating table—an invaluable system of remote control. Each generator furnishes the three separate potentials required by the transmitter tubes. For the receivers there is a complete storage battery system which is also instantly available for emergency transmission use, a simple throwing of levers being all that is required.

And the not-to-be-forgotten life boats are also equipped with radio transmitting and receiving apparatus; that is, four of them which are designed to serve as "flagships" of the emergency fleet in case a "Man the boats" order ever rings through the air. These life boats are powered with gasoline engines and are capable of carrying 160 people each.

Power for radio transmission is obtained from a small generator driven by the engine, and the transmitters in these life boats, each of 250 watts power, are capable of sending clear signals over at least 60 miles. The antennas are held aloft by two masts that may be raised quickly to a height of 29 feet. The emergency receivers employ only two tubes for phone reception.

The radio room is indeed quite spacious, well lighted and singularly free of even the faintest remembrance of the "radio shacks" and storage battery fumes of other days. It is situated forward near the captain's quarters and the navigating bridge on the starboard side, and adjoining it are the staterooms of the men comprising the ship's radio personnel. From the standpoint of a marine radio installation the equipment and operating efficiency of the *Bremen* sets a fast pace for other liners to match. On this newest of the ocean greyhounds marine radio has indeed come into its own.

This Message Covers America

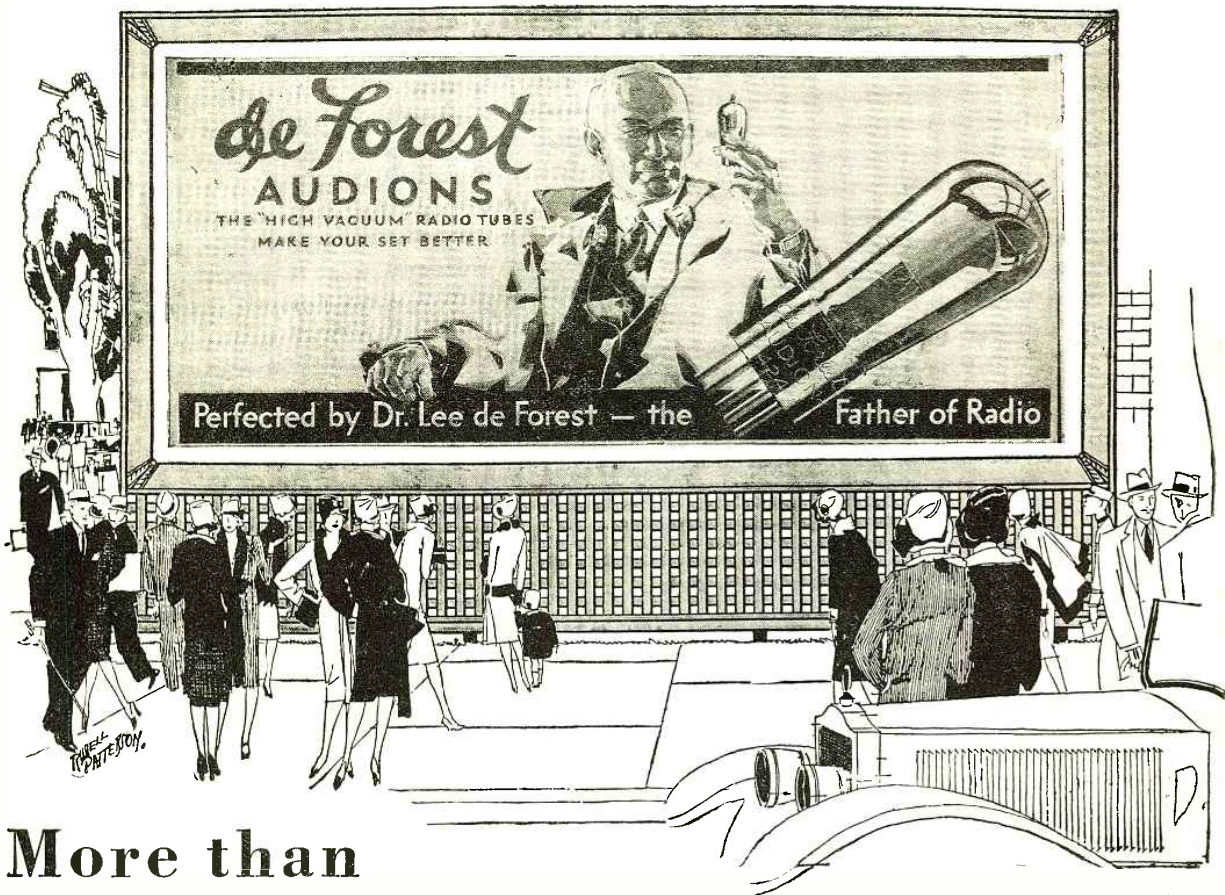

More than
 4200 full color, 24 sheet posters
 in 460 cities and towns, in 40 states!

Think of the effect of this huge billboard campaign on your sales. It starts next month!
 ▲ ▲ No matter where your store is located it is sure to be near or in some trading center where your customers will see these posters. This posting is one of the forms of advertising to be used to help De Forest dealers. ▲ ▲ Make this campaign your campaign. Make it work for you day and night. Identify your store as De Forest headquarters in your neighborhood by utilizing the large array of window material and dealer helps. ▲ ▲ If you haven't already had the money-making De Forest dealer proposition outlined to you, write to us at once and we will place you in touch with the De Forest jobber in your territory.

DE FOREST RADIO COMPANY, JERSEY CITY, N. J.

Branch Offices located in

Boston	Atlanta	Minneapolis	Denver	Detroit
New York	Pittsburgh	St. Louis	Los Angeles	Dallas
Philadelphia	Chicago	Kansas City	Seattle	Cleveland

de Forest
AUDIONS

Become a Trained Radio-Technician

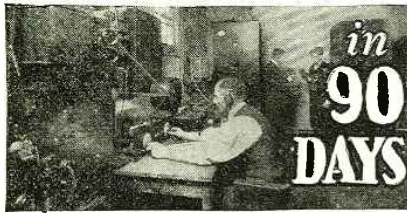

RADIO INDUSTRY Pleads For "Registered" Radio Experts



MICHAEL ERT, Pres., Michael Ert, Inc., and Pres., Registered Radio Trade Assn., and Director, Wis. Radio Trade Assn.

Opportunity beckons as never before in the Radio Industry. Good paying positions, interesting work, a chance to become independent—radio offers all this and more to ambitious men who seize the opportunity NOW!

Radio Trade Association Approves S. of E. Radio Graduates

The Wisconsin Radio Trades Ass'n now compels every radio service man to pass severe examinations and become registered. Dealers are tired of untrained, incompetent help. Radio trade associations the country over are planning to follow Wisconsin's example. *The School of Engineering is the only institution in the country whose course is approved by a radio trade association.* Graduates of the S. of E. are "registered" without examination—14 S. of E. men successfully employed by R.C.A. Photophone, Inc.

Most Thorough Practical Radio Course in America

Here in this big splendidly equipped electrical school (from which Station WISN is operated) you can secure in three months the most thorough, the most compact and practical radio training offered anywhere. Covers entire field of radio! Complete course includes Radio Laboratory Practice, Radio Telephony Theory, Radio Transmission, Code Instruction, Electrical Mathematics, Service and Installation, Radio Sales and Merchandising. Daily broadcasting from WISN. All training is 100% practical. You learn everything in three short months!



TELEVISION INCLUDED

Complete Radio Course also includes study of fundamentals of Television and latest developments in that gigantic new field. Enables anyone to keep up with progress of this new industry.

EARN WHILE YOU LEARN

Not only do we help place our men after graduation, but we can arrange for part-time employment for ambitious men who can finance their tuition. This will cover part if not all of your living expenses while you are taking the Radio Course at the School of Engineering.

SEND FOR FREE BOOK

Send today without obligation, for FREE catalog describing the wonderful opportunities in radio, the three month Radio Course, and details of our Earn While You Learn Plan

SCHOOL OF ENGINEERING OF MILWAUKEE

School of Engineering
Milwaukee, Wis.

Dept. R. N. II-29

Without obligation, please send me FREE Book describing your 3 months Radio-technician course and full details of your "Earn While You Learn Plan."

Name Age.....

Address

City State.....

Television Abroad (Continued from page 418)

light have, however, already been prepared, but have the disadvantage, as compared with the other fillings, of lack of permanency. If, however, a black-and-white picture is desired, it can be obtained, with the above disadvantage.

On account of the horizontal arrangement of the Nipkow disc, it is necessary, for comfortable reception, to use a periscope. The arrangement is so carried out by Mihaly that the room need not be darkened throughout.

By special arrangement of holes (in the disc) in the receiver, the variations in modulation occasioned by the transmitted picture are brought to complete expression, that is, a better delineation is obtained, without having to increase the frequency.

The operation of Mihaly's receiver is very simple. If it is desired to go over from broadcast reception to television, a change-over switch is operated which transfers the output of the receiver from the loud speaker to the televisior. The switch connects up the glowlamp at the same time, the latter operating at 120-180 volts. The phonic wheel is then started up by hand and brought to synchronization, the latter being easily effected by oral observation of the interference waves produced. Synchronism being obtained, the disc is brought into correct phase by operating the phase-corrector knob—that is, the picture is brought into correct position. Once adjusted, the receiver requires no further attention.

Another arrangement of Mihaly's should be pointed out, by means of which ordinary film photographs can be transmitted. If it is desired simply to project a film of any kind, it would be difficult with distant views to make all the details sufficiently clear at the receiver. In this case the technician operating the transmitter is able by moving the light-receiving apparatus to and fro, or sidewise, to bring that portion of the picture to projection on which it is desired to focus attention, remaining incidentals being neglected, so that everything can be followed with certainty under all circumstances. The arrangement is so constructed that the objective always comes into the correct focal position for the sharp delineation of the picture.

Now it is naturally of great interest to see how far a satisfactory picture transmission is possible on broadcast waves which can only have a definite higher

limit of frequency numbers, in order that stations operating on neighbouring waves shall not be distorted, that is to say on broadcast waves with permissible width of sidebands. As already stated, Mihaly has constructed his apparatus from the start according to conditions laid down by the Imperial Post Office. He was therefore bound to produce the best possible pictures inside the prescribed frequency limits. Baird, on the other hand, uses a high number of picture points, which definitely cannot be permissible for ordinary broadcast transmitters. Whether his pictures will have sufficient detail when the transmission is limited to the prescribed frequencies, remains to be demonstrated. It is, of course, to be understood that with the possibility of going over to higher frequencies, more detail can be obtained.

This, however, cannot happen in the range of ordinary broadcasting, and so far is only possible in the region of the short waves. These however, have a number of disadvantages with regard to broadcasting, which at present cannot be overcome. As, however, it is not clear that later on it will be necessary to tread this particular route to increase the number of picture points with corresponding increase in detail, the greatest attention should be paid to short-wave transmission and reception with reference to television. The optical and electrical arrangements of the television transmitters and receivers will certainly allow of a considerable increase in frequency.

With regard to the present state of Mihaly's process, it can be said that the first laboratory-stage difficulties have been overcome, and that attention can now be paid to the construction of popular receiving sets. The fundamentals are firmly established, and slight improvements in the nature of other arrangements of perforations and the like can be made in each apparatus by changing the Nipkow disc (cost about M. 2.—) at any time. The fact that the public shows an extraordinarily keen interest in television may justify the immediate production of such a receiver.

Summarising, it can be stated that the way suggested by Herr von Mihaly appears clear throughout, as the requirements of such a procedure, outlined in the foregoing, appear already to have been very largely fulfilled by Herr von Mihaly.

Television Field Tests Under Way

CERTAIN television broadcasting interests are making field surveys in a quiet but effective manner, according to J. E. Smith, president, National Radio Institute of Washington, D. C. This marks the laying of a solid foundation; for in television, more than in sound broadcasting, it is essential to begin with clean signals. The television image is especially susceptible of distortion from excessive regeneration.

"I am pleased to note," states Mr.

Smith, "that television broadcasters are not making the mistake of the pioneer sound broadcasters. With the experience of the latter taken very much to heart, sight broadcasters are going about determining just how much territory they can cover reliably under the average run of conditions. They are making no wild claims as to their coverage, but, rather, are apparently going to confine their marketing efforts only in territories positively covered by good television signals."

Over 2,000,000 now in use

New Facts About Mershons

self-healing \ long-lived \ compact

That YOU should know

51

Reasons

Mershon Condensers — in actual competitive tests, exhaustive and painstaking tests, conducted by the best engineering talent in the industry, were chosen by:

Zenith
Crosley
Sparton
Balkeitt
Colin B. Kennedy

and

45

other nationally known manufacturers

The Mershon condenser is now acknowledged as the ultimate type condenser for all power pack uses.

Through extended engineering developments Mershon is now recognized as the safest, longest lived, best all around type of condenser available.

The unusual engineering facilities of the Amrad Corporation, heretofore available only to nationally known manufacturers, are now to be placed at the disposal of the thousands of professional radio men, set builders, dealers, etc. The entire staff of five of the best known engineers is now ready to help you with your condenser and radio problems. This staff of engineers can be of real help to you. They can show you how to determine the useful life of a Mershon before you ever put it in service. Mershon is the only condenser built that can give you this very real advantage and service.

The Mershon Condenser is the only condenser that is free from the effects of weather (heat and moisture).

Mershon is by far the most flexible and adaptable condenser. It teams ideally with other parts. In many cases it will offset minor defects of smaller parts.

Mershons are ideally suited for "245" power packs of any type.

Even with all these advantages, Mershon condensers are less expensive.

All capacities—all sizes available.

Send for special proposal to dealers

Mershon Division
of
Amrad Corporation

Medford Hillside

Massachusetts

Amrad Corporation, Medford Hillside, Mass.

Gentlemen:

Please send me your free booklet on Mershon Condensers which explains in detail their use in power packs, noise filters, amplifiers, transmitting circuits, television, weather telegraphs, and telegraphy.

I have checked the most interesting subject.

My Name

My Address

City

State

Please print plainly.

Over 2,000,000 now in use

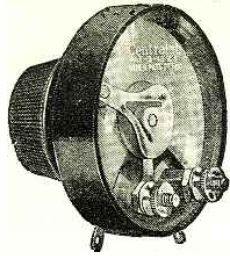

**LIKE A SHIP
without A
... RUDDER**

the "control" is gone . . . not powerless . . . but rudderless . . . no longer does she respond to the helmsman.

Your radio without a good resistance device like the CENTRALAB resistance, doesn't respond to the slightest touch of the "helmsman."

You steer your way through the ether by fits and starts . . . augmenting the "static storms" by internal "self-inflicted" noises.

Better be sure that your radio is "Centralab" equipped.

"Volume Control, Voltage Controls and Their Uses"

is the title of an interesting pamphlet that is yours for the asking. . . .

CENTRAL RADIO LABORATORIES
20 Keefe Avenue Milwaukee, Wis.

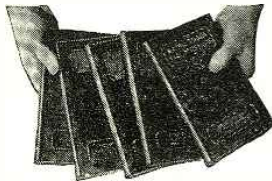

**Everything you want to
know about RADIO**

(Includes Picture Transmission and Reception)

EVERY branch of radio knowledge is covered in this complete 5-volume Radio Library. For everybody in the radio field—mechanics, operators, inspectors, service men, salesmen, owners of radio stores. Written by such experts as Harry F. Dart, E.E.; H. H. Beverage, Radio Engineer; E. H. Hansen, Consulting Radio Engineer; C. H. Vose, of the Radio Engineering Dept. of General Electric Co., and other prominent Radio Engineers. Gives you the whole science of radio in clear, understandable English. 300 pictures and diagrams. 600 pages. Handsomely bound, pocket-size volumes, stamped in gold. Worth many times its moderate cost. Send coupon with \$7.50, check or money-order. Money back if not satisfied.

INTERNATIONAL CORRESPONDENCE SCHOOLS
Dept. 8284-H, Scranton, Pa.

I am enclosing \$7.50, for which please send me your 5-volume RADIO LIBRARY. It is understood that I may return the books in five days and you will refund my money if I am not satisfied.

Name _____
Address _____

FREE Wholesale Radio Catalog
SEND FOR IT TODAY
Send for our new illustrated catalog of nationally known AC sets, kits, parts, accessories, consoles, etc. All lines at Lowest Wholesale Prices. Write for your FREE copy today.
SHURE BROS. CO.
Dept. 317 335 W. Madison St. CHICAGO, ILL.

A Short-Wave Transmitter

(Continued from page 427)

served. Just as an automobile engine must have three things to run: gas and air mixture reaching cylinder, ignition reaching cylinder, and low friction in moving parts; so must the Hartley oscillator have correct circuit arrangements (close coupling between grid and plate coil), filament and plate voltages

tests with 80 meter coils almost any sort of an antenna may be used; a single wire forty to sixty feet long, in connection with a water-pipe ground, will do well enough. The rather extensive subject of efficient antennas for different wave bands, as well as frequency measurement, will be covered in a future article.

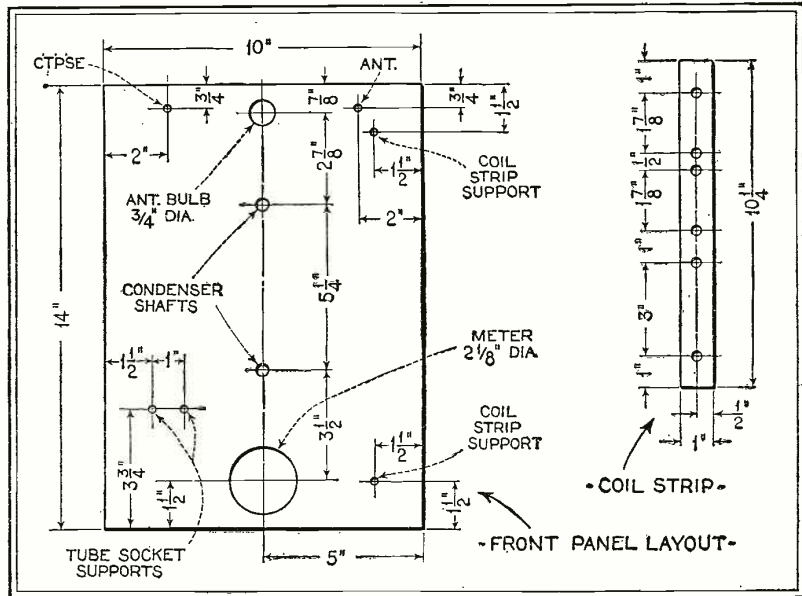

Fig. 7

reaching tube, and low resistance in tanking the bulb will light. For the first few tests with the 80 meter coils almost any circuit. The fact of oscillation can be quickly checked by holding near the plate coil a single turn of wire terminating in a flashlight bulb; if the tube is oscillating the bulb will light. For the first few

Remote control desk installed in the living room. Just to the right of the receiver is the key, the receiver filament switches and then the line switches and indicator bulbs

Power Supply

In the photographs it will be noticed that a lamp bank appears prominently in the power supply. This is because the writer's lighting circuit happens to be 240 volts d. c., and all plate and filament voltages are obtained from this source. The connections for this form of supply are shown in Fig. 3. The modulator and oscillator filaments are connected in series, with the oscillator at the minus end to give it the highest plate voltage as well as a slight increase in filament current due to the modulator

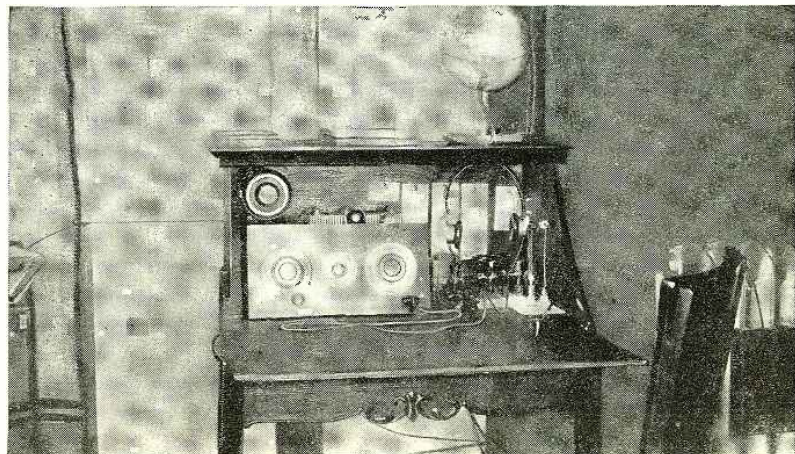
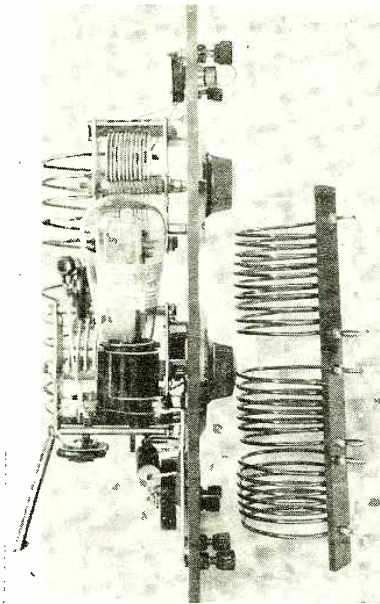

plate current. If 110 volt rather than 240 or 220 volt d. c. were used the connections would be the same, except that a 90 to 150 volt dry or storage B battery would be cut into the B+ lead as shown by the dotted lines, to give the necessary plate voltage of around 200. Where direct current is available, it offers a simple and easily installed method of running the transmitter. The large heat loss in the lamp bank cuts down efficiency, but even so, the expense of running the transmitter is quite small—around a cent an hour.

In many rural locations, and perhaps anywhere as a beginning, it may be advisable to run the transmitter from batteries. The connections for this form of supply are shown in Fig. 4. If the tubes are UX-112A and UX-171A the A battery is a single six volt storage unit, and the B battery should be about 135 volts of the heavy duty type. Of course these receiving tubes will not send out a very strong signal, but it should be readable enough up to 100 miles or so in daylight



Right side view of the transmitter with the 40-meter coils inserted in the coil socket—80-meter coils leaning against dial

and a good deal further at night. Before long, however, the operator will wish the more certain results of the larger tubes. Then the A battery will be two six volt units in series, and the B battery voltage should be at least 180 volts, dry or storage. Of course dry B batteries are fairly expensive, and operating costs will probably run around ten cents per hour with the small tubes and over twenty-five cents per hour with the large ones: nevertheless, batteries are clean and simple to install, the initial investment is low, and some locations permit nothing else.

The third type of power supply, and probably by long odds the most popular one, is 110 volts a. c., diagrammed in



*“This set, Dad,
just seems to lack something.”*

IS your radio set that way, too? Perhaps it looks well, —is easy to operate,—yet just seems to fall short of the fine reception which you hear elsewhere—

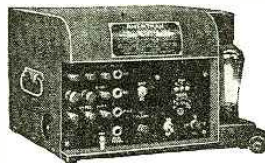

AmerTran ABC Hi-Power Box—500 volts DC plate voltage, current up to 110 ma; AC filament current for all tubes for any set. Adjustable bias voltages for all tubes. Price, east of Rockies—less tubes—\$130.00.

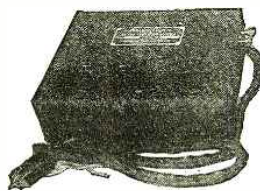

Complete 2 stage audio amplifier. First stage AmerTran DeLuxe for UX 227 A C and second stage AmerTran Push-Pull for two 171 or two 210 Power Tubes. Price, east of Rockies—less tubes—\$80.00.

No matter what your set is you have yet to hear the music as it is broadcast from the studio with all of the overtones and shadings from the lowest stop on the organ to the piercing note of the piccolo.

AmerTran audio systems will give you every tone broadcast—just as it is broadcast from the studio. A pair of DeLuxe transformers, or the superb power amplifier (push-pull for 210 tubes) and the ABC Hi-Power Box. No matter what AmerTran audio system you choose, your set will function more perfectly. See your dealer or write to us.

AMERTRAN

AMERICAN TRANSFORMER COMPANY
Builders of Transformers for more than 29 years
34 Emmet St. Newark, N. J.



**Moulded Mica Condenser
Acknowledged Standard**

ACCURACY, minimum dielectric losses and freedom from change under the influence of varying temperature, weather and chemical action have contributed to the acknowledged pre-eminence of the moulded mica condenser for use in radio frequency circuits.

In Aerovox Moulded Mica Condensers—made in a variety of shapes and sizes to fit every requirement—only the best grade of India Ruby mica, pure tinfoil plates and high quality bakelite are employed. High quality materials, skilled workmanship and constant research combine to produce a moulded mica condenser that is accurate, permanent and efficient.

Send for Catalog

Complete specifications of Aerovox moulded mica condensers and other units are contained in a complete catalog that will be sent free of charge on request.

The Research Worker

contains, each month, valuable information on radio design. It will be sent free on request.

AEROVOX WIRELESS CORP.
78 Washington St., Bklyn., N. Y.
PRODUCTS THAT ENDURE

ELECTRIFY YOUR RADIO FOR ONLY \$6.85 COMPLETE

Why discard your present good set when you can electrify it for only \$6.85, and banish the annoyance and expense of buying new "B" batteries?



OVER 100,000 TOWNSEND "B" POWER UNITS IN USE

Hooked up in a few minutes. Use same tubes—no changes. You'll be amazed at the improvement in reception and distance setting. Send name and address today for full details, proof and Free Trial Offer.

TOWNSEND LABORATORIES,
725 Townsend St., Chicago, Ill.

Please send me full information on the Townsend "B" Power and Free Trial Offer.

Name

Address

City..... State.....

RADIO BARGAINS!

Used 5-tube sets \$14.90, guaranteed

1003 Sec. 600 V. 7½ V. C. T. to first choke, 7½ V. C. T., 2.5 V. C. T. to case 1½ V. 3 \$5.00 chokes. For one 281, one 250, one 227, four 226..

1002 Sec. 450 V. 7½ V. C. T. to first choke, 7½ V. C. T. 2½ V. C. T. to case 1½ V. 3 \$4.75 chokes. For one 281, one 250, one 227, four 226..

875 Secondary 375 volts—375 volts, 5, 5, 2½, 1½ and 1¼. High and low primary and 2 chokes. \$4.25 For 280, two 171A, five 226 and one 227.....

Audio Transformers 75c; Condensers 50c; Rheostats 25c; 1-tube sets \$1.95; A. C. Filament transformers \$1.90. Complete list upon request.

Chas. Hoodwin Co.

4240 Lincoln Ave. Dept. 1116 Chicago, Ill.
Dealers in Bankrupt Radio Stocks

Fig. 5. A center tap and by-pass condenser must be added to the oscillator circuit, as noted in B, Fig. 2. The 7.5 volt filament transformer, preferably a separate one, is readily obtainable, and the remainder of the circuit is practically a B eliminator of the receiving type, using a UX-280 tube and a somewhat simplified filter. If desired, almost any manufactured B eliminator can be used here, or two UX-281's may be used with suitable transformers to put about 400 volts on the tubes. There is a ballast resistance of about 10,000 ohms across the filter output to draw some current when the key is up and reduce the load changes.

Modulator and Local Controls

The modulator proper takes up very little space on the under side of the top

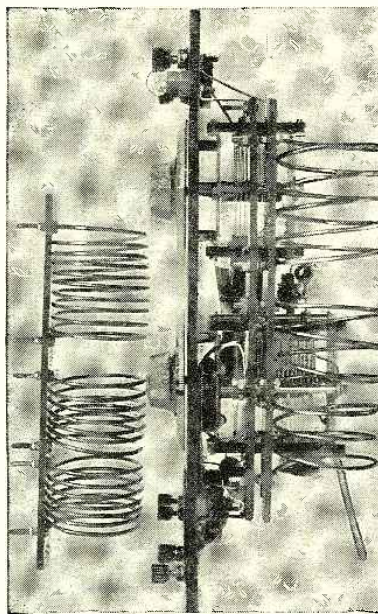

Left side view of the transmitter with 40-meter coils inserted in the socket—the 80-meter coil is leaning against the dial

shelf of the modulator—power supply frame. It consists only of the tube, a spring Benjamin socket, and a Thordarson T—2357 microphone coupling transformer. (The microphone itself is a standard Frost one or the common telephone variety.) The 30 henry 80-150 mil. modulation choke, in this case the secondary of an old power transformer, is mounted on the bottom shelf. This also would be the place for batteries and a. c. transformers if used. The modulator circuits are included in the power supply diagrams of Fig. 3, 4 and 5. The "local controls," five switches mounted on the upper side of the top shelf of the frame, are used for turning the transmitter on and off during observation and adjustments, and for changing the circuits to code or phone operation. The left switch (line) turns on the power supply and lights the tube filaments, functions also performed by a similar switch at remote

LIFE-TIME DX AERIAL

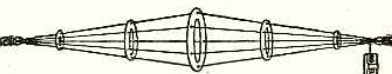

Guaranteed Double Volume and Sharper Tuning

Description of Lifetime DX Aerial

No. 30—LENGTH 30 FEET:

Assembled ready to string up. Brings in volume of 150-ft. aerial but retains the selectivity of a 30-ft. aerial. Rings are heavy gauge solid zinc. Duplicates in design and non-corrosive materials the aerials used by most of largest Broadcasting Stations. Design permits using this powerful aerial in 30-ft. space (preferably outside). Sharpens tuning of any receiving set because of short length but has enormous pick-up because 150 ft. of No. 12 enamelled wire is used. Made for owners of fine radio sets who want great volume on distance without destroying sharp tuning. (Also used by many owners of short-wave outfits.) "Makes a good radio set better."

PRICE, \$10.00

No. 60—LENGTH 60 FEET:

Assembled—ready to string up. "Big Boy" size. (Same description as above except that 300 ft. of wire is used, making this the most efficient and powerful aerial possible to manufacture.)

PRICE, \$12.50

Manufactured by
THOROLA RADIO PRODUCTS,
1014 So. Michigan Avenue Chicago, Illinois

Stop Using A Truss

STUART'S ADHESIF PLAPAO-PADS are entirely different—being mechanico-chemico applicators—made self-adhesive purposely to keep the muscle-tonic called "Plapao" continuously applied to the affected parts, and to minimize danger of slipping and painful friction. The fabric is soft as velvet, and being adhesive

clings closely to the body without straps, buckles or springs. Easy to apply, comfortable, inexpensive.



Awarded Gold Medal



Awarded Grand Prix

For almost a quarter century stacks of sworn testimonials from many different countries report success—without delay from work. The epidermatic absorption of Plapao and the utilization of "plaster therapy" tend toward a natural process of recovery, after which no further use for a truss.

Test of factor "PLAPAO" sent FREE

Mail Coupon below TODAY—

Plapao Laboratories, Inc.
393 Stuart Bldg., St. Louis, Mo.
Gentlemen: Send me a Free Trial Plapao and 48-page book on Rupture. No charge for this now or later.

Name.....
Address.....

TRANSFORMERS FOR RADIO POWER SUPPLY

A-B-C Power for all receivers, Primary 105 to 115 volts



50 or 60 cycles Secondaries—2½ volts, 9 amperes—2½ volts, 3 amperes—5 volts center-tapped, 4 amperes—300 volts each side of center-tap, 125 milliamperes. All lugs mounted on bakelite, concealed inside case, completely shielded. Mounting for sub-panel or regular. Price \$11.90. Write for our literature. Dealers get in now.

JEFFRIES TRANSFORMER CO.
7427 Alameda Blvd. Los Angeles, California

control over line No. 1. The second switch (code phone), in connection with a similar one at remote control, makes line No. 2 either a keying or a microphone circuit. The third switch (modulator plate) takes the plate voltage off the modulator tube during code operation. The fourth switch (key) acts as a local control key for testing, and remains closed during phone operation. The fifth switch (choke short) shorts the modulation choke during code transmission. To recount the switch line-up: for code, code-phone to code, modulator plate open, key open, choke short closed; for phone, code-phone to phone, modulator plate closed, key closed, choke short open. Though this switching seems a trifle complicated, it gives complete remote control of either code or phone with only four connecting wires.

Remote Controls and Receiver

In the remote control desk the receiver itself occupies the most prominent place. This may be any good design of short-wave receiver and needs no cabinet because of the closing desk. It is placed well back in the left hand part of the desk, with the B batteries behind it, and the A battery coming in through a cable.

The remote control circuits are shown in Fig. 6. Just to the right of the receiver is the key, of radio type with large contacts. The standard filter for eliminating key clicks in nearby receivers is a condenser across the key and a small audio choke in series with it, but when keying of necessity in the positive side of d. c. supply, this system has not proved of much value. For use with this transmitter we developed another scheme, consisting of two condensers across the key with center tap grounded and radio-frequency chokes in series with it. This suppresses the clicks to a point where they do not annoy broadcast listeners in the same building. In the desk the condensers and chokes are mounted just behind the key.

Next to the right is the receiver filament switch, separately mounted so that the receiver can be turned on and off without disturbing the tuning. The next switch turns the transmitter on and off over line No. 1. On the right of this switch are three indicating lights, one an auto headlight bulb showing transmitter on or off. In front of this are two small pilot bulbs, one in the key circuit to show oscillator plate current and the other in series with the microphone. These lights are of course much cheaper and more compact than meters, and they give a fair idea of what the transmitter is doing, besides acting as safety fuses. Up on the side of the desk wall are the microphone jack and a switch throwing either the key or the mike to line No. 2. For code transmission this switch is thrown to the key; and the operator, sitting before the receiver, closes the transmitter switch and taps the key. For phone transmission (the local control switches of course being changed) the DPDT switch is thrown to microphone

Racon Horns

THE WORLD'S BEST

And Now Comes Latest Improvement—Racon Electro-Dynamic Type Horn Unit

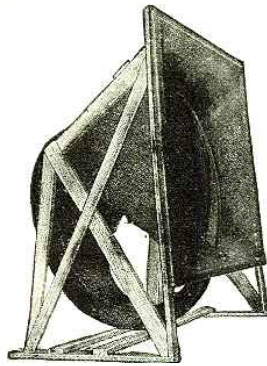

No. 4320
Air Column 10", Bell 40" x 40",
Depth 34", Weight 45 lbs.
For Theatre Use



New Racon Junior
Electro-Dynamic Type
Horn Unit



No. 1315
Air Column 10 1/2", Bell
18" x 24", Depth 13"
For Radio Use



Racon Giant
Electro-Dynamic Type
Horn Unit
U. S. Pat. No. 1,711,514
Can be supplied with A. C.
operated field exciter.
Guaranteed without hum.

The Racon Electro-Dynamic Type Horn Unit for radio combines the rich full tones of the dynamic type with the clearness and distinctness, without distortion, of the horn type.

Racon has always led in improvements and is today recognized as the leader. Note the march of progress:—First came the air column speaker—then the magnetic cone—followed by the long air column and then the dynamic cone,

And NOW the Famous New Racon Electro-Dynamic Type Horn Unit, with Long Air Column Horn.

Racon Electric Co., Inc.

Specialists in Acoustic Chambers

FACTORIES:

18 Washington Place, New York Slough, Bucks, England 3 Mutual Street, Toronto Canada

Write for Catalog

The New HAMMARLUND



Shielded Polarized R. F. Choke Coil

A RADIO frequency choke specially developed for modern high-gain shield-grid receivers.

Shielded in an aluminum shell and polarized.

Minimum external field. No undesired coupling to cause circuit instability or feed-back.

High inductance—low distributed capacity.

Efficient. Compact. Convenient.

Write Dept. RN-11 for Details

HAMMARLUND MFG. CO.

424-438 W. 33rd St., New York

For Better Radio
Hammarlund
PRECISION
PRODUCTS

RADIO OPERATORS WANTED



Radio operators are officers aboard ships. Well paid, pleasant work, travel. You can qualify in a short time in our well-equipped school under expert instructors.

Write now for free booklet on "Opportunities in Radio."

West Side Y. M. C. A.
Radio Institute

319 West 57th St., New York, N. Y.

Choice of 1200
Newest
RADIO
VALUES

SEND for our 1930 catalog. Filled with amazing values in screen grid radios, push pull audio, consoles, kits, parts. All standard makes and guaranteed merchandise.

FREE

WESTERN RADIO MFG. CO.
1728 W. LAKE ST. CHICAGO ILL.

and the microphone plugged into its jack. Then all the operator has to do is to close the transmitter switch and talk into the mike.

In General

In another article we shall narrate some actual tests with this low power home transmitter, and touch in addition many details of short wave operation. In putting a new transmitter into service it is best to go slowly, testing each circuit separately before it becomes part of the whole. Small difficulties can then be ironed out as they arise, and they always do arise, even in the best design. But if performance is carefully watched at each stage—plate current, plate temperature,

oscillation, r. f. output, etc.—getting "signs of life" out of a new transmitter will be found one of the most interesting experiences which radio offers.

In this description of a low power transmitter for the home many things have of necessity been discussed, and others perhaps more generally understood have been omitted. Detailed constructional information has been furnished as a guide for the beginner; and as solid data on a station that is neat but effective. An amateur station is of course an individual matter, and not to be fitted into any standardized mould. The experimenter, particularly, will wish to build his station in accordance with his own ideas. Let us hope at least that novice and old timer alike may find here some useful ideas of general design.

"Public Interest, Convenience and Necessity?"

(Continued from page 429)

The most un-radio-minded layman will readily infer that this work has necessitated the review of thousands of applications, thousands of letters and entailed thousands of interviews and telephone conversations on the part of the commissioners and their staff. Hundreds of hearings and conferences have also been held.

Not in the history of federal bureaus has any commission ever been called upon to perform so great a task in so short a span of time. The already overloaded departments of the federal government could not have treated with radio problems on this scale without a great increase in personnel and what would have been tantamount to the setting up of a radio commission within the department to which it might have been assigned. By its segregation and absolute independence, radio has been regulated and its major problems have been solved without handicapping any other federal bureau. More important still is the fact that no prejudice can possibly exist toward any of the major government departments because of the adverse rulings of the Commission on the applications of any specific persons or corporations. The latter point is pertinent, since many of the government departments depend upon large corporations allied with the radio industry for statistics and information.

Any appreciation of the national service rendered by the Radio Commission must, of necessity, take into consideration the ever-changing picture of radio. Within the two years of its tenure in of-

fice, many fixed principles of radio engineering have been shattered by new ideas. Scores of new inventions have brought improvement to radio sending and reception. The entire radio industry has moved forward, discarding the old and accepting the new, with the remarkable swiftness of Sir David Brewster's kaleidoscope.

No inconsiderable number of these changes have been fostered by the Commission in order that broadcast and communications might be extended; to eliminate harmonics, hold broadcasting stations to their exact frequencies and otherwise cause improvement in radio operation. Such improvement has been achieved by constant research and a careful study of the ideas and inventions contributed to the radio industry by individuals and independent agencies throughout the world.

Out of the experience of the Radio Commission, it has been seen that radio must parallel and not destroy existing public communication companies. Prominent leaders in Congress consider it desirable that telephone, telegraph, electric power, cable and radio transmission between the states be regulated by one single commission.

In the event this is effected by the Couzens bill, now pending in Congress, those citizens who are opposed to commissions will find the United States government minus two commissions but possessed of a new and larger commission with greater power and of more far-flung importance than any other federal commission yet conceived of—the Federal Communications Commission.

As we mentioned in the introduction to the foregoing article, a great many broadcast listeners, and especially radio fans, have been vociferous in their criticism of the Federal Radio Commission's work. The one point on which a great many critics seem to agree, is that the Commission should have cut down drastically on the total number of broadcast stations. After a year's experience of

the new allocations, our readers undoubtedly have crystallized their views. We shall be glad to consider, for publication, any constructive suggestions they may have to offer: either in the form of an article, or merely a letter. Those which the editors consider of interest to the readers of RADIO NEWS will be published and paid for at space rates.—THE EDITORS.

The Junior Radio Guild

(Continued from page 441)

ductor, you will remember has been fixed at 400 meters, but even so, a slight reading is noted on the measuring device. When the r. f. oscillator is adjusted to 325 meters a greater reading is obtained; when it is adjusted to 350, then 375, the reading on the measuring instrument goes higher the nearer the oscillator setting approaches the 400 meter setting; when it is set at 400 meters the maximum reading is obtained and as it is set to 425, 450, 475, and 500 meters, the readings diminish. If these readings were transferred to a paper so as to represent a curve, we would obtain a clearer idea of how the curve rises to a maximum at 400 meters and then diminishes to a minimum at 500. Such a curve, called a "tuning response curve," and shown in Fig. 17, tells us many things. First, it indicates that there is a distinct "broadness of tuning" in the detector circuit. That is, the circuit will tune satisfactorily to the wavelength to which it is adjusted but at the same time it will also receive, to a lesser degree, of course, the signals which are transmitted on adjacent wavelengths. Secondly, due to this "broadness of tuning," the signals from a station operating on a nearby wavelength adjustment are received with approximately 75%, 50%, or 25% the intensity of the signal to which the circuit is adjusted, depending upon the nearness of the adjacent wavelength channels to the one to which the detector circuit is adjusted.

How can this "broadness of tuning" be eliminated so that the tuning circuit is selective? The answer is, "by adding a radio frequency amplifier." How will the radio frequency amplifier make the receiver more selective? "By exerting a filtering action upon the signals received so that only that one to which the several circuits are tuned will be received."

In a tuned radio frequency amplifier, that is, one where a tuning condenser is employed, such as that which is used and described here, the tuning response curve obtained is much sharper than that obtained for the detector tuning system. This is because the two tuning circuits are operating under different conditions. Hence the same broadness of tuning as occurred with the detector circuit will not result with the use of the r. f. amplifier, for the simple reason that the r. f. amplifier, being sharply tuned to, let us say, the 400 meter station, will pass through it the signals from that station only and will not be affected by the signals from adjacent stations. To clearly understand this it will be well to compare the tuning response curve for the detector shown in Fig. 17 with the one for the r. f. amplifier shown in Fig. 18. Note that the latter is much narrower and has steeper sides, indicating that the circuit is not susceptible to the signals coming from stations on adjacent wavelengths. Thus, in the use of a radio frequency amplifier we not only increase the sensitiveness of the receiver, making it possible to listen-in on signals from dis-

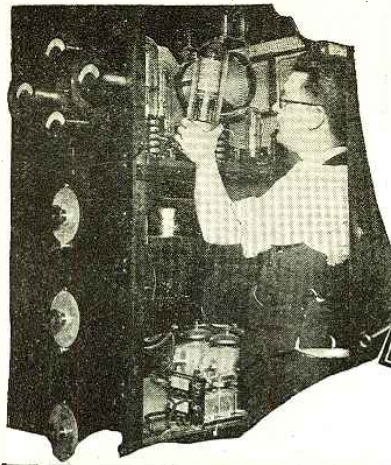

FREE RADIO BOOK~ describes many opportunities to make big money in the Radio field.

**Hundreds of Men
Have Won Success
This Way**

The National Radio Institute is the oldest and largest Radio home-study school in the world. It has prepared hundreds of men for the Radio profession—some of them now holding leading positions in this industry. You'll find N. R. I.-trained men in practically every Radio organization of any importance throughout the world. The same practical tested training that enabled these men to get ahead is now open to you. And this training has been improved, enlarged greatly to keep up with the constant expansion of Radio opportunities.

**Has Made \$10,000
More in Radio**



"I can safely say that I have made \$10,000 more in Radio than I would have made if I had continued at the old job. When I enrolled with you I didn't know a volt from an ampere. I advise all ambitious young men to get into Radio. There is no greater opportunity."

Victor L. Osgood,
7101 Bay Parkway,
Brooklyn, N. Y.

\$3,000 a Year



"I cannot give too much credit to the N. R. I. for what I have been able to do in Radio. I have averaged \$3,000 a year for the past three years. I am in the Radio business. I consider all the success I have obtained so far due entirely to your training."

Fred A. Nichols,
Hereford, Colo.

Here's a book that's shown man after man the way to "cash in" on the big opportunities in Radio. I'm not asking \$5 or \$6 for this book—it's FREE. If you're earning a penny less than \$50 a week clip the coupon below and get a copy of this free Radio book for yourself.

**Salaries of \$50 All the Way Up to \$250 Weekly
Not Unusual**

Radio—the NEW, speedy, growing, live-wire profession—needs trained men for its good jobs. Television, trans-Atlantic Radio telephony, many other wonderful inventions and developments are being made constantly in this field! Each one means more big-money opportunities for a trained Radio man. My book gives the facts about these Radio opportunities. And more—it tells how you can get all the training in Radio you need, quickly and easily in your spare hours at home, by my new and practical methods. In a short time you, too, as have hundreds of others, can be prepared to take advantage of these big-money Radio opportunities—salaries of \$50 all the way up to \$250 a week not unusual. My Free Book will give you all the Facts and Proof.

Extra Dollars for You Almost At Once

Think of making \$15, \$20, \$30 extra each week "on the side," without interfering with your regular job! I'll show you how to do that, too, by using spare time that you're wasting now. I'll show you how to turn what I'm teaching you into cash almost at once, when you and I get started together. My Free Book tells you all about it. If you send for the book today, and if you have the average man's ability, it's possible for you to be making extra money thirty days from now. And you'll be ready for a good full-time Radio position after eight to twelve months of spare-time training.

**I'll Send You This Big 64-Page
Book FREE**



J. E. Smith

My book is filled with photos and facts—the paying facts you want to read. If you're interested in Radio, or if you're interested in making more money, you owe it to yourself to read this book. The book absolutely won't cost you a cent, and you place yourself under no obligation by sending for it. No previous Radio experience needed to take advantage of this offer. No special schooling required.

Address J. E. SMITH, President

National Radio Institute, Dept. 9YTI, Washington, D. C.

**Mail
coupon
Today!**

J. E. SMITH, President,
National Radio Institute,
Dept. 9YTI, Washington, D. C.

Dear Mr. Smith: Kindly send me your free 64-page Radio book, with all information about learning Radio for bigger pay. I understand this places me under no obligation.

Name.....

Address.....

Town..... State.....

**WIRELESS EGERT
ENGINEERING CO., INC.
ANNOUNCES**

**A Frequency Meter
for the Short
Wave Four**

Range 1360 K. C. to 18700 K. C.
(16 to 220 Meters)

Of course you all know of the Short Wave Four as described in August issue of Radio News. The Set has had an overwhelming success. Have you one? Foreign stations are guaranteed. We are now announcing a frequency meter which will aid you in securing the Short Wave station you want. This Frequency Meter comes in a highly polished Walnut cabinet.

- Let us send you a reprint of the August issue.
- Price of Complete Set of Short Wave Parts **\$62.50**
 - Price of Foundation Unit including cans, hardware, etc. **\$29.50**
 - Price of Frequency Meter **\$12.50**

SPECIAL! SPECIAL!

We are also equipped to do all kinds of special work. We can build any kind of OSCILLATOR, WAVEMETER, RESISTANCE BRIDGES, SHORT WAVE APPARATUS or any sort of Laboratory work. Estimates cheerfully given, just send us a line.

Order on this Coupon

WIRELESS EGERT ENGINEERING, INC.,
179 Greenwich St., New York

Enclosed please find money order \$12.50, for which you will kindly send at once Frequency Meter, Foundation or Complete Short Wave Four kit.

Name.....
St. and No.....
City and State.....

tant stations, but also the selectivity of the receiver has been improved to such an extent that only that station to which the several tuning circuits are adjusted is received, to the exclusion of all others.

*The Complete R. F. Amplifier
Circuit*

In the radio frequency amplifier which is added to the receiver described here two different types of amplifying tube have been employed. Two stages of amplification are used. The circuit is found in Fig 20. The first or antenna stage is an untuned stage using the new 222 shield-grid tube. This tube is used primarily to couple the antenna to the second stage of radio frequency amplification which uses the common 201A type of tube, the circuit being tuned. The 222 tube, besides functioning as a coupling tube, also produces a high amplification of the signal due to the enormous amplifying properties of this tube. The 201A has a practical amplification factor of approximately 8, while the 222 tube has a practical amplification factor of about 125. The question might arise, "If the 222 tube has such a tremendous amplifying power, why not use it also in the second r. f. stage in preference to the 201A tube?" Well, the answer is that, first, too much difficulty is experienced when the shield-grid tube is used in a tuned circuit. Secondly the entire tuning circuit is simplified when a coupling tube is used, for it allows one dial to turn both the tuning condensers together, with the assurance that both condensers will be accurately tuned to the same wavelength. Thirdly, since it is wise to use a tuned circuit in one of the r. f. amplifiers so as to obtain the benefits of the filtering action together with the amplifying action which is produced by its use, then it is well to employ the 201A in preference to the 222. Fourthly, with the combination as used here sufficient sensitivity, selectivity, and amplification is obtained to be entirely satisfactory for all general purposes.

*Stabilizing a Radio Frequency
Amplifier*

Radio vacuum tubes, besides being used as rectifiers and amplifiers, are also capable of being used as generators of radio frequency energy. In this capacity they are employed to generate the radio frequency carrier wave in transmitters, as explained in Lesson Number One.

There are times when, in a radio frequency amplifier, the tubes used therein begin to act as oscillators or generators of radio frequency energy. This condition is caused when, through the medium of the minute capacity which is set up between the grid and plate elements of a tube, the grid and plate circuits of the amplifier are coupled together.

When the r. f. amplifiers of a receiver begin to oscillate in this fashion the reception efficiency falls off and the receiver as a whole becomes quite unstable in operation. Troublesome squeals and howls are set up which accompany the reception of signals and make for a very unsatis-

**The
Most Interesting
Evening
I Ever Spent**

UP TILL 9 o'clock the party was a complete flop. Nobody seemed to be able to get things going. Then Tom walked in. Tom's a live wire, if there ever was one.

He said he'd heard about a one man show anyone could perform with the help of a book he knew about. He had sent for that book, and said he was going to put on the show.

We thought he was joking and laughed at him, but he sat us all down in the living room, got out a pack of old playing cards, and started to do things that made our eyes pop out of our heads.

For over 2 hours he made those playing cards almost talk. What he could do with those cards just didn't seem human. After it was all over, the gang all crowded around, shaking his hand, and patting him on the back. The girls all said, "Oh, Tom! You're wonderful!" It was by far the most interesting evening I had ever spent.

I asked him how he learned it all, for I knew he didn't know a single thing about card tricks a week before. For answer he pulled out a shiny new quarter, and said that one just like it had taught him every trick he had showed us.

And it was a fact! Tom had simply enclosed a quarter with the coupon below, and gotten Walter Gibson's Famous Book of Popular Card Tricks by return mail. You, too, can entertain yourself and your friends with the 101 card tricks it teaches. No sleight of hand is necessary—no hard work to learn. Simply read the book carefully and you can do every trick in it.

And it costs only 25c! Send for it today. The demand is great, and we only have a few hundred on hand.

**MAIL
COUPON
BELOW**

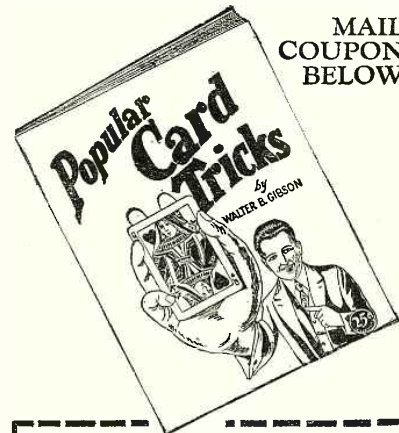

Experimenter Publications, Inc.
Dept. 2411c, 381 Fourth Ave., New York, N. Y.

I enclose 25c. (in stamps or coin) in full payment for Walter Gibson's Book of Popular Card Tricks, which, it is understood, will be sent me by return mail.

Name.....
Street & No.....
City.....State.....

PROTECT your RADIO

**USE THE
CORWICO
VULCAN
LIGHTNING ARRESTER**

\$1

\$100 GUARANTEE

The Corwico Vulcan Lightning Arrester not only protects your radio set against lightning, but also dissipates accumulated static charges, thus improving reception.

Any radio protected by a Corwico Vulcan Lightning Arrester that is damaged by lightning will be repaired by us up to a cost of \$100.

Why take chances with storms and lightning when you can have guaranteed protection and better reception with a Corwico Vulcan Lightning Arrester for only one dollar?

**AT ALL DEALERS
Or Direct Upon Receipt of Price
CORNISH WIRE CO.
36 Church Street, New York City**

**MAKERS OF
CORWICO BRAIDITE HOOK UP WIRE**

factory condition of instability.

Fortunately this situation can be corrected by connecting in the circuit a small neutralizing condenser which can be varied in capacity and adjusting it until a point is reached where its capacity equals the capacity set up within the tube by the grid and plate elements. Then, due to a peculiar connection of the plate coil in the tuned r. f. amplifier a voltage equal to, but opposite in direction to that causing the disturbance is applied to the grid of the tube through the neutralizing or stabilizing condenser, thus eliminating or rather remedying the trouble. This neutralizing condenser is indicated in the r. f. amplifier circuit shown in Fig. 20 as C7.

Referring to the amplifier circuit, Fig. 20, the variable resistance which was previously connected across the primary coil of the detector three-circuit tuner is again used as a volume control, but also as a coupling medium between the antenna and the 222 tube. Thus, by placing the volume regulator in the antenna circuit the amount of signal which is actually passed to the first tube of the receiver is at all times under the control and regulation of the operator and the probability of the production of distortion or overloading of the tubes due to too great a signal, especially from local stations, is minimized. This would not be the case if the volume control were situated elsewhere in the circuit.

Peculiarities of the Screen-Grid Tube

By referring to the symbol chart in Lesson Number One, you will see that a screen-grid tube has four elements, whereas the common type of tube, such as the 201A, has only three elements. It is because of this fourth element and its peculiar placement inside the tube that a very high order of amplification is obtained. In using this tube there are certain precautions which must be observed. First, the screen-grid element is operated at 45 volts positive polarity; secondly, this element must be properly by-passed with a suitable condenser, C6, so that the radio frequency energy which is generated in the tube can find its way direct to the negative side of the filament line without having to course through the long B battery leads, where they surely would cause trouble by intercoupling with the r. f. currents in other nearby circuits, thus making for instability in operation; thirdly, the plate of the tube must be operated at 135 volts plate voltage to obtain maximum results. In the plate circuit, too, suitable measures are taken through the use of a by-pass condenser, C5, and fixed resistor unit, R8, to by-pass the r. f. currents to the negative side of the filament circuit. In this plate circuit the resistor retards the flow of the r. f. currents through the B battery circuit while the by-pass condenser offers a shorter, more direct, and easier path for these r. f. currents back to the filament. In order to completely stabilize the r. f. amplifier it is just as necessary to include these by-pass condensers and the fixed resistor in the circuit as it is to employ the neutralizing condenser in the second r. f. stage.

Are you a man who "Wouldn't swap his battery set"

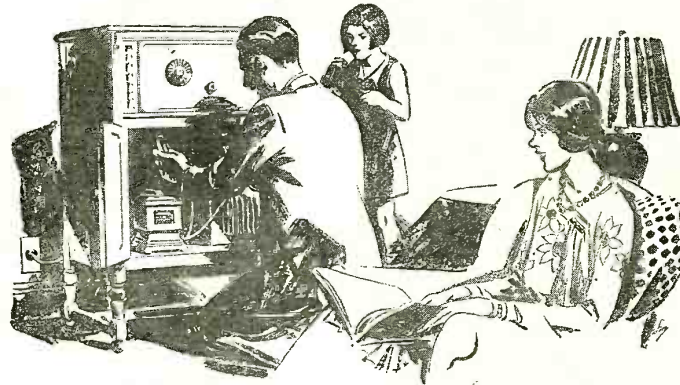

If you have a battery-operated set, you can enjoy it more completely by getting away from all battery-charging problems. Just buy yourself a General Electric Charger—a Tungar.

All you have to do is turn a switch when you're tuning out for the night. You'll find fully charged batteries in the morning. Ask your dealer which Tungar is best for your own set.



\$14 **\$24** **\$10**
2-ampere Tungar 5-ampere Tungar Trickle Charger
(East of the Rockies)

For complete information write
Section RN-11
Merchandise Department
General Electric Company
Bridgeport, Connecticut



Tungar—a registered trademark
—is found only on the genuine.
Look for it on the name plate.

GENERAL ELECTRIC

Merchandise Department General Electric Company Bridgeport, Connecticut



GEARS

In stock—immediate delivery
Gears, speed reducers, sprockets,
thrust bearings, flexible couplings,
pulleys, etc. A complete line is
carried in our Chicago stock. Can
also quote on special gears of any
kind. Send us your blue-prints and
inquiries.
Write for Catalog No. 40
Chicago Stock Gear Works
769-773 W. Jackson Blvd., Chicago, Ill.

No matter what your resistance problem may be—whether an unknown high resistance value for a critical receiving circuit or a heavy duty low resistance value for grid-biasing the largest audio power tube or even transmitting tube—
Remember CLAROSTAT for Every Purpose
there's a
Clarostat Mfg. Co., 281 N. 6th St., Bklyn., N.Y.

Makes Any Tube Last LONGER and Perform BETTER

By automatically keeping voltage exactly right for each tube, AMPERITE lengthens tube life and improves reception. *Never wears out.* Insist on AMPERITE. A type for every tube—A.C. or D.C. \$1.10 with mounting (in U. S. A.) At all dealers.



This symbol in a radio diagram means—

AMPERITE
The "SELF-ADJUSTING" Rheostat

AMPERITE Corporation
561 BROADWAY, NEW YORK

FREE Amperite Vest Pocket Tube Chart
Write Dept. R.N. 11

SHORT WAVES

without the expense of a new set!

The Submariner

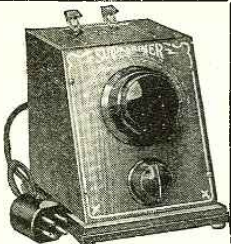

WILL CONVERT YOUR RADIO SET INTO AN EFFICIENT SHORT-WAVE RECEIVER

Simply remove a tube from the set and place it in the "Submariner," then insert plug from "Submariner" in the socket from which tube was taken, attach aerial and ground to clips of "Submariner." Write for our money-back guarantee. Enthusiastic owners have written us from all parts of the world. Stations 3,000 miles away have been received. Vernier dial 32 to 1 ratio. Users are getting foreign stations the year around. There is very little static and short waves carry a much greater distance.

FOUR MODELS

20 to 65 meters for battery tubes, \$15.00. For all electric, \$17.50. Interchangeable coil model, 10 to 160 meters, \$22.50, for A.C. or D.C. receiver. No. 4 coil, 100 to 340 meters, \$29.00 additional. In ordering, be sure and state name of set and the number on each tube. Ask your dealer for one. If he does not carry them, he will get one for you.

If you are unable to get one locally, it will be sent postpaid upon receipt of money order or certified check. Sent C.O.D. only if \$1.00 accompanies order. This is to insure carrying charges. Price in Canada and some other foreign countries, 60c additional. Cannot be sent C.O.D. outside U. S. ORDER TO-DAY.

J.-M.-P. MANUFACTURING CO., Inc.
3413 Fond du Lac Ave. Milwaukee, Wis., U. S. A.

A Radio Parts Guide THE NEW YAXLEY Catalog



Send for it today for complete listings of Radio Convenience Outlets, Connector Plugs, Rheostats, Fixed and Grid Resistances, Jacks, Jack Switches, Phone Plugs, etc.

YAXLEY MFG. CO.

Dept. N, 1528 W. Adams St., Chicago, Ill.

6 FOOT MODEL ZEPPELIN Flies For Miles

Large 6-foot air bag with inflators, parachute with automatic release and complete instructions for flying. Will fly for miles at height of 1000 feet. Send 25c for year's subscription to *Everyday Life* and 75c extra, \$1.00 in all and we will send you our magazine for one year and the ZEPPELIN Air Ship. All charges prepaid. A great offer to introduce. EVERYDAY LIFE, Dept. 22 A.S. 337 W. Madison St., CHICAGO

How to Build a Two-Stage Radio Frequency Amplifier

First, obtain the parts as listed. Then note carefully the position of these various parts as indicated in the photographs and sketches accompanying. Next, place these parts on the baseboard, locating them in the positions as shown. Do not fasten the parts to the baseboard until you are certain that the position of one does not interfere with the placement, movement, and operation of another. When, finally, you are satisfied that you have obtained the correct layout as shown, the parts may be permanently fastened to the baseboard.

Then, on the panel, in the holes provided for it, mount the r. f. tuning condenser, C4, in the same manner that the detector tuning condenser was mounted. Now, loosen the setscrews on the rotor section of the detector tuning condenser, C1, remove the brass shaft, and then replace with the bakelite shaft, passing it through the rotor sections of both tuning condensers. Tighten the setscrews. When this has been completed, the r. f. amplifier is ready for wiring.

Wiring Instructions

First, the filament circuits will be wired, then the grid circuits, then the plate circuits, and finally the miscellaneous circuits, such as by-pass, volume control, etc.

Connect a wire from the terminal marked "F+" on the socket V4 to the terminal of the amperite R6, nearest it. Connect a wire from the "F+" terminal on socket V5 to the terminal of the amperite R7, nearest it. Connect the other remaining terminal on amperite R7 and continue the connection to the "Red" terminal on the cable connector receptacle or to the nearest point of that circuit, namely, the A-plus line. Connect a wire from the A— terminal on socket V5 to the A— terminal on socket V4 and thence to the A— terminal on socket V3 or to any point of the same circuit. This completes the filament wiring.

Now, connect a wire from the "G" terminal of socket V4 to the "yellow" terminal on the connector cable receptacle. Connect a wire from the top or No. 5 terminal on the coil unit T4 to the "G" terminal on socket V5. Continue this connection to the stator plates on the r. f. tuning condenser, C4, mounted on the panel. Connect the middle, or No. 6, terminal on the bakelite strip at the bottom of T4 to the rotor plates on condenser C4. Continue the connection to the "F—" terminal on socket V5. (For identification of the terminals on the r. f. coil T4, see the symbol chart on page 4 of Lesson No. 1).

Under the nut of the terminal "G" on socket V5 is fastened the neutralizing condenser C7. Connect a wire from the remaining terminal on C7 to the C or No. 3 terminal on the primary of the three-circuit tuner, T1. (See Fig. 20 identification of terminals).

From the terminal No. 1 on this coil



Become a Member of the JUNIOR RADIO GUILD

and Receive Your Introductory Lesson FREE!

In just a few short weeks you can build your own radio set, make sets for your friends at a big profit, and become an authority on radio for your whole neighborhood.

It's lots of fun, too, when you learn through the Junior Radio Guild, because you actually build sets as you learn. And there is practically no hard study, because we tell you all about radio in simple, easy words that even a baby could understand.

Over 12,000 boys are already members of this great organization sponsored by RADIO NEWS, and they have told so many of their friends about what wonders it has done for them, that membership is increasing rapidly.

BIG MONEY If You Learn Now!

All you have to do to become a member of the Junior Radio Guild, absolutely FREE, is to mail us the coupon below. The 25c we ask for is merely to cover the cost of the beautiful bronze membership pin and your membership card. You receive your introductory lesson absolutely FREE!



Mail the Coupon Today!

JUNIOR RADIO GUILD, Dept. 2411u
381 Fourth Avenue, New York, N. Y.

Gentlemen:

Please enroll me as a member of the JUNIOR RADIO GUILD. I enclose 25c (coin or stamps) to cover the cost of my membership pin and membership card. I also understand that I will get the introductory lesson in Radio Instruction for Boys FREE by return mail.

Name.....

Address.....

City..... State.....

there has already been connected a wire running to one of the outer terminals of the volume control resistance, R1. This connection is removed from R1 and is then connected to the "P" terminal on socket V5. The terminal No. 2 on the three-circuit tuner coil, otherwise indicated as terminal "B," instead of connecting to the other outer terminal of the volume control resistance R1, as at present, is disconnected from R1 and is connected to the "Blue" terminal on the cable receptacle.

TWO-STAGE RADIO FREQUENCY AMPLIFIER PARTS LIST

- One Hammarlund Midline Condenser, .0005 mfd. (C4)
- One Hammarlund SGT-23 Coil (T4)
- One Hammarlund Equalizer Condenser (C5)
- One Hammarlund Bakelite Shaft (10 inches)
- Two Sockets
- Two Amperites, one type 622 (R6) and one type 1A (R7)
- One Durham Fixed Resistor, 7500 ohms (R8)
- One Durham Single Resistor Mount
- Three Electrad By-pass Condensers, .5 mfd. (C6, C7, C8)

Connect a wire from the "P" terminal on the socket V4 to the terminal No. 1 on the r. f. coil, T4. Connect a wire from terminal No. 4 on this same coil to one side of the single resistor mount R8. Connect the other side of the single resistor mount to the "Gray" terminal of the cable receptacle.

Connect a wire from terminal No. 4 on T4 to one side or terminal on the by-pass condenser, C5. Connect a wire from the other terminal of this condenser to the F— terminal on the socket V4. Connect a wire from the "G" terminal on socket V4 to one terminal on by-pass condenser C6. Connect a wire from the other terminal on this condenser to the F— terminal on socket V4. Connect a wire from terminal No. 2 on T1, the three-circuit tuner coil, to one terminal of the by-pass condenser C8. Connect a wire from the other terminal on this condenser to the F— terminal on socket V1.

Connect one outside terminal of R1 to the antenna clip. Connect the other outside terminal of R1 to the ground clip and to the F— terminal on V4. Connect the center terminal of R1 to the cap at the top of the 222 tube by means of a piece of flexible wire.

If you have not already done so, connect the small dial light in the circuit, one terminal connecting to the frame of the one tuning condenser, the other connection connecting to the frame of the other tuning condenser. This completes the wiring of the receiver.

How to Operate the Receiver

There are a number of minor adjustments which must be made before the receiver will operate satisfactorily as a five-tube receiver. First, it is necessary to turn the dial around to the "100" mark. In this position the rotor plates of the detector condenser should be "all in." Now, loosen the setscrews in the

The NEW H-F-L Mastertone Laboratory Made Receiver

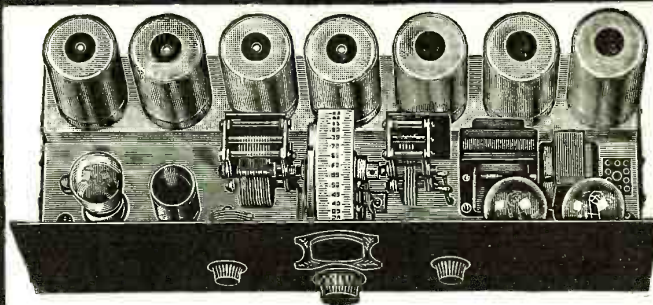

Completely Built and Assembled by H-F-L Engineers—Shipped ready to Operate

All metal completely shielded chassis: 7" x 21" x 7½". Fits nearly all consoles. 11 tubes operating at peak efficiency [5-224; 3-227; 2-245; 1-280.] Single dial positive one-spot tuning; Humless AC Operation; Uses 5 Screen-Grid tubes, 5 Tuned R. F. Circuits; High Power Screen-Grid detector, with 175 volts impressed on plate; Automatic line voltage control inbuilt holds voltage against fluctuating; 100-Volt DC Dynamic field supply incorporated; 3 stage Phonographic amplifier; Finest quality precision made parts.

Amazing Power

Startling realism! Unfailing accuracy! Its great power and sweet tone awe and thrill, setting new standards of performance achieved by H. F. L. engineers after two years of tireless research and tests under all conditions.

Keenest Sensitivity

Unlike any ever known! Gets distant stations clearly, sharply, distinctly with only wire screen or metal plate aerial built in cabinet.

Highly Developed Circuit

Intermediate employs 4 screen-grid tubes with 5 tuned filter circuits, easily adjustable to peak of tuned frequency. Positive 10 Kilocycle selectivity. Most highly engineered receiver ever built.

The New Audio System

Uniform amplification over entire musical scale. Operates with dynamic, magnetic or horn speakers without a bit of hum.

The H-F-L Power Master

Not an ordinary power pack, but a specially developed unit of the Mastertone, built separately to simplify installation. Has oversized transformer, full wave type 280 rectifier tube.

Built by Hand—Yet Low in Price—

Quality—not quantity—the H-F-L Mastertone standard. One demonstration will convince you that its the master receiver of all times. Fully guaranteed.

Write today for complete description and price.

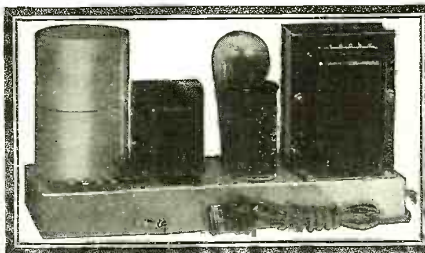

HIGH FREQUENCY LABORATORIES
28 North Sheldon St. Dept. 211 Chicago, Ill.

SET BUILDERS and DEALERS

Send for ROYAL-EASTERN'S NEW 124-page 1930 General Wholesale Catalogue

It is free. No obligation to buy

Every worth-while radio, electrical and sporting goods item is featured at lowest wholesale prices. Being the largest Radio and Electrical Mail Order House in the East, we can serve you best. We buy no seconds. We have no job lots. Only fresh and clean products in original factory cartons.

32 YEARS OF SERVICE TO THE TRADE—THREE BRANCHES—BEST CREDIT RATING—WE CARRY LARGEST STOCK IN THE EAST

Our Banking Affiliations and Depositories
The National City Bank of New York, N. Y.
Irvine Trust Company, New York
Brooklyn National Bank, Brooklyn, N. Y.
Bank of Manhattan, Long Island City, N. Y.
Huguenot Trust Co., New Rochelle, N. Y.

Send for Catalogue Today. It's free

Royal-Eastern Electrical Supply Company

14-A West 22nd Street

New York, N. Y.

RUSH-ABSOLUTELY FREE!
 THIS E-F ANGLE SCREWDRIVER—of tempered crucible
 Spring steel—has 7 powerful edges
 for large & small screws. Works
 on obstructions where other
 won't—101 other uses. Carries like
 pen-knife—often more valuable.
 Sent Free on Receipt of Coupon.

Name _____
 Route No., St. _____
 P. O. _____
 City, St. _____

Interested in Factory Representative Proposition!
 In User Literature! **THE FLASH SALES CORP.**
 J. E. G. 4809 N. Ashland Ave., CHICAGO, ILL.

CLIP HERE—MAIL TO

Also **FREE ON COUPON**—the "\$5,000" CIRCULAR
 giving amazing 125-Picture story of
The "Pocket Machine Shop!"



with its **1-TON POWER-GEAR**
 It Outrips a 40-Lb. Visel



The "hand-grip" of a tiny Rubber band holds the Hardest-to-Hold thing known against a 300-Pound Pull

Its **10-to-1 ratio Power-Gear** Transmission gives **YOUR** hands the **1-TON GRIP** of 20 Hands, yet—**YOU CAN GRIP A HAIR.**

An Automatic Lock-Grip Ratchet Wrench

Speed VISE Parallel PLIERS Plus

No. 3—for all Wire, chain, spring-making, fence work, etc.
 No. 2—for all Pipe work, "chewed" nuts in tight places, etc.
 No. 1, Universal—for ALL Pliers, Nut Wrench, Vise and Clamp, Spring-making Work, etc.

EIPEL-FLASH PIERRENCH KIT
 (Say "Eye-lai-Flash") "The T.N.T. of Tools!"

You get the amazingly Quicker, Better, Easier, Universal Tool Service of Nos. 1, 2 & 3—Convertible in 1/5 second—in this new 24-Ounce Master Tool Kit—for the Price of One Good Tool; yet it Does the Work of the best other tools Weighing 60 pounds and Costing \$50.00!

Hundreds of Thousands of Men and Women are using these wonder Kits to make Homes and Estates more comfortable—Farms, Shops, etc., more profitable; to get more and better service from Auto's and all mechanical devices with a huge saving in money, time and energy! Used by the U. S. Army and Navy. Just try a Pierrench Kit Once, and you will more go back to other tools than to the ancient O-car!

With each Kit a 64-page Manual of Mechanics A GUARANTEED SUPER-QUALITY PRODUCT (©'29 J.E.)

ALSO BIG FALL AND WINTER MONEY-MAKER
 for Pierrench Factory Representatives—Full or Part Time.
 Amazing Demands—sell at sight—makes \$75-\$200 weekly all year round. Seasonal Demand Doubles Profits. A Cash Rep. made \$97 in 20-Min. Group Sale; a Mich. Rep. \$368 in 12 days; another \$375 in 5 days. Everybody wants the Kit!

Mail Valuable Coupon Above NOW!



One hand on the wheel, both eyes on the road and a fresh uncrumpled cigarette served to your lips at a press of your thumb! Only with the Ejector is this possible. No other case has its automatic action—no other so protects cigarettes from crushing, from handling.

Ejector is the modern, smart way to carry and serve cigarettes.

Write enclosing price if your dealer cannot supply you.

Colorful Enamel and fine engine-turned designs at your dealers—up to \$6.00. Model C \$1.50. Model C50 \$3.00.

THELYONS MFG. COMPANY
 Dept. M, Mt. Carmel, Conn.

EJECTOR
 The Perfect One Hand CIGARETTE CASE

rotor plate section of the r. f. tuning condenser, C4, and by hand turn the whole section so that they, too, are "all in." Then tighten the setscrews. Now, when the dial is turned the rotor plates of both condensers will be "all in" at 100 and "all out" at 0.

Connect the batteries to the wires of the cable plug so that the connections coincide with the diagram given in Fig. 9, in Lesson Two. With the antenna and ground and loud speaker attached to their respective terminals the receiver is then ready for operation.

Carefully observe the following instructions concerning the adjustment of the r. f. and detector circuits. Because of the fact that one dial is used to tune in both tuning circuits, it is necessary, if a station is to be tuned in properly, that at any particular setting of the dial the wavelength adjustment of the r. f. stage should be the same as the detector stage, and vice versa. An easy way to check this condition is to turn the dial slowly from the 100 mark to zero, noting on a piece of paper as you go along the setting of the stations tuned in. On weak signals it may be necessary to turn up the volume control so as to make the response loud enough to be heard. After you have compiled a list of stations, go back to the first one on the list, tune it in carefully and then loosen the setscrews on the rotor section of the r. f. condenser. Now, with the hand, carefully and slowly turn this section first one way and then the other, meanwhile holding the dial firm so as not to let it rotate. If, when you turn the rotor section slightly out of mesh with the fixed plates the station is received louder, then that is an indication that there are too many turns on the secondary coil of T4 and therefore less condenser capacity is required to tune the circuit to the same station to which the detector circuit is tuned. Obviously, the remedy is to remove turns until the condenser, C4, is set at the same position as the detector tuning condenser. If you find that to get maximum response from the station you must turn the rotor section into mesh farther than originally, then this indicates that there are too few turns on the secondary coil of T4 and therefore more condenser capacity is required to tune the two circuits to the same station. Since it is not a simple matter to add turns to the secondary coil, then the trouble must be taken care of by removing turns from the detector secondary coil of T1 until both condensers are in the same position for the same station.

In the matter of removing turns for either the secondary of T4 or T1, it is imperative that the work be done exceedingly carefully. Remove one turn at a time and then go through the whole pro-

cedure of testing the circuits to see whether the condenser positions jibe. If they do not, then take off another turn and repeat the process. The importance of doing this work carefully cannot be overemphasized. It is well, in this adjustment, that before any turns are removed the position of the rotor sections be checked on several of the stations tuned in.

How to Neutralize the R. F. Amplifier

During the balancing procedure explained above it may be noticed that reception of signals is accompanied by a squeal similar to that produced when the regeneration control of the detector circuit is advanced too far. This squeal is an audible indication that the tuned r. f. amplifier stage is oscillating; that is, it is acting as an oscillator similar to that of a transmitter and under these conditions is transmitting radio frequency energy to the detriment of successful operation of the receiver. To prevent this condition the neutralizing condenser C5 is used together with the neutralizing section of winding of the plate coil of T1. At the proper setting of C5, a radio frequency energy will be fed back to the grid of the second stage r. f. amplifier equal in strength but opposite in direction to that creating the disturbance, thus canceling it out.

The procedure to be followed in neutralizing the r. f. amplifier is as follows: loosen the setscrews of the r. f. tuning condenser C4 and with the hand rotate it over a small arc, say 10 points or less. It will be noted, as the condenser plates are rotated, that two distinct and unequal whistles will be heard at the point where a station is tuned in. The main idea is to slowly turn the adjusting screw on the neutralizing condenser first one way, then the other, until a position is found where both whistles are of equal intensity and tone with perhaps a silent spot in between them. At this point the receiver may be considered neutralized. It may be necessary in carrying out the above procedure to slightly advance the regeneration control of the detector circuit so as to obtain a small amount of regeneration. If the receiver has been properly neutralized, all the squeals will have vanished when a station is received, providing, of course, that the regeneration control has been completely retarded. When you are sure that the receiver is satisfactorily neutralized, run the dial up to 100, push the rotor section of the r. f. condenser "all in," tighten its setscrews, and then the receiver is completely adjusted and ready to operate.

Bureau to Transmit Standard Frequencies

PARTICULARLY of interest to radio experimenters who are working on television sets will be the standard frequency transmissions scheduled by the United States Bureau of Standards. One transmission a month is planned. The short waves will be covered, from 1,500 to 4,000 kilocycles (200 to 75

meters) on October 21, and from 4,000 to 7,600 kilocycles (75 to 39.47 meters) on November 20. The broadcasting frequencies, 550 to 1,500 kilocycles (545 to 200 meters) will be covered on September 20 and December 20. Each transmission will start at 10 p. m., Eastern Standard Time.

Radio News Floating
Laboratory

(Continued from page 415)

short lunch hours it was made ready in time for the Labor Day week-end.

On the Saturday preceding Labor Day, then, the finished experimental receiver was brought down to the Sheepshead Bay Yacht Club, together with tools and food supplies and miscellaneous paraphernalia. With two volunteer aids, to supplement our regular staff of three, the accumulation of dunnage and stuff on the float looked to be enough to sink a battleship. In fact, as load after load was stowed aboard the little 26-foot cruiser, it was reminiscent of some of those old movie comedies where a Ford car disgorges several hundred people.

It took time to stow away the various items in ship-shape fashion, and to complete the shielding of the boat's ignition system. As a result, we didn't pull away from the anchorage until mid-afternoon; contenting ourselves with a short run, off Rockaway point.

The receiver was hooked-up, and—as so often happens in such cases—showed no sign of life. With darkness coming on, it was deemed wise to head for a sheltered spot in which to anchor overnight; postponing examination of the receiver until daylight.

It was then, that we learned the emergency capabilities of the radio trouble finder. Suspending its loop from the mast yard-arm and feeding its output through a push-pull '71 amplifier to our loud speaker, we had a passable broadcast receiver.

Early on Sunday, one of our volunteer chefs produced flapjacks and maple syrup for breakfast. While he was performing his feats of legerdemain, a brief examination of the experimental boat receiver revealed the trouble, and we finished breakfast to the tune of a Sunday morning program from WABC; and with such volume that it was necessary to cut down to a minimum, to avoid blasting the speaker. WEAf, WJZ and WOR came in, in fine shape; to say nothing of several smaller stations in Brooklyn, Manhattan and New Jersey. By this time, it was past noon, and we had picked up anchor and headed for Rockaway point.

From there, just to test our book knowledge of navigation, we set a compass course for Sandy Hook, by means of the chart. What made it really interesting, was the fact that visibility was low, and Sandy Hook was quite hidden in the haze. It was with no small show of pride that our pilot, a short time later pointed out Sandy Hook light looming dead ahead; though the rest of us insisted it was fool's luck, rather than proof of navigational skill.

Approaching the sandy shore of the Hook, it occurred to some brilliant member of the party that we had not yet succeeded in getting a good "action picture" of our floating laboratory under full headway. Why not have one of us hop off, in shallow water, take a camera, and get a few such pictures? Like many brilliant inspirations, this one struck a few nags.

Caution being the supreme virtue of a good pilot, ours announced that he

Every Latest Feature
for Performance and Quality

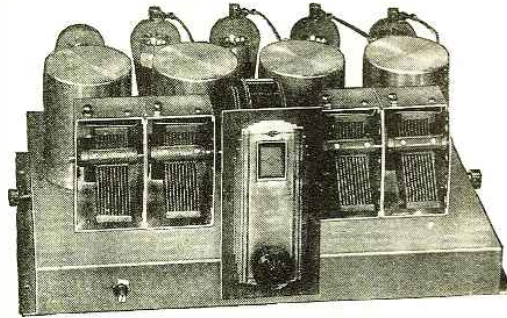

This new National MB-29 has every latest feature for performance and quality. *Four Screen Grid Tubes* for maximum sensitiveness—*Band Filter Tuning* for selectivity without cutting of side-bands—*Power Detection* is for securing maximum results from the new type high percentage broadcast modulation—*Power Audio Amplification*, with two 245's in push-pull. Beautifully finished, rugged, shielded aluminum chassis with precision matched coils and condensers—*New National Projector Dial*. These are just the high spots. The new National MB-29 is simply full of new and ingenious features for your convenience and pleasure.

A selection of beautiful types of consoles available for housing the MB-29, in popular combinations.

NATIONAL CO., Inc. Malden, Mass.

Est. 1914

Write us today for full particulars and prices, mentioning Radio News.

NATIONAL SCREEN-GRID—MB-29

SCORE  for
FERRANTI

2 1/2 miles of wire

Inductance of 175 henries with 1 mill D. C.



FERRANTI A. F. 5 is the only commercially available transformer with **TWO and ONE-HALF MILES** of wire in its windings and 26,000 turns in its Secondary Coil. Having the highest Primary Inductance of any transformer that you can buy, you are assured of a higher energy transfer at all frequencies, as well as of *positive* 25 cycle reproduction.

A. F. 5 Audio Transformer\$14
Ferranti O. P. M. C series Output Transformer Improves Reception...\$16

Write for correct type for your speaker

Of course you want such transformers. Then insist on FERRANTI from your dealer. Write us if he will not supply you.



Inc.

130 W. 42nd St. Desk 511
New York, N. Y.

BE A RADIO DOCTOR



Radio servicing offers the biggest opportunity for the man interested in radio. About 10,000,000 receivers need service some time or other, many are naturally inefficient and can be improved on.

The Radio Doctors, Inc., is the only institution teaching exclusively radio repairs, having specialized on this phase of radio for a number of years.

\$3,000 to \$5,000 per year

The professional "Radio Doctor" receives \$2.00 or \$3.00 per visit and is welcomed in the best of homes—may I tell you more about this new, fascinating and extremely profitable business? Write now for free booklet, "Why the Radio Doctor." (Early inquiries will receive a blueprint of a recent well-known manufactured superheterodyne.)

E. W. PARKER, Pres. RADIO DOCTORS, INC., Dept. N9, 131 Essex Street, Salem, Mass.



A Seaburg Console For Your Chassis

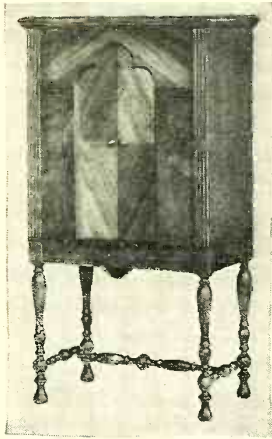

A beautiful console of artistic design and dignified appearance built to satisfy the discriminating buyer.

Selected butt walnut panels; patented sliding doors; lacquered finish.

Will accommodate any standard receiver. (Atwater Kent, Fada, Sparton, Crosley, etc., etc.)

Special Baffle arrangement for Speaker.
Write for special discount folder.

Seaburg Manufacturing Company
Jamestown New York

MEN! Daringly Different



from any other publication; our big intimate Magazine is strictly for you! *Can't be described—must be seen!* No Fake, no Fada, no Fiction, no Foolishness—but surprisingly original, courageous, and 100% valuable to you. Devoted seriously to intimate subjects in which **NORMAL MEN** everywhere are individually interested—such as Physical Fitness, Personal Hygiene and Prevention, Virile Manhood, Masculinity, Social and Married Life, etc. Thousands of men would not sell their copies for money. You will know **WHY** when you see it. If you are married or ever expect to be, both you and wife will benefit—for **IT DOES NOT DUPLICATE ANY OTHER MAGAZINE** but actually deals with vital subjects heretofore not generally discussed in print. Endorsed by men's physicians. And edited to meet a long-felt need.

Are You Normal?
If so, our big 100% **MEN'S MAGAZINE** is just what you need! Act now!

No book can possibly be as satisfactory. **CUT THIS OUT**, send with \$1 now for 5 no. trial subs. with 5 big back numbers besides. (10 copies in all) **SAMPLE COPY 25c.** (None free.) Satisfaction guaranteed or money promptly refunded. No chance to lose!

Locoma Pub. Co.
Dept. 40, Battle Creek, Mich.

YOUNG MEN interested in themselves must not miss the above offer.

LEARN TELEGRAPHY

Be an expert Morse or Continental code operator! **BIG PAY—TRAVEL—FUN—ADVENTURE** After a few short weeks of practical study with **TELEPLEX** you will be an expert operator. This amazing instrument teaches you right in your own home. Works like a phonograph. No knowledge needed—beginners learn at once! **NOT A SCHOOL**. Free 10 days' trial. Write for **FREE** booklet L-11.

TELEPLEX CO., 72 Cortlandt Street, New York City



To be sure of getting your copy each month, subscribe to **RADIO NEWS**, \$2.50 year. Experimenter Publications, Inc., 381 Fourth Avenue, New York City.

wouldn't venture too close ashore until he was sure of the depth. Your correspondent volunteered to dive over and find out. Reaching a point where he could stand up, the boat was maneuvered near enough so that a camera could be handed to him on the end of a boat hook. What seemed at the time a perfectly insignificant incident, happened at that moment. An unusually high wave broke, and in spite of holding the camera high overhead, some spray managed to hit the lens; spoiling what should have been five perfectly good pictures. It may, or may not, be of wide interest to record that there are underfed crabs in shallow water off Sandy Hook.

From Sandy Hook, we headed out into the open ocean, until there was no land in sight on any side. Naturally, we could not have the weather made to order, else we would have had either a light fog or a completely overcast sky. However, there was sufficient imagination on board so that we could ignore the direction-finding qualities of the sun.

It was here that the loop was brought into play. With the chart spread out, and with the local broadcasting stations marked thereon, we first obtained the direction of station WJZ at Boundbrook, N. J., then tuning in WEAJ and finding its minimum signal by rotating the loop, we noted down its direction. Then, simply as an additional check, we followed the same procedure with station WABC. Strange to relate, lines plotted from these three stations on the chart in pencil came within a small fraction of an inch of meeting at one point; that point, by all the laws of navigation, being the exact location from which we had taken these bearings. And that, as a matter of fact, is how simple it is to find one's position when lost in a fog while cruising off shore.

We made several such tests again on Monday morning, with equally gratifying results, but time did not permit venturing far enough to bring into play the radio beacon reception for which this receiver has also been designed. This, as well as certain refinements dictated by experience, will have to await our next issue.

It may not be amiss to record that the volume and quality of reception of broadcast programs created quite a stir as we came back into Sheepshead Bay channel. In fact this—the less important phase of what we had been aiming at—was more than successful. The quality and volume of the broadcast entertainment made available by this experimental receiver was far beyond anything we have heard on board boats of even 50-foot or more in length.

For those impatient experimenters who are not willing to wait, we are giving a complete description of the experimental model of this receiver. In next month's issue, however, we hope to have not only reports of further experimental work, but also a complete constructional article on the final version of this motor boat, automobile and airplane receiver.

The Circuit

In the circuit which has been chosen for the experimental model **RADIO NEWS** boat receiver five tubes have been employed. The first three tubes are of the a. c. screen-grid type and are em-

ployed in the first three tuned radio-frequency amplifier circuits. The fourth tube, also a 224 screen-grid tube, is used as a power detector in a tuned detector circuit. The fifth tube, a regular battery operated tube of the 201A variety, is used in the first audio-frequency amplifying stage, which employs resistance-coupling to match the high impedance of the detector plate circuit. The filaments of the various tubes are connected as shown in the circuit diagram, Fig. 1, so as to obtain the required C biasing for the various radio-frequency stages.

Just a word here about the reasons for the use of the a. c. type of tubes in a d. c. operated circuit. It is a well known fact that where a receiver is subject to excessive vibration, the ordinary 201A type of tube is not at all satisfactory, for the reason that its delicate filament will be caused to vibrate, and thus ruin the quality of the received signals. Just one thing more, a frail filament such as is found in the regular 201A type of tube is more seriously affected by irregularities in the voltage supply than is the a. c. type of tube. Heater type a. c., because of their sluggishness in response to variations in voltage supply, have been employed for this reason.

Of course, the use of the a. c. type of tube, with its high amperage filament, might seem to apply a rather severe load on six volt storage batteries. The total current for all five tubes, however, amounts to some 3-3/4 amperes, which is not excessive when it is considered that the storage battery is constantly being charged by the generator.

To guard against interaction between the tubes and the coil-condenser combinations, each of the various parts of the circuit, such as all of the tubes, all of the tuning condensers and all of the tuning coils have been placed in separate shielded compartments and in the case of the coils themselves these have been individually shielded, one from the other. By this method of shielding not only is intercoupling between the tuned stages prevented, but also pick up from external sources is limited to entry through the antenna circuit alone.

The coils which are employed in this circuit were wound to tune with the .0005 mfd condenser from about 200 meters to approximately 550 meters—the regular broadcast range. Then, to make the circuit tunable to compass signals, a churst condenser was provided for each stage, with a switch to cut it in or out of the circuit.

When it is desired to use the loop to tune to the long wave signals which are transmitted by these radio beacons and compass bearing stations it is merely necessary to turn the switch for each of the tuned circuits, which throws in the variometers in shunt with the regular tuning condensers, thus raising the wavelength range of the receiver as a whole. The circuit then tunes from some 700 meters to about 1,000 meters.

Details for the winding of the coils are shown in Fig. 2. The accompanying photographs together with the details of the circuit and the winding data for the tuning coils are sufficient for those who wish to actually build one of these experimental boat receivers along the lines

followed in the receiver described here. In a following issue we hope to publish complete constructional details of a final model of this receiver, giving actual dimensions of the shielded compartments together with an actual layout of all the parts employed.

In the work leading up to the design of this boat receiver and in the actual design of the receiver itself we have had the hearty cooperation of such companies as Bullard Davis, Inc., who have very generously placed at our disposal one of their trouble finders; the National Carbon Co., who have supplied us with the necessary Layerbilt B batteries; the Kelvin-White Co., who have loaned us a ship's compass for use in our navigation work; and the Insulating Corporation of America who have very generously placed at our disposal the facilities of their organization in providing us with the tube socket shelf and other drilled Bakelite work which was required in the construction of this receiver.

* * * *

As these pages go to press, we have just time for an additional note. On the Saturday and Sunday following Labor Day, the Floating Laboratory Crew encountered exactly the weather conditions necessary for a real test of direction-finding; thick fog. This time, real direction-finding was important, as we had been drifting with the tide. We found out some interesting things—which will have to await the December issue for recital. At any rate, we managed to get back!

Boat Receiver Parts List

- C1, C2, C3, C4 Hammarlund four gang Battleship condensers, type BSQ-50, 10005 mfd.
- C5, C6, C7, C8 X-L Variodensers, .001 mfd.
- C9 Hammarlund midget condenser, type MC.
- C10, C11, C12 Aerovox 400 v. by-pass condensers, .5 mfd.
- C13 Aerovox 400v. by-pass condenser, 1 mfd.
- C14 Aerovox fixed condenser, .001 mfd.
- S1,S2,S3,S4 Carter battery switches, No. 2.
- S5 Carter Imp power switch, No. 110.
- L1, L2, L3, L4 Home-made Inductances (as explained in text).
- L5, L6, L7 Hammarlund r. f. chokes, No. 85.
- L8 Loop (For .0005 mfd. condenser).
- R1 Electrad Royalty potentiometer, type B, 0-100,000 ohms.
- R2 Carter Super Hi-Watt rheostat, No. SW-1, 1 ohm.
- R3 Radiall amperite, type 1A.
- R4 Durham grid resistor, .25 megs.
- J1 Carter jack, No. 104.
- One Four tube socket shelf (insulating Co. of America).
- One Hammarlund drum dial.
- One Yaxley connector cable and plug, No. 660.
- Two Binding posts.
- One Carter two way plug.
- One Double resistor mount.
- Four Eveready-Raytheon 224 Screen-Grid a. c. tubes.
- One Eveready-Raytheon 201A tube.
- Three Eveready 45 volt Layerbilt B batteries, No. 486.

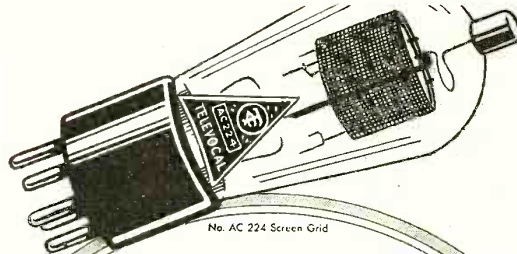

Televocal
Quality Tubes

Instantaneous—no— but close to it. And the programs come in clear as a bell, and free from all hum, crackle or buzz. Tremendous undistorted volume—more than you need—producing an unequalled fidelity of tone, even under a full load.

QUICK HEATING reproductions of programs from stations never heard before. Sturdy and rugged construction, built to withstand the shocks and knocks of everyday use.

There is a Televocal Tube for every need at all good dealers. They cost no more and give longer service.

Televocal Corporation

TELEVOCAL BUILDING, DEPT. A 11
588—12th St., West New York, N. J.

SAVE MONEY ON RADIO!

LARGE Discounts on Lafayette All-Electric, Screen-Grid Radio Receivers

The 1930 Lafayette Screen-Grid Radio Set is the sensation of the field. We offer you an opportunity to sell this tremendously popular receiver to people who want the finest in radio. Most liberal discounts to dealers and agents. Because of the tremendous demand for the Lafayette it sells at a price *amazingly low*.

30-Day Free Trial!

The 1930 Lafayette has every new feature of radio construction. All Electric Volume Screen-Grid Selectivity 245-Push Pull Amplification Illuminated Single Dial Control Clearest Reception of Any Set on the Market!

30 Different Cabinet Models. Finest custom-built work. **AND—A 30-DAY FREE TRIAL ON EVERY LAFAYETTE SET. UNCONDITIONALLY GUARANTEED!**

We Offer Greatest Bargains on Nationally Known Products

WHOLESALE PRICES on nationally-known merchandise! Biggest discounts on standard equipment. **TREMENDOUS SAVINGS**. Everything shown in our newest 1930 Catalog—just out. *Nothing to compare with it!* Immediate personal service on all your orders.

Mail Coupon for Big Catalog—Absolutely Free!

DEALERS—AGENTS—Mail the coupon below AT ONCE for your FREE copy of the new 1930 Wholesale Radio Service Catalog. See our money-saving bargains—beautifully reproduced in color. Over 200 pages of big specials. You buy under our "Satisfaction or money back guarantee." Get your copy *to-day*. *Rush coupon!*

Mail to: **WHOLESALE RADIO SERVICE COMPANY**
36 Vesey Street, Dept. A-15, New York City

Name

Street

Town State

NEWEST 1930 CATALOG



CODE AT HOME RADIO AND TELEGRAPHY

OMNIGRAPH Has Helped Thousands To Better Positions U. S. Govt. Depts., Colleges, Scientists, and Schools use it

Be an operator, broadcaster, experimenter, etc. Read telegraph and short wave codes by aid of the Omnigraph easily and quickly. World's hobby. Models \$17-\$40. Catalog free. Mention age.

OMNIGRAPH MFG. CO., 810 E 39th St., C4, Brooklyn, N. Y.

Over the Mountains from Los Angeles



Think of it! FIVE HUNDRED FIFTY-NINE MILES over rough mountainous country burning only ELEVEN GALLONS OF GASOLINE. Imagine more than FIFTY MILES TO THE GALLON. That is what the WHIRLWIND CARBURETING DEVICE does for D. R. Gilbert, enough of a saving on just one trip to more than pay the cost of the Whirlwind.

THE WHIRLWIND SAVES MOTORISTS MILLIONS OF DOLLARS YEARLY

Whirlwind users, reporting the results of their tests, are amazed at the results they are getting. Letters keep streaming into the office telling of mileages all the way from 22 to 59 miles on a gallon, resulting in a saving of from 25% to 50% in gas bills alone.

Mark A. Estes writes: "I was making 17 miles to the gallon on my Pontiac Coupe. Today, with the Whirlwind, I am making 35.5-10 miles to the gallon." P. P. Goerzen writes: "34.6-10 miles with the Whirlwind, or a gain of 21 miles to the gallon." R. J. Tulp: "The Whirlwind increased the mileage on my Ford truck from 12 to 26 miles to gallon and 25% in speed." Car owners all over the world are saving money every day with the Whirlwind, besides having better operating motors. Think what this means on your own car. Figure up your savings—enough for a radio—a bank account—added pleasures. Why let the Oil Companies profit by your waste? Find out about this amazing little device that will pay for itself every few weeks.

FITS ALL CARS In just a few minutes the Whirlwind can be installed on any make of car, truck or tractor. It is actually less work than changing your oil, or putting water in the battery. No drilling, tapping or chances of any kind necessary. It is guaranteed to work perfectly on any make of car, truck or tractor, large or small, new model or old model. The more you drive the more you will save.

SALESMEN AND DISRIBUTORS WANTED Free Sample and \$100.00 a Week Offer

Whirlwind men are making big profits supplying this fast selling device that car owners cannot afford to be without. Good territory is still open. Free sample offer and full particulars sent on request. Just check the coupon.

GUARANTEE No matter what kind of a car you have—no matter how big a gas eater it is—The Whirlwind will save you money. We absolutely guarantee that the Whirlwind will more than save its cost in gasoline alone within thirty days, or the trial will cost you nothing. We invite you to test it at our risk and expense. You are to be the sole judge.

FREE TRIAL COUPON

WHIRLWIND MFG. CO., 999 U.S. Third St., Milwaukee, Wis. Gentlemen: You may send me full particulars of your Whirlwind Carbureting device and free trial offer. This does not obligate me in any way whatever.

Name.....
 Address.....
 City.....
 County..... State.....
 Check here if you are interested in full or part time salesmen positions.

Chi-Rad's New 1930 RADIO CATALOG

Sent FREE to Set Builders

Now ready—Chi-Rad's latest money-saving catalog. All the latest parts, accessories, kits and sets such as: New Super-Watt Shield-grid Short Wave Receiver, kit \$29.40, or completely constructed \$42.50; New National Shield-grid Short Wave Receiver, kit \$33.00, or completely constructed \$39.00; 3000 volt new type R3 Rectobulbs \$10.00.

Send today for your free copy

CHICAGO RADIO APPARATUS CO., 415 S. Dearborn St., Dept. RN., Chicago, Ill.

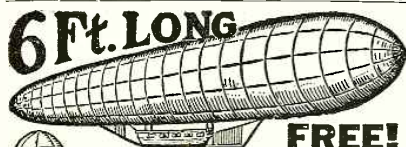

Boys! Here's the great Navy model Airship. Large 6-foot air bag with inflators, parachute with automatic release and complete instructions for flying. Will fly for miles at height of 1000 feet. Great chance to study aerial navigation. Send name and we'll send 6 of our new art pictures to dispose of on special 5c offer. Send the \$1.50 you collect as a reward for this service we will send this wonderful Airship with full instructions free.

C. M. THOMAS, 337 W. Madison St., 11-K-22, Chicago

To be sure of getting your copy each month, subscribe to Radio News, \$2.50 year. EXPERIMENTER PUBLICATIONS, Inc., 351 Fourth Avenue, New York City.

Voltage Dividers

(Continued from page 437)

tubes are connected and then all the current of all the tubes travels through the resistors which are connected between the "B—" tap and the negative terminal of the filter circuit output to complete the circuit to the rectifier.

In calculating the resistance required in each section of the grid bias section of the voltage divider, therefore, all the current drawn by the receiver and amplifier must be considered as flowing through these grid bias resistors. The bleeder current, of course, also flows through these resistors.

In the case of the voltage divider arrangement shown in Fig. 3, the current originating at the rectifier goes on to the respective taps on the voltage divider and thence to the plates of the various tubes.

From the plates of the tubes, the circuit is completed to the rectifier through the filaments and grid bias resistors, back to the "B—" terminal or negative terminal of the filter circuit output.

Since the "free" ends of the grid bias resistors are connected to the centertaps of the respective tube filaments, and since the "B—" terminal is the most negative point of the system, it follows that the free ends of these grid bias resistors are at a positive potential with respect to the "B—" terminal. The extent to which they are positive depends on the resistance of the units and the current flowing through them.

The grid returns of the various tube circuits, when using the voltage divider system shown in Fig. 3, are brought back to the "B—" terminal. Therefore since the filaments are positive with respect to the "B—" terminal, it follows that the connection of the grid returns of the tubes to the "B—" lead puts a negative potential on the grids equal to the voltage drop between the filament of any given tube and the "B—" lead.

The manner in which the grid bias is obtained is therefore the main point of difference between the two voltage divider systems, although the general effect obtained is the same. The method shown in Fig. 3 has the advantage over that shown in Fig. 2 in that it eliminates coupling between the grid circuits of the various tubes by providing separate and isolated grid bias resistors instead of a single resistor common to all the grid circuits.

With the facts in hand regarding the output of the filter circuit and the requirements of the receiver, we can proceed to the calculation of the resistances required in the voltage divider shown in Fig. 2.

Determining the Correct Value of Resistance

The output voltage, we have seen, is to be 301.5 volts with a load of 97.5 milliamperes. At the 250-volt tap, 64 milliamperes are drawn off for the 45

We Pay YOU Big Money for Your Spare Time

Do easy, interesting work in your home town. We pay big money for your spare time. Pays just as well at night as it does during the day. Many of our staff have earned as high as \$35.00 a week extra in their spare time by just following our simple instructions.

No Experience or Capital Necessary

Anybody can make big money with us. You don't need to be brilliant or talented. There is nothing difficult to learn, and we supply all the material for beginning at no cost to you whatsoever. You can start without a cent in your pocket and earn \$5 the very first day.

Begin Earning at Once

Fill out and mail us the coupon below, and next week you can have plenty of extra money. Write us now! We want to tell you all about it.

Mackinnon-Fly Publications, Inc.,
 2411, n. 381 Fourth Ave., New York

\$ **Mackinnon-Fly Publications, Inc.,** Dept. 2411, n. 381 Fourth Ave., New York **\$**

Gentlemen: Please tell me how I can easily earn BIG MONEY in my spare time without investing a penny.

Name.....
 Street.....
 City..... State.....

\$175.00
KOLSTER DYNAMIC
REPRODUCER

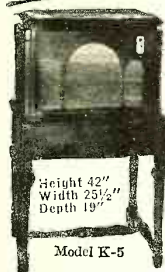

Combined with
210 Power Amplifier and
"B" Supply Unit

F O R \$49.50
(without tubes)

This famous genuine Kolster K-5, AC Electro-Dynamic Reproducer is complete with a 210 Power Amplifier and "B" Supply Unit all self-contained on a steel frame. This real fine matched rugged Unit weighs 45 lbs. without the Cabinet. The Cabinet itself is Pencil-Striped Walnut, beautifully designed with Cathedral grille.

If desired, the 210 Power Amplifier will also supply 22, 67 and 90 volts "B" current, sufficient for any set using up to 8 tubes. An automatic voltage regulator tube, UX-874, maintains the "B" voltage silent and steady.

This Electro-Dynamic Reproducer can be used with any battery or AC set, replacing the last audio stage, or be used with all tubes of the set. Wherever used it will bring out every shading and range of tone; every note is reproduced with utmost faithfulness, pure and undistorted. It will modernize any radio receiver.

Uses 1—UX-210, 2—UX-281 and 1—UX-874 tubes. A 20-ft. cable is included with each instrument. Operates direct from 50-60 cycle, 110-120 volt AC current.

Brand new in original factory cases and guaranteed. Every Reproducer is serial-numbered and has factory guarantee tag enclosed.

AMERICAN SALES COMPANY
19-21 Warren St. New York City

PSORIASIS

IT IS UNNECESSARY TO SUFFER WITH THIS DREADFUL SKIN DISEASE. I SUFFERED FOR YEARS. WRITE R. S. PAYNE, 234 E. 2nd ST., COVINGTON, KENTUCKY.



Send for my Book
STRONG ARMS and BROAD SHOULDERS

for 25c coin or 30c stamps
Illustrated with 20 full-page half-tone cuts, showing exercises that will quickly develop, beautify and gain great strength in your shoulders, arms and hands, without any apparatus. Equal to a \$20.00 Course

PROF. ANTHONY BARKER
1235 6th Ave., Studio D, New York City

New, Quick Way to Become An Expert at Bridge

GET THIS NEW
PICTURE-METHOD BOOK
BY W. C. WHITEHEAD

"Bridge by Whitehead" is causing widespread interest throughout the entire country. The new picture method that is used to illustrate every play has reduced the intricacies of the game to a minimum. Everyone can now learn to play this popular game with ease. "Bridge by Whitehead" is the most complete instruction course ever written. Just the thing for beginners or old-timers.

Write today. 100 pages—replete with illustrations—large 9x12 size.

Only 50c

EXPERIMENTER PUBLICATIONS, INC.,
Dept. 2411C, 381 Fourth Ave.,
New York, N. Y.

type power tubes, leaving 33.5 milliamperes to flow through resistance R1 of the voltage divider. To obtain a voltage of 180 volts at the next tap, resistance R1 must cause a 70-volt drop with a current of 33.5 milliamperes flowing through it. The resistance required may be obtained by dividing the drop in voltage required by the current in amperes passing through the resistor (70 divided by .0335), which equals 2,089 ohms.

At the 180-volt tap, 8 milliamperes are drawn off for the screen-grid tube plate circuits, leaving the balance of 25.5 milliamperes to flow through resistor R2. The voltage drop required between the 180-volt tap and the 90-volt tap being 90 volts, a resistance of 3,529 ohms to produce the necessary 90-volt drop with a current of .0255 ampere.

At the 90-volt tap 3.5 milliamperes are drawn off for the plate circuit of the CX-326 tube, leaving 22 milliamperes to pass on through resistor R3. The drop required between the 90-volt terminal and the 75-volt terminal is 15 volts. This voltage drop may be obtained by using a 682-ohm resistor, which will produce a drop of 15 volts with a current of 22 milliamperes.

Since there is practically no current drawn at the 75-volt tap, the current of 22 milliamperes will also flow through resistor R4, which must produce a drop of 30 volts from the 75-tap to the 45-volt tap. A resistor of 1,364 ohms will be required for this purpose.

At the 45-volt tap, 2 milliamperes are drawn off for the detector tube circuit, leaving the remainder of 20 milliamperes to flow through resistor R5, across which the drop must be 45 volts. This voltage drop, with a current of 20 milliamperes, is obtained by using a resistor of 2,500 ohms.

Since all the plate circuits of the receiver and amplifier terminate at the filaments, which are connected to the "B—" terminal of the voltage divider, all the current in the plate circuits of the receiver and the "bleeder" current flowing through resistor R5 must flow through resistors R6, R7 and R8 to complete the power circuit to the negative lead of the power supply unit.

The total current flowing through R6, R7 and R8 is 97.5 milliamperes or .0975 ampere, no current being drawn at the grid bias taps.

To produce a drop of 1.5 volts with a current of .0975 ampere, resistor R6 must have a resistance of 15.3 ohms. To produce a drop of 4.5 volts to make a total drop of 6 volts between the "B—" terminal and the 6-volt terminal, with a current flow of 97.5 milliamperes, resistor R7 must have a value of 46 ohms. To produce an additional drop of 45.5 volts, the difference between 6 volts and 51.5 volts, resistor R8 must have a value of 466.6 ohms.

The same general procedure is followed in calculating the resistance values required for the voltage divider shown in Fig. 3. In this case, however, it must be remembered that the actual voltages applied to the plate circuits, as measured between the filaments and plates of

FREE RADIO BOOK

Little Salesman
Dealers Confidential Net Price List
RADIO CATALOG

New England Mills Company
851-53-55 Washington Blvd. Chicago, Ill.

Send for it TODAY!

DEALERS, SET BUILDERS, AGENTS, RADIO SERVICE & REPAIR MEN.

NEW ENGLAND MILLS offers everything in radio at Wholesale Prices that spell real savings! That's what you will find in this great catalog just off the press, featuring Radio's newest creations in sets, kits, parts and supplies. Everything in our catalog is backed by the guarantee of this old, stable concern and its vast resources, accumulated through 17 years of faithful service to its customers.

Radio Dealers Save Money
on complete radio sets of every description, dynamic and magnetic speakers, A. C. and all other types of tubes, eliminators, batteries, radio cabinets—in fact everything required by dealers for resale or servicing. Buy right, sell right and make money.

Set Builders and Repair Men
Earn big money by rebuilding and modernizing old sets. Catalog contains everything required for this work; also the latest nationally renowned kits—knocked down or completely assembled chassis ready to install in table or console cabinets, all at wholesale prices.

A. C. Electric Radios
Large selections of the finest A. C. Electric, 6, 7, 8 and 9 tube chassis and complete sets obtainable at the amazingly low prices we quote. Every modern radio improvement is embodied in these marvelous electric radios. Backed by guarantee of satisfaction of this 17 year old institution.

Battery Sets for Unwired Homes
Rural communities with homes not wired for electric radios offer a good market for battery sets, repairs and replacements. We have a large stock of batteries, eliminators, speakers, tubes, transformers, coils, and all kinds of accessories for battery sets. Best known, nationally advertised goods, such as Cunningham, Sonatron and Arcurus tubes, Burgess batteries, Jewel instruments, Bel-den Products, Utah, Temple, Farrand and other popular dynamic and magnetic speakers.

Send for Free Book—NOW!
Radio dealers, agents, set builders, service men, etc., cannot afford to be without the New England Mills catalog. We maintain a complete radio service department, supervised by expert radio engineers who will help you with all your radio problems. All roads cataloged are stocked for immediate shipment. Write for this book today. It's FREE! Send request on business stationery. Catalog also contains complete line of tires, tubes, auto supplies, electrical and sporting goods.

NEW ENGLAND MILLS CO.
851 Washington Blvd. Dept. 12 Chicago, Ill.

MARVELOUS NEW PATENTED SCREW-HOLDING SCREW DRIVER

Non-magnetic. Holds screws tight! Removes them INSTANTLY from inaccessible places. Factories, radio electricians, machinists, etc., buy on sight! Indispensable. Price \$1.50 only. (Sent postpaid receipt money order.)

DISTRIBUTORS: Genuine opportunity earn big money. Exclusive territory. Write or wire quick for full details.

JIFFY-TITE MFG. CO., 1250 Water St. Boston, Mass.

Airplane Blueprints
Lincoln Sport Plane, \$6.75
Gerber Monoplane, \$1.00
SCIENCE & INVENTION
381 Fourth Ave., N. Y. C.

the respective tubes, must be the nominal voltages indicated to the right, at the voltage taps, and allowance must be made for the subtraction of the grid bias voltages at the respective taps.

While the nominal voltage at the "+ Max." tap is 250 volts, the actual voltage as measured between that terminal and the "B—" terminal is 301.5 volts, allowing for the 51.5 volts allowed for grid bias. The difference between 301.5 volts and 51.5 volts gives a net voltage of 250 volts for the plate circuit of the power tubes.

Similarly the voltage required at the 180-volt terminal should be 181.5 volts to allow for the 1.5 volts grid bias for the 24 type tubes. The voltage at the 90-volt terminal should be 96 volts to allow for the 6 volts grid bias for the 26 type tube. The voltage at the 75-volt terminal should be 76.5 and that at the 45-volt terminal should be 45, because no grid

bias is used with the detector of this receiver.

The values of resistance required in the voltage divider are calculated in the same way as they were in the voltage divider shown in Fig. 2. The voltages used at the various taps to calculate the values of the resistors, however, should be the actual voltages required at those taps, to allow for the bucking effect of the grid bias voltages.

Resistor R9 must produce a drop from 301.5 to 181.5 volts or 120 volts with the current of .0335 ampere which remains after 64 milliamperes are drawn off at the 250-volt tap. The resistance required is therefore 3,582 ohms.

Resistor R10 must produce a voltage drop from 181.5 to 96 volts or 85.5 volts with a current of .0255 ampere which remains after 8 milliamperes are drawn off at the 180-volt tap. Resistance R10 must therefore be 3,353 ohms.

Resistor R11 must produce a voltage drop of from 96 to 76.5 volts, a drop of 19.5 volts with a current of .022 ampere which remains after 3.5 milliamperes are drawn at the 90-volt tap. This resistor should have a value of 886 ohms.

Resistor R12 must produce a drop of 31.5 volts from 76.5 to 45 volts. With a current of .022 ampere this will require a resistance of 1,432 ohms.

Resistor R13 must produce a drop of 45 volts at .02 ampere, the remainder after 2 milliamperes are drawn off at the 45-volt tap. The unit used at this point should therefore have a value of 2,500 ohms.

Since the only current flowing in resistor R14 is the 3.5 milliamperes required in the plate circuit of the 26 type tube, the drop of 6 volts can be obtained by using a resistor of 1,714 ohms.

The resistor required at R15 to produce a drop of 51.5 volts with a current of 64 milliamperes, drawn by the two 45 type tubes, is 805 ohms.

In making up a voltage divider it is important to use resistors capable of carrying safely the currents which they will be called upon to carry. In this connection manufacturers' catalogs should be consulted to determine the type of resistor capable of handling the calculated currents.

It is not absolutely necessary that the values of resistance be exactly as calculated. A variation of ten per cent will have little effect on results.

If the general procedure used in the above two concrete examples of the design of two of the most common forms of voltage dividers are kept in mind, no trouble should be experienced in designing voltage dividers for any combination of tubes.

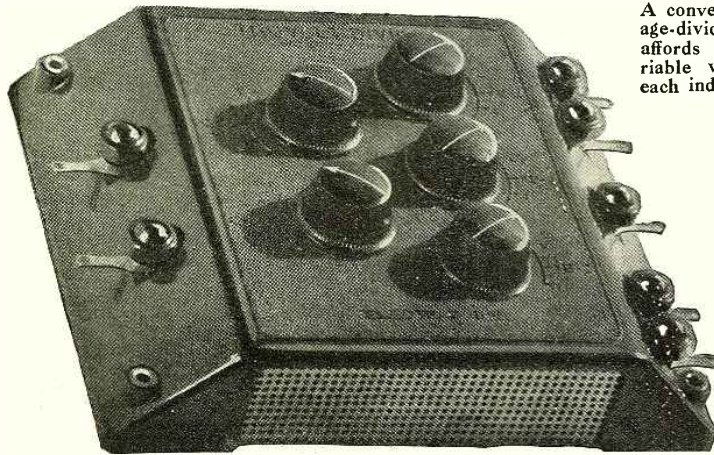

A convenient voltage-divider which affords readily-variable voltages at each individual tap

INDEX TO ADVERTISERS

PAGE	PAGE	PAGE	PAGE
A	F	N	
Advance Electric Co. 477	Ferranti, Inc. 471	National Carbon Co., Inc. 452	Scott Transformer Co. 390-391
Aerovox Wireless Corp. 462	Flash Sales Corp. 470	National Co., Inc. 471	Seabury Mfg. Co. 472
Allied Radio Corporation	G	National Radio Institute. 389-465	Short Wave and Television Co. 392
Inside Back Cover	General Electric 467	National School of Visual Education 477	Shure Bros. Co. 460
American Sales Co. 475	H	New England Mills Co. 475	Silver-Marshall, Inc. 394
American Transformer Co. 461	Hammarlund Mfg. Co. 464	O	T
Amperite Corporation 468	Hammarlund-Roberts, Inc. 453	Omnigraph Mfg. Co. 473	Teleplex Co. 472
Amrad Corporation 459	High Frequency Labs. 469	P	Televoal Corp. 473
B	Hoodwin Co., Chas. 462	Payne, R. S. 475	Thomas, C. M. 468-474
Barawik Company, The. Insert	I	Pilot Radio & Tube Corp. 480	Thorola Radio Products 462
Barker, Prof. Anthony. 475	Independent Electric 479	Plapao Labs., Inc. 462	Townsend Labs. 462
C	International Correspondence Schools 460	R	Triad Mfg. Co., Inc. 462
Cameradio Co. 477	International Resistance Co. 454	Racon Electric Co., Inc. 463	Inside Front Cover
Central Radio Labs. 460	J	Radio Doctors, Inc. 471	V
Chicago Radio Apparatus Co. 474	Jeffries Transformer Co. 462	Radio Institute of America. 451	Van Nostrand Co., D. 456
Chicago Salvage Stock Store 393	J-M-P Mfg. Co., Inc. 468	Radio Training Association of America 385	W
Chicago Stock Gear Works. 467	Jiffy-Tite Mfg. Co. 475	Royal Eastern Electrical Supply Co. 469	Western Radio Mfg. Co. 464-479
Clarostat Mfg. Co., Inc. 467	L	S	West Side Y. M. C. A. Radio Institute 464
L. L. Cooke School of Electricity 397	Locoma Pub. Co. 472	Samson Electric Co., Inc. 455	Whirlwind Mfg. Co. 474
Cornish Wire Co. 466	Lyons Mfg. Co. 470	School of Engineering of Milwaukee 458	Wholesale Radio Service Co. 473
Coyne Electrical School 387	M		Wireless Egert Engineering, Inc. 466
D	Mason, Fenwick & Lawrence. 479		Workrite Radio Corp., The. Insert
De Forest Radio Co. 457	Metal Cast Products Co. 479		Y
E	Midwest Radio Corporation		Yaxley Mfg. Co. 468
Electrad, Inc. 395	Back Cover		
Excello Products Corp. Insert			

While every precaution is taken to insure accuracy, we cannot guarantee against the possibility of an occasional change or omission in the preparation of this index.

Why the Baffle?

(Continued from page 434)

quality. Special transformers to meet various requirements are made by the different transformer manufacturers, including Thordarson, Dongan, Samson, Amertran, Silver-Marshall. Any experimenter seriously interested in good quality ought to obtain from these manufacturers all the data they have available on the characteristics of these special transformers.

To install such transformers it is necessary to disconnect the output transformer supplied with the loud speaker and then reconnect the two leads from the moving coil to the secondary terminals of the special transformer—really a very simple change.

Two More Cardinal Considerations for Good Quality

Now assuming that we have built or bought a baffle that will meet the requirements given in the first part of this article and that we have decided whether or not a special output transformer will be required, are there any other factors of

importance in getting the best results from our loud speaker? There are two points; first the matter of having sufficient power available from the receiver to properly operate the loud speaker and secondly the location of the loud speaker in the room.

Regarding the first point, of power output, we suggest that the reader refer to the article by the author on page 146 in the August issue. Here will be found all the essential data on what type of tubes to use in the power stage to insure proper operation of the loud speaker.

The cabinet in which the unit has been placed should not be placed flat up against a wall. The wall will act as enclosure for the back of the cabinet and cabinet resonance may occur. It is best therefore, to leave a space of about one-half or one foot between the back of the cabinet and the wall. In general, the loud speaker should be located so that it points directly towards the point where the listener usually sits. The high frequencies are radiated from a loud speaker in the form of a beam and best high frequency response is therefore obtained by listening at a point located directly in line with the loud speaker.

This matter of the proper location of the loud speaker may or may not be important—how important it is depends to a large degree on the acoustical characteristics of the room—but it is certainly worth while to experiment with the loud speaker in various locations before finally deciding on its permanent location.

Modern apparatus—good audio systems, detector circuits giving less distortion, high gain r. f. amplifiers, band pass circuits, good loud speakers—have all made it possible to obtain from a well designed radio a quality of reproduction that can really be considered excellent. But it is only by careful consideration of a number of important details that the best possible reproduction can be obtained. Some of these details in connection with dynamic loud speakers have been discussed in the preceding pages. Given proper consideration they will enable the experimenter to make certain that he is obtaining the best possible performance from his loud speaker.

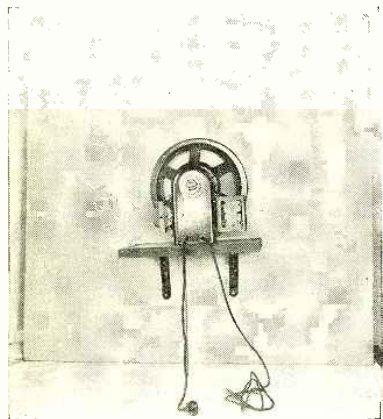

The relative size of the suitable types of square or flat baffle may be gained from a comparison of the Celotex baffle, shown here, with the dynamic speaker unit mounted thereon

In the November Issue of Amazing Stories

MICROCOSMIC BUCCANEERS, by Harl Vincent. This well-known author avails himself of the conception of planetary atoms—or worlds within worlds—to build a story of unusual scientific interest. Not only is the theory of the atomic universe considered in a most plausible manner, but even the fourth dimension seems to become a practical idea.

THE UNDERSEA TUBE, by L. Taylor Hansen. As far back as the '60's Mr. Beach, who was then editor of the Scientific American, conceived the idea of a subway tube, cylindrical in cross-section, in which cars were to be driven by air pressure applied directly in the tube behind them. That such an idea might eventually become a practical solution of the problem of sub-ocean travel, is not at all beyond the pale of possibility. Mr. Hansen, who is now known to our readers, gives us a fascinating story of scientific interest and speculation.

COLD LIGHT, by William Lemkin, Ph.D. There is hardly anything nowadays that is not done electrically; electricity has become an undisputed power in our lives. But suppose some chemist should work out the formula by which light could be obtained without electricity—a light, in fact, far superior to electric light? Perhaps because Dr. Lemkin is interested in the subject himself, his story contains a good deal of excellent chemistry that is essentially founded on good scientific experiment.

THE MOON WOMAN, by Minna Irving. This is a unique story of suspended animation and possible future developments on our planet, with a surprise ending.

THE SECRET KINGDOM, by Allen S. and Otis Adelbert Kline. (A serial in three parts.) Part II. In this instalment we learn more of the customs of the hidden race of Incas and of some of their scientific progress. It easily maintains the pace set by the first instalment.



To eliminate "static" from motors, street cars, telephones and electrical appliances, plug in a Falck Claroceptor between wall socket and radio set. This new improvement by a pioneer manufacturer grounds and thus blocks out line interference noise and radio frequency disturbances. Also improves selectivity and distance. Requires no changes in set. Measures just 3 1/2 x 5 1/2 x 2 1/2 inches. Thousands all over America now use the Claroceptor for clearer A.C. reception. Get one right away—at radio parts dealers. Write for descriptive folder.

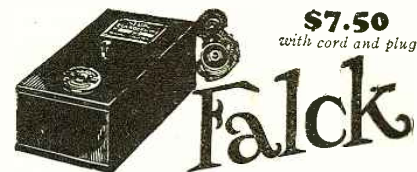

\$7.50 with cord and plug

Falck CLAROCEPTOR

Manufactured by ADVANCE ELECTRIC CO. 1260 W. Second Street Los Angeles, Cal. JOBBERS AND DEALERS. GET OUR PROPOSITION

BIG-PAY JOBS in ELECTRICITY

\$60.00 to \$150.00 WEEKLY

Amazing new method. Trains you quicker and better. Motion Pictures in your own home make every point clear. Genuine DeVry motion picture projector at no extra cost. Thousands of feet of film furnished. We pledge to give you training and employment service necessary to secure a better job at bigger pay or refund money. Get full facts. No obligation. Write quick while offer lasts.



Motion Pictures Train You QUICK

National School of Visual Education. Dept. 11-N 537 S. Dearborn St., Chicago, Ill.

Send book, "The Film Way to Bigger Pay," with facts about this new, easier way to master electricity.

Name..... Age.....
 St. or R. F. D.....
 City.....
 State.....

MAIL THIS COUPON NOW!

TRI-STATE HEADQUARTERS Pennsylvania—Ohio—West Va. WHOLESALE RADIO

To DEALERS and SET BUILDERS we offer the most prompt and efficient service. We handle only the best merchandise and give MAXIMUM DISCOUNTS.

★ GET OUR CATALOG ★

CAMERADIO
 430 WOOD ST.
 at Diamond St.
 PITTSBURGH PA.

Read Classified Advertising—It Pays!!!

Advertisements in this section twenty-six cents a word for each insertion. Name and address must be included at the above rate. Cash should accompany all classified advertisements unless placed by an accredited advertising agency. No advertisements for less than 10 words accepted. Objectionable or misleading advertisements not accepted. Advertisements for these columns should reach us not later than 1st or 2nd month preceding issue.

Classified Advertising Manager—Experimenter Publications, Inc., 381 Fourth Avenue, New York City

Advertising Agencies

1 inch Display, 50 Monthlies Thrice, \$8.00. Meyer Agency, 4112R Hartford, St. Louis, Mo.

Agents Wanted

Bankrupt and Bargain Sales. Big profits. We start you, furnishing everything. DISTRIBUTORS, Dept. 373, 429 W. Superior, Chicago.

Big Ohio Corporation wants county manager. Opportunity \$50 to \$75 weekly. Earnings start immediately. Good for \$5,000 yearly. We furnish everything, deliver and collect. Capital or experience unnecessary. Fyr-Fyter Co., 1905 Fyr-Fyter Bldg., Dayton, Ohio.

Guaranteed Genuine Gold Leaf Letters anyone can put on store windows. Large profits, enormous demand. Free samples. Metallic Letter Co., 422 N. Clark, Chicago.

Airplanes, Aviation

Mounted propeller, 12-inch and circulars on 3-foot model aeroplanes, 10c. Aero Shop, 3050 Hurbit Ave., Detroit, Mich.

Propellers, for airplanes, boats, sleds, road speedsters. Crawford Motor and Airplane Incorporated, Seal Beach, California.

Business Opportunities

Amateur Cartoonists: Sell your cartoons, new plan. Smith's Service, EX1194, Wenatchee, Wash.

Inventions Commercialized. Patented or unpatented. Write, Adam Fisher Mfg. Co., 278 Enright, St. Louis, Mo.

Free Book. Start little Mail Order business. Hadwil, 5A-74 Cortlandt Street, N. Y.

A Splendid Side Line—We Sell Pass Books, check covers, coin bags, etc., mainly to banks. They are centrally located and do business quickly. Little time is lost. Our samples are light, compact, easily carried. Sales run into money, items repeat well, commission is liberal, and all paid immediately. We also have an excellent line of advertising novelties for merchants. Our quality is good, the variety extensive, the styles interesting. Line is big enough to devote your whole time if you wish. We are manufacturers, own our buildings, been in business fifteen years, make thirteen thousand sales a year, ship to every state. You could work wherever you happen to be. Correspondence invited. Continental Bank-Supply Co., Mexico, Missouri.

Correspondence Courses

Used correspondence school courses sold on repurchase basis. Also rented and exchanged. Money-back guarantee. Catalog free. (Courses bought.) Lee Mountain, Pisgah, Alabama.

Detectives

Detectives. Work home or travel. Experience unnecessary. Particulars free. Write George Wagner, 2190 Broadway, N. Y.

For Inventors

Inventions Commercialized. Patented or unpatented. Write, Adam Fisher Mfg. Co., 278 Enright, St. Louis, Mo.

Help Wanted—Instruction

Wonderful Opportunities in Government Jobs for Men-Women, 18-55; \$125-\$250 month. About 40,000 openings yearly. Are you eligible? We advise you free. Write, Instruction Bureau, 251, St. Louis, Mo.

I Catch from 45 to 60 foxes in from 4 to 5 weeks' time. Can teach any reader of this magazine how to get them. Write for particulars. W. A. Hadley, Stanstead, Que.

Be a Detective—Biggest paying work everywhere. Write National Headquarters, 169 East 83rd, New York.

Miscellaneous

Gigantic Mail; send me 25c (coin or stamps) for one pound of mail. Ted Armour, 136 East 28th St., New York.

Brass Gears and Model Supplies. Send for catalogue. The Pierce Model Works, Tinley Park, Ill.

Inventions Commercialized. Patented or unpatented. Write, Adam Fisher Mfg. Co., 278 Enright, St. Louis, Mo.

Patent Attorneys

Inventors—Should write for our Guide Book, "How to Obtain a Patent," and Record of Invention Blank, sent Free. Send model or sketch of inventions for our inspection and instructions free. Radio, Electrical, Chemical, Mechanical and Trademark Experts. Terms Reasonable. Victor J. Evans & Co., 922 Ninth, Washington, D. C.

Patents—Write for Free Instructions. Send Drawing or Model for Examination. Carl Miller, Registered Patent Attorney (former Patent Office Examiner), 262 McGill Building, Washington, D. C.

Patents

Inventions Commercialized. Patented or unpatented. Write, Adam Fisher Mfg. Co., 278 Enright, St. Louis, Mo.

Radio

Burnt out audio transformers repaired, \$5.00 a dozen. Guaranteed one year. John B. Spangler, Jeffersontown, Ky.

Wanted: Men to work with National Radio Service organization. No selling scheme. Radio Doctors, Inc., Dept. N., Essex St., Salem, Mass.

Song Writers

Song writers: Substantial Advance royalties are paid on publisher's acceptance. Write for free booklet on developing ideas for song, words or music required by Talking Pictures. Newcomer Associates, 1674 Broadway, New York.

Song Poem Writers: "Real" Proposition. Hibbeler, D191, 2104N, Keystone, Chicago.

Salesmen Wanted

Amazing screw-holding screw driver! Factories, garages, workers buy on sight! Profit 75c each. Exclusive territory. Free trial offer. Jiffy, 1221 Winthrop Bldg., Boston.

Stamps and Coins

Free packet with bargain lists, postage 2c. Rheame, 745 Henri Julien, Montreal, Canada.

Telegraphy

Learn Morse and wireless telegraphy. Big salaries. Tremendous demand. Expenses low, can earn part. Catalog free. Dodge's Institute, Cour Street, Valparaiso, Indiana.

STATEMENT OF OWNERSHIP

SHIP

On April 15th this publication was acquired by the Mackinnon-Fly Publications, Inc. This company is also the publisher of PLAIN TALK, SCREEN BOOK MAGAZINE, WILD WEST STORIES and COMPLETE NOVEL MAGAZINE, COMPLETE DETECTIVE NOVEL MAGAZINE, SCIENCE AND INVENTION, AMAZING STORIES, YOUR BODY QUARTERLY, AMAZING STORIES QUARTERLY and AERO MECHANICS.

STATEMENT OF THE OWNERSHIP, MANAGEMENT, CIRCULATION, ETC., REQUIRED BY THE ACT OF CONGRESS OF AUGUST 24, 1912, of Radio News published monthly at New York, N. Y., for April 1, 1929.

State of NEW YORK }
County of NEW YORK }^{ss.}

Before me, a notary public in and for the state and county aforesaid, personally appeared Gustav Gardner, who, having been duly sworn according to law, deposes and says that he is an Assistant Vice-President of Irving Trust Company, owner, as Trustee in Bankruptcy of the Radio News and that the following is, to the best of his knowledge and belief, a true statement of the ownership, management (and if a daily paper, the circulation), etc., of the aforesaid publication for the date shown in the above caption, required by the Act of August 24, 1912, embodied in section 411, Postal Laws and Regulations, printed on the reverse of this form, to wit: 1. That the names and addresses of the publisher, editor, managing editor, and business managers are: Publisher, Irving Trust Company, as Trustee in Bankruptcy of Experimenter Publishing Company, 233 Broadway, N. Y. City; Editor, Arthur J. Lynch, 230 Fifth Ave., N. Y. City; Managing Editor, None; Business Managers, B. A. Mackinnon, 230 Fifth Ave., N. Y. City. 2. That the owner is: The Irving Trust Company, of 233 Broadway, New York City, as Trustee in Bankruptcy of said Experimenter Publishing Company, Inc., said Irving Trust Company having been duly appointed Receiver in Bankruptcy on February 20, 1929, and Trustee on March 28, 1929. 3. That the known bondholders, mortgages, and other security holders owning or holding 1 per cent or more of total amount of bonds, mortgages, or other securities are: None. 4. That the two paragraphs next above, giving the names of the owners, stockholders, and security holders, if any, contain not only the list of stockholders and security holders as they appear upon the books of the company but also, in cases where the stockholder or security holder appears upon the books of the company as trustee or in any other fiduciary relation, the name of the person or corporation for whom such trustee is acting, is given; also that the said two paragraphs contain statements embracing affiant's full knowledge and belief as to the circumstances and conditions under which stockholders and security holders who do not appear upon the books of the company as trustees, hold stock and securities in a capacity other than that of a bona fide owner; and this affiant has no reason to believe that any other person, association, or corporation has any interest direct or indirect in the said stock, bonds, or other securities than as so stated by him. 5. That the average number of copies of each issue of this publication sold or distributed through the mails or otherwise, to paid subscribers during the six months preceding the date shown above is (This information is required from daily publications only). Signed, Irving Trust Company, by G. Gardner, Assistant Vice-President. Sworn to and subscribed before me this 2nd day of April, 1929. (Seal.) Hiram S. Gans. (My commission expires March 30, 1930.)

A Preparatory Course in Aviation

Only 50c for this Big Book that tells all about Aviation. Written in plain, understandable language for the beginner.

Chapters by leading authorities include: Principles of Flight, Types of Aircraft, Principles of Stability, How an Airplane Is Piloted, Aircraft Engineering, Fuselage Design Construction, Landing Gear, Propellers, Parachutes, How to Become a Flyer, etc. AERO-MECHANICS also contains hun-

dreds of diagrams and pictures which make the study of aviation remarkably easy.

Send for AERO-MECHANICS today! It is a way to quickly learn all the things you must know before you can actually fly.

Experimenter Publications, Inc.
Dept. 2411a, 381 Fourth Avenue
New York, N. Y.

No Only 50c Complete!



Complete Short-Wave Manual

Up-to-the-Minute Data—All Worth-While Circuits
FULL SIZE BLUEPRINTS

Some of the finest programs are being broadcast over the short-wave bands. There are many reasons for this. Paramount among them all is the fact that that entertainment, broadcast in this band, can be received over distances which with the ordinary broadcast receiver would be impossible!

Thousands of letters, which pour in an unremitting stream into our offices, tell the same tale—it is a common and everyday matter to receive programs from all foreign countries, from the most distant climes. England, France, Germany, towns on the African continent, from every conceivable corner of the globe where a station is located—programs come in with surprising volume and clarity. One would think they were hearing a New York, Chicago or San Francisco station until the voice of the announcer, many thousands of miles away, discloses the true location of station.

The **SHORT-WAVE MANUAL** tells plainly how to construct all these short-wave circuits, which our tireless laboratory researches have shown to be most efficient.

Large size book (same size as Radio News) with a beautiful colored cover. Replete with illustrations, diagrams and with **FULL SIZE BLUEPRINTS**. This big valuable book will show you how to receive all the foreign countries clearly and easily. Write today for your copy.

Clip and Mail This Coupon only 50c
the copy

EXPERIMENTER PUBLICATIONS, Inc.
Dept. 2411g, 381 Fourth Avenue, New York

Gentlemen:

Enclosed find 50c for which please send me a copy of **THE SHORT-WAVE MANUAL**.

Name

Address

City State

On Short Waves

(Continued from page 448)

music frequency band other than the one to which it is tuned.

Various combinations of the three audio methods reviewed may be employed. The best known is where the detector tube is followed by a stage of transformer, the second being resistance coupled and the output stage being either single or push-pull output transformer type. With an audio amplifier of this type, excellent quality and volume are obtainable. The resistance stage between transformers entirely eliminates the tendency of the secondary of the first transformer resonating at some frequency with primary of the second transformer, providing a reasonably flat frequency response curve of from 50 to 6,000 cycles.

PCJ, Holland

From Henry Drewett, of Haverhill, Mass., comes a confirmation from the short-wave broadcast station PCJ of Enid-hoven, Holland. This station, due to the expense in answering the tremendous amount of mail received from their short-wave listeners, request that each writer who desires a confirmation of the broadcast from this station enclose in a letter an international coupon which may be purchased from any postal station for 9 cents.

"Although I am not so old at the short-wave game, I have recently made up for lost time," writes Mr. George C. Starry, of Darry, Pa. "Several months ago, I considered the S.-W. band a joke, hearing this and that fan saying that they could hear England, Holland, Australia, etc. I have tried my luck with a few receivers, both of the home-made and commercial varieties, but was only able to pick up the nearby locals on the broadcast band and some CW signals as well as amateur phones. However, I was not as yet disgusted, so began a little of experimenting with the commercial receiver I had on hand.

"The trouble was that the receiver wouldn't go into oscillation very well and I found that I was passing up some of the stations. The second trouble was that the receiver would not tune low enough. This I remedied by removing some of the turns on the tuning coil. By experiment it has been found in my location that an antenna about 125 feet long, running from north and south with the lead-in off the southerly end has provided better results than any of the others tried. The antenna and lead-in are kept very tight to prevent any possible chance of signal swaying. Two grounds are used, one to the radiator in my room, the other to the cold water pipe in the cellar. Of course, all connections are tight and well soldered, eliminating any scratchy noises. Some of the stations I hear regularly are: G5SW, PHI. MRH, VKA, 2ME, 2FC, CJRX, CJA, W6N, WLW, WGY, KDKA, PCJ, also the transatlantic phone and the Dutch West Indies phone. All stations are of course heard on the loud speaker."

* * *

From Mr. Donald F. Wright of San Pedro, Cal., comes verified reports on broadcast station KZRM and its associated short-wave station K1XR of Radio Manila, K1XR operating on 24.5 meters simultaneously with KZRM, Manila, Philippine Islands.

NEW Amazing Plan

Earn \$5000 to \$15000 a Year

Why slave away in a poor-paying job? At last, the average fellow can get out of the rut. Let me show you how to make big money.



You can make big money charging batteries with my Service Station charger. Stuart Trego made \$175.00 the first week. William Gillespie made enough to pay for his charger in two days. Bill Galloway is clearing from five to seven thousand a year easily. You can do the same. My charger handles 50% to 70% more batteries than similar chargers.

Step Into Your Own Business!

You don't need experience or schooling. I explain everything. Start at once—get all the charging business in your neighborhood.

Ed Welch set up his business in his basement; by the next day he had made \$41.00.

\$10.00 Starts You!

Just think—only \$10 down is all you need. Where else could you start in business for only \$10 down. Your greatest opportunity.

Fill in coupon. Mail NOW! Get my BIG PROFITS book free. Tells you how easy it is to become successful.

Mail This Coupon

C. F. HOLMES, Chief Engineer
Independent Electric Works
4912 No. Clark Street, Chicago, Dept. A
Dear Mr. Holmes: Sure I want that book of Big Profits. Send it to me at once.

Name

Address

Choice of 1200 Newest RADIO VALUES

SEND for our 1930 catalog. Filled with amazing values in screen grid radios, push pull audio, consoles, kits, parts. All standard makes and guaranteed merchandise.

WESTERN RADIO MFG. CO.
128 W. LAKE ST. CHICAGO ILL.

WANTED MEN

A chance to start your own business
MAKING METAL TOYS AND NOVELTIES



Big demand for Toy Soldiers, Animals, 5 and 10c Store Novelties, Ash-trays, etc. We co-operate in selling goods you make, also buy them from you. Small investment needed to start and we help you build up. WE FURNISH COMPLETE OUTFITS and start you in well-paying business. Absolutely NO EXPERIENCE and no special place needed. A chance of a lifetime for man with small capital. CHRISTMAS RUSH is now starting, so if you mean strictly business write

AT ONCE for full information.
METAL CAST PRODUCTS COMPANY
Dept. 12, 1696 Boston Road, New York City

MASON, FENWICK & LAWRENCE
PATENT LAWYERS
600 F St., N. W., Washington, D. C.
Estb. over sixty years. Send sketches. Electrical, Aeronautical and Chemical Inventions carefully handled. Practice before the U. S. Courts and the Patent Office. Prompt and careful service. Write us. Protect your inventions.
TRADE MARKS REGISTERED



NOW PILOT'S ELECTRIC SUPER-WASP

Short Wave
PLUS Screen Grid
PLUS A. C. Operation



10,000 Mile Range
—Covers all bands
14 to 500 Meters

Employs Super-Sensitive Screen Grid Tube and New 227 PILOTRON especially developed for A. C. Super-Wasp

NOW you can enjoy the thrill of international short-wave radio from your electric light socket! Utterly uncanny is the A. C. Super-Wasp's ability to jump 10,000 miles, "pulling in" novel short-wave broadcasts from all over Europe, Central and South America, Canada, South Africa and Australia! Easily assembled in single evening.

The Pilotron 227 used as detector is a new type tube developed especially for the critical requirements of short-wave reception! Precisely because of this it is an eminently superior tube for any broadcast receiver!



A. C. Operated SUPER-WASP

(Catalog No. K-115)

Custom
Set-Builder's
Price in U. S. A.

\$34⁵⁰

*Slightly Higher West
of the Rockies*

Power Pack extra
(Pilot K-111 ABC Power
Pack is recommended)



Battery-Operated SUPER-WASP

(Catalog No. K-110)

Custom
Set-Builder's
Price **\$29⁵⁰**

*in U.S.A.
Slightly Higher West of the
Rockies.*

Special Notice to Owners of BATTERY-OPERATED SUPER-WASPS

Some S. W. fans will continue to prefer a battery-operated Super-Wasp. However those who desire to change over to A. C. operation, will find full details in Pilot's Special Data Sheet, obtainable free from your Pilot dealer or direct from the factory.

Join the Guild!

50c brings you four quarterly issues Radio Design, official organ of Radio International Guild. Subscription also includes one year's Guild membership with membership pin and certificate furnished without charge. Timely construction articles include full story on new A. C. Super-Wasp. Radio Design, Department 3, 103 Broadway, Brooklyn, New York.

Qualified Dealers!

Financially responsible and technically informed dealers are invited to secure details of Pilot's authorized Agency Plan.

PILOT RADIO & TUBE CORP.

WORLD'S LARGEST RADIO PARTS PLANT — ESTABLISHED 1908

323 BERRY ST.

BROOKLYN, N.Y.

Trade Mark



Registered

A NEW SCREEN GRID RECEIVER

Engineered to a new
Height of Perfection

Here is a new receiver featuring a Screen Grid circuit—245 push-pull power audio—power detector—8 tubes—with A-C. All electric humless operation. A tuned detector stage imparts unusual power to the receiver. Ultra selective—sturdy construction—R C A licensed.



FREE RADIO CATALOG

Send for this new, big catalog—196 pages full of the very latest in radio, such as this new Screen Grid Chassis, as well as many other special features. All priced to you at wholesale—offering remarkable values on everything in radio.

Our recent purchases totaling over one million (\$1,000,000) dollars in standard radio receiving sets coupled with our tremendous stock of standard accessories, parts and kits has enabled us to make startling price reductions. Write today for the complete story as given in this large 196-page catalog of radio bargains.

EVERYTHING IN RADIO AT UNHEARD OF PRICES

New Screen Grid A. C. Humless All-Electric sets—standard A-C sets as well as battery operated receivers in an attractive array of consoles ranging from small table model types to gorgeous pieces of radio furniture. They represent the finest offerings of the season. The price range is especially attractive presenting unusual values as low as \$15.95.

Get this Allied catalog. Buy low so you can make more profit. Deal with an organization of experts who are trained to render real service in radio.

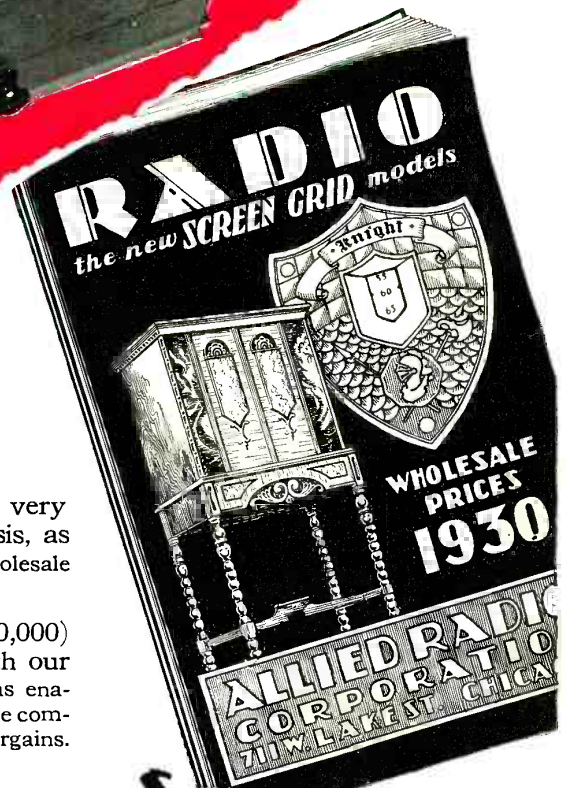

\$15.95

A
Reliable,
High-grade
Radio House

ALLIED RADIO CORPORATION

711 W. Lake Street Dept. B-2 Chicago

Backed by
Resources
totaling over
\$3,000,000

FACTORY TO YOU—SAVE 50%—COMPARE WITH COSTLIEST OUTFITS BEFORE YOU BUY

a powerful new Miraco ^{Set or complete outfit} **30 DAYS FREE**
Electric or Battery



Get Our Send No Money 10th Anniversary Offer!

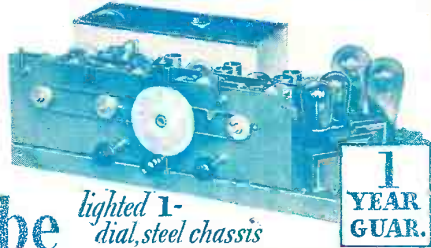

9 tube *lighted 1-dial, steel chassis*
perfected SCREEN GRID—
latest **PUSH-PULL** Amplification

1 YEAR GUAR.

New SCREEN AERIAL Console SUPER-DYNAMIC Cathedral Tone!

Mastercrest-built with beautiful genuine walnut; sparkling maple panels; 4-way matched sliding doors. Lifting top. Concealed SCREEN aerial makes outdoor aerial unnecessary. Super-Dynamic Cathedral Tone Reproducer.

Built like—looks like—performs like newest sets in many outfits up to \$300! Latest, finest, costliest construction! Uses "224" SCREEN GRID, "245" PUSH-PULL POWER, "227" HUM-FREE POWER DETECTOR AND "280" RECTIFIER AC TUBES. Phonograph pick-up connection. Local-Distance switch. Built-in power section on steel shielded chassis. Lighted one-dial tuning. Razor-edge selectivity; super-dynamic cathedral tone quality; marvelous distance getter. Solid one-year guarantee if you buy it for

Only **\$49⁸⁸**
COMPLETELY ASSEMBLED

Values possible because you deal direct with big factory

NEW LOW FACTORY PRICES SAVE 50%

Beautiful Variety of Latest Fine Consoles, AC or Battery Sets

30 DAYS FREE TRIAL

Richly designed, latest type, Lo-Boy Mastercrest console; beautiful two-tone finish in walnut. A gem that costs little. Hinged top lid.

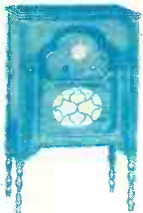

An exquisitely new and fine, genuine walnut desk-type Mastercrest console. Very pretty and a rare bargain. Hinged top.



Spanish Treasure chest design, Mastercrest console. Finest selected grain, solid walnut. Antique wrought hardware. Marvellous value. Hinged top.



These Consoles are Equipped with **SUPER DYNAMIC CATHEDRAL TONE REPRODUCERS**



Table compact style Mastercrest cabinet in handsome walnut and gold-striped finish. Separate Cathedral Tone Super-Dynamic Speaker to match. Wonderful bargain!

MIRACO

TRADE MARK REGISTERED

CATHEDRAL TONED, SUPER SELECTIVE, POWERFUL DISTANCE GETTERS

You needn't send us a cent! America's big, old, reliable Radio Factory springs its 10th Anniversary Surprise in high-grade, 1-year guaranteed sets at history's lowest prices!

With its latest perfected Screen-Grid, push-pull, super-powered and hum-free AC electric Miraco's—you are guaranteed satisfaction, values and savings unsurpassed. *Get Amazing Special Offer!*

At our risk compare a Miraco with highest priced radios, for 30 days in your home. Surprise and entertain your friends—get *their* opinions. Unless 100% delighted, *don't buy!* Your decision is final—no argument!

Only marvelously fine radios, of latest perfected type, at rock-bottom prices, can back up such a guarantee. Send postal or coupon for *Amazing Special Factory Offer!*

Don't Confuse with Cheap Radios

With Miraco's rich, clear cathedral tone, quiet operation, razor-sharp separation of nearby stations, tremendous "kick" on distant stations and latest improvements—you'll be the envy of many who pay 2 or 3 times as much!

Send for proof that delighted thousands of Miraco users cut through locals, get coast to coast, with tone and power of costly sets. Miraco's are custom-built of finest parts—product of 10 years' successful experience. Approved by Radio's highest authorities.

Deal Direct with Big Factory

Miraco outfits reach you splendidly packed, rigidly tested with *everything in place ready to plug in!* No assembling! Entertain yourself 30 days—then decide. Liberal one-year guarantee on each set. Play safe, save lots of money, insure satisfaction—deal direct with Radio's old, reliable builders of fine sets—10th successful year. SEND POSTAL OR COUPON NOW for Amazing Offer!

USER-AGENTS WANTED Exclusive Territory—Demonstrator Supplied

Spare or full time. No contract, no experience required. Big money! Send coupon now!

Special! Electric Super AC-7 \$39⁸⁵



MIDWEST RADIO CORP., 404-AN Miraco Bldg., Cincinnati, Ohio

BEAUTIFULLY ILLUSTRATED LITERATURE, AMAZING SPECIAL FACTORY OFFER, TESTIMONY OF NEARBY USERS—

All the proof you want—of our honesty, fairness, size, financial integrity, radio experience and the performance of our sets—including Amazing Factory Offer—sent without obligation!

Free!



MIDWEST RADIO CORPORATION
Pioneer Builders of Sets—10th Successful Year
404-AN Miraco Bldg., Cincinnati, Ohio

THIS COUPON IS NOT AN ORDER

WITHOUT OBLIGATION, send latest literature, Amazing Special Free Trial Wholesale Price Offer, testimony of nearby users, and all Proof. User Agent Dealer
 Check here if interested in an EXCLUSIVE TERRITORY PROPOSITION
NAME ADDRESS